

**NASA
Technical
Paper
2275**

February 1984

Comparison of Predicted
and Experimental Thermal
Performance of Angular-
Contact Ball Bearings

Richard J. Parker

NASA
TP
2275
c.1

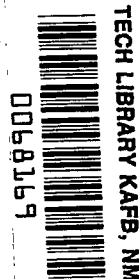

LOAN COPY: RETURN TO
AFWL TECHNICAL LIBRARY
KIRTLAND AFB, N.M. 87117

NASA



**NASA
Technical
Paper
2275**

1984

Comparison of Predicted and Experimental Thermal Performance of Angular- Contact Ball Bearings

Richard J. Parker

*Lewis Research Center
Cleveland, Ohio*

NASA

National Aeronautics
and Space Administration

Scientific and Technical
Information Branch

Summary

The computer program Shaberth was used to calculate the thermal performance of ball bearings for which sufficient test data were available to make a comparison over a range of test conditions. Three angular-contact ball bearings of differing sizes were selected. The variables used for comparison of experimental and calculated data were bearing and oil-out temperatures and bearing heat generation. An equation was derived based on this comparison for the lubricant percent volume in the bearing cavity XCAV as a function of lubricant flow rate through the cavity, shaft speed, and bearing pitch diameter. The predicted bearing heat generation, inner- and outer-race temperatures, and oil-out temperatures agreed very well with the experimental data obtained from three sizes of ball bearings (35-, 120-, and 167-mm bore) over a speed range from 1.0 to 3.0 million DN. This agreement provides experimental verification of thermal performance prediction capabilities of Shaberth.

The equation derived for the lubricant percent volume in the bearing cavity XCAV appears to be valid over the range of shaft speeds and lubricant flow rates for the three bearing sizes investigated. The predicted trends of increasing temperature and heat generation with increased shaft speed and of decreasing temperature and increasing heat generation with increased lubricant flow rate were verified by the experimental data.

Introduction

Rolling-element bearing life and performance predictions have been greatly enhanced by the use of some of the newer computer codes now available to design engineers. The ability to simulate closely the performance of a rolling-element bearing also aids in the failure analyses of systems where either the bearing or external conditions imposed on the bearing are suspect.

Computer analysis has progressed from the early elastic solutions of ball-bearing load distributions considering inertial and centrifugal effects (ref. 1) to a more generalized theory including lubrication and traction effects (ref. 2) and to current programs such as Shaberth (ref. 3) and Cybean (ref. 4), which include thermal analysis and calculation of temperature distributions in the bearing. These latter programs give essentially steady-state solutions (considered quasidynamic) and are useful for the majority of high-speed rolling-element bearing applications.

Computer programs of a fully dynamic nature have also been developed (refs. 5 to 9) in which time transient motions and forces of the rollers or balls and the cage are determined. Computing time with a dynamic program

such as that described in reference 7 can become excessive (ref. 10). A direct comparison of a quasidynamic program (ref. 3) and a fully dynamic program (ref. 6) was described in reference 10. The quasidynamic program is more practical as a bearing design tool where fatigue life, torque, and heat generation are of primary interest. The dynamic program, although consuming large amounts of computer time, appears to be valuable as a diagnostic tool, especially where cage motions are of interest. Shaberth and Cybean, both quasidynamic computer programs, are discussed in more detail in references 11 to 13.

The new computer codes generate output data describing bearing performance at given input conditions. Output data such as load distributions, Hertzian stresses, operating contact angle or skew angle, component speeds, heat generation, local component temperatures, bearing fatigue life, and power loss are typical. But, how well does the output predict actual conditions within an operating bearing? A major problem has been that of obtaining appropriate experimental data with enough detail and accuracy to make a correlation meaningful. Only a few attempts have been made to compare predicted performance with experimental data.

A comparison of calculated and experimental performance of high-speed ball bearings is presented in reference 14. The analysis provided a good prediction of temperatures and power losses in jet-lubricated 120-mm-bore angular-contact ball bearings. In this work the critical assumptions were the form of the lubricant traction model and the lubricant volume percent (the assumed volume percent of the bearing cavity occupied by the lubricant).

Reference 15 presents a good correlation of predicted and experimental race temperatures and heat generation for 118-mm-bore cylindrical roller bearings at speeds up to 3.0 million DN. This work also shows the importance of knowing the operating diametral clearance that exists when mounting fits, temperatures, and rotational speed are considered.

Another correlation of predicted and experimental data for cylindrical roller bearings is shown in reference 16. Experiments were performed with 124.3-mm-bore bearings at speeds to 3 million DN, and the results were compared with analysis using the computer program described in reference 17. Predictions of both heat rejection to the oil and outer-race temperature were within 10 percent of the experimental values.

The work reported in references 14 and 15 emphasizes the importance of selecting an appropriate volume percent of lubricant in the bearing cavity, since heat generation and bearing temperatures are dependent on this factor. It is expected that lubricant volume percent varies with bearing type, size, design, lubrication method, lubricant flow rate, and shaft speed.

The objectives of the work reported herein were (1) to calculate the operating characteristics and performance of three sizes of ball bearings with the computer program Shaberth, (2) to compare the calculated temperatures and heat generation with experimental data, and (3) to derive an equation for lubricant volume percent as a function of bearing size, lubricant flow rate, and shaft speed based on this comparison.

Computer Program

The Shaberth computer program used in this work was an upgraded version of the original program developed for the U.S. Army in 1974. In general, Shaberth simulates the thermomechanical performance of load support systems consisting of a shaft supported by up to five rolling-element bearings. Any combination of ball, cylindrical, or tapered roller bearings can be used to support the shaft. The applied loading can consist of point or distributed forces or moments and shaft misalignments. The program was upgraded in 1981 to add new capabilities and to improve its execution performance. This upgraded version of Shaberth was used in the present work and is described in detail in reference 3, which is a user's manual complete with program formulation, input instructions, and sample outputs.

Bearing Test Data

Data from the ball bearing tests were used for comparing calculated and experimental performance. Tests with 35-mm-bore angular-contact ball bearings with jet lubrication at speeds to 72 000 rpm were reported in reference 18. Data for through-the-inner-race (under-race) lubrication with the same 35-mm-bore bearings were reported in reference 19. For both of these sets of experiments, shaft speed and lubricant flow rates were varied, and bearing inner- and outer-race temperatures, oil-in and oil-out temperatures, and bearing torque were measured.

Operating characteristics of 120-mm-bore split-inner-race ball bearings at speeds to 25 000 rpm with through-the-inner-race (under-race) lubrication are reported in references 20 and 21. Bearing inner- and outer-race temperatures, oil-in and oil-out temperatures, and bearing power consumption were determined as lubricant flow rates and shaft speeds were varied.

In addition to the published experimental bearing data used in this correlation, unpublished data from tests with 167-mm-bore split-inner-race ball bearings were also used (private communication, P. F. Brown, 1982). These data included bearing outer-race temperature, oil-in temperature, and oil-out temperature from three separate

zones as measured for various shaft speeds and lubricant flow rates. All four sets of data were obtained using MIL-L-23599 lubricant. Also, all tests were run with pure thrust load on the bearings.

Results and Discussion

The computer program Shaberth was used to calculate the performance of ball bearings for which sufficient test data were available to effect a comparison over a range of operating conditions. The operating conditions which were varied were shaft speed, lubricant flow rate, and method of lubrication. Generally, for a given bearing design and size, the applied load and oil-in temperature were held constant. The variables used for comparison of experimental and calculated data were bearing and oil-out temperatures and bearing heat generation.

Percent Lubricant Volume

A significant parameter required as input for programs such as Shaberth and Cybean (ref. 4) is the percent of the bearing cavity volume that is occupied by lubricant, also called the lubricant volume percent or cavity factor XCAV. This factor describes the density of the lubricant-air mixture and is used primarily in the calculation of ball or roller drag. The bearing cavity is defined as the space between the inner and outer races that is not occupied by the cage and the balls or rollers. The authors of references 3 and 4 recommend that the values used for XCAV be less than 5 percent. It is expected that XCAV should vary with lubricant flow rate, shaft speed, and bearing size. Previous work (refs. 14 and 15) has shown that XCAV values of 2 to 3 percent generally correlate well with experimental data over a small range of conditions. Lubricant flow rate and shaft speed were not correlated with XCAV in these previous works.

To assess the effects of shaft speed and lubricant flow on XCAV, Shaberth was used to calculate the performance of 35-mm-bore angular-contact ball bearings with jet lubrication for speeds from 28 000 to 72 200 rpm and lubricant flow rates from 76 to 1894 cm³/min (0.02 to 0.50 gpm). The thrust load and oil-in temperatures were held constant at 667 N (150 lb) and 394 K (250° F), respectively. Experimental bearing temperatures and power loss from torque measurements for these conditions are published in reference 18. Data for tests without outer-race cooling were used for comparison. Measured oil-out temperature was obtained from the authors of reference 18.

The nodal system used to model the 35-mm bearing, shaft, and housing used for the test data is shown in figure 1(a). Nodes 1 to 17 are metal nodes; node 18 is the air in the bearing cavity; node 19 is the shaft support bearing node where an assumed constant heat input to

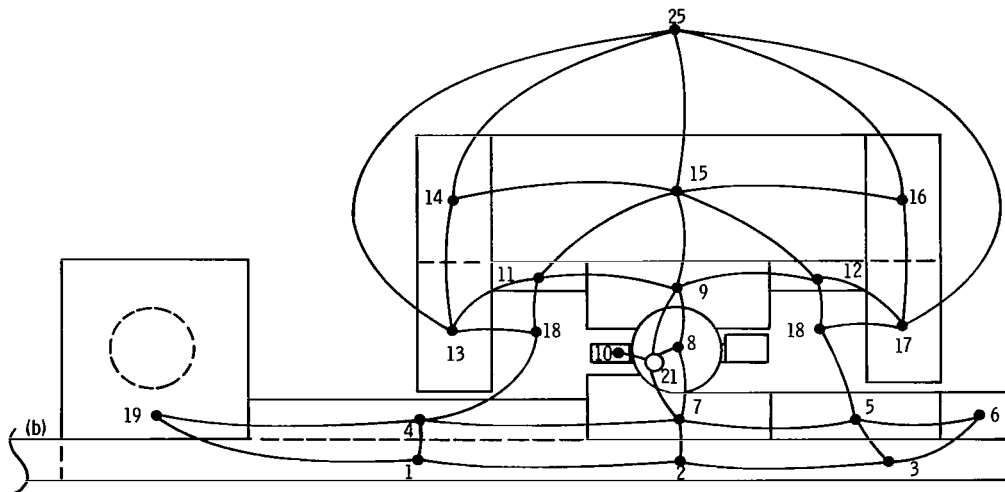
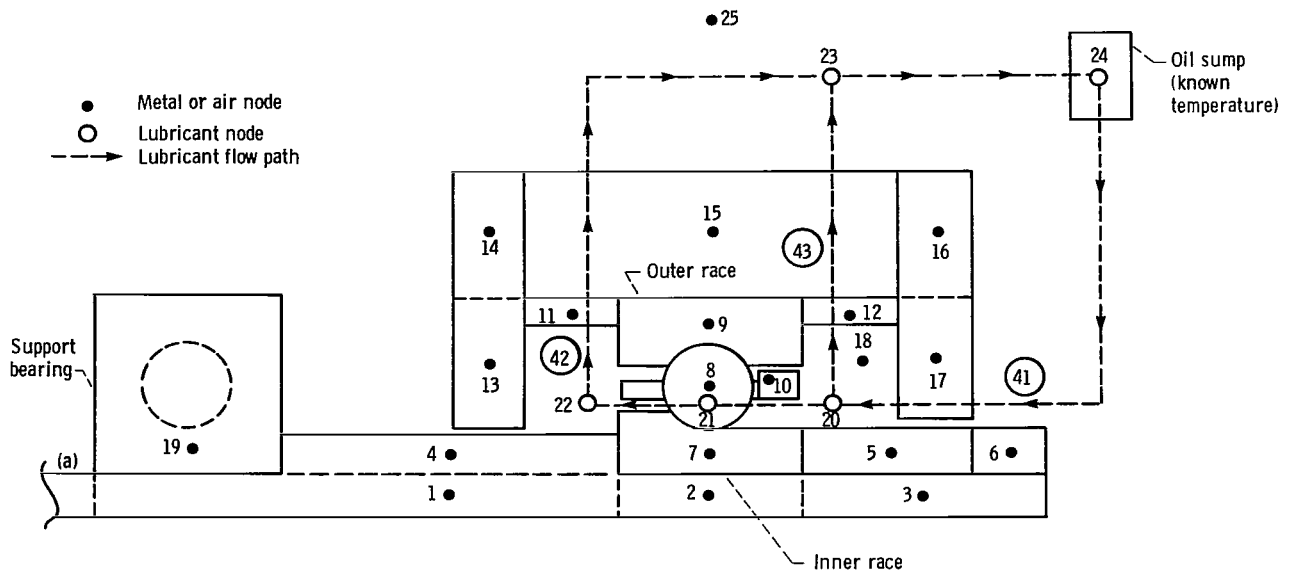

(a) Metal, air, and lubricant nodes.
(b) Conduction and convection heat flow paths.

Figure 1. — Nodal system and heat flow paths used to model 35-mm-bore ball bearing, shaft, and housing for jet lubrication.

the system is applied; nodes 20 to 24 are lubricant flow path nodes; and node 25 is the ambient air outside the housing. Heat-transfer areas and conduction and convection paths were determined as suggested in the user's manual (ref. 3). Heat radiation was neglected in these calculations. Conduction and convection heat flow paths are shown in figure 1(b).

The program was run with this model for each of 13 shaft speed—lubricant flow rate conditions for which test data existed. The effect of lubricant volume percent XCAV on calculated total bearing heat generation is

shown in figure 2. As expected, heat generation increases with increased XCAV with a greater effect of XCAV at higher speeds.

To simulate more accurately the lubricant flow path through a jet lubricated bearing, one must know or assume the portion of total flow that actually enters the bearing cavity and flows through the bearing and that portion which is deflected back or never enters the bearing cavity. These flow paths are shown in figure 1(a), where path 41 is the total flow and path 42 is the flow that passes through the bearing. This ratio of flows in paths

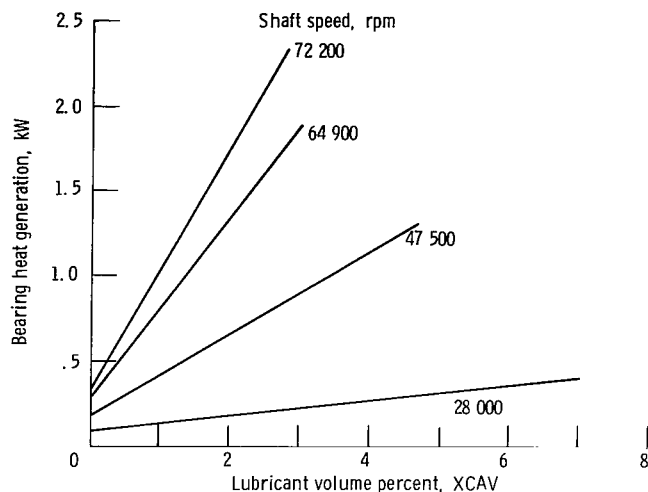

Figure 2. - Effect of lubricant volume percent on bearing heat generation calculated by Shaberth using 35-mm-bore ball bearing and jet lubrication.

42 to 41 is called the penetration ratio (refs. 22 and 23) and varies with jet velocity, shaft speed, and bearing design. Since jet velocity was constant for these experiments with this bearing, only the effect of shaft speed needs to be considered.

The program was then run with values of XCAV from 1.0 to 7.0 percent and penetration ratios from 32 to 90 percent to determine the values required for best fit with the experimental data. It was found, as expected, that XCAV primarily affected heat generation rate, and penetration ratio primarily affected bearing and oil-out temperatures. Table I shows values of XCAV and penetration ratio that give best fits with experimental data.

This lubricant volume percent from table I was plotted against shaft speed and lubricant flow rate to determine the relationship among the variables. An equation of the form

$$XCAV = K_1 N^a W^b \quad (1)$$

where N is shaft speed, W the lubricant flow rate through the bearing cavity, and K_1 a constant, appears to describe the relationship reasonably well. As shown in the appendix, the exponents a and b were determined to be -1 and 0.37 , respectively, and the constant K_1 is 2.84×10^5 for W in gpm and N in rpm. In SI units, K_1 is 1.35×10^4 for W in cm^3/min and N in rpm.

A comparison of predicted and experimental temperatures for the 35-mm-bore ball bearing with jet lubrication is shown in figures 3 and 4. Figure 3 shows excellent correlation at a constant total lubricant flow rate of $760 \text{ cm}^3/\text{min}$ (0.2 gpm) over the shaft speed range of 28 000 to 72 200 rpm. Figure 4 shows the comparison of predicted and experimental temperatures over a flow

TABLE I. - COMPUTER PROGRAM INPUTS OF LUBRICANT VOLUME PERCENT AND PENETRATION RATIO

[35-mm-bore ball bearing with jet lubrication.]

Shaft speed, rpm	Total lubricant flow rate		Lubricant volume percent, XCAV	Penetration ratio, percent
	cm^3/min	gpm		
28 000	91	0.024	3.0	90
	300	.08	5.0	
	760	.20	6.0	
	1900	.50	7.0	
47 500	91	0.024	1.0	66
	300	.08	2.0	
	760	.20	2.5	
	1900	.50	4.0	
64 900	300	0.08	1.2	50
	760	.20	1.6	50
	1900	.50	2.4	50
72 200	760	0.20	1.5	43
	1900	.50	2.4	43

rate range at two speeds. Correlation is excellent at the higher flow rates. The general trend of rapidly increasing temperature with decreased flow rate is predicted well. However, there is a deviation at the lowest flow rate of $91 \text{ cm}^3/\text{min}$ (0.024 gpm) that predicts a significantly higher temperature than was measured. The reason for this difference is not yet understood.

Analysis with 167-mm-Bore Ball Bearing

To investigate the effect of bearing size on the performance predicting capability of Shaberth and equation (1) for XCAV, analytical results were compared with unpublished experimental data obtained for thrust-loaded 167-mm-bore split-inner-race ball bearings lubricated through the inner race (private communication, P. F. Brown, 1982). These data covered a range of speeds from 6000 to 15 000 rpm, or the same range of DN values (1.0 to 2.5×10^6) as the 35-mm bore bearing data. (DN is a speed parameter which is equal to the product of the bearing bore size in millimeters and the shaft speed in rpm.) For the experimental data used for comparison, the total lubricant flow rate to the bearing was held approximately constant, but the flow rates through several paths varied with speed, as shown in table II. The three paths, shown in figure 5, are the lubricant flow through slots beneath the inner race for cooling only and the flows out through either side of the bearing. The thrust load and oil-in temperature on these tests were held constant at 3100 N (7000 lb) and 393 K (248° F), respectively. Measurements were made of outer-race temperature and flow rates and oil-out

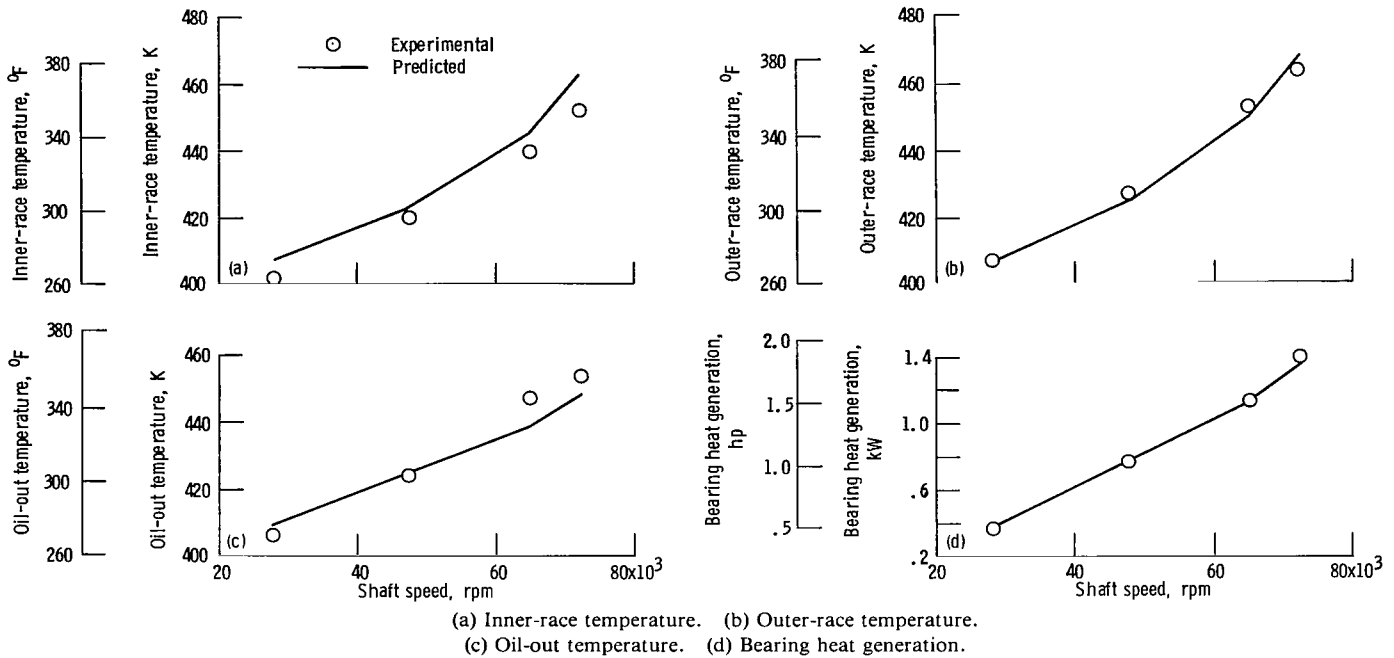

Figure 3. – Predicted and experimental thermal performance of 35-mm-bore ball bearing as function of shaft speed. Thrust load, 667 N (150 lb); oil-in temperature, 394 K (250° F); total lubricant flow rate, 760 cm³/min (0.2 gpm); jet lubrication.

temperatures of each of the three flow paths. The heat rejected to the lubricant was calculated for each path and totaled for an indication of the total bearing heat generation.

Figure 5 also shows the nodal system used to model the 167-mm ball bearing and its environment. Shaberth was executed to determine the performance using this model, and values of XCAV were selected for best fit with the experimental heat rejection data.

Without a size correction, equation (1) yielded values of XCAV unreasonably high for these conditions. It was concluded that bearing size should indeed be included in the criteria for determining suitable XCAV. An equation was developed of the form

$$\text{XCAV} = KNaWbd_m^c \quad (2)$$

for bearing pitch diameter as a size criteria where d_m is the bearing pitch diameter and K is a constant.

Furthermore, to account for pitch diameter, the equation for XCAV becomes

$$\text{XCAV} = 8.62 \times 10^5 \frac{W^{0.37}}{Nd_m^{1.7}} \quad (3a)$$

for W in gpm, N in rpm, and d_m in inches. For SI units,

$$\text{XCAV} = 10.0 \times 10^6 \frac{W^{0.37}}{Nd_m^{1.7}} \quad (3b)$$

for W in cm³/min, N in rpm, and d_m in mm.

The performance of the 167-mm bearing was calculated at the previously mentioned test conditions using values of XCAV from equation (3). A comparison of these analytical results with the experimental data is shown in figure 6. The correlation is excellent, although the oil-out temperatures tend to deviate somewhat at the higher speeds. Inner-race temperature was not measured in the tests, but the calculated values appear to be reasonable, and they follow the same trend as was seen for the 35-mm bearing with through-the-race lubrication. The temperature of the inner race tends to be lower and affected less by shaft speed than is that of the outer race.

Through-Race Lubrication with 35-mm-Bore Ball Bearing

Reference 19 contains experimental performance data for 35-mm-bore ball bearings identical to those discussed previously except that lubrication is supplied centrifugally through holes in the inner race rather than through jets. Shaberth was used to calculate the bearing performance under this lubrication condition. The nodal system with lubricant flow paths used for this analysis is shown in figure 7. The lubricant flow paths model the experimental condition wherein half the total lubricant flow rate to the bearing passes through slots under the inner race and the other half is fed into the bearing cavity through holes in the bottom of the inner raceway groove. It was assumed that the latter flow split equally to exit each side of the bearing cavity. Also, two nodes (in fig. 7)

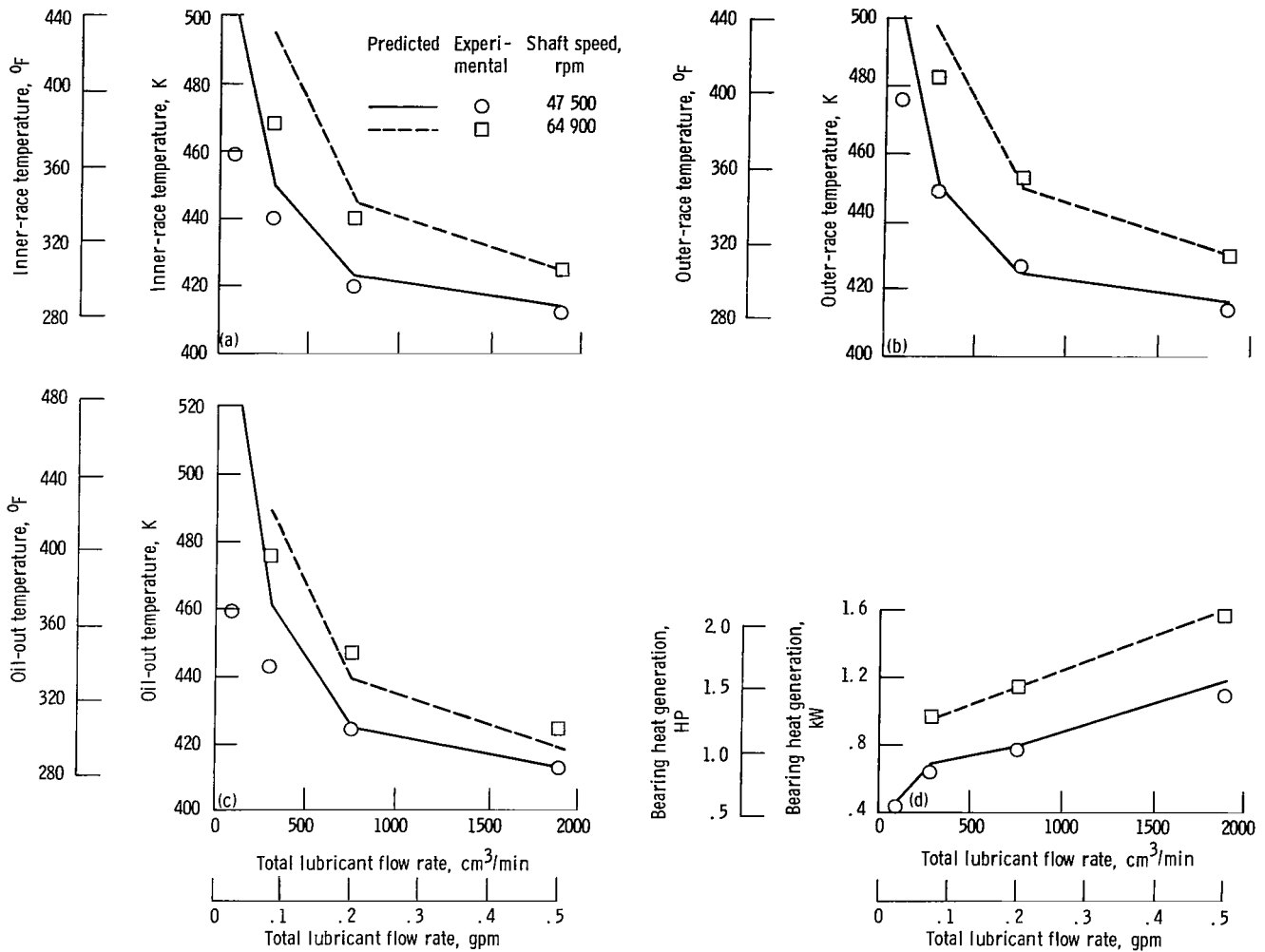

(a) Inner-race temperature. (b) Outer-race temperature.
(c) Oil-out temperature. (d) Bearing heat generation.

Figure 4. - Predicted and experimental thermal performance of 35-mm-bore ball bearing with jet lubrication as function of lubricant flow rate. Thrust load, 667 N (150 lb); oil-in temperature, 394 K (250° F).

TABLE II. - FLOW RATE CONDITIONS FOR 167-mm-BORE BALL BEARING TESTS AND COMPUTER PREDICTIONS

Shaft speed		Lubricant flow rate ^a				XCAV ^b
rpm	Million DN	Total cm ³ /min (gpm)	W_2 cm ³ /min (gpm)	W_3 cm ³ /min (gpm)	W_4 cm ³ /min (gpm)	
6 000	1.0	13 700 (3.63)	946 (0.25)	7 720 (2.04)	5 070 (1.34)	5.1
8 400	1.4	15 200 (4.02)	984 (0.26)	8 330 (2.20)	5 900 (1.56)	3.8
12 000	2.0	15 800 (4.17)	4 920 (1.30)	5 410 (1.43)	5 450 (1.44)	2.7
15 000	2.5	15 700 (4.15)	6 890 (1.82)	4 840 (1.28)	3 970 (1.05)	2.3

^aFlow rate through bearing cavity, used for XCAV calculation, is $W_2 + W_3$ (see fig. 5).

^bXCAV calculated with eq. (3).

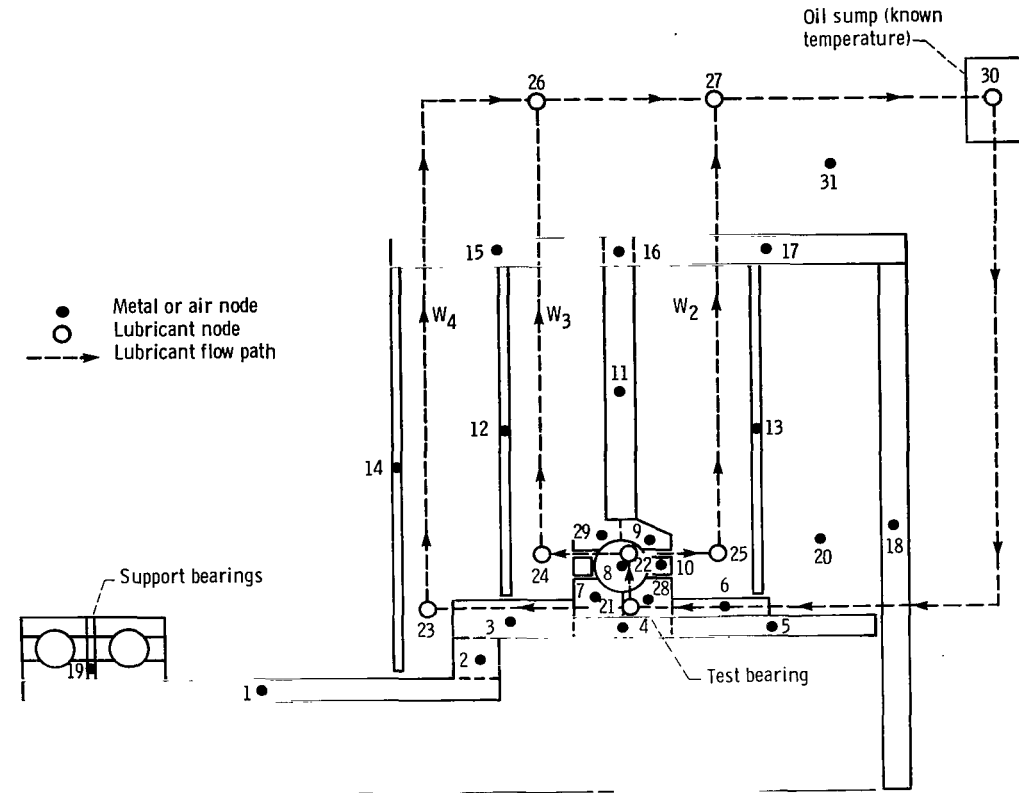

Figure 5. – Nodal system and lubricant flow paths used to model 167-mm-bore ball bearing test.

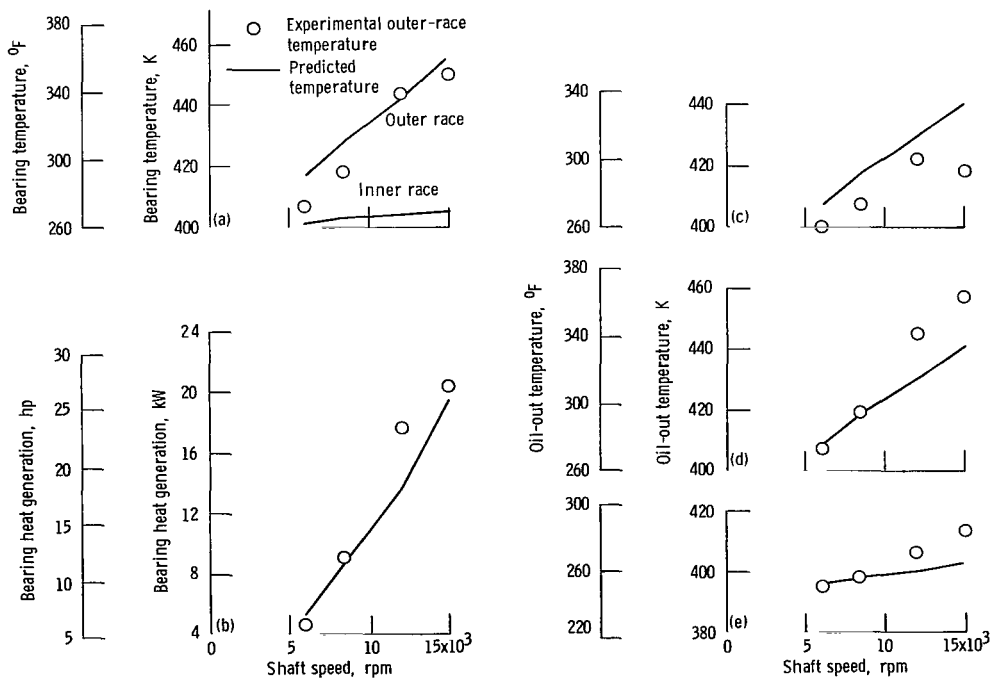

Figure 6. – Predicted and experimental thermal performance of 167-mm-bore ball bearing. Thrust load, 31 100 N (7000 lb); oil-in temperature, 393 K (248° F); see table II for flow rates.

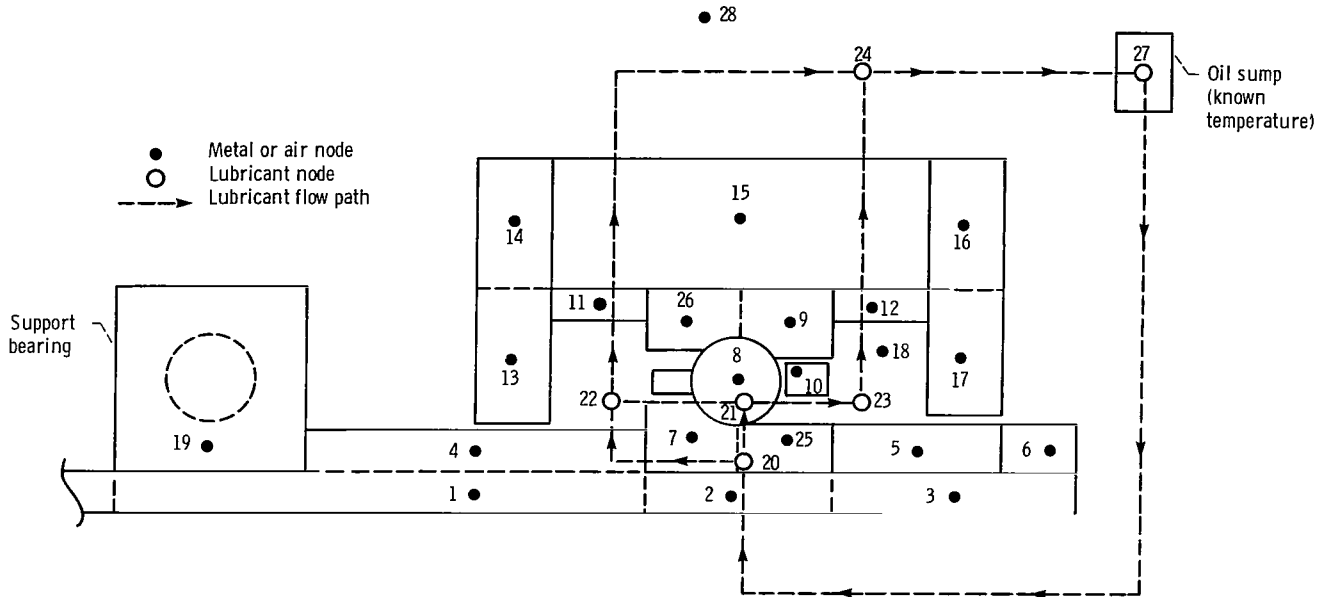

Figure 7. – Nodal system and lubricant flow paths used to model 35-mm-bore ball bearing tests with through-the-race lubrication.

were defined for each race to give a finer grid to show an axial temperature gradient in the races of the thrust loaded bearing.

The experimental data used for the comparison covered the same range of shaft speed and total lubricant flow rates as did the data for the jet-lubricated 35-mm bearing. Also, thrust load and oil-in temperature were held constant and at the same values as they were for the jet-lubricated case.

Shaberth was executed with input conditions of the test data with the model shown in figure 7 and with XCAV values calculated from equation (3). The results of the analysis and a comparison with the experimental data are shown in figures 8 and 9. Excellent correlation was attained for both magnitude of temperature and heat generation as well as for trends with increasing shaft speed and lubricant flow rate.

Analysis with 120-mm-Bore Ball Bearing

Experimental data are published in references 20 to 21 on 120-mm-bore split-inner-race ball bearings with through-the-inner-race lubrication. To further assess the capability of Shaberth to predict thermal performance of ball bearings and assess the validity of equation (3) for XCAV, a series of conditions was selected for comparison of analytical and experimental data from the 120-mm-bore ball bearings. The conditions included shaft speeds from 12 000 to 25 000 rpm (1.5 to 3.0×10^6 DN), total lubricant flow rates from 3030 to 6060 cm^3/min (0.8 to 1.6 gpm), a thrust load of 22 240 N (5000 lb), and oil-in temperatures of 394 to 427 K (250° to

310° F). The experimental data included inner- and outer-race temperatures, oil-out temperature, and bearing power loss as estimated from total test rig motor power usage.

The nodal system and lubricant flow paths used for the analysis by Shaberth are shown in figure 10. Since the test data were obtained with two identical bearings thrust-loaded against and in relatively close proximity to one another, the capability of Shaberth to simulate such an arrangement was used. The lubricant flow paths include flow to the bearing cavity through slots at the inner-race split and flow through radial holes in both sides of the inner race to the cage riding lands. Also included is a flow path for outer-race cooling as shown in figure 10. The tests selected for comparison had a constant ratio of 1/3 for the flow rate to the bearing cavity relative to the flow to the cage lands. In addition, a constant flow rate of 1890 cm^3/min (0.5 gpm) was used for outer-race cooling for all tests used for comparison.

Values of XCAV were calculated with equation (3), and the program was run at each test condition. A comparison of the experimental and predicted temperatures is shown in figures 11 and 12. Experimental data are shown as open symbols, while the predicted data are shown by solid lines.

Predicted bearing temperatures are 2 to 16 K (4° to 28° F) less than experimental values for the given range of speed and flow rate conditions. Agreement is best at the low-speed, low-flow-rate condition. The correlation with oil-out temperature, on the other hand, is much better as can be seen in figures 11(c) and 12(c).

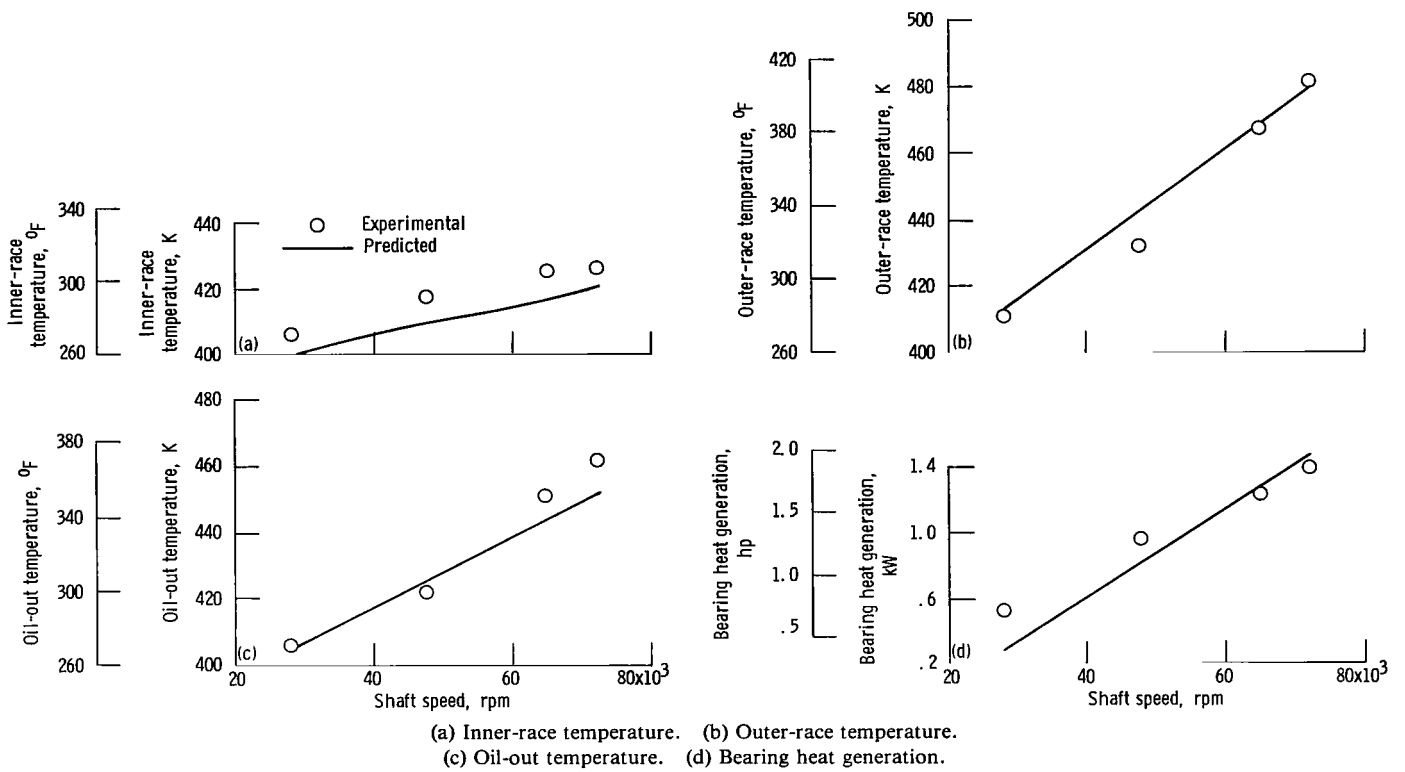

Figure 8. – Predicted and experimental thermal performance of 35-mm-bore ball bearings with through-the-race lubrication as function of shaft speed. Thrust load, 667 N (150 lb); oil-in temperature, 394 K (250° F); total lubricant flow rate, 760 cm³/min (0.2 gpm).

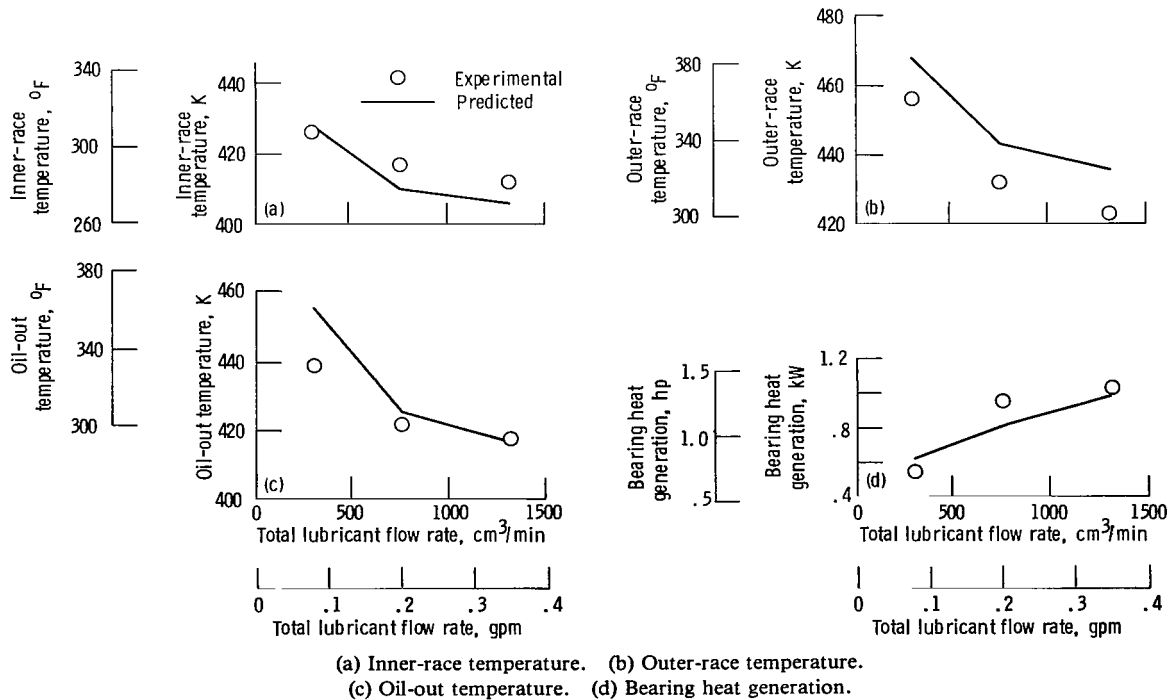

Figure 9. – Predicted and experimental thermal performance of 35-mm-bore ball bearing with through-the-race lubrication as function of lubricant flow rate. Thrust load, 667 N (150 lb); oil-in temperature, 394 K (250° F); shaft speed, 47 500 rpm.

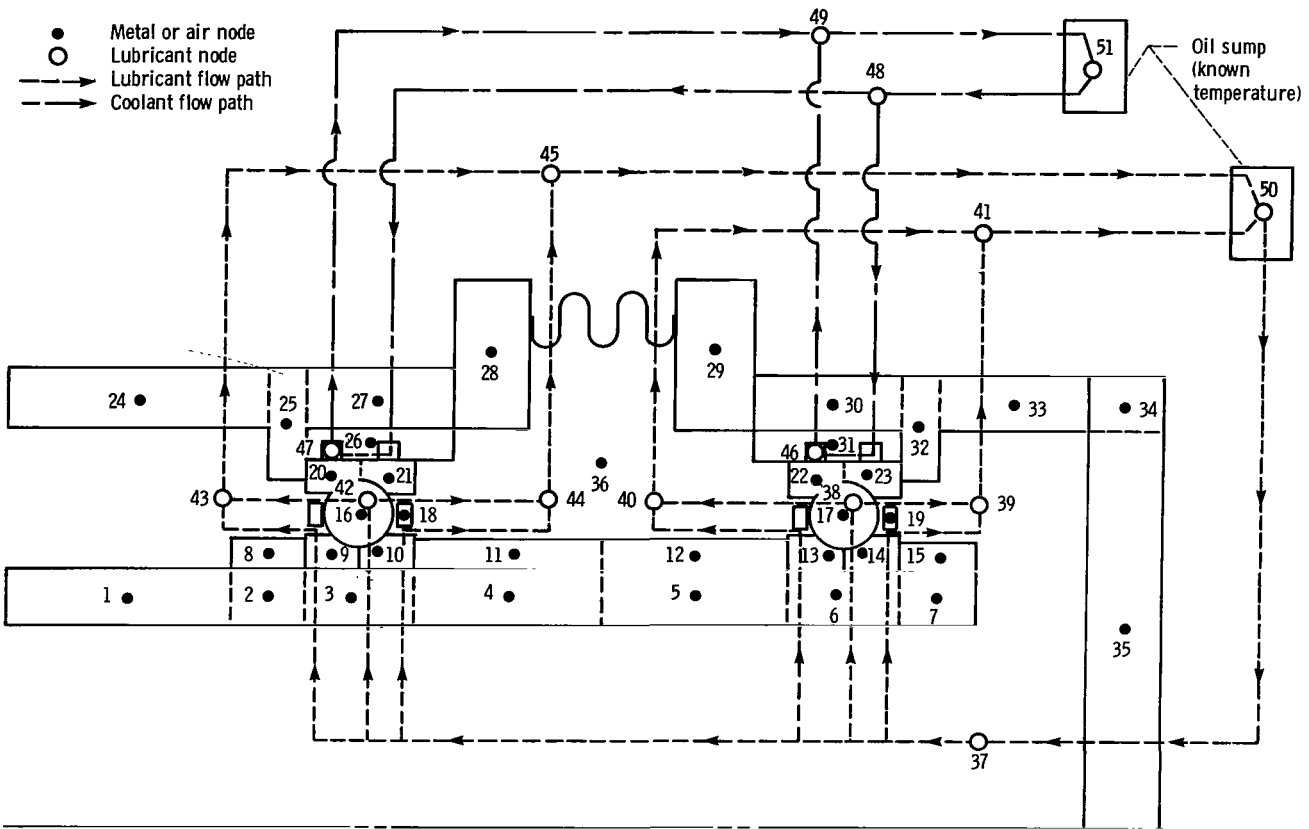

Figure 10. - Nodal system and lubricant and coolant flow paths used to model 120-mm-bore ball bearing system.

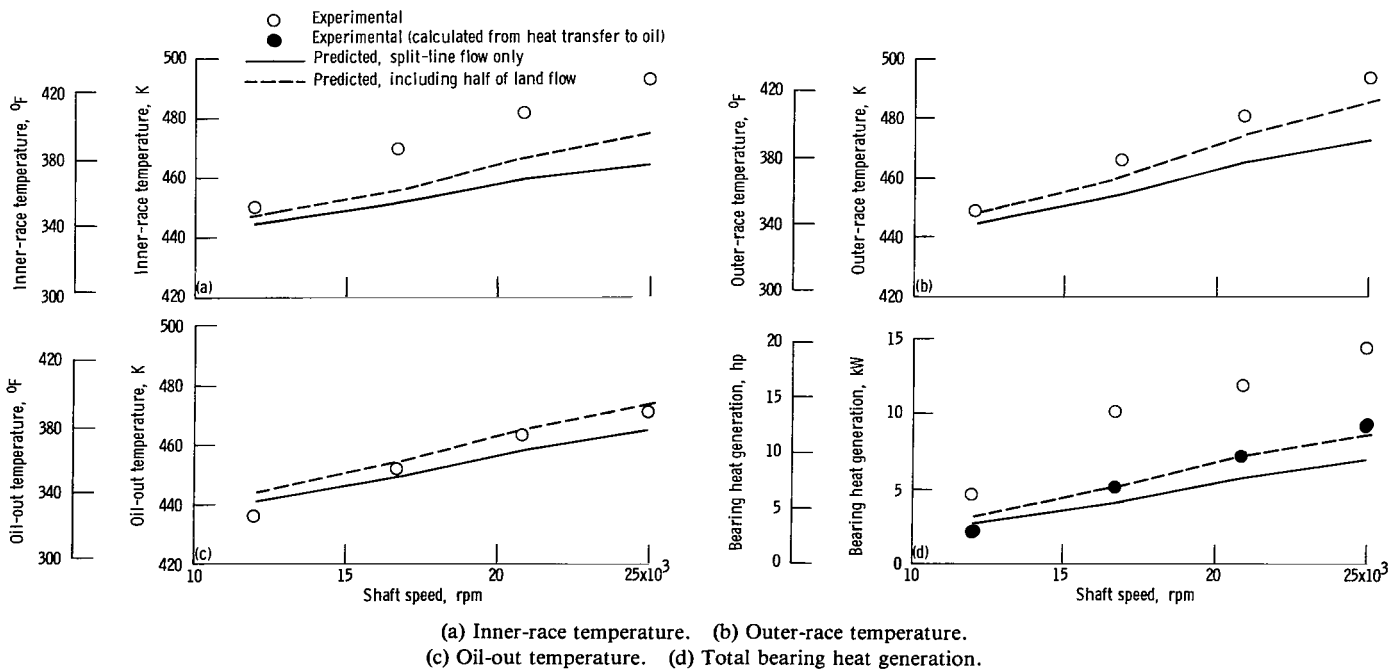
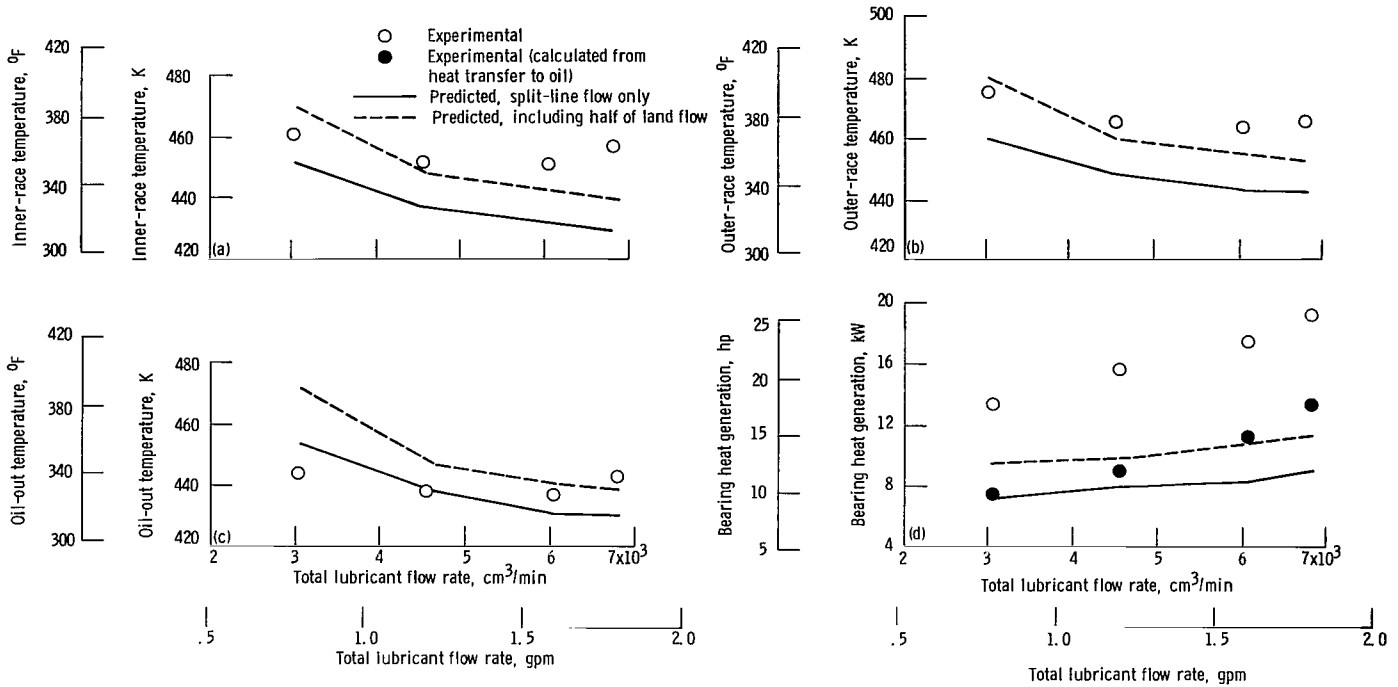

Figure 11. - Predicted and experimental thermal performance of 120-mm-bore ball bearing as function of shaft speed. Thrust load, 22 240 N (5000 lb); oil-in temperature, 427 K (310° F); total lubricant flow rate, 4 740 cm³/min (1.253 gpm).



(a) Inner-race temperature. (b) Outer-race temperature.
(c) Oil-out temperature. (d) Total bearing heat generation.

Figure 12. – Predicted and experimental thermal performance of 120-mm-bore ball bearing as function of total lubricant flow rate. Thrust load, 22 240 N (5 000 lb); oil-in temperature, 394 K (250° F); shaft speed, 25 000 rpm.

For these analyses, the lubricant flow paths shown in figure 10 were used, and only the portion of total flow directed through the split line of the inner race was used to initially determine the values for XCAV. It is expected that part of the lubricant supplied through holes in the inner-race lands would also enter the bearing cavity and should be included in the determination of XCAV. It was assumed that, at most, half that lubricant flow rate to the lands would enter the bearing cavity. The analysis was performed again with adjusted XCAV values to take this greater flow into account. The results are shown as dashed lines in figures 11 and 12. These calculated bearing temperatures are in much better agreement with the experimental values.

These results show the effects of a careful and realistic modelling of the bearing lubricant flow paths. It is apparent that an error in the flow through the bearing can significantly affect XCAV and bearing temperatures.

The comparison of experimental and calculated bearing heat generation is shown in figures 11(d) and 12(d). The predicted heat generation is significantly less than the experimental values and, in most cases, is only approximately 50 percent of the experimental heat generation. It should be recalled that the experimental heat generation data (as published in refs. 20 and 21) was estimated from rig drive motor power usage from which

an estimated tare loss for the drive system and support bearing was deducted.

To obtain another estimate of the experimental heat generation, the heat rejected to the lubricant was calculated from the difference between oil-in and oil-out temperatures and the flow rates (including the outer race cooling). The results of these calculations are shown as the solid data points in figures 11 and 12. The predicted heat generation is in much better agreement with these experimental heat generation estimates. The trends of increasing heat generation with increasing speed and flow rate compare well. It is suggested that the bearing heat generation calculated from motor power loss is probably overestimated, and that that determined from heat rejected to the oil is a better estimate of the bearing heat generation. Actual bearing heat generation probably is somewhere between these estimates. This latter means of heat generation estimation was used for the previously discussed 167-mm-bore ball bearing data as well as for the 35-mm bore bearing data. For the 35-mm-bore bearings, reference 19 shows very close agreement between bearing heat generation as determined from heat rejected to the lubricant and bearing torque measured by a strain gage torque cell. It is expected that, for the 120-mm-bore ball bearings, the experimental heat generation determined from heat rejected to the lubricant

should also be the better estimate. Therefore, the predicted heat generation obtained using Shaberth with XCAV as calculated from equation (3) agrees very well with the experimental data.

General Comments

In general, the predicted temperatures and bearing heat generation obtained using Shaberth were in very good agreement with the experimental data. Table III shows correlation coefficients for comparisons between predicted and experimental temperature and heat generation for all the bearing cases considered herein. In 11 of the 15 comparisons, correlation coefficients of 92 percent or greater were obtained. Eight of those were 97 percent or greater. The least correlation appeared to be for oil-out temperature which may be expected since the oil flow paths from the bearing and the related heat-transfer paths are the most difficult to model.

The equation derived for the lubricant volume percent or cavity factor XCAV, which is required for input to Shaberth for determining the ball drag portion of bearing heat generation, appears to be valid over the range of shaft speeds and lubricant flow rates for the three bearing sizes investigated. The use of equation (3) for calculating XCAV, which takes into account lubricant flow rate, shaft speed, and bearing size, provides a means for estimating XCAV which was previously not available. Typical calculated values for XCAV from equation (3) are generally in the range suggested by the authors of references 3 and 4 (less than 5 percent) and the authors of references 14 and 15 (2 to 3 percent). The values calculated by equation (3) which showed very good correlation with the experimental data for the three ball bearings investigated ranged from 1.3 to 7.5 for the

35-mm-bore bearing with jet lubrication, 1.6 to 9.5 for the 35-mm-bore bearing with through-race lubrication, 2.3 to 5.1 for the 167-mm-bore bearing, and 1.3 to 3.0 for the 120-mm-bore bearing. The effects of XCAV on calculated bearing heat generation and bearing temperatures and oil-out temperatures are significant. A more accurate estimate of XCAV can provide a much better estimate of bearing heat generation and temperatures than was previously available.

Furthermore, a reasonable estimate of the actual lubricant flow rate through the bearing cavity must be made. Consideration must be given to penetration ratio, where jet lubrication is used, and to the portion of the cage land lubricant flow that enters the bearing cavity, where applicable.

All the tests and analysis were performed using MIL-L-23699 type lubricants. Shaberth can accept, as input, properties of other type lubricants. Until equation (3) is validated with other lubricants, it should not be used with lubricants whose properties vary significantly from MIL-L-23699.

Ball-bearing performance predictions have been improved because of recently developed and improved computer programs such as Shaberth. With more accurate definitions of lubricant percent value XCAV, as defined by equation (3), the performance prediction is further improved.

Summary of Results

The computer program Shaberth was used to calculate the thermal performance of ball bearings for which sufficient test data are available to make a comparison over a range of test conditions. Three bearings of differing sizes were selected. The variables used for

TABLE III. - CORRELATION COEFFICIENTS FROM THE COMPARISON OF EXPERIMENTAL AND PREDICTED TEMPERATURES AND HEAT GENERATION

Bearing data	Correlation coefficient, percent			
	Inner-race temperature	Outer-race temperature	Oil-out temperature	Heat generation
35-mm bore, jet lubrication	96	98	78	99
35-mm bore, through-the-race lubrication	99	99	99	99
167-mm bore, through-the-race lubrication	---	97	81	97
120-mm bore, through-the-race lubrication	81	92	74	95

comparison of experimental and calculated data were bearing and oil-out temperatures and bearing heat generation. An empirical equation was derived for the lubricant percent value in the bearing cavity XCAV as a function of lubricant flow rate through the cavity, shaft speed, and bearing pitch diameter. The following results were obtained:

1. Predicted bearing heat generation and temperatures agreed very well with experimental data obtained from three sizes of ball bearings and thus provided experimental verification of the computer program Shaberth. Correlation coefficients were generally greater than 92 percent.

2. An equation derived for the lubricant percent volume in the bearing cavity XCAV appears to be valid over a range of shaft speeds and lubricant flow rates for the three bearing sizes investigated.

3. The predicted trends of increasing temperature and heat generation with increased shaft speed and of decreasing temperature and increasing heat generation with increased lubricant flow rate were verified by the experimental data.

Lewis Research Center
National Aeronautics and Space Administration
Cleveland, Ohio, October 27, 1983

Appendix—Derivation of Lubricant Volume Percent Equation

It is expected that the lubricant volume percent XCAV, required for input in Shaberth, is a function of lubricant flow rate through the bearing cavity, shaft speed, and bearing size. To assess this relationship, experimental and analytical data for the 35-mm-bore ball bearing with jet lubrication were compared at various XCAV values. Table I gives the values of XCAV which gave the calculated total bearing heat generation equal to the experimental data. Since jet lubrication was used in these tests, the penetration ratio must be considered, which defines the portion of the total jet flow that actually enters the bearing cavity.

Penetration ratios determined for these data are also shown in table I. The actual lubricant flow rate W through the bearing cavity is the total flow rate times the penetration ratio. Figure 13 is a plot of W and XCAV from table I. The required values for XCAV appear to fall on the same line for 64 900 and 72 200 rpm. A cross plot of XCAV against shaft speed for four values of W from figure 13 is shown in figure 14. Figure 14 shows that straight lines with a slope of -1 fit these cross-plotted

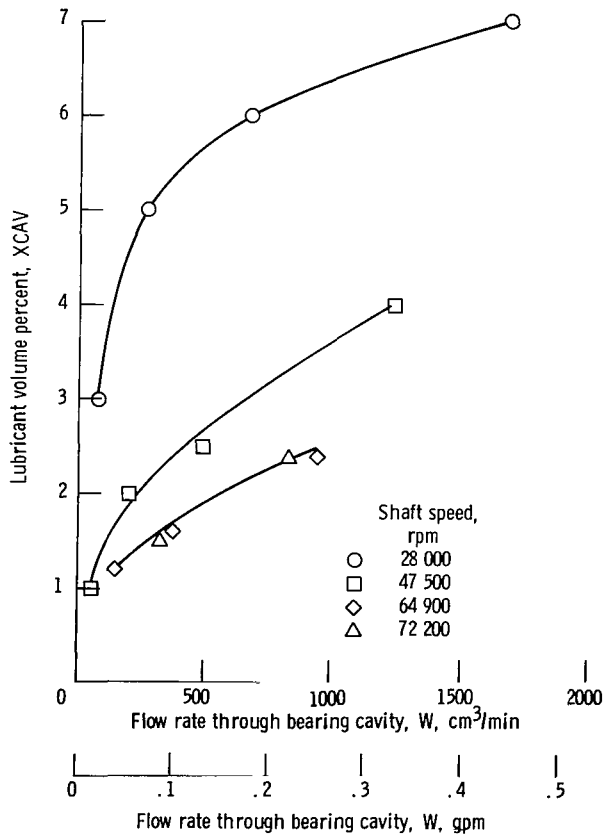

Figure 13. — Values of XCAV that gave calculated total bearing heat generation equal to experimental heat generation for 35-mm-bore ball bearing and jet lubrication.

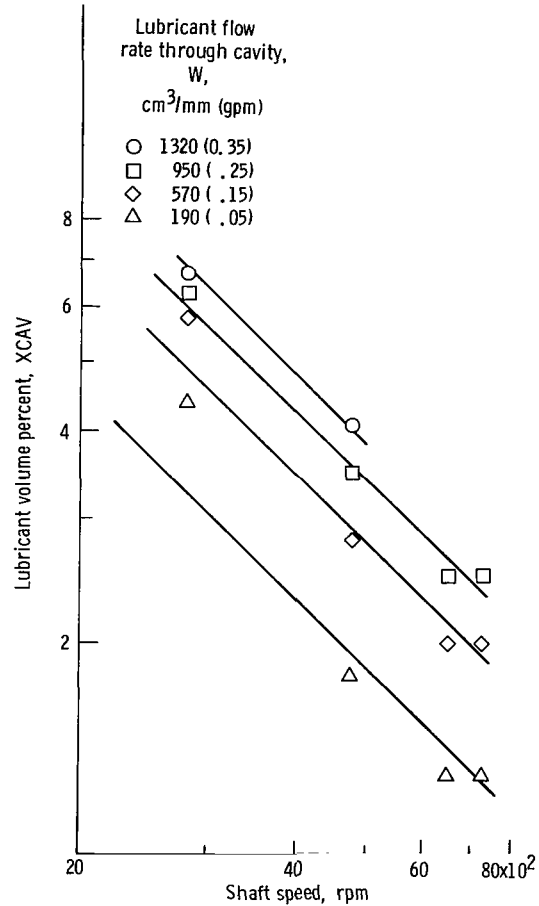

Figure 14. — Cross plot of shaft speed and XCAV from figure 13. Slope, -1.0 .

points well. This implies that a relationship such as $XCAV \propto N^{-1}$ is appropriate for the effect of speed.

Figure 15 is a cross plot of W against XCAV for three speeds taken from figure 14. Here straight lines with a slope of 0.37 fit the points extremely well, implying the relationship $XCAV \propto W^{0.37}$.

Therefore, for the 35-mm bearing data alone, that is, without considering a size effect, the lubricant volume percent XCAV can be defined by

$$XCAV = K_1 \frac{W^{0.37}}{N} \quad (A1)$$

where $K_1 = 2.84 \times 10^5$ for W in gpm, $K_1 = 1.35 \times 10^4$ for W in cm^3/min , and N is in rpm.

Figure 16 shows a scatter diagram of the values of XCAV from table I (based on the experimental data) and

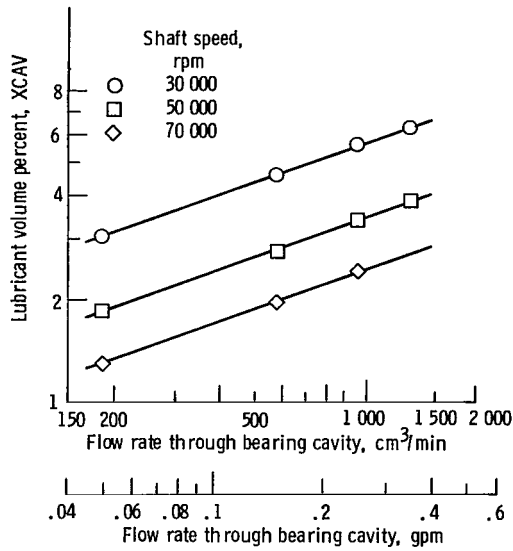

Figure 15. – Cross plot of flow rate through bearing cavity and XCAV of three speeds from figure 14. Slope, 0.37.

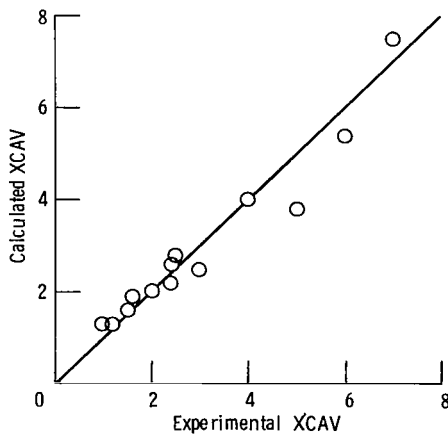

Figure 16. – Scatter diagram of experimental values of XCAV (from table I) and values of XCAV calculated with equation (A1). Correlation coefficient, 97 percent.

the values of XCAV calculated from equation (A1). The comparison shows excellent fit with a correlation coefficient of 97 percent.

The effect of bearing size on XCAV was determined by considering the experimental data from the 167-mm-bore ball bearings. Bearing heat generation was calculated with Shaberth using a range of XCAV values, and those values which gave heat generation equal to experimental data were determined for each condition. It was then determined that, without a bearing size correction, equation (A1) greatly overestimates the values of XCAV for this larger bearing.

For convenience and to be consistent with the form of equation (A1), the selected adjustment for size was the bearing pitch diameter raised to a power. The relationship determined by comparing values of XCAV, which gives a reasonable first-order approximation of the bearing size effect, is

$$XCAV \propto d_m^{-1.7} \tag{A2}$$

To account for bearing size, lubricant flow rate, and bearing shaft speed, the lubricant volume percent can be defined as

$$XCAV = 8.62 \times 10^5 \frac{W^{0.37}}{Nd_m^{1.7}} \tag{A3a}$$

for W in gpm, N in rpm, and d_m in inches. For SI units,

$$XCAV = 10.0 \times 10^6 \frac{W^{0.37}}{Nd_m^{1.7}} \tag{A3b}$$

for W in cm^3/min , N in rpm, and d_m in mm.

References

1. Jones, A. B.: A General Theory for Elastically Constrained Ball and Radial Roller Bearings Under Arbitrary Load and Speed Conditions. *J. Basic Eng.*, vol. 82, no. 2, June 1960, pp. 309-320; discussion, p. 320.
2. Harris, T. A.: An Analytical Method to Predict Skidding in Thrust-Loaded, Angular-Contact Ball Bearings. *J. Lubr. Technol.*, vol. 93, no. 1, Jan. 1971, pp. 17-23; discussion, pp. 23-24.
3. Hadden, G. B.; et al.: Research Report—User's Manual for Computer Program AT81Y003 SHABERTH. Steady State and Transient Thermal Analysis of a Shaft Bearing System Including Ball, Cylindrical and Tapered Roller Bearings. (SKF-AT81D040, SKF Technology Services; NASA Contract NAS3-22690.) NASA CR-165365, 1981.
4. Kleckner, R. J.; Pirvics, J.; and Castelli, V.: High-Speed Cylindrical Rolling Element Bearing Analysis "CYBEAN"—Analytic Formulation. *J. Lubr. Technol.*, vol. 102, no. 3, July 1980, pp. 380-388; discussion, pp. 388-390.
5. Walters, C. T.: The Dynamics of Ball Bearings. *J. Lubr. Technol.*, vol. 93, no. 1, Jan. 1971, pp. 1-10.
6. Gupta, P. K.: Dynamics of Rolling-Element Bearings, Part III: Ball Bearing Analysis. *J. Lubr. Technol.*, vol. 101, no. 3, July 1979, pp. 312-318.
7. Gupta, P. K.: Dynamics of Rolling-Element Bearings, Part I: Cylindrical Roller Bearing Analysis. *J. Lubr. Technol.*, vol. 101, no. 3, July 1979, pp. 293-302; discussion, pp. 303-304.
8. Conry, Thomas F.: Transient Dynamic Analysis of High-Speed Lightly Loaded Cylindrical Roller Bearings, I—Analysis. NASA CR-3334, 1981.
9. Conry, Thomas F.; and Goglia, Peter R.: Transient Dynamic Analysis of High-Speed Lightly Loaded Cylindrical Roller Bearings, II—Computer Program and Results. NASA CR-3335, 1981.
10. Schulze, Dale R.: An Evaluation of the Usefulness of Two Math Models for Predicting Performance of a 100-mm Bore, Angular Contact, High-Speed, Thrust Bearing. AFWAL-TR-80-2007, Air Force Wright Aeronautical Laboratories, 1980. (AD-A089161.)
11. Pirvics, J.: Computerized Analysis and Design Methodology for Rolling Element Bearing Load Support Systems. Bearing Design—Historical Aspects, Present Technology and Future Problems, W. J. Anderson, ed., American Society of Mechanical Engineers, 1980, pp. 47-85.
12. Gupta, P. K.: A Review of Computerized Simulations of Roller Bearing Performance. Computer-Aided Design of Bearings and Seals, Francis E. Kennedy and Herbert S. Cheng, eds., American Society of Mechanical Engineers, 1976, pp. 19-29.
13. Sibley, L. B.; and Pirvics, J.: Computer Analysis of Rolling Bearings. Computer-Aided Design of Bearings and Seals, Francis E. Kennedy and Herbert S. Cheng, eds., American Society of Mechanical Engineers, 1976, pp. 95-115.
14. Coe, Harold H.; and Zaretsky, Erwin V.: Predicted and Experimental Performance of Jet-Lubricated 120-Millimeter-Bore Ball Bearings Operating to 2.5 Million DN. NASA TP-1196, 1978.
15. Coe, Harold H.; and Schuller, Fredrick T.: Comparison of Predicted and Experimental Performance of Large-Bore Roller Bearing Operating to 3.0 Million DN. NASA TP-1599, 1980.
16. Brown, Paul F.; Dobek, Louis J.; and Tobiasz, Edward J.: High Speed Cylindrical Roller Bearing Development. PWA-FR-12598, Pratt and Whitney Aircraft Group, United Technologies Corp., 1980. (AFWAL-TR-80-2072, AD-A095357.)
17. Brown, P. F.; et al.: Development of Mainshaft High Speed Cylindrical Roller Bearings for Gas Turbine Engines. PWA-FR-8615, Pratt & Whitney Aircraft Group, 1977. (AD-052351.)
18. Schuller, Fredrick T.; Pinel, Stanley I.; and Signer, Hans R.: Operating Characteristics of a High-Speed, Jet-Lubricated 35-Millimeter-Bore Ball Bearing With a Single-Outer-Land-Guided Cage. NASA TP-1657, 1980.
19. Schuller, Fredrick T.; and Signer, Hans R.: Performance of Jet- and Inner-Ring-Lubricated 35-Millimeter-Bore Ball Bearings Operating to 2.5 Million DN. NASA TP-1808, 1981.
20. Zaretsky, Erwin V.; Bamberger, Eric N.; and Signer, Hans R.: Operating Characteristics of 120-Millimeter-Bore Ball Bearings at 3×10^6 DN. NASA TN D-7837, 1974.
21. Bamberger, Eric N.; Zaretsky, Erwin V.; and Signer, Hans R.: Effect of Speed and Load on Ultra-High-Speed Ball Bearings. NASA TN D-7870, 1975.
22. Parker, R. J.: Lubrication of Rolling Element Bearings. Bearing Design—Historical Aspects, Present Technology and Future Problems, W. J. Anderson, ed., American Society of Mechanical Engineers, 1980, pp. 87-110.
23. Miyakawa, Y.; Seki, K.; and Yokoyama, M.: Study on the Performance of Ball Bearings at High DN Values. (NAL-TR-284, National Aerospace Lab.; Tokyo, Japan, 1972.) NASA TT F-15017, 1973.

1. Report No. NASA TP-2275		2. Government Accession No.		3. Recipient's Catalog No.	
4. Title and Subtitle Comparison of Predicted and Experimental Thermal Performance of Angular-Contact Ball Bearings				5. Report Date February 1984	
7. Author(s) Richard J. Parker				6. Performing Organization Code 505-40-42	
9. Performing Organization Name and Address National Aeronautics and Space Administration Lewis Research Center Cleveland, Ohio 44135				8. Performing Organization Report No. E-1751	
12. Sponsoring Agency Name and Address National Aeronautics and Space Administration Washington, D.C. 20546				10. Work Unit No.	
15. Supplementary Notes				11. Contract or Grant No.	
16. Abstract Predicted bearing heat generation and bearing temperature were verified by experimental data for ball bearings over a range of sizes, shaft speeds, and lubricant flow rates. The computer program Shaberth requires, as input, a factor which describes the air-oil mixture in the bearing cavity for calculation of the ball drag contribution to bearing heat generation. An equation for this lubricant percent volume in the bearing cavity was derived and appears to be valid over the range of test conditions including bearing bore sizes from 35 to 167 mm and shaft speeds from 1.0 to 3.0 million DN.				13. Type of Report and Period Covered Technical Paper	
17. Key Words (Suggested by Author(s)) Bearings Ball bearings Bearing analysis			18. Distribution Statement Unclassified - unlimited STAR Category 37		
19. Security Classif. (of this report) Unclassified		20. Security Classif. (of this page) Unclassified		21. No. of pages 16	22. Price* A02

National Aeronautics and
Space Administration

Washington, D.C.
20546

Official Business

Penalty for Private Use, \$300

THIRD-CLASS BULK RATE

Postage and Fees Paid
National Aeronautics and
Space Administration
NASA-451



4 1 10, D, 840221 S00903DS
DEPT OF THE AIR FORCE
AF WEAPONS LABORATORY
ATTN: TECHNICAL LIBRARY (SUL)
KIRTLAND AFB NM 87117

NASA

POSTMASTER: If Undeliverable (Section 158
Postal Manual) Do Not Return
