

N 84 - 20699 .

NASA CR-168321
BAC D180-28274-1



National Aeronautics and
Space Administration

**EVALUATION OF PROPELLANT TANK INSULATION
CONCEPTS FOR LOW-THRUST CHEMICAL
PROPULSION SYSTEMS**

EXECUTIVE SUMMARY

BOEING AEROSPACE COMPANY

prepared for

**NASA Lewis Research Center
Contract NAS3-22824**

**NASA CR-168321
BAC D180-28274-1**



**National Aeronautics and
Space Administration**

**EVALUATION OF PROPELLANT TANK INSULATION
CONCEPTS FOR LOW-THRUST CHEMICAL
PROPULSION SYSTEMS**

EXECUTIVE SUMMARY

by T.J. Kramer, E.W. Brogren, and B.L. Siegel

BOEING AEROSPACE COMPANY

prepared for

**NASA Lewis Research Center
Contract NAS3-22824**

1. Report No. CR 168321		2. Government Accession No.		3. Recipient's Catalog No.	
4. Title and Subtitle EVALUATION OF PROPELLANT TANK INSULATION CONCEPTS FOR LOW-THRUST CHEMICAL PROPULSION SYSTEMS - EXECUTIVE SUMMARY				5. Report Date March 1984	
				6. Performing Organization Code	
7. Author(s) T. Kramer, E. Brogren, B. Siegel				8. Performing Organization Report No. BAC D180-28274-1	
9. Performing Organization Name and Address Boeing Aerospace Company P.O. Box 3999 Seattle, WA 98124				10. Work Unit No.	
				11. Contract or Grant No. NAS3-22824	
12. Sponsoring Agency Name and Address NASA Lewis Research Center 21000 Brookpark Road Cleveland, OH 44135				13. Type of Report and Period Covered Contractor Report	
				14. Sponsoring Agency Code	
15. Supplementary Notes Project Manager, J. C. Aydelott Lewis Research Center Cleveland, OH 44135					
16. Abstract An analytical evaluation of cryogenic propellant tank insulations for liquid oxygen/liquid hydrogen low-thrust 2224N (500 lbf) propulsion systems (LTPS) was conducted. The insulation studied consisted of combinations of N ₂ -purged foam and multilayer insulation (MLI) as well as He-purged MLI-only. Heat leak and payload performance predictions were made for three Shuttle-launched LTPS designed for Shuttle bay packaged payload densities of 56 kg/m ³ (3.5 lbf/ft ³), 40 kg/m ³ (2.5 lbf/ft ³) and 24 kg/m ³ (1.5 lbf/ft ³). Foam/MLI insulations were found to increase LTPS payload delivery capability when compared with He-purged MLI-only. An additional benefit of foam/MLI was reduced operational complexity because Orbiter cargo bay N ₂ purge gas could be used for MLI purging. Maximum payload mass benefit occurred when an enhanced convection, rather than natural convection, heat transfer was specified for the insulation purge enclosure. The enhanced convection environment allowed minimum insulation thickness to be used for the foam/MLI interface temperature selected to correspond to the moisture dew point in the N ₂ purge gas. Experimental verification of foam/MLI benefits was recommended. A conservative program cost estimate for testing a MLI-foam insulated tank was 2.1 million dollars. It was noted this cost could be reduced significantly without increasing program risk.					
17. Key Words (Suggested by Author(s)) Heat Transfer, Foam Insulation, Space Propulsion, Cryogenics			18. Distribution Statement Unclassified - Unlimited		
19. Security Classif. (of this report) Unclassified		20. Security Classif. (of this page) Unclassified		21. No. of Pages	22. Price*

* For sale by the National Technical Information Service, Springfield, Virginia 22161

FOREWORD

This final report was prepared by the Boeing Aerospace Company, under Contract NAS3-22824. The contract was administered by the National Aeronautics and Space Administration Lewis Research Center. Mr. J. C. Aydelott provided technical direction. The period of study was from October 1981 to October 1982.

TABLE OF CONTENTS

	Page
LIST OF FIGURES	vii
LIST OF TABLES	ix
SUMMARY	1
1.0 INTRODUCTION	3
2.0 INSULATION CONCEPTS	5
3.0 LTPS CONCEPTUAL DESIGNS	11
4.0 PREDICTED PROPELLANT THERMAL LOADS	17
5.0 INSULATION OPTIMIZATION	25
6.0 EXPERIMENTAL PROGRAM PLAN	29
7.0 STUDY CONCLUSIONS AND RECOMMENDATIONS	35
REFERENCES	37

LIST OF FIGURES

		Page
3-1	Baseline LSS Payload	12
4-1	Predicted Heat Flux Through Helium-Purged MLI During the Ground-Hold Mission Phase	18
4-2	Predicted Heat Flux Through Nitrogen-Purged MLI/Foam Insulations During the Ground-Hold Mission Phase	19
4-3	Time-Averaged Heat Flux Through Helium-Purged MLI for Mission Phase Extending from Insulation Evacuation Through LMSS/LTPS Separation from the Orbiter	21
4-4	Time-Averaged Heat Flux Through Nitrogen-Purged MLI/Foam Insulation for Mission Phase Extending from Insulation Evacuation Through LMSS/LTPS Separation from the Orbiter	22
4-5	Time-Averaged Heat Flux Through Propellant Tank Insulation for Mission Phase Extending from LMSS/LTPS Separation from the Orbiter Through Insertion of LTPS in Disposal Orbit	23
6-1	Facility Layout and Requirements	30
6-2	Hydrogen Back Pressure and Vent System	31

LIST OF TABLES

		Page
2-1	Task I Candidate Insulations	6
2-2	Moisture Content and Dew Point of N ₂ Purge Gas Candidates	7
2-3	Task II Insulations Selected for Application to LTPS Designs	8
3-1	Task II Mission Timeline	13
3-2	Task I LTPS Mass Summary	14
3-3	Task II LTPS Mass Summaries	15
5-1	Optimum LTPS Conceptual Design Summary	26

SUMMARY

An analytical evaluation of cryogenic propellant tank insulations for liquid oxygen/liquid hydrogen low-thrust 2224N (500 lbf) propulsion systems (LTPS) was conducted. Insulations, consisting of combinations of foam and multilayer insulation (MLI), as well as MLI-only, were investigated. The purpose of the study was to analytically assess the benefits of a combined foam/MLI system relative to MLI alone and develop an experimental technology development plan for a combined MLI/foam propellant tank insulation system concept.

Helium-purged MLI with no foam substrate was selected as the baseline insulation concept. The MLI/foam combination insulations studied were purged with nitrogen.

Thermal analysis models of three baseline LTPS conceptual designs were developed to predict heat leak into the propellant tanks during ground-hold, launch, and orbital mission phases. The three LTPS studied were designed for shuttle orbiter launch and packaged payload densities of 56 kg/m^3 (3.5 lbf/ft^3), 40 kg/m^3 (2.5 lbf/ft^3) and 24 kg/m^3 (1.5 lbf/ft^3).

Heat leak information generated by the thermal analysis models was used to evaluate the influence of tank insulation design variables on LTPS and payload size and mass. The insulation design variables studied were; 1) foam and MLI thickness, 2) foam/MLI interface temperature, 3) purge gas, 4) foam material and 5) purge enclosure heat transfer environment during prelaunch operations. Insulation designs which maximized payload mass were identified.

It was found that LTPS payload mass could be increased by replacing He-purged MLI with MLI/foam combination insulations. Enhanced convection heat transfer in the purge enclosure was required during purging to achieve the desired MLI/foam interface temperature with a minimum thickness of foam. Purging with N_2 rather than He reduced tank heat leak during ground hold. Boiloff losses were therefore reduced and the effective propellant density was increased due to a lower rate of boiling. Optimum insulation thickness depended on payload density and whether or not foam was used. Typically, He-purged MLI thickness ranged from 2.3 to 5.1 cm (0.91 to 2.0 in.). Optimum MLI/foam insulations ranged from 3.3 to 5.8 cm (1.3 to 2.3 in.). In evaluating the effect of MLI/foam interface temperature on payload mass, the lowest temperature considered (144°K (-100°F)), gave the highest mass. Of the two foam materials studied, the adhesively bonded Rohacell 31 was preferred over spray-on BX 250A due to its lower density.

A preliminary test plan, conceptual test hardware designs and cost estimates for an experimental program were developed. The objectives of the experimental program are to measure the performance of foam-plus-MLI cryogenic insulation and to verify the analysis of Task I. The plan provides for testing a one-half scale liquid hydrogen tank in an existing vacuum chamber facility. The foam-plus-MLI system and, for comparison purposes, a MLI-only system would be tested separately. Each test would simulate the pressure and temperature environment of a complete STS ground hold, launch, ascent, and orbit. The cost of the 24-month program was estimated as just over two million 1982 dollars. Possible variations on the plan and their effect on costs were briefly investigated.

1.0 INTRODUCTION

This report describes a study of propellant tank insulations for cryogenic low-thrust propulsion systems (LTPS). The work was performed for the National Aeronautics and Space Administration Lewis Research Center under contract NAS3-22824.

A 12 month technical effort was conducted to analyze multilayer insulations (MLI) and MLI/foam combination insulations for application to cryogenic propellant tanks on low thrust propulsion systems launched from the Space Transportation System (STS) or Space Shuttle as it is more commonly known. Insulation thermal performance, weight, volume and impact on payload delivery to geosynchronous Earth orbit (GEO) were predicted and an experimental plan to determine the thermal performance of combined MLI/foam insulations was developed.

NASA and DOD studies have forecast the need for low-thrust chemical orbit-to-orbit propulsion systems to transport acceleration-sensitive large space structures (LSS) from low Earth to geosynchronous orbit. These propulsion systems will likely utilize the cryogenic propellants liquid hydrogen and oxygen (LH₂ and LO₂), thus requiring high performance insulation systems to minimize propellant losses due to environmental heating.

The work described in this report provides an analytical evaluation of cryogenic tank insulation systems which combine MLI with a foam substrate. The purpose of the study was to: 1) select combined insulation systems which encompass the advantages of each insulation component and 2) assess the combined systems' relative benefits as compared to MLI alone and, 3) plan further technology development for combination insulations for cryogenic propellant tanks. Although the results are generally applicable to any STS-transportable tankage, the study was restricted to the consideration of low-thrust propulsion systems. These systems were assumed to employ a single 2224 N (500 lbf) thrust LO₂ and LH₂ rocket engine in all cases. Specific impulse, at a 6:1 mixture ratio, was set at 4560 N-sec/kg (465 seconds). The LTPS and its LSS payload were assumed to form a single STS Orbiter payload. Size and mass of the combined LTPS/LSS were restricted by the Orbiter cargo bay volume and the STS payload placement capability. In developing mission timelines for the study, it was assumed that LTPS/LSS erection, deployment and checkout in the Orbiter cargo bay would require slightly less than 43 hours of mission time. The LSS payload was assumed to be transported to GEO in the fully deployed configuration.

This study consisted of 3 technical tasks. The objective of Task I was to perform a preliminary analysis to predict the thermal performance of candidate LH₂ and LO₂ propellant tank insulations and evaluate the potential benefits of MLI/foam insulation. The effect of foam substrates on propellant vent losses, and the density of tanked propellants prior to launch, were determined. Combined MLI/foam insulations were compared with MLI only. Comparisons were made, for a single LTPS configuration, on the basis of operational complexity and on LTPS volume, mass and payload placement capability.

Following the preliminary comparison of insulation concepts, 5 candidate designs were selected for detailed evaluation in Task II. The objective of Task II was to assess the impact of candidate insulations on the payload placement capability of a range of LTPS designs. One of the candidate insulations was helium-purged MLI, and the other 4 were N₂-purged MLI/foam combinations.

Three LTPS designs were considered in the Task II insulation studies. Each design was developed for a specific packaged payload density. The 3 densities selected were 56 kg/m^3 , 40 kg/m^3 and 24 kg/m^3 (3.5 lbm/ft^3 , 2.5 lbm/ft^3 and 1.5 lbm/ft^3). Packaged payload density is defined as the mass of the payload divided by its volume in the stowed configuration for launch in the STS Orbiter cargo bay. Detailed thermal analyses were conducted to predict the environmental heat loads on the propellant tanks of each LTPS design. A range of insulation thicknesses and MLI/foam interface temperatures were studied and parametric tank insulation performance data was developed. This performance data, along with parametric sizing and mass relationships for tanks, structure and insulation, was used to optimize the insulation designs for maximum LTPS payload placement capability. Payload capabilities of vehicles having optimized MLI/foam-insulated tanks were compared with the payload capabilities of vehicles having tanks insulated with MLI only.

In Task III, a test program was designed and planned to experimentally evaluate the thermal performance of a MLI/foam insulated LH₂ tank. The specific objectives of this effort were to: 1) identify the test variables and determine the range of variation of each needed to evaluate insulation performance and verify thermal performance predictions; 2) define instrumentation requirements; 3) develop preliminary test hardware designs; 4) develop a test plan and schedule, and 5) estimate test program cost.

2.0 INSULATION CONCEPTS

This section describes the LTPS propellant tank insulation concepts selected in Task I of this study. As described in the preceding section, two basic generic types of insulation were investigated. One generic type studied was multilayer insulation consisting of alternating layers of metallized Kapton (polyimide) film and Dacron net spacers. This insulation has been used as a cryogenic tank insulation for over 20 years. It was selected as the baseline insulation because it is low-risk and is well-characterized.

When used to insulate cryogenic propellant tanks, MLI must be purged of all gases that would liquify or freeze at liquid hydrogen or liquid oxygen temperatures. Helium is normally used for purging because;

- a. it can be easily purified to eliminate contaminants
- b. its condensation temperature at sea level pressure is well below the temperature of liquid hydrogen 21°K (-422°F) and liquid oxygen 92°K (-294°F) and
- c. it has a high mass diffusivity and readily diffuses through the MLI.

An important disadvantage of using helium as a purge gas is its relatively high thermal conductivity. This characteristic of helium causes high heat leaks into the propellants during fill and hold operations on the ground.

The second generic type of insulation evaluated in this study consisted of a combination of closed-cell foam and MLI. In this design, the foam covers the exterior of the tank and the MLI is attached over it. The presence of the foam between the MLI and tank wall raises the minimum temperature of the MLI during ground hold purging. Therefore, nitrogen gas can be used to purge both the hydrogen and oxygen tank MLI blankets. The principal advantage of using nitrogen rather than helium is that its thermal conductivity is one sixth that of helium. Hence, ground-hold heat leak is diminished. The thicknesses of the foam and MLI can be selected to give the desired interface temperature during purging operations. The performance gain achieved through the use of foam/MLI combinations is countered by the greater weight of the foam which increases the overall insulation system mass.

Initially, 9 sets of candidate insulations (each set consisting of a LH₂ and a LO₂ tank insulation design) were studied. These candidate insulations are summarized in Table 2-1.

Following the Task I thermal analysis of the candidate insulations, 5 insulation designs were selected for further study in Task II. One of the 5 designs was helium-purged MLI, which was retained as the baseline insulation representing state-of-the-art technology. The other 4 insulations selected were MLI/foam combinations. In these insulations, the foam/MLI interface temperature was determined by the water content of the N₂ purge gas. Table 2-2 summarizes the water vapor content and dew point temperature of 3 grades of N₂ that could be used to purge the STS cargo bay.

Three values of foam/MLI interface temperature were specified, based on the dew point data summarized in Table 2-2. The two highest interface temperatures were approximately equal to the dew points of orbiter cargo bay purge gas and the 99.998% purity N₂. A third, lower temperature, was chosen so the benefit of incorporating a thin layer of foam into the insulation design could be determined.

The interface temperatures chosen for the foam/MLI candidate insulations were, 244°K (-20°F), 200°K (-100°F) and 144°K (-200°F). Table 2-3 summarizes the insulation designs

CONFIGURATION ◆	TYPE PURGE GAS	MLI THICKNESS cm (in)	FOAM ■ TYPE	LH ₂ TANK		LO ₂ TANK	
				FOAM THICKNESS cm (in)	INTERFACE TEMPERATURE K (F)	FOAM THICKNESS cm (in)	INTERFACE TEMPERATURE K (F)
1 △	HELIUM	4.18 (1.65)	—	0	22 (-420)	0	92 (-294)
2	NITROGEN	2.72 (1.07)	BX 250A	0.33 (0.13)	83 (-311)	0	92 (-294)
3	NITROGEN	2.72 (1.07)	ROHACELL 31	0.26 (0.10)	83 (-311)	0	92 (-294)
4	NITROGEN	2.21 (0.87)	BX 250A	1.48 (0.58)	167 (-159)	1.01 (0.40)	167 (-159)
5	NITROGEN	2.21 (0.87)	ROHACELL 31	1.21 (0.48)	167 (-159)	0.85 (0.33)	167 (-159)
6	NITROGEN	1.80 (0.71)	BX 250A	2.61 (1.03)	211 (-80)	2.09 (0.82)	211 (-80)
7	NITROGEN	1.80 (0.71)	ROHACELL 31	2.21 (0.87)	211 (-80)	1.79 (0.70)	211 (-80)
8	NITROGEN	1.40 (0.55)	BX 250A	3.86 (1.52)	244 (-21)	3.23 (1.27)	244 (-21)
9	NITROGEN	1.40 (0.55)	ROHACELL 31	3.54 (1.39)	244 (-21)	3.04 (1.20)	244 (-21)



◆ All configurations are purged by gas diffusion during the ground-hold mission phase.

■ Foam type; Manufacturer: BX 250A; Stepan Chemical Co., USA
Rohacell 31; RÖHM-GMBH, Chemische Fabrik Co., Germany

* Predicted ground-hold temperature at the MLI/foam or the MLI/tank interface.

△ Baseline configuration

Table 2-1: Task 1 Candidate Insulations

Source	Moisture content (parts/million)	Dew point, K (°F)
Nitrogen gas used for STS payload compartment during ground hold 	140	238 (-31)
Available from gas suppliers  99.995 % purity 99.998 % purity	10.5 to 16 1.5 to < 5	217 to 219 (-70 to -65) 200 to 211 (-100 to -80)

 Reference: "Spacelab Payload Accomodation Handbook", Document No. SLP/2104, June 1977

 Suppliers contacted: ARCO Industrial Gases and Linde Division, Union Carbide Corporation

Table 2-2: Moisture Content and Dew Point of N₂ Purge Gas Candidates

		MLI/FOAM -- NITROGEN PURGE					
		TYPE FOAM					
		MINIMUM PURGE GAS TEMPERATURE K (°F)					
PAYLOAD PACKAGE DENSITY kg/m ³ (lb _m /ft ³)	HYDROGEN-OXYGEN TANK CONFIGURATION	MLI -- HELIUM PURGE (CHOSEN AS BASELINE)		ROHACELL 31 244 (-20)	ROHACELL 31 200 (-100)	ROHACELL 31 144 (-200)	BX250A 200 (-100)
		X		X	X	X	X
56 (3.5)	TANDEM ELLIPSOIDAL	X		X		X	
40 (2.5)	ELLIPSOIDAL H ₂ - TOROIDAL O ₂	X		X		X	X
24 (1.5)	ELLIPSOIDAL H ₂ - TOROIDAL O ₂	X		X		X	

Table 2-3: Task II Insulations Selected for Application to LTPS Designs

that were selected for Task II optimization studies and shows which designs were applied to each LTPS.

3.0 LTPS CONCEPTUAL DESIGNS

This section describes the low-thrust propulsion system designs developed to support the evaluation of propellant tank insulations. These designs were used to determine the impact of propellant tank insulation options on LTPS payload delivery capability. Design data was developed in sufficient detail to allow the benefits of foam/MLI combinations to be compared with those of MLI only. The mission timeline shown in Table 3-1 was used in the Task II studies.

The Harris hoop column Land Mobile Satellite System described in Reference 1 was used as the payload configuration for all LTPS designs considered. The deployed payload characteristics were used to determine reaction control system propellant and main engine thrust vector control requirements during orbit transfer, and to model the effects of shadowing and reflection on the thermal environment of the LTPS during deployment, checkout and orbit transfer.

Figure 3-1 shows the baseline LSS payload configuration. The launch environment was as defined in Reference 2, "Space Shuttle Payloads Accommodation". For the orbital environment, solar heat flux was assumed to be 1352 W/m^2 , earth average radiosity was 221 W/m^2 and the earth average albedo factor was 0.36. STS Orbiter cargo bay depressurization characteristics were based on STS-III flight measurements.

In Task I of this study, a single LTPS point design was defined. The design was based on the expendable, STS Orbiter-launched orbit transfer vehicle concept developed by Boeing under contract NAS8- 33532, "Orbital Transfer Vehicle Concept Definition Study", Reference 3.

A mass summary of the Task I LTPS point design is presented in Table 3-2.

In Task II, 3 LTPS designs were developed. Each design was developed for a specific value of payload packaging density. The 3 values of payload density were 56 kg/m^3 , 40 kg/m^3 and 24 kg/m^3 . The LTPS designed for the 56 kg/m^3 payload density incorporated tandem ellipsoidal dome propellant tanks.

The 2 LTPS designed for the 40 kg/m^3 and 24 kg/m^3 payload densities employed toroidal LO_2 tanks. This tank shape shortened the length of the LTPS. The reduction in length was accomplished by nesting the rocket engine in the center of the torus. By shortening the LTPS for the less-dense payload applications, it was possible to increase the payload mass delivered to GEO. This increase was possible because the Orbiter cargo bay length, rather than the total LTPS/payload launch mass, constrained the weight of the LTPS payload.

The 3 point designs developed for Task II served as baselines, or starting points, for the sizing of LTPS for each of the propellant tank insulation concepts studied. These point designs established the materials, configurations, and physical arrangement of all the LTPS versions studied. A summary of the physical characteristics of the 3 Task II LTPS designs is presented in Table 3-3.

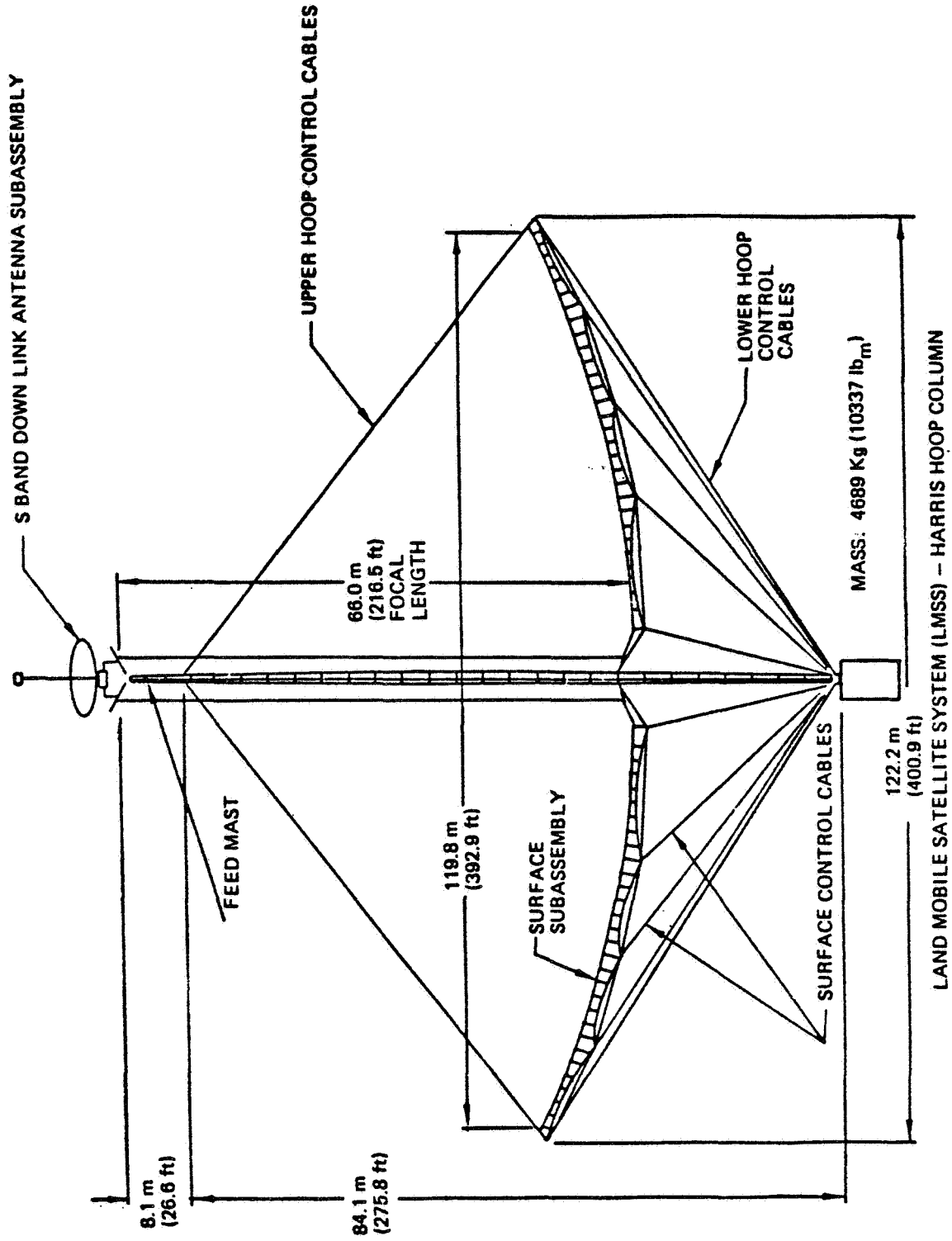

Figure 3-1: Baseline LSS Payload

NO.	EVENT DESCRIPTION	ET AT END OF EVENT	CONSIDERATIONS
1	TERMINATE LO ₂ TOPPING	T - 4 MIN.	• PROVIDE TIME TO PURGE THE CARGO BAY CRYOGENIC LINES
2	TERMINATE LH ₂ TOPPING	T - 4 MIN.	
3	LOCKUP TANKS	T - ZERO	• REFERENCE - NASA CONTRACTOR REPORT 165293, CONTRACT NAS3-21954, MARTIN-MARIETTA
4	RESUME VENTING OF TANKS	T + 90 SEC.	
5	STS IN LEO (278 x 278 km)	T + 47 MIN.	• BAC IUS STUDIES
6	OPEN PAYLOAD BAY DOORS	T + 100 MIN.	
7	ORBIT AND PAYLOAD CHECKOUT WITH GROUND STATIONS	T + 8 HR.	
8	ERECT LTPS/LSS	T + 17 HR.	• CREW WORK/REST CYCLE CONSTRAINTS - NASA CONTRACTOR REPORT 160861, CONTRACT NAS9-15718, ROCKWELL
9	DEPLOY AND CHECKOUT LSS	T + 46 HR.	
10	CHECKOUT LTPS	T + 46 HR.	• LSS COMPRISED OF DEPLOYABLE STRUCTURES AND APPENDAGES
11	MANEUVER ORBITER AND DISCONNECT	T + 50 HR.	
12	PHASE FOR ORBIT TRANSFER	T + 61 HR.	
13	TRANSFER FROM LEO TO GEO (8 PERGEE BURNS)	T + 89.6 HR.	• J.V. BREAKWELL STUDIES, STANFORD UNIVERSITY
14	COAST PERIOD	T + 102 HR.	• TYPICAL FOR NON-CIRCULAR FINAL ORBITS
15	RELEASE LSS AND SEPARATE	T + 103 HR.	
16	REMOVE LTPS TO DISPOSAL ORBIT (GEO + 1150 N.Mi.)	T + 116 HR.	• NASA/MSFC QTV STUDIES

Table 3-1: Task II Mission Timeline

	Kg (lb _m)
SUBSYSTEMS	
ENGINE	38.6 (85.1)
AVIONICS	294.0 (648.2)
POWER SUPPLY AND DISTRIBUTION	288.0 (634.9)
ATTITUDE CONTROL	62.6 (138.0)
FUEL CELL REACTANTS	39.9 (88.0)
THERMAL MANAGEMENT	81.6 (179.9)
TOTAL SUBSYSTEM MASS	804.7 (1774.0)
STRUCTURAL HARDWARE	821.0 (1810.0)
INSULATION	53.5 (117.9)
BODY SHELL	177.8 (392.0)
TANKS	370.6 (817.0)
RESIDUAL PROPELLANTS	165.6 (365.1)
TOTAL BURNOUT MASS	2393.2 (5276.0)
MAIN IMPULSE PROPELLANTS	17256.4 (38050.1)
LOSSES	375.7 (828.3)
TOTAL EXPENDED MASS	17632.1 (38872.0)
TOTAL INITIAL MASS	20025.3 (44148.0)
PAYLOAD MASS	7075.1 (15601.0)
ASE	2554.0 (5630.5)
TOTAL LIFTOFF MASS	29654.3 (65379.5)

Table 3-2: Task I LTPS Mass Summary

LTPS Configuration	Packaged Payload Density		
	56 Kg/m ³ (3.5 lb _m /ft ³)	40 Kg/m ³ (2.5 lb _m /ft ³)	24 Kg/m ³ (1.5 lb _m /ft ³)
<p>LTPS Mass Summary Kg (lb_m)</p> <p>LTPS Configuration</p>	<p>804.70 (1,774)</p> <p>821.00 (1,810) 53.52 (118) 177.80 (392) 370.60 (817) 67.13 (148) 87.54 (193) 10.89 (24) 2393.00 (5,278) 17336.00 (38,218) 9.979 (22) 179.20 (395) 84.37 (186) 33.11 (73) 68.95 (152) 17711.00 (39,046) 6835.00 (15,068) 2564.00 (5,631) 29473.00 (65,039)</p>	<p>804.70 (1,774)</p> <p>980.70 (2,184) 60.78 (134) 181.00 (399) 371.50 (819) 45.36 (100) 87.54 (193) 12.70 (28) 2554.00 (5,631) 17341.00 (38,229) 12.25 (27) 131.50 (290) 61.69 (136) 33.11 (73) 68.95 (152) 17648.00 (38,907) 6706.00 (14,785) 2546.00 (5,612) 29454.00 (64,935)</p>	<p>804.70 (1,774)</p> <p>927.20 (2,044) 50.80 (112) 141.50 (312) 308.80 (683) 45.36 (100) 61.69 (136) 10.43 (23) 2236.00 (4,930) 12298.00 (27,113) 10.43 (23) 133.80 (295) 62.60 (138) 33.11 (73) 68.95 (152) 12556.00 (27,881) 4414.00 (9,731) 2546.00 (5,612) 21658.00 (47,748)</p>
<p>Fixed mass</p> <ul style="list-style-type: none"> ● Engine ● Avionics ● Thermal management ● Power supply and dist. ● Attitude control ● Fuel cell reactants <p>Structural hardware</p> <p>Insulation</p> <p>Body shell</p> <p>Tanks</p> <p>Residual propellants</p> <p>Propellant loading uncertainty</p> <p>Propellant 5 min. hold boil-off</p> <p>Total burnout mass</p> <p>Main impulse propellants</p> <p>Vent loss before launch</p> <p>Vent loss after first burn</p> <p>Vent loss after first burn</p> <p>Start stop losses</p> <p>RCS propellants</p> <p>Total expended mass</p> <p>Payload</p> <p>ASE</p> <p>Total mass</p>			

Table 3-3: Task II LTPS Mass Summaries

4.0 PREDICTED PROPELLANT THERMAL LOADS

Thermal Math Models of the LTPS baseline configurations were developed to determine the time-varying nature of the propellant thermal loads. The models accounted for variations in environmental heat sources and heat transfer mechanisms. They also included the effects of LTPS heat capacitance and purge enclosure convective heat transfer during the ground-hold mission phase. The models were designed to allow a wide range of insulation thicknesses and types (either helium-purged MLI or nitrogen-purged MLI with a foam substrate) to be evaluated.

Two extreme ground-hold purge enclosure environments were modeled. In one extreme, natural convective coupling between the Orbiter bay and the MLI was assumed to exist. This condition yielded relatively cold tank insulation temperatures. In the other extreme, forced convection in the purge enclosure was assumed. This condition was simulated by setting the MLI outer surface temperature equal to 294°K (70°F) during the ground-hold and initial-ascent mission phases. Physically this extreme could be achieved by either introducing enough warm gas into the purge enclosure to ensure a warm MLI surface temperature, or altering the LTPS design to allow greater thermal contact between the Orbiter bay and the MLI surface. This ground-hold environment will be referred to as enhanced or forced-convection, and it serves to contrast results obtained for the natural-convection environment which would be difficult, if not impossible to achieve. The natural-convection condition however, was analytically considered because it represents a lower bound for the ground-hold heat transport mechanism.

In sizing propellant tank volumes, it was assumed that all heat fluxes to the propellant boiled off liquid. Propellant tank heat fluxes were predicted for the baseline LTPS conceptual designs. Figure 4-1 shows the predicted ground-hold thermal fluxes through helium-purged MLI. This figure shows the effect of environmental conditions on insulation heat flux. Enhanced-convection modeling assumed that the temperature drop across the insulation did not change with insulation thickness. In this case, the heat flux is therefore inversely proportional to the MLI thickness. This relationship is the reason for the linear dependence of heat flux on insulation thickness shown in Figure 4-1 for the enhanced convection environment. Natural-convection modeling yielded a decreasing MLI surface temperature with a decreasing MLI thickness. As shown in Figure 4-1, the heat flux for the natural-convection environment was always less than that for the enhanced-convection environment. Furthermore, at larger MLI thicknesses (small values of inverse thickness) the surface temperature approached the 294°K (70°F) temperature used for the enhanced-convection case and the heat flux predictions for the two environments became identical.

Figure 4-2 shows similar predictions for the ground-hold heat leak through MLI/foam insulations. Insulation conductance, rather than thickness, was used to correlate the heat flux for these concepts. The insulation conductance was determined by dividing the product of MLI and foam conductance by their sum.

Thermal analysis results showed that ground-hold environments effected MLI performance until the LTPS and LSS were separated from the Orbiter. In the initial phase of this transition period, the foam sublayer cooled to within several degrees of the propellant temperature. The MLI also underwent a temperature change from the ground-hold and initial-launch mission phases.

Propellant heating rates, generated by the thermal analysis models were integrated with respect to time. The thermal load attributed to foam cooling was subtracted from the

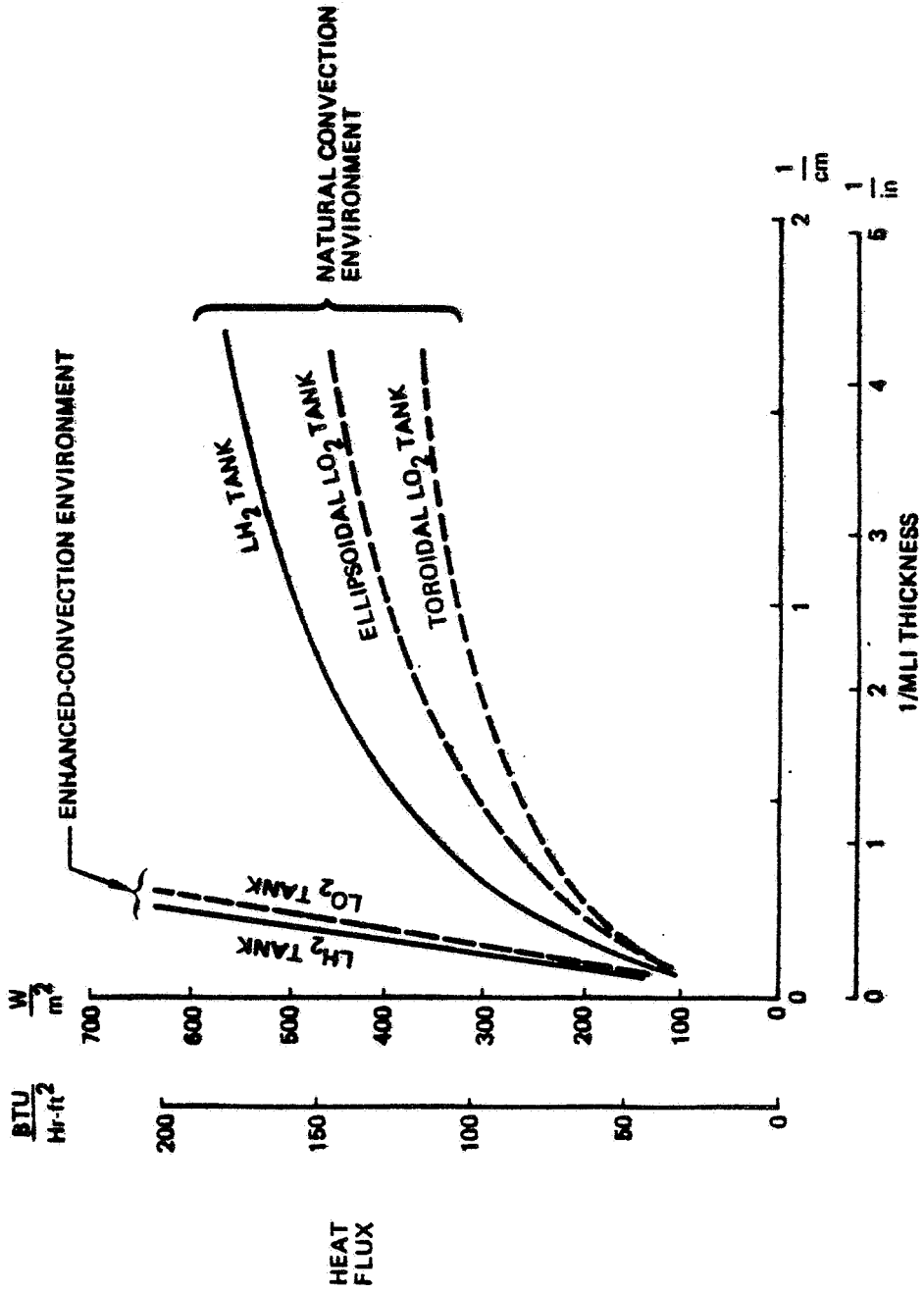

Figure 4-1: Predicted Heat Flux Through Helium-Purged MLI During the Ground-Hold Mission Phase

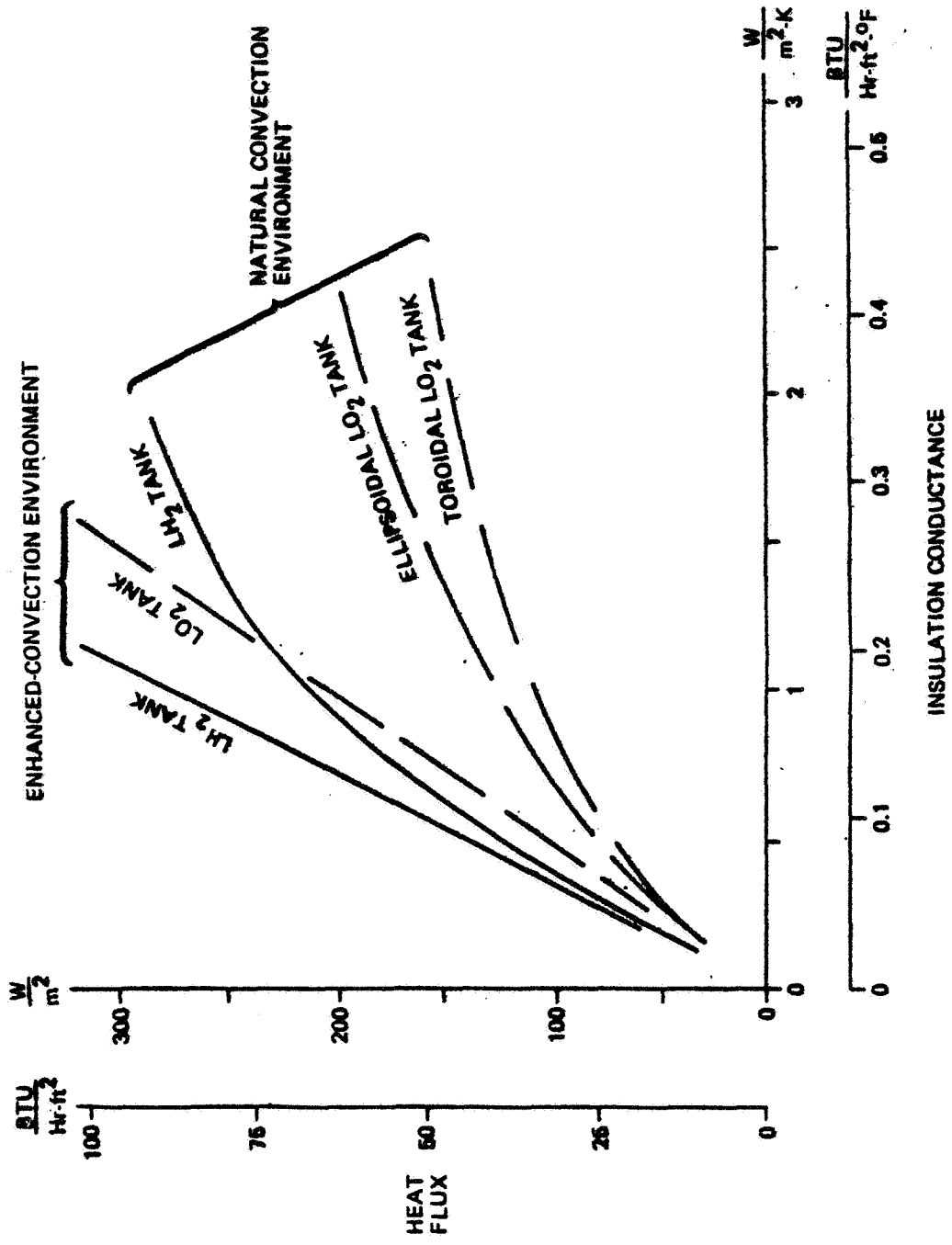

Figure 4-2: Predicted Heat Flux Through Nitrogen-Purged MLI/Foam Insulation During the Ground-Hold Mission Phase

total integrated heat flux to define the heat leak through the insulation. Dividing by the tank area and the duration of the transition period (50 hours) yielded a time-averaged insulation heat flux. This heat flux also included the effects of purge gas depressurization, changing LTPS environmental heat sources, and MLI capacitance.

Figures 4-3 and 4-4 show the heat fluxes predicted for MLI and MLI/foam insulations during ascent through separation of the LTPS/payload from the Orbiter.

Prelaunch conditions had no effect on predicted insulation heat flux histories after LTPS/LSS separation from the Orbiter. Furthermore, no differences in predicted fluxes were observed between MLI/foam and MLI-only concepts with an equivalent MLI thickness. Figure 4-5 illustrates the time-averaged heat fluxes for the LTPS free-flight mission phases.

For the 11 hour hold on LEO, there was no significant difference between the hydrogen and oxygen tank heat fluxes. After initiation of orbit transfer, the average tank heat fluxes became smaller because of reduced albedo and earth-infrared thermal loads. The heat flux for the hydrogen tank is also seen to be less than that for an oxygen tank with an equivalent MLI thickness. This relative ordering was caused by the LSS shadowing of the hydrogen tank and thermal radiation from the engine to the oxygen tank.

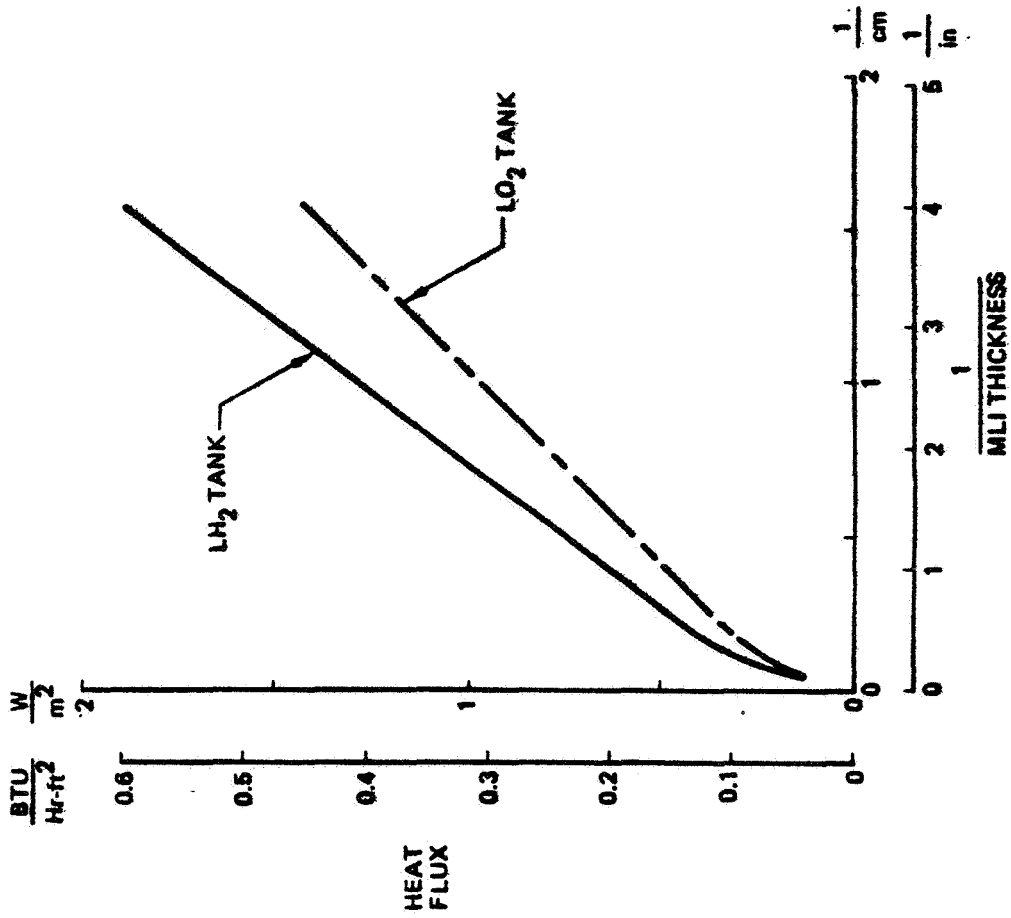

Figure 4-3: Time-Averaged Heat Flux Through Helium-Purged MLI for Mission Phase Extending From Insulation Evacuation Through LMSS/L TPS Separation From the Orbiter

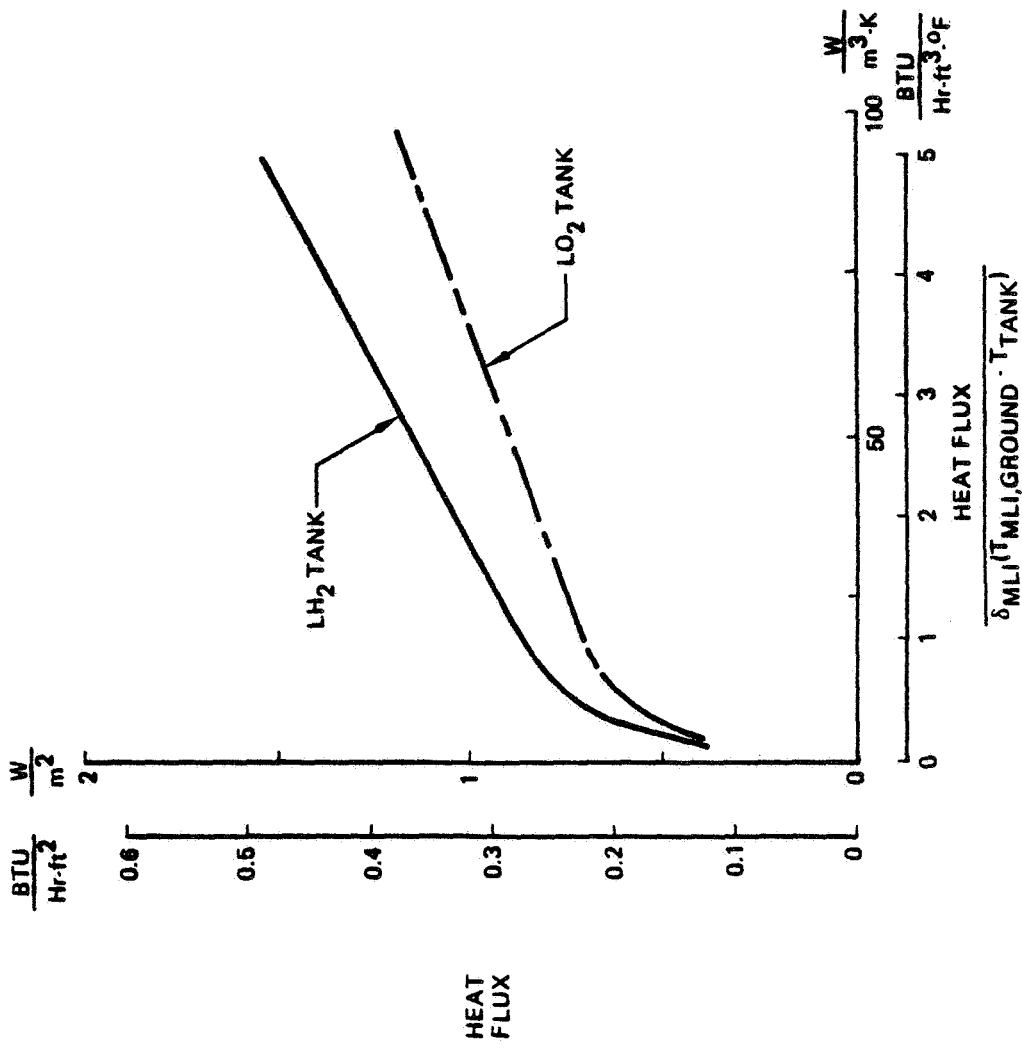

Figure 4-4: Time-Averaged Heat Flux Through Nitrogen-Purged MLI/Foam Insulations for Mission Phase Extending From Insulation Evacuation Through LMSS/LTPS Separation From the Orbiter

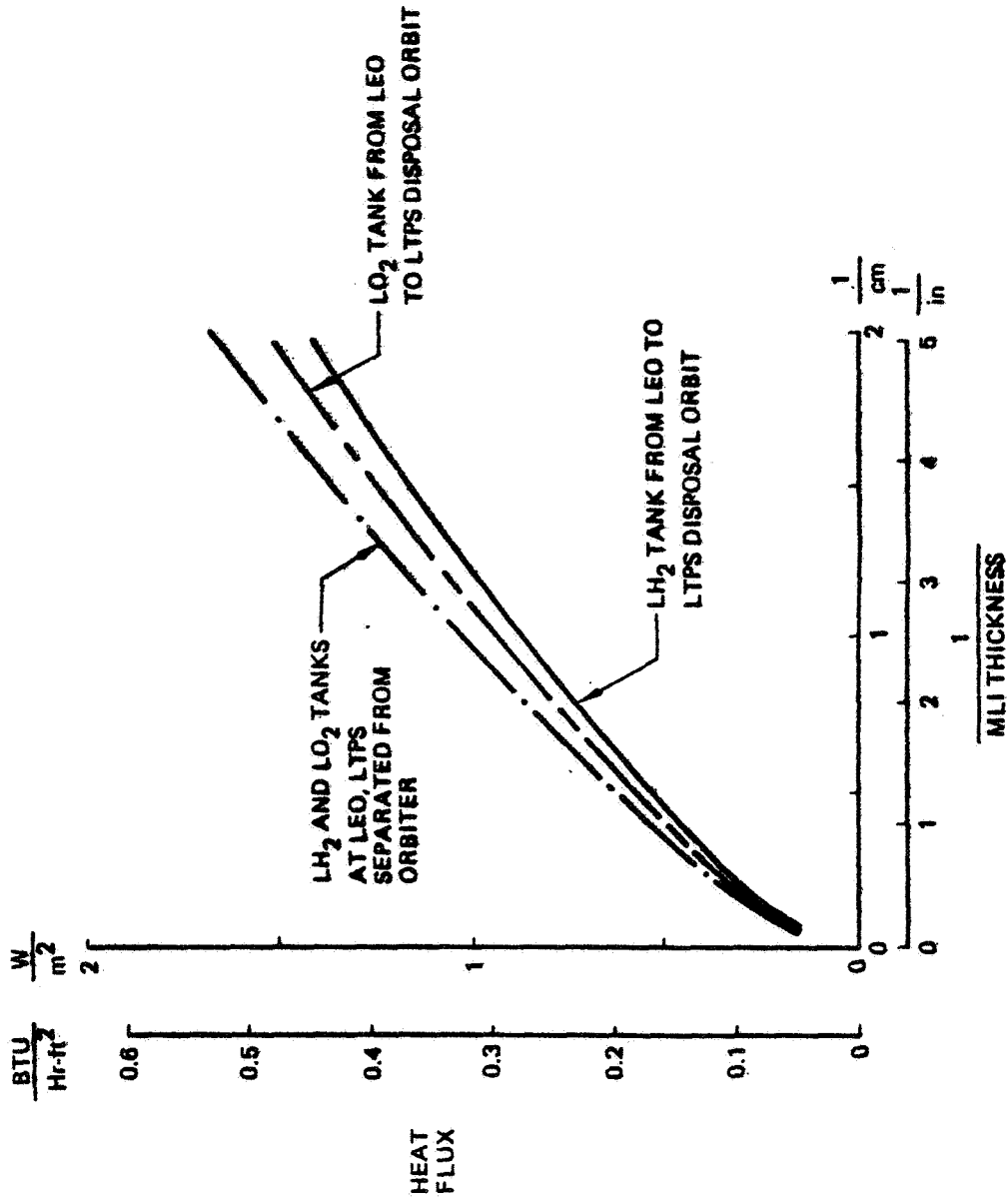

Figure 4-5: Time-Averaged Heat Flux Through Propellant Tank Insulations for Mission Phase Extending From LMSS/L TPS Separation From the Orbiter Through Insertion of the LTPS in Disposal Orbit

5.0 INSULATION

Optimum insulation designs were calculated for each of the 13 design conditions indicated in Table 2-3. Five insulation concepts were studied. Helium-purged MLI was selected as the state-of-the-art baseline. The other 4 insulations investigated were foam/MLI combinations purged with nitrogen. Three of the combination insulations consisted of Rohacell 31 foam and MLI. Foam-thickness-to-MLI-thickness ratios were selected to give foam-MLI interface temperature of 244°K (-20°F), 200°K (-100°F) and 144°K (-200°F) during ground hold purging. The fifth insulation consisted of BX250A foam and MLI with an interface temperature of 200°K (-100°F).

Insulation systems were optimized for two ground hold conditions because the convective environment within the purge enclosure was found to have a significant influence on insulation thickness and payload mass. As discussed in section 4.0, the conditions studied represent the two convective heat transfer extremes that could occur between the MLI outer layer and the purge enclosure inner surface.

An iterative procedure was used to identify the insulation thickness that maximized LTPS payload delivery capability. The procedure consisted of the 4 following steps which were repeated until the maximum payload case was found.

- a. Estimate a new insulation thickness by incrementally changing the current value.
- b. Calculate propellant tank heat leak over the entire mission.
- c. Calculate new values of propellant tank volume and wall thickness.
- d. Calculate new values of LTPS mass and length and payload mass and length.

The 3 Task II baseline LTPS conceptual designs were used as starting points for the optimization procedure. Computer programs were developed to perform the LTPS and payload sizing calculations thereby greatly reducing the computational time required to find the optimum insulation thicknesses. One program optimized tank insulation systems for the natural-convection purge enclosure condition and the other optimized insulations for enhanced convection conditions.

The programs were run interactively with the user estimating new values of insulation thickness and the program responding with predicted payload mass. For the highest density payload case (56 kg/m³ (3.5 lb/ft³)), the optimization of LTPS payload essentially involved a trade between insulation mass and the combined masses of vented propellant and tankage. In this case, orbiter payload launch mass was the prime constraint. For lower density payloads, the principal constraint was orbiter cargo bay length, and the LTPS payload capability was influenced primarily by insulation thickness and tank length.

The insulation optimization study lead to the following significant results:

- a. LTPS payload mass was increased by as much as 184 kg (406 lb) by replacing helium-purged MLI with nitrogen-purged MLI/foam combinations when enhanced convection was maintained in the purge enclosure.
- b. From the standpoint of maximum payload capability, the best foam/MLI interface temperature was 144°K (-200°F). However, the loss in payload mass in going from 144°K (-200°F) to 244°K (-20°F) was only a maximum of 42 kg (93 lb).

Table 5-1 contains summaries of the 26 payload-optimized LTPS propellant tank insulation designs identified in the insulation optimization analysis for the enhanced convection

PACKAGED DENSITY Kg/m ³ (lb _m /ft ³)	TYPE	MLI/FOAM INTERFACE TEMPERATURE, K (F)	TYPE TANK	TANK VOLUME, m ³ (ft ³)	TANK ULLAGE VOLUME, %	INSULATION THICKNESS, cm (in.)		EXPENDED PROPELLANTS, Kg (lb _m)		LTPS		PAYLOAD	
						MLI	FOAM	LOST	MAIN IMPULSE	BURNOUT MASS, Kg (lb _m)	STAGE LENGTH, m (ft)	ORBITER BAY LIMITATION	MASS, Kg (lb _m)
56 (3.5)	MLI	N/A	LH ₂ LO ₂	40.2 (1419) 15.1 (533)	8.0 8.0	5.72 (2.25) 4.32 (1.70)	0 0	337 (743)	17272 (38078)	2757 (6078)	8.11 (26.60)	MASS	6617 (14568)
	MLI/ ROHACELL 31	144 (-200)	LH ₂ LO ₂	39.0 (1376) 14.4 (508)	5.4 5.6	1.52 (0.60) 1.93 (0.76) 1.14 (0.45)	0.56 (0.22) 0.41 (0.16)	372 (820)	17264 (38060)	2577 (5681)	7.77 (25.48)	MASS	6760 (14903)
	MLI/ ROHACELL 31	200 (-100)	LH ₂ LO ₂	38.9 (1373) 14.4 (508)	4.9 5.5	1.14 (0.45) 1.37 (0.54)	1.14 (0.45) 1.07 (0.42)	386 (851)	17260 (38061)	2680 (5898)	7.77 (25.48)	MASS	6749 (14879)
	MLI/ ROHACELL 31	244 (-20)	LH ₂ LO ₂	39.2 (1383) 14.4 (508)	5.0 5.4	0.71 (0.28) 0.89 (0.35)	1.83 (0.72) 1.93 (0.76)	422 (930)	17260 (38028)	2585 (5698)	7.80 (25.68)	MASS	6718 (14811)
	MLI	N/A	LH ₂ LO ₂	36.6 (1292) 4.1 (148)	1.1 1.3	6.10 (2.40) 5.08 (2.00)	0 0	328 (723)	17208 (37937)	3238 (7141)	6.89 (22.60)	VOLUME	6186 (13638)
	MLI/ ROHACELL 31	144 (-200)	LH ₂ LO ₂	36.6 (1292) 13.8 (487)	0.8 1.6	1.32 (0.52) 1.19 (0.47)	0.48 (0.19) 0.25 (0.10)	429 (946)	17036 (37558)	2931 (6462)	6.89 (22.60)	VOLUME	6370 (14043)
	MLI/ ROHACELL 31	200 (-100)	LH ₂ LO ₂	36.7 (1296) 13.8 (487)	0.8 1.6	0.99 (0.39) 0.89 (0.35)	0.99 (0.39) 0.69 (0.27)	467 (1030)	17029 (37542)	2928 (6465)	6.89 (22.60)	VOLUME	6361 (14023)
	MLI/ BX250A	200 (-100)	LH ₂ LO ₂	36.8 (1298) 13.9 (490)	0.8 1.6	0.94 (0.37) 0.84 (0.33)	1.12 (0.44) 0.57 (0.22)	482 (1063)	17044 (37575)	2949 (6501)	6.92 (22.70)	VOLUME	6353 (14006)
	MLI/ ROHACELL 31	244 (-20)	LH ₂ LO ₂	36.8 (1299) 13.9 (490)	0.8 1.6	0.69 (0.27) 0.56 (0.22)	1.75 (0.69) 1.72 (0.68)	577 (1272)	17015 (37511)	2924 (6446)	6.95 (22.80)	VOLUME	6338 (13973)
	MLI	N/A	LH ₂ LO ₂	28.0 (988) 10.6 (374)	0.9 0.1	3.18 (1.25) 2.79 (1.10)	0 0	363 (778)	12585 (27745)	2853 (6290)	5.97 (19.58)	VOLUME	4165 (9182)
	MLI/ ROHACELL 31	144 (-200)	LH ₂ LO ₂	27.0 (963) 10.1 (356)	1.2 1.1	1.17 (0.46) 1.09 (0.43)	0.43 (0.17) 0.23 (0.09)	396 (873)	12362 (27253)	2564 (5653)	5.85 (19.19)	VOLUME	4218 (9299)
	MLI/ ROHACELL 31	200 (-100)	LH ₂ LO ₂	27.0 (963) 10.1 (356)	1.2 1.2	0.97 (0.38) 0.81 (0.32)	0.97 (0.38) 0.64 (0.25)	423 (933)	12350 (27227)	2552 (5616)	5.85 (19.19)	VOLUME	4214 (9290)
MLI/ ROHACELL 31	244 (-20)	LH ₂ LO ₂	27.2 (960) 10.1 (356)	1.0 1.3	0.66 (0.26) 0.53 (0.21)	1.70 (0.67) 1.17 (0.46)	607 (1338)	12338 (27200)	2553 (5628)	5.86 (19.29)	VOLUME	4206 (9273)	

Table 5-1: Optimum LTPS Conceptual Design Summary for Enhanced-Convection Ground-Hold
Purge Enclosure Environments

cases. For each LTPS, Table 5-1 shows tank volume, percent ullage volume, optimum values of foam and MLI thickness, and propellant vent loss and mass consumed by the main impulse engine. In addition, the LTPS mass and length are given and maximum payload mass is provided.

6.0 EXPERIMENTAL PROGRAM PLAN

In Task III, a preliminary plan was developed to experimentally evaluate the relative performance of MLI-plus-foam and MLI-only insulation systems and to experimentally verify insulation performance predictions. The plan specified a testing approach and identified the particular parameters and measurement ranges required to meet test objectives. Preliminary designs of hardware items unique to the test program were developed and cost estimates for the experimental program were formulated.

The experimental program plan that was developed represents a compromise between a simple test designed to measure undisturbed one-dimensional heat flow through tank insulation, and a test designed for full simulation of all thermal influences in a LTPS application. The first extreme would typically be planned around a guarded flat plate calorimeter while the other extreme would involve a full scale cryogenic tank, with realistic full scale supports, plumbing, insulation attachments, etc. The approach selected also represents a compromise in costs and potential benefits between the two possible extremes.

The test article selected was a half-scale liquid hydrogen tank, based on the shape and size of the tank for the 40 kg/m^3 (2.5 lb/ft^3) payload density LTPS design from Task II. The choice of a half-scale tank was felt to be an appropriate compromise between a full scale tank with its greater fabrication and handling costs and a limited choice of vacuum chambers, and a smaller tank with its less representative simulation in terms of area/volume ratio, relative contribution of discrete heat leaks, and less realistic insulation configuration.

The laboratory facility assumed for planning and costing the experimental program is an existing vacuum chamber to be located at one of the test pads at the Boeing Tulalip Test Site. Cryogenic facilities, power, safety, control, and handling services are available at the site, located within 50 miles of the plant where engineering and fabrication work will take place.

A schematic layout of test facility cryogenic, gas, vacuum, electrical, and data acquisition systems was developed to aid in estimating facility modification, set-up and calibration costs. This layout and basic facility requirements are shown in Figure 6-1. Individual lines, pumps, valves, tanks, etc., were not sized, but the layout plan provided a basis for an overall estimate of components and materials, as well as design and fabrication effort, required to prepare the facility for testing.

The test tank pressure control and hydrogen boil-off flow measuring and vent system is a key part of the facility system. Layout of this part of the system is shown in more detail in Figure 6-2. Multiple circuits and devices are required for the back pressure control and boil-off flow rate measurement because of the wide variation in heat flow to the tank between ground hold (sea level pressure and MLI purge) simulation and orbit (space vacuum) simulation.

Approximately 300 channels of instrumentation will be used to control and monitor the pressure gages, flow meters, and temperature sensors for the tests. In addition to measuring the performance of the test article, the system will include sensors placed at strategic points to monitor the function of the various facility systems.

Determination of the hydrogen boil-off flow rate is the single most important instrumentation requirement for the program and a difficult one to satisfy accurately because of

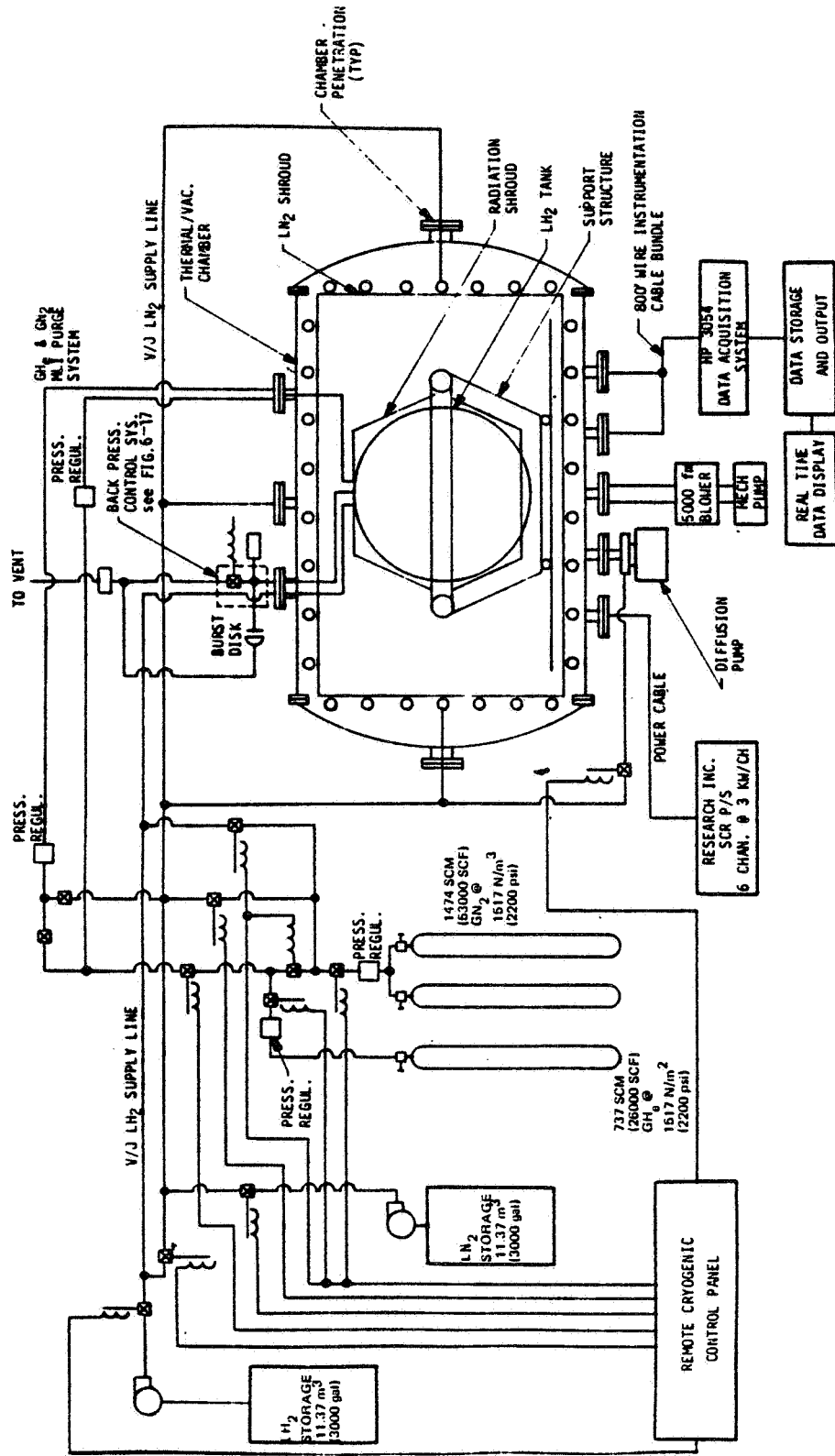

Figure 6-1: Facility Layout and Requirements

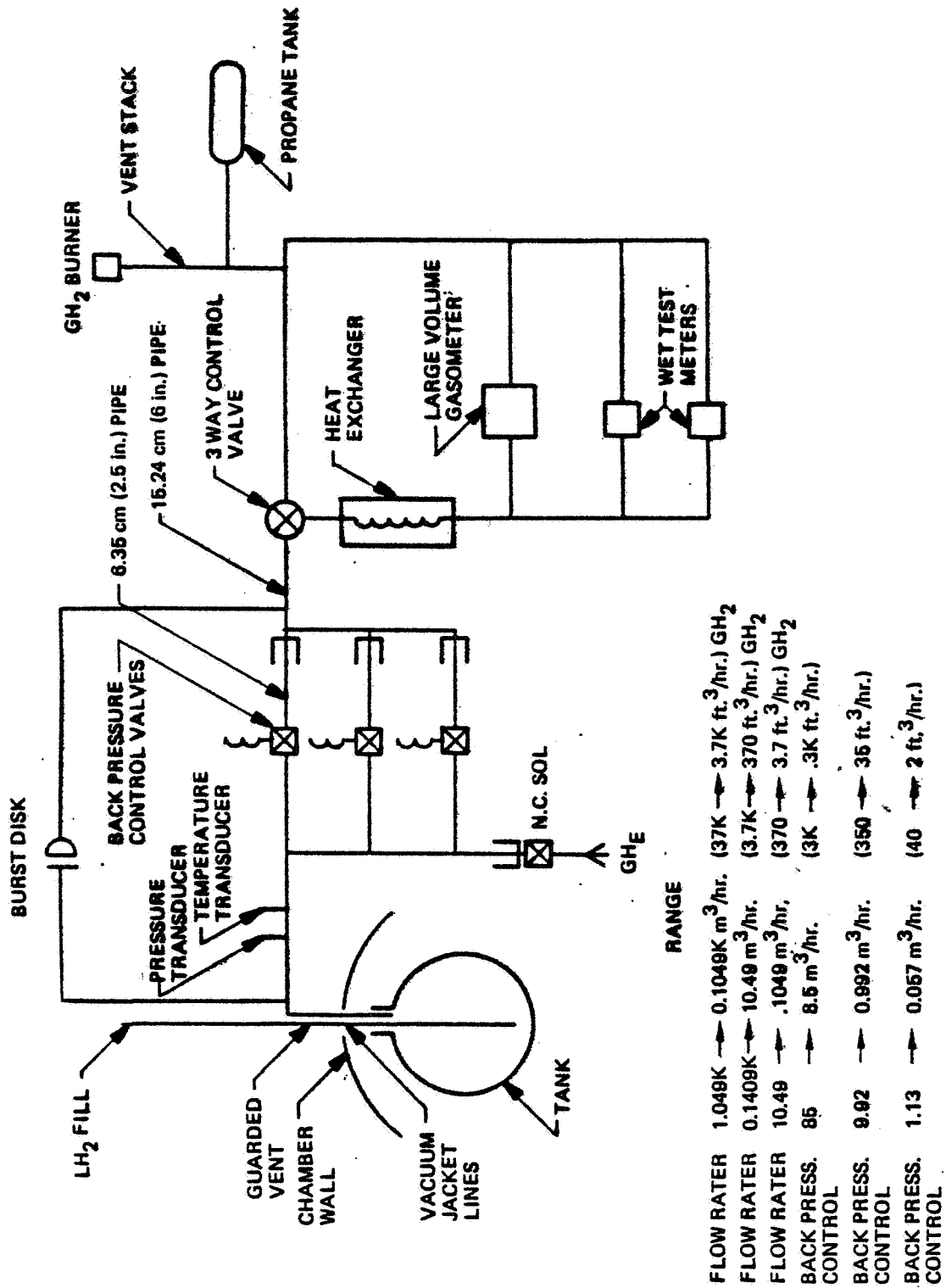

Figure 6-2: Hydrogen Back Pressure and Vent System

the expected wide range of flow rates. Three separate flow meter systems are planned, operating over different but overlapping measurement ranges as shown in Figure 6-2. Final selection of particular devices requires further study, as part of the detailed test planning. Instruments considered for this application include hot film anemometers, Matheson mass flow meters, wet test meters, and Hastings-Radist mass flow meters.

A back pressure control system will be used to maintain a constant pressure in the tank and a constant hydrogen saturation temperature. A silicon diode thermometer tree with 50 sensors will be used to measure liquid and gas temperatures within the tank and to determine liquid level. All wires into the tank will be routed through the guarded connector to minimize heat leak.

Temperature sensors will be attached through the insulation layers and on the purge bag at 26 locations. Silicon diode thermometers will be used on the tank wall and Type "E" chromel-thermocouples will be used within the insulation and on the purge bag. Sensor lead wires, except for those to thermocouples on the purge bag and insulation outer surface, will be routed so as to minimize absorption of radiant heat from the thermal shroud.

The thermal radiation shroud will be divided into 28 heat zones for use of independently monitored and controlled heater arrays. The shroud zones will be heated to simulate a typical mission radiation environment profile and adjusted to provide a uniform distribution of insulation surface temperatures.

The cost estimate for the experimental program was developed by integrating two basic approaches to defining the magnitude of the program effort. In the first approach, a list of individual tasks constituting the program was formulated and costs in terms of labor, materials, and other expenses were estimated for each task. The tasks included all those necessary to plan the program, administer and manage it, prepare for the tests, carry out the tests, and evaluate and report the results. The second approach took into account the sequential dependence and completion time required for the program tasks and led to a schedule of program activities. The core of this schedule, the portion describing the direct preparation and execution of the tests, was formulated first. Periods for detailed planning and early design work and the beginning of the program, and for evaluation and reporting at the end, were added to the core schedule.

Cost estimates were formulated in 1982 dollars. Labor costs were developed from estimates of the actual hours required to perform the tasks and burdened labor rates, which included all overhead and distributed costs except the program fee. Costs of materials, dedicated equipment, and purchased components were estimated from vendor quotes, available price lists, or recent experience. Scrap allowances were added to material quantities where they could be computed, e.g., to film, net, and foam stock for insulation fabrication.

Test consumables, i.e., cryogenics, gases, solvents, cleaners, and lubricants, were all considered as overhead items and thus do not appear in the cost estimates. For the purpose of labor dollar estimates, five categories of labor were identified, and hourly rates for each category selected on the basis of the average skill level deemed appropriate for the tasks of the program. Contract administration and program utility and housekeeping support were considered overhead items and are accounted for as part of the burdened rates for direct labor. Costs for computer time, required for the pre- and post-test thermal analyses, were estimated on the basis of experience with similar analyses carried out in Tasks I and II of the present program.

The breakdown and schedule of program tasks, at the level used for cost estimating, were organized into four major categories. Summation of costs from the four task categories, plus the program fee, is as follows:

Engineering and administration	\$ 843,300
Fabrication and assembly	\$ 430,100
Facility preparation	\$ 410,300
Test activities	\$ 321,500
Fee	\$ 140,400
Total	<u>\$2,145,600</u>

The total labor required is 39,200 hours and a material, equipment and purchased components cost of \$233,100 is included in the fabrication and facility preparation tasks.

7.0 STUDY CONCLUSIONS AND RECOMMENDATIONS

The results of this study have shown potential benefits can be derived from the application of a foam substrate beneath cryogenic propellant tank multilayer insulation. Specific benefits are; 1) increased payloads for LTPS; and 2) reduced operational complexity due to the use of Orbiter cargo bay N₂ purge gas for MLI purging. In order to gain the benefit of increased payload mass when compared to helium purged MLI-only, it was found to be necessary to specify enhanced convection heat transfer in the purge enclosure. The enhanced convection environment provided increased thermal coupling between the warm Orbiter cargo bay and the outer layer of the propellant tank MLI. A minimum thickness of MLI and foam were, therefore, required to achieve the desired MLI/foam interface temperature to preclude condensation of moisture in the N₂ purge gas.

A number of grades of N₂ were investigated as potential purge gases. The gas used to purge the Orbiter cargo bay has a dew point of approximately 244°K (-20°K). MLI/foam combinations designed for this dew point resulted in the largest payload penalties of all combination insulations investigated. However, for enhanced-convection ground-hold purge enclosure environments, even the insulation designed for the maximum MLI/foam interface temperature outperformed MLI-only on the basis of LTPS payload delivery capability.

The payoff of using MLI/foam combination insulations was the greatest for the LTPS designed for the larger payload densities of 56 kg/m³ (3.5 lbm/ft³) and 40 kg/m³ (2.5 lbm/ft³). For low density payloads, the use of either MLI/foam or MLI-only insulations resulted in almost identical LTPS payload capacities. However, the benefits of being able to use Orbiter bay purge gas for MLI purging warrant the selection of MLI/foam insulations for low-density payload LTPS applications as well as for high-density payloads.

In general, however, considering all payload densities, the best MLI/foam interface temperature, from the standpoint of LTPS payload mass, was 144°K (-200°F). This temperature was the lowest value investigated. The difference in predicted LTPS payload capacity in going from a 144°K (-200°F) interface temperature to 244°K (-20°F) was only about 42 kg (93 lbm). Therefore the payload penalty incurred in selecting the higher interface temperature appears to be acceptable because Orbiter bay purge gas could then be used for MLI purging.

The benefits of MLI/foam insulations should be verified experimentally. In addition to validating predicted system performance, the potential impact of moisture condensation within a N₂-purged MLI/foam insulation could be assessed.

Estimated program costs for fabricating and testing an MLI/foam insulated scale tank are conservative. Over 25% of the 2.1 million dollar cost is allocated to management, administration, technical direction, and coordination. With some judicious paring these costs could be reduced significantly without increasing program risk. The use of an existing tank as the test article would reduce program cost by only \$50,000. The cost of performing the necessary testing is slightly more than \$320,000. Engineering and facility preparation were the other primary program labor cost items.

Although the results of this analytical study should be generally applicable to any Shuttle transportable cryogenic tankage, additional analysis should be performed to finalize the relative merits of MLI versus MLI/foam as part of the preliminary design of the cryogenic tankage for a particular application. These studies should specifically address the effect of different mission time lines, the advantages of applying non-uniform foam thickness to the tanks and design techniques to preclude N₂ condensation on penetrations.

REFERENCES

1. Sullivan, M.R.: Hoop/Column Antenna Development Program, Large Space Antenna Systems Technology - 1982, NASA Conference Publication 2269, Part 1, 1983.
2. Anon.: Space Shuttle Payload Accommodations - Shuttle Orbiter/Cargo Standard Interfaces, JSC 07700 Volume XIV, Attachment 1 (ICD 2-19001), Revision G, NASA Lyndon B. Johnson Space Center, 1980.
3. Anon: Orbit Transfer Vehicle Concept Definition Study, Boeing Document D180-26090-3, Contract NAS8-33532, 1980.