



FINAL REPORT

FOR THE

**ADVANCED TURBOCHARGER
DESIGN STUDY PROGRAM**

BY

**D.G. CULY AND R.W. HELDENBRAND
GARRETT TURBINE ENGINE COMPANY
PHOENIX, ARIZONA**

AND

**N.R. RICHARDSON
AIRESEARCH INDUSTRIAL DIVISION
GARRETT AUTOMOTIVE PRODUCTS COMPANY
TORRANCE, CALIFORNIA**

PREPARED FOR

NATIONAL AERONAUTICS AND SPACE ADMINISTRATION

**NASA-LEWIS RESEARCH CENTER
(CONTRACT NAS3-22750)**

1 Report No NASA CR-174633		2 Government Accession No.		3 Recipient's Catalog No	
4 Title and Subtitle ADVANCED TURBOCHARGER DESIGN STUDY PROGRAM - FINAL REPORT				5 Report Date 1 January 1984	
				6 Performing Organization Code	
7. Author(s) D.G. Culy, R.W. Heldenbrand, N.R. Richardson				8 Performing Organization Report No GTEC 21-4498	
9. Performing Organization Name and Address Garrett Turbine Engine Company Phoenix, Arizona				10. Work Unit No	
				11 Contract or Grant No NAS 3-22750	
12. Sponsoring Agency Name and Address National Aeronautics and Space Administration Washington, D.C. 20546				13. Type of Report and Period Covered	
				14 Sponsoring Agency Code	
15 Supplementary Notes					
16 Abstract <p>The Advanced Turbocharger Design Study was conducted from April 1, 1981 to April 30, 1983 as a joint effort of the Garrett Turbine Engine Co. and the AiResearch Industrial Division of The Garrett Corporation. The program consisted of: (1) the evaluation of three advanced engine designs to determine their turbocharging requirements, and of technologies applicable to advanced turbocharger designs; (2) trade-off studies to define a turbocharger conceptual design and select the engine with the most representative requirements for turbocharging; (3) the preparation of a turbocharger conceptual design for the Curtiss Wright RC2-32 engine selected in the trade-off studies; and (4) the assessment of market impact and the preparation of a technology demonstration plan for the advanced turbocharger. Supporting subcontract effort was provided by Cessna Aircraft Co. for aircraft performance and cost, and by Avco-Lycoming for baseline reciprocating engine performance.</p>					
17. Key Words (Suggested by Author(s)) Advanced Turbocharger Design Study			18 Distribution Statement Unclassified - unlimited		
19 Security Classif (of this report) Unclassified		20 Security Classif (of this page) Unclassified		21. No of Pages -	22 Price* -

* For sale by the National Technical Information Service, Springfield, Virginia 22151

"Page missing from available version"

FOREWORD

The Advanced Turbocharger Design Study (ATDS), Contract NAS3-22750, was conducted by the Garrett Turbine Engine Company (GTEC) and the AiResearch Industrial Division (AID), divisions of The Garrett Corporation, for the National Aeronautics and Space Administration, Lewis Research Center. Subcontract support was provided by the Cessna Aircraft Co., Pawnee Division and by AVCO-Lycoming, Williamsport Division.

The authors would like to thank the following NASA-Lewis personnel for their specific contributions to the program: K. L. Abdalla, T. J. Wickenheiser, and W. F. Hady. Special appreciation is also extended to Teledyne Continental Motors and to the Curtiss-Wright Corporation for the essential information supplied by them that made this program possible.

"Page missing from available version"

TABLE OF CONTENTS

	<u>Page</u>
1.0 SUMMARY	1
2.0 INTRODUCTION	3
2.1 Background	3
2.2 ATDS Program Scope	3
2.3 Related Work Effort	4
2.4 Significance of the ATDS Program	4
2.5 Purpose of the ATDS Program	5
3.0 PROGRAM APPROACH	7
3.1 Requirement Definition	7
3.2 Technology Survey	8
3.2.1 Component Technology	16
3.2.2 Cycle Technology	26
3.2.3 Design Opportunities	38
3.2.4 ATDS Technology Survey Results	41
3.3 Turbocharger Trade-Off Studies	41
3.3.1 Evaluation Criteria	41
3.3.2 Turbocharger System Configurations	43
3.3.3 Exhaust Pulse Utilization	53
3.3.4 Engine Vibration	59
3.4 Turbocharger Conceptual Design	59
3.4.1 Compressor	60
3.4.2 Turbine Aerodynamic Design	64
3.4.3 Turbine Rotor Mechanical Design	67
3.4.4 Ceramic Turbine Rotor Material and Process Analysis	70
3.4.5 Turbocharger Design Details	70
3.4.6 Bearings	73
4.0 TECHNOLOGY IMPACT	83
4.1 Key Technology Requirements	83
4.2 Overall Market Impact	85
4.2.1 General-Aviation Market	88
4.2.2 Truck Market	80
4.2.3 Marine Market	89
4.2.4 Off-highway Market	90
4.2.5 Automotive Market	90
4.2.6 Locomotive Market	92

TABLE OF CONTENTS (Contd)

	<u>Page</u>
4.2.7 Ground Power Market	92
4.2.8 Market Impact Summary	94
4.3 ATDS - Related Programs	94
5.0 TURBOCHARGER TECHNOLOGY - FUTURE PLANS	99
5.1 Summary	99
5.1.1 Cycle Definition	99
5.1.2 Advanced Turbochargers	100
5.1.3 Required Technology Advances	100
5.2 Recommended Follow-On Effort	104
5.2.1 Technology Requirements Coordination	105
5.2.2 Advanced Component Turbocharger Testing	105
5.2.3 Component Technologies	107
6.0 CONCLUSIONS AND RECOMMENDATIONS	113
REFERENCES	115
APPENDICES	
I CESSNA-PAWNEE SENSITIVITY STUDIES	
II ATDS AIRPLANE COST EQUATIONS	

LIST OF ILLUSTRATIONS

<u>Figure</u>	<u>Title</u>	<u>Page</u>
1	Advanced Technology Engines	8
2	Engine Contractors Turbosystem Requirements	10
3	Engine Temperature Rise Characterization	11
4	Characterization of Engine Indicated SFC	12
5	Characterization of Engine Friction Horsepower	13
6	Characterization of Engine Fuel/Air Ratio	13
7	Standardized Basis for Relative Technical Risk Assessments	16
8	Centrifugal Compressor Industry Capability Available in 1986	17
9	Turbine Industry Capability	17
10	Elements of the Maximum Complexity Microprocessor System	26
11	Heat-Exchanger Core Configurations	27
12	Heat-Exchanger Pressure Drop Characteristics	28
13	Heat-Exchanger Airflow/Effectiveness Characteristics	28
14	Conventional Design Intercooler Core Weight	29
15	Intercooler Core Weight for Minimal Cooling Air Face Area Design	29
16	Heat-Exchanger Sensitivities	30
17	The Hyperbar System	32
18	Bottoming Cycle Schematic	35
19	Steam Bottoming Cycle Performance	36
20	Steam Bottoming Cycle Performance	37
21	Schematic of the Turbocharger APU Mode	39
22	Performance of the Turbocharger as an APU	40

LIST OF ILLUSTRATIONS (Contd.)

<u>Figure</u>	<u>Title</u>	<u>Page</u>
23	Technical Survey Results	41
24	Cessna Airplane Sensitivities to BSFC	43
25	Cessna Airplane Sensitivities to BSFC	44
26	Cessna Airplane Sensitivities to Engine Weight	44
27	Cessna Airplane Sensitivities to Engine Weight	45
28	Cessna Airplane Sensitivities to Block Fuel	45
29	Turbocharger Component Sensitivities	46
30	ATDS Tradeoff Study Matrix	46
31	Port Opening/Closing Geometries	53
32	Port Effective Areas	54
33	Turbocharger Location Tradeoff for RC2-32 Engine (25,000 Ft, 250 HP)	55
34	Exhaust Energy Recovery for RC2-32 Engine (25,000 Ft, 250 HP)	55
35	Exhaust Configuration Influences Energy Recovery by Turbocharger for RC2-32 Engine (25,000 Ft, 250 HP)	56
36	Turbocharger Location Affects Available Engine Power for RC2-32 Engine (25,000 FT, 250 HP)	57
37	Effect of Exhaust Manifold Volume for GTSI0-420/SC (25,000 Ft, 250 HP)	58
38	Exhaust Energy Recovery for GTSI0-420/SC (25,000 Ft, 250 HP)	58
39	Exhaust Energy Recovery (GTSI0-420/SC 25,000 FT, 250 HP Divided Exhaust System)	59
40	Compressor Flow Path is Compact	62
41	High Efficiency and Pressure Ratio are Major Advancements	63

LIST OF ILLUSTRATIONS (Contd.)

<u>Figure</u>	<u>Title</u>	<u>Page</u>
42	Turbine Stator and Rotor Flow Path	65
43	High Turbine Efficiency Dictates Long Flow Path	65
44	Advanced Turbocharger Stage Inlet and Exit Diagrams	66
45	Required Turbine Performance is Close to State-of-the-Art	66
46	Turbine Blade Vibration Study Shows Basic Concept Feasibility	68
47	Blade Natural Frequencies are Greater Than the Minimum Requirement	68
48	Turbine Rotor Blade Taper Chosen for Low Stress	69
49	ATDS Turbocharger Cross Section	71
50	Advanced Turbocharger Weighs Half of Conventional	71
51	ATDS Conceptual Design Outline	73
52	Compressor Performance RC2-32 Engine	74
53	ATDS Foil Bearing Load Capacity	78
54	ATDS Foil Bearing Power Consumption	79
55	Details of Typical Gas Lubricated Foil Bearing	80
56	Shaft Whirl Analysis of the ATDS Rotor on Foil Bearings	80
57	ATDS Technology will have a Broad Market Impact	94
58	Foil Bearing Technology Roadmap	101
59	Ceramic Rotor Technology Roadmap	102
60	Integration of Engine and Turbocharger Technologies/Development Activities	104

LIST OF TABLES

<u>Table</u>	<u>Title</u>	<u>Page</u>
1	Engine Master Data Chart	9
2	ATDS Characterization of Engine Airflow	10
3	Engine Airflow Characterization	11
4	NASA Aircraft Parameters	14
5	Engine Parameters at 25,000-Foot Cruise Condition (ISA, 250 BHP)	14
6	Selected Candidates for Technology Survey	15
7	Compressor Technology Industrial Capability	18
8	Turbine Technology Industrial Capability	18
9	ATDS Compressor Efficiency Technology Evaluation Current Technology: 70-Percent at 2.6 PR at 50 PPM	19
10	ATDS Turbine Efficiency Technology Evaluation Current Technology: 70-Percent at 2.6 PR, 50 PPM)	19
11	Industrial Capabilities for Advanced Rotor Material	21
12	Lightweight Housing Materials Industry Capabilities	21
13	Advanced Rotor Materials Technology Evaluation	22
14	Lightweight Housing Materials Evaluation	22
15	Industrial Capabilities for Variable-Geometry Technology	23
16	Variable-Geometry Compressor Technology Evaluation Current Technology: GTEC Production ATM's and Engine	24
17	Variable-Geometry Turbine Technology Evaluation Current Technology: GTEC Production Axial Flow	24

LIST OF TABLES (Contd)

<u>Table</u>	<u>Title</u>	<u>Page</u>
18	Electronic System Evaluation for Turbocharged Engines	25
19	ADTS Microprocessor Control Technology Evaluation	27
20	Charge Air Cooler Technology Evaluation Current Technology: AID Production Nonflying and Garrett Production Flying	30
21	Two-Stage Turbocharger Technology Evaluation Current Technology: Series Connection or Two Turbos	31
22	Mechanical Compounding Technology Evaluation Current Technology: Production IN R-3350	32
23	Hyperbar Technology Evaluation Current Technology: Limited French Production	33
24	Exhaust Pulse Utilization Technology Evaluation Current Technology: Well-Developed	34
25	Exhaust Pulse Tuning Technology Evaluation Current Technology: Requires Analysis for Each Engine	34
26	Intake Pulse Tuning Technology Evaluation Current Technology: Well-Developed. Requires Analysis of Each Engine	35
27	Bottoming Cycle System Operating Conditions	36
28	Bottoming Cycle Technology Evaluation Current Technology: Laboratory Demonstration Only	37
29	Gas-Lubricated Foil Bearings Technology Evaluation. Current Technology: Cold: GTEC Production Hot: Laboratory Demonstration Only	38
30	Bearing Industry Capability	39

LIST OF TABLES (Contd)

<u>Table</u>	<u>Title</u>	<u>Page</u>
31	APU-Mode Turbocharger Technology Evaluation Current Technology: Related to Well-Developed Hyperbar and APU Technologies	40
32	NASA CR-165564 Evaluation Scheme	42
33	ATDS Benefit Ranking	42
34	Individual Component Technology Trade-Offs for ATDS	47
35	Optimized TIO-540 SI RECIP Engine, Current Technology	47
36	Optimized GTSIO-420/SC Highly Advanced SCSI RECIP	48
37	Optimized GTDR-246 Highly Advanced Diesel	48
38	Optimized RC2-32 Highly Advanced SCSI Rotary	49
39	Technology Trade-Off Evaluation Points	49
40	Turbocharger Requirement Commonality	50
41	Recommended Features for RC2-32 Turbocharger Conceptual Design	52
42	ATDS Engine Vibration Estimates	60
43	RC2-32 Turbocharger Flow Requirements (25,000 Ft., 250 BHP)	61
44	Component Design Points for 25,000-Foot Condition (200 to 225 KTS, 250-Engine BHP)	61
45	Compressor Aerodynamic Design	63
46	ATDS Conceptual Design Bill of Materials	72
47	RC2-32 Ratings for Both Turbocharged and Nonturbocharged Engines	74
48	Aircraft Operational Mode and Associated Loads	75
49	Bearing Capacity	76

LIST OF TABLES (Contd)

<u>Table</u>	<u>Title</u>	<u>Page</u>
50	Key Turbocharger Technology Requirements	83
51	Turbocharger Features have Broad Appeal	86
52	Suggested Areas of Emphasis	86
53	Factors Needing Further Demonstration	86
54	General-Aviation Market	88
55	Truck Market	89
56	Marine Market	90
57	Off-Highway Market	91
58	Automotive Market	92
59	Locomotive Market	93
60	Ground Power Market	93
61	Overall Market Impact Summary	95
62	Existing Technology Programs	95
63	Concepts that must be Addressed by Future Programs	97

1.0 SUMMARY

The GTEC Advanced Turbocharger Design Study (ATDS) Program, NASA Contract NAS3-22750, was conducted to determine the potential of advanced turbochargers as candidates for application to advanced technology engines in light, general-aviation aircraft capable of moderately-high altitude operation. The primary objectives of this program were to:

- o Define the benefits expected from applying advanced turbocharger concepts to advanced technology intermittent combustion (IC) engine concepts.
- o Define the turbocharger technology programs needed to realize the most significant advancements.
- o Describe the scenario necessary to convert this technology into a cost-effective turbocharger family having numerous applications.

Studies conducted by several airframe manufacturers were used to define the mission profiles and aircraft performance for several engine configurations. Garrett then selected four of these concepts for analysis in the ATDS Program.

At the onset of the ATDS Program, three advanced turbocharged reciprocating engines were modeled for a 250-bhp cruise, 25,000-foot altitude condition. The performance of these designs was then compared to a current baseline configuration. The four engines were:

- o TIO-540 (Baseline Engine) - Current Technology Spark-Ignition Turbocharged Reciprocating Engine
- o GTSIO-420/SC - Highly Advanced Spark-Ignition Stratified-Charge Turbocharged Reciprocating Engine
- o RC2-32 - Highly Advanced Spark Ignition Stratified Charge Turbocharged Rotary Combustion Engine
- o GTDR - Highly Advanced Two-Stroke Diesel Turbocharged Radial Engine.

The RC2-32 engine was ultimately selected as the reference engine for designing the advanced turbocharger, since its overall needs were the approximate median of the turbocharger requirements of all of the advanced engine designs under study. The results of the ATDS Program showed that the ATDS turbocharger concept is, indeed, a viable candidate for such an application. Moreover, many of the technologies satisfy the needs of nonaviation applications, as well. However, it was also determined that additional component

development programs must be instigated immediately to enable the ATDS turbocharger concept to be committed to production. These include such programs as compressor and turbine aerodynamics, advanced turbine materials, gas-foil bearing technology, and structural advancements (i.e., advanced lightweight materials).

2.0 INTRODUCTION

This document is submitted to NASA by Garrett Turbine Engine Company (GTEC) and AiResearch Industrial Division (AID), divisions of The Garrett Corporation. It presents the Final Report for the Advanced Turbocharger Design Study (ATDS) Program as requested in Exhibit A, Task IV of Contract NAS3-22750. The program was conducted from April 1, 1981 through April 30, 1983 for the NASA-Lewis Research Center (NASA-LeRC).

AID performed over 40 percent of the ATDS effort, and is the world's largest producer of turbochargers for both the general- and nonaviation marketplace. Over 60,000 turbochargers are produced each month--400 of which are used in light, general-aviation aircraft. AID has contributed major advancements in the areas of control systems and heat exchangers, as well as turbocharger aerodynamics, all of which have expanded the use of turbochargers in general-aviation aircraft for moderately high-altitude operation.

2.1 Background

The desire to provide a lightweight aircraft capable of high-altitude operation, coupled with the anticipated problems associated with availability, cost, and quality of aviation fuels led to the examination of alternate powerplant configurations for this application. On-going progress in this technology that can be directly applied to turbochargers led NASA-LeRC to undertake a re-examination of the issues of turbocharger design, technology, and application.

2.2 ATDS Program Scope

The program effort comprised the following tasks:

- o Task I - To evaluate advanced engine performance parameters to determine turbocharger requirements, and to evaluate technologies potentially applicable to advanced turbocharger designs.
- o Task II - To perform trade-off studies to define technologies and features for a conceptual design, and to select the engine with the most representative turbocharger requirements.
- o TASK III - To prepare a conceptual design of an advanced turbocharger system for the reference engine selected in Task II.

- o Task IV - To assess the overall market impact of an advanced turbocharger. To prepare a technology demonstration plan for advanced general-aviation turbochargers.

The turbocharging requirements of three advanced reciprocating engines in the 250-bhp cruise, 25,000-foot altitude class were used to assess the needed technologies for this application. These were then compared to the requirements of a current production turbocharged piston engine. These four engines (selected from NASA programs currently underway) were:

- o TIO-540 (Baseline engine) - Current Technology Spark-Ignition Turbocharged Reciprocating Engine
- o GTSIO-420/SC - Highly Advanced Spark-Ignition, Stratified Charge, Turbocharged Reciprocating Engine
- o RC2-32 - Highly Advanced Spark Ignition Stratified Charge Turbocharged Rotary Combustion Engine
- o GTDR - Highly Advanced Two-Stroke Diesel Turbocharged Radial Engine.

2.3 Related Work Effort

Portions of the ATDS Program activity were subcontracted to the Cessna Aircraft Co., Pawnee Division and to the AVCO-Lycoming, Willamsport Division. Cessna support provided aircraft performance and cost sensitivities to engine parameters which were used to evaluate the ATDS installation. These sensitivities are listed in Appendix I. Lycoming support provided data for the baseline engine. Results of engine design studies prepared for NASA by Teledyne Continental Motors and by the Curtiss-Wright Corporation for the highly advanced spark ignition, diesel, and rotary engines were also taken into consideration.

2.4 Significance of the ATDS Program

The ATDS Program established that advanced technology turbochargers are viable candidates for meeting the general-aviation needs of the future. The study identified that a family of turbochargers is needed with the range of flow capacities and pressure ratios required for the diverse requirements of both aviation and nonaviation engines.

Technology demonstration programs were also identified that, if initiated immediately, would lend impetus to development of advanced turbocharger designs.

The studies showed that the RC2-32 best represented the turbo-charger requirements, since its pressure ratio, airflow, and system configuration needs had many points in common with the other two advanced engines. The trade-off studies identified a single-spool, single-stage free-floating configuration as the simplest and most cost-effective system. The concept features gas-lubricated bearings, a ceramic turbine rotor, a high-pressure-ratio compressor, and lightweight structures.

In addition, market impact studies conducted as part of the program identified the ATDS turbocharger technologies as having many applications, besides that of general aviation; i.e., automotive, marine, and ground-power usage.

2.5 Purpose of the ATDS Program

The primary objective of the ATDS Program was to develop a new turbocharger concept for potential use in future light aircraft capable of high-altitude operation. A secondary objective was to evaluate and assess the market potential for this newly evolved turbocharger not only in the general aviation marketplace, but in related markets, (i.e., automotive, locomotive, marine, etc.).

Page intentionally left blank

Page intentionally left blank

3.0. PROGRAM APPROACH

3.1 Requirement Definition

A review of the several NASA advanced engine and airframe studies was conducted to select the operating parameters to be used in the ATDS Program. Using this information, three advanced engines and one baseline engine were selected for ATDS evaluation. These were:

<u>Study/Configuration</u>	<u>Model No.</u>	<u>Contractor</u>
Highly Advanced Spark-Ignition Stratified Charge Turbocharged Recipricating Engine	GTSIO-420/SC	Teledyne Continental Motors/ Aircraft Products Div. (TCM/APD)
Highly Advanced Spark Ignition Stratified-Charge Turbocharged Rotary Engine	RC2-32	Curtiss-Wright (C-W)
Highly Advanced Two-Stroke Diesel Turbocharged Radial Engine	GTDR-246	Teledyne Continental Motors/ General Products Div. (TCM/GPD)
Current Technology Spark-Ignition Turbocharged Reciprocating (Baseline) Engine	TIO-540	AVCO-Lycoming (AL)

The selected advanced engine configurations are described in Figure 1 and Table 1. Near the end of the program, NASA requested that final comparisons allow for a reduction of displacement of the diesel engine from 246 cubic inches, based on expected technology advancements to improve comparability among engine technology levels. In comparisons made on this basis, the diesel engine is identified as "GTDR" rather than as "GTDR-246". The turbocharger system requirements for each engine (as identified by each engine company) are also listed in Table 2. The wide variations in these requirements are more apparent in Figure 2. These comparisons show the diverse requirements of the advanced engines, and also show that a significantly different turbocharger system design would result for each engine. For the turbocharger matching studies, each engine was aerothermodynamically defined in terms of airflow, temperature rise, indicated specific fuel consumption (ISFC), friction horsepower, and fuel/air ratio as functions of operating conditions. These parameters were derived from data obtained from both

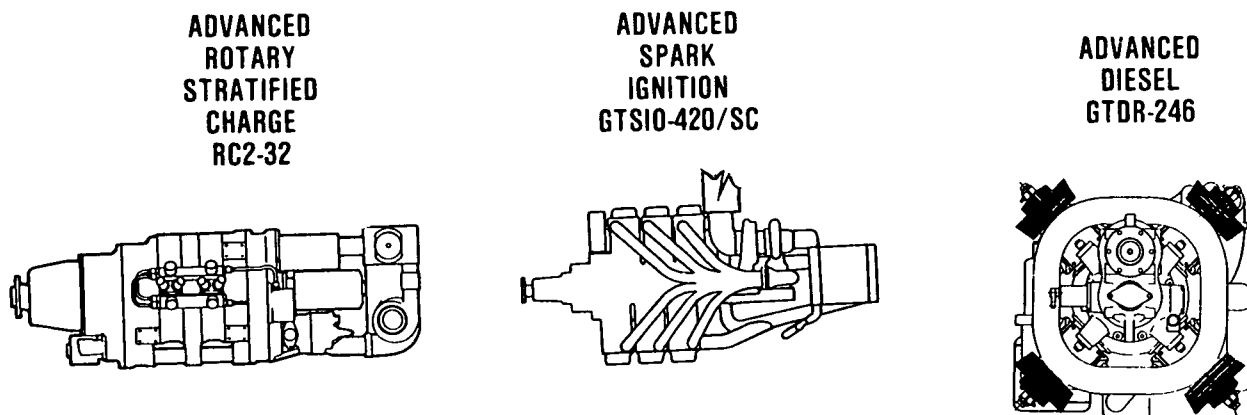

Figure 1. Advanced Technology Engines.

NASA and the engine contractors and are shown in Figures 3 through 6, and Table 3. Single- and twin-engine aircraft data for the four engines was supplied by NASA. Sensitivities of aircraft performance, takeoff gross weight (TOGW), and direct operating cost (DOC) to engine parameter changes were supplied by Cessna, and appear in Appendix I. The overall aircraft parameters used for the study are identified in Table 4, while the baseline engine parameters(1,2,5) are listed in Table 5. The sensitivity factors of each are included in Appendices I and II.

3.2 Technology Survey

For the technology survey, the turbocharger system technologies were divided into three classifications: component technologies, cycle technologies, and design opportunities. A large number of concepts were screened prior to this classification. Each survey candidate (Table 6) was then subjected to a technical risk and manufacturing cost evaluation. This provided estimates of the potential availability and cost of incorporation of each candidate in any proposed turbocharger system. Relative technical risk of each technology was defined as a function of four factors:

- o Concept originality -- If the concept were new, or if it were related to an existing concept.
- o Functional design -- If the design fulfilled the need of the system concept.

TABLE 1. ENGINE MASTER DATA CHART.

ENGINE TYPE	SPARK IGNITION			DIESEL			ROTARY											
	CURRENT/BASELINE TS10-550			MODERATE RISK GTS110-420			HIGH RISK GTS10-420/SC			HIGH-RISK 1992 TECH			ADVANCED RC2-47			HIGHLY ADVANCED RC2-32		
Engine Wt. (lb)1 Basic + Additional	585 + 121 = 706			485 + 121 = 606			405 + 121 = 526			367 + 121 = 488			348 + 139 = 487			255 + 138 = 393		
Scaling (Basic WT)	$W_B \approx HP \cdot 0.818$			$W_B \approx HP \cdot 0.818$			$W_B \approx HP \cdot 0.818$			Specific Wt = scaled as shown in Enc. 2			$W_B = 92 \cdot 0.8$ (TOHP)			$W_B = 854 \cdot 53$ (TOHP)		
Dimensions (in.)																		
	L	50.62			59.25			59.25			41.30			52.0			48.6	
	W	34.06			33.375			33.375			24.00			18.0			16.0	
	H	20.02			19.25			19.25			25.00			17.0			16.0	
Scaling (inches)																		
L	None	None			None			None			None			44.8+0.0225 (TOHP)			42.3+0.019 (TOHP)	
W	None	None			None			None			None			None			None	
H	None	None			None			None			None			None			None	
CG Locations 2																		
Aft	23.6			32.6			33.6			15.7			22.8			22.7		
Below	0.9			0.56			0.52			ON			ON			ON		
Right	0.65			0.80			0.90			ON			ON			ON		
Power (HP) at ISA condition	4 ALT MCP CRUISE			ALT MCP CRUISE			ALT MCP CRUISE			ECON. ALT MCP/CRUISE CRUISE			ALT MCP CRUISE			ALT MCP CRUISE		
	0 350 247			0 350 229			0 350 228			0 to			0 to			0 to		
	5K 359 256			5K 367 242			5K 364 243			17K 360 297			21K 320 250			21K 320 250		
	10K 358 262			10K 374 251			10K 368 252											
	15K 348 263			15K 366 256			15K 360 257											
	20K 327 259			20K 351 256			20K 343 255			20K 320 264								
	25K 298 250			25K 323 250			25K 316 250			25K 250 206			25K 275 250			25K 275 250		
	30K 265 240			30K 290 240			30K 280 240			30K 185 153			30K 227 208			30K 227 208		
	35K 231 228			35K 252 228			35K 245 228			35K 120 99			35K 290 176			35K 290 176		
	RPM 2800 2300			RPM 2400 2150			RPM 2400 2150			RPM 2300 2300			RPM 2400 2000			RPM 2400 2000		
SFC (LB/HP-HR)	0 to			0 to			0 to			0 to			0 to - -			0 to - -		
	35K 0.600 0.446			35K 0.486 0.358			35K 0.334 0.331			17K 0.313 0.290			25K			25K		
										20K 0.317 0.293								
										25K 0.323 0.299								
										30K 0.330 0.305			30K 0.380 0.367			30K 0.370 0.354		
										35K 0.336 0.311			35K 0.382 0.369			35K 0.378 0.351		
Scaling Power	Linear			Linear			Linear			Linear			Linear			Linear		
SFC	None			None			None			None			None			None		
Cooling Requirements (% SHP)	100%			77.6%			79.3%			70.3%			58.5%			61.1%		
<p>1 Basic wt (lb) scaled with power output. Additional wt not constant (unscaled) All wts = lb.</p> <p>2 Center of gravity (CG) locations referenced to prop flange and crankshaft (), except for gate. Gate lateral and vertical positions referenced to prop shaft</p> <p>3 Current and moderate risk spark ignition engines. Experience Δ power loss of 1% per 6°F rise in ambient temperature. Other IC engines not sensitive to temp. variation. Gate data based on density altitude.</p>																		

TABLE 2. ATDS CHARACTERIZATION OF ENGINE AIRFLOW.

PARAMETER	CURRENT TIO-540 SI RECIP	ADVANCED GTSIO-420/SC SI RECIP	ADVANCED RC2-32 SI ROTARY	ADVANCED GTDR-246 DIESEL
Compressor				
Airflow, lb/min	36.7	36.2	47	52.0
Pressure ratio	3.6	3.3	5.5	7.3
Efficiency, %	0.75	0.57	0.70	0.82
Intercooler				
Effectiveness	0.5	0.4	0.5	0.5
Turbine				
Gas flow, lb/min	28.0	27.6	38.5	53.7
Inlet temperature, °F	1360	1518	1029	1117
Inlet pressure, psia	15.0	18.3	29.2	30.3
Pressure ratio	2.7	3.35	5.4	5.6
Efficiency, %	0.70	0.62	0.74	0.72

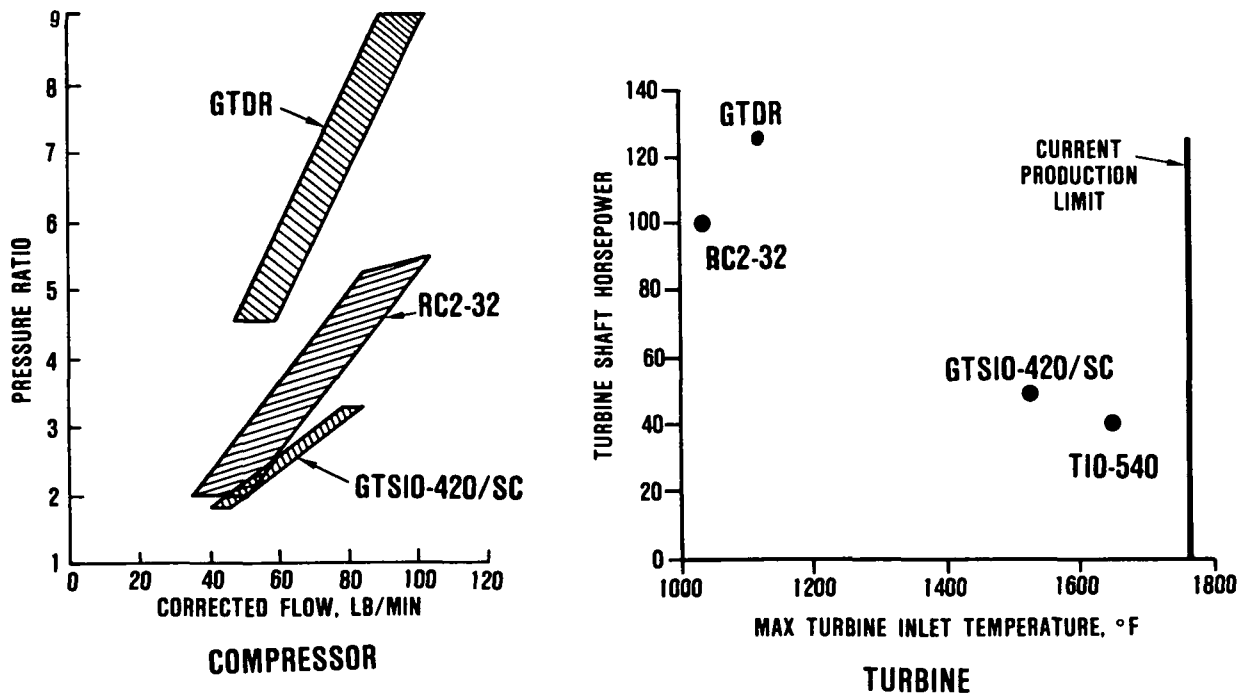

Figure 2. Engine Contractors Turbosystem Requirements.

TABLE 3. ENGINE AIRFLOW CHARACTERIZATION.

ENGINE	CHARACTERIZATION
TIO-540	$W_E = \frac{0.234 \frac{PIE}{PIT} + 0.648}{\sqrt{\frac{TIE}{519}}} \frac{540 (ERPM) PIE}{2606 TIE}$
GTSIO-420/SC	$W_E = (0.4 \frac{PIE}{PIT} + 0.7) \frac{420 (ERPM) PIE}{2606 TIE}$
RC2-32	$W_E = [0.3455 + 8.257 \times 10^{-6} (ERPM)] \frac{PIE}{\sqrt{TIE}}$ $\times (1 - \frac{PIT}{PIE} + \frac{ERPM}{208.5})$
GTDR-246	$W_E = \frac{15.63(CA) PIE N}{\sqrt{TIE}}$ $(CA) = 1.833 - 1.267 \times 10^{-4} (ERPM)$ $N = 3.8875 \sqrt{\left(\frac{PIE}{PIT}\right)^{-1.434} - \left(\frac{PIE}{PIT}\right)^{-1.717}}$
ERPM = Engine speed, rpm PIE = Engine inlet pressure, in Hg A PIT = Turbine inlet pressure, in Hg A TIE = Engine inlet temperature, °R CA = Effective area, sq. inch W _E = Engine Airflow, lb/min	

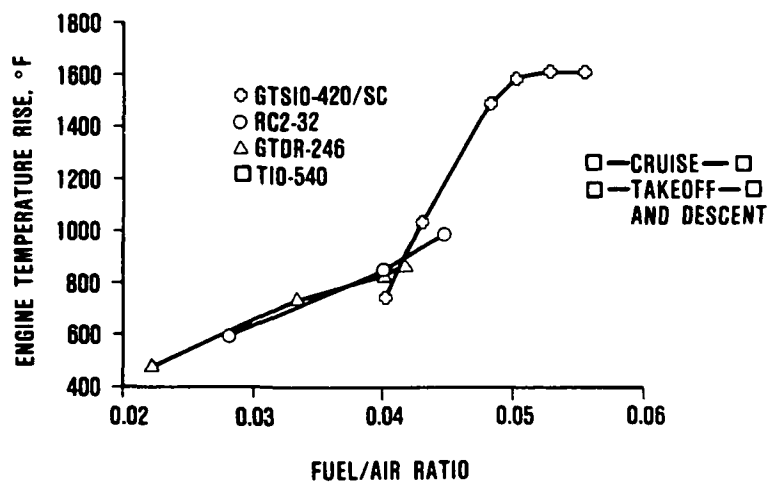

Figure 3. Engine Temperature Rise Characterization.

- o Operating requirements -- If the levels of component loading, efficiency, etc., were technologically realistic for the anticipated time period in operational introduction.
- o Mechanical design -- If the mechanical design met functional and operating requirements.

Figure 7 shows the probability of failure (risk) assigned to the five phases of product development identified by the study.

Relative manufacturing costs were defined as a function of three factors:

- o Level of operating parameters (i.e., pressure, temperature, life, reliability, and maintainability)
- o Material cost -- Exotic to conventional, and strategic versus nonstrategic.
- o Fabrication difficulties -- Material machinability, castability, weldability, and adaptability to automated assembly.

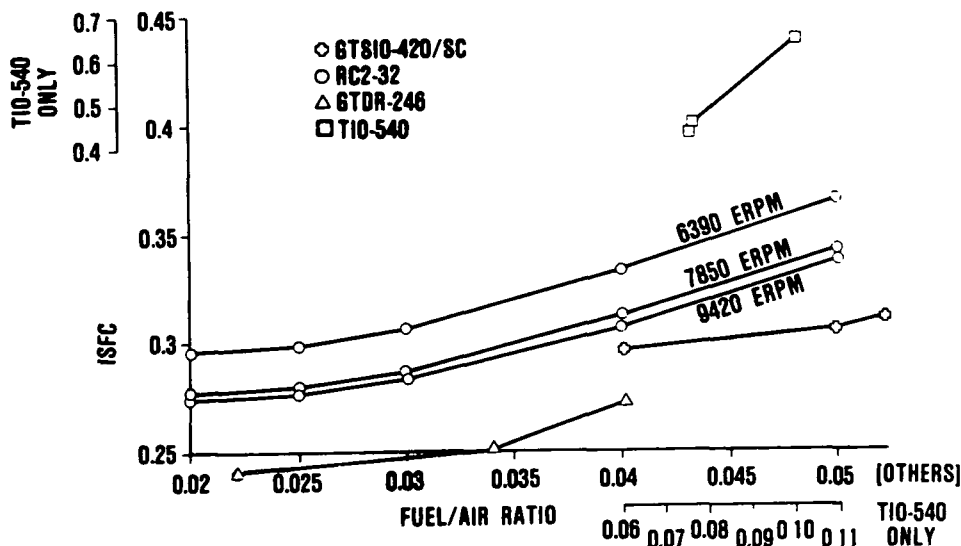

Figure 4. Characterization of Engine Indicated SFC.

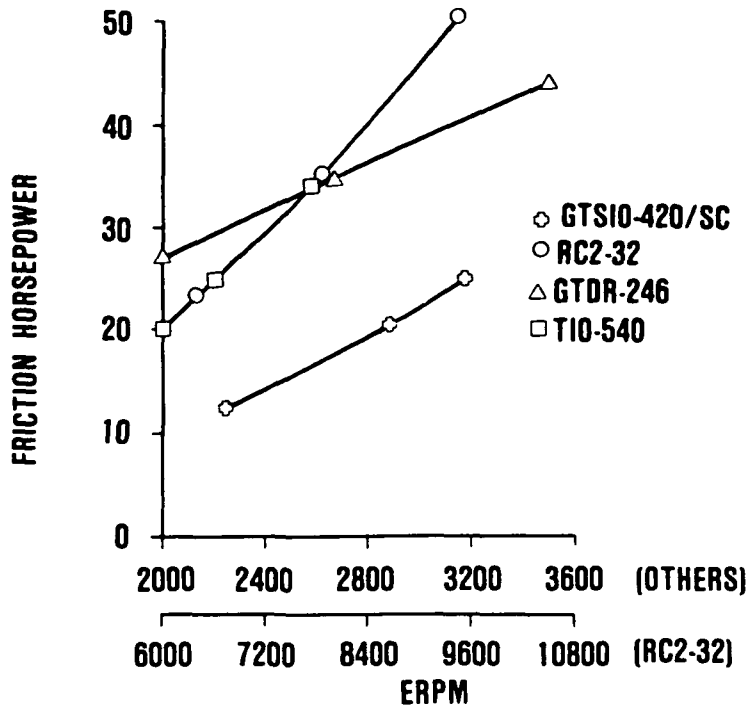

Figure 5. Characterization of Engine Friction Horsepower.

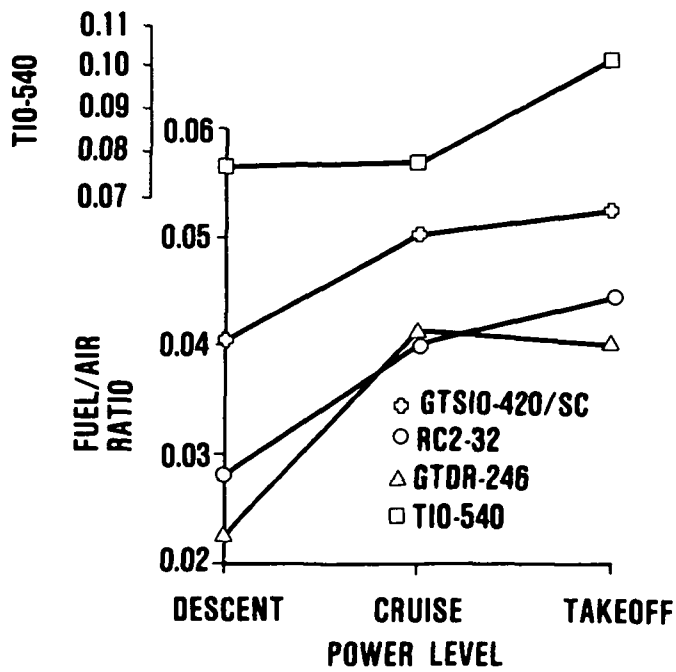

Figure 6. Characterization of Engine Fuel/Air Ratio.

TABLE 4. NASA AIRCRAFT PARAMETERS.

FIXED-ENGINE SIZE, VARIABLE AIRFRAME, FIXED PAYLOAD-RANGE*								
ENGINE	CURRENT SI RECIP**		ADVANCED SI RECIP		ADVANCED ROTARY		ADVANCED DIESEL	
AIRCRAFT TYPE	SINGLE	TWIN	SINGLE	TWIN	SINGLE	TWIN	SINGLE	TWIN
Takeoff gross weight, lb	4460	6850	3888	5907	3691	5454	3849	5753
Empty weight, lb	2736	4428	2340	3802	2127	3327	2310	3680
Takeoff Power, HP	340	340	350	350	320	320	340	340
Cruise speed**, kt	206	228.5	220	240.5	229	252	218	244
Mission fuel, lb	440	855	287	581	296	592	278.5	555
Acquisition cost, ks	202	381.5	186	347	175	320.5	188	338.5
DOC, \$/hr	122	230	106	198	103	190	107	195

*TCM/APD TSIO-550

**Single: Payload = 1200 lb: Range = 700 NMI
Twin: Payload = 1200 lb: Range = 800 NMI

***Cruise at 25,000 feet, ISA

TABLE 5. ENGINE PARAMETERS AT 25,000-FOOT CRUISE CONDITION (ISA, 250 BHP)

PARAMETER	SI RECIP. TIO-540 (BASELINE)	GTSIO- 420/SC ADVANCED SI RECIP.	RC2-32 ADVANCED SI ROTARY	GTDR ADVANCED DIESEL
BSFC, lb/hr-bhp	0.500	0.331	0.355	0.323
Fuel/air ratio, lb/lb	0.077	0.0500	0.04	0.0414
Airflow, lb/min	26.6	27.6	37.9	52
Temperature rise, °F	1255	1600	870	880

TABLE 6. SELECTED CANDIDATES FOR TECHNOLOGY SURVEY.

COMPONENT TECHNOLOGY	CYCLE TECHNOLOGY	DESIGN OPPORTUNITIES
Compressor efficiency Turbine efficiency Advanced rotor materials Variable compressor geometry Variable turbine geometry Microprocessor control Intercooler/aftercooler	Two-stage turbocharger Pressure turbocompounding Mechanical turbocompounding Hyperbar system Turbocharger matching Exhaust pulse utilization Exhaust pulse tuning Intake pulse tuning Bottoming cycles	Compact designs Improved bearings Turbocharger driven accessories Turbocharger in APU mode Lightweight housing materials

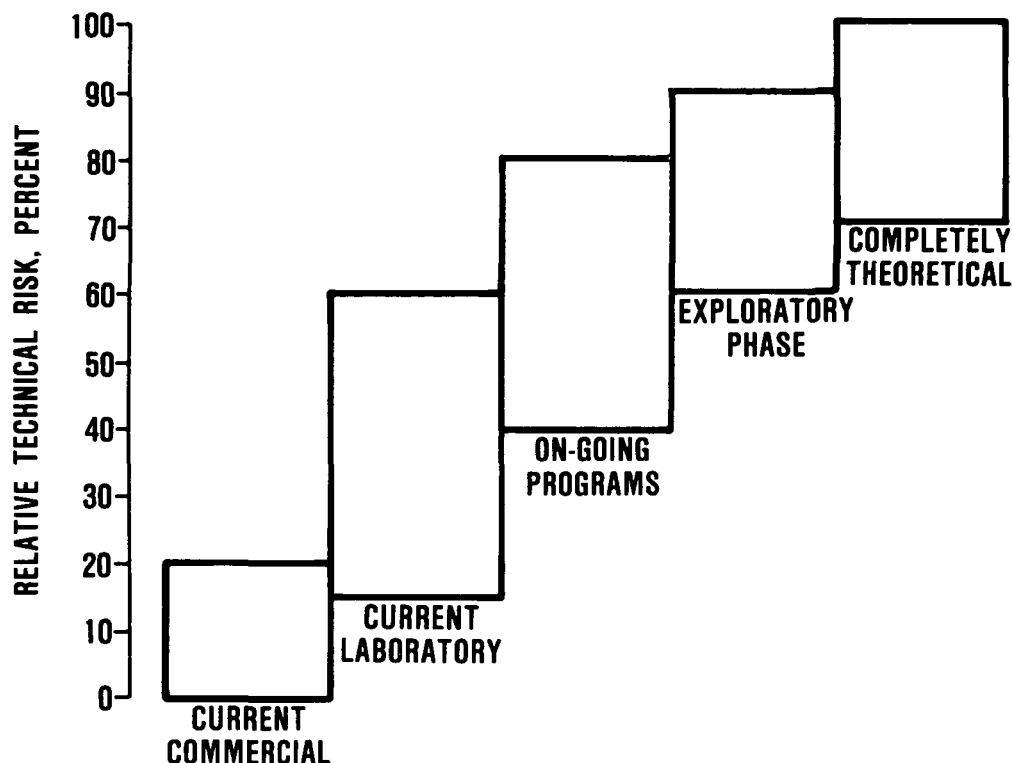

Figure 7. Standardized Basis for Relative Technical Risk Assessments.

3.2.1 Component Technology

The following technologies were applicable to potential turbo-charger component candidates and were subsequently evaluated in the ATDS Program.

3.2.1.1 Compressor/Turbine Efficiency Improvements - It is obvious that turbocharger aerodynamic components can benefit from advancements made in gas-turbine engine technology. This technology can be easily transferred to large turbochargers, since the same manufacturing processes are used for both and can be justified by similar cost-quantity relationships. However, to date, the price-quantity relationships in the small-turbocharger market have made it unfeasible to incorporate the latest gas turbine aerodynamic technology. This trend is expected to continue until the turbo-charger thermodynamic work becomes a sufficiently large proportion of the total powerplant work, which will mean that the improved efficiency attained will offset the high cost of obtaining it.

Current expectations of industrial compressor and turbine capabilities (allowing for 3 years of component development) are shown in Figures 8 and 9 and Tables 7 and 8, while the ATDS technology evaluation for these components are listed in Tables 9 and 10, respectively. The turbine efficiencies shown assume good diffusion of the turbine exit flow to minimize dumping losses.

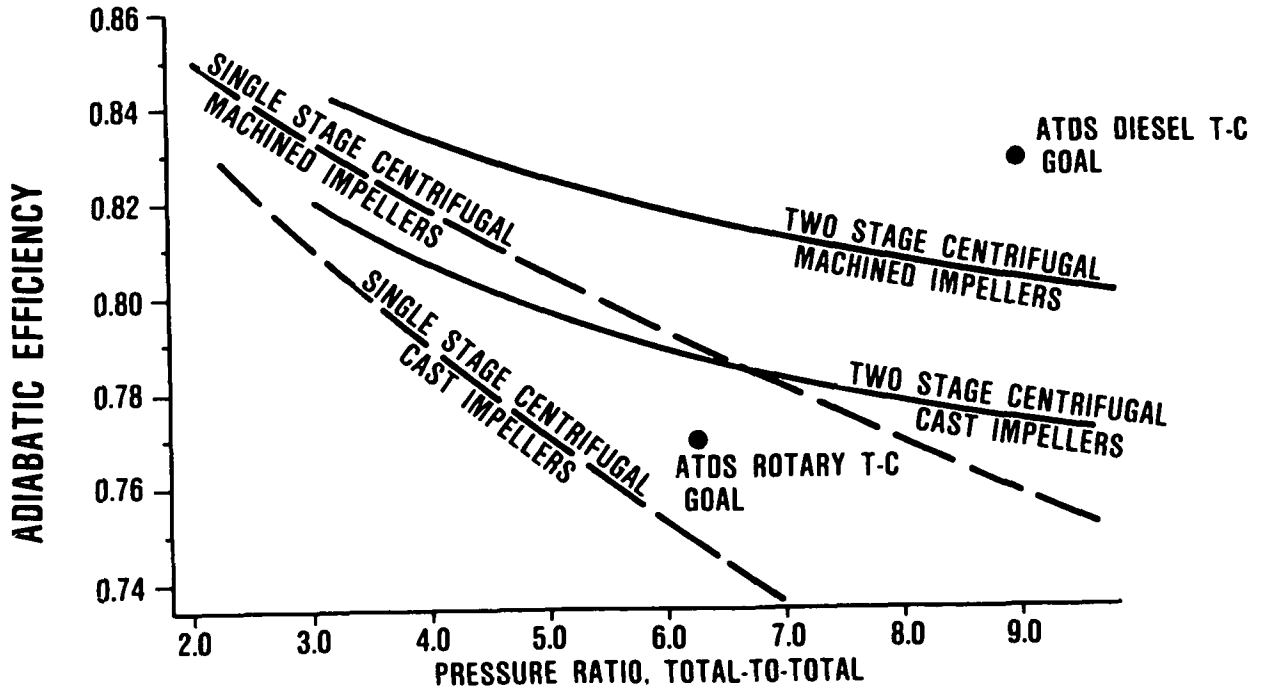

Figure 8. Centrifugal Compressor Industry Capability Available in 1986.

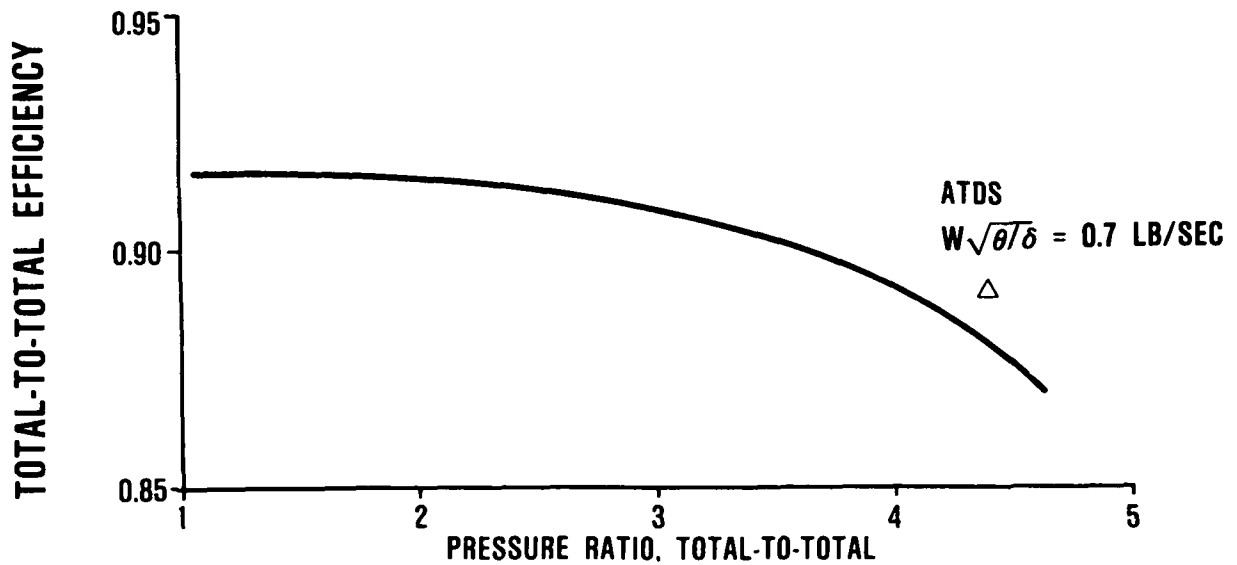

Figure 9. Turbine Industry Capability.

TABLE 7. COMPRESSOR TECHNOLOGY INDUSTRIAL CAPABILITY.

STATUS	CAPABILITY
Current commercial practice	TH08A turbocharger, P/P = 2.5 $\eta = 0.74$
Current laboratory state-of-the-art	GT601 Truck Engine, P/P = 5.0 $\eta = 0.78$ (machined titanium)
Firmly planned on-going program	AGT101 Automobile Engine, P/P = 4.3 - 5.0 $\eta = 0.80$ (PM aluminum)
Exploratory experimental phase	"Arbitrary" blades: Twisted β diffuser, 3-D shape duplicator machined
Theoretical	Advanced design tools not developed

TABLE 8. TURBINE TECHNOLOGY INDUSTRIAL CAPABILITY.

STATUS	CAPABILITY
Current commercial practice	TH08A turbocharger, P/P = 2.5 $\eta = 0.73$
Current laboratory state-of-the-art	Include vaned scroll, exit diffuser $\eta = 0.80$ to 0.83
Firmly planned on-going program	AGT101 automobile engine using ceramic rotor (2500 °F) $\eta = 0.85$ P/P = 4.0
Exploratory experimental phase	Variable-geometry nozzle
Theoretical	3-D nozzle, clearance control

TABLE 9. ATDS COMPRESSOR EFFICIENCY TECHNOLOGY EVALUATION.
CURRENT TECHNOLOGY: 70-PERCENT AT 2.6 PR AT 50 PPM

ADVANCED TECHNOLOGY STATUS	RELATIVE TECHNICAL RISK	RELATIVE MANUFACTURING COST
Current commercial practice/ Experience (AID production)	Low	Low
Current laboratory state-of-the-art (GTEC GT-601)	Low	High
Expected results of significant on-going or firmly planned pro- grams (AGT-101, powdered metal Aluminide)	Moderate	Low
In exploratory experimental phase no major program commitment (3-D Blades)	High	Low
Theoretical (3-D viscous, LDV)	Very high	Very high

TABLE 10. ATDS TURBINE EFFICIENCY TECHNOLOGY EVALUATION.
CURRENT TECHNOLOGY: 70-PERCENT AT 2.6 PR,
50 PPM).

ADVANCED TECHNOLOGY STATUS	RELATIVE TECHNICAL RISK	RELATIVE MANUFACTURING COST
Current commercial practice/ experience (AID production)	Low	Low
Current laboratory state-of-the-art (GTEC production)	Low	Moderate
Expected results of significant on-going or firmly planned pro- grams (3-D nozzles)	Moderate	Moderate
In exploratory experimental phase with no major program commitment (variable geometry, clearance control)	High	Moderate
Theoretical	High	Unknown

As shown in Figure 8, state-of-the-art impeller fabrication imposes a significant penalty in attainable efficiency if the impeller is a cast design. In the case of a single-stage 6:1 compressor, this penalty exceeds 3 points in efficiency. The turbocharger marketplace has accepted this performance decrement in order to maintain the lowest possible cost.

Programs are being conducted to develop a HIPped powder-metal fabrication process for titanium impellers. Results have been encouraging, in that the material properties of sample impellers produced through this process have approached those of forged designs. Achieving blade profile tolerances equivalent to those typical of the machining process is a major problem. However, improvement in this area indicates that with sufficient process development efforts, the required tolerances can be met. When that occurs, the performance of machined blading can be achieved at significantly reduced costs. A parallel approach to improved compressor performance can be achieved through advanced aerodynamic development techniques that would meet turbocharger performance requirements for aircraft diesel engines. These aerodynamic improvements would be achieved through both better flow visualization and in measurement techniques (such as 3-D viscous modeling to improve visualization and laser velocimetry to improve measurement).

3.2.1.2 Advanced Lightweight Materials - A large number of advanced material systems are under development for the aerospace industry that have high strength-to-weight ratios. However, these materials would benefit turbocharger technologies only if they can demonstrate significant primary and secondary effects. For example, a ceramic turbine rotor would not only reduce rotating group weight but would also:

- o Allow the use of lightweight housings, since the mass and size of the largest particle to be contained in the event of a rotor burst is much less
- o Enhance consideration of foil bearings because of low rotating group weight.

Present industrial capabilities for advanced rotor materials are listed in Table 11, while Table 12 lists the status of current lightweight housing materials. Other advanced material systems (i.e., titanium aluminides, carbon-carbon, and wire-reinforced composites) are not as attractive as those listed. The ATDS technology evaluations for the advanced rotor materials and lightweight housing materials are listed in Tables 13 and 14, respectively.

3.2.1.3 Variable Geometry - Variable-geometry techniques have proven to be very effective in turbomachinery applications. However, this effectiveness is dependent on the physical size of the flow channel. Leakage through the clearances required to facilitate rotation of the airfoil has proportionately greater adverse

TABLE 11. INDUSTRIAL CAPABILITIES FOR ADVANCED ROTOR MATERIAL.

STATUS	PART
Current commercial practice	Cast aluminum compressor: GMR235 turbine
Current laboratory state-of-the-art	Machined titanium compressor, sintered Si_3N_4 or SiC turbine
Firmly planned on-going programs	PM aluminum compressor Si_3N_4 or SiC turbine (AGT)
Exploratory experimental	Sintered reaction bonded silicon nitride, carbon-carbon, Ti_3Al , wire-reinforced composite
Theoretical	None considered

TABLE 12. LIGHTWEIGHT HOUSING MATERIALS INDUSTRY CAPABILITIES.

STATUS	PART
Current commercial practice	Cast A356 aluminum Ni resist
Current laboratory state-of-the-art	Graphite/epoxy, stainless-steel sheet
Firmly planned on-going program	Hybrid fiber/epoxy
Exploratory experimental phase	High modulus injection-molded systems
Theoretical	High modulus polymers not requiring fiber reinforcement

TABLE 13. ADVANCED ROTOR MATERIALS TECHNOLOGY EVALUATION.

ADVANCED TECHNOLOGY STATUS	RELATIVE TECHNICAL RISK	RELATIVE MANUFACTURING COST
Current commercial practice/ experience (AID production), GMR235 And INCO 713 LC.	Low	Low
Current laboratory state-of-the-art (GTEC production), Mar-M 247, IN 100	High	High
Expected results of significant on-going or firmly planned pro- grams (AMMRC sintered Si ₃ N ₄ , AGT-101)	Moderate	Moderate
In experimental phase with no major program commitment (sintered RBSN)	Low	Low
Theoretical	-	-

TABLE 14. LIGHTWEIGHT HOUSING MATERIALS EVALUATION.

ADVANCED TECHNOLOGY STATUS	RELATIVE TECHNICAL RISK	RELATIVE MANUFACTURING COST
Current commercial practice/ experience (AID production) cast iron, cast aluminum	Low	Low
Current laboratory state-of-the- art (GTEC production Hastelloy S, 321 Stainless Steel)	Low	Moderate
Expected results of significant on-going or firmly planned pro- grams	None Planned	None Planned
In exploratory experimental phase with no major program commitment	High	Unknown
Theoretical	High	Unknown

effects on component efficiency as the height of the flow passage decreases. For the study, a suitable efficiency decrement percent was applied to the variable compressor and the turbine stators. The present industrial capability for variable compressor and turbine geometry is shown in Table 15, while the ATDS technology evaluation of variable geometry for the compressor and turbine are presented in Tables 16 and 17, respectively.

3.2.1.4 Microprocessor Control - For complex powerplant systems that combine turbocharging and auxiliary power unit functions, the control of all system components would best be accomplished using a microprocessor that integrated all functions, as shown in Figure 10. However, as the powerplant becomes less complex, the need for integrated microprocessor controls becomes less pronounced. The control needs for the four selected engines are shown in Table 18, while the ATDS technology evaluation of microprocessor controls is presented in Table 19.

TABLE 15. INDUSTRIAL CAPABILITIES FOR VARIABLE-GEOMETRY TECHNOLOGY.

STATUS	CAPABILITY
Compressor	
Current commercial practices	Variable IGVs control flow and pressure ratios. Possible applicability to GTDR engine.
Current laboratory state-of-the-art	Variable diffuser (radial or axial) controls flow with relatively constant pressure ratio
Turbine	
Current commercial practice	ATM80 (radial): TSCP700 (axial)
Current laboratory state-of-the-art	TFE731-2 VCD: GT601 truck
Theoretical	Clearance control for zero losses

TABLE 16. VARIABLE-GEOMETRY COMPRESSOR TECHNOLOGY EVALUATION
CURRENT TECHNOLOGY: GTEC PRODUCTION ATM'S AND ENGINE.

ADVANCED TECHNOLOGY STATUS	RELATIVE TECHNICAL RISK	RELATIVE MANUFACTURING COST
Current commercial practice/ experience (AID production)	None Existing	None Existing
Current laboratory state-of- the-art (GTEC production)	Low	Moderate
Expected results of significant on-going or firmly planned pro- grams (USAF variable cycle)	Low	Moderate
In exploratory experimental phase, with no major program commitment	None planned	None planned
Theoretical	High	Unknown

TABLE 17. VARIABLE-GEOMETRY TURBINE TECHNOLOGY EVALUATION
CURRENT TECHNOLOGY: GTEC PRODUCTION-AXIAL FLOW.

ADVANCED TECHNOLOGY STATUS	RELATIVE TECHNICAL RISK	RELATIVE MANUFACTURING COST
Current commercial practice/ experience (AID production)	None existing	None existing
Current laboratory state-of- the-art (GTEC production)	Low	Moderate
Expected results of significant on-going or firmly planned pro- grams (high-turning blade)	Moderate	Moderate
In exploratory experimental phase, with no major program commitment	High	Unknown
Theoretical	High	Unknown

TABLE 18. ELECTRONIC SYSTEM EVALUATION FOR TURBOCHARGED ENGINES.

	TIO-540 SC RECIP. (BASELINE)	GTSIO- 420/SC (SC RECIP)	GTDR-246 (DIESEL)	RC2-32 (ROTARY ENGINE)
Benefits	Turbo Control Simplified calibration Easy transition to full electronic engine control	Same as baseline	Configuration requires electronic controls Includes other engine controls	No turbocontrol required
Risks	Low risk to achieve concepts Moderate risk of not achieving cur- rent reliability	Same as baseline	Low risk to achieve control concept High risk of not achieving cur- rent reliability	Not applicable
Relative manufacturing costs baseline = 1.0	1.8	1.8	5.2	Not applicable

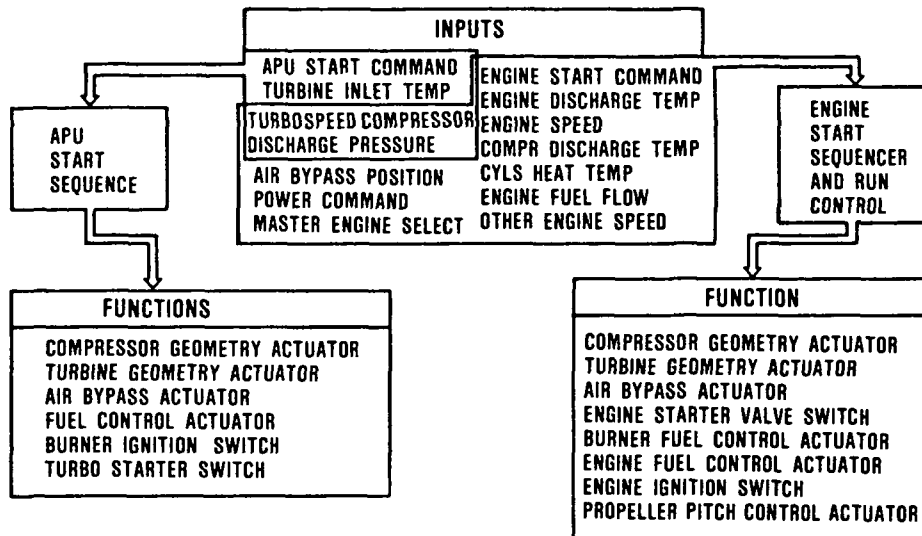

Figure 10. Elements of the Maximum Complexity Microprocessor System.

3.2.1.5 Charge Air Coolers- Cooling the engine charge air will allow lower inlet pressures and can reduce thermal and mechanical stresses in the engine design. Two baseline heat-exchanger designs were selected for comparison: a conventional approach that minimizes the length of the cooling air passage to minimize the cold-side pressure drop and maximizes cooling airflow, and an alternate approach that requires a longer charge-air pass to obtain decreased cooling air inlet face area (Figure 11). Both configurations had the same effectiveness and pressure-drop characteristics (Figure 12 and 13). For scaling the nominal design up or down to match each of the four engines, a family of sizing curves was developed (Figures 14 and 15). Effectiveness versus weight characteristics were examined for two ratios of cold-flow to hot-flow (Figure 16). As indicated, the conventional design (with a 2:1 ratio of cold to hot flow) was the lightest approach for any desired effectiveness or size (airflow) and was ultimately selected for further evaluation. The ATDS technology evaluation for charge air coolers is presented in Table 20.

3.2.2 Cycle Technology

3.2.2.1 Two-Stage Series Turbocharger - The most cost-effective way to achieve high pressure ratio (where demanded by the application) appeared to be by coupling two high-production, moderate-pressure-ratio turbochargers in series. This approach would also allow a broader operating range of high part-load efficiency than would be attainable with a single stage. Table 21 is the ATDS

TABLE 19. ADTS MICROPROCESSOR CONTROL TECHNOLOGY EVALUATION.

ADVANCED TECHNOLOGY STATUS	RELATIVE TECHNICAL RISK	RELATIVE MANUFACTURING COST
Current commercial practice/ experience (AID production)	None existing	None existing
Current laboratory state-of- the-art (GTEC production)	Low	High
Expected results of significant on-going or firmly planned pro- grams (Garrett development)	Moderate	High
In exploratory experimental phase, with no major program commitment	High	High
Theoretical	High	High

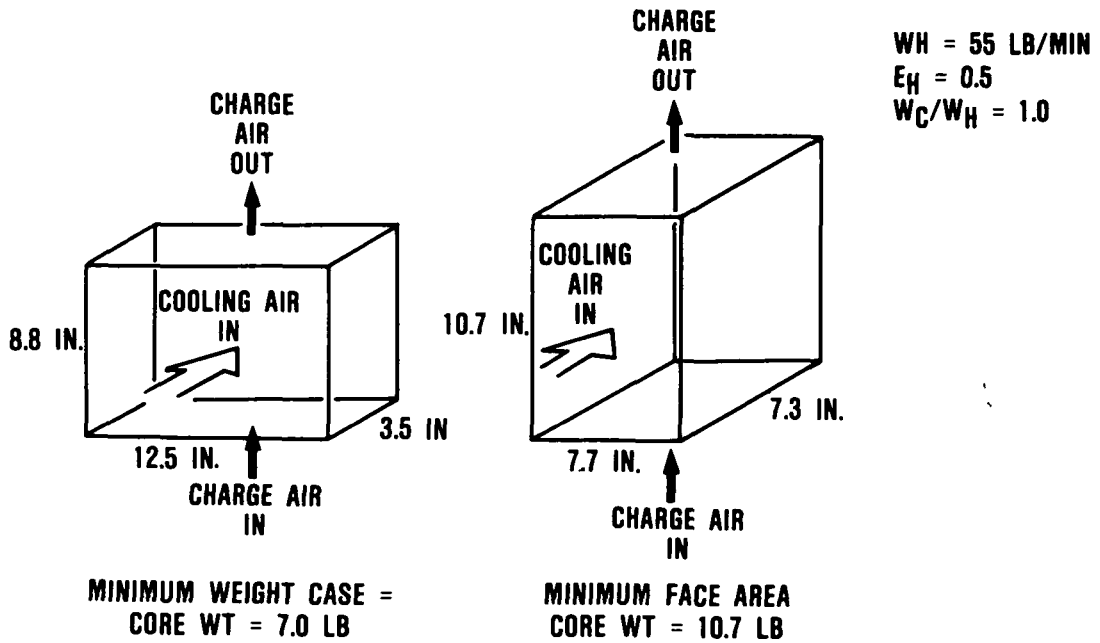

Figure 11. Heat-Exchanger Core Configurations.

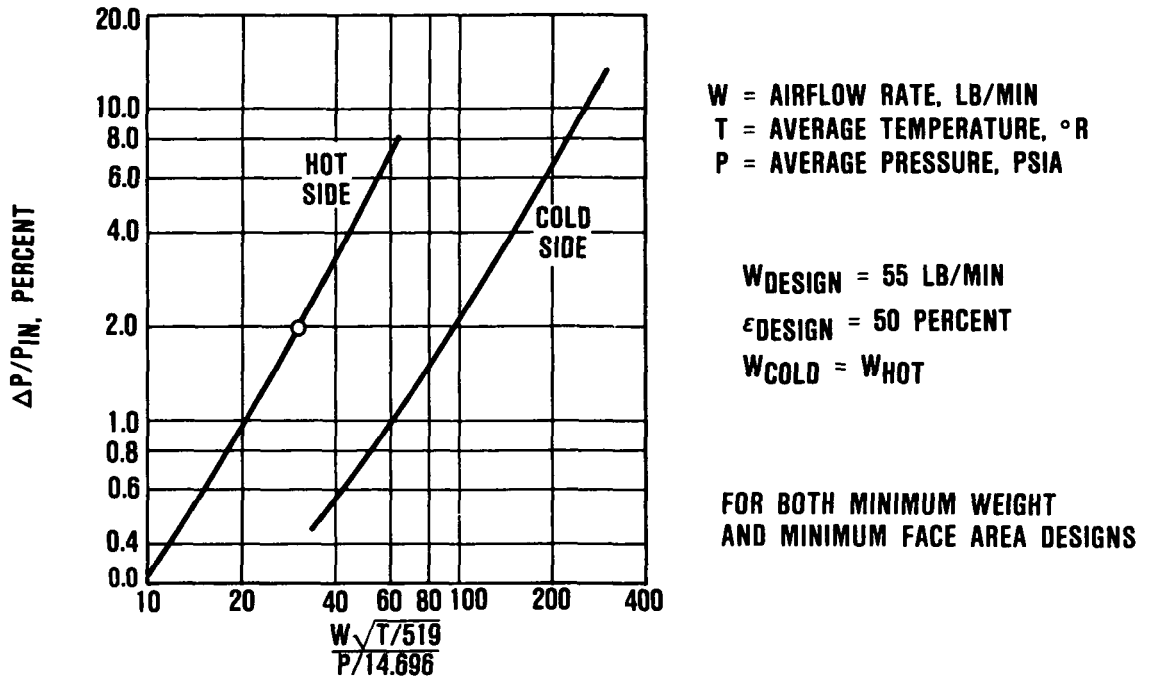

Figure 12. Heat-Exchanger Pressure Drop Characteristics.

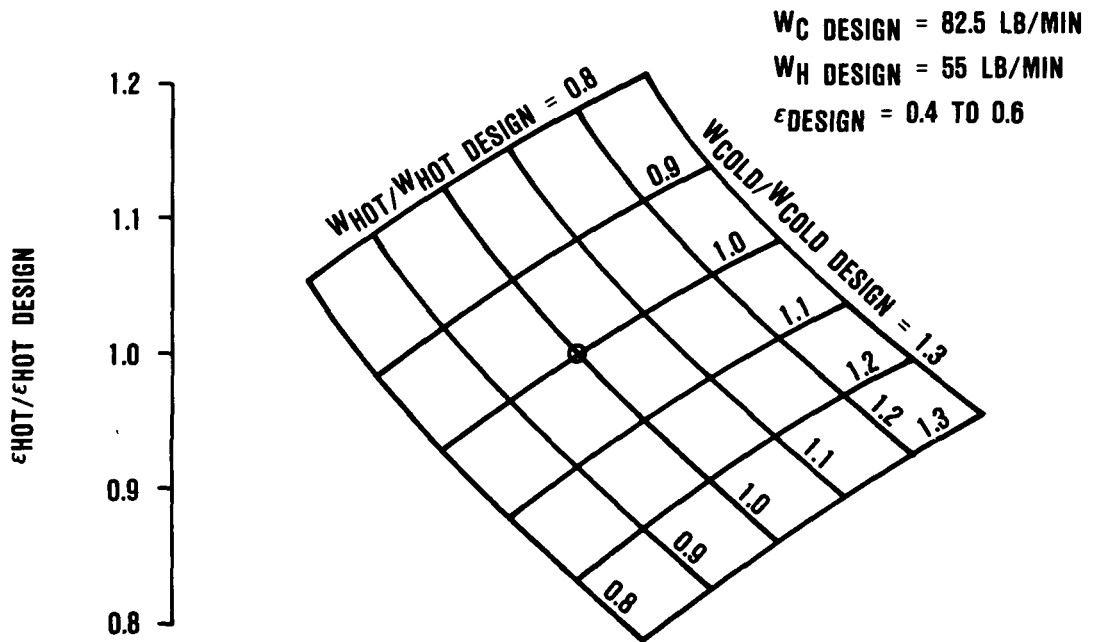

Figure 13. Heat-Exchanger Airflow/Effectiveness Characteristics.

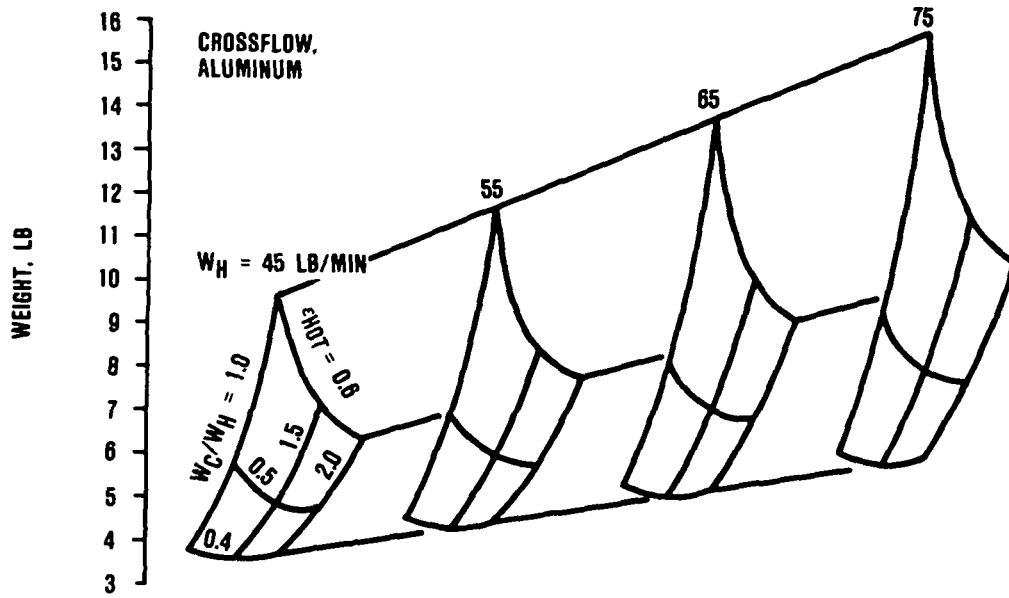

Figure 14. Conventional Design Intercooler Core Weight.

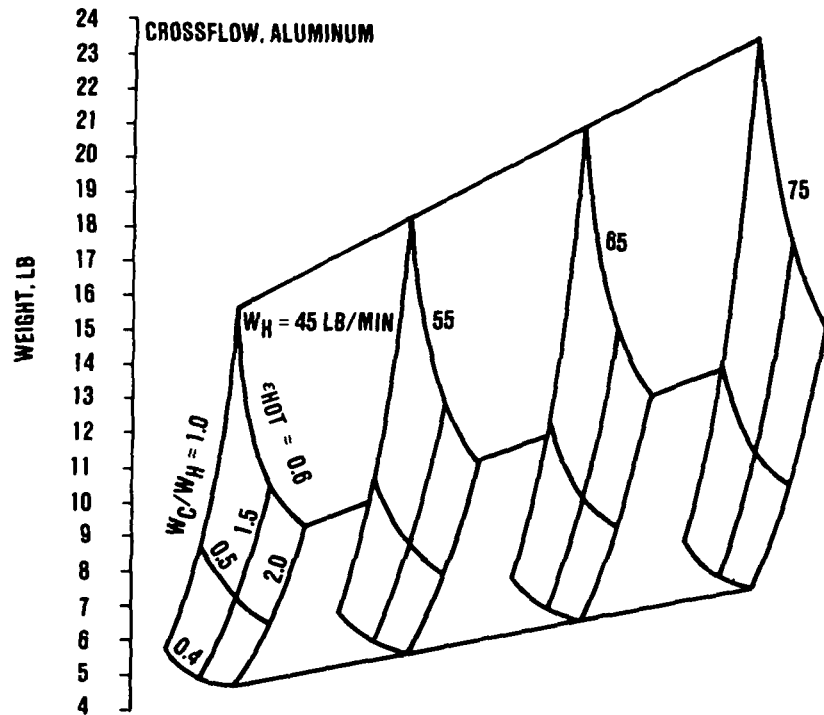

Figure 15. Intercooler Core Weight for Minimal Cooling Air Face Area Design.

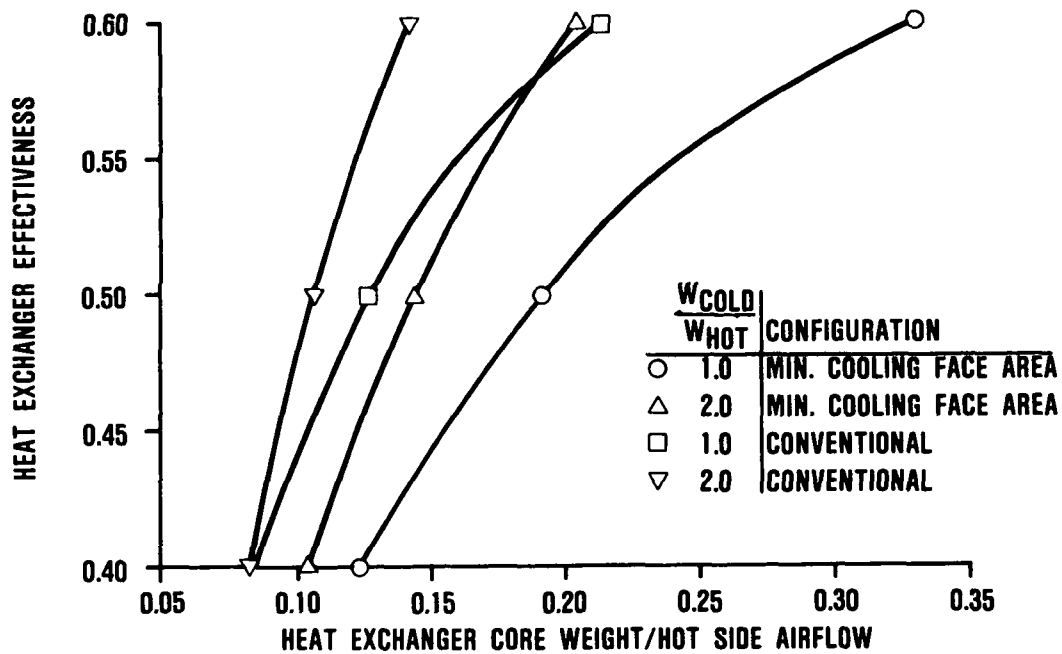

Figure 16. Heat-Exchanger Sensitivities.

TABLE 20. CHARGE AIR COOLER TECHNOLOGY EVALUATION
CURRENT TECHNOLOGY: AID PRODUCTION
NONFLYING AND GARRETT PRODUCTION FLYING.

ADVANCED TECHNOLOGY STATUS	RELATIVE TECHNICAL RISK	RELATIVE MANUFACTURING COST
Current commercial practice/ experience	Low	Low
Current laboratory state-of- the-art (AID production)	Low	Moderate
Expected results of significant on-going or firmly planned pro- grams (Garrett production)	None planned	None planned
In exploratory experimental phase, with no major program commitment	None planned	None planned
Theoretical	-	-

TABLE 21. TWO-STAGE TURBOCHARGER TECHNOLOGY EVALUATION
CURRENT TECHNOLOGY: SERIES CONNECTION OF TWO
TURBOS.

ADVANCED TECHNOLOGY STATUS	RELATIVE TECHNICAL RISK	RELATIVE MANUFACTURING COST
Current commercial practice/ experience	Low	Moderate
Current laboratory state-of- the-art	Low	High
Expected results of significant on-going or firmly planned pro- grams	None planned	None planned
In exploratory experimental phase, with no major program commitment	None planned	None planned
Theoretical	Very high	Moderate

technology evaluation of the two-stage series configuration. The cost, volume, and weight of the installation were strong negative factors. In retrospect, a concentric two-spool arrangement is now recommended as a candidate for applications requiring high pressure ratio (i.e., diesel aircraft engines, and nonflying diesels in mountainous terrain). This arrangement would minimize the weight and volume penalty of the two-spool turbocharger.

3.2.2.2 Mechanical Turbocompounding - The addition of a second turbine with the shaft mechanically connected to the engine was considered as a means of maximizing the extraction of energy from the engine exhaust. This approach was demonstrated on two aircraft engines--the Curtiss-Wright R3350 production engine and an experimental version of the Allison V1710 engine, and also experimentally demonstrated by Cummins on a truck diesel engine. Table 22 shows the ATDS technology evaluation for the mechanical compounding approach.

3.2.2.3 Hyperbar - French manufacturers of large diesel engines have been using the hyperbar system (Figure 17) for over 10 years. Until this study, the scalability of the hyperbar concept to small aircraft engines (where weight and volume are more critical) was not considered. The ATDS evaluation of the hyperbar technology for use in four general-aviation engines is shown in Table 23.

TABLE 22. MECHANICAL COMPOUNDING TECHNOLOGY EVALUATION
CURRENT TECHNOLOGY: PRODUCTION IN R-3350.

ADVANCED TECHNOLOGY STATUS	RELATIVE TECHNICAL RISK	RELATIVE MANUFACTURING COST
Current commercial practice/ experience	None existing	None existing
Current laboratory state-of- the-art (Cummins demonstrator)*	Low	Moderate
Expected results of significant on-going or firmly planned pro- grams	None planned	None planned
In exploratory experimental phase, with no major program commitment (Adds variable geometry)	High	Moderate
Theoretical	-	-
*Demonstrated by Cummins for highway diesel use.		

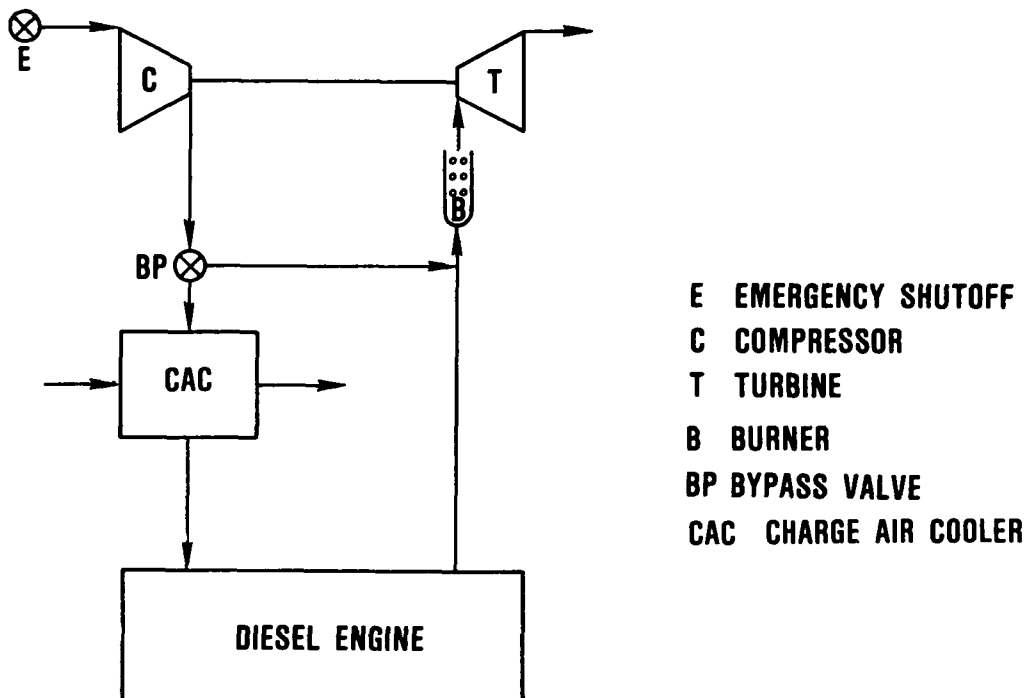

Figure 17. The Hyperbar System.

TABLE 23. HYPERBAR TECHNOLOGY EVALUATION
 CURRENT TECHNOLOGY: LIMITED FRENCH
 PRODUCTION.

ADVANCED TECHNOLOGY STATUS	RELATIVE TECHNICAL RISK	RELATIVE MANUFACTURING COST
Current commercial practice/ experience	None Existing (in U.S.)	None Existing (in U.S.)
Current laboratory state-of- the-art	Low	High
Expected results of significant on-going or firmly planned pro- grams	None Planned	None Planned
In exploratory experimental phase, with no major program commitment	-	-
Theoretical	-	-

3.2.2.4 Intake Tuning, Exhaust Tuning, and Exhaust Pulse Utilization - Benefits obtained from intake and exhaust effects depend on the specific engine and turbocharger combination used. Intake tuning improves volumetric efficiency of four-stroke-cycle engines, while exhaust tuning improves scavenging of two-stroke-cycle engines. Effects of exhaust pulse utilization by the turbine must be estimated for the particular speed, torque, exhaust configuration, and scavenging requirements of each engine. Preliminary technology evaluations are shown in Tables 24, 25, and 26. More detailed studies of the exhaust pulse utilization in the advanced technology spark ignition engines were performed later in the program and are discussed in Paragraph 3.3.3.

3.2.2.5 Bottoming Cycles - Vapor-generating bottoming cycle techniques have been evaluated for large stationary and marine powerplants and highway truck engines, but not for aircraft applications. For this study, a system was defined as shown in Figure 18 and Table 27, with the evaluation for two conditions of boiler saturation pressure and condensing temperatures (Figures 19 and 20). This data was then used to make the technology evaluation shown in Table 28.

TABLE 24. EXHAUST PULSE UTILIZATION TECHNOLOGY EVALUATION.
CURRENT TECHNOLOGY: WELL-DEVELOPED.

ADVANCED TECHNOLOGY STATUS	RELATIVE TECHNICAL RISK	RELATIVE MANUFACTURING COST
Current commercial practice/ experience	Low	Low
Current laboratory state-of- the-art	Low	Moderate
Expected results of significant on-going or firmly planned pro- grams	-	-
In exploratory experimental phase, with no major program commitment	-	-
Theoretical	-	-

TABLE 25. EXHAUST PULSE TUNING TECHNOLOGY EVALUATION.
CURRENT TECHNOLOGY: REQUIRES ANALYSIS FOR
EACH ENGINE.

ADVANCED TECHNOLOGY STATUS	RELATIVE TECHNICAL RISK	RELATIVE MANUFACTURING COST
Current commercial practice/ experience	Low	Low
Current laboratory state-of- the-art	Moderate	Low
Expected results of significant on-going or firmly planned pro- grams	-	-
In exploratory experimental phase, with no major program commitment	-	-
Theoretical	-	-

TABLE 26. INTAKE PULSE TUNING TECHNOLOGY EVALUATION.
 CURRENT TECHNOLOGY: WELL-DEVELOPED. REQUIRES
 ANALYSIS OF EACH ENGINE.

ADVANCED TECHNOLOGY STATUS	RELATIVE TECHNICAL RISK	RELATIVE MANUFACTURING COST
Current commercial practice/ experience	Low	Low
Current laboratory state-of- the-art	Moderate	Low
Expected results of significant on-going or firmly planned pro- grams	-	-
In exploratory experimental phase, with no major program commitment	-	-
Theoretical	-	-

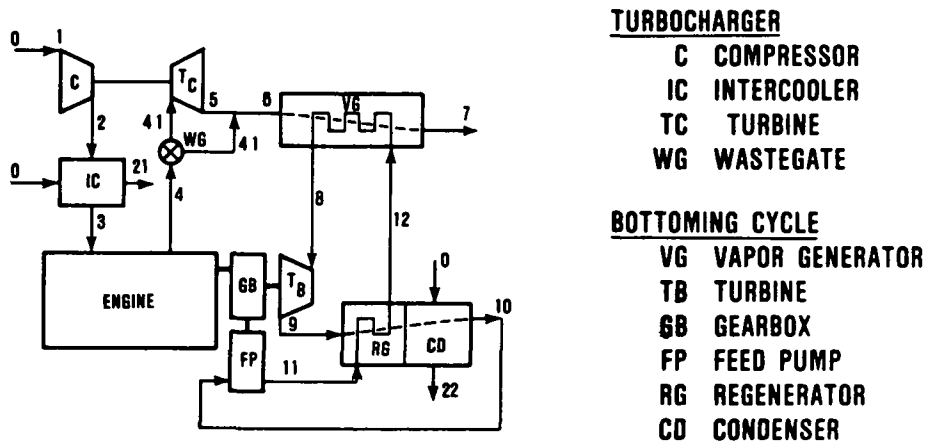

Figure 18. Bottoming Cycle Schematic.

TABLE 27. BOTTOMING CYCLE SYSTEM OPERATING CONDITIONS.

STATION		FLOW RATE (LB/MIN)	PRESSURE (PSIA)	TEMPERATURE (°R)	(η)
0	Ambient		5.461	429.6	
1	Compressor inlet	51.98	5.461	429.6	
2	Compressor exit	51.98	39.58	826.83	0.823
3	Intercooler exit	51.98	38.79	555.8	
4	Engine exhaust	53.70	30.48	1577.4	
4.1	T _C turbine inlet	48.27	30.33	1577.4	
	bypass	5.43		1577.4	0.718
5	T _C turbine exit	48.27	6.076	1191.33	
	bypass	5.43		1577.4	
6	Vapor generator inlet	53.7	6.064	1230	

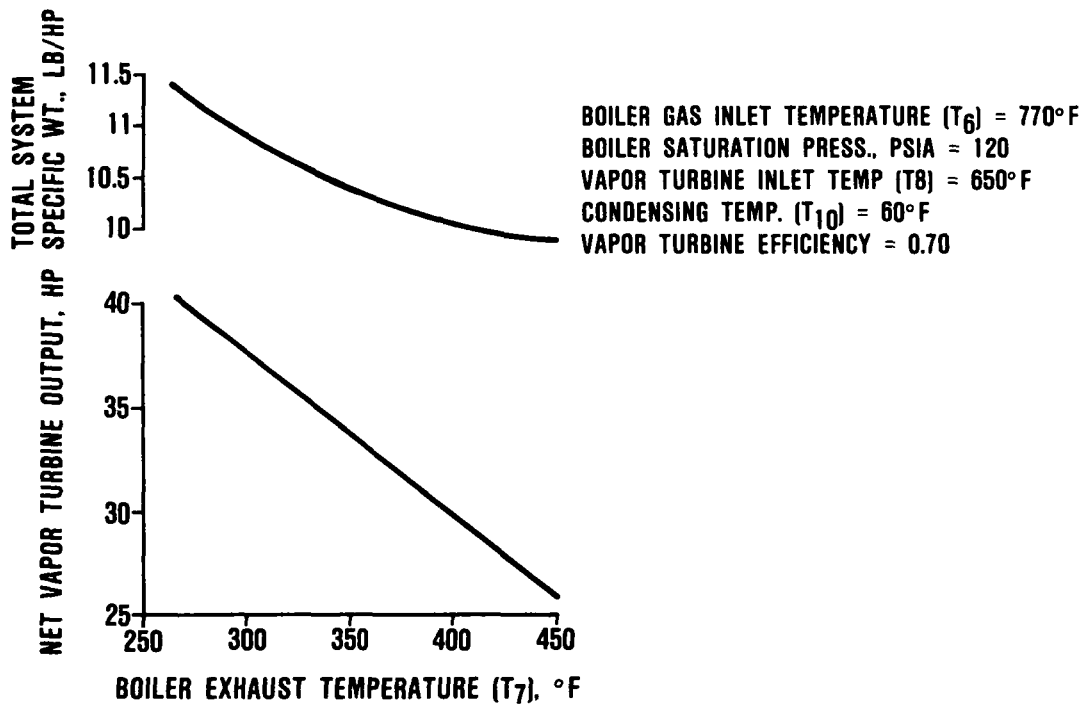
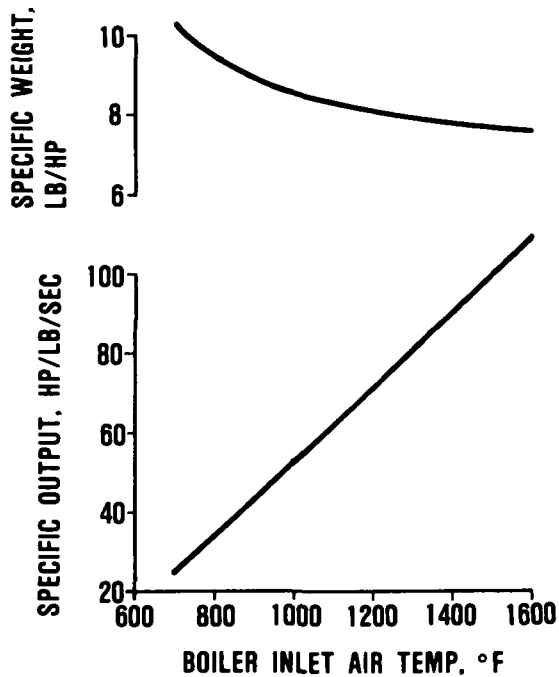

Figure 19. Steam Bottoming Cycle Performance.



BOILER SATURATION PRESSURE = 250 PSIA
 VAPOR TURBINE INLET TEMP. = 650°F
 CONDENSING TEMPERATURE = 100°F
 VAPOR TURBINE EFFICIENCY = 0.70

Figure 20. Steam Bottoming Cycle Performance.

TABLE 28. BOTTOMING CYCLE TECHNOLOGY EVALUATION.
 CURRENT TECHNOLOGY: LABORATORY
 DEMONSTRATION ONLY.

ADVANCED TECHNOLOGY STATUS	RELATIVE TECHNICAL RISK	RELATIVE MANUFACTURING COST
Current commercial practice/ experience	None existing	None existing
Current laboratory state-of- the-art	High	High
Expected results of significant on-going or firmly planned pro- grams	Sub- stantial	High
In exploratory experimental phase, with no major program commitment	-	-
Theoretical	-	-

3.2.3 Design Opportunities

3.2.3.1 Improved Bearings - Experience has shown that currently used journal bearings require a consistent supply of oil that must be cleaner than that required by the engine. High-DN rolling-element bearings--although well-developed for gas turbine engines--are too expensive for application in a small high-speed turbocharger and are also dependent on the integrity of the oil supply. Since installation considerations favor a turbocharger that is independent of the engine oil supply, study emphasis was placed on bearing systems not requiring engine oil. Gas-lubricated bearings were an obvious candidate for this application. The results of the ATDS gas-lubricated foil bearing technology evaluation are shown in Table 29, and were based on the considerations listed in Table 30. Gas-lubricated foil bearings were believed to offer significant benefits; however, not all of the penalties were apparent at this phase of the study. Therefore, a detailed design analysis was specified as part of Task III, and is discussed in Paragraph 3.4.5 of this report.

TABLE 29. GAS-LUBRICATED FOIL BEARINGS TECHNOLOGY EVALUATION. CURRENT TECHNOLOGY:
COLD: GTEC PRODUCTION
HOT: LABORATORY DEMONSTRATION ONLY

ADVANCED TECHNOLOGY STATUS	RELATIVE TECHNICAL RISK	RELATIVE MANUFACTURING COST
Current commercial practice/ experience	High (for turbo)	Low
Current laboratory state-of- the-art	High	Low
Expected results of significant on-going or firmly planned pro- grams	Moderate	Low
In exploratory experimental phase, with no major program commitment	Moderate	Low
Theoretical	-	-
Note: High-temperature and dynamic stability capability needed.		

TABLE 30. BEARING INDUSTRY CAPABILITY.

Current commercial practice	Bronze or aluminum journal Bearings
Current laboratory state-of-the-art	High DN antifriction Bearings (not considered feasible)
Coated foil bearings (1200°F)	Journal - Kaman silica-chromia-alumina (SCA) Low cost
Foil	Sputtered titanium carbide
Benefit	Eliminates oil system: Improves installation
Penalty	High start-up friction

3.2.3.2 Turbocharger Auxiliary Power Unit (APU) Application - The semi-independent turbocharger configuration proposed for the GTDR-246 engine led to consideration of a system combining the features of the hyperbar approach and an accessory drive gearbox, as shown in Figure 21. Performance of this APU system was estimated and

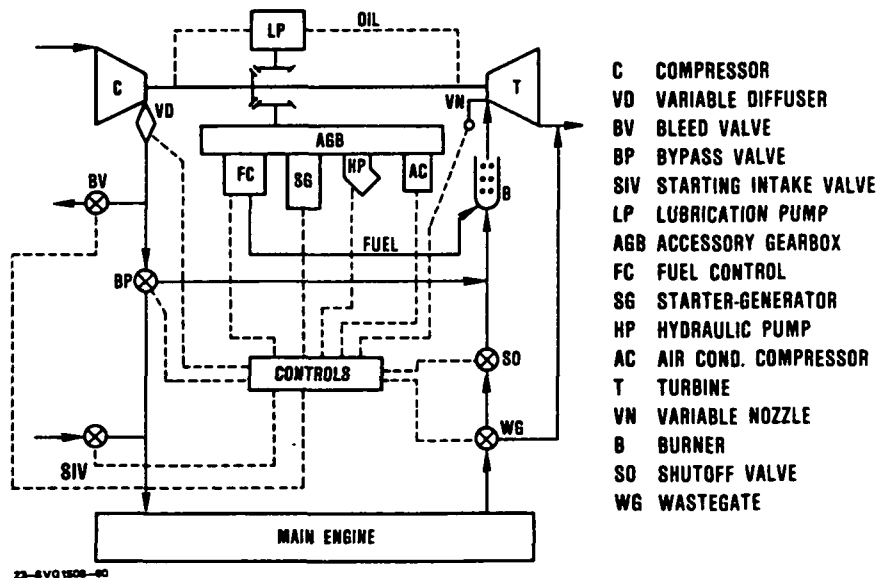

Figure 21. Schematic of the Turbocharger APU Mode.

benefits assessed. The preliminary estimates of the performance of a current production turbocharger adapted for use as an APU are shown in Figure 22. The overall technology evaluation is listed in Table 31.

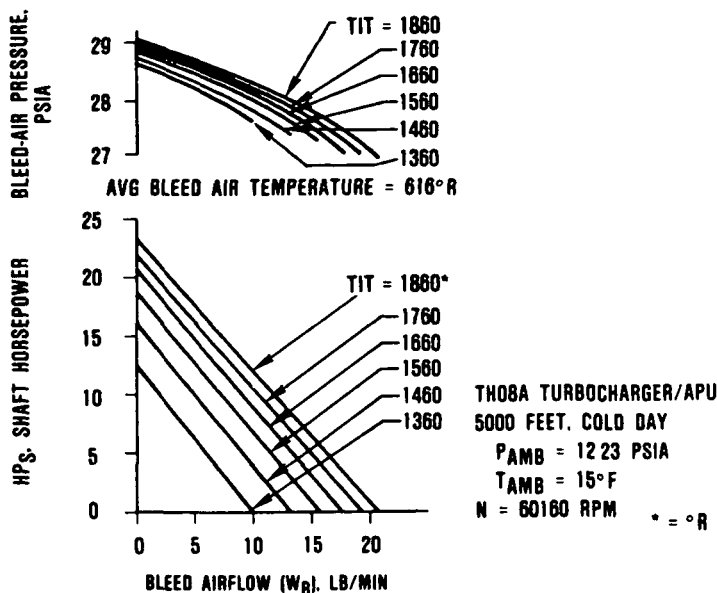

Figure 22. Performance of the Turbocharger as an APU.

TABLE 31. APU-MODE TURBOCHARGER TECHNOLOGY EVALUATION. CURRENT TECHNOLOGY: RELATED TO WELL-DEVELOPED HYPERBAR AND APU TECHNOLOGIES.

ADVANCED TECHNOLOGY STATUS	RELATIVE TECHNICAL RISK	RELATIVE MANUFACTURING COST
Current commercial practice/ experience	None Existing	None Existing
Current laboratory state-of- the-art	-	-
Expected results of significant on-going or firmly planned pro- grams	-	-
In exploratory experimental phase, with no major program commitment	-	-
Theoretical	High	High

3.2.4 ATDS Technology Survey Results - Figure 23 summarizes the overall results of the ATDS technology survey. These results were then applied to the trade-off analysis by using these technologies to optimize turbocharger systems for each of the four engines.

3.3 Turbocharger Trade-off Studies

3.3.1 Evaluation Criteria

For the ATDS trade-off studies, the contract directed the use of a benefit/penalty assessment scheme setup as performed by Cessna in a prior study(6) (Table 32), but adapted to the needs of the advanced turbocharger design study, as shown in Table 33. Only those factors which would be significant to the pilot or operator were considered. Fuel usage was considered an evaluation factor, in addition to DOC even though it contributes to DOC, since fuel conservation is a separate, important element of national policy. Trip time was also an evaluation factor, but was determined not to be significantly affected by variations in turbocharger system design. The evaluation points assigned to fuel consumption and operating cost maintain the same relative weighting of cost and fuel as the evaluation system used in Table 32.

	COMPRESSOR EFFICIENCY	TURBOCHARGER EFFICIENCY	ROTARY AIRFLOWS	MATERIALS LIGHTWEIGHT	HOUSING DESIGN	COMPRESSOR MATERIALS	TURBOCHARGER GEOMETRY	MANUFACTURING COST	INHERENT IN CONSIDERATION OF MATCHING TURBOCHARGER TO ENGINE	INTERFERENCE FIT	WARRANTY	TURBOCHARGER PRESSURE	TURBOCHARGER WEIGHT	TURBOCHARGER EFFICIENCY	TURBOCHARGER MATCHING	TURBOCHARGER WEIGHT	TURBOCHARGER EFFICIENCY	TURBOCHARGER WEIGHT	TURBOCHARGER EFFICIENCY	TURBOCHARGER WEIGHT	TURBOCHARGER EFFICIENCY	TURBOCHARGER WEIGHT	TURBOCHARGER EFFICIENCY	TURBOCHARGER WEIGHT	TURBOCHARGER EFFICIENCY	TURBOCHARGER WEIGHT	
RELATIVE TECHNICAL RISK, PERCENT																											
a. CURRENT COMMERCIAL PRACTICE/EXPERIENCE	0	0	0	0	-	0	-	0	-	(1)	-	-	(2)	0	0	0	-	(3)	0	(4)	-						
b. CURRENT LABORATORY STATE-OF-THE-ART	0	10	40	20	20	0	0	0	0	/	-	-	/	0	3	3	5	/	50	/	20						
c. ONGOING OR FIRMLY PLANNED PROGRAMS	30	20	15	25	-	-	20	-	-	/	-	-	/	-	-	-	-	/	-	/	-						
d. EXPLORATORY EXPERIMENTAL PHASE	60	-	30	25	-	-	-	-	-	/	15	-	/	-	-	-	-	/	-	/	-						
e. COMPLETELY THEORETICAL	90	50	-	20	50	80	-	10	-	/	15	40	/	-	-	-	-	/	-	/	-						
RELATIVE MANUFACTURING COST CURRENT EXPERIENCE = 1.0																											
a. CURRENT COMMERCIAL PRACTICE/EXPERIENCE	1.0	1.0	1.0	1.0	-	1.0	-	1.0	-	(1)	-	-	(2)	1.0	1.0	1.0	-	(3)	1.0	(4)	-						
b. CURRENT LABORATORY STATE-OF-THE-ART	20.0	1.2	3.0	3.0	1.0	1.1	1.0	1.0	1.0	/	-	-	/	1.2	1.1	1.1	1.0	/	20	/	1.0						
c. ONGOING OR FIRMLY PLANNED PROGRAMS	4.0	1.2	2.0	2.0	-	-	4	-	-	/	-	-	/	-	-	-	-	/	-	/	-						
d. EXPLORATORY EXPERIMENTAL PHASE	2.0	-	3.0	0.6	-	-	-	-	-	/	1.0	-	/	-	-	-	-	/	-	/	-						
e. COMPLETELY THEORETICAL	*	2.0	-	0.5	2.0	4.0	-	1.0	-	/	1.3	1.0	/	-	-	-	-	/	-	/	-						

(1) INHERENT IN CONSIDERATION OF MATCHING TURBOCHARGER TO ENGINE
(2) MATCHING IS THE CONSIDERATION OF THE NONOPTIMUM MATCH OF THE TURBOCHARGER TO THE ENGINE IN RETURN FOR GREATER COMMONALITY OF INVENTORY PARTS
(3) MUST BE CONSIDERED AS A TRADE-OFF VERSUS PERFORMANCE
(4) NO PERCEIVED ADVANTAGE TO DRIVE ACCESSORIES WITH TURBOCHARGER

*UNKNOWN

Figure 23. Technical Survey Results.

TABLE 32. NASA CR-165564 EVALUATION SCHEME.

AIRCRAFT CHARACTERISTIC	EVALUATION CRITERIA	WEIGHTING FACTOR
Fuel usage	10 points for 25-percent less fuel than baseline	10
DOC	10 points for 25-percent lower	8
Acquisition cost	10 points for 25-percent lower purchase price	6
Multifuel capability	0 points AVGAS only 1 point jet fuel only 2 points (both)	5
Flyover noise	+1 quieter than baseline 0 same as baseline (± 2 dBA)	10
Installation factor	0 equivalent to baseline 1 somewhat better than baseline 2 much better than baseline	10

TABLE 33. ATDS BENEFIT RANKING

AIRCRAFT CHARACTERISTIC	CRITERIA	EVALUATION POINTS
Total operating cost	Each 1 percent less than baseline	+10
Trip time	1 percent less than baseline	+ 3
Fuel use	1 percent less than baseline	+ 7

As stated, Cessna supplied GTEC with aircraft performance sensitivities to changes in engine characteristics. Selected sensitivities are shown in Figures 24 through 28. The complete Cessna package is included Appendices I, II, and III of this report. The sensitivity of engine BSFC to turbocharger component efficiencies was estimated based on the effects of engine pressure difference on mean effective pressure for 4-stroke-cycle engines, and on engine flow for the 2-stroke-cycle engine. Resulting sensitivities are shown in Figure 29.

3.3.2 Turbocharger System Configurations - The overall trade-off matrix involved all combinations of engines, turbocharger configurations, and technologies (Figure 30). Preliminary screening of applicable technologies eliminated some component and cycle technologies from further consideration, as indicated in Table 34. The remaining technologies and design opportunities were considered elements of alternate turbosystems for each advanced technology engine. These alternate systems were then compared on the basis of fuel consumption, purchase, and maintenance cost for each engine. These benefits were evaluated according to the benefit ranking system. Results of each evaluation are summarized in Tables 35 through 38. The system on each engine with the highest score for that engine was selected for comparison of turbocharger system requirements among engines. Features not inherent to the alternate

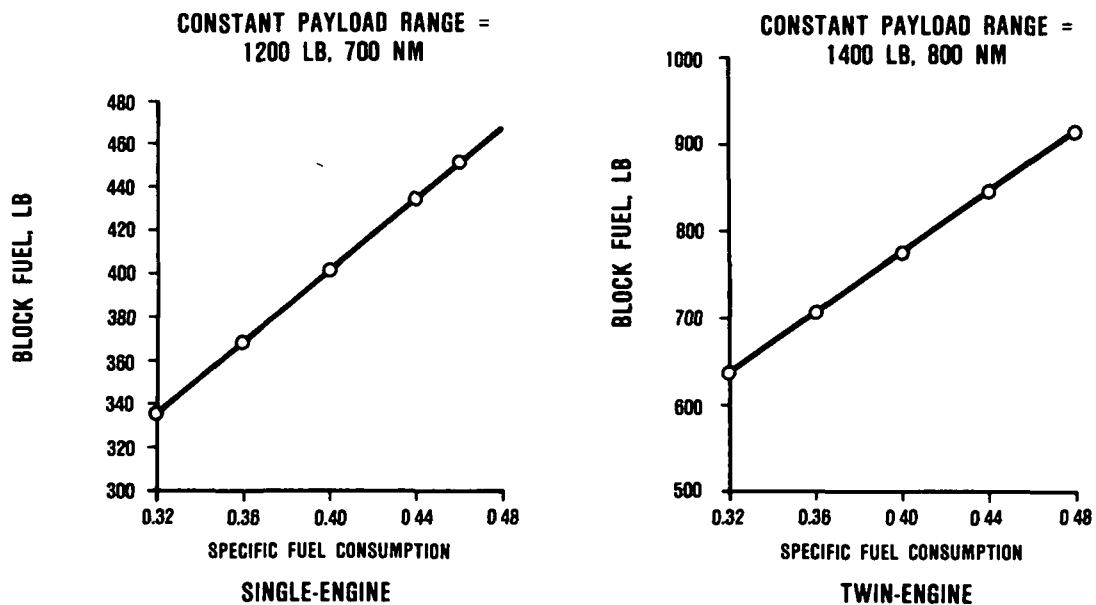

Figure 24. Cessna Airplane Sensitivities to BSFC.

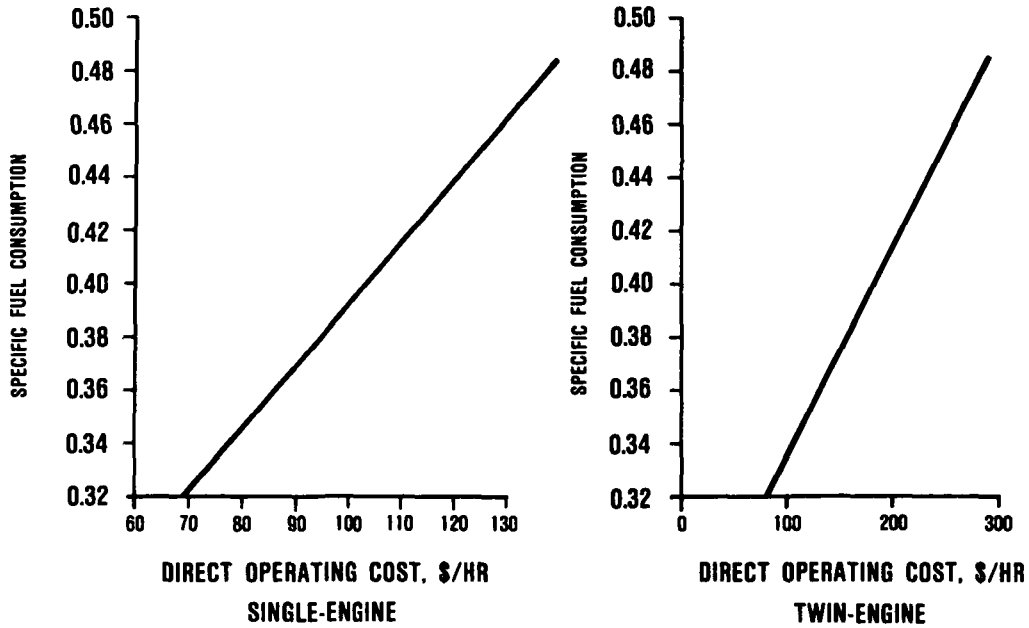

Figure 25. Cessna Airplane Sensitivities to BSFC.

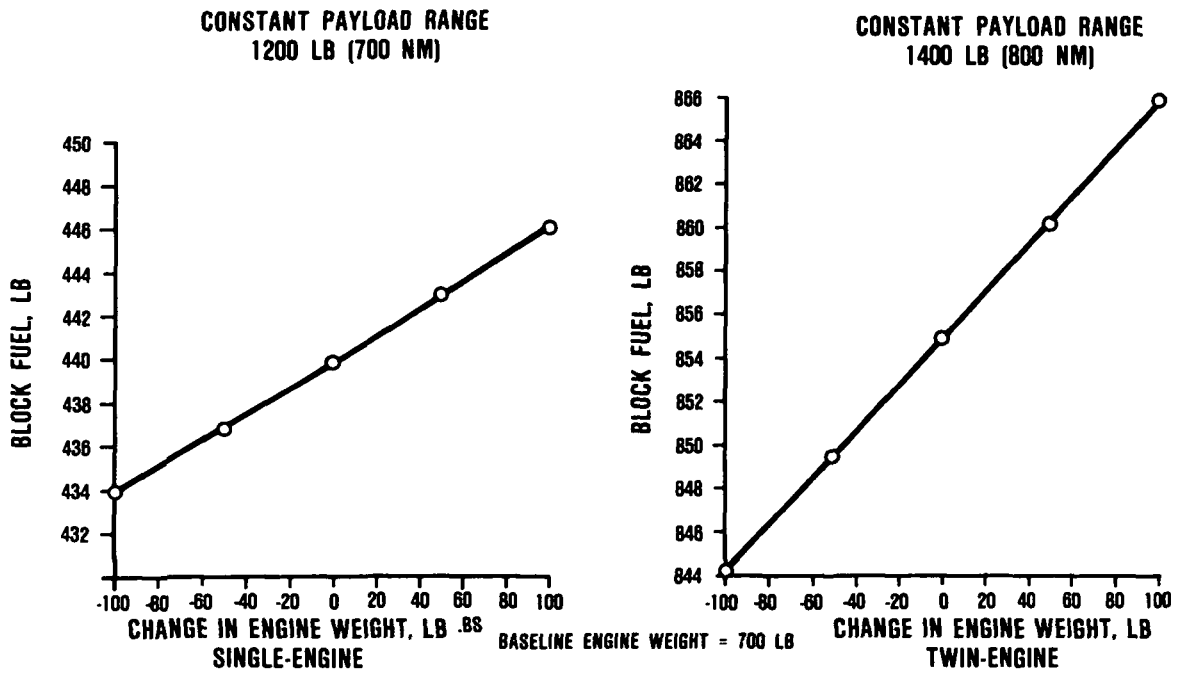

Figure 26. Cessna Airplane Sensitivities to Engine Weight.

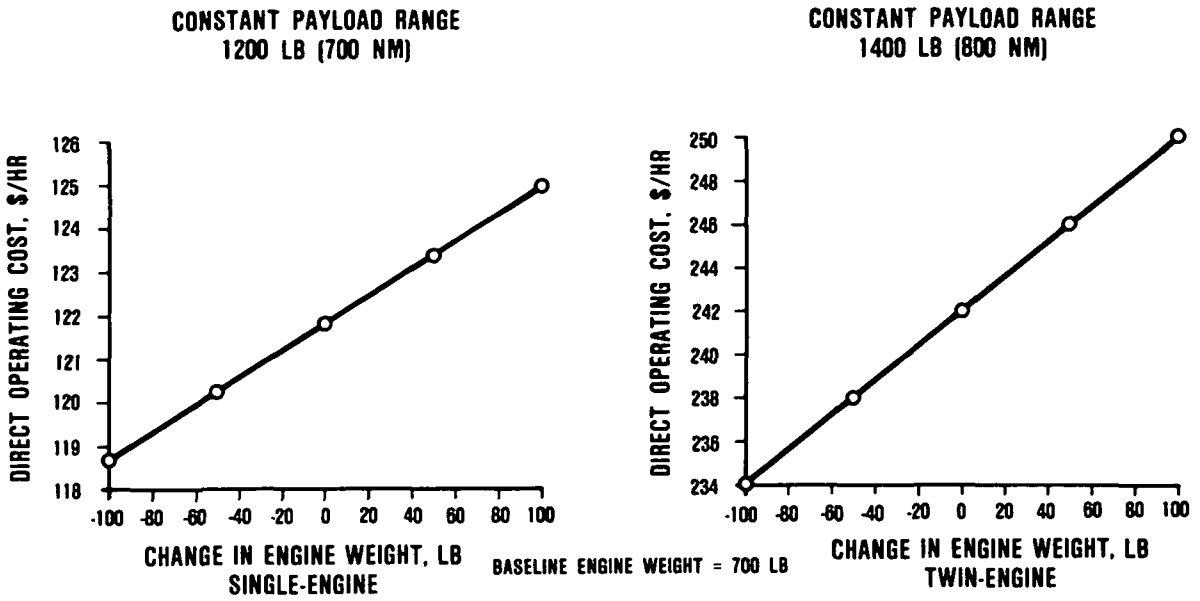

Figure 27. Cessna Airplane Sensitivities to Engine Weight.

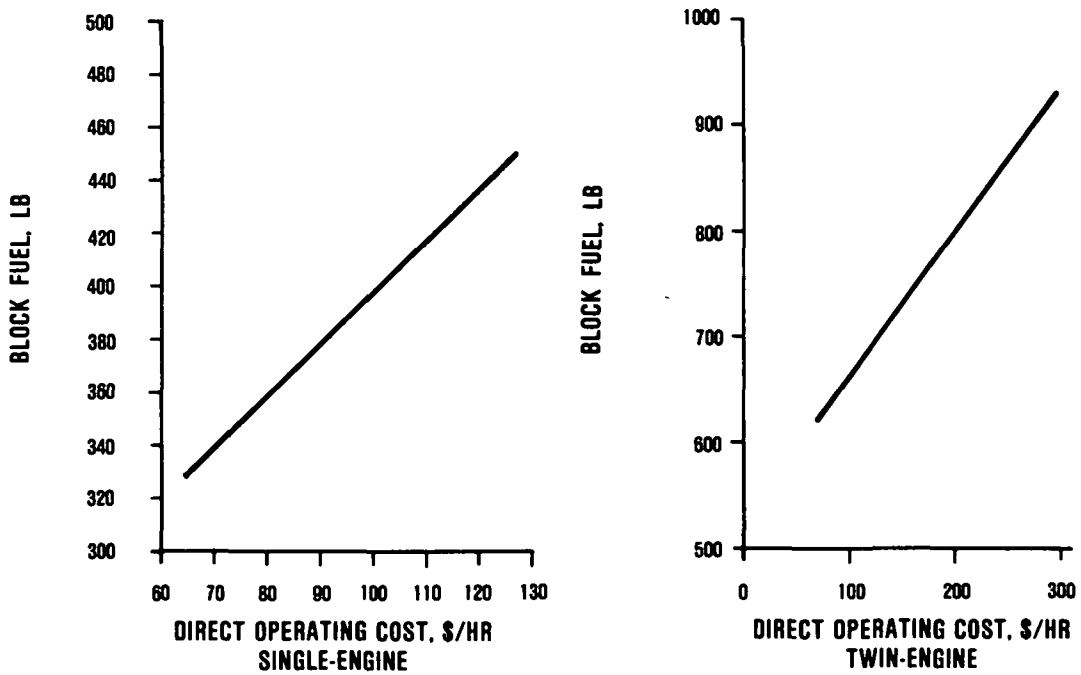

Figure 28. Cessna Airplane Sensitivities to Block Fuel.

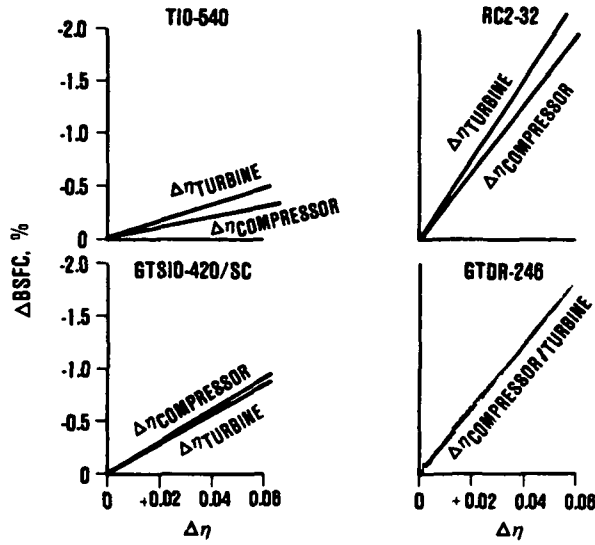

Figure 29. Turbocharger Component Sensitivities.

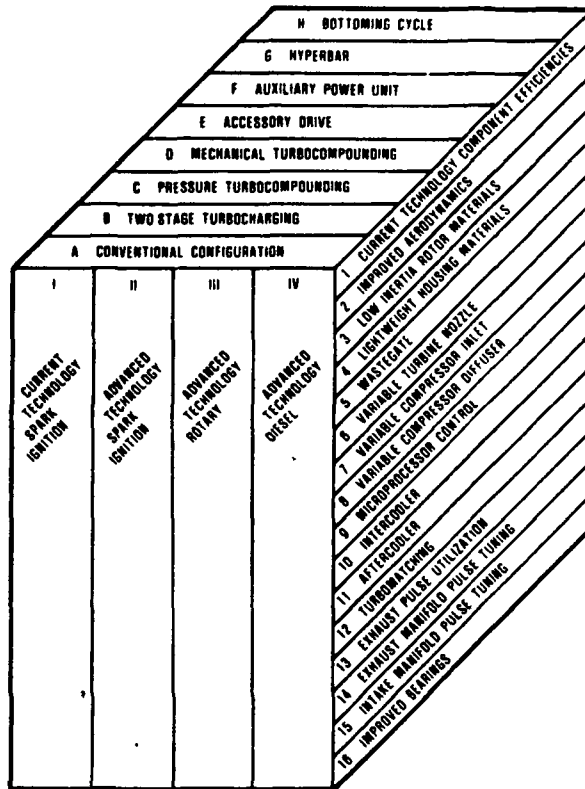

Figure 30. ATDS Tradeoff Study Matrix.

TABLE 34. INDIVIDUAL COMPONENT TECHNOLOGY TRADE-OFFS FOR ATDS.

	SCREENED FOR INDIVIDUAL ENGINES	SCREENED AS A TECHNOLOGY	REASON
COMPONENT TECHNOLOGY			
Compressor efficiency	--	X	(2)
Turbine efficiency	--	X	(2)
Advanced rotor materials	--	X	(2)
Variable compressor geometry	--	X	
Variable turbine geometry	X	--	
Microprocessor control	X	--	
Intercooler/aftercooler	X	--	
CYCLE TECHNOLOGY			
Two-stage turbocharging	X	--	
Pressure turbocompounding	--	X	(1)
Mechanical turbocompounding	X	X	Evaluated for elimination, but not for inclusion.
Hyperbar system	--	X	
Turbocharger matching	--	X	(1)
Exhaust pulse utilization	X	--	
Exhaust pulse tuning	X	--	Beneficial if no pulse utilization.
Intake pulse tuning	--	X	(2)
Bottoming cycles	--	X	Excessive weight penalty.
DESIGN OPPORTUNITIES			
Compact designs	--	X	(2)
Improved bearings	--	X	(2)
Turbocharger-driven accessories	--	X	
Turbocharger in APU mode	--	X	
Lightweight housing materials	--	X	
(1) Consideration is implicit in the turbocharger match. (2) Beneficial to all engine systems; only consideration is cost of improvement.			

TABLE 35. OPTIMIZED TIO-540 SI RECIP ENGINE, CURRENT TECHNOLOGY.

TURBOCHARGER REQUIREMENTS	BASELINE SYSTEM	TRADEOFF SYSTEM	EVALUATION POINTS
	Wastegate	Variable-geometry turbine	
Compressor P/P	3.5	3.2	
Turbine P/P	3.0	2.5	
Benefit relative to baseline		-1% BSFC	+7
Penalty relative to baseline		+1% cost	-10
	Σ Evaluation		-3

TABLE 36. OPTIMIZED GTSIO-420/SC HIGHLY ADVANCED SCSI RECIP.

TURBOCHARGER REQUIREMENTS	BASELINE SYSTEM	TRADEOFF SYSTEM	EVAL POINTS	TRADE-OFF SYSTEM	EVAL POINTS
Components	Turbocompound, wastegate	Noncompounded variable-geometry turbine		Noncompounded, wastegated turbine	
Compressor P/P	Power turbine and wastegate 3.0	Variable turbine nozzle 2.4		Wastegate 2.7	
Turbine P/P	2.0	1.7		2.3	
Power turbine P/P	2.5	-		-	
Benefit relative to baseline		No separate power turbine and transmission (weight and size)	+26	No separate power turbine and transmission	+26
Penalty relative to baseline		Variable-geometry turbine housing 7.4%-cruise BSFC	-12 -52	8.4%-cruise BSFC	-59
	Σ Evaluation		-38		-33

TABLE 37. OPTIMIZED GTDR-246 HIGHLY ADVANCED DIESEL.

TURBOCHARGER REQUIREMENT COMPONENTS	BASELINE SYSTEM	TRADEOFF SYSTEM	EVALUATION POINTS	TRADEOFF SYSTEM	EVALUATION POINTS
	Single-spool turbo, aftercooled; variable geometry	Two-spool Turbo, aftercooled		Single-spool turbo, Not aftercooled	
	One turbo with turbo-driven accessories	Two turbos in series		One turbo	
Compressor P/P	7.2	2.8 ea			
Turbine P/P	5.6	2.5 ea			
Benefit relative to baseline		Aerodynamic commonality commercial market	+27	-3.0% BSFC, no aftercooler	+21 +5
Penalty relative to baseline		Weight, size, and extra ducts (cost) Extra aftercooler Or high-temp., Two-Stage Compressor	-43		
	Σ Evaluation		-16		+26

Note: All systems may require intercooler to limit engine intake temperature.

turbosystems were evaluated for their contribution to system performance. Table 39 shows evaluation point assignments for each of these features. Results of these comparisons are shown in Table 40, in which similarities to different engine requirements are outlined.

TABLE 38. OPTIMIZED RC2-32 HIGHLY ADVANCED SCSI ROTARY.

TURBOCHARGER REQUIREMENTS	BASELINE SYSTEM	TRADEOFF SYSTEM	EVAL POINTS	TRADE-OFF SYSTEM	EVAL POINTS
Components	Free-floating aftercooled One turbo	Two-spool aftercooled Two turbos in series		Free-floating nonaftercooled One turbo no aftercooler	
Compressor P/P	5.5	2.5 ea		5.7	
Turbine P/P	5.4	2.5 ea		5.1	
Benefit relative to baseline		Commonality with commercial market	+14	-3.8% BSFC and no aftercooler	+27 +5
Penalty relative to baseline		Weight, size and extra ducts (cost) extra aftercooler or high-temp., two stage compressor	-16		
	Σ Evaluation		-2		+32
NOTE: All systems may require wastegate or variable-geometry turbine to limit firing pressure. Intercooler may be required to limit engine intake temperature.					

TABLE 39. TECHNOLOGY TRADE-OFF EVALUATION POINTS.

TURBOCHARGER REQUIREMENT	CURRENT SI RECIP TI10-540		SI RECIP GTSIO-420/SC		ADVANCED SI ROTARY RC2-32		DIESEL GTDR-246	
	BSFC	COST	BSFC	COST	BSFC	COST	BSFC	COST
Intercooler/aftercooler	Required		Required		Not Used		Not Used	
Wastegate	Required		Required		Not Used		Not Used	
Variable-geometry turbine	--	--	--	--	--	--	--	-24
Fixed-vane turbine inlet	3	-3	5	-4	Required		Not Used	
Vaned compressor diffuser	2	-3	5	-3	Required		Required	
Turbine exhaust diffuser	2	-1	3	-1	Required		Required	
Turbine pulse utilization*	3	0	5	0	13	0	9	0
Intake tuning	-1	-1	0	-1	2	-2		-1
Intercooler improvement	18	-6	0	0	Not Used		Not Used	
Microprocessor control	0	-7	0	-8	0	-8	Required	
Lightweight rotor/housing	0	-4	0	-5	0	-5	0	-5
Lightweight compressor housing	0	-2	0	-2	0	-2	0	-2
*Questionable with wastegate								

TABLE 40. TURBOCHARGER REQUIREMENT COMMONALITY.

TURBOCHARGER REQUIREMENT	TIO-540 CURRENT SI RECIPI	GTSIO-420/SC SI RECIPI	RC2-32 SI ROTARY	GTDR-246 DIESEL
Compressor airflow, lb/min	35.9	34.4	45.5	52.2
Compressor pressure ratio, %	3.9	3.1	5.9	6.5
Turbine inlet temp, °F	1370	1690	1230	1245
Turbine pressure ratio, %	3.4	2.1	5.3	4.2
Intercooler	Yes	Yes	NO	NO
Wastegate	Yes	Yes	NO	NO
Variable-geometry turbine	No	NO	NO	Yes
Fixed-vane turbine inlet	No	Yes	Yes	NO
Vaned compressor diffuser	No	Yes	Yes	Yes
Turbine exhaust diffuser	Yes	Yes	Yes	Yes
Turbine pulse utilization*	Yes	Yes	Yes	Yes
Intake tuning	No	NO	Yes	Yes
Intercooler improvement	Yes	NO	NO	NO
Microprocessor control	No	NO	NO	Yes
Lightweight rotor/housing	No	NO	NO	NO
Lightweight compressor housing	No	NO	NO	NO

*Questionable with wastegate

The alternate system evaluated for the TIO-540 spark ignition engine was the same as the baseline engine (i.e., a current production turbocharger system, except for the substitution of a variable-geometry turbine nozzle for the wastegate). A charge air cooler is desirable to maintain power during climb to altitude, but is not essential in obtaining cruise power at altitude. For current systems, the turbocharger is generally matched so that the wastegate is nearly closed at both high-altitude and economy-cruise power. Using a variable-geometry turbine correctly matched at this point should produce little improvement in cruise fuel economy. The cost of incorporating a variable-geometry design will depend on the degree of its incorporation in other high-production applications. In turn, this acceptance depends on achievement of a low-cost, effective means of clearance control around the movable vanes.

Two alternate systems were evaluated for the GTSIO-420/SC engine. The baseline system selected by the engine designers included a wastegate and mechanical turbocompounding. To quantify the benefits of these components, one of the systems incorporated a conventional, wastegated, noncompounded system and the other was defined with a noncompounded, variable-geometry turbine nozzle. Benefits and penalties of the variable-geometry turbine parallel those established for the TIO-540 engine configuration. The compound turbine significantly improved cruise BSFC; moreover, the advantages in fuel economy and operating cost were not outweighed by weight and system cost increases.

The RC2-32 engine was designed without an exhaust bypass or variable-geometry turbine, but included an aftercooler. The alternate systems evaluated for the RC2-32 engine were a series turbocharger system (meeting the high-pressure requirements associated with commonly available turbochargers) and a nonaftercooled, single-stage turbocharger system. The lower cost realized with the series system were outweighed by the added complexity of the installation, including either an interstage cooler or a special high-temperature compressor wheel for the high-pressure stage. Though eliminating the aftercooler decreases both weight and cost and increases thermal efficiency, it could prove desirable in reducing thermal and mechanical stresses.

The system evaluation for the GTDR-246 engine followed that of the the RC2-32 engine, due to the similar pressure ratios and fuel/air ratios of each. Inclusion of variable-geometry turbine nozzle or a wastegate is necessary to limit the back-pressure that would impair scavenging efficiency.

The RC2-32 engine was selected as the reference engine for which the conceptual turbocharger design of Task III was to be performed, limiting the effort required to a single turbocharger design, since the requisite turbocharger parameters were most representative of those for all of the advanced engines.

Estimated manufacturing costs were based on the relatively small manufacturing quantities of a turbocharger specially designed for an aircraft. This initially led to the selection of conventional turbine and housing materials and the use of oil-lubricated journal bearings. However, subsequent direction by NASA reduced the relative importance of cost in the selection of technologies for the conceptual design. This allowed the incorporation of air-lubricated bearings, lightweight turbine materials and housings in the design. The resulting recommended features incorporated in the conceptual design are shown in Table 41.

Variable turbine nozzle vanes were eliminated before conceptual design features were established because of relatively high manufacturing costs. This technology was considered again during a later program review. Tables 35 through 38 showed that variable geometry offers a significant performance improvement when compared to wastegate control and is an important part of the baseline system for the diesel engine. Reduction of the relative importance of cost makes the performance improvements the dominant consideration. While variable nozzle vanes have been demonstrated in laboratory turbochargers, durability and leakage through clearances around the vanes have hindered incorporation in high-performance production turbochargers. These problems are expected to yield to determined development efforts. However, determining the optimum nozzle control scheme for the best engine performance and fuel economy will constitute a significant advancement of technology.

TABLE 41. RECOMMENDED FEATURES FOR RC2-32 TURBOCHARGER CONCEPTUAL DESIGN.

- o Single-spool
- o Vaned compressor diffuser
- o Fixed vane turbine nozzle
- o Turbine exhaust diffuser
- o No intercooler
- o No wastegate
- o Air bearings
- o Ceramic turbine rotor

3.3.3 Exhaust Pulse Utilization

3.3.3.1 RC2-32 Engine

NASA requested further study of exhaust pulse utilization for the RC2-32 engine. To accomplish this, a University of Manchester Institute of Technology (UMIST) Mark 12 Engine Simulation Computer Program was used. This computer program simulates pressure waves in manifolds, without requiring details of the combustion process. The RC2-32 rotary engine was modeled as a 6-cylinder reciprocating engine with short ducts between gas exchange ports and the manifolds. This model was the best available simulation of exhaust ports that serve three combustion chambers. Crankshaft angles were reconciled to the UMIST Program by considering an imaginary output shaft turning at two-thirds actual crankshaft speed. Port areas were estimated from scaled plots of rotor position in the trochoid, including the effects of assumed pocket geometries in the rotor faces (Figures 31 and 32). The four engine configurations were:

- o Two turbochargers mounted close to the engine, each receiving exhaust gasses from one rotor
- o One turbocharger mounted close beside the engine, receiving exhaust gasses from both rotors

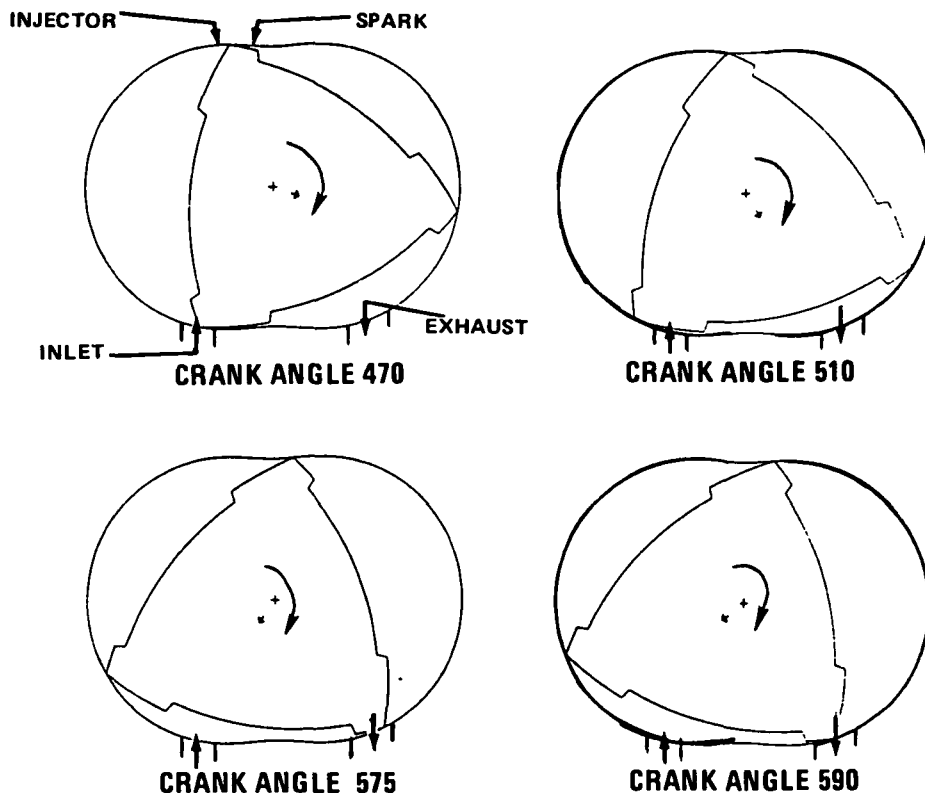

Figure 31. Port Opening/Closing Geometries.

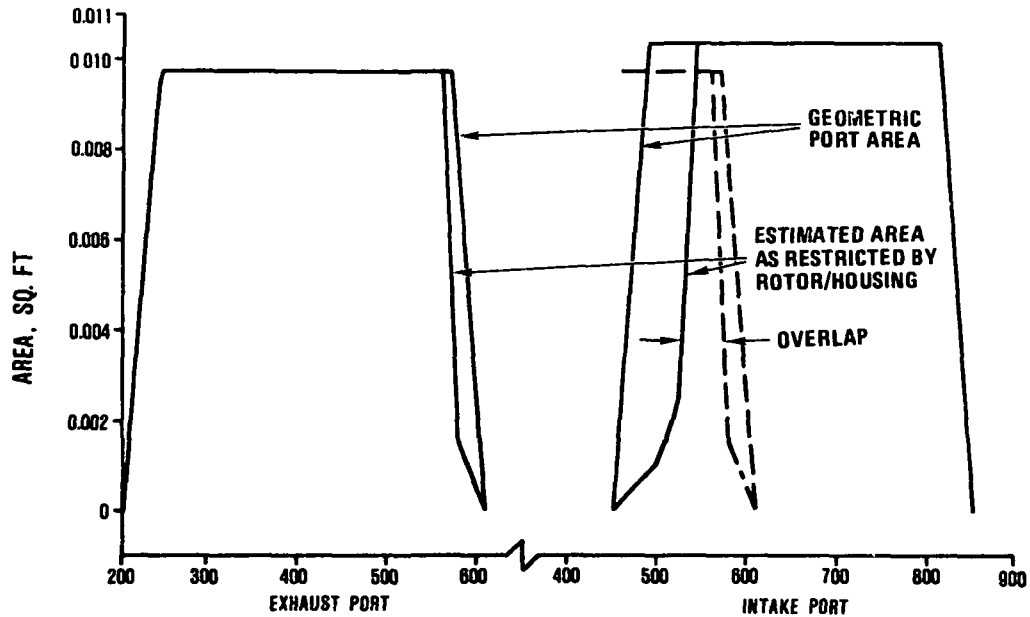

Figure 32. Port Effective Areas.

- o Two turbochargers mounted to the rear of the engine, each receiving the exhaust gasses from one rotor
- o One turbocharger mounted to the rear of the engine and receiving the exhaust gasses from both rotors.

The effects of using one turbocharger per rotor or of placing the turbines close to the exhaust ports minimized exhaust manifold volume and increased pulse amplitudes in the exhaust stream. Most of the exhaust flow occurred at turbine pressure ratios greater than the time average (Figure 33). This caused an increase in the power that could be extracted by a theoretical adiabatic expansion of flow from exhaust manifold conditions. However, the wide variation in turbine inlet pressure during one exhaust pulse caused a poor match between the gas velocity entering the turbine wheel and the wheel speed, that reduced instantaneous turbine efficiency at extremes of inlet pressure (Figure 34). Therefore, power extracted by a real turbine with larger pulse amplitudes may be increased by a smaller proportion (relative to the performance of a constant-pressure system) than the power extracted by an ideal turbine. Energy recovery integrated over the engine cycle is compared for the four possible turbocharger mounting arrangements in Figure 35.

To properly evaluate the benefits of increased utilization of pulse energy in exhaust, various offsetting effects were considered. Each difference in energy extraction by the turbine was used to estimate a difference in average back pressure on the engine in

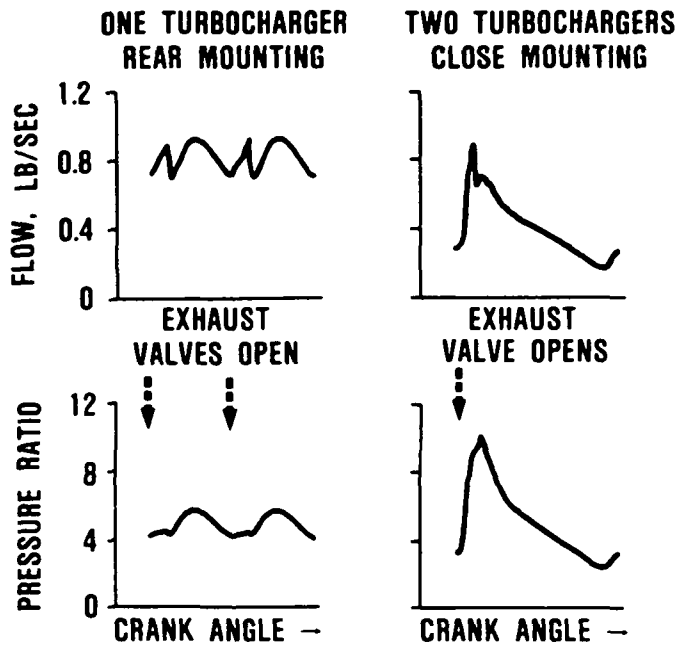

Figure 33. Turbocharger Location Tradeoff for RC2-32 Engine (25,000 Ft, 250 HP).

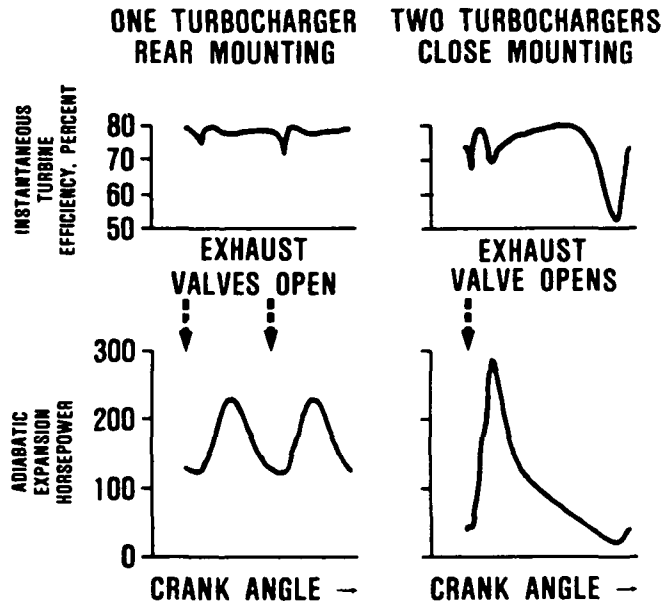

Figure 34. Exhaust Energy Recovery for RC2-32 Engine (25,000 Ft, 250 HP).

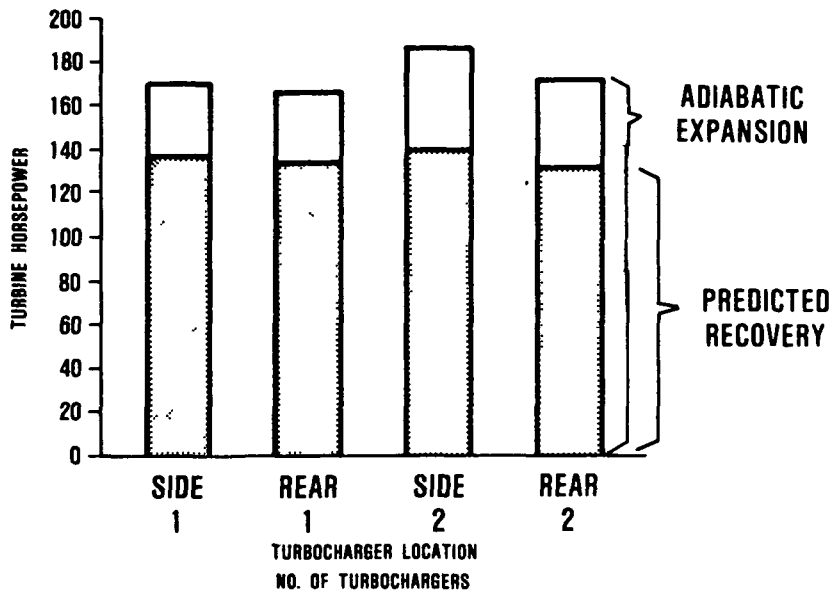

Figure 35. Exhaust Configuration Influences Energy Recovery by Turbocharger for RC2-32 Engine (25,000 Ft, 250 HP).

cases where the turbine was resized to extract just enough energy to drive the compressor. This estimate was accomplished parametrically to avoid excessive use of computer time in iterating conditions and turbine parameters to obtain an exact match. The torque exerted on the rotor was also integrated to compare differences due to pressure fluctuations during the gas exchange process. Finally, the effects of differences in power required to overcome drag of an appropriate nacelle were estimated for each configuration. These effects are shown in Figure 36, where the effect for each engine is measured as the amount of improvement from an arbitrary baseline for that effect.

Cylinder pressure simulations for different configurations of exhaust system and turbocharger showed noticeable engine performance differences during the gas-exchange period. The pressure plot for the single, rear-mounted turbocharger system showed a pressure wave in the engine inlet port and combustion chamber that was timed to produce significant torque on the rotor. This intake tuning effect overcame the exhaust system performance advantage of individual, side-mounted turbochargers. Since pulse timing is a critical factor, further studies should be conducted to provide insight into the best use of this effect on the engine.

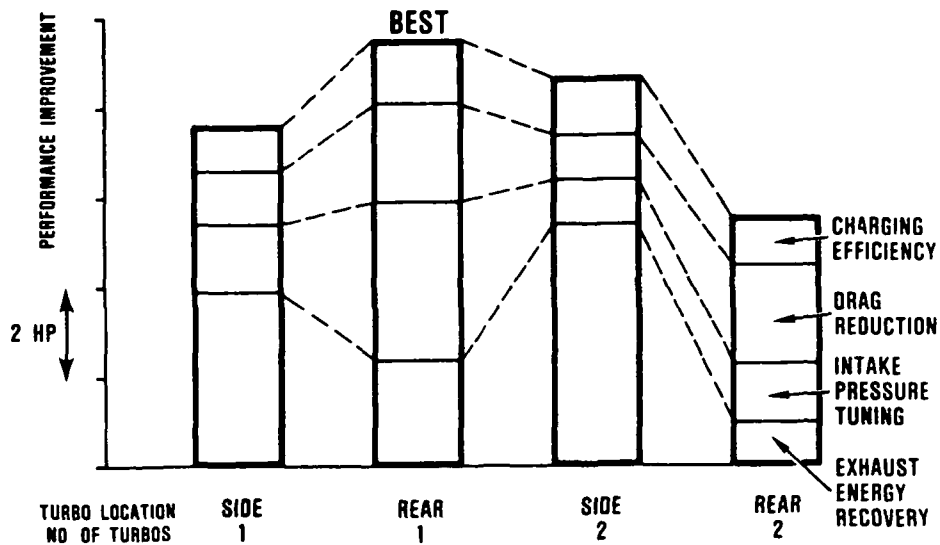

Figure 36. Turbocharger Location Affects Available Engine Power for RC2-32 Engine (25,000 FT, 250 HP).

3.3.3.2 GTSIO-420/SC Engine

Results similar in form to those for the RC2-32 were obtained in a less detailed evaluation conducted on the GTSIO-420/SC exhaust system, where the performance of a partially divided exhaust configuration⁽²⁾ was compared to a fully divided exhaust system. The divided system included separate turbines, or a single divided turbine, with a smaller total manifold volume. To obtain substantially better exhaust energy recovery, a 10-fold volume reduction was necessary. Results of the comparison are shown in Figures 37, 38, and 39. It is recognized that such a drastic volume reduction would be extremely difficult to obtain without a substantial redesign of the GTSIO-420/SC exhaust system and turbocharger installation.

3.3.3.3 GTDR-246 Engine

The 2-stroke diesel engine was not susceptible to improvements made by exhaust pulse energy recovery. Techniques that increase pulse recovery also momentarily increase exhaust manifold pressure. This increase in exhaust pressure reduces engine scavenging flow, subsequently reducing combustion efficiency.

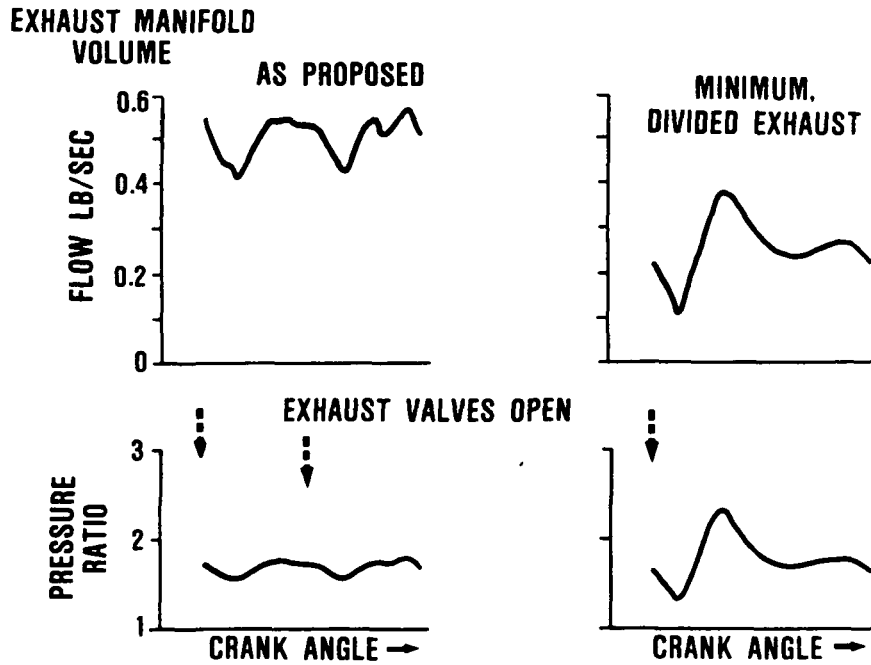

Figure 37. Effect of Exhaust Manifold Volume for GTS10-420/SC (25,000 Ft, 250 HP).

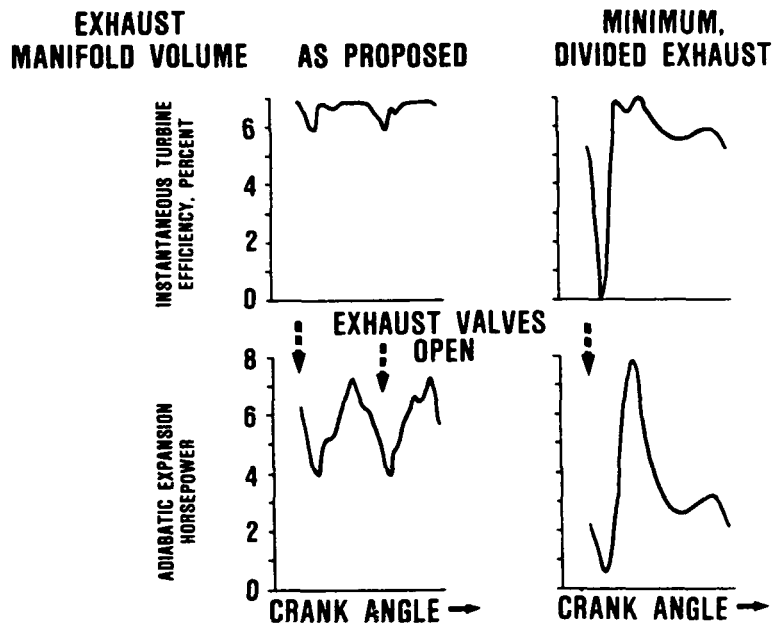

Figure 38. Exhaust Energy Recovery for GTS10-420/SC (25,000 Ft, 250 HP).

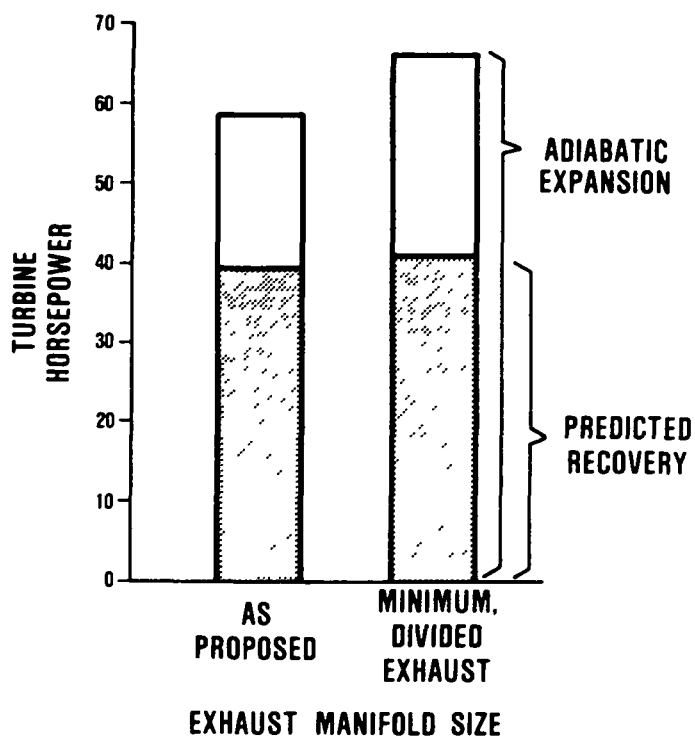

Figure 39. Exhaust Energy Recovery (GTSIO-420/SC 25,000 Ft 250 HP Divided Exhaust System).

3.3.4 Engine Vibration

Because of their lower load capacity, air bearings are more sensitive than oil-film bearings to engine and turbocharger rotor vibration. The vibration estimates for the three advanced technology engine candidates are presented in Table 42. The RC2-32 engine vibration study was conducted by Curtiss-Wright. The GTDR-246 engine vibration estimates were made from an analysis of reaction torque. This was based on a NASA bearing load profile(2) which was then adjusted for engine speed and power rating. The vibration estimates for the GTSIO-420/SC were made through comparisons with vibration characteristics of existing TSIO engines.

3.4 Turbocharger Conceptual Design

Task III included layout design and performance estimates for the turbocharger. An estimate of production cost and market penetration for the designed unit had been originally planned as part of this task; however, the program was redirected to de-emphasize economic considerations. Instead, efforts were extended in the area of exhaust pulse utilization analyses and in foil bearing design.

TABLE 42. ATDS ENGINE VIBRATION ESTIMATES.

ENGINE	MAXIMUM VIBRATION LEVEL (g)	FREQUENCY OF MAXIMUM VIBRATION (Hz)
RC2-32	5g ⁽¹⁾	314
GTDR-246	3.6g ⁽²⁾	233
GTSIO-420/SC	7g ⁽³⁾	160
<p>(1) Vibration at periphery of engine</p> <p>(2) Vibration at turbine bearing as (Figure 3-6, NASA CR-3261)</p> <p>(3) Vibration of turbocharger centerline as (Figure 23, NASA CR-165162).</p>		

The turbocharger requirements of the three advanced technology engines were sufficiently different that one design could not satisfy the requirements of all three. Many requirements of the RC2-32 engine were also characteristic of the other engines; i.e., the RC2-32 engine turbocharger was more representative than one designed for either of the reciprocating engines.

The airflow requirements were reviewed for the compressor and turbine and are shown in Table 43. It was determined that 26 percent of the compressor flow does not have to be delivered at peak pressure ratio.

The conceptual design effort consisted of establishing the flow path for the compressor and turbine based on the flows and temperatures already established. Pressure ratios were determined from estimated aerodynamic efficiencies and engine airflow characteristics (Table 44). Thus, the size and speed of the rotating group allowed the geometry of the gas-lubricated foil bearings -- including their spacing -- to be established. Off-design performance was estimated, and layout and envelope drawings were prepared. The following paragraphs discuss the details of this effort.

3.4.1 Compressor

A preliminary design optimization study for the compressor design point indicated that maximum efficiency would be obtained at

TABLE 43. RC2-32 TURBOCHARGER FLOW REQUIREMENTS
(25,000 Ft., 250 BHP).

Requirement	FLOW (LB/MIN)	
	Compressor	TURBINE
Engine combustion	36.5	36.5
Engine scavenge	3.7	3.7
Cabin pressurization	9.0*	--
Bearing cooling	4.9*	--
Fuel	--	1.5
Total	54.1	41.7
	(0.90 lb/sec)	(0.70 lb/sec)

*Bleed may be obtained from an intermediate pressure level

TABLE 44. COMPONENT DESIGN POINTS FOR 25,000-FOOT
CONDITION (200 TO 225 KTS, 250-ENGINE BHP).

PARAMETER	COMPRESSOR	TURBINE
Pressure ratio	6.15	5.04
Corrected flow, lb/sec	2.2 (0.90, physical)	0.81 (0.70, physical)
Efficiency, %	76.5	82.0
Inlet temperature, °R	440	1620
Inlet pressure, psia	5.46	27.5
Corrected speed, rpm	85,576 (80,000, physical)	45,300

approximately 60,000 rpm. However, preliminary matching with the turbine on the basis of maximum combined efficiency showed the desirability of 80,000-rpm speed. This 80,000-rpm design speed slightly compromised compressor performance. However, it resulted in optimum turbocharger system performance, since the turbine optimized at much higher rotating speeds. In addition, this higher speed resulted in a more compact unit.

The centrifugal impeller for the ATDS turbocharger is a 50-degree, backward-curved design incorporating 15 main blades and 15 splitter blades. The radial diffuser incorporates 22 vanes and exits through a 90-degree bend into a collecting scroll which, in turn, feeds the intake manifold (Figure 40).

This design was scaled from an existing, demonstrated gas turbine engine compressor. While the ATDS compressor required a different mechanical configuration, the aerodynamic features of the design were consistent with proven design criteria. The expected compressor performance map is shown in Figure 41, with relative design parameters listed in Table 45. This design was selected because it has demonstrated performance in the flow regime below 5-lb/sec, and because the configuration could be manufactured using known processes.

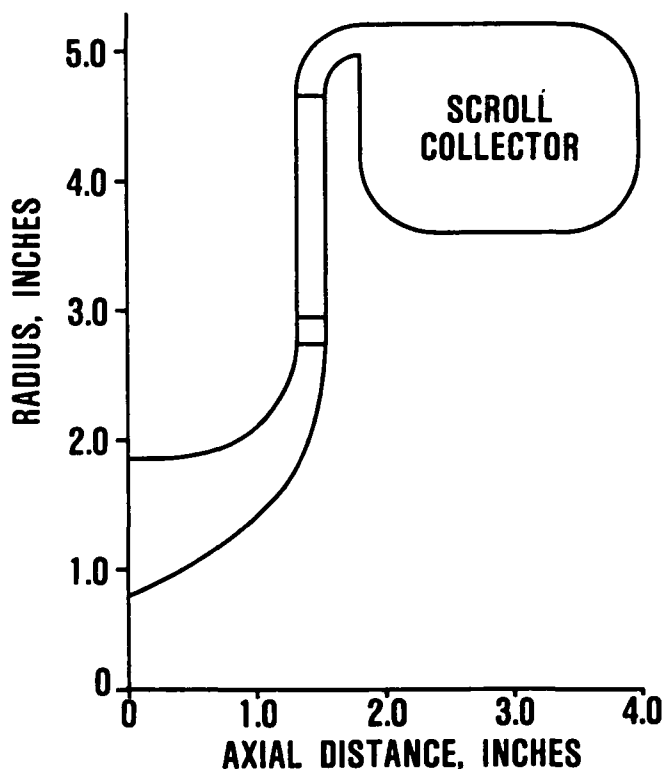

Figure 40. Compressor Flow Path is Compact.

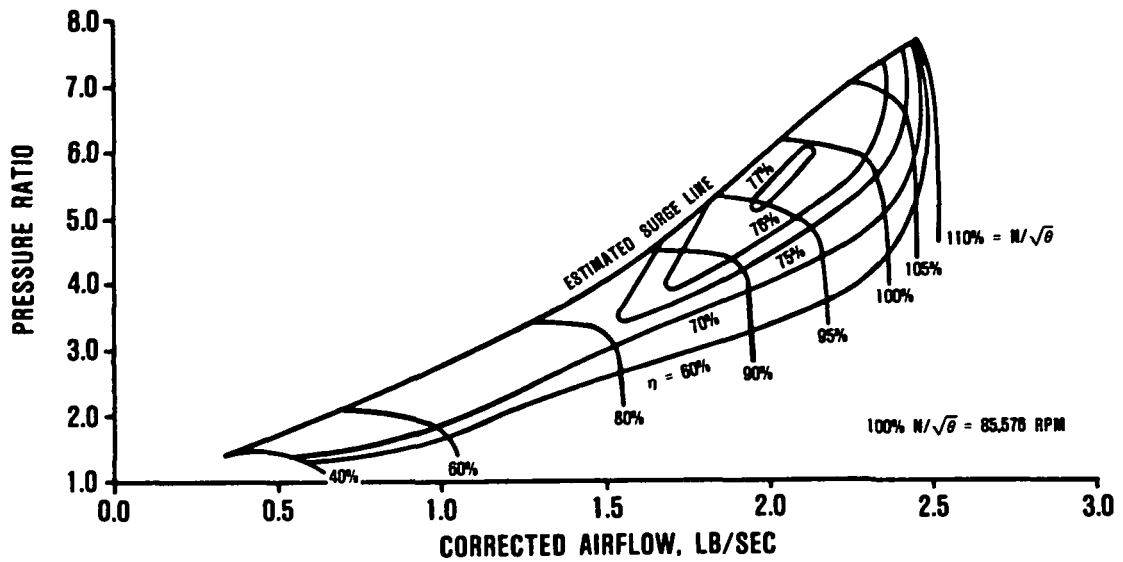

Figure 41. High Efficiency and Pressure Ratio are Major Advancements.

TABLE 45. COMPRESSOR AERODYNAMIC DESIGN.

PART	DESCRIPTION
Blade, qty.	15 (full) + 15 splitter blades
Vane, qty.	22
B Width, inch	0.218
Corrected flow, lb/sec	2.2
Corrected speed, rpm	85,576
Pressure ratio	6.15 (total-static)
Impeller tip diameter, inch	5.40
Impeller inlet diameter, inch	3.55
Diffuser exit diameter, inch	9.64
Diffuser inlet diameter, inch	5.90

Mechanical design of impellers in the 1700- to 1800-ft/sec tip-speed range is a well-developed technology. Therefore, the impeller mechanical design analysis was omitted in order to more thoroughly examine areas of greater uncertainty, such as ceramic turbine rotor design and use of foil bearings to support the rotating group.

3.4.2 Turbine Aerodynamic Design

The ATDS turbine design included the definition of the gas path from inlet of the 90-degree elbow (upstream of the scroll) to the diffuser exit plane. The design objective was to maximize turbocharger performance while maintaining the required geometric envelope. For the ATDS Program, the turbine stator/rotor were first sized and then assessed for the feasibility of acceptable scroll configurations and exhaust diffusers.

A parametric study was conducted to define the geometric and velocity diagrams for candidate stator/rotor configurations. To accomplish this, specific speed and stage work coefficients were varied over a wide range. Candidate turbines with diameters greater than the maximum envelope were disregarded. To optimize overall performance, the products of turbine total-to-total efficiency and the corresponding compressor efficiency were calculated for the remaining configurations. The turbine providing the maximum product of compressor and turbine efficiencies was then optimized and is shown in Figure 42.

The turbine scroll was defined using the results of the parametric study. Because of the maximum performance requirement, a carefully configured geometry was chosen. A large inlet-to-exit area ratio and overall symmetry about the stator were established to ensure low losses due to secondary flows.

The exhaust pipe from the engine was located at a 90-degree angle to the scroll inlet. To ensure desirable scroll inlet flow conditions, a low-loss "arthritic" elbow⁽³⁾ was incorporated.

Since no diffuser length limit was set, the exhaust diffuser was designed with a high (0.76) pressure recovery coefficient, as shown in Figure 43. This maximized turbine total-to-static performance.

The parametric study resulted in a candidate blade shape similar to the GTEC AGT101 ceramic turbine rotor blade. The turbine velocity diagram and performance curves are presented in Figures 44 and 45. A comparison of this design with current industrial capability (Figure 9) showed that further technology efforts are required to meet this goal.

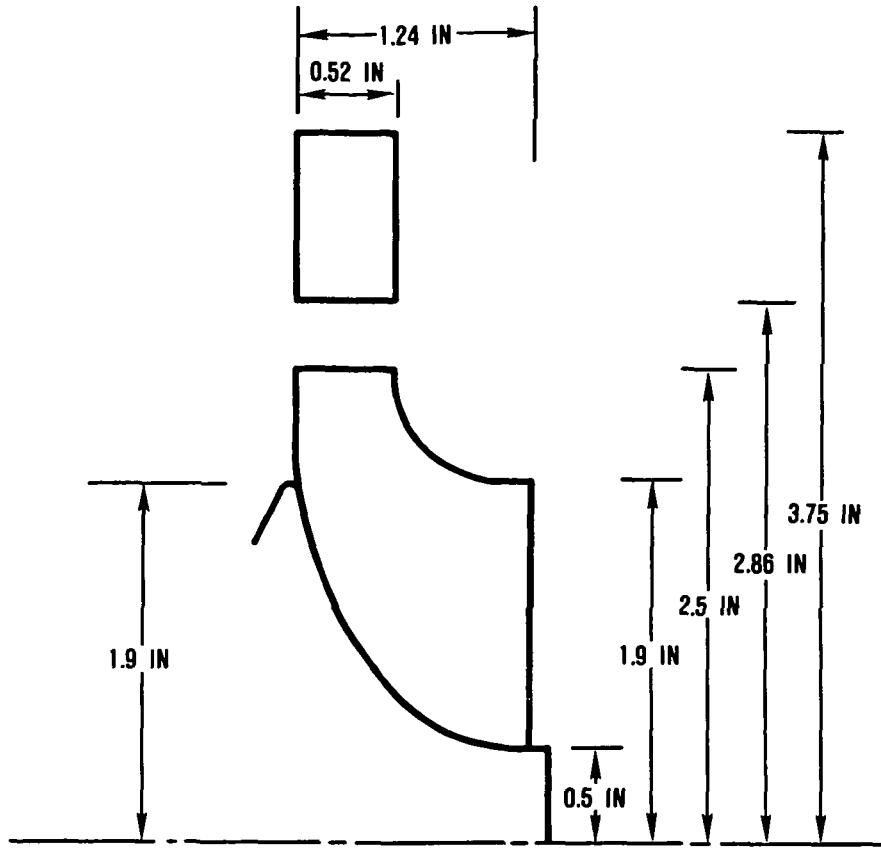

Figure 42. Turbine Stator and Rotor Flow Path.

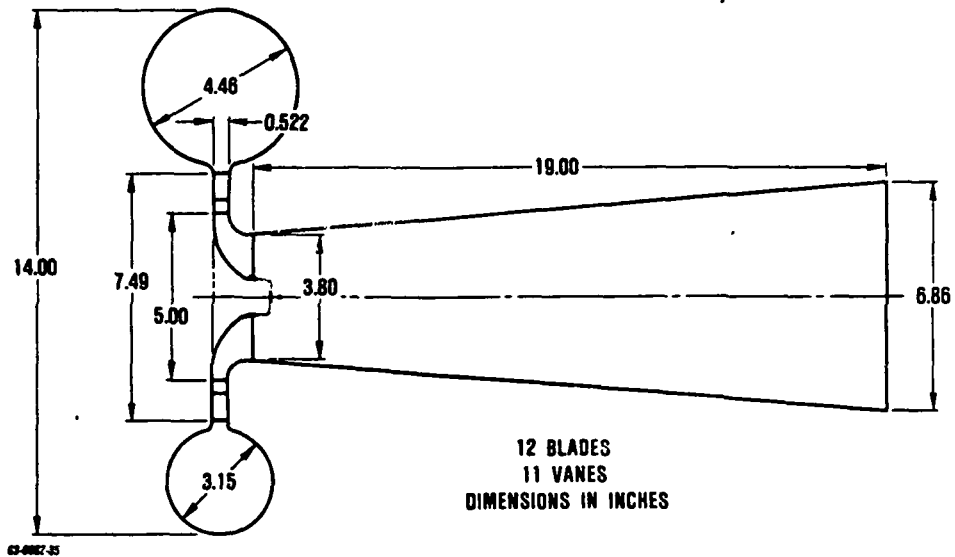

Figure 43. High Turbine Efficiency Dictates Long Flow Path.

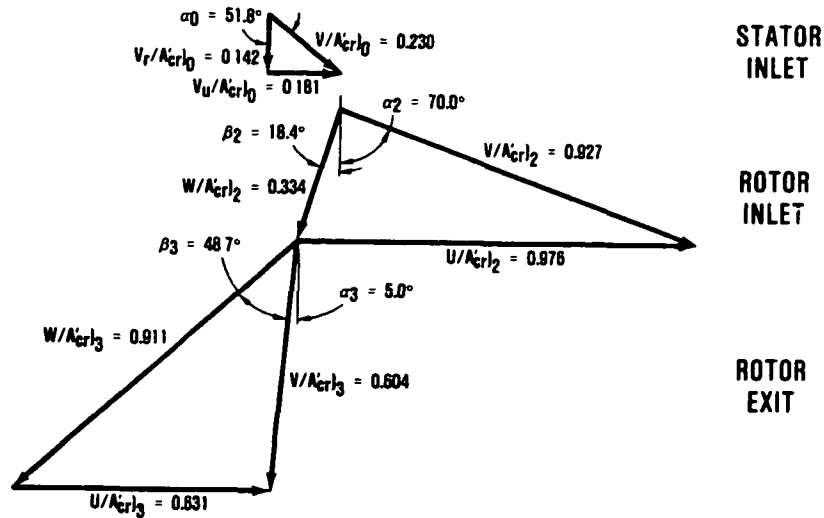

Figure 44. Advanced Turbocharger Stage Inlet and Exit Diagrams.

Further turbine performance optimization is needed during the detailed design process since the wheel is not stress-limited, and additional performance can be gained by increasing tip speed. Since the physical speed is fixed, tip speed can only be increased by increasing the rotor-tip radius. To maintain the given envelope, a trade-off of scroll and stator/rotor performance is necessary.

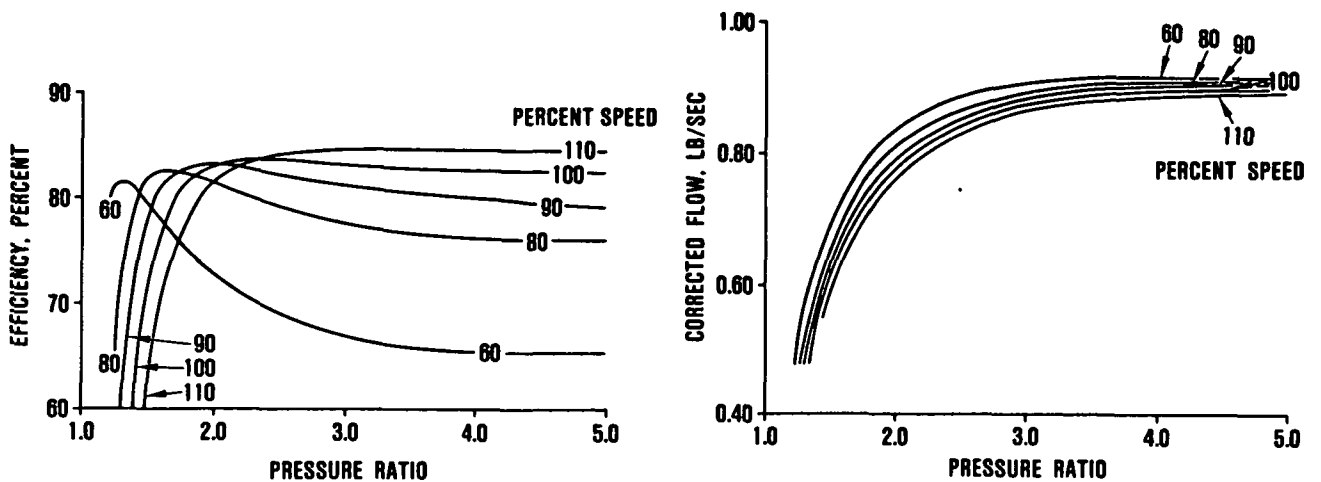

Figure 45. Required Turbine Performance is Close to State-of-the-Art.

Increasing performance by increasing tip speed is a routine turbine design effort. However, assessing scroll performance decrements will require rigorous analyses and development testing. The proposed approach is to design a mixed-flow stator; that is, one having an axial component of velocity in addition to the normal radial and tangential components. This will allow the scroll to be offset in the axial direction such that the maximum radius constraint will not be violated. The scroll configurations will be optimized using GTEC's 3-D finite-element program, while the stator will be defined using the GTEC 3-D viscous finite-difference procedure. Stator end-wall contouring will be required to minimize the secondary flow losses resulting from the nonsymmetric scroll configuration. Using axial-radial turning in the stator instead of in the scroll will result in the advantage of a higher rate of flow acceleration within the stator.

3.4.3 Turbine Rotor Mechanical Design

Stress calculations were performed on the ceramic turbine wheel, including stress-rupture, vibration, and maximum stress levels. Results showed that a radial wheel aerodynamic design is mechanically feasible as a ceramic component. No stress-rupture life limitations were encountered. For the stress-rupture analyses, maximum allowable stress for the Si_3N_4 ceramic part was set at ≤ 20 ksi.

The GTEC 3-D vibration program, ISOVIB, was used to calculate the resonant frequencies, the normal displacements, and the relative stress levels of each vibratory mode. The normal mode shapes for the first ten modes are shown in Figure 46. The frequencies associated with the first eight modes are shown on the Campbell diagram, Figure 47. The criterion used to enhance the probability of success for wheels of this type is to keep the lower order frequencies above the expected 4/rev excitation source. As shown in Figure 47, the lowest mode was above 6/rev at 111-percent turbine design speed (89,017 rpm), which can be experienced at 20,000 feet at climb power.

To meet the stress requirement of all airfoil points at ≤ 20 ksi, the GTEC life analysis program, 6WIBUL, was used to determine the required taper ratio at critical locations at the airfoil (Figure 48). The blade area ratio required to meet the stress requirement was 7.23:1 (i.e., area at the hub line divided by the area at the tip). The inducer thickness was held at 0.030 inch. The inducer radius was 2.5 inches, with a hub-line radius at the discharge of 0.50 inch. This hub-line radius, tip thickness, and area ratio yielded a blockage at the hub line (i.e., worst case) of 56.9 percent. The maximum blockage at the exducer at 20-ksi maximum stress was 12.76 percent.

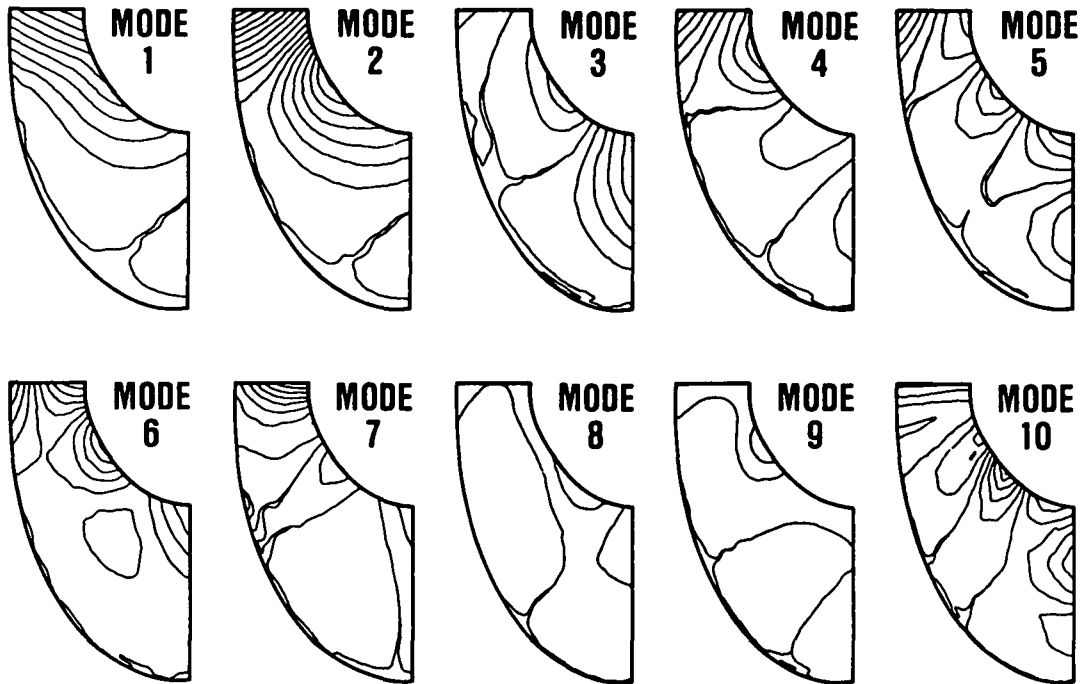

Figure 46. Turbine Blade Vibration Study Shows Basic Concept Feasibility.

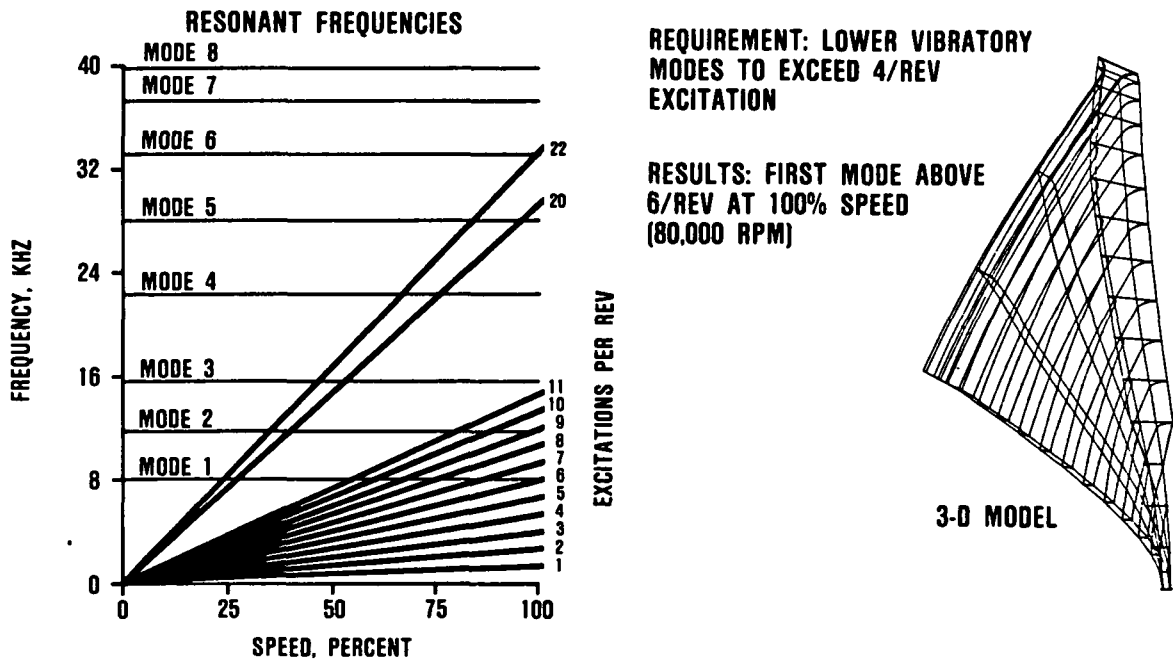

Figure 47. Blade Natural Frequencies are Greater Than the Minimum Requirements.

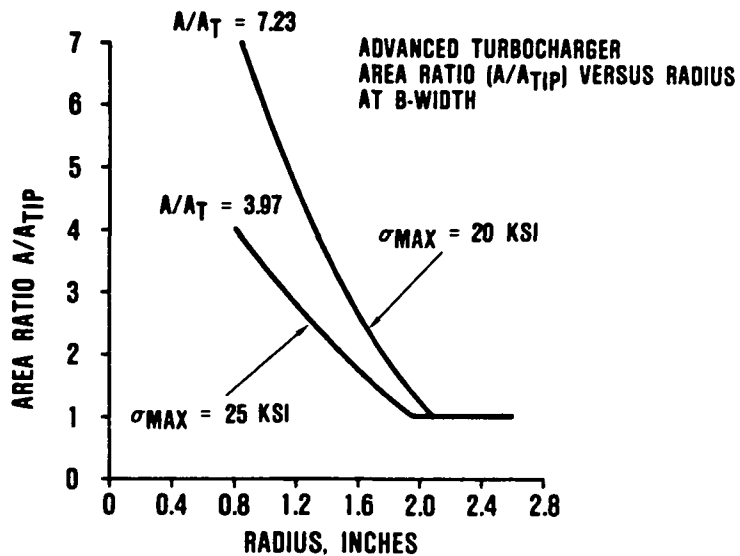

Figure 48. Turbine Rotor Blade Taper Chosen for Low Stress.

Since the wheel was not stress-rupture limited, the area ratio optimized for maximum stress-rupture life could not be achieved. The ≤ 20 -ksi stress requirement was used as the criterion for establishing the taper ratio of the airfoil. A ceramic turbine wheel has already been successfully operated at 20-ksi by GTEC for the AGT-101 Program.

In the ATDS ceramic turbine rotor feasibility study, no stress or vibration problems were indicated that would prevent initiation of a detailed design effort. However, prior to committing a part to a production development effort, the following should be investigated:

- o Detailed 2- and 3-D analyses should be conducted to verify the integrity of parts prior to development and production.
- o Although high strengths were obtained in test specimens and wheels, surface and embedded flaws in some parts created stress concentrations which could cause higher than tolerable stresses. Additional materials testing should be performed to quantify the effects of long hold times at high speeds, and the effects of speed and temperature cycling on the long-term properties of ceramics.

3.4.4 Ceramic Turbine Rotor Material and Process Analysis

It is recognized that the use of ceramic rotor materials yields less weight and eventually leads to lower costs. Less weight, in turn, means less inertia thus lower gyroscopic reactions and faster acceleration/deceleration. Moreover, this decreased weight allows the use of foil bearings, which a heavier rotor would not permit. Due to the fracture properties of ceramic materials, burst containment shielding can be decreased, thus reducing the overall weight of the turbine housing. Projected lower turbine costs were based on the projected lower cost and high availability of ceramic raw materials when compared to metal alloys. Fabrication costs of ceramics are also predicted to be lower than for metal alloys.

GTEC has extensive experience in analysis and test evaluation of both Si_3N_4 and SiC rotating components. Sintered silicon nitride (Si_3N_4) was selected for the ATDS turbine rotor because it exhibited high strength at the planned operating temperature. Moreover, elastic modulus of Si_3N_4 is lower than silicon carbide (SiC), thus reducing component stress. The strength of Si_3N_4 ceramics is increasing at a faster rate than SiC .

Injection molding techniques were selected for fabrication because they are a demonstrated production method that produces close-tolerance ceramics.

Significant accomplishments have been made in the fabrication of ceramic components for both DOE and DOD advanced heat engine programs. These advances have provided evidence that operation of ceramic parts in high-temperature engine environments is feasible. Current ceramic development programs, particularly those for ceramic rotors, have been aimed at feasibility demonstrations only, and not at developing sufficient technology to warrant full-scale production development. These programs have demonstrated that a sufficient technology base is needed consisting of additional material and process development, design methodology, and a data base for life prediction prior to commitment to development and commercial production of reliable, cost-effective ceramic engine components.

3.4.5 Turbocharger Design Details

The preceding evaluations resulted in the ATDS turbocharger layout shown in Figure 49. The spacing between the two rotor housings was determined by the dynamics of the rotating group in a foil-bearing suspension system. The weight breakdown and bill-of-material are shown in Figure 50 and Table 46, respectively. This weight is approximately one-half that of a turbocharger with the same impeller diameter and using current design approaches. Envelope drawings of the turbocharger are shown in Figure 51.

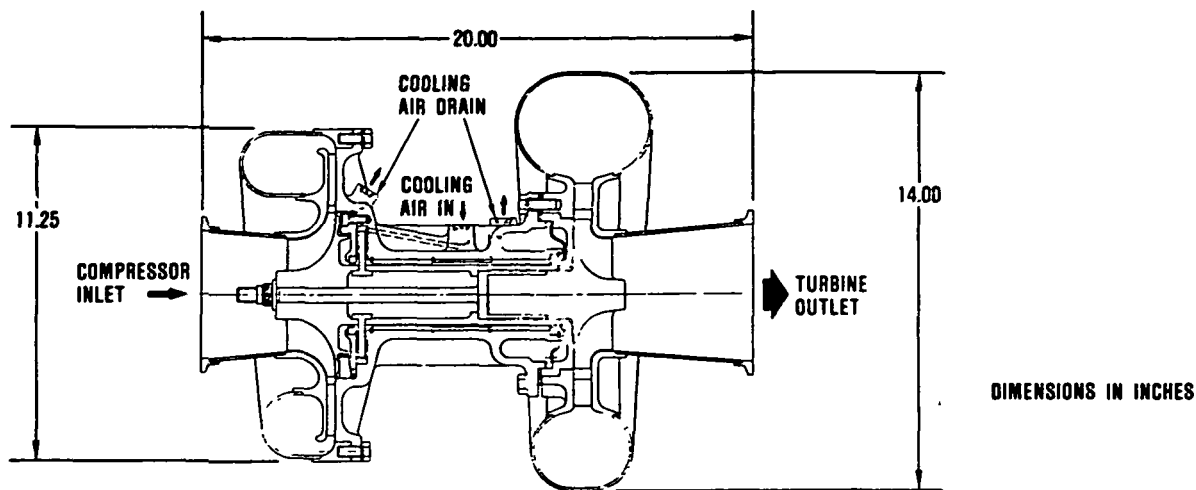

Figure 49. ATDS Turbocharger Cross Section.

The only constraint placed on turbocharger size was a maximum diameter not greater than the 16-inch diameter of a RC2-32 engine. The high pressure-ratio and efficiency requirements of the RC2-32 engine necessitated a much larger turbocharger size than for current units. However, ATDS technology represents higher specific

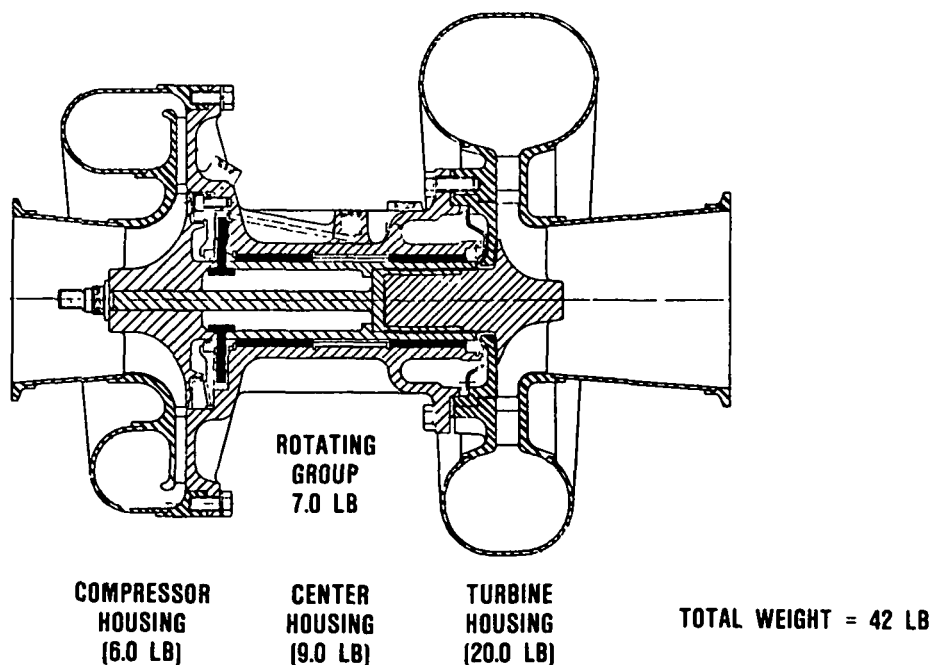

Figure 50. Advanced Turbocharger Weighs Half of Conventional.

TABLE 46. ATDS CONCEPTUAL DESIGN BILL OF MATERIALS.

PART	MATERIAL
Compressor housing assembly brazed	
Shroud and vane ring	Al casting
Scroll	Al sheet
Outer ring	Al stage
Outlet	Al sheet
Outlet flange	Al plate or tube
Inlet cone	Al sheet
Inlet flange	Al plate or tube
Turbine housing assembly - brazed	
Shroud and vane ring	Fe casting
Scroll	CRES sheet
Inlet	CRES sheet
Inlet flange	CRES plate or tube
Outlet cone	CRES sheet
Outlet flange	CRES plate or tube
Center housing and rotating assembly	
Shaft wheel assembly - bonded	
Turbine wheel	Ceramic
Shaft assembly - welded	
Shaft	Steel bar
Cup	Nickel alloy bar
Sleeve	Steel tubing
Thrust disk	Steel bar
Compressor wheel	Titanium
Washer	Steel
Nut	Steel
Center housing assembly	
Center housing	Al casting
Bearing foils - journal	CRES sheet
Bearing springs - journal	CRES sheet
Seal ring	Al bar or tube
Retaining rings - bearing	Steel
Retaining ring - seal	Steel
Bearing foils - thrust	CRES sheet
Bearing springs - thrust	CRES sheet
Seal plate assembly - pressed	
Seal plate	Al casting
Seal ring	Al bar or tube
Cap screws	CRES
Heat shield	CRES sheet
Turbine shroud	Fe casting
Shims	CRES sheet
Bolts	CRES
Lock washers	CRES
Shims	CRES sheet

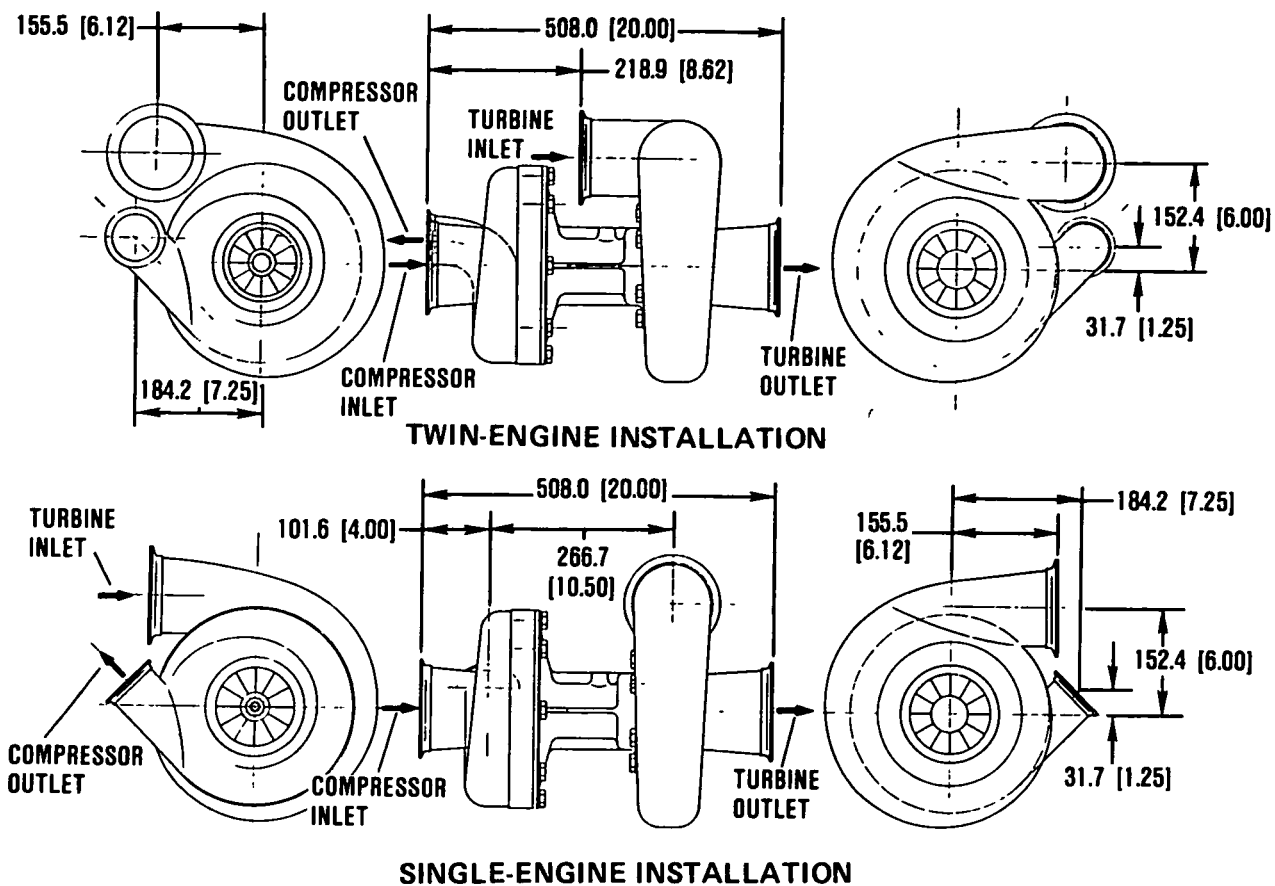

Figure 51. ATDS Conceptual Design Outline.

power (i.e., turbocharger shaft power divided by airflow) than today's turbocharger. Moreover, overall powerplant size would significantly decrease for an equivalent power output, due to the higher working fluid density and higher peak cycle pressure.

Overall performance of the ATDS is better indicated by the power augmentation it provides the RC2-32 engine. Table 47 lists both the turbocharged and nonturbocharged power outputs of the engine at several operating points. The compressor map for the ATDS (Figure 52) shows the engine operating lines at several conditions.

3.4.6 Bearings

A preliminary design study was completed that investigated the feasibility of using gas-lubricated foil bearings on the ATDS conceptual design. The bearing load requirements at different modes of aircraft operation are listed in Table 48, and were based on information received from Cessna. These loads were increased by design margins totaling 72.5 percent for use in journal bearing sizing and load capacity calculations. Total loads were obtained

TABLE 47. RC2-32 RATINGS FOR BOTH TURBOCHARGED AND NONTURBOCHARGED ENGINES.

ENGINE SPEED (RPM)	ALTITUDE (FEET)	ENGINE HORSEPOWER	
		(TURBOCHARGED)	(NONTURBOCHARGED)
9420	0	320	168
	20,000	320	83
7850	0	250	136
	25,000	250	55
6390	0	134	107
	25,000	134	44

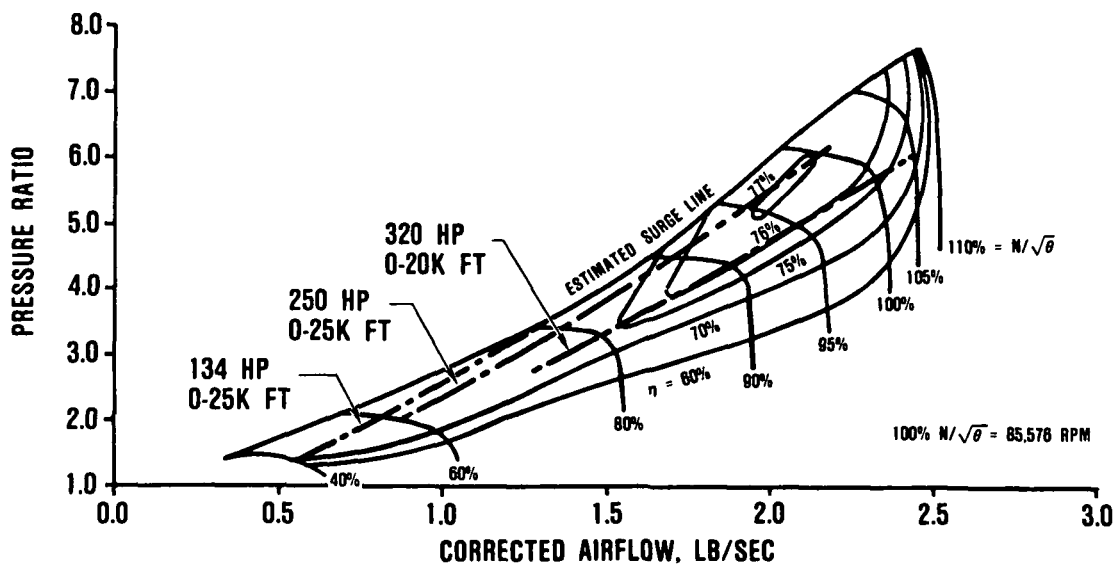

Figure 52. Compressor Performance RC2-32 Engine.

for each mode (Table 49) and compared to bearing load capacity (Figure 53). Detailed calculations were performed on the journal bearings. For this application, the journal bearings are expected to experience more severe loads than the thrust bearings. The loads imposed on the bearings were derived from:

- o Gyroscopic forces from aircraft turn, roll, and spin
- o Engine and airframe vibration

TABLE 48. AIRCRAFT OPERATIONAL MODE AND ASSOCIATED LOADS.

LANDING	
Landing shock loads, g	= 4.25
Aircraft vibration at engine idle, g	= 1.5
Turbocharger speed, rpm	= 25,000
TURNING	
Turn rate	= 75 deg/dec in a 4.0g coordinated turn at 80-degree bank
Aircraft vibration at Cruise throttle, g	= 2.15
Turbocharger speed, rpm	= 45,000
ROLLING	
Roll rate, deg/sec	= 100
Aircraft vibration at throttle, g	= 2.15
Turbocharger speed, rpm	= 45,000
SPINNING	
Spin rate, deg/sec	= 180
Aircraft vibration at engine idle, g	= 1.15
Turbocharger speed, rpm	= 25,000
MANEUVERING	
Maneuvering loads, g	= 4.4
Aircraft vibration at cruise throttle, g	= 2.15
Turbocharger speed, rpm	= 45,000

TABLE 49. BEARING CAPACITY.

AIRCRAFT OPERATING MODE	LOADING		TURBOCHARGER MOUNTING ORIENTATION							
			LONGITUDINAL TO NACELLE			TRANSVERSE TO NACELLE				
			BEARING LOAD	BEARING CAPACITY	BEARING LOAD	BEARING CAPACITY	BEARING LOAD	BEARING CAPACITY		
SOURCE	MAGNITUDE	ACTUAL	DESIGN	REQUIRED	AVAILABLE	ACTUAL	DESIGN	REQUIRED	AVAILABLE	
		Land								
	Landing Loads	4.25g	22.2 lb					22.2 lb		
	T/C Rotor Unbalance at 25 krpm	3.4 lb	3.4 lb					3.4 lb		
	Aircraft Vibration at Engine Idle	1.5g at 200 Hz	7.8 lb					7.8 lb		
	TOTAL		34.9	60.2	15.1	28.0		34.9	60.2	15.1 28.0
Turn										
	Turn Rate	75 deg/sec in a 4.0g coordinated turn at 80°	39.1 lb					39.1 lb*		
	T/C Rotor Unbalance at 45 krpm	11.1 lb	11.1 lb					11.1 lb		
	Aircraft Vibration at Cruise-Throttle	2.15g	11.2 lb					11.2 lb		
	TOTAL		61.4	105.5	26.5	42.0		61.4	105.9	26.5 42.0
Roll										
	Roll Rate	100 deg/sec	--					39.8 lb		
	T/C Rotor Unbalance at 45 krpm	11.1 lb	11.1 lb					11.1 lb		
	Aircraft Vibration at Cruise Throttle	2.15g at 262 Hz	11.2 lb					11.2 lb		
	TOTAL		22.3	38.5	9.6	42.0		62.1	107.1	26.8 42.0
Spin										
	Spin Rate	180 deg/sec	--					39.7 lb*		
	T/C Rotor Unbalance at 25 krpm	3.4 lb	3.4 lb					3.4 lb		
	Aircraft Vibration at Engine Idle	1.15g at 133 Hz	6.0 lb					6.0 lb		
	TOTAL		9.4	16.2	4.1	23.0		49.1	84.7	21.2 23.0

TABLE 49. BEARING CAPACITY (Contd).

AIRCRAFT OPERATING MODE	LOADING		TURBOCHARGER MOUNTING ORIENTATION									
			LONGITUDINAL TO NACELLE				TRANSVERSE TO NACELLE					
			BEARING LOAD		BEARING CAPACITY		BEARING LOAD		BEARING CAPACITY			
SOURCE	MAGNITUDE	ACTUAL	DESIGN	REQUIRED	AVAILABLE	ACTUAL	DESIGN	REQUIRED	AVAILABLE			
Maneuver	Maneuvering Load	4.4g	23.0 lb					23.0 lb				
	T/C Rotor Unbalance at 45 krpm	11.1 lb	11.1 lb					11.1 lb				
	Aircraft Vibration at	2.15g at Cruise Throttle	11.2 lb	262 Hz				11.2 lb				
	TOTAL		45.3 lb	76.1 lb	19.5 psi	42.0 psi	45.3 lb	78.1 lb	19.5 psi	42.0 psi		

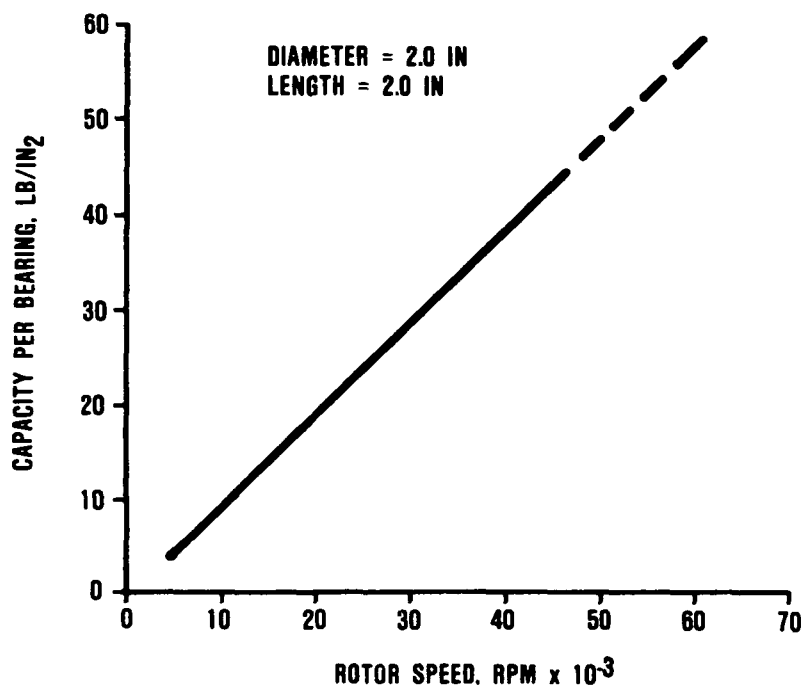

Figure 53. ATDS Foil Bearing Load Capacity.

- o Turbocharger rotor unbalance
- o Landing shock 'g' loads
- o Aircraft maneuvering 'g' loads.

The compressor and turbine wheels designed for the ATDS are similar in size to AID T18A turbocharger wheels. Therefore, physical characteristics of the ATDS turbocharger wheels (i.e., mass, moment of inertia, center of gravity, unbalance forces, etc.) were estimated in relation to the physical characteristics of T18A wheels. In addition, a parallel study of the power loss and load capacity of a T18A sized free-floating sleeve oil journal bearing was completed and used as a basis of comparison for the two bearing designs. Figure 54 presents the power consumption versus load on one journal bearing at 80,000-rpm rotor speed. This is approximately 50-percent of that of an oil-film bearing sized for a comparable turbocharger. However, the additional power required for supplying cooling air is substantially greater than the power required to supply lubricating oil. Depending on the means used for supplying cooling air, the total power demand for an ATDS air bearing would be from 70- to 250-percent of the total power demand of a similarly sized oil-film bearing. The results of this design study showed that:

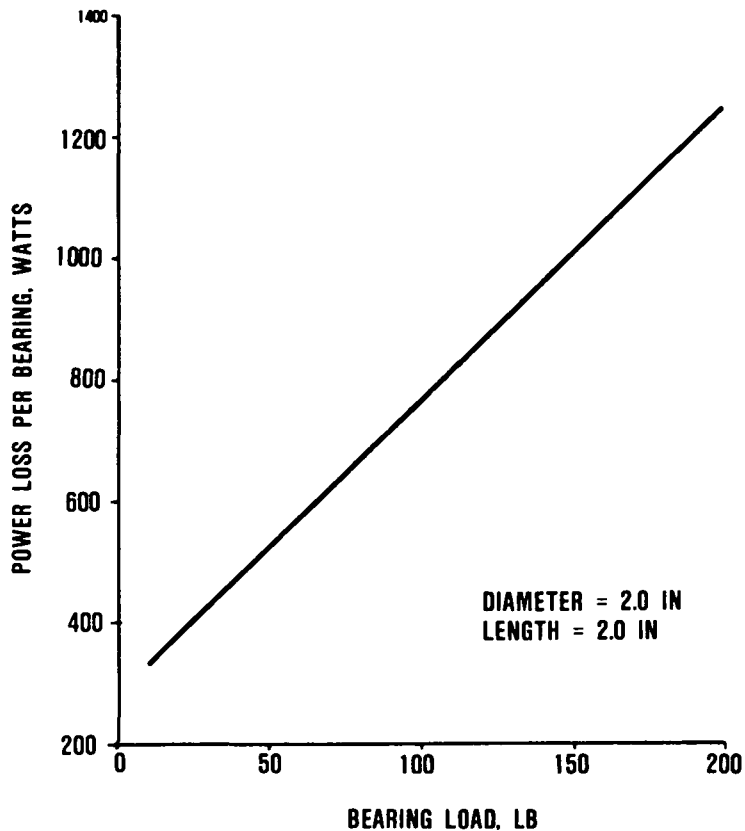

Figure 54. ATDS Foil Bearing Power Consumption.

- o Two 2- x 2-inch air journal bearings [similar to an AiResearch design used on the DC-10 environmental control unit (Figure 55)] will provide sufficient load capacity for the ATDS turbocharger when subjected to aircraft operation loads outlined in Table 49.
- o An aircraft spinning at a rate of 180 deg/sec, at a turbocharger speed of 25,000 rpm at engine idle is expected to be the worst-case operation mode to which the journal bearings are subjected.
- o Load capacity of a 2- x 2-inch air journal bearing at 40,000 rpm turbospeed is 4 times less than that of a T18A-sized oil journal bearing suitable for a similar sized machine.
- o Critical speeds are shown in Figure 56.
- o The power consumption of one air journal bearing at 80,000-rpm turbospeed at aircraft cruise power is 0.60 hp (compared to 1.22-hp power consumption for one T18A-sized oil journal bearing).

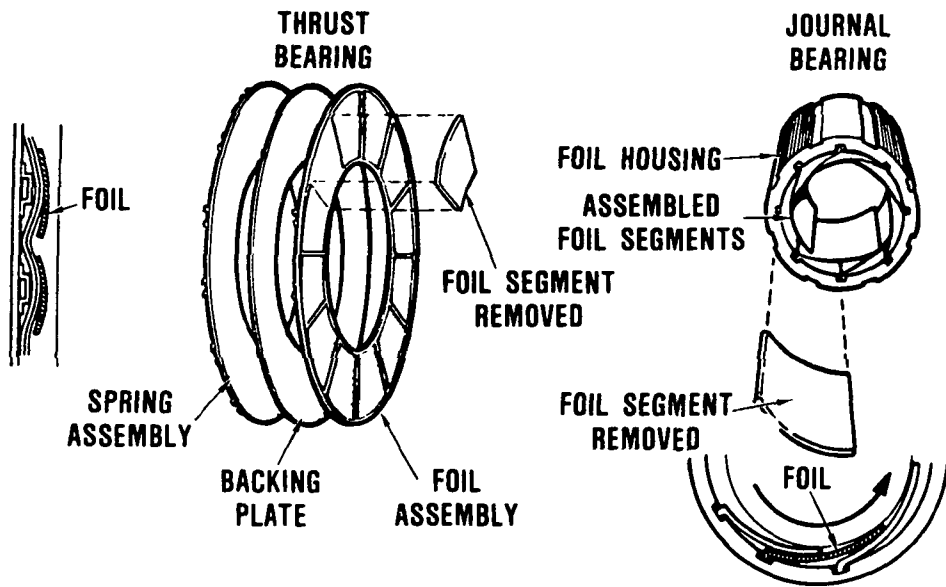

Figure 55. Details of Typical Gas Lubricated Foil Bearing.

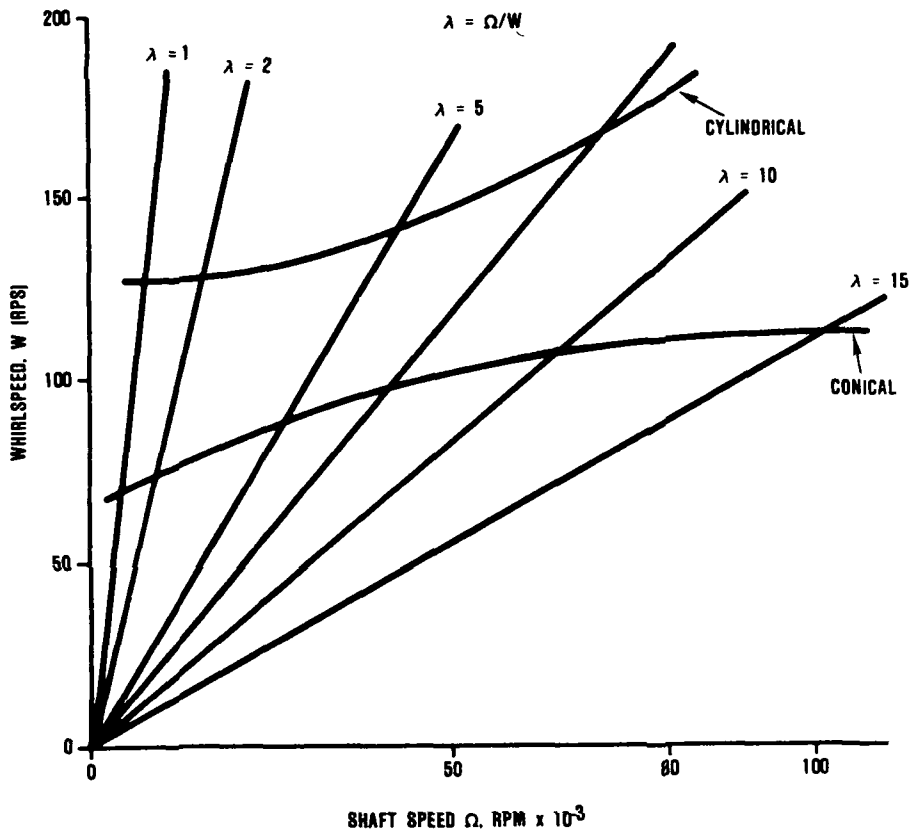

Figure 56. Shaft Whirl Analysis of the ATDS Rotor on Foil Bearings.

- o Bearing design should be optimized after compressor and turbine wheel geometries and other turbine/rotor components are finalized, and after completion of a detailed critical speed analysis of the turbine rotor.
- o Total system power loss should be calculated for each design to compare air bearing and oil bearing designs on the basis of their power consumption. For example, a total power loss for an air bearing design should include power loss due to bearing friction and cycle air-bleed for bearing lubrication and cooling. For an oil bearing design, this should include power losses due to bearing friction and oil supply losses for bearing lubrication and cooling.
- o Further development of high-temperature coatings for foils and journals is also required in order to achieve the reliability currently demonstrated by Teflon and polyamide coatings at moderate temperatures.

A TiC foil coating currently used in conjunction with the Kaman SCA journal coating has demonstrated acceptable bearing performance at temperatures exceeding 1200°F. However, this coating is very brittle and thickness must be maintained at 15,000 Å. While this coating has demonstrated good wear and friction resistance, its thinness raises questions regarding conformability, which is characteristic of relatively thick (~1 mil) low-temperature coatings. Since TiC has no wear-in characteristics, load capacity and wear tolerance is reduced. A high-temperature foil coating that possesses such wear characteristics should be identified.

Page intentionally left blank

Page intentionally left blank

4.0 TECHNOLOGY IMPACT

4.1 Key Technology Requirements

The key technologies required to achieve the proposed ATDS design are listed in Table 50 which includes current status and availability. For turbochargers, the production capability of gas turbine engines was defined as laboratory demonstration capability because of differences in manufacturing technology.

It is evident that high-pressure-ratio compressor efficiency at low flows must be developed. This need is particularly apparent in the case of a turbocharger for aircraft diesel engine applications, where a 7.3-pressure ratio at 83-percent efficiency may be required. The overall industry capability, as previously shown in Figure 8, indicates that this requirement will be the most difficult to satisfy.

TABLE 50. KEY TURBOCHARGER TECHNOLOGY REQUIREMENTS.

REQUIREMENTS	AVAILABLE	UNDER INVESTIGATION	NEEDS ADDITIONAL DEMONSTRATION
High-pressure-ratio aerodynamics		X	X
o Efficiency		X	X
o Flow range		X	X
Foil bearings		X	X
o Cooling		X	X
o Dynamics		X	X
Ceramic turbine			
o Useful materials data base		X	X
Lightweight housings	X		
o Containment	X		
o Acoustics	X		
Gas seals	X		
Engine exhaust system optimization	X	X	

Surge margin (flow range) in high-pressure-ratio compressors is difficult to obtain where higher pressure ratios are demanded. Techniques to increase surge margin should begin by increasing the amount of backward curvature on impeller vanes, and then by progressing to the use of variable diffuser vane angles. To date, development activity in this area has been concentrated at lower pressure ratios for backward curvature, and at higher flows for variable diffuser vanes. Further technology demonstrations are required to ensure that broad surge margins are possible at the flows and pressure ratios required for advanced turbochargers.

Hydrodynamic lubrication processes (including the use of air) generate sufficient friction that a significant part of the air supply required by the bearing is used to remove heat generated by this friction. The turbine-end foil bearing also requires cooling because of the heat conducted from the turbine. The total cooling required is a significant proportion of compressor airflow. As a result of this cooling requirement, considerable incentive exists to identify foil coatings that can withstand higher temperatures and to develop design techniques that reduce aerodynamic losses in the foil suspension system. To do this, further development effort is required.

Cold foil bearing support of a rotor is an existing production capability that is used for aircraft cabin air-conditioning units. Use of hot foil journal bearings (with no thrust loading) has been demonstrated in three gas turbine engines. However, the ATDS design requires full support (journal and thrust bearings) of a hot rotor. This capability has not yet been demonstrated. Furthermore, test experience indicates that the dynamics of the foil suspension favors very light rotors, and that development of high-temperature, low-friction foil coatings is necessary to meet this need. Foil bearings are sensitive to rotor mass, which increases as the cube of linear dimension increases, while bearing capability increases only as a square function. To date, this has prevented the use of foil bearings in larger turbochargers. Moreover, the ability of the foil bearing suspension system to absorb shock or impact loads without rotor contact and foil wear is another uncertainty that requires development effort before foil bearings can be committed to production.

Ceramic turbine rotors have been the focus of much development activity, yet the durability and reliability required for an aircraft turbocharger have yet to be demonstrated. An urgent need exists for a material and process that has consistent, dependable properties. The most ambitious ceramic demonstration programs now in work are just that--demonstrator programs with no durability validation planned. The ATDS Program has shown that continued ceramic material and process development is needed to provide reproducible properties in rotors sized and configured for turbocharger use.

Certification of general-aviation engines to date has been accomplished using turbochargers with thick housings designed to contain a 3-piece burst of a heavy metal wheel. The use of a ceramic rotor will permit the use of a lighter weight turbine housing, since a ceramic wheel burst would generate only lightweight, small-sized particles. This has provided the motivation to develop lightweight housings and more carefully assess their containment capability. The acoustic properties of these lightweight housings must also be studied, since they may transmit significantly increased noise levels. It should be noted that the design and analysis technology for lightweight housings is already well-developed for gas turbines, and additional technology demonstration is not expected to be required.

The use of a foil bearing suspension system could allow greater displacement of the rotating group during transient maneuvers, startups, shutdowns, and impact loading than experienced with conventional bearing support. This could result in more frequent contact with labyrinth seals that are not designed for such contact. This problem could be alleviated with a design that allows easy seal replacement, but a longer-term solution is needed. Abradable seal technology is well-developed in gas turbines, and this approach should be studied as an alternate technique for use in advanced turbocharger designs.

The exhaust optimization studies conducted in Task III indicated that engine/turbocharger installation efficiency will benefit from further work on the intake and exhaust systems. Basic analytical tools are available (i.e., UMIST Mark 12, etc.) but adaptations may be needed for rotary engines.

In summary, further technology demonstration/development programs are required prior to the commitment of the ATDS design for commercial development. These additional efforts are justified by the desirable turbocharger features listed in Table 51. Areas of particular emphasis are listed in Table 52, while the specific factors needing further demonstration are identified in Table 53. These justifications are examined with respect to other market needs in the following paragraphs.

4.2 Overall Market Impact

The turbocharger market can be divided into at least seven categories:

- o General aviation
- o Highway trucks
- o Marine
- o Off-highway vehicles

TABLE 51. TURBOCHARGER FEATURES HAVE BROAD APPEAL.

- o No oil lubrication
- o High-temperature capability turbine
- o Lower weight
- o Higher pressure ratio for higher engine power density
- o Less rotating mass
- o Reduced heat storage
- o High-efficiency aerodynamics

TABLE 52. SUGGESTED AREAS OF EMPHASIS.

COMPONENT	POTENTIAL
Foil bearings	Greatest benefit in engine system reliability improvement
Ceramic turbine	Greatest benefit in weight and transient performance improvement
Compressor	Greatest benefit in system efficiency improvement
Lightweight housing	Greatest benefit in weight and transient performance improvement when combined with ceramic turbine

TABLE 53. FACTORS NEEDING FURTHER DEMONSTRATION.

COMPONENT/PART	ADVANTAGES
Ceramics and foil bearings	Applicable for large-sized components
Foil bearings	Resistance to impact loads
Compressor	Greater flow range for commonality
Ceramic turbine materials	Consistent properties

- o Automobiles
- o Locomotive
- o Ground power (stationary/mobile).

The ground power category was divided into stationary (large) and mobile (small) classes to further illustrate the applicability of the key technologies from the ATDS design. The impact of the entire design, as well as that of the following four key technologies was used to assess the need for ATDS technology:

- o High compressor pressure ratio
- o Full gas-bearing-supported rotor
- o Ceramics for radial turbines
- o Lightweight housings.

The assessment of the turbocharger market impact was based on an ATDS design that was sized for the RC2-32 engine. Therefore, market penetration of the ATDS turbocharger was closely tied to that of the RC2-32 engine. High-altitude operation requires high inlet boost, and, other than general-aviation aircraft, very few applications require significant operation at altitudes over 5000 feet. It was uniformly desirable that the turbocharger and engine lubrication system be separate. Though all other engine applications with a fixed-load operating line require a broad flow-range turbocharger, the diesel does not. Moreover, engines with a wide variation in load require good turbocharger transient response. A standard set of needs and how well they were met by the ATDS was reviewed for each potential market. These were:

- o Increased pressure ratio
- o Mounting attitude insensitivity
- o Small size (volume)
- o Large range of flow capacity
- o Higher efficiency
- o Greater reliability
- o Independence from engine lubrication system
- o Large surge margin
- o Better transient response
- o Impact loading tolerance.

4.2.1 General-Aviation Market - The ATDS Program has shown that the proposed design has the potential for major impact in the general-aviation market. Its four key technologies supply the specific needs listed in Table 54. It is expected that at least three variations to the design will be needed to match the pressure/flow characteristics of Otto, rotary, and diesel engines (expected to be in production in the 1990's). Size and exhaust considerations dictate rear installation. In the event that very high-pressure-ratios are needed by diesel aircraft engines, a two-stage compressor may be required. Ultimately, a turbocharger would be optimized for each engine class, since turbocharger market penetration is tied to individual engine model installations.

4.2.2 Truck Market - By far the largest turbocharger market at this time is for highway truck engines. A number of turbocharger models are available for this market, with approximately 200,000 units-per-year produced. Truck engines require a turbocharger with good transient response and broad surge margin (Table 55). At high pressure ratios, both requirements could be met using single-stage units with variable geometry. Another way to meet this requirement is to use two stages in series, or possibly two-spool units. Small size is almost as critical a factor as with aircraft applications. The high utilization of trucks places a premium on efficiency over

TABLE 54. GENERAL-AVIATION MARKET.

NEEDS	ATDS-SUPPLIED
Increased pressure ratio	Yes
Mount attitude insensitivity	Yes
Small size	No
Higher efficiency	Yes
Greater reliability/Life	Yes
Independence from engine lube system	Yes
PENETRATION BY ATDS	
Current design - As great as that of each engine application Selected components - Major (turbo optimized for engine class)	

TABLE 55. TRUCK MARKET.

NEEDS	ATDS-SUPPLIED
- Increased pressure ratio	Yes
- Wide flow range	No
- Small size	No
- Higher efficiency	Yes
- Greater reliability/life	Yes
- Better transient response	Yes
- Independence from engine lube system	Yes
PENETRATION BY ATDS	
<ul style="list-style-type: none"> - Current Design - Minor (a range of sizes is needed) - Selected components - Major: (foil bearings, low-mass turbine housing, ceramic turbine) 	

a broad range, which also favors the two-stage turbocharger. Ceramic rotor and foil-bearing suspension would be of particular value in truck applications, to provide independence from the engine lubrication system, which is relatively dirty.

4.2.3 Marine Market - The marine market is not as large nor as price-sensitive as the highway truck market. Marine diesel engines range from less than 100 to over 20,000-horsepower and require a large range of turbocharger flow. Because most engines operate under fixed propeller load characteristics, this turbocharger application does not require broad surge margin. It is not known how easily the ceramic turbine and foil bearings will scale up to accommodate larger flow capacities. Specific speed considerations indicate that axial flow turbines are preferable with large engines. ATDS suitability for the marine market is summarized in Table 56.

TABLE 56. MARINE MARKET.

NEEDS	ATDS-SUPPLIED
- Increased pressure ratio	Yes
- Large range of flow capacity	Partly
- Higher efficiency	Yes
- Greater reliability/life	Yes
- Better transient response	Yes
- Independence from engine Lube system	Yes
PENETRATION BY ATDS	
<ul style="list-style-type: none"> - Current design - moderate (limited by engine applications) - Selected Components - Major (turbo optimized for engine class) to moderate will depend on scaled-up capability for ceramic wheel and foil bearings) 	

4.2.4 Off-highway Market - The off-highway market (including military tracked vehicles) is dominated by diesel engines and has a moderately wide range of flow capacity requirements (Table 57). It is expected that rough terrain would place high impact loading on a turbocharger rotor. Thus, air bearings might not have adequate load capacity for this application. Depending on the drive train design, high surge margins may or may not be required. Again, since engine scale-up capabilities are uncertain, ceramic turbine and foil bearing technologies may not be applicable to larger sized engines in off-highway applications.

4.2.5 Automotive Market - The automotive market offers high production potential for small turbochargers. Automobile engines require good surge margin and small-sized turbochargers. This can be accomplished by adapting the ATDS technologies to the specific needs of the automotive engine (Table 58). The problem of down-scaling these technologies from the ATDS is one of manufacturing at

TABLE 57. OFF-HIGHWAY MARKET.

NEEDS	ATDS-SUPPLIED
- Increased pressure ratio	Yes
- Varied flow range (Mechanical Trans - wide range Hydraulic Trans - narrow range)	Partly
- Large flow capacity range	Partly
- Higher efficiency	Yes
- Greater reliability/life	Yes
- Better transient response	Yes
- High-amplitude vibration tolerance	No
- Independence from engine lube system	Yes
PENETRATION BY ATDS	
<ul style="list-style-type: none"> - Current Design - Moderate (mostly on units with hydraulic transmission) - Selected Components - Moderate (i.e., foil bearings may not have adequate stiffness) to Major (depends on scaled-up capability for ceramic wheel and foil bearings) 	

a competitive price; i.e., the performance difference between tomorrow's and today's technologies may not justify the cost differences unless advanced manufacturing technology developments are made that allow new turbochargers to use processes similar to today's turbocharger.

TABLE 58. AUTOMOTIVE MARKET.

NEEDS	ATDS-SUPPLIED
- Mount attitude insensitivity	Yes
- Increased pressure ratio	Yes
- Wide flow range	No
- Very small size	No
- Higher efficiency	Yes
- Greater reliability/life	Yes
- Better transient response	Yes
- Independence from engine lube system	Yes
PENETRATION BY ATDS	
<ul style="list-style-type: none"> <li data-bbox="232 1024 1090 1087">- Current Design - Minor (A range of sizes is needed) <li data-bbox="232 1119 999 1182">- Selected Components - Major (easily scaled down) 	

4.2.6 Locomotive Market - The locomotive market is small, and uses large diesel engines almost exclusively. The high-pressure-ratio compressor is the only ATDS technology that can definitely be scaled up for a locomotive turbocharger (Table 59).

4.2.7 Ground Power Market - The ground power market is divided into two groups--mobile and stationary engines. Although each group includes a wide range of airflow capacities, the mobile market is dominated by small engines, while the stationary market is dominated by large engines. ATDS technology is applicable to mobile engines. However, stationary engines will require large turbochargers, and uncertainty exists concerning the scaling of ATDS technology. The needs of the ground power market (Table 60) are not unique. However, a general improvement in turbocharger parameters would be beneficial in this area.

TABLE 59. LOCOMOTIVE MARKET.

NEEDS	ATDS-SUPPLIED
<ul style="list-style-type: none"> - Increased pressure ratio - Large flow capacity - Higher efficiency - Greater reliability/life - Independence from engine lube system 	<p style="text-align: center;">Yes No Yes Yes Yes</p>
PENETRATION BY ATDS	
<ul style="list-style-type: none"> - Current Design - Minor (Too small) - Selected Components - Major (If scale-up capability exists) 	

TABLE 60. GROUND POWER MARKET.

NEEDS	ATDS-SUPPLIED
<ul style="list-style-type: none"> - Increased pressure ratio - Wide flow range - Large flow capacity range - Higher efficiency - Greater reliability/life - Better transient response - Independence from engine lube system 	<p style="text-align: center;">Yes Yes Partly Yes Yes Yes Yes</p>
PENETRATION BY ATDS	
<ul style="list-style-type: none"> - Current Design - Moderate (for engines with airflow match) - Selected Components - Major (Family of sizes needed) 	

4.2.8 Market Impact Summary - A matrix summary of the impact of the ATDS technologies is shown in Figure 57. The perspective of the entire market indicates that emphasis should first be placed on developing a ceramic turbine -- not so much because of its temperature capabilities, but because of its light weight and potentially low manufacturing cost. The second-most important technology for further study is the foil bearing, principally because it reduces the risk of damage and/or shutdown of the engine. The third most important technology is the high-pressure-ratio compressor, which will provide engine cycles with higher compressor efficiency and pressure ratio.

A cursory estimate of the benefits of the ATDS technology based on an assumption of a one-million-unit annual turbocharger market in 1990 is shown in Table 61. This table also shows the utilization assumed for a representative application in each market. The assumption of only a 1-percent SFC improvement results in a potential gain of \$54-million-per-year for newly produced engines. Based on an average useful life of at least 10 years, the lifetime benefit would be \$540 million dollars. Moreover, the weight savings offered by the ATDS technology for weight-sensitive applications would result in a multimillion-dollar benefit in DOC savings.

4.3 ATDS - Related Programs

Several technology programs underway or recently completed that involve scaled components of turbocharger size, or components that are scalable for turbocharger use (Table 62) are:

	ATDS DESIGN (AS-IS)	HIGH- PRESSURE COMPRESSOR	FOIL BEARINGS	CERAMIC TURBINE	LIGHT WEIGHT HOUSING
GENERAL AVIATION	●	●	●	●	●
TRUCK	•	•	●	●	•
OFF-HIGHWAY	•	•	•	●	•
MARINE	•	•	•	●	•
AUTOMOTIVE	•	•	●	●	•
LOCOMOTIVE	•	•	•	•	•
GROUND POWER (MOBILE)	•	•	●	●	•
(STATIONARY)	•	•	•	•	•

MAJOR = ● MODERATE = • MINOR = ◦

Figure 57. ATDS Technology will have a Broad Market Impact.

TABLE 61. OVERALL MARKET IMPACT SUMMARY.

	MEAN CRUISE SHP	X	MEAN CRUISE SFC	X	MEAN HRS/ YR	X	1.20/6.5 = \$/YR/ UNIT	X	UNITS/ YR =	FUEL COST \$ x 10 ⁶ /YR
General- aviation*	250		0.42		300				10,000	58
Truck*	100		0.35		1000				400,000	2,585
Marine	200		0.35		500				100,000	646
Automotive*	20		0.55		200				200,000	81
Locomotive	2000		0.35		1500				1,000	194
Off-highway	200		0.50		500				100,000	925
	TOTAL									\$5,414 x 10 ⁶
*Weight-sensitive										
1-percent Fuel Savings = \$54 Million/Year										

- o NASA Scaled Centrifugal Compressor Program (Contract NAS3-2243) demonstrated the scalability of an existing 25-lb/sec design to both 10- and 2-lb/sec. However, no development activity is planned.
- o AFAPL Variable-Cycle Technology Propulsion System Assessment Program (Contract F33657-79-C-0726) developed an extended surge margin in a 25-lb/sec centrifugal compressor through the use of variable geometry. No scaling of the resulting design is planned.

TABLE 62. EXISTING TECHNOLOGY PROGRAMS.

COMPONENT	PROGRAM	SPONSOR	STATUS
Compressor	Scaled centrifugal Variable Cycle Centrifugal	NASA AFAPL	In test In test
Ceramic turbine	AGT101	DOE	Preliminary design
	Injection molding demo	AMMRAC	Hardware
Foil bearing	AGT101	DOE	Early testing
	TJE331 foil bearing demonstrator	AFAPL	AF planning
	APU gas-lubricated foil bearing	AFAPL	Testing underway
Lightweight housing	None	--	--

- o NASA/DOE AGT101 Program (Contract DEN3-167) entails operation of a demonstrator engine by 1985, with both ceramic turbine and foil bearing applications included. However, the foil bearing design is a journal bearing only, with the rotating group supported at the compressor end with a ball bearing that also absorbs thrust. Again, no provision exists for production development.
- o AMMRC Low-Cost, Net-Shape Ceramic Radial Turbine Rotor Program - Demonstrated the capability of injection-molding the appropriate geometry; however, durability or reliability were not taken into consideration.
- o AFAPL TJE331 Foil-Bearing Demonstrator Program (not yet contract status) - Though demonstration is planned, no production development is planned as part of the contract. The TJE331 is a single-spool, expendable turbojet engine. For this program, the design would be modified to incorporate full foil bearing support of the rotating group. Again, development for production is not part of the planned program.
- o AFAPL Gas-Lubricated Foil Bearing Development Program (Contract F33615-73-C-205) - A nearly completed demonstrator program. Development for production is not planned. Incorporates a bearing system configuration like that used in the AGT101 (i.e., ball-thrust and foil journals).

It is apparent that none of these programs provide the essential turbocharger technology that would allow commitment to production turbocharger development. The prospects for success of each program are good to the level of technology stated; that is, a feasibility demonstration of objectives. However, only a few of these objectives coincide with the objectives of an advanced turbocharger design. NASA modification or addition to several of these programs is possible, but even this would not ensure reaching the long-range goals of the ATDS Program.

Formulation of component technology demonstration programs specifically directed toward turbocharger development is necessary to establish the ATDS turbocharger concept for production. The programs listed in Table 63 are necessary to accomplish this. Detailed recommendations for each program are discussed in Section 5.

TABLE 63. CONCEPTS THAT MUST BE ADDRESSED BY FUTURE PROGRAMS.

COMPONENT/PART	NEED
Ceramic turbine rotor	Characterization and demonstration
Foil bearing	Operating parameters
High-pressure-ratio compressor	Flow range and efficiency improvement
Lightweight housing	Containment and acoustic investigation
Turbocharger	Full-scale demonstrator

Page intentionally left blank

Page intentionally left blank

5.0 TURBOCHARGER TECHNOLOGY - FUTURE PLANS

5.1 Summary

Advanced technology engines developed in response to NASA's program for general-aviation aircraft will require turbocharging to achieve design performance. Turbocharger pressure ratios of 5 to 8, required by these advanced technology engines at 25,000 feet, are substantially higher than any existing turbochargers can provide. Moreover, turbochargers designed for these new engines using today's technology would be substantially heavier (85 versus 42 lb) than any units currently acceptable for aircraft application. The alternative of using two turbochargers in series to achieve the necessary pressure ratios would provide acceptable performance but would still be heavy and would make it harder to install the turbocharged engine in an aircraft nacelle. Therefore, new turbochargers will be needed that require the use of advanced technologies to support the advanced technology engines and to attain the desired goals in improved fuel consumption and performance. These advanced turbochargers require:

- o Determination of the compound (engine and turbocharger) cycles
- o Definition and build of turbochargers appropriate to each engine cycle
- o Development of additional technology in air bearings, ceramics for rotating aerodynamic components, and control of variable-geometry elements.

The Garrett Corporation has contributed substantial advancements to the state of technology in each of these areas. The resulting technical capabilities and technology base will be used in acquiring the advancements necessary for an advanced technology turbocharger.

5.1.1 Cycle Definition

Cycle definition will require effort to coordinate requirements and available technology for the intermittent combustion (IC) engine and turbomachinery portions of the complete compound engine. AID has contributed to optimization of the overall cycle for its many engine customers through its application of engineering expertise and custom aerodynamic development capabilities. GTEC has developed an extensive capability for integration of combustion cycles with turbomachinery aerodynamics, and has also developed compound engines combining IC engines with turbomachinery. These technologies have direct application to the Advanced Technology Engine Program.

5.1.2 Advanced Turbochargers

The assembly and test of turbochargers incorporating all the advanced technologies is required to determine the proof of concept. The conceptual design portion of the advanced turbocharger design study is an example of layout of an advanced technology test unit for the RC2-32 engine. GTEC and AID routinely design and build prototype and breadboard turbomachinery for specific application and laboratory investigations. While simulation of turbocharging (most applicable to a constant-pressure application) and adaptations of off-the-shelf turbochargers for some individual operating points can assist in investigating engine operating characteristics, the final testing of engine technology advancements cannot be considered complete without including a complete, appropriately sized turbocharger. No program currently under way incorporates such high-pressure-ratio aerodynamics in a practical turbocharger, even if the recommended features of air bearings, variable geometry, and ceramic turbine were deferred.

5.1.3 Required Technology Advances

5.1.3.1 Air Bearings

Air bearings have been employed in production bearing systems for rotors experiencing moderate gas temperatures, and in development programs as hot-end bearings for gas turbine engines. Air bearing demonstration and development programs currently under way are shown in Figure 58. These programs and production experience have shown that gas-lubricated foil bearings are capable of withstanding starting and shutdown friction at elevated temperatures, and that bearings can be designed with adequate dynamic stiffness at moderate temperatures. None of these programs, however, has yet addressed the dynamics of a rotor fully supported on air-lubricated journal and thrust bearings which are capable of withstanding large changes in operating temperatures. This need is currently being addressed at AID through technology programs for small turbochargers, and is also under consideration by the Air Force Aero Propulsion Laboratory (AFAPL) for short-life applications. However, these programs do not fully address the requirements for long life and the large sizes needed for an advanced turbocharger.

5.1.3.2 Ceramics

Ceramic technology efforts currently underway are shown in Figure 59 and include:

- o AGT Programs
- o AMMRC/Garrett Radial Rotors Program

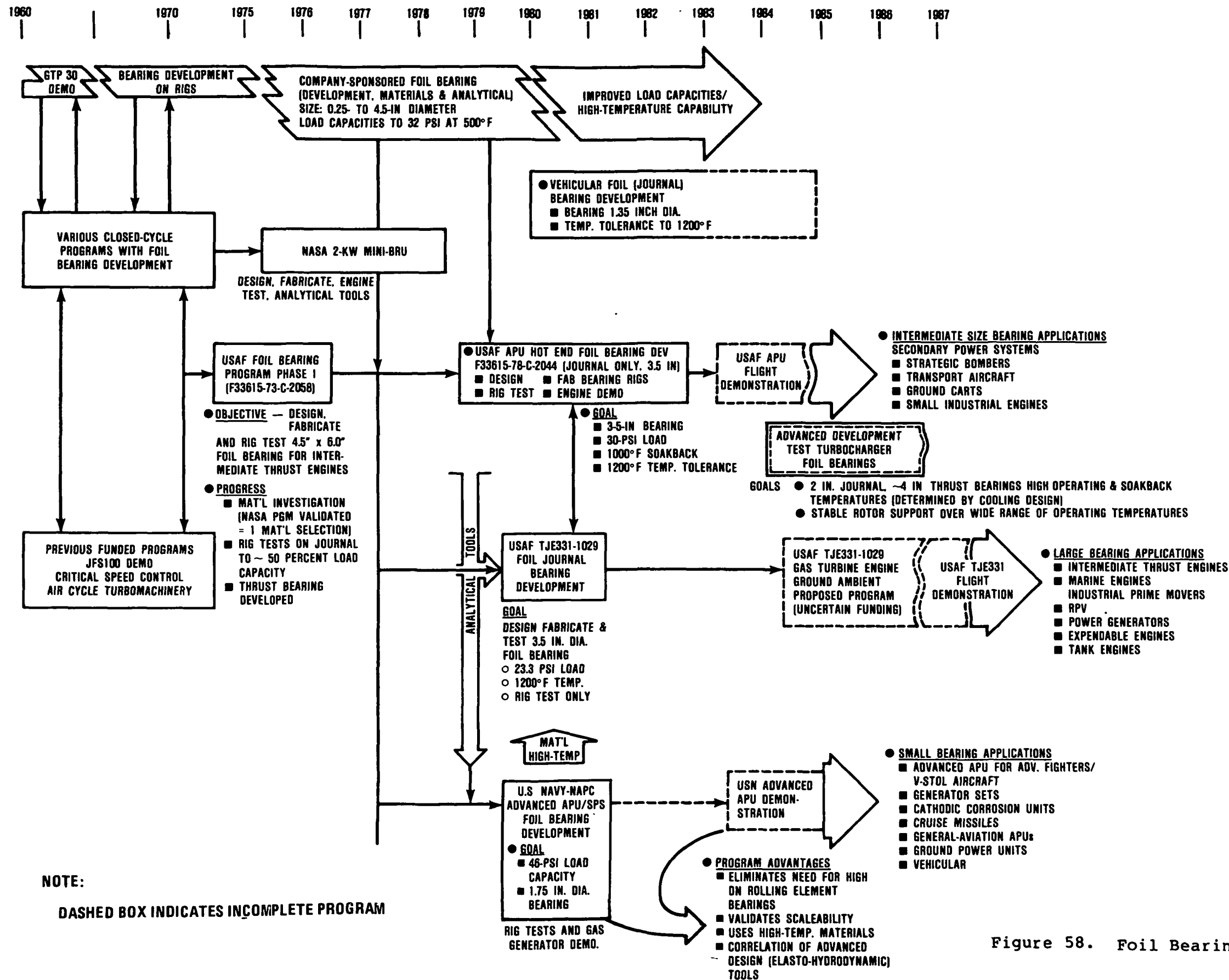

Figure 58. Foil Bearing Technology Roadmap.

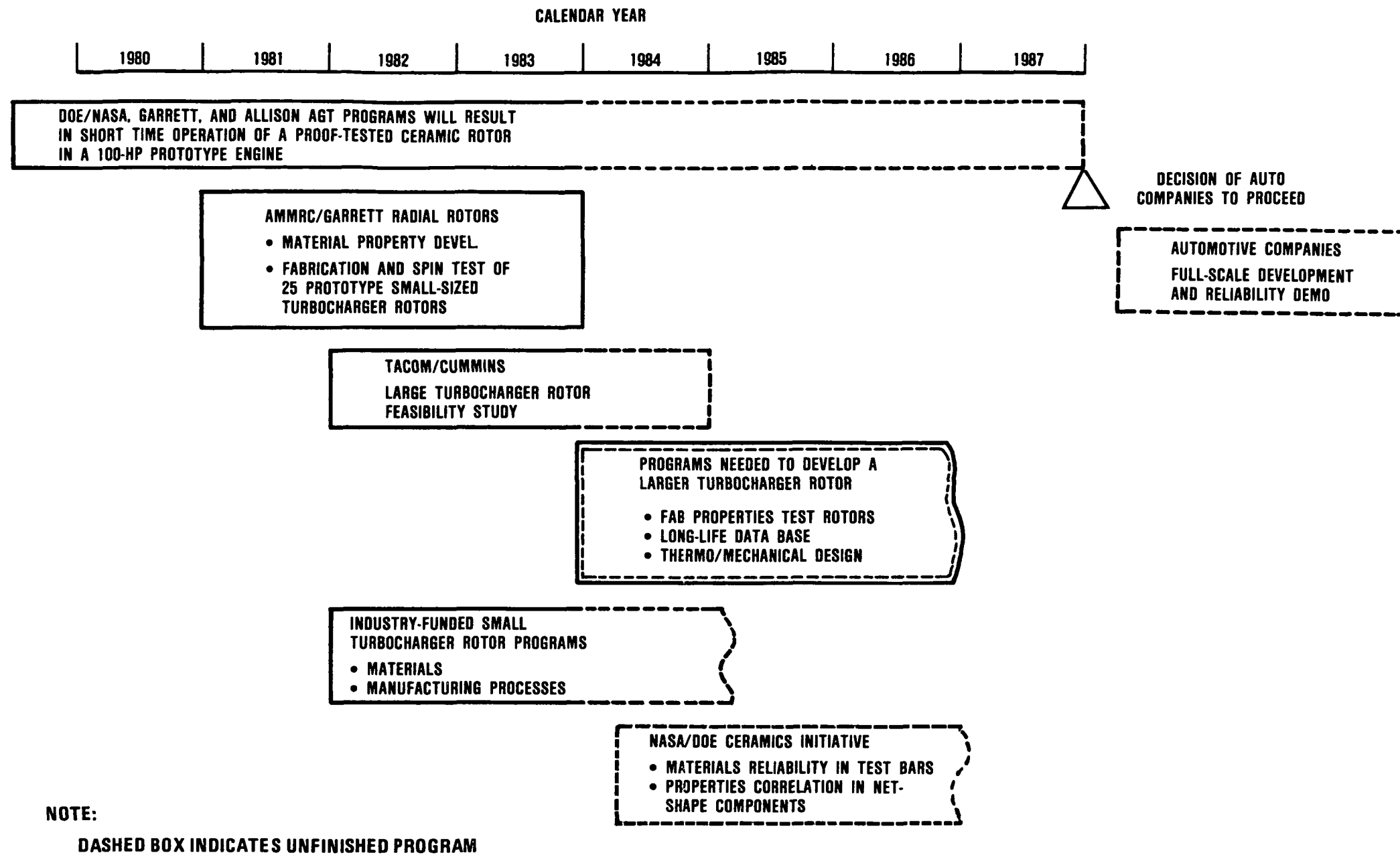

Figure 59. Ceramic Rotor Technology Roadmap.

- o TACOM/Cummins Large Rotor Study
- o Garrett Small Turbocharger Programs.
- o NASA/DOE Ceramics Initiative.

Though each of these programs will contribute technology that will be useful in the advanced turbocharger technology development program, none provides the long-term materials properties needed to undertake the design of a turbine with adequate reliability for an aircraft engine. Material properties that are both a function of material processing as well as size will not be sufficiently addressed in the turbine wheel size (i.e., 5.5-inch diameter) required of the advanced turbocharger.

The AMMRC and Garrett company-funded programs are farthest along in studying material properties in actual aerodynamic shapes, but are directed at rotors of 2- to 3-inch tip diameter. Material property development in the AMMRC/Garrett Radial Rotors Program is limited to short-time properties. The AGT Programs, which address an appropriate sized turbine, have met with success only by selecting samples with acceptable short-term properties. None of the currently active programs, including the Cummins Feasibility Study, address the determination of long-term material properties. Though the ceramic initiative being pursued by NASA/DOE has recognized the importance of both long-term property characterization and reliability design techniques, these aspects will not be addressed until the late 1980's. This would delay the availability of the technology advances demanded by the general-aviation market.

However, experience gained in the AGT and AMMRC programs indicates that the short-term properties of silicon nitride are good enough to justify the design of a rotor for an advanced technology turbocharger. Sufficient design latitude was found during the ATDS conceptual design effort to give reasonable expectation that a suitable design can be achieved once the long-term properties are known.

5.1.3.3 Variable Geometry

Garrett has acquired substantial experience in several areas related to control requirements for variable geometry. Turbine engines manufactured by GTEC use integrated control systems for all phases of operation that include some variable-geometry elements. However, performance optimization for turbine engine control is related only to the combustion process and the turbomachinery aerodynamics. The additional complexity of the IC engine as the power producer creates a new requirement for technology development. AID has current experience in controls for exhaust bypass valves on turbocharged IC engines, but this control function has not been

integrated with other controls on the engine. Past AID programs have controlled variable turbine inlet guide vanes to maintain constant compressor pressure rise, but again, the overall engine performance has not been thoroughly optimized.

5.2 Recommended Follow-On Effort

The requirements definition, technology survey, and studies in connection with the conceptual design effort show the feasibility of advancements in turbocharger technology for general aviation. The key consideration in the advancement of turbocharger technology is the integration of the engine and turbocharger technology demonstrations and eventual development activities shown in Figure 60. This plan has a baseline goal of 1991 for an aircraft incorporating advanced engine and turbocharger technologies, and is based on an optimistic schedule that includes the development of an advanced engine. Moreover, proper timing of the advanced test turbocharger programs is necessary so that capabilities are assured prior to committing the turbocharger to the performance requirements of a specific engine. It is apparent that to meet these goals, the following component technology and coordination programs must begin immediately. Slippage in initiation of the component programs will either lead to a delay of turbocharger availability, or force the design to a lower technology level.

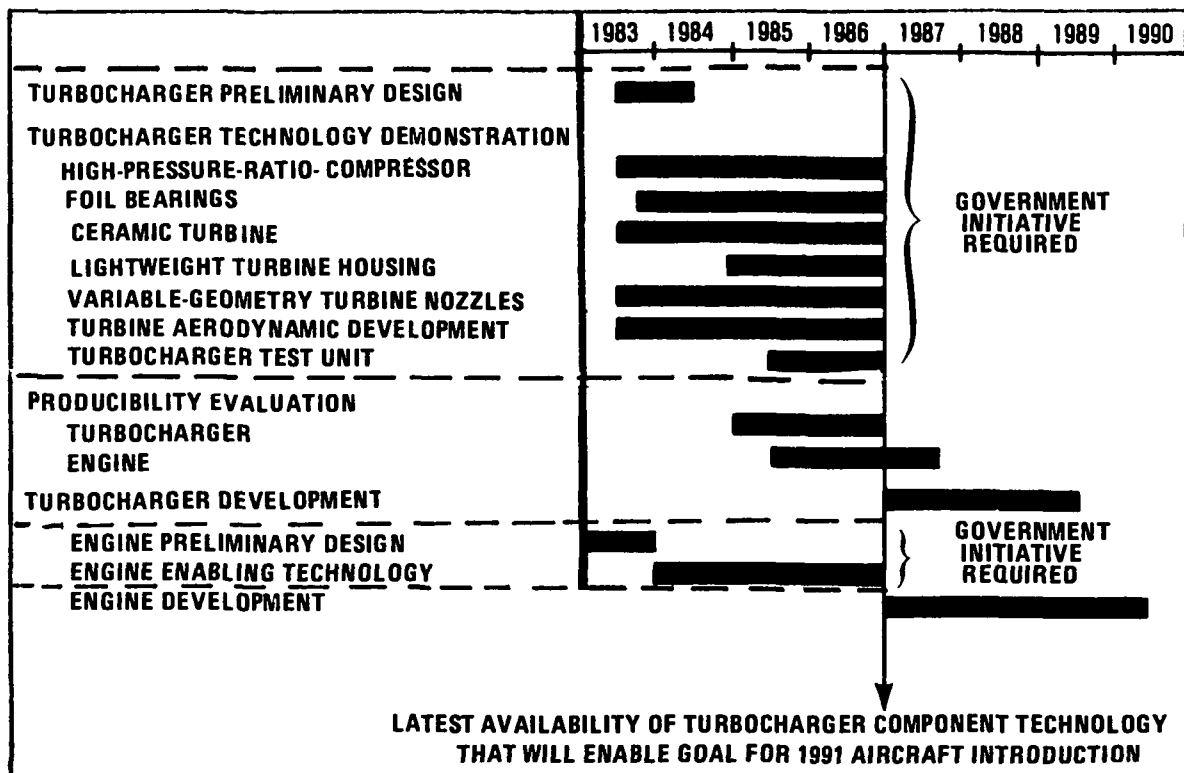

Figure 60. Integration of Engine and Turbocharger Technologies/Development Activities.

The following recommendations describe the required programs, and indicate whether current industry efforts will achieve suitable results or whether additional efforts are required.

5.2.1 Technology Requirements Coordination

Coordination of the preliminary designs of engine, turbocharger, and related control components and systems, considering continuing technology advances, is fundamental to ensuring that support continues to be directed toward the most advanced technology programs.

Successful integration of engine, turbocharger, and control system technology requires thoughtful assessment of the relative difficulty of obtaining advances in each technology. Tradeoffs of potential advances must be continually reviewed throughout preliminary design of the engine, including its appropriate turbocharger. Technology and design coordination would define aerodynamic cycle requirements, establish thermal loading of the turbocharger as affected by mounting location, coordinate cooling provisions for the engine and turbocharger, and optimize turbocharger mounting dynamics and vibration response.

A program should be initiated to coordinate technology advancement requirements for general aviation engines. This program should be conducted in conjunction with, and would aid in managing technology advancement programs for engine and turbocharger technologies.

The design phase of each advanced technology engine should include--at least quarterly--cycle design and technology reviews attended by the engine and turbocharger contractors. At each review, the more difficult requirements of the engine and turbocharger should be presented for discussion of alternative technologies. Following each such review, the engine and turbocharger participants would report their evaluations of the alternatives presented.

5.2.2 Advanced Component Turbocharger Testing

An important milestone in NASA's general-aviation engine technology advancement programs should be the buildup of several turbocharger units utilizing components derived from the separate advanced technology programs. Other program recommendations herein reflect the technology advancements appropriate and necessary to achieve this milestone. Significant technologies that should be incorporated in the turbochargers include variable geometry of turbines and/or compressors, air bearings, and ceramic turbine rotors. To date, these three concepts have never been combined in a single turbocharger design. Each of these concepts by itself should improve turbocharger life and performance.

The initial advanced turbocharger configuration could be based on the design generated in the ATDS for the RC2-32 rotary engine. This design could be modified to incorporate the use of a variable turbine inlet nozzle. This configuration could be established as soon as the interface configuration, engine speed, and engine displacement are determined. Design efforts would establish configurations of the aerodynamic rotating group, air bearings, and variable turbine inlet nozzles. The turbine should be designed using the best available information on properties of available ceramic materials. It is expected that enough acceptable turbine wheels can be produced to satisfy the requirements of the engine technology demonstration. Concurrent with the advanced turbocharger testing program, separate rotor testing should be performed to determine ceramic property data for correlation with test bar data.

Variable turbine inlet nozzles should provide some improvement in engine efficiency and at the same time, provide better control of the fuel/air ratio for the four-stroke cycle of the rotary engine. This technology would also improve performance of the two-stroke cycle diesel engine by maximizing the scavenging pressure drop across the engine. The degree of improvement in each case would depend greatly on the control logic selected. Each engine and turbocharger designer would have the opportunity and responsibility to investigate logic alternatives, including parameters to be sensed and the options of open-loop versus closed-loop control of parameters of interest. While a schedule of vane position or engine inlet manifold pressure versus operating conditions may be sufficient to obtain acceptable operation of the engine, there are opportunities for interactive optimization of fuel/air ratio or even of fuel consumption at any operating condition.

Concurrent with the RC2-32 Advanced Turbocharger Program, definition of the aerodynamic cycle for the 1992 Advanced Technology Diesel Engine (ATDE) should begin. The coordination program recommended above would be instrumental in optimizing the complete engine/turbocharger cycle, including selecting accessories related to semi-independent operation of the turbocharger. Cooperative evaluation of the requirements for achieving high pressure ratios with good efficiency, compared with the benefits of minimizing engine size and speed, would establish the degree of turbocharging to be used. Cycle analysis and preliminary aerodynamic design would then establish whether variable compressor geometry as well as variable turbine inlet nozzles are desirable. During cycle definition, substantial effort should be devoted by the turbocharger and engine designers to determine the optimal control logic for the variable geometry features. Progress on the diesel engine would not be impeded by a slightly later start, since laboratory simulation of turbocharging would acceptably represent actual turbocharging for the two-stroke diesel engine during its preliminary technology and cycle development.

Requirements for an advanced turbocharger for the advanced technology spark ignition engine should be determined in conjunction with the technology test program for that engine.

A program should be initiated for advanced turbochargers for the candidate advanced technology engines. Each turbocharger should be developed in four phases:

- o Preliminary design of the machine and its controls
- o Rig testing as required to confirm design characteristics
- o Construction and testing of the advanced turbocharger on a hot gas test stand
- o Delivery of the unit to the engine manufacturer for testing.

5.2.3 Component Technologies

5.2.3.1 Air Bearings

Use of air bearings would eliminate turbocharger dependence on the engine oil system. Engine wear particles could not harm the turbocharger bearings. Weight of oil lines would be eliminated, along with the problems of safely routing them to the turbocharger. Heating of engine oil would be reduced, and oil drain provisions would no longer constrain turbocharger mounting attitudes. To gain these benefits in turbochargers for advanced technology engines, technology development is required in areas of thermal control, cooling, duty cycle determination, and bearing stability.

5.2.3.1.1 Air Bearing Temperature Control Technology

Successful application of air bearings to turbochargers may require new techniques of temperature control in the bearing housing. To define technology requirements in this area, a comprehensive thermal study of a turbocharger bearing system is necessary. The conceptual design developed by the ATDS is an appropriate model for this study. Evaluation of various means of temperature control at the bearing foils would assist in setting realistic targets for foil coating temperature capability and contribute input to ongoing foil coating development and evaluation programs. Estimates of bearing temperature changes in operation would also contribute design input to the bearing dynamics technology program. Turbine inlet temperatures considered should allow for the effects of reduced engine cooling in future engine technology advancement programs. Program results would be sufficiently broad in scope to benefit a variety of advanced engine technologies. No existing program is structured to produce parametric results to guide application of bearing temperature control technologies over this broad operating range.

A comprehensive thermal study of the ATDS bearing system should be performed in support of the overall effort of designing

advanced turbochargers. Parametric studies should be made to evaluate the effects of changes in materials conductivity, areas of thermal flow paths, cooling air flow velocity, pressure, and temperature, and turbine inlet gas temperature on bearing component temperatures.

5.2.3.1.2 Air Bearing Cooling Air Sources

Alternative means of providing air for bearing cooling should be evaluated. The high compressor pressure ratio required in aircraft applications produces hotter and higher pressure air than required for bearing cooling. Aircraft applications have unusually difficult requirements in these respects, and there is no existing program that will supply applicable information. Possible air sources for cooling include the turbocharger compressor, either at the normal discharge station or at an intermediate pressure bleed location; mechanically or pneumatically driven air compressors or fans; and aspiration of ambient air to augment a reduced compressor bleed flow. Definition of air temperature and pressure would establish these parameters for use in the bearing system thermal study. An appropriate air source might also supply air to pressurize the cabin at less overall energy cost. Evaluations of possible air sources should be used in design and technology tradeoffs by engine and turbocharger designers.

A program should be initiated to evaluate alternative air sources for bearing cooling. This study should include cycle analysis and performance specifications of alternate cooling air supply components, and comparisons of engine and turbocharger performance.

5.2.3.1.3 Air Bearing Duty Cycles

The air bearing duty cycles in IC engine powered general-aviation aircraft need further definition. A study and experimental program should characterize turbocharger and rotating group motion during starting, running, and shutdown, and determine the greatest likely bearing loads due to hard landings, taxiing, and combinations of flight maneuvers. A variety of aircraft missions should be used to establish the time/temperature profile and load in situations that can cause contact between the rotor and bearings. The resulting operating profiles can be combined with the improved understanding of transient dynamics to establish more complete requirements for foil design and coating materials. Evaluation of the effects of mounting methods and location on the duty cycle parameters would contribute to selection of an optimized installation by the engine and turbocharger designers. The operating profiles to be established are unique to aircraft applications, and at present there are no programs to adequately define the applicable duty cycle.

A program should be initiated to provide a comprehensive definition of the duty cycle of air bearings in IC engine-powered

general-aviation aircraft, considering the frequency and duration of all operating conditions over a variety of mission types.

5.2.3.1.4 Air Bearing Stability Analysis Technology

Garrett experience in application of compliant foil gas bearings covers a wide spectrum of rotor configurations, performance requirements, and operating environments. In the course of performing each rotor dynamics analysis, the interaction of rotor and bearings is examined using parametric techniques. Incomplete knowledge of foil bearing dynamic properties and lack of an integrated model of the bearing and rotor prevents purely analytical predictions of the susceptibility of the rotor to self-excited subsynchronous whirl. This whirl phenomenon is a common occurrence during the development phase of rotor-foil bearing systems, especially when:

- o Journals are closely spaced
- o Significant vibration inputs exist that could excite resonant responses
- o Large variations in temperature are present at the bearings that cause significant changes in dimensions or properties between various operating conditions.

If journal spacing can be reduced, the turbocharger is shortened by the same amount and the engine installation is directly improved. In particular, externally induced vibration distinguishes turbocharger applications from the typical gas turbine applications (for which most foil bearing development has been done). Changes in power settings and altitude in aircraft applications cause heat input and cooling air-flow differences that significantly change bearing temperatures.

Several companies in the industry are devoting significant effort to improving their analytical performance prediction capabilities for air bearings. These efforts are expected to assist in development of optimized applications of air bearings in advanced turbochargers.

5.2.3.2 Ceramics

Ceramic materials will contribute greatly to the success of air bearings in turbochargers. Their light weight and low thermal conductivity will reduce bearing loads and bearing temperatures, significantly easing the demand for advancements in bearing technology. The light weight of a ceramic turbine wheel also allows substantial weight reduction in the housings and structure that must contain the products of any wheel burst. The reduction of inertia improves transient response of the turbocharger; however, this advantage is less important in general-aviation aircraft than

the direct weight saving in the turbocharger and mounting structures.

Current ceramic development programs have demonstrated adequate short-term behavior of ceramic materials in radial aerodynamic wheels. However, the scope of current programs does not include establishing long-term behavior characteristics of these materials. The results to date of these programs have shown the need to improve the reliability and reproducibility of ceramic compositions. Knowledge of the long-term material behavior and improved reliability is required to permit confident design of rotating components. The ceramics initiative being pursued by NASA and DOE recognizes the importance of long-term properties characterization and reliability design techniques, but will not address these aspects until the late 1980's. This scheduling will delay availability of the technology advances demanded by the general-aviation market.

A program should be initiated to determine the mechanical properties (including long-term behavior) of currently available sintered silicon-nitride ceramics. The results of these test bar evaluations would be compared with the results obtained during testing of actual ceramic rotors. A statistically iterative experimental procedure would be used to identify and reduce the variability in materials and processing, thus improving the reliability of the ceramic rotor. This data would specifically benefit the highly advanced technology engine programs within appropriate schedule requirements. More advanced materials that will emerge from the Ceramics Initiative will provide the increased temperature capabilities necessary for turbochargers used on engines having reduced cooling.

5.2.3.3 Variable Geometry

Use of variable geometry in the turbine nozzles will provide the engine designer with control over the fuel/air ratio in the engine. It also allows each operating condition to benefit from turbomachinery operation closer to optimum. For four-stroke cycle engines the benefits lie principally in controlling peak firing pressure and thermal load on the engine. For two-stroke cycle engines, scavenging pressures are improved and combustion efficiencies increased significantly. Optimization of variable geometry requires iteration of the turbine wheel design with nozzle vane shape, location, motion, and engine and turbomachinery interactions, including scheduling or active optimization of turbine nozzle position, fuel input, and such variables as fuel injection or valve timing. No programs addressing technology of variable-geometry optimization for turbocharged engines are known to exist.

A program should be initiated to investigate interaction of variable-geometry control with controllable functions on the advanced technology engines. The program should provide for alternate turbine designs; nozzle vanes and motion; aerodynamic analysis of overall turbine performance; and simulation and confirmation tests of turbine performance on the engines.

Page intentionally left blank

Page intentionally left blank

6.0 CONCLUSIONS AND RECOMMENDATIONS

Use of turbochargers is necessary in advanced technology engine development programs. In this vein, careful integration of the turbocharger into each overall system must be accomplished. Turbocharger development must lead or, at worst, pace that of the engine in order to assure optimal system performance capability.

Turbocharger technology improvements can be developed and will continue to draw on gas turbine technology as it advances. The transfer of this technology will be motivated by the economic incentives tied to fuel prices, aircraft utilization, and market penetration of the advanced engines.

Additional component technology demonstrations are required before the advanced turbocharger can be committed to production development. These include compressor and turbine aerodynamics, advanced turbine materials, foil bearing dynamics and durability, and lightweight structural acoustics and containment capability.

A large family of turbochargers is needed that will encompass a range of flow capacities and pressure ratios that can meet the diverse engine requirements for general-aviation aircraft. The desirable features of the ATDS are equally needed in nonaircraft applications, and the magnitude of this total market places great importance on the acquisition of these technologies. The evaluation of the schedules for engine and turbocharger development indicates that component technology demonstration programs should be initiated as soon as possible.

Turbocharger demonstration programs should be initiated that support the engine technology demonstrators. Turbocharger design and development should be carried out concurrently--and actually integrated--with development of the engines for which they are intended.

Many of the turbocharger markets are characterized by price-quantity relationships that place great importance on volume production at the lowest possible cost. As a result, processes must be used that do not have a development base in the gas turbine industry. The risks involved in advanced process development make it difficult for any one company engaged in turbocharger production to justify the total development effort needed for an advanced turbocharger design. Government sponsorship of the initial component technology demonstration program will provide the impetus needed for the turbocharger industry to undertake further development of advanced turbocharger designs.

The relationships of the necessary program components were shown in Figure 60. Once the enabling technology is made available, the producibility of engine and turbocharger designs will be

realistically evaluated by the industries involved. Provision of information for this evaluation is the key activity by which NASA can effectively support the nation's aircraft industry.

REFERENCES

1. Stuckas, K.J., "Advanced Technology Spark-Ignition Aircraft Piston Engine Design Study," NASA CR-165162, Teledyne Continental Motors, Aircraft Products Div., November, 1980.
2. Brouwers, A.P, "150- and 300- kW Lightweight Diesel Aircraft Engine Design Study," NASA CR-3260, Teledyne Continental Motors, General Productions Div., April 1980.
3. "Design of Fluid Duct Bends for Low Pressure Loss," NASA Technical Brief No. 68-10395, October, 1968.
4. Miccio, J., "Variable Cycle Technology, Propulsion System Program," Garrett No: 21-3347(16), July 1983.
5. Badgley P., et al., "Advanced Stratified Charge Rotary Aircraft Engine Design Study", NASA CR-165398, Vol. 1, Curtiss-Wright Corp., July, 1981.
6. Huggins, G., and Ellis, D., "Advanced General-Aviation Comparative Engine/Airframe Integration Study," NASA CR-165564, September, 1981.

Page intentionally left blank

Page intentionally left blank

APPENDIX I

CESSNA-PAWNEE SENSITIVITY STUDIES

(57 Pages)

Page intentionally left blank

Page intentionally left blank

ATDS Airplane Sensitivity Charts

(Single Engine Airplane)

ORDINATE		ABSCISSA
Takeoff Distance	Versus	Brake Horsepower
Maximum Takeoff Weight	Versus	Brake Horsepower
Rate of Climb at Sea Level	Versus	Brake Horsepower
Rate of Climb at 25,000 Ft	Versus	Brake Horsepower
Minimum Weight Required	Versus	Brake Horsepower
BEW	Versus	Brake Horsepower
Cruise Speed at 25,000 Ft	Versus	Brake Horsepower
Range	Versus	Brake Horsepower
Minimum Weight Required	Versus	Specific Fuel Consumption
BEW	Versus	Specific Fuel Consumption
Range	Versus	Specific Fuel Consumption
Maximum TOGW	Versus	Δ Engine Weight
Takeoff Distance	Versus	Δ Drag
Rate of Climb at Sea Level	Versus	Δ Drag
Rate of Climb at 25,000 Ft	Versus	Δ Drag
Cruise Speed at 25,000 Ft	Versus	Δ Drag
Minimum Weight Required	Versus	Δ Drag
BEW	Versus	Δ Drag
Takeoff Distance	Versus	TOGW
Rate of Climb at Sea Level	Versus	TOGW
Rate of Climb at 25,000 Ft	Versus	TOGW
Cruise Speed at 25,000 Ft	Versus	TOGW
Stall Speed	Versus	TOGW
Block Fuel	Versus	Specific Fuel Consumption
Block Fuel	Versus	Δ Engine Weight
Block Fuel	Versus	Δ Drag
Direct Operating Costs	Versus	Δ Engine Weight

EFFECT OF BHP ON TAKEOFF DISTANCE
WITH TAKEOFF GROSS WEIGHT = 4460 LBS

SINGLE ENGINE AIRPLANE

GARRETT ADVANCED TURBOCHARGER
SENSITIVITY STUDY

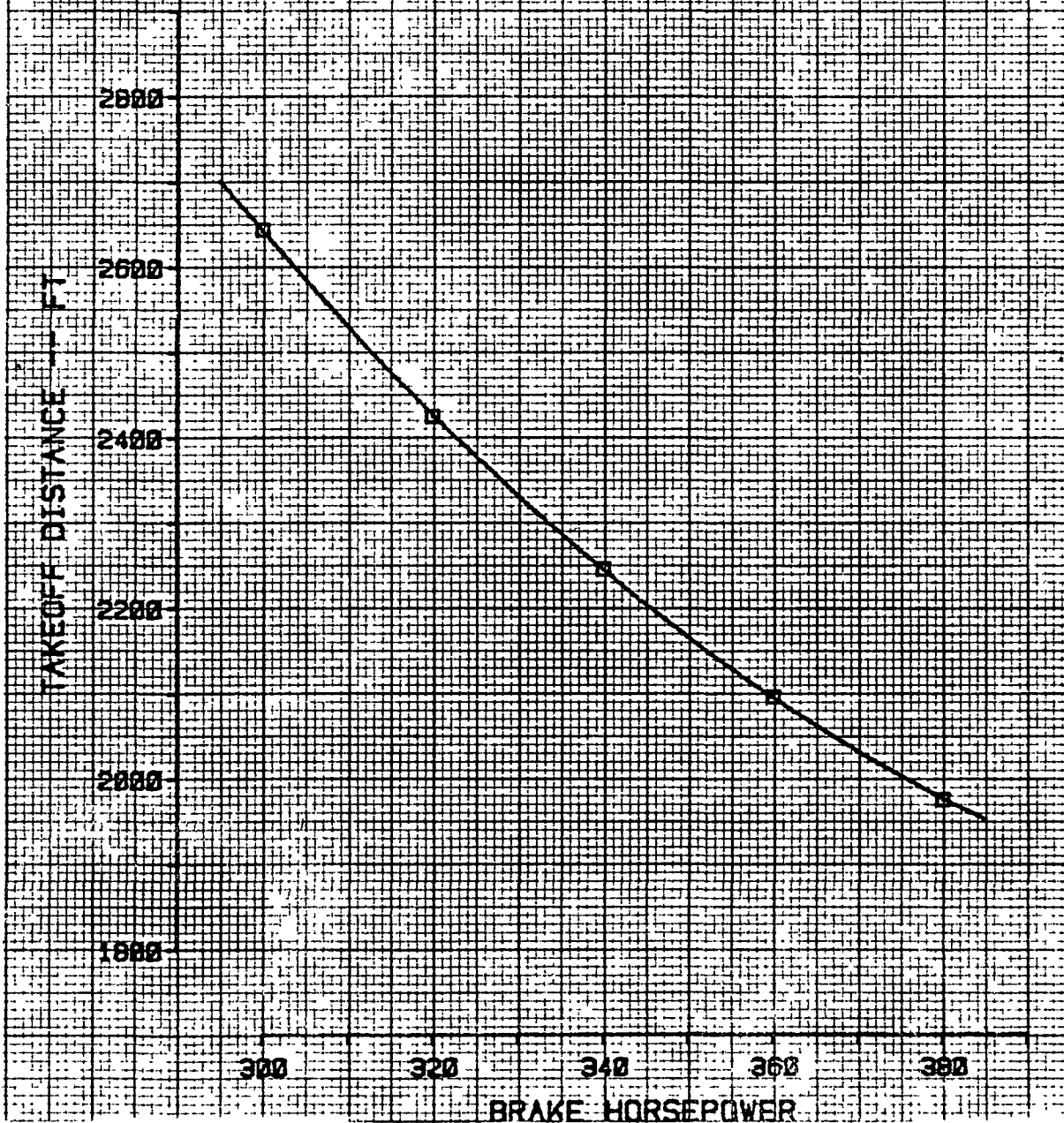

EFFECT OF BHP ON MAXIMUM WEIGHT
WITH TAKEOFF DISTANCE = 2240 FT

SINGLE ENGINE AIRPLANE

GARRETT ADVANCED TURBOCHARGER
SENSITIVITY STUDY

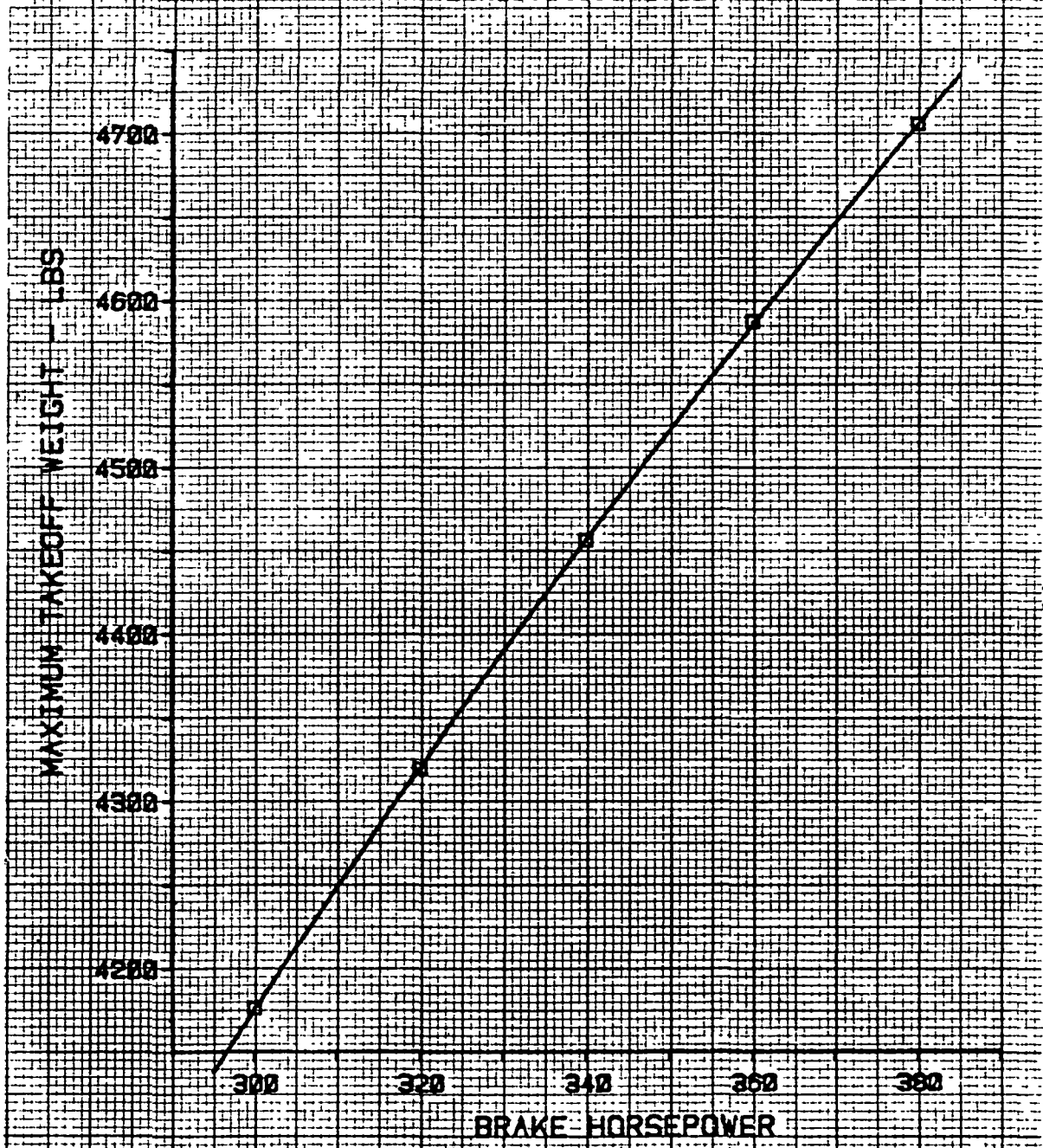

EFFECT OF BHP ON CLIMB RATE
FOR A CONSTANT WEIGHT
4460 LBS
SEA LEVEL

SINGLE ENGINE AIRPLANE

GARRETT ADVANCED TURBOCHARGER
SENSITIVITY STUDY

RATE OF CLIMB @ SEA LEVEL -- FPM

1200
1100
1000
900
800

300 320 340 360 380

BRAKE HORSEPOWER

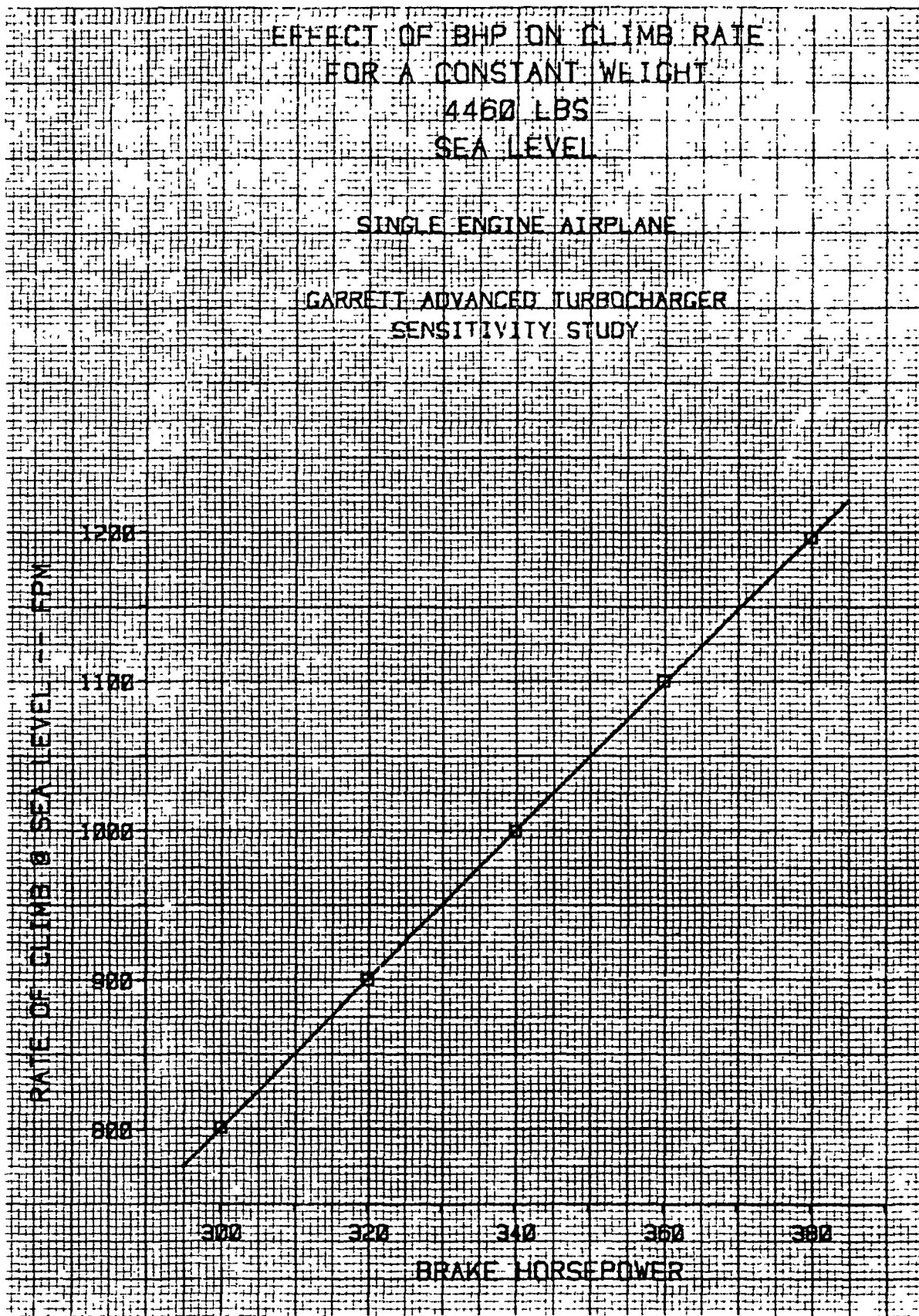

EFFECT OF BHP ON CLIMB RATE
FOR A CONSTANT WEIGHT

4460 LBS

25000 FT

SINGLE ENGINE AIRPLANE

GARRETT ADVANCED TURBOCHARGER
SENSITIVITY STUDY

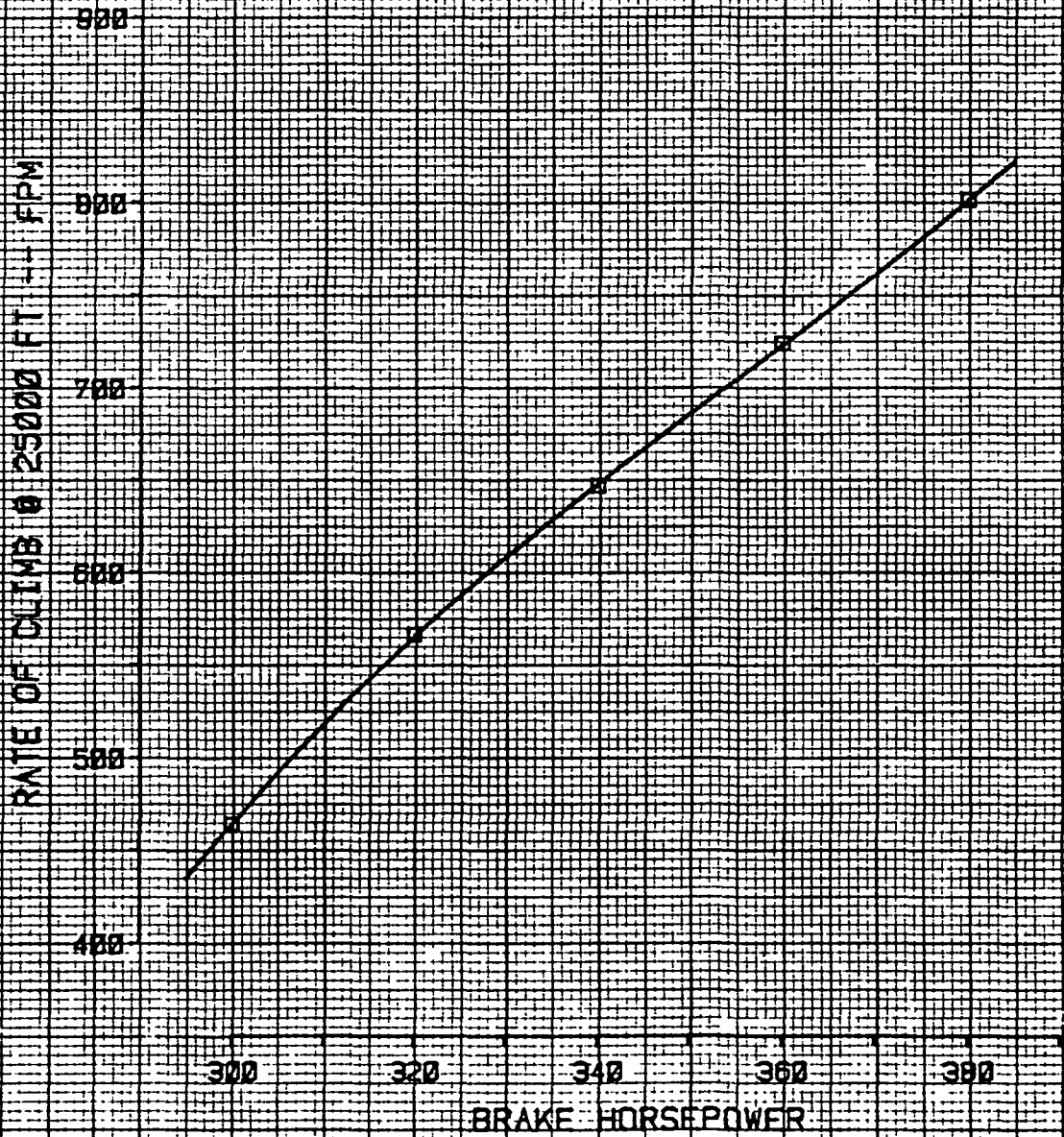

EFFECT OF BHP ON WEIGHT
FOR A CONSTANT PAYLOAD RANGE
1200 LBS, 700 NM
GARRETT ADVANCED TURBOCHARGER
SENSITIVITY STUDY

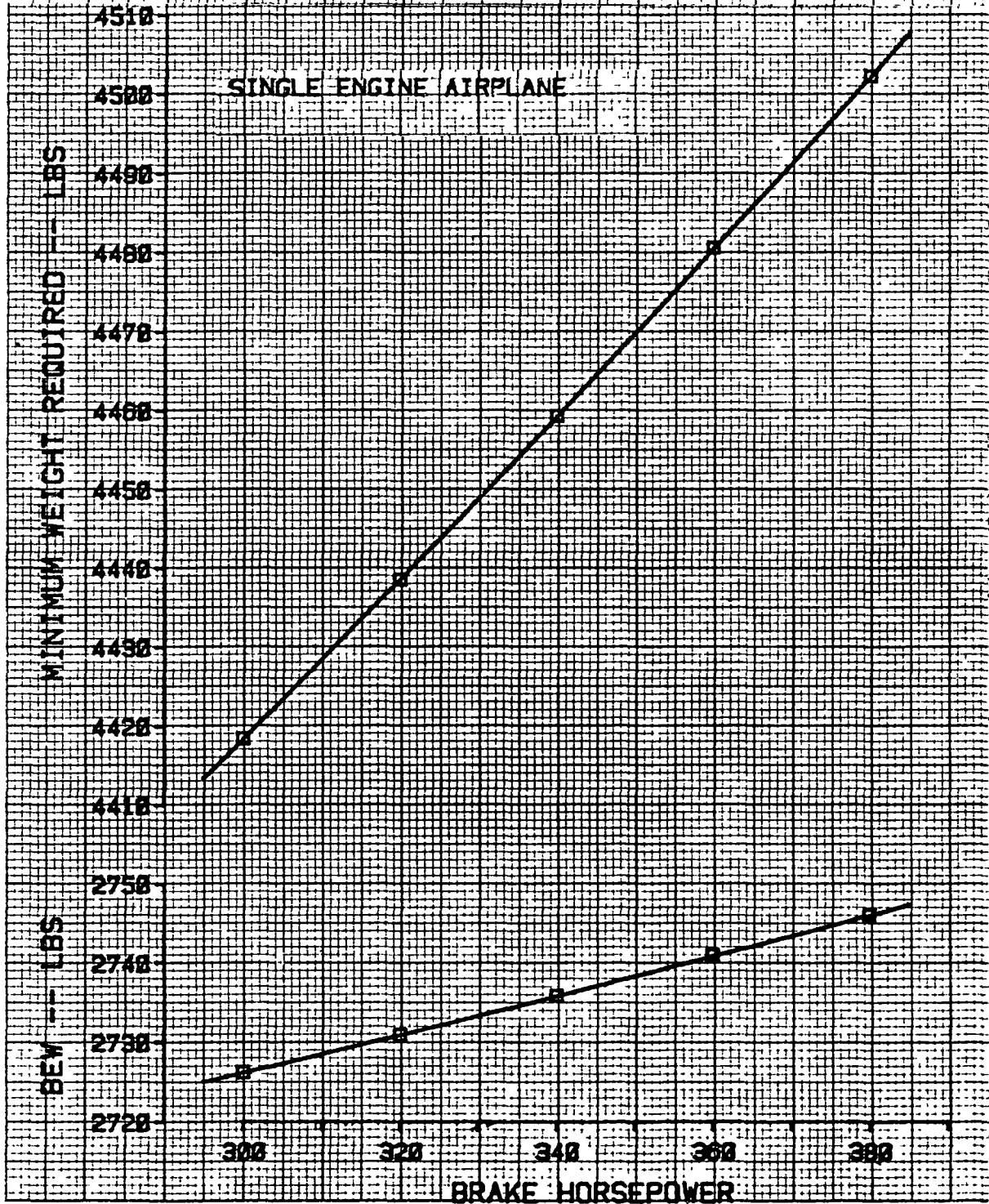

EFFECT OF BHP ON CRUISE SPEED
FOR A CONSTANT WEIGHT
4460 LBS
GARRETT ADVANCED TURBOCHARGER
SENSITIVITY STUDY

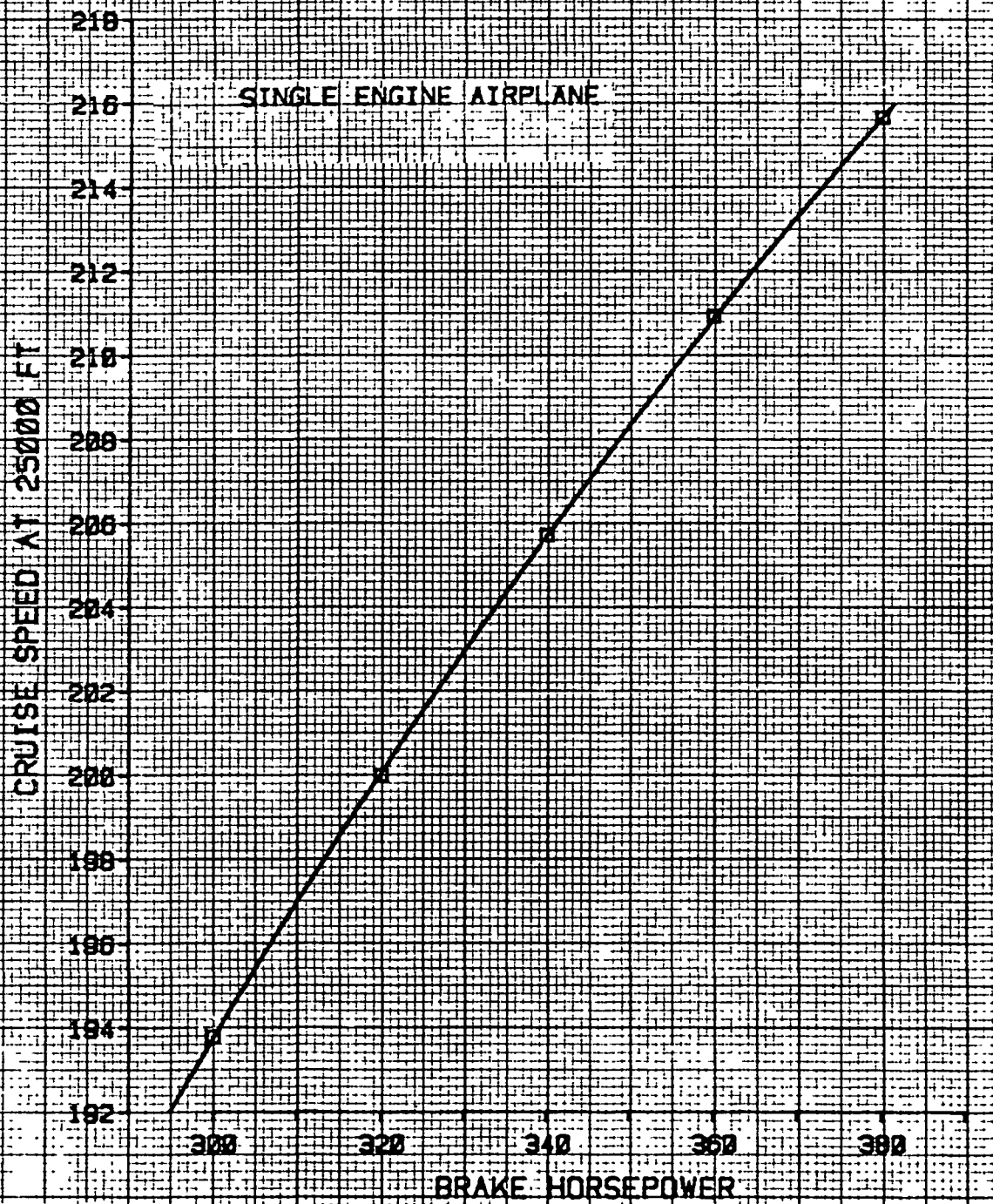

EFFECT OF BHP ON RANGE
FOR A CONSTANT WEIGHT AND PAYLOAD
4460 LB TOGW, 1200 LB PAYLOAD
GARRETT ADVANCED TURBOCHARGER
SENSITIVITY STUDY

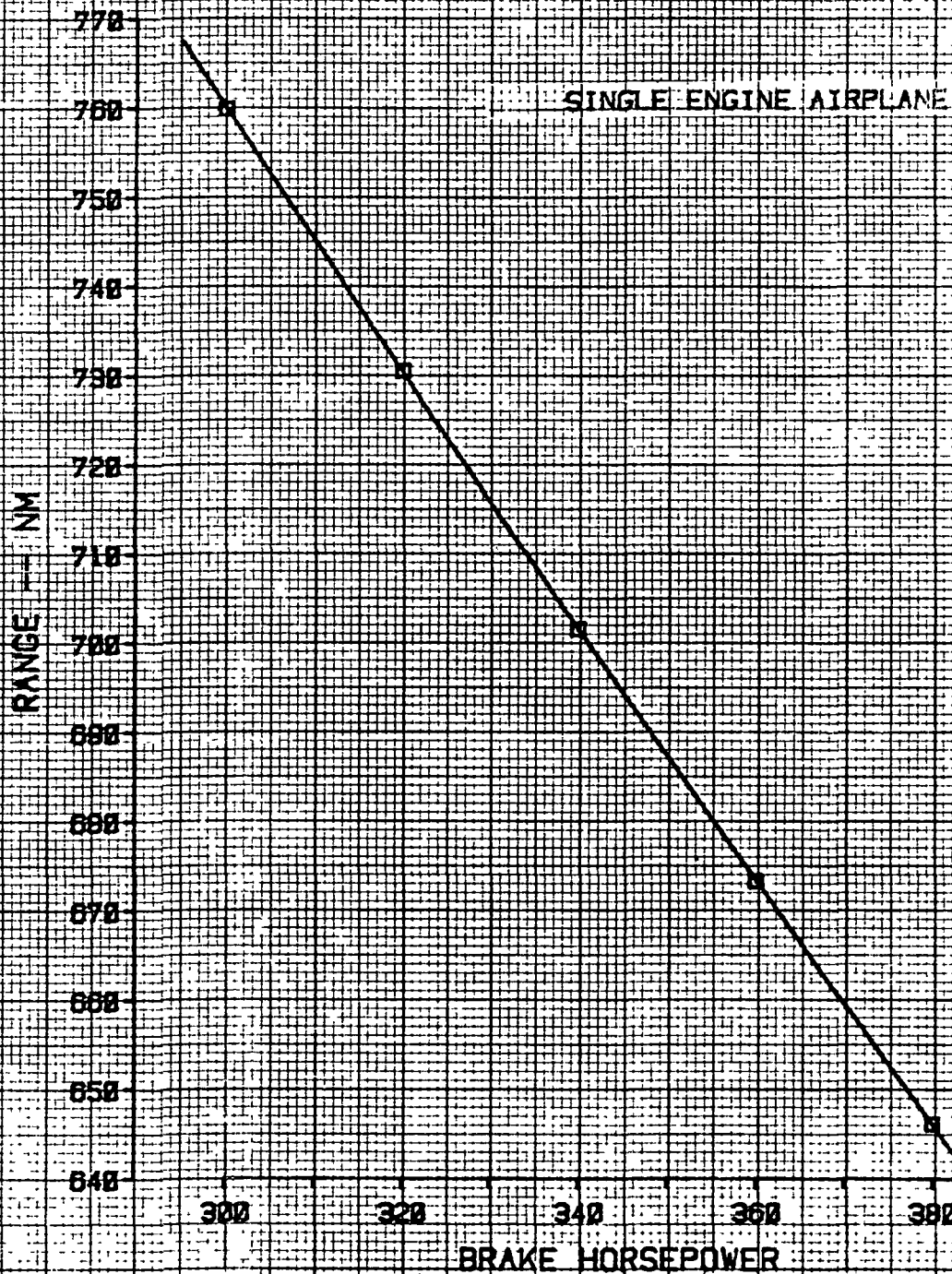

EFFECT OF SFC ON WEIGHT
 FOR A CONSTANT PAYLOAD RANGE
 1200 LBS. 700 NM

GARRETT ADVANCED TURBOCHARGER
 SENSITIVITY STUDY

MINIMUM WEIGHT REQUIRED --- LBS

BEW --- LBS

SINGLE ENGINE AIRPLANE

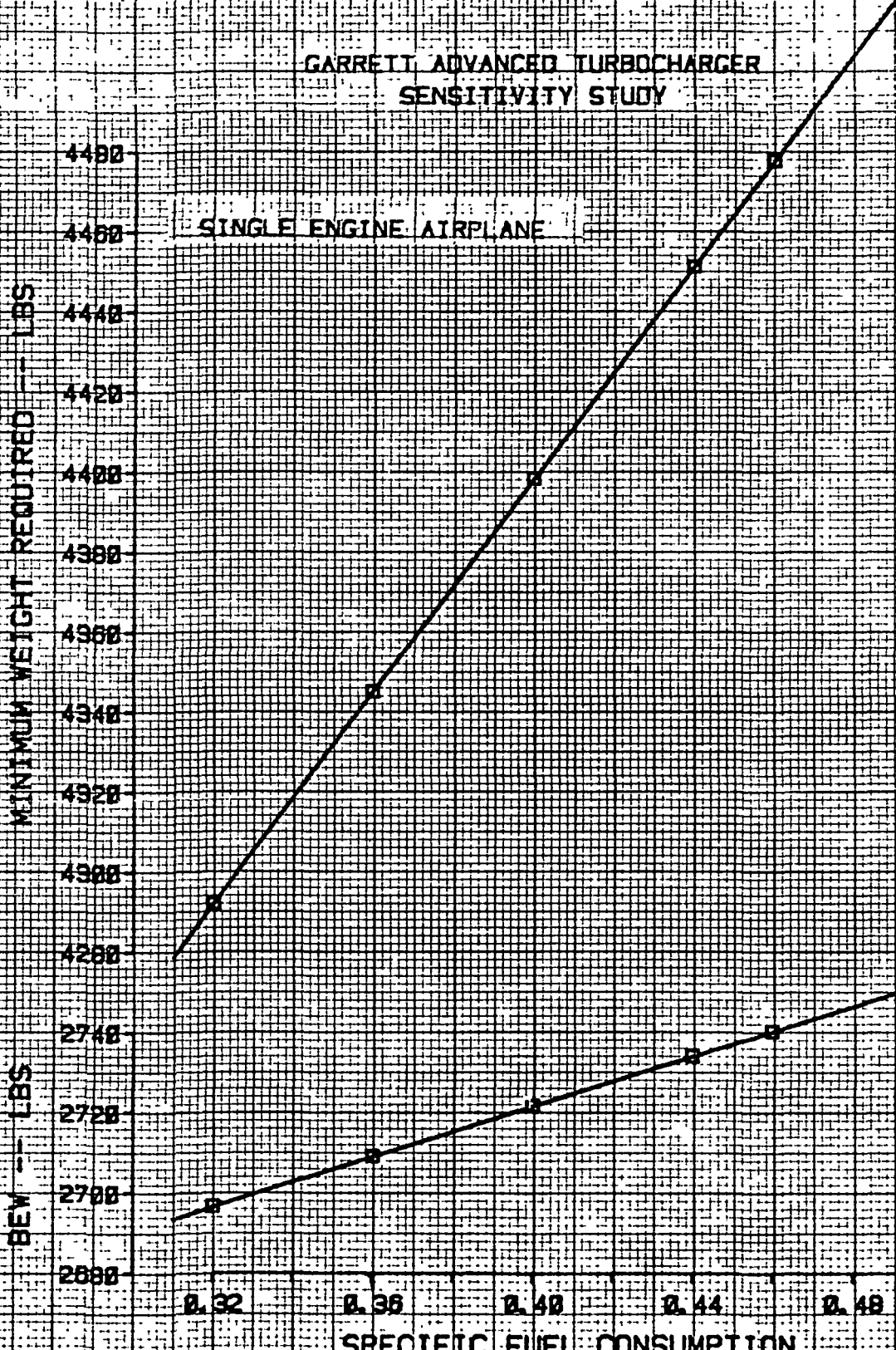

EFFECT OF SFC ON RANGE
 FOR A CONSTANT WEIGHT AND PAYLOAD
 4460 LB TOGW, 1200 LB PAYLOAD
 SINGLE ENGINE AIRPLANE

GARRETT ADVANCED TURBOCHARGER
 SENSITIVITY STUDY

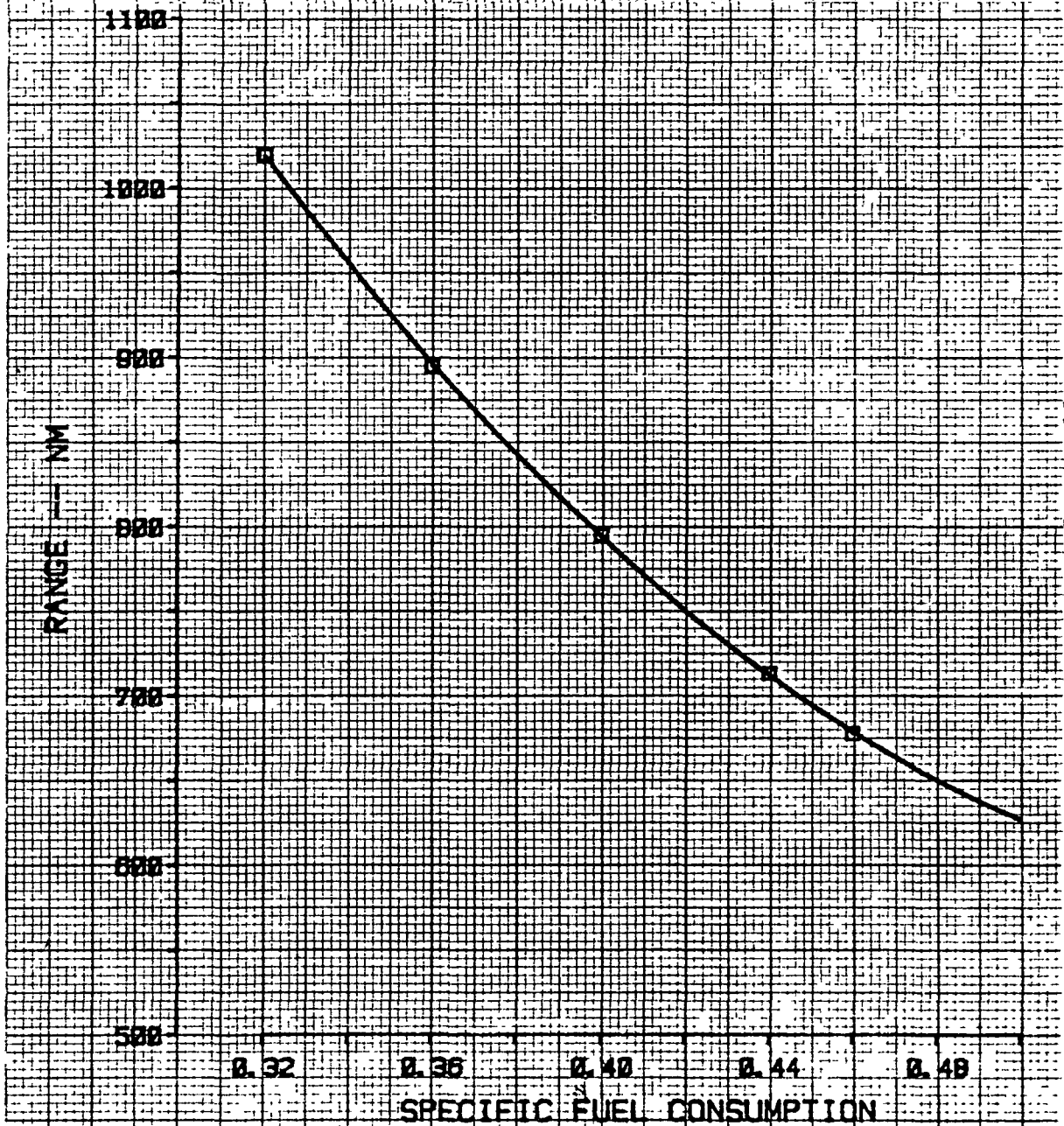

EFFECT OF ENGINE WEIGHT ON TOGW
FOR A CONSTANT PAYLOAD RANGE
1200 LBS 700 NM

SINGLE ENGINE AIRPLANE

GARRETT ADVANCED TURBOCHARGER
SENSITIVITY STUDY

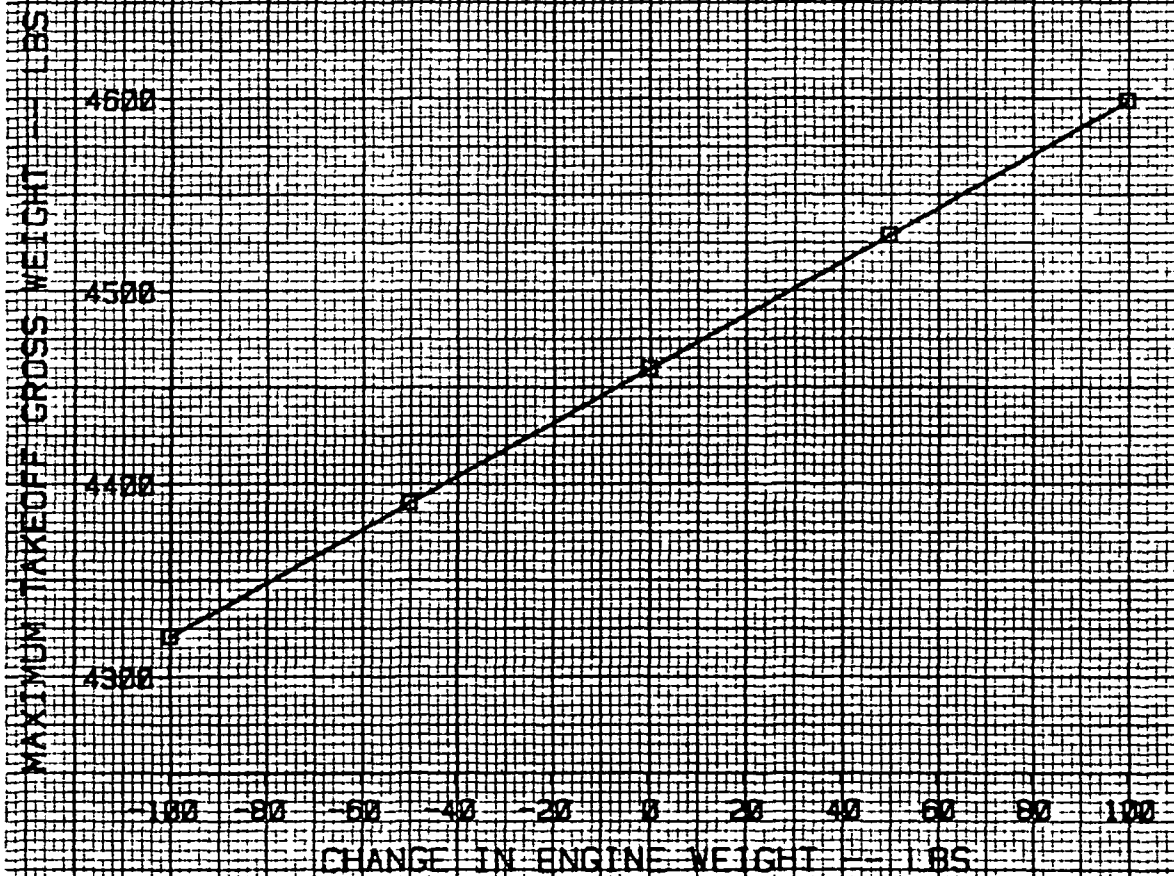

EFFECT OF DRAG ON TAKEOFF DISTANCE
WITH TAKEOFF GROSS WEIGHT = 4460 LBS

SINGLE ENGINE AIRPLANE

GARRETT ADVANCED TURBOCHARGER
SENSITIVITY STUDY

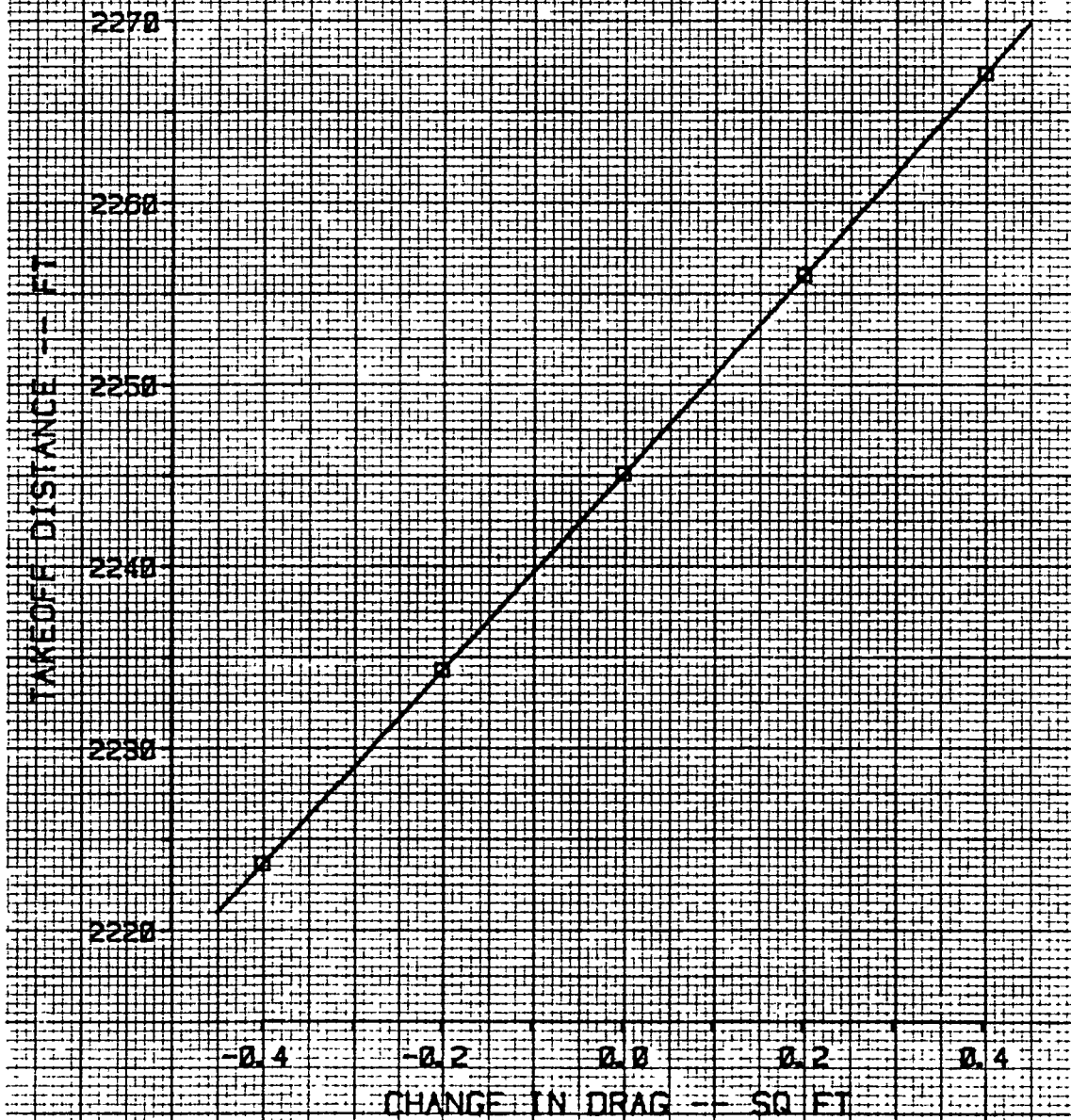

EFFECT OF DRAG ON CLIMB RATE
FOR A CONSTANT WEIGHT

4460 LBS

SEA LEVEL

SINGLE ENGINE AIRPLANE

GARRETT ADVANCED TURBOCHARGER

SENSITIVITY STUDY

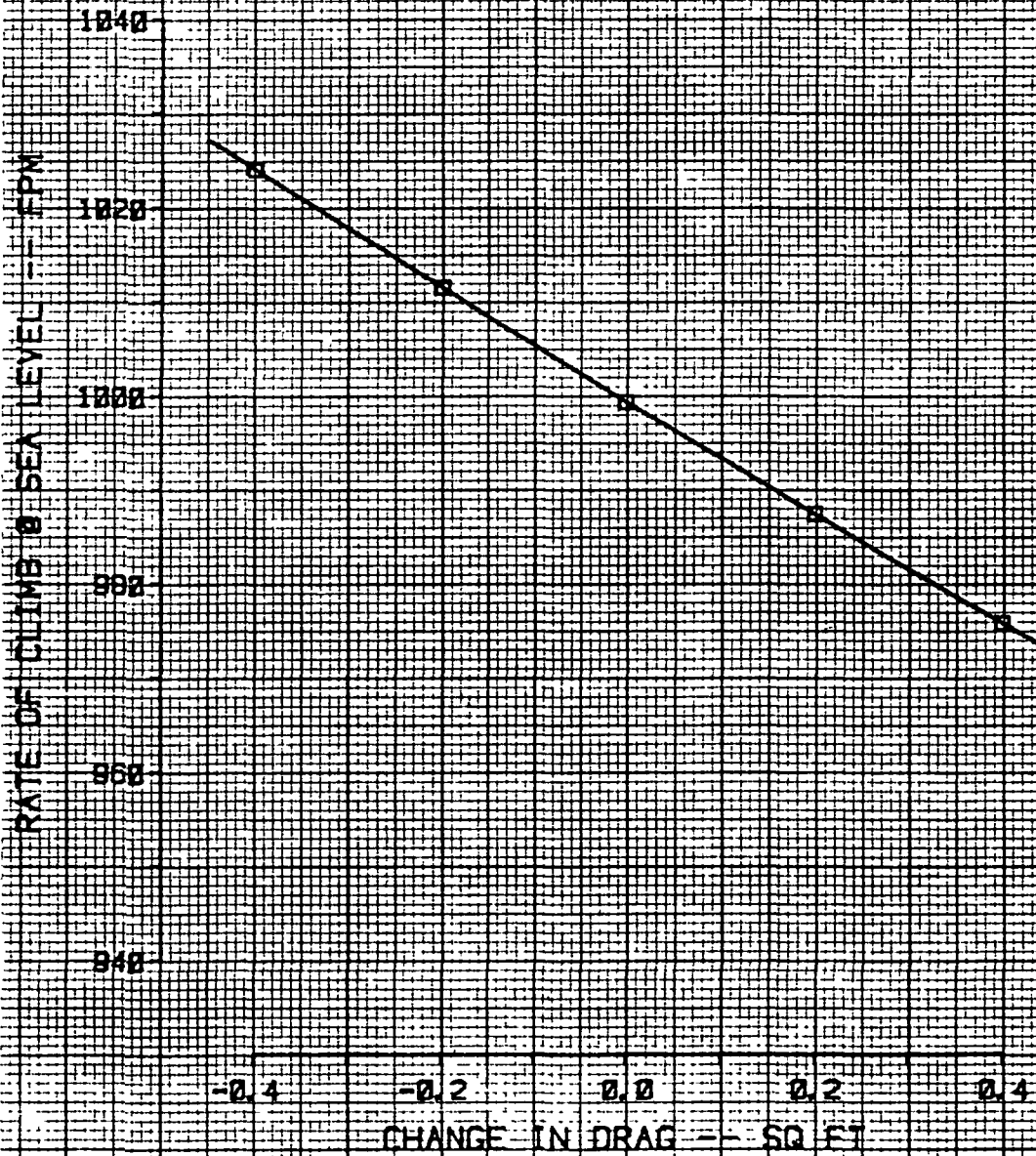

EFFECT OF DRAG ON CLIMB RATE
FOR A CONSTANT WEIGHT

4460 LBS

25000 FT

SINGLE ENGINE AIRPLANE

GARRETT ADVANCED TURBOCHARGER
SENSITIVITY STUDY

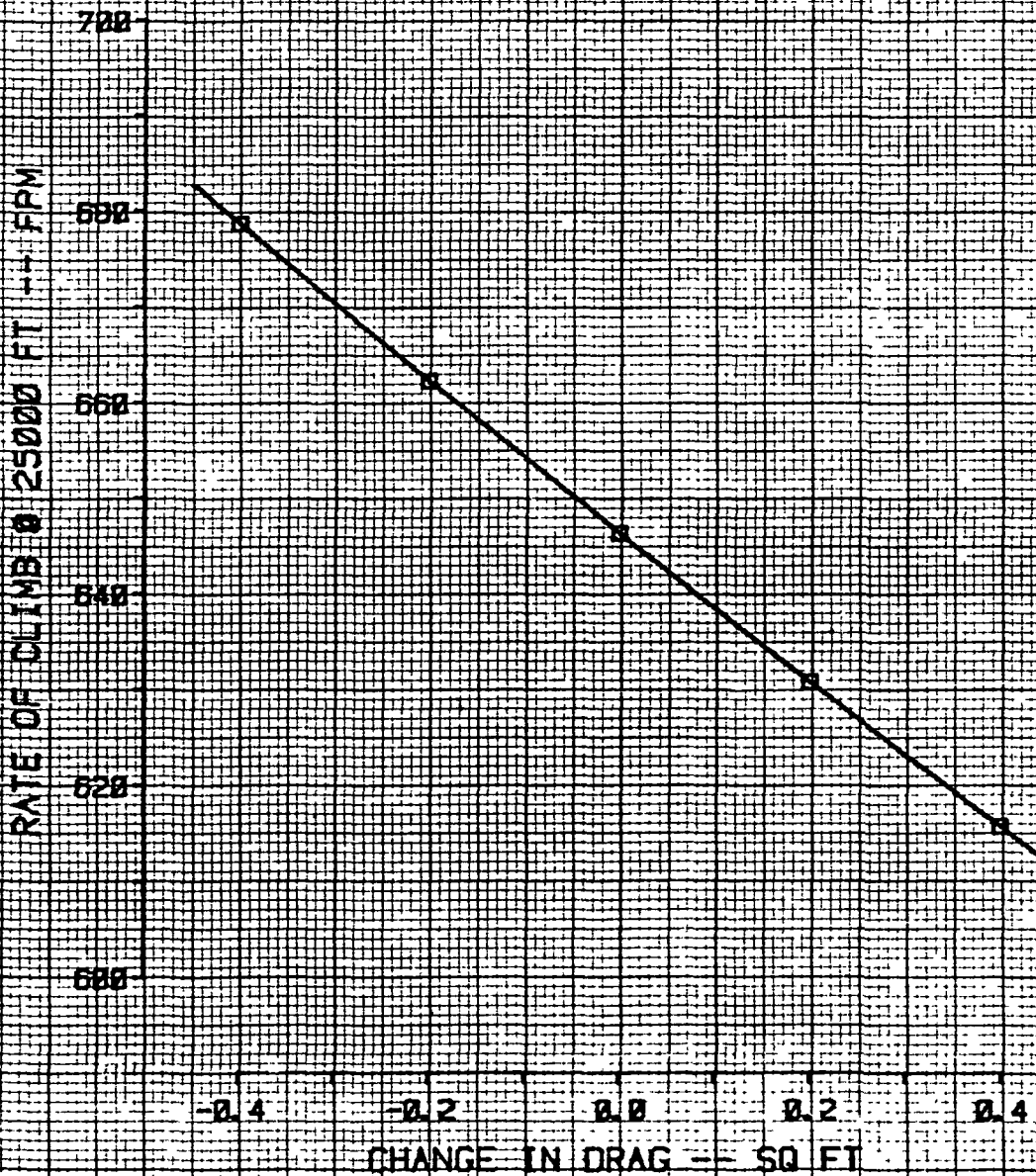

EFFECT OF DRAG ON CRUISE SPEED
FOR A CONSTANT WEIGHT

4460 LBS

SINGLE ENGINE AIRPLANE

GARRETT ADVANCED TURBOCHARGER
SENSITIVITY STUDY

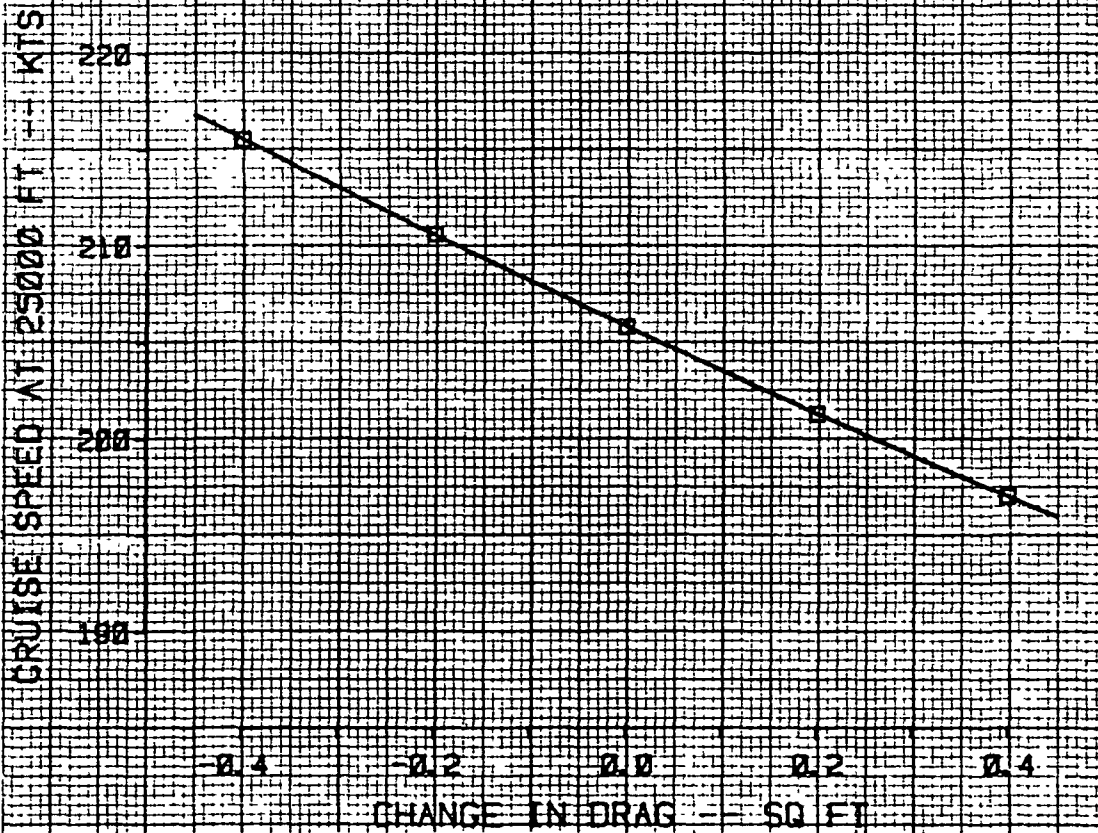

EFFECT OF DRAG ON WEIGHT
 FOR A CONSTANT PAYLOAD RANGE
 1200 LBS. 700 NM
 SINGLE ENGINE AIRPLANE

GARRETT ADVANCED TURBOCHARGER
 SENSITIVITY STUDY

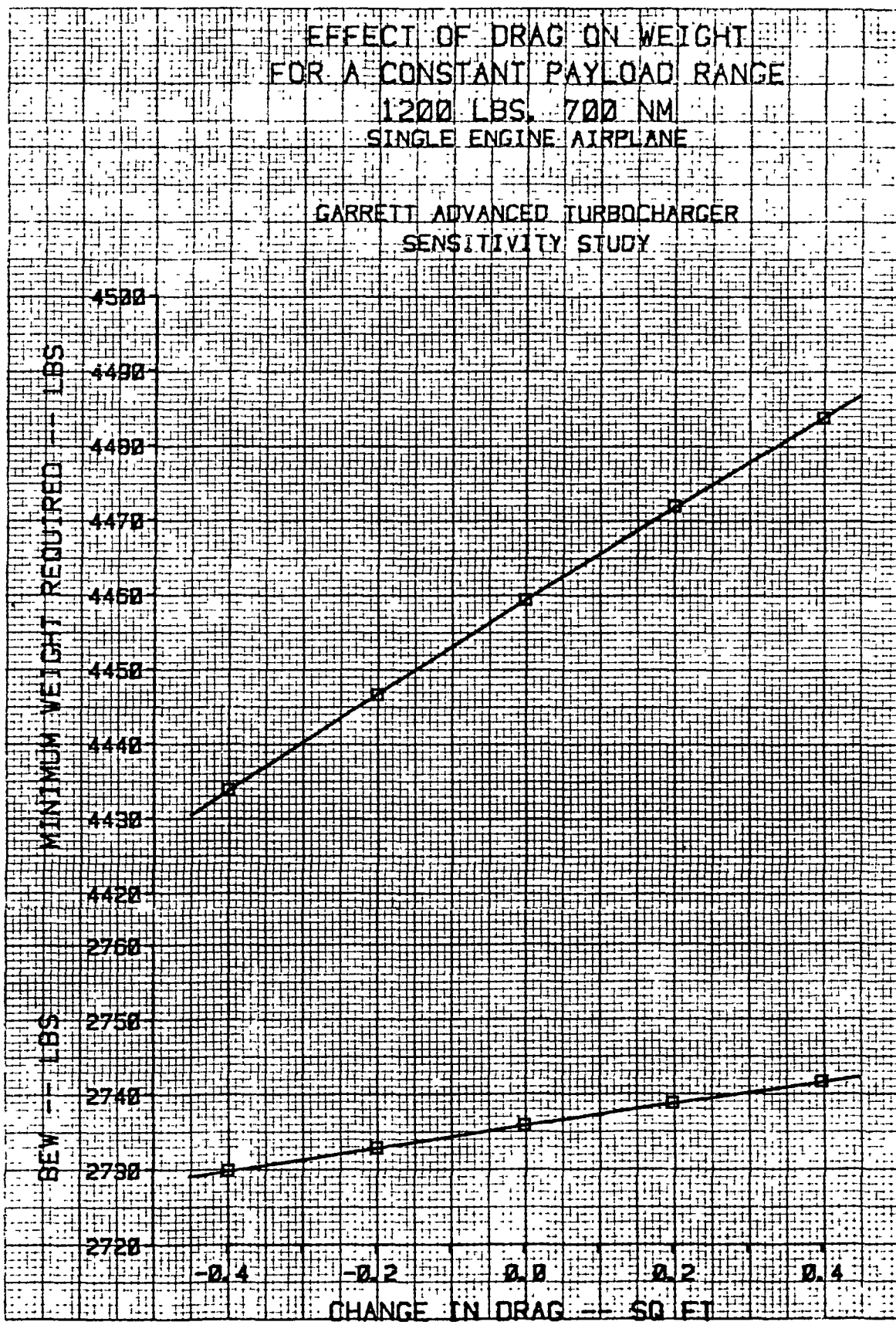

EFFECT OF GROSS WEIGHT ON TOFL
FOR A CONSTANT PAYLOAD RANGE
1200 LBS. 700 NM

SINGLE ENGINE AIRPLANE

GARRETT ADVANCED TURBOCHARGER
SENSITIVITY STUDY

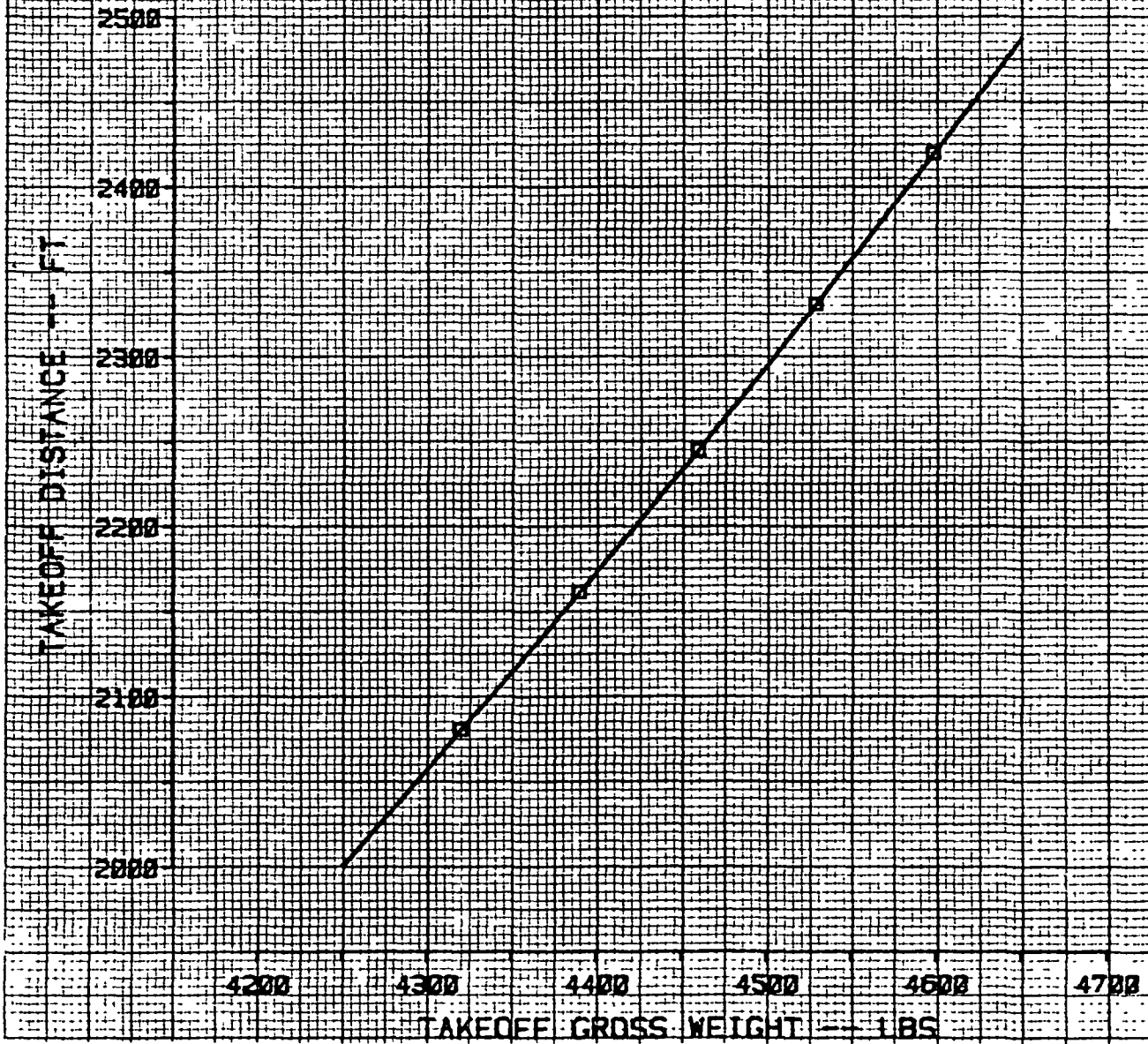

EFFECT OF GROSS WEIGHT ON CLIMB RATE
FOR A CONSTANT PAYLOAD RANGE
1200 LBS. 700 NM
SEA LEVEL
SINGLE ENGINE AIRPLANE

GARRETT ADVANCED TURBOCHARGER
SENSITIVITY STUDY

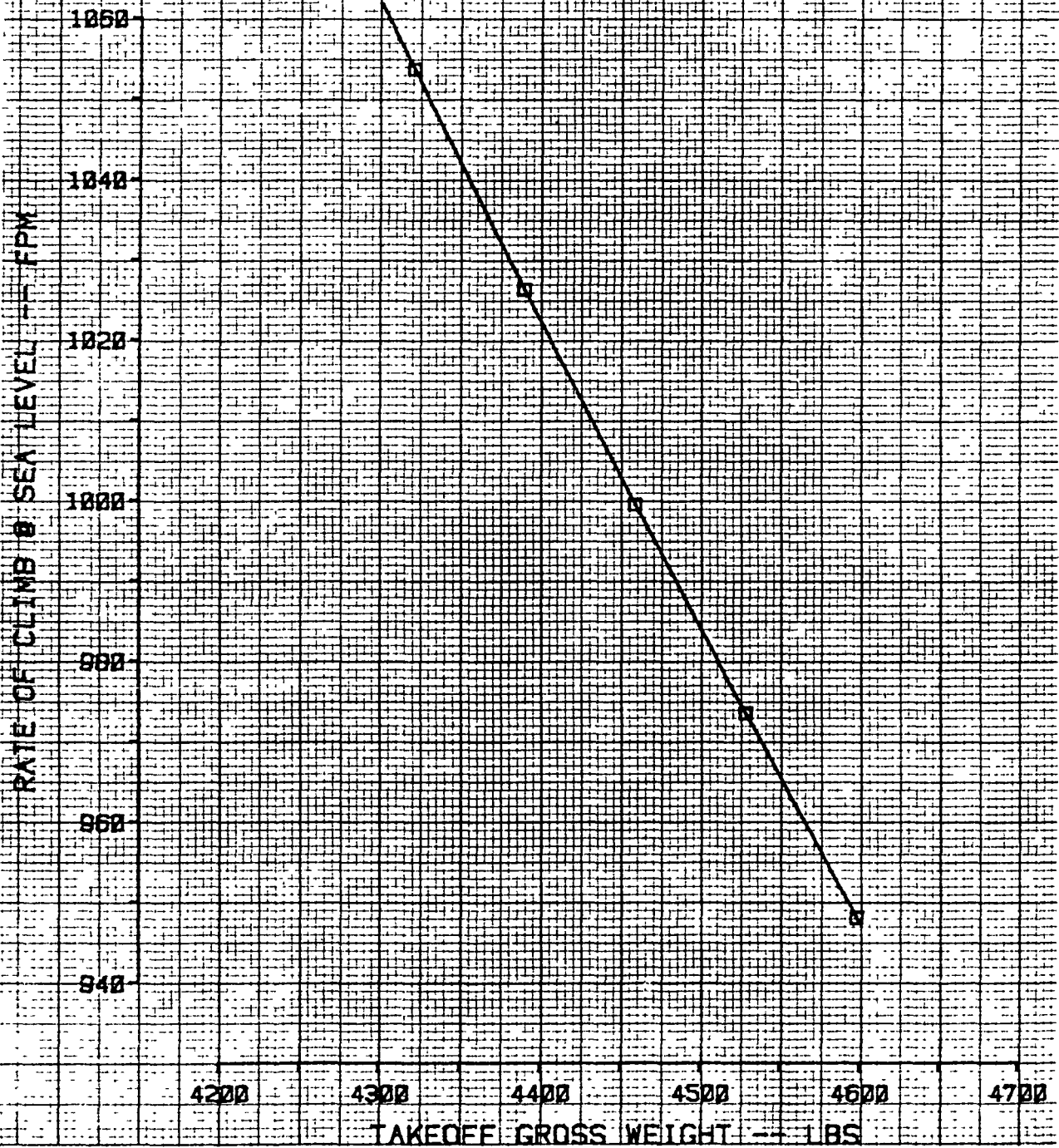

EFFECT OF GROSS WEIGHT ON CLIMB RATE
FOR A CONSTANT PAYLOAD RANGE
1200 LBS. 700 NM
25000 FT

SINGLE ENGINE AIRPLANE

GARRETT ADVANCED TURBOCHARGER
SENSITIVITY STUDY

RATE OF CLIMB @ 25000 FT -- FPM

720
700
680
660
640
620
600
580

4200

4300

4400

4500

4600

4700

TAKEOFF GROSS WEIGHT -- LBS

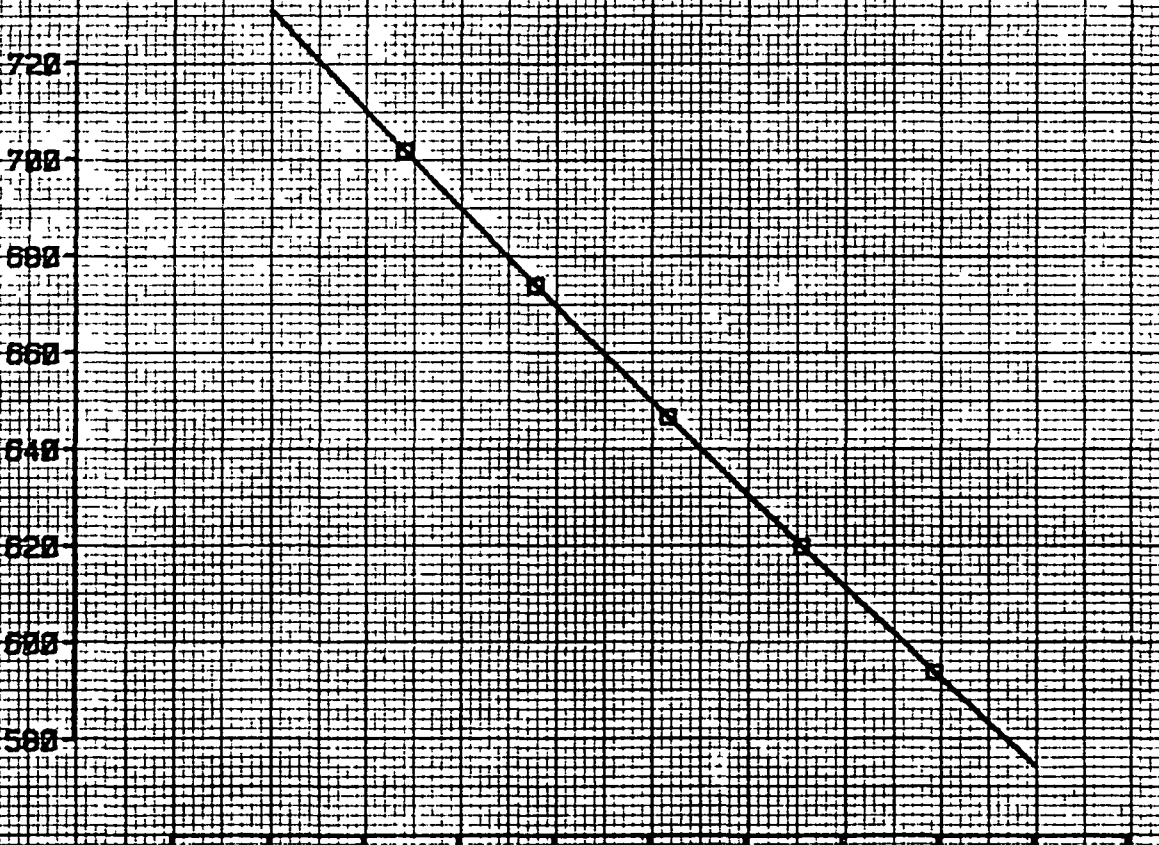

EFFECT OF GROSS WEIGHT ON CRUISE SPEED
FOR A CONSTANT PAYLOAD RANGE
1200 LBS, 700 NM
SINGLE ENGINE AIRPLANE

GARRETT ADVANCED TURBOCHARGER
SENSITIVITY STUDY

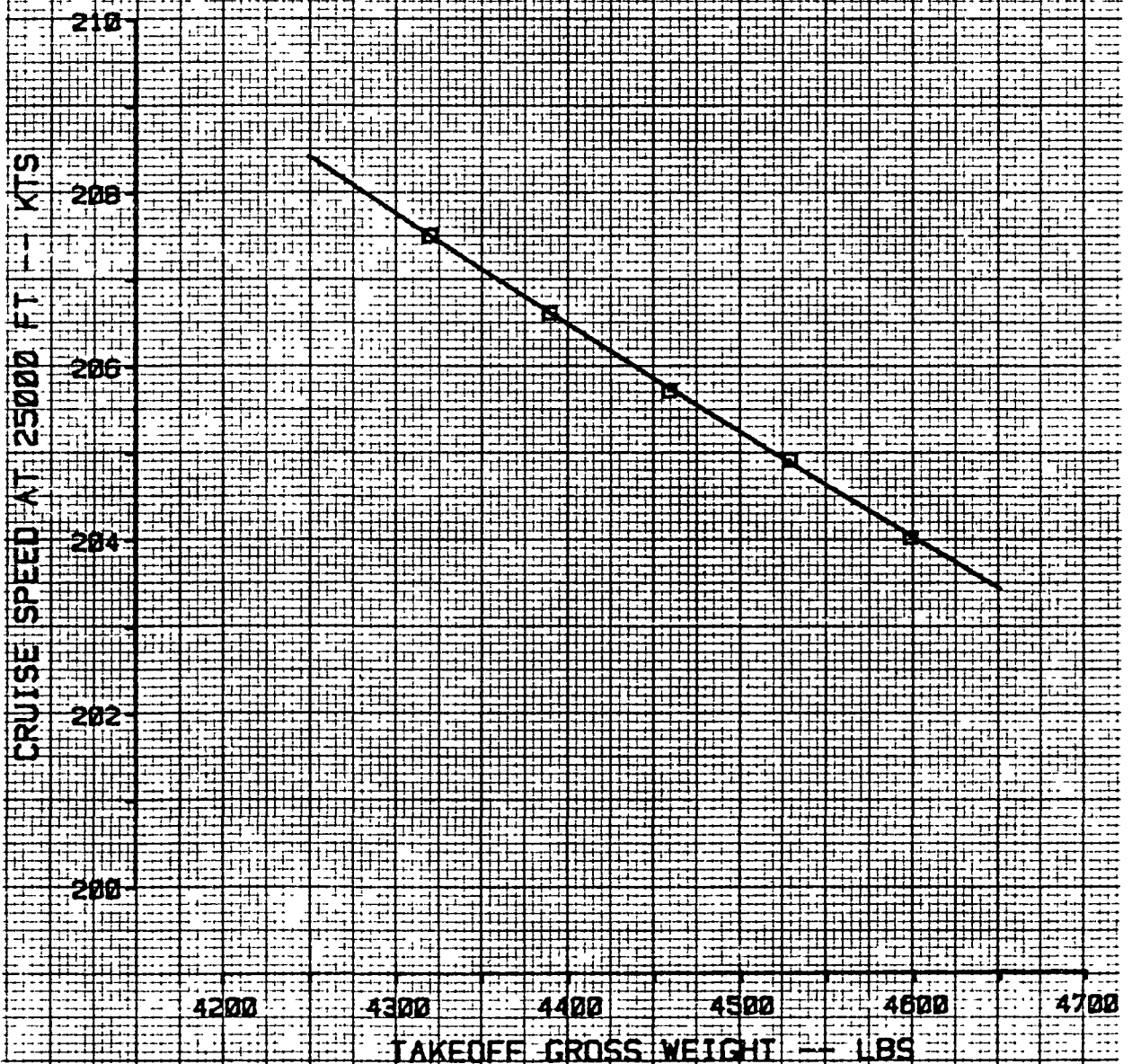

EFFECT OF GROSS WEIGHT ON STALL SPEED
FOR A CONSTANT PAYLOAD RANGE
1200 LBS., 700 NM

SINGLE ENGINE AIRPLANE

GARRETT ADVANCED TURBOCHARGER
SENSITIVITY STUDY

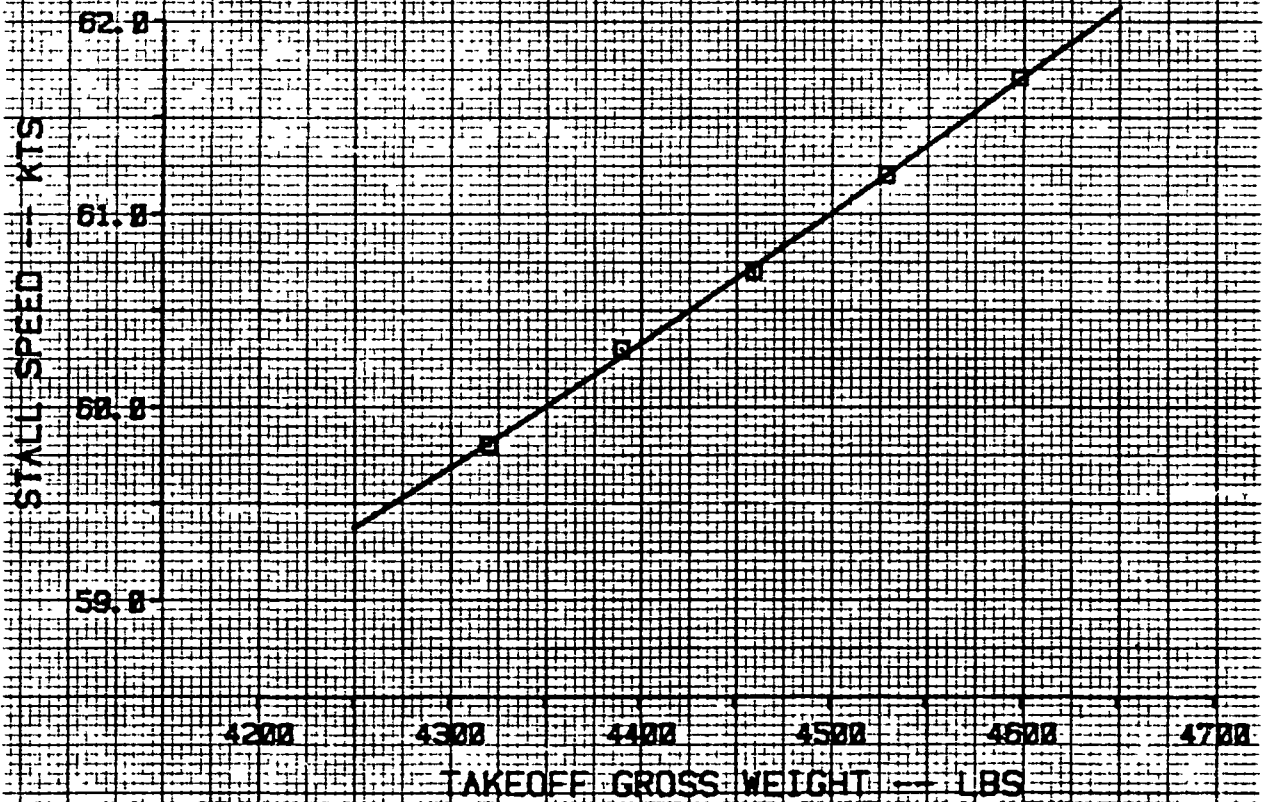

EFFECT OF SFC ON BLOCK FUEL
FOR A CONSTANT PAYLOAD RANGE
1200 LBS, 700 NM

SINGLE ENGINE AIRPLANE

GARRETT ADVANCED TURBOCHARGER
SENSITIVITY STUDY

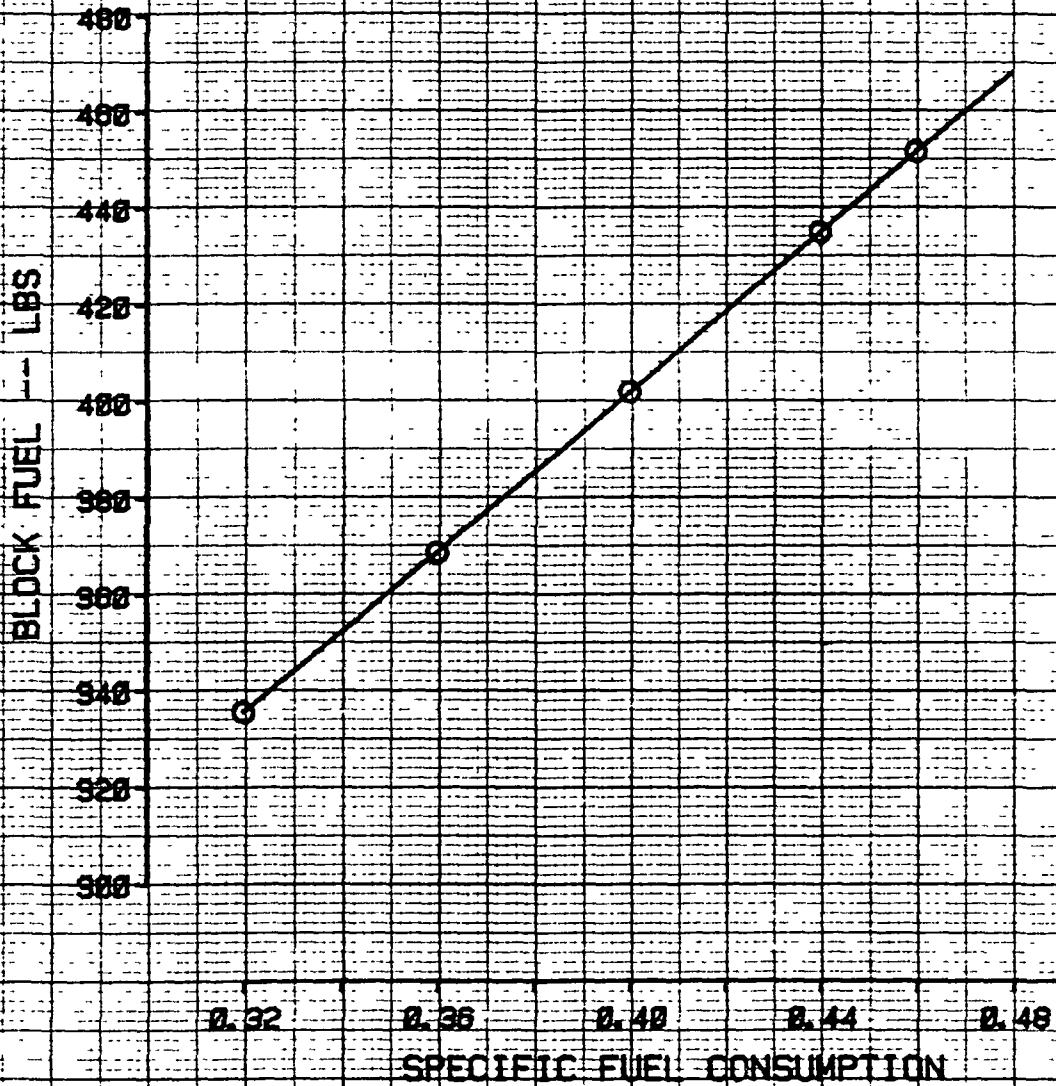

EFFECT OF ENGINE WEIGHT ON BLOCK FUEL
FOR A CONSTANT PAYLOAD RANGE
1200 LBS. 700 NM

SINGLE ENGINE AIRPLANE

GARRETT ADVANCED TURBOCHARGER
SENSITIVITY STUDY

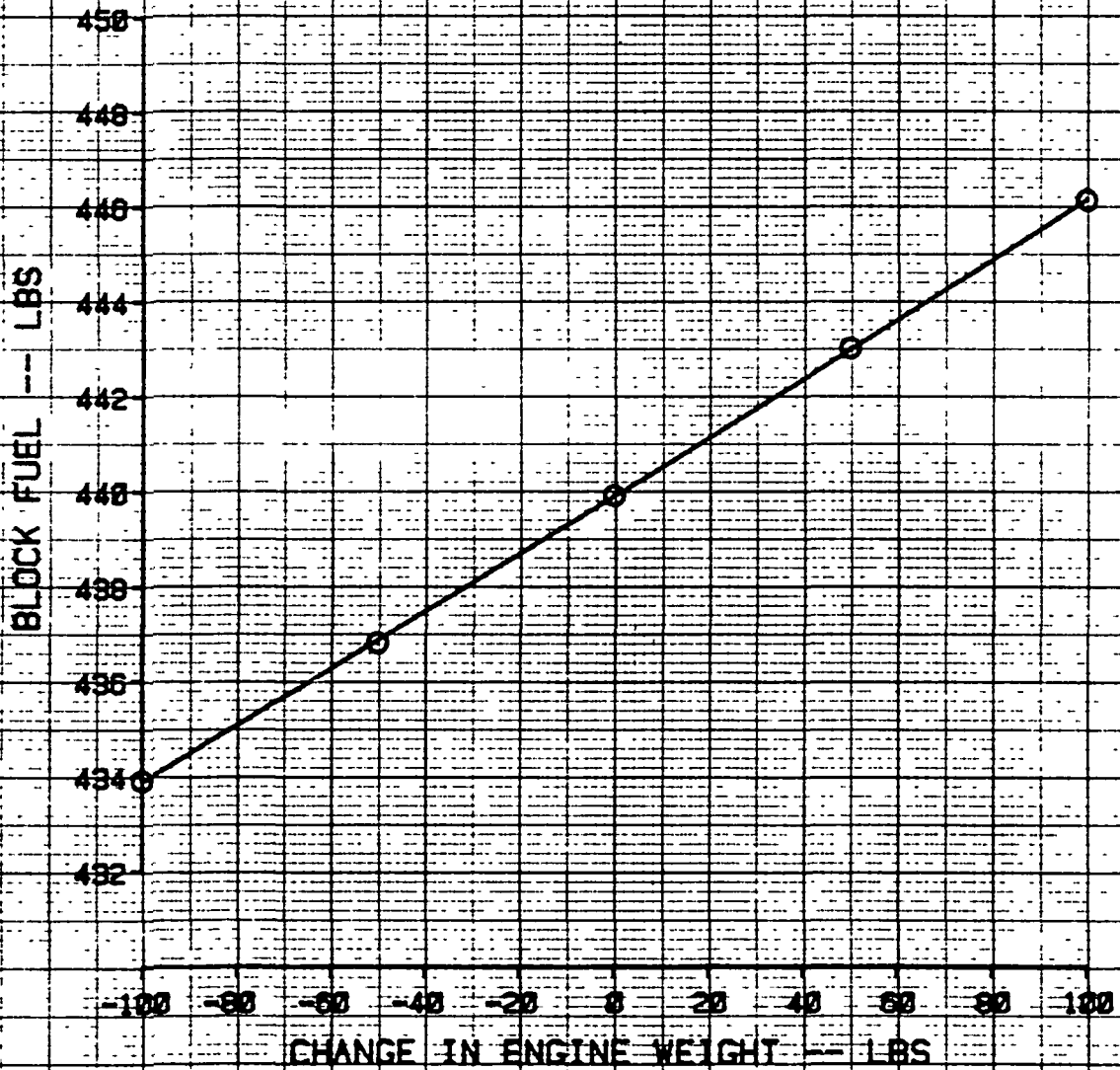

EFFECT OF DRAG ON BLOCK FUEL
FOR A CONSTANT PAYLOAD RANGE
1200 LBS, 700 NM

SINGLE ENGINE AIRPLANE

GARRETT ADVANCED TURBOCHARGER
SENSITIVITY STUDY

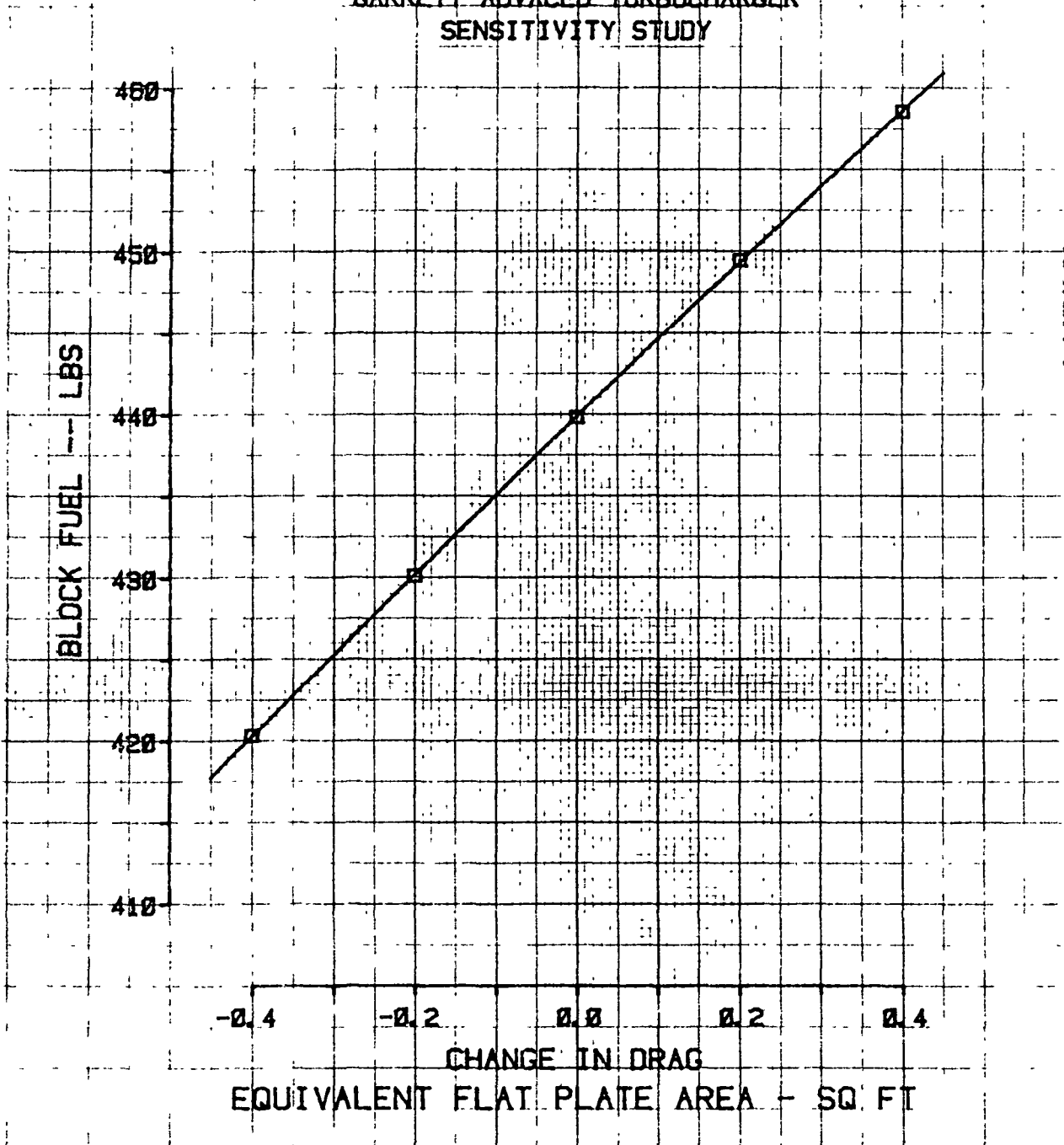

EFFECT OF ENGINE WEIGHT ON DOC
FOR A CONSTANT PAYLOAD RANGE
1200 LBS. 700 NM

SINGLE ENGINE AIRPLANE

GARRETT ADVANCED TURBOCHARGER
SENSITIVITY STUDY

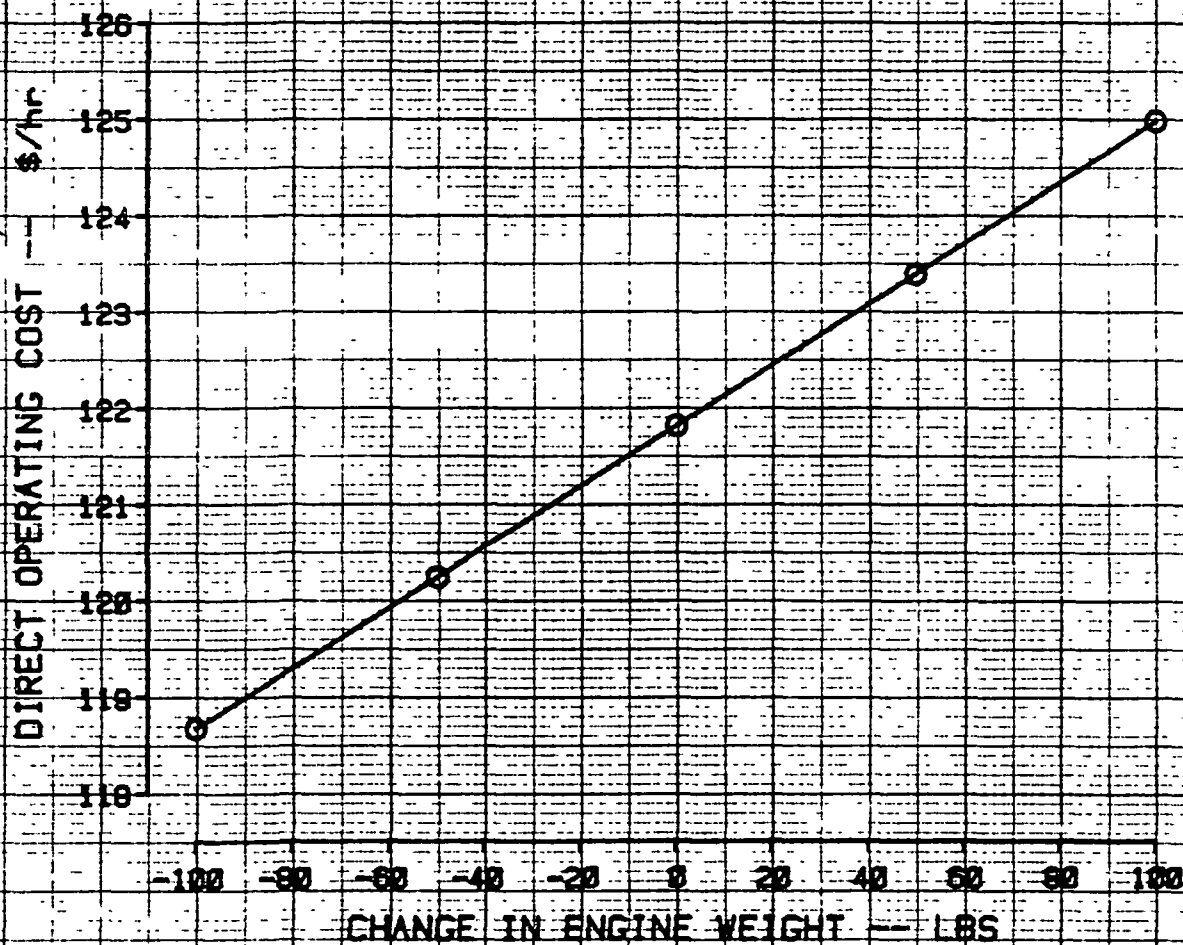

ATDS Airplane Sensitivity Charts

(Twin-Engine Airplane)

ORDINATE		ABSCISSA
Takeoff Distance	Versus	Brake Horsepower
Maximum Takeoff Weight	Versus	Brake Horsepower
Rate of Climb at Sea Level	Versus	Brake Horsepower
Rate of Climb at 25,000 Ft	Versus	Brake Horsepower
Single Engine ROC at Sea Level	Versus	Brake Horsepower
Single Engine ROC at 5000 Ft	Versus	Brake Horsepower
Cruise Speed at 25,000 Ft	Versus	Brake Horsepower
Minimum Weight Required	Versus	Brake Horsepower
BEW	Versus	Brake Horsepower
Range	Versus	Brake Horsepower
Minimum Weight Required	Versus	Specific Fuel Consumption
BEW	Versus	Specific Fuel Consumption
Range	Versus	Specific Fuel Consumption
Maximum TOGW	Versus	Δ Engine Weight
Rate of Climb at Sea Level	Versus	Δ Drag
Rate of Climb at 25,000 Ft	Versus	Δ Drag
Single Engine ROC at Sea Level	Versus	Δ Drag
Single Engine ROC at 5000 Ft	Versus	Δ Drag
Minimum Weight Required	Versus	Δ Drag
BEW	Versus	Δ Drag
Takeoff Distance	Versus	Δ Drag
Cruise Speed at 25,000 Ft	Versus	Δ Drag
Takeoff Distance	Versus	Takeoff Gross Weight
Rate of Climb at Sea Level	Versus	Takeoff Gross Weight
Rate of Climb at 25,000 Ft	Versus	Takeoff Gross Weight
Single Engine ROC at Sea Level	Versus	Takeoff Gross Weight
Single Engine ROC at 5000 Ft	Versus	Takeoff Gross Weight
Cruise Speed at 25,000 Ft	Versus	Takeoff Gross Weight
Stall Speed	Versus	Takeoff Gross Weight

ATDS Airplane Sensitivity Charts

(Twin-Engine Airplane Contd)

ORDINATE	Versus	ABSCISSA
Block Fuel	Versus	Specific Fuel Consumption
Block Fuel	Versus	Δ Engine Weight
Block Fuel	Versus	Δ Drag
Direct Operating Costs	Versus	Δ Engine Weight

EFFECT OF BHP ON TAKEOFF DISTANCE
WITH TAKEOFF GROSS WEIGHT = 6850 LBS

TWIN ENGINE AIRPLANE

GARRETT ADVANCED TURBOCHARGER
SENSITIVITY STUDY

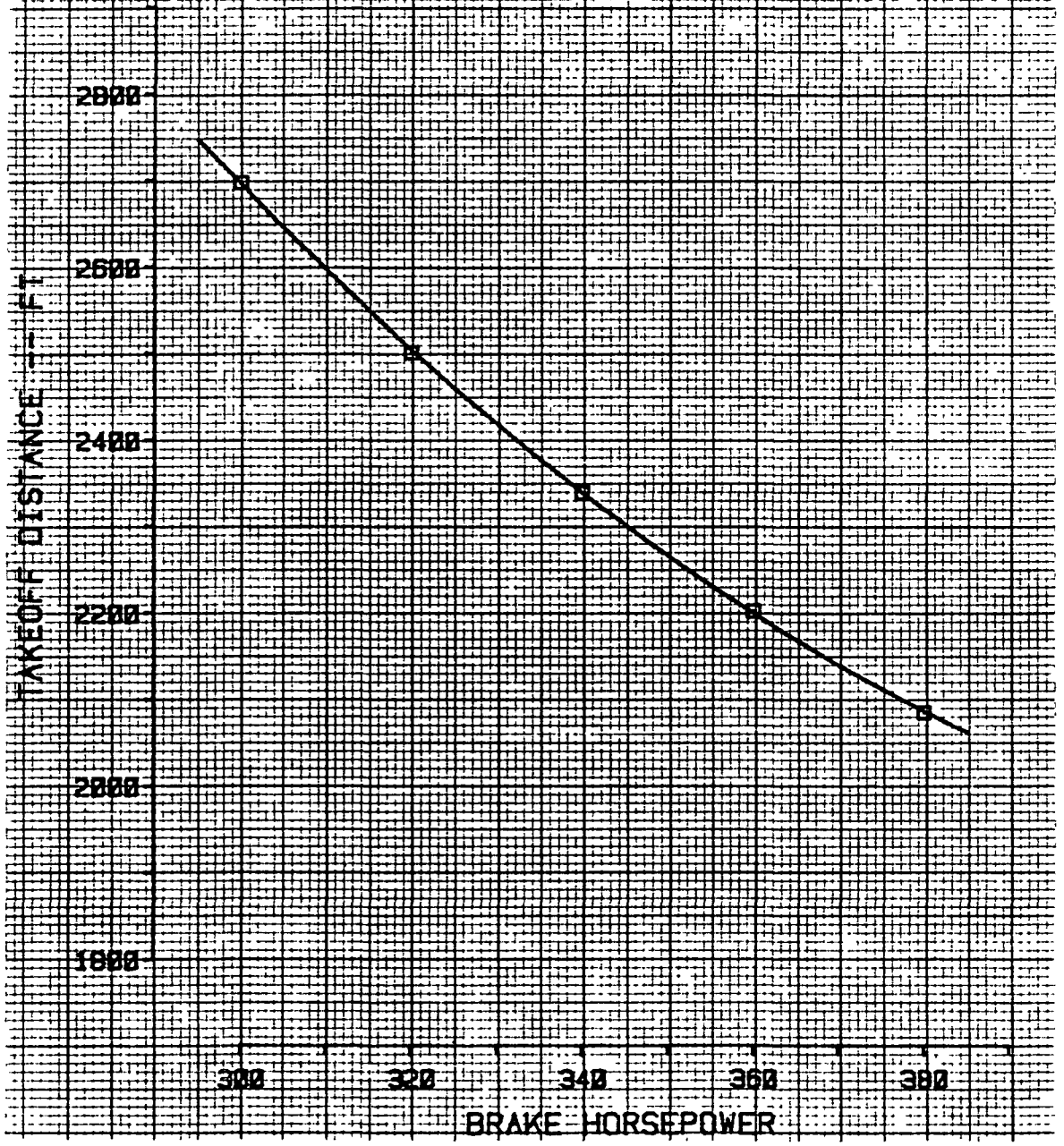

EFFECT OF BHP ON MAXIMUM WEIGHT
WITH TAKEOFF DISTANCE = 2338 FT

TWIN ENGINE AIRPLANE

GARRETT ADVANCED TURBOCHARGER
SENSITIVITY STUDY

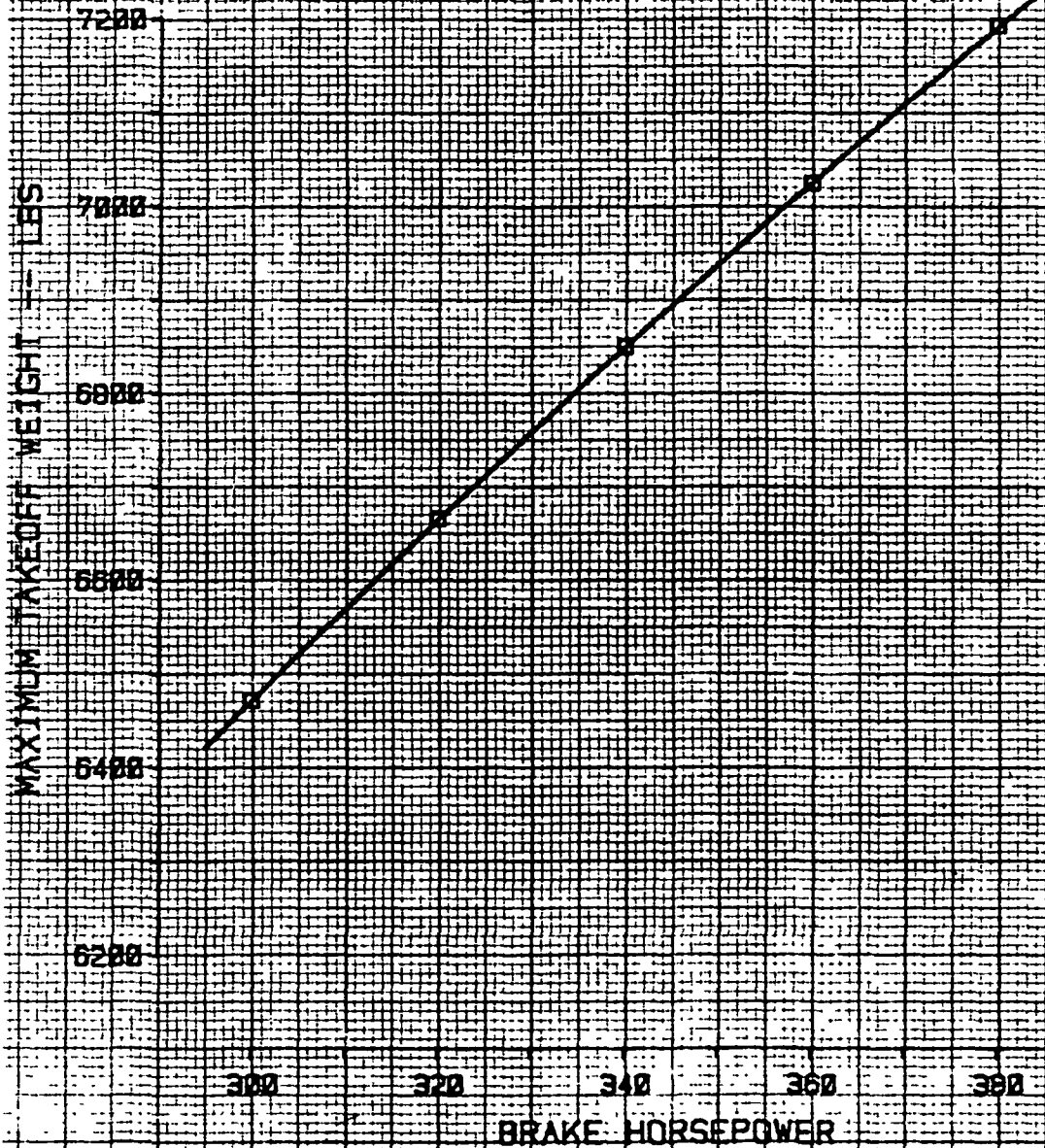

EFFECT OF BHP ON CLIMB RATE
FOR A CONSTANT WEIGHT
6850 LBS
SEA LEVEL

TWIN ENGINE AIRPLANE

GARRETT ADVANCED TURBOCHARGER
SENSITIVITY STUDY

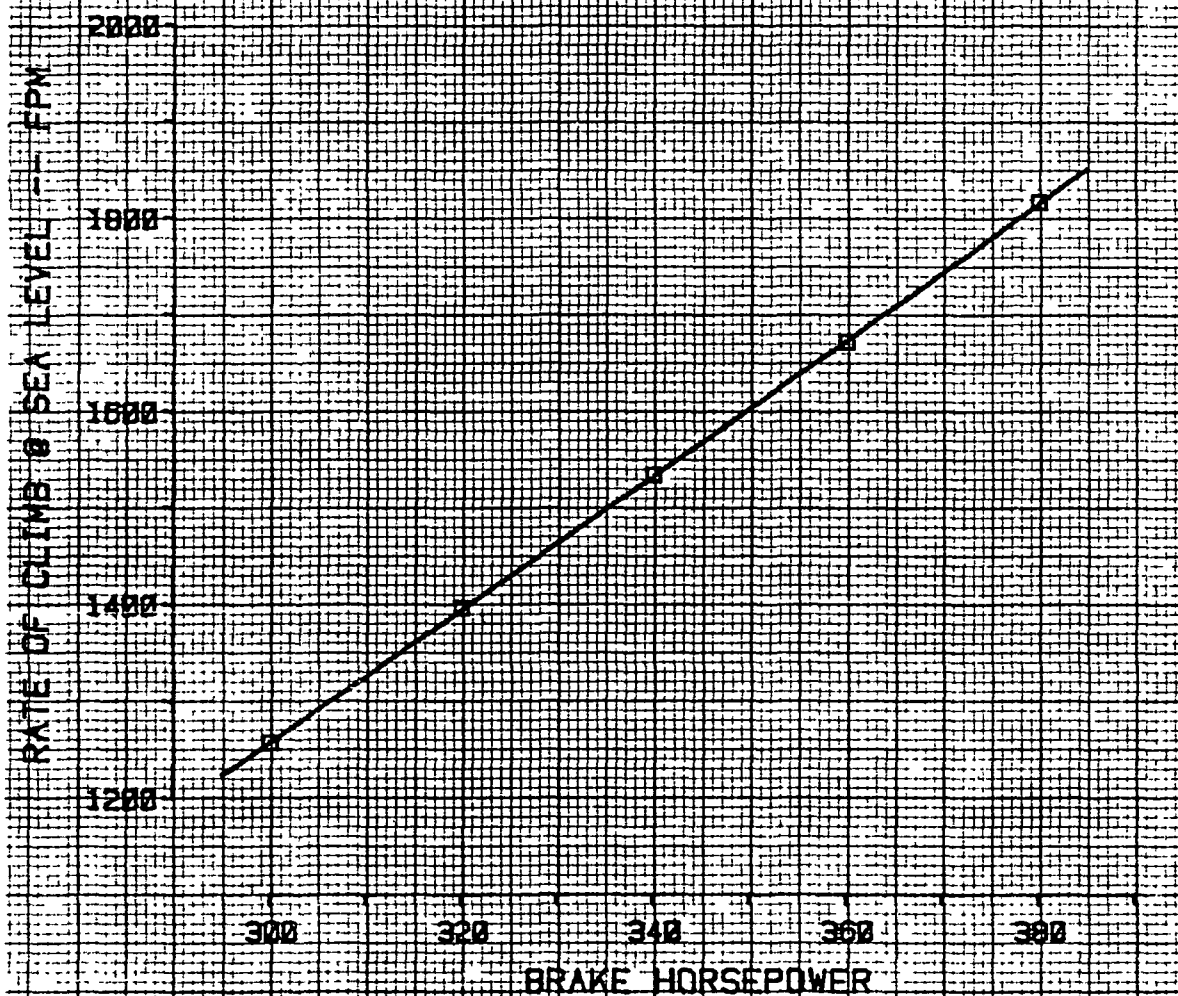

EFFECT OF BHP ON CLIMB RATE
FOR A CONSTANT WEIGHT

6850 LBS
25000 FT

GARRETT ADVANCED TURBOCHARGER
SENSITIVITY STUDY

TWIN ENGINE AIRPLANE

RATE OF CLIMB @ 25000 FT -- FPM

1300
1200
1100
1000
900
800
700

300 320 340 360 380

BRAKE HORSEPOWER

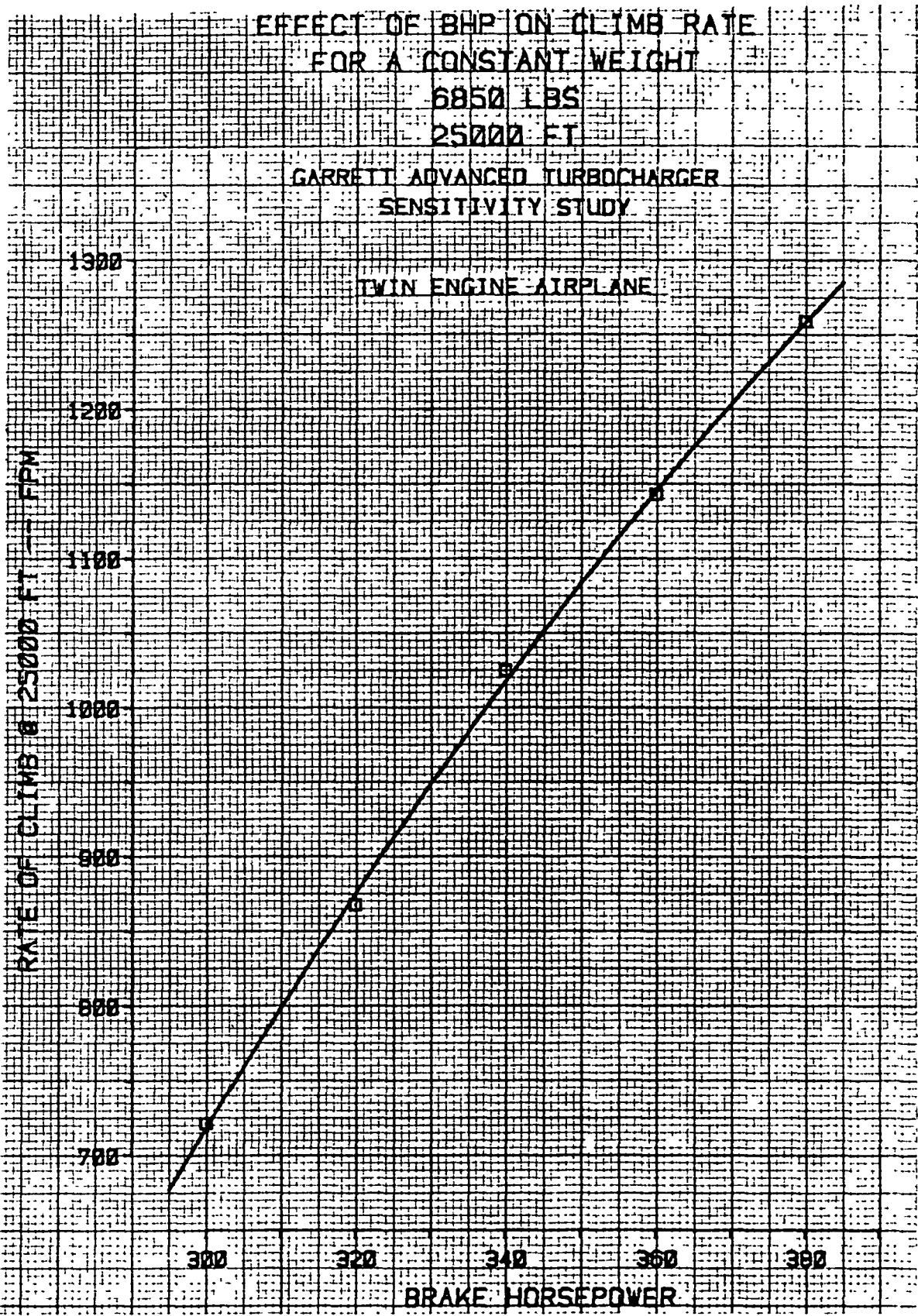

EFFECT OF BHP ON S/E CLIMB RATE
FOR A CONSTANT WEIGHT
6850 LBS
SEA LEVEL

TWIN ENGINE AIRPLANE

GARRETT ADVANCED TURBOCHARGER
SENSITIVITY STUDY

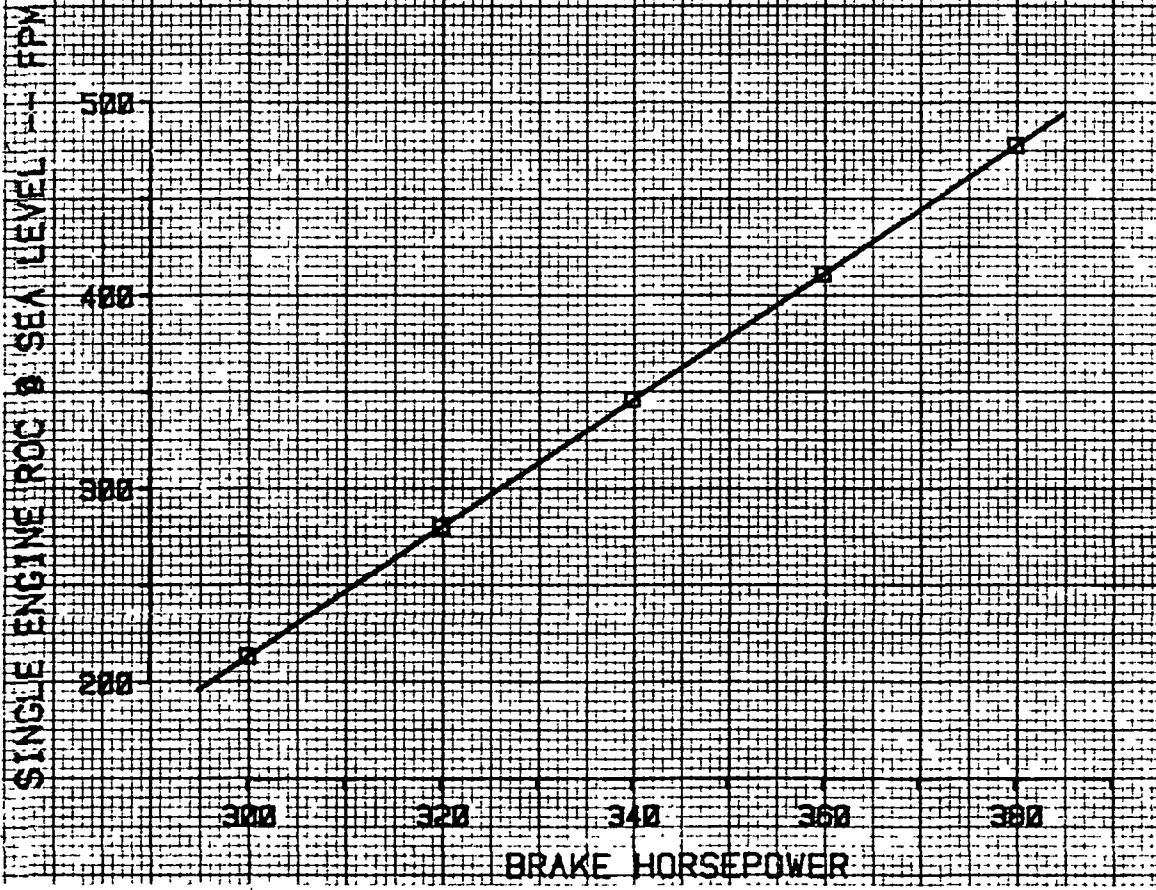

EFFECT OF BHP ON S/E CLIMB RATE
FOR A CONSTANT WEIGHT

6850 LBS

5000 FT

TWIN ENGINE AIRPLANE

GARRETT ADVANCED TURBOCHARGER
SENSITIVITY STUDY

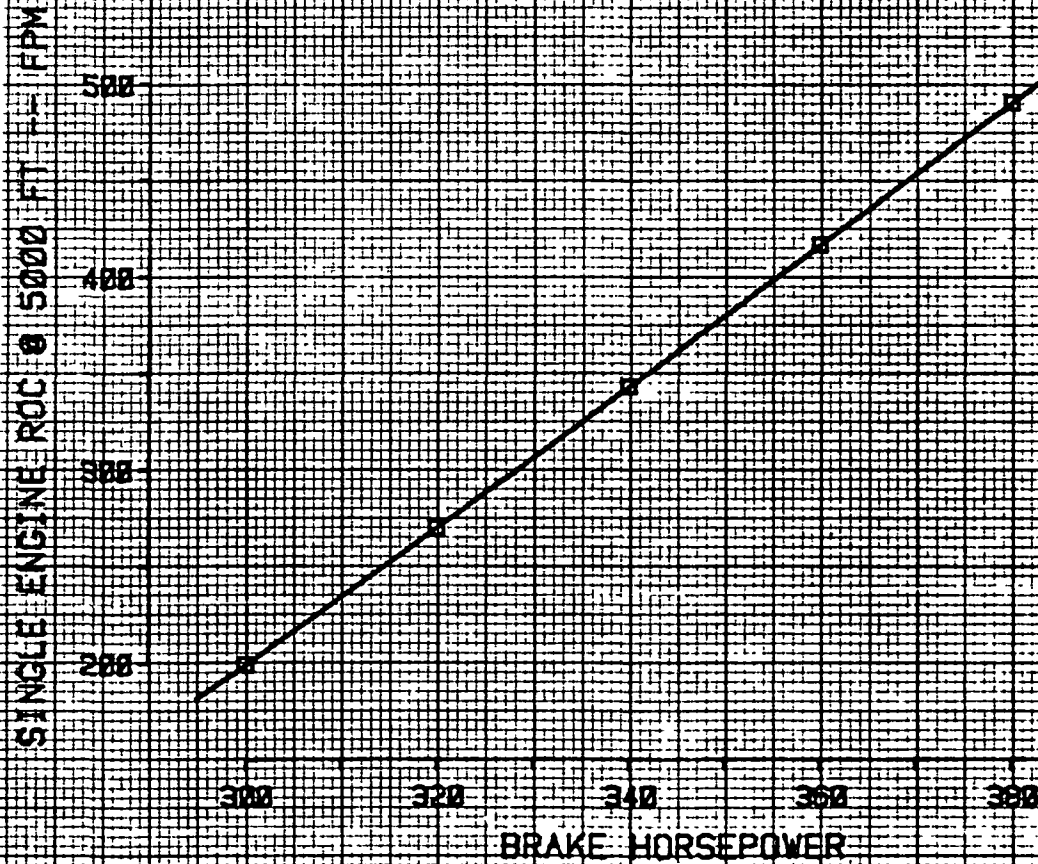

EFFECT OF BHP ON CRUISE SPEED
FOR A CONSTANT WEIGHT

6850 LBS

TWIN ENGINE AIRPLANE

GARRETT ADVANCED TURBOCHARGER
SENSITIVITY STUDY

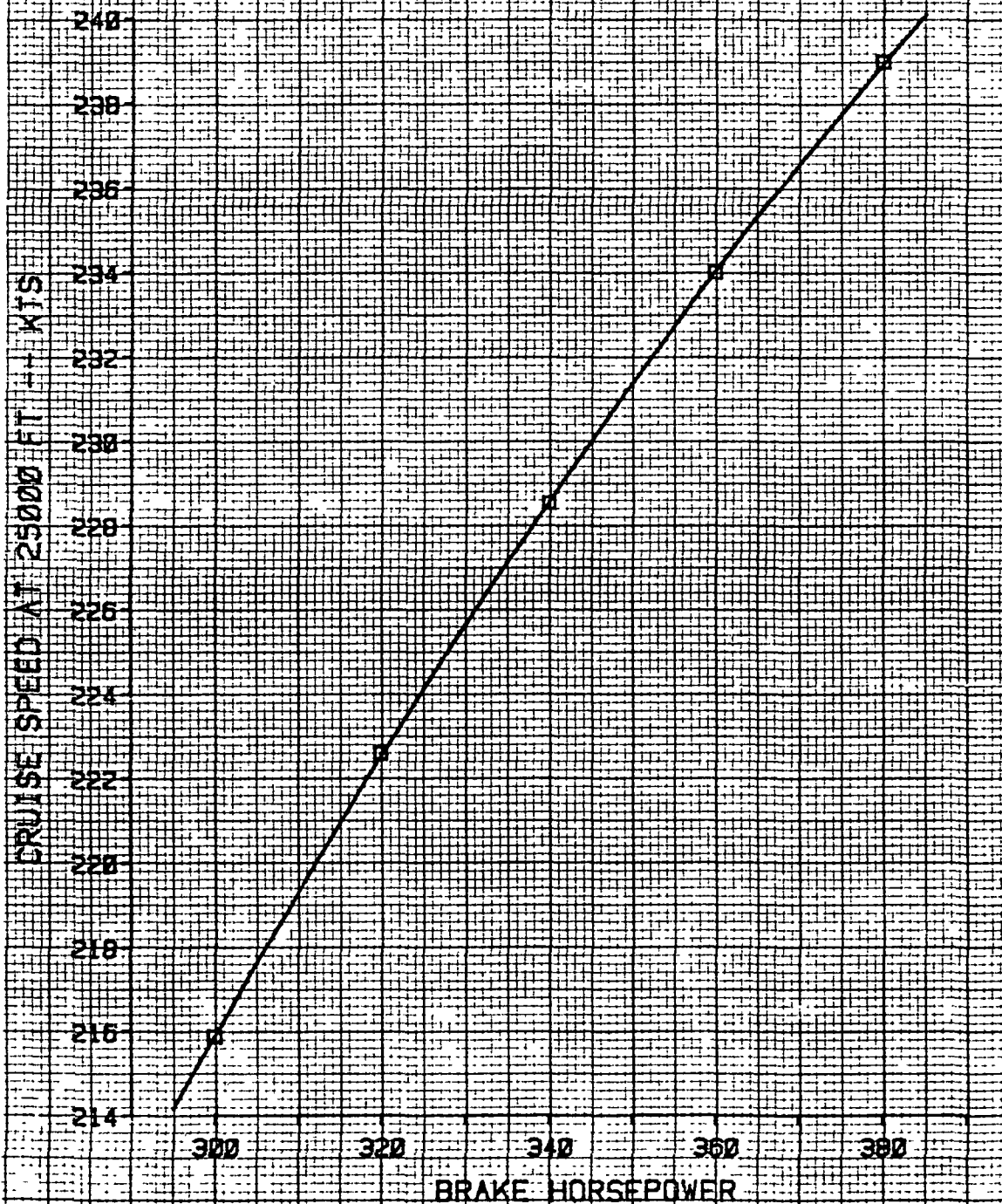

EFFECT OF BHP ON WEIGHT
 FOR A CONSTANT PAYLOAD RANGE
 1400 LBS. 800 NM

GARRETT ADVANCED TURBOCHARGER
 SENSITIVITY STUDY
 TWIN ENGINE AIRPLANE

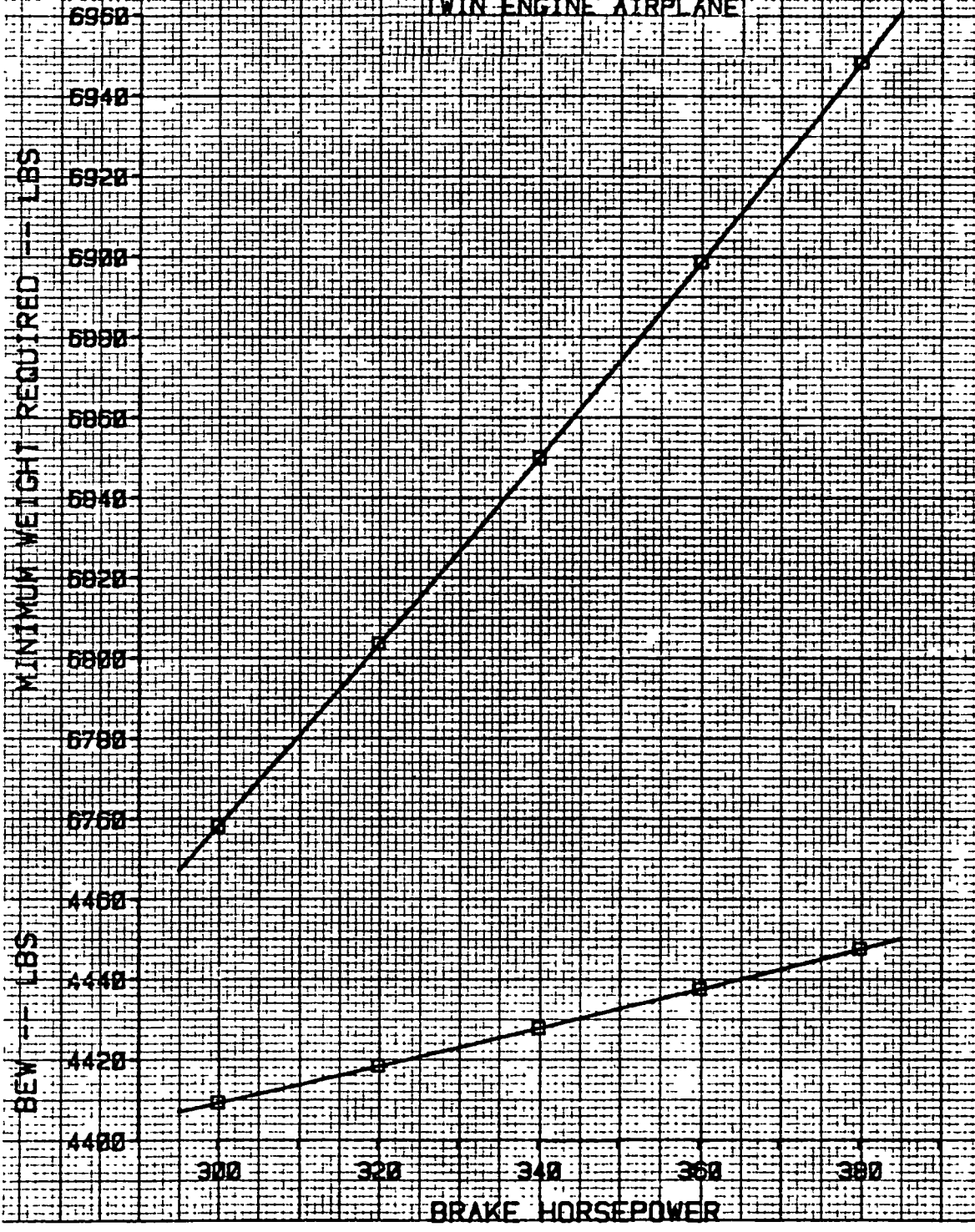

EFFECT OF BHP ON RANGE
FOR A CONSTANT WEIGHT AND PAYLOAD
6850 LB TOGW, 1400 LB PAYLOAD

TWIN ENGINE AIRPLANE

GARRETT ADVANCED TURBOCHARGER
SENSITIVITY STUDY

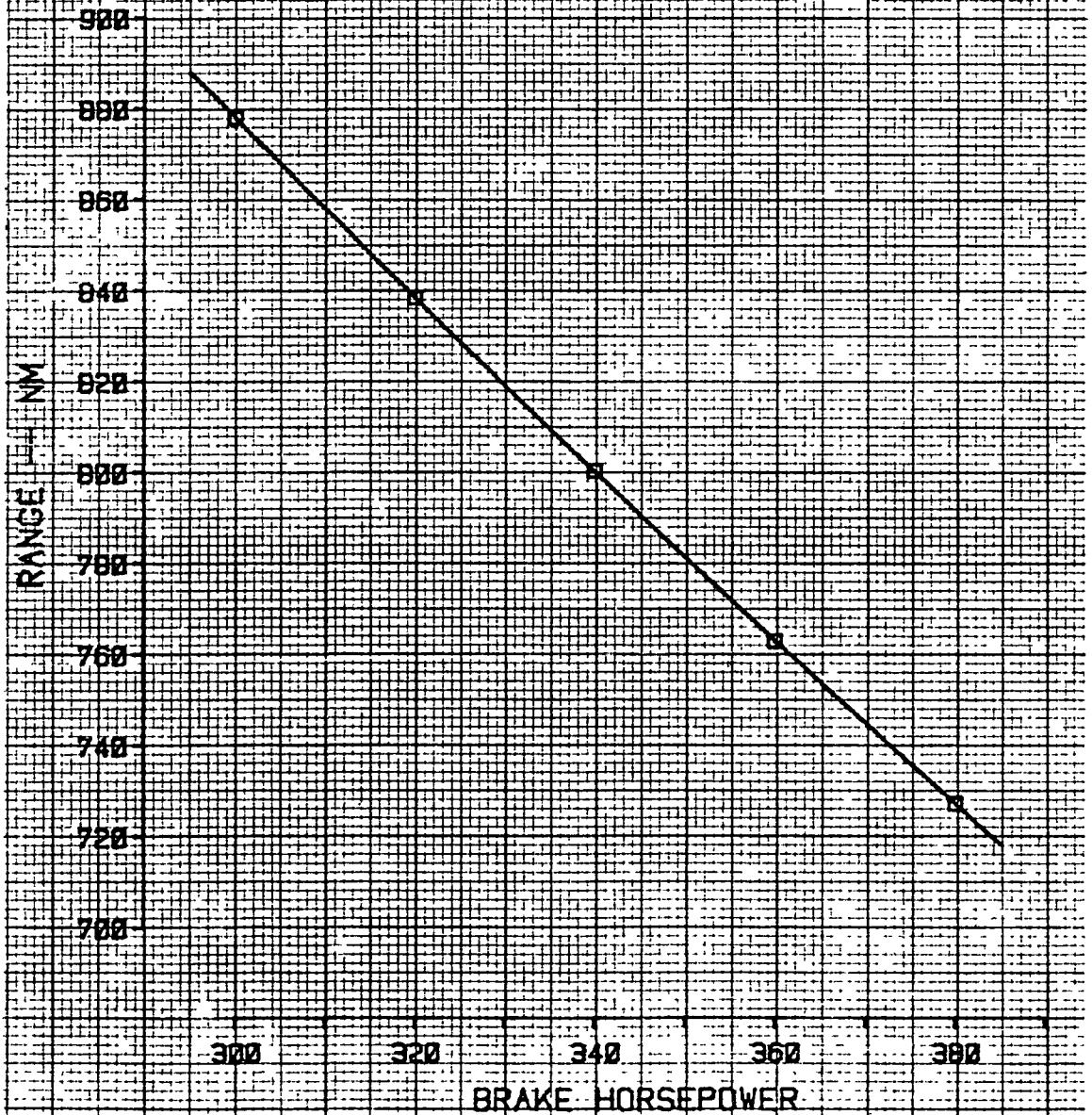

EFFECT OF SFC ON WEIGHT
 FOR A CONSTANT PAYLOAD RANGE
 1400 LBS, 800 NM
 GARRETT ADVANCED TURBOCHARGER
 SENSITIVITY STUDY

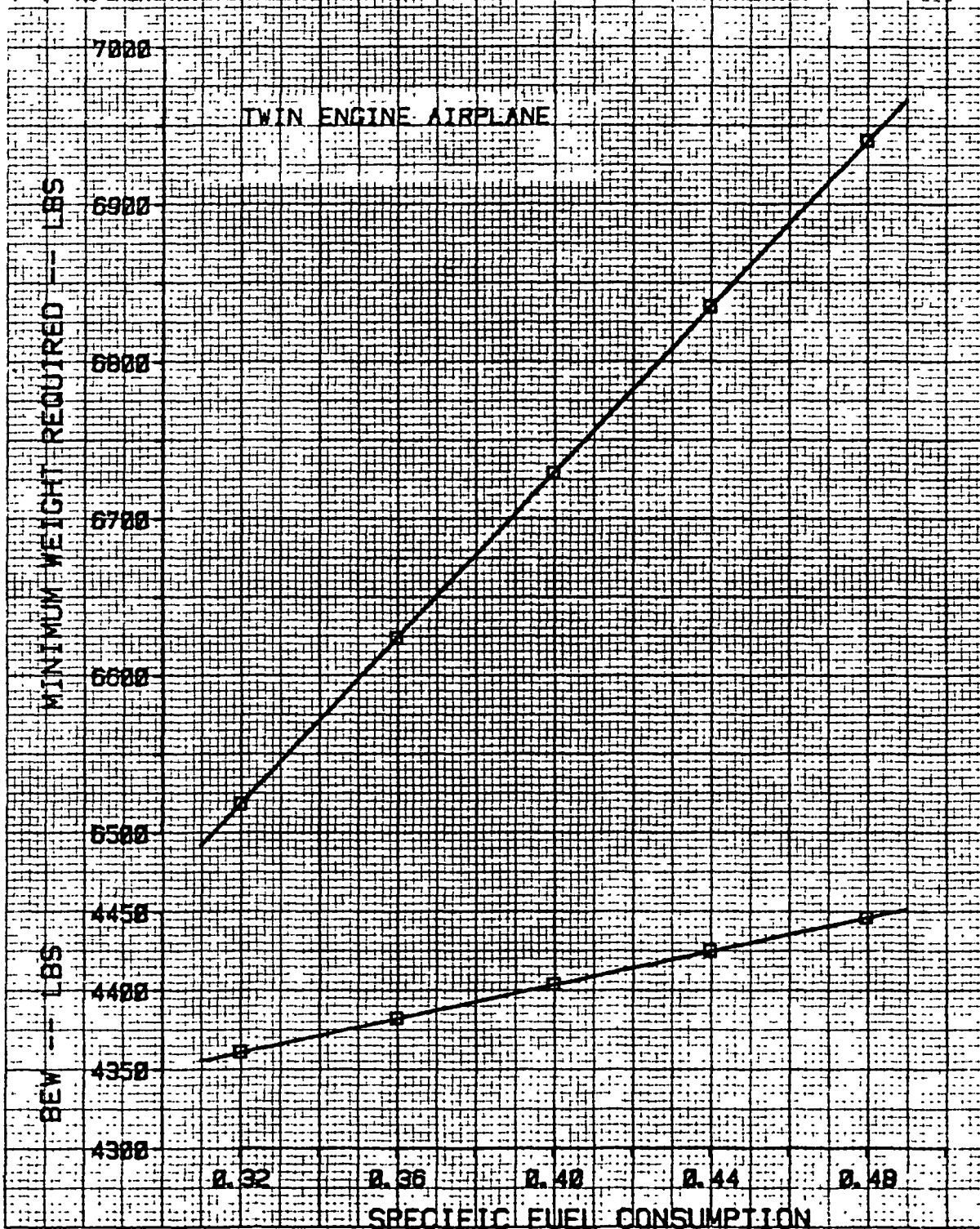

EFFECT OF SFC ON RANGE
FOR A CONSTANT WEIGHT AND PAYLOAD
6850 LB TOGW, 1400 LB PAYLOAD
TWIN ENGINE AIRPLANE

GARRETT ADVANCED TURBOCHARGER
SENSITIVITY STUDY

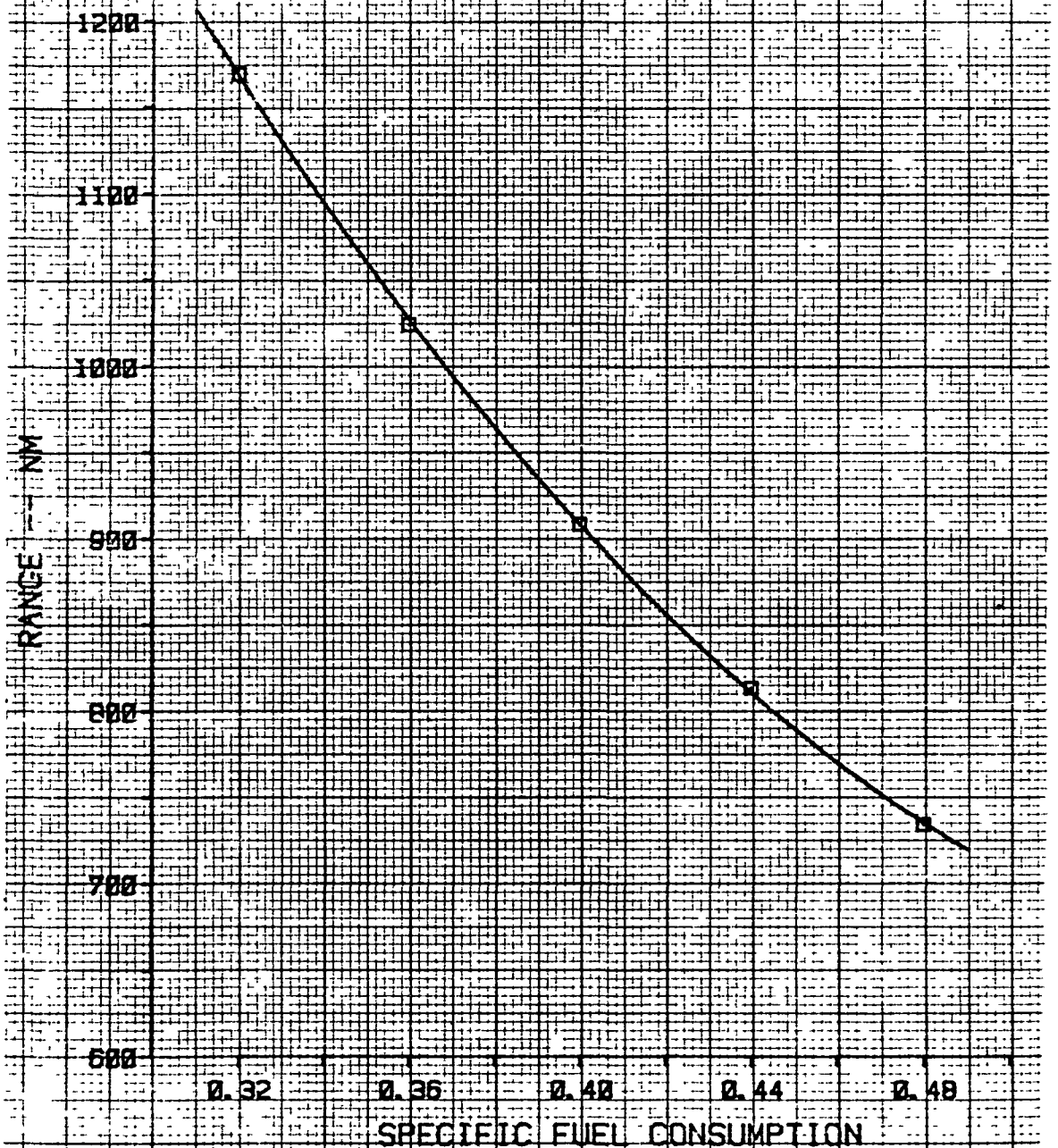

EFFECT OF ENGINE WEIGHT ON TOGW
FOR A CONSTANT PAYLOAD RANGE
1400 LBS. 800 NM

TWIN ENGINE AIRPLANE

GARRETT ADVANCED TURBOCHARGER
SENSITIVITY STUDY

MAXIMUM TAKEOFF GROSS WEIGHT -- LBS

7200
7000
6800
6600
6400

-100 -80 -60 -40 -20 0 20 40 60 80 100

CHANGE IN ENGINE WEIGHT -- LBS

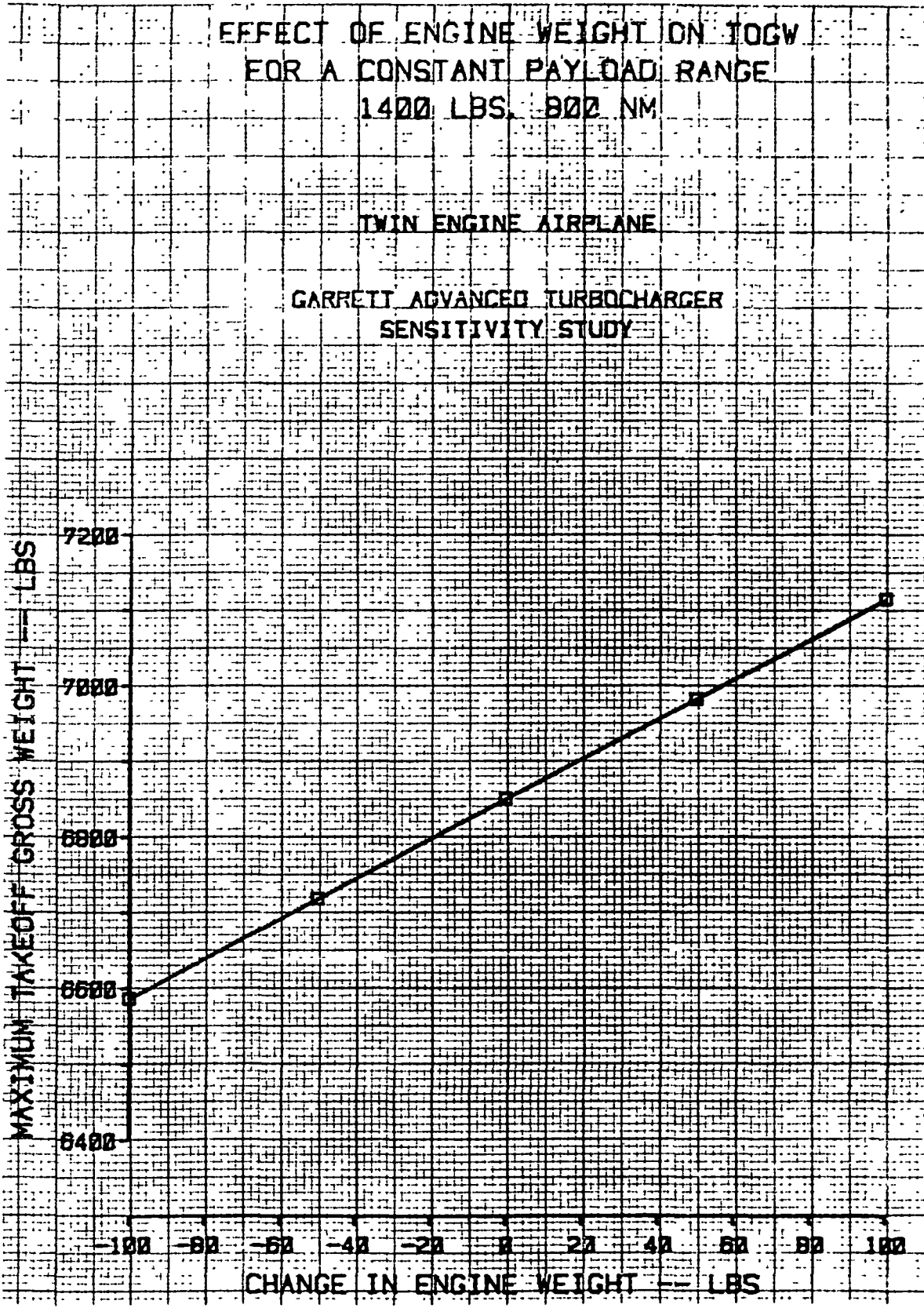

EFFECT OF DRAG ON CLIMB RATE
FOR A CONSTANT WEIGHT
6850 LBS
SEA LEVEL

TWIN ENGINE AIRPLANE

GARRETT ADVANCED TURBOCHARGER
SENSITIVITY STUDY

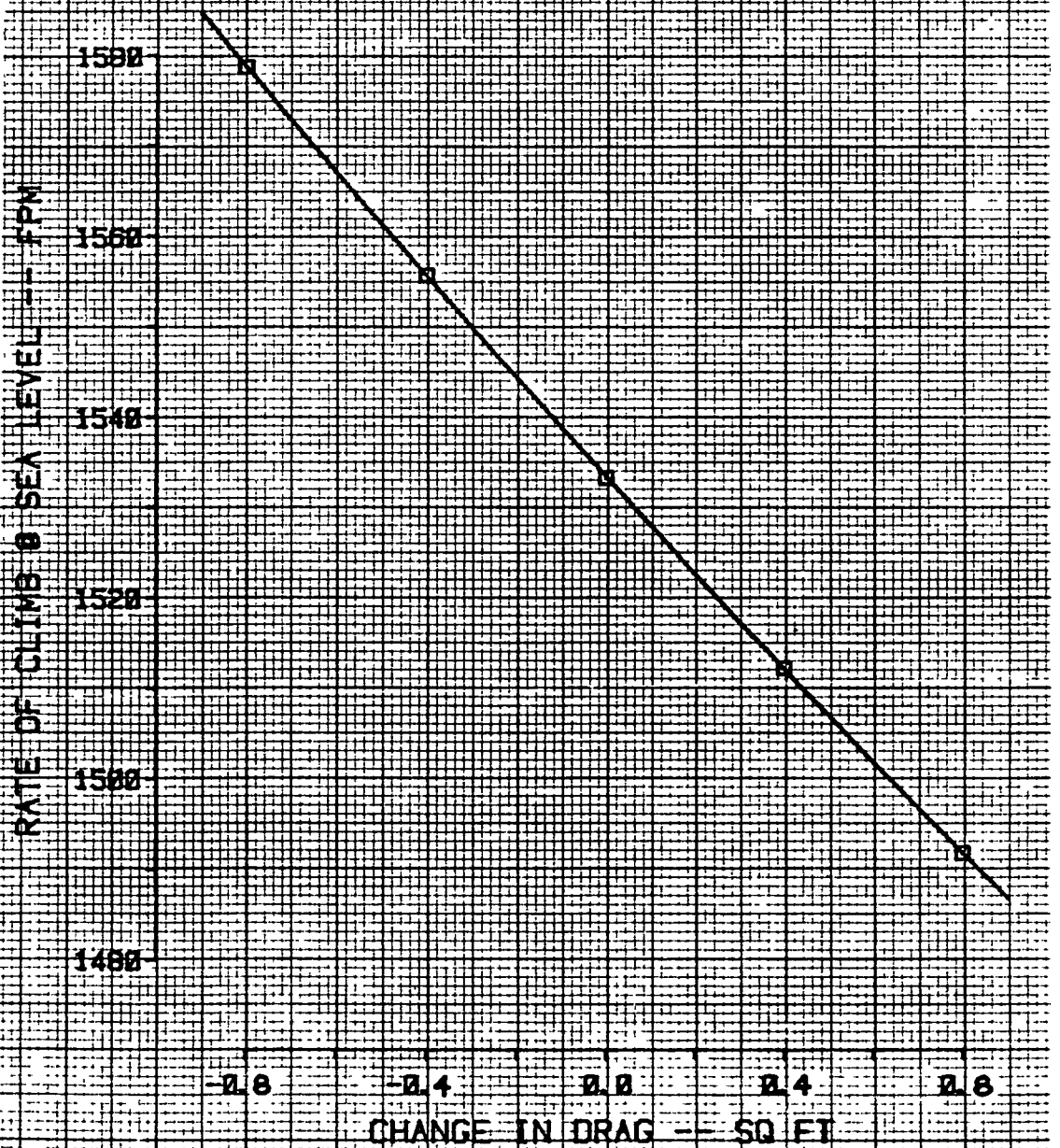

EFFECT OF DRAG ON CLIMB RATE
FOR A CONSTANT WEIGHT

6850 LBS

25000 FT

TWIN ENGINE AIRPLANE

GARRETT ADVANCED TURBOCHARGER
SENSITIVITY STUDY

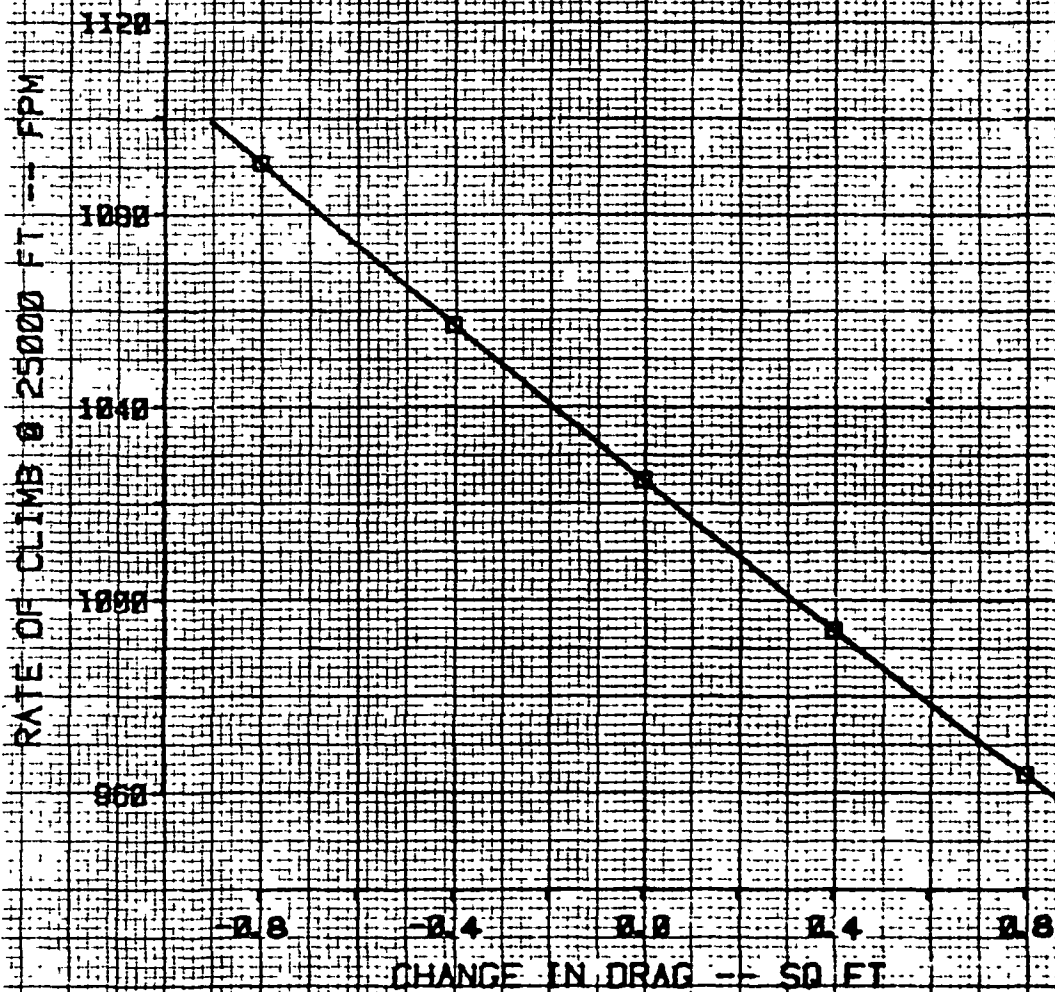

EFFECT OF DRAG ON S/E CLIMB RATE
FOR A CONSTANT WEIGHT

6850 LBS

SEA LEVEL

TWIN ENGINE AIRPLANE

GARRETT ADVANCED TURBOCHARGER
SENSITIVITY STUDY

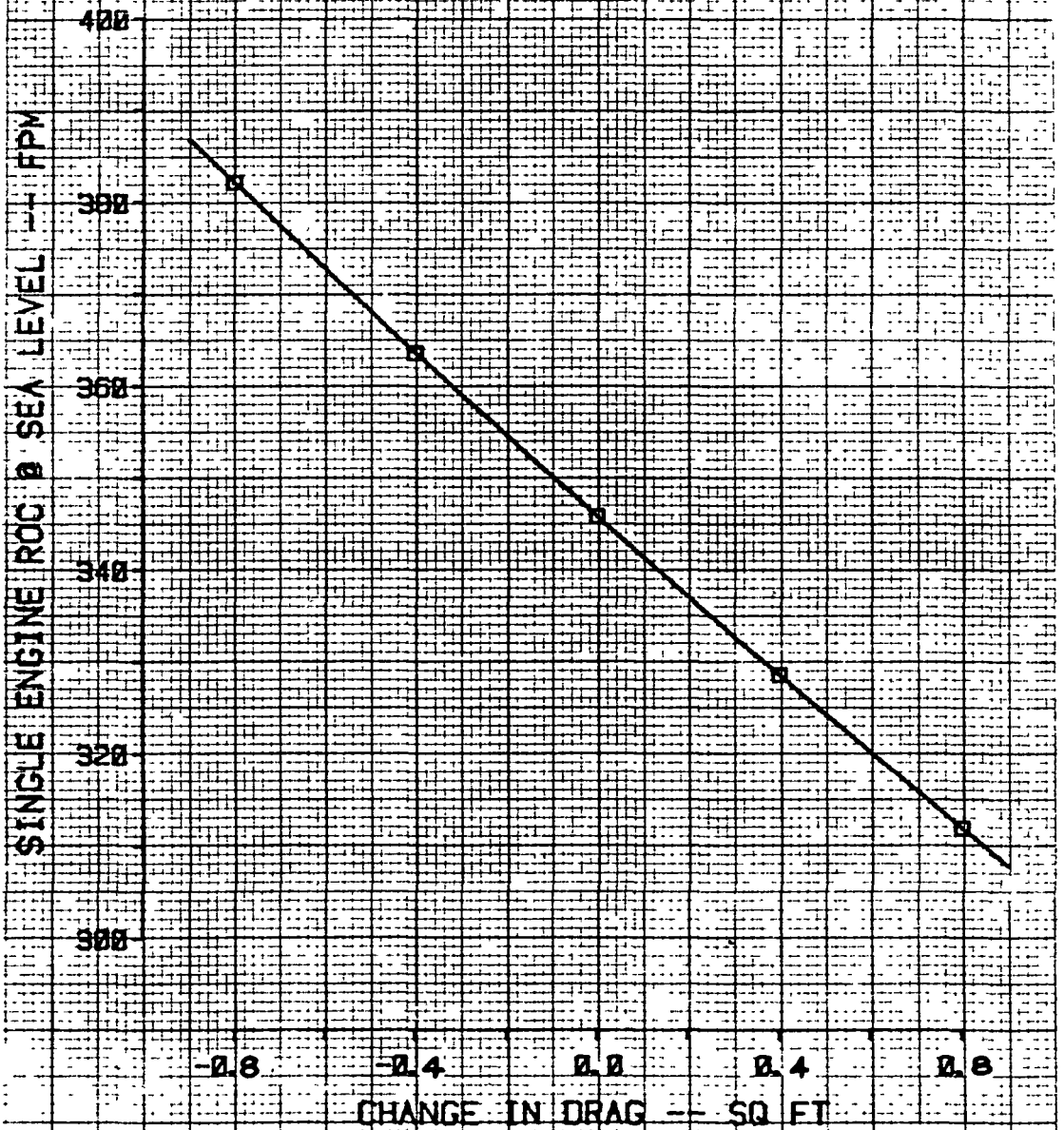

EFFECT OF DRAG ON S/E CLIMB RATE
FOR A CONSTANT WEIGHT

6850 LBS

5000 FT

TWIN ENGINE AIRPLANE

GARRETT ADVANCED TURBOCHARGER
SENSITIVITY STUDY

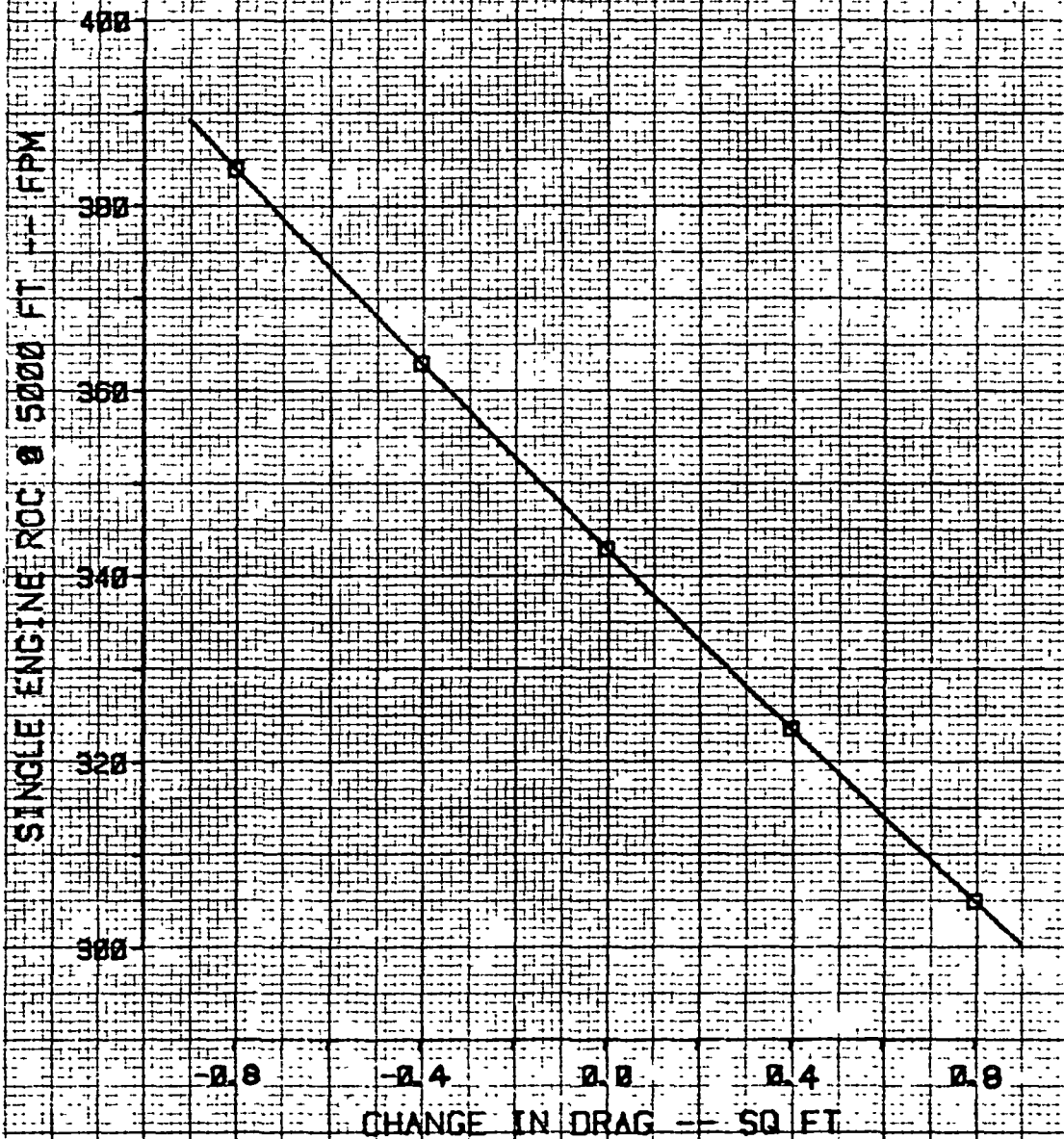

EFFECT OF DRAG ON WEIGHT
 FOR A CONSTANT PAYLOAD RANGE
 1400 LBS. 800NM

TWIN ENGINE AIRPLANE

GARRETT ADVANCED TURBOCHARGER
 SENSITIVITY STUDY

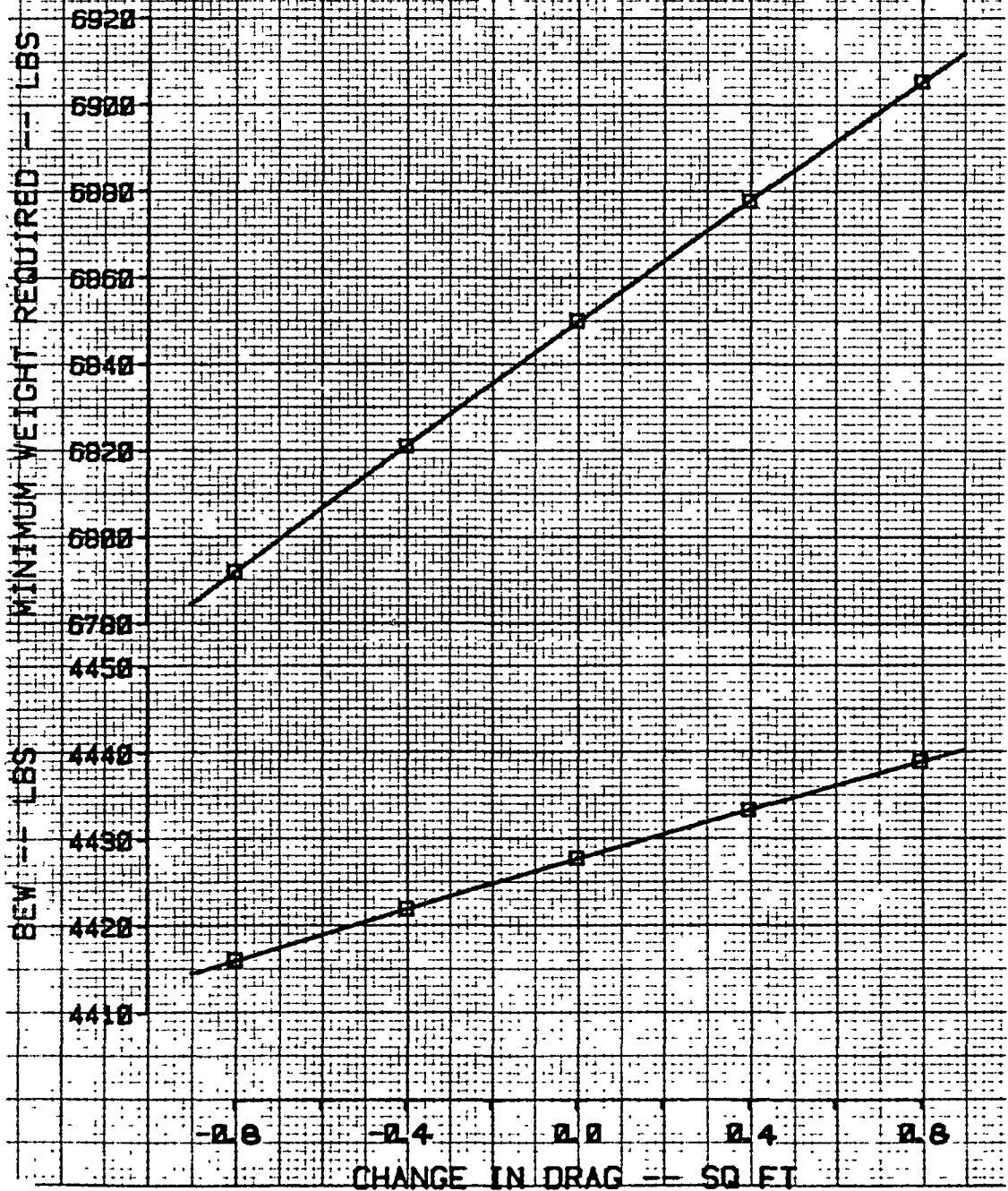

EFFECT OF DRAG ON TAKEOFF DISTANCE
WITH TAKEOFF GROSS WEIGHT = 6850 LBS

TWIN ENGINE AIRPLANE

GARRETT ADVANCED TURBOCHARGER
SENSITIVITY STUDY

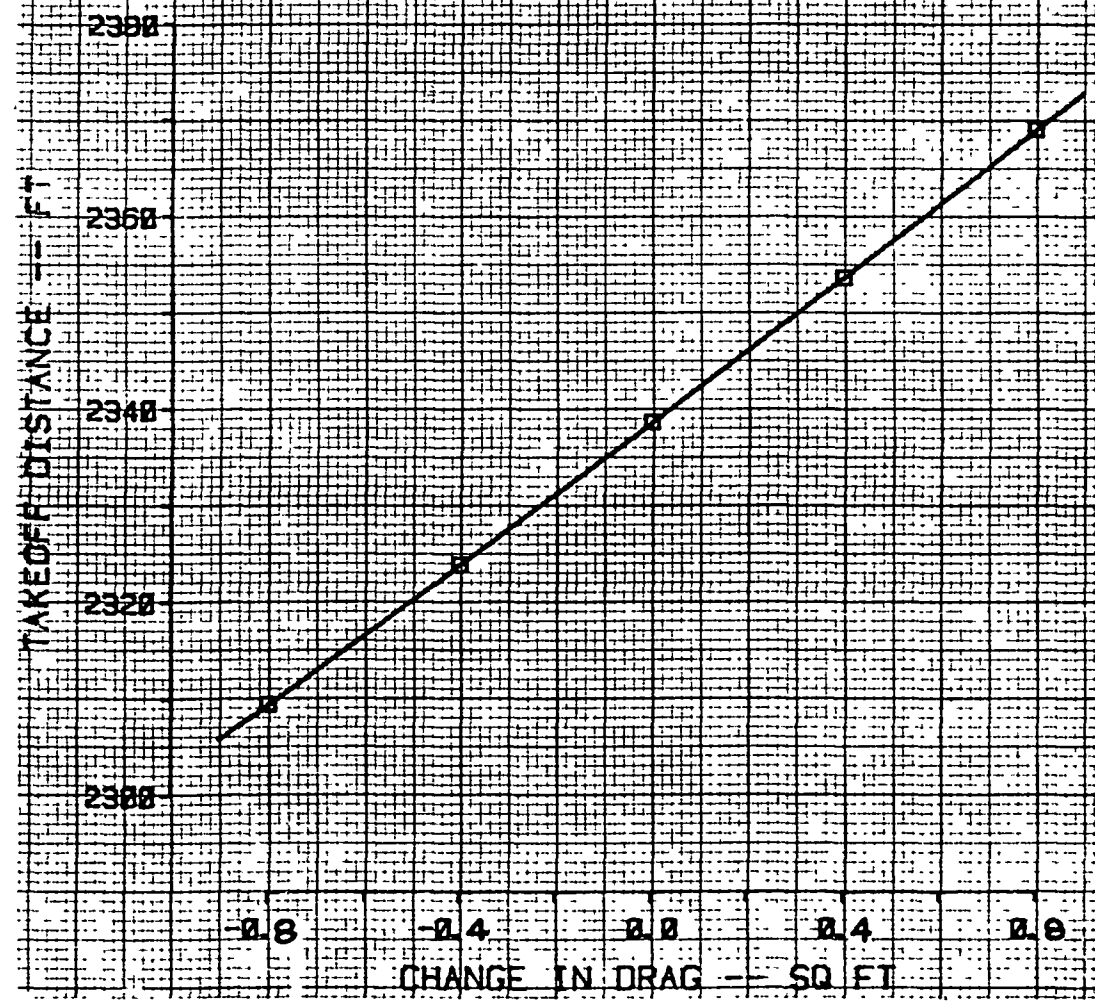

EFFECT OF DRAG ON CRUISE SPEED
FOR A CONSTANT WEIGHT
6850 LBS

TWIN ENGINE AIRPLANE

GARRETT ADVANCED TURBOCHARGER
SENSITIVITY STUDY

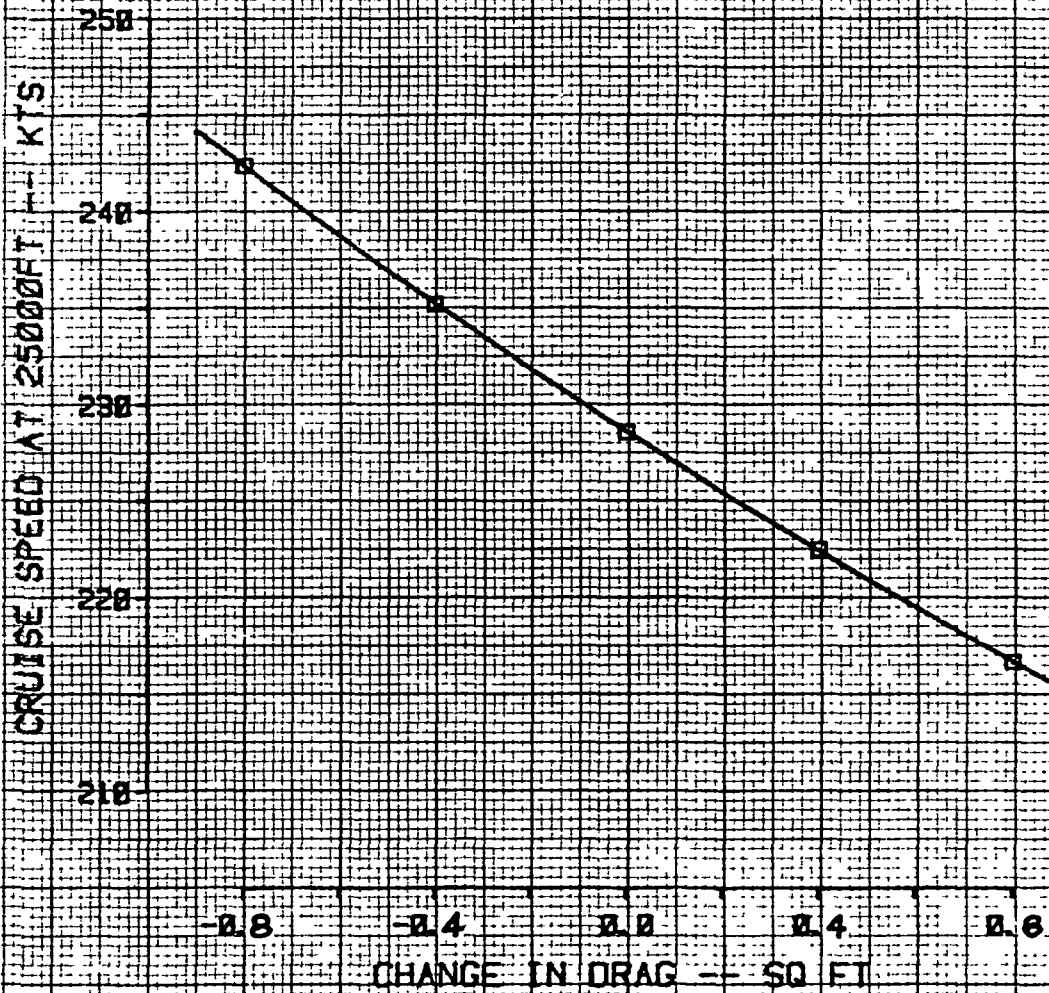

EFFECT OF GROSS WEIGHT ON TDF
FOR A CONSTANT PAYLOAD RANGE
1400 LBS, 800 NM
TWIN ENGINE AIRPLANE

GARRETT ADVANCED TURBOCHARGER
SENSITIVITY STUDY

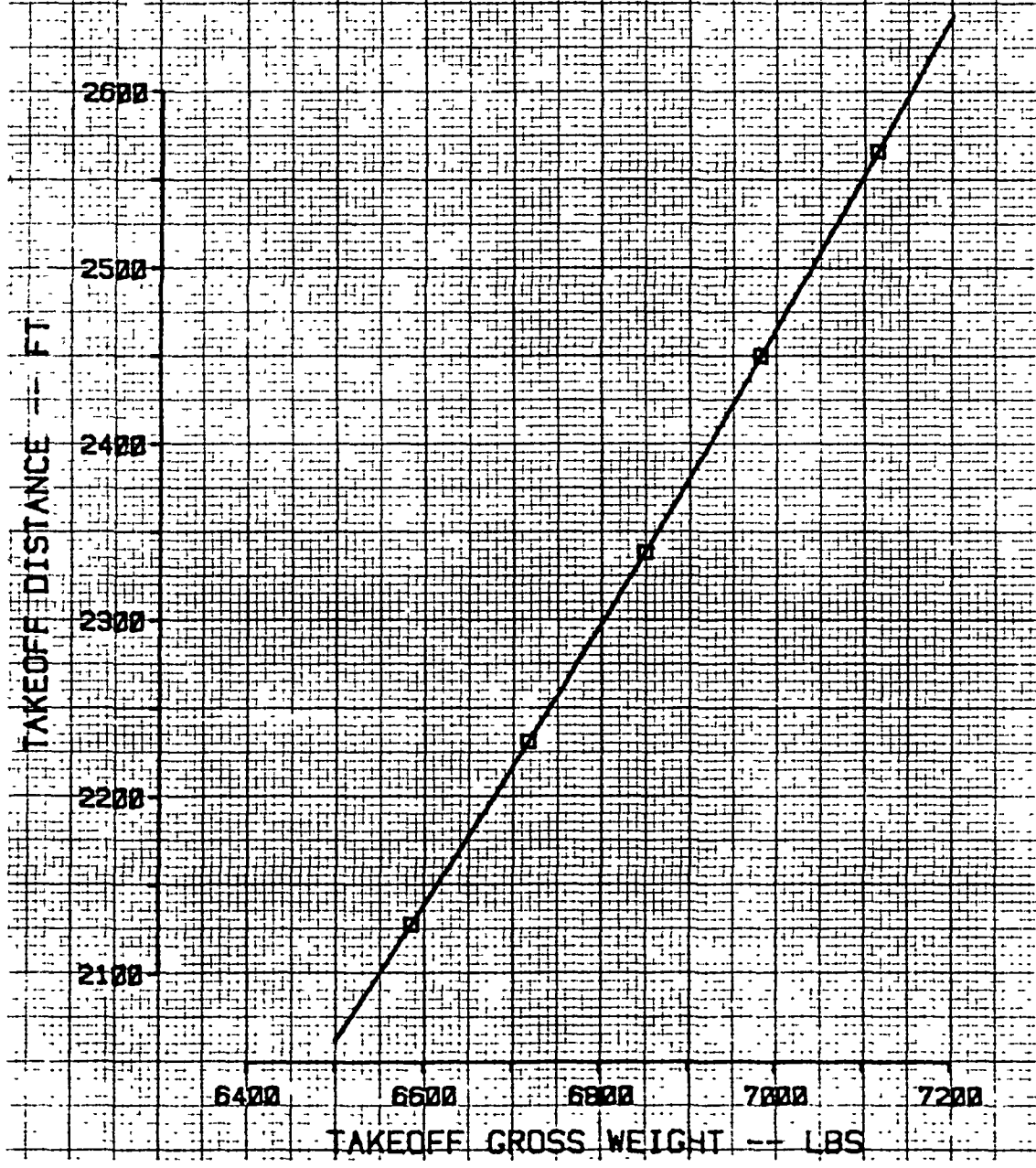

EFFECT OF GROSS WEIGHT ON CLIMB RATE
FOR A CONSTANT PAYLOAD RANGE
1400 LBS, 800 NM
SEA LEVEL
TWIN ENGINE AIRPLANE

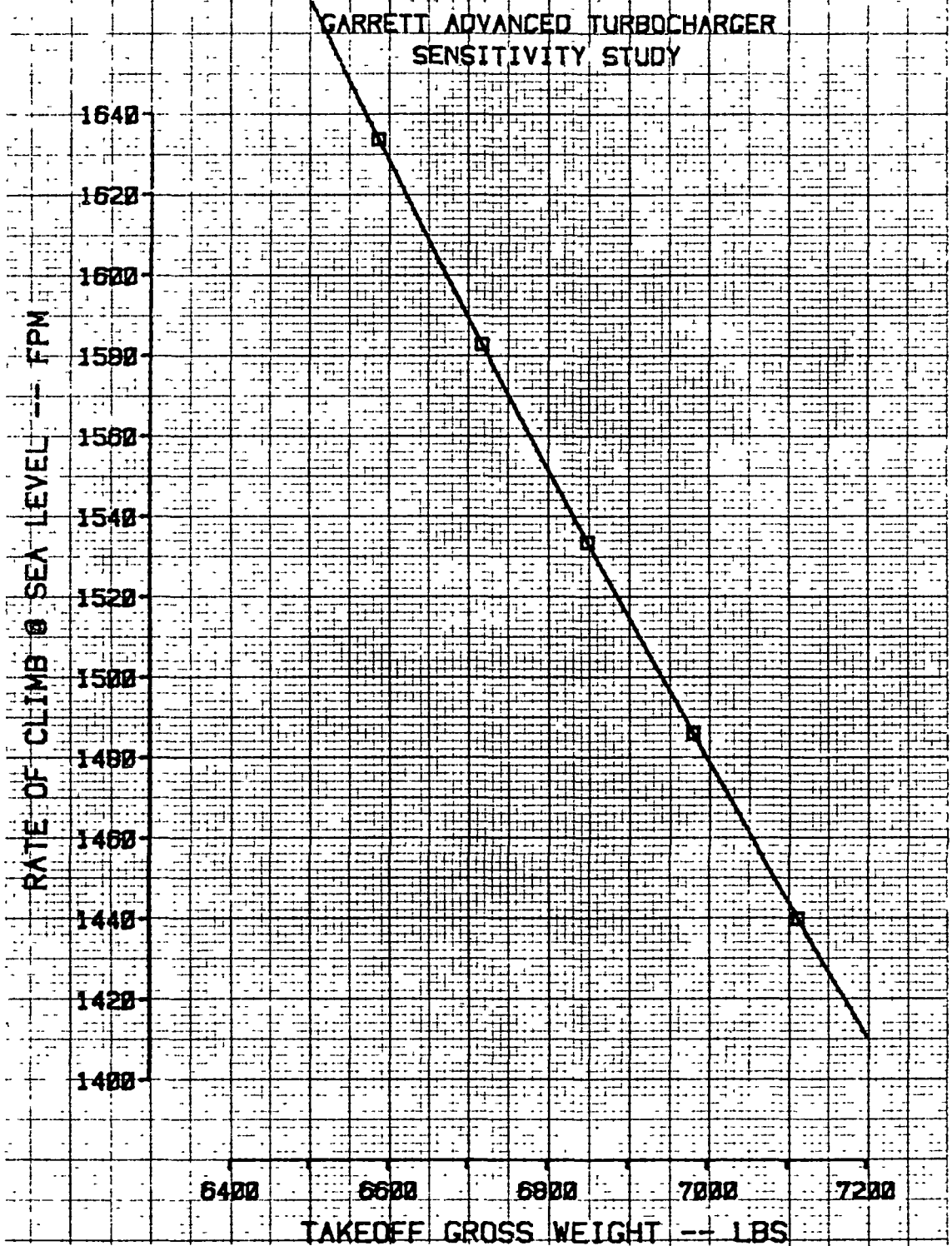

EFFECT OF GROSS WEIGHT ON CLIMB RATE
FOR A CONSTANT PAYLOAD RANGE

1400 LBS, 800 NM

25000 FT

TWIN ENGINE AIRPLANE

GARRETT ADVANCED TURBOCHARGER
SENSITIVITY STUDY

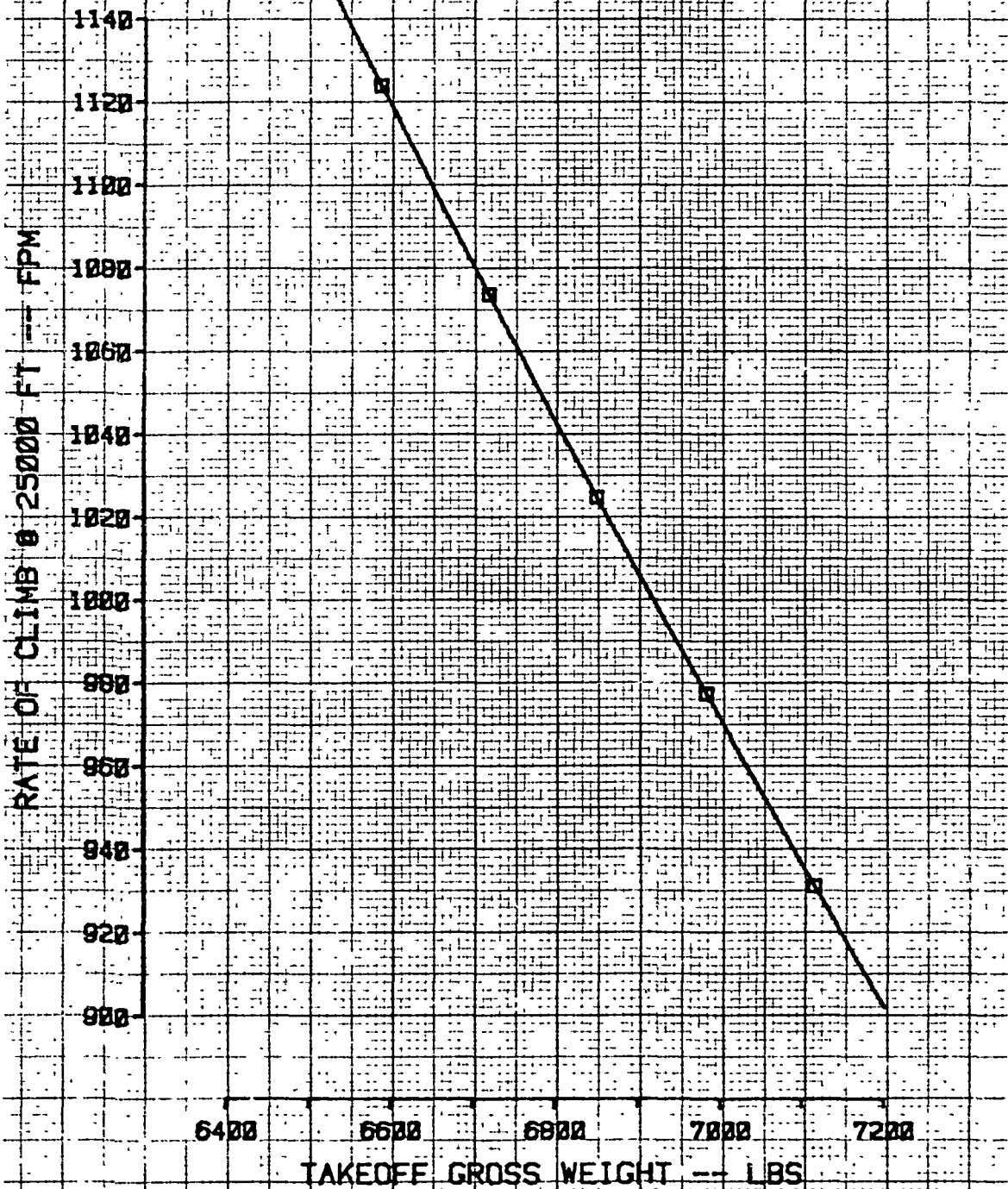

EFFECT OF GROSS WEIGHT ON S/E CLIMB RATE
FOR A CONSTANT PAYLOAD RANGE
1400 LBS. 800 NM
SEA LEVEL

TWIN ENGINE AIRPLANE

GARRETT ADVANCED TURBOCHARGER
SENSITIVITY STUDY

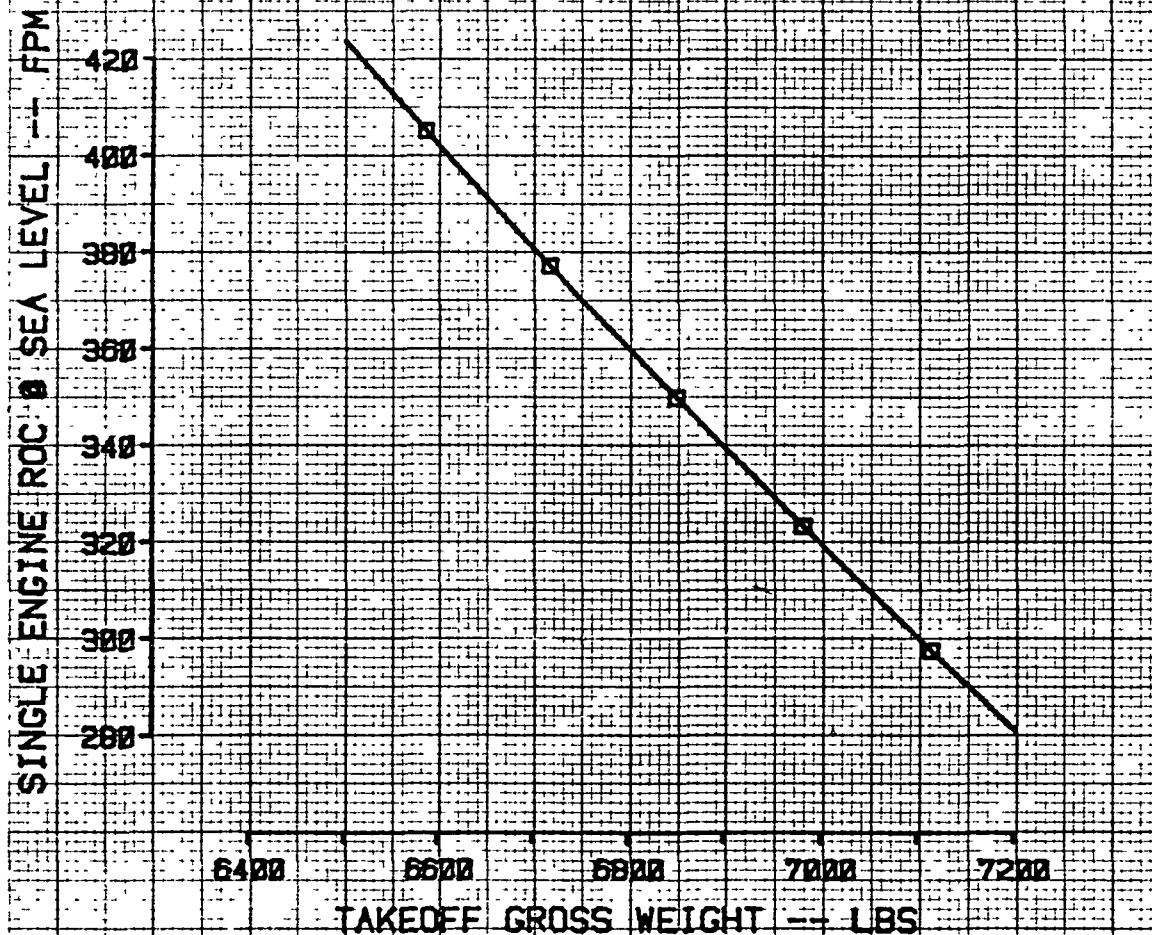

EFFECT OF GROSS WEIGHT ON S/E CLIMB RATE
FOR A CONSTANT PAYLOAD RANGE
1400 LBS, 800 NM
5000 FT

TWIN ENGINE AIRPLANE

GARRETT ADVANCED TURBOCHARGER
SENSITIVITY STUDY

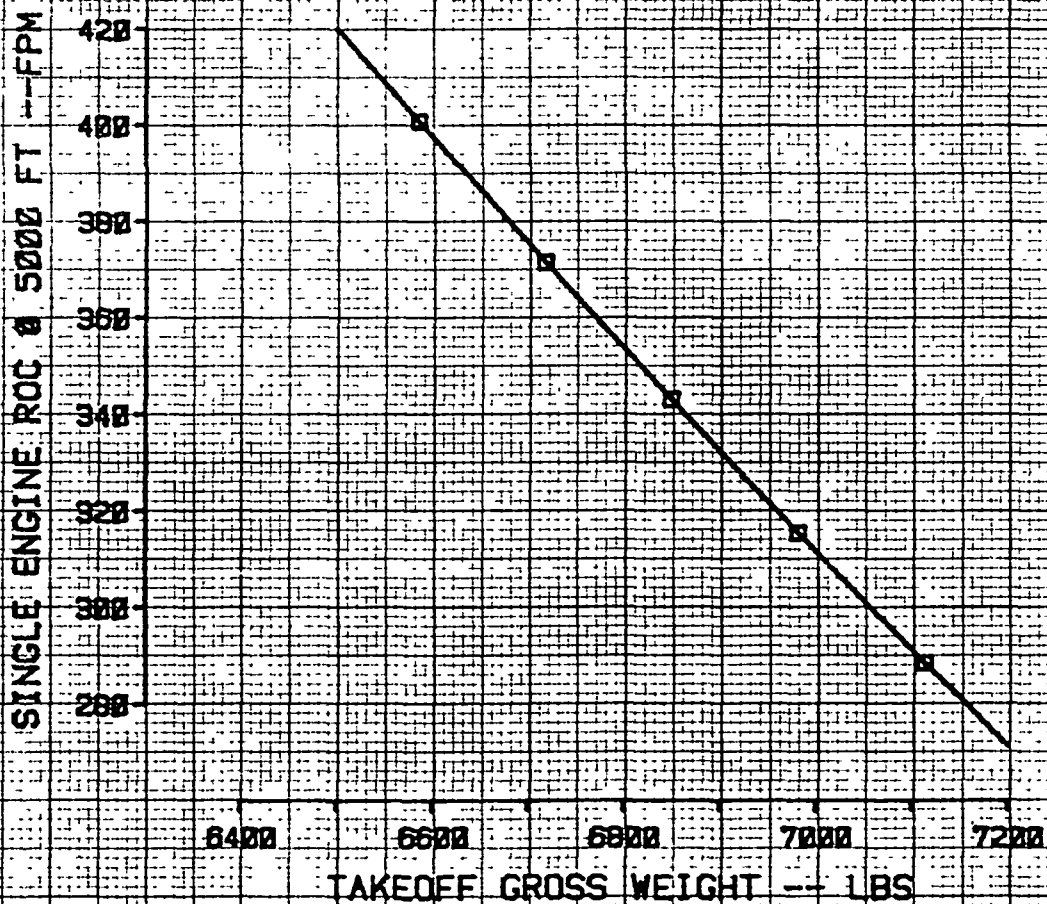

EFFECT OF GROSS WEIGHT ON CRUISE SPEED
FOR A CONSTANT PAYLOAD RANGE
1400 LBS. 800 NM
TWIN ENGINE AIRPLANE

GARRETT ADVANCED TURBOCHARGER
SENSITIVITY STUDY

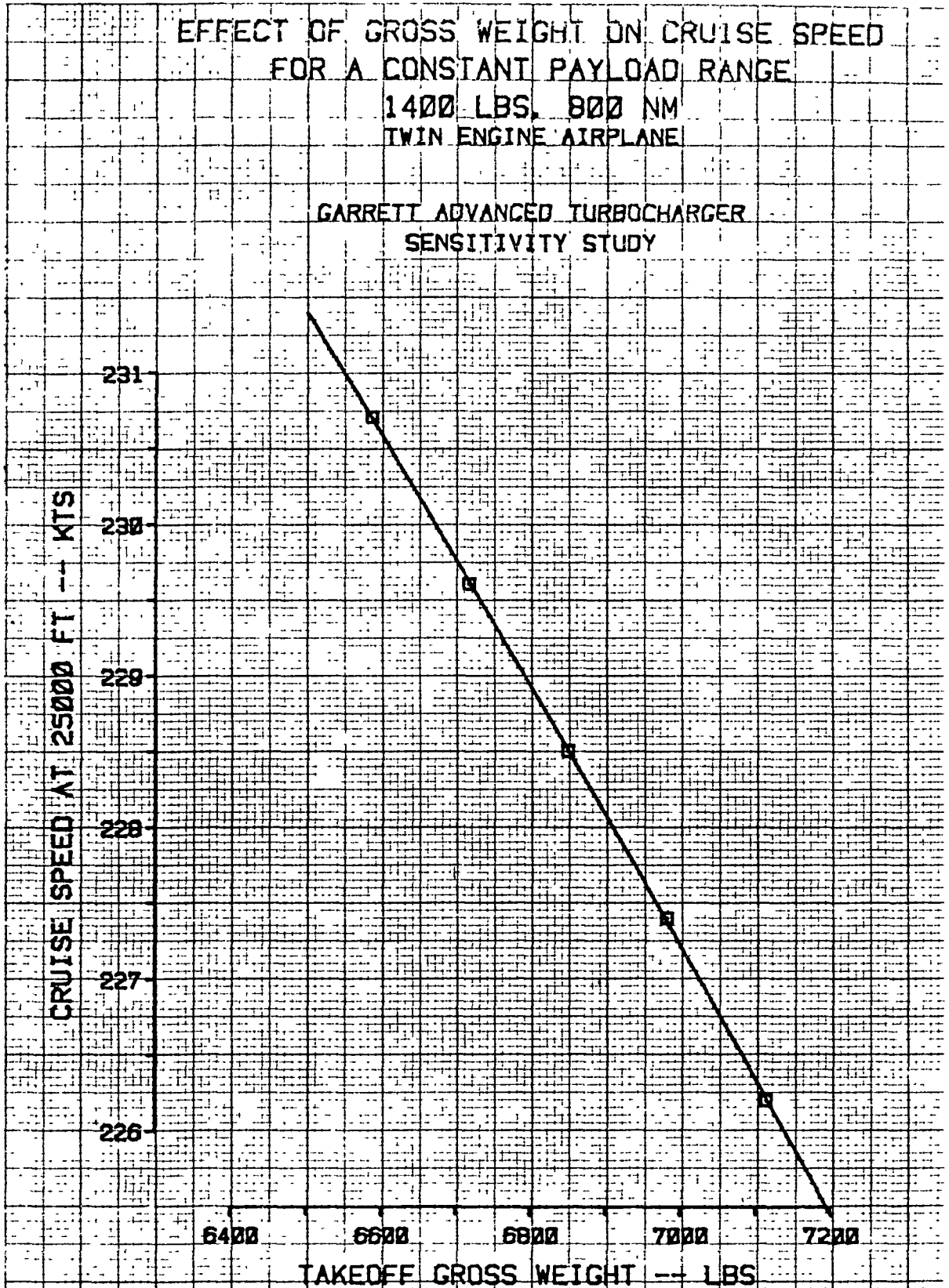

EFFECT OF GROSS WEIGHT ON STALL SPEED
FOR A CONSTANT PAYLOAD RANGE
1400 LBS, 800 NM

TWIN ENGINE AIRPLANE

GARRETT ADVANCED TURBOCHARGER
SENSITIVITY STUDY

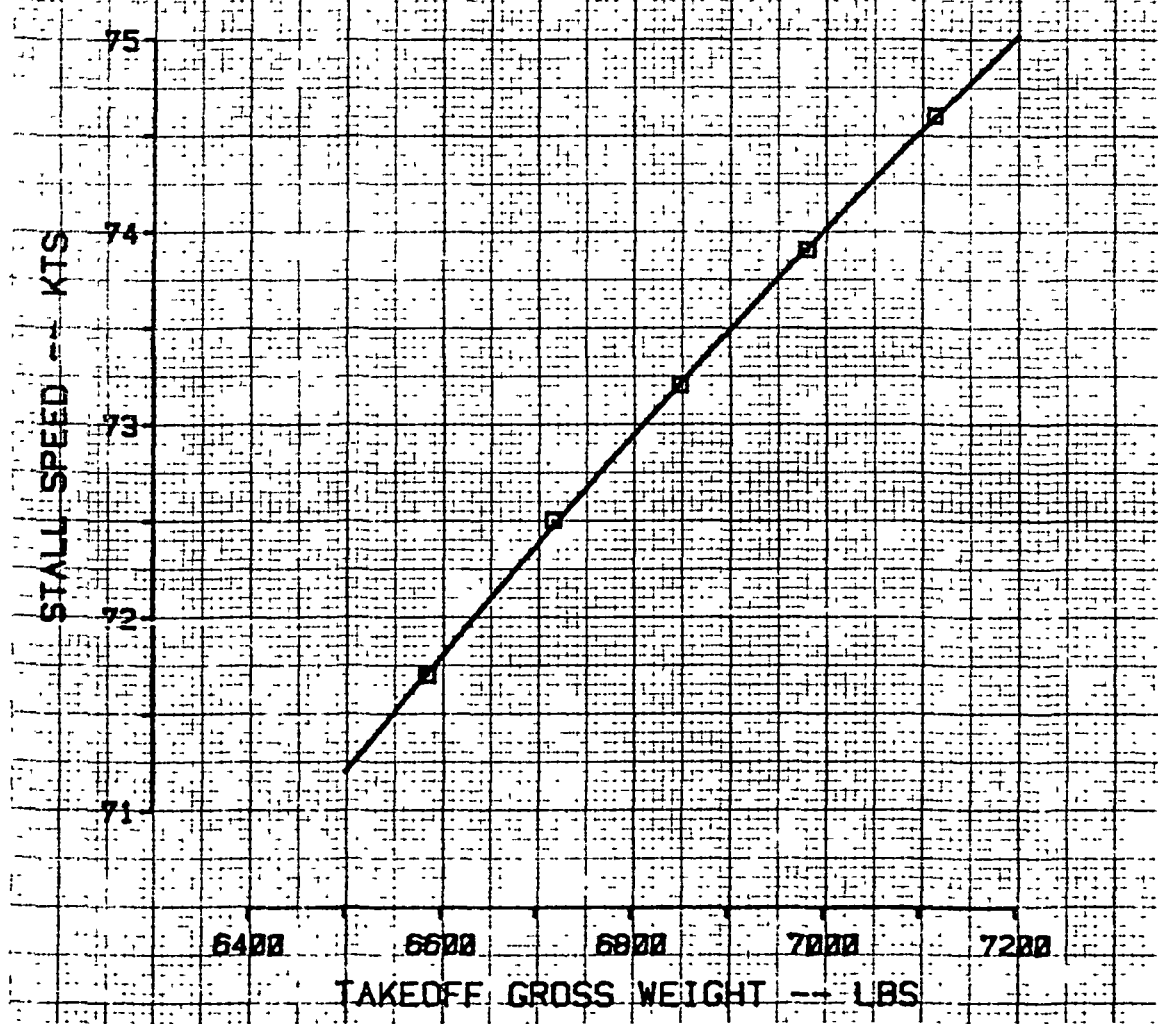

EFFECT OF SFC ON BLOCK FUEL
FOR A CONSTANT PAYLOAD RANGE
1400 LBS. 800 NM

TWIN ENGINE AIRPLANE

GARRETT ADVANCED TURBOCHARGER
SENSITIVITY STUDY

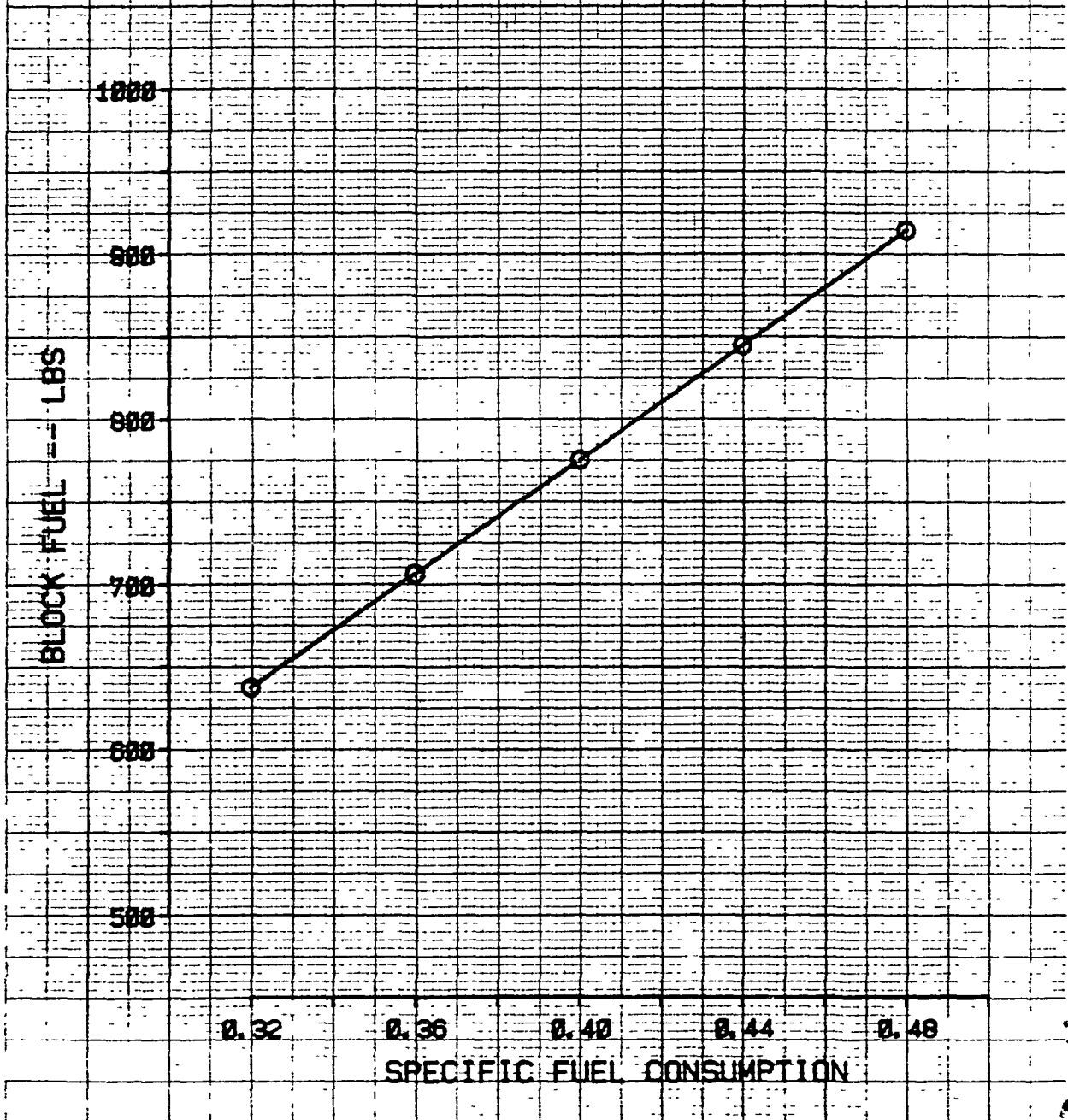

EFFECT OF ENGINE WEIGHT ON BLOCK FUEL
FOR A CONSTANT PAYLOAD RANGE
1400 LBS, 800 NM

TWIN ENGINE AIRPLANE

GARRETT ADVANCED TURBOCHARGER
SENSITIVITY STUDY

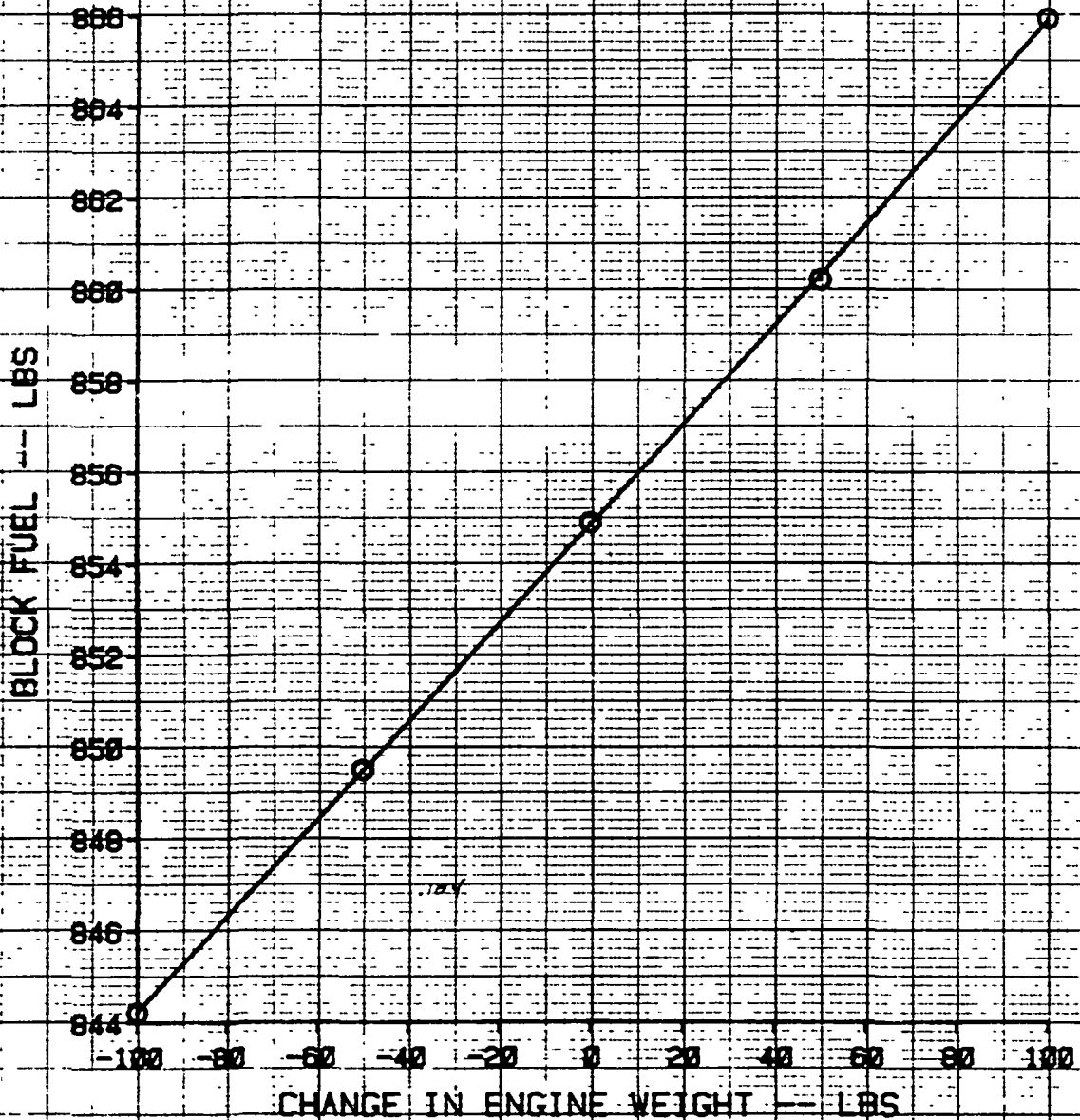

EFFECT OF DRAG ON BLOCK FUEL
FOR A CONSTANT PAYLOAD RANGE
1400 LBS. 800 NM

TWIN ENGINE AIRPLANE

GARRETT ADVANCED TURBOCHARGER
SENSITIVITY STUDY

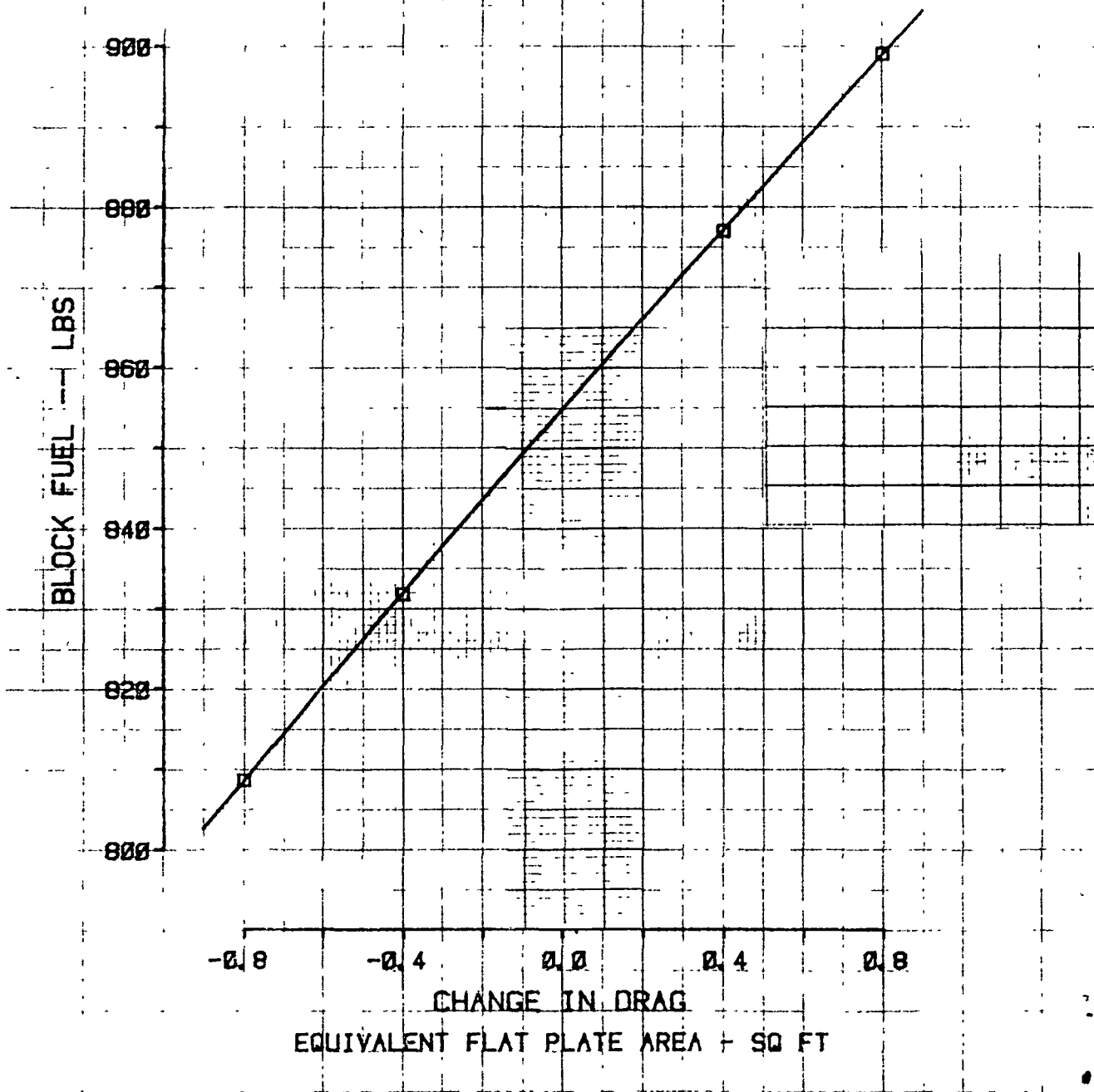

EFFECT OF ENGINE WEIGHT ON DOC
FOR A CONSTANT PAYLOAD RANGE
1400 LBS. 800 NM

TWIN ENGINE AIRPLANE

GARRETT ADVANCED TURBOCHARGER
SENSITIVITY STUDY

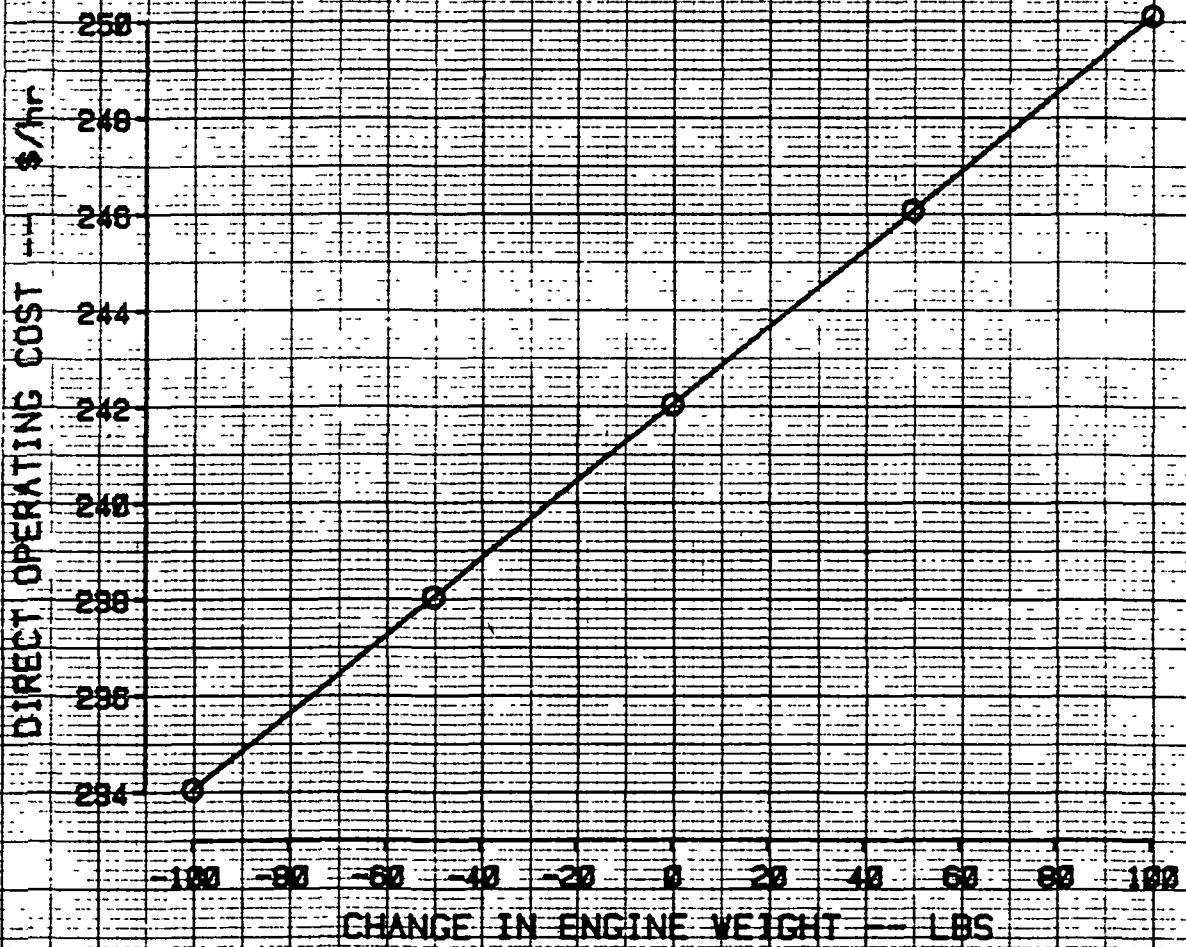

Page intentionally left blank

Page intentionally left blank

APPENDIX II

**ATDS AIRPLANE COST EQUATIONS
(7 Pages)**

Page intentionally left blank

Page intentionally left blank

TITLE _____



PAGE _____

PREPARED BY _____ DATE _____

REPORT NO _____

CHECKED BY _____ DATE _____

REVISION _____

MODEL _____

CESSNA AIRCRAFT CO

PAWNEE DIVISION

WICHITA KANSAS

PRICING

The selling price (for purposes of estimating the value of new models) is considered to be the sum of 3 components.

1. The base price - that which is manufactured by Cessna (also accounts for minor purchased parts);
2. The powerplant contribution to the price - includes engine, propeller, and governor; and
3. The part of the price attributable to optional equipment (of which avionics account for about 50% of the value).

The base price is computed by:

$$\text{Base Price} = a (W_{EP})^b (V_{MAX})^c (S_W)^d (GW)^e$$

- where
- a = 7.268188×10^{-4}
 - b = 1.06942
 - c = 1.05600
 - d = .65289
 - e = .22723

This is an empirical equation generated by applying a least squares regression analysis to the existing 1981 Cessna fleet. (The constant is valid only for pressurized aircraft.) The factors in the above equation are:

- W_{EP} - Dry Empty Weight minus Weight of Powerplant (engine, governor, propeller)
- V_{MAX} - Maximum Speed (knots)
- S_W - Wing Area (ft²)
- GW - Takeoff Gross Weight (lbs)

Values of these factors for each plane and the resulting base price are shown in Table II-1.

The price increment attributable to the powerplane is very difficult to estimate since it involves estimating the OEM cost not only of the engine but the propeller as well. Then the markup applied to the powerplant of that individual airplane must be considered. When the engine is not only new but is of a type not previously used in production aircraft the job becomes virtually impossible to do with any degree of certainty. Based on existing products and the fact that these are larger engines than now used in most Cessna products an increment of \$35,000 per engine was chosen for all engines in the study.

The price increment attributable to optional equipment varies widely depending on the equipment chosen. Airplanes of this category can normally be expected to be equipped with radar, airconditioning, and a de-icing package in addition to the usual avionics and interiors. Based on present Cessna prices for equipped planes that include these features an increment of \$48,000 was chosen for the single engine planes and \$82,000 for the twin engine planes.

The total estimated selling price is shown in Table AII-1.

TITLE _____



PAGE _____

PREPARED BY _____ DATE _____

REPORT NO _____

CHECKED BY _____ DATE _____

REVISION _____

MODEL _____

CESSNA AIRCRAFT CO

PAWNEE DIVISION

WICHITA KANSAS

DIRECT OPERATING COST

The components considered in generating DOC and an outline of how they are generated are shown in Table AII-2. The following discussion covers how these values were calculated in this study.

For the engines considered herein no data was available to accurately estimate the cost of either the engine periodic maintenance nor the reserve for engine overhaul. Values of \$9/engine and \$8/engine were chosen which are in line with the current values for the larger TS10-S20's.

Propeller overhaul, airframe maintenance and systems maintenance are calculated as shown. The factors used in the empirical curve fits for the last two components are shown in Table AII-3.

Hull and liability insurance rates are found in Table AII-4. The rate for the single engine aircraft is .0160 and for the twin is .0150. A utilization of 500 hours/year was assumed for both.

Fuel cost was calculated assuming a cost of \$1.70 per gal, a density of 6 lb/gal, a BHP in cruise of 250, and the SFC's shown in Table AII-3.

The oil consumption was assumed to be .1 GPH per hour per engine at a cost of \$6/gallon.

Depreciation is based on the total aircraft selling price. It is, therefore, not independent of the assumed price for the engine.

Reserves for avionics was based on assuming that avionics accounts for 50% of the optional equipment price.

Table AII-5 shows the values of each component of the DOC and the total for each plane.

TITLE _____



PAGE _____

PREPARED BY _____ DATE _____

REPORT NO _____

CHECKED BY _____ DATE _____

REVISION _____

MODEL _____

CESSNA AIRCRAFT CO

PAWNEE DIVISION

WICHITA KANSAS

TABLE AII-1
FACTORS USED IN COMPUTING AIRCRAFT PRICE

	SINGLE ENGINE			TWIN ENGINE		
	TSIO-550	RC2-47	RC2-32	TSIO-550	RC2-47	RC2-32
W _{pp}	1910.4	1630.0	1615.6	2314.5	2084.1	2038.3
V _{MAX}	209.1	249.5	252.8	243.3	275.4	279.5
S _w	177	150	142.5	170	162.5	154.5
GW	4550	3900	3775	6625	5650	5375
Base Price	131677	116053	113171	203799	191644	182601
Powerplant Price	35000	35000	35000	70000	70000	70000
Optional Equip Price	48000	48000	48000	82000	82000	82000
Total	214677	199053	196171	355799	343644	334601

TABLE AII-2

DIRECT OPERATING COSTS FOR GENERAL AVIATION AIRCRAFT
- 1981 Estimate

1) ENGINE PERIODIC MAINTENANCE

Use past experience (i.e. similar engine/airframe combination) or engine manufacturer's estimate.

Otherwise use:

$$\frac{\text{Number of labor hours for 100 hour inspection} \times \text{labor rate}}{100}$$

Then double this answer to account for parts.

Labor rate right now runs \$20/hour S/E
\$25/hour M/E
\$30/hour Turboprops

*Turboprops must be considered under a different formula. Instead of being inspected every hundred hours, they undergo a series of Hot Section Inspections during the overhaul period. These are usually of considerably greater time than 100 hours. For some engines the work scheduled for each HSI is different as the time from last overhaul increases.

$$\frac{\Sigma (\text{cost of labor} + \text{cost of parts}) \text{ for HSI's} + \text{misc. (filters, igniters +)}}{\text{TBO}} \quad (\text{labor not included in HSI})$$

2) RESERVES FOR ENGINE OVERHAUL

The assumption (conservative) is made that every other overhaul will require, instead of an overhaul, a remanufactured engine. Therefore:

$$\frac{(\text{overhaul cost} + \text{cost of remanufactured engine})/2}{\text{TBO}}$$

*For Turboprops:

$$\frac{\text{overhaul cost (labor + parts)} + \text{allowance for premature removal** of engine and engine accessories*** and engine components****}}{\text{TBO}}$$

*Information not given to Curtiss-Wright by phone in January

**Allowance for engine removal amounts to 1/5 to 1/2 of engine overhaul cost

***Starter generator, etc.

****Turbines, nozzles, etc.

TABLE AII-2 (CONTINUED)

3) PROPELLER OVERHAUL

Propeller			DOC (\$/hr)
Fixed Pitch	}	LSE .43	.11
S/E Controllable		HPSE .60	
		Centurion class .82	
M/E controllable (per propeller)			.90

4) AIRFRAME MAINTENANCE

This number is based on a parametric fit of the available data.

$$\text{DOC} = 1.472 + .000534 \text{ TOGW} - .000373 \text{ BHP (Total)} \\ + 2.774 \text{ (only for twins)} + 1.878 \text{ (only if pressurized)}$$

5) INSURANCE (HULL + LIABILITY)

See attached charts

6) FUEL COST

$$\text{DOC} = \frac{\text{price}}{\text{gal}} \times \frac{\text{gal per}}{\text{hour}} \text{ (present price of AV gas is calculated at \$1.30 gal)}$$

7) OIL COST

$$\text{DOC} = \frac{\text{price}}{\text{gal}} \times \text{GPH used (present price of oil is \$6/gal which also accounts for cost of oil filter)}$$

or alternately use

$$\text{DOC} = \frac{\text{actual price}}{\text{gal}} \times \frac{\text{GPH used} + \text{cost of filter}}{\text{(including \# hrs between filter change both consumed and lost during change)}}$$

8) DEPRECIATION

$$= \frac{\text{Total equipped airplane price}}{7.5 \times \text{utilization rate/year}} \text{ i.e. discounted to zero residual in 7.5 years}$$

9) RESERVES FOR AVIONICS

$$\frac{10\% \text{ of total avionic package (standard + optional)}}{1000}$$

10) RESERVES FOR SYSTEMS MAINTENANCE

$$\text{DOC} = -.513 + 000803 \text{ TOGW} + 1.109 \text{ (if pressurized)}$$

Again this is a parametric fit of available data

TABLE AII-3
FACTORS USED IN COMPUTING DIRECT OPERATING COST

	SINGLE ENGINE			TWIN ENGINE		
	<u>TS10-550</u>	<u>RC2-47</u>	<u>RC2-32</u>	<u>TS10-550</u>	<u>RC2-47</u>	<u>RC2-32</u>
TOGW	4550	3900	3775	6675	5650	5375
BHP 707	350	320	320	700	640	640
Price	214677	199053	196171	355799	343644	334601
Optional Equip Price	48000	48000	48000	82000	82000	82000
SFC	.446	.371	.355	.446	.371	.355

INSURANCE RATES APPLICABLE TO 1981 CESSNA MODELS

October, 1980

TABLE AII-4

Pleasure & Business Rates For Well-Qualified Pilots:

<u>Hull Value</u>	<u>Single Engine Rate</u>	<u>Multi-Engine Rate</u>
\$15,000 - 24,999	3.00%	
25,000 - 39,999	2.75	
40,000 - 59,999	2.50	
60,000 - 99,999	2.00	
100,000 - 149,000	1.75	
150,000 - 200,000	1.60	
150,000 - 299,999		1.75%
300,000 - 499,999		1.50
500,000 - 750,000		1.35
750,000 - 1 Mil.		1.10
1 Mil - 1.5 Mil.		1.00

Legal Liability limit of \$5,000,000 combined single limit.

<u>Seats</u>	<u>Annual Premium</u>
4	\$ 575
5	675
6	725
7	825
8	975
9	1,075
10	1,175
11	1,250

TITLE _____
 PREPARED BY _____ DATE _____
 CHECKED BY _____ DATE _____
 CESSNA AIRCRAFT CO



PAGE _____
 REPORT NO _____
 REVISION _____ MODEL _____
 PAWNEE DIVISION WICHITA KANSAS

TABLE AII-5
 DIRECT OPERATING COST

	SINGLE ENGINE			TWIN ENGINE		
	TS10-550	RC2-47	RC2-32	TS10-550	RC2-47	RC2-32
Engine Maintenance	9.00	9.00	9.00	18.00	18.00	18.00
Engine Overhaul	8.00	8.00	8.00	16.00	16.00	16.00
Propeller	.82	.82	.82	.90	.90	.90
Airframe	5.65	5.31	5.25	9.92	8.90	8.76
Insurance Liab	1.45	1.45	1.45	1.65	1.65	1.65
Insurance Hull	6.87	6.37	6.28	10.67	10.31	10.44
Fuel	31.59	26.28	25.15	63.18	52.56	50.29
Oil	.60	.60	.60	1.20	1.20	1.20
Dep	57.25	53.08	52.31	94.88	91.64	89.23
Res for Avionics	2.40	2.40	2.40	4.10	4.10	4.10
Systems	4.25	3.73	3.63	5.92	5.13	4.91
Total	127.88	117.04	114.89	226.42	210.39	205.08