

## **General Disclaimer**

### **One or more of the Following Statements may affect this Document**

- This document has been reproduced from the best copy furnished by the organizational source. It is being released in the interest of making available as much information as possible.
- This document may contain data, which exceeds the sheet parameters. It was furnished in this condition by the organizational source and is the best copy available.
- This document may contain tone-on-tone or color graphs, charts and/or pictures, which have been reproduced in black and white.
- This document is paginated as submitted by the original source.
- Portions of this document are not fully legible due to the historical nature of some of the material. However, it is the best reproduction available from the original submission.

SQT

NASA CR-168268

# Solar Photovoltaic Powered Refrigerators/Freezers for Medical Use in Remote Geographic Locations

(NASA-CR-168268) SOLAR PHOTOVOLTAIC POWERED REFRIGERATORS/FREEZERS FOR MEDICAL USE IN REMOTE GEOGRAPHIC LOCATIONS Final Report (Solar Power Corp.) 58 p HC A05/MF A01

N84-25163  
Unclass  
CSCL 10B G3/44 13424

Ghazi Darkazaili, Ph.D., P.E.

and

Gerald F. Hein, Ph.D.

Oct. 1983



Prepared for  
 NATIONAL AERONAUTICS AND SPACE ADMINISTRATION  
 Lewis Research Center  
 Under Contract DEN 3 - 238

## TABLE OF CONTENTS

	PAGE
INTRODUCTION	1
SYSTEM ANALYSIS AND CONCEPTUAL DESIGN	4
System Analysis	4
Arraying	4
Energy Requirements	8
Conceptual Design	14
Performance Analysis and Sizing	17
Array	17
SYSTEM DESIGN	22
Variable Tilt Array	22
Array Wiring	22
Photovoltaic Module	24
Module Reliability	30
Module Framing, Mounting and Support Structure	30
Electric Plant Subsystem	30
Wiring	31
Controls and Monitoring Subsystem	31
Regulator BVR 12-30	31
Instrumentation and Monitoring	33
Protection and Safety	33

THE REFRIGERATOR/FREEZER	35
TEST PROGRAM	43
Qualification Tests	43
Acceptance Test Procedures	53
Summary of Test Results	63
CONCLUSIONS	67

APPENDIX

A - STATEMENT OF WORK: Contract DEN3-238

B - ADLER-BARBOUR PERFORMANCE DATA AND CALCULATIONS

## INTRODUCTION

In many regions throughout the world the lack of immunization capabilities causes otherwise curable diseases to become a serious threat to human life. One of the obstacles preventing widespread immunization has been the virtual nonexistence of reliable, low maintenance refrigeration systems for storage of vaccines in remote locations.

In an effort to fulfill the need for such a refrigeration system, NASA and the Center for Disease Control (CDC) began investigating various system designs. When it became apparent that photovoltaics could possibly supply the energy required to the compressor of the refrigerator, NASA issued a Request for Proposal (RFP No. 3-142887) to several firms involved in the manufacture of photovoltaic devices. The Statement of Work (SOW) in the RFP outlined the development and testing of a photovoltaic powered medical refrigeration system. These tests were to be conducted by an independent test laboratory according to the standard test procedures of the American National Standards Institute (ANSI), and modified World Health Organization (WHO) test procedures.

Solar Power Corporation, located in Woburn, Massachusetts was selected by NASA to carry out the terms of the SOW (see Appendix A).

The purpose of this report to describe the work done by Solar Power Corporation and Adler-Barbour Marine Systems in fulfillment of the requirements of the Statement of Work. Included are the general descriptions of the SPC developed refrigeration system, SPC-RF103, its design and analysis, the test procedures and the results of those tests on the first SPC-RF103 photovoltaic refrigerator/ freezer (RF) for medical applications.

The Solar Power Corporation photovoltaic powered medical refrigeration system, SPC-RF103, is a stand alone refrigerator/freezer designed for high reliability.

The system used to perform the qualification and acceptance tests consists of the following components:

### I. PHOTOVOLTAIC ARRAY

- A. Two subarrays
- B. Cables
- C. Junction boxes

### II. ELECTRICAL STORAGE

- A. 6 12V Delco 2000 batteries in parallel.
- B. Battery voltage regulator

III. REFRIGERATOR/FREEZER

- A. Separate refrigerator and freezer compartments.
- B. High reliability, high efficiency compressor, evaporator.
- C. Thick insulated walls for low heat transfer.
- D. Top opening.
- E. Separate interior hinged lids for refrigerator and freezer.
- F. Rugged corrosion resistant construction.
- G. Battery storage compartment.

IV. INSTRUMENTATION AND MONITORING

- A. Seven (7) day recording temperature indicator.
- B. Freezer temperature/thermostat indicator.
- C. SPC instrumentation package (described later).

V. SAFETY

- A. Audible alarm for high temperature
- B. Current surge protection
- C. Low battery voltage disconnect

The system consists of a photovoltaic array and an integrated refrigerator/freezer - electrical energy storage unit. The array converts sunlight directly into useful DC electricity with no moving parts. The photovoltaic array supplies electrical energy to the load which may be either the batteries (electrical energy storage) or the RF compressor. The heavily insulated RF assembly is top opening with separate hinged lids for the refrigerator and freezer. A conventional compressor/evaporator provides for heat removal from within the RF unit.

Batteries supply the load with energy required when the array output is not sufficient.

A detailed system description is presented later in the report. An illustration of the SPC-RF103 unit is presented in Figure 1. A system schematic is given later (Figure 6).

ORIGINAL PAGE IS  
OF POOR QUALITY

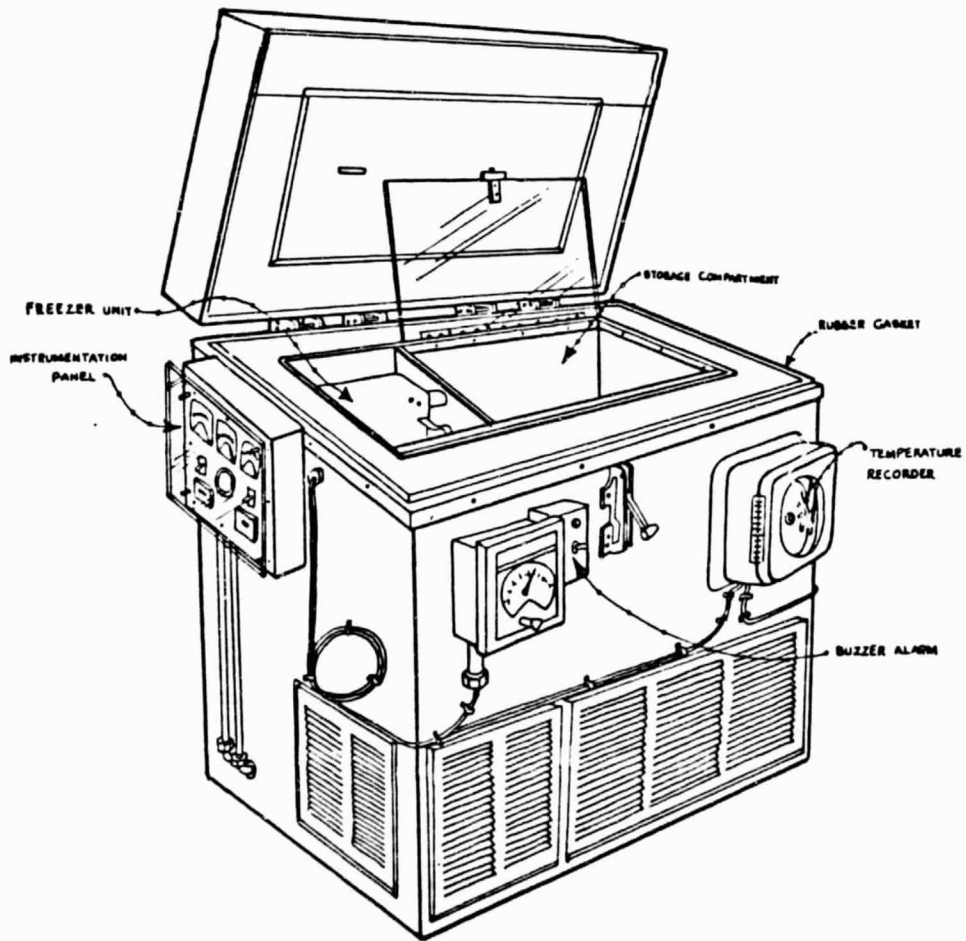

FIGURE 1

ILLUSTRATION OF SPC RF-103 REFRIGERATOR/FREEZER

SYSTEM ANALYSIS AND CONCEPTUAL DESIGN

System Analysis

The systems analysis and conceptual design concentrate upon what SPC interprets as design - performance requirements. Normally, this includes computer sizing using SPC data, but NASA has obviated the need for SPC data with the supply of its own nominal insolation regime. SPC has incorporated the NASA data into the SPC sizing program to perform a sizing analysis, a relatively straight/forward procedure when loads are known. In this case, the load is uncertain but boundable. The systems analysis concentrates upon the two major design drivers from a performance or operational point of view. These are the array size and determining energy requirements.

Arraying

The need for a universal arraying system (as specified in the RFP) for latitudes ranging from 40°S to 40°N in increments of 10° of latitude that is also easy to set-up in the field requires ingenuity in design. This requirement is increased by the need for an array with an adjustable tilt angle which is also simple and easy to vary in the field. Using Cooper's equation to estimate the angle of declination of the sun:

$$\delta = 23.45 \sin \left( 360 \times \frac{284 + n}{365} \right),$$

where n is the day of the year and north is positive and south negative. The declination angles for the first and fifteenth days of each month at 0° latitude are:

January	1	-23.0°	July	1	23.2°
	15	-21.3°		15	21.5°
February	1	-17.5°	August	1	18.2°
	15	-13.3°		15	13.8°
March	1	- 8.7°	September	1	8.5°
	15	- 2.8°		15	2.6°
April	1	4.0°	October	1	- 3.4°
	15	9.4°		15	- 9.2°
May	1	14.9°	November	1	-14.7°
	15	18.8°		15	-18.9°
June	1	21.9°	December	1	-21.8°
	15	23.3°		15	-23.3°



In order to develop the universal array with variable tilt, some observations, conventions and assumptions are required. It is less expensive to develop the array if the design places the tilt bearing in the center of the array rather than at the north or south ends. Figure 2 depicts such a scheme. Assume that the array in this figure is placed at the equator. On June 21, the sun is  $23.45^\circ$  above the equator and on December 21, the sun is  $23.45^\circ$  below the equator. On March 21 and September 21, the sun would be directly above the equator. If the convention is adopted that tilting the array so that it faces north for June is a north tilt of the array, tilting the array so that it faces south for December is a south tilt and having the array flat for the equinoxes is 0; then it is possible to develop a table of adjustment settings for the array for the equator. To simplify the mechanics, adjustments will be made in increments of  $+5^\circ$ . If another convention is adopted that adjustments will be made on the first day of the month, then the array settings for the equator can be developed by rounding off to the nearest  $5^\circ$  setting for the average of the first and last days of the month since that is a reasonable estimate of the average declination angle for the entire month. The first step in this process is to round off the solar declination angles calculated from Cooper's equation. These rounded angles are:

ROUNDED SOLAR DECLINATION ANGLES

January	$-20^\circ$	July	$20^\circ$
February	$-15^\circ$	August	$15^\circ$
March	$-5^\circ$	September	$5^\circ$
April	$10^\circ$	October	$-10^\circ$
May	$20^\circ$	November	$-20^\circ$
June	$25^\circ$	December	$-25^\circ$

For the equator, it is a simple task to use the declination angles to develop the table of array settings based on the conventions discussed above. For example, since the average declination angle is  $-20^\circ$  for January, the array should be rotated  $20^\circ$  in the south direction. The RFP also stated that the array would be used for many other areas from  $40^\circ\text{S}$  to  $40^\circ\text{N}$  latitude. Table 1 shows the array tilt indicator settings that will be incorporated into the training and instruction manuals for field use to the nearest  $5^\circ$  of latitude. This table can be used between  $40^\circ\text{S}$  and  $40^\circ\text{N}$ . The user need only know the latitude of the location where the refrigerator is being used. For example if the location were  $14^\circ\text{N}$  latitude, the user would find the indicator settings for each month under the column for  $15^\circ\text{N}$  latitude. The array tilt lock bolt will be simple to use and also serves as a shear bolt holding the array in place as will be discussed in the array design section.

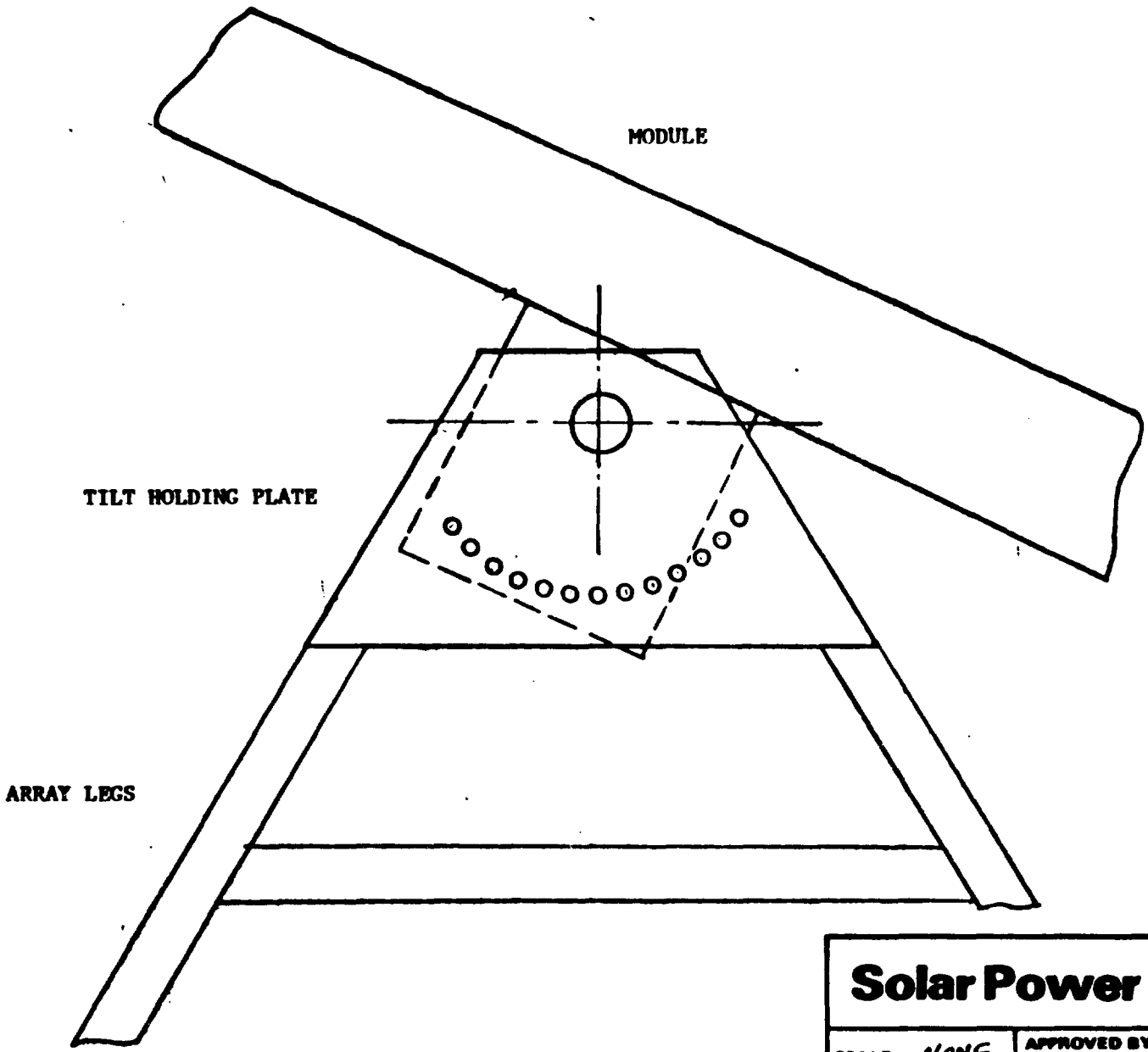

ORIGINAL PAGE IS  
OF POOR QUALITY

-6-

**FIGURE 2**  
CENTER BEARING ARRAY TILT ASSEMBLY

<b>Solar Power Corporation</b>		
SCALE: <i>NONE</i>	APPROVED BY:	DRAWN BY:
DATE:		<i>PMW</i>
CENTER BEARING ARRAY TILT		DRAWING NUMBER: <b>A-PMW 109</b>

ARRAY TILT INDICATOR SETTING

MONTH	LATITUDE								EQUATOR	LATITUDE							
	SOUTH LATITUDE									NORTH LATITUDE							
	40	35	30	25	20	15	10	5		0	5	10	15	20	25	30	35
JANUARY	N20	N15	N10	N 5	0	S 5	S10	S15	S20	S25	S30	S35	S40	S45	S50	S55	S60
FEBRUARY	N25	N20	N15	N10	N 5	0	S 5	S10	S15	S20	S25	S30	S35	S40	S45	S50	S55
MARCH	N35	N30	N25	N20	N15	N10	N 5	0	S 5	S10	S15	S20	S25	S30	S35	S40	S45
APRIL	N50	N45	N40	N35	N30	N25	N20	N15	N10	N 5	0	S 5	S10	S15	S20	S25	S30
MAY	N60	N55	N50	N45	N40	N35	N30	N25	N20	N15	N10	N 5	0	S 5	S10	S15	S20
JUNE	N65	N60	N55	N50	N45	N40	N35	N30	N25	N20	N15	N10	N 5	0	S 5	S10	S15
JULY	N60	N55	N50	N45	N40	N35	N30	N25	N20	N15	N10	N 5	0	S 5	S10	S15	S20
AUGUST	N55	N50	N45	N40	N35	N30	N25	N20	N15	N10	N 5	0	S 5	S10	S15	S20	S25
SEPTEMBER	N45	N40	N35	N30	N25	N20	N15	N10	N 5	0	S 5	S10	S15	S20	S25	S30	S35
OCTOBER	N30	N25	N20	N15	N10	N 5	0	S 5	S10	S15	S20	S25	S30	S35	S40	S45	S50
NOVEMBER	N20	N15	N10	N 5	0	S 5	S10	S15	S20	S25	S30	S35	S40	S45	S50	S55	S60
DECEMBER	N15	N10	N 5	0	S 5	S10	S15	S20	S25	S30	S35	S40	S45	S50	S55	S60	S65

-7-

ORIGINAL PAGE IS  
OF POOR QUALITY

Energy Requirements

The transfer of heat is usually considered to occur by three processes:

1. Conduction is the transfer of heat from one part of a body to another by short-range interaction of molecules and/or electrons.
2. Convection is the transfer of heat by the combined mechanisms of fluid mixing and conduction.
3. Radiation is the emission of energy in the form of electromagnetic waves.

Since there is no fluid flow other than air at low velocities, convection is not significant in this refrigerator problem. Film coefficients are on the order of 1000 and this coefficient is used in the form of 1/1000 and so is insignificant as an additive term (see below). Radiation is also insignificant compared to conduction.

The basic Fourier conduction law for isotropic material is:

$$q = -k \nabla t$$

where q is the heat transferred, k is the thermal conductivity of the material which varies with the temperature of the material, and t represents temperature. Thus, an arithmetic mean is often used for k.

The primary means of heat transfer is through the walls of the refrigerator compartments (see Figure 3). For this situation, Fourier's equation becomes.

$$q = \frac{t_o - t_i}{\frac{1}{h_i A_i} + \frac{\mathcal{L}}{k A_m} + \frac{1}{h_o A_o}}$$

where  $h_i$  and  $h_o$  are film coefficients, k is the thermal conductivity of the walls,  $A_i$ ,  $A_m$  and  $A_o$  are equal and are the wall areas,  $t_o$  and  $t_i$  are outside and inside temperatures and  $\mathcal{L}$  is the wall thickness. The units for q are watts (BTU/hr).

Since the film coefficients for water are approximately 1000, it is obvious that the convection and radiation coefficients disappear compared to k which is less than 1. Thus the equation reduces to

$$q = \frac{t_o - t_i}{\frac{\mathcal{L}}{k A_m}}$$

ORIGINAL PAGE IS  
OF POOR QUALITY

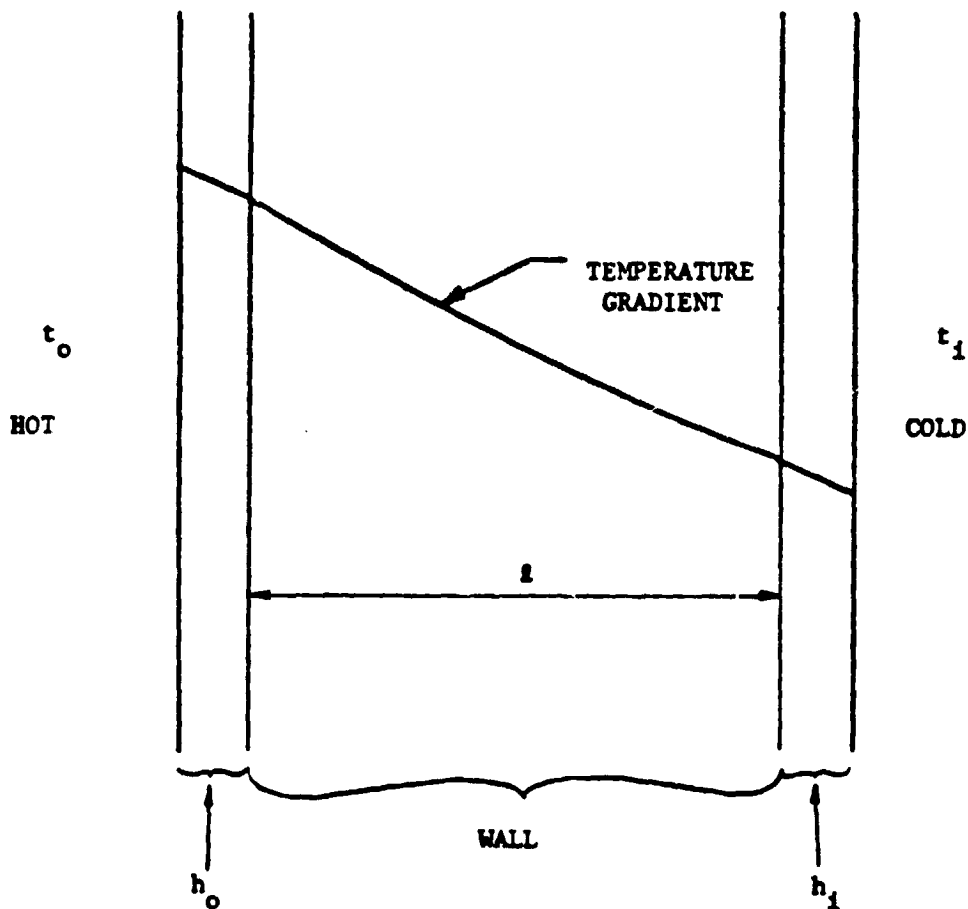

FIGURE 3

HEAT TRANSFER THROUGH A WALL

$t_o, t_i$  = temperatures outside and inside wall, respectively

$h_o, h_i$  = film coefficients outside and inside wall, respectively

ORIGINAL PAGE IS  
OF POOR QUALITY

where  $t_o$  is the ambient temperature,  $t_i$  is the inside temperature,  $l$  is the thickness,  $k$  is the thermal conductivity of the wall and  $A_m$  is the wall area.

For this refrigerator, there are six heat shielding walls to consider. The dimensions are: 0.381m X 0.356m; 0.762m X 0.356m; and 0.762m X 0.381m (15" X 14"; 30" X 14"; and 30" X 15"). The total area of these walls is 1.394m<sup>2</sup> (15 ft<sup>2</sup>). Using the Fourier equation as an approximation, the heat penetration can be estimated as a function of wall thickness. If  $k$  is averaged to  $2.44 \times 10^{-2}$  W/ $\pi$ -°C (0.013 BTU/Ft<sup>2</sup>-Hr-F°/Ft),  $t_o$  equals 43.0°C (109.4°F) and  $t_i$  equals 6.0°C (42.8°F), then the function for  $q$  and  $l$  is:

$$q = \frac{109.4 - 42.8}{\frac{l}{(0.013)} (15)} = \frac{12.99}{l}$$

The unit for  $l$  is in meters (feet). The values of  $q$  for various thicknesses of insulation are shown in Figure 4. For various values of  $l$  up to 0.305m (1 foot)  $q$  is:

$l$	$q$
0.076m (0.25 ft)	16.58W (51.96 BTU/hr)
0.102m (0.33 ft)	12.35W (38.88 BTU/hr)
0.152m (0.50 ft)	8.29W (25.98 BTU/hr)
0.203m (0.67 ft)	6.21W (19.49 BTU/hr)
0.229m (0.75 ft)	5.50W (17.32 BTU/hr)
0.305m (1.00 ft)	4.13W (12.59 BTU/hr)

With 0.152m (6") of insulation, heat penetration through walls is estimated to be 8.3W (26 BTU/hr). The base load of the refrigerator at 6.0°C (42.8°F) in a 43.0°C (109.4°F) ambient is 8.3W (26 BTU/hr) or approximately 16.6 A-hr per day at 12 volts. Increasing insulation beyond 0.152m (6") thus has very little cost effectiveness and will probably increase operational problems and would exceed the design height limitation. It would require 0.305m (1 ft) of insulation on each side to make a significant difference in the energy requirement. Maintaining the freezer cavity at lower temperatures than 6.0°C (42.8°F) would increase the A-hr require-

**FIGURE 4**

**HEAT GAIN AS A FUNCTION OF INSULATION THICKNESS**

$$q = \frac{1.26}{l} \quad \frac{(12.99)}{(l)}$$

**HEAT  
GAIN  
(WATTS)**

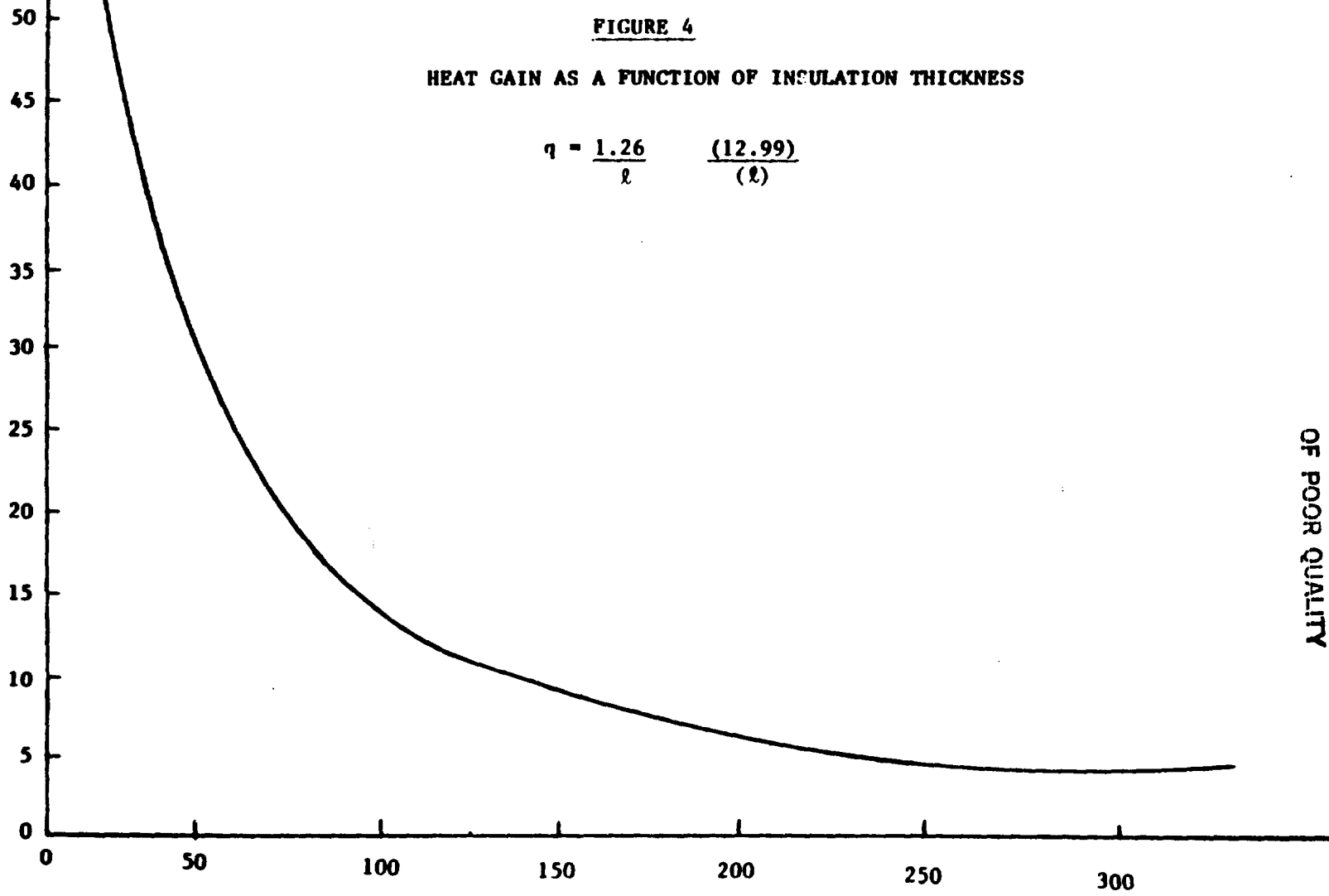

**INSULATION THICKNESS (mm)**

**ORIGINAL PAGE 19  
OF POOR QUALITY**

ments by up to 3 or 4 A-hr if  $-15^{\circ}\text{C}$  ( $5^{\circ}\text{F}$ ) is desired in the freezer. Thus a 20 A-hr daily requirement to maintain the inside temperature is not unreasonable with a  $43.0^{\circ}\text{C}$  ( $109.4^{\circ}\text{F}$ ) ambient. Edge and corner losses will not greatly change this estimate as can be seen from the following calculations. Conduction shape factors are derived from the Fourier equation in the form:

$$q = kS \Delta T$$

for various geometries. Figure 5 is a sketch illustrating dimensions for use in calculating three dimensional shape factors. The relationships are obtained from any text on heat transfer and are:

$$S = S_{\text{wall}} + S_{\text{edge}} + S_{\text{corner}}$$

$$S_{\text{wall}} = \frac{A}{L} \qquad S_{\text{edge}} = 0.54D \qquad S_{\text{corner}} = 0.15L$$

where A is area of a wall, L is the wall thickness and D is the length of an edge. For

$$\begin{aligned} S_{\text{walls}} &= \sum_i A_i/L_i = 30 \\ S_{\text{edges}} &= \sum_i 0.54 D_i = 10.6 \\ S_{\text{corners}} &= \sum_i 0.15 L_i = 0.6 \end{aligned}$$

then  $S = 12.6\text{m}$  ( $41.2 \text{ ft}$ ) and  $q = 11.37\text{W}$  ( $35.7 \text{ BTU/hr}$ ). The edge and corner losses combined with the additional requirements to maintain  $-15^{\circ}\text{C}$  ( $5^{\circ}\text{F}$ ) for the freezer still puts the A-hr delivered on the order of 20 per day as an estimate. This estimate must then be increased to allow for the true Carnot efficiency of the compressor.

NASA also required that 2.0 kg of ice (or about 7 trays of ice cubes) be made per day by the refrigerator. This is 4.4 pounds of water. Since the heat of fusion of water is  $334.9\text{kJ/kg}$  ( $144 \text{ BTU/lb}$ ) and it is presumed the ice will be chilled to around  $-20^{\circ}\text{C}$  ( $-4^{\circ}\text{F}$ ), the energy requirement is about  $1055 \text{ kJ}$  ( $1000 \text{ BTU}$ ) or approximately 26 A-hr per day if ambient is  $43^{\circ}\text{C}$  ( $109.4^{\circ}\text{F}$ ). The total requirement specified is thus 46 A-hr per day before derating and allowing for opening and closing. Allowing for Carnot efficiency, battery efficiency and instrumentation draw could increase this to over 60 A-hr per day. Actual experimental values recorded during the testing of the SPC-RF103 are presented later.

If the  $60^{\circ}\text{C}$  cell temperature requirement is met, the module max power current is 2.164 amps at  $100 \text{ mW/cm}^2$  and AM 1.5. This requirement will determine the number of photovoltaic modules needed to operate the refrigerator/freezer. The procedure used to select the number of modules will be described later in this report.



ORIGINAL PAGE IS  
OF POOR QUALITY

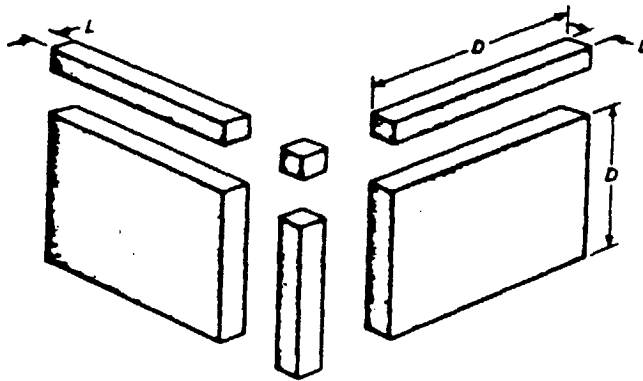

FIGURE 5

DIMENSIONS USED TO CALCULATE 3-DIMENSIONAL SHAPE FACTORS

After performing the previous energy analysis independently of Adler-Barbour, the manufacturers of the refrigerator/freezer unit, SPC obtained the following Adler-Barbour calculations for 43°C ambient:

No load steady state	21.62 A-hr/day
Loaded steady state	53.42 A-hr/day
Steady state with ice	63.12 A-hr/day

These values match quite well with the estimates obtained from the analysis performed by SPC.

### CONCEPTUAL DESIGN

The photovoltaic plant design integrates the site, the load, and the human interfaces with the system hardware. Figure 6 shows the connections between major hardware elements.

Components and subsystems have been designed or chosen according to product availability and maturity, efficiency, reliability, safety, and cost criteria as well as site and human interface requirements. Subsystems are interdependent also. The design of the subarrays and their wiring arrangement was, in turn, determined by these limits as well as the practical limits on the physical size that can be adjusted and serviced with hand-operated equipment. The design criteria and parameters for each component and subsystem are given in later sections along with full descriptions of the selected designs.

The photovoltaic plant must operate over all possible environmental conditions and must behave predictably during outages or human intervention. To satisfy these requirements, operational modes have been defined.

Operational modes are startup, operation, shutdown, and emergency shutdown. These occur as normal operating modes or degraded operating modes. Additional operating modes also considered are maintenance/diagnostic modes.

Normal operating modes occur with the system full-up with all subsystems operating at their rated capacity. Degraded operating modes occur with the system operating below its rated capacity due to partial outages of subsystems and/or components.

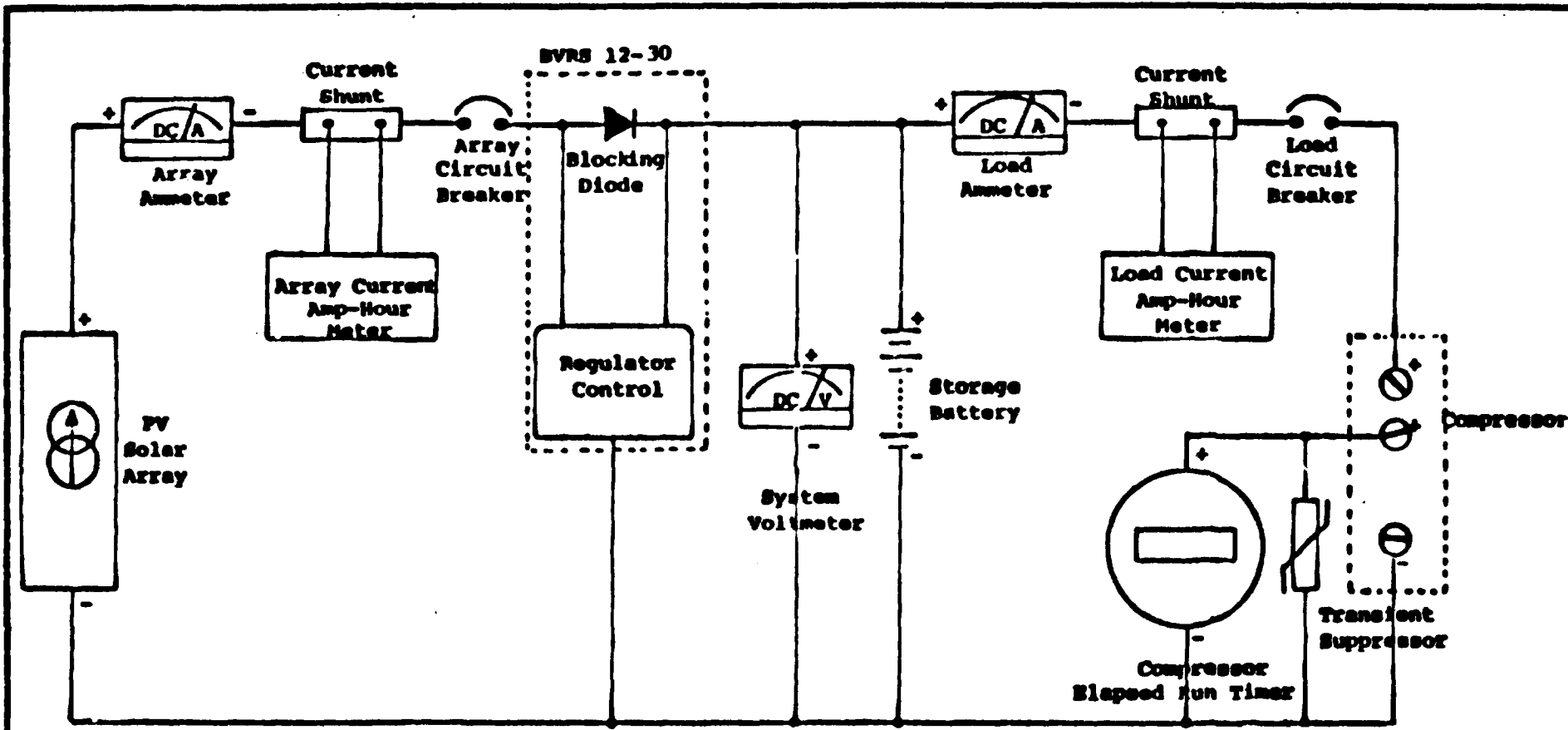

FIGURE 6

SPC - RF103 PHOTOVOLTAIC POWERED MEDICAL REFRIGERATOR/FREEZER

COMPONENT BLOCK DIAGRAM

ORIGINAL PAGE IS  
OF POOR QUALITY

Characteristics of the operating modes are steady-state and transient operational conditions. Conditions characteristic of the operating modes are:

1. Steady State Conditions

a. Daylight

Power delivered to load at 12 Vdc. Excess power, if any, is shorted through the array.

b. Nighttime or Very Heavy Cloud Cover

Operation from batteries with voltage monitoring from BVR to activate signal alarm for low voltage.

2. Transient Conditions

a. Startup and Shutdown

Output is automatically connected to battery-load circuit. Transient suppression controls voltage spikes and limits array current to battery and load.

b. Clouds or Partial Moving Shadows

Array output follows insolation. The BVR controls voltage and current to the battery and load. Partial shadowing affects output of only those strings shadowed.

c. Surge

Surge protection devices in the BVR are activated at input and output.

3. Maintenance/Diagnostic Modes

a. Monitoring

Metering exists for battery voltage, array string current and set voltages for testing. Visual indication is obtained from the instruments.

b. Manual Shutdown or Backup Activities

If the PV generator is off-line, the system will go to the battery. If the battery is disconnected, the system will shut-down. Emergency shut-down is through the master switch to the loads and disconnection of subsystems.

### Performance Analysis and Sizing

The input parameters for the performance analysis are shown in Table 2. The insolation data were taken from the RFP. The SPC Model G361 module output characteristics including efficiency and insolation coefficients, are well documented through SPC's own testing and JPL Block III module procurements.

The results of the sizing analysis are shown in Tables 3, 4, and 5 for 8, 9, and 10 module arrays respectively. The results indicate that the nine module array (Table 4) will provide sufficient energy to operate the RF unit at the specified conditions.

The conceptual design results from the system analysis and consists of the following:

#### Array

A variable tilt angle array and integral mount easily operated by individuals in a medical clinic in a developing country is the basic requirement. The array is divided into two sections, each allowing up to 5 modules. The initial design point recommendation by SPC is nine modules in two sections (5-4). If the tests indicate a need for 10, 8, or 7, SPC can alter the section sizes to 5-5, 4-4 or 4-3.

The wiring from the sectional arrays leads to a junction box which feeds into the regulator and battery and then to the load.

The sizing analysis was performed using the basic design drivers from the RFP and the analysis developed by SPC. The SPC sizing program does not allow a monthly variation of tilt angle and so it was necessary to make multiple runs of the program at various tilt angles and then combine the information.

The next section includes the development of the conceptual design into a preliminary design of subsystems and component specifications.

TABLE 2  
SIMULATION MODEL INPUT VALUES

Weather	NASA Data
Module Packing Factor	72%
Cell Efficiency at 28°C	11%
Efficiency Temperature Coefficient	-0.485%/°C
Cell Temperature Insolation Coefficient	0.325°C/mW/cm <sup>2</sup>
Average Wiring and Parasitic Losses	2%
Ground Reflections	0
Load Profile (Continuous)	60 A-hr/day @ 12 Vdc

ORIGINAL PAGE IS  
OF POOR QUALITY

TABLE 3  
SIZING ANALYSIS

8 G12-361 MODULES

LOCATION: 0° LATITUDE TEMP: 43°C MODULE TEMP: 60°C STORAGE: 600 A-HR

MONTH:           JAN   FEB   MAR   APR   MAY   JUN   JUL   AUG   SEP   OCT   NOV   DEC  
FLT LANGLEYS   280   310   320   350   300   240   250   280   320   280   250   280

<u>MONTH</u>	<u>TILT</u>	<u>CURRENT</u>	<u>LNGLYS</u>	<u>DAILY LOAD</u>	<u>DAILY OUTPUT</u>	<u>MONTHLY DEFICIT</u>	<u>MONTHLY SURPLUS</u>
JAN	20S	2.164	314	60	63.1		96.1
FEB	15S	2.164	330	60	66.2		173.6
MAR	5S	2.164	327	60	65.5		170.5
APR	10N	2.164	366	60	73.6		408.0
MAY	20N	2.164	330	60	66.3		195.3
JUN	25N	2.164	276	60	55.5	135.0	
JUL	20N	2.164	280	60	56.2	117.8	
AUG	15N	2.164	298	60	59.8	6.2	
SEP	5N	2.164	327	60	65.7		171.0
OCT	10S	2.164	291	60	58.5	46.5	
NOV	20S	2.164	275	60	55.2	144.0	
DEC	25S	2.164	322	60	64.7		145.7

NOTES

1. Tilt corresponds to convention developed previously.
2. Current specified is for each module.
3. Daily load and daily output are given in Amp-Hours per day.
4. Monthly deficit and monthly surplus are given in Amp-Hours per month.

TABLE 4  
SIZING ANALYSIS

9 G12-361 MODULES

LOCATION: 0° LATITUDE TEMP: 43°C MODULE TEMP: 60°C STORAGE: 600 A-HR

MONTH:            JAN   FEB   MAR   APR   MAY   JUN   JUL   AUG   SEP   OCT   NOV   DEC  
FLT LANGLEYS   280   310   320   350   300   240   250   280   320   280   250   280

<u>MONTH</u>	<u>TILT</u>	<u>CURRENT</u>	<u>LNGLYS</u>	<u>DAILY LOAD</u>	<u>DAILY OUTPUT</u>	<u>MONTHLY DEFICIT</u>	<u>MONTHLY SURPLUS</u>
JAN	20S	2.164	314	60	71.0		341.0
FEB	15S	2.164	330	60	74.5		406.0
MAR	5S	2.164	327	60	73.7		424.7
APR	10N	2.164	366	60	82.7		681.0
MAY	20N	2.164	330	60	74.5		449.5
JUN	25N	2.164	276	60	62.4		72.0
JUL	20N	2.164	280	60	63.3		102.3
AUG	15N	2.164	298	60	67.3		226.3
SEP	5N	2.164	327	60	73.9		417.0
OCT	10S	2.164	291	60	65.8		179.8
NOV	20S	2.164	275	60	62.1		63.0
DEC	25S	2.164	322	60	72.8		396.8



ORIGINAL PAGE IS  
OF POOR QUALITY

TABLE 5  
SIZING ANALYSIS

10 G12-361 MODULES

LOCATION: 0° LATITUDE TEMP: 43°C MODULE TEMP: 60°C STORAGE: 600 A-HR

MONTH:            JAN   FEB   MAR   APR   MAY   JUN   JUL   AUG   SEP   OCT   NOV   DEC  
FLT LANGLEYS   280   310   320   350   300   240   250   280   320   280   250   280

<u>MONTH</u>	<u>TILT</u>	<u>CURRENT</u>	<u>LANGLYS</u>	<u>DAILY LOAD</u>	<u>DAILY OUTPUT</u>	<u>MONTHLY DEFICIT</u>	<u>MONTHLY SURPLUS</u>
JAN	20S	2.164	314	60	78.9		585.9
FEB	15S	2.164	330	60	82.8		638.4
MAR	5S	2.164	327	60	81.9		678.9
APR	10N	2.164	366	60	91.9		957.0
MAY	20N	2.164	330	60	82.8		706.8
JUN	25N	2.164	276	60	69.3		279.0
JUL	20N	2.164	280	60	70.3		319.3
AUG	15N	2.164	298	60	74.8		458.8
SEP	5N	2.164	327	60	82.1		663.0
OCT	10S	2.164	291	60	73.1		406.1
NOV	20S	2.164	275	60	69.0		270.0
DEC	25S	2.164	322	60	80.9		647.9

ORIGINAL PAGE IS  
OF POOR QUALITY

## SYSTEM DESIGN

### VARIABLE TILT ARRAY

The arraying scheme utilized by SPC is shown in Figure 7. The array conforms to the specifications stated previously. The tilt angle adjustment bolt holds the array in place. The tilt indicator is shown in Figure 7 and will allow tilting from 60°S to 60°N in increments of 10°.

### ARRAY WIRING

The design objectives that the wiring scheme must meet were defined as follows:

1. Parasitic and DC wiring losses should be less than 2 percent.
2. Voltage and current levels should be compatible with the BVR (Battery Voltage Regulator) input requirements.
3. The installations should be free from electrical hazards to operating personnel and as safe as possible to anyone working on the systems.

Electrical reliability was not compromised in achieving these objectives. Wiring power losses are kept low by selecting wire sizes by resistance criteria rather than normal capacity ratings. The additional cost of larger wire is justified by the relatively high cost of the solar modules. The wire from each module is ITT Cannon Type SJO 18/2 or equivalent. Each 12 volt module is integrated in a parallel connection to a junction box for each array with SJO 18/2 wire. The size of wires from the junction box to the BVR is #6 or #4 wire. The junction boxes' terminal links allow up to 10 modules. The junction boxes are mounted on the arrays. They are weatherproof and custom made by Solar Power. The two wires from the junction boxes are connected in parallel in a terminal junction box and a #4 wire from the terminal junction box leads to the refrigerator/freezer unit.

ORIGINAL PAGE 19  
OF POOR QUALITY

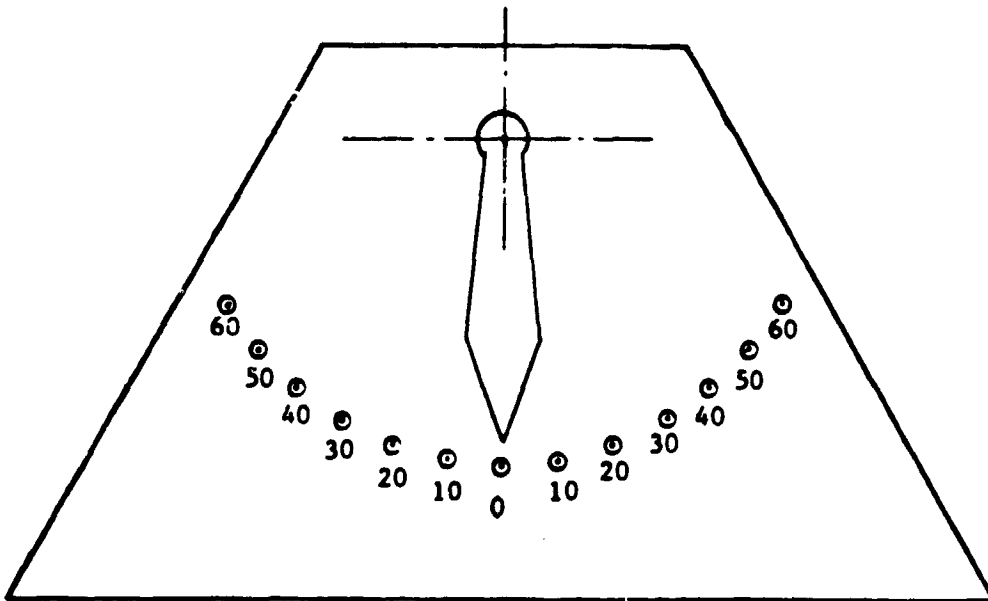
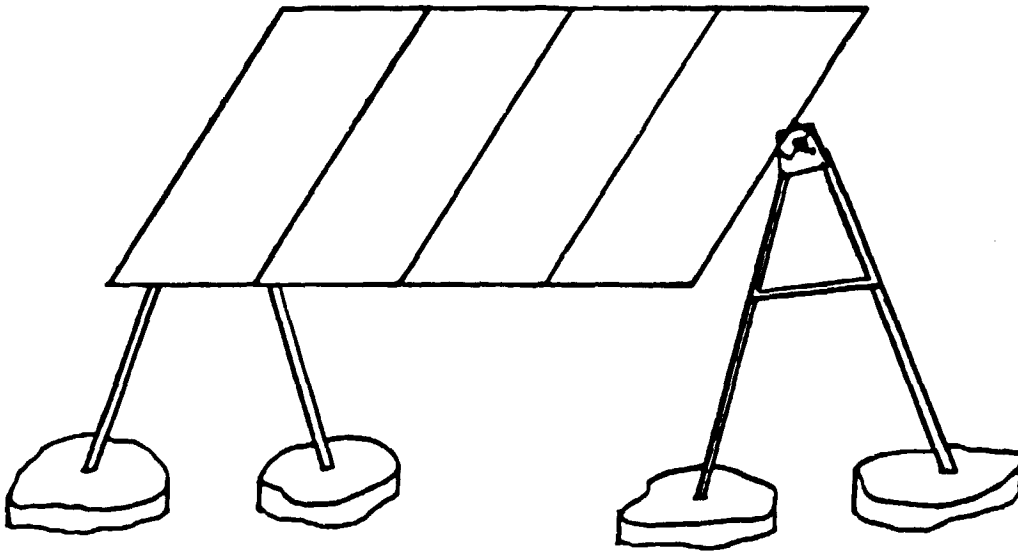

FIGURE 7

SAMPLE ARRAY SCHEME AND ARRAY TILT INDICATOR

## PHOTOVOLTAIC MODULE

The photovoltaic module used in the array is a Solar Power Corporation Module G-361. This 36 cell superstrate type module shown in Figure 8, features a hard glass cover combined with a rugged solar cell mounting and termination technique that provides a practical and economic solution for a wide range of power requirements.

The rationale for this choice of the G-361 module for this application is a combination of characteristics. These characteristics, in order of decreasing importance, are:

1. Proven, reliable design with proven component history.
2. Ability to meet electrical insulation and local site hail impact requirements.
3. Ease of cleaning and maintenance.
4. Low cost.

The tempered water-white glass superstrate provides stiffness as well as a self-cleaning surface that is resistant to environmental loadings such as snow, ice, rain and hail. The module consists of a sandwich of the following items: glass superstrate, cells, interconnects, terminals, junction box, encapsulant, and back sheet.

The superstrate is a tempered, water-white, anti-reflective glass which is highly resistant to breakage. The design wind load of the module is 78.2 m/s (175 mph), which exceeds the wind loadings specified for this proposal. The design torsional flexibility of the modules is 0.006m per meter (1/4" per foot) along the long dimension of the module. The cell configuration (4 rows of 9 cells each) allows the glass size to be consistent with low glass stress levels. The superstrate also provides mechanical protection for the cells from hail impact. The superstrate/encapsulant used in the G-361 module is designed to provide resistance to hail-stones up to 0.051m (2") in diameter.

The silicone rubber encapsulant used in this module is the most reliable material available and has superior weathering characteristics with respect to optical and mechanical properties.

The white back sheet provides a hard surface for the soft encapsulant to reduce the chance of cell damage from foreign objects hitting the surface, and the white color provides power enhancement due to increased internal reflection.

The superstrate/encapsulant/back sheet assembly provides electrical insulation between the cell strings and the mounting frame. The design level of electrical insulation in G-361 modules is 2000 V, considerably higher than any expected operating voltage.

REV	DESCRIPTION	DATE
A	REVISED VIEW	11/20/54

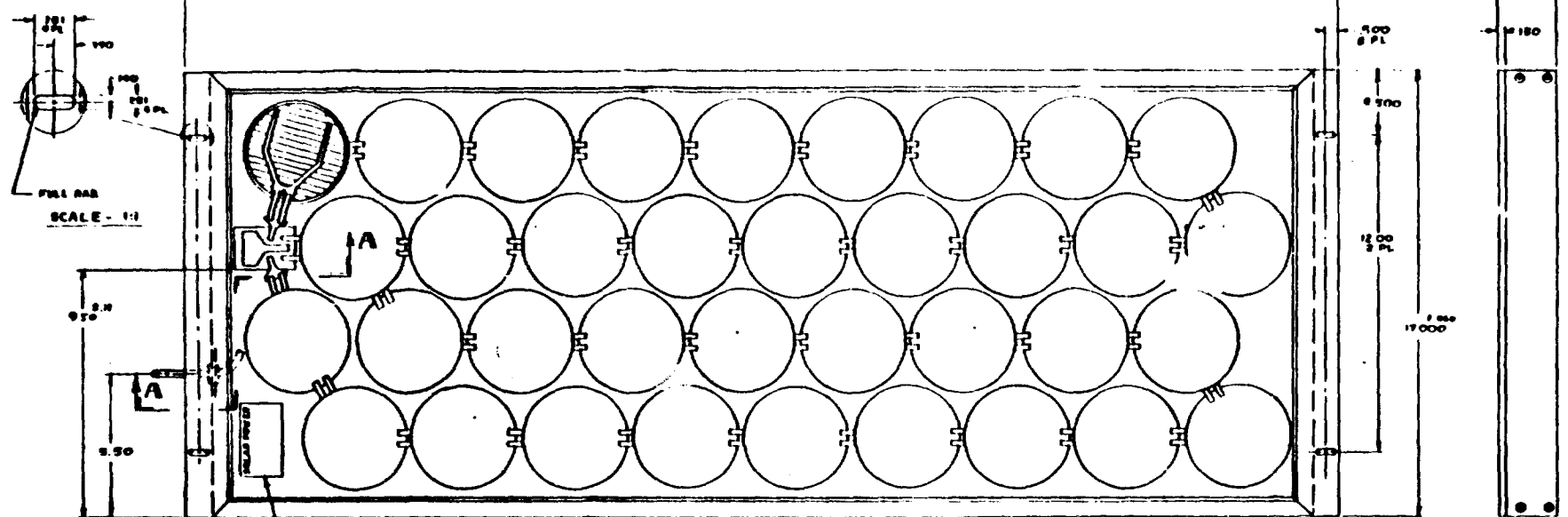

ORIGINAL PAGE IS  
OF POOR QUALITY

-25-

NAMEPLATE LOCATED (SEE A4096)  
APPROXIMATELY AS SHOWN

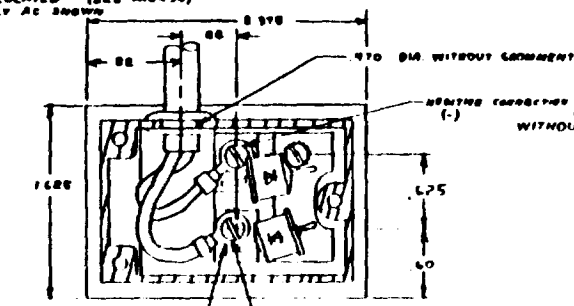

SECTION B-B (COVER REMOVED)  
SCALE 2:1

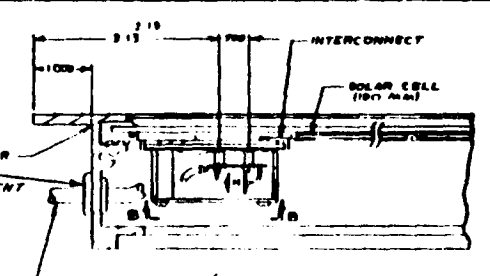

SECTION A-A  
SCALE 1:1

Solar Power Corporation 3610 E SOLAR MOD OUTLINE	
D 5231	A

The tinned copper foil interconnects between cells, and between terminals and cells, have stress relief loops to allow a significant margin of safety in fatigue loading due to thermal stresses. Redundant interconnects enhance the survivability of the module in the event of loss of an interconnect. The electrical termination consists of neoprene jacketed cable with a low-cost environmental type connector at the end to connect to the module junction box.

Cadmium plated, steel terminals are provided to allow interconnection of modules in either series or parallel configurations. The terminals are located in a terminal box constructed of black, glass-reinforced, phenolic material. The terminal box can hold an encapsulating material (urethane) after installation of the necessary output cabling. This makes the terminal box water resistant.

Modules are grouped so that short circuit currents of each module in a series string will not vary more than 5%. The open circuit voltage will not vary more than 10%.

Reverse biasing can occur when there is a limiting cell within a series string of cells. A limiting cell is one which has lower current output than the other cells that it is connected in series with. The current of a cell is directly proportional to the amount of area which is illuminated by the sun. Therefore, dirt or other shadowing of the cell surface or a cracked cell caused by mishandling or vandalism can cause a cell to be limiting.

The potential amount of reverse bias which the limiting cell can reach increases with the number of cells connected in series (high voltage array); it also increases as the operating voltage of a given array moves toward zero (short circuit operation). As either of these conditions occurs, the power dissipated in any current limiting cell which goes into reverse bias raises its temperature above its normal operating value. A system can operate at short circuit by using a shorting type regulator for system regulation, or by deliberately shorting a high voltage array to make it safe to handle for maintenance, testing or cleaning.

The G12-361 module limits the amount of reverse voltage that can be imposed on a cell, thereby, limiting the amount of heat dissipated in that cell. This is accomplished with the addition of two bypass diodes in each module. The G12-361 module with 36 cells in series has one bypass diode across each string of 18 cells. As far as reverse bias effects are concerned, bypass diodes reduce the effective number of series-connected cells to the number within the bypass diode connections. The maximum reverse voltage that a limiting cell can see is the maximum voltage that can be generated by this series string. Since 18 cells in series can generate only half the voltage that 36 cells can generate, the two bypass diodes per module cut the maximum heat dissipation in half.

To incorporate the two bypass diodes, two extra redundant interconnects have been added from the terminal box to the center of the series string of cells (between the eighteenth and nineteenth cell). The interconnects are connected to two of the four output terminals in the terminal box to allow the bypass diodes to be installed across each 18 cell series string. A conformally coated PC board is used to mount the bypass diodes which is then mounted on the two output terminals. This allows only two terminals for output connections instead of four. Figure 9 shows the two added interconnects and the terminal box with the installation of the bypass diodes.

The addition of two bypass diodes reduces the potential temperature limit that any cell can reach to a level well below the module design criteria. This ensures the long-term reliability of the module. There is no loss in electrical performance with the incorporation of bypass diodes because, unlike blocking diodes, bypass diodes do not reduce the output voltage. The G12-361 module specifications are, thus, unaffected. This design makes the G12-361 module ideal for low voltage, high voltage, and short circuit applications.

An SPC G-Series Product Data Sheet is included to summarize the G-361 module characteristics.

The module meets the requirements of the DOE Specification 5260-2. Specifically, the module:

- Has been tested and exceeds temperature requirements.

- Has been tested and meets thermal cycling and shock requirements between -40°C and 90°C.

- Has been tested and exceeds hail requirement.

ORIGINAL PAGE 19  
OF POOR QUALITY

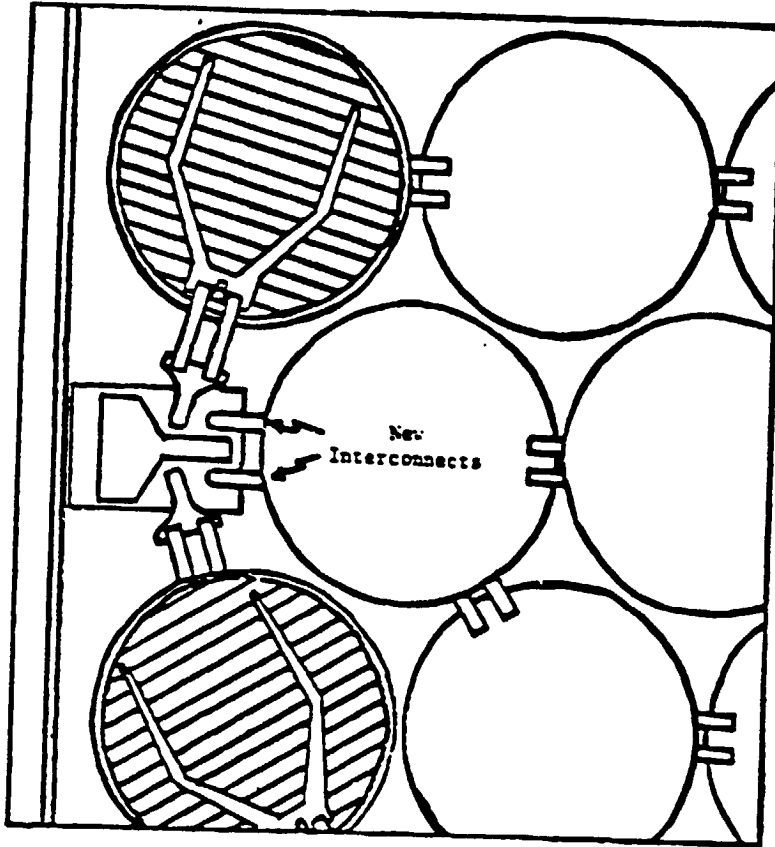

New Interconnect Addition

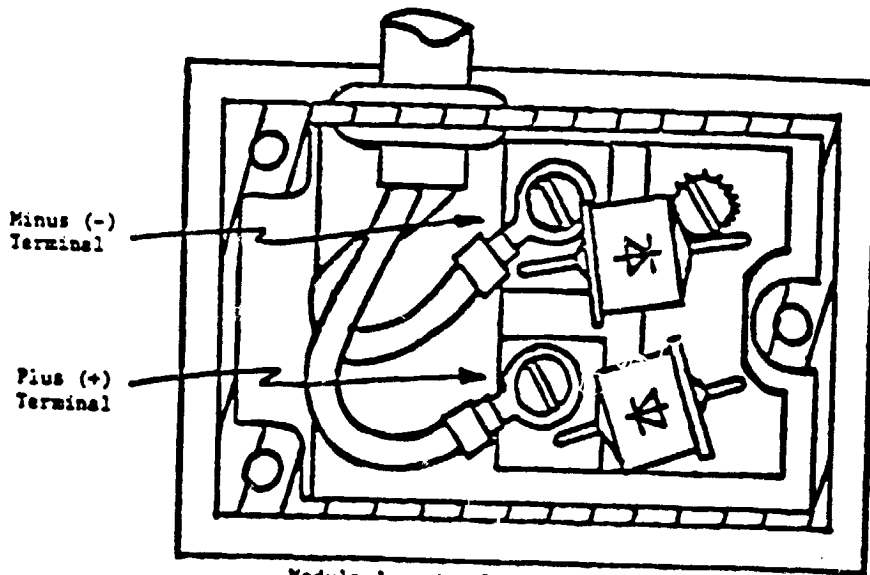

Module Junction Box with Diode PC Board

FIGURE 9

INTERCONNECTS AND BYPASS DIODES IN G MODULE



# Solar Power Corporation

Affiliate of EXON Corporation

## G-Series PRODUCT DATA SHEET

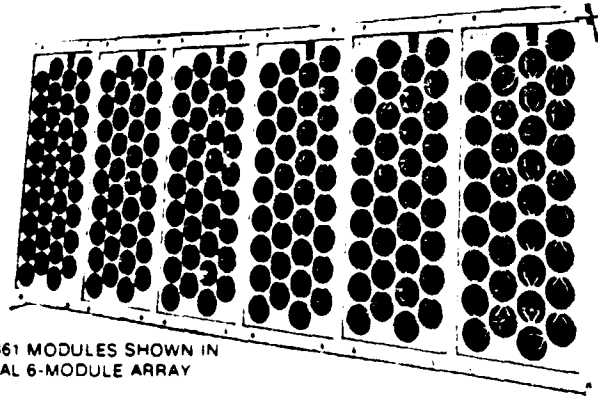

G-12-361 MODULES SHOWN IN  
TYPICAL 6-MODULE ARRAY

# SOLAR ELECTRIC GENERATOR MODULES

### SPC Module Feature Benefits

- Factory sealed integral junction box protects wire terminals and diodes against environment (an SPC first).
- White plastic film backing improves module efficiency (also an SPC first).
- Double diode module permits high voltage use (another SPC first).
- Corrosion resistant cell metalization eliminates hermetic seal requirements
- UV resistant transparent encapsulant protects cell and interconnect
- Lightweight, corrosion-resistant anodized aluminum ensures strong support frame
- Corrosion resistant redundant electrical interconnects
- Wind loading capacity withstands up to 175 mph (280 kph)
- Unique construction with thermally-matched component materials accommodates expansion/contraction
- Integral array junction box facilitates wiring and provides environmental protection
- Low iron, high transmission, tempered glass provides durability and maximum light penetration
- Self-arraying flanges ensure simple assembly
- Ten feet of 18-2 neoprene jacketed output cable offers minimal voltage drop
- Fully tested modules ensure reliable long-term service in any environment

tempered glass that provides a durable protective barrier against salt spray, sand storms, hail stones, snow, ice, attack by birds and vermin. The exterior, friction-resistant glass surface minimizes debris buildup.

The solar cells are encapsulated with silicone rubber, which bonds to the glass. This seals the solar cells and electrical connections from the environment. The rear surface is protected by a white polyester backing. An optional galvanized steel screen is available to protect the rear of the module from damage by birds or animals.

The anodized aluminum support frame is designed with self-arraying flanges for simple assembly onto an array-mounting rail. The protective glass sheet and encapsulated cells are held in the support frame by a one-piece silicone gasket which isolates the assembly from shocks transmitted through the frame.

### Electrical Wiring

Individual modules are supplied with an output cable and blocking or bypass diode. Blocking diodes prevent power drain from the battery at night, while bypass diodes

prevent excessive heating in series-connected modules. The diodes and the output cable connectors are sealed in a glass-reinforced junction box at the rear of each module.

### Solar Cells

Solar Power Corporation photovoltaic cells are manufactured to the highest standards of excellence. Beginning with a wafer of pure, single-crystal silicon, impurities are added to produce a positive-negative layer. The junction of the two layers gives the silicon wafer its photo-sensitive diode effect. When the photons from the sun penetrate the junction, a flow of electrons is produced.

Through a proprietary metalization process, electrical contacts are applied to the top and bottom surface of the solar cell to collect the electrical energy. The top grid contact offers high conductivity with maximum light-gathering surface area. The metalization process provides a strong conductor bond which will withstand wide temperature variations and resist corrosion.

Cells are connected in series or parallel and feature completely redundant cell-to-cell stress relieved interconnects.

Solar Power Corporation G-Series Modules are engineered to operate reliably in a wide variety of applications and environments. They meet and/or exceed the stringent test requirements of Jet Propulsion Laboratory's document No. 5101-65. Above and beyond excellent electrical design, extensive measures have been taken to assure protection of electrical components from shock, humidity and temperature fluctuations. The resulting modules are high performance, long life electrical generators that require little or no maintenance.

### Packaging

The top surface material of a G-Series module is low-iron, high-transmission,

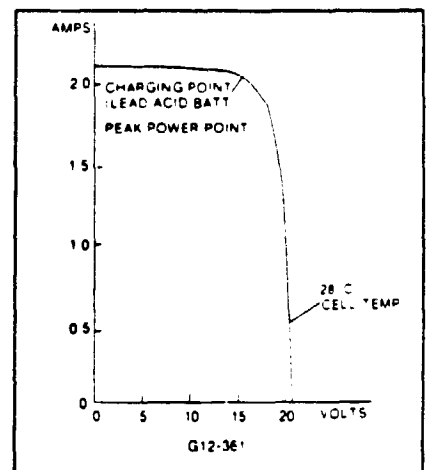
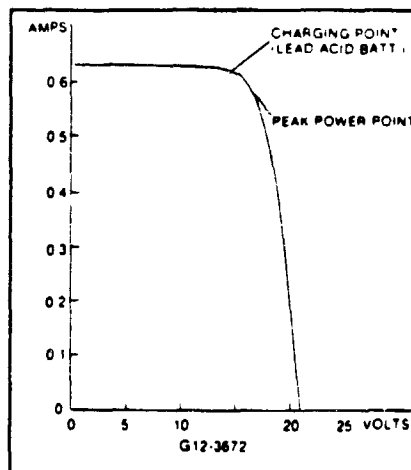

Typical I-V curves of SOLAR POWER CORPORATION modules

### MODULE RELIABILITY

The G-361 series module reflects the intent of MIL-STD-765 and MILSTD-785A. Unfortunately, no government agency has been able to complete a classical attribute test because most programs have not been in existence long enough to have all modules in a test fail. Based on JPL data and SPC data, the MTBF easily exceeds 50,000 operating hours. The MTR has been demonstrated to be much less than one hour based on recent field trials for small arrays. Although safety is addressed elsewhere, it is noted that the modules meet all safety requirements; there are no exposed wires on the modules and junction boxes are secured with three Phillips head fasteners on plastic. Modules are inspected and tested using the Specification 5101-21 Revision B, "Acceptance/Rejection Criteria for JPL/LSA Modules."

### MODULE FRAMING, MOUNTING AND SUPPORT STRUCTURE

The photovoltaic modules are assembled into an anodized aluminum support frame with self-arraying flanges for simple assembly onto an array mounting rail. The protective glass sheet and encapsulated cells are held in the support frame by a one piece silicone gasket which isolates the assembly from shocks transmitted through the frame. The framed modules are mounted onto aluminum rails having a minimum yield strength of  $262 \times 10^6$  N/m<sup>2</sup> (38,000 psi), or equal.

All bolts, nuts, washers, and split lock washers are stainless steel meeting ASTM A276 Type 304, or equal. Captives are by Engineered Fasteners Division of Eaton Corp., or equal.

### ELECTRIC PLANT SUBSYSTEM

The electric plant subsystem consists of the wiring, the BVR, controls and monitoring, the battery storage, and the wiring to the load. This section will cover the batteries and the other items from above as well as interface elements.

The batteries will not only supply power to the load during inferior insolation conditions but also will be used to augment the normal array supply during system operational conditions. The batteries will also provide current surges. SPC specified Delco 2000 brand lead calcium batteries for all storage requirements for this application. Delco batteries have proven reliability and performance, high efficiencies, long cycle life, low self-discharge and resistance to rough handling, particularly when compared to pure lead plate batteries.

The capacity specifications of the battery storage bank are dependent upon the detailed integration of the overall power demand placed upon the system by the load, matched against the power that must be supplied by the system, i.e., the optimized combination of the photovoltaic array and storage batteries. Detailed daily, monthly and seasonal variations in insolation levels and worst-case continuous sunless days during the most recent ten year interval are usually considered, in addition to system and component efficiencies, cell temperatures, and module and equipment degradation when sizing batteries. Battery operating voltages are determined by the load and system requirements. Specific battery charging voltages are approximately 15% to 20% higher than the normal operating voltages. Battery charging voltages are critical since over charging of batteries will cause gassing and reduction of electrolyte levels in the batteries. Conversely under-charging will not allow the batteries to fully charge, which could result in abnormally low depths of discharge during high energy demand periods and the excessive current drains during sunless hours. Both over and under charging of batteries could eventually cause battery damage and curtail the battery life expectancy.

The Delco 2000 batteries have a 105 A-hr capacity at the 100 hour rate at 25°C. Self-discharge rate is 4 A-hr per month at 27°C. Dimensions are 330.2 mm X 172.0 mm X 238.8 mm (12.99" X 6.77" X 9.37"). The batteries weigh 27.3 Kg (60 lb). The refrigerator battery storage area will allow 6 of these batteries in a 3 by 2 matrix wired in parallel.

#### WIRING

The wiring from the junction box on the array to the BVR will be 10 or more meters as required and will be #6, or #4 AWG wire.

#### CONTROLS AND MONITORING SUBSYSTEM

The controls and monitoring subsystem includes the following items:

- Battery Voltage Regulator (BVR)
- Instrumentation and Monitoring Equipment

#### REGULATOR BVR 12-30

Solar Power Corporation's shorting Battery Voltage Regulators are designed to provide exacting battery voltage control, low quiescent power consumption and reliable, long service life.

Available in weather-resistant or nonweather-resistant configurations, the BVR series battery voltage regulators are of shorting design. Once the regulating voltage is set, the BVR series regulators allow only enough current to flow into the battery as needed to maintain a full state of charge. Additional solar array output current is then diverted through to a power transistor which is turned on in saturation mode rather than a linear mode. As a result, when the battery terminal voltage reaches a preset full charge level, the control circuit sends an ON signal to the power switch. Then, the power switch is driven into the saturation mode and effectively shorts the array output to prevent array current from charging the battery. In cases where the battery falls below full charge, the regulator circuit draws only enough power to operate the terminal voltage level detector (typically 1mA or less). The low "off" state power drain of the BVR shorting battery voltage regulator prevents unnecessary waste of valuable solar-generated power in the regulator circuits when the battery is below full charge. The battery voltage upper limit is selected to minimize electrolysis of water in the electrolyte. In addition to preventing unnecessary electrolyte loss, BVR shorting battery voltage regulators protect against equipment or battery damage due to excessive voltage.

<u>Model No.</u>	<u>Typical Regulating Voltage</u>	<u>Current</u>	<u>Weight</u>	
			<u>Net</u>	<u>Shipping</u>
BVR 12-30	14.4 Vdc	20.0A	5.9 kg	9.1 kg

All BVR series battery voltage regulators use solid state devices. A MIL STD 723 integrated circuit is used as the heart of each voltage regulator. All boards are conformally coated.

Precision metal film resistors are used in voltage level detection circuits. Reverse polarity protection and the system blocking diodes are incorporated into the unit. All power handling devices are derated to assure long life, even at constant maximum power dissipation levels. Connections to printed circuit boards are made via terminal blocks capable of handling up to #6 or #4 AWG wire, and provide a solid gas-tight seal. Either weather-resistant feedthroughs or strain relieving cable clamps are offered.

### INSTRUMENTATION AND MONITORING

The instrumentation and monitoring package includes:

- System Voltmeter
- Array Ammeter
- Load Ammeter
- Array Amp Hour Meter
- Load Amp Hour Meter
- Battery Circuit Breaker
- Load Circuit Breaker
- Low Voltage Disconnect and Visual Alarm
- Elapsed Time Indicator

The instrumentation is mounted beneath a clear plexiglass protective cover on the side of the SPC-RF103. Table 6 is a list of the components of the monitoring and instrumentation equipment provided by SPC.

In addition SPC manufactures a low voltage alarm signal that monitors the battery terminal voltage. When the terminal voltage measured by this circuit drops below a preset level (nominally 12.0 volts), the low voltage signal will activate the alarm and disconnect. This relay will isolate the refrigerator from the system.

The circuit conforms to MIL specs and includes a conformal coating for the PC board. The circuit is factory set but can be adjusted in the field if necessary.

### Protection and Safety

The protection and safety subsystem was approached with two basic criteria:

- Maximize protection and safety for personnel through proper labeling and marking, and safety design components.
- Maximize protection and safety for plant equipment.

The personnel protection and safety aspects deal with installation and maintenance. Sure-Seal or equivalent connectors are used at the terminal point of each module and its entry into the junction box. These connectors maximize safety to personnel and are extremely reliable. Wire gages for these type connectors range from 14 to 18. The connectors are polarized against mis-mates, are water submersible, rated for temperatures from -40°C to 105°C, UV resistant and last in a variety of corrosive environments. They are field serviceable and by nature suppress arcing. Moreover, contacts are not accessible with human fingers and hands.

TABLE 6  
INSTRUMENTATION AND MONITORING EQUIPMENT

DC Panel Ammeter (0 to 30A)	50-250300NLNL	GE
Current Shunt (50 Amp 50 mV)	HA-50-50 (or 06709)	Empro (Simpson)
Amp-Hour Integrator	C-13	Campbell Scientific
Circuit Breaker	JA1B3A-30-2	Heineman
Voltage Regulator (Temp Comp)	BVR 12-30	SPC
DC Panel Voltmeter (0 to 30V)	50-250320NDND	GE
DC Panel Ammeter (0 to 15A)	50-250300NLNL	GE
Current Shunt (50 Amp/50 mV)	HA-50-50 (or 06709)	Empro (Simpson)
Circuit Breaker	JA1B3A-10-2	Heineman
Elapsed Time Indicator	H-400	General Time
Transient Suppressor (for Timer)	V24ZA4(MOV)	GE

Cam-Lok type connectors are used for the array wiring into the equipment cabinet for the larger wires. These are equally as good as Sure-Seals. Cam-Lok high-amperage safety connectors are used for the connections to the batteries also. A switch is located in the equipment cabinet for master ON/OFF control.

In addition to safety connectors, array sections will be clearly marked in yellow. The safety procedures documentation will include all descriptions of safety equipment and procedures in detail.

Equipment protection is emphasized also. Blocking diodes are used for battery protection against spurious deep discharge and transient suppression for arrays. Diodes are also used to prevent hot spots in modules, a technique discovered during the Mt. Laguna installation for DOD by SPC.

#### THE REFRIGERATOR/FREEZER

The refrigerator/freezer offered with the SPC-RF103 system is manufactured by Adler-Barbour Marine Systems, Inc. The compressor is manufactured by Danfos and has proven to be reliable. The details of the refrigerator are included here as developed by Adler-Barbour. Performance data and calculations, as furnished by Adler-Barbour, are given in Appendix B.

PRODUCT INFORMATION SHEET

SOLAR PHOTOVOLTAIC POWERED REFRIGERATOR/FREEZER FOR MEDICAL  
USE IN REMOTE GEOGRAPHICAL LOCATIONS

SPC-RF103 REFRIGERATOR/FREEZER SPECIFICATIONS

The SPC-RF103 is a chest type unit (top opening) constructed and designed to the following specifications:

- The SPC-RF103 box, the compressor, condensor, fan motor assembly, condensor, battery complement, electronic controls and instrumentation are assembled as an integral unit.
- The SPC-RF103 is packaged to provide maximum personnel safety. All rotating and moving components (condensor fan) are shrouded for personnel safety and additionally located in enclosed compartments. Batteries are contained within their own compartment and are isolated from all running and electronic components. Battery, electronic and mechanical (refrigeration) compartments are fully accessible for ease of servicing, maintenance and component replacement (if necessary). All compartments are fully ventilated.
- The compressor motor is a 12 volt DC brushless motor with electronic commutation. This completely eliminates the brushes and commutator ring assembly and makes possible its truly hermetic compressor design. Operating range is 10.5 - 15 volts DC. The compressor system is extremely reliable and is in current production by our company (in excess of 3000 units) as a marine refrigeration system since 3/80. It has very low energy consumption and can withstand continuous tilting at 30 degrees in any plane. The compressor also has solid state battery protection, solid state and redundant fused protection against overload and solid state protection in the event of start failure.

- The dimensions of the SPC-RF103 are as follows:

Height of assembly	43"	109.30 CM
Length of assembly	43"	109.30 CM
Width of assembly	27"	68.63 CM
Weight of assembly	210 LBS.	95.20 KG less batteries
- Gross Volume		103.24 Litres
- Net usable volume		93.77 Litres
- Gross freezer volume		34.41 Litres
- Net usable freezer volume		25.47 Litres
- Gross refrigerator volume		68.82 Litres
- Net usable refrigerator volume		68.30 Litres
- Shipping volume/weight/# of packages:		
	28.9 CU. Ft./260 Lbs./ 1 (less batteries)	
	.81 CU. M./117.9 KG/1 (less batteries)	



PRODUCT INFORMATION SHEET - Cont'd

- Outer liner of the SPC-RF103 box is of epoxy coated aluminum. Box inner liner is constructed of a specially formed aluminum one piece extrusion. Both inner and outer liners are durable, easily cleaned and resistant to deterioration from exposure to foods, vaccines and most chemicals. The inner and outer liners are sealed together utilizing a special reflecting aluminized mylar film vapor barrier (located between the polyurethane foam insulation and the inner and outer liners) to minimize moisture penetration due to atmospheric and/or temperature-induced vapor pressure differences between the environment and the insulation cavity.
- The material used for insulation is polyurethane (2.0 pound density closed-cell). 15.24 CM (6.0") of insulation is provided in all dimensions to assure adequate cold retention, minimize compressor energy requirements, and, provide the greatest overall system economic benefit.
- The SPC-RF103 has a single outer lid which is hinged, self-closing and lockable. Outer and inner lid gaskets with receiving interfacing gasket form a triple sealing arrangement capable of withstanding normal medical use and providing the necessary sealing to minimize heat leaks.
- The SPC-RF103 has separate plexiglass interior lids for the freezer and refrigerator compartments. The interior lids are hinged and designed to reduce heat transfer between the compartments and the outer lid.
- The SPC-RF103 utilizes a finned copper condensor (as opposed to steel) for greater efficiency and thermal heat rejection. All fasteners are non-corrosive (either stainless steel, aluminum or brass) and all finishes are primed baked enamel. System compressor, electronics and condensor fan motor are all designed and built to ignition protection standards. Compressor system is fused with a Buss GLN-10 fuse (with spare attached to compressor wire harness).
- The SPC-RF103 utilizes a filtered cleanable aluminum condensor air-intake for continued efficient operation in sandy or dusty environments. Each unit is equipped with a spare replacement filter.
- The SPC-RF103 battery complement is of the lead calcium externally connected single cell type designed specifically for the PV systems and are housed in a vented and lockable portion of the equipment enclosure (compartmentized and isolated from electronic and mechanical components).
- The SPC-RF103 utilizes a rollbonded aluminum, primary surface type, capillary fed evaporator (freezing unit). Aluminum evaporator is coated with an F.D.A. approved baked powdered epoxy finish.

PRODUCT INFORMATION SHEET - Cont'd

- The SPC-RF103 is equipped with the following instrumentation:
  - Load ammeter
  - Lead amp-hour meter (counting integrator)
  - Compressor motor run-time meter
  - Controlling thermostat with temperature indicator
- The SPC-RF103 is designed to maintain the following temperatures at a design ambient operational temperature of 43 degrees Centigrade (110 degrees Fahrenheit):
  - Freezer compartment range:  $-25^{\circ}$  to  $-15^{\circ}\text{C}$  ( $-13^{\circ}$  to  $5^{\circ}\text{F}$ )
  - Refrigerator compartment range:  $+4^{\circ}$  to  $+8^{\circ}\text{C}$  ( $39^{\circ}$  to  $47^{\circ}\text{F}$ )

Each compartment is controlled by its own adjustable thermostatic control.

DATE	BY	REVISION

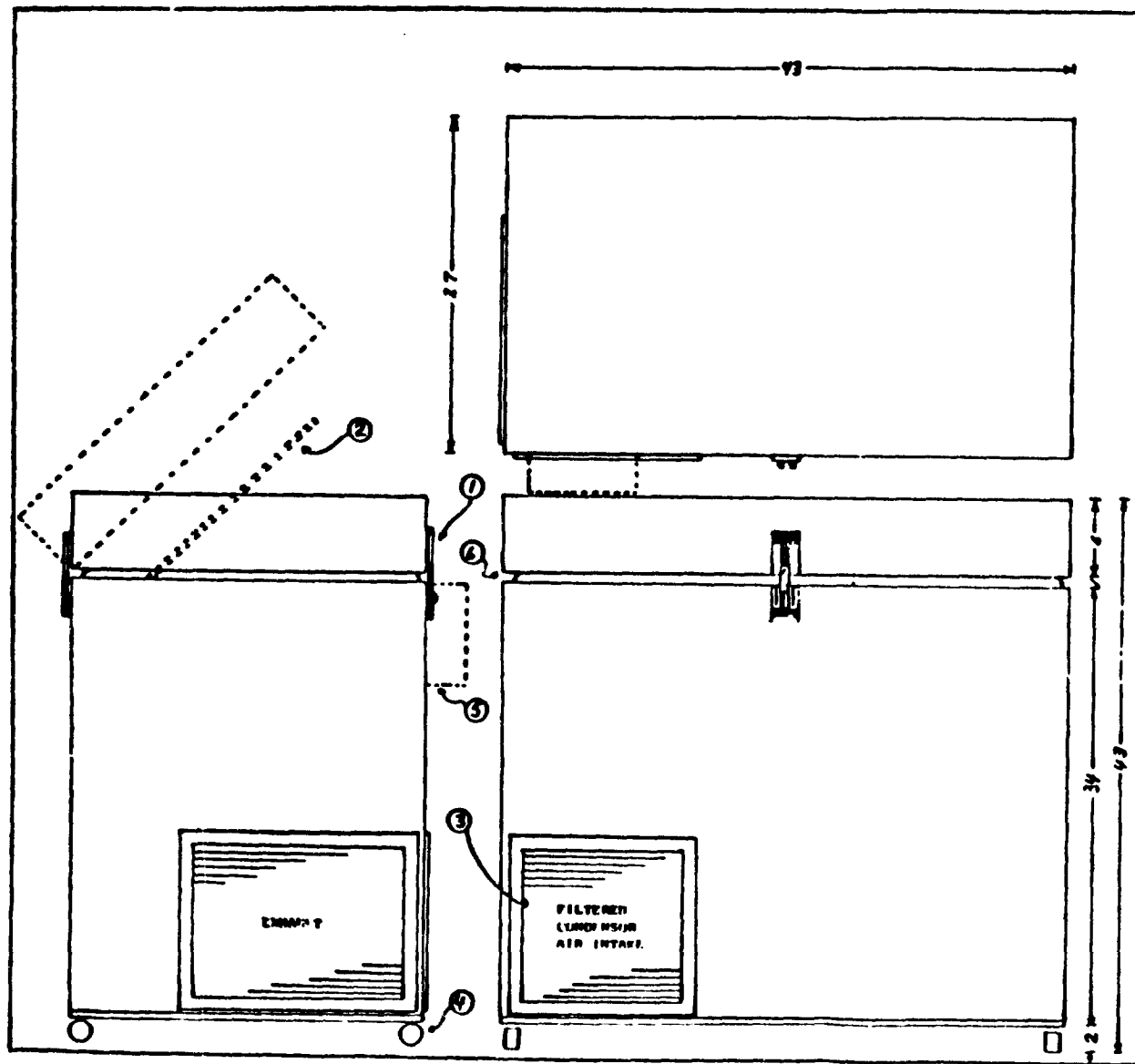

ORIGINAL PAGE IS  
OF POOR QUALITY

NOTES:

- 1 SELF CLOSING & LOCKABLE LATCH
- 2 DENTS LIFT UP INNER DOOR
- 3 CLEANABLE SLIDE-IN AIR FILTER
- 4 CASTORS
- 5 INTIMIDATION
- 6 FLEXIBLE SEAL GASKET

TOLERANCES UNLESS OTHERWISE SPECIFIED	ADLER-PARSONS MARINE SYSTEMS INC.		
DECIMAL	NONE FOR:	SCALE 1/8"=1"	DRAWN BY ON
FRACTIONAL	TITLE		
ANGULAR	DATE 6/80	DRAWING NUMBER REP-14287 REVISION A	
1			APPROVED BY

FIGURE 10

FRONT, TOP AND SIDE OF REFRIGERATOR/FREEZER

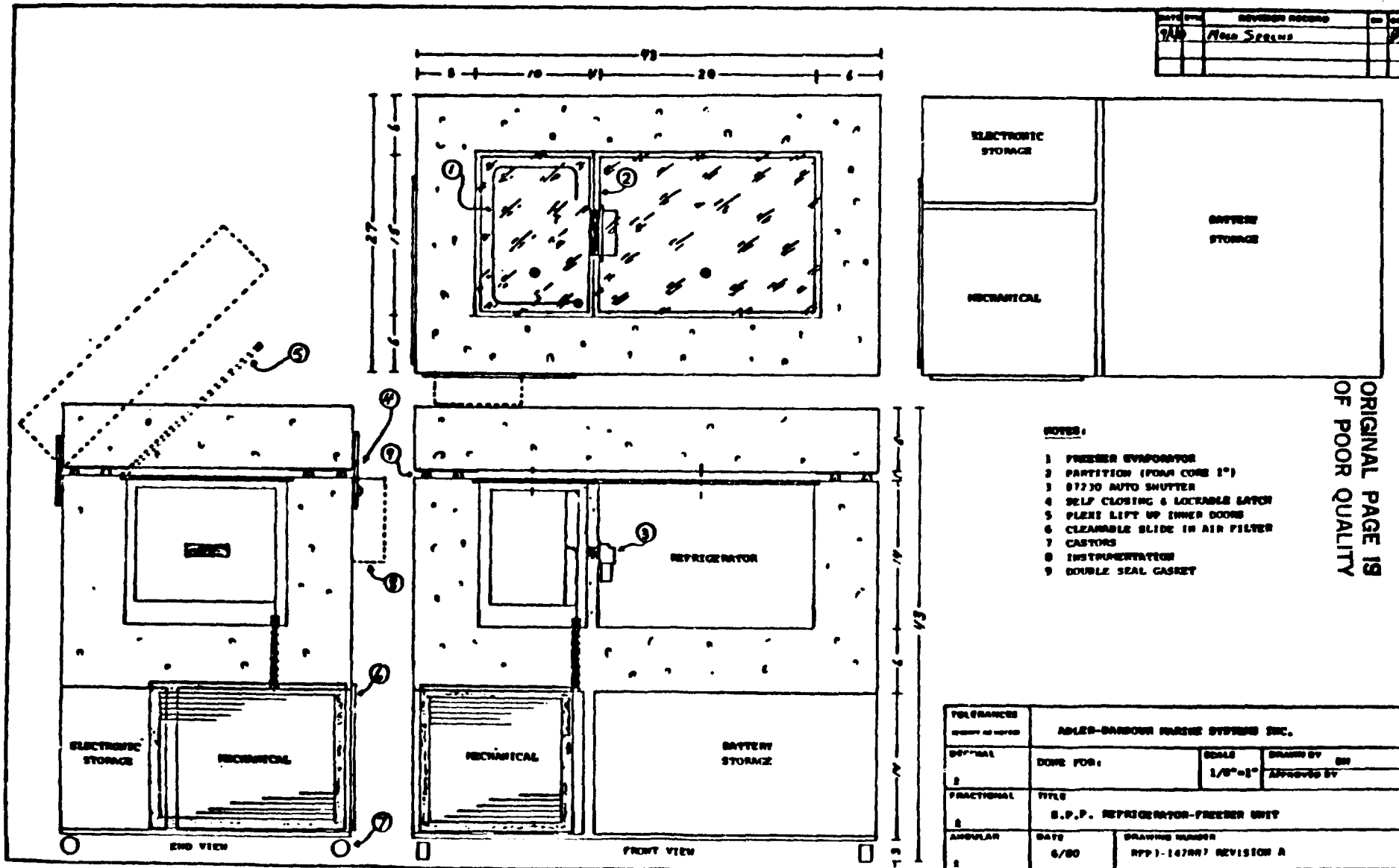

ORIGINAL PAGE 19  
OF POOR QUALITY

FIGURE 11  
CUTAWAY VIEWS OF REFRIGERATOR/FREEZER

ORIGINAL PAGE 19  
OF POOR QUALITY.

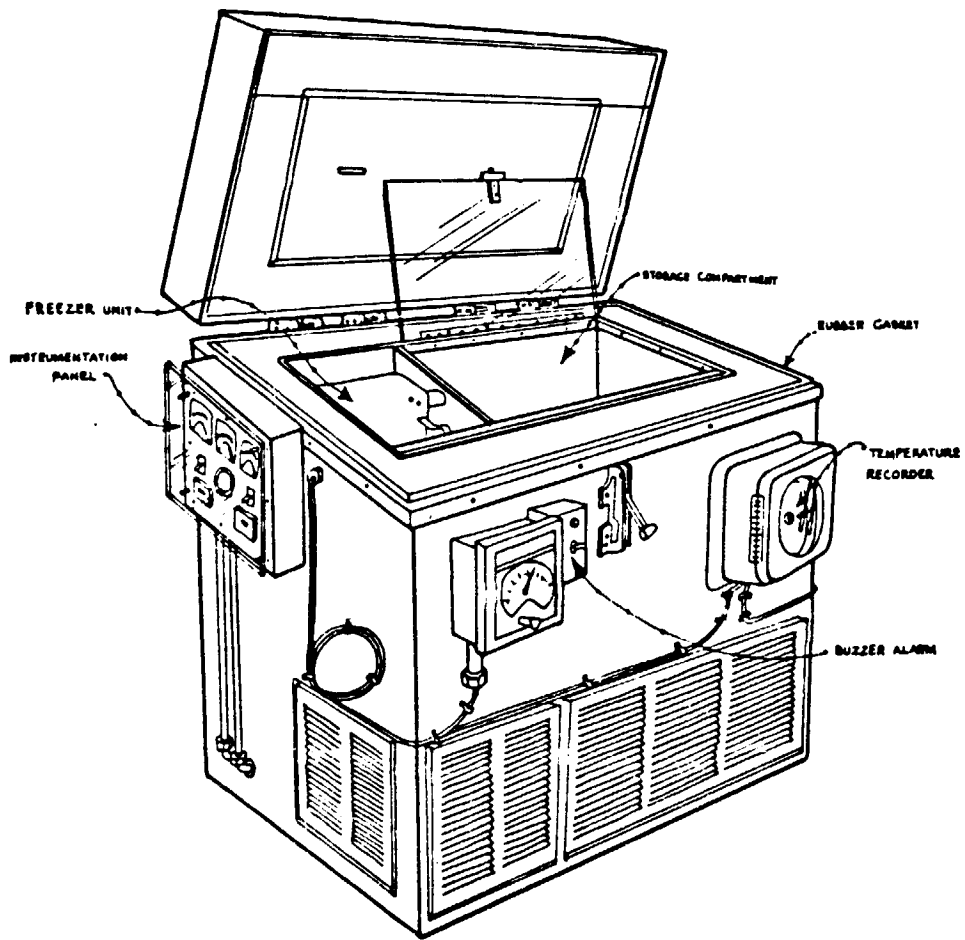
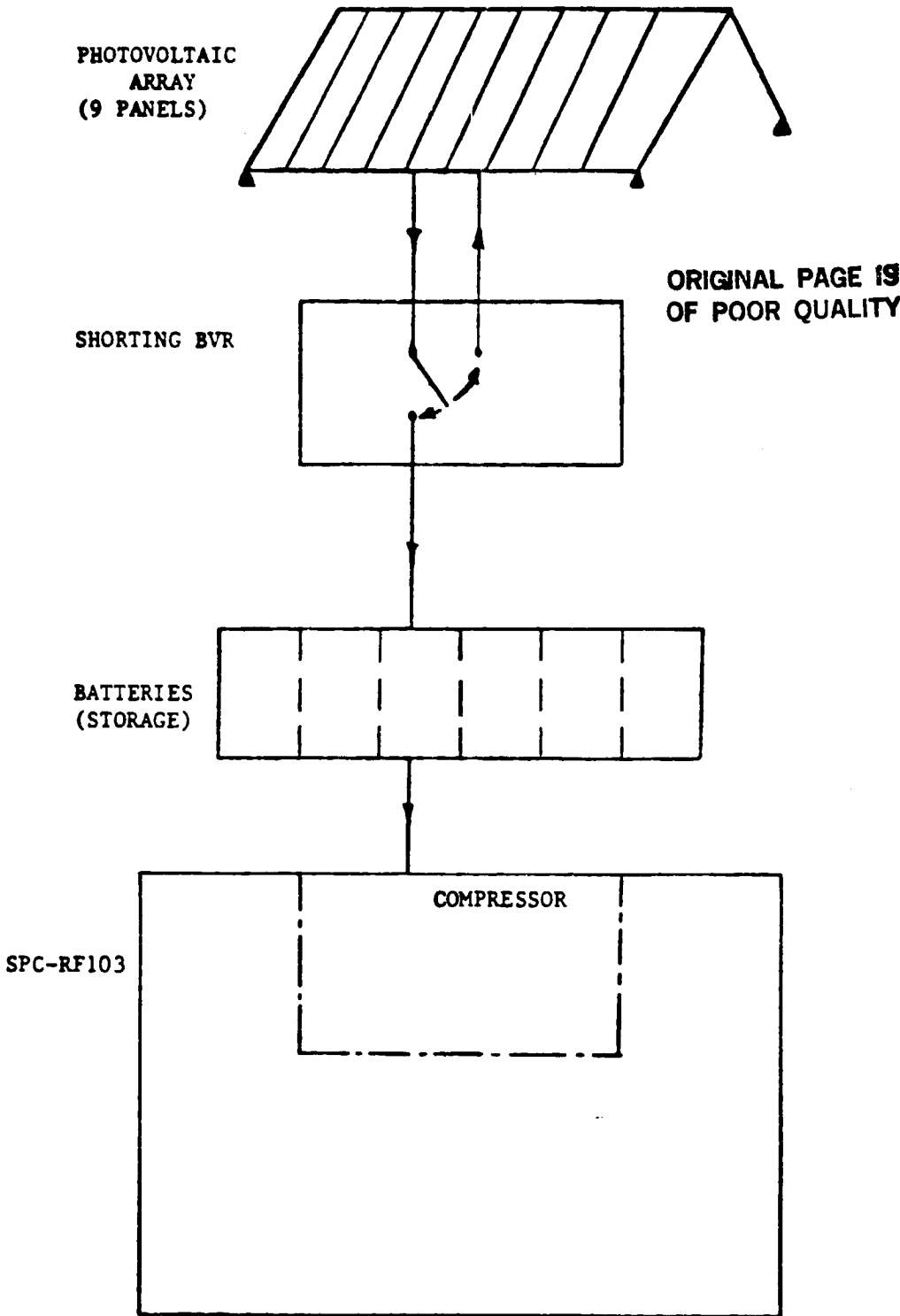

FIGURE 12



<b>Solar Power Corporation</b>		APPROVED BY:		DRAWING NUMBER: <b>A-1MW-110</b>
		SCALE: <b>NONE</b>	DATE: <b>12/81</b>	
		DRAWN BY: <b>1'MW</b>		
		<b>SPC-RF103 SCHEMATIC</b>		

**FIGURE 13**  
**SYSTEM SCHEMATIC**

**SPC - RF103**

## TEST PROGRAM

The SPC-RF1 photovoltaic powered medical refrigerator/freezer was subjected to a two-phase test program of its thermal performance. These phases, Qualification and Acceptance, consisted of the following tests:

1. Qualification Test Phase
  - a. No Load Pulldown Test
  - b. Coldpack Freezing Test
  - c. Steady State Test
  
2. Acceptance Test Phase
  - a. No Load Pulldown Test
  - b. Steady State Test
  - c. Hold-over Time Test (Temperature Rise)

The test procedures used were based on "Modified WHO Standard Testing Procedure for Refrigerators and Freezers for Use in the Cold Chain", Sections 7 and 8 from ANSI/AHAM HRF-1-1979, "Household Refrigerators, Combination Refrigerator-Freezers, and Household Freezers", and Sections 2.2 and 5.0 (in its entirety) from the "Statement of Work".

All of the above tests were performed on the SPC-RF103 by the Electrical Testing Laboratory (ETL) in Cortland, New York. ETL is a recognized independent testing laboratory.

All tests were monitored in their entirety by staff from Solar Power Corporation, ETL, NASA/Lewis Research Center, and Adler-Barbour Marine Systems, Inc.

Figure 12 shows the refrigerator/freezer unit with Solar Power Corporation's instrumentation and monitoring package. Figure 13 is a schematic of the complete SPC-RF103 system.

The qualification and acceptance phase test procedures and results are described in detail in the following sections.

### 1. QUALIFICATION TESTS

The SPC-RF103 refrigerator/freezer (R/F) was positioned in an environmental test chamber capable of controlling sensible heat at  $43^{\circ}\text{C} \pm 2^{\circ}\text{C}$  and relative humidity at 45 to 50%. Instrumentation used during the tests for monitoring system performance is described in Table 7. Power to the systems' 12 volt (nominal) mechanical refrigeration system was supplied by a 90 ampere hour automotive type battery and an unregulated commercial grade 10 amp battery charger. The system, as tested during this qualification phase, did not include the photovoltaic array.

Instrumentation was set up as follows:

- Fluke - set for readouts at five (5) minute intervals (events) on thirteen channels. Unweighted thermocouples were placed in and around the R/F unit as shown in Figure 14. Thermocouples placed within the R/F unit were supported in such a manner that there was at least 1.5 cm (1/2 inch) of air space separating the thermocouples from any surface.
- Recording Voltmeter - wired to the supply battery to continuously record the system's supply voltage.
- Recording Ammeter - wired to the positive leg of the mechanical refrigeration system's wiring by use of a "shunt" to continuously record the system's operating current.
- Counting Integrator - also wired to the positive leg of the mechanical refrigeration system's wiring by use of a "shunt" to record cumulative ampere hours during operation.

#### 1.A No Load Pulldown Test

The purpose of this test is to establish that the cabinet temperature will be reduced from ambient to required storage temperature, determine the rate at which this change takes place and to observe the lowest steady state temperatures attained in the storage compartments. This test is based primarily on Section 7.5 of Appendix D, "7.5.1 Purpose".

The R/F unit was allowed to thermally stabilize (soak) within the environmental chamber at 43°C (110°F) for 8 hours prior to the beginning of the test. Upon completion of the soak period the inner and outer lids were closed and the mechanical refrigeration system was activated. The system was operated continuously until the freezer compartment temperature, as indicated by thermocouple number six (6), fell below -15°C and the refrigerator compartment temperature, as indicated by thermocouple number five (5), fell below 5°C.

Samples of the data are presented from Fluke and Counter Integrator readings at the following three time intervals:

1. Start of test (after 8 hour soak period).
2. Freezer temperature compliance ( $T_6 = -15^\circ\text{C}$ )
3. Refrigerator temperature compliance ( $T_5 = 5^\circ\text{C}$ )



TABLE 7  
INSTRUMENTATION USED TO MONITOR SYSTEM PERFORMANCE\*

INSTRUMENT	OUTPUT
Fluke Digital Recorder	13 channel input for 13 thermocouples, output in °C every 5 minutes with day of year, hours, minutes, seconds (day: hr: min: sec).
Strip Chart Voltmeter	Continuous recording of supply voltage.
Strip Chart Ammeter	Continuous recording of refrigeration system operating amperage.
Counting Integrators for Load and Array	Display of accumulated ampere hours (to 0.1 A-hr).
Counting Hour Meter	Display of accumulated hours (hr: min: sec)

\*A refrigerant pressure gauge manifold assembly was utilized at various times during the testing to monitor operating refrigerant pressures.

ORIGINAL PAGE IS  
OF POOR QUALITY

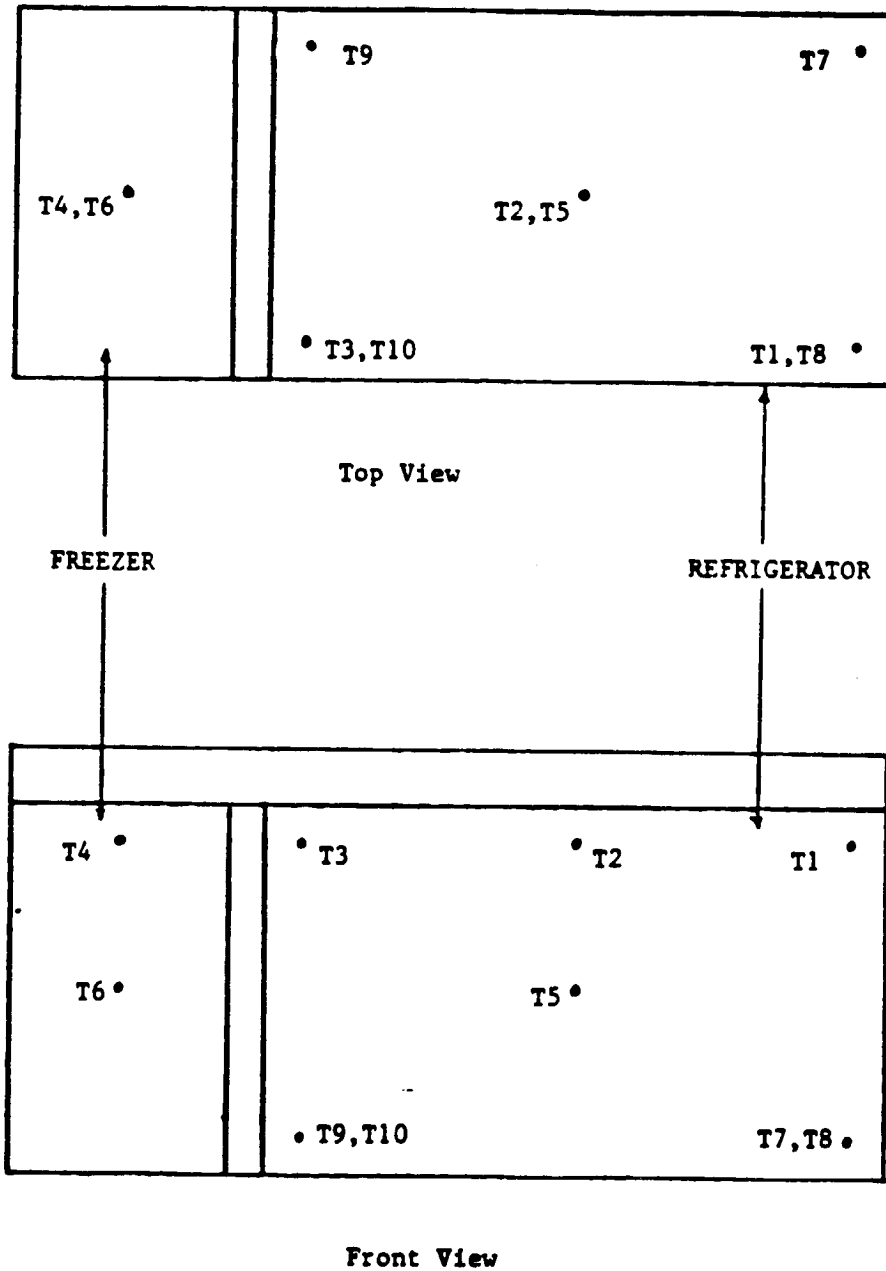

FIGURE 14

LOCATION OF THERMOCOUPLES IN REFRIGERATOR AND FREEZER

TIME: 118:12:30:01 (START OF TEST)

<u>LOCATION</u>	<u>TEMPERATURE (°C)</u>	<u>LOCATION</u>	<u>TEMPERATURE (°C)</u>
1	43.0	8	43.1
2	43.0	9	43.2
3	42.9	10	42.9
4	42.6	11	42.9
5	43.0	12	42.9
6	42.6	13	43.0
7	43.0		

COUNTING INTEGRATOR	000.0	AMPERE HOURS
TOTAL ELAPSED TIME	00:00:00	HR:MIN:SEC

TIME: 118:16:30:01 (FREEZER TEMPERATURE COMPLIANCE)

<u>LOCATION</u>	<u>TEMPERATURE (°C)</u>	<u>LOCATION</u>	<u>TEMPERATURE (°C)</u>
1	18.0	8	13.4
2	17.6	9	12.4
3	17.2	10	12.7
4	- 5.5	11	42.9
5	15.5	12	43.0
6	-15.4	13	46.4
7	13.1		

COUNTING INTEGRATOR	NOT RECORDED	
TOTAL ELAPSED TIME	04:00:00	HR:MIN:SEC

TIME: 118:20:30:01 (REFRIGERATOR TEMPERATURE COMPLIANCE - END OF TEST)

<u>LOCATION</u>	<u>TEMPERATURE (°C)</u>	<u>LOCATION</u>	<u>TEMPERATURE (°C)</u>
1	6.8	8	4.0
2	6.4	9	2.9
3	6.0	10	2.9
4	-13.8	11	42.8
5	4.8	12	42.7
6	-20.7	13	45.9
7	3.8		

COUNTING INTEGRATOR	42.8	AMPERE HOURS
TOTAL ELAPSED TIME	7:40:00	HR:MIN:SEC

The results of this and all other tests are presented in the Test Results Section of this report.

Figure 15 represents results obtained from the current, voltage and temperatures ( $T_5$  and  $T_6$ ) vs. time for the period of the test.

1.B Coldpack Freezing Test

A total of two (2) kilograms of distilled water were poured into 6 identical containers, (about 350 ml in each), three of which were instrumented with thermocouples as shown in Figure 16. The containers were Thermos Brand "Icepacks" Model No. 3500/8706, manufactured by the Thermos Division of King Seeley Thermos Company. The internal capacity of the Icepack is 0.5 liters.

The icepacks were allowed to "soak" in the environmental chamber until they stabilized at 43°C and then they were inserted into the freezer compartment of the R/F unit as shown in Figure 17. The test was terminated when the icepacks were frozen as indicated by subcooling after the latent change of state of the water occurred at 0°C, a temperature below 0°C indicates subcooling at atmospheric temperature. Thermocouples number fourteen (14), fifteen (15) and sixteen (16) were inserted in the icepack solutions, and connected to channels 14, 15 and 16 of the Fluke.

The time reading of 118:23:00:00 (data below) is the start of this test, represented by insertion of the icepacks into the freezer compartment and the closing of the inner and outer lids.

TIME: 118:23:00:00 (START OF COLDPACK FREEZING TEST)

<u>LOCATION</u>	<u>TEMPERATURE (°C)</u>	<u>LOCATION</u>	<u>TEMPERATURE (°C)</u>
1	5.0	9	2.0
2	4.6	10	1.9
3	4.2	11	42.9
4	17.9	12	42.8
5	3.7	13	46.3
6	- 0.1	14	48.1
7	3.0	15	47.5
8	3.2	16	49.0

COUNTING INTEGRATOR  
TOTAL ELAPSED TIME

55.6 AMPERE HOURS  
00:00:00 HR:MIN:SEC

The reading of 119:00:50:00 shows that thermocouples fourteen (14), fifteen (15) and sixteen (16) indicate subcooled solution and the termination of this test:

FIGURE 15

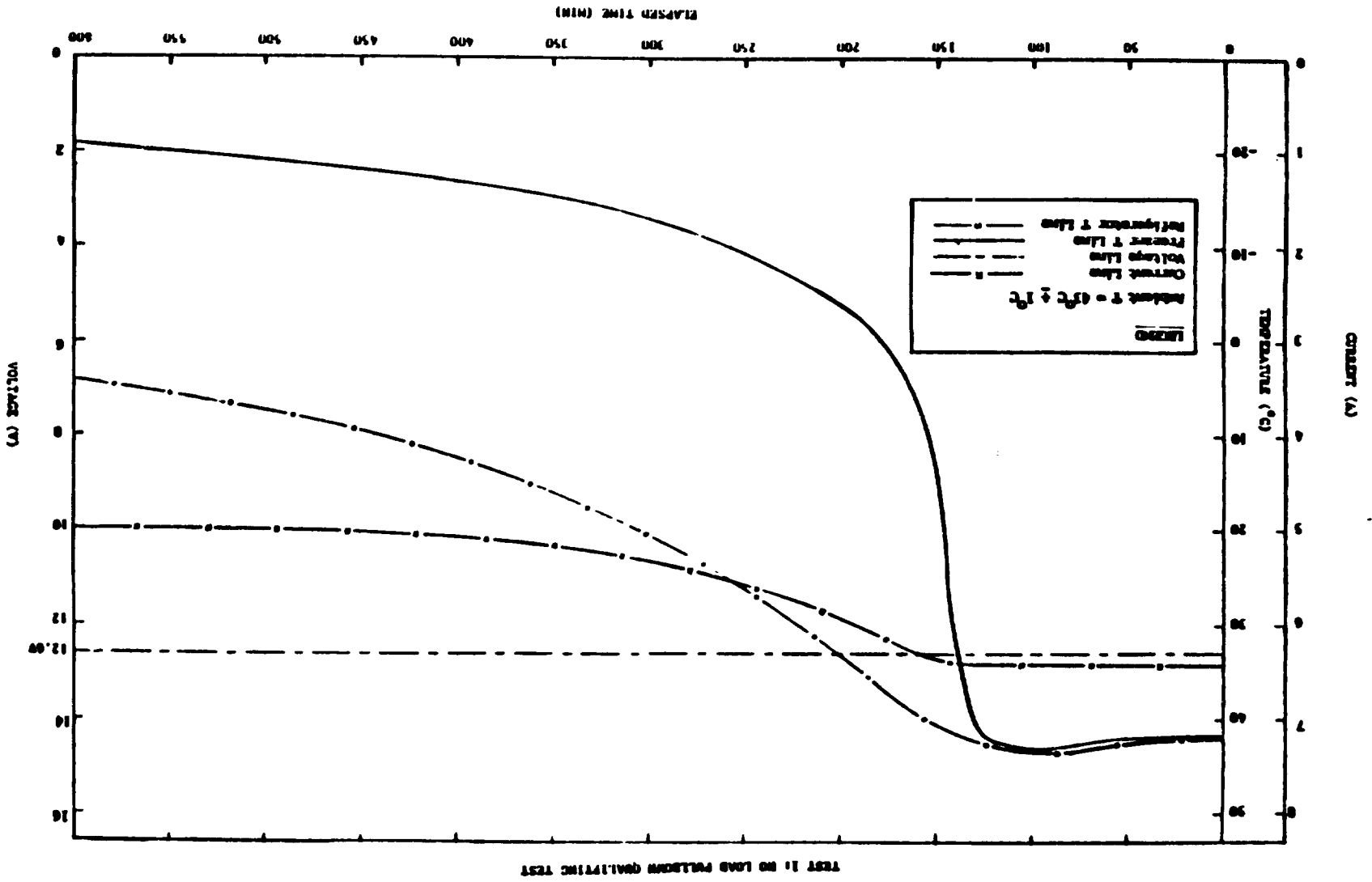

QUALITY CONTROL

ORIGINAL PAGE IS  
OF POOR QUALITY

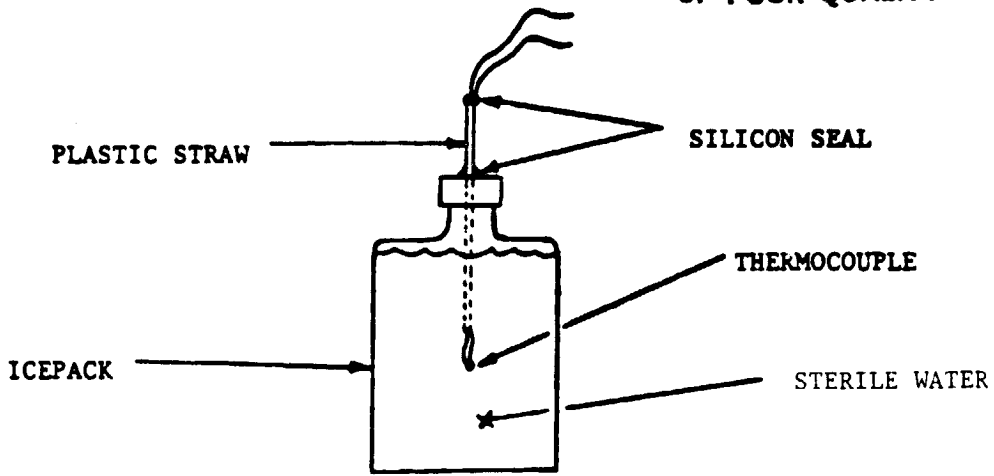

FIGURE 16

THERMOCOUPLE PLACEMENT IN ICEPACK

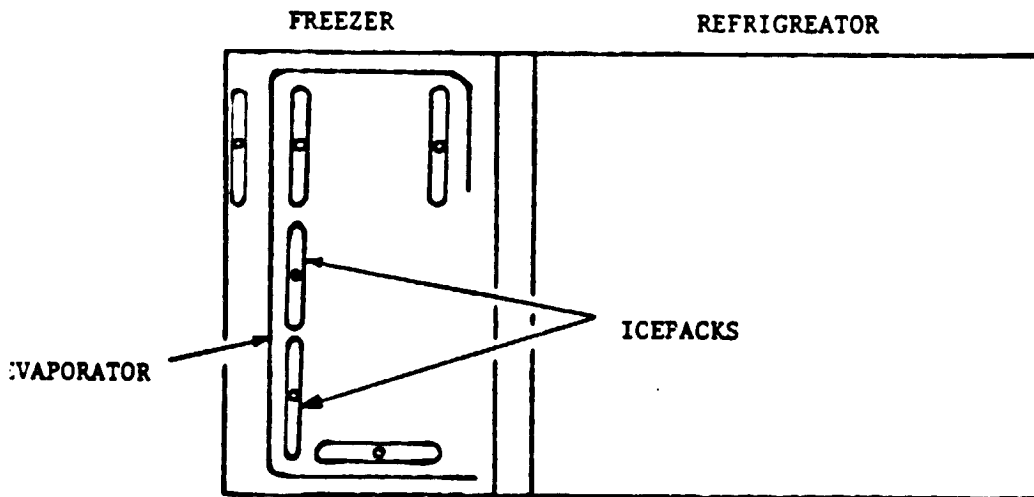

FIGURE 17

LOCATION OF ICEPACK BOTTLES IN FREEZER

ORIGINAL PAGE 19  
OF POOR QUALITY

TIME: 119:00:50:00 (END OF TEST)

<u>LOCATION</u>	<u>TEMPERATURE (°C)</u>	<u>LOCATION</u>	<u>TEMPERATURE (°C)</u>
1	10.1	9	8.6
2	9.6	10	8.1
3	9.6	11	42.9
4	.2	12	43.1
5	9.5	13	47.7
6	- 7.2	14	- .2
7	8.8	15	- 1.6
8	8.7	16	- 2.4

COUNTING INTEGRATOR  
TOTAL ELAPSED TIME

66.9 AMPERE HOURS  
1:50:00 HR:MIN:SEC

The next reading at 119:01:00:00 indicates additional subcooling at thermocouples fourteen (14), fifteen (15) and sixteen (16):

TIME: 119:01:00:00

<u>LOCATION</u>	<u>TEMPERATURE (°C)</u>	<u>LOCATION</u>	<u>TEMPERATURE (°C)</u>
1	10.2	9	8.5
2	9.7	10	8.0
3	9.6	11	42.7
4	- 0.5	12	42.9
5	9.3	13	47.7
6	- 7.8	14	.4
7	8.8	15	- 3.2
8	8.5	16	- 4.3

COUNTING INTEGRATOR  
TOTAL ELAPSED TIME

67.8 AMPERE HOURS  
2:00:00 HR:MIN:SEC

The system was left operating overnight with the following temperatures recorded:

TIME: 119:08:45:00

<u>LOCATION</u>	<u>TEMPERATURE (°C)</u>	<u>LOCATION</u>	<u>TEMPERATURE (°C)</u>
1	6.5	9	3.0
2	6.0	10	2.9
3	5.7	11	43.2
4	-10.6	12	43.4
5	4.8	13	46.3
6	-17.6	14	-22.7
7	3.6	15	-22.3
8	4.0	16	-22.9

Figure 18 represents results obtained for the current, voltage and temperatures (thermocouples 5 and 6) vs. time for the period of the test.

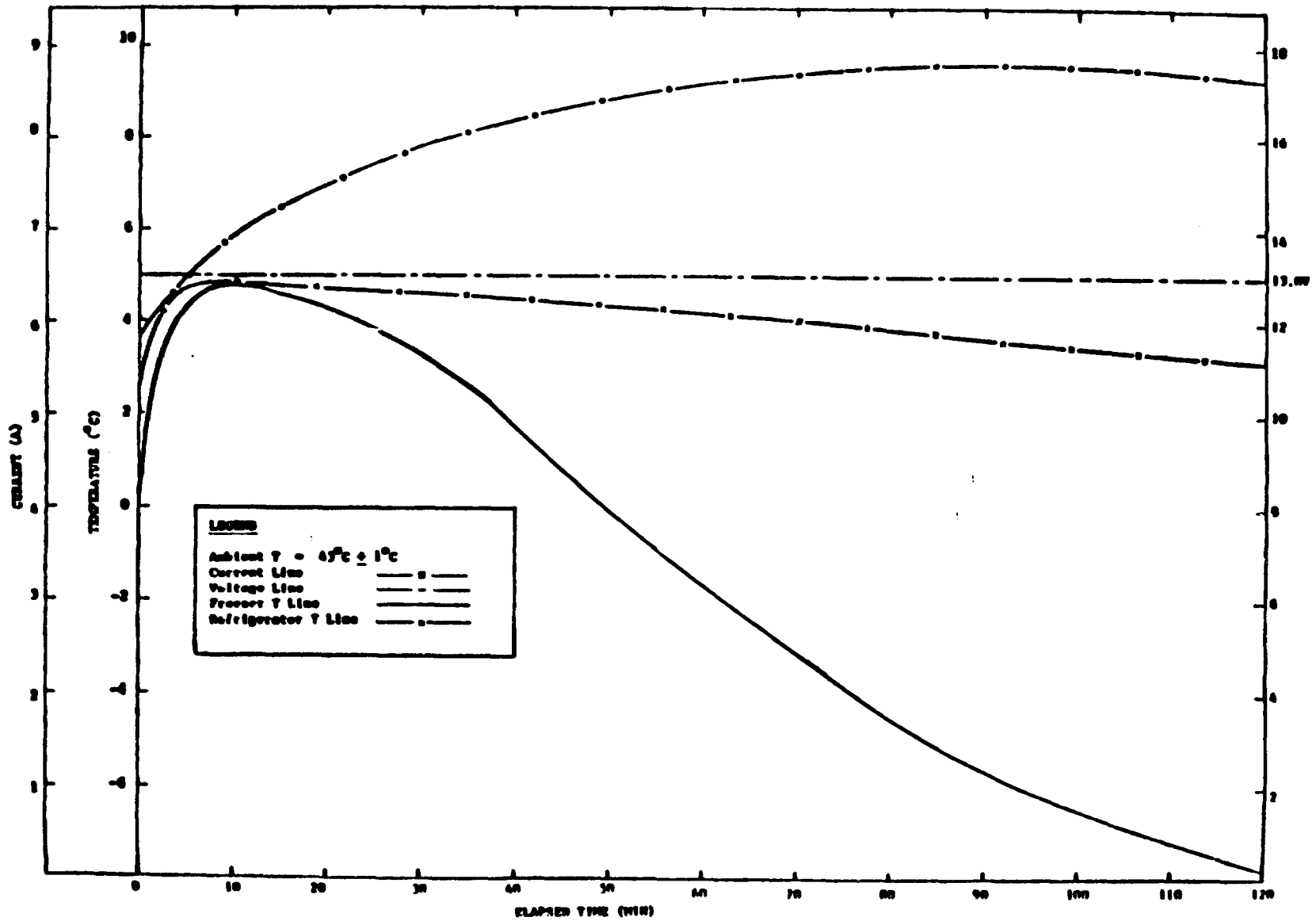

FIGURE 18



### 1.C Steady State Test

This test is based primarily on Sections G2.3 and G6.1 of Appendix A of the Modified WHO Standard Test Procedure. The test determines the ability of the RF system to maintain internal set temperatures under high temperature environmental conditions (43°C) while continuing to operate with low duty cycles at steady state.

The refrigerator compartment of the RF unit was loaded with three cases (each case containing 100 30 ml bottles) of sterile water simulating packaged liquid vaccines. Thermocouples were inserted in the corner vaccine bottle in the top and bottom cases and in the center bottle in the middle case as illustrated in Figure 19. The freezer compartment was left empty. Care was taken to ensure free air circulation inside the refrigerator. There were no air gaps between the cases of vaccine. A gap of at least fifteen millimeters was allowed between the vaccine packages and all internal walls.

Thermal stabilization is achieved when ON/OFF cycling of the refrigerator system as controlled by the thermostat maintains internal temperature of the refrigerator compartment within the range of 4°C to 8°C at each thermocouple point. The refrigerator/freezer, loaded with the simulated vaccine, was operated for a period of over 30 hours after stabilization was achieved. The Control Thermostat of the RF unit was set at -15°C. The Control Thermostat is permanently mounted on the front face of the RF unit. The adjustable thermally activated damper between the freezer and refrigerator compartments was set to maintain the refrigerator compartment temperature at 6°C.

Figure 20 represents the current, voltage, and refrigerator and freezer compartments temperatures as a function of time. Figure 21, an expanded section (A-A) of Figure 20, shows in detail the ON/OFF cycle under steady state conditions.

It should be noted that although the voltage line is drawn as a straight line at 13.0 volts, there were brief periods where, due to the unregulated power supply being utilized, the voltage did rise as high as 15.0 volts. This condition seemed mostly to occur on the off cycle of the RF system operation.

## 2. ACCEPTANCE TEST PROCEDURES

- Test 1 - No Load Pulldown
- Test 2 - Steady State
- Test 3 - Holdover Time

TOP VIEW

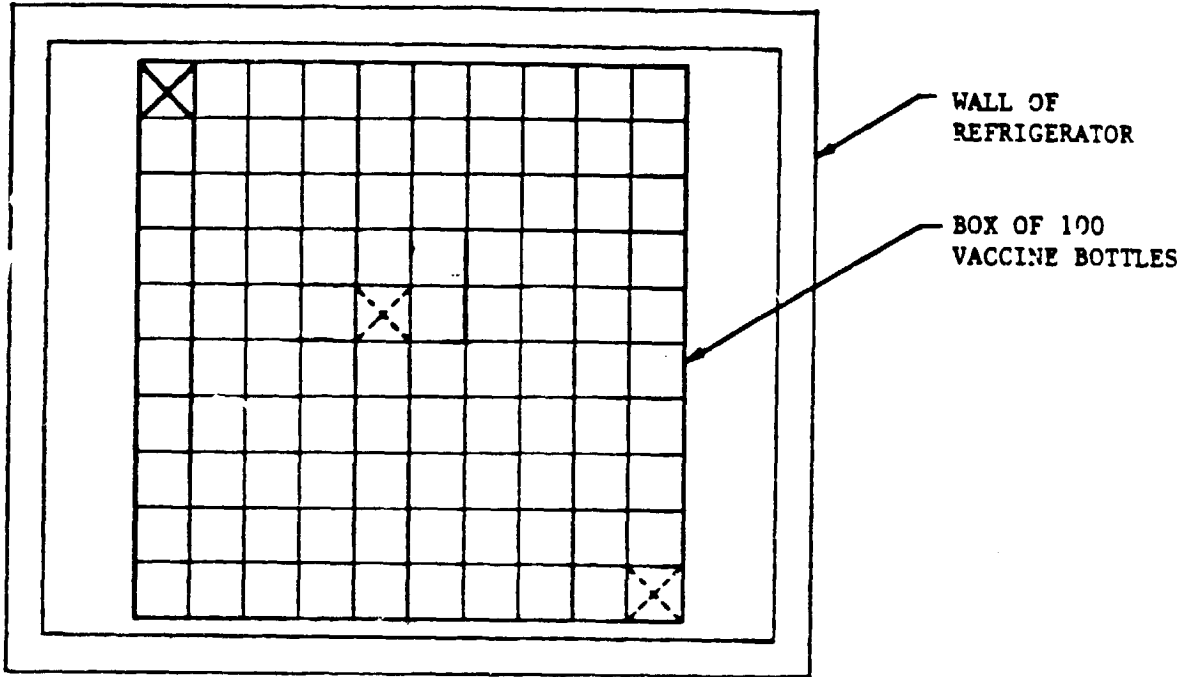

FRONT VIEW

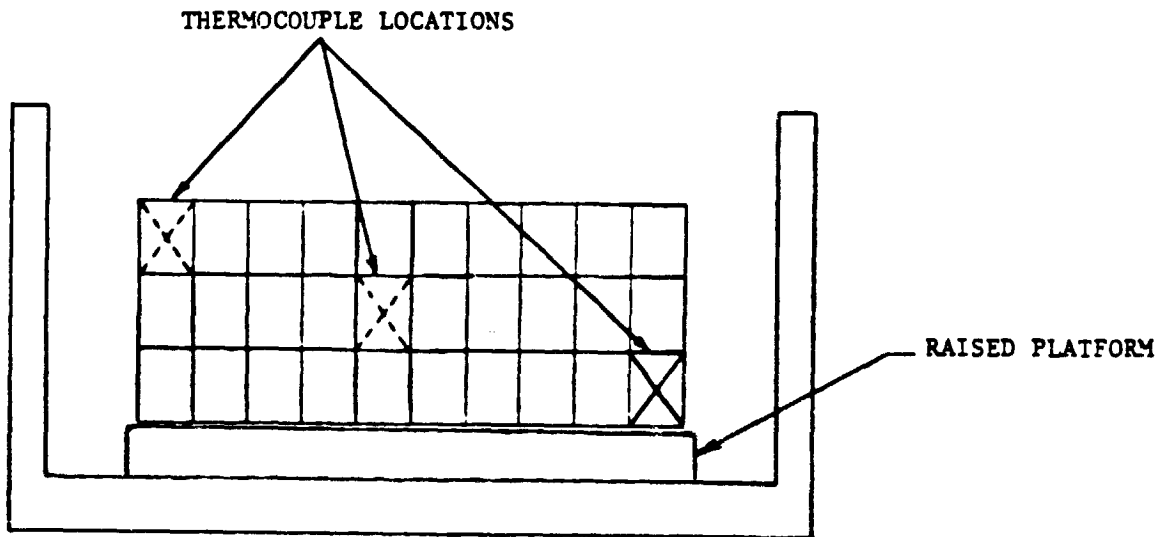

FIGURE 19

THERMOCOUPLE LOCATIONS IN CASES OF VACCINE

TEST 3: STEADY STATE QUALIFYING TEST

FIG. 20. STEADY STATE QUALIFYING TEST

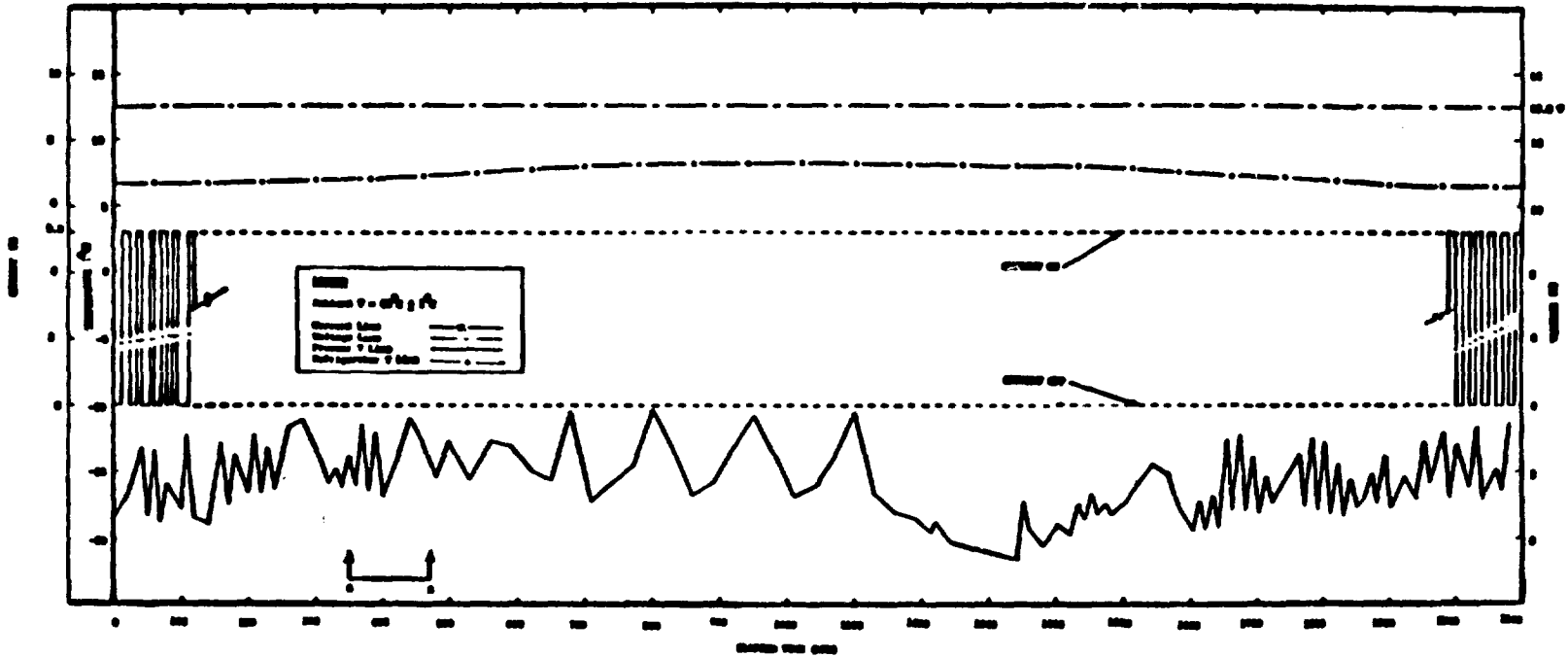

FIGURE 20

TEST 3: STEADY STATE QUALIFYING TEST  
TIME INTERVAL A-A

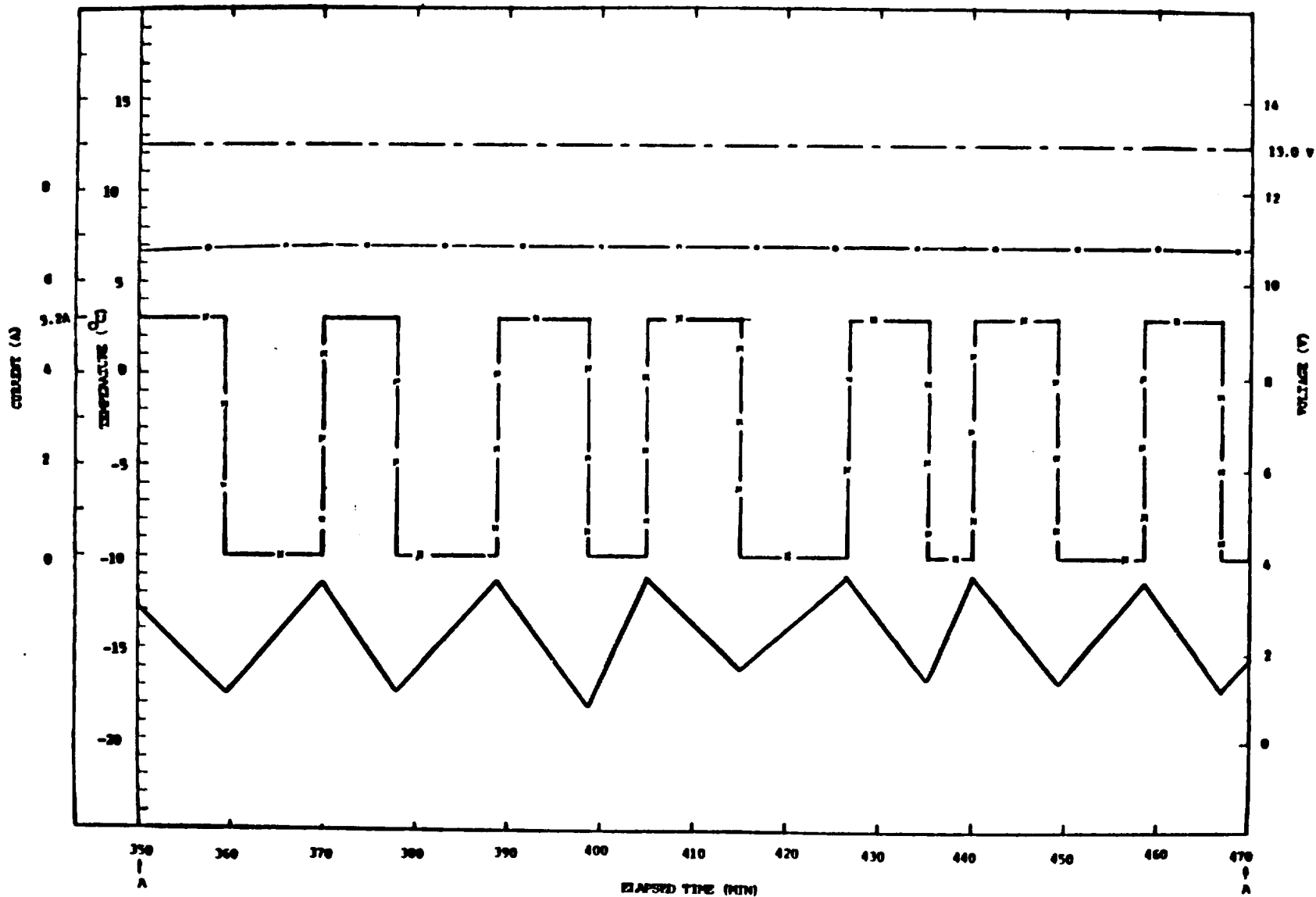

FIGURE 21

ORIGINAL PAGE IS  
OF POOR QUALITY

Positioning of the RF unit and instrumentation was as in Qualification Tests. In addition, a strip chart voltmeter supplied a continuous recording of the array output voltage and a strip chart ammeter supplied a continuous recording of the array output current. Power to the refrigeration system was supplied by a solar photovoltaic array consisting of nine SPC G12-361 panels connected in parallel. A set of six (12 volt) batteries connected in parallel was used to provide storage capacity for the system. An SPC power conditioner, and control unit was incorporated in the RF system to prevent battery overcharging.

2.A No Load Pulldown

This test was based on Section 7.5 of the WHO test procedure as was the NO LOAD PULLDOWN Test as described in the Qualifying Tests Section.

The RF unit was allowed to "soak" in the environmental chamber for a period of 4 hours, empty, with the inner lids closed and the outer lid open, at 43°C (110°F). Upon completion of the "soak" period, the freezer-to-refrigerator damper was adjusted to its maximum opening, the outer lid was closed and the refrigeration system activated.

This test was considered to be completed when a temperature of 6°C or less in the refrigerator compartment was observed, as measured by thermocouple number five (5).

The following data were obtained at the beginning and end of the test, respectively:

TIME: 173:13:15:00 (START TEST)

<u>LOCATION</u>	<u>TEMPERATURE (°C)</u>	<u>LOCATION</u>	<u>TEMPERATURE (°C)</u>
1	43.2	9	43.2
2	43.5	10	42.9
3	43.3	11	43.6
4	43.4	12	43.5
5	43.5	13	44.1
6	43.3	14	43.1
7	42.9	15	43.7
8	43.0	16	43.3
ARRAY A-hr INTEGRATOR	0.0	AMPERE HOURS	
REFRIGERATION SYSTEM A-hr	0.0	AMPERE HOURS	

TIME: 173:13:15:00 (END OF TEST)

<u>LOCATION</u>	<u>TEMPERATURE (°C)</u>	<u>LOCATION</u>	<u>TEMPERATURE (°C)</u>
1	8.0	9	3.2
2	8.2	10	4.7
3	6.8	11	42.9
4	- 6.6	12	42.9
5	5.8	13	44.6
6	14.2	14	8.0
7	5.6	15	43.0
8	5.2	16	6.6

ARRAY A-hr INTEGRATOR	51.2 A-hr
REFRIGERATION SYSTEM A-hr	56.9 A-hr
TOTAL ELAPSED TIME	10 HOURS, 55 MINUTES

A graph of the test data is presented in Figure 22.

### 2.B Steady State Test

The steady state acceptance test was performed under the same conditions as the steady state qualifying test with the exception of the refrigeration system power supply, which in this case was a photovoltaic array and a battery.

The total time of the test, after the soak period of four hours, was 72 hours. During the test the refrigerator and freezer compartments maintained average temperatures of 6°C and -15°C respectively.

The following 2 sets of data were recorded at the midpoint and end of the test:

TIME: 176:00:00:00 (TEST MIDPOINT)

<u>LOCATION</u>	<u>TEMPERATURE (°C)</u>	<u>LOCATION</u>	<u>TEMPERATURE (°C)</u>
1	7.4	9	4.7
2	7.2	10	4.8
3	6.1	11	43.1
4	-10.0	12	43.2
5	5.9	13	44.4
6	-14.1	14	7.5
7	6.2	15	43.3
8	5.9	16	5.7

TEST 1: NO LOAD PULLDOWN ACCEPTANCE TEST

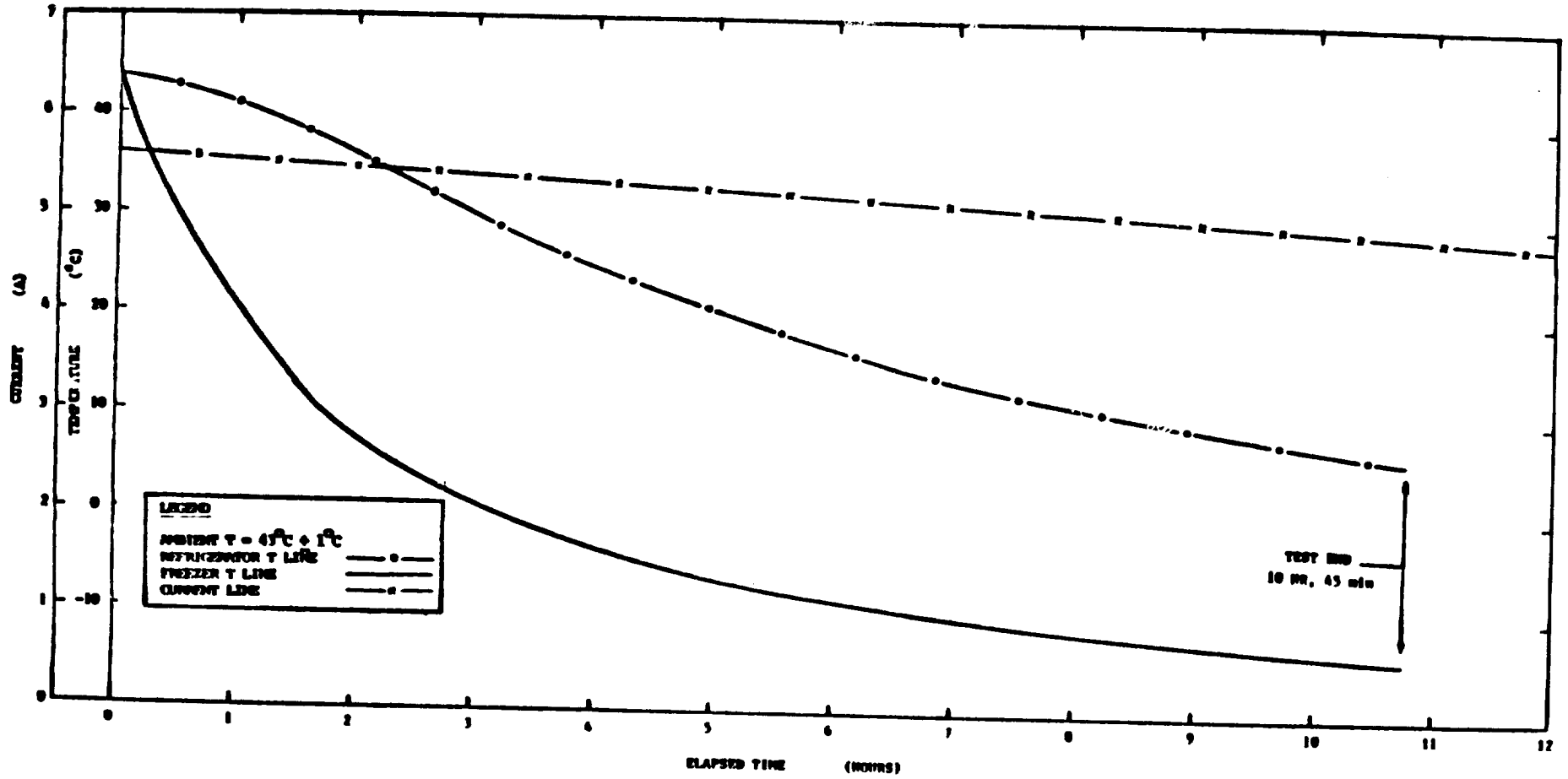

FIGURE 22

TIME: 177:11:50:00 (END OF TEST)

<u>LOCATION</u>	<u>TEMPERATURE (°C)</u>	<u>LOCATION</u>	<u>TEMPERATURE (°C)</u>
1	7.3	9	4.6
2	7.1	10	4.7
3	6.0	11	43.8
4	-10.1	12	43.8
5	5.8	13	45.5
6	-14.5	14	7.3
7	6.1	15	44.0
8	5.9	16	5.6

Whereas the array output current and voltage varied greatly as a function of the levels of insolation (sunshine) the battery voltage remained fairly constant at approximately 13 V. The requirement of a 6°C +2°C average temperature in the refrigerator compartment and -15°C +2°C average in the freezer compartment was satisfied. Figure 23 shows the two compartment temperatures as a function of time throughout the test. Data recorded during a 1 hour period in the middle of the test are shown in Figure 24.

### 2.C Holdover Test

The same "vaccine" as used in the Qualifying test phase was placed in the refrigerator compartment. The system was turned on and the "vaccine" allowed to stabilize within the 4°C to 8°C range before the refrigeration system was turned off signifying the beginning of the test. The freezer compartment was empty throughout the test.

The results of this test do not affect the outcome of the test program as a whole. The test is conducted purely for information gathering and cannot be "passed" or "failed".

The following three (3) sets of data are at the start of the test, the moment when the freezer temperature is first seen over 10°C, and the moment when the refrigerator compartment is first seen over 10°C (end of the test).

TIME: 178:19:35:00

<u>LOCATION</u>	<u>TEMPERATURE (°C)</u>	<u>LOCATION</u>	<u>TEMPERATURE (°C)</u>
1	7.9	9	5.3
2	9.0	10	5.0
3	6.6	11	43.0
4	-11.0	12	43.1
5	6.4	13	44.6
6	- 8.6	14	7.8
7	7.5	15	43.2
8	7.4	16	6.7



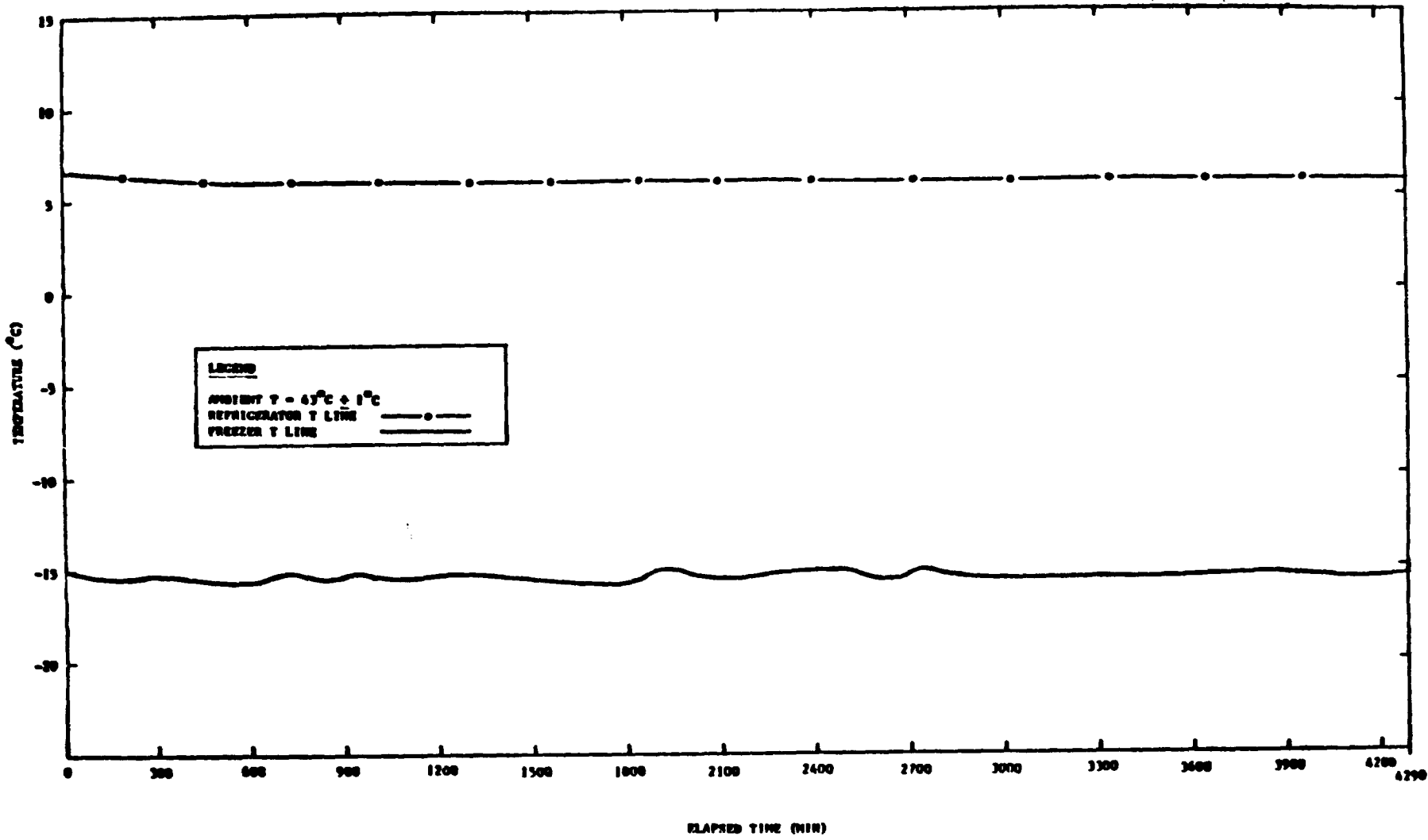

FIGURE 23

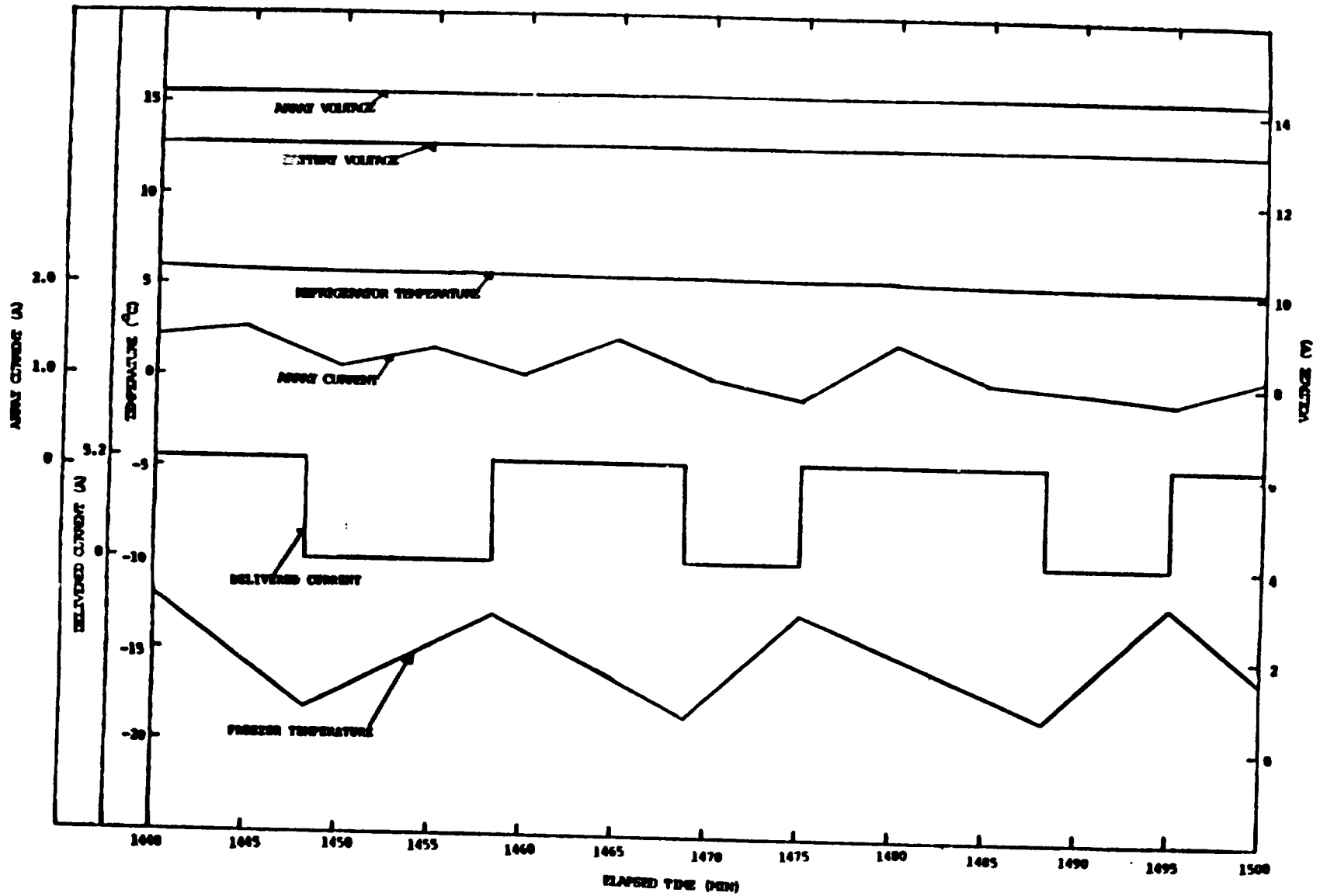

FIGURE 24

TIME: 179:01:55:00

<u>LOCATION</u>	<u>TEMPERATURE (°C)</u>	<u>LOCATION</u>	<u>TEMPERATURE (°C)</u>
1	10.0	9	8.8
2	11.3	10	8.5
3	9.2	11	42.6
4	8.9	12	42.6
5	6.6	13	43.0
6	10.0	14	9.9
7	9.7	15	42.7
8	9.7	16	9.1

TIME: 179:14:05:00

<u>LOCATION</u>	<u>TEMPERATURE (°C)</u>	<u>LOCATION</u>	<u>TEMPERATURE (°C)</u>
1	16.6	9	15.8
2	18.0	10	15.5
3	16.4	11	42.9
4	20.9	12	42.9
5	10.0	13	43.4
6	21.7	14	16.3
7	15.7	15	43.0
8	15.8	16	16.5

Due to the thermal mass of the "vaccine" within the refrigerator compartment the temperature in that compartment rose more slowly than the temperature in the freezer compartment. Figure 25 represents the data obtained during the test.

SUMMARY OF TEST RESULTS

The following two tables (Table 8 and Table 9) provide a summary of the results of the two test phases. Qualification phase results are presented in Table 8 and Acceptance phase results in Table 9.

TEST 3: BOLDOVER ACCEPTANCE TEST

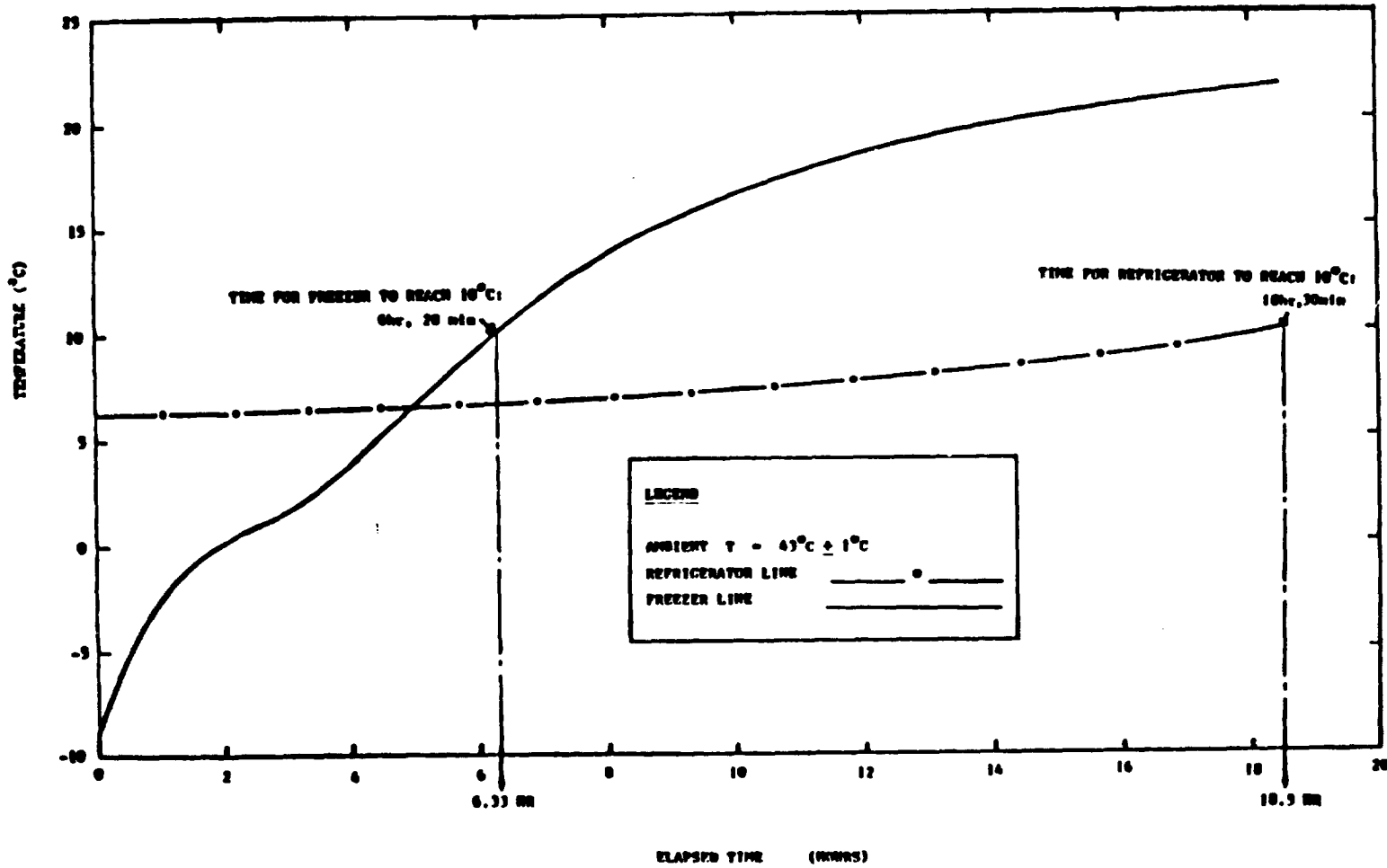

FIGURE 25

ORIGINAL PAGE IS  
OF POOR QUALITY

TABLE 8

QUALIFICATION PHASE TEST RESULTS

TEST	LENGTH OF TEST (HR, MIN)	AMP-HOURS USED (A-HR)	DUTY CYCLE (%)	AVG CURRENT (A)
1.A NO LOAD PULLDOWN (FIGURE 11)	7 HR, 40 MIN	42.8	100	5.58
1.B COLDPACK FREEZING (FIGURE 14)	1 HR, 50 MIN	11.3	100	6.16
1.C STEADY STATE	72 HR	225	60	3.12

TABLE 9

ACCEPTANCE PHASE TEST RESULTS

TEST	LENGTH OF TEST (HR, MIN)	AMP-HOURS USED (A-HR)	DUTY CYCLE (%)	AVG CURRENT (A)
2.A NO LOAD PULLDOWN	10 HR, 40 MIN	56.9	100	5.21
2.B STEADY STATE	72 HR	216.0	57	3.0
2.C HOLDOVER				
1. FREEZER	6 HR, 20 MIN	0	0	0
2. REFRIGERATOR	18 HR, 30 MIN			

## CONCLUSIONS

The photovoltaic refrigerator/freezer developed by Solar Power Corporation under the sponsorship of NASA resulted with a reliable product that exceeds the WHO vaccine storage requirements. SPC acknowledges the government sponsorship of this Program without which the refrigerator/freezer development would most likely not have occurred.

Prior to the testing program Solar Power Corporation designed and developed the R/F unit in accordance with the RFP. Several deficiencies in the original design were determined during the testing program. These deficiencies were corrected and implemented. The final result of the program is a better product primarily for NASA and ultimately the people receiving the vaccinations.

Although somewhat unsure of the need for everything required by NASA originally, Solar Power demonstrated to itself and the WHO that a photovoltaic powered vaccine storage refrigerator cannot provide sufficient reliability without an adequate developmental testing program. Several needs had to be studied and evaluated.

Specifically the requirements are:

1. Fundamentally reliable components.
2. Careful integration.
3. Thorough laboratory and field testing.

The components consisted of the following:

1. Photovoltaic modules
2. Refrigerator/freezer
3. Power processing electronics and regulator
4. Reliable instrumentation for monitoring

Solar Power has a proven history of manufacturing reliable photovoltaic modules. JPL Block IV testing of the Solar Power modules resulted in the first Block testing results without a single problem/failure report. The refrigerator/freezer selected was demonstrated to be extremely reliable and may be the most energy efficient in existence. The power processing electronics originally proposed were thought to be some of the most reliable. This was not correct. Solar Power discovered that an essential

though often overlooked item in the system is the power processing electronics. As a result Solar Power learned that the electronics are likely to fail if not properly integrated into the system. In addition, poorly designed electronics may induce failures in the refrigerator/freezer, and cause battery failures. Solar Power corrected its design deficiencies by using an all new and entirely solid state set of power processing electronics that will not inhibit or degrade proper performance of the system.

The instrumentation system as originally designed included components suggested by NASA and others selected by Solar Power. Ultimately one of the mechanical components was found to be unreliable. To fix this problem, Solar Power designed a solid state replacement for the component.

In the final analysis, Solar Power learned that previous experiences of its own and NASA's were not adequate to replace the approach requested by NASA.

This design approach resulted in a much better system integration and a thorough laboratory and field testing program. The program required nearly two years to complete. In retrospect, the delay was more than justified.



APPENDIX A

STATEMENT OF WORK: CONTRACT DEN3 - 238

Contract DEN3-238

PHOTOVOLTAIC POWERED REFRIGERATOR/FREEZER SYSTEM FOR  
STORAGE OF MEDICAL SUPPLIES

Preface to Statement of Work

A. Background

The purpose of this contract is to develop a photovoltaic (PV) powered refrigerator/freezer system for use in medical outposts in remote areas of developing countries. At present the three billion people of the less developed world suffer from a plethora of infectious diseases. Because these infections tend to flourish at the poverty level, they are important indicators of a vast state of collective ill health. The concomitant disability has an adverse effect on agricultural and industrial development, and the infant and child mortality inhibits attempts to control population growth.

Vaccination has been used extensively in developed countries over the last few decades for the prevention of a number of important communicable diseases such as poliomyelitis, small pox, diphtheria, and measles. The experiences gained in these countries are now being transferred on a gradually increasing scale to the developing world. However, the application of vaccination in developing countries has met with a number of problems of an economic, operational, and technological nature. One of the main problems consist in the refrigerated storage and transportation of vaccines, the so-called "cold chain". The cold chain is a system for distributing vaccines in the potent state from the manufacturer to the actual vaccination site. Vaccines exposed to elevated temperatures suffer a permanent loss of

- 2 -

potency. To remain efficacious most vaccines must be maintained during storage and transport at 4° to 8° C. For the more sensitive polio and measles vaccines, a -20° C temperature is recommended for extended storage times.

The available technical solutions to the problem of maintaining the cold chain are mainly based on the presumption that there is a steady supply of electric power, which is frequently not the case in developing countries. The problem is much more serious for these countries in that (1) many of them have a hot tropical climate, and (2) much of the cold chain equipment produced in developed countries is unsuitable for tropical countries.

The development of effective photovoltaic-powered refrigerator/freezer boxes, to be used as peripheral units in the cold chain, is seen by the World Health Organization and the Center for Disease Control (U.S. Department of Health and Human Services) as vital to the success of immunization programs in the developing countries. At present 75% of the population that is to be reached by the immunization programs are in areas not served by reliable refrigeration. Dr. Stanley O. Foster, Center for Disease Control, has estimated that 30,000 refrigeration units will be needed in the next 5 years to support present programs in remote areas when no reliable commercial power supply is available. Photovoltaic-powered refrigeration units could fulfill this need for remote refrigeration.

**B. Approach**

The overall approach to the development of a PV Powered Refrigerator/Freezer System is shown schematically in the attached flow diagram. The proposer will design a standardized PV power supply and refrigerator/freezer unit based on the general guidelines and specifications presented in the request for proposal and which meets the specific system and component performance requirements specified under the Technical Tasks of the Statement of Work. It is left to the ingenuity of the proposers to design the system and to propose the fabrication methods such that the performance requirements are achieved in the most cost effective manner.

Based on the proposed design of the selected contractor, ten systems will be fabricated and subjected to acceptance tests. All systems must pass acceptance tests prior to delivery to NASA. Each system will be packaged separately in a manner suitable for export by air freight and will include all ancillary equipment, hardware, and installation instructions as well as, operation and maintenance manuals in English, French, and Spanish.

FLOW DIAGRAM

ORIGINAL PAGE IS  
OF POOR QUALITY

PHASE I

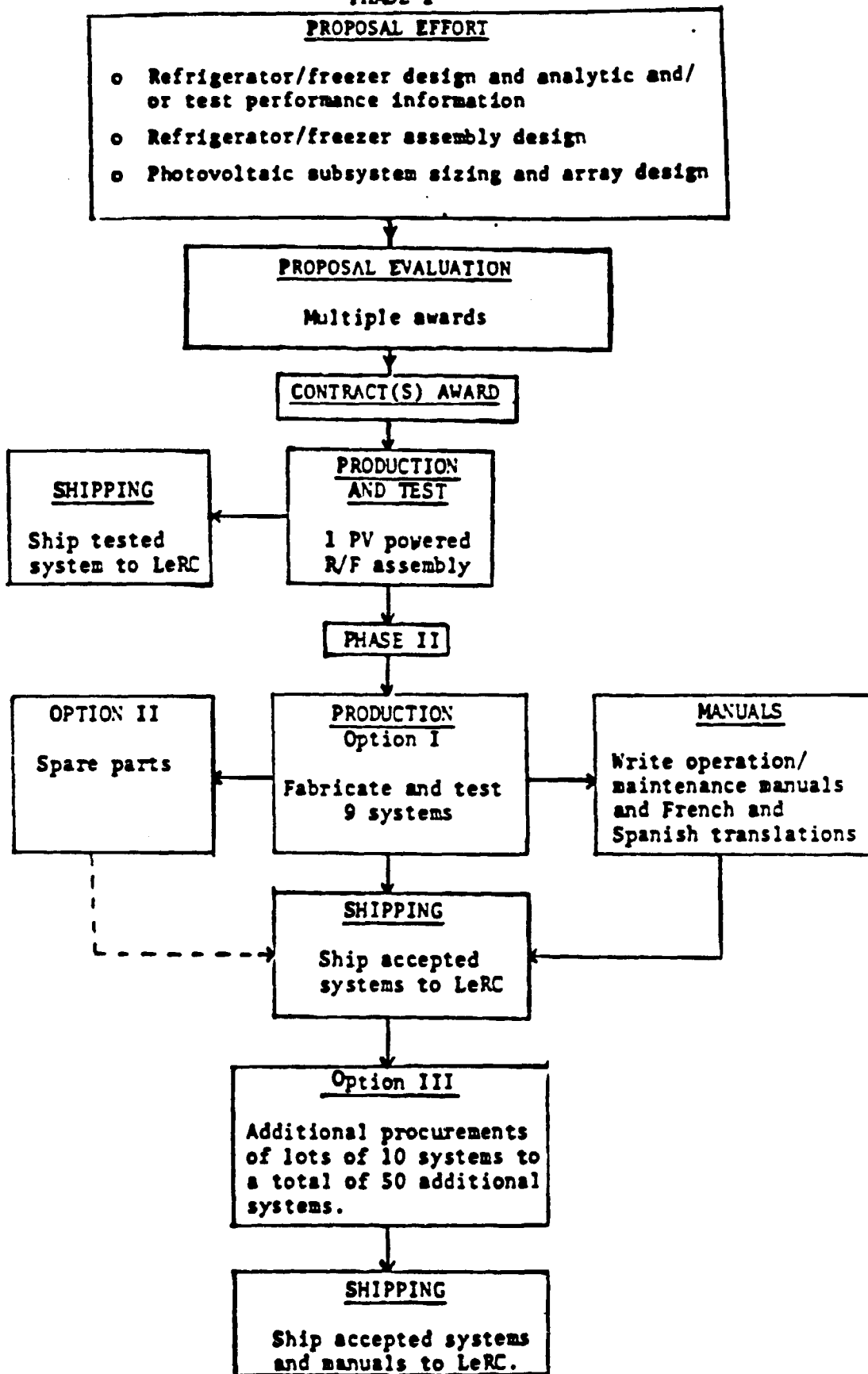

**PHOTOVOLTAIC POWERED REFRIGERATOR/FREEZER SYSTEM FOR  
STORAGE OF MEDICAL SUPPLIES**Statement of WorkORIGINAL PAGE IS  
OF POOR QUALITYObjective

The objective of this contract is to design, fabricate and test a Photovoltaic (PV) Powered Refrigerator/Freezer (R/F) System(s) for the storage of medical supplies in remote areas of developing countries.

Scope of Work

The contractor shall furnish the necessary personnel, facilities, materials, equipment and services to perform the work described under the Technical Tasks listed below. In general, this effort is composed of two phases. In Phase I the contractor shall fabricate and test one (1) qualification model PV powered R/F System and be prepared to perform an option to deliver nine (9) additional PV powered R/F Systems. The initial PV powered R/F System must meet the system and component performance requirements detailed in the Technical Tasks and must pass the specified tests performed by the contractor and verified by NASA.

Phase II will be initiated, upon acceptance, by NASA, of the Phase I PV powered R/F System. The contractor shall then be prepared to deliver the ten (10) systems (9 from Option I, Phase II, and the qualification model of Phase I), manuals and other specified software to NASA to complete the contract requirements. At the option of NASA, spare parts and/or production lots of ten systems each may then be procured under terms negotiated as part of this contract agreement.

Technical Tasks

General Guidelines and Requirements - The PV powered R/F systems will be used in medical outposts in remote areas in

developing countries. Such use requires a reliable PV power supply and an efficient, reliable refrigeration unit to minimize energy requirements while continuously maintaining the required temperatures in the R/F unit. The R/F configuration and operation requirements shall be designed to meet the medical use requirements of the systems in their intended environment. For ease of shipping and installation, the system shall be designed as two separate assemblies: (1) A PV array assembly consisting of the PV modules, array structure, array harness, and main power cable and (2) Another assembly containing all other components including the R/F box, compressor motor/condensor, battery complement, controls, regulator, instrumentation, and assembly tools.

All PV powered R/F systems shall be the same size (i.e., same peak-watt PV array, battery capacity, R/F capacity, etc). This standardization is required to reduce unit costs by eliminating the need for custom engineering and thus lead ultimately to an off-the-shelf supply situation.

The assemblies shall be furnished fully suitable for export air shipment to the developing countries. This will require packaging of the PV powered R/F systems (including battery complement, manuals and spare parts, if the option is exercised) to meet applicable air freighting requirements.

#### PHASE I

##### TASK 1.0 - System Requirements

1.1 All system components shall be designed and fabricated to operate reliably under the full range of environmental conditions including tropical sea level locations (e.g., Maldive Islands,

- 6 -

Gabon), desert locations (e.g., sub-Sahara), and high altitude locations (e.g., altiplano Peru).

1.2 All circuit boards shall be conformally coated per MIL-I-46058C, dated April 3, 1979, and which document is incorporated herein as reference 1.

1.3 The PV powered R/F system shall be designed to meet or exceed the performance requirements in the most cost-effective manner. The contractor shall consider the following elements in developing his design: R/F box insulation thickness, door sealing mechanisms, compressor power consumption and location, refrigeration capability, PV array size, and battery capacity.

1.4 The systems shall be shipped as assemblies consistent with the provisions of Task 7.

#### TASK 2.0 - Refrigerator/Freezer (R/F) Requirements

The R/F shall be a chest type unit (top opening) and shall meet the following specifications and requirements:

##### 2.1 Functional and Configuration Requirements

- o The R/F box, the compressor/motor/condensor, battery complement, controls, regulator and instrumentation shall be assembled as an integral unit.
- o The R/F assembly shall be packaged to provide maximum personnel safety. The design of enclosures and arrangement of components shall provide for good ventilation of the battery complement and compressor, and ease of servicing.



- 7 -

- o The compressor motor shall be a DC type and operate at a nominal 12 volts.
- o The dimensions of the R/F assembly shall conform to the following:
  - Total maximum height of assembly: 110 cm
  - Total usable storage volume: minimum 60 liters  
maximum 100 liters
  - Freezer compartment usable volume: minimum 20 liters,  
maximum 1/3 total R/F volume
- o The materials used for the box inner and outer liner jackets shall be durable, easily cleaned, and resistant to deterioration from exposure to foods and vaccines. The inner and outer liners shall be sealed together to minimize moisture penetration due to atmospheric and/or temperature induced vapor pressure differences between the environment and the insulation cavity.
- o The material used for insulation shall be foamed-in-place polyurethane type and shall be of sufficient thickness to provide adequate cold retention, minimize compressor energy requirements, and, in general, provide the greatest overall system economic benefit.
- o The R/F box shall have a single outer lid which is hinged, self-closing and lockable. The outer lid gasket shall be capable of withstanding normal medical use and provide the necessary sealing to minimize heat leaks.
- o The R/F box shall have separate interior lids for the freezer and refrigerator compartments. The interior lids

shall be hinged and designed to reduce heat transfer between the compartments and the outer lid.

## 2.2 Performance Requirements

- o With the R/F box empty and the complete assembly stabilized in a 43° C ambient environment, the assembly shall be capable of achieving refrigerator compartment temperatures in the range of 4° to 8° C (per temperature sensing locations given in Figure 1) within 24 hours after compressor startup.
- o The system shall be capable of continuously maintaining refrigerator compartment temperatures in the range of 4° to 8° C (per temperature sensing locations given in Figure 1) when the refrigerator compartment is filled with a uniformly distributed water load in the ratio of 1/3 liter liquid per liter of refrigerator compartment volume,<sup>1</sup> with an empty freezer compartment, and with the complete R/F assembly in a 43° C environment. Further, the system shall be capable of meeting this requirement with 70% or less compressor run (on) time.
- o The R/F assembly shall be capable of freezing a minimum of 2 kg of water every 24 hours with the initial water temperature being 43° C and with the R/F assembly operating in a stable cycling mode in a 43° C ambient environment.

<sup>1</sup>NOTE: See Appendix A, Section G2.3. - Water load shall be in small glass vials simulating vaccine storage bottles (e.g., Steri-vial water for injection, in 30 cc glass bottles).

FIGURE 1

TEMPERATURE SENSING LOCATIONS

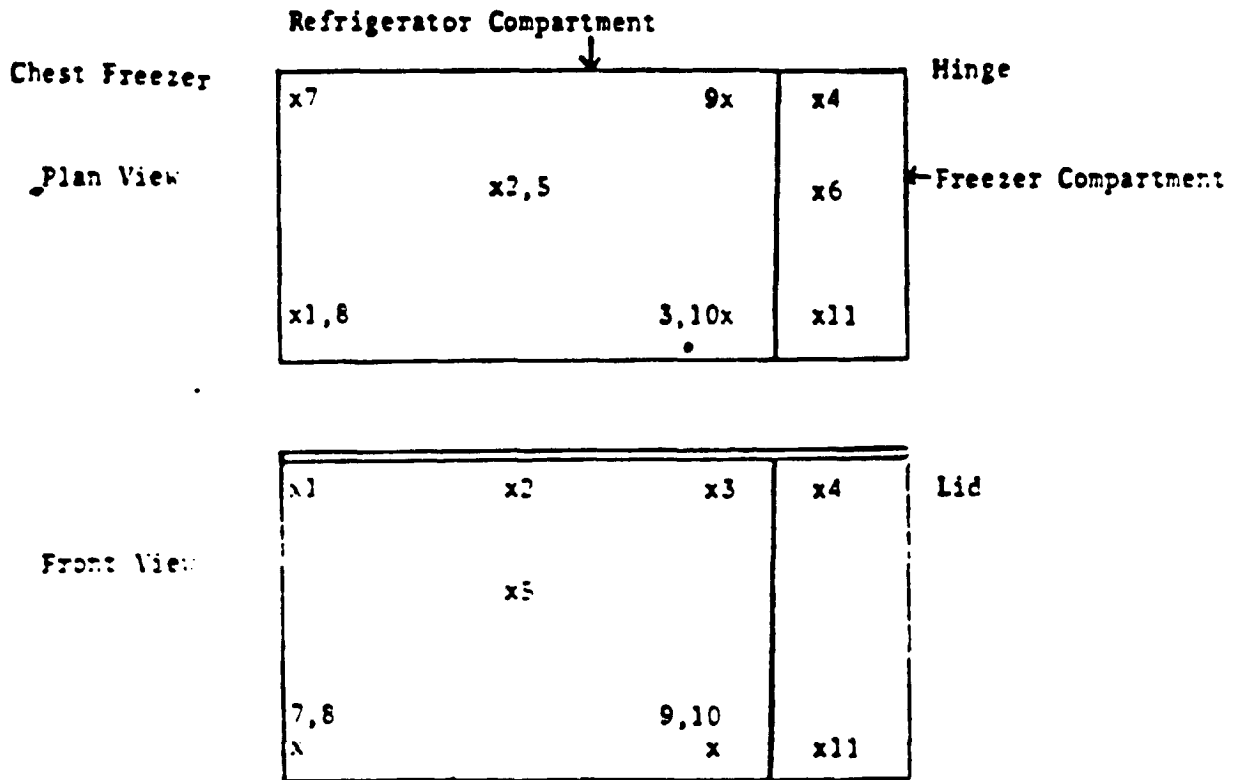

**TASK 3.0 - Photovoltaic (PV) Power Supply Requirements**

The contractor shall provide a PV power supply to power the R/F unit, instrumentation, and controls. The PV power supply shall be based on a system schematic submitted as part of the contractor's proposal.<sup>1</sup> The PV power system shall consist of a PV array (including PV modules, support structure, and electrical cabling); system voltage regulator; instrumentation and controls; and battery complement. The minimum requirements and specifications for these components are as follows:

**3.1 PV Module Requirements**

- o The PV modules shall consist of silicon solar cells and shall be glass covered or of the glass superstrate type construction. The number of PV modules required and the manufacturer's model type shall be in accordance with that specified in the contractor's proposed design.

**3.2 PV Array Structure Requirements - The PV array structure shall conform to the following:**

- o Be capable of withstanding wind loads of  $\pm 50$  lb/ft<sup>2</sup>, and
- o Contain a wiring harness connecting all modules to a common point for connection to an electric power cord, and
- o Include an electric power cord ten meters long with weatherproof connectors at both ends to interface with the PV modules and the R/F assembly, and
- o Provide for ease of installation, and

---

<sup>1</sup>Note: See Special Instructions to Offerors regarding PV array and battery sizing requirements.

- o Provide for simple tilt-angle adjustment of 0° to 60° from horizontal, and
- o Include all hardware required for mounting the array either on a metal roof or a wood or masonry/adobe wall.

**3.3 Battery Requirements - The battery complement shall conform to the following:**

- o Contain lead-calcium cells
- o Be externally connected single cells or internally connected "SLI" configuration.
- o Be designed for use with PV systems
- o Be housed in a vented locked portion of the equipment enclosure

**3.4 Battery Charge/System Voltage Regulator Requirement -**

The battery charge/system voltage regulator shall be capable of meeting the specific charge voltage versus temperature requirements of the selected battery.

**3.5 Instrumentation Requirements - Each PV power supply shall include the following instruments:**

- o System voltmeter
- o Array ammeter
- o Array amp-hour meter
- o Load ammeter
- o Load amp-hour meter
- o Compressor motor run-time meter

**3.6 Control Requirements - Each PV power supply shall include, as a minimum, the following controls:**

- o A battery circuit breaker
- o A low voltage disconnect designed to disconnect the refrigerator in the event system voltage drops below battery manufacturer's recommended battery low voltage limit. There shall be incorporated into the low voltage disconnect a low-power-consumption, visual alarm for signaling load disconnect.

#### TASK 4.0 - Fabrication and Assembly Requirements

4.1 The contractor shall fabricate and assemble one PV powered R/F system based on the contractor's design and in accordance with the system and component specifications and requirements detailed in Tasks 1, 2, and 3 of this statement of work. The system shall be completed, Qualification and Acceptance tested, and delivered to NASA-LeRC within four (4) months from date of contract award.

4.2 PHASE II - At the option of NASA, the contractor shall fabricate, test and ship nine (9) additional systems as discussed under the Special Instructions to Offerors and Task 8 - Deliverables of this statement of work, in accordance with Tasks 1, 2 and 3.

4.3 At the option of NASA, the contractor shall fabricate, test and ship duplicate PV powered refrigerator/freezers for medical storage in lots of ten (10) up to a total of fifty (50).

#### TASK 5.0 - Test Requirements

The one (1) R/F System shall be subjected to the Qualification Test of Section 5.1. All ten (10)(1 Qualification Model and 9 units, if option I is exercised) PV powered R/F Systems

must pass the Acceptance Tests described in Section 5.2. These tests shall be conducted by the contractor. NASA-LeRC personnel shall have the right to witness testing of each system.

The NASA Contracting Officer shall be given 10-days advance written notification prior to testing. The witnessing of such in-plant testing shall not preclude the Government from retesting the units at destination prior to acceptance. Copies of all test data shall be supplied to the NASA Contracting Officer. Within one week of receipt of such data indicating satisfactory system performance, NASA will issue authorization to the contractor to ship the systems.

#### 5.1 Qualification Test

The contractor shall submit one (1) R/F assembly (complete except for battery complement) to the following series of tests. The unit selected must be identical in all aspects to the option units.

##### 5.1.1 No-Load Pull Down Test at 43° C Ambient Temperature

This test shall be performed in accordance with the requirements of Section 7.5 of the ANSI procedure (Appendix B) except as follows:

a. The test shall include measurements of input energy from start until the several conditions specified under 7.5.4(d), (e) and (f) are achieved.

b. For DC powered refrigerators, amend 7.4.1, in part, to read "12.0  $\pm$ 0.1 V DC measured at the motor terminals."

- 14 -

c. The several temperatures of each compartment shall be recorded from the start of pull down through achievement of steady state operation and reported as a plot of temperatures versus time. This plot is required in addition to the reporting requirements of ANSI Section 7.5.4.

#### 5.1.2 Performance Tests at 43° C Ambient Temperature

These tests shall be made with the refrigerator loaded with vaccine or simulated vaccine (water) according to the W.H.O. Standard Test Procedure for Refrigerators and Freezers for Use in the Cold Chain - Draft 10.4.80, as modified for this SOW, and included in this SOW as Appendix A, except that performance tests shall be run only at 43° C. The Steady-State, Ice Making, and Holdover Tests shall be performed according to Section GG of these modified W.H.O. Test Procedures.

#### 5.1.3 Criteria for Passing the Qualification Test

The R/F assembly will be deemed to pass the Pull-Down, Steady-State, and Ice Making Tests if the R/F assembly meets the performance requirements stated under Task 2.2 when subjected to the above test conditions. The Holdover Test is required only for information purposes and will not be used as a criteria for passing.

#### 5.2 Acceptance Tests

The contractor shall submit all ten units (Qualification model and nine (9) others if Option I is exercised) to the following tests:



5.2.1 The contractor shall conduct a Pull-Down and Steady-State Acceptance test with the R/F box empty in a 43° C environment, with a single weighted temperature sensor at locations 5 and 6 (see Figure 1), and with the PV array supplying system power. The PV array may be in natural or artificial sunlight. Artificial sunlight intensity shall not exceed 1 kW/m<sup>2</sup> at the surface of the PV array. At no time during this test shall battery depth-of-discharge exceed 35%. The contractor may use a separate test battery for these tests. However, it shall be mounted in the R/F assembly during the test and shall be fully recharged after each R/F assembly test.

The following data shall be recorded as a function of time (either continuously or at five minute intervals) from start of Pull-Down to completion of the Steady-State tests:

- o Ambient temperature measured at the same height as the top of the R/F assembly
- o System voltage
- o Array current
- o Array tilt angle
- o Compressor motor current
- o Insolation
- o Temperatures at positions #5 and #6 (Fig. 1)

The total array ampere-hours per day (24 hours) shall be recorded for the duration of the Pull-Down and Steady-State Tests. The compressor motor ampere-hours and motor run time shall be recorded from start of the Pull-Down Test to the start of the

Steady-State Test and then on a per 24-hour basis for the duration of the Steady-State Test.

5.2.1.1 Pull-Down Acceptance Test

The R/F assembly shall be placed in a 43° C ambient temperature environment for four hours. The R/F compressor shall then be started and the system allowed to run until the temperature at location #5 (Fig. 1) of the R/F box is 6° C.

The R/F assembly will be deemed to have failed the Pull-Down Test if any of the following conditions occur:

- o The unit fails to achieve 6° C at temperature sensor location #5 within +10% of the time required for the representative lot unit (Task 5.1) to achieve 6° C at location #5.
- o The compressor motor ampere-hour consumption from start of pull-down to 6° C at location #5 exceeds, by more than 10%, the representative lot test unit ampere-hour consumption under the same conditions.

5.2.1.2 Steady-State Acceptance Test

After the 6° C has been attained per Section 5.2.1.1, the R/F shall be run for 72 consecutive hours to establish that the system functions properly at 43° C.

The R/F assembly will be deemed to have failed the Steady-State Test if any of the following conditions occur:

- o The compressor fails to cycle once temperatures at location #5 are between 4° and 8° C.
- o The compressor cycle ON time is more than 10% greater than that of the representative lot test unit.
- o The compressor motor ampere-hour consumption per 24-hour day is more than 10% greater than that of the representative lot test unit.

### 5.3 PV Array Acceptance

NASA reserves the right to reject modules which do not meet the criteria set forth in "Rejection Criteria for JPL LSSA Modules," November 3, 1978, 5101-21 Rev. B which document is incorporated herein as reference 2.

### 5.4 Other Information and Certification

In addition to the acceptance test results, the contractor shall provide the following information and certifications for each system:

5.4.1 The contractor shall provide an I-V curve of the PV array or of individual modules taken per the requirements of "Revised Terrestrial Photovoltaic Measurement Procedures," June 1977 ERDA/NASA 1022/77/16 incorporated herein as reference 3.

5.4.2 The contractor shall certify that the battery complement has been brought to 100% state-of-charge per the battery manufacturers instruction and that if the battery was used in the acceptance tests, that it was not subjected to depths-of-discharge greater than 35%.

- 18 -

5.4.3 The contractor shall certify that the voltmeter, ammeters, and ampere-hour meters have been calibrated and are functioning properly following the tests required in Section 5.1.4.

#### TASK 6.0 - Manual and Data Form Requirements

##### 6.1 Manual Requirements

The contractor shall provide an operation and maintenance manual for the PV powered R/F system. Separate copies of the manual shall be in English, French, and Spanish. The manual shall be technically complete, shall enable non-technical personnel to understand system operation and maintenance, data acquisition, and failed component identification and replacement, and shall otherwise as a minimum contain:

- o A complete description of the PV power assembly and of the refrigerator/freezer assembly.
- o Complete system assembly and installation instructions including array tilt angles for systems located at 10°, 20°, 30°, and 40° latitude.
- o System operating instructions
- o Detailed system electrical schematic and mechanical drawings.
- o A complete parts list with the description, model number, and manufacturers name and address for all major components including the PV modules, cable connectors, voltage regulator, battery (batteries), control components, instrumentation, and refrigerator/freezer box, motor and compressor.

- o A system troubleshooting guide and repair/replacement procedures. The guide and procedures shall be directed at field level repair.
- o Instructions for recording system data on a daily basis and forwarding same to LeRC on a weekly basis, and a sample data recording form for recording one week's worth of daily data. The following data shall be recorded daily: date, time of day, ambient temperature, system voltage, array current and ampere-hours, load current and ampere-hours, and motor run time.

#### 6.2 Data Recording Form Requirements

The contractor shall develop and provide daily data recording forms. The forms shall provide for seven (7) daily entries of the data listed in Section 6.1. Column headings shall be in English, French, and Spanish. The data forms shall be contained in a separate loose-bound volume for ease in recording and for removal for forwarding to NASA-LeRC.

#### TASK 7.0 - Packaging Requirements

7.1 Each PV Powered R/F System shall be packaged for export air shipment in accordance with the following requirements:

- o Packaging shall be in class 2 1300 weather resistant grade containers such as TRI WALL CONTAINERS, Woodbury, NY. Each package shall be securely mounted and strapped to a wood skid for ease in loading and unloading.

act DEN  
- 3-238

- o Polyurethane foam of at least a 2-inch thickness shall be used to line inner walls of each package.
- o Batteries shall be wrapped in plastic of at least a 2 mil (0.002 inch) thickness and shall otherwise meet all applicable air freighting packaging requirements.

7.2 Each PV Powered R/F System may be packaged in either three or four separate containers at the option of the contractor. If three containers are used the components shall be packaged as follows:

Container 1 - PV Assembly

Container 2 - Remainder of System including manuals, drawings, forms, etc.

Container 3 - Spare parts if ordered by NASA

If four containers are used the distribution of the contents shall be as stated above except the battery complement shall be packaged separately.

#### TASK 8.0 - Deliverables

8.1 The contractor shall, within four (4) months from contract award date, deliver to NASA-LeRC the following items:

Item 1 - Qualification Model packed as per Task 7 of this statement of work.

Item 2 - All qualification and acceptance test results, information and certifications required under Task 5 of this statement of work.

Item 3 - Monthly Reports: A brief technical narrative of accomplishments to date shall be furnished each month in addition to the NASA Form 533M Report entitled "Monthly Contractor Financial Management Report."

8.2 Option 1 - The contractor shall, within three (3) months of this option being exercised, deliver to NASA-LeRC:

Item 1 - Nine (9) Production-type PV Powered R/F Systems packaged per the requirements cited under Task 7, with

assembly tools and each including nine (9) copies of the Operation and Maintenance Manuals (three each in English, French, and Spanish) and 150 copies of the Daily Data Recording Forms and one (1) copy for the Qualification Model.

Item 2 - Twenty-seven (27) copies of the Operation and Maintenance Manual (9 each in English, French, and Spanish) in addition to and packaged separately from the Item 2 requirement.

Item 3 - A camera-ready copy of each of the three Operation and Maintenance Manuals (English, French, and Spanish).

Item 4 - A camera-ready copy of the Daily Data Recording Form.

Item 5 - Costing data

8.3 Option II - R/F PV System spare parts

8.4 Option III - R/F System in lots of 10 up to 50.

APPENDIX B

ADLER-BARBOUR PERFORMANCE DATA  
AND CALCULATIONS



ORIGINAL PAGE IS  
OF POOR QUALITY

PRODUCT INFORMATION DATA

SPC-RF103 PERFORMANCE DATA AND CAPACITIES

In determining performance projections for the SPC-RF103 Solar Photovoltaic Powered Refrigerator Freezer we have used the following data:

- o Design Temperatures:
 

	°F	°C
Ambient	+109.4	+ 43.0
Freezer Section		
Minimum	- 6.0	- 21.1
Maximum	+ 5.0	- 15.0
Average	0.0	- 17.8
Ice Making Test Final Steady State	- 4.0	- 20.0
Refrigerator Section		
Minimum	+ 39.2	+ 4.0
Maximum	+ 46.4	+ 8.0
Average	+ 42.8	+ 6.0
  
- o Insulation: Rigid expanded polyurethane, 2.0 Lb./CU. FT. density. "K" Factor = .14 (BTU/CU. FT./HR/IN. THK/F<sup>OT</sup>.D.)
  
- o Capacity and Current Consumption VS. Load:

EVAP. TEMP. F	- 31	- 22	- 13	- 10	- 4	+ 5	+ 14	+ 21
C	- 35	- 30	- 25	-23.3	-20	-15	- 10	- 5
CAPACITY BTU/H	68	104	148	164	200	248	304	356
@ 43°C KCAL/H	17.1	26	37	41	50	62	76	89
CURRENT AMPS CONSUMPTION	4.25	4.7	5.2	5.3	5.6	6.2	6.7	7.2
NOTE				A	B			C

NOTE A: Represents final steady state condition.

NOTE B: Represents average capacity and amp draw during pulldown and ice freezing.

NOTE C: Represents start up condition.

ORIGINAL PRINTING  
OF POOR QUALITY

PRODUCT INFORMATION DATA - Cont'd

Note: For calculating the load capacity and current consumption during pull down and ice freezing, a simple averaging plot has been utilized.

o Freezer Load at Steady State  $-4^{\circ}\text{F}$

(Total outside area = 16.65 square feet)

$$\text{HEAT GAIN/HR} = \frac{\text{AREA} \times \text{T.D.} \times \text{K}}{\text{INSUL. THICK. IN.}} = \frac{16.65 \times 113 \times 0.14}{6} = 43.90 \text{ BTU/HR}$$

o Refrigerator Load at Steady State  $+43^{\circ}\text{F}$

(Total outside area = 24.01 square feet)

$$\text{HEAT GAIN/HR} = \frac{\text{AREA} \times \text{T.D.} \times \text{K}}{\text{INSUL. THICK. IN.}} = \frac{24.01 \times 66 \times 0.14}{6} = 36.97 \text{ BTU/HR}$$

Note: The small effect of the partition on overall heat entry calculations is negligible and has been omitted from this summary.

o Combined cabinets (freezer & refrigerator) at steady state = 80.87 BTU/HR

Combined cabinets (freezer & refrigerator) average, during pulldown

$$\begin{aligned} + 5^{\circ}\text{F (FREEZER)} &= 40.0 \text{ BTU/HR} \\ + 46^{\circ}\text{F (REFRIGERATOR)} &= 35.52 \text{ BTU/HR} \end{aligned}$$

$$\text{PULLDOWN} = 75.52 \text{ BTU/HR}$$

o Ice Making:

4.41 LB (2 KG) of water @  $109.4^{\circ}\text{F}$  ( $43^{\circ}\text{C}$ ) to be frozen, sub-cooled and stabilized at  $-4^{\circ}\text{F}$ :

LATENT HEAT OF FUSION	$144.0 \times 4.41 =$	635.0
SPECIFIC HEAT (1 BTU/LB/F)	$113.4 \times 4.41 =$	<u>500.0</u>
TOTAL		1,135.1

o Results:

Time to achieve steady state and cycle, from start ( $43^{\circ}\text{C}$  or  $109.4^{\circ}\text{F}$ ), no load; based upon:

COMBINED CABINET (REFRIGERATOR & FREEZER)	=	75.52 BTU/HR
CONDENSING UNIT CAPACITY	=	200.00 BTU/HR
CONDENSING UNIT CURRENT CONSUMPTION	=	5.60 AMPS/HR

Total specific heat of cabinet liner, insulating foam and miscellaneous materials from start (at  $43^{\circ}\text{C}$  or  $109.4^{\circ}\text{F}$ ) to steady state: 480 BTU

PRODUCT INFORMATION DATA - Cont'd.

- o Cabinet Load Calculations (Based on 100 Litre gross internal capacity)

- Heat Gain is taken as:

$$\text{GAIN (BTU/H)} = \frac{\text{AREA} \times \text{T.D.} \times \text{K}}{\text{INSUL. THICK. IN.}} \quad \text{WHERE:}$$

AREA = SQ. FT. of surface area of foam insulation

T.D. = TEMPERATURE DIFFERENTIAL across insulation

K = 0.14 (BTU/Sq. FT./HR/IN. /F<sup>o</sup>T.D.)

Insulation Thickness = 6"

- Ice Freezing Load is taken as:

2 KG. of water (4.41 LB.) @ 43<sup>o</sup>C (+109.4<sup>o</sup>F) to be frozen and subcooled to -20<sup>o</sup>C (-4<sup>o</sup>F).

SPECIFIC HEAT @ 1 BTU/LB/<sup>o</sup>F (No distinction between liquid VS. frozen state.

LATENT HEAT OF FUSION @ 144 BTU/LB.

- Steady state freezer and refrigerator heat gains are calculated separately at the following mean temperature:

FREEZER @ -4<sup>o</sup>F; T.D. VS. Ambient = 113.4<sup>o</sup>F

REFRIGERATOR @ +43<sup>o</sup>F; T.D. VS. Ambient = 66<sup>o</sup>F.

- Specific Heat @ 480 BTU

The specific heat of the internal cabinet liner and miscellaneous structure (plus that of the insulation adjusted for temperature gradient) are significant as they affect performance during initial pulldown from ambient.

- o The resulting heat gains in BTU/HR and BTU/24 HR are translated into current consumptions per the foregoing tables.

The data are then plotted to produce the following:

- A Time to achieve a steady state and cycle, no load (water freezing) from +43<sup>o</sup>C start.
- B Total ampere hours to achieve A
- C Time to achieve a steady state and cycle, including water freezing load (2.2 KG) from +43<sup>o</sup>C start.
- D Total ampere hours to achieve C
- E 24 hour average ampere requirement, representing steady state operation (after load is frozen and stabilized) at design temperature.

C-2

PRODUCT INFORMATION DATA - Cont'd

o Yields:

- A Time to achieve a steady state and cycle, no load (water freezing) from +43°C start:

$$\begin{array}{r} 200 \quad \text{BTU/HR Unit Capacity} \\ - 75.52 \quad \text{BTU/HR Fzr/Ref. Load (Av.)} \\ \hline = 124.48 \quad \text{BTU/HR Avail. for Specific Heat} \end{array}$$

$$\text{SO: } \frac{480 \quad \text{BTU}}{124.48 \quad \text{BTU/HR}} = 3.86 \quad 3.86 \text{ Hrs.}$$

Total Heat Removal During Period:

$$480 + (3.86 \times 75.52) = 772 \text{ BTU}$$

- B Total ampere hours to achieve steady state, no load:

$$3.86 \times 5.6 \text{ (AMPS)} = 21.62 \text{ AMP HOURS}$$

- C Time to achieve a steady state and cycle, including water freezing load from + 43°C start:

$$\begin{array}{r} 772 \text{ (BTU PULLDOWN)} + 1135.10 \text{ (FREEZE \& SUBCOOL WATER)} \\ = 1907 \\ \hline \frac{1907}{200 \text{ (BTU/HR COND. UNIT CAP)}} = 9.54 \text{ HOURS} \end{array}$$

- D Total ampere hours to achieve steady state (with load)

$$9.54 \times 5.6 \text{ (AMPS)} = 53.42 \text{ AMP HOURS}$$

- E 24 hour average ampere requirement, representing steady state operation (after load is frozen and stabilized at design temperature of:

$$\begin{array}{r} - 4^{\circ}\text{F} \quad \text{(FREEZER SECTION)} \\ + 43^{\circ}\text{F} \quad \text{(REFRIGERATOR SECTION)} \end{array}$$

Based on:

$$\begin{array}{r} \text{Condensing unit capacity} = 163 \text{ BTU/HR} \\ \text{Condensing unit current consumption} = 5.3 \text{ AMPS/HR} \end{array}$$

$$\text{(FREEZER HEAT GAIN) } 43.90 \text{ BTU/HR} + \text{(REFRIGERATOR HEAT GAIN) } 36.97 \text{ BTU/HR} = \text{(COMBINED HEAT GAIN) } 80.87 \text{ BTU/HR}$$

$$\text{TOTAL 24 HOUR HEAT GAIN} = 80.87 \text{ BTU/HR} \times 24 = 1940.90 \text{ BTU/24 HR}$$

$$\frac{1940.9 \text{ BTU/24 HR}}{163 \text{ BTU/HR}} = 11.91 \text{ HOURS OF OPERATION PER 24 HOURS}$$

PRODUCT INFORMATION DATA - Cont'd

11.91 HOURS X 5.3 AMPS = 63.12 AMP-HOURS PER 24 HOURS

CYCLE TIME PER 24 HOURS AT 43°C (109.4°F): 49.62% ON  
50.38% OFF