

INERTIAL ENERGY STORAGE FOR SPACECRAFT

G. Ernest Rodriguez
Goddard Space Flight Center

ABSTRACT

The feasibility of inertial energy storage in a spacecraft power system is evaluated on the basis of a conceptual integrated design that encompasses a composite rotor, magnetic suspension, and a permanent magnet (PM) motor/generator for a 3-kW orbital average payload at a bus distribution voltage of 250 volts dc. The conceptual design, which evolved at the Goddard Space Flight Center (GSFC), is referred to as a "Mechanical Capacitor." The baseline power system configuration selected is a series system employing peak-power-tracking for a Low Earth-Orbiting application. Power processing, required in the motor/generator, provides potential alternative that can only be achieved in systems with electrochemical energy storage by the addition of power processing components. One such alternative configuration provides for peak-power-tracking of the solar array and still maintains a regulated bus, without the expense of additional power processing components. Precise speed control of the two counterrotating wheels is required to reduce interaction with the attitude control system (ACS) or alternatively, used to perform attitude control functions. Critical technologies identified are those pertaining to the energy storage element and are prioritized as composite wheel development, magnetic suspension, motor/generator, containment, and momentum control. Comparison with a 3-kW, 250-Vdc power system using either NiCd or NiH₂ for energy storage results in a system in which inertial energy storage offers potential advantages in lifetime, operating temperature, voltage regulation, energy density, charge control, and overall system weight reduction. The key disadvantages are attitude control interface and launch constraints. A hardware development program is required to verify analytical assumptions used to perform feasibility studies. The objective of this program is to develop an integrated magnetically suspended reaction wheel capable of performing energy storage and momentum/torque functions.

INTRODUCTION

Energy storage and conversion have been and will continue to be key elements in developing earth applications and science-oriented spacecraft. Most spacecraft flown to date utilize photovoltaic technology for energy conversion and electrochemical technology for energy storage. Performance improvements of these technologies, as well as the search for new ones, are constantly pursued through various research and development programs. An attractive alternative to electrochemical energy storage is inertial energy storage. The development and applications of composite materials in super flywheels has aroused considerable interest in spacecraft power system applications because of the potential high energy density capability. The concept of inertial energy storage for a photovoltaic powered spacecraft encompasses various basic elements, which are:

- flywheel spinning at an angular velocity ω
- flywheel supported by a shaft and bearings
- motor/generator to convert available electrical energy from the photovoltaic source to mechanical energy and/or to convert stored mechanical energy in the flywheel to electrical energy for the spacecraft load
- a suitable fixed platform for the integration of the spinning assemblies.

These basic elements are configured as shown in Figure 1 for illustrative purposes. The energy stored in this system can be quantized by the familiar equation:

$$E = \frac{1}{2} I \omega^2$$

where I = moment of inertia
 ω = angular velocity.

Assessment of inertial energy storage for spacecraft power systems has been the subject of study at GSFC in task 4 under the NASA Research and Technology Objective and Plan (RTOP) titled "Advanced Power System Technology" (506-55-76). This task was initiated to develop concepts, perform feasibility analysis, design, develop and demonstrate high overall system efficiency and reliability in a spacecraft power system, and evolved from the development at GSFC of the "Mechanical Capacitor" (References 1 through 5).

INITIAL GUIDELINES

Initial guidelines for the assessment of inertial energy storage for spacecraft are well documented in Reference 6. These guidelines were based on a Low Earth Orbit mission, typically 60 min sun, 30 min eclipse, sized for payload power in the range of 2.5 kW to 25 kW (orbital average), with modularity in mind to allow for growth potential. Initial studies were to concentrate on a power system sized for an operational load of 2.5 kW at 90% duty cycle, and a peak of 7.5 kW at 10% duty cycle. This corresponds to an orbital average load of 3 kW. Target driven mass estimates were 115 kg for the solar array, (based on 56 W/kg technology) 115 kg for the storage element, (based on 22 W/hr/kg energy storage density), and 70 kg for power conditioning components (based on 43 W/kg technology), for which the total mass estimate is 300 kg, representing 10 W/kg power system technology.

POWER DISTRIBUTION

Ac/dc power distribution was a power system issue under consideration at the beginning of the study effort. The energy conversion process within the motor/generator involves ac voltage/current generation, and as such, the feasibility of ac power distribution was investigated. The basis for the investigation was not power distribution per se, but rather the interconnection of the source, energy storage element and load. This is illustrated in Figure 2, where two approaches are considered. These two approaches are simply conversion of the source to ac to match the energy storage element, or conversion of the storage element to dc to match the source.

Conversion of the storage element to dc was the method selected for the following reasons:

- allows simple method of paralleling modules
- allows speed control of individual wheels as a simple method of momentum management
- allows for a simple and effective way to achieve high efficiency (in/out) and a regulated bus.

The inherent ac voltage/current generation within the motor/generator is of insufficient power quality (variable voltage and frequency) for ac power distribution. In addition the corresponding low frequency would result in higher mass (transformer) penalties at the user interface than can be achieved with state-of-the-art 20 kHz power conditioning equipment.

POWER SYSTEM CONFIGURATION

Most spacecraft power system configurations can be categorized into two basic types:

- series system
- shunt system.

Series/shunt applies to the power processing element that is used to control the solar-array power. Although combinations or variations of these two are used for mission-unique applications, generally, the series system is used in LEO missions and the shunt system is used in GEO missions. The series element allows maximum extraction of solar-array

power (peak-power-tracking) as the array temperature (and thus array power) undergoes large temperature excursions, typical of LEO, and provides a means for keeping the excess array power distributed on the array when not required by the spacecraft load. In GEO missions, the array temperature remains constant during the extended sunlight periods, and the shunt element provides an efficient means for transferring the array power to the spacecraft load by shunting only what is in excess.

A unique characteristic of the inertial energy storage system is that the power conditioning electronics required for the motor/generator inherently provide a means for charge and discharge control over the design speed range of the flywheel, and thus additional power conditioning elements are not required as in an electro-chemical storage system. For a LEO mission, the series system configuration would be the same for either an electrochemical or inertial storage system, but for GEO the charge and discharge regulators (required for a regulated bus) in an electrochemical based system could be eliminated in an inertial storage system. The additional losses incurred by the charge/discharge regulator result in a combined in/out efficiency of about 65% whereas for the inertial system the efficiency would be more like 80%. This, however, is not a serious penalty because of the long sunlit/eclipse duty ratio but could result in a mass penalty. Detailed system comparisons have not been performed for the GEO mission.

Alternative system configurations can be realized with the inertial energy storage elements. One such system, shown in Figure 3, utilizes the motor control electronics to peak power track the array and the generator electronics to regulate the bus voltage. This would require additional motor/generator windings and electronics, but the net savings in mass and efficiency may still be significant over the baseline series system. Further detailed trade-off studies are necessary for evaluating this configuration.

DOE FLYWHEEL TECHNOLOGY PROGRAM

Flywheel development, prompted by the energy shortage and stimulated by an organized effort of the DOE, resulted in many approaches brought to the testable model stage. The DOE Flywheel Technology program concentrated on the development of the composite rotors, sized at approximately 500 watt hours, and primarily intended for vehicular application. High strength fibers are used at the outer periphery for high energy density and various schemes were devised to interface the outer rim with an inner disk. Several of the rotors developed are shown in Figures 4 and 5.

The Lawrence Livermore National Laboratories (LLNL), under contract with the DOE, narrowed their selection to three promising candidates:

- the cruciform spokes by Ganet-Air Research
- the laminated disk and rim by LLNL & GE
- the woven spiral by AVCO Corporation.

These three designs were tested at the conclusion of the DOE program. Of the three designs, only the spiral weave design exhibits a desirable form factor providing an essential monolithic "thick rim" with adequate volumetric efficiency and an ID/OD ratio sufficiently low to support an integral motor/generator at an acceptable stress level. Unfortunately, development problems were encountered in the fabrication of this design. Of the three designs tested, the hybrid GE design performed quite satisfactorily, exhibiting a higher burst energy than expected and demonstrated 10^4 cycles.

An alternative design not tested is the "best rim" design reported in Reference 4. This design utilizes various concentric graphite epoxy rims which are pre-stressed, thus allowing a smaller ID/OD ratio that can be achieved by only one rim.

GSFC CONCEPTUAL FLYWHEEL DESIGN

The conceptual design of an integrated flywheel energy storage system for spacecraft power application is depicted in Figure 6. This design consists of two counter-rotating wheels (for momentum cancellation) suspended magnetically at the inner radius of the "thick rim" composite rotor, and including an integral permanent magnet, ironless

armature, brushless dc motor/generator. Stationary components would include the stator windings for the motor/generator, control windings for the magnetic suspension, and the necessary electronics. Most of the heat would be generated within the stationary housing, and thus heat extraction is not a serious problem. This design approach is a radical departure from the configuration shown in Figure 1, but represents an attempt to eliminate the problems of power transmission through shafts, reduce gyroscopic loads on shaft bearings, and maximize high energy density potential of the rim with high volumetric efficiency by utilizing the volume of the "hole" in the middle. Critical technologies associated with a successful design of this integrated flywheel design are the following:

- thick rim composite rotor
- magnetic suspension of rotating mass
- high efficiency motor/generation employing permanent magnet, ironless armature, brushless dc motor technology
- M/G electronics to provide for motor/generator interface and speed control
- safe containment of the rotating mass.

BENEFITS COMPARISON

A comparison study was conducted to evaluate the benefits/merits of an inertial storage power system with an electromechanical storage system. This study was conducted by performing a "point" design for a NiCd, NiH₂ and inertial energy storage based systems. The system configuration selected for all three is the series system employing a peak power tracker series element. Results of this point design are tabulated in Table I for comparison. The inertial energy storage system exhibits potential improvements in all categories, with the important note that care must be taken to ensure attitude control system compatibility. The high momentum inherent in energy storage wheels requires careful control and thus provides an attractive alternative approach to combine attitude control functions with the energy storage wheels.

INTEGRATED ATTITUDE CONTROL ENERGY STORAGE

An attractive concept for combining the functions of energy storage and attitude control functions was described by Henry Hoffman at the Integrated Flywheel Technology Workshop at GSFC on August 2, Reference 7. Theoretically, one wheel only provides energy storage and impacts the attitude control system; two wheels provide energy storage and one-axis attitude control; three wheels provide energy storage plus two-axis attitude control; and four wheels provide energy storage and three-axis attitude control. Thus, a minimum of four wheels are required to perform four functions; energy storage and 3-axis control. More than four wheels provide for redundancy configuration and modularity. A conceptual drawing of the required four wheel in a tetrahedral configuration (no axis colinear) is illustrated in Figure 7. The fundamental control law for any given number of wheels with non-colinear axis is given as:

$$\begin{pmatrix} X_1 & X_2 & X_3 & \dots & X_N \\ Y_1 & Y_2 & Y_3 & \dots & Y_N \\ Z_1 & Z_2 & Z_3 & \dots & Z_N \\ \omega_1 & \omega_2 & \omega_3 & \dots & \omega_N \end{pmatrix} \begin{pmatrix} T_1 \\ T_2 \\ T_3 \\ \vdots \\ T_N \end{pmatrix} = \begin{pmatrix} T_X \\ T_Y \\ T_Z \\ E \end{pmatrix}$$

CONCLUSIONS

The application of inertial energy storage for a spacecraft power system relies on the key characteristics of the energy storage element. Power distribution (ac versus dc), power system configuration, performance, and system compatibility have been evaluated on the basis of the conceptual flywheel system design (developed at GSFC and referred to as the "Mechanical Capacitor") consisting of two counterrotating composite rotors, suspended magnetically at the inner diameter and accelerated/decelerated by a PM brushless, ironless dc motor/generator contained within the stationary inner volume. This energy storage element exhibits characteristics similar to those of an electrochemical energy storage element, which makes it an almost one-for-one replacement. Ac power distribution is not found to be advantageous since the inertial energy storage element does not exhibit the desirable characteristics required by an ac power distribution system. The power system configuration selected is identical with state-of-the-art systems using electrochemical energy storage. A unique system configuration identified incorporates the main functions of power conditioning within the energy storage element, reducing the system component count from three to two, namely solar array (1) and energy storage (2). Performance is highlighted as long lifetime (20 to 30 years), high temperature waste heat rejection, simple state-of-charge detection and control, inherent high-voltage implementation, high-pulse power capability, higher energy density (Wh/kg) than NiCd, and higher volumetric density than NiH_2 (Wh/m³). These features, although potential, make inertial energy storage a significant improvement over electrochemical systems. Compatibility with other systems is found to be adequate, with the recognition that momentum disturbance to the attitude control systems must be precisely controlled or alternatively used for attitude control as well.

Self-discharge, or energy storage efficiency, containment, and launch restrictions are three areas that require careful consideration in the intended application. For example, in LEO applications the self-discharge of the inertial energy storage element does not significantly affect the overall system performance. In unmanned vehicles, containment requirements would be less demanding than in manned vehicles. Spacecraft acquisition during launch may require electrochemical energy storage in a launch mode in which the energy storage wheels must be "locked."

Combined application of inertial energy storage and attitude control functions has been the focus of attention in two reported studies, one by NASA/Langley Research Center (LaRC) in 1974 (Reference 8) and the other by the European Space Agency (ESA) in 1978 (Reference 9). Both reports find the combined functions to be feasible and result in conceptual designs and methods to accomplish the objective. The NASA/LaRC study effort progressed to the development of inertial energy storage hardware using titanium for the wheel and conventional bearings. The ESA study has not proceeded to the development of hardware but identifies the merits of magnetic bearings and composite rotors. In either case, the subject of inertial energy storage for spacecraft application remains a "study" effort, and until competitive hardware is developed, its application will remain on paper. Since the inertia required for energy storage is significantly larger than that required to perform attitude control functions, a conservative program (and lower risk) to undertake is to develop the fundamental inertial energy storage hardware. Once developed, the hardware application will follow, for if it is to be used in power systems, it must be controlled, and if it must be controlled, it should be used for attitude control as well.

The mechanical capacitor conceptual design considered in this feasibility study is based on three key technologies, two of which are well developed and have been demonstrated, but yet remain to be used in flight hardware. These two technologies, magnetic bearings and dc PM ironless armature, brushless motors, ideally suited for use in momentum wheels for attitude control, do not exist in the list of flight-approved hardware. Conventional bearings and ac motors, presently used in most momentum wheels, do not offer the high performance required for an inertial energy storage system to be competitive with electrochemical systems. Conceivably, if a flywheel system as conceptually described can be successfully demonstrated, it would facilitate or encourage the use of these two technologies in momentum wheels. On the other hand, if these two technologies existed in present flight hardware, a significant data base would have been available to substantiate the feasibility of inertial energy storage. However, the key single most critical technology is the high-speed composite rotor, which, although significant progress has been achieved within the last two years, requires further development, verification, and system implementation.

In terrestrial applications, inertial energy storage becomes competitive over electrochemical systems from a "maintenance free" consideration. Similarly, in spacecraft applications, long lifetime is the key advantage of inertial energy storage over electrochemical storage. To realize this, successful integration of the critical technologies identified must be pursued.

During the last few years, flywheel technology was supported primarily by the Department of Energy, and is now terminated. Recent results obtained by the General Electric Company under this program are very encouraging in that they support the assumptions used for energy density capability in this study. In addition, results on cyclic testing have verified 10^4 cycles, which is one order-of-magnitude improvement over past performances and approaches the potential cycle life of 10^5 cycles referenced in this report.

RECOMMENDATIONS

Significant potential advantages of inertial energy storage for spacecraft power systems as identified warrant the development of hardware to a proof of principal stage. To accomplish this, a sizable commitment in resources is required to demonstrate a complete power system. At a minimum, the development of a suitable composite rotor should be pursued with less risk involved at the expense of a longer time span in achieving the proof of principal hardware. Magnetic suspension and motor/generator development should be accomplished together, following demonstration of a successful rotor design. Verification of the fundamental energy storage function would occur when the rotor, suspension, and PM motor/generator are integrated as one. After the energy storage function has been demonstrated, the next step would be attitude control compatibility verification. The development and demonstration of a complete power system would be the final phase.

The following program has been suggested and recommended to OAST. The objective of the program is to develop a prototype magnetically suspended reaction wheel to perform both energy storage and one axis attitude control of momentum and torque. This program is based on negligible return from further paper studies and the need to verify analytical study assumptions.

The following system technologies and goals are recommended:

- high energy density composite hubless rotor with an ID/OD ratio of ≈ 0.5 yielding a maximum operational energy density of 50 W hr/kg and an energy storage capacity of 1.6 kw hr. (75% DOD)
- magnetic suspension of the hubless rotor to yield low standby power consumption and low high-speed losses at 40 KRPM.
- permanent magnet, ironless armature, brushless dc motor/generator with 3 ϕ stator windings sized for a 2.5 kw nominal power rating, peak 7.5 kW at 250 Vdc, and yielding better than 95%
- power conditioning electronics for the motor/generator, yielding a power efficiency of better than 95% and capable of providing speed control for both bus regulation and momentum control.
- integration of the above to perform in a LEO space environment corresponding to 10^5 charge/discharge cycles at 75% DOD.

REFERENCES

1. Kirk, J. A., P. A. Studer, and H. E. Evans, *Mechanical Capacitor*, NASA/GSFC TN D-8185, November 1975.
2. Michaels, T. D., E. W. Schliebin, and R. D. Scott, *Design Definition of a Mechanical Capacitor*, Final Report, NASA/GSFC, May 1977.
3. Scott, R. D., *Mechanical Capacitor Energy Storage System*, RCA, Advanced Technology Laboratories, Final Report, NASA CR-170613, February 1978.
4. Kirk, James A., "Flywheel Energy Storage—I Basic Concepts," *Int. J. Mech. Sci.*, Vol. 19, January 1977, pp. 223-231.
5. Kirk, James A., "Flywheel Energy Storage—II Magnetically Suspended Super Flywheel," *Int. J. Mech. Sci.*, Vol. 19, January 1977, pp. 233-245.
6. Slifer, Luther W., Jr. *Initial Guidelines and Estimates for a Power System with Inertial (Flywheel) Energy Storage*, NASA/GSFC TM 82134, December 1980.
7. Integrated Flywheel Technology, *Proceedings of Workshop*, Aug. 2,3, 1983, NASA Conference Publication 2290.
8. Notti, J. E., A. Cormack III, and W. C. Schmill, *Integrated Power/Attitude Control System (PACS) Study*, Vols I & II, NASA Contract Report, NASA CR-3383, April 1974.
9. Guyen, N., H. Nahia, and Marian Francois, *Study of System Implications of High Speed Flywheels as Energy Storage Devices on Satellites*, MATRA Note No. 30/1020, ESA Contract No. 3261/77/NL/AK, October 1978.

Table I

BENEFITS COMPARISON

(For 3 kW, 250 Vdc LEO S/C Power System)

	NICD (SOA)	NIH ₂ (Projected)	Flywheel (Projected)
Lifetime (yr)	5	5	20
DOD (%)	25	40	75
*Energy Density (W hr/kg)	5.5	13.9	17.6
*Volumetric Energy (kW hr/m ³)	8.2	7.2	20.8
Voltage Regulation (±%)	14	14	2
Thermal Constraint (°C)	0 to 20	0 to 20	-25 to +50
High Voltage	Many series cells	Many series cells	Easily accommodated (M/G design)
Charge Control	Complicated	Pressure sensing may simplify	Wheel speed affords easy detection and control
Launch Constraint	None	None	Wheels locked
Compatibility with ACS and structure	No interaction	No interaction	Critical – differential speed control required – balance Benefit – perform ac function

*Usable

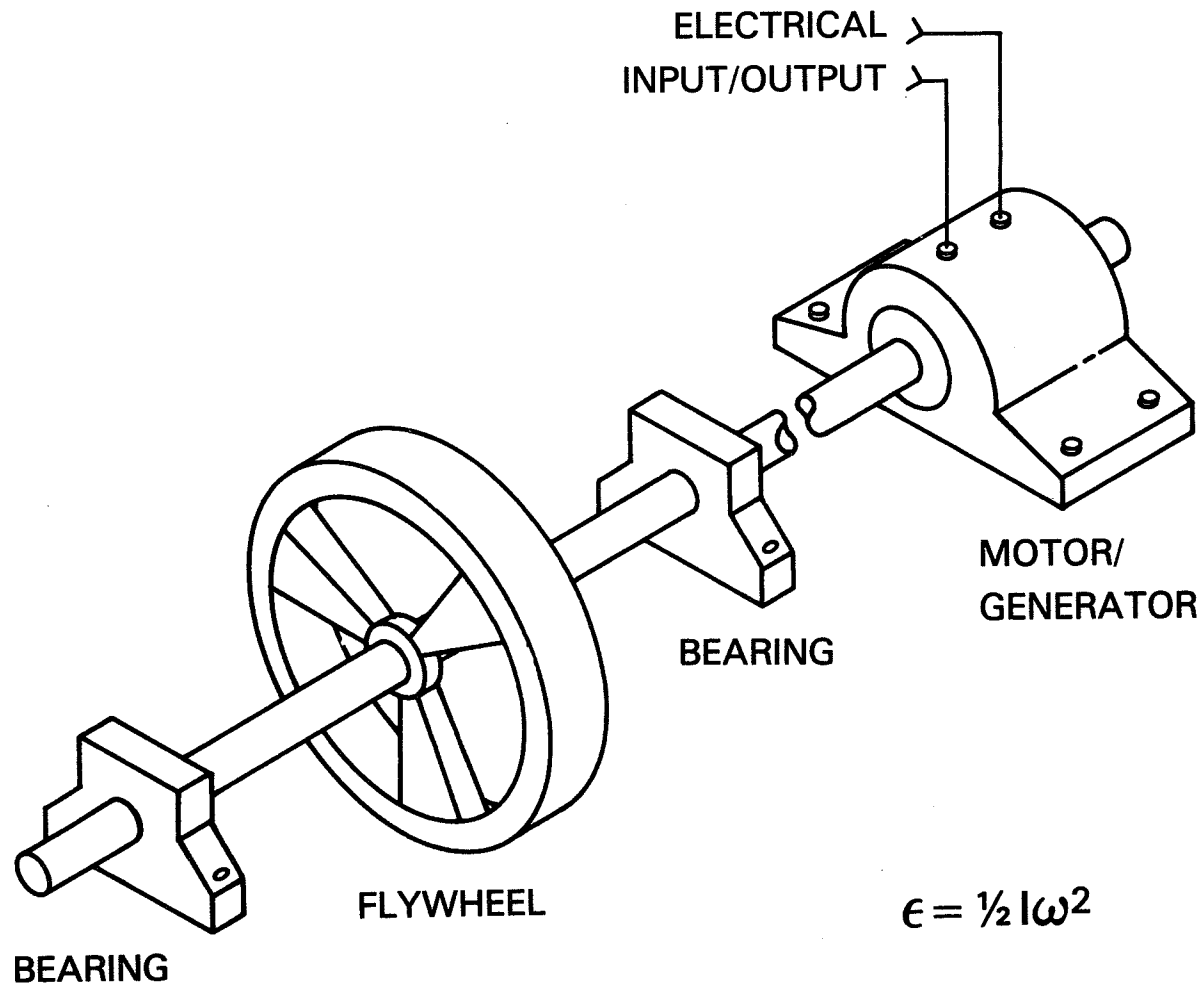

Figure 1. Inertial Energy Storage Element

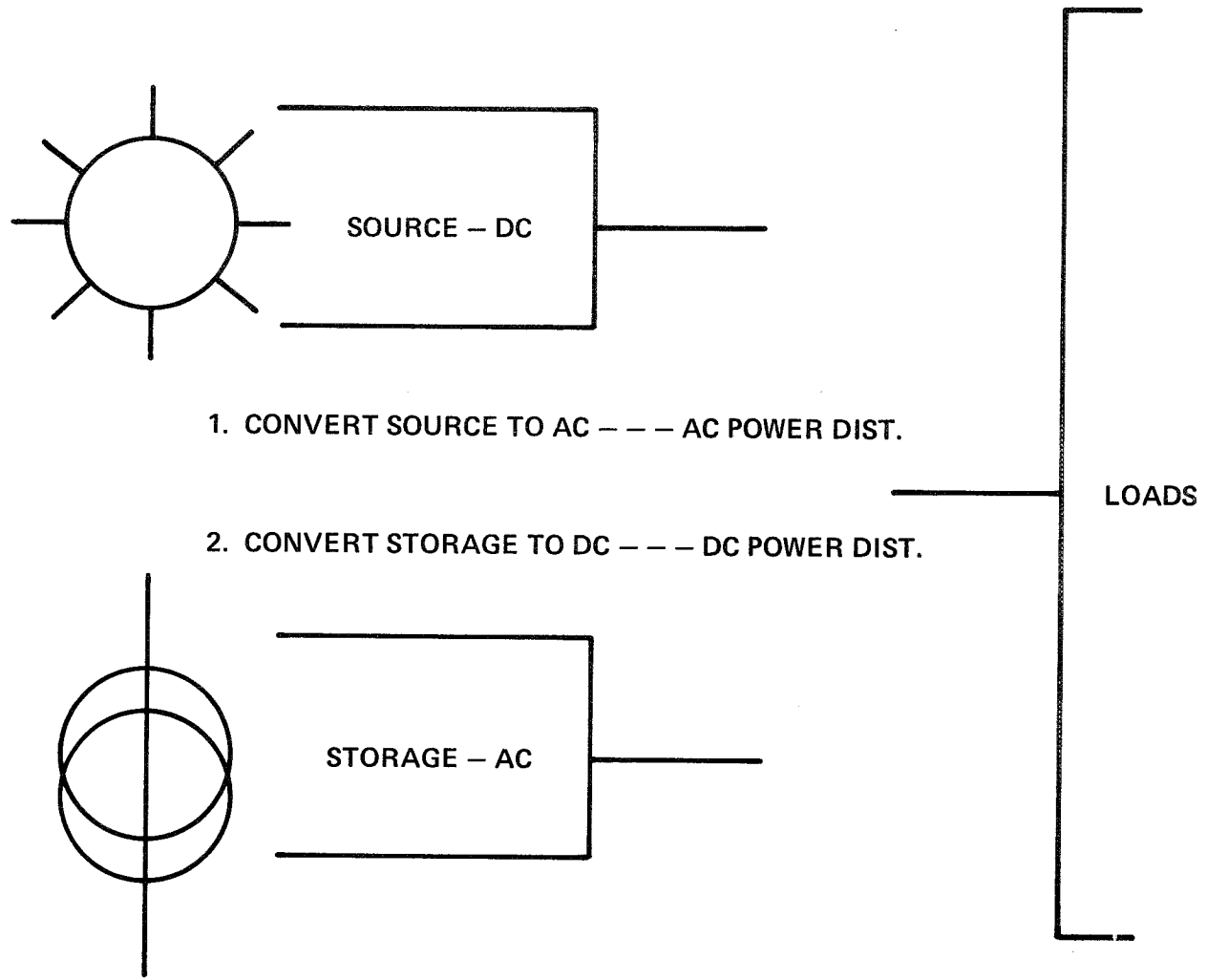

Figure 2. Power System Distribution Alternatives

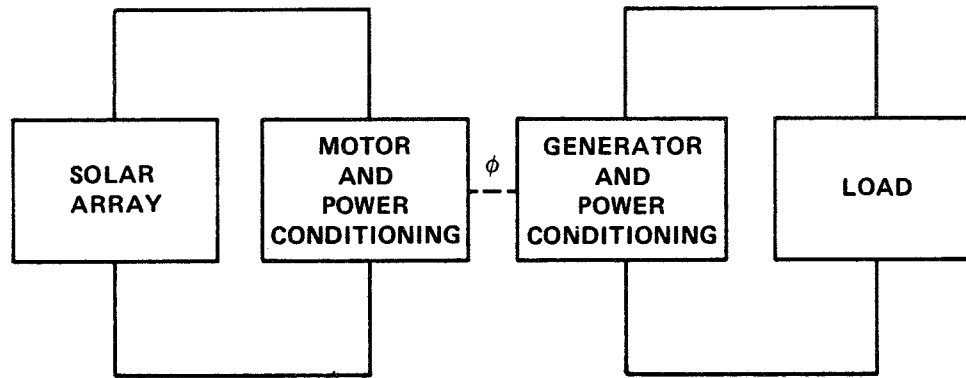

Figure 3. Peak-power-tracker, Regulated Bus System

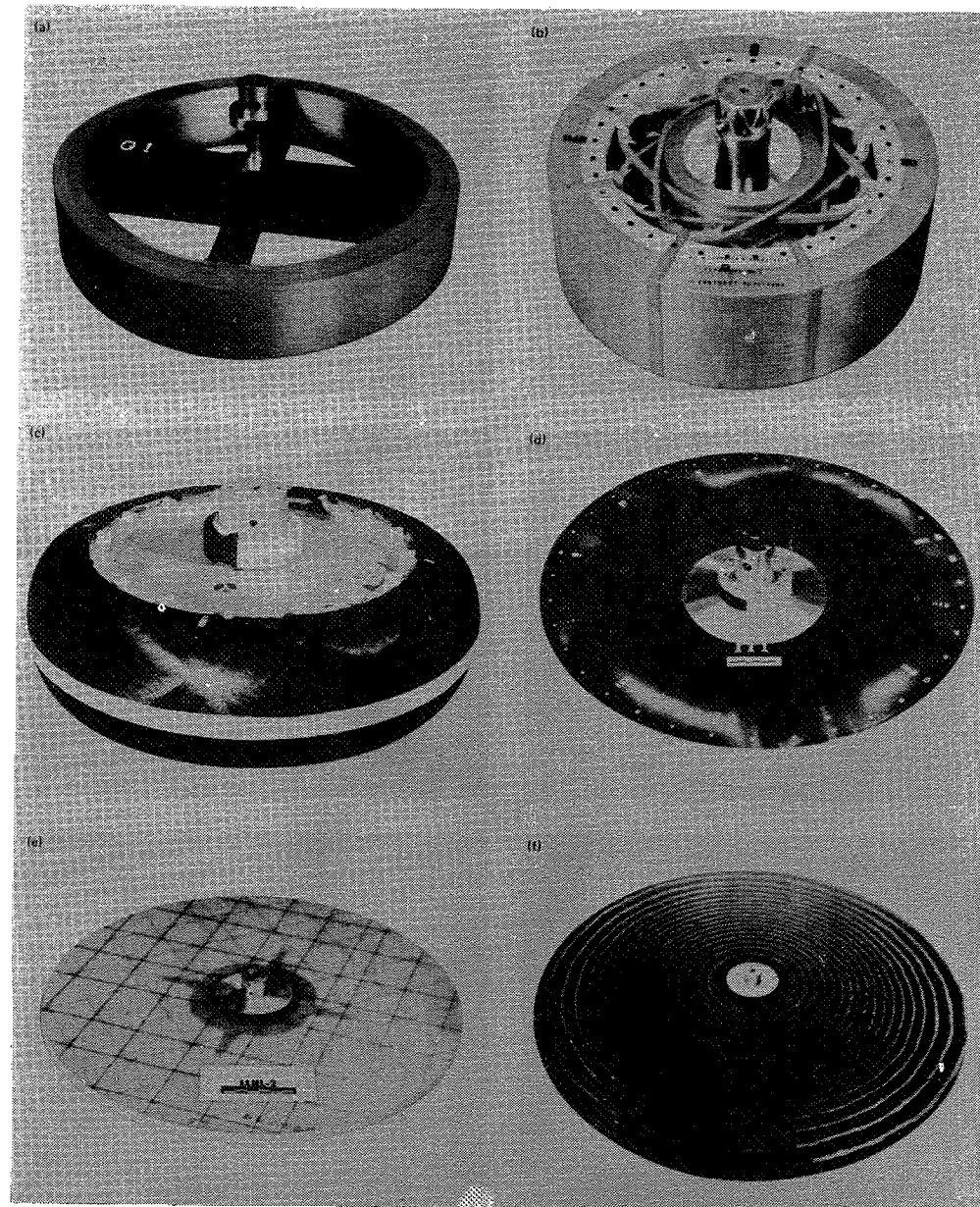

Figure 4. Composite Rotor Designs, DOE/LLNL

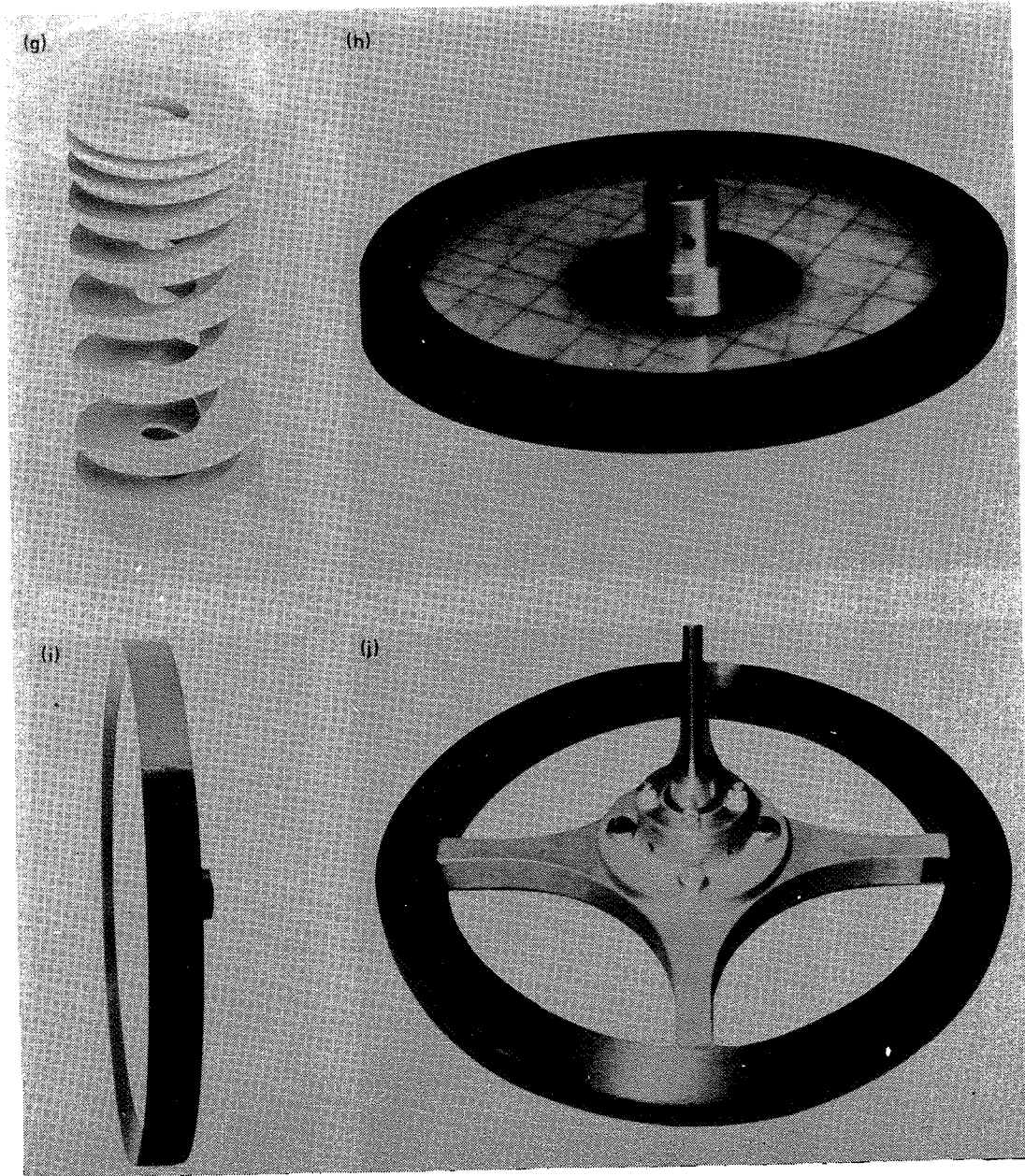

Figure 5. Composite Rotor Designs, DOE/LLNL

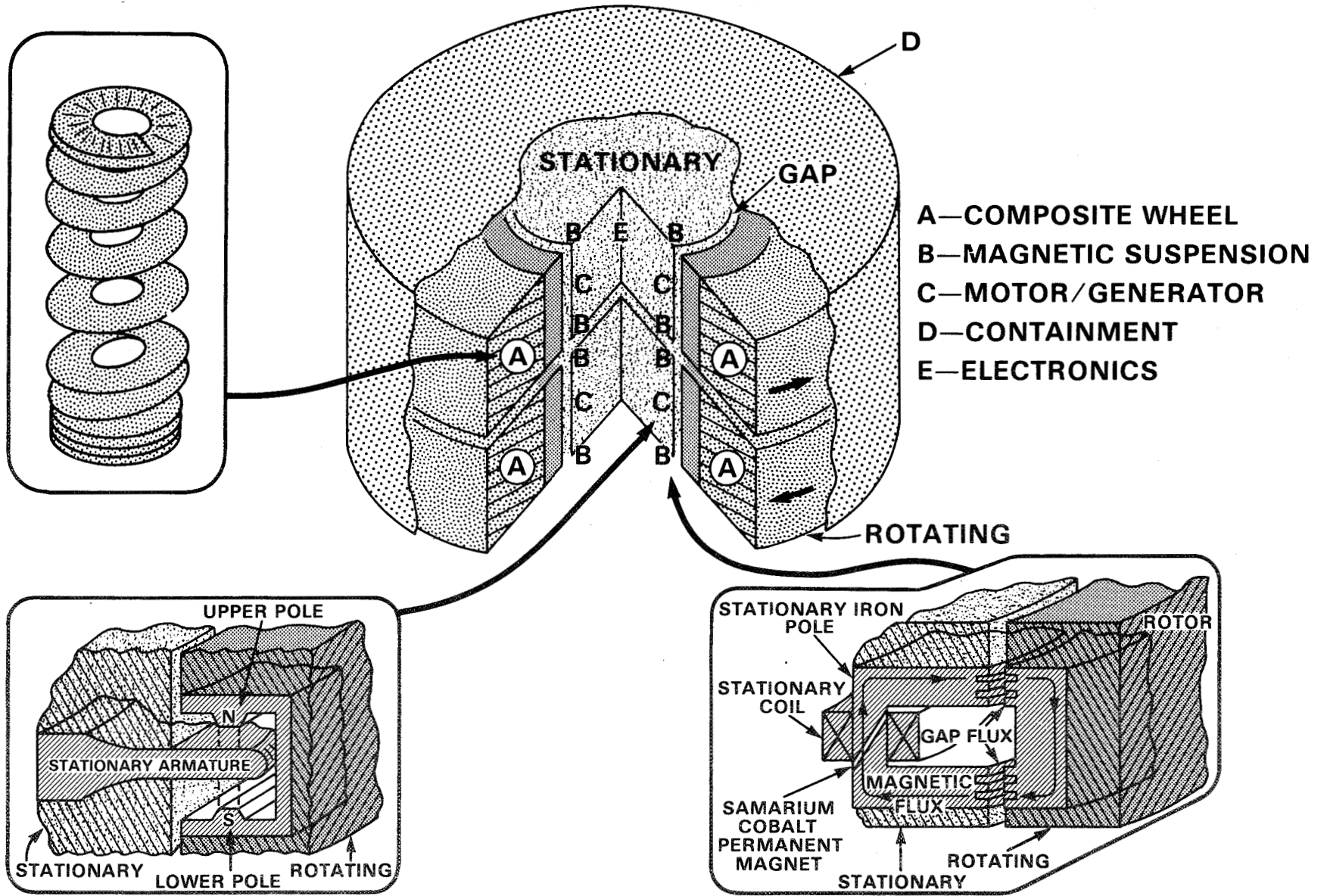

Figure 6. Conceptual Spacecraft Power System Flywheel Design

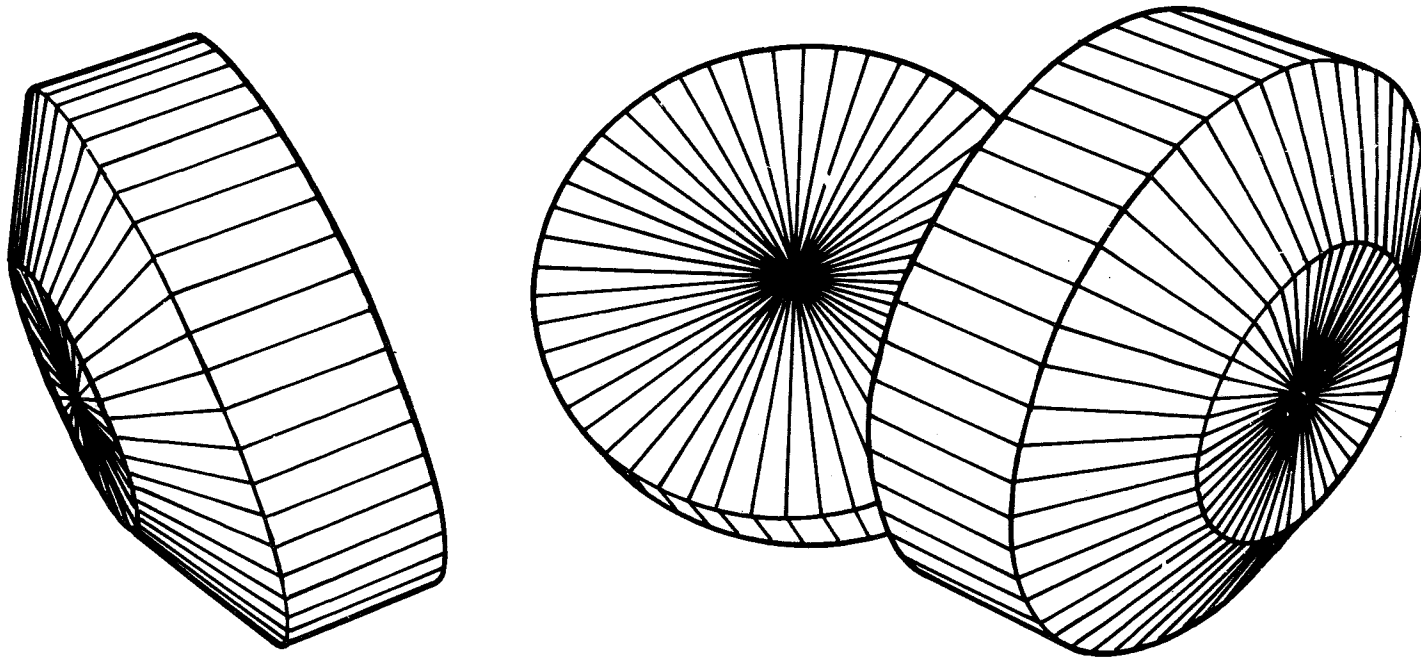
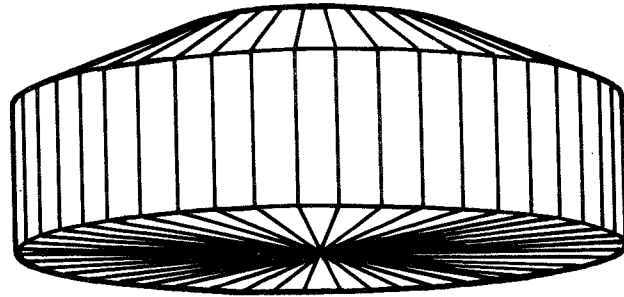

Figure 7. Four Wheel Tetrahedral Configuration for 3-axis Control and Energy Storage

SESSION I

DISCUSSION

- Q. Galassi, Hughes Aircraft: When you figured out the number of storage devices you needed, did you base your analysis on a three axis vehicle versus a spin-stabilize vehicle?
- A. Rodriguez, GSFC: Well, no. We're not talking about a spin-stabilized vehicle. It's just for a typical three axis control vehicle.
- Q. Galassi, Hughes Aircraft: If you did do any analysis on a spin stabilized, if you put it at the center of spin or the axis, could this be also used in that capacity and that type of vehicle?
- A. Rodriguez, GSFC: Oh, yes I'm sure it could be.
- Q. Somoano, JPL: What is it exactly that limits the cycle life?
- A. Rodriguez, GSFC: Well, one of the things that limits it is the stress. The wheel is the fiber composites at this point in time, the stress is an unknown item. The wheel that was tested at Lawrence-Livermore that GE developed, for example, that wheel was tested for 10^4 cycles. So, we know that wheel capability is up to that point you can do that. 10^5 cycles is, as I have demonstrated here, a limit that we think can be achieved. But it is just basically stress-fatigue of the material - just up and down, up and down, and it wears out. If it wasn't for that, we could perhaps conceive a much greater lifetime.
- Q. Milden, Aerospace: How much and how long - how much would it cost to have flight quality hardware, thing number one, thing number two - how long would it take to get flight quality hardware?
- A. Rodriguez, GSFC: That's a tough question. We anticipate about four to five years before we have a proof-of-concept type of a unit because we're talking about a rather unique approach in here where you have two systems that are interacting that need to be resolved. There's a lot of interactions going on. In terms of how much, I'm not quite sure whether you're addressing the actual cost once the design is developed or to develop that design. Could you perhaps clarify. I don't visualize the flywheel system itself as any more costly than typical electrochemical systems to date. But in terms of developing, of course, there's a considerable development cost.

- Q. Question inaudible.
- A. Rodriguez, GSFC: Okay. In the conceptual design that we have, the wheels rotate around 30-40 thousand revolutions per minute. That's your max speed.
- Q. George, MSFC: The question of speed brings to mind the diameter that you're talking about. The earlier effort on a magnetically suspended wheel, if I remember correctly, was rather large - six feet in diameter and it was humming along about 7,000 rpm's. What are you talking about here?
- A. Rodriguez, GSFC: Well, the wheel that we have - a conceptual design for the time being is 20 inches outside diameter, 10 inches inside diameter. So the magnetic suspension would occur perhaps at a diameter of 10 inches. I think you might be talking about the AMCD that was developed at Langley? Goddard? It is a 5½ foot diameter wheel. However that wheel was principally for momentum control. It's a little bit different concept but still the same basic fundamentals are there. You have the magnetic suspension at three different points on that wheel. I believe you're right. It's about 3,000-4,000 rpm's. We're talking about a much smaller wheel.
- Q. Miller, McDonald-Douglas: I was wondering what is the principal failure mode of such a wheel? Is it disintegration? And if it is, how do you get this past your safety people?
- A. Rodriguez, GSFC: The failure mode of the wheel depends on the wheel design itself. You can design them in different modes. One of the attractive features is that if you design in such a way that the outer fibers begin to fail first, then you have what we call a safe containment. It doesn't blow up or it doesn't fragmentize like a metallic wheel does. So we feel that the containment issue is easier handled with this kind of a design.
- Q. Miller, McDonald-Douglas: In other words it kind of eliminates from the outer edge?
- A. Rodriguez, GSFC: Yes, correct.
- Q. Gross, Boeing: Ernie, what did you calculate the power consumption for the magnetic bearings to be for this design?
- A. Rodriguez, GSFC: Let's see, I remember there is a number that Dave Eisenhower published in the paper and I don't recall the exact number. I think it's 1/10th of a watt per pound or something of that nature. If you check with me later, I'll give you a reference on that article and you can look it up. It's pretty well documented.

- Q. Colburn, Lockheed: It appears you're mixing together an attitude control system and a power system and the common ground is the static reaction wheels or momentum storage wheels. Have you done any analysis on the requirements of a reaction wheel used in an attitude control loop versus what the power system requirements are? It seems to me, you made the assumption that these two common pieces of hardware are compatible in two somewhat different roles. Have you investigated that any?
- A. Rodriguez, GSFC: Well, we really haven't gotten into the attitude control function in a whole lot of detail. But, I believe I could say that, yes, we looked at it. The energy storage wheel that we're talking about here has a momentum capacity of roughly 9,000 newton meters/seconds and the typical reaction wheel that is used, let's say, on the MMS spacecraft as, for example, is only 20 newton meters/seconds. So, you're talking about two orders of magnitude difference just in momentum. So, the point is that the wheel is needed for energy storage not for attitude control. The attitude control system doesn't need a wheel anywhere near this size. We need it for energy storage for the power system and, as long as it's there, then why not use it for the attitude control system function? The other area that we looked at is the task capability of the wheel and we really haven't gotten into that too much, but I think you can perform both the momentum control and the task capabilities that are required by the attitude control system by sizing the wheel for energy storage. Oh yes, one of the things that happened this summer - we had a flywheel technology workshop here at Goddard where it was primarily attended by colleagues within NASA and DOE. But the two items that were considered there were the attitude control and energy storage functions as a system.
- Q. Question inaudible.
- A. Rodriguez, GSFC: Okay. That's a good question. Did everybody hear the question, he wants to know how does the magnetic bearings compare with what I'm talking about here and the system that the Lincoln Labs designed, I believe. A fellow by the name of Milner, I think, designed a system that was a one kilowatt-hour wheel. If you looked at my earlier view graph where I had a shaft and a motor and bearing and that kind of a concept - that's the kind of concept that Lincoln Labs designed. They essentially had a wheel hanging on the end of a shaft, and then they had magnetic bearings to support that shaft and that mass, and a permanent magnet-motor generator to turn the whole shaft. So essentially the elements that I'm talking about they have designed but in a different configuration. One of the things that I think Phil Studer emphasizes with the magnetic suspension is that when you try to design magnetic bearings where you're going to have to have at least two on the end of a shaft, you're going to get into some pretty stiff problems because of tasks

- A. Rodriguez, GSFC (Con't): on those bearings. So what he is proposing is that the magnetic bearing be in the center of a wheel rather than out on the ends of a shaft. Move the bearings towards the center. Maybe that wasn't too clear in the concepts that I showed here. You can do it either way. Now I showed perhaps the magnetic suspension on the top and bottom portion of the inside of the rim but you could also put it right in the center. The concept then is to move the magnetic bearings toward the center.
- Q. Koehler, Ford: In the case of a multi-wheel system, if one wheel fails does that mean an immediate failure of the satellite?
- A. Rodriguez, GSFC: Well, yes with the minimum four wheel system that I proposed - yes. If you had failure with the one wheel you would lose some control and it most likely would be failure of the mission depending on the particular mission in mind. But the approach to have redundancy would be to have more than four wheels. So your minimum requirement is four wheels.
- Q. Roth, NASA HQ: I'm just wondering for the uninitiated, what are you doing here that's different specifically from what's been done in the past? I mean we've kind of been beating around all that.
- A. Rodriguez, GSFC: Well I believe what's been done in the past if you're referring to the IPAX that Langley developed.
- Q. Roth, NASA HQ: Anything over the last 10 or 20 years. What makes this stand out or makes it unique from any of the other work?
- A. Rodriguez, GSFC: Basically it doesn't exist. There is no hardware that utilizes a composite wheel for the high energy density - number one. There is no system that I know of that uses the magnetic bearings that I just talked about. There is no motor generator design that I'm aware of in this kind of a system. So those three things exist independently by themselves, but they don't exist in an integrated system. And I believe that for a spacecraft application, you have to have all these three things integrated. The design of the motor generator is not a straight-forward design. The design of the magnetic bearings is not straight-forward. They all have to be interleaved because the rotating dynamics of that mass makes them involve each other quite extensively. So I believe that's perhaps why we're all at where we're at, because basically the technology is there, it just has to be put together.
- Q. Jagielski, GSFC: Ernie, you were talking about the power density of the flywheel. Was that specifically for just one flywheel - just for one single axis, and if you were talking about redundancy how would that alter the power density of the flywheel system?

- A. Rodriguez, GSFC: Yes, I talked about a power density of say $2\frac{1}{2}$ kilowatts - $7\frac{1}{2}$ kilowatts. That would be for a pair of wheels. That was our original concept when we got into the study, and that is signed for a payload - spacecraft payload of 3 kilowatts. Now if you have a different application where the power is higher or lower then you would have to size your wheels accordingly. Does that answer your question Jim?