

SOME EFFECTS OF DIGITAL SAMPLING ON
ORBITER FLIGHT CONTROL SYSTEM OPERATION

S. V. Murray
NASA Lyndon B. Johnson Space Center
Houston, Texas

ABSTRACT

An entry dynamic stability ground test of the OV102 Space Shuttle Orbiter revealed some small amplitude oscillatory output of the flight control system which could have constrained flight of the STS-1 mission. These limit-cycle-type outputs were attributed to a combination of rigid body motion of the Orbiter on its landing gear (not a factor in flight) and some interesting effects of its digital flight control system. These effects included frequency aliasing and phenomena associated with digital quantization of low-amplitude sensor signals. An understanding of these digital effects suggests some significant improvements possible in future designs.

INTRODUCTION

The Space Shuttle Orbiter employs a sophisticated variable gain, closed-loop, digital flight control system, designed to operate over a very wide range of flight conditions. A number of redundant sensors are used, including rate gyro assemblies (RGA's), accelerometer assemblies (AA's), and inertial measurement units (IMU's). Data from these and other sensors are processed by the digital autopilot (DAP) algorithms in the Shuttle's general-purpose computers (GPC's). Desired commands are then sent to the flight control effectors, which include main and OMS engine gimbals, elevons, body flap, speedbrake, and rudder. Unlike previous autopilot designs, the Shuttle cannot be flown open loop. Even in manual modes, the sensor-computer-effector loop remains unbroken; the control stick merely replaces automatic guidance as one of the many inputs to the control system.

In designing the DAP software for the GPC's, both the desired effectiveness of the control effector in controlling the Orbiter state and the undesired effect of effector motion feeding back through the Orbiter structure into the sensor had to be considered. For example, an abrupt movement of the elevons causes a structural vibration which produces a nontrivial feedback from the rate gyros. Designing the control system, then, required an accurate understanding of the Orbiter's structural dynamics and the incorporation of appropriate digital filters to reduce these effects.

HOT FIRE TEST

Since it is difficult to predict the structural dynamics of a vehicle to a high level of accuracy by analysis only, verifying the dynamic stability of the flight control-structural system was an obvious candidate for vehicle tests. U.S. Air Force specifications require automatic flight control systems to demonstrate a gain margin of at least 6 decibels during ground tests (ref. 1). A gain margin test was first conducted on OV102 in November 1979 as part of the APU hot fire at the Kennedy Space Center. This closed-loop test was conducted with the software in major mode 305 (terminal area energy management - from Mach = 2.5 through rollout). The forward loop gains were patched to be 6 decibels higher than nominal, and pulse-type programmed test inputs were applied. The result was a 3.6-hertz oscillation in the roll axis coupled by the first fin-bending mode through the roll rate gyro into aileron motion of the control surfaces. Amplitude was limited by the control surface rate limit in the software. It was also surprising to find that yaw rate gyros 1 and 2 were responding at 6.5 hertz and yaw rate gyros 3 and 4 responding at 3.6 hertz. Figure 1 illustrates these motions. Figure 2 shows the different mounting locations for gyro packages 1 and 2 up on the fuselage side frames. These side frames were twisting in yaw and the first wing bending mode frequency (6.5 hertz) during the coupled 3.6-hertz limit cycle. These findings resulted in changes to the Orbiter structural model, a corresponding redesign of the bending filters in the DAP software, and a relocation of RGA's 1 and 2 as shown in figure 2.

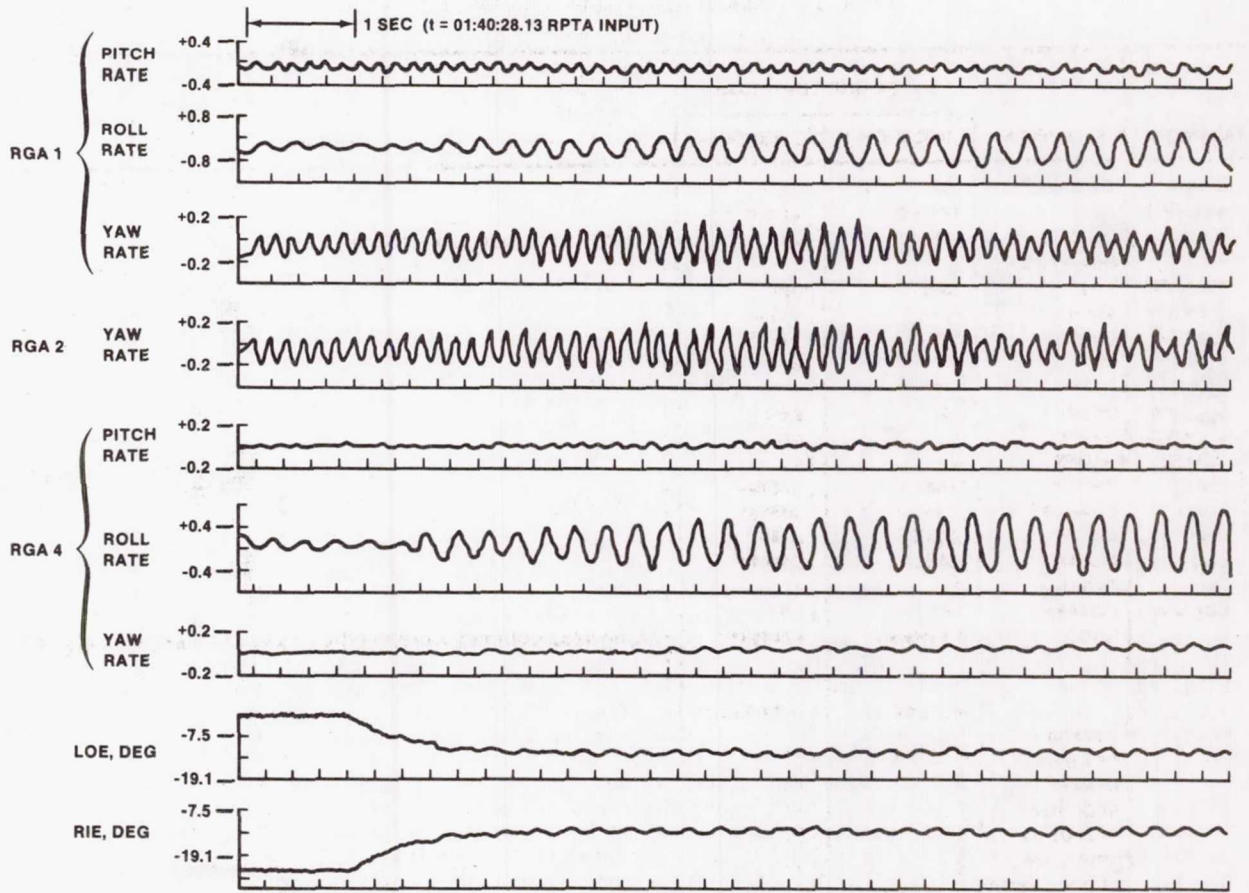

FIGURE 1.- HOT-FIRE TEST DATA (+6 dB GAIN).

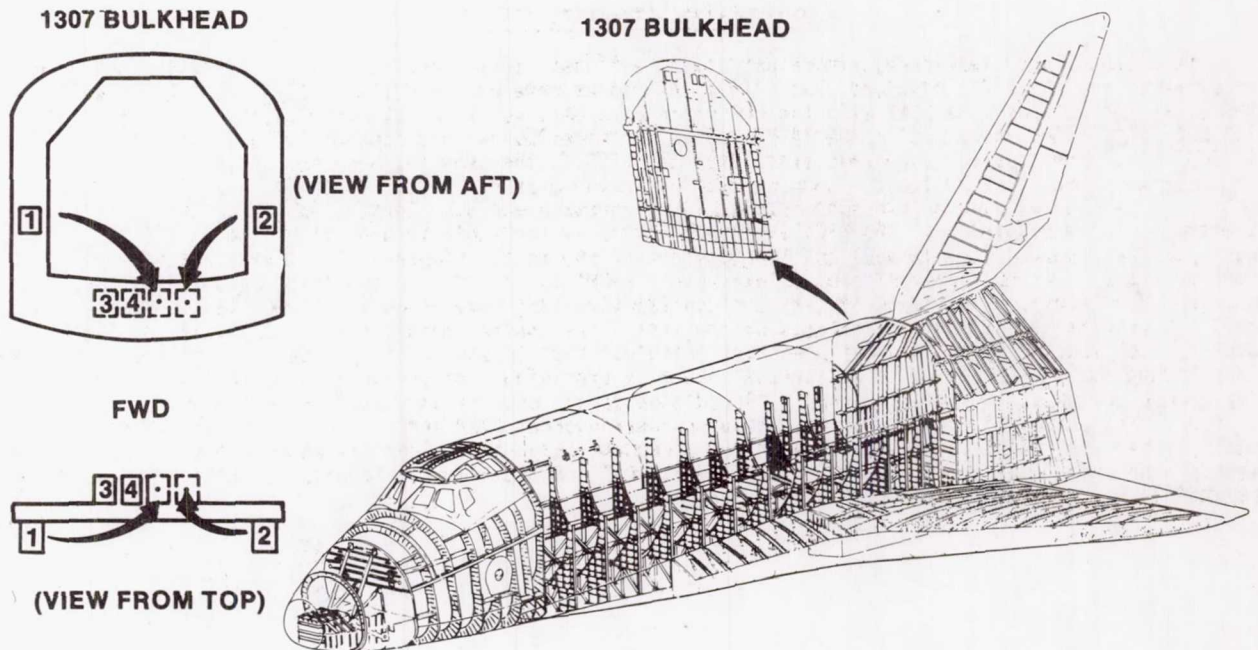

FIGURE 2.- RATE GYRO RELOCATION.

ORIGINAL PAGE IS
OF POOR QUALITY.

TABLE 1.- EDST FLIGHT CONDITION IDENTIFICATION

PARAMETER	FSSR NAME	FLIGHT CONDITION		COMMENT
		CONDITION 1	CONDITION 2	
MACH	MACH	3.4	0.6	*SET TO FORCE GDQ, GDA TO LIMIT VALUE
ALT, FT	ALT	114,000	41,000	
\bar{q} , PSF	QBAR	85°	90	
	REL-VEL-MAG			
TAS, FPS	TAS	3535	581	
α , DEG	ALPHA	20	13.6	
θ , DEG	THETA	15.2	1.6	
ϕ , DEG	PHI	0	0	
α_c , DEG	DEFB	-7.7	-7.7	
α_{sb} , DEG	DSBC	5.0	5.0	
α_{bf} , DEG	DBFRC	0	0.0	*GAIN VALUE EQUIV TO "AUTO" WITH CSS OR GAIN ENABLE SELECTED
α_{pr} , DEG	DROFB	0	0	
SIN α	SINALF	.34202	.23514	
COS α	COSALF	.93969	.97196	
SIN θ	SINTH	.26219	.2792	
COS θ	COSTH	.96502	.99961	
SIN ϕ	SINPHI	0	0	
COS ϕ	COSPHI	1.0	1.0	
	GDQ	5.0 (MAX)	2.08284*	
		-7.7 DEG	-7.7 DEG	
	DETRIM	0	0	
	DATRIM	↑	↑	
	DRTRIM	↑	↑	
	ROLLOUT	↑	↑	
	FLATURN	↑	↑	
	WOWLON	↓	↓	
	GROUND STEER	0	0	

ENTRY DYNAMIC STABILITY TEST

Because of this experience, a more extensive test was planned, and successful completion would be required before the STS-1 mission. Two flight conditions were examined (table 1). The first was in the entry mode (major mode 304) with the DAP patched to believe it was at Mach 3.4 and an altitude of 114 000 feet. The second was in the TAEM mode (major mode 305) with a Mach of 0.6 and an altitude of 41 000 feet. For this entry dynamic stability test (EDST), the vehicle would be resting on its landing gear with the tires deflated. Shop hydraulics would be used instead of vehicle auxiliary power units. A patched version of the appropriate flight software would be loaded, and necessary vehicle systems would be powered up. The KSC launch processing system would be used to uplink flight software patches, command step inputs, and thereby control the test. Figure 3 illustrates the vehicle configuration. The multiplexer/demultiplexer units (MDM's), in addition to their obvious function, provided the necessary analog-to-digital and digital-to-analog conversions. It will be shown that this A-D process had significant effects on the test. The Shuttle modal test and analysis set (SMTAS) consisted of special test equipment used for sinusoidal test inputs, data collection, and reduction. Step inputs would be provided to excite the system by providing torque commands, normally used only for ground checkout, to the rate gyros. In addition to the closed-loop test, an open-loop test was planned. Here, the DAP commands to the actuators were disconnected and a sine wave substituted in their place. This signal was slowly swept from frequencies of 1 to 18 hertz, which allowed measurement of the actual aerosurface command to sensor to DAP command transfer functions. This test would be useful in understanding the closed-loop response.

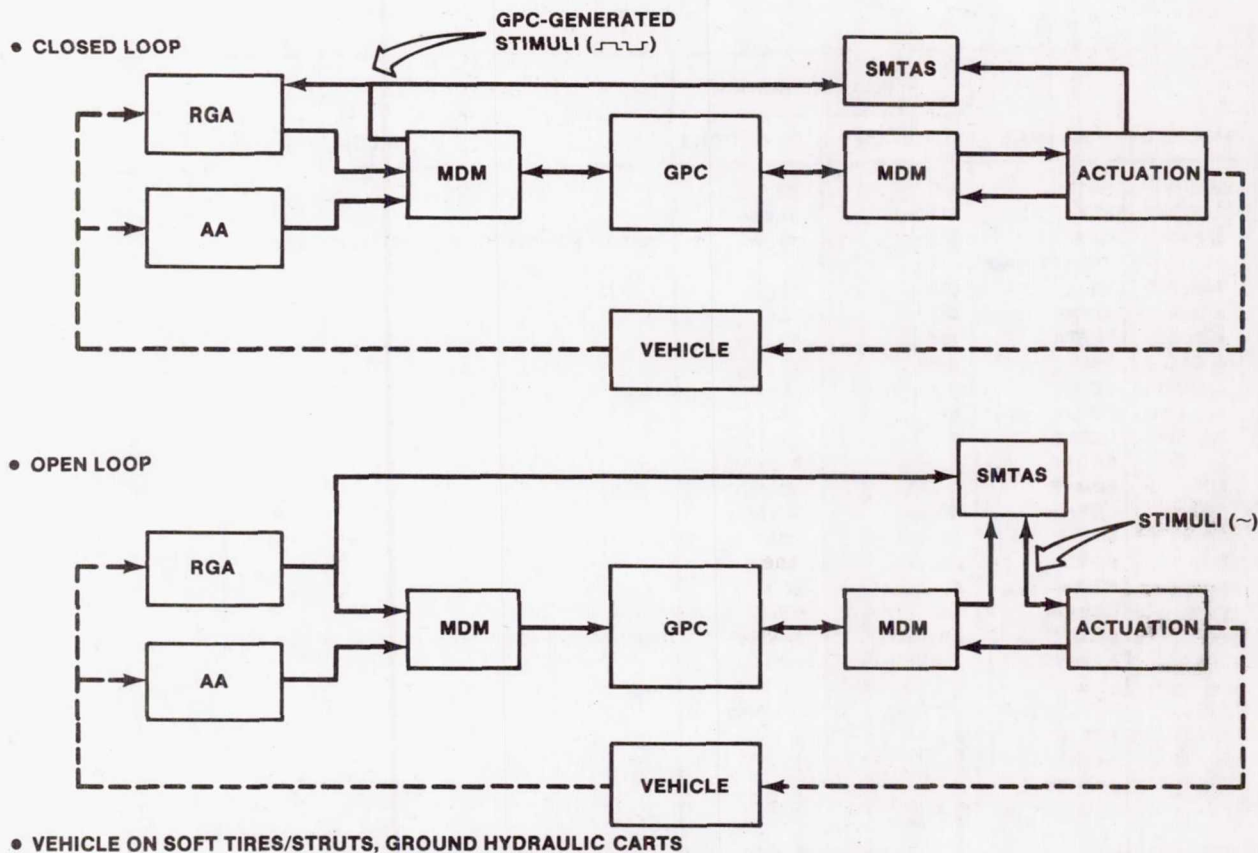

FIGURE 3.- OPEN- AND CLOSED-LOOP CONFIGURATIONS.

RESULTS

Consequently, the EDST was conducted on OV102 in August of 1982. The low-altitude (MM 305) case was stable and well damped at both nominal and +6 decibel DAP gains. The high-altitude case, at nominal gains before any test stimuli were applied, entered a sustained symmetric elevon oscillation of about 0.6 degrees peak-to-peak at 2.5 hertz. This had not been predicted pretest, but since the amplitude was small and the response to step input was damped, the test was continued.

When the gains were increased +6 decibels, an antisymmetric elevon oscillation of 3 degrees peak-to-peak at 2.5 hertz were encountered, again before any test stimuli were applied. This oscillation was a limit cycle, signifying that the elevon motion had reached the rate limit applied for hydraulic/mechanical considerations. To complete the test, the gains were backed down to +3 decibels above nominal in the roll and yaw channels, while being kept at +6 decibels in pitch. Here the oscillations continued but were symmetric, and the amplitude was limited to about 1 degree, less than the limit cycle. The response to step inputs was damped.

DISCUSSION

The results of this test caused concern about their potential impact to the STS-1 mission. Were these effects liable to appear in flight? Were they acceptable? If a significant redesign of the flight system were required, it would cause a very substantial impact to the whole STS schedule. These oscillations were attributed to two causes: (1) the interaction of the Orbiter with its suspension system (landing gear) and (2) a combination of effects unique to digital systems.

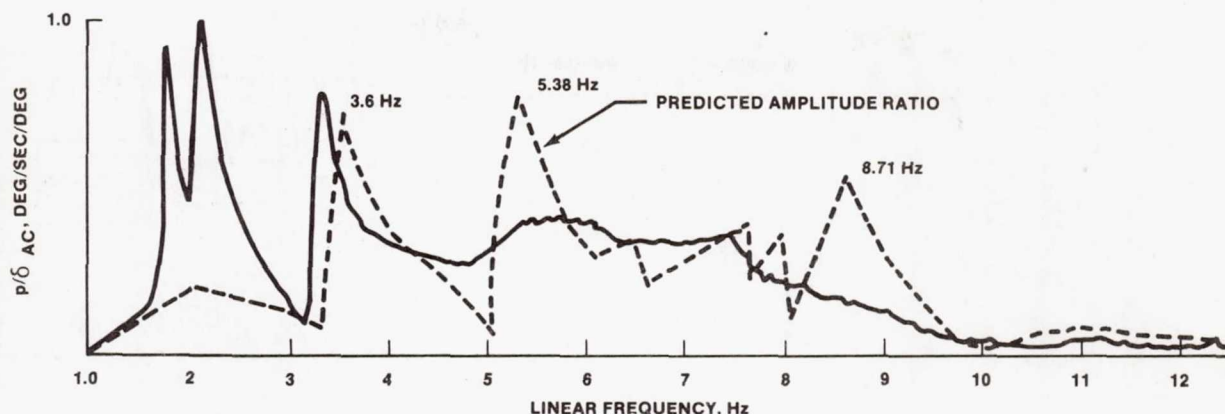

FIGURE 4.- PSA 3 ROLL TRANSFER FUNCTION PLOT
SWEEP 2-1 - AILERON ROLL.

The open-loop tests showed that the lower-frequency structural modes agreed very well with the models, but at higher frequencies they were much more heavily damped than had been predicted. The tests also showed that the rigid body mode of the Orbiter on its landing gear had a higher than predicted natural frequency, and, in the roll channel, a much higher than predicted frequency response. Figure 4 shows the predicted versus actual frequency response in the roll channel. This figure is a composite made from two frequency sweeps: one from 1 to 2 hertz, the other from 2 to 12.5 hertz. The second peak after 2 hertz is probably a start-up transient response reflecting the 1.9-hertz landing gear mode. This higher-than-predicted rigid body mode was the proximate cause for the +6 decibel antisymmetric instability. But why was this instability at 2.5 hertz instead of the 1.9-hertz rigid body mode? What caused the lower amplitude symmetric motion at the lower gains? For this, some digital effects which provided the real "lessons learned" should be examined.

These digital effects were the phenomena of frequency aliasing and the effects of digital quantization of small amplitude signals. Frequency aliasing is caused by the fact that a digital system can sense a signal only at discrete time intervals. The sampling theorem requires that the frequency of the signal being measured be no greater than one-half of the frequency of the sampling itself. The Orbiter's RGA's are sampled at 25 hertz. Thus, the highest frequency input which could be effectively handled (or Nyquist rate) is 12.5 hertz. Signals higher than this are "folded over" around the Nyquist rate to a lower frequency. For example, a 23-hertz signal would reflect around 12.5 hertz to appear as a 2-hertz signal to the flight system. Figure 5 helps to provide an intuitive appreciation of the effect. In theory, high-frequency structural modes could be reflected down to appear to the DAP as low-frequency inputs, effectively circumventing the digital filters designed to attenuate them. Because of this concern, open-loop frequency sweeps were made during the EDST up to frequencies of 18 hertz. However, these sweeps showed that the high-frequency structural modes were much more heavily damped than predicted and should not have been important. Aliasing was important, however, but only as it was associated with some small amplitude signal quantization effects.

The stair steps in figure 6 represent the way an analog signal from an RGA is quantitized into a digital signal in the Shuttle MDM. For normal large amplitude signals, the steps are relatively small enough to represent a straight line with a gain of unity. However, as the relative size of the signal decreases, the effective gain can increase dramatically. The small signal shown is engaging one quantization step, and it is obvious that its gain could increase to a very high number, dependent on the bias and amplitude of the input. The output from this system would be a bit toggling square wave. Figure 7 illustrates the way a square wave can be represented in terms of its Fourier components. Consider a 7.5-hertz square wave. Its primary Fourier component would be well attenuated by the DAP bending filter. However, its third Fourier harmonic would be 22.5 hertz, which would alias to 2.5 hertz. It is also interesting that the third harmonic of 2.5 hertz is the original 7.5 hertz, thus making it possible for the signal to feed itself. In fact, there is a family of frequencies which have harmonics capable of aliasing in such a way as to reinforce themselves as shown in table 2. Factors which limit their actual impact are the DAP bending filters and the fact that for a square wave, the amplitude of the harmonic component is inversely proportional to its order.

These effects can be seen in some data taken during the open-loop test. Figure 8 is actual data taken during a frequency sweep. The first three channels are RGA inputs to the DAP. The last channel is a DAP elevon command, which was disconnected from the actuators to open the loop. On the left side, the elevons are being driven at about 7.5 hertz with the frequency slowly increasing with time.

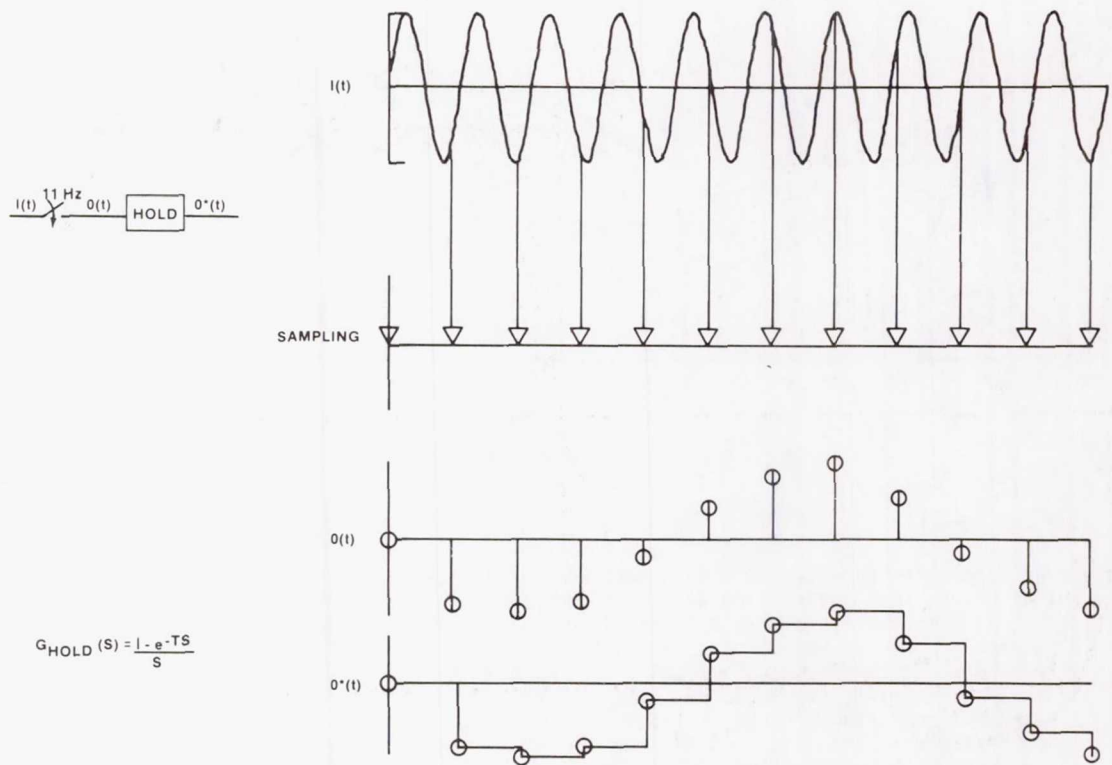

FIGURE 5.- SAMPLING/HOLD CHARACTERISTICS (ALIASING).

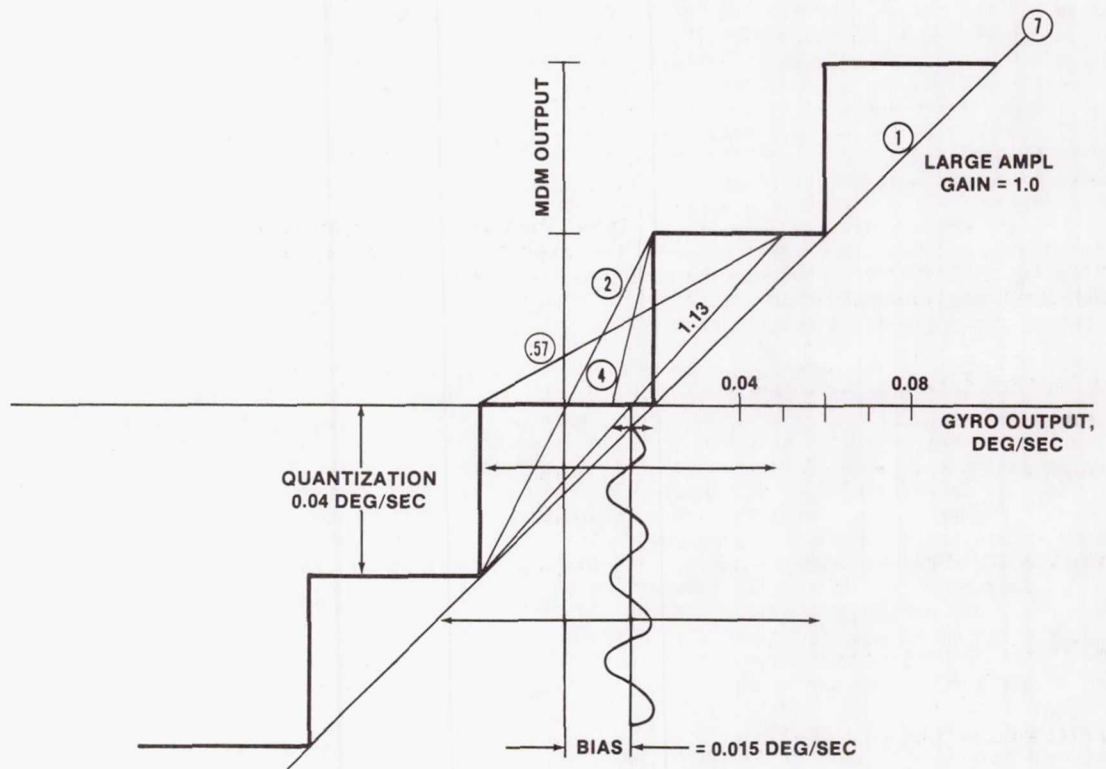
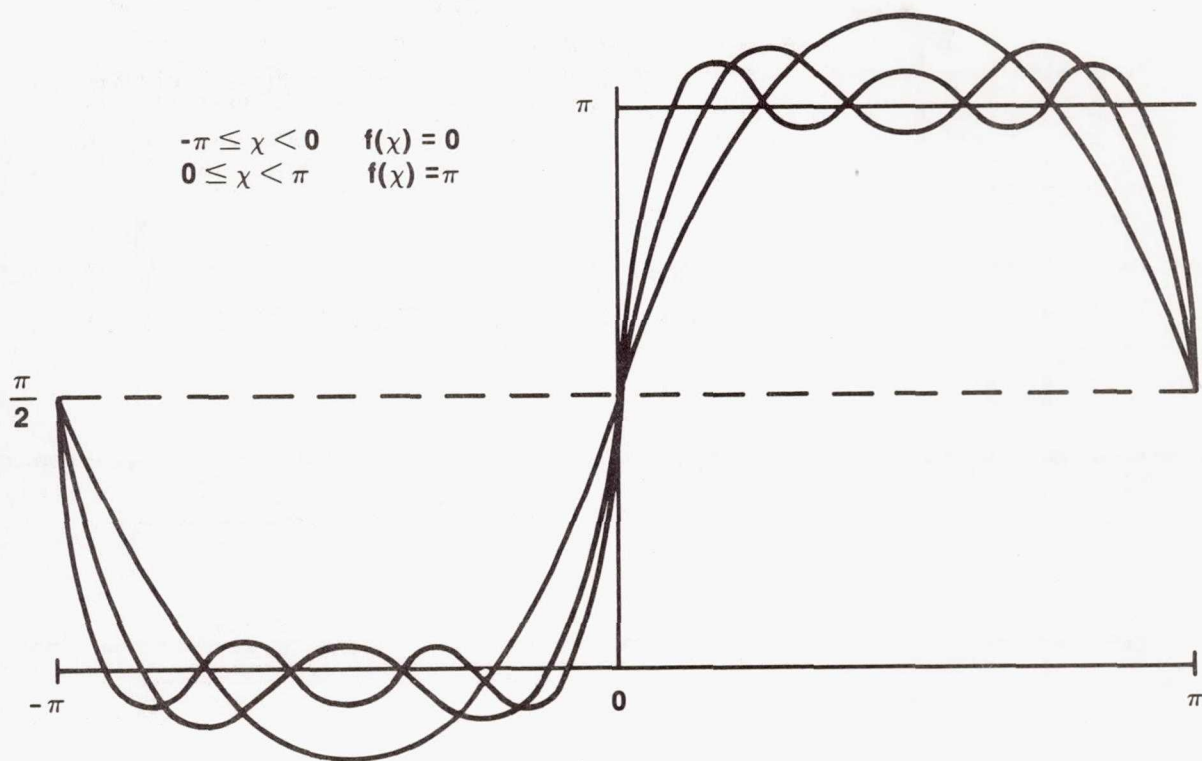

FIGURE 6.- MDM QUANTITIZATION EFFECTS.



$$f(\chi) = \frac{\pi}{2} + 2 \left(\frac{\sin \chi}{1} + \frac{\sin 3\chi}{3} + \frac{\sin 5\chi}{5} + \dots \right)$$

FIGURE 7.- FOURIER COMPONENTS OF A SQUARE WAVE.

TABLE 2.- TWENTY-FIVE-HERTZ SAMPLING CHARACTERISTICS

	FUNDAMENTAL FREQUENCY	3RD HARMONIC FREQUENCY	ALIASED FREQUENCY
3RD HARMONIC CHARACTERISTICS	6.25	18.75	6.25
	12.50	37.5	12.5
(3RD HARMONIC) ² CHARACTERISTICS	2.5	7.5	22.5
	3.125	9.375	28.125
5TH HARMONIC CHARACTERISTICS	4.167	20.833	4.167
	6.25	31.25	6.25
(5TH HARMONIC) ² CHARACTERISTICS	0.9615	4.8077	24.038
	1.0416	5.2083	26.0416
7TH HARMONIC CHARACTERISTICS	3.125	21.875	3.125
	4.167	29.167	4.167
(7TH HARMONIC) ² CHARACTERISTICS	0.50	3.50	24.50
	.5208	3.646	25.5208

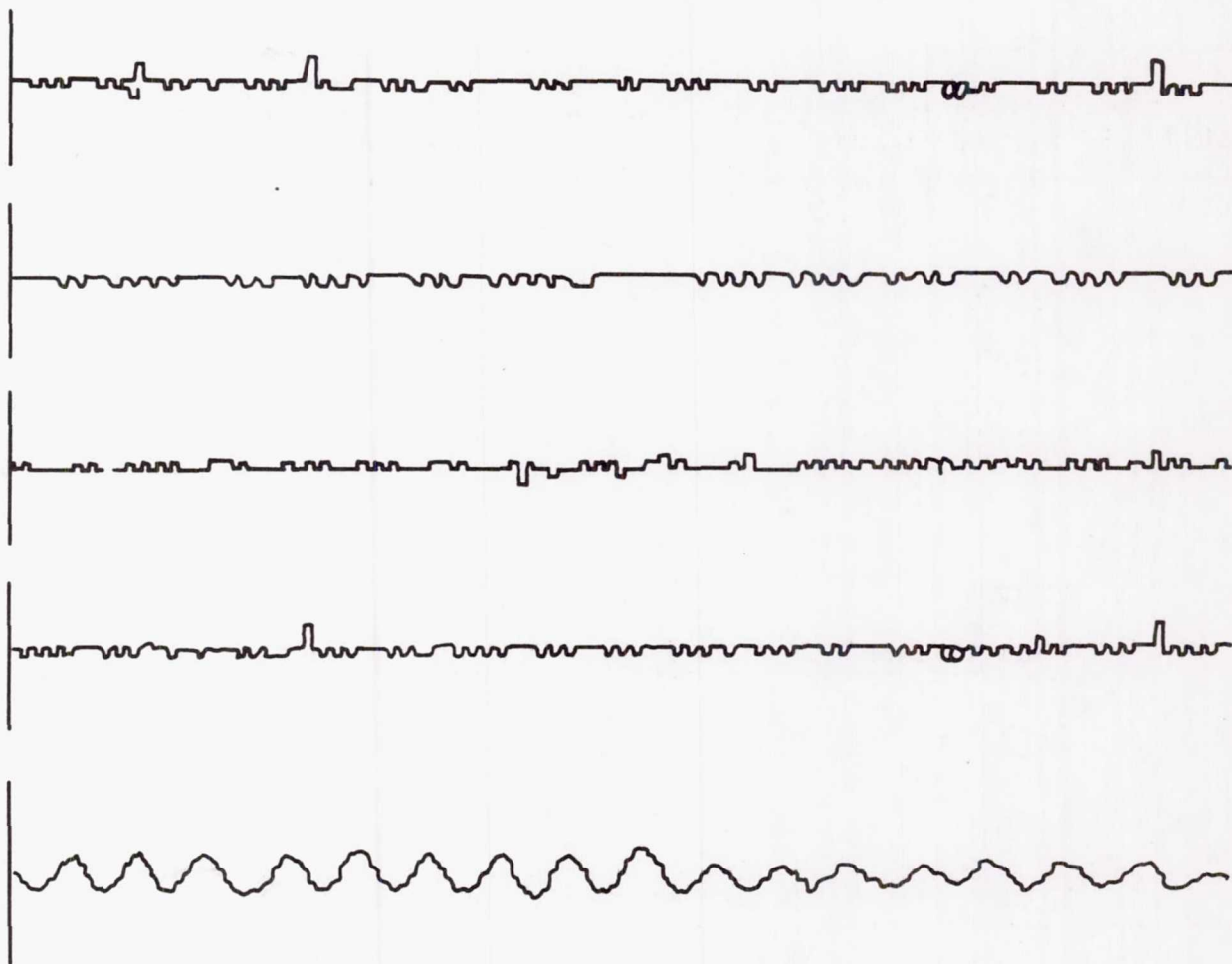

FIGURE 8.- DAP FILTER RESPONSE TO TOGGLING INPUT

The RGA's are mostly toggling 1 bit producing the small square waves discussed, only occasionally engaging a second quantization level. Now observe the DAP command, a very significant sine wave with a frequency of about 2.5 hertz.

In looking at this type of data, other cases showed significant aliased harmonics in the output although they did not feed themselves and thus did not contribute to oscillatory behavior. The key here seemed to be whether or not the sampled, aliased harmonic had a period which was an integral multiple of the sampling period. Those which did could be expressed "cleanly" by the digital system. Those which did not experienced frequent phase shifts as the signal "beat" against the sample rate and quickly lost their significance. Table 3 shows the harmonics greater than 1.5 hertz, which meet this criterion for a 25-hertz sampling system and the inputs necessary to create them.

The driving signals greater than 10 hertz appear to be aliasing second harmonics which would invalidate our odd-only rule derived from the Fourier components of a square wave. Actually, these are fifth and seventh harmonics aliased around 50 to 75 hertz. The cases where this effect would be important would be where an open-loop "noise" source existed; e.g., an ac signal in an RGA which might alias to manifest itself in unexpected places.

As stated, only a few of these frequencies can feed back to reinforce themselves, and some of these are attenuated by the bending filter. Let's consider another effect of the bending filter. Figure 9 shows three plots. The first plot (a) is the frequency response of a zero order hold (sample and hold) with a sample rate of 25 hertz. The second plot (b) shows the frequency response of the Shuttle pitch channel bending filter. The curve between 20 and 30 hertz is obtained by

TABLE 3.- VULNERABLE FREQUENCIES IN TWENTY-FIVE-HERTZ SYSTEM,

FREQUENCY OF ALIASED HARMONIC, Hz		FREQUENCY OF DRIVING SIGNALS		
5		10		
3.5714	10.714	7.1429		
3.125		9.375		
2.7778	11.1111	5.5556		
2.5		7.5		
2.2727	11.3636	9.0909	6.8182	4.5455
1.9231	11.538	7.6923	5.7692	3.8462
1.7857		8.9286	5.357	
1.6667	11.667	6.6667	3.3333	
1.5625		7.8125	4.6875	

reflecting the bending filter curve around 25 hertz and scaling it by the frequency response of the zero order hold. The third plot (c) shows this 20 to 30-hertz region increased +6 decibel. Notice how perfectly the filter tunes to 22.5 and 27.5 hertz which, of course, alias to 2.5 hertz.

Figure 10 gives a good overview of the system with the effects discussed. It can be seen why the 2.5-hertz phenomena were encountered. The pressing question after the DST was whether or not it was safe to fly. The landing gear mode, of course, would not be a factor in flight. For landing and rollout, the DAP would be in the low-altitude flight condition, which was found to be quite stable. What about the digital effects? Could they lead to large instabilities? The answer is no because they are bounded to small amplitude. Considering figure 6, it is obvious that as the input signal increases to engage more quantization steps, its gain rapidly decreases to approach unity. Or, using the Fourier approach, the more quantization steps a signal engages, the more it resembles a sine wave and the weaker its harmonics become. After the DST, these effects were modeled in a time domain simulation. The results are shown in figures 11 and 12. It is obvious that while the effects are significant at low amplitudes, as either the amplitude is increased or the quantization level is reduced, they rapidly become less important.

CONCLUDING REMARKS

So the Shuttle is safe to fly. What can be learned from this experience that can be applied to future projects? First, this stresses the importance of a high sample rate. Increasing this rate, in addition to eliminating many other undesirable effects, reduces the number of significant harmonics which can be aliased. Second, the size of any analog to digital quantization levels should be carefully considered in view of the application. In the case examined, the quantization was quite appropriate for low-altitude flight. But it became inappropriate with the control system gains

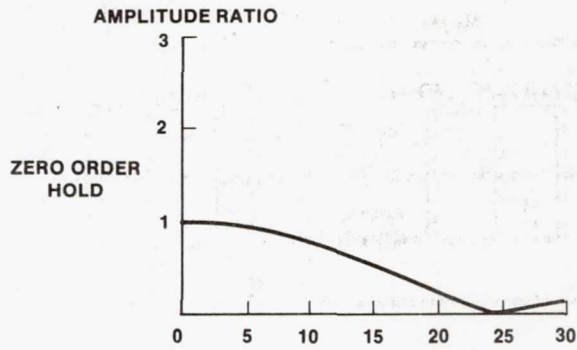

(a) ZERO ORDER HOLD.

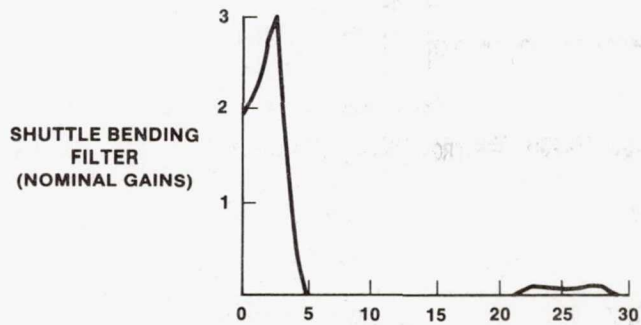

(b) SHUTTLE BENDING FILTER
(NOMINAL GAINS).

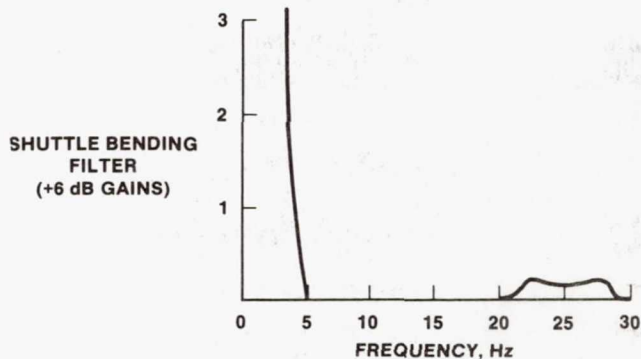

(c) SHUTTLE BENDING FILTER
(+6 dB GAINS).

FIGURE 9.- BENDING FILTER FREQUENCY RESPONSE.

required for flight at high altitude and Mach number. It may be worthwhile to study some new approaches, such as variable quantization levels, as illustrated in figure 13. This would provide higher resolution around a trim point than could be provided over the whole range. In some cases, the best approach might be a hybrid system with completely analog inner loops and digitally-controlled gains. Finally, the software control laws should be designed with an appreciation of these effects. There was no hard reason for the Shuttle bending filter to peak at 2.5 hertz or to have such a pronounced peak at all. It was merely tolerated, with no appreciation of the consequences, to gain a marginally better band pass. As future control systems evolve, an understanding of these digital effects will be important for achieving optimal designs.

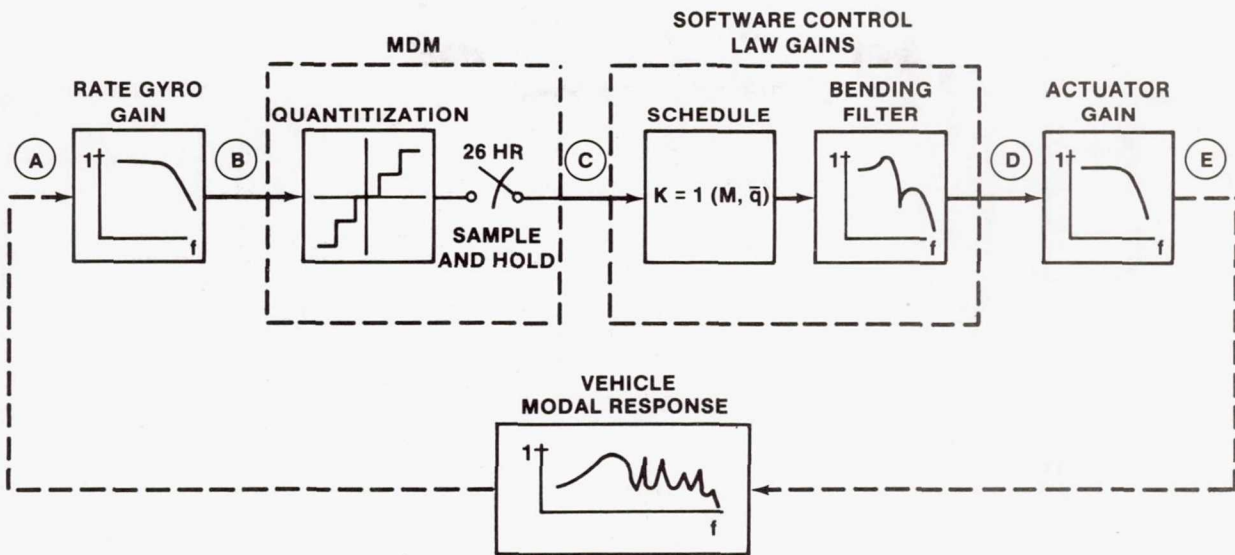

FIGURE 10.- FLIGHT CONTROL SYSTEM (FLEXIBLE-MODE-RELATED CONFIGURATION).

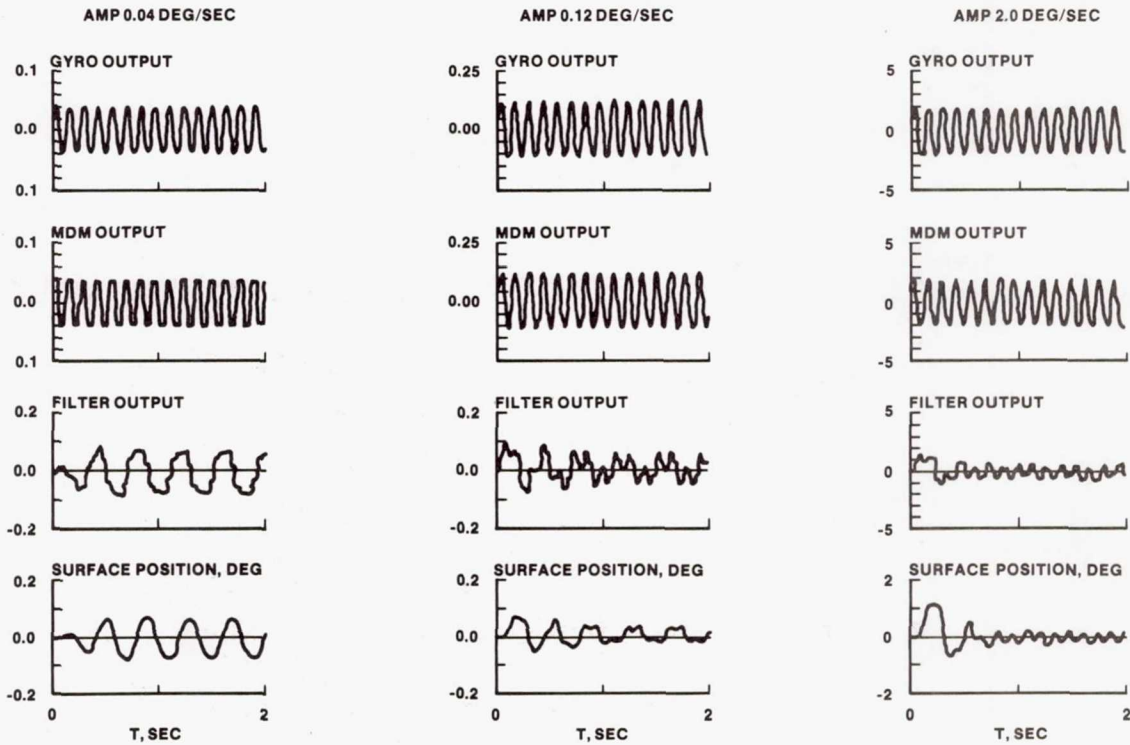

FIGURE 11.- VARIATION OF GYRO OUTPUT AMPLITUDE.

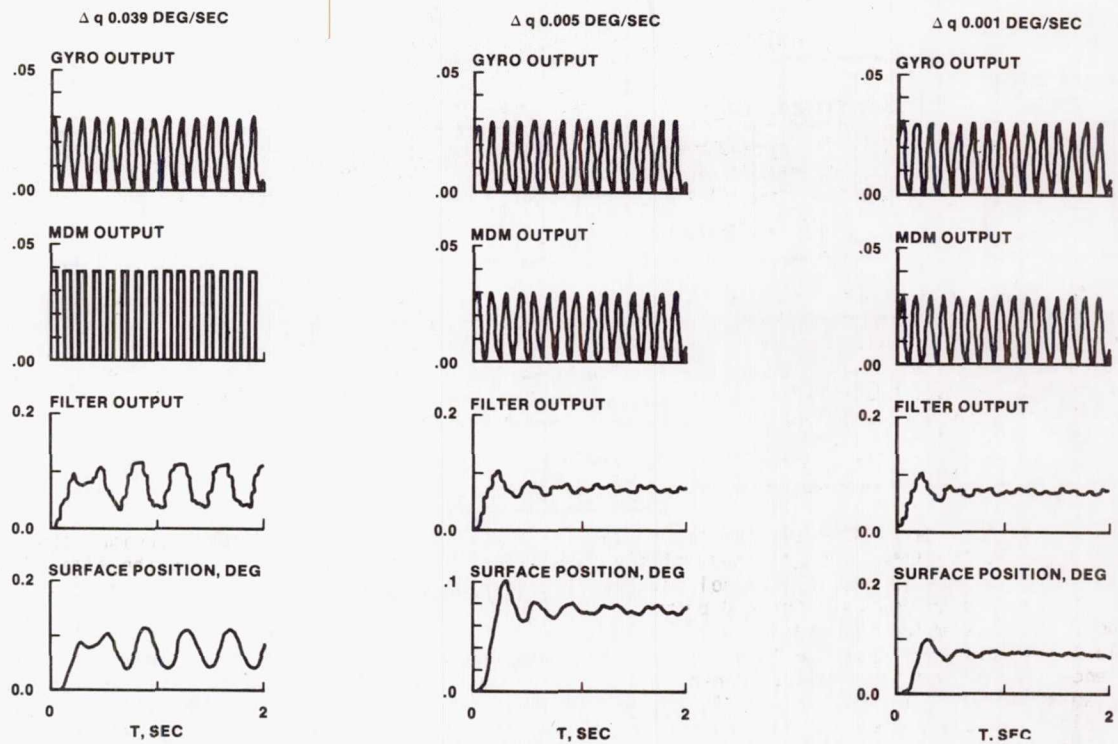

FIGURE 12.- VARIATION OF MDM QUANTITIZATION LEVEL.

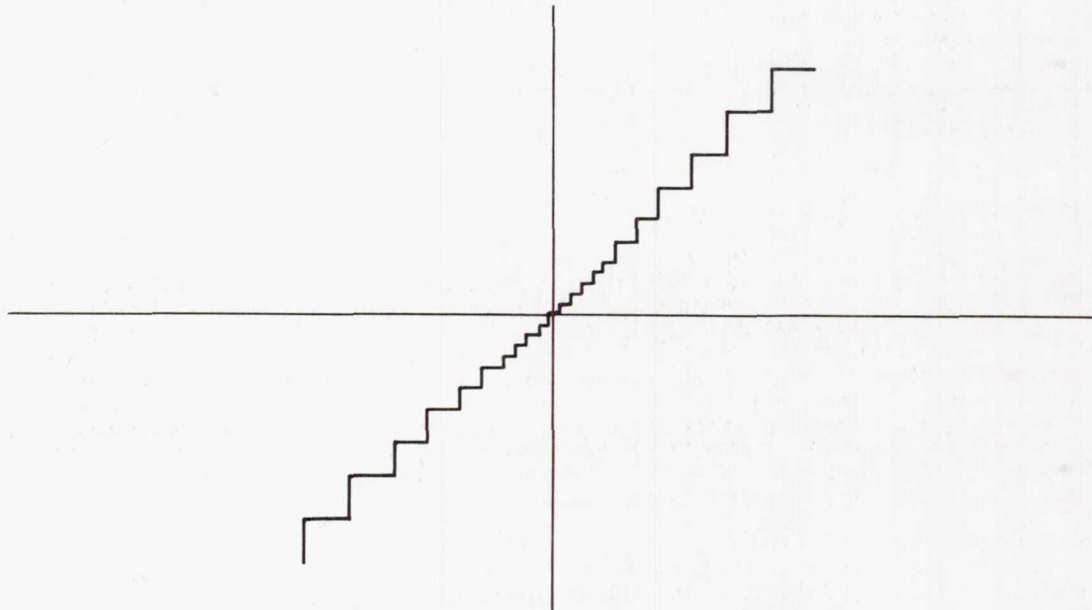

FIGURE 13.- VARIABLE QUANTITIZATION LEVEL SYSTEM.

REFERENCE

1. Background Information and User Guide for MIL-9490D - Flight Control Systems Design. General Specification for Design, Installation, and Test of Piloted Aircraft. AFFDL-TR-74-116, Jan. 1975, p. 43.