

THE SPACE SHUTTLE LAUNCH VEHICLE AERODYNAMIC
VERIFICATION CHALLENGES

R. O. Wallace, L. D. Austin, J. G. Hondros
NASA-Lyndon B. Johnson Space Center
Houston, TX

T. E. Surber, L. M. Gaines, J. T. Hamilton
Rockwell International Corporation
Downey, CA

ABSTRACT

The Space Shuttle aerodynamics and performance communities were challenged to verify the Space Shuttle vehicle (SSV) aerodynamics and system performance by flight measurements. Historically, launch vehicle flight test programs which faced these same challenges were unmanned instrumented flights of simple aerodynamically shaped vehicles. However, the manned SSV flight test program made these challenges more complex because of the unique aerodynamic configuration powered by the first man-rated solid rocket boosters (SRB). The analyses of flight data did not verify the aerodynamics or performance preflight predictions of the first flight of the Space Transportation System (STS-1). However, these analyses have defined the SSV aerodynamics and verified system performance. The aerodynamics community has also been challenged to understand the discrepancy between the wind tunnel and flight defined aerodynamics. This paper presents the preflight analysis challenges, the aerodynamic extraction challenges, and the postflight analyses challenges which led to the SSV system performance verification and which will lead to the verification of the operational ascent aerodynamics data base.

INTRODUCTION

The challenge of the Space Shuttle program was to develop a reusable spacecraft which would experience a conventional launch through a high dynamic pressure environment, perform an on-orbit mission and return to a conventional aircraft type landing. These requirements were satisfied by a complex configuration comprised of the first winged orbital spacecraft (Orbiter), first man-rated SRB, and external fuel tank (ET) (figure 1). During the development of this vehicle, the aerodynamics and performance communities were challenged to assure flight safety by analysis and to verify the SSV aerodynamics and system performance by flight test. Historically, flight test programs of launch vehicles have been unmanned instrumented flights. However, the Space Shuttle program management decided to perform an orbital manned mission on the first mission of the flight program. This decision was based on program mission requirements, compressed development schedules, and impact of vehicle loss.

PREFLIGHT ANALYSIS CHALLENGE

The manned SSV flight test program challenged the ascent communities to insure flight safety. Extensive preflight analyses were performed to identify the SSV system performance and structural sensitivities to potential inflight dispersions. Once these sensitivities were identified ascent trajectory profiles were designed which satisfied the STS mission requirements and maintained adequate margins of safety. Initial ascent trajectory design concepts for the SSV employed a gravity turn technique to maximize vehicle performance. This concept maintained a zero angle-of-attack ($\alpha = 0$) throughout the first stage of flight. While this design approach was found to be adequate for earlier generation launch vehicles, the resulting structural load environment for the SSV was unacceptable. Therefore, the primary challenge for the ascent community was to identify the ascent flight constraints within which the SSV trajectory profile could be designed to provide adequate margins for the vehicle structure while minimizing the impact to the STS performance capability (illustrated in figure 2 and 3). With the cooperation of the structural, aerodynamic and trajectory design communities, an approach¹ using structural load indicators was developed which modeled each of the critical SSV structural areas (see figures 4 and 5) in terms of the external forces on the element: thrust; aerodynamics; and inertia. These structural load indicator models were evaluated for various flight conditions to derive the flight constraint envelopes. To insure adequate structural margins, the structural load indicator models were evaluated using a six degree-of-freedom ascent trajectory simulation to determine sensitivities and criticality of the various indicators to potential inflight dispersions. Figure 6 illustrates the constraint envelope and inflight dispersions evaluated in terms of flight conditions. Figure 7 presents the measured wind dispersions used in figure 6 to provide protection for inflight winds

and maintain a high launch probability. Figure 8 presents the resultant flight constraint boundaries and trajectory design dynamic pressure and angle-of-attack requirements. These analyses pointed out the sensitivity of the SSV to the Orbiter aerodynamics which resulted in the requirement to extract the Orbiter aerodynamics from flight measurements.

By the mid 1970's, to provide adequate structural margins on the Orbiter wing and Orbiter/ET/SRB (element) attach struts, an angle-of-attack of -2° was required during the transonic regime of the ascent trajectory. This more negative α profile was achieved at the cost of approximately 700 pounds of payload capability relative to the initial trajectory design. In the late 1970's, the aerodynamic data base uncertainties were increased from a level which considered only wind tunnel data scatter (tolerance) to a level which also considered model scale to full scale aerodynamic uncertainties (variations). This increase was made to protect the SSV against the potential modeling and scale effect uncertainties associated with the complex SSV configuration. This change in the potential inflight dispersions resulted in an ascent trajectory profile design with $\alpha = -3^\circ$ and a further loss of payload capability of approximately 800 pounds relative to the $\alpha = -2^\circ$ design. Thus, the trajectory design for the STS-1 had protected the SSV against aerodynamic uncertainties and inflight dispersions to provide adequate performance, acceptable structural loads and to insure high launch probability.

AERODYNAMICS EXTRACTION CHALLENGE

Since the preflight analyses were based on ground test defined aerodynamics, the aerodynamics community was challenged to develop techniques to extract the aerodynamic characteristics of the SSV, elements and components from flight data. An extraction procedure was developed which substituted known or measured quantities into the equations of motion² and solved for the aerodynamic forces and moments. The SSV was instrumented to measure the required quantities: linear and angular accelerations, angular rates, thrust vector of each Space Shuttle main engine (SSME) and SRB (i.e., magnitude and direction), and trajectory parameters. These measurements could not be used directly to extract the aerodynamic characteristics, but required some adjustments. Analysis techniques were developed to account for vehicle characteristics, instrumentation location and instrumentation system biases. The SSME thrust vector analysis combined the elasticity of the Orbiter thrust structure and measurement of thrust vector control (TVC) actuator stroke to determine the direction of the thrust vector. Similarly, the structural characteristics of the SRB were combined with the SRB TVC actuator stroke measurement to determine the SRB thrust vector direction.

Since the center of gravity (cg) of the SSV moves during flight, techniques were required to relate the accelerometer measurements to the cg location. Acceleration measurements were taken at several locations on the Orbiter and SRB. The acceleration analysis used all compatible measurement in a least-squares procedure to define the SSV cg acceleration. Since the Orbiter is not a rigid body, accelerometer misalignment studies were required to determine the effect of body bending on the aerodynamic extraction results. These analyses indicated that the expected misalignments would not effect the aerodynamic extraction results.

Flight measurement of the SSV trajectory parameters and configuration parameters were required to relate the extracted aerodynamics to the ascent aerodynamic design data base. An air data system was designed into the tip of the ET to provide pressure measurements from which the angle-of-attack, angle-of-sideslip, dynamic pressure and Mach number could be determined (figure 9). An extensive wind tunnel calibration program was conducted to provide correlation between these pressure measurements and the required trajectory parameters.³ Also, flight measurement of the Orbiter elevon position was required. Measurements of the elevon actuator stroke were made and converted to elevon angular position data. Also, techniques were developed to extract elevon hinge moments from actuator pressure measurements and strain gauge measurements. The flight elevon position analysis combined the position measurement, the extracted hinge moments, and the aeroelastic characteristics of the elevon support structure to determine the aeroelastic elevon position.

Since preflight analysis had identified structural sensitivities to the element (Orbiter, ET and SRB) aerodynamics, extraction procedures were developed to define the element aerodynamics. The element extraction procedure required the same measurements as previously described. However, to isolate one element from the SSV the measurement of the interface loads were required. Each Orbiter to ET strut and each SRB to ET strut (figure 4 and 5) (except the forward ball fitting) were instrumented. From the measurement of the strut loads, each body axis interface force could be determined. A precise calibration of each flight test strut assembly was performed. These calibrations were used to determine the flight measured strains. As with other measurements,

biases were required to be removed. Removal of the airload and inertial load acting on each strut was required. The initial weight of the Orbiter prior to SSME ignition was used to determine the Orbiter strut bias. A pre-ignition SRB strut bias could not be determined since a preload was present on the SRB struts on the pad which was released at lift-off. The SRB strut bias was determined by using the strut calibration zero load point and the strut measurement at SRB separation.

Prior to the first flight of the SSV the capability to extract the SSV, element and component (elevator hinge moment) aerodynamics was achieved by the aerodynamics community. Although preflight analyses had indicated that the wing and vertical tail (components) were critical structure at some flight conditions, no procedures were developed to extract these component aerodynamics. The available strain gauge instrumentation was considered a structures community responsibility. Furthermore, the limited amount of pressure instrumentation was considered verification data and no procedures were developed to model these data.

POSTFLIGHT ANALYSIS CHALLENGES

The aerodynamics and performance communities were further challenged by the anomalies which occurred during STS-1. The first-stage trajectory was steeper than expected (lofted) which resulted in a SRB staging altitude approximately 10,000 feet higher than predicted (figure 10). Post flight extraction of the aerodynamic forces and moments revealed that significant differences existed from the baseline longitudinal forebody and base aerodynamics of the SSV and elements (figures 11 and 12).

These results challenged the aerodynamic community to understand these results and provide models of the flight derived aerodynamics. The performance communities were challenged to reconstruct the observed trajectory anomalies and verify subsystem models for trajectory design and performance prediction.

Initially, the aerodynamics community thought that the extracted aerodynamic results were incorrect because the observed discrepancies were larger than the conservative aerodynamic variations. However, preliminary trajectory reconstructions supported the flight derived aerodynamics, and extensive review of the extraction procedure, particularly thrust vectors, resulted in only minor modifications. STS-2 and -3 resulted in similar extracted aerodynamic characteristics. As the flight test program continued, the trajectory reconstruction analyses developed confidence in the trajectory design. STS-4 was designed to provide the aerodynamics community with flight data at a less negative angle-of-attack. After STS-4, gradient and intercept analyses of the derivatives ($\partial C/\partial \alpha$ and $\partial C/\partial \beta$) indicated that the wind tunnel data base derivatives and absolute levels were incorrect as shown in figures 13 and 14. These results were modeled into the present SSV and element aerodynamic data bases.

As these models were being developed, the aerodynamic community was attempting to understand the discrepancy between wind tunnel and flight aerodynamics. Center-of-pressure analyses indicated that a positive normal force increment was acting on the aft region of the SSV and primarily on the Orbiter. Assessment of limited pressure instrumentation on the Orbiter fuselage, wing and base indicated that a higher than predicted base pressure environment existed during flight which had fed forward of the Orbiter base. A review of the plume simulation used for SSV wind tunnel tests was conducted. Studies using an analytical program and flight test base pressures concluded that the plume simulation parameter (used to set test conditions) was deficient and required a temperature function to account for hot gas effects.⁴ A post flight wind tunnel test was conducted to simulate the flight base pressure environment. Preliminary results seem to verify flight pressure measurements in the elevator region of the wing and aft fuselage (figure 15 and 16). Analyses of the post flight wind tunnel test are continuing and will determine what part of the observed difference was due to plume simulation deficiencies. The remaining difference is assumed to be Reynold's number effects. Since post flight wind tunnel data analyses will not be complete for some time and since only limited flight pressure data was obtained, problems in modeling the flight force and moment increments into the external pressure distributions have prevented complete verification of the ascent aerodynamic data bases.

Since the SSV pressure distributions are questionable, the day-of-launch assessment of wing loads is questionable. Wing pressure distributions are inputs to the current load indicator equations. Techniques were developed to determine the wing load distribution from flight strain gauge data. Attempts to modify the wind tunnel derived pressure distributions based on flight pressure measurements have failed to match loads data extracted from wing strain gauge data. However, the gauge data was questioned and a check calibration performed after STS-5 revealed that

several key gauges either had the wrong scaling factors or reversed polarity. After using the check calibration data, the extracted wing loads comparisons did not improve. Currently, the aerodynamics and structures communities are implementing plans to correlate calculated internal stresses using revised pressure distributions with measured flight stresses. The results of this effort will be verified SSV pressure distributions.

The performance communities' trajectory reconstruction work provided the basis for verification of the SSV system performance. The trajectory reconstruction of STS-4 using flight derived aerodynamics and post flight subsystem model updates (SSME Isp and thrust; SRB Isp and thrust; and gimbals) matched the vehicle tracking data (BET), air data system parameters, occurrence of flight events, ET propellants remaining at MECO (table 1) and attach structure loads. Figures 17, 18, and 19 present the trajectory parameter reconstruction comparisons. These reconstructions also provide load comparisons of previously critical structural loads (figure 20). The trajectory reconstruction task also produced a reassessment of trajectory design constraints. In terms of payload capability, the flight base aerodynamics increased the SSV performance approximately 1000 pounds. However, the current evaluation of wing loads reflected a need to bias the ascent trajectory profile to $\alpha = -5^\circ$ to maintain acceptable margins. This angle-of-attack requirement during the first stage cost approximately 1100 pounds of payload capability relative to the $\alpha = -3^\circ$ used during the flight test program. Figure 21 summarizes the impact of maintaining structural margin requirements as a result of changes to the aerodynamic data base on the ascent trajectory design and SSV performance from the early design phase of the SSV to the current operational baseline. Therefore, verification of SSV performance was achieved by trajectory and load reconstructions that modeled subsystem changes and accounted for as flown wind profiles.

CONCLUSION

The Space Shuttle aerodynamics and performance communities have met the challenges of the Space Shuttle Program. From a trajectory design and performance point of view, the SSV aerodynamic characteristics and payload capabilities have been defined, modeled and verified. In addition the element aerodynamic characteristics have been defined and verified, which prior to STS-1 were considered most significant to the SSV structure and to trajectory design. However, the flight results changed the emphasis from the element aerodynamics to the external pressure distribution of the Orbiter wing. Because of limited external flight pressure instrumentation, flight strain gauge data must be used to extract the external pressure distributions. Attempts to model the strain gauge results failed to predict measured stresses when pre-STS-1 wing load indicator equations were used. The aerodynamics community initiated regression analyses of flight wing strain measurements to produce wing load indicators that would provide an adequate tool for day-of-launch wing load calculations to insure flight safety. Once this method was shown to provide excellent prediction capability, the structure community implemented the procedure for critical wing structure. Also, the aerodynamics community initiated a cooperative effort of the aerodynamics and structures communities to define the SSV pressure distribution through an iterative procedure of pressure distribution definition, internal loads calculations, and flight comparisons. The initial step in this effort has pointed out that the current pressure distributions are not adequate. Review of the effort to date, points out the need for the structures community to insure that the effects of fuselage torsion and bending on strain gauge measurements are defined, understood and modeled. Therefore, the above cooperative effort will provide definition and verification of the ascent aerodynamics pressure distributions which will complete the ascent aerodynamics operational data base.

Finally, the efforts of the aerodynamics and performance communities to meet the Space Shuttle challenges have provided the Shuttle Program management insight to trajectory design constraints, performance improvements and limitations, effects of flight defined aerodynamics, and day-of-launch risk assessments.

REFERENCES

1. Leahy, K. S.: Techniques for Assessment of Ascent Aerodynamic Characteristics of the Space Shuttle Launch System, presented as paper at Shuttle Performance; Lessons Learned Conference at Langley Research Center, Hampton, Virginia, March 8-10, 1983.
2. Gaines, L. M.; Osborn, W. L.; and Wiltse, P. D.: Launch Vehicle Aerodynamic Flight Test Results, presented as paper at Shuttle Performance; Lessons Learned Conference at Langley Research Center, Hampton, Virginia, March 8-10, 1983.

3. Hillje, Ernest R.; and Nelson, Raymond L.: Ascent Air Data System Results from the Space Shuttle Flight Test Program, presented as paper at Shuttle Performance; Lessons Learned Conference at Langley Research Center, Hampton, Virginia, March 8-10, 1983.
4. Roberts, Barney B.; Wallace, Rodney O.; Craig, Mark K.; and Kanipe, David B.: Rocket Exhaust Plume Induced Flowfield Interaction Experiences with the Space Shuttle, presented as paper at AIAA 18th Thermophysics Conference at Montreal, Canada, June 1-3, 1983.
5. Hamilton, J. T.; Wallace, R. O.; and Dill, C. C.: Launch Vehicle Aerodynamic Data Base Development Comparison with Flight Data, presented as paper at Shuttle Performance; Lessons Learned Conference at Langley Research Center, Hampton, Virginia, March 8-10, 1983.
6. "Orbital Flight Test Aerodynamic Data Analysis, Space Transportation System Launch Vehicle, Volume 2", STS81-0558, Volume 2A, April 1982, Revision 2A-2, Space Division, Rockwell International.

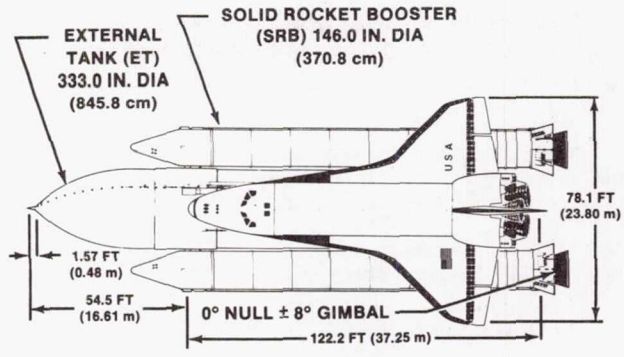

GROSS LIFT-OFF WEIGHT-2022.6 x 10⁶g (4459K LB)

- ORBITER 68.5 x 10⁶g (151K LB)
- SRB (2) 1172.1 x 10⁶g (2584K LB)
- ET 756.1 x 10⁶g (1667K LB)
- PAYLOAD (DOWN) ... 14.5 x 10⁶g (32K LB (DESIGN))

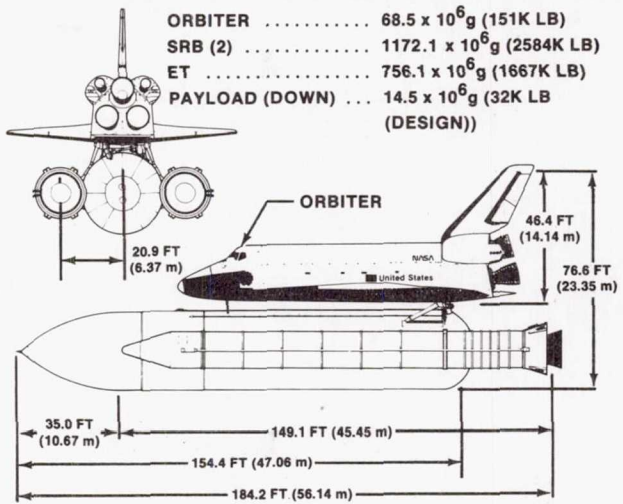

Fig. 1 Space Shuttle Launch Vehicle Configuration.

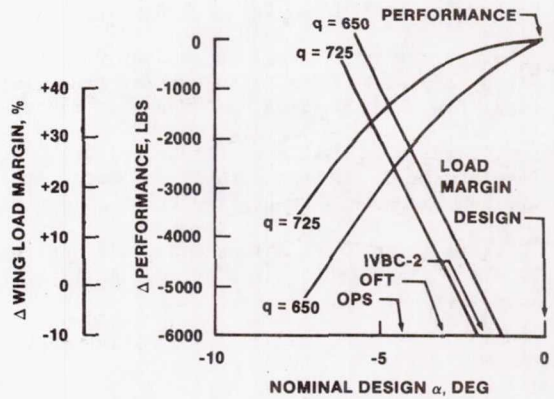

Fig. 3 Wing Load and Performance Trade Study with Angle of Attack.

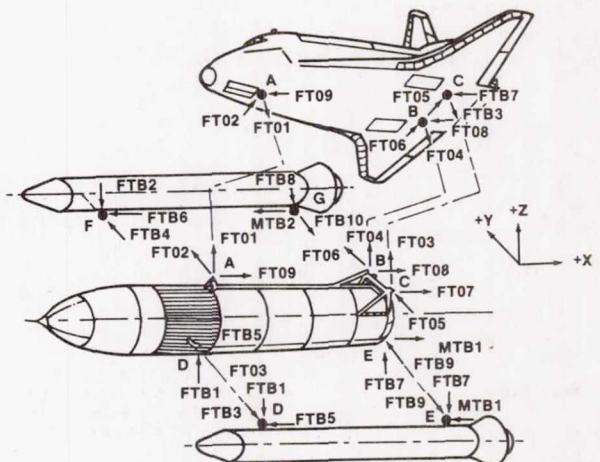

Fig. 4 Body Axis Interface Load Indicators.

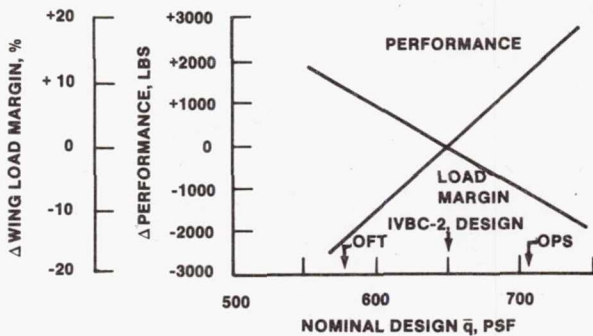

Fig. 2 Wing Load and Performance Trade Study with Dynamic Pressure.

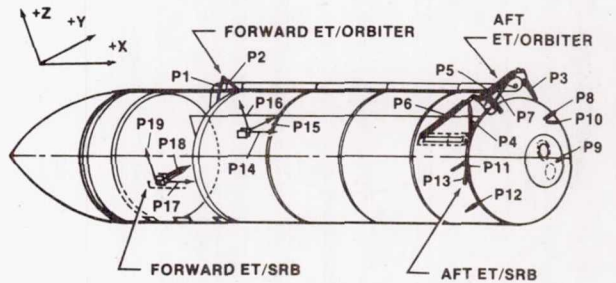

Fig. 5 Attach Strut Load Indicators

ORIGINAL PAGE IS OF POOR QUALITY

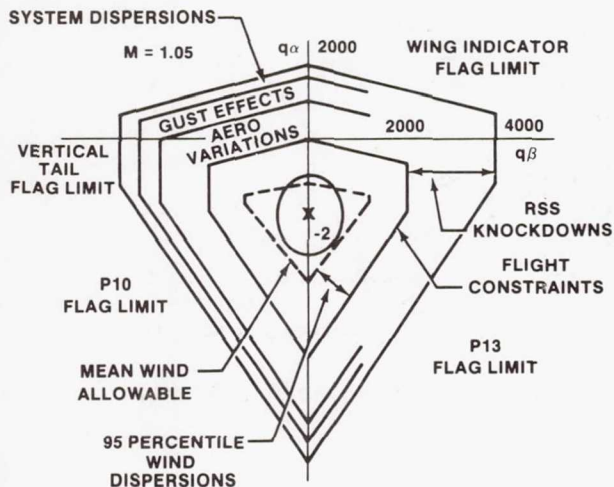

Fig. 6 Flight Constraint Envelope.

- STS-1 CYCLE 3 ELEMENT AERO DESIGN DATA BASE
- STS-1 CYCLE 3 ELEMENT AERO VARIATION

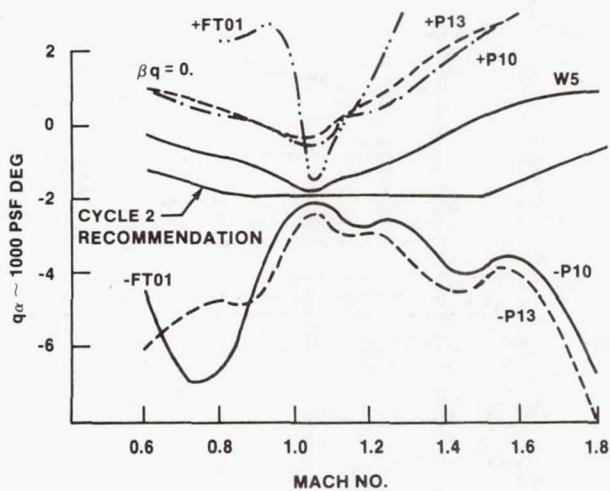

Fig. 8 Flight Constraint Boundary.

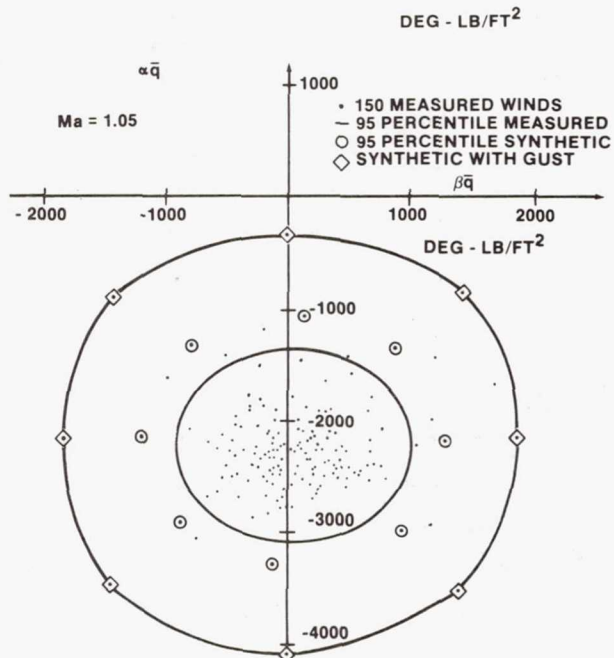

Fig. 7 SSV Response to Wind Profiles in the Pitch and Yaw Planes.

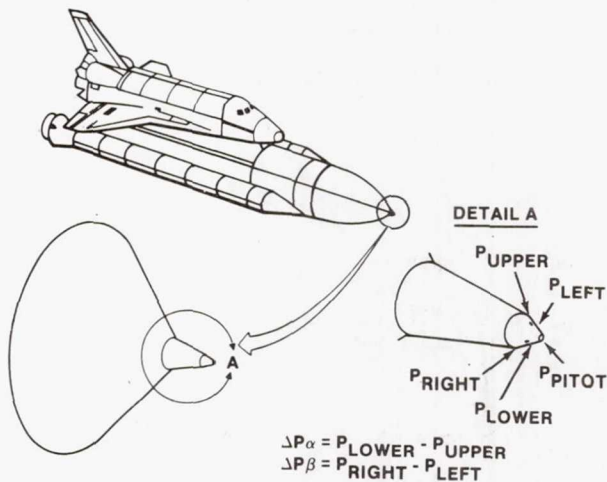

Fig. 9 Ascent Air Data System Configuration.

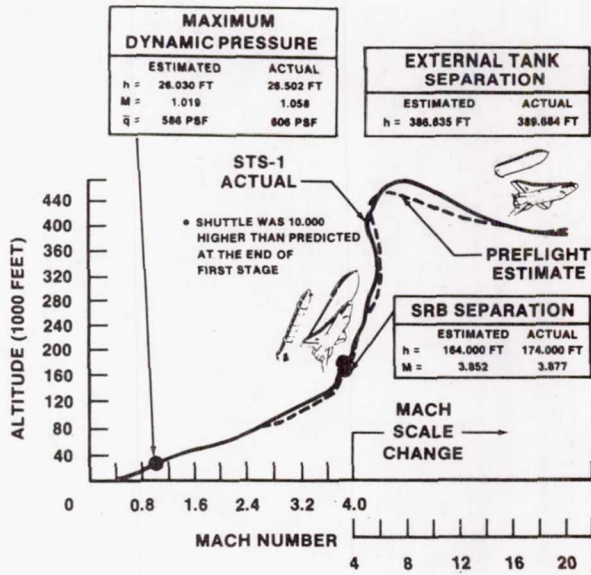

Fig. 10 STS-1 Trajectory Anomaly

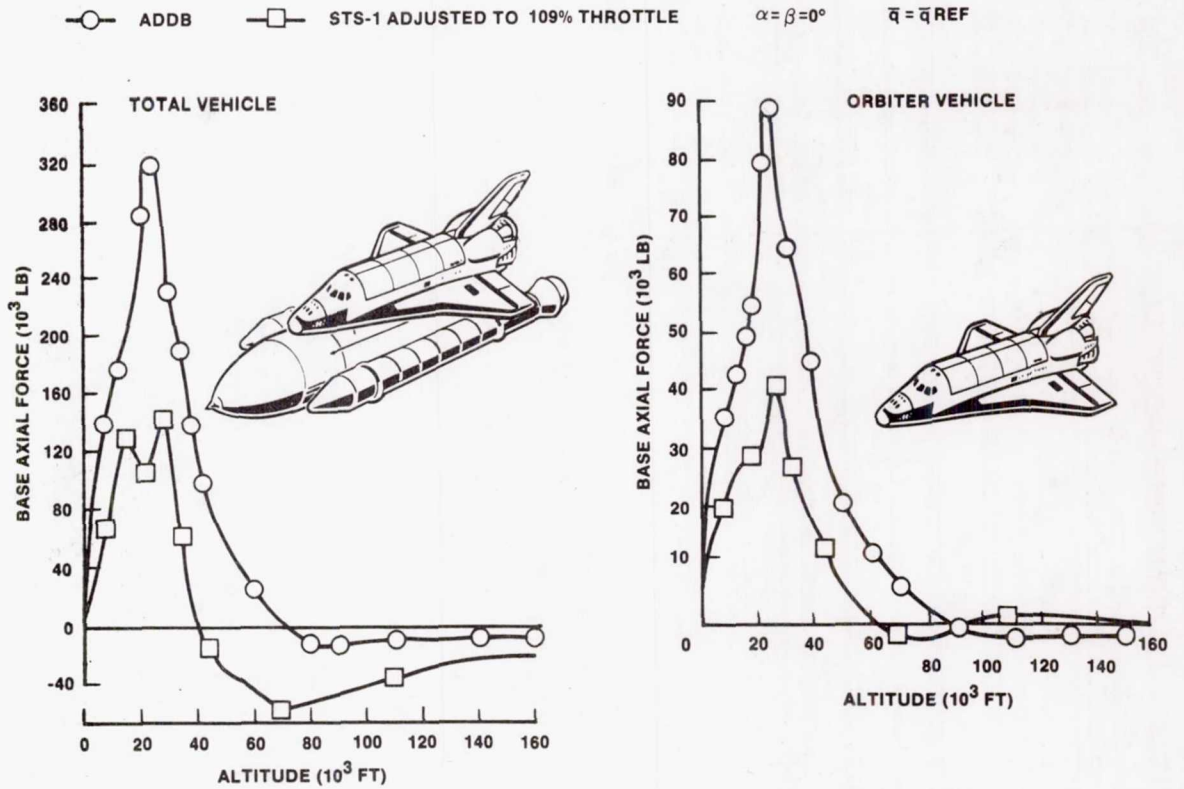

Fig. 11 Comparison of STS-1 Flight Base Axial Force and Design Data Base Axial Force.

STS-1 EXTRACTED AERODYNAMICS

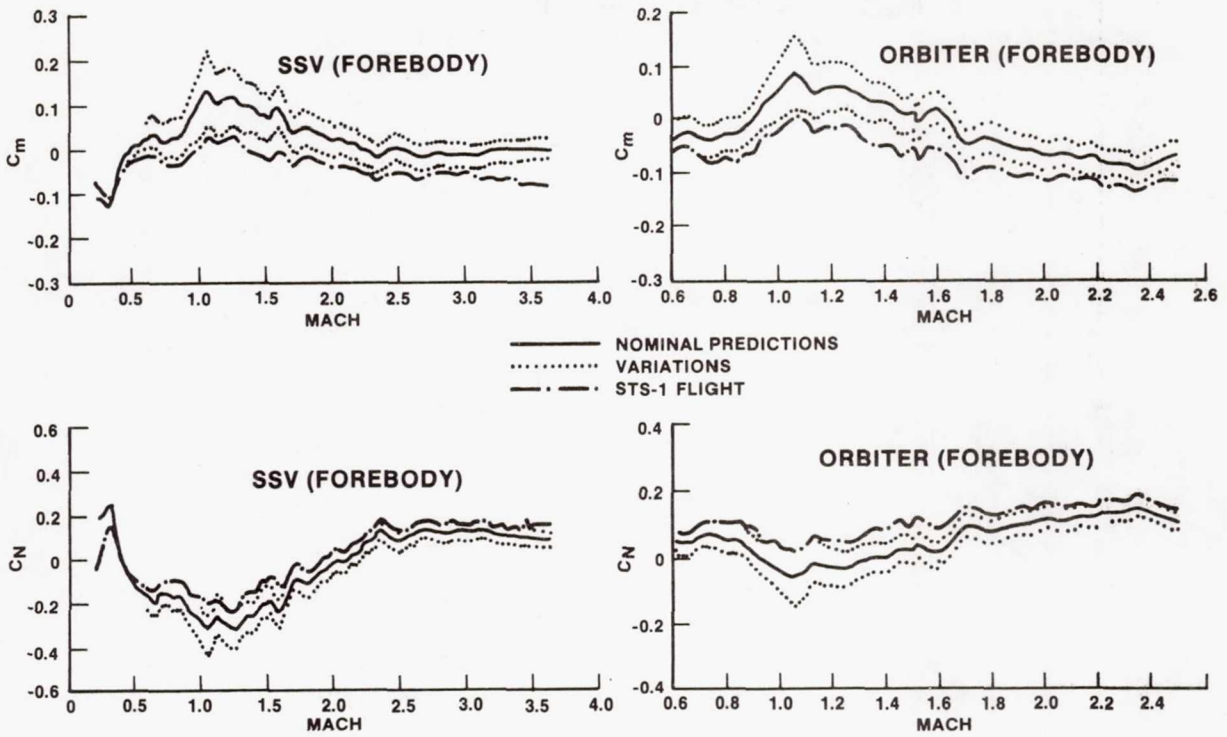

Fig. 12 STS-1 Normal Force and Pitching Moment Comparisons.

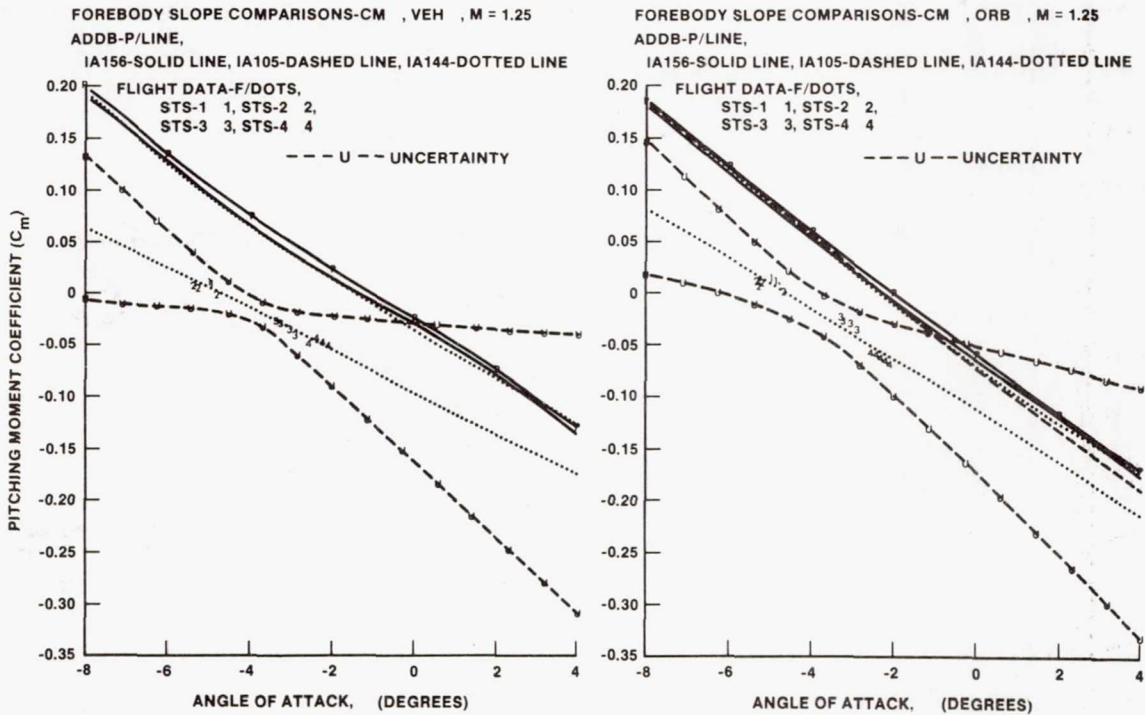

Fig. 13 Gradient Analysis of Flight Pitching Moment.

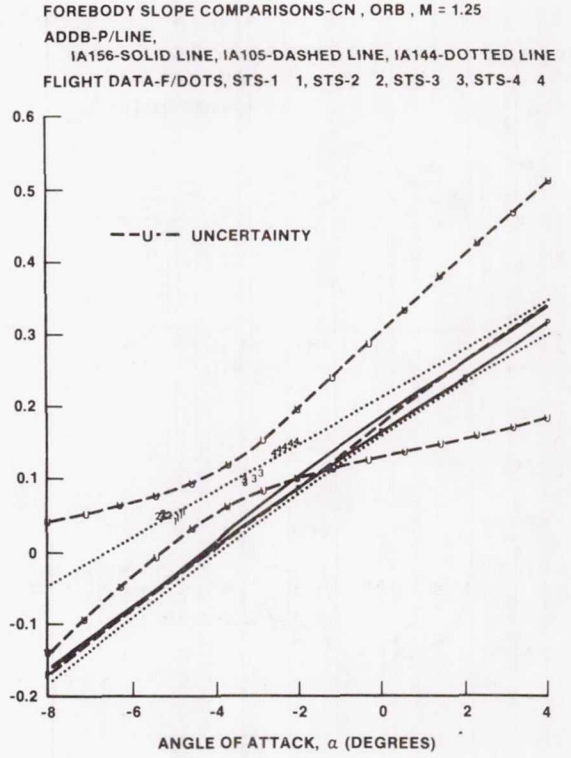
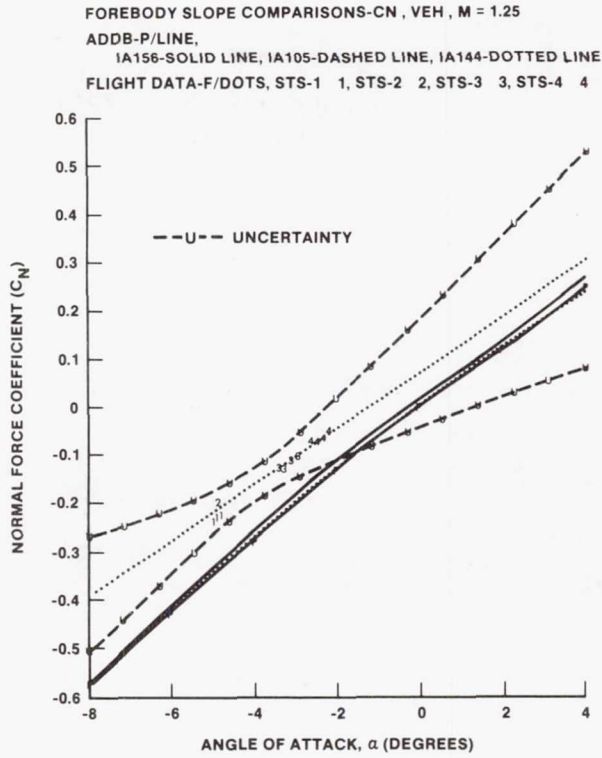

Fig. 14 Gradient Analysis of Flight Normal Force.

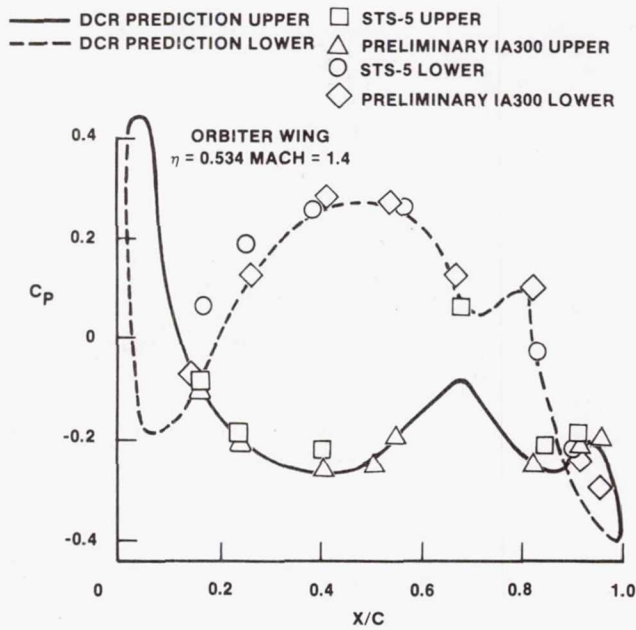

Fig. 15 Wing Pressure Distribution Comparison.

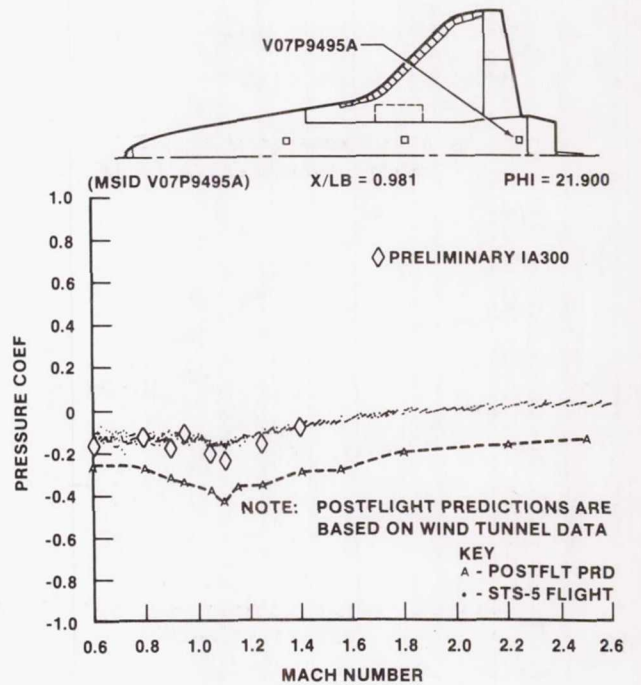

Fig. 16 AFT Fuselage Pressure Distribution Comparison.

**COMPARISON OF STS-4
ASCENT AIR DATA WITH BET**

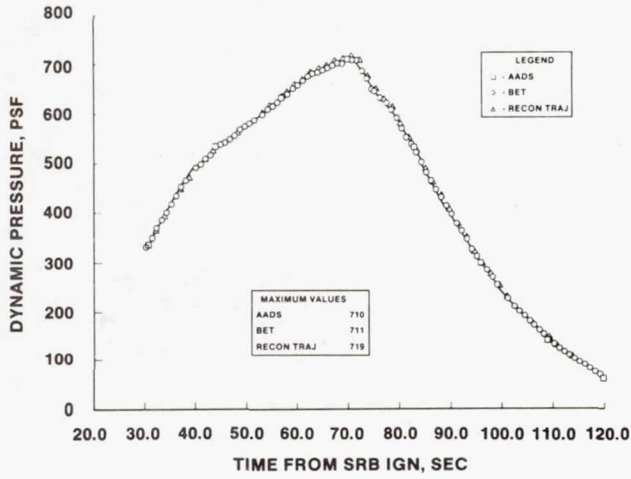

Fig. 17 STS-4 Dynamic Pressure Reconstruction.

**COMPARISON OF STS-4 ASCENT
AIR DATA WITH BET**

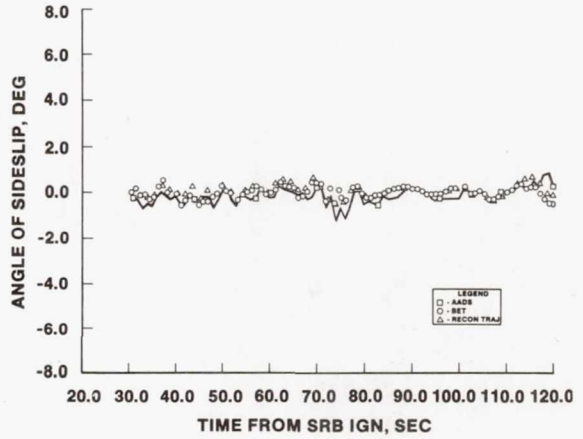

Fig. 19 STS-4 Angle-of-side Reconstruction.

**COMPARISON OF STS-4
ASCENT AIR DATA WITH BET**

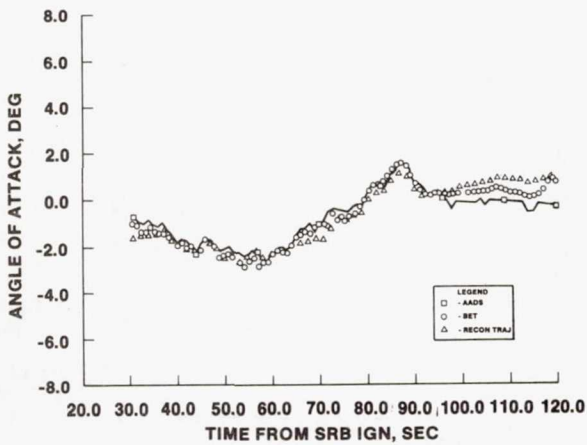

Fig. 18 STS-4 Angle-of-Attack Reconstruction.

STS-4 ASCENT TRAJECTORY RECONSTRUCTION

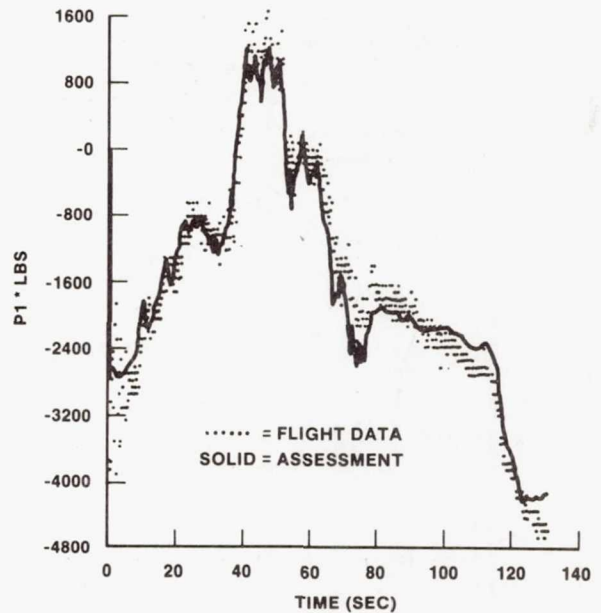

Fig. 20 STS-4 Attach Load Reconstruction.

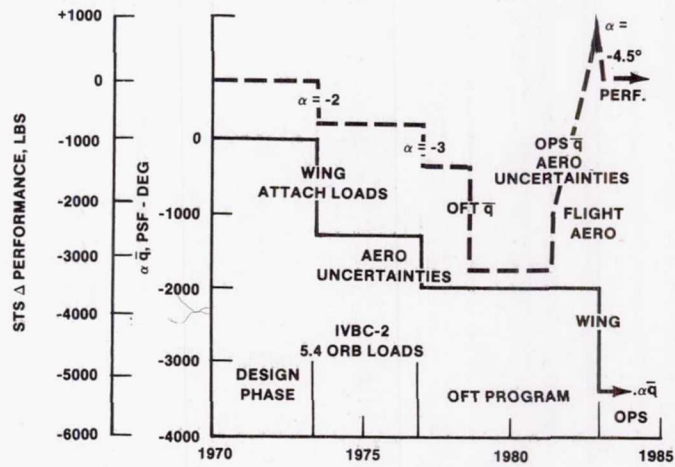

Fig. 21 Summary of System Performance Effects and Design $\alpha \bar{q}$ Based on SSV Aerodynamic History.

Table 1. Summary of STS-4 Trajectory Reconstruction.

STS-4 RECONSTRUCTION SUMMARY

| PARAMETER | FLIGHT DATA | RECONSTRUCTION |
|--------------------------|----------------|----------------|
| MAX \bar{q} | 711. (BET) | 719. |
| MAX PITCH ATTITUDE ERROR | + 3.8° | + 3.5° |
| STAGING H | 154,450. (BET) | 154060. |
| STAGING V_R | 4277. (BET) | 4287. |
| STAGING δ_R | 28.8 | 28.4 |
| 3 g THROTTLE | 458.6 | 458.4 |
| MECO CMD | 512.7 | 512.5 |
| LIQUIDS REMAINING LOX | 8466. | 8460. |
| LH ₂ | 3513. | 3540. |