

EXPERIMENTAL STUDY OF MAIN ROTOR TIP
GEOMETRY AND TAIL ROTOR INTERACTIONS
IN HOVER. VOL I - TEXT AND FIGURES

(NASA-CR-177336-Vol-1) EXPERIMENTAL STUDY
OF MAIN ROTOR TIP GEOMETRY AND TAIL ROTOR
INTERACTIONS IN HOVER. VOLUME 1. TEXT AND
FIGURES Progress Report, Aug. 1982 - Nov.
1983. (Sikorsky Aircraft Stratford, Conn.)

N85-22344

Unclas
G3/01 20167

D. T. Balch and J. Lombardi

CONTRACT NAS2-11266
February 1985

NASA



**EXPERIMENTAL STUDY OF MAIN ROTOR TIP
GEOMETRY AND TAIL ROTOR INTERACTIONS
IN HOVER. VOL I - TEXT AND FIGURES**

**D. T. Balch
J. Lombardi**

**Sikorsky Aircraft Division
United Technologies Corporation
Stratford, CT 06602**

**Prepared for
Ames Research Center
under Contract NAS2-11266**



**National Aeronautics and
Space Administration**

**Ames Research Center
Moffett Field, California 94035**

TABLE OF CONTENTS

	<u>Page</u>
ABSTRACT	i
SUMMARY	1
INTRODUCTION	3
LIST OF TABLES	4
LIST OF FIGURES	5
LIST OF SYMBOLS	9
TEST FACILITIES, APPARATUS AND PROCEDURES	10
Basic Model Test Rig	
Model Hover Test Facility	
Data Acquisition/Reduction	
Model Rotor Blades and Tips	
Test Procedures	
TEST RESULTS AND DISCUSSIONS	19
Data Repeatability/Scatter	
Isolated BLACK HAWK Main Rotor	
Isolated S-76 Main Rotor	
Main Rotor and Tail Rotor	
CONCLUSIONS	28
REFERENCES	30
TABLES	32
FIGURES	37

SUMMARY

The topic of Main Rotor/Tail Rotor/Airframe interaction in hover has been identified as being one that could increase operational efficiency of future rotary wing aircraft. However, the question of the sensitivity of some of the hover improvements to be gained by the use of advanced geometry tip configurations, when operating in close proximity to a tail rotor, needs to be addressed. To assist in identifying and quantifying the impact of the tail rotor on the improvements in main rotor hover performance attainable by using advanced geometry rotor tip configurations, NASA Ames awarded Sikorsky Aircraft Contract NAS2-11266 to undertake a series of model scale tests. The initial phase of the investigation involved main rotor only tests with two current advanced technology rotors (representing a scaled UH-60A BLACK HAWK rotor and a scaled S-76 rotor) and eight different tip configurations - three for use on the BLACK HAWK and five for use on the S-76. In this phase the full impact of the tip geometry changes on the rotor hover performance, as a function of rotational tip Mach number and ground effect, were investigated using all eight tip options. From these results, four of the more advanced tip configurations were selected for the second phase, with two tips each being tested on the two main rotors. This test assessed main rotor performance in the presence of an operating tail rotor (configured both as a tractor and pusher tail rotor). The tip Mach number and ground effect ranges were identical for the two tests. Details of the test configurations investigated are given in Table 1.

The peak isolated rotor performance was obtained with a tip that combined sweep, taper and anhedral. When tested in the presence of the tail rotor, however, this tip configuration exhibited greater thrust degradation due to the tail rotor compared to the other tested tips. The BLACK HAWK rotor, when using the double swept tip with anhedral, experienced 0.6% more thrust loss due to the tail rotor than the rotor did when using the double swept tip. The S-76 rotor, when using the swept tapered tip with anhedral, experienced 0.8% less thrust loss due to the tail rotor than the rotor did when using the 60% tapered tip. All tips, out of ground effect, on average showed a rotor performance loss in thrust of approximately 2% when subjected to the influence of the tail rotor. The use of either a pusher or tractor tail rotor at any of the test tip Mach numbers did not influence the magnitude of the interference measured on the S-76 rotor but did on the BLACK HAWK rotor. Moving the rotor into ground effect did reduce the impact of the tail rotor on the interference by approximately .7%. Again, all rotor tips produced a similar trend.

Overall, the test results showed that the tail rotor effects on the advanced tip configurations tested are not substantially different from the effects on conventional tips, and the benefits obtained from advanced tips should be retained even when operating in the presence of a tail rotor.

The customary system of units was used for principal measurements and calculations. Expressions in both SI units and customary units are used with the SI units stated first and the customary units afterwards, in parenthesis.

INTRODUCTION

In recent years the topic of Main Rotor/Tail Rotor/Airframe interaction has received more and more attention. The two areas of interaction in hover and in forward flight have, for the most part, each been addressed separately. In the area of hover interaction, two major studies were funded by NASA Ames and documented in References (1) and (2) by Sikorsky and Bell respectively. They concentrated on proving that the interaction existed and quantifying the magnitudes of the mutual interferences involved. In addition, both reports looked at the impact of a number of helicopter preliminary design variables on the interactions. Included in the main rotor design variables for the Reference (1) Sikorsky test were four tip configurations. The tip configurations included a 20° swept tip, a 35° swept tapered tip, an elliptic tip and a square tip. Unfortunately, the tips were each mounted on rotors with other configuration differences, and hence no systematic effect of the tail rotor interaction as a function of tip geometry was possible.

The advent of advanced composite materials, has removed some of the previous design limitations on main rotor tip geometry. Rotor designers now have the flexibility to incorporate the advanced tip designs evolved by the aerodynamicists. In this regard, the topic of optimum main rotor design for isolated conditions has received considerable attention in the last few years. References (3) through (14) present the results of a number of such studies conducted on the subject. Virtually all of these studies, however, have concentrated on the performance benefits of the new tip shapes without considering the potential degrading effect due to the necessary tail rotor operating close by. Their flow fields have not been addressed theoretically, because of the complexity of the flow fields involved. This report does, however, address the topic via the model scale test approach, and the result can be applied to equivalent isolated main rotor performance that was generated either from analysis or test.

LIST OF TABLES

<u>Table No.</u>	<u>Title</u>	<u>Page No.</u>
1.	Test Configurations	32
2.	Model Rotor Characteristics	33
3.	Main Rotor Alone Performance Increases	34
4.	% Loss of Main Rotor Thrust due to Addition of Tail Rotor, OGE	35
5.	% Loss of Main Rotor Thrust due to Addition of Tail Rotor, $M_t = 0.6$	36

LIST OF FIGURES

<u>Figure No.</u>	<u>Title</u>
1.	Model Test Cell Hover Facility
2.	Model Test Cell Hover Facility
3.	Typical Main Rotor C_t/Sigma - C_q/Sigma Relationship
4.	Typical Main Rotor Full Range Figure of Merit - C_t/Sigma Relationship
5.	Typical Main Rotor Expanded Scale Figure of Merit - C_t/Sigma Relationship
6.	Typical Tail Rotor C_t/Sigma - C_q/Sigma Relationship
7.	BLACK HAWK Rotor Geometry
8.	S-76 Rotor Geometry
9.	Tip Configurations Tested
10.	Mach Number Trends, OGE, BLACK HAWK Rotor with 20° Swept Tips
11.	Mach Number Trends, OGE, BLACK HAWK Rotor with Double Swept Tips
12.	Mach Number Trends, OGE, BLACK HAWK Rotor with Double Swept Tips with Anhedral
13.	BLACK HAWK Tip Comparison, OGE, $M_t = 0.55$
14.	BLACK HAWK Tip Comparison, OGE, $M_t = 0.6$
15.	BLACK HAWK Tip Comparison, OGE, $M_t = 0.65$

LIST OF FIGURES (Cont'd)

<u>Figure No.</u>	<u>Title</u>
16.	BLACK HAWK Tip Comparison, IGE Z/R = 1.2, $M_t = 0.6$
17.	BLACK HAWK Tip Comparison, IGE Z/R = 0.75, $M_t = 0.6$
18.	BLACK HAWK Rotor, Ground Effect Augmentation
19.	Mach Number Trends, OGE, S-76 Rotor with Rectangular Tips
20.	Mach Number Trends, OGE, S-76 Rotor with 60% Tapered Tips
21.	Mach Number Trends, OGE, S-76 Rotor with 20° Swept Tips
22.	Mach Number Trends, OGE, S-76 Rotor with Swept Tapered Tips
23.	Mach Number Trends, OGE, S-76 Rotor with Swept Tapered Tips with Anhedral
24.	S-76 Tip Comparison, OGE, $M_t = 0.55$
25.	S-76 Tip Comparison, OGE, $M_t = 0.6$
26.	S-76 Tip Comparison, OGE, $M_t = 0.65$
27.	S-76 Tip Comparison, IGE Z/R = 1.2, $M_t = 0.6$
28.	S-76 Tip Comparison, IGE Z/R = 0.75, $M_t = 0.6$
29.	S-76 Rotor, Ground Effect Augmenta- tion
30.	Tail Rotor Effect, OGE, $M_t = 0.55$, BLACK HAWK Rotor with Double Swept Tips
31.	Tail Rotor Effect, OGE, $M_t = 0.6$, BLACK HAWK Rotor with Double Swept Tips

LIST OF FIGURES (Cont'd)

<u>Figure No.</u>	<u>Title</u>
32.	Tail Rotor Effect, OGE, $M_t = 0.65$, BLACK HAWK Rotor with Double Swept Tips
33.	Tail Rotor Effect, OGE, $M_t = 0.55$, BLACK HAWK Rotor with Double Swept Tips with Anhedral
34.	Tail Rotor Effect, OGE, $M_t = 0.6$, BLACK HAWK Rotor with Double Swept Tips with Anhedral
35.	Tail Rotor Effect, OGE, $M_t = 0.65$, BLACK HAWK Rotor with Double Swept Tips with Anhedral
36.	Tail Rotor Effect, IGE $Z/R = 1.2$, $M_t = 0.6$, BLACK HAWK Rotor with Double Swept Tips
37.	Tail Rotor Effect, IGE $Z/R = 0.75$, $M_t = 0.6$, BLACK HAWK Rotor with Double Swept Tips
38.	Tail Rotor Effect, IGE $Z/R = 1.2$, $M_t = 0.6$, BLACK HAWK Rotor with Double Swept Tips with Anhedral
39.	Tail Rotor Effect, IGE $Z/R = 0.75$, $M_t = 0.6$, BLACK HAWK Rotor with Double Swept Tips with Anhedral
40.	Tail Rotor Effect, OGE, $M_t = 0.55$, S-76 Rotor with 60% Tapered Tips
41.	Tail Rotor Effect, OGE, $M_t = 0.6$, S-76 Rotor with 60% Tapered Tips
42.	Tail Rotor Effect, OGE, $M_t = 0.65$, S-76 Rotor with 60% Tapered Tips
43.	Tail Rotor Effect, OGE, $M_t = 0.55$, S-76 Rotor with Swept Tapered Tips with Anhedral

LIST OF FIGURES (Cont'd)

<u>Figure No.</u>	<u>Title</u>
44.	Tail Rotor Effect, OGE, $M_t = 0.6$, S-76 Rotor with Swept Tapered Tips with Anhedral
45.	Tail Rotor Effect, OGE, $M_t = 0.65$, S-76 Rotor with Swept Tapered Tips with Anhedral
46.	Tail Rotor Effect, OGE, $M_t = 0.55$, S-76 Rotor with Swept Tapered Tips
47.	Tail Rotor Effect, OGE, $M_t = 0.6$, S-76 Rotor with Swept Tapered Tips
48.	Tail Rotor Effect, OGE, $M_t = 0.65$, S-76 Rotor with Swept Tapered Tips
49.	Tail Rotor Effect, IGE Z/R = 1.2, $M_t = 0.6$, S-76 Rotor with 60% Tapered Tips
50.	Tail Rotor Effect, IGE Z/R = 0.75, $M_t = 0.6$, S-76 Rotor with 60% Tapered Tips
51.	Tail Rotor Effect, IGE Z/R = 1.2, $M_t = 0.6$, S-76 Rotor with Swept Tapered Tips with Anhedral
52.	Tail Rotor Effect, IGE Z/R = 0.75, $M_t = 0.6$, S-76 Rotor with Swept Tapered Tips with Anhedral
53.	Tail Rotor Effect, IGE Z/R = 1.2, $M_t = 0.6$, S-76 Rotor with Swept Tapered Tips
54.	Impact of Tail Rotor on Performance Improvements

LIST OF SYMBOLS

a	Speed of sound
b	Number of blades = 4
c	Blade chord
c_q	Rotor torque coefficient = $\frac{Q}{\pi\rho\Omega^2R^5}$
C_t	Rotor thrust coefficient = $\frac{T}{\pi\rho\Omega^2R^4}$
FMR	Figure of Merit = $\frac{(C_t)^{3/2}}{\sqrt{2} C_q}$
M_T	Rotor rotational tip Mach number = $\frac{\Omega R}{a}$
Q	Rotor torque
R	Rotor radius
Sigma	Rotor solidity = $\frac{bc}{\pi R}$
T	Rotor Thrust
t/c	Airfoil maximum thickness to chord ratio
Z	Distance between ground plane and the centroid of the rotor hub
ρ	Mass density of a
σ	Rotor solidity = $\frac{bc}{\pi R}$
Ω	Rotor rotational velocity, radians per second

TEST FACILITIES, APPARATUS AND PROCEDURES

Basic Model Test Rig

The Basic Model Test Rig (BMTR) is a self-contained helicopter test rig which can handle a range of rotor systems and fuselage skins as well as model support schemes.

The rotor power, rotor control and data measurement systems are completely self-contained. All that is required to provide a working test configuration is the attachment of power, hydraulic, control and data signal lines and a support structure.

The main rotor of the BMTR is driven by a 90 HP 3 phase synchronous electric motor through a reducing gear box. The BMTR transmission was modified during this contract. This modification involved upgrading the transmission to make it capable of handling the 90 HP motor used in the test rather than the 60 HP motor used previously. Not only does the new transmission have a greater horsepower capability, but it is also in a much more compact form. The 90 HP motor mounting position was changed from horizontal to vertical on the modified transmission. The slip ring, optical encoder and control mixer box remained unchanged during the transmission modification. The load cell, used to measure main rotor torque was changed from a Revere Model USP1-.5-B-5283 to an Interface Model SSM-250. As a result of these modifications it was found, when comparing otherwise identical pre and post modifications runs, that main rotor thrust at fixed power dropped by approximately 2% at the higher thrust levels. However, close to identical pre and post modifications can be obtained throughout the thrust range by reducing the pre modification measured lifts and torques by 4.5%. This data adjustment has been applied to all pre-modification data presented in this report. The resulting main rotor Figures of Merit are now in line with those obtained by other model test facilities.

The main rotor forces and moments are measured on a six element strain gage balance (Task 2.5 Mk XIX). Rotor torque is measured by the separate load cell described above.

All tail loads are measured separately on another 6 component balance, a Task Model 2.0 Mk III strain gage balance. This balance measures the net system thrust on the tail rotor (tail rotor thrust plus thrust recovery, less fin side force reaction) as distinct from tail rotor thrust alone. The tail rotor power is supplied by a 20 horsepower 3-phase synchronous direct drive electric motor.

Main rotor control inputs are made via jack screws and a conventional rotor swashplate. The control inputs are measured at the outputs from the jack screws by potentiometers. The cyclic inputs are monitored to give zero flapping as measured on a blade flap potentiometer. Tail rotor inputs are made similarly with a jack screw and a non-tilting swashplate. The tail collective inputs are also measured via a potentiometer on the pushrod. It should be noted that because of the effects of flexibility of the system the methods of blade pitch measurement used do not generally give the actual blade pitch angles.

The effects of the tail rotor "delta 3" angle, (the pitch-flap coupling), are not included. This "delta 3" angle (of 45°) has the effect of giving an actual blade pitch angle different from the input angle. While the absolute blade angles cannot be defined exactly, the changes in blade angles due to interference effects are correctly measured.

The main rotor collective was set to zero during the installation of blades. Any adjustment in individual blade pitch that was needed to bring the blades into track (all blades following the same tip path plane) could shift this reference point slightly.

When the tail rotor was changed from tractor to pusher configuration, the drive motor and control inputs were flipped over. This causes a change in the sense of the control input jack screw and potentiometer. During data reprocessing, this shift in tail rotor collective slope (and zero) caused by the tail rotor reconfiguration has been accounted for.

The main rotor torque measurements are made separately using a load cell attached between the transmission box and the model frame. However, the tail rotor shaft torques were not measured separately but were measured on the pitching moment elements of the tail balance. This pitching moment was assumed to be equal to the applied tail rotor torque.

To minimize any errors in this approach, all the runs were conducted without the stabilator to eliminate any download contamination of the pitching moment reading.

The BMTR is capable of handling the fuselage skins of any appropriately scaled aircraft. The 1/5.727 scale fuselage of the UH-60A BLACK HAWK was chosen for this contract. The removable skins are not hard mounted to the BMTR structure. This makes the skins independent of the main and tail balances.

Model Hover Test Facility

The tests involved in this study were conducted on the Sikorsky Model Hover Test Facility using the Basic Model Test Rig (BMTR). This test facility includes the hover pad, the model assembly area and the data acquisition, recording and processing systems.

The five sided hover test cell Figures 1 and 2 measures 18.0m (59 ft) long by 12.8m (42 ft) wide and is enclosed by nine 9.1m (30 ft) high garage-type doors. These doors are used to minimize the impact of winds and can be individually set to any desired height. Previous to this contract, runs were made at various door heights to determine the optimum settings to minimize wind induced rotor performance effects for all wind conditions below 20 knots. A door height of 1.2m (4 ft) was selected for the majority of the test. Occasionally a run was made with the doors fully opened to verify that the measured performance was not influenced by the proximity of the enclosure doors.

A major feature of the hover pad is the hydraulic ram on which the BMTR is mounted. This ram can be raised or lowered with a 7.62m (25 ft) stroke capability. The fully lowered ram puts the model rotor head 105 cm (41 in.) above the ground. This corresponds to a height to radius ratio (Z/R) of 0.75. This value was also used as one of two in-ground effect (IGE) conditions. The fully extended ram positions the model rotor head to a Z/R value of approximately 6.5. This value is well in excess of the height needed to simulate out of ground effect (OGE) hover. Since a Z/R of 6.5 puts the model rotor very close to the top of the enclosure, a Z/R value of 3.0 was selected for the OGE segments of the test to insure a minimum of upper flow disturbance.

An airspeed anemometer and weather vane are mounted directly above the model on top of the enclosure. With the doors open, the airspeed reading and wind direction indicator match the readings taken in the Sikorsky Aircraft control tower. However, with the doors at normal running height, the anemometer reading is considerably lower than the true outside airspeed. Comparisons of rotor performance changes with anemometer readings under high outside wind conditions have shown that the anemometer reading is an accurate indication of the wind condition that the rotor experiences. Anemometer readings of 2-4 kph (1-2 knots) were established as acceptable for taking performance data which was independent of the ambient wind conditions.

The controls for the BMTR are located in the control room of the test facility building. Independent controls for the main rotor and tail rotor RPM's and collective angles are used. Main rotor lateral and longitudinal cyclic control is also available.

The main rotor electrical power supply (3-phase, variable frequency) was a Servo Optics 440V 500A solid state "Static Drive" unit. The Sikorsky 440V 200A "Varidrive" unit was used to power the tail rotor. This unit was fabricated from components supplied by various manufacturers.

The main voltage supply used to drive the HP 9845T computer, the NEFF signal conditioning unit and the strain gage power supply was stabilized using a Deltec Corporation DLC 1860 signal conditioning unit.

Data Acquisition and Reduction

All data acquisition and on-line processing tasks were performed by the Experimental Aeromechanics Model Rotor Test System. This system utilizes a Hewlett-Packard 9845T micro-computer coupled with a Neff System 620 Data Acquisition System. The HP9845T is a 16 bit computer which is capable of complete control over monitoring model integrity as well as acquiring, processing, and storing performance data. The data acquisition program used in this test acquires the following parameters from the Neff system:

- Six component main rotor balance output
- Six component tail rotor output
- Torque cell output
- Main and tail rotor RPM
- Tail rotor collective position
- Main rotor collective and cyclic control positions in the shaft axis system
- Transmission oil pressure and drive motor temperatures
- NEFF System 620 status information

When the system is in on-line monitoring mode, each of the above parameters is sampled once, converted into engineering units and displayed on the system CRT. Update time for this mode is under two seconds. The NEFF system is equipped with 1 HZ filter networks which attenuate all but the quasi-steady state loads. This mode is used to facilitate each data point set up conditions and provides general system monitoring.

When the system is in the data acquisition mode, all the strain gauge parameters are sampled 10 times and algebraically averaged. The other parameters, being steady state values, are only sampled once. The averaged raw data is recorded on digital tape then processed into engineering values and output on the computer's integral printer. The update time of this mode is approximately 40 seconds. During this time, the CRT display is frozen. The averaging of 10 samples plus the NEFF 1 HZ filtering handles any non-steady state component in the strain gauge loads.

At the completion of each run the data recorded on tape were reprocessed to include the start and end zero's as well as being corrected for any significant variations in input parameters, such as ambient conditions. Many of the rotor parameters were then processed further into nondimensional forms (the definitions of which are presented in the List of Symbols).

The important main and tail rotor parameters can be plotted against each other directly using the HP computer. Currently included are main rotor C_t/σ and C_q/σ against collective, main rotor C_t/σ against C_q/σ , main rotor Figure of Merit against C_t/σ (full and expanded scale) and tail rotor C_t/σ against C_q/σ .

Examples of these plots for a typical test configuration (S-76 Main Rotor with 60% tapered tips and tractor tail rotor, OGE and $M_T = 0.55$) are presented in Figures 3-6. The actual data points are shown on these plots with a least squares curve fit routine giving a line through the data for all plots except those involving main rotor collective. The curve fit equations for each test condition, together with the standard deviation and mean error, are given at the top of the appropriate tables in the data package of Volume II.

The bulk of the computer plotted results presented in this report involve comparison between rotor performance levels as a result of configuration or operating condition changes. These plots entail two or more curves taken from separate data runs and do not include the actual data points. The lines represent the least squares best curve fit.

Model Rotors Blades and Tips

Two sets of main rotor blades were used in the test. The S-70 BLACK HAWK and S-76 blade sets are dynamically scaled versions of the actual aircraft rotor blades. The aerodynamic geometries of these rotors are shown in Figures 7 and 8. The two rotor sets were tested with a number of different geometry tips.

The S-70 BLACK HAWK blades are 1/5.727 scale with a -16° equivalent linear twist and utilize the SC1095 and SC1094 R8 airfoil sections. They have a radius of 1.428m (56.224 inches), a chord of 0.0906m (3.566 inches) and a solidity of .0815. The S-70 blades were tested with the 20° swept tip of the baseline UH-60A as well as with a 20° , 35° double swept tip which incorporates a 60% taper and with a 20° , 35° double swept tip with 20° anhedral. These tips were 6% of the blade's radius, and are shown in Figure 9. The three tips were tested alone and the double swept tip and double swept tip with anhedral were also tested with the tail rotor.

The S-76 blades are 1/4.71 scale and possess a -10° linear twist and a solidity of .0704. These blades have a radius of 1.423m (56.04 in.), a chord of .0787m (3.1 in.) and use the SC1095 and SC1094 R8 airfoils. The S-76 blades were tested with five different tips, each of 5% of the radius. The tips are rectangular, 20° swept, 60° tapered, 35° swept with 60% taper, and 35° swept with 60% taper and a 20° anhedral. The tips are also shown in Figure 9. The five tips were tested alone and the 60° tapered, 35° swept with 60% taper and 35° swept with 60% taper and 20° anhedral were tested with the tail rotor.

The tail rotor used for this test is non-scaled dynamically and aerodynamically, and has a radius of .2921m (11.5 inches) and a solidity of .2214. It employs four blades with -4° linear twist and an NACA 0012 airfoil section. The tail rotor is located at the scale BLACK HAWK locations, without cant, with the option of operating in the pusher or tractor mode. In both cases the tail rotor rotation is maintained with the lower blade travelling forward. The details of the main and tail rotor blades are presented in Table 2.

The S-70 BLACK HAWK and S-76 blades were mounted with extenders. This was done to simulate the actual main rotor/tail rotor clearance of the BLACK HAWK helicopter. Details of the clearance, separation and blockages experienced are presented in Table 2.

Test Procedures

The test runs were carried out using a basic procedure. This procedure was only modified for those runs involving simultaneous operation of main and tail rotors.

Following the preparation of the model configuration, the pretest calibrations were performed. The model was then exercised over the full test range of thrust values (to minimize residual "sticktion") and start zeros were taken. The first test data point taken was always a "dynamic zero". For main or tail rotor alone, these operations correspond to a near zero thrust condition at the required tip Mach number. The "dynamic zero" data point serves as an initial check of the system, a condition during which blade flapping can be set to zero and a low thrust test point which helps to ensure a good data curve fit throughout the thrust range.

When operating both the main and tail rotors, the main rotor was set to the same near zero thrust condition with the tail rotor thrust adjusted to produce a tail yawing moment equal and opposite to the yawing moment produced by the main rotor torque. The main and tail rotor balance loads were monitored and continually updated with the on-line display of the computer CRT. These data were used to insure correct main and tail rotor thrust settings.

The sequence of events used to take a test point involved initially setting the main or tail rotor collective and then adjusting the RPM to achieve the desired Mach number. If the main and tail rotor were operating simultaneously, it was next required to readjust the tail rotor collective so that the yawing moment produced by the tail rotor thrust balanced the main rotor torque within 2% of the maximum torque value.

Following the "dynamic zero" data point, test points were taken at 2° collective increase steps to approximately 60% of the maximum collective for that run. From this point +1° collective intervals were used for data points up to the rotor maximum collective. The maximum collective was defined by the rotor thrust limit, main rotor torque limit, or main rotor stall.

Data were then taken with reducing collective at half degree intervals down to the lower end of the range of interest. On-line monitoring of the data allowed any repeat or additional points required to be identified and obtained. This sequence of data acquisition minimized drive motor and gearbox temperature rise and was only possible because of minimal data hysteresis apparent in the data system.

Following acquisition of the test data, an end "dynamic zero" was taken. After RPM shutdowns, the end zeros and calibrations were taken. Each data run was recorded on magnetic tape under its own identification number for future access, reprocessing, and/or plot generation.

TEST RESULTS AND DISCUSSIONS

Data Repeatability/Scatter

During the course of the test, between each mounting of the test rotors with the many tip configurations, a set of non-scale wide chord rotor blades were installed and run to check the system accuracy and repeatability. A total of 23 such runs were made on these "calibration" blades, out of ground effect, at a tip Mach number of 0.6. After eliminating the known questionable runs (due to end zero error or high/gusty wind conditions) the remaining runs showed a data repeatability of .6% on Figure of Merit or .4% on rotor lift at constant power.

Main rotor data scatter was found to be acceptably low (as the typical data runs of Figures 3-6 showed) with a typical C_q/σ standard deviation of .000040.

Isolated BLACK HAWK Main Rotor

The BLACK HAWK rotor was tested with 3 tip configurations. These consisted of the baseline UH-60A 20° swept tip, the 20/35° double swept tip and the 20/35° double swept tip with 20° anhedral, (see Figure 9 for configuration details). The 3 tip configurations were tested out of ground effect at 3 tip Mach numbers of 0.55, 0.60 and 0.65 plus 2 inground effect tests, at z/R 's of 1.2 and 0.75, at a single tip Mach number of 0.6. The details of the model configurations tested are given in Table 1.

The trend of out of ground effect rotor Figure of Merit with tip Mach number for the baseline 20° swept tip is presented in Figure 10. The loss in Figure of Merit due to a Mach number increase from .55 to .65 was found to be .023 at a C_t/σ of .08. This Mach number trend is very similar to that demonstrated on the full scale BLACK HAWK rotor on the hover whirl stand. However the full scale rotor experiences a smaller loss of Figure of Merit over the same Mach number range, then the model rotor. The full scale BLACK HAWK tip Mach number is 0.628 at the design 1219m (4000 ft) 35°C (95°F) atmospheric condition.

When increased tip sweep and taper is introduced into the tip, as in the double swept tip, the loss of Figure of Merit due to tip Mach number is significantly reduced (Figure 11), and amounts to a Figure of Merit loss of only .013 at a C_t/σ of .08 for a Mach number increase from .55 to .65.

Introducing 20° anhedral into the double swept tip reduces the loss of performance with increasing tip Mach number even more, (Figure 12). Here the total loss of Figure of Merit over the full Mach number range is only .005 at a C_t/σ of .08.

(4)

This change in Mach number effect is also very apparent when the benefits of the alternate tip configurations are compared to the baseline swept tip at fixed Mach number. In Figure 13 the 3 tips are compared at fixed out of ground effect, 0.55 tip Mach number conditions. At this condition the double swept tip has the lowest Figure of Merit while the double swept with anhedral tip has the highest with the anhedral tip having a maximum Figure of Merit increase of .012 compared to the baseline swept tip. Moving to a tip Mach number of 0.6, OGE, (Figure 14) the sharp Mach number trend on the swept tip now results in the lowest overall performance for this tip with the double swept, anhedral tip now having a maximum Figure of Merit .025 above that for the swept tip.

At the highest test tip Mach number of 0.65, Figure 15, the double swept, anhedral tip configuration is still the best and now shows a Figure of Merit increase of .03 above that for the swept tip.

In ground effect at a tip Mach number of 0.6, the tips all show an increase in Figure of Merit compared to out of ground effect. Figure 16 shows the results at a B/R of 1.2 and indicates similar trends when compared to OGE. Figure 17 shows the results for a B/R of 0.75 and illustrate that the benefits of the anhedral tip start to fall off when the ground effect become significant. This is as might be expected as the concept of the anhedral tip is to push the tip vortex down relative to the following blade. In ground effect the downwash velocities for a given thrust level are reduced resulting in less clearance between the shed tip vortex and the following blade.

The actual thrust augmentation ratios for the 3 tip configurations as a function of rotor B/R are presented in Figure 18 for a tip Mach Number of 0.6 and a fixed rotor C_q/σ of .007. This figure also shows that as the tip vortex strength is reduced by tapering the tip (as used in the double swept tip) the lower downwash velocities in ground effect reduce the following blade interference and yield better inground effect augmentation.

Based on these main rotor runs alone, the two tip configurations selected for study with the tail rotor operating were the double swept tip and the double swept tip with anhedral.

Isolated S-76 Main Rotor

The S-76 rotor was tested with 5 tip configurations. These consisted of the baseline S-76 swept tapered tip, a rectangular tip, a tapered tip with 60% tip chord, a swept tip and a swept tapered tip with 20° anhedral. The latter tip was specially fabricated for this test. All other tips, including those used on the BLACK HAWK rotor were already in existence, having been previously fabricated under Sikorsky Aircraft IR&D funding. These

tips are shown in Figure 9. As with the BLACK HAWK rotor, all tips were tested at 3 tip Mach numbers OGE, and 2 IGE conditions at 1 tip Mach number.

The out of ground effect rotor Figure of Merit trend with tip Mach number for the rectangular tips is presented as Figure 19. The data at the lowest tip Mach number of 0.55 appear slightly low, especially at the lower C_t/σ s. None the less, the loss in Figure of Merit due to a tip Mach number increase from .55 to .65 was still tested as .031 at a C_t/σ of .085.

The use of taper on the unswept blade tip, as shown in Figure 20, reveals a very similar loss of Figure of Merit of .032 with increase in tip Mach number. However, this value was obtained at a lower C_t/σ of .08, as the data test range was lower during this series of runs.

If a sweep of 20° is incorporated in the tip, the effects of increasing the tip Mach number are significantly reduced as shown in Figure 21. Again, the lowest Mach number data appears slightly low, especially at the lowest thrust levels. The tested loss of Figure of Merit at a C_t/σ of .085 was .014. Introducing taper to the swept tips, increases this Figure of Merit loss slightly to .018 at the same C_t/σ of .085 (Figure 22). With the added feature of 20° anhedral, the loss of Figure of Merit drops slightly to .016 at a C_t/σ of .085 (Figure 23).

Of the tips tested on both rotors the two tips which are the closest geometrically are the two 20° swept tips. Comparisons between the OGE performances of the two rotors (Figures 10 and 21) show that the BLACK HAWK rotor has approximately .02 higher peak Figure of Merit at a tip Mach number of 0.6 than the S-76 rotor.

From these S-76 rotor trends we find that taper does not significantly improve the Mach number characteristics of the rotor, tip sweep does and anhedral has a minor impact. This contrasts with the BLACK HAWK results where both taper and anhedral had a beneficial impact. This result is not surprising since the higher tip angles of attack on low twist rotors should be less accommodating to the further increase in tip angle forced by taper. In fact, tip taper will be effective in improving rotor performance only when the tip operates well below drag divergence conditions. Likewise, sweep is more effective on low twist rotors due to high tip loading and accompanying Mach penalties.

When all 5 tips are compared to each other under the same operating conditions, the relative merits of each of the tips are apparent. Figure 24 presents the results for all of the S-76 tips, out of ground effect, at a tip Mach number of 0.55. The lowest performance tip throughout the thrust range is the rectangular tip. Introducing 20° of sweep increases the performance

(4)

slightly - more so at the higher thrust levels. If the tip is kept straight but taper is incorporated, significant performance benefits at the lower thrust levels result with less advantage apparent at the higher thrust levels. The combination of sweep and taper provides the same improved Figure of Merit throughout the thrust range that taper alone gives at the lower thrust levels. Finally, introducing anhedral to the swept tapered tip bumps performance up yet further throughout the thrust range. The total Figure of Merit increase possible when progressing from a rectangular tip to a swept tapered tip with anhedral at a C_t/σ of 0.095 is .041 or 6% at a tip Mach number of 0.55.

When the results are compared at the higher tip Mach number of 0.6 (Figure 25), the previous trends are all still apparent with the total Figure of Merit increase possible now up to .045 at the lower C_t/σ of .09.

At the highest test tip Mach number of 0.65 (Figure 26) the previous general trends still hold; only now the unswept tips are starting to pay more of a penalty so that at the highest thrust levels the swept tip shows a much larger improvement over the rectangular tip than before and the straight tapered tip now gives lower performance than the swept tip at the higher thrust levels. The total Figure of Merit increase recorded has now risen to .057 or 8.8%, at a C_g/σ of .0875.

Figure 27 compares the relative results for the 5 tips at a tip Mach number of 0.6 when operating in ground effect at a Z/R of 1.2. The general trend of configuration change effects is very similar to that shown OGE (Figure 25) except, as with the BLACK HAWK rotor, the anhedral tip does not improve as much when in ground effect as the other tips.

Moving into ground effect further to a Z/R of .75 (Figure 28), the anhedral tip loses a little more of its advantage. At the higher thrust levels, under these operating conditions, the rectangular tip, tapered tip and swept tip all possess similar performance.

If the performance levels of the two rotors with the comparable 20° swept tip are compared (Figures 17 and 28) at a tip Mach Number of 0.6 and a Z/R of 0.75, the OGE performance advantage of the BLACK HAWK rotor over the S-76 rotor has now virtually disappeared at the higher thrust levels, although a small advantage still exists at the lower thrust levels.

The actual thrust augmentation ratio for the 5 tip configurations as a function of rotor Z/R is presented in Figure 29 for a tip Mach number of 0.6 and a fixed rotor C_q/σ of .007. This figure confirms and quantifies the loss of ground effect augmentation at both Z/R conditions as a result of using the anhedral tip compared to the other tips. Also shown is a loss of augmentation

at the high B/R when using the swept tapered tip. These results are both consistent with the BLACK HAWK trends with tip geometry (Figure 18) although in all cases the magnitude of the augmentations involved are almost twice as much for the S-76 rotor compared to the BLACK HAWK. This result is consistent with the findings of the previous study [Reference (1)] which showed that higher twist rotors have lower thrust augmentation capabilities.

With the systematic variation in rotor tip configurations undertaken in this test, the incremental influence of each tip change on the rotor figure of merit experienced has been determined and is presented in Table 3 for a constant rotor Ct/σ of .085 for an OGE tip Mach number of 0.6. From this we can see that tip taper and sweep have comparable effect, and adding taper to a swept tip or sweep to a tapered tip have comparable results. The increases in figure of merit on the high twist BLACK HAWK rotor were lower than on the S-76 rotor.

From these results the primary choices for the follow on testing with tail rotor are the anhedral tip and swept tapered tips. However, these 2 configurations were also selected for the testing with the BLACK HAWK rotor and the duplication was not considered appropriate. From the BLACK HAWK series, the effects of anhedral could be assessed and which if then applied to the S-76 series of tests would not require the swept tapered tip tests. For this reason the second tip selected for testing on the S-76 rotor was the tapered tip.

The S-76 rotor with the swept tapered tips was also tested in this phase as additional runs not required in the original contract Statement of Work. Unfortunately not all test variables were possible due to time constraints, with the result that only those runs involving the pusher tail rotor configuration were completed.

BLACK HAWK Main Rotor with Tail Rotor

As indicated previously, four tip configurations were tested in the presence of a tail rotor, with the tail rotor in both pusher and tractor configurations. Three runs were made out of ground effect with tip Mach numbers of 0.55, 0.6 and 0.65 plus two in-ground effect runs at Z/R's of 1.2 and 0.75 at a tip Mach number of 0.6.

The two tip configurations tested on the BLACK HAWK rotor were the double swept tip and double swept tip with anhedral, while the 2 tip configurations tested on the S-76 rotor were the 60% tapered tip and the swept tapered tip with anhedral, (plus the limited runs on the swept tapered tip).

The impact of the tail rotor, both pusher and tractor, on the out of ground effect hover figure of merit of the BLACK HAWK rotor with the double swept tips operating with a tip Mach number of 0.55 is shown in Figure 30. The operating tail rotor has a similar impact on reducing the main rotor performance in either the pusher or tractor mode. At representative thrust levels this loss of performance is approximately a 1.2% loss of thrust at constant power.

However the results with the same rotor and tip configuration at a tip Mach number of 0.6 (Figure 31) shows that the tractor tail rotor imposes a smaller penalty on the main rotor performance than the pusher tail rotor but the actual penalty for the tractor is still higher than at the lower tip Mach number. The tractor tail rotor penalty was found to be 1.7% loss of thrust while the pusher penalty was as high as 3.1%.

Similarly at a tip Mach number of 0.65 (Figure 32) the tractor tail rotor causes a lower performance loss on the main rotor than does the pusher tail rotor. The actual losses measured with this operating configuration were a 1.5% loss with the tractor tail rotor and a 2.5% loss with the pusher tail rotor.

When the BLACK HAWK tips are changed to incorporate anhedral the impact of the tail rotor on the main rotor performance was very similar to that discussed above. At the low Mach number of 0.55 (Figure 33), the 2 tail rotor modes of operation have essentially identical impact on the main rotor performance - a loss of approximately 1.7% in thrust for both. At the two higher Mach numbers of 0.6 and 0.65 (Figures 34 and 35 respectively) the tractor tail rotor causes a lower thrust loss than the pusher tail rotor with both losses being more than either caused at the lower tip Mach number. The actual losses of main rotor thrust as a function of the tip configuration, tip Mach number and tail rotor operating mode are presented in Table 4. As indicated, when a tail rotor is operating close to an advanced geometry tip on an BLACK HAWK rotor the rotor will experience a thrust loss averaging

2.5% which is 0.6% higher than that experienced with less advanced tip configurations.

Operating the BLACK HAWK rotor with the double swept tips inground effect, at a tip mach number of 0.6, retains most of the OGE trends, with just a small reduction in the thrust loss experienced by the main rotor. When in ground effect at a Z/R of 1.2 (Figure 36) or 0.75 (Figure 37) the main rotor thrust loss when the tail rotor is operating in the pusher mode is always more than when operating in the tractor mode. In fact at the lower thrust levels, when operating the tail rotor in the tractor mode, the main rotor can even experience a thrust gain compared to isolated rotor. The further in ground effect the main rotor is operating, the larger this thrust gain becomes. This low thrust level performance increase was not seen on the S-76 rotor or in the previous test (Reference 1) and is probably the result of the high BLACK HAWK rotor twist plus tip configuration combination. The trend due to both components is in this direction.

The addition of anhedral to the tip configuration, resulted in the isolated BLACK HAWK main rotor trends in ground effect changing significantly. Similarly when the BLACK HAWK rotor with the double swept tips with anhedral is operated in ground effect, in the presence of a tail rotor, the trends are changed. At a Z/R of 1.2 (Figure 38) and a Z/R of 0.75 (Figures 39) the results have a similarity to the OGE results of Figure 34, showing a variation with the mode of tail rotor operation. However unlike the double swept tip, no significant reduction in the interference seen by the main rotor due to the operation of the tail rotor is apparent when moving into ground effect. This trend further erodes the benefits to be gained IGE from the use of anhedral tips. A quick comparison between the tail rotor operating IGE performance for the double swept tips (Figure 37) and the comparable performance with the anhedral tips (Figure 39) shows this clearly.

The actual losses of main rotor thrust as a function of the tip configuration, Z/R and tail rotor operating mode are presented in Table 5.

S-76 Main Rotor with Tail Rotor

The first tip tested on the S-76 rotor with the tail rotor operating was the 60% tapered tip. Figure 40 shows the OGE impact of the tail rotor, tractor and pusher, at a tip Mach number of 0.55. A small impact of tail rotor operating mode is evident (the tractor tail rotor this time showing the highest interference by a small amount). A tip Mach number of 0.6 (Figure 41) causes the highest interference for both modes. At the highest Mach number of 0.65 (Figure 42) the trends are again very similar with less sensitivity to the tail rotor operating mode but the same level of

overall interference as experienced at the lower Mach number. The magnitudes of the thrust losses are presented in Table 4.

When the tapered tip on the S-76 had sweep and anhedral introduced, for all of the OGE conditions (3 Mach numbers of 0.55-Figure 43, 0.6-Figure 44, and 0.65-Figure 45), the mode of tail rotor operation had minimal effect on the interference measured on the main rotor. Also, the magnitude of the interference was reduced compared to the tapered tip. The magnitude of interference was reduced from an average of approximately 2.3% for the tapered tip to approximately 1.5% for the swept, tapered tip with anhedral.

Figures 46, 47 and 48 show the OGE results for the swept tapered tip configuration at tip Mach numbers of 0.55, 0.6 and 0.65 respectively with the tail rotor operating only in the pusher mode. A consistent, approximately 1.7% loss of main rotor thrust was recorded due to the use of the pusher tail rotor. This thrust loss is very comparable to that recorded with the swept tapered anhedral tips (1.6%) and less than measured with the 60% tapered tips (2.2%) when operating with a pusher tail rotor. These results are all presented in Table 4.

Switching back to the 60% tapered tips and moving into ground effect, at a Z/R of 1.2, Figure 49, the mode of operation effect for tail rotor, just as for OGE, was found to be small. However at the lowest Z/R of 0.75, Figure 50, the tractor tail rotor produced more main rotor interference. The overall effect of moving into ground effect, as with the double swept tip on the BLACK HAWK rotor, was to reduce the interference seen by the main rotor by approximately 1%.

For the S-76 rotor with the swept tapered tips with anhedral, moving into ground effect provided conflicting trends. At a Z/R of 1.2 (Figure 51), the tractor tail rotor results indicated no interference effects, with normal (slightly less than OGE) interference with the pusher tail rotor. At a Z/R of 0.75 (Figure 52), the tail rotor modes produced similar interferences. Overall the effect of moving IGE was to reduce the interference by approximately 0.6%.

Unfortunately, the IGE testing with the swept tapered tip on the S-76 was not completed but did show (Figure 53), at a Z/R of 1.2, a significant reduction of interference felt by the main rotor due to the tail rotor presence.

The full tabulation of the main rotor interferences measured with the tail rotor operating as a function of main rotor, tip geometry, tip Mach number and tail rotor operating mode is presented for OGE conditions in Table 4 and for IGE conditions in Table 5.

From these results a comparison can be made between the performance improvements to be had from the use of advanced geometry tip configurations when tested under main rotor only and main rotor with tail rotor conditions. Figure 54 presents such a comparison and shows a plot of the percentage performance improvements available when using 4 alternate tip configurations when tested alone and in the presence of a tail rotor. The 4 tips shown are the double swept tips and double swept tips with anhedral used on the BLACK HAWK rotor and the 60% tapered tips and swept tapered tips with anhedral used on the S-76 rotor. The performance improvements quoted use the baseline tips appropriate to each of the rotors, that is the 20° swept tip on the BLACK HAWK rotor and the swept tapered tip on the S-76 rotor. The 45° line represents the situation where the performance improvements measured rotor alone are exactly maintained when operating with the tail rotor. The results from this test being very close to the 45° line show that the tail rotor influence does not significantly change the benefits to be derived from the use of the advanced geometry tip configurations tested, when compared to the benefits measured by main rotor alone testing.

CONCLUSIONS

Main Rotor Alone

- The higher twist BLACK HAWK rotor (with baseline swept tips) has higher OGE performance than the S-76 rotor (with baseline swept tapered tips).
- The high twist BLACK HAWK rotor experiences less thrust augmentation IGE than the S-76 rotor. In fact, the peak IGE figure of merit of the S-76 rotor with the 20° swept tips at a Z/R of 0.75 is the same as that for the BLACK HAWK rotor with 20° swept tips.
- Introducing taper (via the double sweep feature) and then anhedral on the BLACK HAWK rotor progressively reduced the sensitivity of the rotor to tip Mach number for OGE conditions. Except at the lowest test tip Mach number, the above changes also give the rotor progressive increases in figure of merit, resulting in the double swept tip with anhedral having a 6.7% increase in peak figure of merit over the baseline tip, at the highest test tip Mach number 0.65.
- Moving the BLACK HAWK rotor into ground effect with the alternate tip configurations shows that the ground effect augmentation reduces progressively with the introduction of taper and anhedral. However, the out of ground effect advantages of the tip changes are such as to still give a performance advantage of the new tips in ground effect.
- The S-76 rotor tip configuration with the greatest OGE sensitivity to tip Mach number was the 60% tapered tip followed by the rectangular tip, swept tapered tip, swept tip and swept tapered tip with anhedral.
- The S-76 tip configuration with the lowest OGE peak figure of merit (at a tip Mach number of 0.60) was the rectangular tip, followed by the 60% tapered tip, swept tip, swept tapered tip and swept tapered tip with anhedral. However at lower thrust levels, the 60% tapered tip performance was second only to the swept tapered tip with anhedral.
- Moving the S-76 rotor into ground effect with the alternate tip configurations reveals 3 of the tips give essentially identical thrust augmentation trends. These 3 tips, the rectangular, tapered and swept, also have the lowest OGE peak figure of merit. The swept tapered and swept tapered with anhedral tips have lower thrust augmentation, but still superior figures of merit relative to the other 3 tips.

Main Rotor Plus Tail Rotor

- Operating in the presence of the tail rotor, out of ground effect, the BLACK HAWK anhedral tip configuration showed a slightly greater average thrust reduction (2.5%) than the double swept tips without anhedral (1.9%). The S-76 anhedral tip however, showed no thrust reduction relative to the swept tapered tip and less reduction (1.4%) than the tapered tip (2.4%).
- In ground effect, the average thrust reductions due to the tail rotor presence were unchanged or lower, for the rotor tip configurations tested.
- The thrust reductions due to the tail rotor generally increased with increasing main rotor tip Mach number but not in all cases or by the same magnitude.
- Out of ground effect, the BLACK HAWK rotor with double swept tips and double swept tips with anhedral showed an average 2.7% thrust reduction with the tail rotor operating in the pusher mode and a 2.2% reduction with the tail rotor operating in the tractor mode. The S-76 rotor tip configurations did not show any clear sensitivity to the tail rotor operating mode.
- In ground effect, the greater sensitivity to the pusher configuration was still evident for the BLACK HAWK double swept tip but the double swept tip with anhedral configuration did not show the same sensitivity to tail rotor mode of operation.
- Overall the data implies that the tail rotor effects on the advanced tip configurations tested are not substantially different from the effects on conventional tips. Therefore the majority of the benefits obtained from advanced tips should be retained.

REFERENCES

1. Balch, D. T., Saccullo, A. and Sheehy, T. W., "An Experimental Study of Main Rotor/Tail Rotor/Airframe Interactions in Hover," NASA-CR-166485, June 1983.
2. Menger, R. P., Wood, T. L. and Brieger, J. T., "Effects of Aerodynamic Interaction between Main and Tail Rotors on Helicopter Hover Performance and Noise", NASA CR-166477, February 1983.
3. Philippe, J. J. and Chattot, J. J., "Experimental and Theoretical Studies on Helicopter Blade Tips at ONERA", Paper No. 46, 6th European Rotorcraft and Powered Lift Aircraft Forum, 1980.
4. Tauber, M. E., Change, I. C., Caughey, D. and Philippe, J. J., "Comparison of Measured and Calculated Pressures on Straight-and Swept-Tip Model Rotor Blade", NASA TM-XXXX, 1983.
5. Philippe, J. J. and Vuillet, A., "Aerodynamic Design of Advanced Rotors with New Tip Shapes", 39th Annual Forum of the American Helicopter Society, St. Louis, Missouri, 1983.
6. McVeigh, M. A., McHugh, F. J., "Recent Advances in Rotor Technology at Boeing Vertol", Paper No. 82-38, American Helicopter Society 38th Annual Forum, Anaheim, California, May 1982.
7. Wilby, P. G. and Philippe, J. J., "An Investigation of the Aerodynamics of an RAE Swept Tip Using a Model Rotor", Paper No. 2.5, Eight European Rotorcraft Forum, Aix-en-Provence, France, September 1982.
8. Caradonna, F. X. and Tung, C., "Experimental and Analytical Studies of a Model Helicopter Rotor in Hover", NASA TM 81232, September 1981.
9. Caradonna, F. X. and Philippe, J. J., "The Flow over a Helicopter Blade Tip in the Transonic Regime", Paper No. 21, Second European Rotorcraft Forum, Buckeburg, West Germany, September 1976.
10. Chattot, J. J., "Calculation of Three-Dimensional Unsteady Transonic Flows Past Helicopter Blades", NASA Tech Paper 1721 October 1980.

REFERENCES (Cont'd)

11. Grant, J., "The Prediction of Supercritical Pressure Distributions on Blade Tips of Arbitrary Shape over a Range of Advancing Blade Azimuth Angles", Vertica, 1979, Volume 3, Numbers 3/4 pp 275-292.
12. Ballard, J. D., Orloff, K. K., and Luebs, A. B., "Effect of Tip Planform on Blade Loading Characteristics for a Two-Bladed Rotor in Hover", NASA TM 78615, November 1979.
13. Philippe, J. J., Lafon, P. and Bohl, J. C., "Experimental Studies of Unsteady Aerodynamics of Helicopter Rotor Models in a Wind Tunnel", Aeronautical and Astronautical Association of France, TN 79-21, November 1978.
14. Stroub, R. H., "Full-Scale Wind Tunnel Test of a Modern Helicopter Main Rotor-Investigation of Tip Mach Number Effects and Comparisons of Four Tip Shapes", Paper No. 03, American Helicopter Society 34th Annual Forum, Washington, D. C., May 1978.

ROTOR	TIP	OGE			IGE			TAIL ROTOR	
		$M_T=0.55$	$M_T=0.6$	$M_T=0.65$	$Z/R=1.2$	$Z/R=.75$	PUSHER	TRACTOR	
BLACK HAWK S-76	20° SWEPT	✓	✓	✓	✓	✓	-	-	
	DOUBLE SWEPT	✓	✓	✓	✓	✓	✓	✓	
	DOUBLE SWEPT WITH ANHEDRAL	✓	✓	✓	✓	✓	✓	✓	
	RECTANGULAR	✓	✓	✓	✓	✓	-	-	
	60% TAPERED	✓	✓	✓	✓	✓	✓	✓	
	20° SWEPT	✓	✓	✓	✓	✓	-	-	
	SWEPT TAPERED	✓	✓	✓	✓	✓	✓	-	
	SWEPT TAPERED WITH ANHEDRAL	✓	✓	✓	✓	✓	✓	✓	

TABLE 1. TEST CONFIGURATIONS

BLACK HAWK		S-76		TAIL ROTOR
Radius m (ins)	1.428 (56.224)	1.423 (56.04)		0.2921 (11.5)
Chord m (ins)	0.0914 (3.6)	0.0787 (3.1)		0.0508 (2)
Twist	-16° Equiv. Linear	-10° Linear		-4° Linear
Tips	Various on outer 6%	Various on outer 5%		Square
Airfoils	SC1095 SC1094 R8	SC1013 R8 SC1094 R8 SC1095		NACA 0012
Solidity	.0815	.0704		.2214
MR - TR Clearance				
-m(ins)	.026 (1.026)	.031 (1.21)		
% MR radius	1.8%	2.2%		
% Blockage with UH-60A Skins	9.8%	9.9%		12.1%
Tail Rotor-Pylon Separation				20.5%
% TR radius				
Tail Rotor Vertical location compared to main rotor hub - m(ins) (rotor plane horizontal with zero flapping)				.058 (2.28)

TABLE 2. MODEL ROTOR CHARACTERISTICS

ROTOR CT/SIGMA = .085 OGE M_T = 0.6

Figure of Merit Increase

<u>Configuration Change</u>	<u>BLACK HAWK</u>	<u>S-76</u>
60% Taper on Rect. Tip		.0070
20° Sweep on Rect. Tip		.0071
Sweep on Tapered Tip		.0118
60% Taper on Swept Tip	.0065	.0117
Anhedral on Swept and Tapered Tip	.0201	.0277

TABLE 3. MAIN ROTOR ALONE - PERFORMANCE INCREASES

OGE Ct/SIGMA = 0.085

<u>ROTOR</u>	<u>TIP CONFIGURATION</u>	<u>MT</u>	<u>% THRUST LOSS (AV)</u>
BLACK HAWK	DOUBLE SWEPT	0.55	1.2
		0.6	2.4
		0.65	2.0
S-76	MINI ANHEDRAL	0.55	1.8
		0.6	2.7
		0.65	3.1
	SWEPT TAPERED	0.55	1.8
		0.6	1.4
		0.65	2.0
60% TAPERED		0.55	2.6
		0.6	2.2
		0.65	2.4
	SWEPT TAPERED	0.55	1.6
	WITH ANHEDRAL	0.6	1.9
		0.65	0.8

TABLE 4. % LOSS OF MAIN ROTOR THRUST DUE TO ADDITION OF TAIL ROTOR

MT = 0.6 Ct/SIGMA = 0.085

<u>ROTOR</u>	<u>TIP CONFIGURATION</u>	<u>B/R</u>	<u>% THRUST LOSS (AV)</u>
BLACK HAWK	DOUBLE SWEPT	3.0	2.4
		1.2	1.2
		0.75	1.5
	MINI ANHEDRAL	3.0	2.7
		1.2	2.1
		0.75	2.3
S-76	SWEPT TAPERED	3.0	1.4
		1.2	0.4
		0.75	-
	60% TAPERED	3.0	2.2
		1.2	1.7
		0.75	1.1
	SWEPT TAPERED	3.0	1.9
	WITH ANHEDRAL	1.2	0.9
		0.75	1.2

TABLE 5. % LOSS OF MAIN ROTOR THRUST DUE TO ADDITION OF TAIL ROTOR

ORIGINAL PAGE
BLACK AND WHITE PHOTOGRAPH

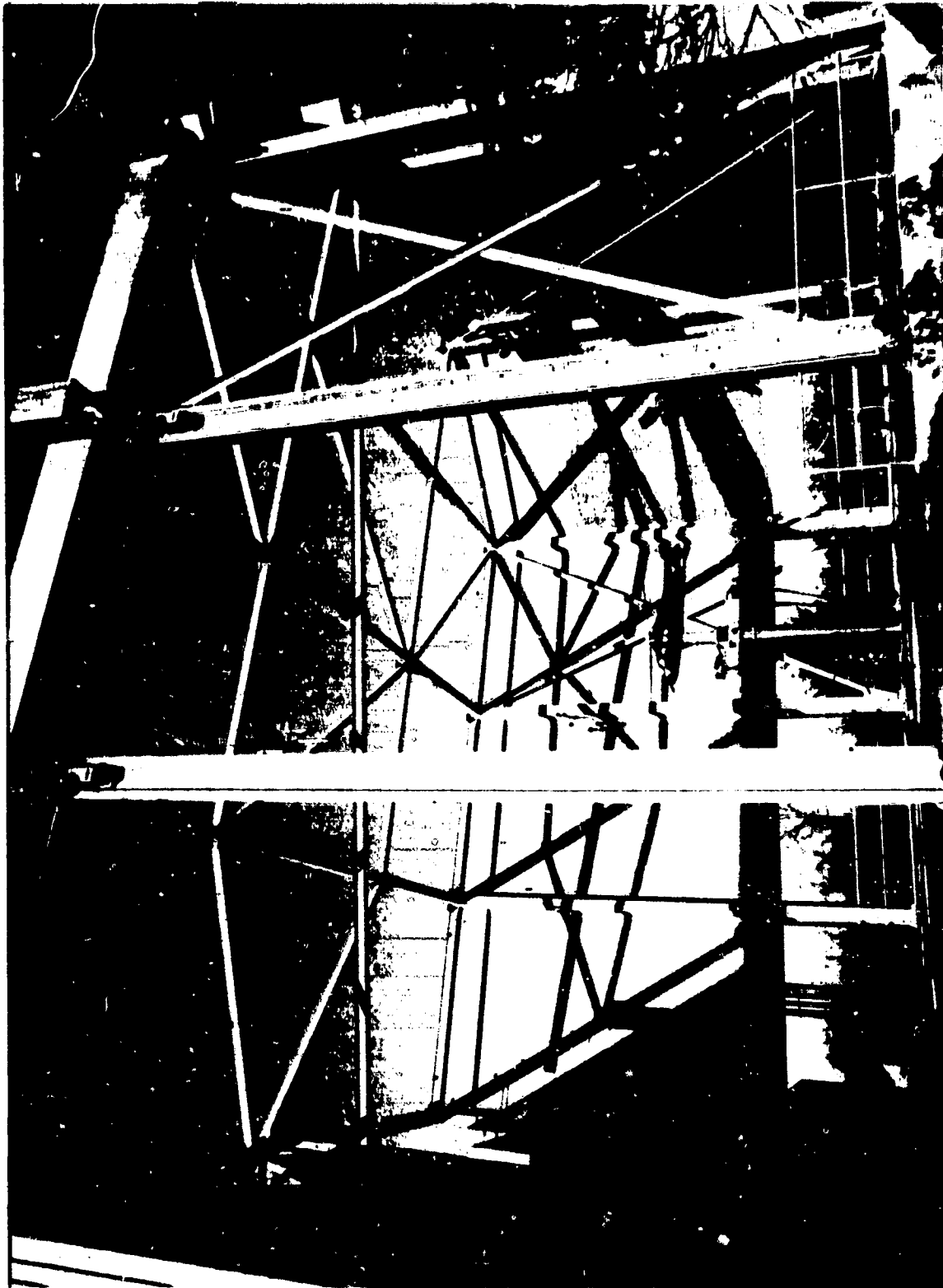

Figure 1. Model Test Cell Hover Facility

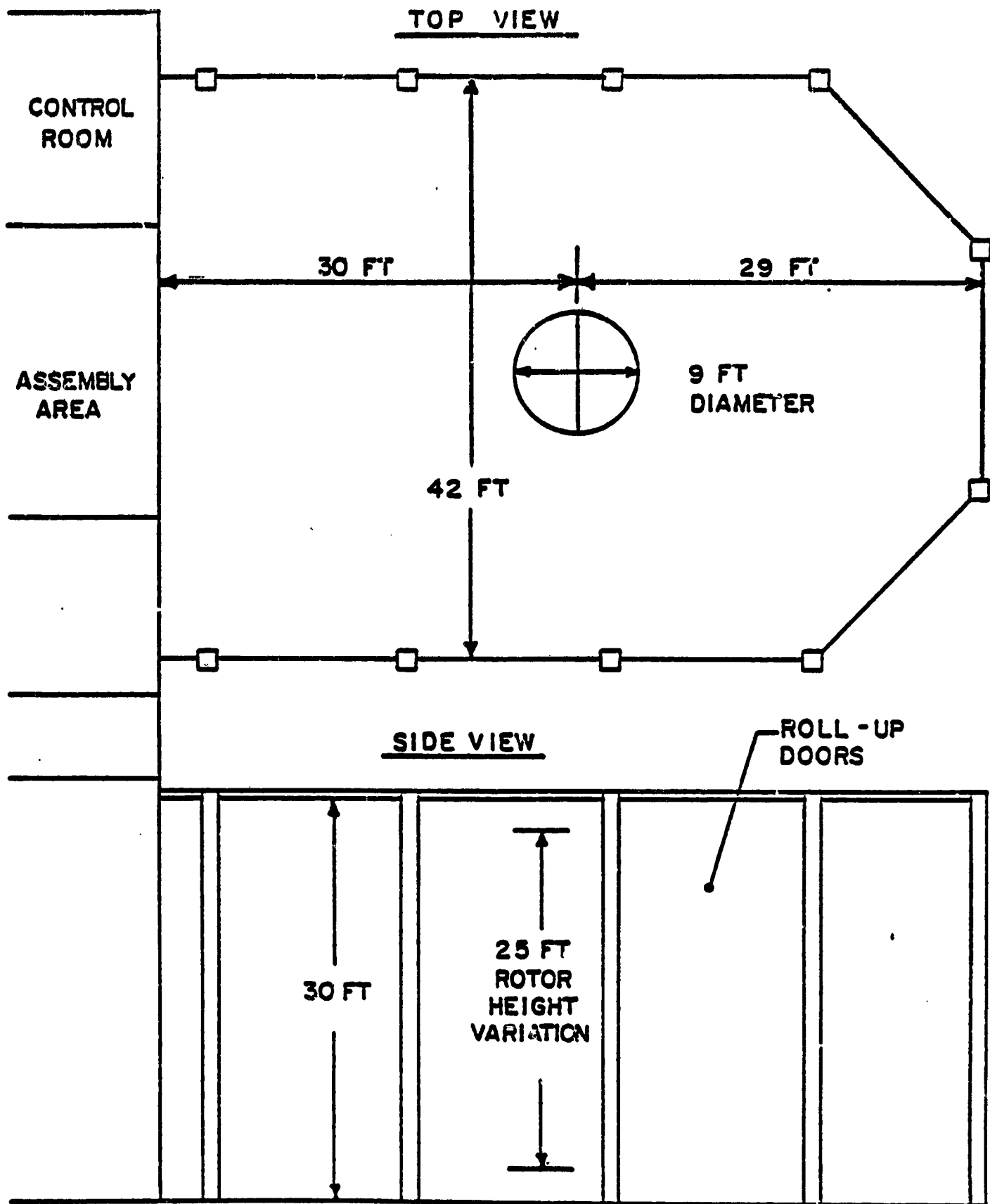

Figure 2. ENCLOSED MODEL HOVER FACILITY.

ORIGINAL PAGE IS
OF POOR QUALITY

This Data Recorded, Processed, and Printed Utilizing
MODEL ROTOR ON-LINE DATA RECORDING AND PROCESSING SYSTEM

Run# = 138.00 z/r = 3.00 Main Tip Mach # = .55 Tail Tip Mach # = .55

Test Date : 4 APRIL 1983

Test Summary : S-76 w/ 60% TAPER/ TRACTOR TAIL ROTOR

CONFIGURATION FILE : DATA10
DATA FILE : TIP138:T14

S76[III]wEXT/wTail/New Torque

FUSELAGE NOT PRESENT

Processing Date : 7 NOVEMBER 1983

Process Summary : FINAL PROCESSING

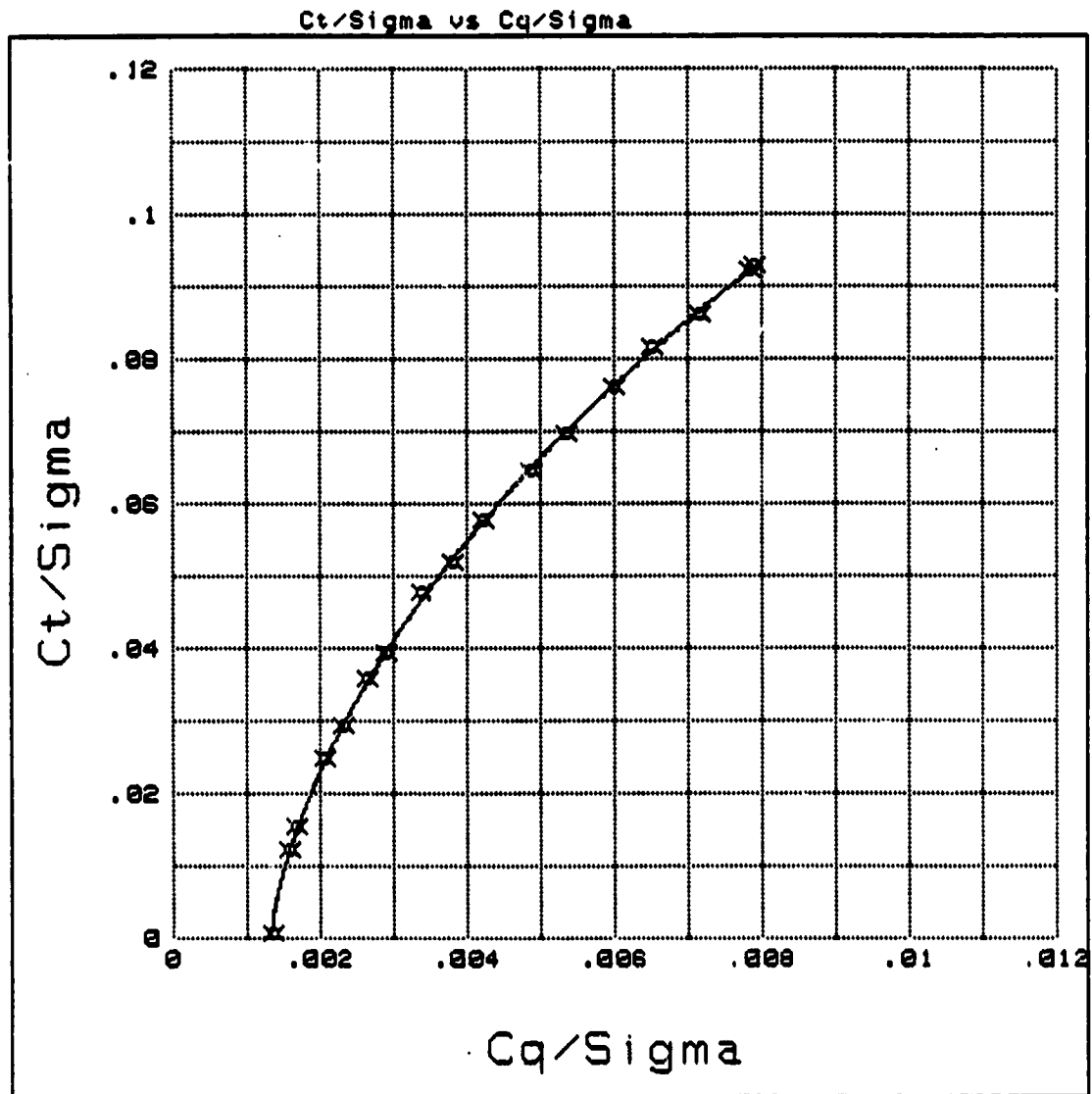

Figure 3. Typical Main Rotor C_t/σ - C_q/σ Relationship

ORIGINAL PAGE IS
OF POOR QUALITY.

This Data Recorded, Processed, and Printed Utilizing
MODEL ROTOR ON-LINE DATA RECORDING AND PROCESSING SYSTEM

Run# = 138.00 z/r = 3.00 Main Tip Mach # = .55 Tail Tip Mach # = .55

Test Date : 4 APRIL 1983
Test Summary : S-76 w/ 60% TAPER/ TRACTOR TAIL ROTOR

CONFIGURATION FILE : DATA10 S76LIIIwEXT/wTail/New Torque
DATA FILE : TIP138:T14

FUSELAGE NOT PRESENT
Processing Date : 7 NOVEMBER 1983
Process Summary : FINAL PROCESSING

Figure of Merit vs C_t/σ

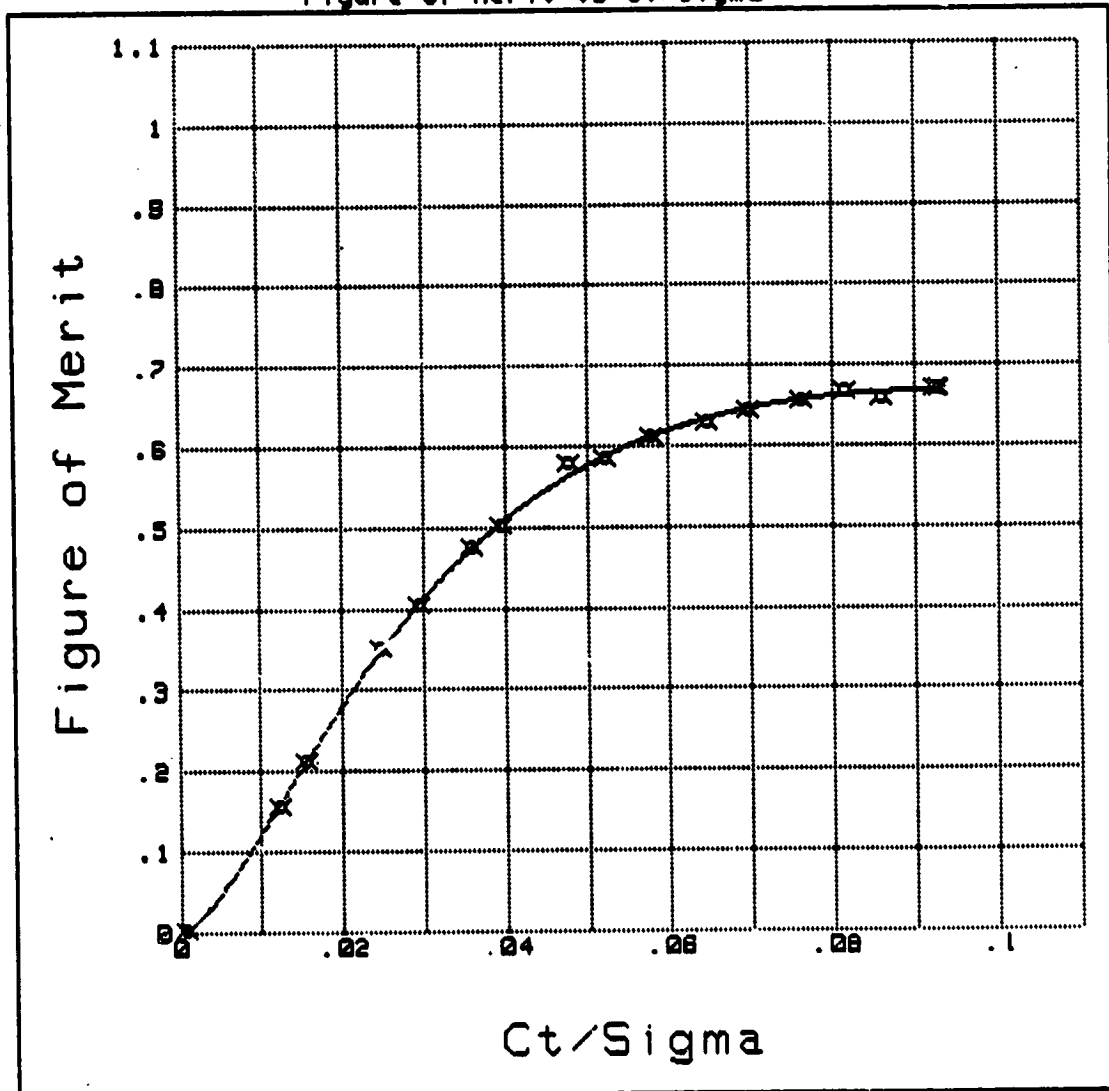

Figure 4. Typical Main Rotor Full Range Figure of Merit - C_t/σ Relationship

This Data Recorded, Processed, and Printed Utilizing
MODEL ROTOR ON-LINE DATA RECORDING AND PROCESSING SYSTEM

Run# = 138.00 z/r = 3.00 Main Tip Mach # = .55 Tail Tip Mach # = .55

Test Date : 4 APRIL 1983

Test Summary : S-76 w/ 60% TAPER/ TRACTOR TAIL ROTOR

CONFIGURATION FILE : DATA10

S76[III]wEXT/wTail/New Torque

DATA FILE : TIP138:T14

FUSELAGE NOT PRESENT

Processing Date : 7 NOVEMBER 1983

Process Summary : FINAL PROCESSING

Figure of Merit vs Ct/Sigma

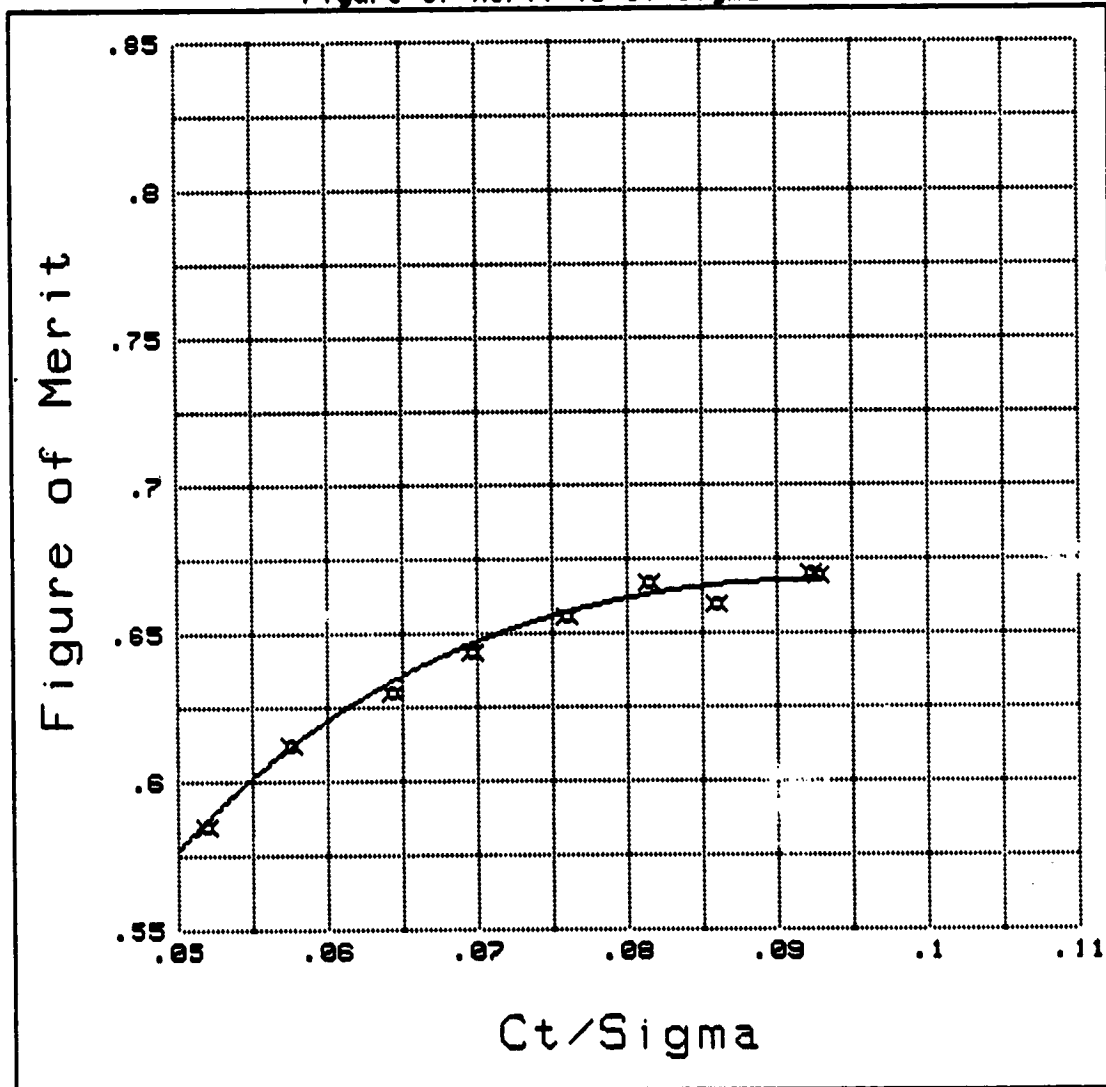

Figure 5. Typical Main Rotor Expanded Scale Figure of Merit - C_t/σ Relationship

ORIGINAL PAGE IS
OF POOR QUALITY

This Data Recorded, Processed, and Printed Utilizing
MODEL ROTOR ON-LINE DATA RECORDING AND PROCESSING SYSTEM

Run# = 138.00 z/r = 3.00 Main Tip Mach # = .55 Tail Tip Mach # = .55

Test Date : 4 APRIL 1983

Test Summary : S-76 w/ 60% TAPER/ TRACTOR TAIL ROTOR

CONFIGURATION FILE : DATA10

S76(III)wEXT/wTail/New Torque

DATA FILE : TIP138:T14

FUSELAGE NOT PRESENT

Processing Date : 7 NOVEMBER 1983

Process Summary : FINAL PROCESSING

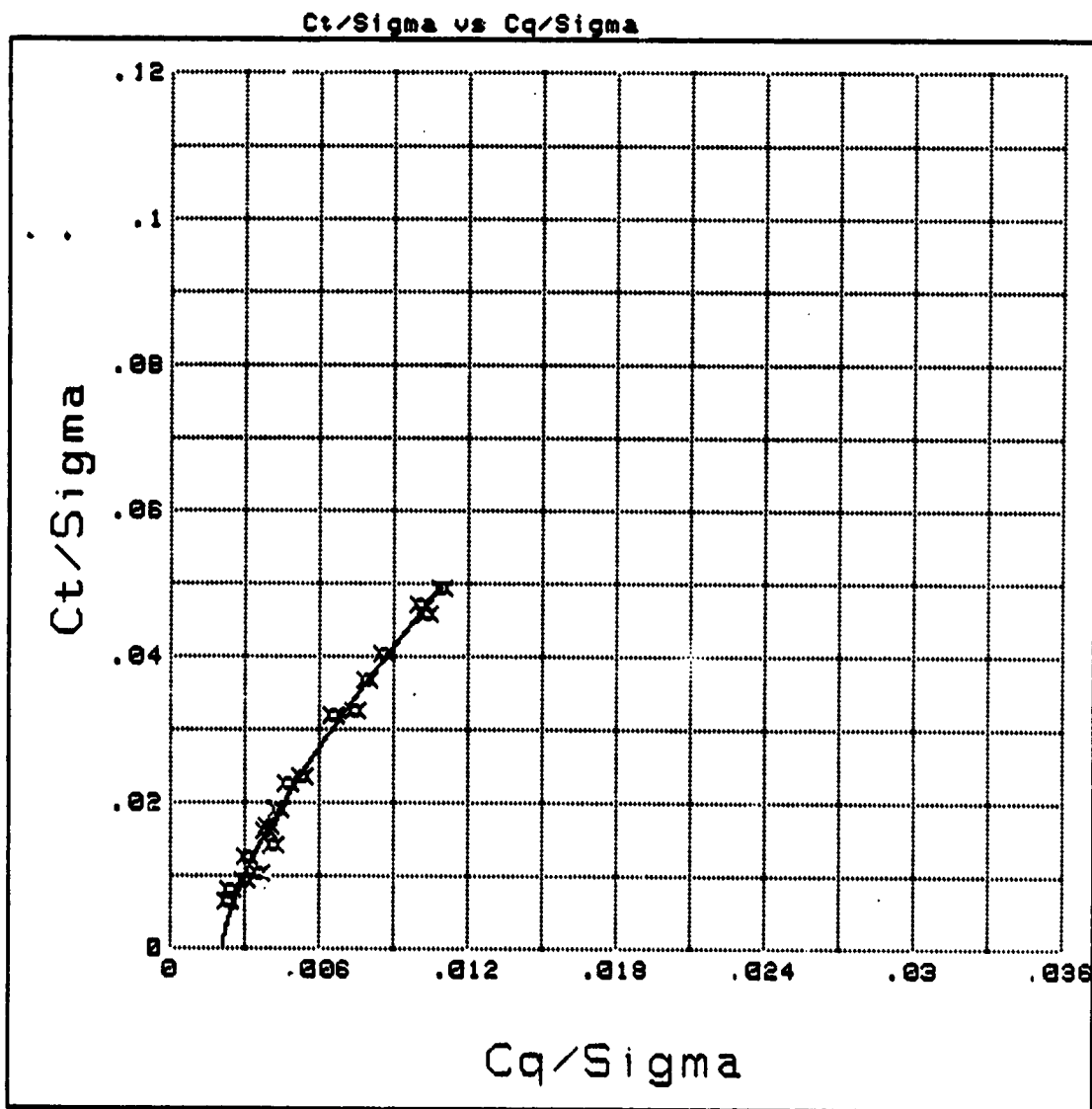

Figure 6. Typical Tail Rotor C_t/σ - C_q/σ Relationship

BLACK HAWK MODEL ROTOR CHARACTERISTICS

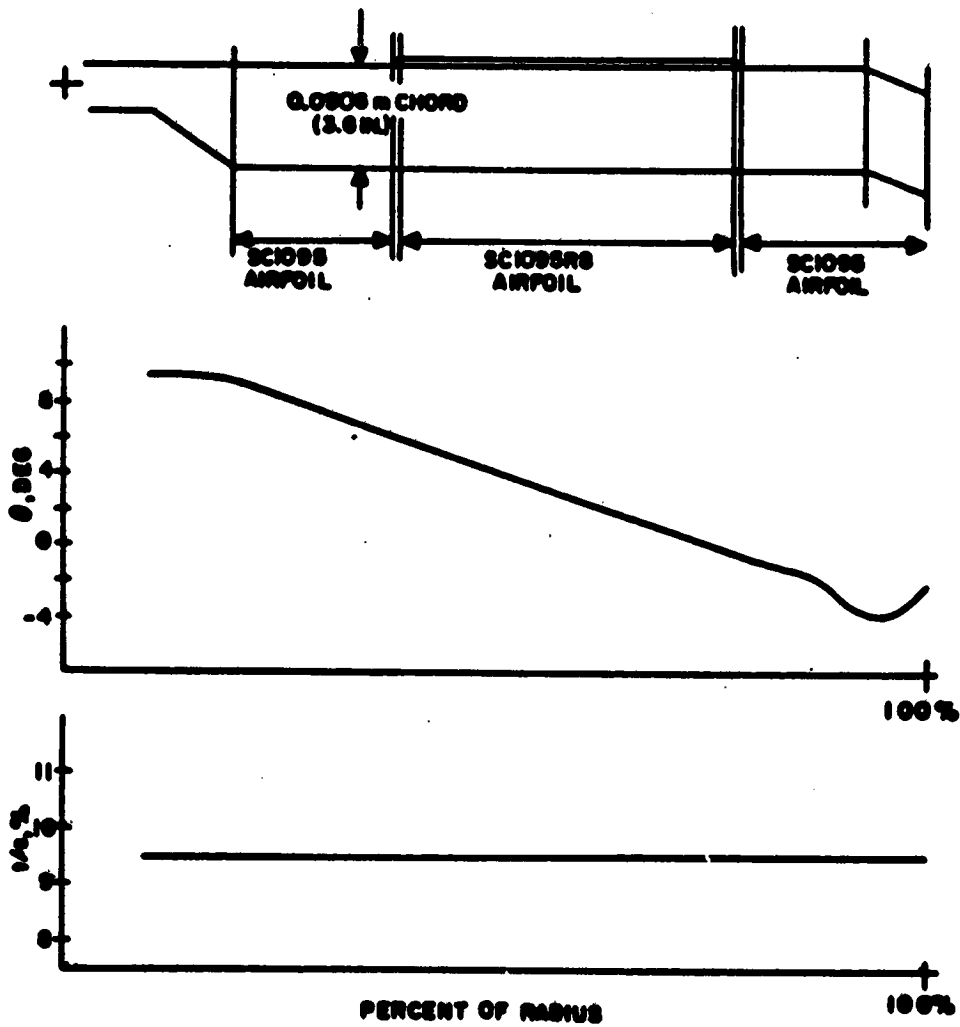

Figure 7. BLACK HAWK Rotor Geometry

S-76 MODEL ROTOR CHARACTERISTICS

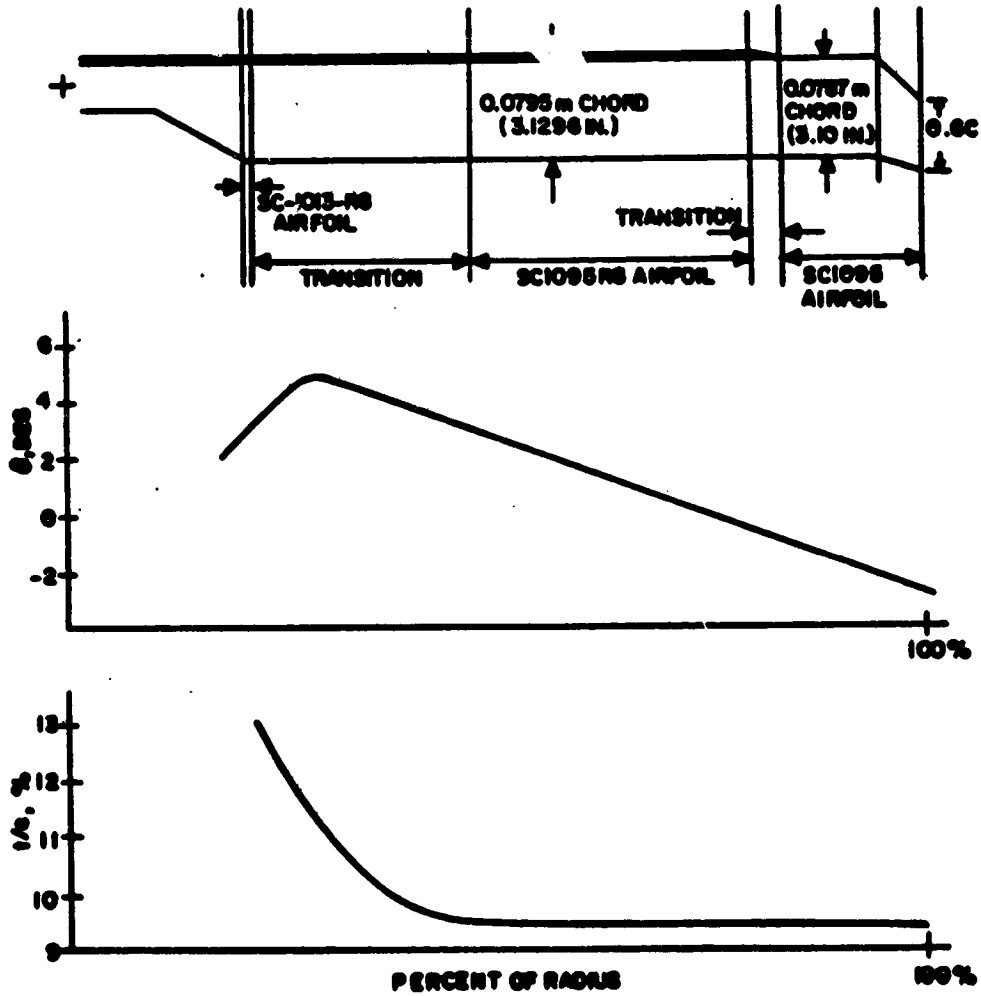
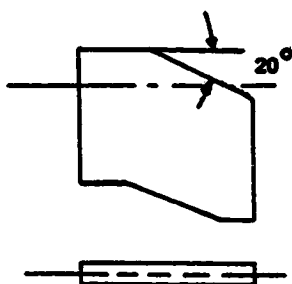
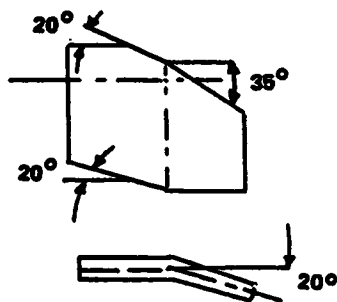

Figure 8. S-76 Rotor Geometry

UH-60A BLACK HAWK ROTOR TIPS



**6% SWEPT TIP (S)
BASELINE UH-60A**



**6% DOUBLE SWEPT TAPERED
MINI-ANHEDRAL (DSTA)**

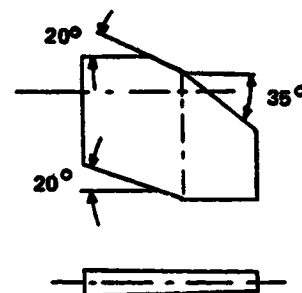

**6% DOUBLE SWEPT
TAPERED TIP (DST)**

S-76 ROTOR TIPS

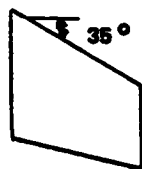

SWEPT TAPERED TIP (ST)

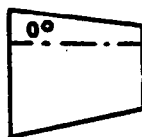

TAPERED TIP (T)

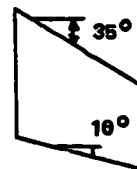

**SWEPT TAPERED
ANHEDRAL TIP (STA)**

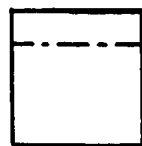

RECTANGULAR TIP (R)

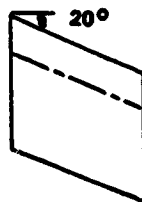

SWEPT TIP (S)



5% TIPS

Figure 9. Tip Configurations Tested

This Data Recorded, Processed, and Printed Utilizing
HP9845B/SERIES 4600 MAGNETIC TAPE DATA PROCESSING SYSTEM

PLOT SERIES : S-70 BLACKHAWK Mt TREND; OGE; 20 Deg SWEPT TIPS

<u>File#</u>	<u>File-Name</u>	<u>Plot#</u>	<u>Plot-Title</u>
26	TIP060	1	Mt= 0.60
27	TIP061	2	Mt= 0.65
28	TIP062	3	Mt= 0.55

Figure of Merit vs Ct/Sigma

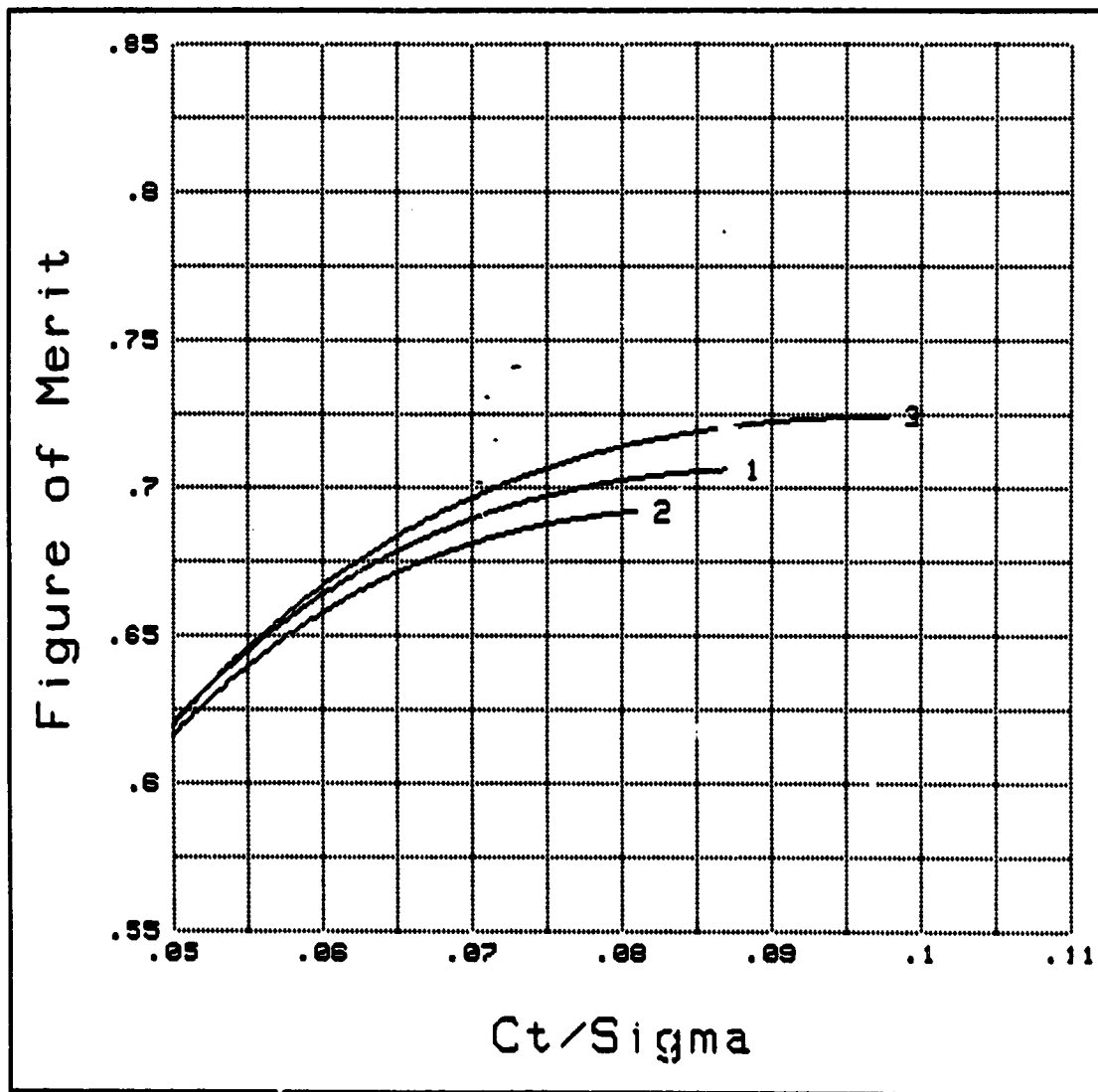

Figure 10.

This Data Recorded, Processed, and Printed Utilizing
HP9045B/SERIES 4600 MAGNETIC TAPE DATA PROCESSING SYSTEM

PLOT SERIES : S-70 BLACKHAWK Mt TREND; OGE; 20 Deg/ 35 Deg DOUBLE SWEPT TIPS

<u>File#</u>	<u>File-Name</u>	<u>Plot#</u>	<u>Plot-Title</u>
6	TIP025	1	Mt= 0.60
7	TIP026	2	Mt= 0.55
8	TIP027	3	Mt= 0.65

Figure of Merit vs Ct/Sigma

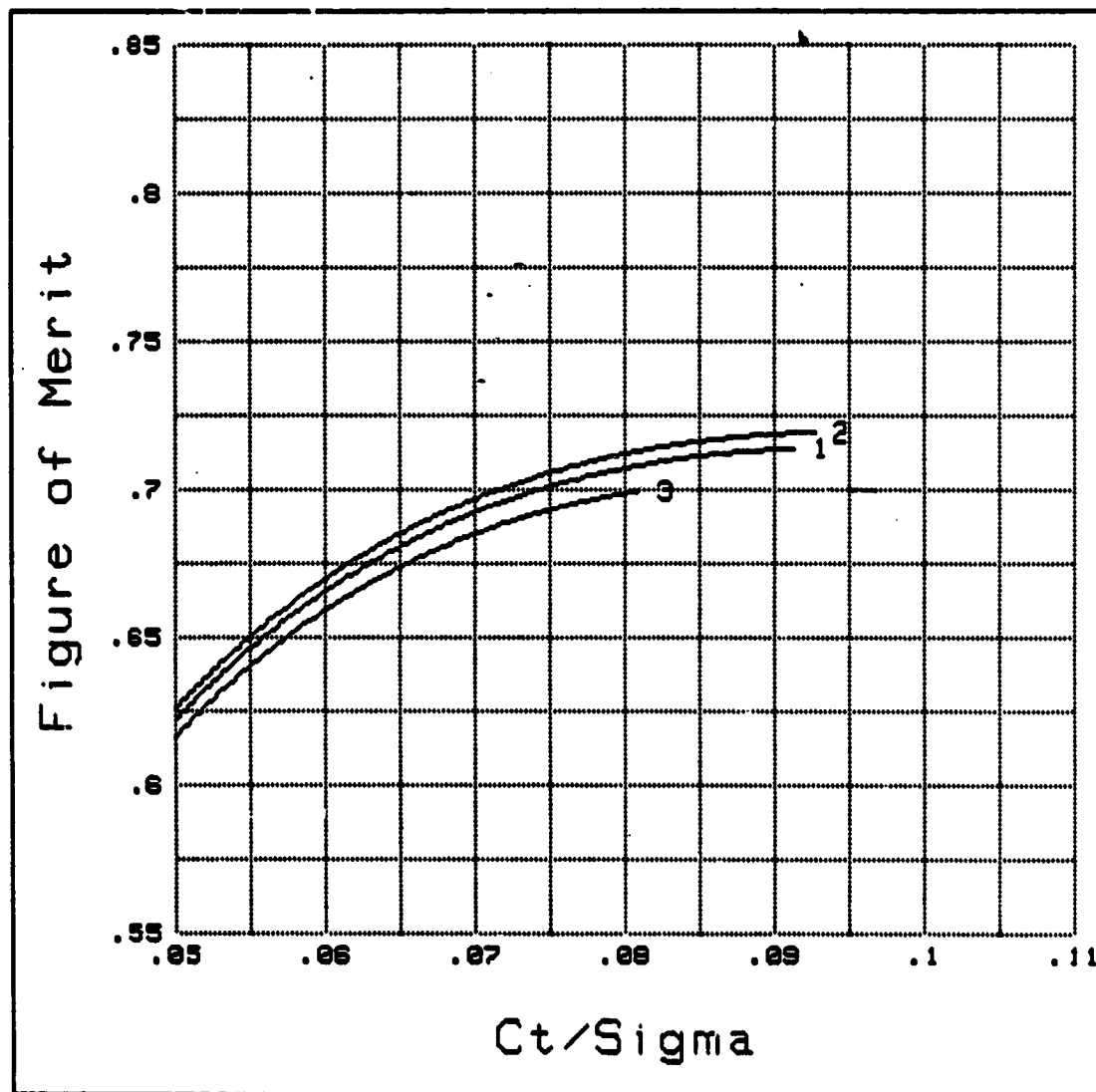

Figure 11.

This Data Recorded, Processed, and Printed Utilizing
HP9845B/SERIES 4600 MAGNETIC TAPE DATA PROCESSING SYSTEM

PLOT SERIES : S-70 BLACKHAWK Mt TRENDS; OGE; 20 Deg/ 35 Deg DOUBLE SWEPT W/
20 Deg ANHEDRAL TIPS

<u>File#</u>	<u>File-Name</u>	<u>Plot#</u>	<u>Plot-Title</u>
18	TIP045	1	Mt=0.65
19	TIP047	2	Mt=0.60
38	TIP046	3	Mt=0.55

Figure of Merit vs Ct/Sigma

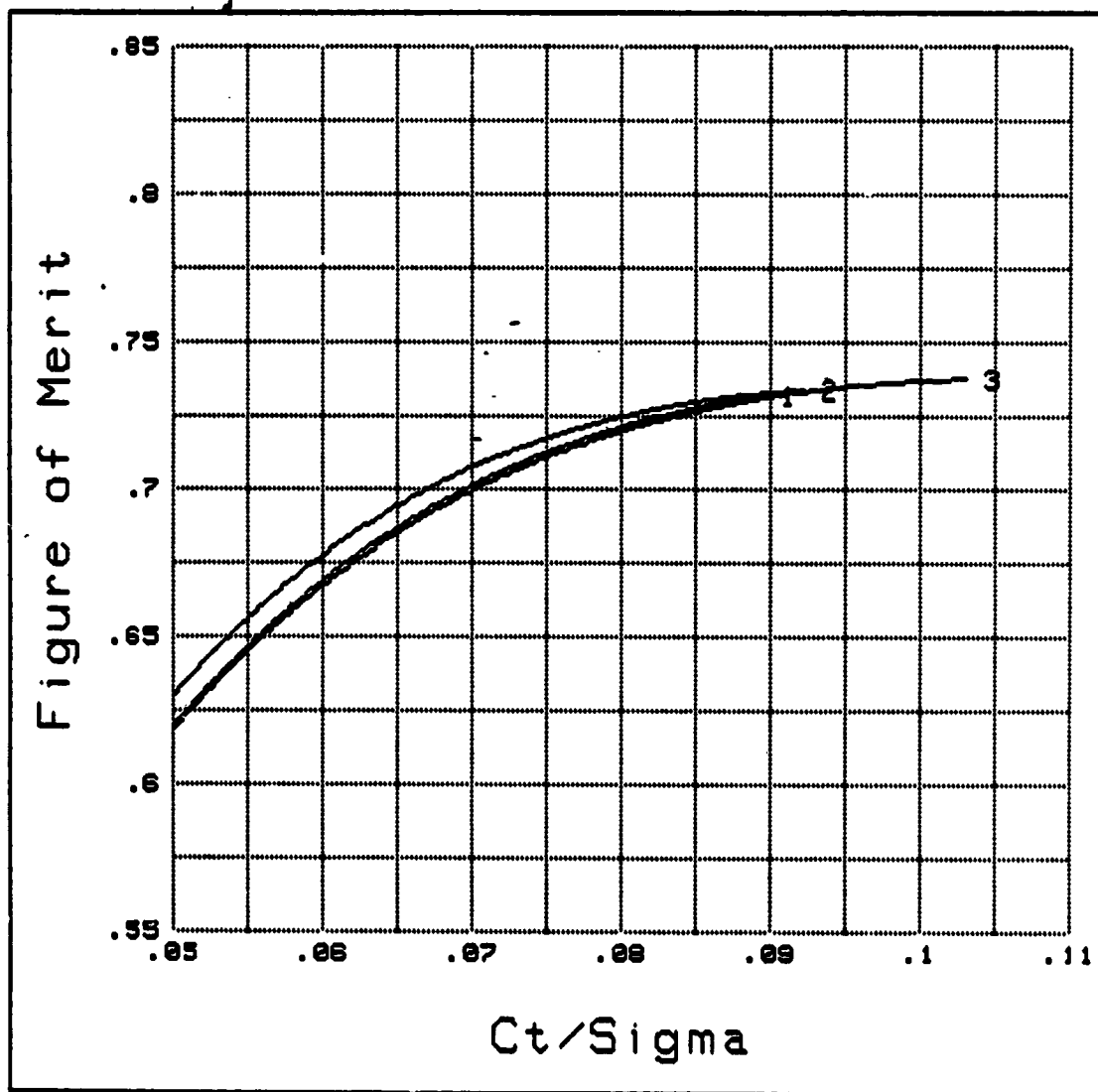

Figure 12.

This Data Recorded, Processed, and Printed Utilizing
HP9845B/SERIES 4600 MAGNETIC TAPE DATA PROCESSING SYSTEM

PLOT SERIES : S-70 BLACKHAWK TIP COMPARISON; OGE; Mt=0.55

<u>File#</u>	<u>File-Name</u>	<u>Plot#</u>	<u>Plot-Title</u>
7	TIP026	1	20 Deg/35 Deg DOUBLE SWEPT
20	TIP062	2	20 Deg SWEPT
30	TIP046	3	20 Deg/35 Deg DOUBLE SWEPT W/ 20 Deg ANHEDRAL

Figure of Merit vs Ct/Sigma

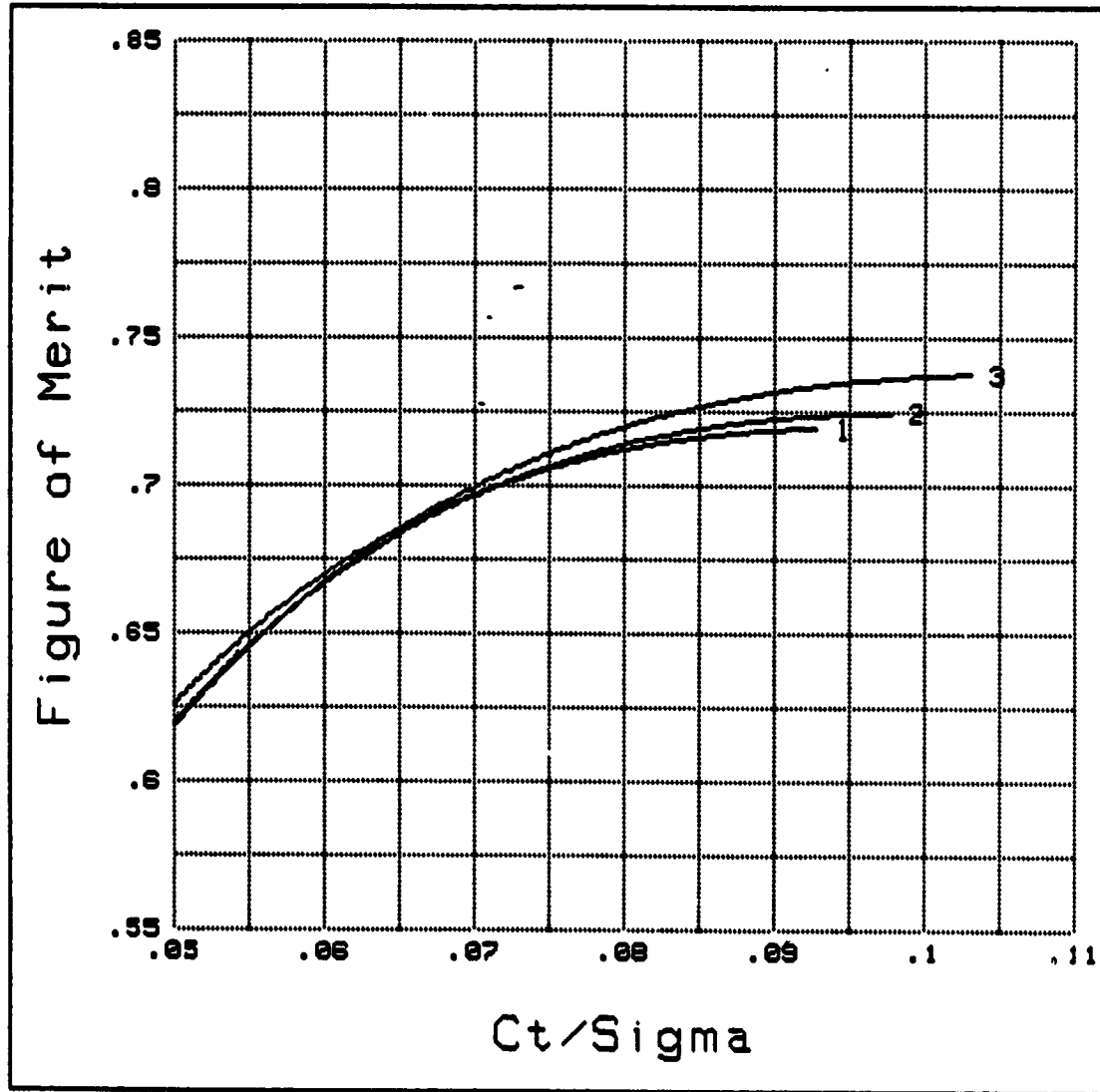

Figure 13.

This Data Recorded, Processed, and Printed Utilizing
HP9845B/SERIES 4600 MAGNETIC TAPE DATA PROCESSING SYSTEM

PLOT SERIES : S-70 BLACKHAWK TIP COMPARISON; OGE; $M_t=0.6$

<u>File#</u>	<u>File-Name</u>	<u>Plot#</u>	<u>Plot-Title</u>
6	TIP025	1	20 Deg/ 35 Deg DOUBLE SWEPT
19	TIP047	2	20 Deg/ 35 Deg DOUBLE SWEPT W/ 20 Deg ANHEDRAL
26	TIP060	3	20 Deg SWEPT

Figure of Merit vs C_t/Σ

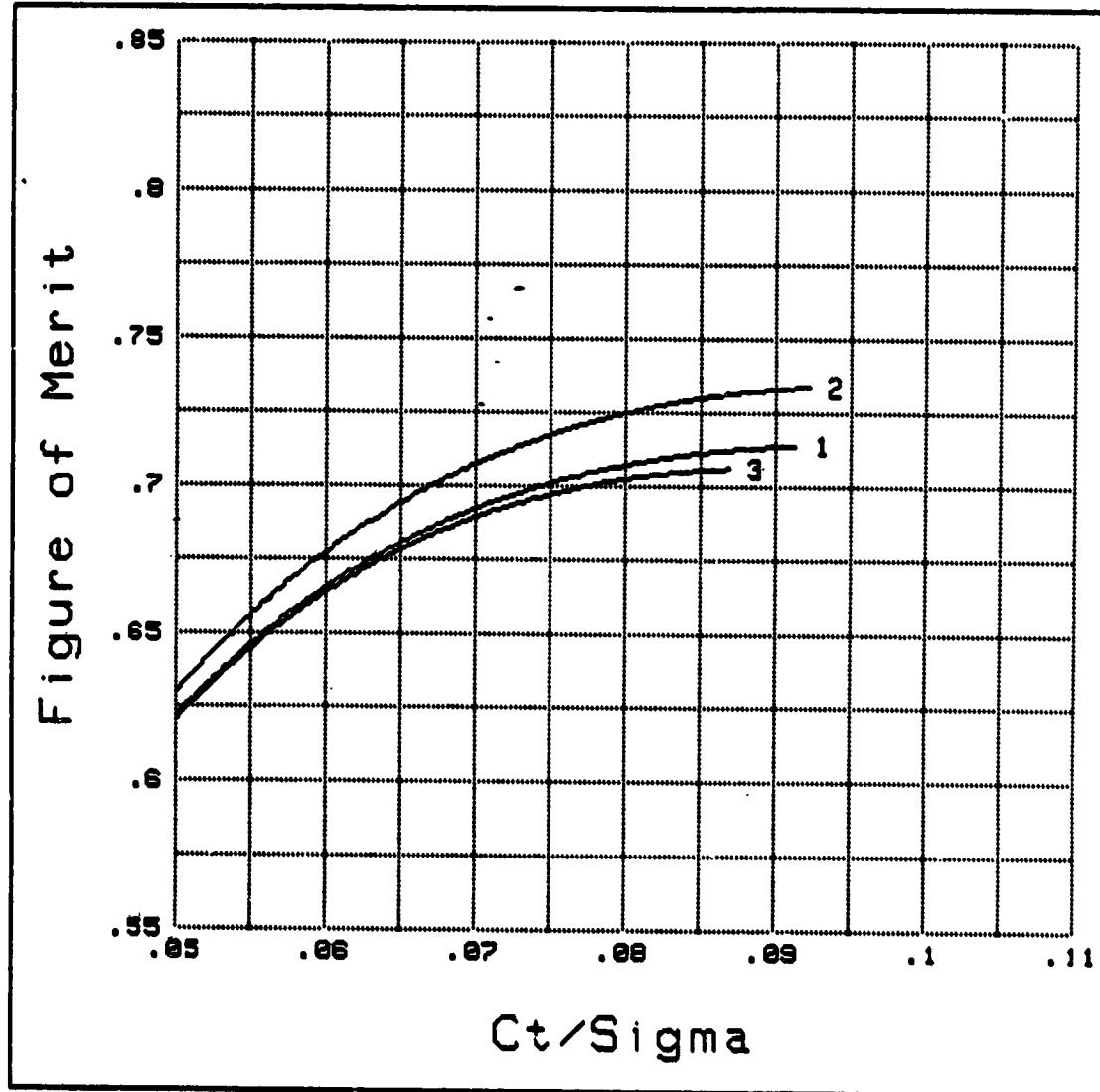

Figure 14.

This Data Recorded, Processed, and Printed Utilizing
HP9845B/SERIES 4600 MAGNETIC TAPE DATA PROCESSING SYSTEM

PLOT SERIES : S-70 BLACKHAWK TIP COMPARISON; OGE; Mt=0.65

<u>File#</u>	<u>File-Name</u>	<u>Plot#</u>	<u>Plot-Title</u>
8	TIP027	1	20 Deg/ 35 Deg DOUBLE SWEPT
18	TIP045	2	20 Deg/ 35 Deg DOUBLE SWEPT W/ 20 Deg ANHEDRAL
27	TIP061	3	20 Deg SWEPT

Figure of Merit vs Ct/Sigma

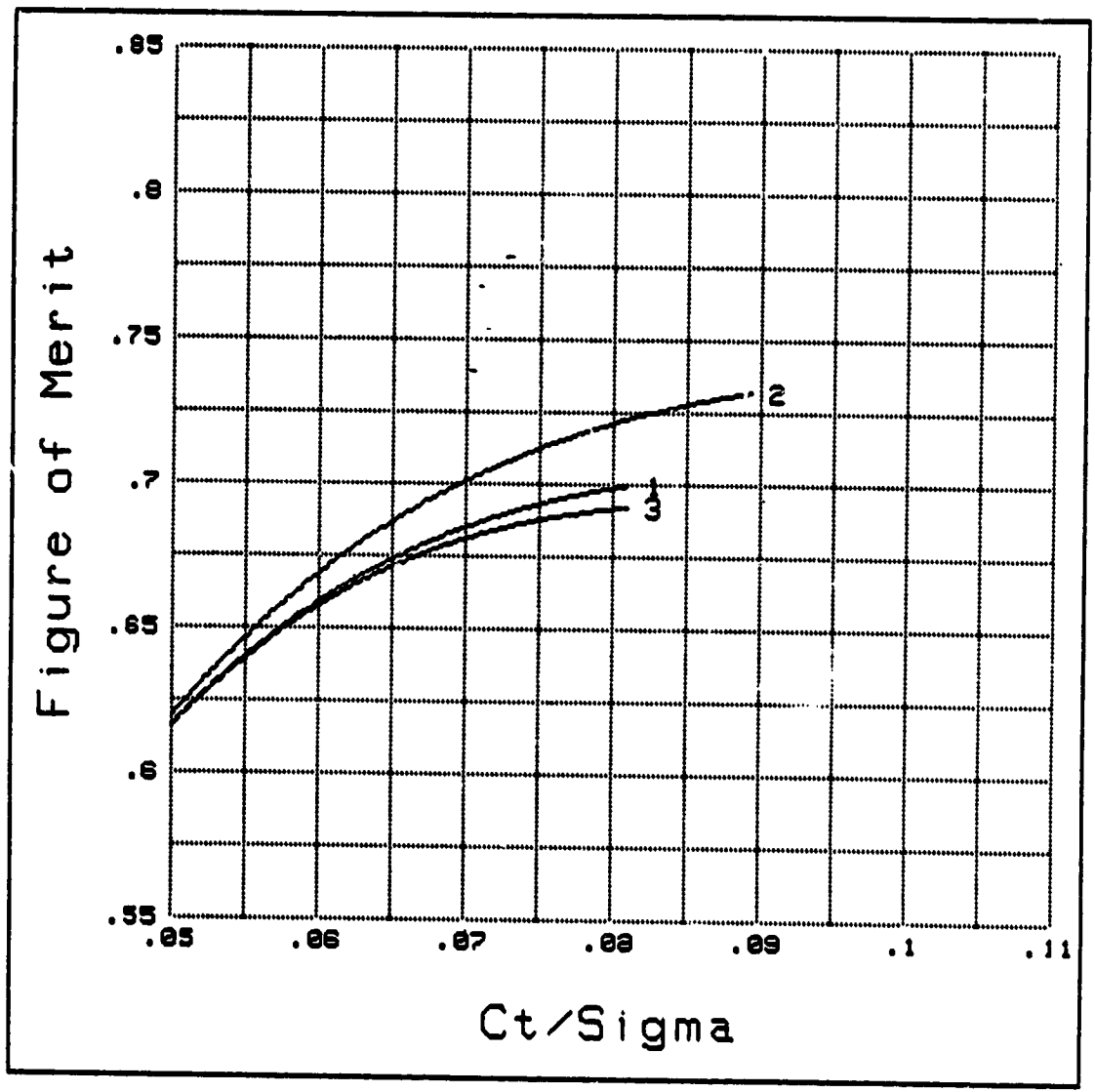

Figure 15.

ORIGINAL PAGE IS
OF POOR QUALITY

This Data Recorded, Processed, and Printed Utilizing
HP3345B/SERIES 4600 MAGNETIC TAPE DATA PROCESSING SYSTEM

PLOT SERIES : 8-70 BLACKHAWK TIP COMPARISON; IGE; Mt=0.6; Z/R= 1.2

<u>File#</u>	<u>File-Name</u>	<u>Plot#</u>	<u>Plot-Title</u>
10	TIP029	1	20 Deg/ 35 Deg DOUBLE SWEPT
17	TIP043	2	20 Deg/ 35 Deg DOUBLE SWEPT W/ 20 Deg ANHEDRAL
30	TIP066	3	20 Deg SWEPT

Figure of Merit vs Ct/Sigma

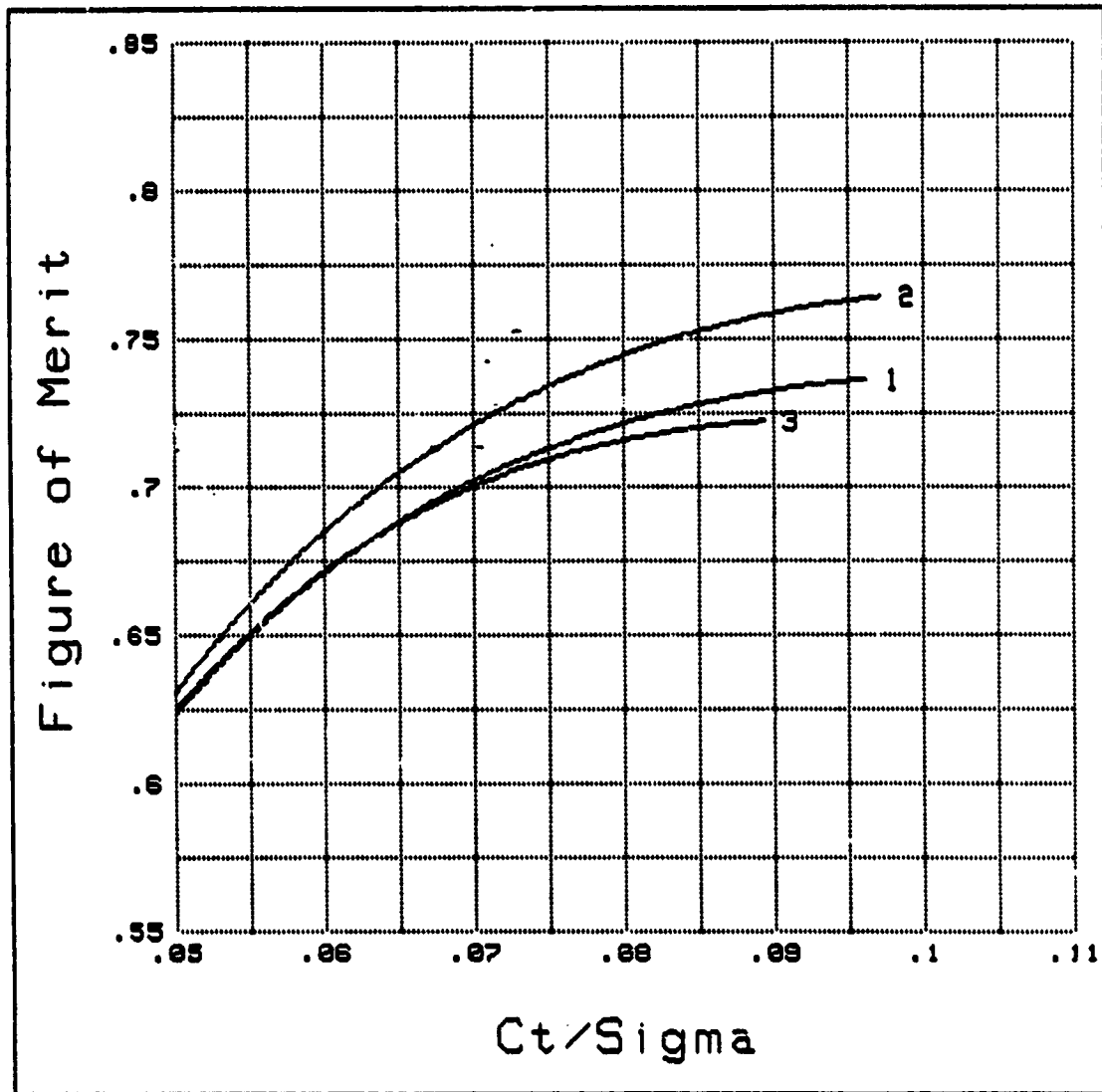

Figure 16.

This Data Recorded, Processed, and Printed Utilizing
HP9845B/SERIES 4600 MAGNETIC TAPE DATA PROCESSING SYSTEM

PLOT SERIES : S-70 BLACKHAWK TIP COMPARISON; IGE; $M_t=0.6$; $Z/R=0.75$

<u>File#</u>	<u>File-Name</u>	<u>Plot#</u>	<u>Plot-Title</u>
9	TIP028	1	20 Deg/35 Deg DOUBLE SWEPT
16	TIP042	2	20 Deg/35 Deg DOUBLE SWEPT W/ 20 Deg ANHEDRAL
29	TIP065	3	20 Deg SWEPT

Figure of Merit vs C_t/Σ

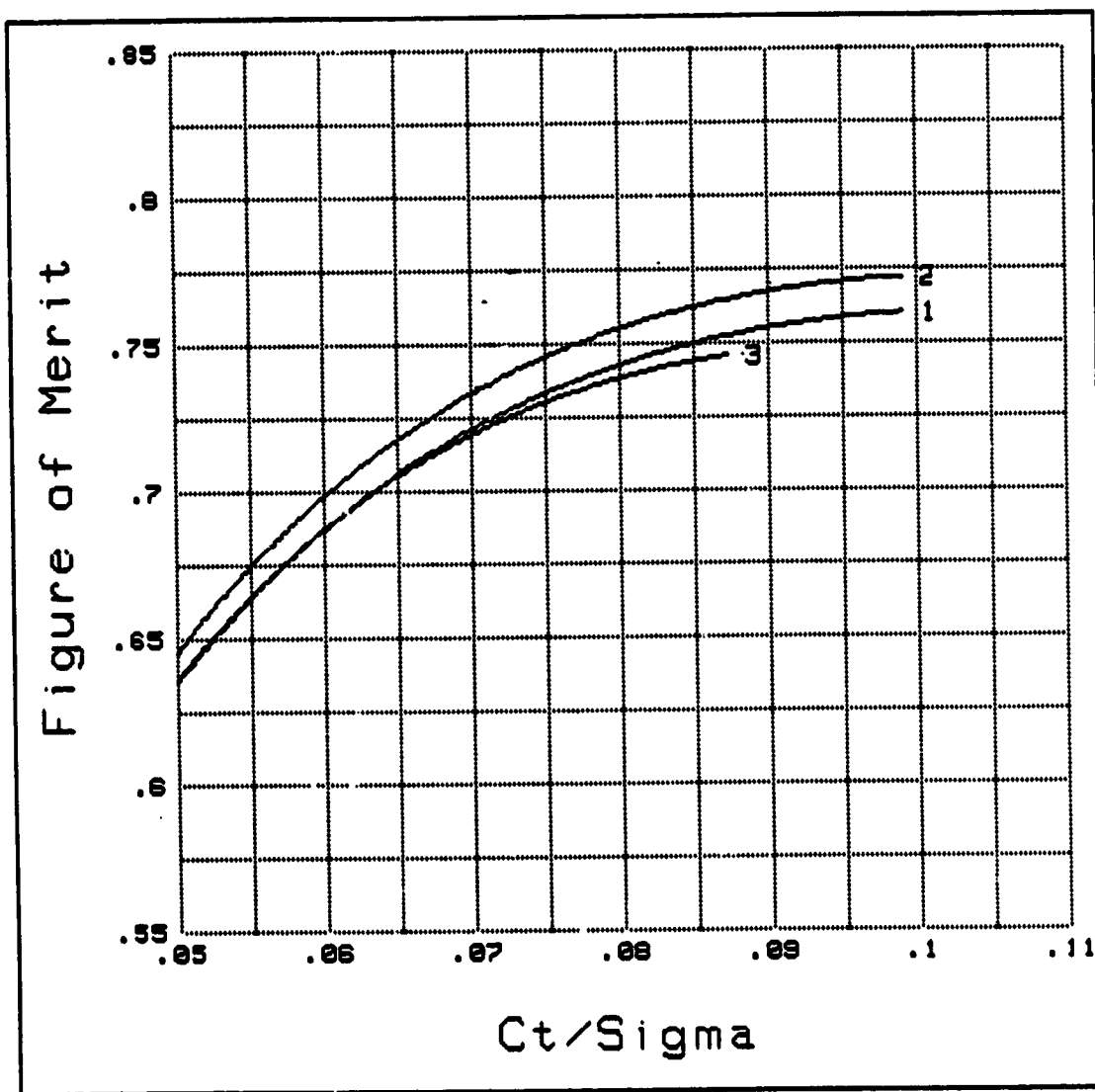

Figure 17.

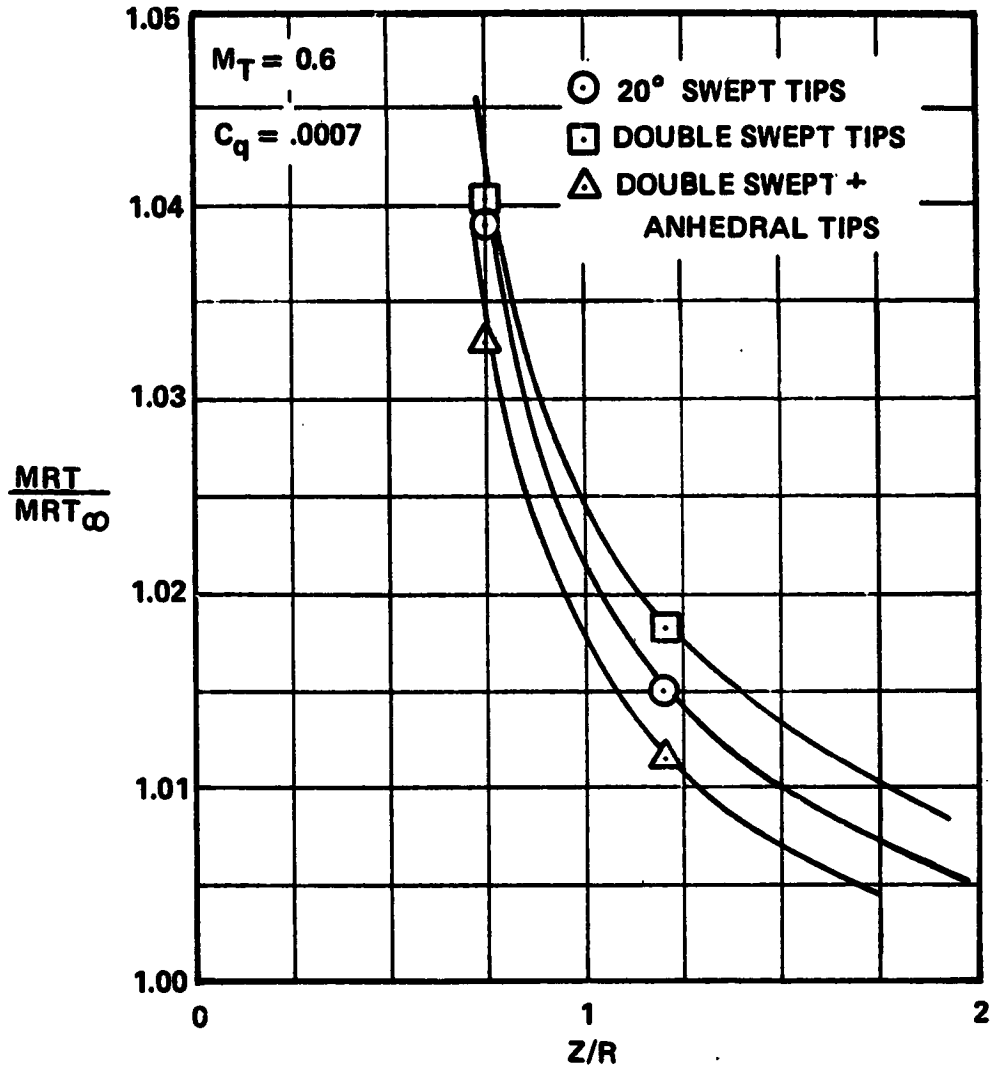

Figure 18. BLACK HAWK Rotor, Ground Effect Augmentation

This Data Recorded, Processed, and Printed Utilizing
HP9845B/SERIES 4600 MAGNETIC TAPE DATA PROCESSING SYSTEM

PLOT SERIES : S-76 Mt TRENDS; OGE; RECTANGULAR TIPS

<u>File#</u>	<u>File-Name</u>	<u>Plot#</u>	<u>Plot-Title</u>
21	TIP054	1	Mt=0.60
22	TIP055	2	Mt=0.65
23	TIP056	3	Mt=0.55

Figure of Merit vs Ct/Sigma

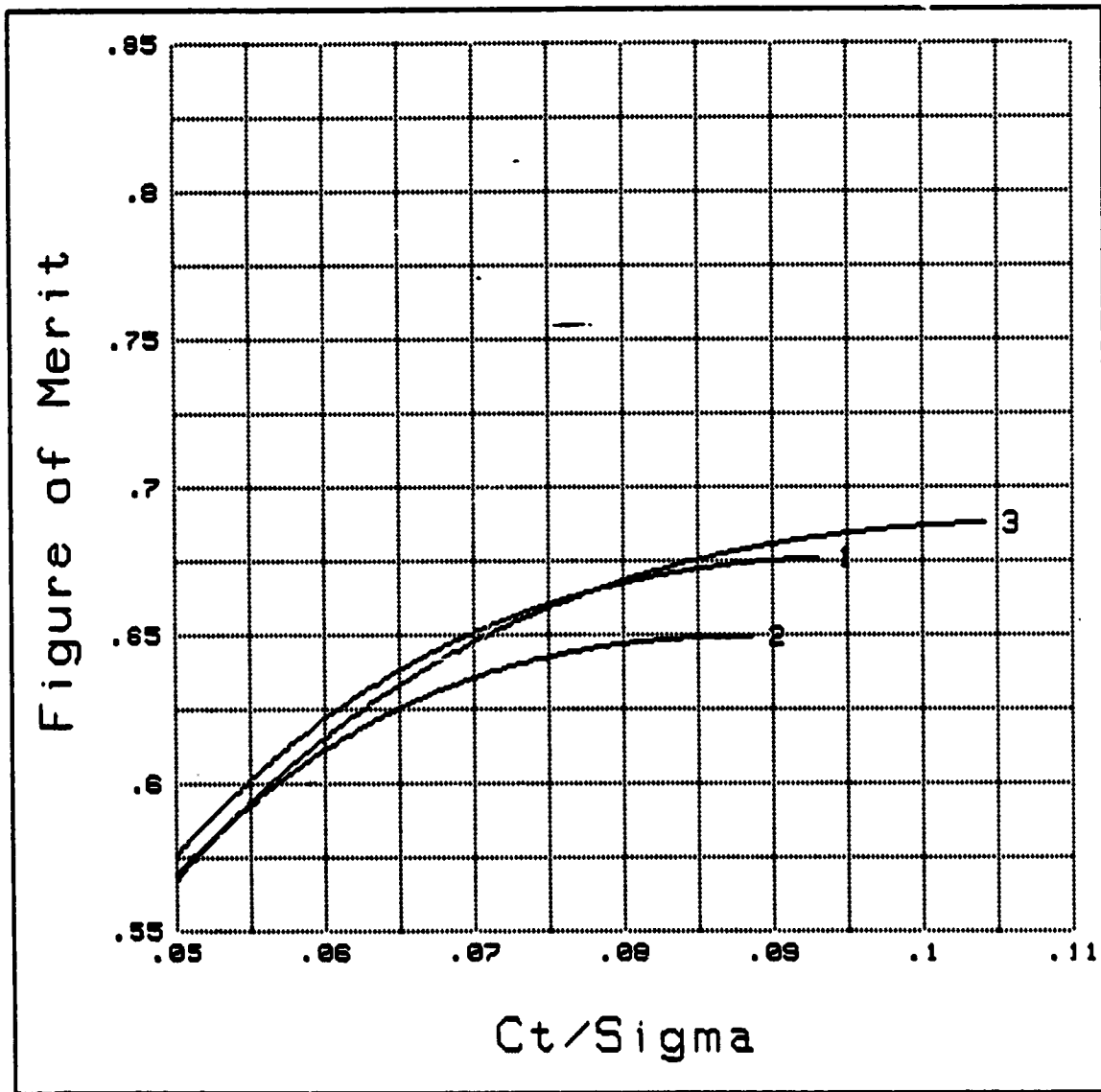

Figure 19.

This Data Recorded, Processed, and Printed Utilizing
HP9845B/SERIES 4600 MAGNETIC TAPE DATA PROCESSING SYSTEM

PLOT SERIES : S-76 Mt TRENDS; OGE; 60% TAPER TIPS

<u>File#</u>	<u>File-Name</u>	<u>Plot#</u>	<u>Plot-Title</u>
33	TIP072	1	Mt=0.55
34	TIP073	2	Mt=0.60
35	TIP074	3	Mt=0.65

Figure of Merit vs Ct/Sigma

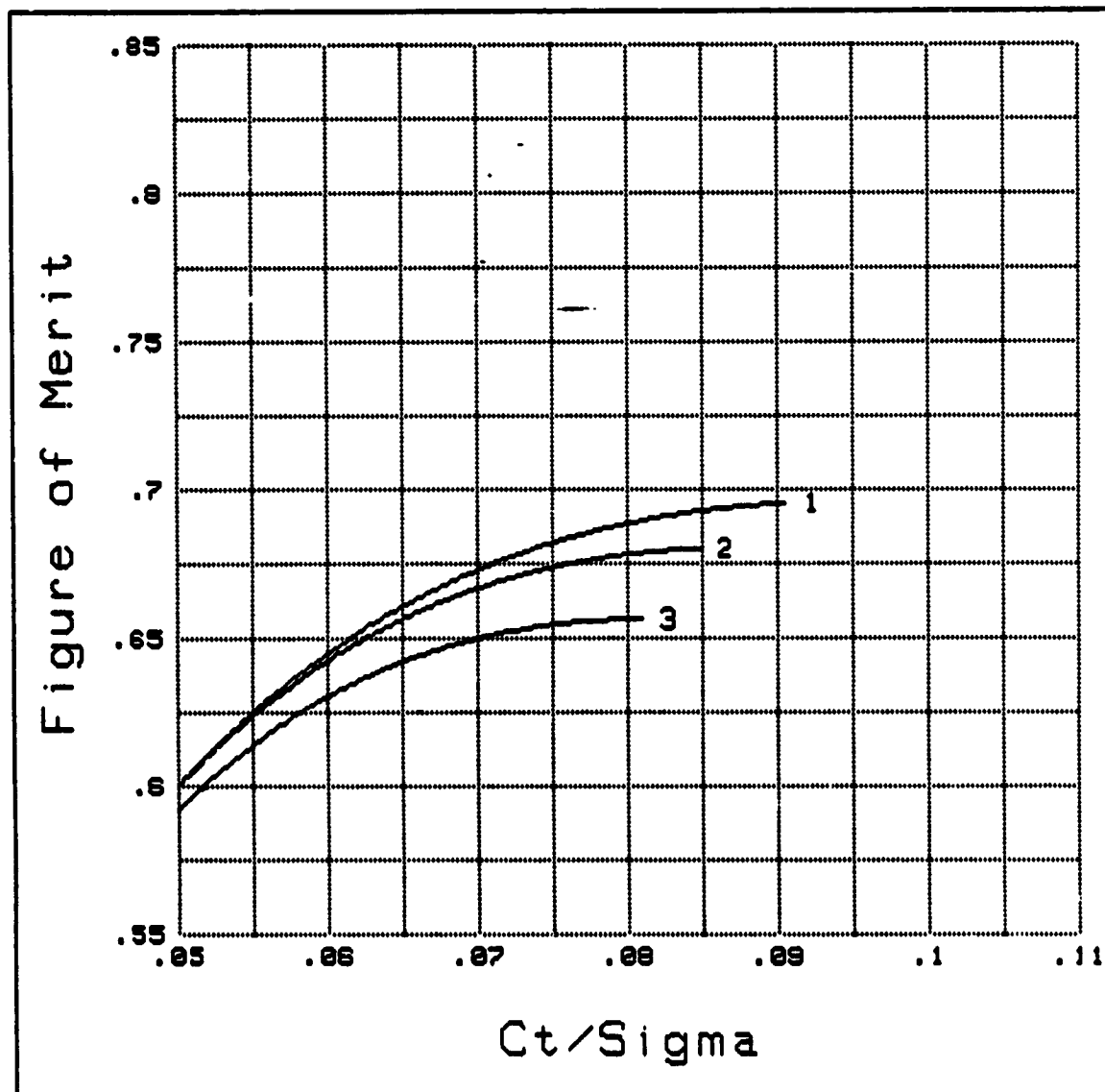

Figure 20.

(3)

This Data Recorded, Processed, and Printed Utilizing
HP9845B/SERIES 4600 MAGNETIC TAPE DATA PROCESSING SYSTEM

PLOT SERIES : S-76 Mt TRENDS; OGE; 20 Deg SWEPT TIPS

<u>File#</u>	<u>File-Name</u>	<u>Plot#</u>	<u>Plot-Title</u>
13	TIP038	1	Mt=0.65
14	TIP039	2	Mt=0.60
15	TIP040	3	Mt=0.55

Figure of Merit vs Ct/Sigma

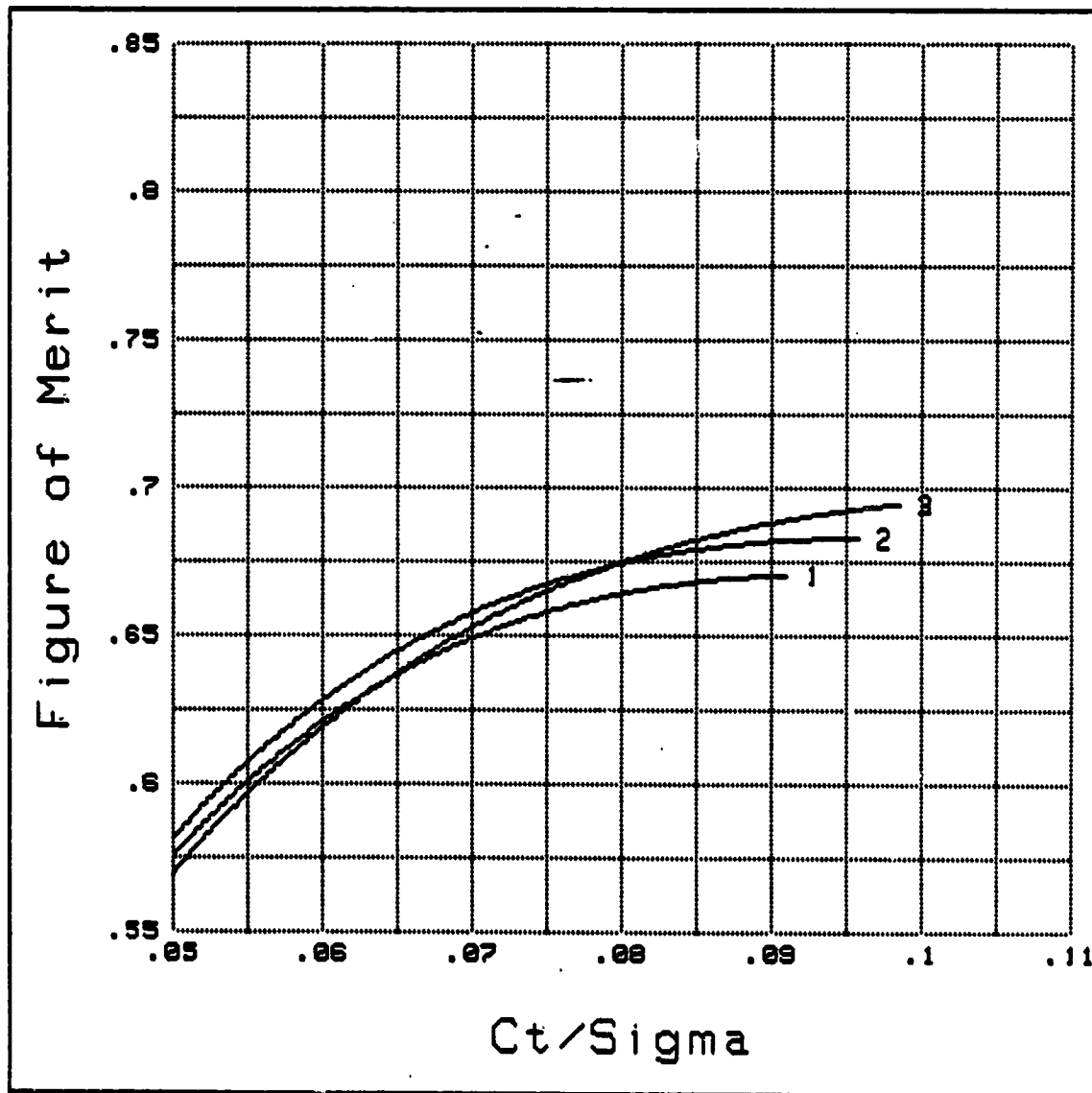

Figure 21.

(4)

This Data Recorded, Processed, and Printed Utilizing
HP9845B/SERIES 4600 MAGNETIC TAPE DATA PROCESSING SYSTEM

PLOT SERIES : S-76 Mt TRENDS; OGE; 20 Deg SWEPT W/ 60% TAPER TIPS

<u>File#</u>	<u>File-Name</u>	<u>Plot#</u>	<u>Plot-Title</u>
1	TIP017	1	Mt=0.60
2	TIP018	2	Mt=0.55
3	TIP019	3	Mt=0.65

Figure of Merit vs Ct/Sigma

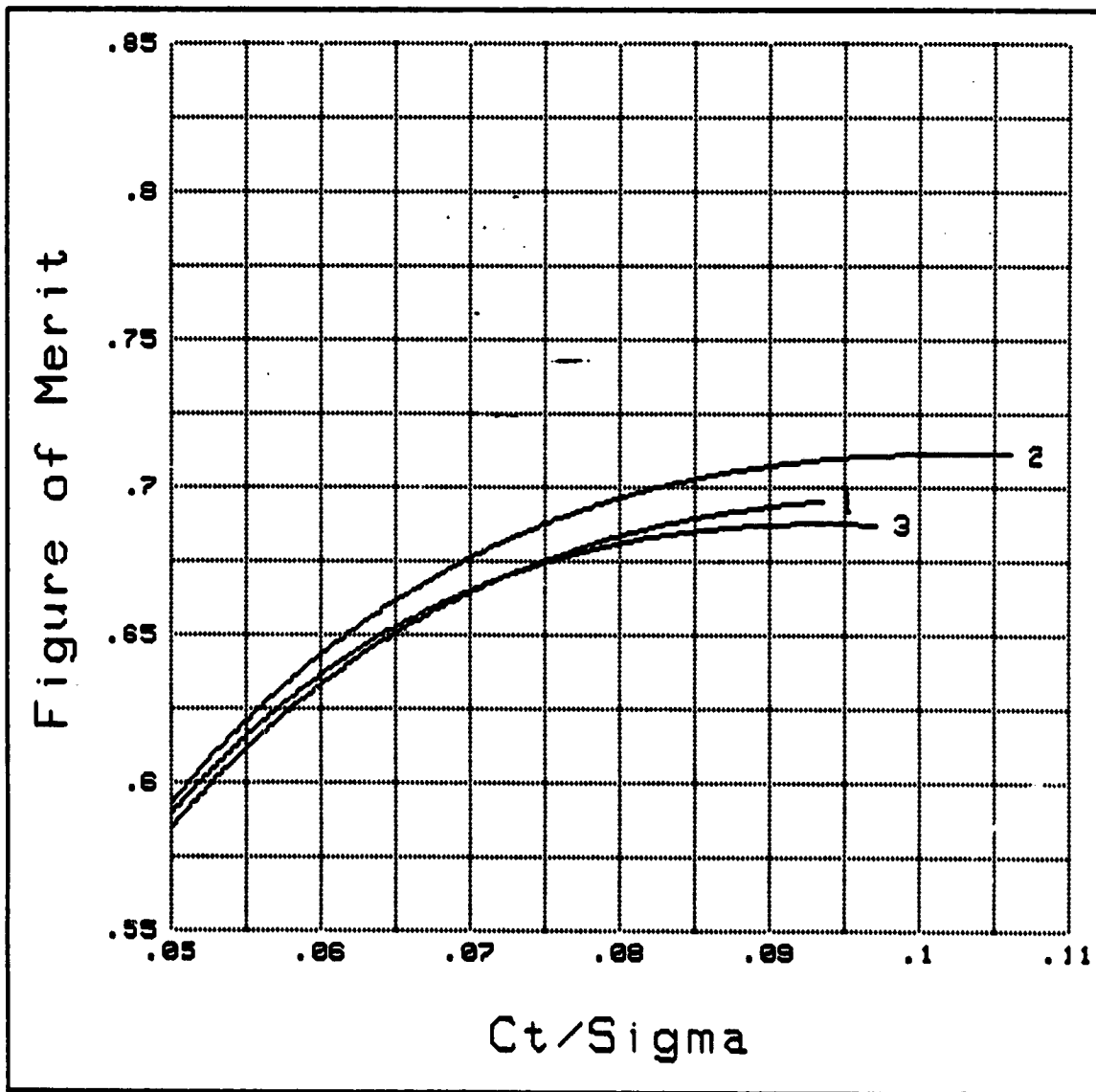

Figure 22.

This Data Recorded, Processed, and Printed Utilizing
HP9045B/SERIES 4600 MAGNETIC TAPE DATA PROCESSING SYSTEM

PLOT SERIES : S-76 Mt TRENDS; OGE; 20 Deg SWEPT W/ 60% TAPER & 20 Deg ANHEDRAL
TIPS

<u>File#</u>	<u>File-Name</u>	<u>Plot#</u>	<u>Plot-Title</u>
36	TIP078	1	Mt=0.60
37	TIP079	2	Mt=0.65
38	TIP080	3	Mt=0.55

Figure of Merit vs Ct/Sigma

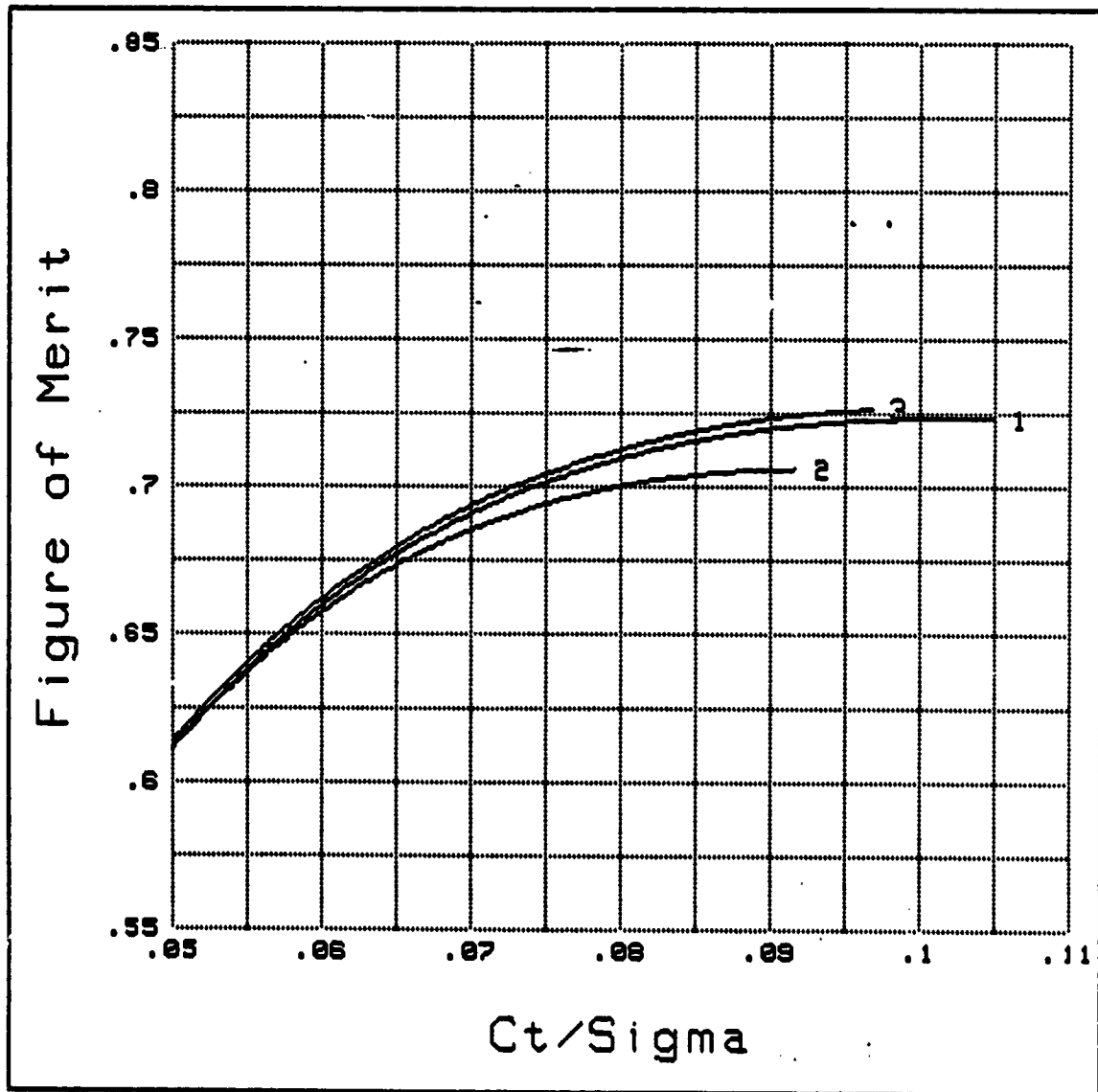

Figure 23.

This Data Recorded, Processed, and Printed Utilizing
HP9845B/SERIES 4600 MAGNETIC TAPE DATA PROCESSING SYSTEM

PLOT SERIES : S-76 TIP COMPARISON; OGE; $M_t = 0.55$

<u>File#</u>	<u>File-Name</u>	<u>Plot#</u>	<u>Plot-Title</u>
2	TIP018	1	20 Deg SWEPT W/ 60% TAPER
15	TIP040	2	20 Deg SWEPT
23	TIP056	3	RECTANGULAR
33	TIP072	4	60% TAPER
38	TIP080	5	20 Deg SWEPT W/ 60% TAPER & 20 Deg ANHEDRAL

Figure of Merit vs C_t/Σ

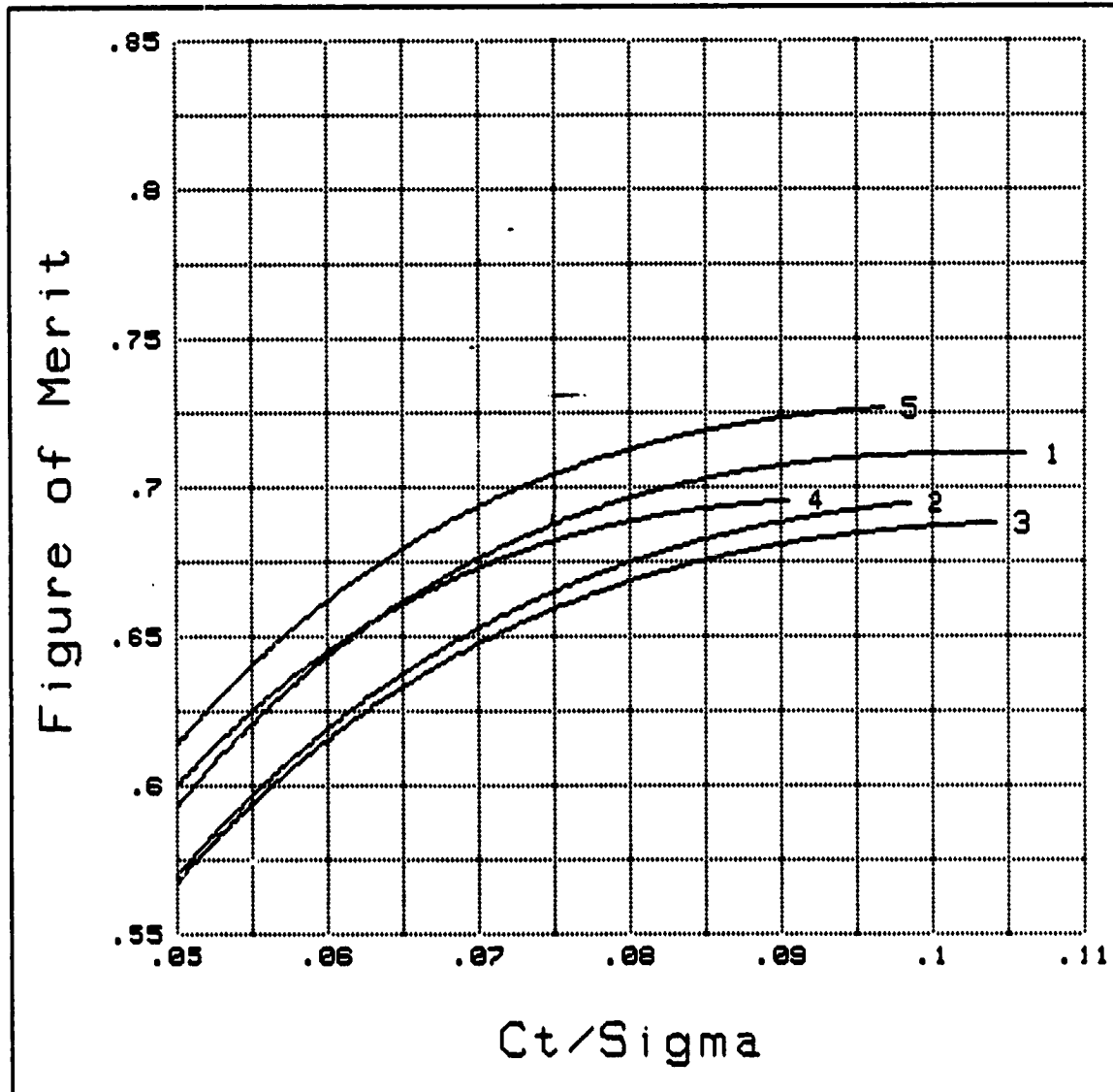

Figure 24.

This Data Recorded, Processed, and Printed Utilizing
HP9845B/SERIES 4600 MAGNETIC TAPE DATA PROCESSING SYSTEM

PLOT SERIES : S-76 TIP COMPARISON; OGE; Mt= 0.6

<u>File#</u>	<u>File-Name</u>	<u>Plot#</u>	<u>Plot-Title</u>
1	TIP017	1	20 Deg SWEPT W/ 60% TAPER
14	TIP039	2	20 Deg SWEPT
21	TIP054	3	RECTANGULAR
34	TIP073	4	60% TAPER
36	TIP078	5	20 Deg SWEPT W/ 60% TAPER & 20 Deg ANHEDRAL

Figure of Merit vs Ct/Sigma

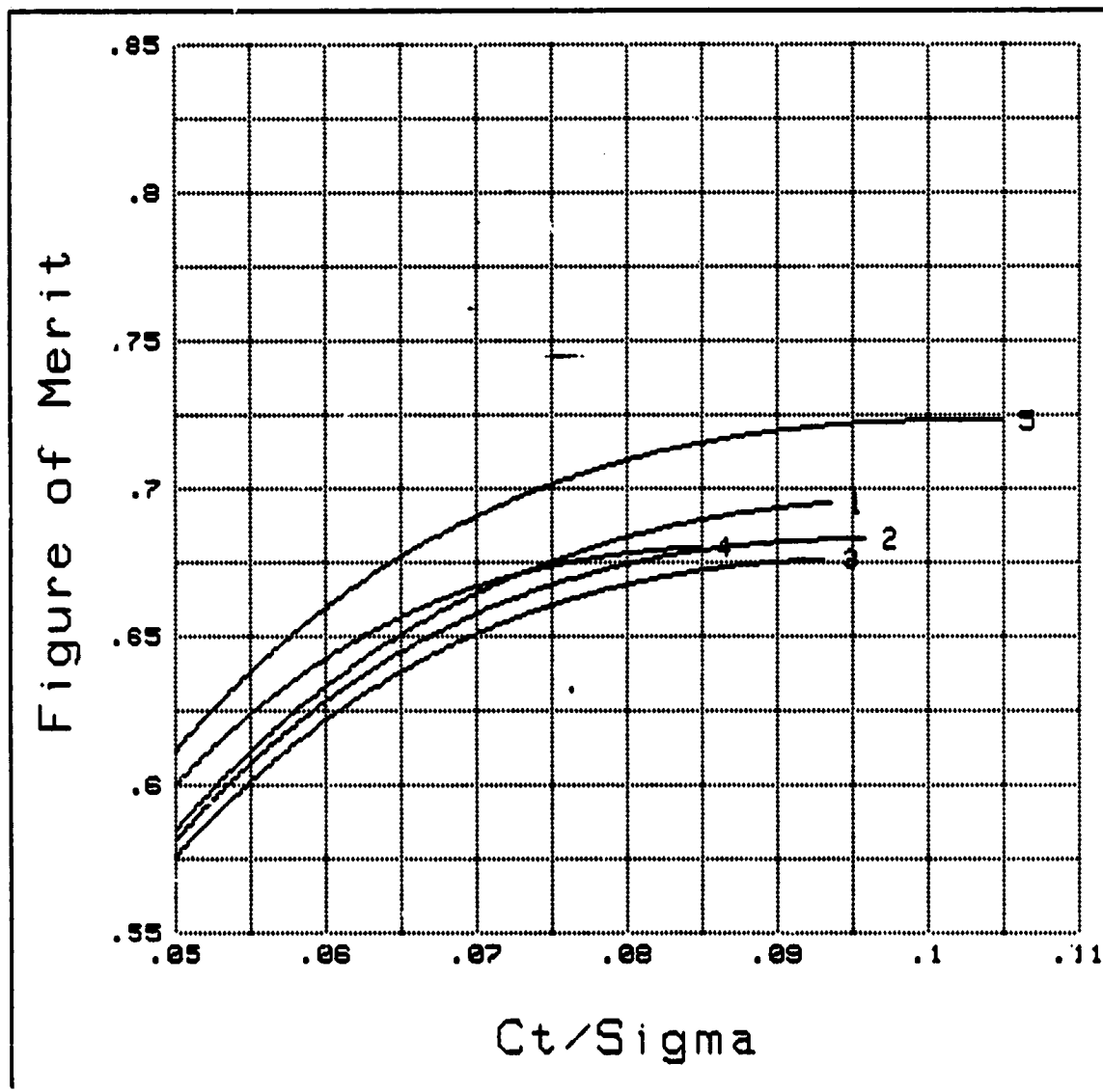

Figure 25.

This Data Recorded, Processed, and Printed Utilizing
 HP9845B/SERIES 4600 MAGNETIC TAPE DATA PROCESSING SYSTEM

PLOT SERIES : S-76 TIP COMPARISON; OGE; Mt = 0.65

<u>File#</u>	<u>File-Name</u>	<u>Plot#</u>	<u>Plot-Title</u>
3	TIP019	1	20 Deg SWEPT W/ 60% TAPER
13	TIP038	2	20 Deg SWEPT
22	TIP055	3	RECTANGULAR
35	TIP074	4	60% TAPER
37	TIP079	5	20 Deg SWEPT W/ 60% TAPER & 20 Deg ANHEDRAL

Figure of Merit vs Ct/Sigma

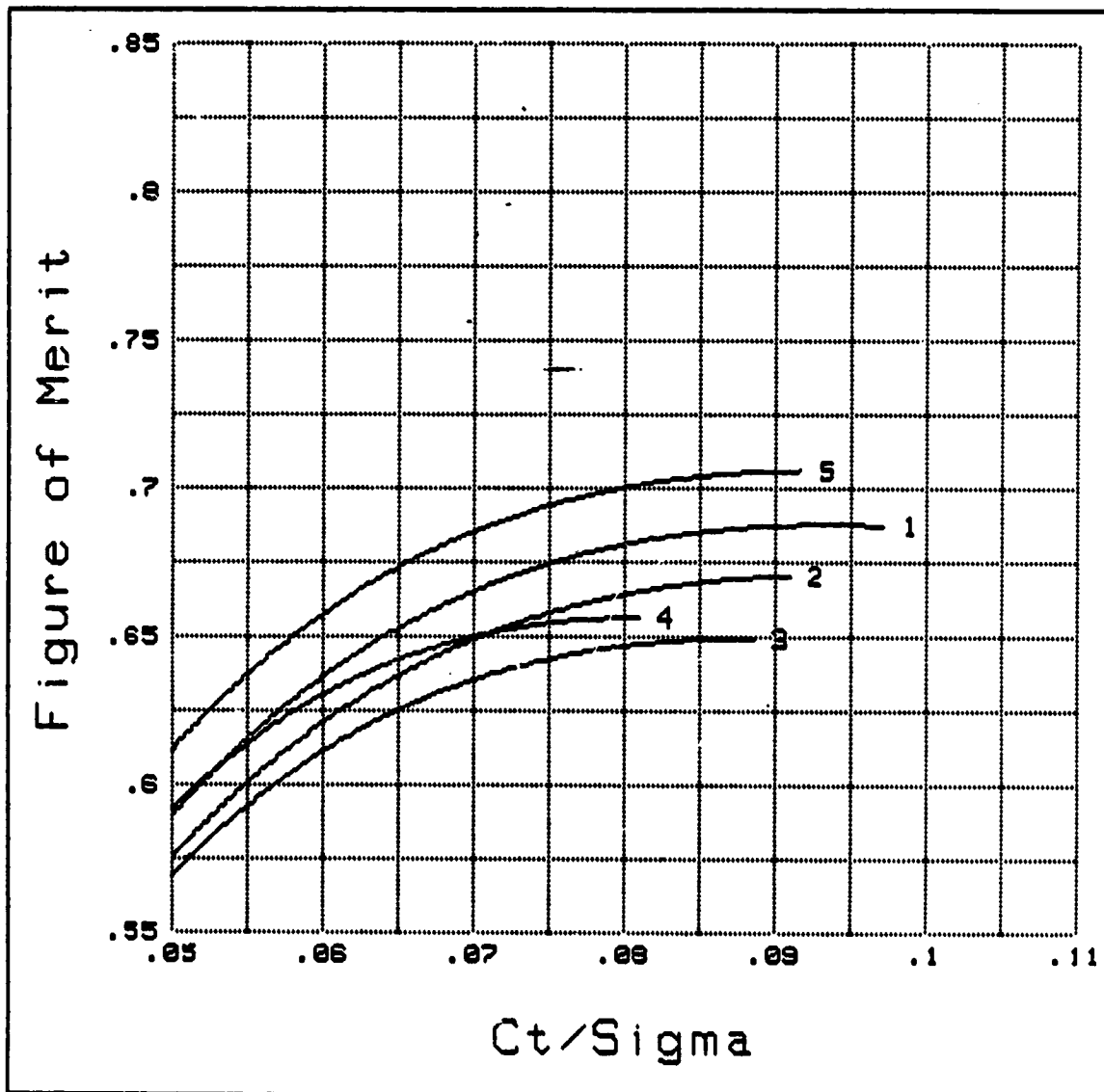

Figure 26.

PLOT SERIES : S-76 TIP COMPARISON; IGE; Mt= 0.6; Z/R= 1.2

<u>File#</u>	<u>File-Name</u>	<u>Plot#</u>	<u>Plot-Title</u>
4	TIP020	1	20 Deg SWEPT W/ 60% TAPER
12	TIP037	2	20 Deg SWEPT
25	TIP050	3	RECTANGULAR
32	TIP071	4	60% TAPER
39	TIP081	5	20 Deg SWEPT W/ 60% TAPER & 20 Deg ANHEDRAL

Figure of Merit vs Ct/Sigma

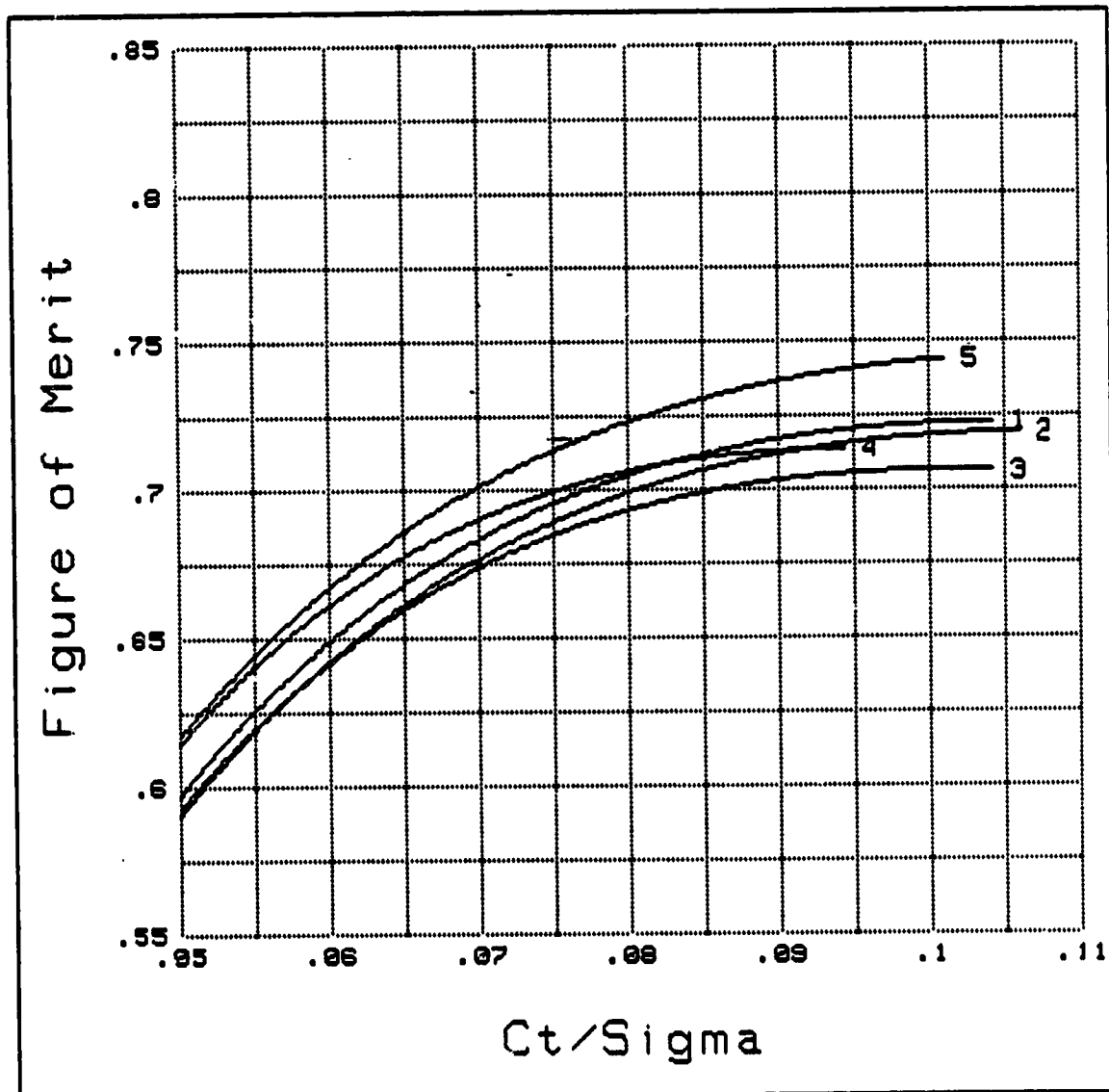

Figure 27.

ORIGINAL PAGE IS
OF POOR QUALITY.

This Data Recorded, Processed, and Printed Utilizing
HP9845B/SERIES 4600 MAGNETIC TAPE DATA PROCESSING SYSTEM

PLOT SERIES : S-76 TIP COMPARISON; ICE; $M_t = 0.6$; $Z/R = 0.75$

<u>File#</u>	<u>File-Name</u>	<u>Plot#</u>	<u>Plot-Title</u>
5	TIP023	1	20 Deg SWEPT W/ 60% TAPER
11	TIP036	2	20 Deg SWEPT
24	TIP057	3	RECTANGULAR
31	TIP070	4	60% TAPER
40	TIP082	5	20 Deg SWEPT W/ 60% TAPER & 20 Deg ANHEDRAL

Figure of Merit vs C_t/Σ

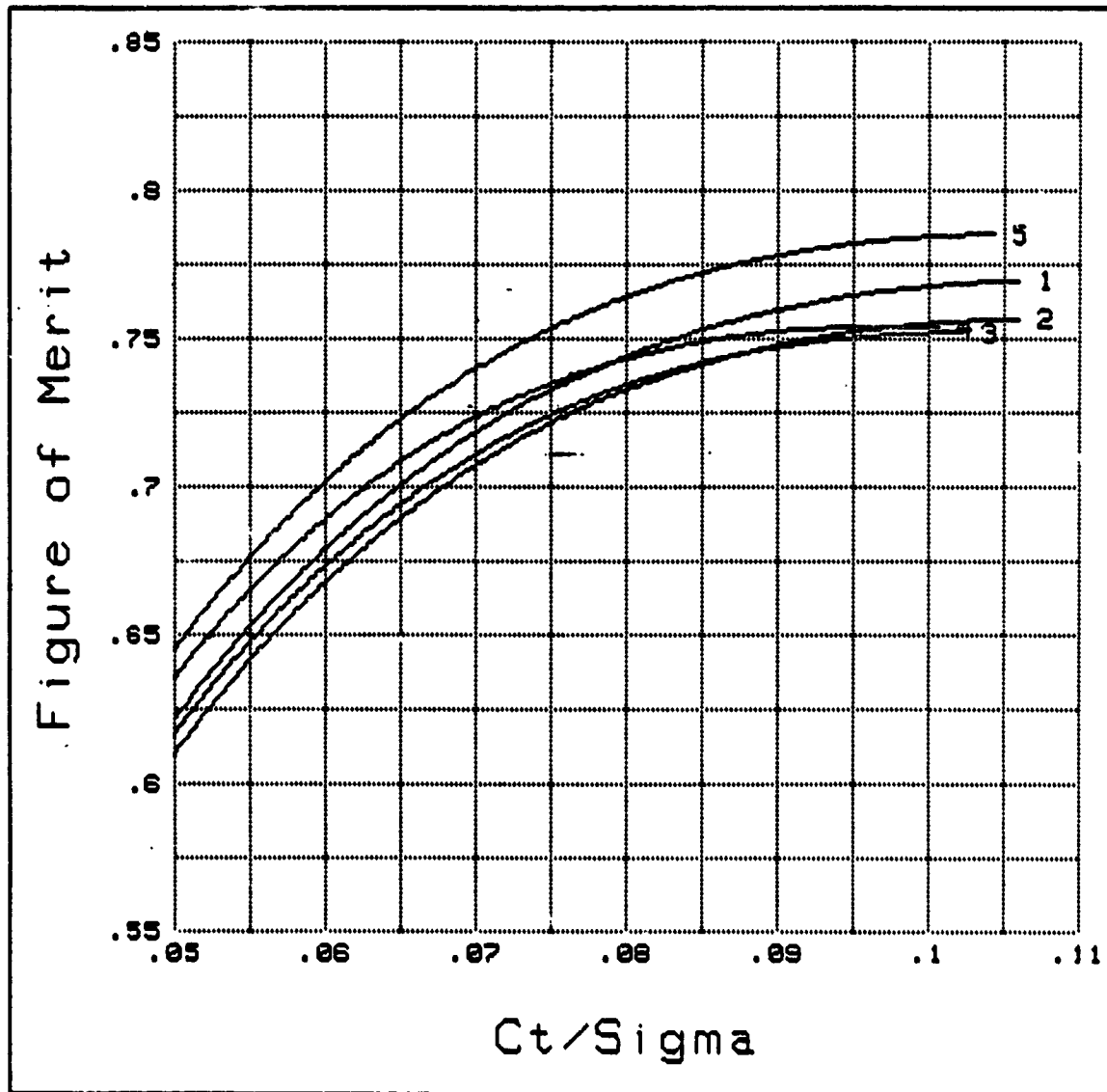

Figure 28.

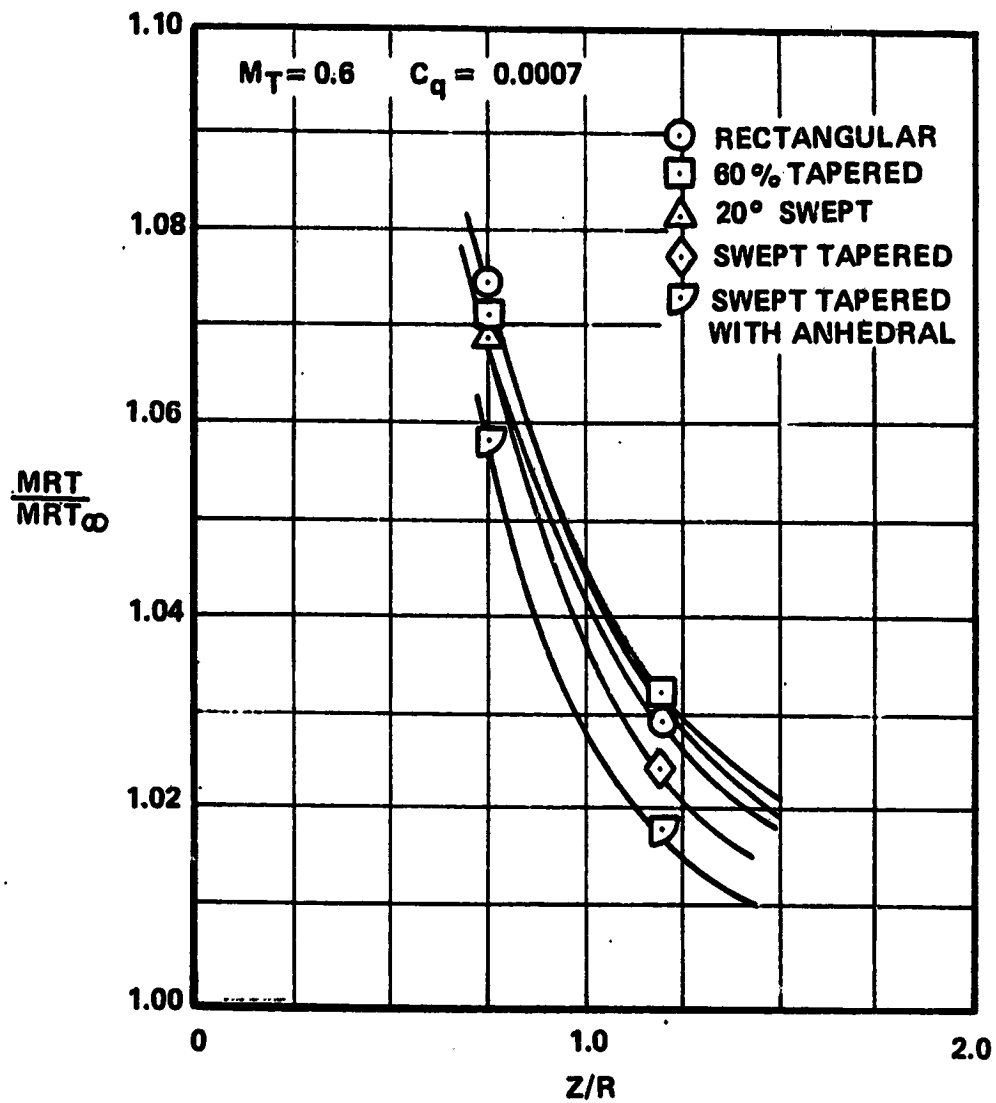

Figure 29. S-76 Rotor, Ground Effect Augmentation

This Data Recorded, Processed, and Printed Utilizing
HP9845B/SERIES 4600 MAGNETIC TAPE DATA PROCESSING SYSTEM

PLOT SERIES : TAIL ROTOR EFFECT; S-70 BLACKHAWK PLUS 20 Deg/35 Deg DOUBLE
SWEPT TIPS; OGE; $M_t = 0.55$

<u>File#</u>	<u>File-Name</u>	<u>Plot#</u>	<u>Plot-Title</u>
12	TIP119	1	TRACTOR TAIL ROTOR
17	TIP124	2	PUSHER TAIL ROTOR
36	TIF026	3	ISOLATED MAIN ROTOR

Figure of Merit vs Ct/Sigma

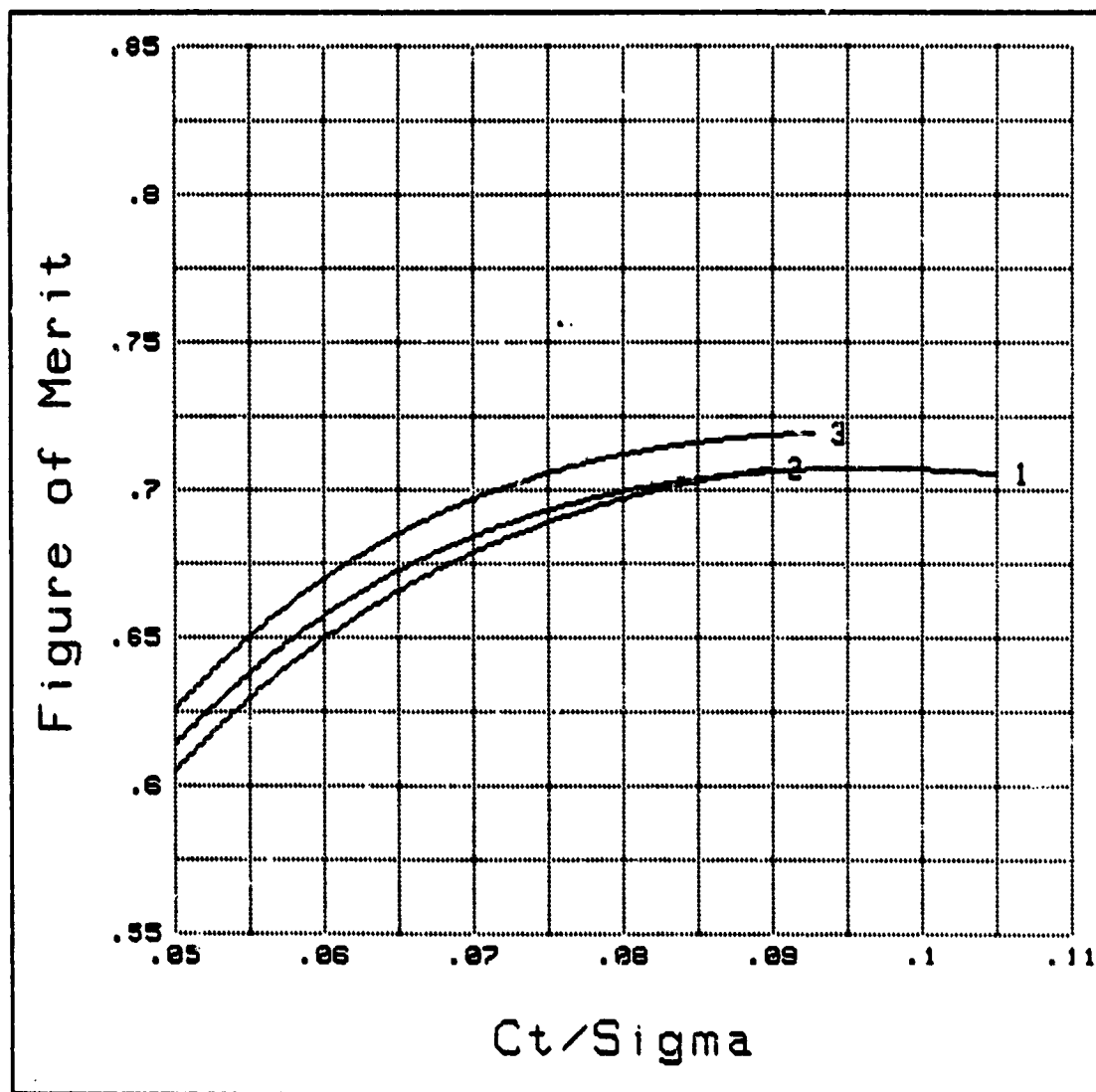

Figure 30.

ORIGINAL PAGE IS
OF POOR QUALITY

This Data Recorded, Processed, and Printed Utilizing
HP9845B/SERIES 4600 MAGNETIC TAPE DATA PROCESSING SYSTEM

PLOT SERIES : TAIL ROTOR EFFECT; S-70 BLACKHAWK PLUS 20 Deg/35 Deg DOUBLE
SWEPT TIPS; OGE; Mt= 0.6

<u>File#</u>	<u>File-Name</u>	<u>Plot#</u>	<u>Plot-Title</u>
1	TIP025	1	ISOLATED MAIN ROTOR
13	TIP120	2	TRACTOR TAIL ROTOR
18	TIP125	3	PUSHER TAIL ROTOR

Figure of Merit vs Ct/Σ

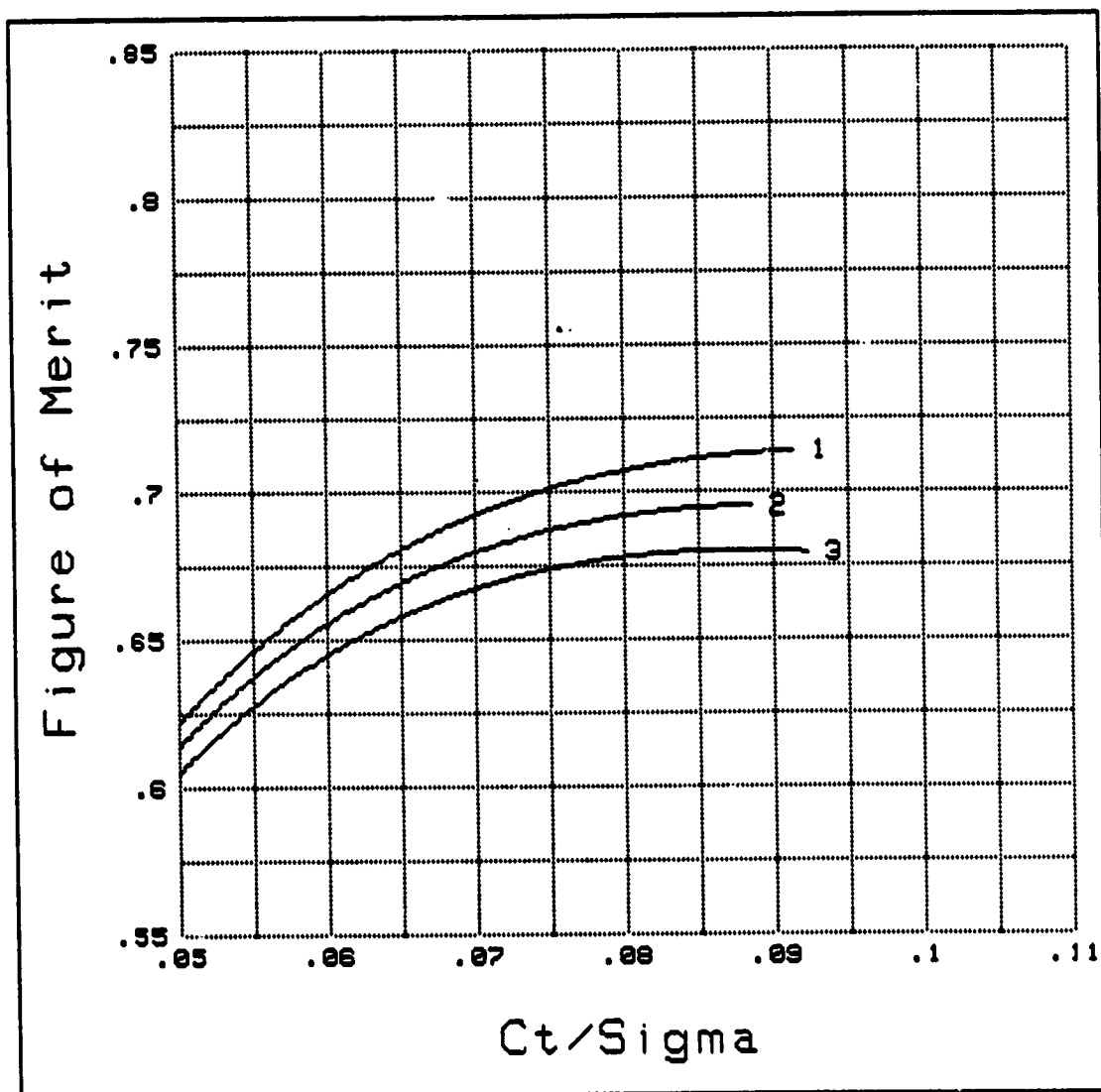

Figure 31.

This Data Recorded, Processed, and Printed Utilizing
HP9845B/SERIES 4600 MAGNETIC TAPE DATA PROCESSING SYSTEM

PLOT SERIES : TAIL ROTOR EFFECT; S-70 BLACKHAWK PLUS 20 Deg/35 Deg DOUBLE
SWEPT TIPS; OGE; $M_t = 0.65$

<u>File#</u>	<u>File-Name</u>	<u>Plot#</u>	<u>Plot-Title</u>
14	TIP121	1	TRACTOR TAIL ROTOR
19	TIP126	2	PUSHER TAIL ROTOR
37	TIP027	3	ISOLATED MAIN ROTOR

Figure of Merit vs C_t/Σ

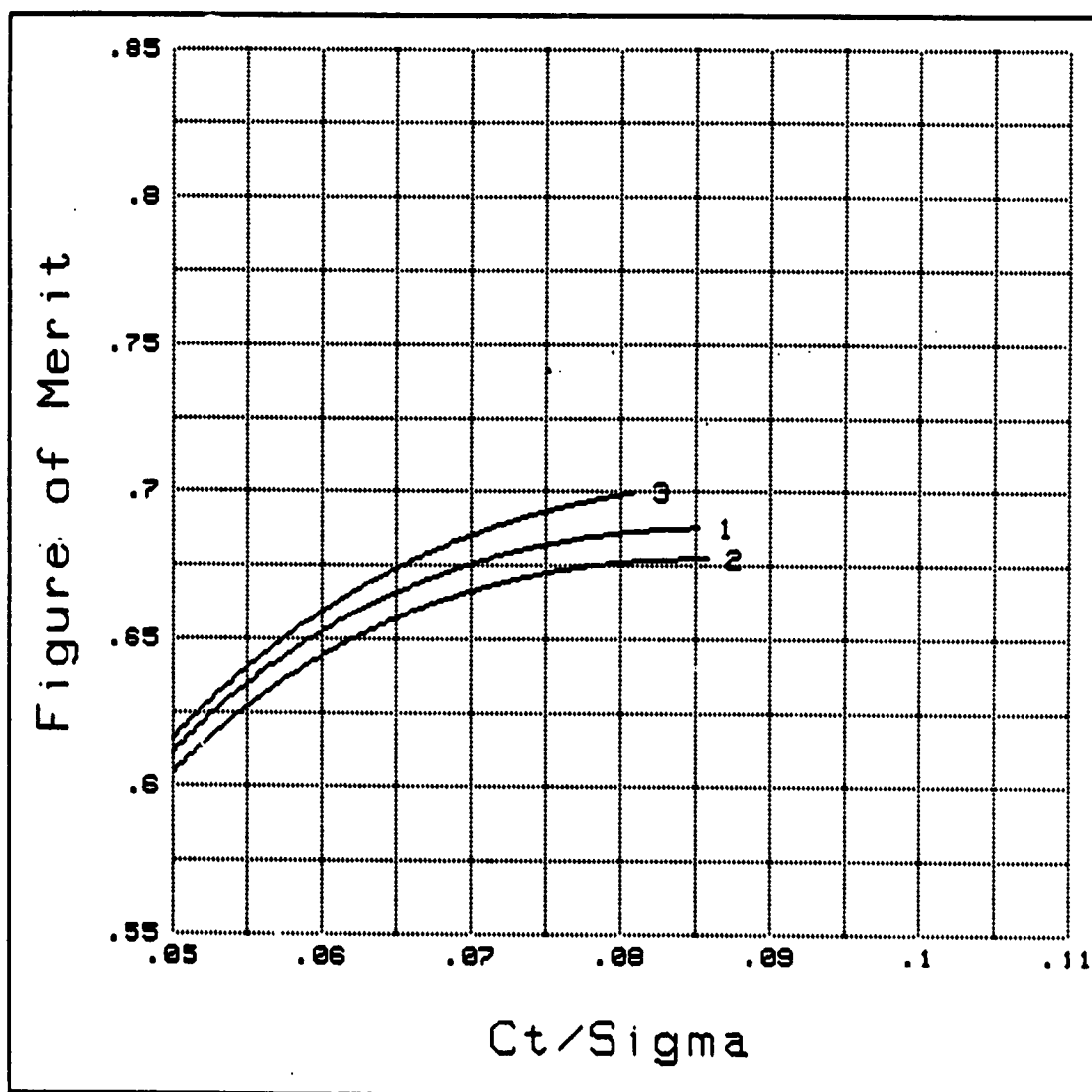

Figure 32.

This Data Recorded, Processed, and Printed Utilizing
 HP9845B/SERIES 4600 MAGNETIC TAPE DATA PROCESSING SYSTEM

PLOT SERIES : TAIL ROTOR EFFECT; S-70 BLACKHAWK PLUS 20 Deg/35 Deg DOUBLE
 SWEPT W/ 20 Deg ANHEDRAL TIPS; OGE; Mt= 0.55

<u>File#</u>	<u>File-Name</u>	<u>Plot#</u>	<u>Plot-Title</u>
26	TIP150	1	TRACTOR TAIL ROTOR
32	TIP159	2	PUSHER TAIL ROTOR
41	TIP046	3	ISOLATED MAIN ROTOR

Figure of Merit vs Ct/Sigma

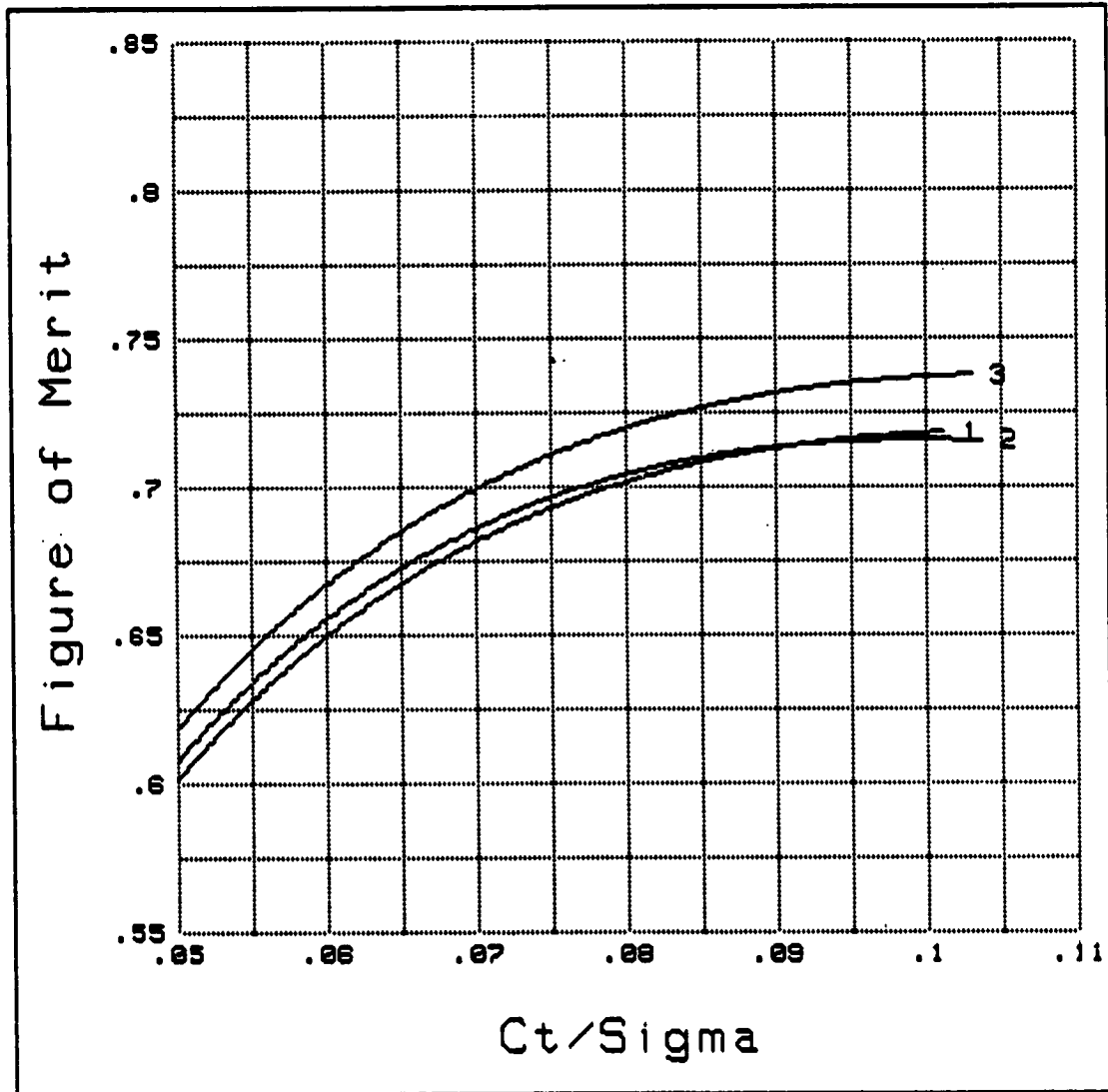

Figure 33.

This Data Recorded, Processed, and Printed Utilizing
HP9845B/SERIES 4600 MAGNETIC TAPE DATA PROCESSING SYSTEM

PLOT SERIES : TAIL ROTOR EFFECT; S-70 BLACKHAWK PLUS 20 Deg/35 Deg DOUBLE
SWEPT W/ 20 Deg ANHEDRAL TIPS; OGE; Mt= 0.6.

<u>File#</u>	<u>File-Name</u>	<u>Plot#</u>	<u>Plot-Title</u>
27	TIP151	1	TRACTOR TAIL ROTOR
33	TIP160	2	PUSHER TAIL ROTOR
42	TIP047	3	ISOLATED MAIN ROTOR

Figure of Merit vs Ct/Sigma

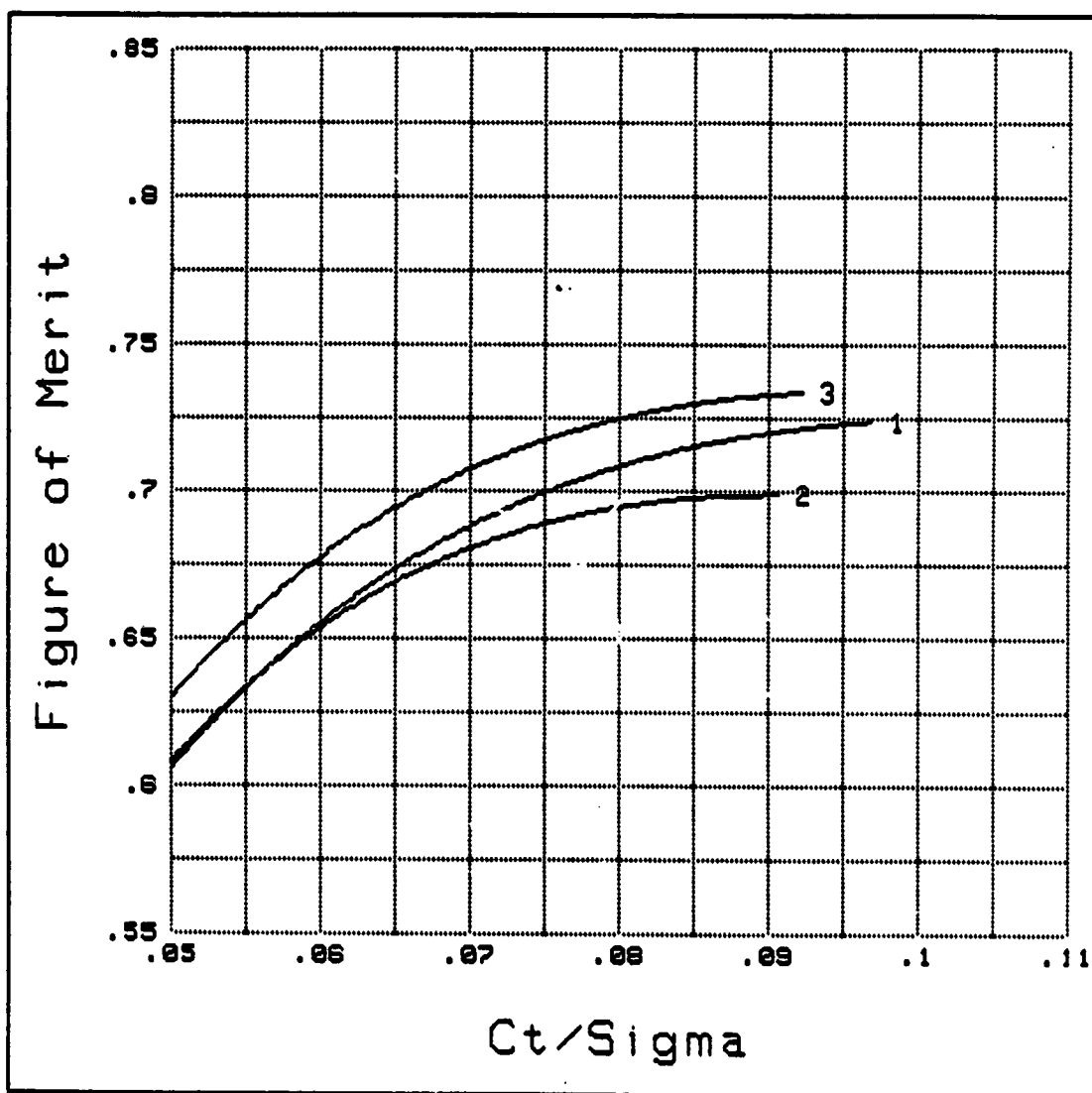

Figure 34.

ORIGINAL PAGE IS
OF POOR QUALITY

PLOT SERIES : TAIL ROTOR EFFECT; S-70 BLACKHAWK PLUS 20 Deg/35 Deg DOUBLE
SWEPT W/ 20 Deg ANHEDRAL TIPS; OGE; $M_t = 0.65$

File#	File-Name	Plot#	Plot-Title
28	TIP152	1	TRACTOR TAIL ROTOR
34	TIP161	2	PUSHER TAIL ROTOR
48	TIP045	3	ISOLATED MAIN ROTOR

Figure of Merit vs C_t/σ

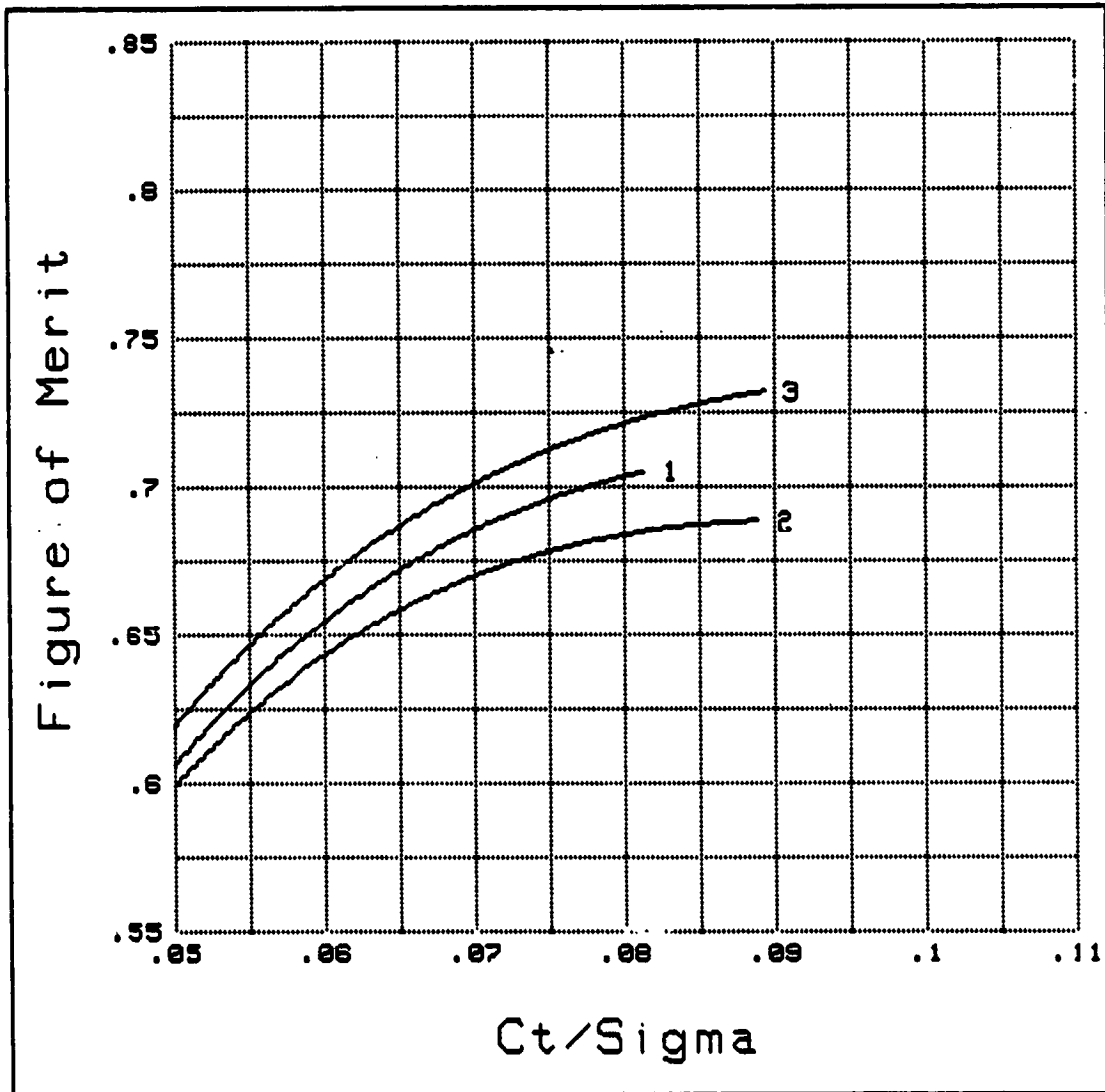

Figure 35.

This Data Recorded, Processed, and Printed Utilizing
HP9845B/SERIES 4600 MAGNETIC TAPE DATA PROCESSING SYSTEM

PLOT SERIES : TAIL ROTOR EFFECT; S-70 BLACKHAWK PLUS 20 Deg/35 Deg DOUBLE
SWEPT TIPS; IGE; Z/R= 1.2; Mt= 0.60

<u>File#</u>	<u>File-Name</u>	<u>Plot#</u>	<u>Plot-Title</u>
2	TIP029	1	ISOLATED MAIN ROTOR
15	TIP122	2	TRACTOR TAIL ROTOR
20	TIP127	3	PUSHER TAIL ROTOR

Figure of Merit vs Ct/Sigma

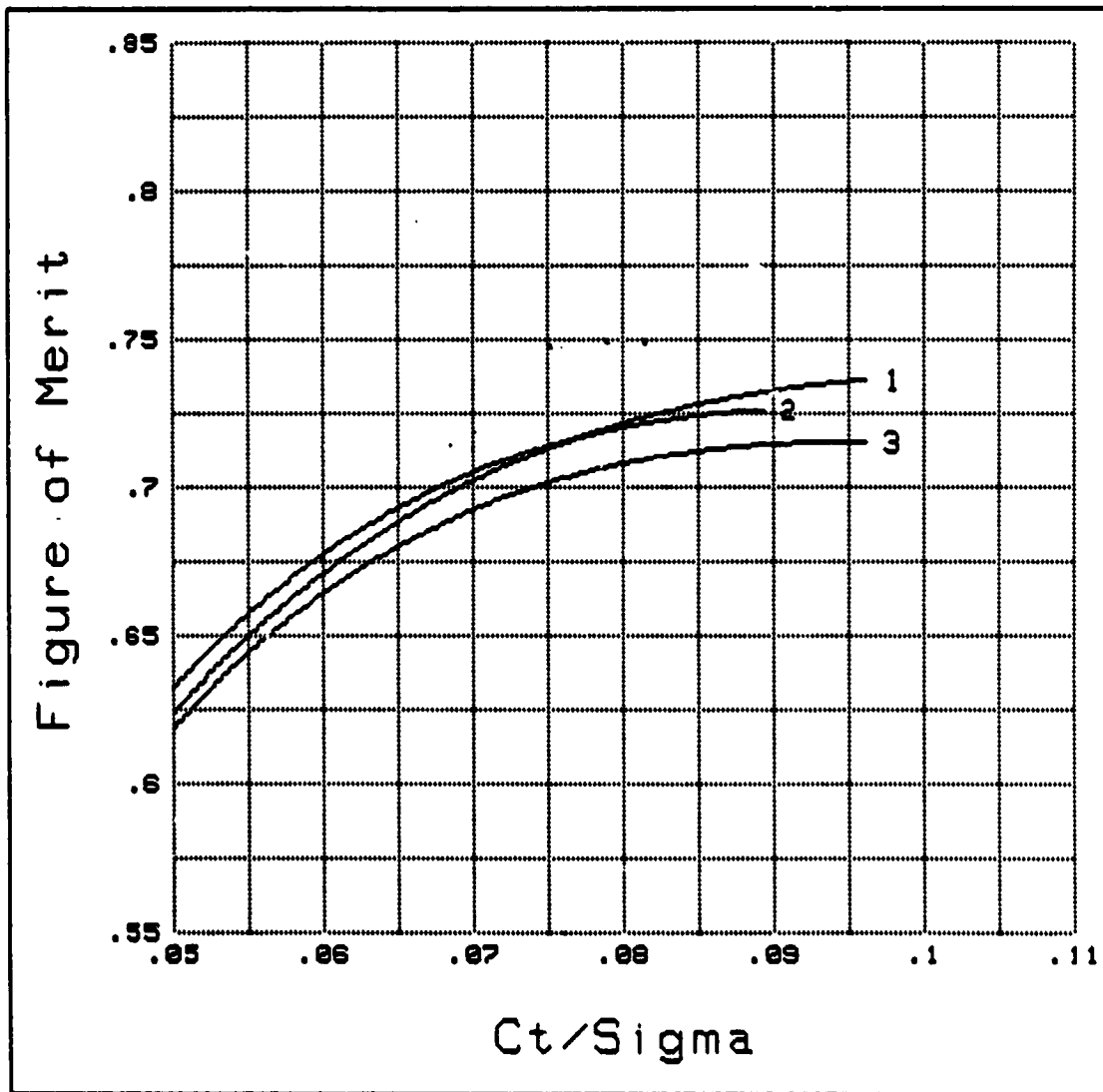

Figure 36.

This Data Recorded, Processed, and Printed Utilizing
HP9845B/SERIES 4600 MAGNETIC TAPE DATA PROCESSING SYSTEM

PLOT SERIES : TAIL ROTOR EFFECT; S-70 BLACKHAWK PLUS 20 Deg/35 Deg DOUBLE
SWEPT TIPS; IGE; Z/R= 0.75 Mt= 0.60

<u>File#</u>	<u>File-Name</u>	<u>Plot#</u>	<u>Plot-Title</u>
16	TIP123	1	TRACTOR TAIL ROTOR
21	TIP128	2	PUSHER TAIL ROTOR
38	TIP028	3	ISOLATED MAIN ROTOR

Figure of Merit vs Ct/Sigma

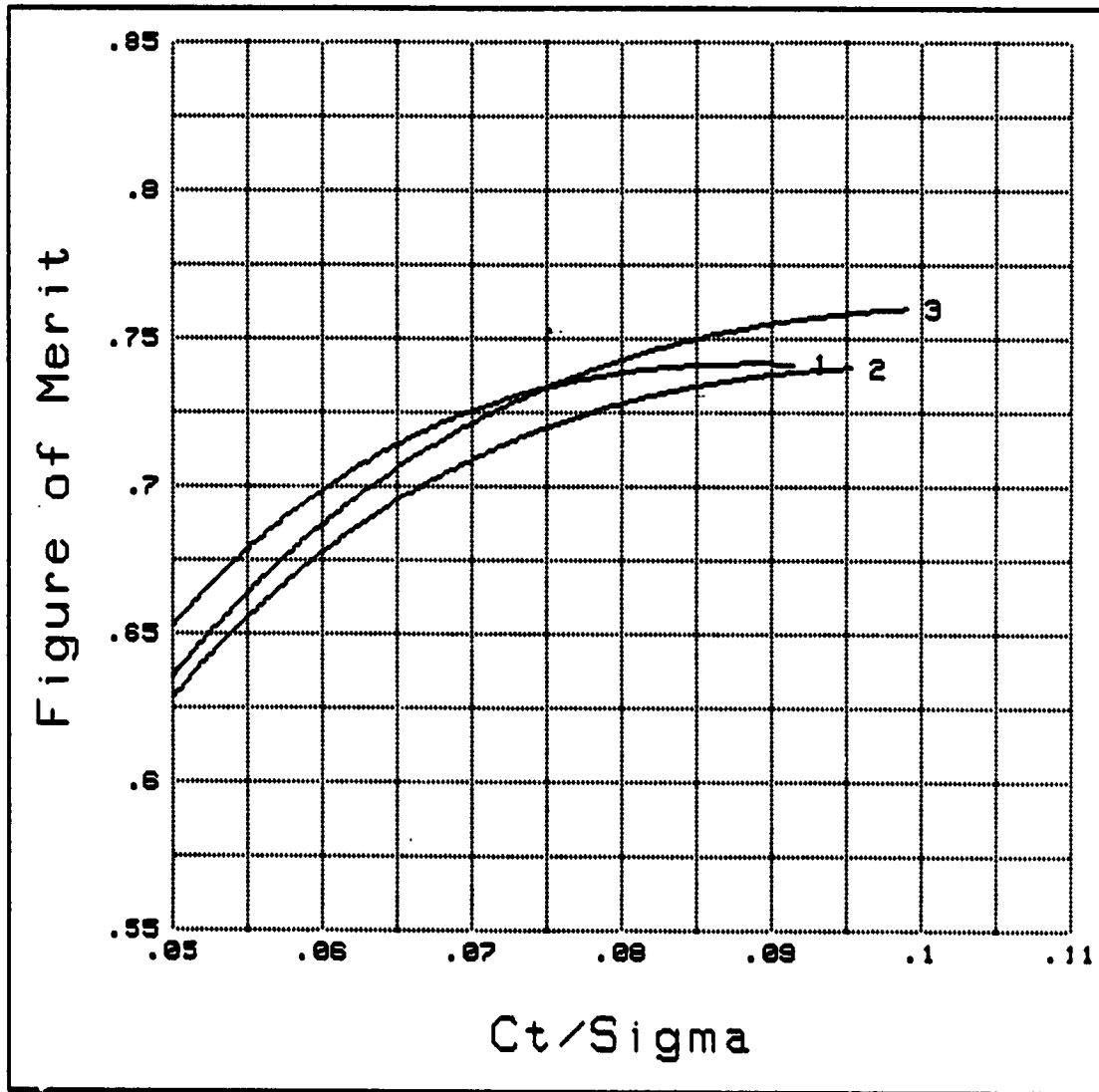

Figure 37.

ORIGINAL PAGE IS
OF POOR QUALITY

This Data Recorded, Processed, and Printed Utilizing
HP9845B/SERIES 4600 MAGNETIC TAPE DATA PROCESSING SYSTEM

PLOT SERIES : TAIL ROTOR EFFECT; S-70 BLACKHAWK PLUS 20 Deg/35 Deg DOUBLE
SWEPT W/ 20 Deg ANHEDRAL TIPS; IGE; Z/R= 1.2; Mt= 0.60

<u>File#</u>	<u>File-Name</u>	<u>Plot#</u>	<u>Plot-Title</u>
3	TIP043	1	ISOLATED MAIN ROTOR
29	TIP155	2	TRACTOR TAIL ROTOR
31	TIP158	3	PUSHER TAIL ROTOR

Figure of Merit vs Ct/Sigma

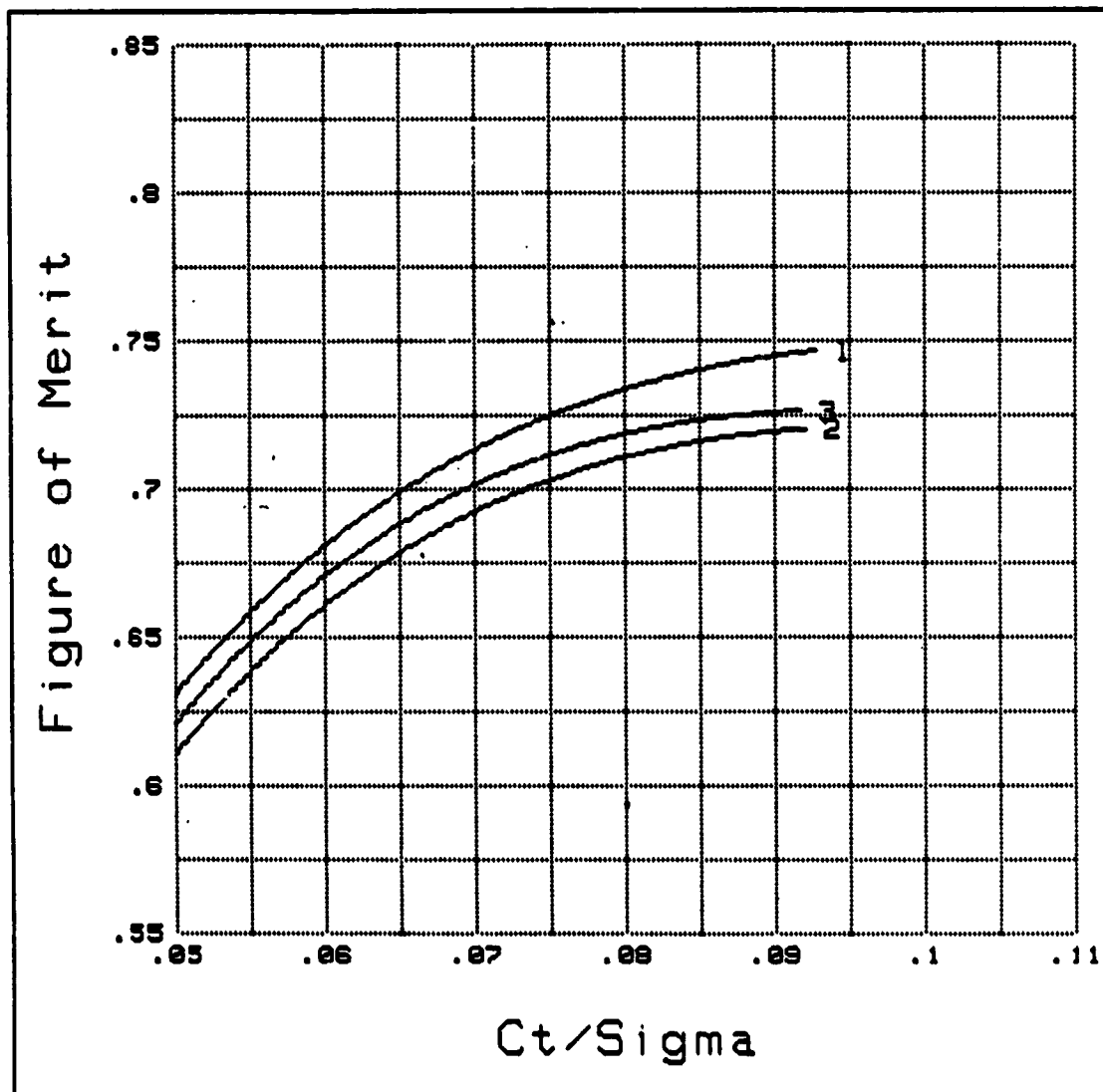

Figure 38.

ORIGINAL PAGE IS
OF POOR QUALITY.

This Data Recorded, Processed, and Printed Utilizing
HP9845B/SERIES 4600 MAGNETIC TAPE DATA PROCESSING SYSTEM

PLOT SERIES : TAIL ROTOR EFFECT; S-70 BLACKHAWK PLUS 20 Deg/35 Deg DOUBLE
SWEPT W/ 20 Deg ANHEDRAL TIPS; IGE; Z/R= 0.75 Mt= 0.60

File#	File-Name	Plot#	Plot-Title
30	TIP157	1	PUSHER TAIL ROTOR
35	TIP154	2	TRACTOR TAIL ROTOR
39	TIP042	3	ISOLATED MAIN-ROTOR

Figure of Merit vs Ct/Sigma

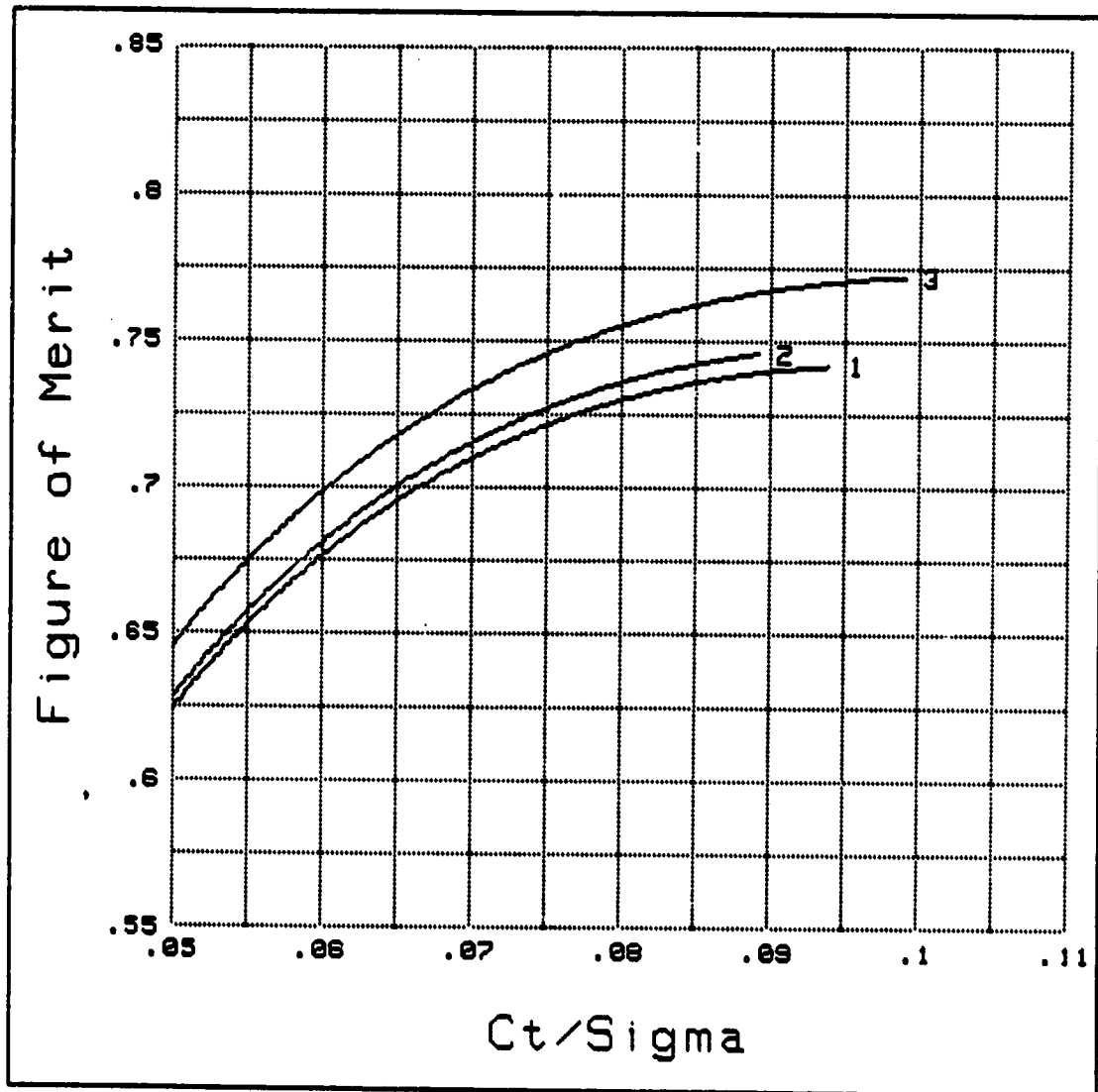

Figure 39.

This Data Recorded, Processed, and Printed Utilizing
HP9845B/SERIES 4600 MAGNETIC TAPE DATA PROCESSING SYSTEM

PLOT SERIES : TAIL ROTOR EFFECT; S-76 PLUS 60% TAPER TIPS; OGE; Mt=0.55

<u>File#</u>	<u>File-Name</u>	<u>Plot#</u>	<u>Plot-Title</u>
6	TIP072	1	ISOLATED MAIN ROTOR
17	TIP131	2	PUSHER TAIL ROTOR
26	TIP138	3	TRACTOR TAIL ROTOR

Figure of Merit vs Ct/Sigma

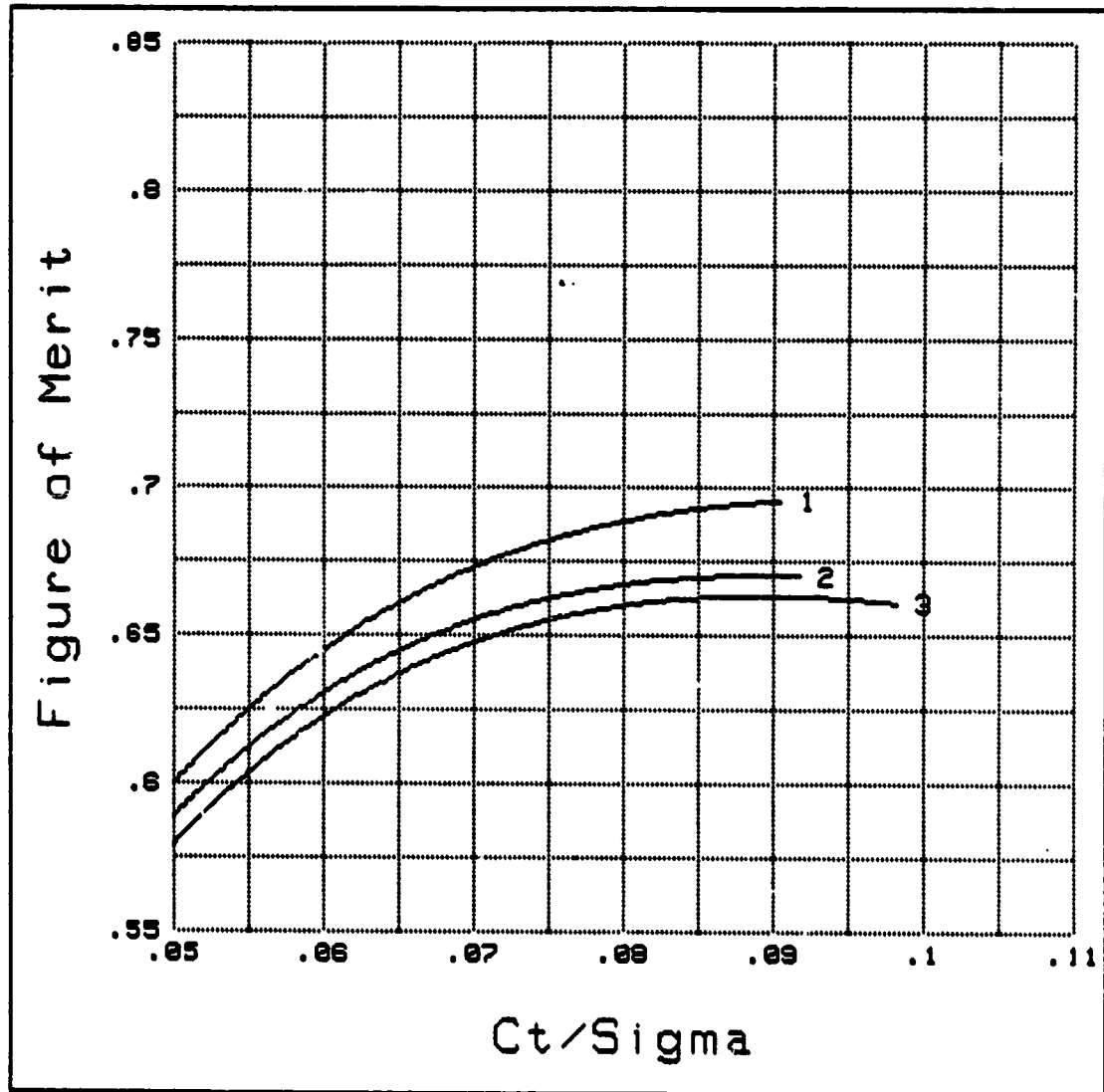

Figure 40.

This Data Recorded, Processed, and Printed Utilizing
HP9945B/SERIES 4600 MAGNETIC TAPE DATA PROCESSING SYSTEM

PLOT SERIES : TAIL ROTOR EFFECT; S-76 PLUS 60% TAPER TIPS; OGE; $M_t = 0.60$

<u>File#</u>	<u>File-Name</u>	<u>Plot#</u>	<u>Plot-Title</u>
7	TIP073	1	ISOLATED MAIN ROTOR
18	TIP132	2	PUSHER TAIL ROTOR
20	TIP139	3	TRACTOR TAIL ROTOR

Figure of Merit vs C_t/Σ

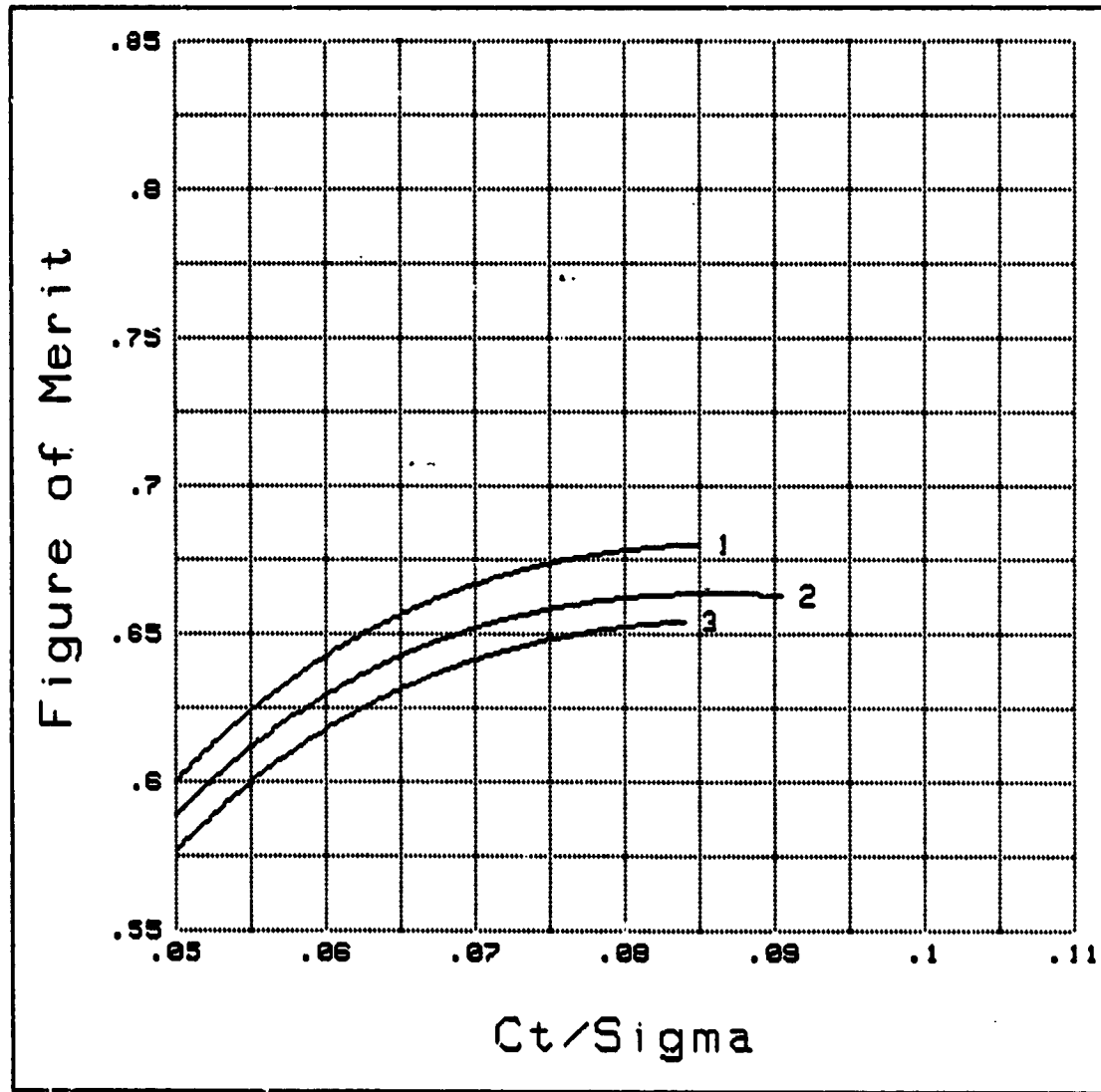

Figure 41.

This Data Recorded, Processed, and Printed Utilizing
HP9845B/SERIES 4600 MAGNETIC TAPE DATA PROCESSING SYSTEM

PLOT SERIES : TAIL ROTOR EFFECT; S-76 PLUS 60% TAPER TIPS; OGE; $M_t=0.65$

<u>File#</u>	<u>File-Name</u>	<u>Plot#</u>	<u>Plot-Title</u>
8	TIP074	1	ISOLATED MAIN ROTOR
19	TIP133	2	PUSHER TAIL ROTOR
21	TIP141	3	TRACTOR TAIL ROTOR

Figure of Merit vs C_t/Σ

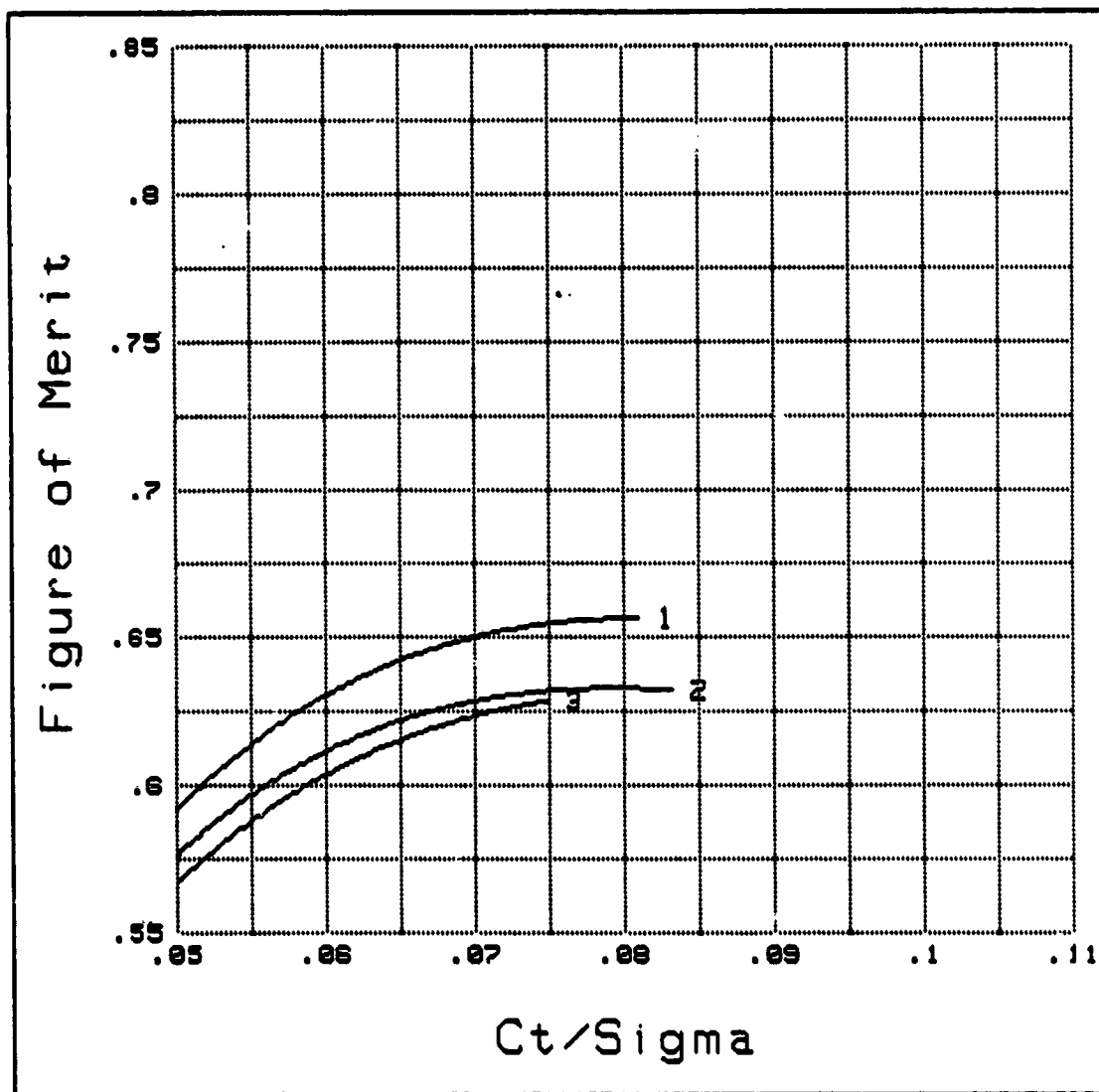

Figure 42.

This Data Recorded, Processed, and Printed Utilizing
HP9845B/SERIES 4600 MAGNETIC TAPE DATA PROCESSING SYSTEM

PLOT SERIES : TAIL ROTOR EFFECT; S-76 PLUS 20 Deg SWEPT W/ 60% TAPER AND
20 Deg ANHEDRAL TIPS; OGE; Mt=0.55

<u>File#</u>	<u>File-Name</u>	<u>Plot#</u>	<u>Plot-Title</u>
11	TIP080	1	ISOLATED MAIN ROTOR
12	TIP089	2	PUSHER TAIL ROTOR
14	TIP112	3	TRACTOR TAIL ROTOR

Figure of Merit vs Ct/Sigma

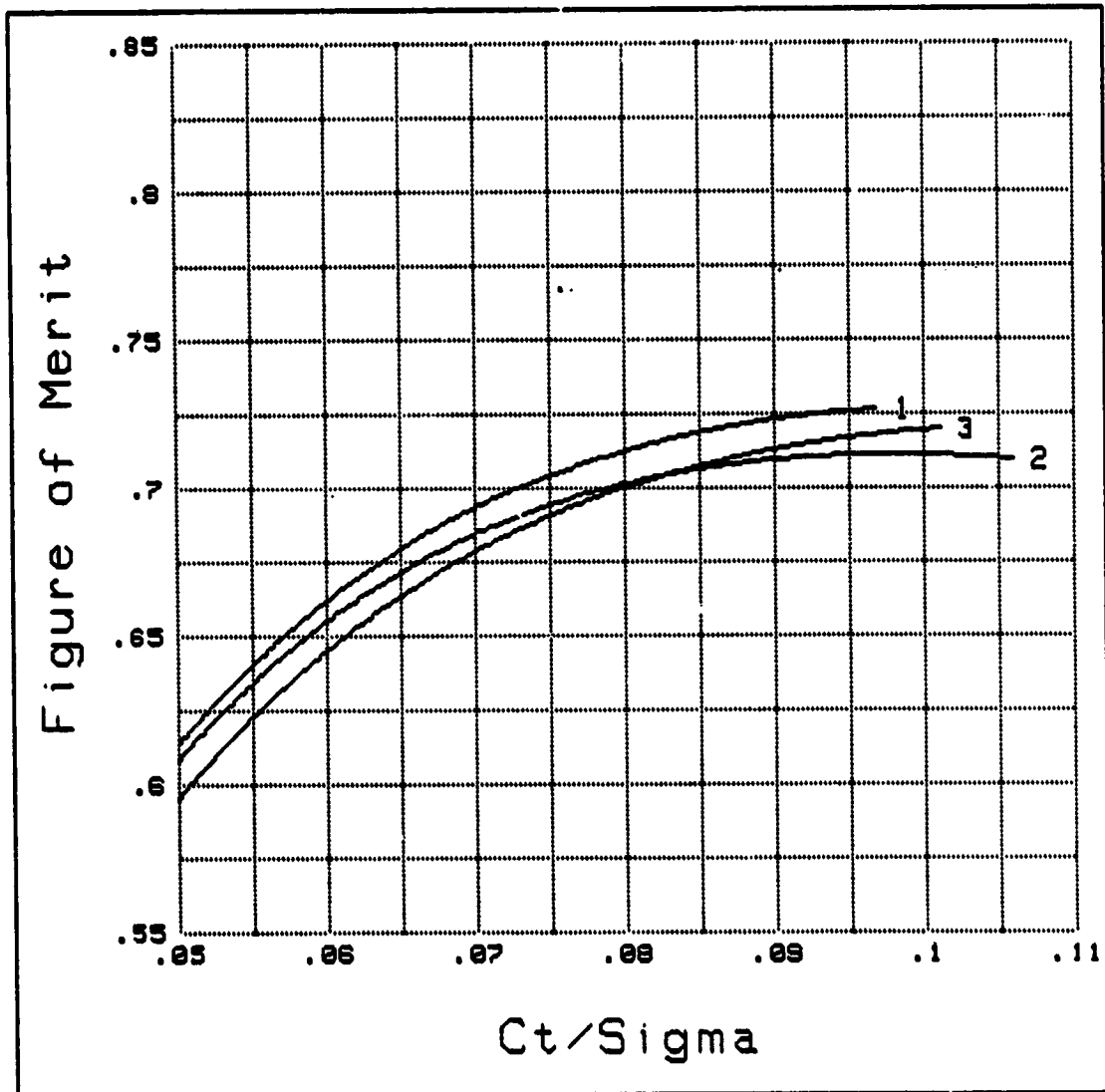

Figure 43.

ORIGINAL PAGE IS
OF POOR QUALITY

This Data Recorded, Processed, and Printed Utilizing
HP9845B/SERIES 4600 MAGNETIC TAPE DATA PROCESSING SYSTEM

PLOT SERIES : TAIL ROTOR EFFECT; S-76 PLUS 20 Deg SWEPT W/ 60% TAPER & 20 Deg
ANHEDRAL TIPS; OGE; Mt= 0.60

<u>File#</u>	<u>File-Name</u>	<u>Plot#</u>	<u>Plot-Title</u>
9	TIP078	1	ISOLATED MAIN ROTOR
13	TIP090	2	PUSHER TAIL ROTOR
15	TIP113	3	TRACTOR TAIL ROTOR

Figure of Merit vs Ct/Sigma

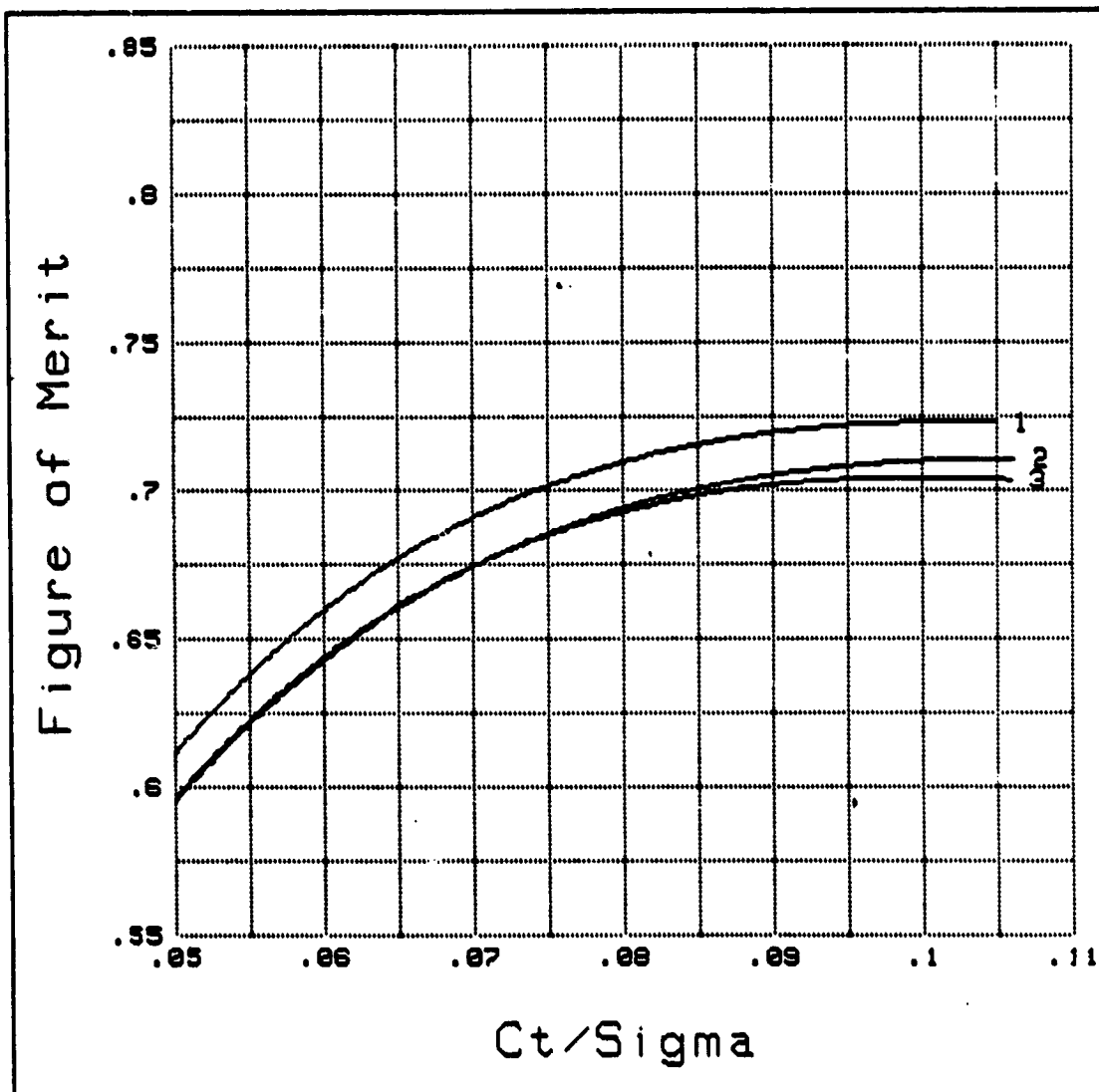

Figure 44.

This Data Recorded, Processed, and Printed Utilizing
HP9845B/SERIES 4600 MAGNETIC TAPE DATA PROCESSING SYSTEM

PLOT SERIES : TAIL ROTOR EFFECT; S-76 PLUS 20 Deg SWEPT W/ 60% TAPER AND
20 Deg ANHEDRAL TIPS; OGE; Mt=0.65

<u>File#</u>	<u>File-Name</u>	<u>Plot#</u>	<u>Plot-Title</u>
1	TIP091	1	PUSHER TAIL ROTOR
10	TIP079	2	ISOLATED MAIN ROTOR
16	TIP114	3	TRACTOR TAIL ROTOR

Figure of Merit vs Ct/Sigma

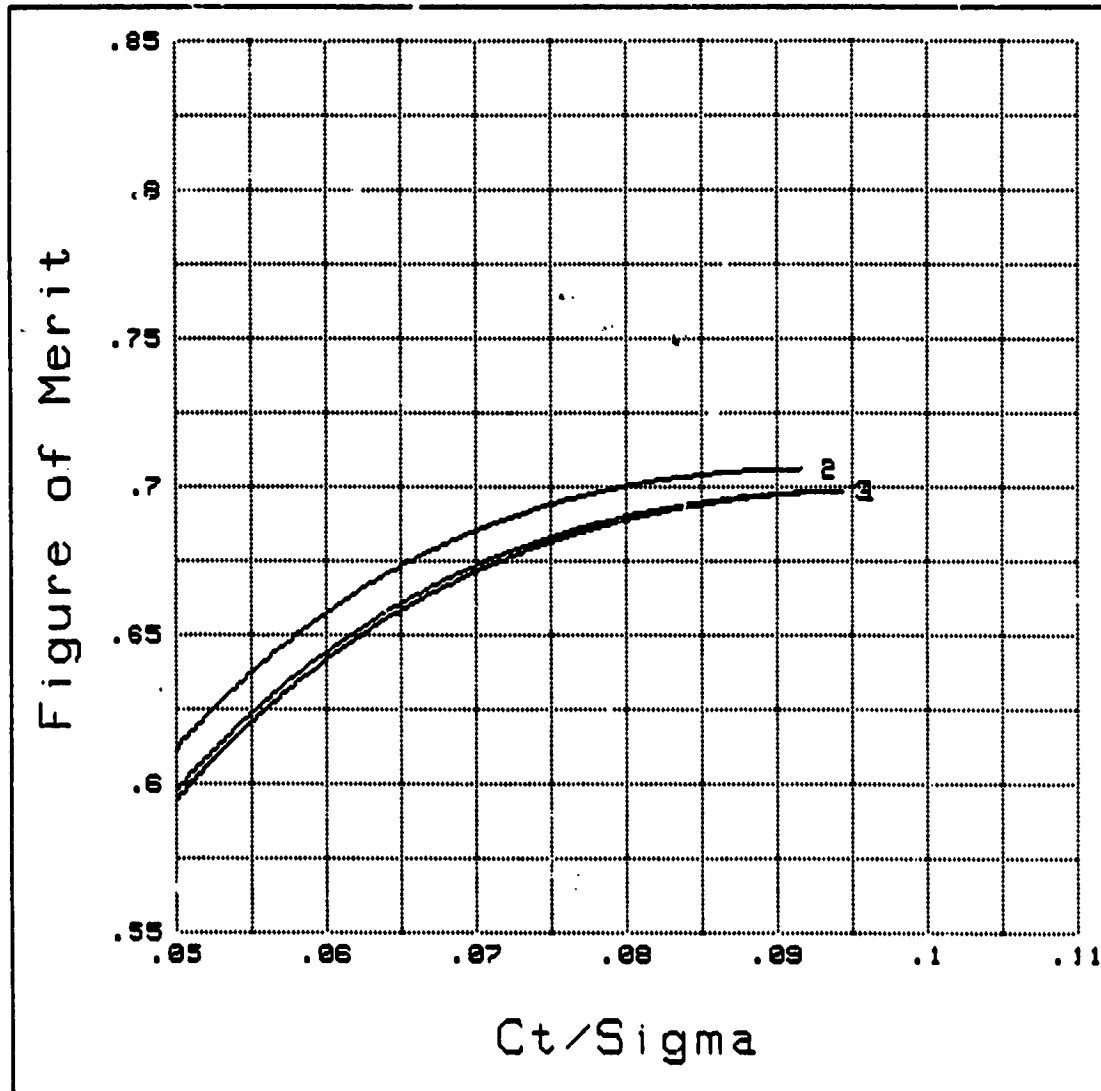

Figure 45.

This Data Recorded, Processed, and Printed Utilizing
HP9845B/SERIES 4600 MAGNETIC TAPE DATA PROCESSING SYSTEM

PLOT SERIES : TAIL ROTOR EFFECT; S-76 PLUS 20 Deg SWEPT W/ 60% TAPER TIPS;
OGE; Mt = 0.55

File#	File-Name	Plot#	Plot-Title
3	TIP018	1	ISOLATED MAIN ROTOR
22	TIP167	2	PUSHER TAIL ROTOR

Figure of Merit vs Ct/Sigma

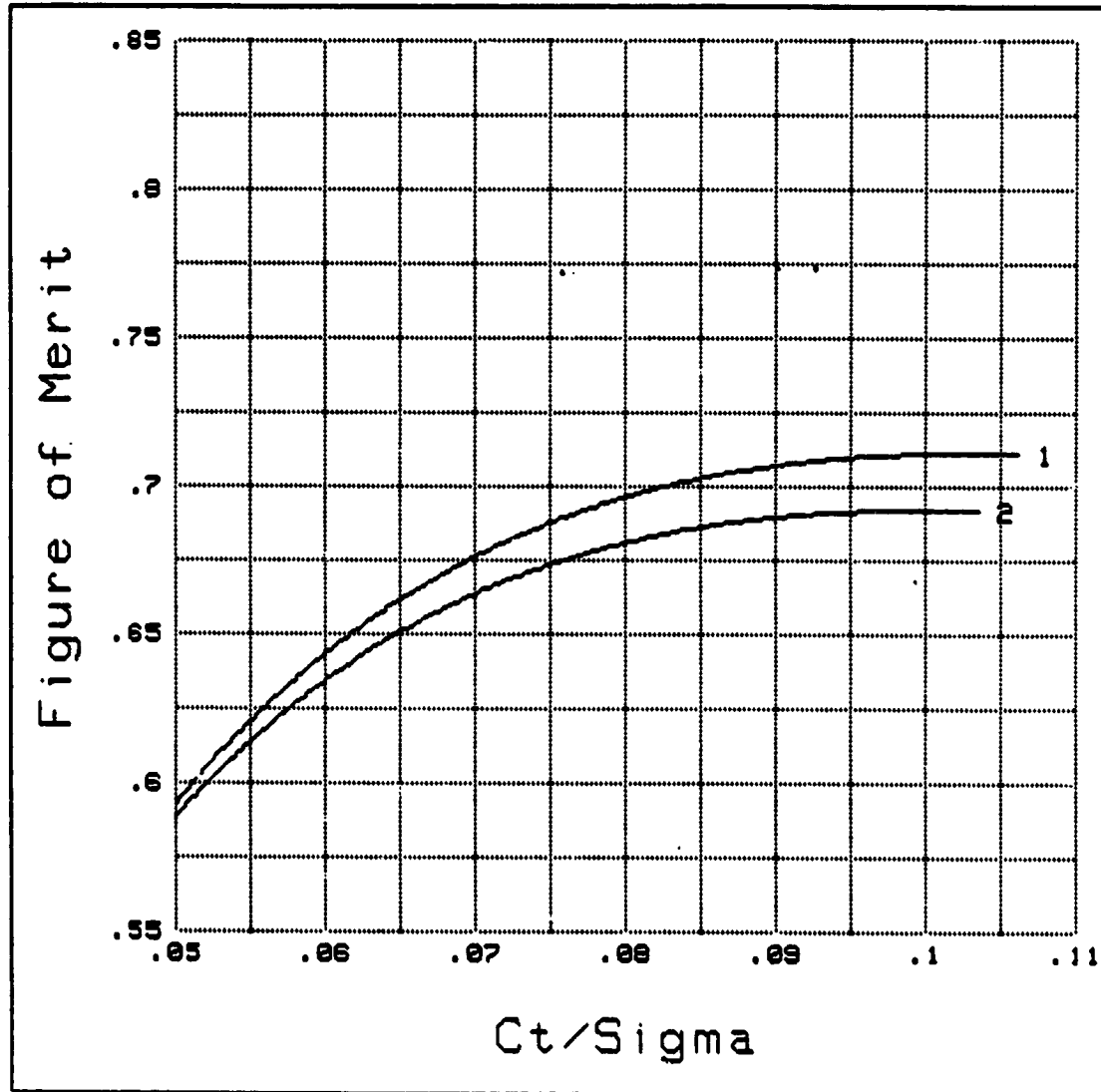

Figure 46

This Data Recorded, Processed, and Printed Utilizing
HP9845B/SERIES 4600 MAGNETIC TAPE DATA PROCESSING SYSTEM

PLOT SERIES : TAIL ROTOR EFFECT; S-76 PLUS 20 Deg SWEPT W/ 60% TAPER TIPS;
OGE; $M_t = 0.60$

<u>File#</u>	<u>File-Name</u>	<u>Plot#</u>	<u>Plot-Title</u>
2	TIP017	1	ISOLATED MAIN ROTOR
23	TIP169	2	PUSHER TAIL ROTOR

Figure of Merit vs C_t/Σ

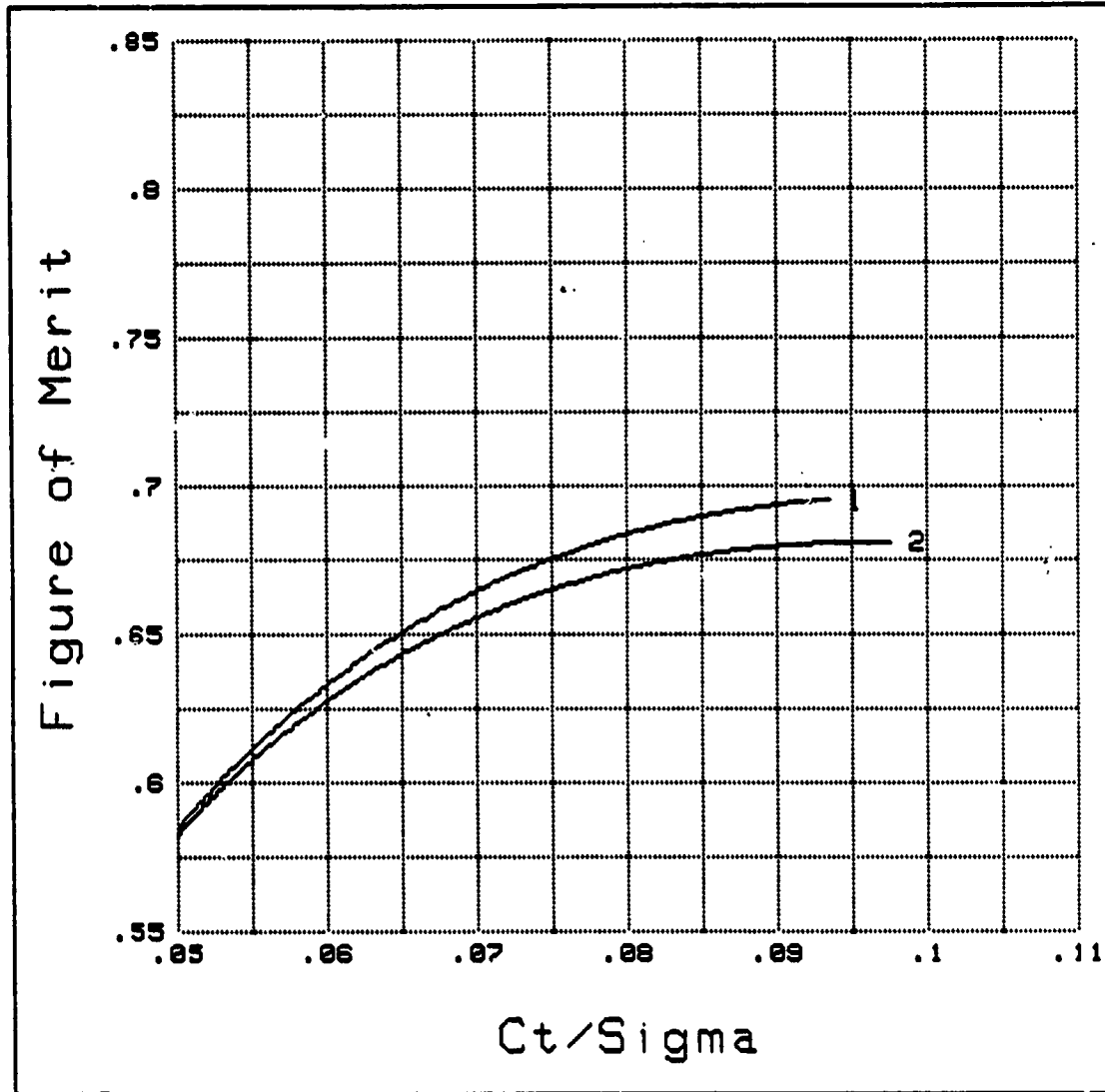

Figure 47.

This Data Recorded, Processed, and Printed Utilizing
HP9845B/SERIES 4600 MAGNETIC TAPE DATA PROCESSING SYSTEM

PLOT SERIES : TAIL ROTOR EFFECT; S-76 PLUS 20 Deg SWEPT W/ 60% TAPER; OGE; Mt =
0.65

<u>File#</u>	<u>File-Name</u>	<u>Plot#</u>	<u>Plot-Title</u>
4	TIP019	1	ISOLATED MAIN ROTOR
24	TIP170	2	PUSHER TAIL ROTOR

Figure of Merit vs Ct/Sigma

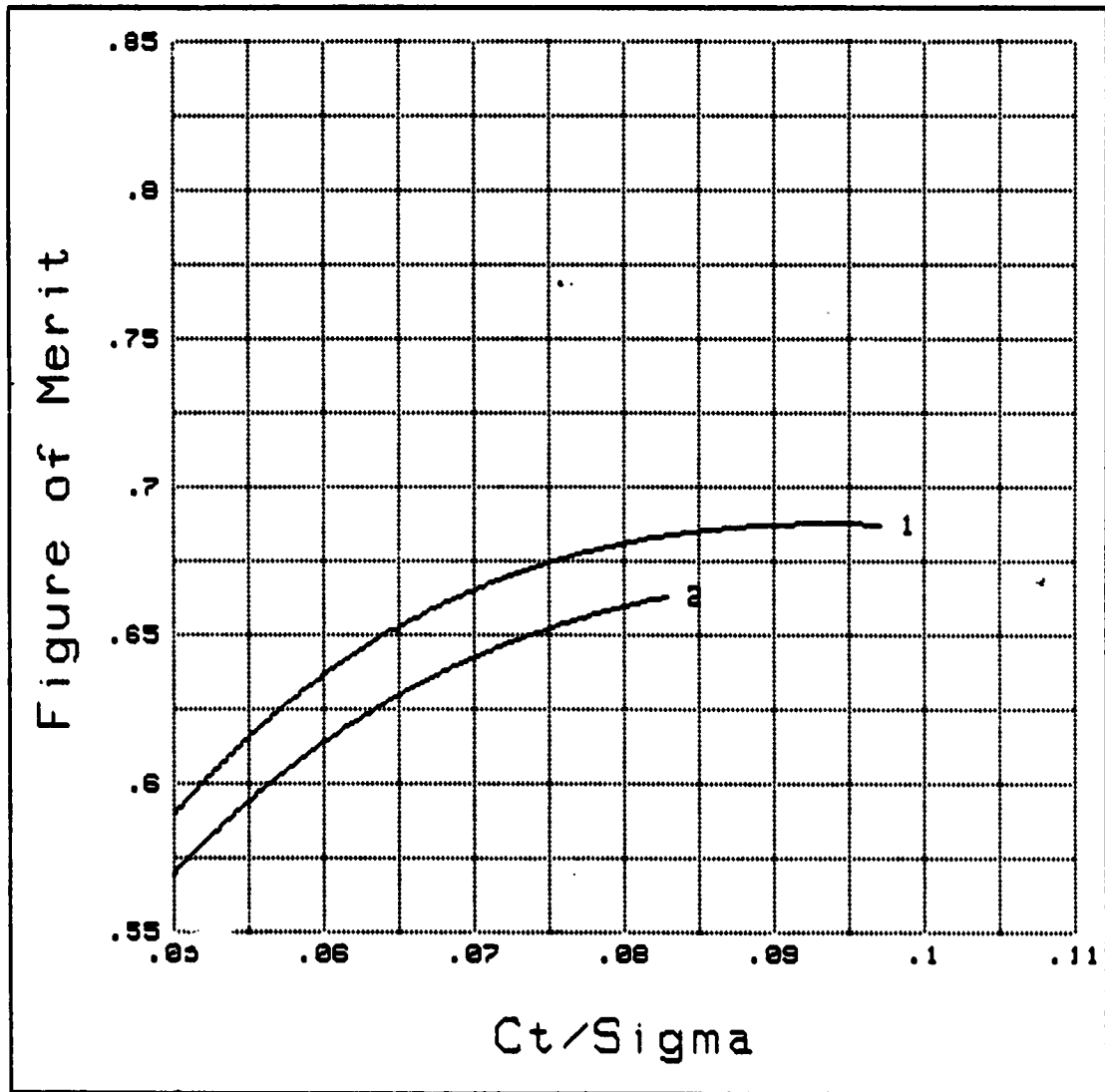

Figure 48.

ORIGINAL FACTOR
OF POOR QUALITY

This Data Recorded, Processed, and Printed Utilizing
HP9845B/SERIES 4600 MAGNETIC TAPE DATA PROCESSING SYSTEM

PLOT SERIES : TAIL ROTOR EFFECTS; S-76 PLUS 60% TAPER TIPS; IGE; Z/R=1.2;
Mt=0.6

<u>File#</u>	<u>File-Name</u>	<u>Plot#</u>	<u>Plot-Title</u>
5	TIP071	1	ISOLATED MAIN ROTOR
22	TIP135	2	PUSHER TAIL ROTOR
24	TIP142	3	TRACTOR TAIL ROTOR

Figure of Merit vs Ct/Sigma

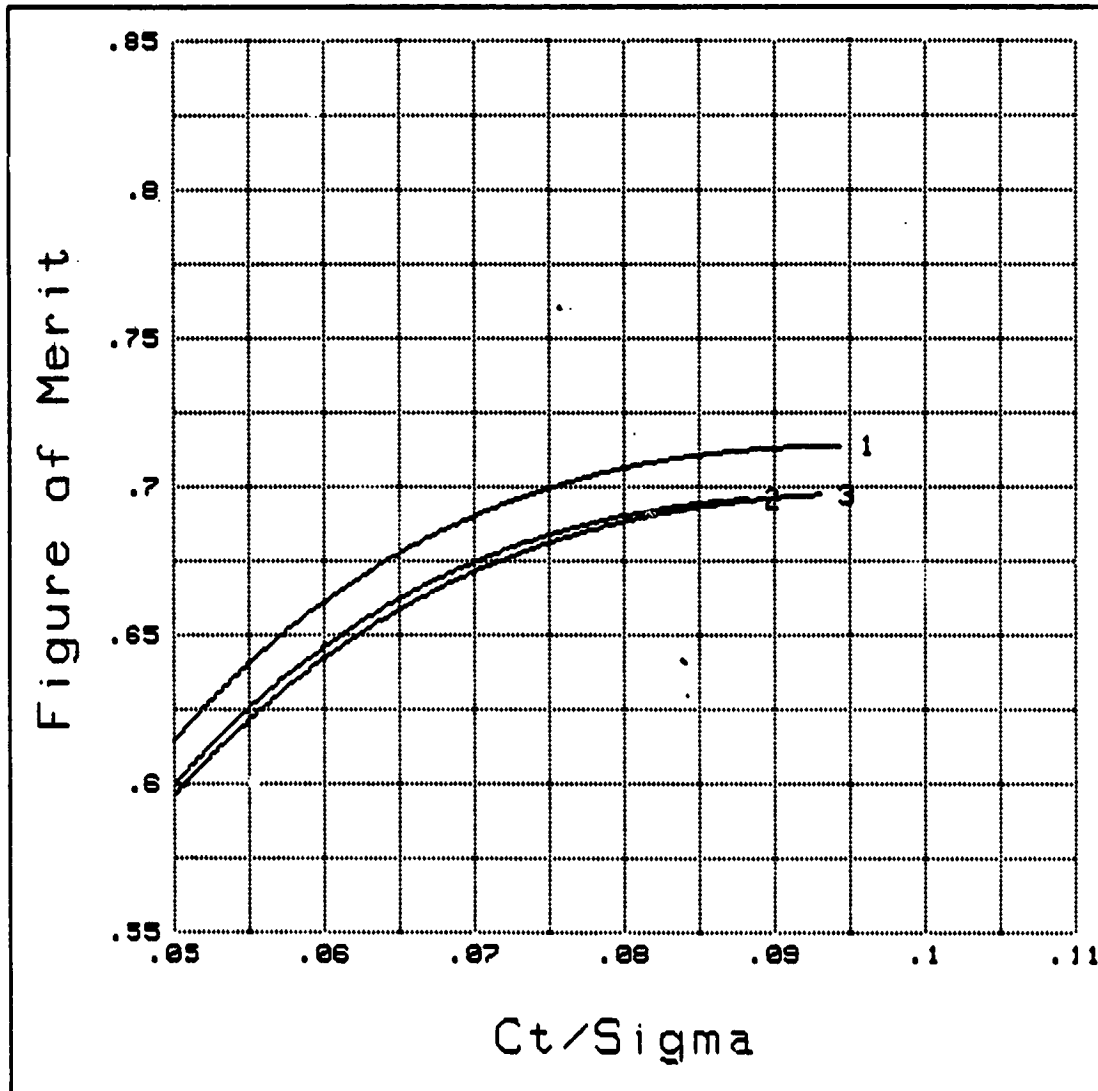

Figure 49.

ORIGINAL PAGE IS
OF POOR QUALITY

This Data Recorded, Processed, and Printed Utilizing
HP9845B/SERIES 4600 MAGNETIC TAPE DATA PROCESSING SYSTEM

PLOT SERIES : TAIL ROTOR EFFECTS; S-76 PLUS 60% TAPER TIPS; IGE; Z/R=0.75
Mt=0.6

<u>File#</u>	<u>File-Name</u>	<u>Plot#</u>	<u>Plot-Title</u>
4	TIP070	1	ISOLATED MAIN ROTOR
23	TIP136	2	PUSHER TAIL ROTOR
25	TIP143	3	TRACTOR TAIL ROTOR

Figure of Merit vs Ct/Sigma

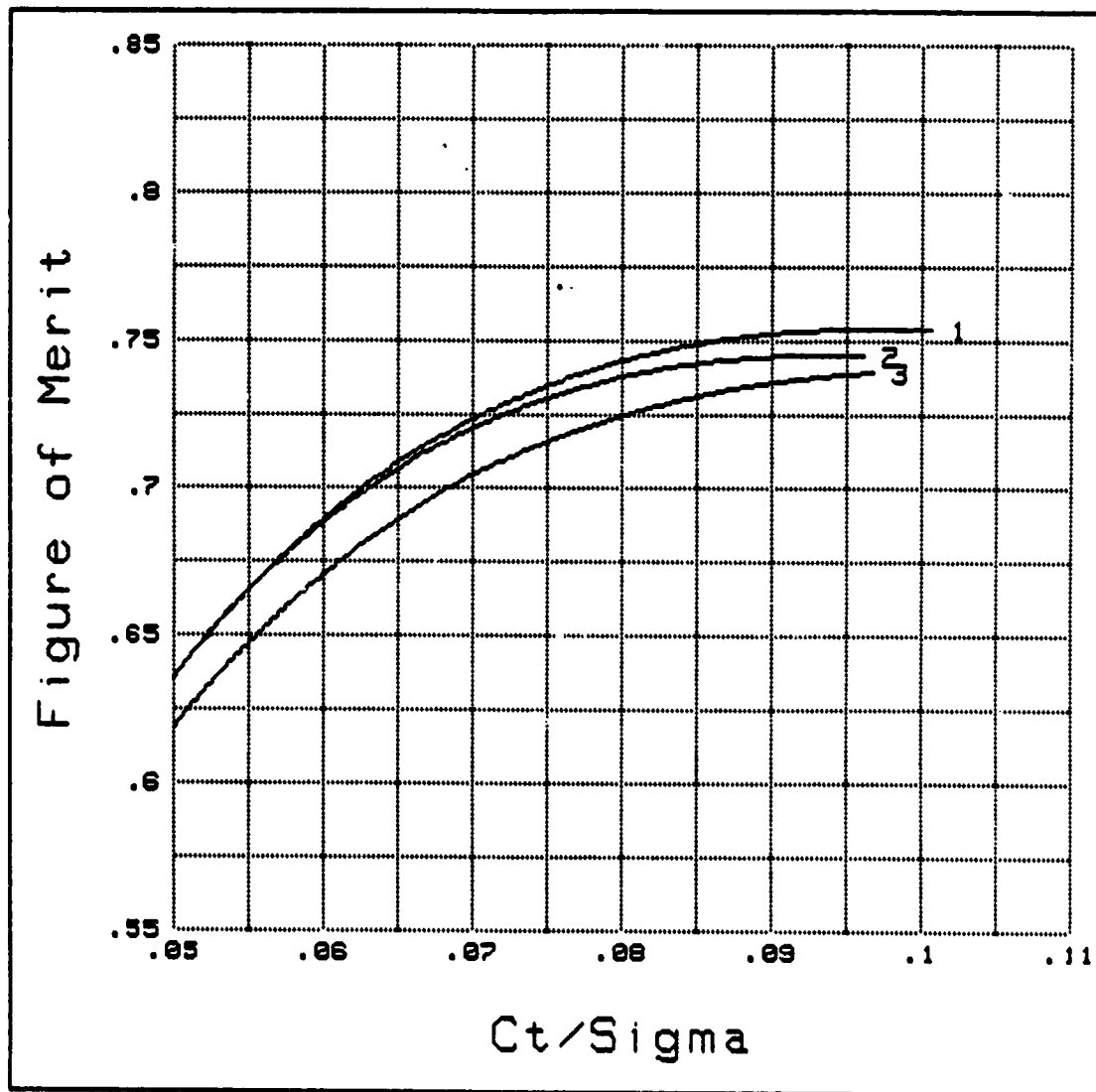

Figure 50.

This Data Recorded, Processed, and Printed Utilizing
HP9845B/SERIES 4600 MAGNETIC TAPE DATA PROCESSING SYSTEM

PLOT SERIES : TAIL ROTOR EFFECTS; S-76 PLUS 20 Deg SWEPT W/ 60% TAPER AND
20 Deg ANHEDRAL TIPS; IGE; Z/R=1.2; Mt=0.6

<u>File#</u>	<u>File-Name</u>	<u>Plot#</u>	<u>Plot-Title</u>
6	TIP081	1	ISOLATED MAIN ROTOR
8	TIP092	2	PUSHER TAIL ROTOR
10	TIP115	3	TRACTOR TAIL ROTOR

Figure of Merit vs Ct/Sigma

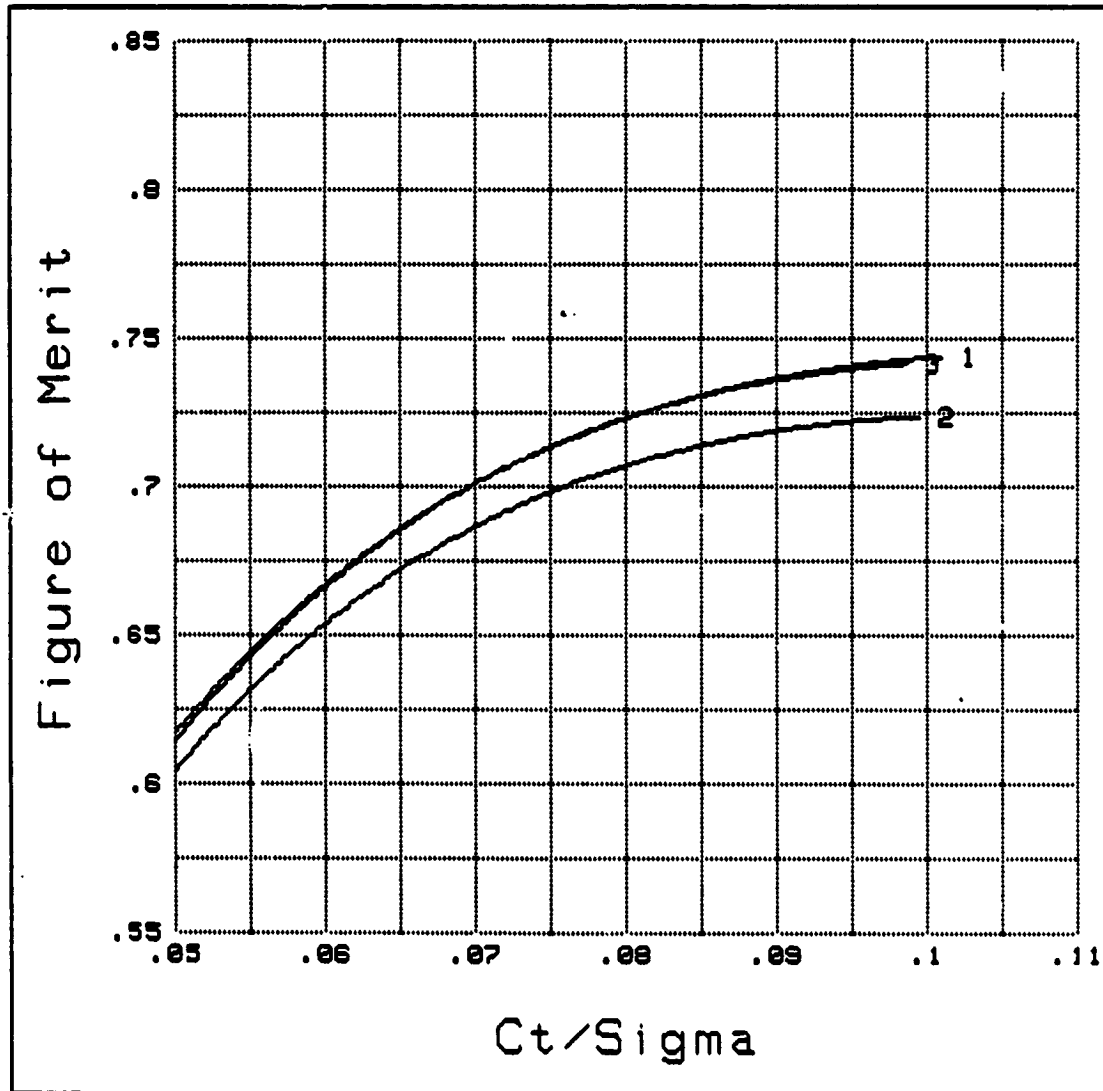

Figure 51.

(4)

This Data Recorded, Processed, and Printed Utilizing
HP9845B/SERIES 4600 MAGNETIC TAPE DATA PROCESSING SYSTEM

PLOT SERIES : TAIL ROTOR EFFECTS; S-76 PLUS 20 Deg SWEPT W/ 60% TAPER AND
20 Deg ANHEDRAL TIPS; IGE; Z/R=0.75; Mt=0.6

<u>File#</u>	<u>File-Name</u>	<u>Plot#</u>	<u>Plot-Title</u>
7	TIP082	1	ISOLATED MAIN ROTOR
9	TIP093	2	PUSHER TAIL ROTOR
11	TIP116	3	TRACTOR TAIL ROTOR

Figure of Merit vs Ct/Sigma

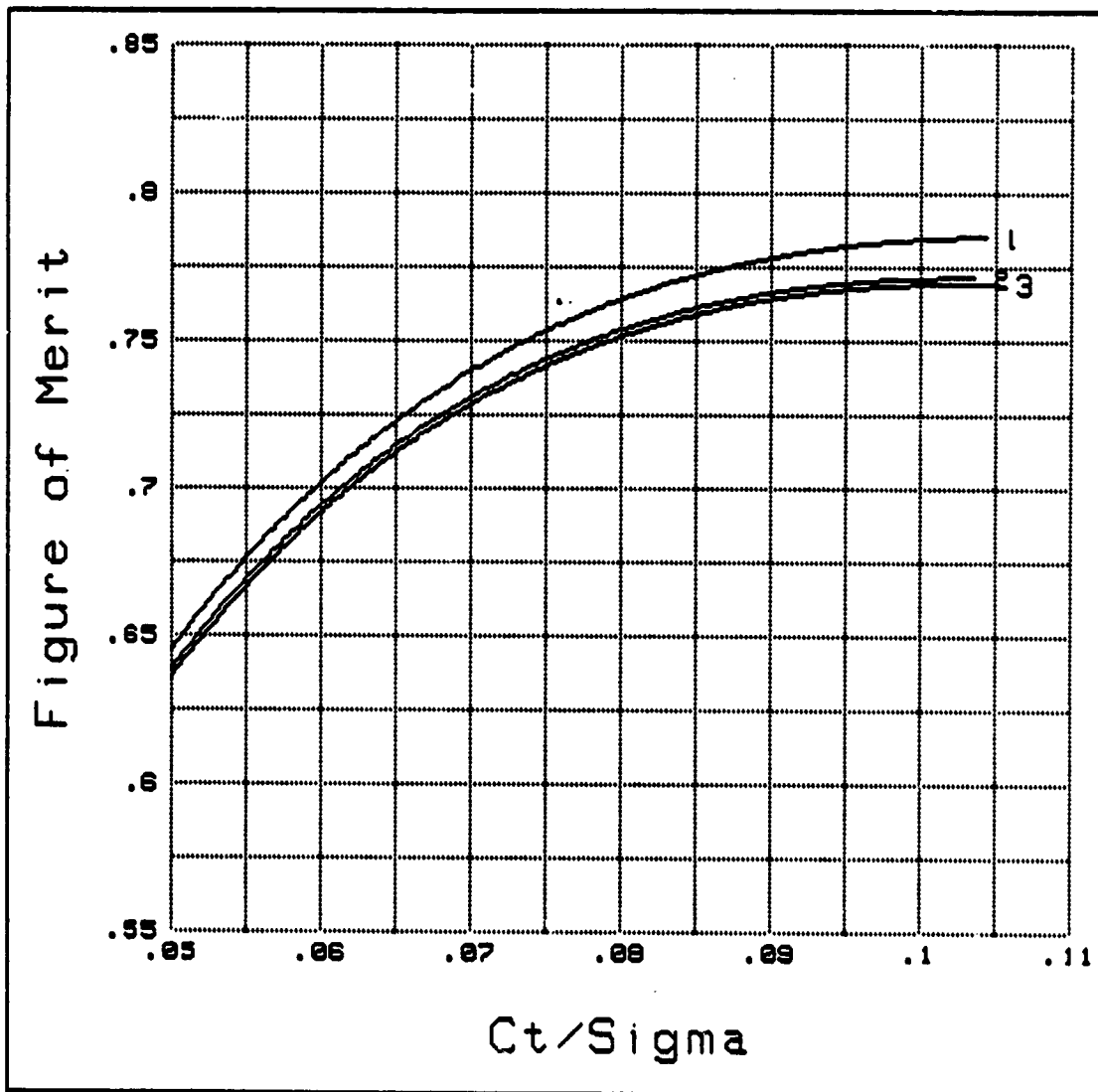

Figure 52.

This Data Recorded, Processed, and Printed Utilizing
HP9845B/SERIES 4600 MAGNETIC TAPE DATA PROCESSING SYSTEM

PLOT SERIES : TAIL ROTOR EFFECT; S-76 PLUS 20 Deg SWEPT W/ 60% TAPER TIPS;
IGE; Z/R=1.2; Mt=0.60

<u>File#</u>	<u>File-Name</u>	<u>Plot#</u>	<u>Plot-Title</u>
5	TIP020	1	ISOLATED MAIN ROTOR
25	TIP171	2	PUSHER TAIL ROTOR

Figure of Merit vs Ct/Sigma

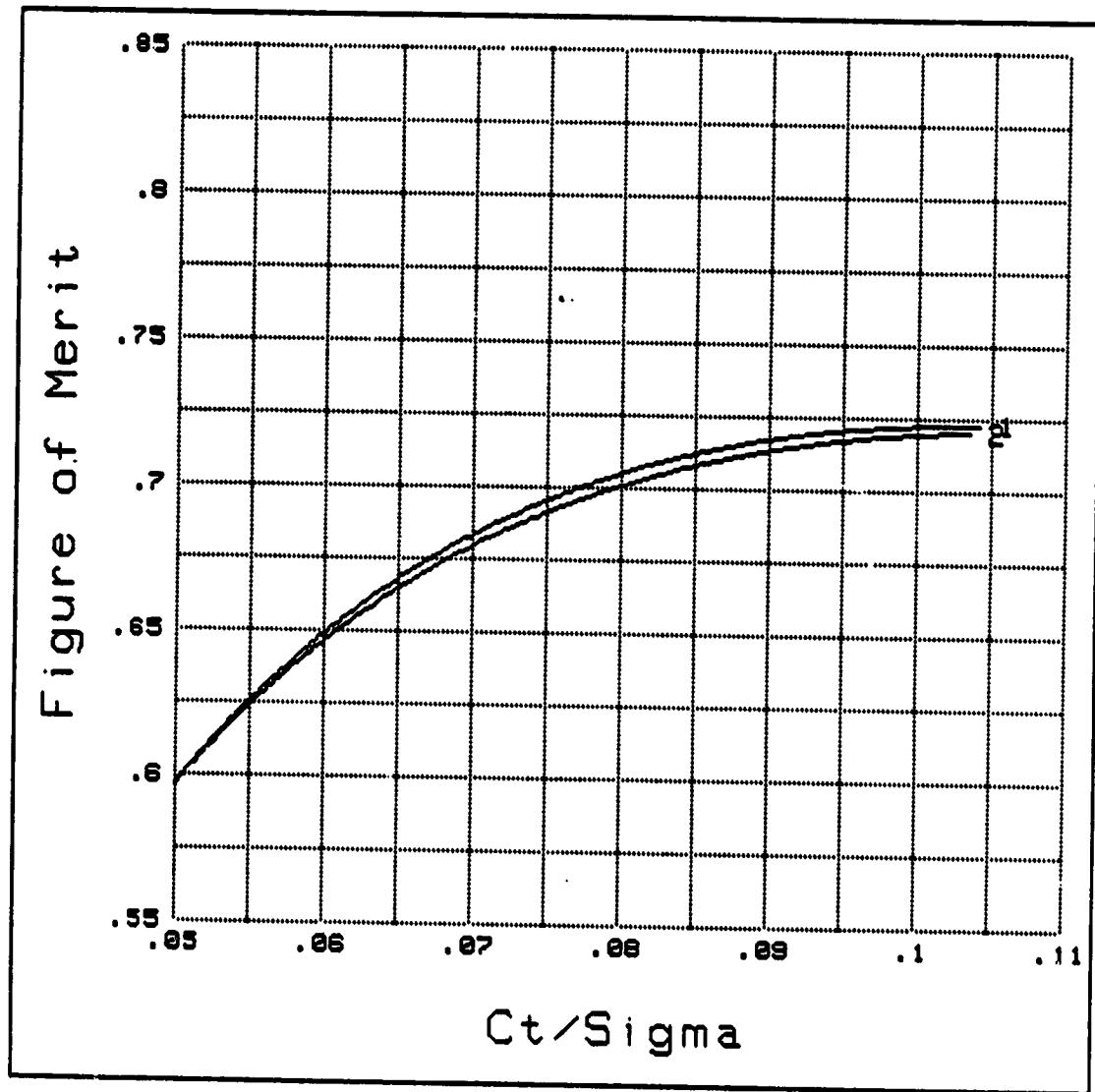

Figure 53.

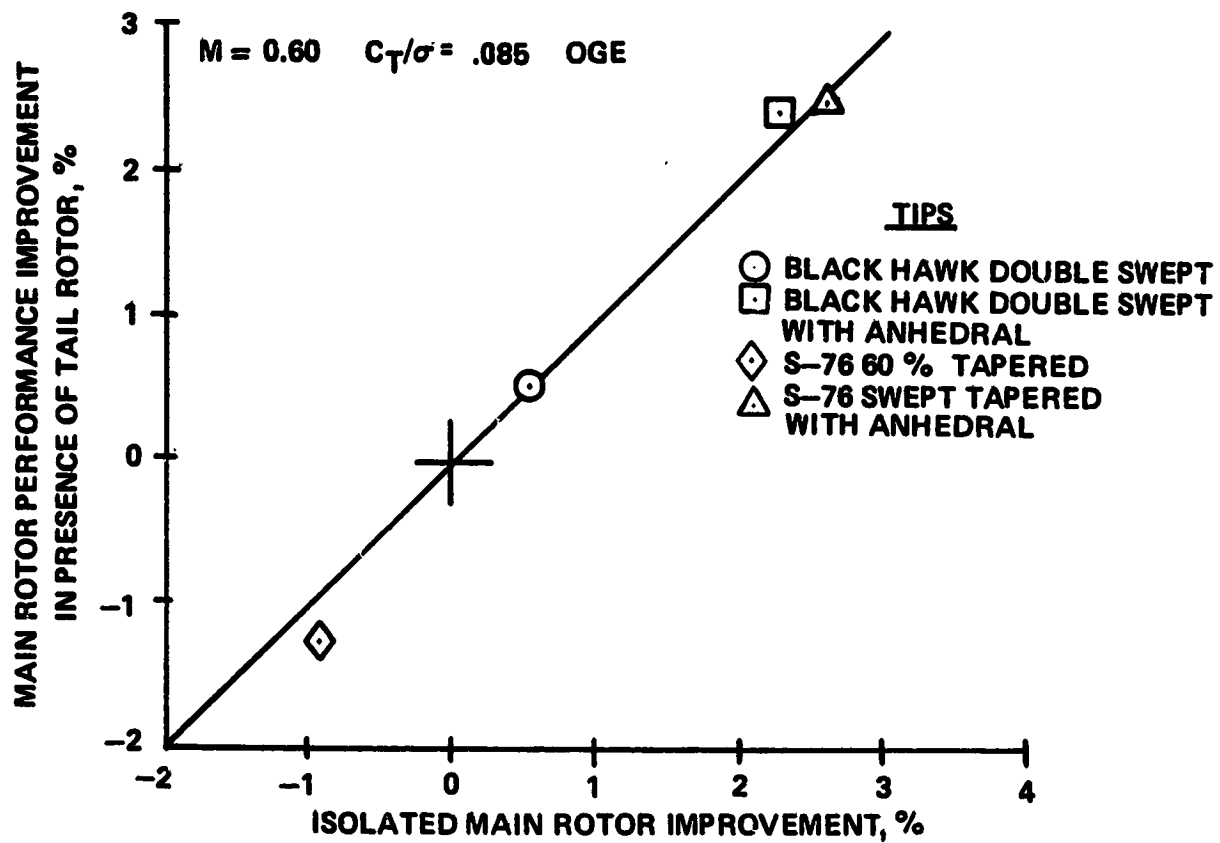

Figure 54. Impact of Tail Rotor on Performance Improvements

1. Report No. CR- 177336		2. Government Accession No.		3. Recipient's Catalog No.	
4. Title and Subtitle Experimental Study of Main Rotor Tip Geometry and Tail Rotor Interactions in Hover. Vol I - Text and Figures				5. Report Date February 1985	
				6. Performing Organization Code	
7. Author(s) D. T. Balch and J. Lombardi				8. Performing Organization Report No.	
9. Performing Organization Name and Address United Technologies Corporation Sikorsky Aircraft Division Stratford, CT 06601				10. Work Unit No. T-3525	
				11. Contract or Grant No. NAS2-11266	
12. Sponsoring Agency Name and Address NASA - Ames Research Center Moffett Field, CA 94035				13. Type of Report and Period Covered Contractor Report Aug. 1982-Nov. 1983	
				14. Sponsoring Agency Code 505-42-11	
15. Supplementary Notes Point of Contact: Technical Monitor, Charles A. Smith NASA Ames Research Center, Moffett Field, CA 94035 (415) 694-6714 FTS 464-6714					
16. Abstract With the acknowledgment of the existence of mutual interference between a hovering main rotor and a tail rotor, a model scale hover test was conducted in the Sikorsky Aircraft Model Rotor hover Facility to identify and quantify the impact of the tail rotor on the demonstrated advantages of advanced geometry tip configurations. The test was conducted using the Basic Model Test Rig and two scaled main rotor systems, one representing a 1/5.727 scale UH-60A BLACK HAWK and the others a 1/4.71 scale S-76. Eight alternate rotor tip configurations were tested, 3 on the BLACK HAWK rotor and 6 on the S-76 rotor. Four of these tips were then selected for testing in close proximity to an operating tail rotor (operating in both tractor and pusher modes) to determine if the performance advantages that could be obtained from the use of advanced geometry tips in a main rotor only environment would still exist in the more complex flow field involving a tail rotor. The test showed that overall the tail rotor effects on the advanced tip configurations tested are not substantially different from the effects on conventional tips and the benefits obtained from advanced tips should be retained even when operating in the presence of a tail rotor.					
17. Key Words (Suggested by Author(s)) Helicopter Aerodynamics Hover Main Rotor Performance Tail Rotor Interference Model Rotor Test Tip Geometry				18. Distribution Statement Unlimited Subject category - 01	
19. Security Classif. (of this report) UNCLASSIFIED		20. Security Classif. (of this page) UNCLASSIFIED		21. No. of Pages 90	22. Price*