

EXTREME PRECISION ANTENNA REFLECTOR STUDY RESULTS

G. R. Sharp  
NASA Lewis Research Center  
Cleveland, Ohio

and

L. D. Gilger and K. E. Ard  
Harris Corporation  
Melbourne, Florida

Large Space Antenna Systems Technology - 1984  
December 4-6, 1984

## INTRODUCTION

The changing thermal environment at geosynchronous orbit can cause antenna structures to warp and distort over the twenty-four-hour orbit period. The distortion pattern and amplitude also vary seasonally. The mechanical distortion of the antenna reflector and structures in turn can cause deleterious effects in the far-field antenna pattern; the main antenna lobe may broaden, its amplitude decrease, its aiming point shift, and the antenna sidelobes increase in amplitude. The resulting degradation in RF performance can be a serious problem in large complex systems.

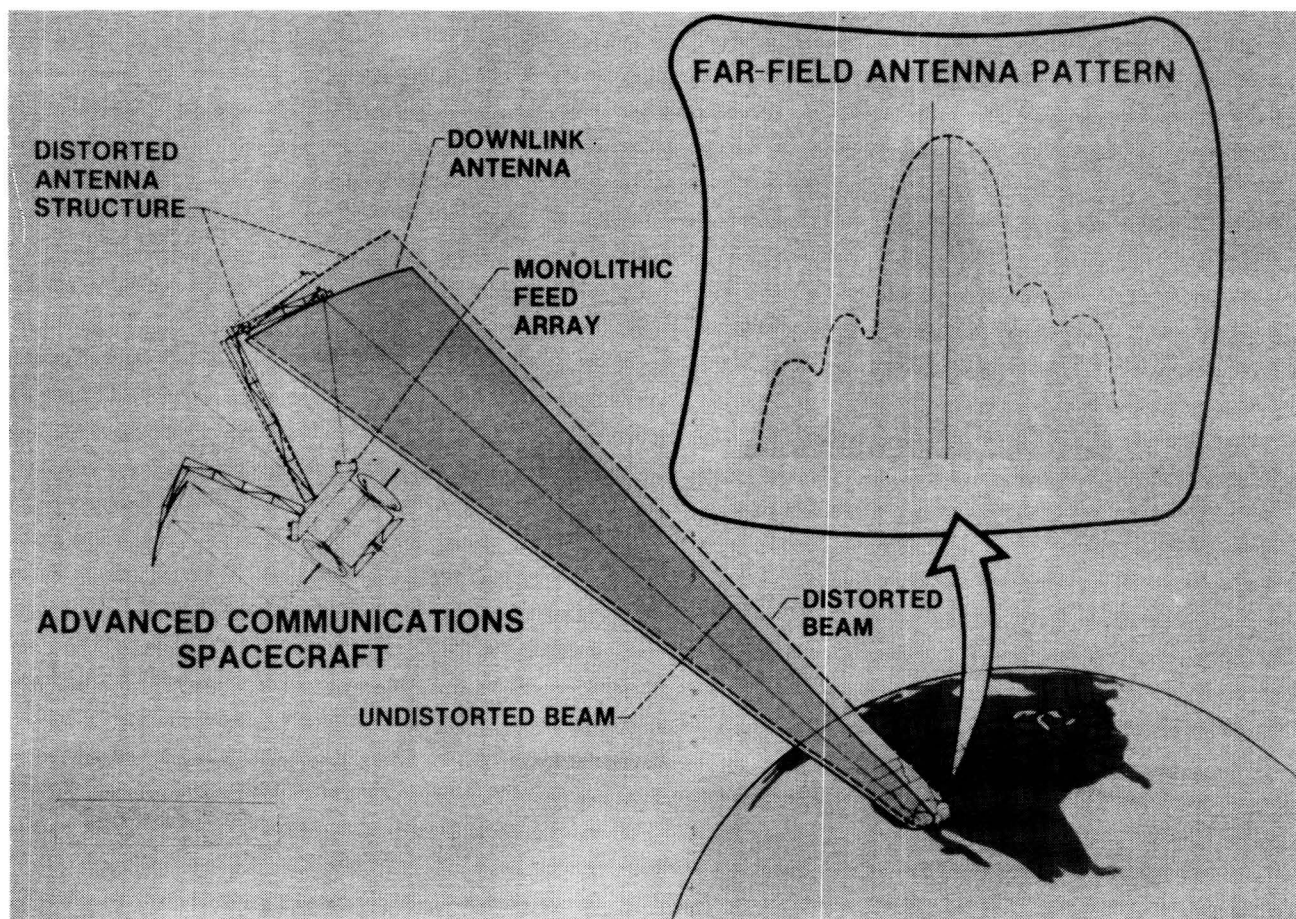

## COMMUNICATIONS ANTENNA DESIGN TRENDS

Communications antennas are now being designed to operate at higher frequencies since the lower frequency bands are becoming crowded. They are also being designed to conserve the frequency spectrum by featuring various frequency reuse concepts. Multiple narrow spot beams are used for trunking and for scanning or beam hopping. If these beams are at the same frequency, they must be isolated by polarization.

Thus, future communications antennas will be more complex than those at present and will require accurate dimensionally stable antenna reflectors and structures built from new materials.

- HIGHER OPERATING FREQUENCIES
- LARGE APERTURE DIAMETERS
- COMPLEX ANTENNAS (MULTIPLE FIXED AND SCANNING BEAMS)

EXTREME PRECISION ANTENNA REFLECTOR AND STRUCTURE DESIGN STUDY OBJECTIVE

The design study objective is shown in the figure below.

SELECT AND ANALYZE THE BEST MECHANICAL /  
THERMAL DESIGN FOR EXTREME PRECISION SPACE-  
BASED ANTENNAS FROM 2M TO 15M-APERTURE  
DIAMETER AND UP TO 90 GHZ

## TASK DESCRIPTION AND STATUS

In early 1982, the Harris Corporation was awarded a contract for an "Antenna Design Study for Extreme Precision Antenna Reflectors and Systems Using Advanced Materials and Structural Techniques," NAS 3-23249 (Research in progress, G. R. Sharp, NASA Ames, L. D. Gilger and K. E. Ard, Harris Corporation). That study is nearing completion. Reports have been published on the materials assessment, thermal control system assessment and thermal distortion analysis techniques tasks. The report on the antenna system design task is nearly complete and materials properties verification testing of the selected materials is in progress.

The combination of computer programs and interconnecting programs used in the thermal distortion analysis task has consequently been refined at NASA LeRC to provide a very accurate tool for calculating the on-orbit variations in antenna patterns.

o TASKS	STATUS
- MATERIALS ASSESSMENT	- COMPLETE
- THERMAL CONTROL ASSESSMENT	- COMPLETE
- THERMAL DISTORTION ANALYSIS TECH.	- COMPLETE
- ANTENNA SYSTEM DESIGN	- COMPLETE
- MATERIALS PROPERTIES VERIFICATION	- IN PROGRESS

## CURRENT ANTENNA REFLECTOR AND STRUCTURE FABRICATION TECHNOLOGY

Currently, antenna reflectors are constructed using carbon fibers in an epoxy matrix in order to minimize weight and the coefficient of thermal expansion and hence antenna thermal distortion. The reflector structures typically are of two types: unidirectional plies of carbon/epoxy arranged to give planarly isotropic near-zero coefficient of thermal expansion in a solid reflector or thin honeycomb sandwich panel reflectors with very thin planarly isotropic carbon/epoxy face sheets. After construction, these reflectors are fastened to a lightweight strongback structure that is used to adjust the reflector to as nearly a true parabolic shape as possible.

Other antenna structures such as the antenna feed support towers are constructed using carbon/epoxy or carbon /polyimide tubes and structural shapes.

A 2.7M-aperture-diameter state-of-the-art offset fed parabolic reflector was recently constructed by TRW as a part of an advanced 30-GHz proof-of-concept antenna system. The 0.25-in.-thick reflector was made from honeycomb sandwich panel with carbon/epoxy face sheets and a Nomex core. The reflector was mounted to a strongback also constructed from carbon/epoxy honeycomb sandwich panel. The strongback was used both to support and for final adjustment of the reflector surface. The maximum zero-to-peak deviation from a true parabola was 0.020 inches. The RMS deviation from a true parabola was 0.0055 inches RMS. When this reflector was manufactured, problems were encountered with excess adhesion to the molding surface. Therefore, accuracy for state-of-the-art manufacturing of a flight-type reflector should be perhaps 0.003 inches RMS.

### o DESIGN

- REFLECTOR - HONEYCOMB SANDWICH PANEL
  - CARBON/GLASS FACE SHEET (PLANAR QUASI-ISOTROPIC LAYUP) (+60<sup>0</sup>, 0<sup>0</sup>, -60<sup>0</sup>)
  - CARBON/GLASS EGGCRATE CORE
  - ASSEMBLY BY SLUMP FORMING AND FRIT BONDING
- ANTENNA STRUCTURE - CARBON/MAGNESIUM OR CARBON/ALUMINUM TUBES AND STRUCTURAL SHAPES

### o ACCURACY (FOR A 4-METER REFLECTOR) (TDAS)

- REFLECTOR - MAXIMUM ZERO-TO-PEAK DEVIATION FROM TRUE PARABOLA
  - .004 INCHES
  - SURFACE ROOT MEAN SQUARE (RMS) DEVIATION FROM TRUE PARABOLA - .001 INCHES RMS

## CURRENT ANTENNA REFLECTOR AND STRUCTURE FABRICATION TECHNOLOGY (CONTINUED)

The advantages of carbon/epoxy construction for antenna reflectors are that the uni-directional plies can be tailored and assembled in such a way as to yield a near-zero coefficient of thermal expansion (CTE) in the plane of the reflector and that the construction technology is well developed.

The drawbacks of carbon/epoxy construction are listed below. The most serious of these are the non-linear coefficient of thermal expansion (reflector operational temperatures at geosynchronous orbit range from -260°F to +175°F) and permanent creep that occurs as construction stresses are relieved.

- o ADVANTAGES OF CARBON/EPOXY CONSTRUCTION
  - NEAR-ZERO COEFFICIENT OF THERMAL EXPANSION (CTE)
  - DEVELOPED TECHNOLOGY
  
- o DISADVANTAGES OF CARBON/EPOXY CONSTRUCTION
  - NON-LINEAR COEFFICIENT OF THERMAL EXPANSION WITH RESPECT TO TEMPERATURE
  - EFFECT OF ABSORBED MOISTURE AND SUBSEQUENT DRY-OUT IN SPACE ON FINAL REFLECTOR SHAPE AND FINAL COEFFICIENT OF THERMAL EXPANSION
  - MICRO-CRACKING - ALLOWS DIMENSIONAL CHANGES FROM FORMED SHAPE TO NEW SHAPE
  - CREEP - IF UNDER CONSTANT STRESS WILL TEND TO RELIEVE STRESS AND MOVE TO NEW POSITION

## CURRENT SPACE ANTENNA REFLECTOR FABRICATION TECHNOLOGY

The method of fabrication for present-day carbon/epoxy antenna reflectors is illustrated. First, a convex plaster mold is prepared of the desired surface contour. Subsequently, a plaster concave and then a high-temperature convex mold are prepared. The antenna shell is cured then on a high-temperature convex mold. It is then fitted to the plaster mold whereon final adjustment of the reflector surface takes place.

### 30-GHZ 9-FT DIA. MBA OFFSET REFLECTOR FABRICATION-FLOW DIAGRAM

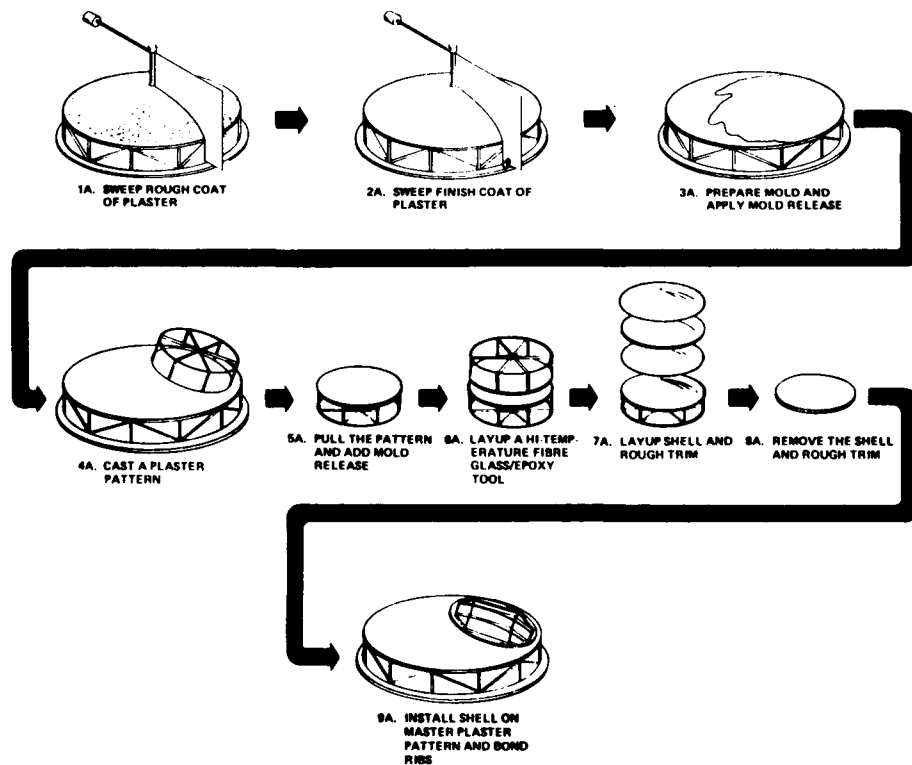



## REFLECTOR FINAL ADJUSTMENT

The reflector is shown after final adjustment to the master mold. This was accomplished by permanently deforming the reflector surface by moving it with respect to a strongback frame and then locking the reflective surface in place.

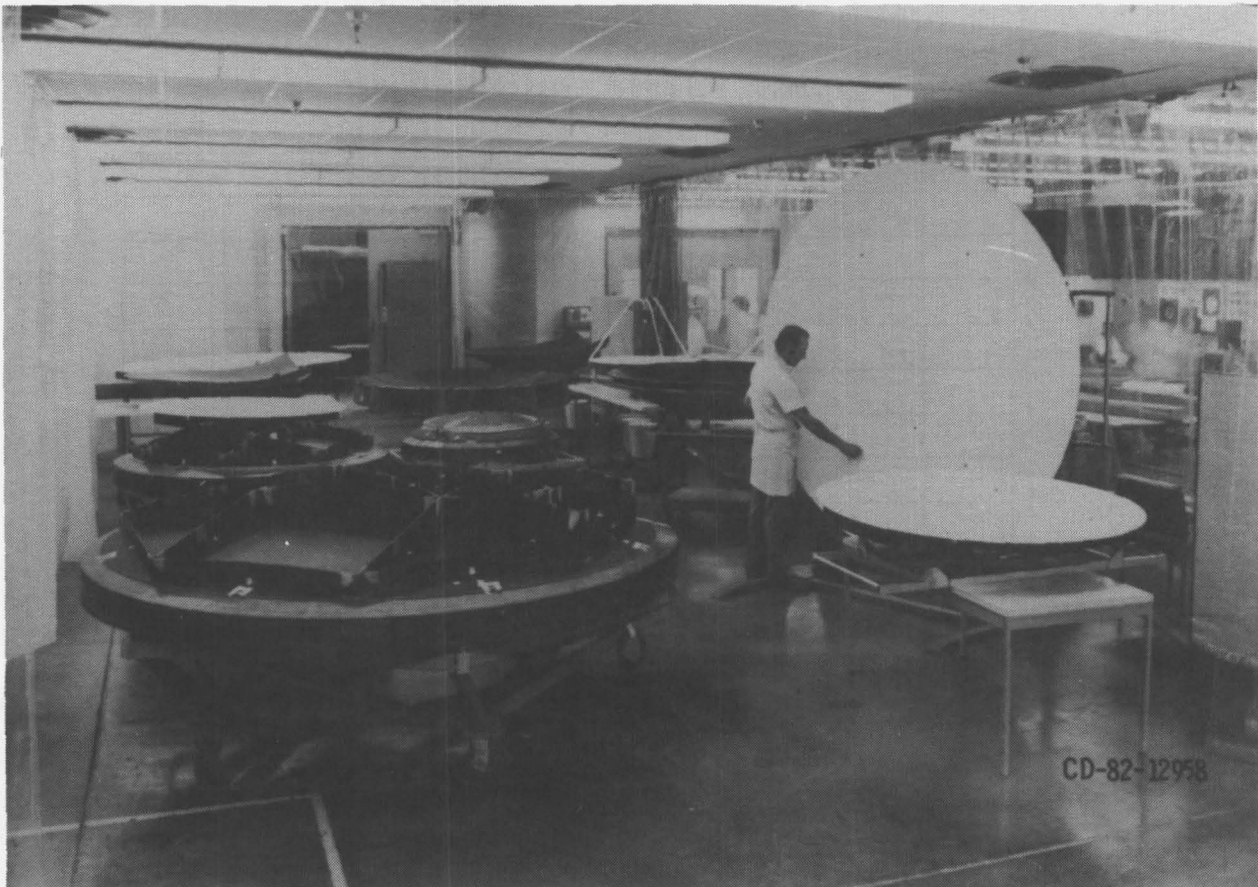

### COEFFICIENT OF THERMAL EXPANSION OF CARBON/EPOXY (HARRIS CORPORATION)

Note that while at room temperature, the coefficient of thermal expansion (CTE) is +0.3, at the typical lower expected operating temperature of -260°F the CTE drops to -0.7. In a situation wherein the unprotected reflector face is coming out of shadow and into sunlight, reflector temperatures can typically simultaneously vary from -20°F to +190°F. Over the range, the CTE could instantaneously vary from -0.5 to +0.05 over the reflector. Thus, the reflector thermal distortion and hence the antenna pattern can be affected by the non-linear CTE properties of the carbon/epoxy composite.

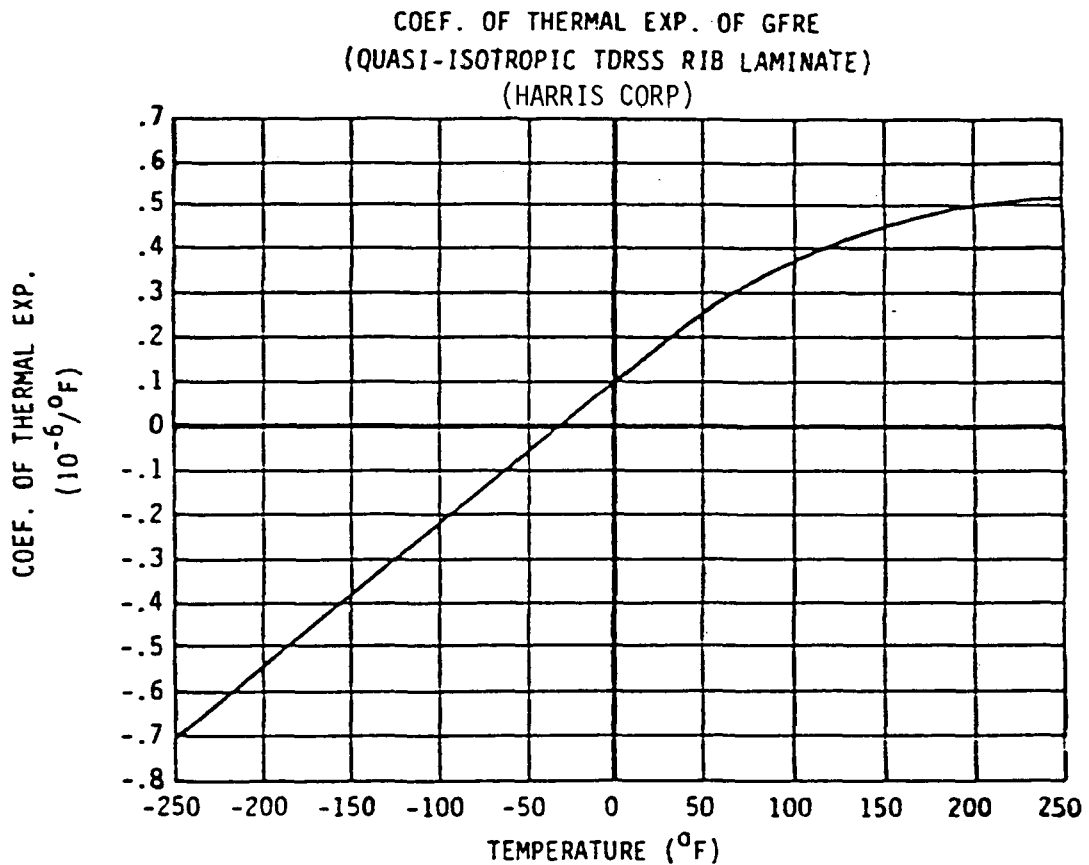

## REQUIRED ANTENNA REFLECTOR AND STRUCTURE FABRICATION TECHNOLOGY

When more accurate reflectors are needed and if the dimensional stability problems of carbon/epoxy construction are to be overcome, new matrices and fabrication technology will be required. Both glass and polyimide matrices were considered for carbon-filament-reinforced composite reflectors.

### o DESIGN

- REFLECTOR - HONEYCOMB SANDWICH PANEL
  - CARBON/EPOXY OR CARBON/POLYIMIDE FACE SHEETS (PLANAR QUASI-ISOTROPIC (+60°, 0°, -60° PLIES))
  - NOMEX OR ALUMINUM HONEYCOMB CORE
  
- ANTENNA STRUCTURE - CARBON/EPOXY OR CARBON/POLYIMIDE TUBES AND STRUCTURAL SHAPES

### o ACCURACY (FOR A 3-METER REFLECTOR)

- REFLECTOR - MAXIMUM ZERO-TO-PEAK DEVIATION FROM TRUE PARABOLA .020 INCHES
- SURFACE ROOT MEAN SQUARE (RMS) DEVIATION FROM TRUE PARABOLA - 0.0055 INCHES RMS

## REQUIRED ANTENNA REFLECTOR AND STRUCTURE FABRICATION TECHNOLOGY (CONTINUED)

Glass was chosen as the favored matrix because carbon/glass composites can be constructed with near-zero coefficients of linear expansion (CTE) and they are impervious to moisture and dryout distortion. Near optical-type stability can be obtained since creep values are low in comparison to carbon/epoxy. Also, extreme precision surfaces can be ground or lapped on the hard stable surface if required. The carbon/glass also has good resistance to particle and ultra-violet radiation and a wider operating temperature range.

However, the carbon/glass used to construct a reflector is processed at high (2,000°F) temperatures. Also, additional development is needed on the processes for manufacturing and assembling the materials.

- o ADVANTAGES OF CARBON/GLASS CONSTRUCTION
  - NEAR-ZERO COEFFICIENT OF THERMAL EXPANSION
  - IMPERVIOUS TO MOISTURE AND DRYOUT DISTORTION
  
- o DISADVANTAGES OF CARBON/GLASS CONSTRUCTION
  - HIGH (2,000°F) GLASS TILE SUB-ASSEMBLY FORMING TEMPERATURE
  - MATERIALS PROCESSING AND ASSEMBLY NEED DEVELOPMENT AND TESTING

## CARBON/GLASS MANUFACTURING SEQUENCE

In a fashion very similar to that for carbon/epoxy, the raw fiber is infiltrated and coated with the matrix (in this case powdered glass). After drying, it is cut just like carbon/epoxy prepreg (carbon fibers or cloth that have been infiltrated with epoxy but not cured). The plies are then stacked in the desired configuration and the volatiles removed. The final step is high-temperature pressing into the finished form (ref. 1).

### TAPE LAYUP PROCESSING

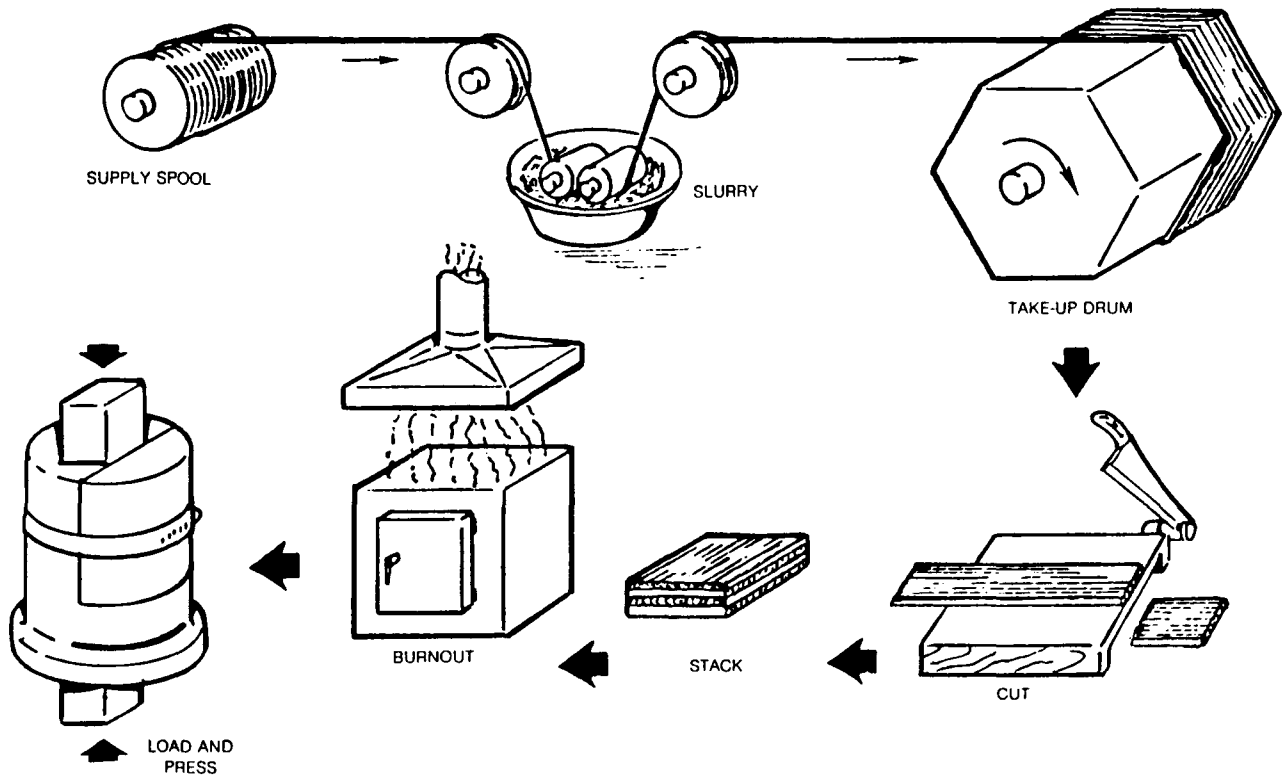

## COEFFICIENT OF THERMAL EXPANSION (CTE) OF CARBON/GLASS

The 0/90-ply orientation HM carbon fiber/borosilicate glass matrix composite CTE changes very little as a function of temperature below 0°C as compared to carbon/epoxy (see figure for coefficient of thermal expansion of carbon/epoxy - Harris Corporation) and even compared to other pure glasses (ULE, Zerodur and fused silica).

### THERMAL EXPANSION OF CONTINUOUS FIBER COMPOSITES RELATIVE TO CURRENT MATERIALS

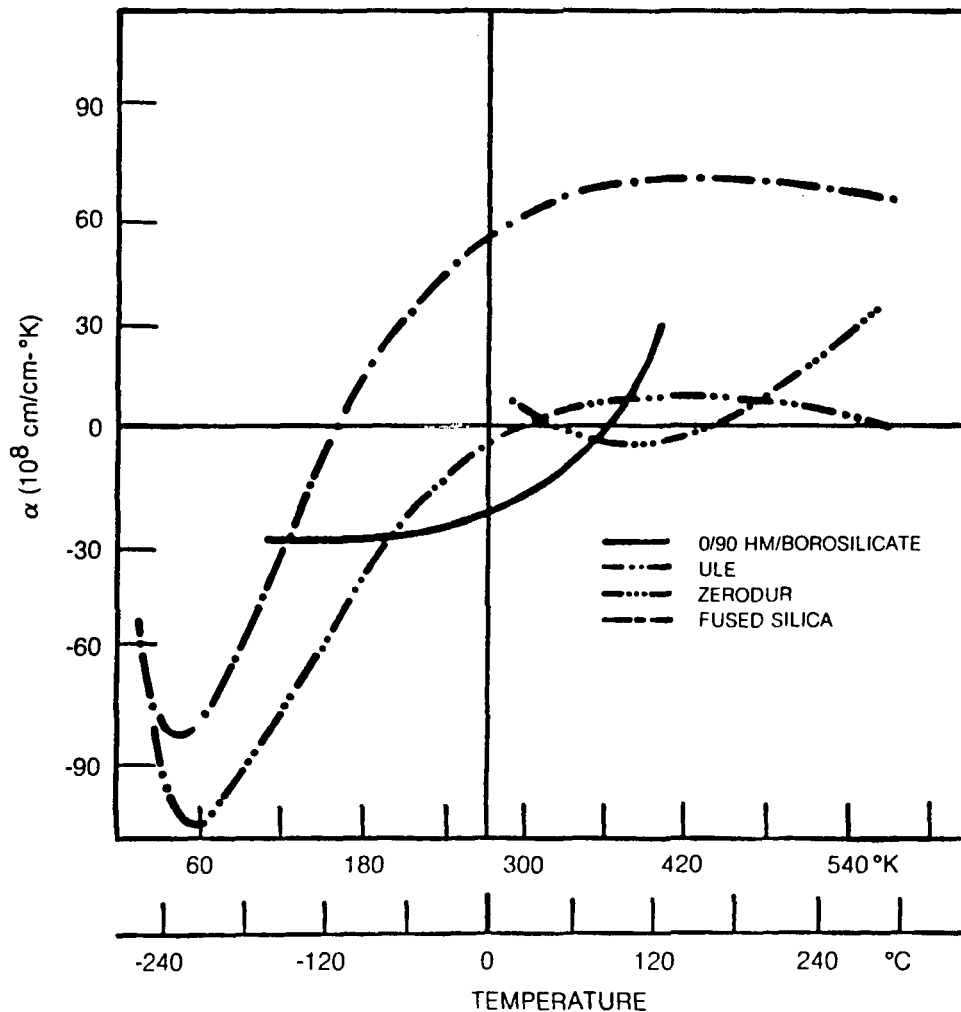

## CARBON/GLASS REFLECTOR ASSEMBLY

A parabolic reflector of carbon/glass would be constructed of honeycomb sandwich panel. The face sheets would be made of tiles laid up in a planarly isotropic pattern (+60°, 0°, -60°). The reflective surface would be of random-oriented fibers. The core would be carbon/glass eggcrate construction. The reflector would be assembled using the tiles and eggcrate core and then heated to slump-form and frit-bond (lower temperature melting ground glass particles) the parts together. Final contour machining of the random fiber surface should assure accuracies of 0.004 in zero-to-peak deviation from a true parabola and RMS deviation of less than 0.001 inches.

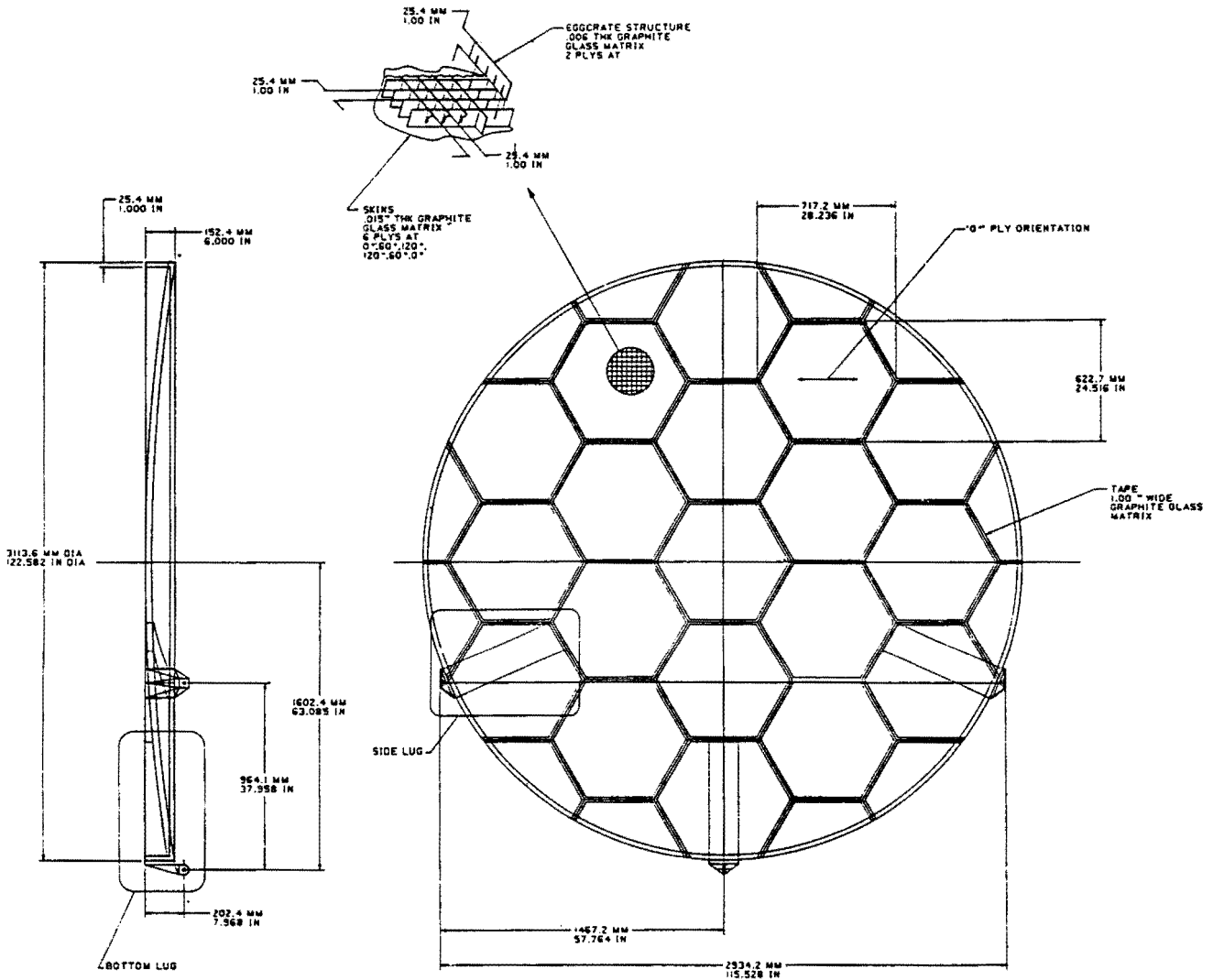

## CARBON/GLASS ANTENNA ASSEMBLY

The carbon/glass antenna reflector is shown here in an offset configuration typical of space communications applications.

### EXTREME PRECISION ANTENNA REFLECTOR

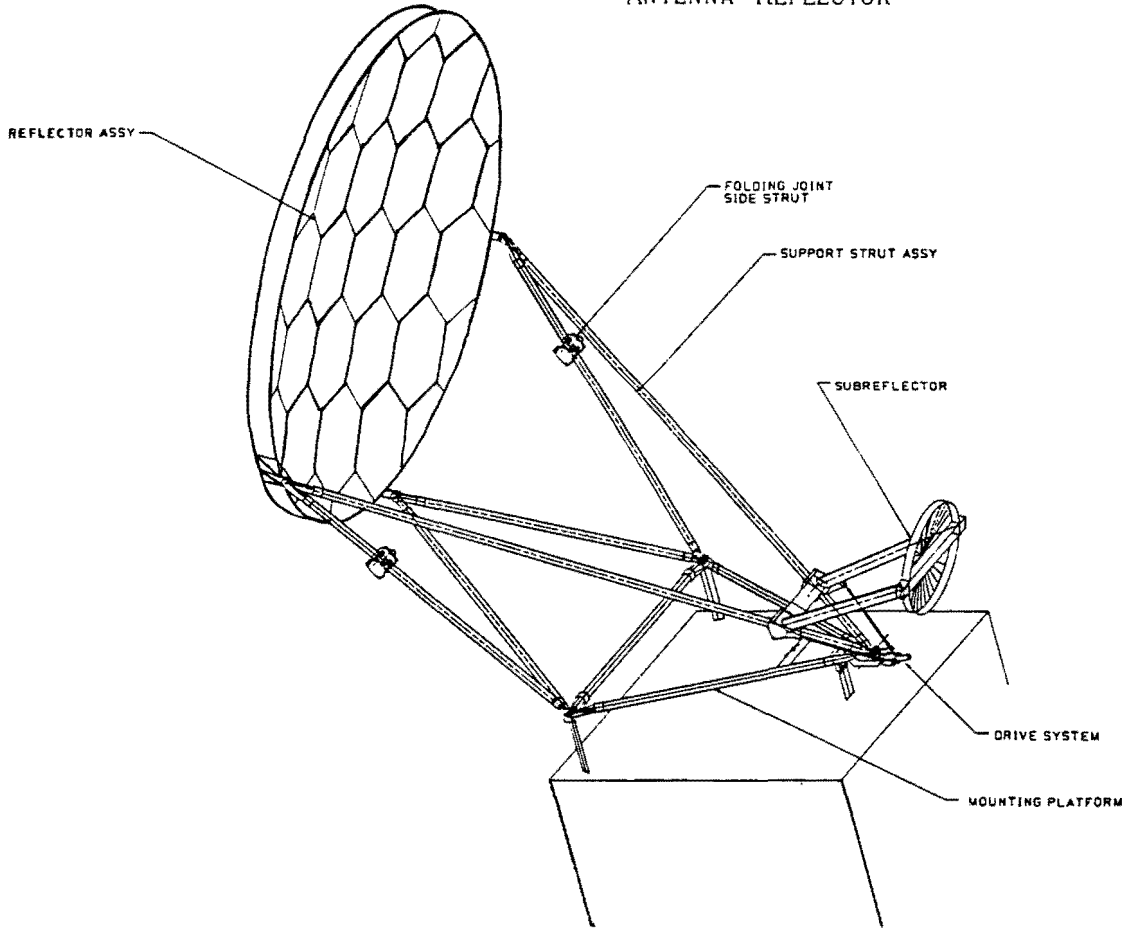



## EXTREME PRECISION DEPLOYABLE REFLECTOR CONCEPT

The 3M-aperture-diameter carbon/glass reflector can be used as a sub-assembly for larger reflectors. Preliminary design studies resulted in this concept for a 10.5-meter offset-fed precision antenna. Because carbon/glass has such a low CTE in combination with excellent dimensional stability, it was determined that a deployable antenna back-up truss or structure would not be necessary for this concept.

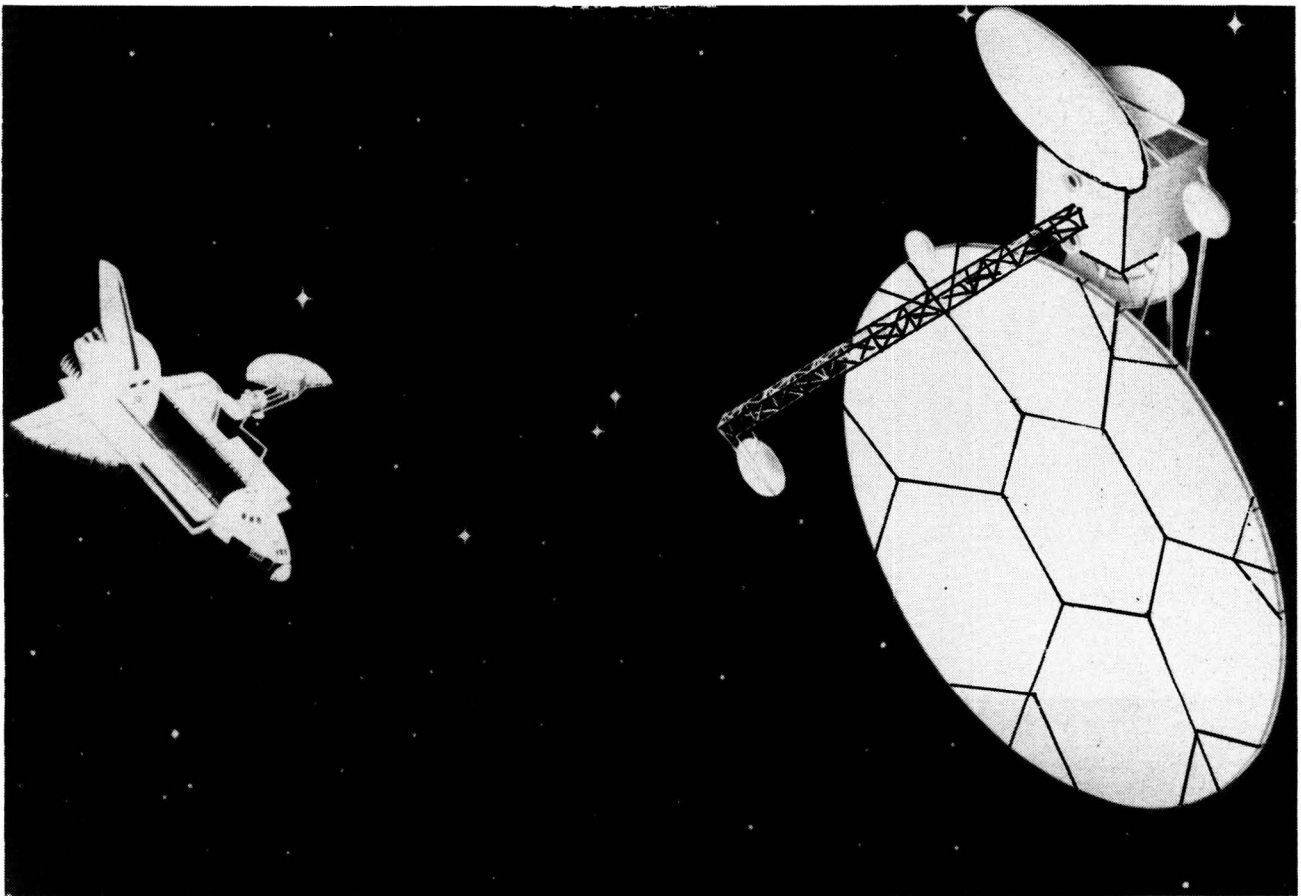

## DEPLOYABLE REFLECTOR DEPLOYMENT SEQUENCE

The deployment sequence for the 10.5M-aperture-diameter antenna is shown here. The upper panel is first lifted clear of the central stack. It is then rotated into position. A jackscrew is then used to lower the panel into place where locking mechanisms will be used to lock it to the central panel. Each subsequent panel is deployed in a similar sequence.

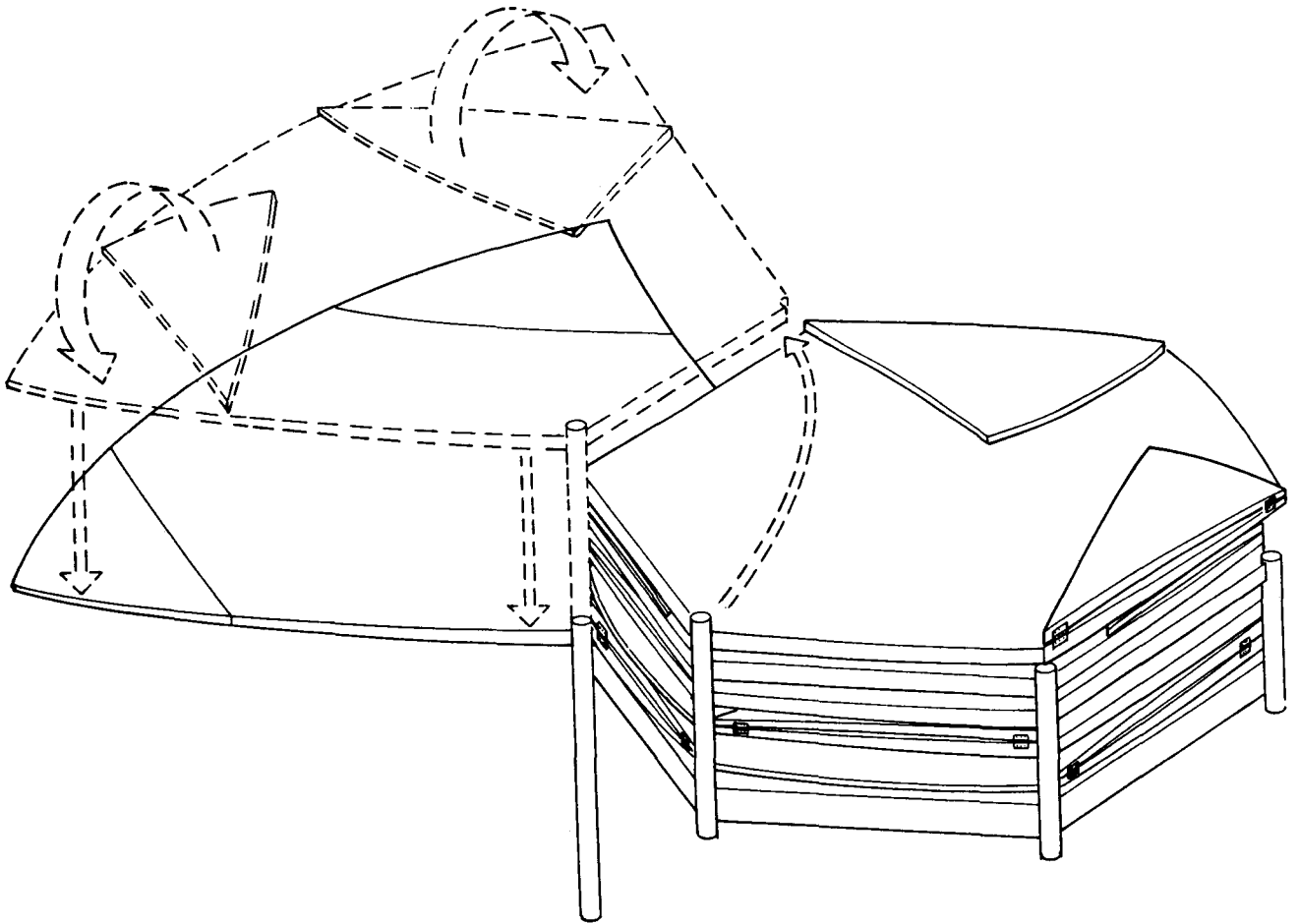

## DEPLOYABLE REFLECTOR DEPLOYMENT SEQUENCE

When all panels have been deployed and locked in place, micro-jacks at the panel edges can be used for final reflector adjustment. This can be done on either a one-time or continual basis.

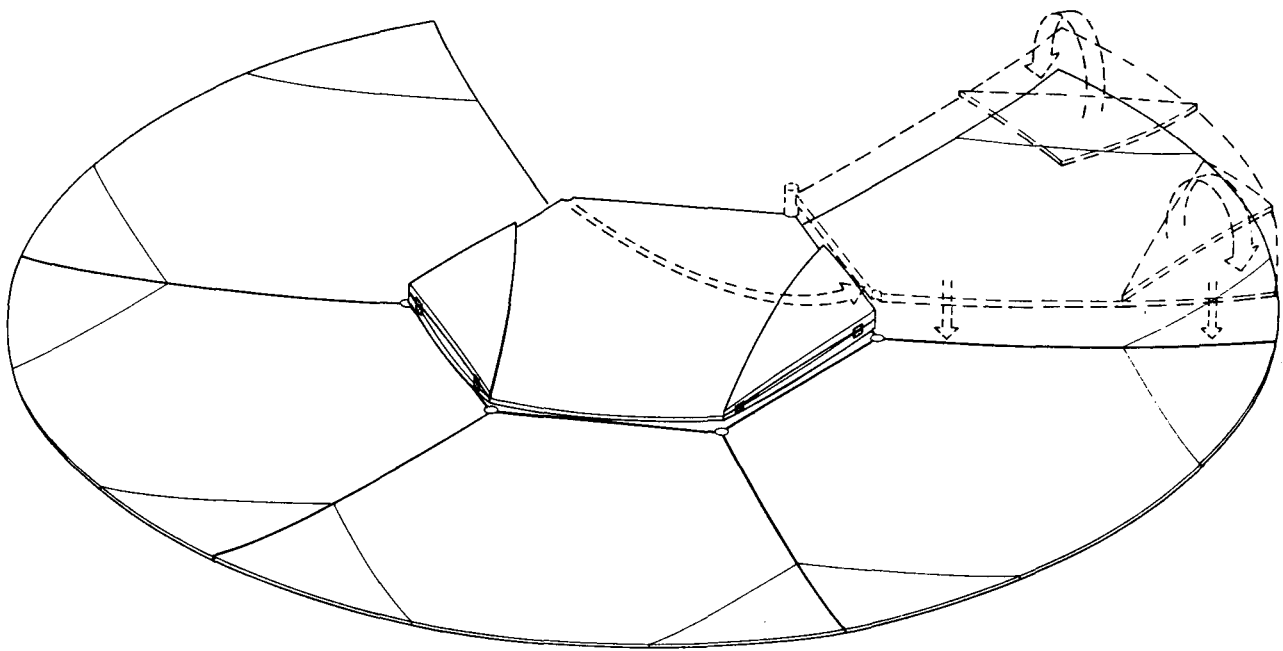

## DEPLOYMENT SEQUENCE FOR LARGER REFLECTORS

Panels can be assembled as sub-stacks in the central stack rather than as single panels. Then, from the initial central stack, a single panel can be used to swing out two more panels (a three-pedal sequence) in addition to itself. A sequence of such deployments could result in a 16-meter deployable reflector. A six-pedal sequence is also shown. Here, a single central panel would deploy a stack of six panels from which the sequences of two and three panels could be deployed.

The design study demonstrated that the great advantage of this method of solid reflector panel deployment was that the packing density in the launch vehicle could be many times that of other deployment methods such as radial or pie-shaped panel deployments which require long narrow stacks for larger diameter reflectors.

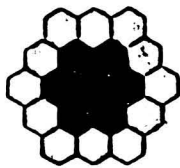

**DOUBLE RING  
16-METER DIAMETER**

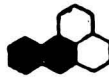

**THREE-PEDAL  
SEQUENCE**

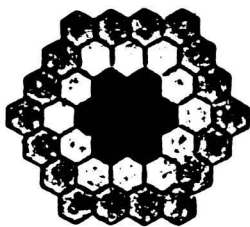
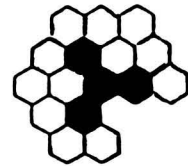

**TRI-RING  
22-METER DIAMETER**



**SIX-PEDAL  
SEQUENCE**

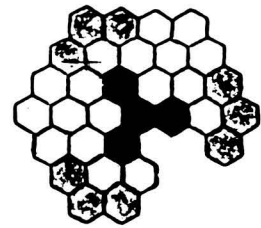

## EXTREME PRECISION ANTENNA FUTURE PLANS

It is planned to design and build an engineering model of a small extremely precise antenna (such as might be suitable for a model of a 60-GHz intersatellite link antenna) in FY '86-87. The antenna would use standard lightweight materials for the reflector support structure. However, the reflector would be constructed from carbon/glass subpanels and thus would act as a pathfinder for lightweight carbon/glass reflector technology.

- o PROGRAM - ENGINEERING MODEL DEVELOPMENT
- o DESCRIPTION - 1 1/2 TO 3-M APERTURE DIAMETER
  - 57 GHz
  - DIRECT FED (SINGLE HORN)
  - FLIGHT-TYPE REFLECTOR, ENGINEERING MODEL STRUCTURE
- o SCHEDULE - FY '86 TO '88
- o ESTIMATED RESOURCES - 1 TO 2 M
- o MAJOR TECHNICAL CHALLENGE - PRECISION REFLECTOR CONSTRUCTION

## REFERENCE

1. K. M. Prewo and E. J. Minford: Graphite Fiber Reinforced Thermoplastic Glass Matrix Composites for Use at 1,000°F, Proceedings of the 16th National SAMPE Conference, Anaheim, CA, April 21-23, 1981.