

SPATIAL DISTRIBUTION READ-OUT SYSTEM FOR
THERMOLUMINESCENCE SHEETS

I. Yamamoto, T. Tomiyama, K. Imaeda and K. Ninagawa
Okayama University of Science, Okayama Japan
T. Wada and Y. Yamashita
Okayama University, Japan
A. Misaki
Saitama University, Urawa Japan

ABSTRACT

A spatial distribution read-out system of thermoluminescence [TL] sheets is developed. This system consists of high gain image intensifier, a CCD-TV camera, a video image processor and a host computer. This system has been applied to artificial TL sheets ($\text{BaSO}_4:\text{Eu}$ doped) for detecting high energy electromagnetic shower and heavy nuclei tracks.

Thermoluminescence [TL] sheet may be a very useful detector to observe high energy cosmic rays. To find a suitable TL sheet, several kind of sheets have been produced by the "Working group for development TLC"¹. We have used Eu-doped BaSO_4 sheets. TL properties of $\text{BaSO}_4:\text{Eu}$ for temperature and wave length are shown in Fig. 1. These properties (; Fig. 1) were measured by using TL spatial distribution read out system which was shown in Fig. 2.

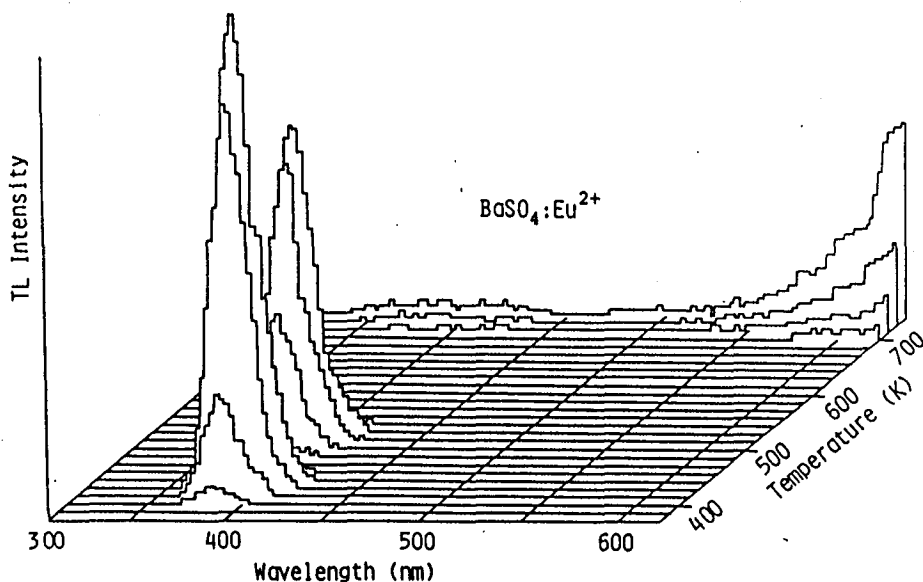

Fig. 1. TL spectra of $\text{BaSO}_4:\text{Eu}$ at various temperatures after ^{90}Sr β -ray exposure to about 100 rad. The emission observed in the red region is due to the incandescence radiation from the sample at high temperatures.

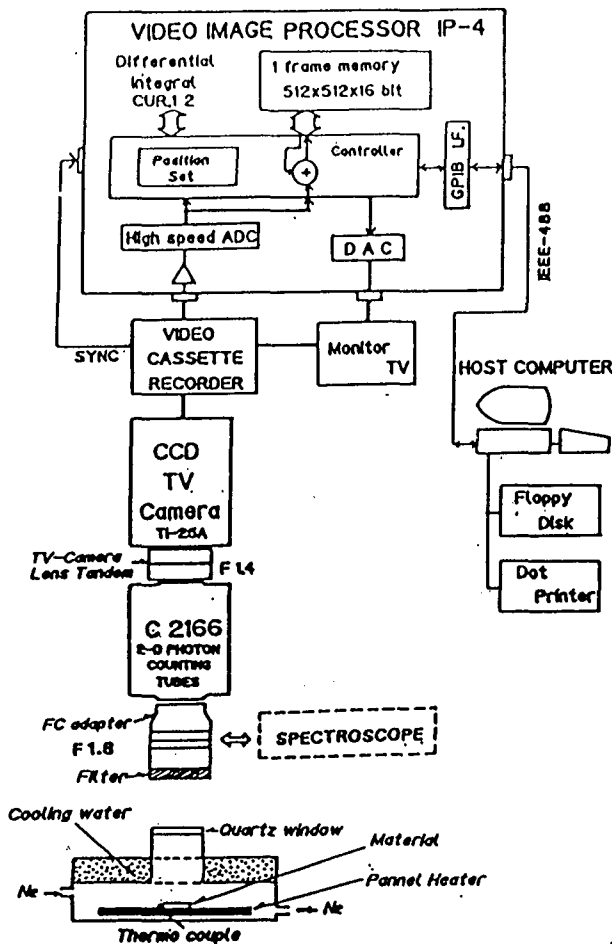

Fig. 2. The TL spatial distribution read out system.

The equipment of Fig. 2 consists of a) a pannel heater, b) a bandpass filter, c) a photon imaging head, d) a CCD TV-camera, e) video cassette recorder, f) a video image processor and g) a host computer.

We show one example of an application in Fig. 3 — the TL read out from a TL teflon-sheet ($\text{BaSO}_4:\text{Eu}$). The sheet was irradiated sideward with ^{90}Sr β -ray. The TL intensity of the "read out line" of Fig. 3a is plotted in Fig. 3b, and these points show the attenuation of β -radiation dose with depth in the teflon-sheet.

A TL calorimeter using these TL sheets had been set at Mt. Fuji (3776 m in altitude) for about one year. We have read out over an area ($2\text{ cm} \times 3\text{ cm}$) of the TL sheet corresponding to a shower spot in an X-ray film. The results of read out 20 TeV shower are shown in Fig. 4.

We tried to read out a few TeV shower from the TL-sheet

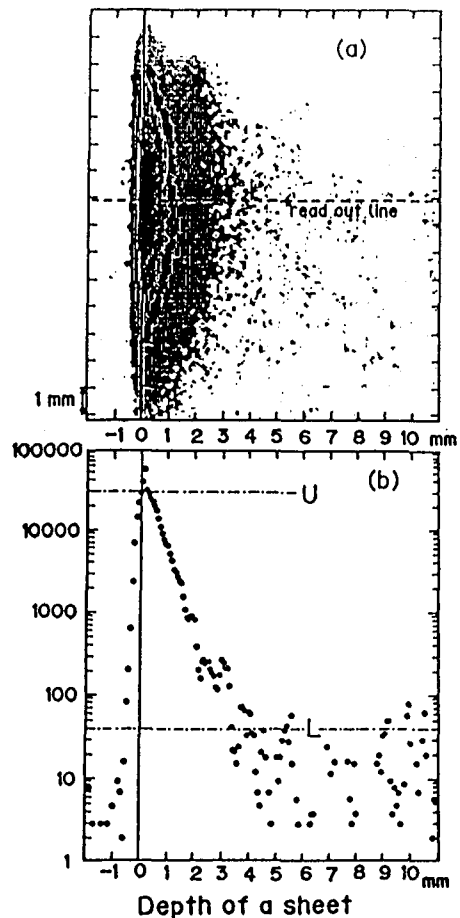
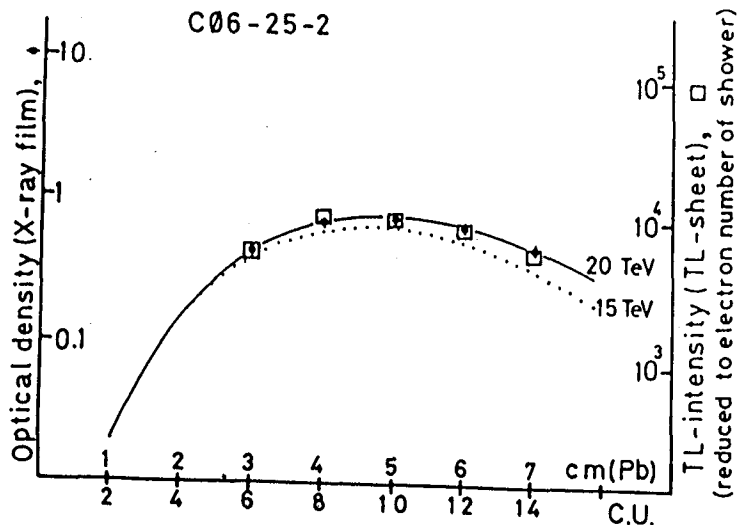

Fig. 3. TL read out example; a TL teflon-sheet was irradiated sideward with ^{90}Sr β -ray.

Fig. 4. The cascade shower curve of TL sheet and X-ray film. Solid curve: a typical 20 TeV cascade shower curve and dotted line: 15 TeV.



of Mt.Fuji TLC. For this purpose, a coincidence method (self-correlation on frame picture) has introduced. This method is using the TL property for temperature, that is glow curve shown in Fig. 5. Results of TL read out in each temperature region are shown in Fig. 6a and 6b. We used the TL sheet of Mt.Fuji-C03-14 C.U. Circled points A - I correspond to shower spots in the X-ray film [C03-14 C.U.]; following the corresponding table:

	shower name C03-	shower energy (TeV)	expected TL yeild at 14 C.U. by shower Max.
A	11.14	4.4	0.47
B	11.05	4.0	0.47
C	11.06	3.5	0.78
D	11.09	2.0	0.68
E	11.08 + 11.07	4.2 + 1.8	0.68
F	11.10	6.8	0.47
G	11.04	6.8	0.22
H	11.02	7.8	0.22
I	11.13	19.0	0.58

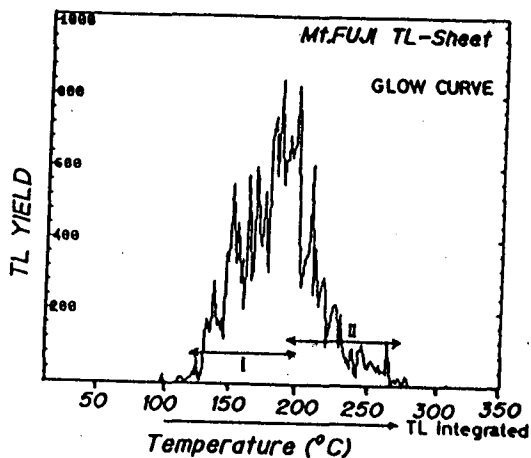

Fig. 5. The glow curve of β -ray irradiated Mt.Fuji TL-sheet. TL yeild of spatial distribution was integrated among increasing temperature.

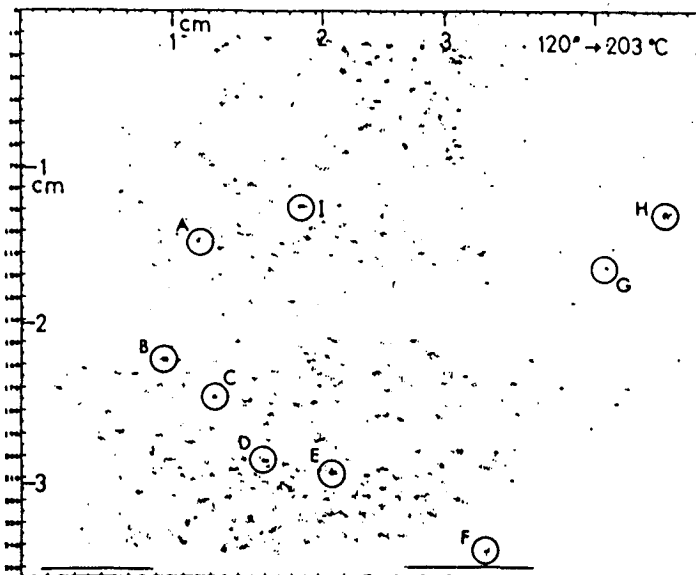

Fig. 6a. A integrated TL spatial distribution in temperature region I of Fig. 5 and the sample sheet is Mt.Fuji-C03-14 C.U.

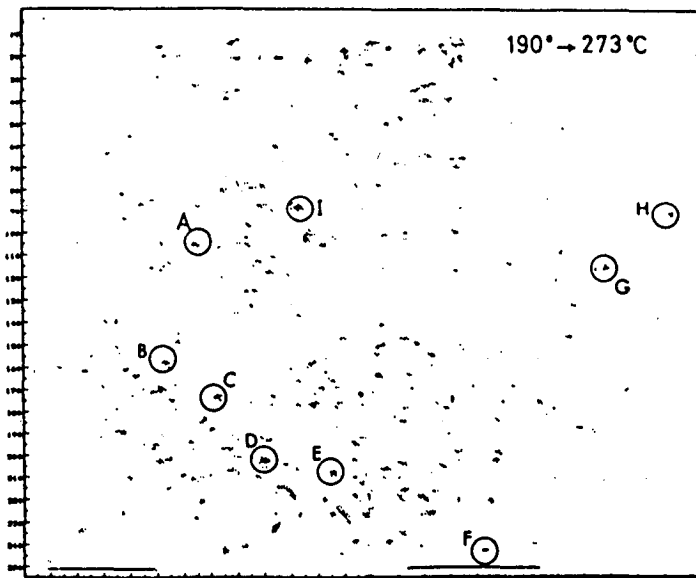

Fig. 6b. A integral TL spatial distribution in temperature region II of Fig. 5 and the same sample as Fig. 6a.

This system has been applied to detect other electromagnetic shower (~ 20 GeV) induced by muons² or to read out TL spatial distributions of natural materials³.

References

1. Okamoto, Y. et. al., (1985), ICR-Report 120-85-1, Tokyo, Japan.
2. Wada, T. et. al., (1985), This conference paper, HE 5.2-10.
3. Ninagawa, K. et. al., (1985), This conference paper, SH 9.1-16.