

Dg

PARAMETRIC TESTING OF A
LINEARLY DRIVEN STIRLING CRYOGENIC REFRIGERATOR

✓
P. R. Stolfi and A. Daniels

PHILIPS LABORATORIES
A Division of North American Philips Corporation
Briarcliff Manor, New York 10510

This paper describes the parametric testing of a novel Stirling cycle cryogenic refrigerator which incorporates electro-magnetic bearings, clearance (i.e., non-contacting) seals and electronically controlled linear motion. The last feature, which involves the use of two linear motors, position transducers and a highly accurate electronic feedback network, produces the system capability which forms the basis for the tests. The test results provide designers with an understanding of the basic operation of the Stirling cycle and give potential users some indication of the capabilities of this refrigerator under off design conditions.

Key Words: Control system performance; cryogenic; linear motors; magnetic bearings; refrigerator; Stirling cycle; test results.

1. Introduction

Philips Laboratories designed, fabricated, and tested a unique Stirling refrigerator which can operate for many years without the need for periodic maintenance and without performance degradation, and which is therefore compatible with spaceborne applications. This was accomplished by suspending the internal moving parts of the refrigerator electro-magnetically, to eliminate contact and the associated wear. The electro-magnetic suspension was further enhanced by the use of a direct (linear) drive and by clearance (rather than contacting) seals.

The testing of the refrigerator went through four phases: subassembly tests of the major components in dedicated test fixtures, performance tests at the design point (5 W at 65°K), parametric tests of the performance sensitivity to changes in various operating parameters and a life test. The first two phases of testing were discussed extensively at a previous conference (1); the third is the subject of this paper. The life test is currently in progress, with over 11,000 hours of maintenance-free and degradation-free operation attained to date. The life test will be discussed briefly at the end of this paper.

Since the purpose of a cryogenic refrigerator is to produce cold at very low temperatures with high efficiency, its performance criteria can be readily defined. Input power, cold production (output power) and operating temperature are obviously very important characteristics. The magnitude of these quantities (e.g., the input required to produce a certain amount of cold) depends on the refrigerator geometry (e.g., the size of the components) and on the operating parameters. Therefore, a measure of any cryogenic refrigerator's capabilities is the way in which the performance criteria - input power, cold production and temperature - vary with the various geometric and operational parameters.

To assess its operational capabilities, a parametric study was performed on the refrigerator system at this stage of its development. Specifically, the study was meant to:

- Establish the optimum operating conditions required to produce the nominal cooling (5 W at 65°K) level.

- Provide potential users with information on how the refrigerator performs under off-design conditions.
- Measure the tolerances of the various predicted design quantities as a step toward initiation of the next design.

The parameters of interest are either characteristic variables of the basic refrigeration cycle or those which will determine the capabilities of the refrigerator for potential users. These parametric tests are considered the first logical step in the design of the next generation of this refrigerator, a design which has already been initiated.

2. The Cycle

The Stirling cycle is based on the linear, reciprocating motion of two elements: the piston and the displacer. The reduction to practice, that is, the mechanization of the piston and displacer motions, has proven to be a difficult task. Three approaches deserve mention: crank drives, free-displacer drives and linearly driven piston and displacer drives.

A crank drive, which converts rotary to reciprocating motion is a complex mechanism. It has a crankshaft, connecting rods (drive linkages) and numerous bearings and pressure seals.

The free-displacer drive, which makes use of the gas compressed by the piston to reciprocate the displacer, requires careful attention to the mass of the displacer and to the magnitude of the gas flow; it also requires adjustment of various parameters once the refrigerator is built.

The linearly driven piston and displacer concept, incorporated into the refrigerator design presented in this paper, is an elegant approach to the mechanization of the Stirling cycle, even though its realization requires the construction of two special-purpose linear motors and an electronic position control system.

Although its mechanization is difficult, such designs are chosen because the Stirling cycle is inherently thermodynamically efficient and is very attractive for applications requiring temperatures in the 8°K - 100°K (-450°F - -280°F) range.

In the refrigerator design presented in this paper, the reciprocation of the piston and displacer is sinusoidal, with the displacer position leading that of the piston by about 70°. The p-v (pressure vs. volume) diagram for an ideal (isothermal) cycle is shown in figure 1b, the approximate position of the piston and displacer at the transitions being noted in figure 1a. The variations in the volume of the expansion space (V_e) and the volume of the compression space (V_c) due to the motions of the piston and displacer are shown in figure 1c.

For the ideal cycle, the cold production Q (Watts) is given by,

$$Q = \omega \int p \, dV_e = -\omega x y P_m A_d \sin \phi_{dr} \quad (1)$$

where, ω = operating frequency (rad/sec)
 p = pressure (N/m²)
 x = amplitude of displacer (m)
 y = amplitude of piston (m)
 P_m = mean pressure in refrigerator (N/m²)
 A_d = surface area of displacer (m²)
 ϕ_{dr} = phase angle between piston and displacer positions (°).

Similarly, the mechanical power which must be provided to the cycle (Watts) is,

$$W = \omega \int p \, dV_c = -\omega x y P_m A_p \sin \phi_{dr} \quad (2)$$

where, A_p = surface area of piston (m²).

For the ideal Stirling cycle, the thermodynamic efficiency is,

$$\eta = \frac{Q}{W} = \frac{T_e}{T_c - T_e} \quad (3)$$

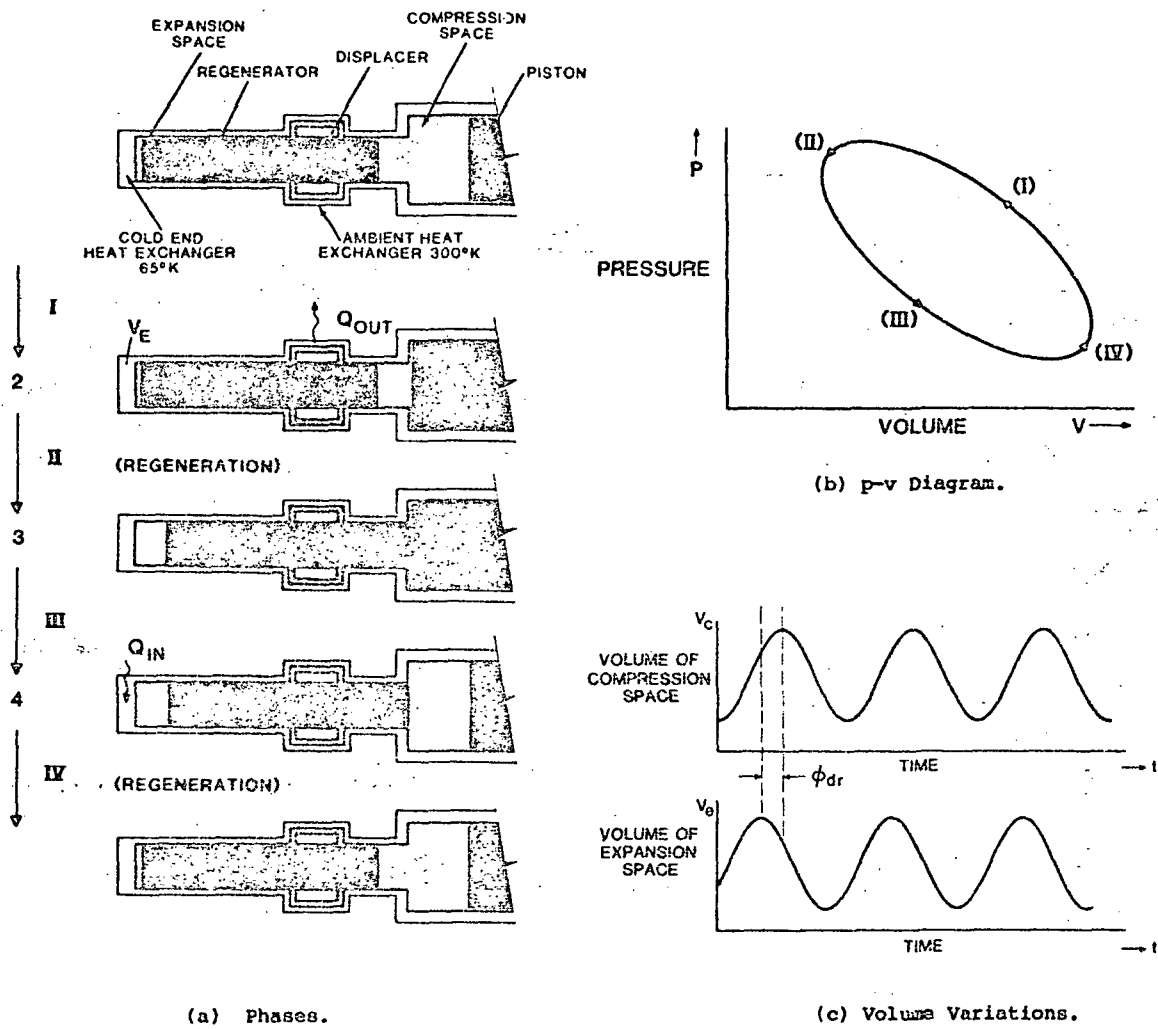

Figure 1. Phases, p-v diagram and volume variations for ideal Stirling cycle.

where, T_e = temperature of expansion space (cold finger) ($^{\circ}\text{K}$)
 T_c = temperature compression space (ambient heat exchanger) ($^{\circ}\text{K}$)

which equals that of the Carnot cycle, meaning that the ideal Stirling cycle is completely reversible.

The actual efficiency of the refrigerator is less than the ideal because losses in the cycle cause the input power to increase and the cold production to decrease. Factors which directly effect the input power include mechanical loss (friction) in the drive, flow losses, and adiabatic losses (i.e., where the process differs from the isothermal ideal). Factors which reduce the cold production include flow, insulation and conduction losses, as well as losses due to the non-ideal nature of the regenerator and heat exchanger. The regenerator, often called the heart of a Stirling refrigerator, stores thermal energy in one half cycle to release it in the other half and thereby increase efficiency. In an ideal regenerator (perfect heat transfer), a temperature gradient is established along the regenerator in the direction of flow, which allows the gas to be cooled down and heated reversibly. Also, the pressure drop across an ideal regenerator is zero. In an ideal heat exchanger, the temperature of the gas is constant, exactly equal to the temperature of the heat exchanger walls, regardless of the amount of heat in the gas. All real regenerators and heat exchangers differ from the ideal to some extent.

From the above discussion, it can be seen that the displacer amplitude (x), piston amplitude (y), operating frequency (ω), mean pressure (P_m), and piston/displacer phase (ϕ_{dr}) are important parameters which characterize the operation of a Stirling refrigerator.

3. Description of the Refrigerator

The useful life of a conventional Stirling refrigerator is limited by two major factors: wear and outgassing. Wear is present in most mechanical devices which have moving parts. Bearings and pressure seals wear out; mechanical rubbing and the associated friction generate potentially harmful particles. The other problem is the outgassing products (impurities) of organic materials in the refrigerator working spaces such as lubricants and seals. These impurities are "gettered" (attracted) by the low temperature regions in the machine and eventually clog critical passages. Since both surface wear and the presence of impurities result in thermal degradation, the simplest and perhaps the only road to longevity is to eliminate both.

The Philips refrigerator was designed to produce 5 Watts of refrigeration at 65 $^{\circ}\text{K}$ for 5 years or longer (2). Four major features of the unit led to the long life attained: a purely rectilinear drive (with linear motors and with an electronic axial-control system), electro-magnetic bearings, clearance seals, and an all metal/ceramic working-gas envelope. The synergistic combination of these four features has completely eliminated wear and impurities.

A cross sectional view of the rectilinear drive and of the linear motors is shown in figure 2. The drive produces the required linear piston and displacer motions directly, i.e., without the use of a crankshaft or linkages. The motors are of the moving-magnet type, which have the

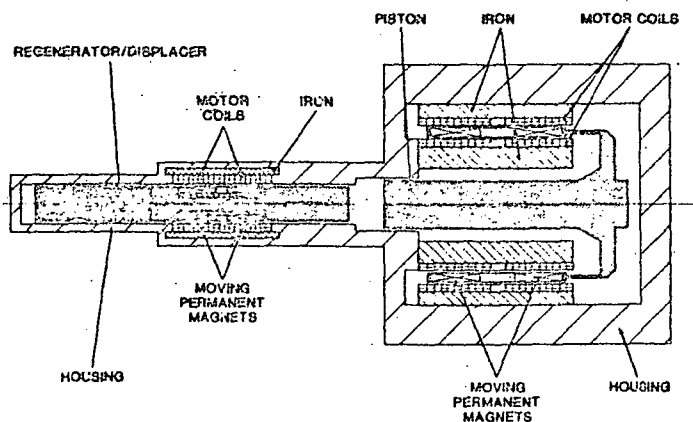

Figure 2. Cross-sectional view of rectilinear drive showing displacer and piston motors.

advantage that no flexing power leads are required. The directly coupled drive eliminates the mechanical drive losses associated with conventional refrigeration devices. Direct coupling requires an axial control system to maintain the proper piston and displacer amplitudes and the phase relationship dictated by the Stirling cycle. The capabilities and versatility of this control are important aspects of this novel refrigerator design and form the system basis which makes the type of testing, described in this paper, possible. The control system is discussed in more detail in section 5.

The electro-magnetic bearings consist of a set of electromagnetic actuators, radial position sensors and an electronic control system. The actuators are small electromagnets, consisting of a coil of wire and iron pole pieces. The radial position sensors are eddy-current type, indicating the radial position by the amount of change in eddy current loss that a radial position change produces in a pick off coil. The radial displacement of the shaft is detected by the sensor which signals the control system to adjust the current in the actuators, thereby suspending and maintaining the reciprocating shaft in the center of its bore. This method permits both the piston and displacer in the refrigerator to be supported without contact and without any bearing friction losses.

The clearance seals are long, narrow, annular passages around the piston and the displacer. Pressure sealing is attained by the flow restriction these passages provide to the oscillating working gas. This method of sealing requires that the piston and displacer reciprocate in close proximity to the adjoining walls. This is made possible by the highly accurate operation of the electro-magnetic bearings.

Since the electro-magnetic suspension, linear drive, and pressure sealing are accomplished without mechanical contact, it was possible to fabricate the working space envelope of the refrigerator (i.e., those internal areas in contact with the working gas) from metal and ceramic only. There are, as a result, no organic compounds of any kind exposed to the working gas. The organic materials required in the construction, such as the insulation of the motor wire or various potting compounds are hermetically sealed in thin-walled envelopes.

A photograph and a cross section of the refrigerator are shown in figure 3. The expander subassembly which houses the displacer is at the left; cold is produced at the far left tip (cold finger). The refrigerator is a single-stage expansion Stirling design (i.e., only one cryogenic temperature, 65°K, is produced) and thus has a single diameter for the displacer bore. The compressor subassembly (in the center of the photograph and right side of cross section) houses the piston and associated parts. The refrigerator has a passive counterbalance, a spring-mass system which significantly reduces the axial vibration of the unit. It is shown at the far right of the photograph and discussed in reference 1.

The moving displacer contains the regenerator, a moving-magnet linear motor, and a non-contacting element for the axial position transducer. The regenerator is fabricated from a phosphor bronze wire mesh which has a high thermal capacity and which remains relatively porous to the reciprocating flow of the helium gas with which the refrigerator is charged. The electro-magnetic bearings which support the displacer (along with the radial position sensors) also form the clearance seals, forcing the gas through the regenerator and through the ambient heat exchanger. The heat exchanger is maintained at ambient temperature by a water jacket; its surface also permits the attachment of a heat pipe instead of the jacket. A vacuum Dewar (partially shown in the cross section and absent in the photograph) lined with super insulation (multi-layers of foil and mesh) thermally isolates the cold finger.

The piston in the compressor subassembly is coupled to its moving-magnet linear motor and to a non-contacting element for its axial position transducer. The electro-magnetic bearing near the compression space forms a clearance seal to the compression pressure; the bearing at the rear of the piston is used for support but forms no seal. All electrical connections are hermetic, using nickel and ceramic feedthroughs.

In the following section, the general procedure for the parametric tests is discussed. Each test involved varying one operating parameter and noting its effect on refrigerator performance (change in the output variables). Section 5 describes the axial control system to provide some understanding of how the parameters can be varied during operation. Finally, section 6, presents test results. It should be noted that all plots and data presented in these sections and section 7 (life testing) represent actual measurements taken on the refrigerator.

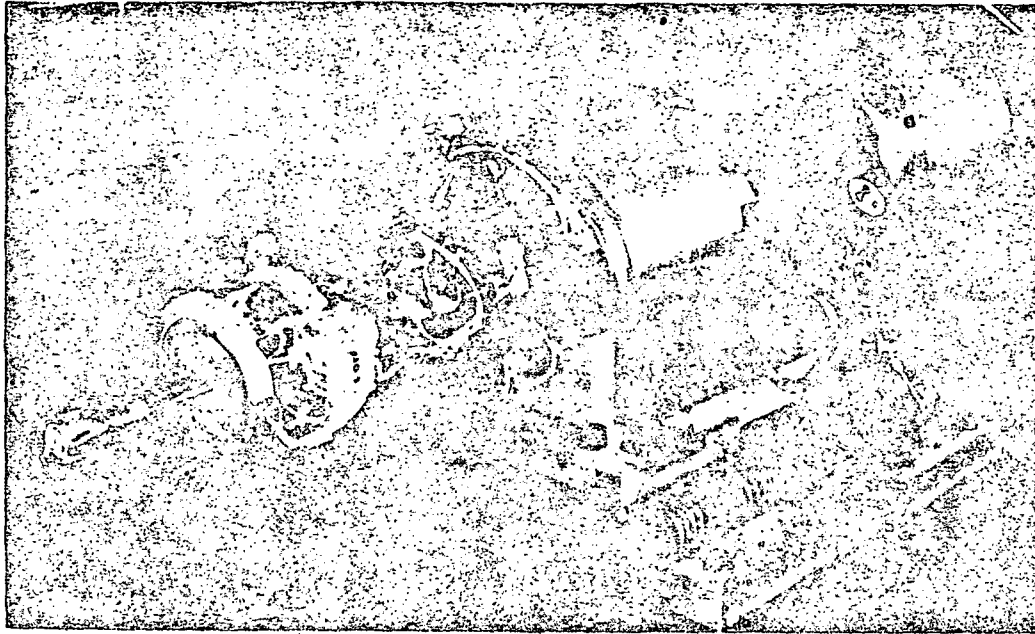

(a) Photograph.

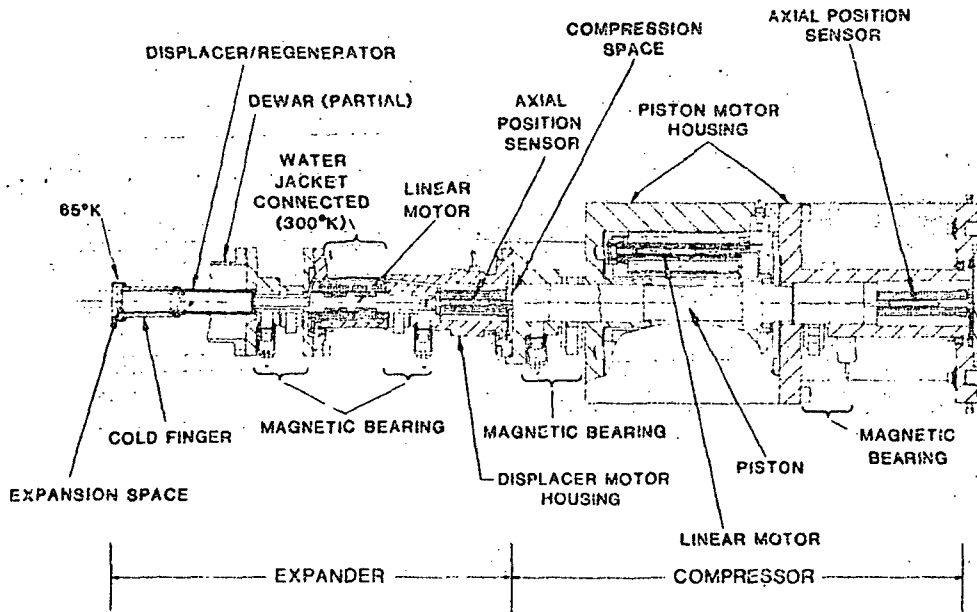

(b) Cross Section.

Figure 3. Photograph and cross section of refrigerator.

4. Overview of the Parametric Testing

The parameters of interest are either characteristic variables of the Stirling cycle (Eqs. 1 and 2) or those which will determine the capabilities of the refrigerator for potential users. Parameters which fall into the first category are piston and displacer amplitudes, operating frequency, mean pressure, and piston/displacer phase. Tests which fall into the second category are output temperature versus cold production and variations in heat-rejection temperature. For simplicity, only one parameter was varied in each test while the others were held constant. The effect of the one parameter on the output variables can then be easily observed. The values at which the other parameters were held constant differ between tests and were chosen so that the parameter which was varied could have a wide excursion. Given this limited scope of the testing, some care must be exercised in the interpretation of results. Even though "optimal" performance was sometimes achieved with only one variable changing, it is possible that a better operating condition exists. The operating parameters are not independent in general and the selection of the operating conditions for performance other than the nominal 5 W at 65°K often involves adjusting several parameters. This also means that if two parameters are varied, the net result on performance may not be the sum of the results of varying each one independently.

A schematic representation of the refrigerator test setup is shown in figure 4. Three pieces of laboratory equipment are required for normal operation: two water coolers and a vacuum station. The water cooler for the ambient heat exchanger removes the heat of compression (thermodynamic cycle) and the ohmic loss of the displacer motor. The water cooler for the piston housing removes only the ohmic loss from the piston motor. (Since this motor is 70% efficient, the power loss is small.) The vacuum station produces the thermally insulating vacuum in the Dewar. The refrigerator was instrumented with transducers to measure temperature, pressure, radial and axial position, coolant flow, and case acceleration (3).

The approach for each test followed a similar procedure. The temperature of the cold tip was first reduced to the nominal 65°K with no heat load applied. This required supporting the piston and displacer with their electro-magnetic bearings, engaging the safety interlock system, and reciprocating the piston and the displacer. The nominal peak displacements for the piston and displacer are 7 mm and 3 mm, respectively, with a nominal phase relationship of 67° (1.17 rad).

Once the desired cold temperature (65°K) was reached, a resistive heater (load) on the cold tip was turned on, a given parameter was varied and its effect on the other system parameters was measured. The signals measured were either slow-varying dc (e.g., cold temperature) or primarily single-frequency ac (at the operating frequency) with a large amount of noise and higher harmonics (e.g., piston motor current). To measure the former, a dc voltmeter was employed, and the

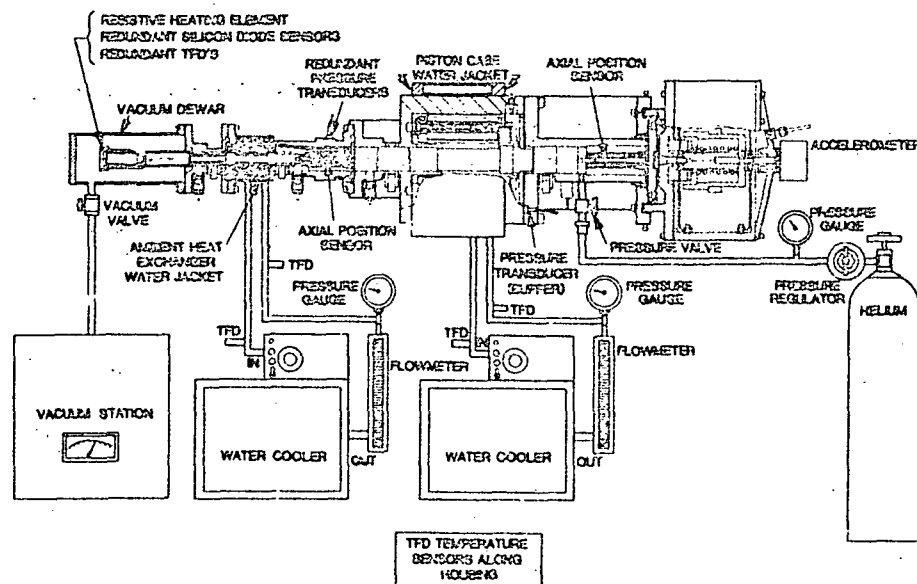

Figure 4. Schematic representation of refrigerator under test.

measured quantity was considered stable when no notable change was observed for about 5 min. The latter was measured with instruments employing one of three standard signal processing techniques: heterodyning with the input reference oscillator used for locking, rms averaging of spectra obtained from a Fast Fourier Transform routine, or time averaging of signals obtained from a high-speed data acquisition system. In this paper, db is defined as $20 \log(\text{quantity})$, the normal mode for the equipment employed. Measured data points are noted; curves are computer-generated using either a linear or polynomial least-squares routine.

5. Axial Control System

As an aid to understanding how parameters can be varied during refrigerator use, the operation and accuracy of the axial control system will be discussed next. A block diagram of the control system is shown in figure 5. The piston amplitude, displacer amplitude, frequency, and piston/displacer phase angle are set with dc voltages which are adjusted at the control panel. The frequency and phase control electronics employ local feedback loops to maintain the accuracy of the reference signals for the displacer and piston closed loop position servomechanisms in spite of component drifts. The reference signals are amplitude-controlled sinusoids with less than 0.1% harmonic distortion. The reference signal to the piston lags the signal to the displacer, producing the desired piston/displacer phase angle. The two closed loop position servomechanisms then control the motions of the piston and displacer with a high degree of accuracy and low harmonic content.

Although the closed-loop position servomechanisms for the piston and displacer look similar in figure 5, they are considerably different because of the extreme dissimilarities in the frequency response of their motor and system dynamics. The displacer, as the measured dynamics of figure 6 indicates, is nearly a pure inertial load. (The additional rolloff which begins at 200 Hz is from filtering the axial position sensor). Principally, the force produced by the motor serves only to accelerate and decelerate the mass. Since the motion is sinusoidal, with the displacer returning to its axial center position after each half cycle, there is no net displacement and no work is done. The mechanical output power is reactive (power factor of 0),

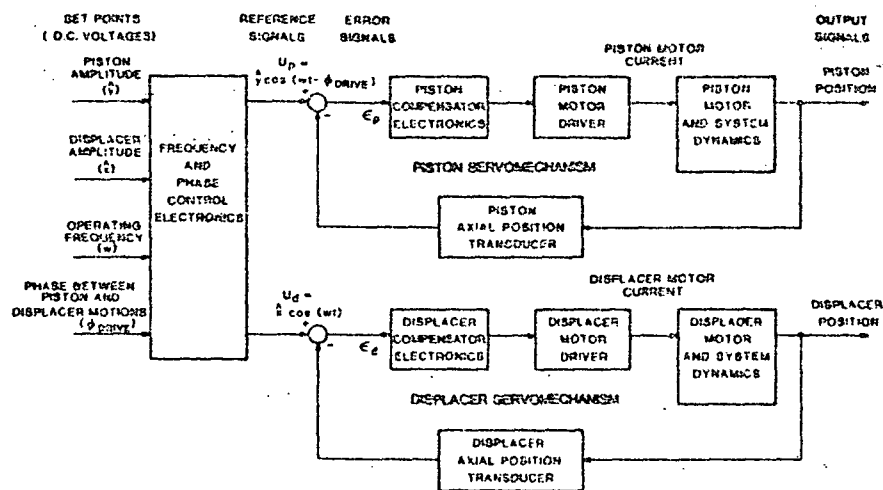

Figure 5. Block diagram of axial control system.

and therefore, the electrical input power to the motor is only the ohmic loss dissipated in having to produce the required force. Ignoring the inductive reactance, therefore,

$$P_d = I_d^2 R_d = \omega^4 x^2 R_d / K_d^2 \quad (4)$$

where P_d = average electrical input power to displacer motor (W)
 I_d = current in displacer motor (A)
 R_d = motor armature resistance (Ω)
 K_d = motor force constant (N/A) (i.e., Force = $K_d I_d$)

The piston, on the other hand, is designed to resonate on the gas spring of compression (the effective "spring" of gas being compressed in a closed cylinder) which leads to highly efficient electromechanical operation. Its motor and system dynamics, as shown in the measured dynamics in figure 6, has a spring-mass resonance characteristic (along with the position sensor filtering). The reactive inertial force is balanced by the reactive gas spring force, and the motor only produces a real (as opposed to reactive) force term which supplies the required mechanical input power to the thermodynamics (power factor of 1). The electrical input power to this motor can thus be separated into two terms: one resulting from supplying the real mechanical input power to the thermodynamics (Equation 2 above) and one relating to the balanced reactive inertial power and gas spring power. For normal operation, the piston is in resonance and the net reactive power is zero; however, for the parametric tests discussed here, the piston does come out of resonance slightly.

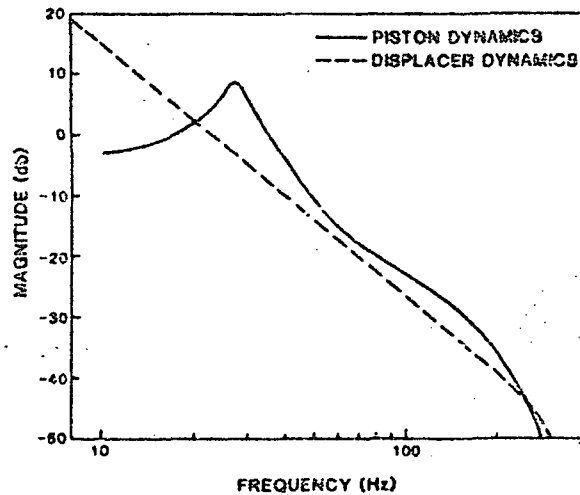
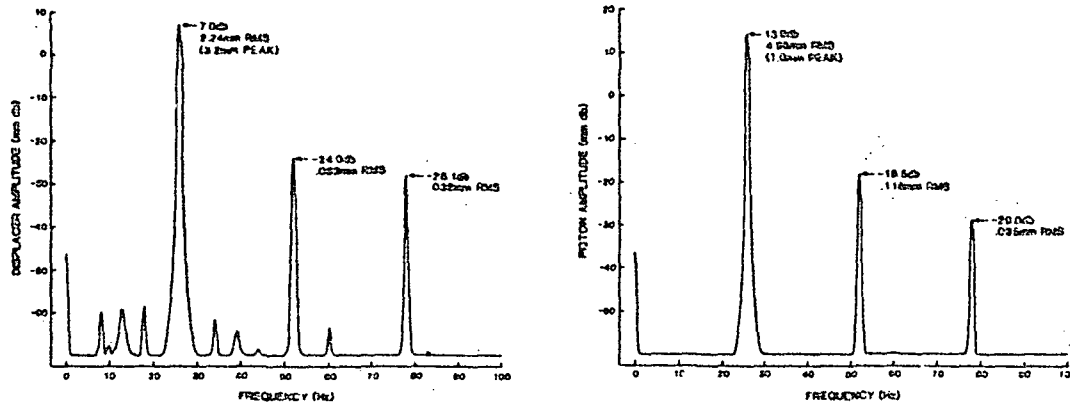

Figure 6. Frequency responses - displacer and piston motor and system dynamics.

The dynamics of a gas spring are different from those of a mechanical spring in two important respects. First, the damping in a gas spring is generally higher than in a mechanical spring. Thus, power is dissipated at resonance which must be supplied by the linear motor, and the quality factor (Q) of the system is low. Second, because of flow losses and leakage past the compression seal, the stiffness of the gas spring is a function of frequency and is slightly nonlinear (i.e., it has some higher harmonic components). These disadvantages of the gas spring are outweighed by the advantage of having a spring for resonance with no mechanical contact, no danger of fatigue failure and no possibility of fracture.

The harmonic operation of the displacer axial control system is illustrated in figure 7a. The system applies current to produce the displacement at the operating frequency (26 Hz) shown in the figure. Power at higher harmonics of the operating frequency is also applied to reduce the harmonic content of the displacement. The amount of rejection of these higher frequencies is determined by the gain of the control system. As discussed in Reference 2, the bandwidth of the displacer control system is 105 Hz, which implies that there is some control system gain at the third harmonic (about 78 Hz). Note in the figure that the second harmonic is 31 dB below the fundamental.

Similarly, the harmonic operation of the piston axial control system is illustrated in figure 7b. The control system bandwidth is 65 Hz, which implies that there is no control system gain and thus no rejection of the third harmonic (the third harmonic content of the displacement is small, however, because of dynamic characteristic of the gas spring). It should be noted that the piston operates at its resonant point with high accuracy (small error in the control loop) because of the high open-loop gain at that frequency (see Ref. 2).



(a) Displacer.

(b) Piston.

Figure 7. Frequency spectrum - displacer and piston displacement.

The low harmonic content of the displacements in the figure means that the assumption of sinusoidal volume variations discussed above is valid. For the most part, the variations in input and output power for different operational parameters are therefore approximated well by Equations 1 and 2.

6. Parametric Test Results

6.1 Heat Load

The variations of output (cold) temperature and of electrical input power to the motors with changes in the load power (ie. the power in the resistive heater mounted on the cold finger) are shown in figure 8. The parameter values that were held constant for this test and for all those that follow are listed in appendix A. As expected, as the applied load power increases, so does the cold temperature. It should also be realized that "no applied load" is not the same as zero power output since there are always parasitic loads on the cold finger. Even with the resistive heater off, heat is being radiated from the inner surface of the vacuum Dewar which encloses the cold finger and is being conducted down the wires which connect the temperature sensors and the resistive heating element, as well as down the body of the cold finger itself. These parasitic loads account for the non-linearity of the temperature line at low applied power.

The electrical input power to the linear motors drops as the applied load power increases. This can be explained by referring to Equation 3 above ($\eta = T_e / (T_c - T_e)$) and by examining

several losses. The thermodynamic efficiency of the refrigerator increases as the temperature of the cold finger (T_0) increases. Thus, although the applied load on the cold finger is higher, the refrigerator can cool this load using less electrical input power because of the increased efficiency of the cycle. (The overall measured efficiency -- applied load power/electrical input power to the piston and displacer motors -- is shown versus applied load power in figure 9.) Also, the radiation and conduction losses decrease as the temperature of the cold finger increases (since there is less of a temperature difference between the cold finger and ambient). Finally, the flow losses decrease because the gas density decreases with the increase in average temperature of the refrigerator (flow friction for turbulent flow is a function of density). This last effect is very small.

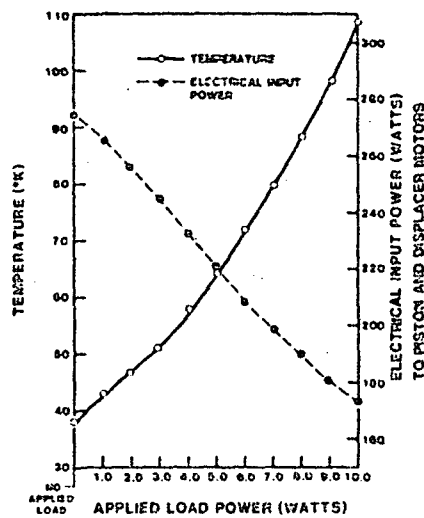

Figure 8. Cold temperature and electric input power to motors vs. applied load power.

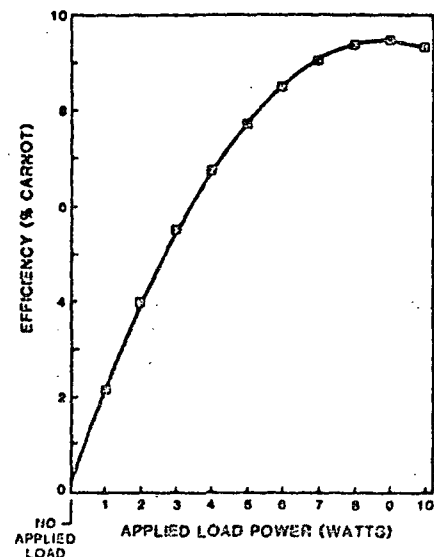

Figure 9. Overall measured efficiency (% of Carnot) vs. applied load power.

It should be noted that the operating parameters of the refrigerator (strokes, frequency, phase, etc.) were not varied for this test. It is possible to produce the off-design cold outputs (i.e., other than 5 W at 65°K) with less electrical input power than given in figure 8 by optimizing these parameters appropriately. Such multi-parameter tests were beyond the scope of this paper. It should also be noted that this test and the heat rejection temperature test which follows are the only ones in which the cold temperature was allowed to vary. In all others, the applied load from the resistive heating element was adjusted to maintain a constant 65°K temperature on the cold finger.

6.2 Operating Frequency

Figure 10 shows the variation of applied load power (cold production) and electrical input power to the motors with changes in the operating frequency. Several effects contribute to the shape of these curves. First, it can be seen from Equations 1 and 2 that both the ideal cold production and the ideal mechanical input power to the Stirling cycle vary linearly with operating frequency (since both are proportional to the number of times that the p-v curve is traversed per unit time). Secondly, many losses such as those due to flow and to imperfect regeneration are functions of gas velocity and therefore of operating frequency. Some losses, such as that caused by the fluid friction of the flowing gas or that resulting from the temperature oscillation of local sections of the regenerator package over a cycle (since the transfer rate between the gas and the regenerator is finite), increase with increasing frequency. Others, such as the clearance seal leakage decrease with increasing frequency. Finally, as discussed, the nature of the displacer and piston motor and system dynamics means that the magnitude and phase of the input power for each are functions of the operating frequency.

For the small range of frequencies considered, the motor and system dynamics produce by far the most significant effect. The displacer motor input power increases as the fourth power of the operating frequency, as noted in Equation 4 and the piston power has a resonant mass-spring characteristic (with some nonlinear effects produced by the gas spring). The sum of these two effects determine the shape of input power variations noted in figure 10. The variation of piston and displacer motor force with operating frequency is shown in figure 11. The displacer motor force varies approximately as the square of the operating frequency as would be true of the purely inertial system, and the piston motor force exhibits the spring-mass characteristic (minimum force at resonance). From this, it is also apparent that the system dynamics dominate the response and any change in the losses is not significant.

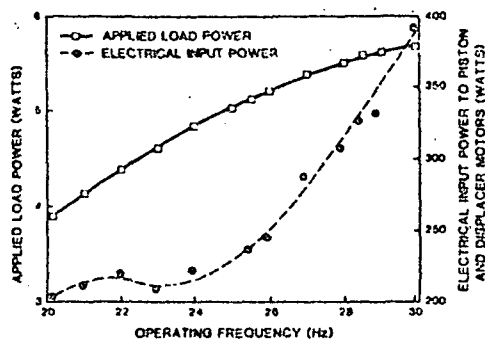

Figure 10. Applied load power and electrical input power to motors vs. operating frequency.

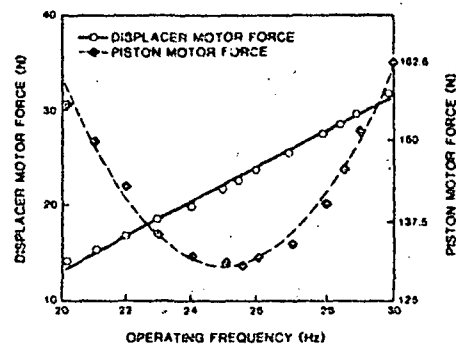

Figure 11. Displacer motor force and piston motor force vs. operating frequency.

Again, some caution should be exercised in interpreting this data. Since this is a test in which only one parameter is varied, conclusions can not be drawn about what is the best frequency at which to operate the refrigerator. Both the mean charge pressure and the piston/displacer phase affect the resonant frequency of the gas spring to some degree. The "optimum" operating frequency must take all such effects into account.

6.3 Piston/Displacer Phase

Figure 12 shows the variations of applied load power and electrical input power to the piston and displacer motors as a function of the piston/displacer phase. For the ideal cycle, the load power and electrical input power should vary as the sine of the phase (see Eqs. 1 and 2). This is the approximate shape of the curves in figure 12. The piston/displacer phase also influences flow losses and the piston gas spring resonance to a lesser degree. These effects are more easily observed in the variations in the piston and displacer motor force shown in figure 13. The

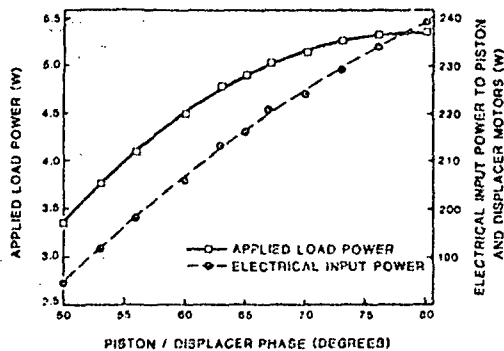

Figure 12. Applied load power and electrical input power to motors vs. piston/displacer phase.

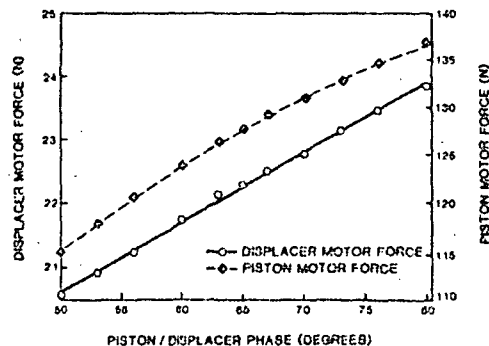

Figure 13. Displacer motor force and piston motor force vs. piston/displacer phase.

displacer motor force shows the effects of the flow losses; the piston force shows the change in resonance. From the figure, it should be noted that the variations in force are less than $\pm 10\%$.

6.4 Displacer Amplitude

The variations of applied load power (cold production) and electrical input power to the piston and displacer motors with displacer amplitude are shown in Figure 14. For the ideal cycle, the applied load power is proportional to displacer amplitude (Eq. 1). Several losses, however, are functions of displacer amplitude; the most notable is one associated with the regenerator, referred to as shuttle loss. As the displacer moves, the regenerator passes over different portions of the housing. As a result, there is a mismatch between the temperature gradient along the housing wall and the temperature gradient along the regenerator, and the mismatch increases for increasing amplitudes of oscillation. This mismatch results in heat transfer between the displacer and the housing walls and thus a loss.

Another important effect in this test and in the one which follows relates to the variation in refrigerator dead volume. The designation 'dead volume' is given to those regions in the working space of the refrigerator which do not change in volume as the displacer and piston move (i.e., do not participate in the thermodynamic cycle (Fig. 15)). Dead volume includes the heat exchanger space, connecting passages, and the unfilled space in the regenerator. Relevant to this test, dead volume also includes those regions in the expansion and compression space which are not swept by the peak amplitude of the displacer motion.

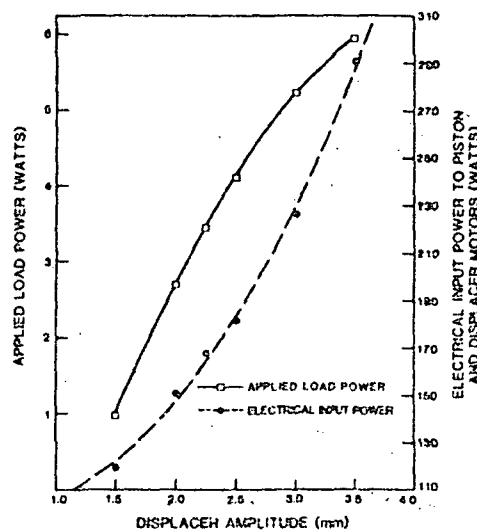

Figure 14. Applied load power and electrical input power to motors vs. displacer amplitude.

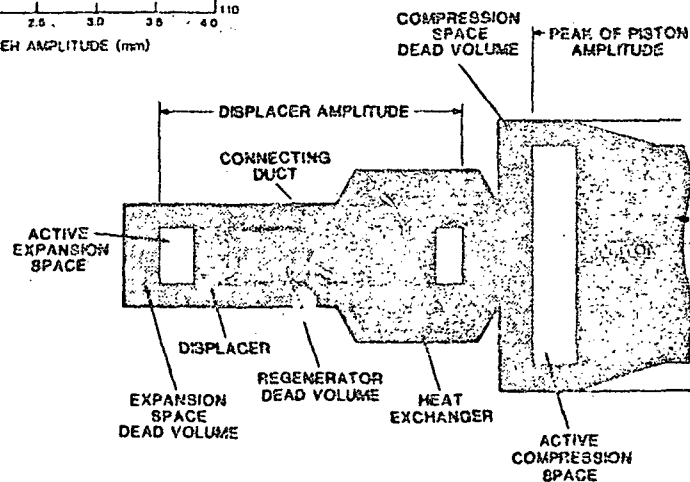

Figure 15. Schematic of dead volume (shaded). (Clearances are out of proportion for clarity).

A discussion of dead volume is given in Appendix B of Reference 2. For this paper, several comments will suffice. In general, dead volume reduces the cold production of a refrigerator. Often, it also reduces the required mechanical input power so that the refrigerator efficiency remains roughly constant. The magnitude of the effect of a given region of dead volume on the cold production or mechanical input power depends on the absolute temperature of that region. The colder the region, the greater the effect.

The electrical input power to the piston motor versus displacer amplitude is shown in figure 16. Since the displacer amplitude has little effect upon the gas spring resonance, the electrical input power to the piston motor is only that which is required to do the thermodynamic work. For the ideal cycle (Eq. 2), the mechanical input power required by the thermodynamics is proportional to displacer amplitude. The piston must also supply the work required to overcome the shuttle loss. Further, from the above discussions about dead volume, the mechanical input power should also be inversely proportional to the displacer amplitude (i.e., the mechanical input power required from the piston should decrease as the displacer amplitude increases because the dead volume decreases and this effect is independent of Eq. 2). In figure 16, the electrical input power to the piston motor varies approximately as the square of displacer amplitude.

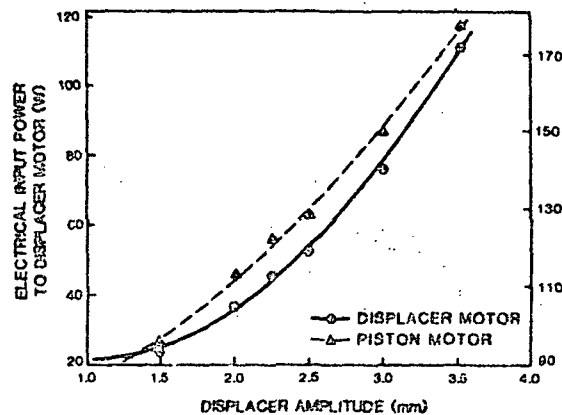

Figure 16. Electrical input power to displacer motor and to piston motor vs. displacer amplitude.

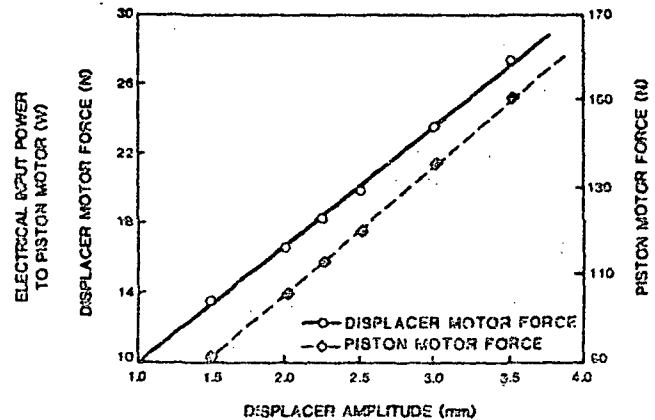

Figure 17. Displacer motor force and piston motor force vs. displacer amplitude.

Consider now the electrical input power to the displacer motor versus displacer amplitude in figure 16. Since the displacer is an inertial load, the electrical input power is expected to vary as the square of the displacer amplitude (Eq. 4), as observed. Figure 17 which shows the variation of displacer motor force with displacer amplitude, also varies linearly, as expected for an inertial load.

6.5 Piston Amplitude

The change in applied load power and in electrical input power to the piston and displacer motors with piston amplitude is shown in figure 18. For the ideal cycle (Eqs. 1 and 2), the applied load power and electrical input power are proportional to piston amplitude. This characteristic was indeed observed. Flow losses and the effects of dead volume both change with piston amplitude tending to cancel. The flow losses increase with increasing amplitude because the peak oscillating pressure and volumetric flow rate increase as more volume is displaced by the piston. The dead volume decreases by the amount above the piston in the compression space as the piston amplitude increases (Fig. 15 above). As discussed, this dead volume effect is minimized because the volume is at the temperature of the ambient heat exchanger (warm).

An elegant characteristic for potential users of this refrigerator is illustrated by the linearity shown in Figure 18. If, for any reason, it is desirable to hold the cold temperature constant as the load varies, then piston amplitude provides a very effective means. A control system can be designed to measure cold temperature and adjust piston amplitude to hold the temperature constant (leaving all other operating parameters - displacer stroke, frequency, phase, etc. - fixed). Since the characteristic in Figure 18 is linear over a wide range, such a control system would be trivial to construct.

Figure 19 shows the variations in the force produced by the piston and displacer motors with piston amplitude. It is apparent from the linear nature of the piston force curve that the piston amplitude minimally affects the resonance of the gas spring.

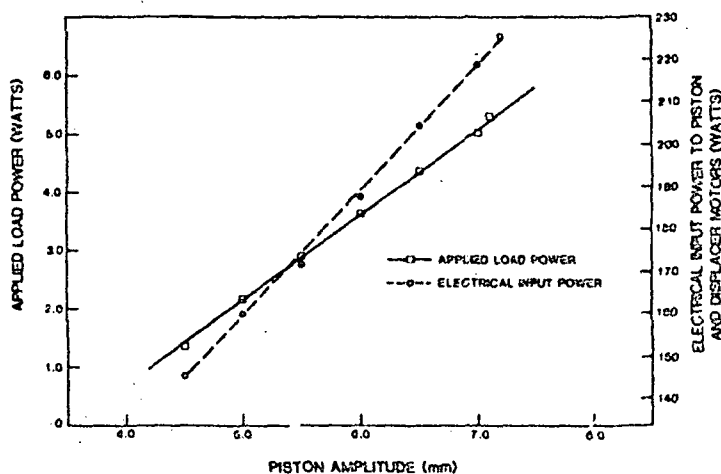

Figure 18. Applied load power and electrical input power to motors vs. piston amplitude.

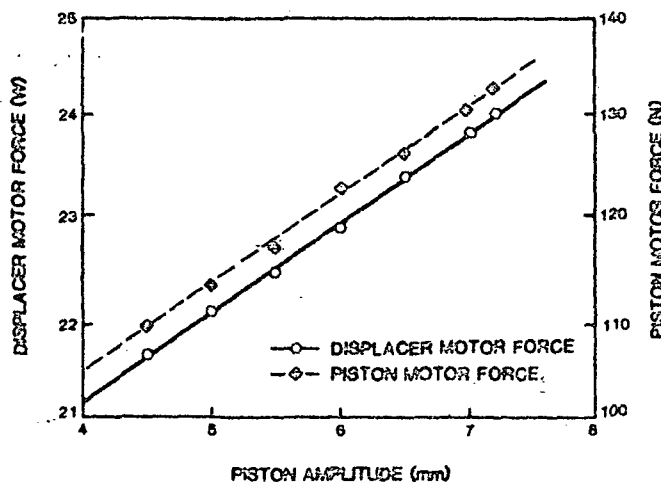

Figure 19. Displacer motor force and piston motor force vs. piston amplitude.

6.6 Mean Pressure

A pressurized bottle of helium was connected to the refrigerator via a pressure regulator and pressure gauge. For the following test, the mean pressure in the refrigerator was varied by adjusting the pressure regulator, while all other operational parameters were held constant (Appendix A). The mean pressure was measured with the pressure gauge, and sufficient time was allowed for the pressure in the refrigerator to stabilize for each measurement data point. The variations of applied load power and electrical input power to the piston and displacer motors with mean pressure are shown in figure 20. For the ideal cycle (Eqs. 1 and 2), these variations are expected to be proportional to mean pressure and, for this small change in pressure ($\pm 10\%$), this was observed.

Flow losses and regenerator losses are functions of pressure. Flow losses increase with pressure (density) because the flow is turbulent. This effect is small as shown by the small change in displacer motor force with mean pressure in figure 21. The regenerator becomes less efficient as the heat capacity of the gas increases with pressure (density) but this effect is also small for the small range of pressure variations used in the test and the relatively high cold temperature of this refrigerator (on an absolute scale). The mean charge pressure also

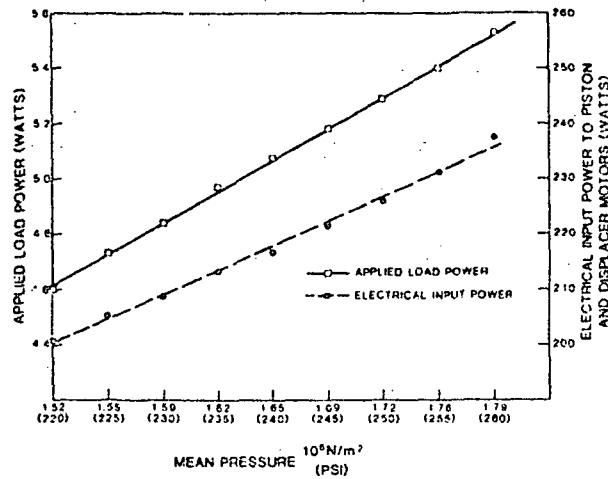

Figure 20. Applied load power and electrical input power to motors vs. mean pressure.

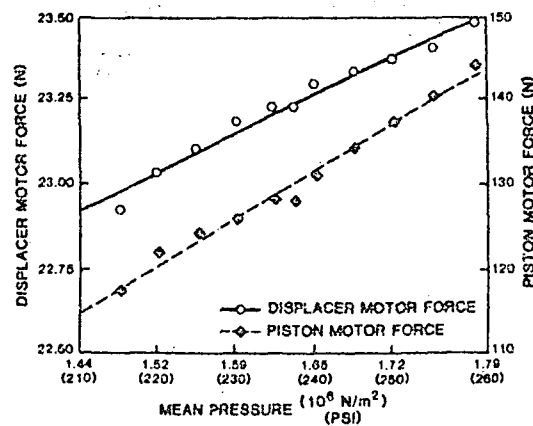

Figure 21. Displacer motor force and piston motor force vs. mean pressure.

determines the resonance of the gas spring and thus affects the electrical input power to the piston motor. The required motor force changes linearly with the mean pressure, again making the effect small for this range of variations tested.

6.7 Heat Exchanger Temperature

As discussed in Section 4 above, the temperature of the ambient heat exchanger is controlled with a closed-cycle water cooler. The water is circulated through a water jacket which surrounds the heat exchanger and returned to the reservoir of the cooler. The cooler has heating and refrigeration capabilities; the temperature of the water in the reservoir is determined by the set point of the thermostat on the water cooler. For the following test, the set point of the water cooler thermostat was varied, and all other operational parameters were held constant. The temperature of the water at the inlet of the water jacket was measured with a thin-film detector (TFD). Since the heat exchanger is not perfect, the temperature of the gas in the heat exchanger was considerably higher than the temperature of the water at the inlet. The gas temperature was not measured directly; however, it has been estimated to be about 15°C higher than the temperature of the water.

The variations in cold temperature and electrical input power to the piston and displacer motors with heat exchanger temperature are shown in figure 22. The cold temperature is proportional to the heat exchanger temperature, with a 3°K [3°C] change in heat exchanger temperature producing an approximate 1°K change in cold temperature.

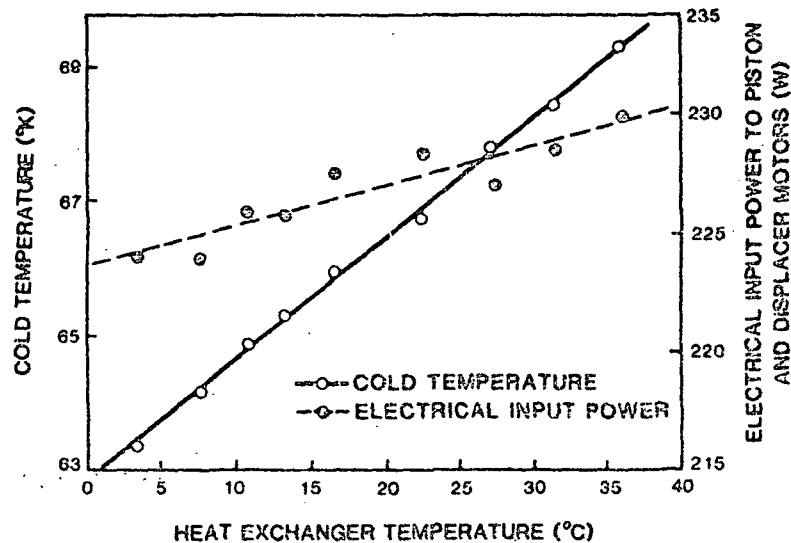

Figure 22. Cold temperature and electrical input power to motors vs. heat exchanger temperature.

The small change in electrical input power to the piston and displacer motors for changes in heat exchanger temperature is to be expected since there is only a negligible change in the efficiency of the refrigerator. Considering the ideal efficiency (Eq. 3), although the numerator increases because the cold temperature (T_c) increases, the denominator ($T_c - T_e$) also increases because of the difference between the cold temperature and heat exchanger temperature increases. There is also some net cancellation in the losses. Insulation losses and conduction losses between the room ambient and the cold finger (such as along the electrical leads to the temperature sensor and to the resistive heating element) decrease because the temperature of the cold finger increases. At the same time, conduction losses between the cold finger and the heat exchanger (i.e., along regenerator and cold finger housing) increase because the temperature difference increases. Also, there is a small decrease in flow losses because the gas density decreases as the average temperature of the refrigerator increases (the flow is turbulent, making the loss a function of density).

7. Life Testing

On August 30, 1984, the refrigerator exceeded 11,000 hours of operation at the nominal operating point of 65°K with a cold production of 5 Watts and continues to operate without problems. During this time, the refrigerator was stopped and restarted over 300 times. The cold temperature (along with several other operational parameters) is being measured with a digital data acquisition system. Measurements are taken every 30 minutes using a sampling frequency of 1 kHz. The samples are averaged over 2 seconds to reduce noise. As of this date, no temperature degradation has been observed to the accuracy of the silicon diode sensors (0.1°K). With the constant cold production, the cold temperature is also measured to be stable within $\pm 0.2^\circ\text{K}$ (i.e., temperature fluctuations including noise induced by the silicon diode thermometer are also about 0.1°K). During this period, the refrigerator has never had to be disassembled for maintenance or inspection.

The electro-magnetic bearings along with their radial position sensors are left on continually even if the refrigerator is not operating or is undergoing tests. As of August 30, 1984, the bearings have logged over 21,000 hours of operation.

A small helium leak (approximately 1 psi per day) due to a manufacturing error has developed in one of the housing flanges. A technique to weld the flanges shut, which is proposed for the final version of the refrigerator and which was successfully demonstrated in a test fixture, was not used in this refrigerator. The helium loss is presently being compensated from a helium bottle.

The electronics which control and drive the refrigerator use only commercial parts (instead of space qualified parts) and no redundancy was attempted. Twice during the life test, a commercial electronic part failed. In both cases, the safety interlock system responded correctly and safely shut down the machine. The failed part was replaced and the life test continued. The final version of this refrigerator for actual spaceborne deployment will use space qualified, redundant electronics.

8. Conclusions

A novel feature of this refrigerator, namely full electronic control of the motion of its moving parts, was utilized to characterize its capabilities under parametric changes. The characterization is useful both for designers of the next generation of the refrigerator and for potential users. Designers have both an indication of the accuracy of their "optimal" design point and a determination of the tolerance of the design point to changes in operational parameters. Potential users have an indication of the operation of the refrigerator under off-design conditions which will broaden the range of potential applications.

Some care must be taken in the interpretation of results. In each test only one parameter was varied and its effect was measured. The data shows the quantitative influence of the parameter on the operation of the refrigerator. In general, however, the effect of each parameter is not independent, and thus the combination of two test results will not show the combined effect of varying the two parameters. This also means that more "optimal" off-design operating points than those shown in this paper generally exist. These off-design points are achieved by varying more than one parameter, depending on the operating point desired.

In spite of the limited scope of this work, the versatility of this refrigerator must be appreciated both as a tool for understanding the Stirling cycle and as a general instrument for a wide variety of cryogenic applications. The capability of having parameters electronically controlled and able to be changed in operation, which made this study possible, sets this design apart from refrigerators built in the past.

This work was supported by the NASA Goddard Space Flight Center (Contract No. NAS5-25172).

Appendix A

The following table lists the values for the refrigerator operating parameters which were held constant during each test. As mentioned above, these values were chosen so that the parameter which was varied could have the largest possible excursion.

<u>Parameters</u>	<u>Tests</u>						
	<u>6.1</u>	<u>6.2</u>	<u>6.3</u>	<u>6.4</u>	<u>6.5</u>	<u>6.6</u>	<u>6.7</u>
	<u>Load</u>	<u>Freq.</u>	<u>Phase</u>	<u>Disp. Ampl.</u>	<u>Pist. Ampl.</u>	<u>Mean Pres.</u>	<u>Rej. Temp.</u>
Cold Temperature (°R)	var	65	65	65	65	65	var
Load Power (W)	var	var	var	var	var	var	5
Operating Frequency (Hz)	25	var	25	25.5	25.5	25	25.5
Piston/Displ Phase (°)	67	67	var	67	67	67	66
Piston Amplitude (mm)	7.3	7.1	7.3	7.0	var	7.2	7.3
Displacer Amplitude (mm)	3.0	3.0	3.0	var	3.0	3.0	3.0
Mean Pressure (psig)	220	241	220	253	245	var	248
Ambient Heat Exchanger							
Inlet Temperature (°C)	10.9	9.3	10.9	10.6	10.7	10.0	var
Piston Case Water Jacket							
Inlet Temperature (°C)	20.3	17	19.1	16	16	15	16

References

- [1] A Magnetically Suspended Linearly Driven Cryogenic Refrigerator. by F. Stolfi, M. Goldowsky, J. Ricciardelli and P. Shapiro, Proceedings of the Second Biennial Conference on Refrigeration for Cryogenic Sensors and Electronic Systems, Greenbelt, Md, December 1982.
- [2] Philips Laboratories, Division of North American Philips Corp., Design and Fabrication of a Long-Life Stirling Cycle Cooler for Space Applications, Phase I and II - Engineering Model, Final Report: Sept. 1978 - Dec. 1982, by F. Stolfi, M. Goldowsky, C. Keung, L. Knox, E. Lindale, R. Maresca, J. Ricciardelli, P. Shapiro, NASA contract NAS5-25172, Briarcliff Manor, N.Y., March 1983.
- [3] Philips Laboratories, Division of North American Philips Corp., Final Report for Parametric Testing of Engineering Model Refrigerator, by F. Stolfi, NASA contract NAS5-26688, Briarcliff Manor, N.Y., February, 1984.