

## N O T I C E

THIS DOCUMENT HAS BEEN REPRODUCED FROM  
MICROFICHE. ALTHOUGH IT IS RECOGNIZED THAT  
CERTAIN PORTIONS ARE ILLEGIBLE, IT IS BEING RELEASED  
IN THE INTEREST OF MAKING AVAILABLE AS MUCH  
INFORMATION AS POSSIBLE

NASA Technical Memorandum 87187



# Thermal-Mechanical Fatigue Test Apparatus for Metal Matrix Composites and Joint Attachments

(NASA-TM-87187) THERMAL-MECHANICAL FATIGUE  
TEST APPARATUS FOR METAL MATRIX COMPOSITES  
AND JOINT ATTACHMENTS (NASA) 21 P  
HC A02/MF A01

N86-15378

CSCS 11F

G3/26

Unclas  
05057

Leonard J. Westfall and Donald W. Petrusek  
*Lewis Research Center*  
*Cleveland, Ohio*

Prepared for the  
First Symposium on Testing Technology of Metal Matrix Composites  
sponsored by the American Society for Testing and Materials  
Nashville, Tennessee, November 18-20, 1985

**NASA**

THERMAL-MECHANICAL FATIGUE TEST APPARATUS FOR METAL MATRIX  
COMPOSITES AND JOINT ATTACHMENTS

Leonard J. Westfall and Donald W. Petra  
National Aeronautics and Space Administration  
Lewis Research Center  
Cleveland, Ohio 44135

SUMMARY

Two thermal-mechanical fatigue (TMF) test facilities were designed and developed, one to test tungsten fiber reinforced metal matrix composite specimens at temperatures up to 1430 °C (2600 °F) and another to test composite/metal attachment bond joints at temperatures up to 760 °C (1400 °F). The TMF facility designed for testing tungsten fiber reinforced metal matrix composites permits test specimen temperature excursions from room temperature to 1430 °C (2600 °F) with controlled heating and loading rates. A strain-measuring device measures the strain in the test section of the specimen during each heating and cooling cycle with superimposed loads. Data is collected and recorded by a computer. The second facility was designed to test composite/metal attachment bond joints and to permit heating to a maximum temperature of 760 °C (1400 °F) within 10 min and cooling to 150 °C (300 °F) within 3 min. A computer controls specimen temperature and load cycling.

INTRODUCTION

Tungsten fiber reinforced superalloy matrix composites have demonstrated a potential for use as high temperature structural materials, reference 1. The use of these materials for turbine applications often depends on their ability to withstand cyclic loading. Studies have been performed on the mechanical and thermal fatigue of fiber reinforced metal matrix composites (refs. 1 to 9). However combined effects of thermal and mechanical fatigue have not been fully investigated. Thermal-mechanical fatigue, however, is one of the primary failure modes considered in the design analysis of high temperature components, and thermal-mechanical failure data for these materials have not been obtained. In the testing of these materials it is desirable to simulate, as closely as possible, the pertinent environmental conditions the structure will experience in service.

The efficient joining of metal matrix composite components to supporting structures is of major concern facing users of these materials. It is essential that the fatigue behavior of bonded joints between composite material components be understood in order to have available design principles and rationale to take advantage of the desirable characteristics of composite materials. It is necessary to develop high efficiency joints so that load will be transferred efficiently from the composite to the supporting structure. To date few experimental studies of composite/metal attachment bond joints have been conducted under cyclic loading and no cumulative damage theories have evolved. Data must be generated that will permit designers to develop allowances for joints between advanced composites and metals. The need to evaluate the thermal-mechanical fatigue behavior of fiber reinforced metal matrix composites and composite/metal joint attachments and to simulate as closely as

possible the pertinent conditions the material will experience in service, stimulated the design and development of fatigue test apparatus for this purpose.

The purpose of this paper is to describe two thermal-mechanical fatigue (TMF) test facilities which were designed and developed at NASA Lewis. One TMF apparatus was designed to test fiber reinforced metal matrix composite specimens and another was designed to test composite/metal attachment bond joints. Test procedures and typical results obtained on tungsten fiber reinforced superalloys and composite attachment bond joints are also described in this paper.

## APPARATUS FOR THERMAL-MECHANICAL FATIGUE TESTING OF COMPOSITE SPECIMENS

### Design Considerations

A thermal-mechanical fatigue test facility was required in which tests could be conducted that would simulate the pertinent loading and environmental conditions that a metal matrix composite component might be exposed to during service. Consideration was given to the following factors in the design capability of the test facility:

1. Testing in either an air or inert atmosphere.
2. Specimen test temperature excursions from room temperature to 1430 °C (2600 °F).
3. Heating rates on the order of 22 °C (40 °F)/sec.
4. Varying the load on the test specimens during each heating and cooling cycle from a zero load condition to a maximum load of 2270 kg (5000 lb).
5. Varying the loading rates on the specimen from 1 kg (2 lb)/sec to 18 kg (40 lb)/sec.
6. Measuring strain occurring in the specimen test section during loading and each heating and cooling cycle.

### Component layout

A photograph of the test apparatus is shown in figure 1. The apparatus consists of a commercially available high load capacity (9100 kg (20 000 lb)) frame with a 20 to 1 lever arm system to impose loads onto test specimens. Loads are applied to the lever arm through a chain connected to a variable speed motor. The load applied by the motor is measured by use of a strain gauge attached to a metal bar in line with the test specimen as shown in figure 1. An electrical signal is sent from the load strain gauge to a control device having upper and lower adjustable limits to control the minimum and maximum loads applied to the test specimen. The load on the test specimen can be varied from 0 to 2270 kg (5000 lb) and loading rates can also be varied from 1 kg (2 lb)/sec to 18 kg (40 lb)/sec. Specimens can be tested either in air or in an inert atmosphere.

The specimens which were tested consisted of hollow tubes with threaded ends that were screwed into grip fixtures. The diameter of the tubes was approximately 1.7 cm (0.67 in.) with a wall thickness of 0.14 cm (0.55 in.). Specimens are heated to the desired temperature by direct resistance heating using a current transformer which is capable of generating approximately 1000 A at 5 V. Large copper cables are connected to both ends of the test specimen using water cooled copper connectors to carry the high currents required to heat the specimen. The water cooled copper connectors served the dual purpose of maintaining a good electrical contact and cooling the ends of the specimen. The bottom grip fixture pull rod connected to the lower portion of the load frame is insulated to insure that all the current passes through the specimen. The total power used to heat the specimen is controlled by adjusting a variable resistor. An adjustable temperature controller enables the upper temperature to be maintained for up to 60 min. Specimen test temperature excursions from room temperature to 1430 °C (2600 °F) can be obtained as well as rapid heating rates, on the order of 22 °C (40 °F)/sec.

### Test Procedure

The test specimen is installed in grip fixtures which are attached to pull rods. The minimum and the maximum loads applied to the specimen are selected and set on the load control device. The rates at which the motor will apply the load is also set. In normal operation the specimen is loaded and heated at the same time with the specimen being cycled from zero to full load in 30 sec. During the load operation the specimen is heated to the desired temperature by direct resistance heating. The total power used to heat the specimen is controlled by adjusting a variable resistor. The proper variable resistor adjustment is selected by determining the time required to heat the specimen to the desired temperature. Normal procedure was to adjust the power settings to produce a 30 sec specimen heating time. The specimen cooling rate is not controlled. The power is shut-off and the specimen is allowed to cool. An adjustable temperature controller having an upper and lower limit is used to establish the specimen temperature limits for the heating excursion. Normal procedure was to cycle the specimen temperature between 425 °C (800 °F) and 1090 °C (2000 °F). The upper temperature limit was maintained, if desired, by using the upper limit switch to transfer the electrical power signal to another circuit having a lower power setting. The switch in power level causes the specimen to slowly cool. The second electrical circuit is designed to allow a small specimen temperature drop of approximately 10 °C (20 °F) before the main power is returned to the specimen. This procedure allows a fast heating rate without an accompanying temperature overshoot. The temperature of the specimen is maintained at the upper temperature limit setting by allowing the power to fluctuate and the temperature to vary within the 10 °C (20 °F) range. A timing device is connected to the upper temperature limit switch of the temperature controller which enables the upper temperature to be maintained for intervals up to 60 min. In normal operation the high temperature hold times were 2 to 5 min.

Several methods were evaluated to measure the temperature. Attempts to measure the temperature of the specimen with a thermocouple attached to the hot section of the specimen failed. Thermocouples spot welded to the hot section of the specimen were damaged by diffusion of the thermocouple material into the surface of the test specimen. Oxidation at the spot weld was another problem encountered during testing. After a number of thermal cycles the thermocouple weld would fatigue, resulting in the loss of a sufficient bond between the weld

and specimen to produce accurate temperature readings. This situation caused the temperature to overshoot. Tying the thermocouple onto the specimen also was not successful since the thermocouple junction could not be kept securely fastened to the surface of the specimen. This resulted in a large error of up to 100 °C. An attempt was made to correct this error by insulating the area around the thermocouple with alumina wool. The insulation caused the surface of the specimen to oxidize under the insulation which resulted in premature specimen failure.

A procedure was developed to accurately measure specimen temperatures which involved the use of an optical pyrometer in conjunction with thermocouples. It was found that a thermocouple could be successfully spot welded onto a specimen if the maximum temperature of the spot weld did not exceed 850 °C (1560 °F) during the test. Since the test specimen has water cooled cooper electrical contacts, the resistance heating of the specimen produces a temperature gradient from 100 °C (210 °F) at the grip section to 1100 °C (2010 °F) in the 1.75 cm (0.7 in.) test section. Successful tests were run by spot welding thermocouples onto the cooler areas of a specimen as shown in figure 2 and reading the test section temperature with an optical pyrometer. The differences in the optical pyrometer and the thermocouple readings were accurately determined by using two thermocouples on a standard specimen, one spot welded to the cool region and one spot welded to the hottest section of the specimen. The temperature difference of the optical pyrometer reading and the spot welded thermocouple reading for the hottest section was compared to the reading of the thermocouple spot welded to the cooler section of the specimen. This technique allowed the control thermocouples to be spot welded to a cool section of the specimen which resulted in long thermocouple junction lives. The optical pyrometer was used to establish the relationship between the test section temperature and the cooler control thermocouple temperature. The control thermocouple limits were set to the proper values to produce the desired temperature limits on the specimen test section. The optical pyrometer was used to measure the temperature of the specimen test section during the hold time. Small adjustments were made to the control thermocouple setting to maintain the proper test section temperature. The axial strain in the specimen was measured during the complete thermal cycle using the strain measuring device shown in figure 2. The strain measuring device consists of a scissor mechanisms with the pivot point located in the center of the scissor arms. The tips of the device consist of ceramic points which contact the specimen surface. The ceramic tips prevent the conduction of electricity and heat to the metal arms of the device. A linear variable displacement transducer (LVDT) capable of producing an electrical signal that has a known relationship with distance is located on the opposite end of the metal arms. A signal is sent from the displacement device to a computer and a digital display. A simple system was developed to calibrate the strain measuring device. A displacement standard was produced by drilling several sets of small holes into a flat metal plate. The distance between holes was within the range of the desired specimen gauge length. The distance between the holes was accurately measured and recorded. The tapered ceramic tips of the measuring device were inserted into the holes and the corresponding voltages produced by the displacement device was recorded. This information was used to produce a plot of distance versus voltage and the equation of the displacement curve was determined by the computer. Subsequent displacement voltages were converted to axial strain.

The strain measuring device was used in the following manner. The ceramic tips were positioned on the specimen test section at a distance apart from one another of approximately 1.75 cm (0.7 in.) prior to starting the test. The voltage output was recorded which accurately determined the exact distance between the tips. The test cycle was started and the voltage variations produced by the straining of the test specimen could be recorded manually at the high and low temperature limits of the cycle and later converted to distances. A computer was installed in the test facility to be used as a high speed recorder. The computer was programmed to record the variation in load, temperature and displacement in real time. The software for the computer was developed to allow the data to be printed in a graphical form if a significant change in displacement had occurred. This system produced a periodic recording of data plus a recording of all of the data for cycles that produced a significant change in displacement.

### Test Results

A typical plot of temperature, load and displacement for a tungsten fiber reinforced superalloy matrix composite cycled between 425 °C (800 °F) and 1090 °C (2000 °F) under a load of 70 MPa (10 000 psi) is shown in figure 3. The plot displays the load, temperature and strain that occurred in the specimen test section as a result of one loading and heating cycle.

At the end of a specified number of cycles the data was graphically displayed. This type of data representation displays the maximum temperature and load along with the change in specimen strain as a function of the number of heating and cooling cycles. A typical plot of a complete test is shown in figure 4.

## APPARATUS FOR THERMAL-MECHANICAL FATIGUE TESTING OF COMPOSITE/ATTACHMENT BOND JOINTS

### Design Considerations

A thermal-mechanical fatigue test facility was required in which tests could be conducted that would simulate the pertinent loading and environmental conditions that a metal matrix composite/attachment bond joint might be exposed to during service. Consideration was given to several factors in the design of the test facility. The test facility was designed to be capable of the following:

1. Testing in either an air or inert atmosphere.
2. Specimen test temperature excursions from room temperature to 760 °C (1400 °F).
3. Heating composite/metal attachment bond joint specimens from room temperature to 760 °C (1400 °F) in 10 min and cooling to 150 °C (300 °F) in 3 min.
4. Varying the load on the test specimens during each heating and cooling cycle from a zero load condition to a maximum load of 2270 kg (5000 lb).

## Component Layout

The essential features of the test apparatus are shown in figure 5. The apparatus consists of a commercially available high load capacity (9100 kg (20 000 lb)) frame with a 10 to 1 lever arm system to impose loads onto test specimens. Loads are applied to specimens by a series of large metal plates that are connected to the lever arm which is connected to a specimen load chain. A mechanically driven load elevator is positioned below the weights and is used to apply and remove the load. The elastic deformation of the mechanical linkage allows the load to be applied in a gradual manner. A computer installed in the test facility was programmed to control the mechanically driven load elevator so that the maximum load is applied at the start of the heating cycle and removed at the start of the cooling cycle. Test specimens can either be tested in air or in an inert atmosphere.

A platinum wound resistance furnace is used to heat specimens to 760 °C (1400 °F) within 10 min. The heating rate and temperature limits the specimen is exposed to is controlled by a computer programmed to control the power input to the furnace. Nitrogen gas is blown onto the surface of the specimen to rapidly cool the specimen to the minimum temperature selected. The computer is programmed to activate a solinoid switch which allows the nitrogen gas to be released onto the specimen. Specimens can be cooled from 760 °C (1400 °F) to 150 °C (300 °F) within 3 min.

Conventional resistance furnaces were not available in which test specimens mounted in grip fixtures could be heated and cooled at the required rate, or that could withstand the heating and cooling cycle without the furnace components fatiguing after a very few cycles. A furnace was designed that in some respects resembled a toaster as shown in figures 6(a and b). A furnace shell was made that consisted of thin ceramic plates that surrounded the specimen. Small ceramic pins were located in the top and bottom of the plates. A small diameter coil of platinum was fabricated and wound vertically between the ceramic pins to create a series of closely spaced heating coils. The furnace was constructed so that the heating coils were positioned close to the grip fixture surface to allow maximum heat flux to the grip and test specimen. This type of furnace design allowed specimens to be heated at the required heating rate and cooling rate since there was less furnace mass to heat and cool.

## Test Procedure

Test specimen configurations were designed to simulate a potential component application for metal matrix composites namely that of a turbine blade. Figure 7 illustrates a probable construction for a metal matrix composite blade. The composite airfoil would be bonded to a root block which in turn would be installed in an engine disk. The airfoil must be securely bonded to the root block such that centrifugally induced loads and thermal loads do not cause failure at the composite/metal attachment bond joint interface. One design consisted of a composite panel containing fibers oriented parallel to the load axis of the specimen and bonded onto a metal root block attachment also parallel to the load axis as shown in figure 8. Another design consisted of a composite panel in which the fibers were flared out at an angle to the load axis of the specimen and bonded to a metal attachment at an angle to the load axis as shown in figure 9. Specimen grip fixtures were designed to match the contour of the two specimen designs. The grip fixtures were fabricated



from a strong nickel base alloy, Udimet 700, and had internal passages machined in them to allow an inert cooling gas to be passed through the mass of the grip to permit high specimen cooling rates. The specimens were installed in the grip fixtures as shown in figure 10.

Specimen test temperature were determined using chromel-alumel thermocouples which were inserted into two holes machined in the grip fixtures. This test temperature measuring procedure was used to eliminate the need to machine holes in test specimens to measure internal temperatures. A dummy test specimen was machined to allow thermocouples to be inserted into holes extending into the midsection of the test specimen so that the internal temperature could be measured. The relationship between the grip thermocouple readings and the dummy test specimen reading was determined when the specimen was at the selected test temperature. The grip thermocouples were subsequently used as the controlling thermocouples for the temperature excursions used in these tests.

A predetermined load was then placed on the load elevator and the chamber closed and double purged with an inert gas and then evacuated with a large mechanical vacuum pump. Test conditions parameters were then inputted into a computer program to control the test facility. Desired load, power to the furnace and duration or number of cycles required for the test were inputted into the computer. The computer then turned on the power supply to the furnace. The power supply was previously set at an amperage selected to allow the fastest specimen heating rate without overheating and failing the furnace coil. Load was then gradually applied to the specimen during the heating cycle through a computer command to the elevator motor which lowered the elevator stand. The test specimen temperature reached 760 °C (1400 °F) within 10 min after the start of heating. At this time the computer sent a command to a power shut-off switch and load elevator which turned off the furnace, removed the load from the specimen, and also activated a solinoid switch. The solinoid switch allowed cool nitrogen gas to be forced through cooling passages machined in the grip fixtures and also to be exhausted onto the composite specimen just above the point where the composite panel was bounded to the root attachment. The grip fixture and test specimen was cooled to 150 °C (300 °F) within 3 min. After the test specimen temperature reached 150 °C (300 °F) the computer gave the necessary command to repeat the cycle until the number of cycles initially inputted was attained. The test specimen was then removed from the grip fixtures and examined for debonding or shearing at the joint interface.

#### Test Results

Typical types of test specimen failures obtained using the specimen design described previously and the thermal mechanical test facility are shown in figures 11 to 14. The test specimen shown in figure 11 failed at the bond between the composite panel and root block attachment. The disbond originated at the section of the test specimen exposed to an exhaust of cool nitrogen gas. The test was stopped before complete disbonding occurred at the bond joint interface.

Figure 12 shows another type failure which can occur during thermal mechanical fatigue namely, delamination of the composite panel. The method of loading the test specimen introduces a separation force perpendicular to the longitudinal axis of the composite panel caused by a bending movement. The

separation force was sufficient to cause delamination of the panel. The bond joint between the panel and the root block remained intact. Figures 13 and 14 show a third type of failure observed due to thermal mechanical fatigue. In both cases the composite panel completely fractured while the bond joint between the panel and the root block attachment remained intact.

#### CONCLUDING REMARKS

The need to evaluate the thermal-mechanical fatigue behavior of fiber reinforced metal matrix composites and joint attachments and to simulate as closely as possible the pertinent conditions the material will experience in service stimulated the design and development of fatigue test apparatus for this purpose.

Two thermal-mechanical fatigue (TMF) test facilities were designed and developed. One TMF apparatus was used to test tungsten fiber reinforced super-alloy matrix composite specimens and another was used to test composite/metal attachment bond joints.

Both test apparatus are designed to produce a thermal cycle that coincides with an increasing load. Where possible, the strain of the specimen was measured. All data was collected by a computer and represented graphically if possible. In both apparatus maximum flexibility was maintained to allow a wide variety of test conditions. Reproducible test conditions were also maintained.

#### REFERENCES

1. Morris, A.W.H.; and Burwood Smith, A.: Fiber Strengthened Nickel-Base Alloy. High Temperature Turbines, AGARD-CP-73-71, AGARD, 1971, pp. 19-1 to 19-3.
2. Dean, A.V.: The Reinforcement of Nickel-Base Alloys with High-Strength Tungsten Wires. J. Inst. Met., vol. 95, 1967, pp. 79-86.
3. Baskey, R.H.: Fiber-Reinforced Metallic Composite Materials. AFML-TR-67-196, Air Force Materials Lab., Wright-Patterson, AFB, 1967.
4. Fleck, J.N.: Fabrication of Tungsten-Wire/FeCrAlY-Matrix Composites Specimens. TRW Report ER-8076, TRW, Inc., Cleveland, OH, 1979.
5. Dudnik, G.I.; Banas, F.P.; and Aleksandrov, B.V.: Nature of Failure of Reinforced Sheets Subjected to Thermal Cycling. Strength Mater., vol. 5, no. 1, Oct. 1973, pp. 106-107.
6. Nilsen, N.; and Sovik, J.H.: Fatigue of Tungsten Fiber Reinforced Nickel. Practical Metallic Composites, Institution of Metallurgists, London, 1974, pp. B51-B54.
7. Banas, F.P.; Baranov, A.A.; and Yakoveleva, E.V.: Deformation of Composite Materials During Alternate Heating and Cooling. Strength Mater., vol. 7, no. 6, Mar. 1976, pp. 744-748.

8. Brentnall, W.D.; and Moracz, D.J.: Tungsten Wire-Nickel Base Alloy Composite Development. (ER-7849, TRW; NASA Contract NAS3 17816), NASA CR-135021, 1976.
9. Friedman, G.I.; and Fleck, J.N.: Tungsten Wire-Reinforced Superalloys for 1093 °C (2000 °F) Turbine Blade Applications. (ER-8135, TRW; NASA Contract NAS3-20084), NASA CR-159720, 1979.

ORIGINAL PAGE IS  
OF POOR QUALITY

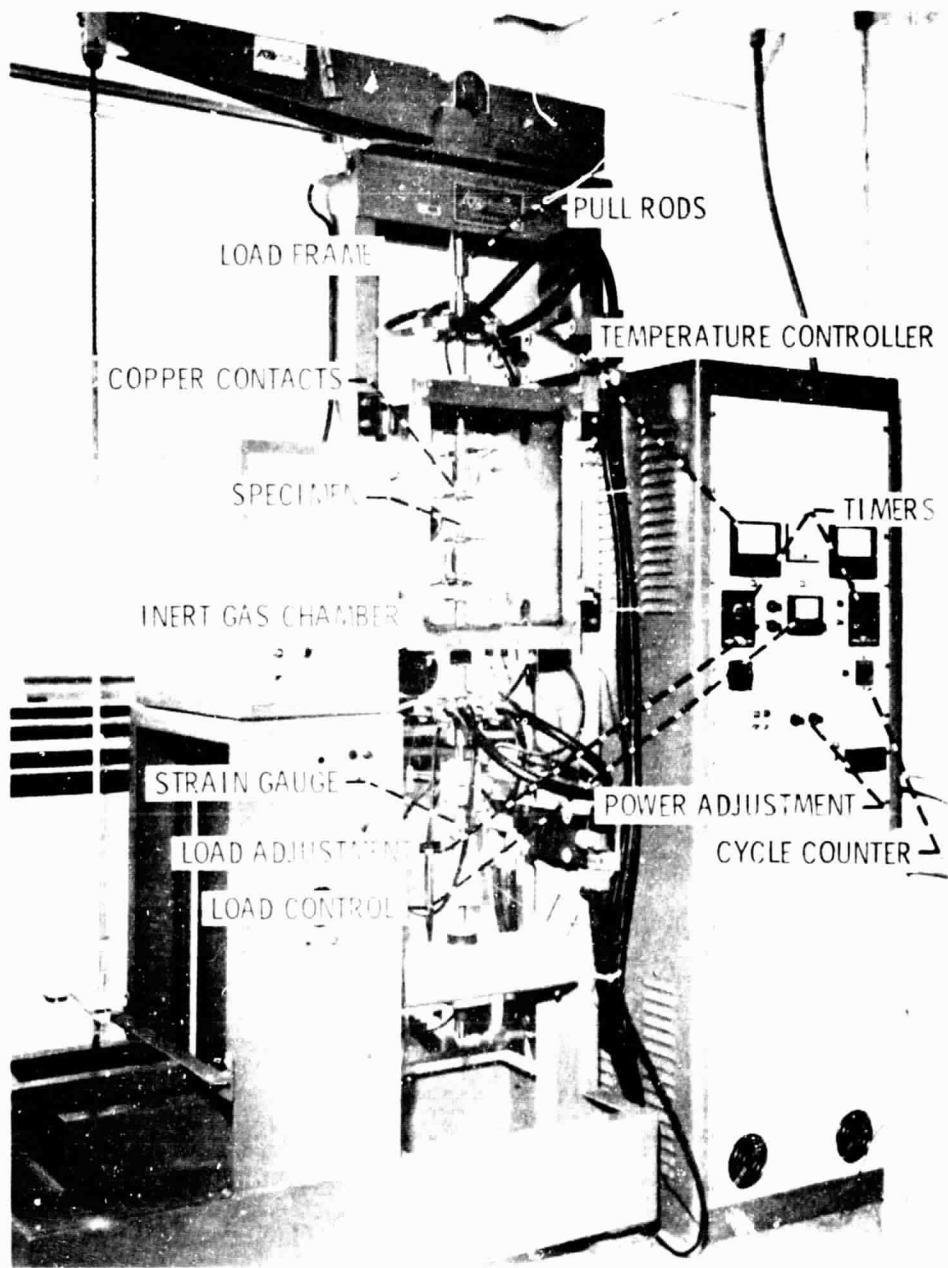

Figure 1. - Photograph of thermal mechanical fatigue apparatus.

ORIGINAL PAGE IS  
OF POOR QUALITY

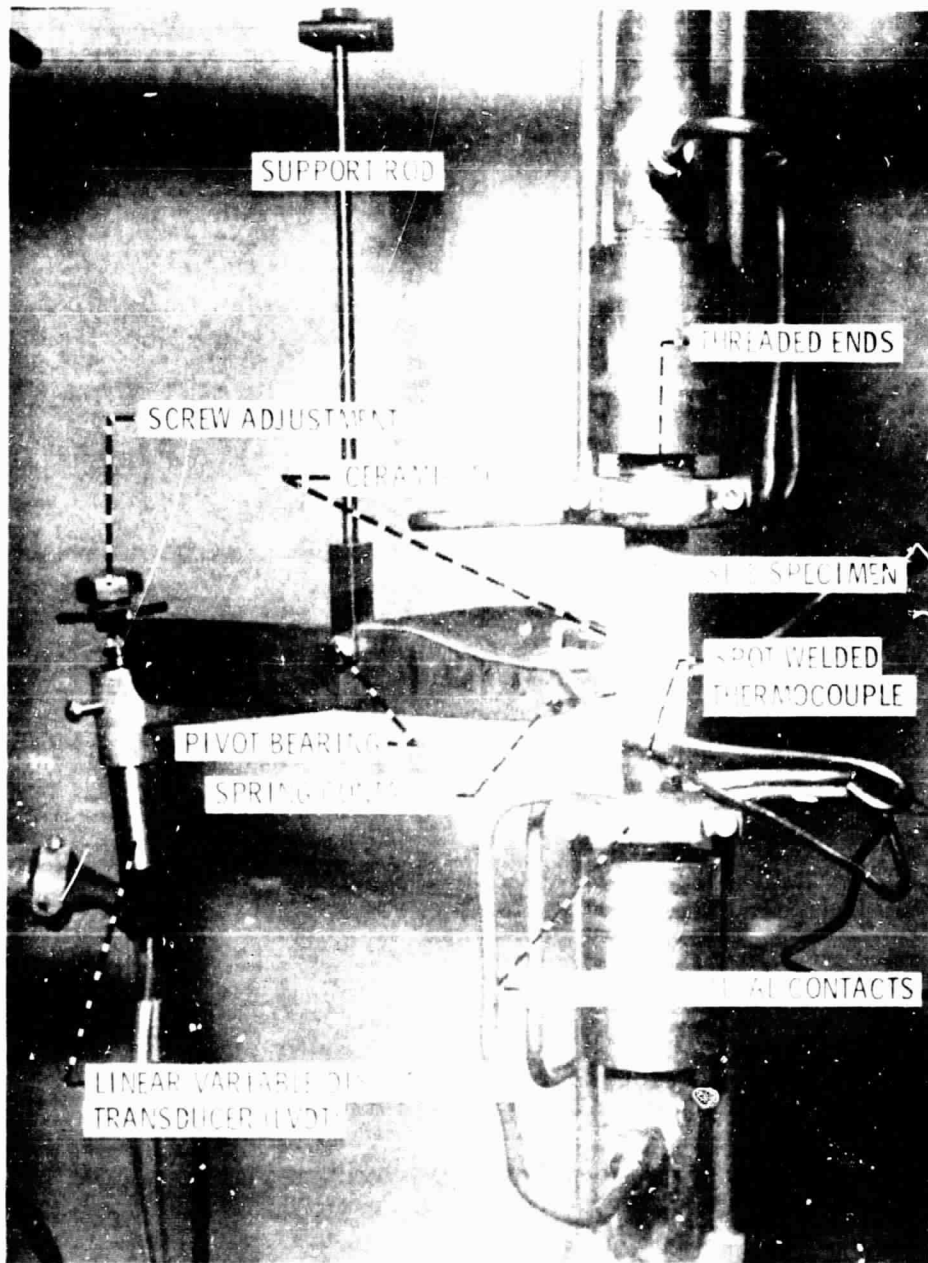

Figure 2. - Photograph of the apparatus used to test the specimen.

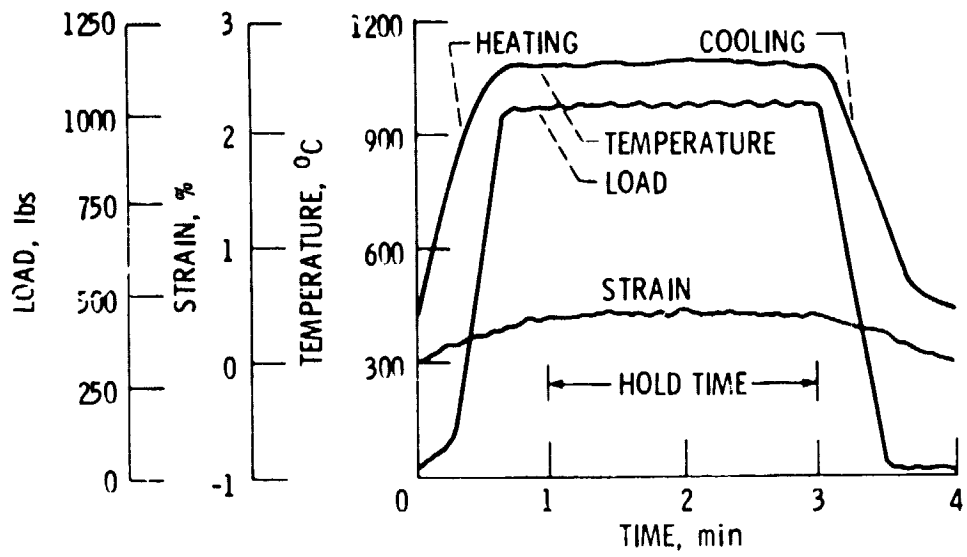

Figure 3. - Typical load and heat cycle plot for thermal mechanical fatigue test.

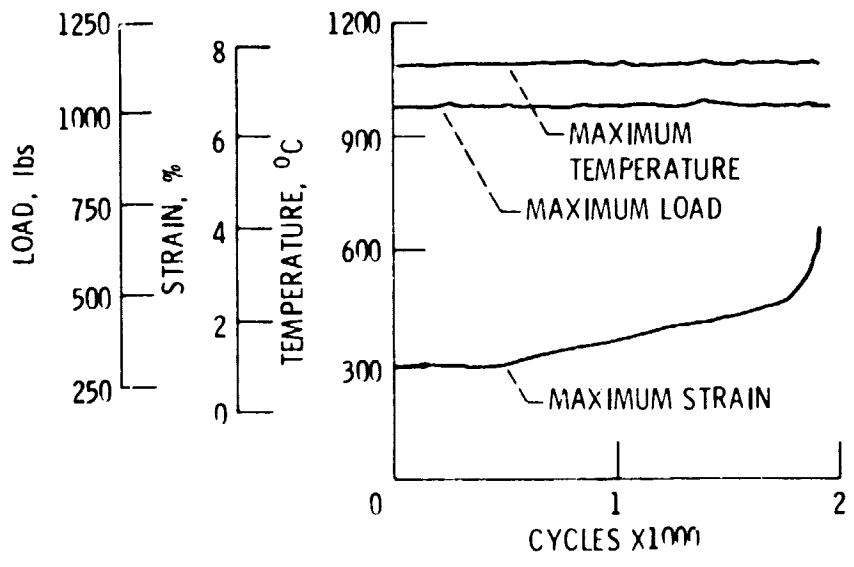

Figure 4. - Typical plot for completed thermal mechanical fatigue test.

ORIGINAL PAGE IS  
OF POOR QUALITY

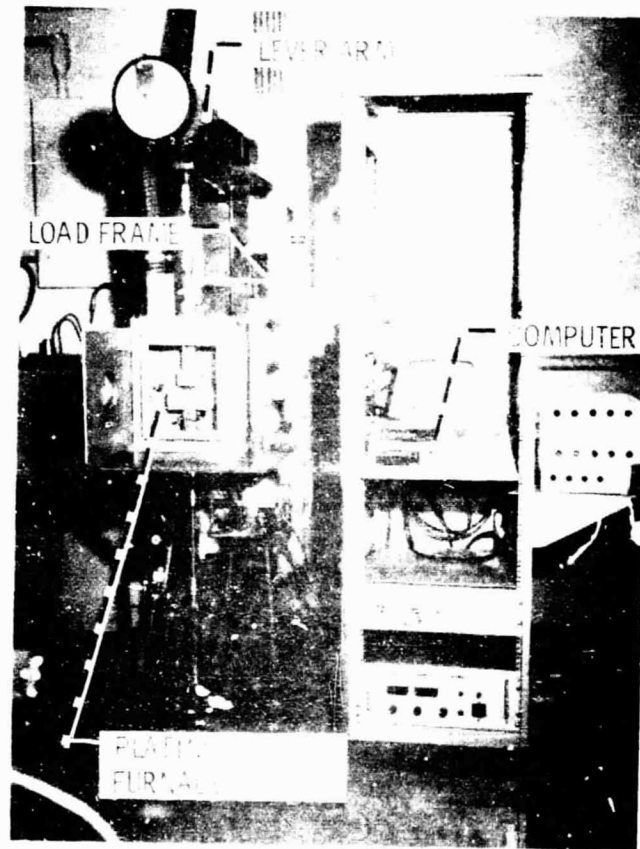
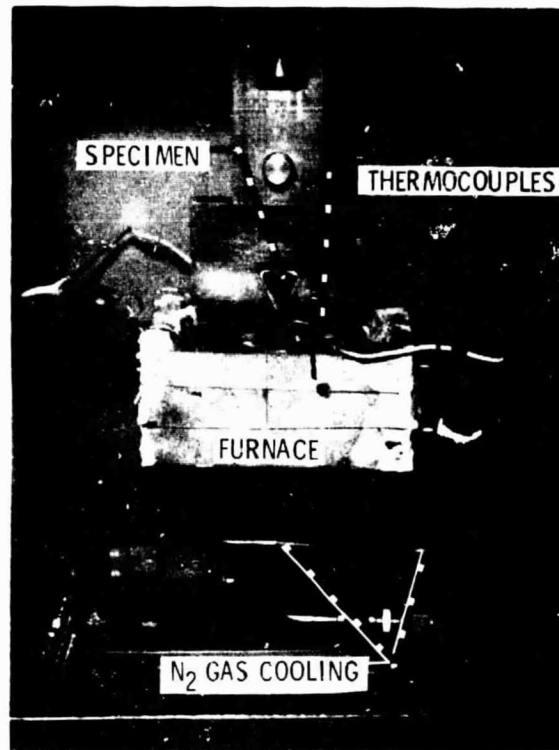
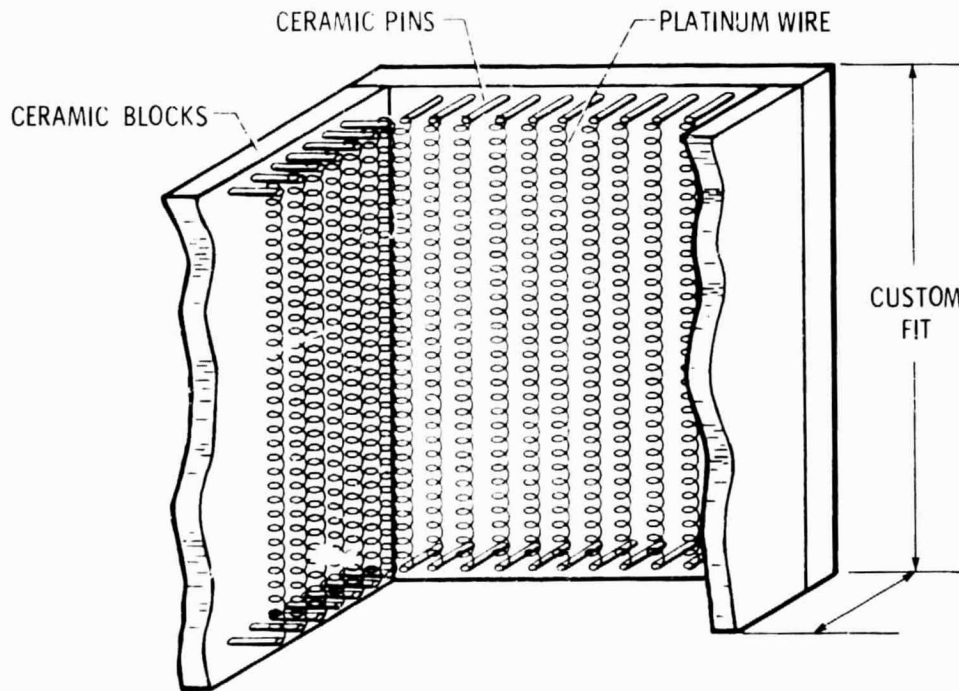

Figure 5. - Photograph of Rest Block test apparatus.

ORIGINAL PAGE IS  
OF POOR QUALITY



(a) Photograph of furnace and test specimen.



(b) Schematic of furnace design.

Figure 6.



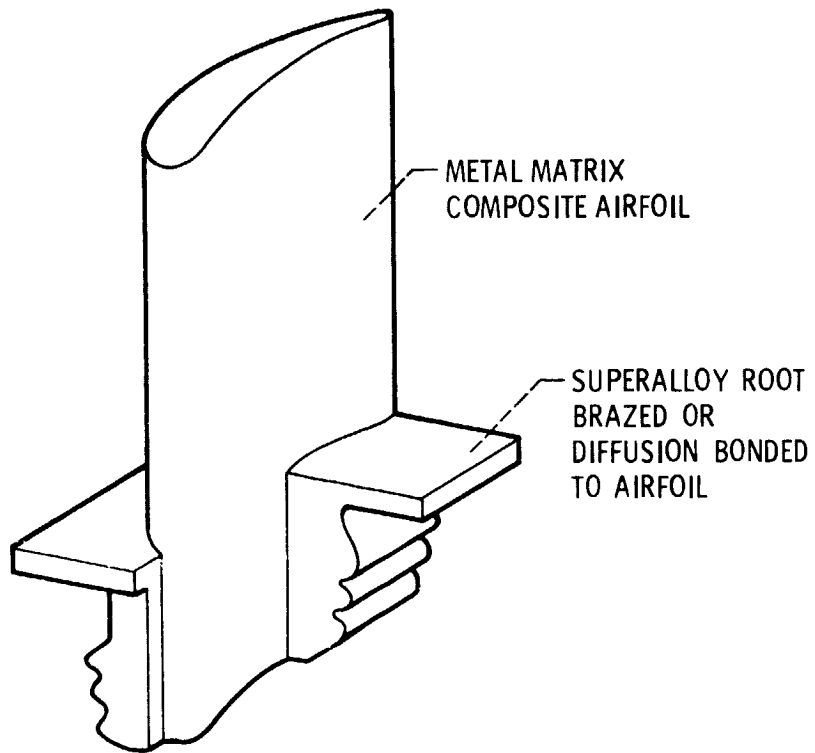

Figure 7. - Metal matrix composite turbine blade.

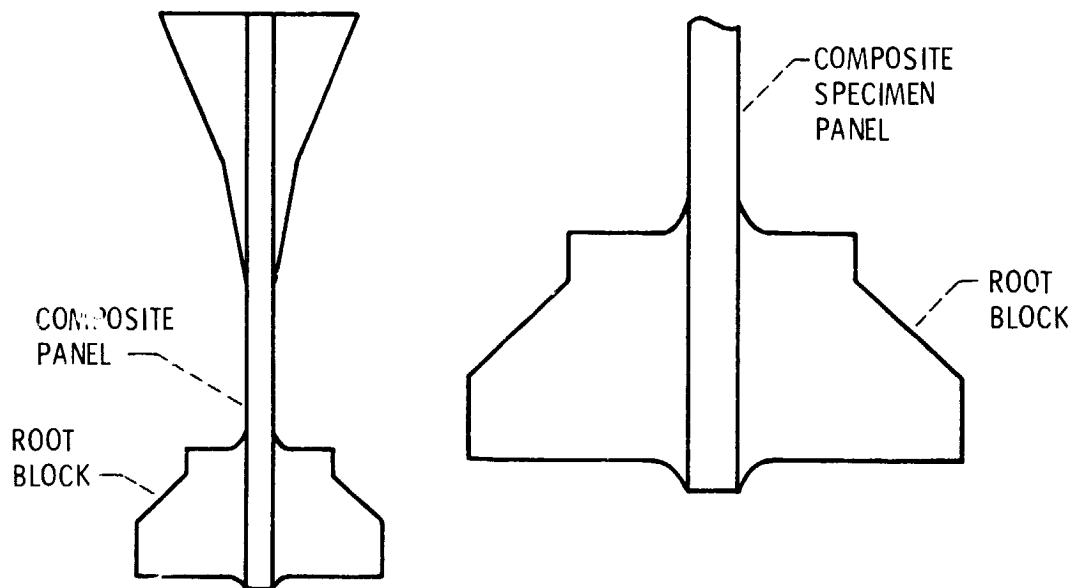

Figure 8. - Root block attachment specimen.

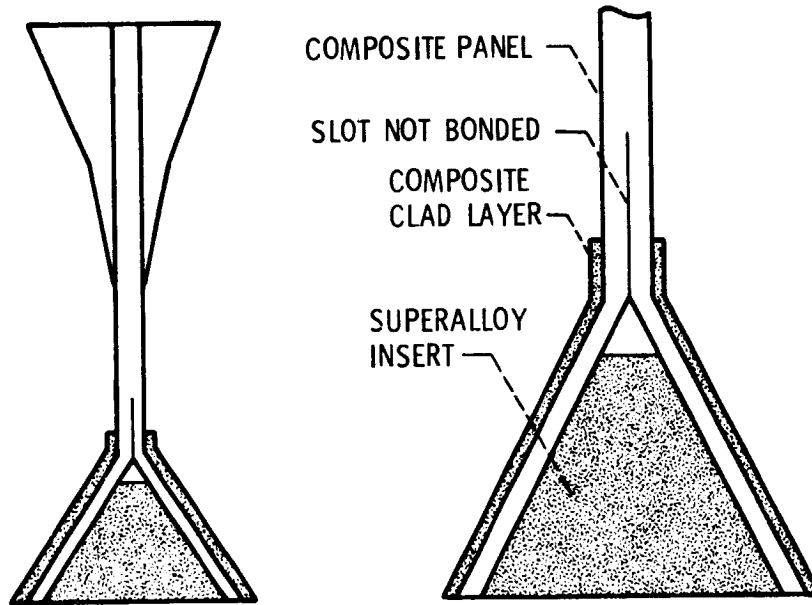

Figure 9. - Dovetail root attachment specimen.

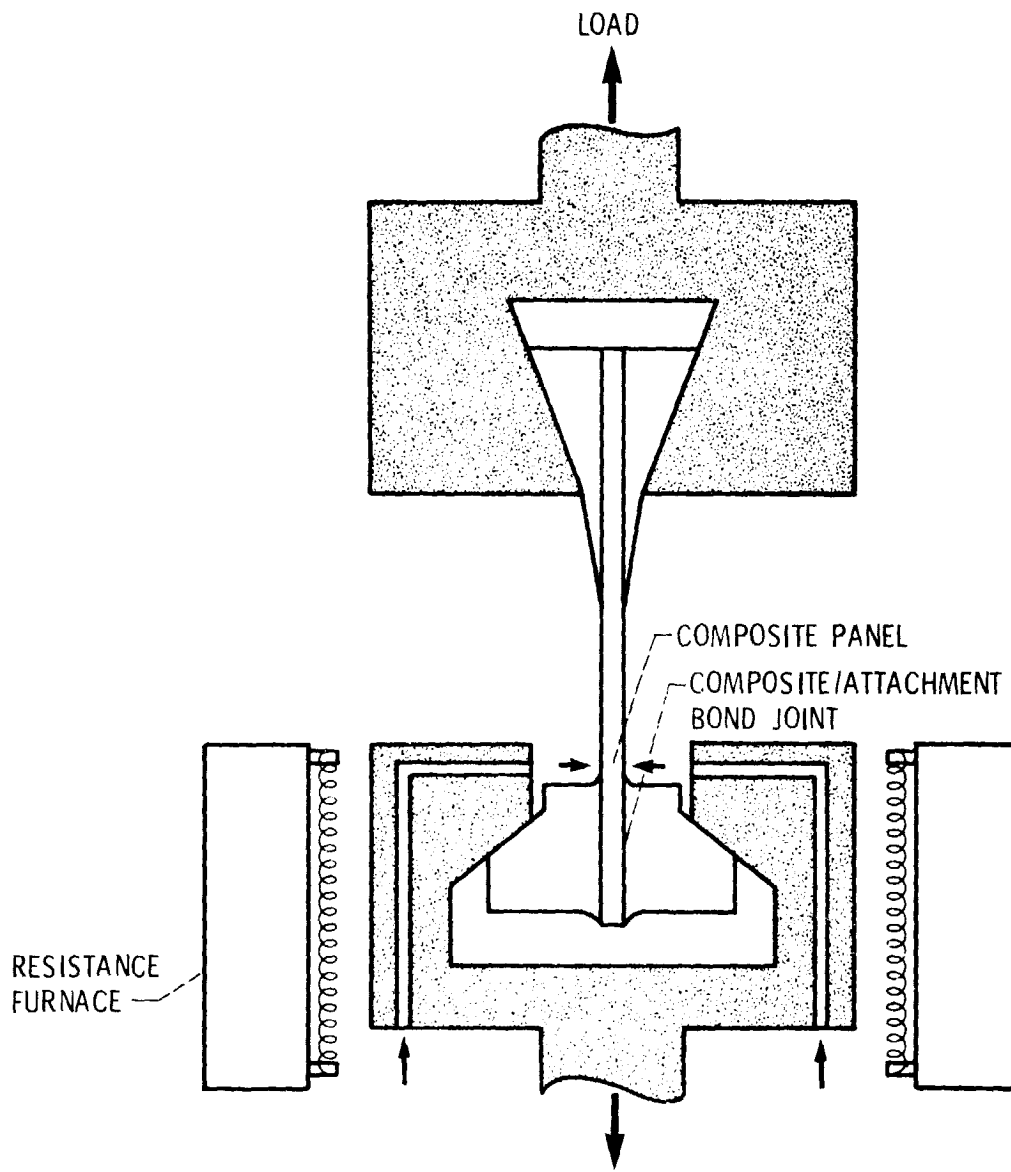

Figure 10. - Root block thermal cycle test.

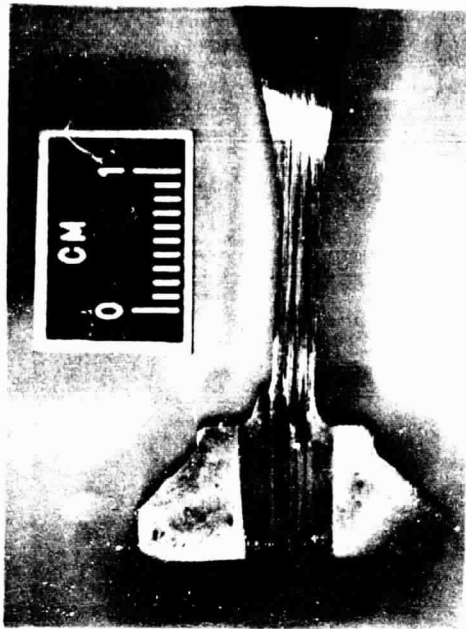

Figure 11. - Typical composite/attached bond joint thermal-mechanical fatigue failure.

ORIGINAL PAGE IS  
OF POOR QUALITY

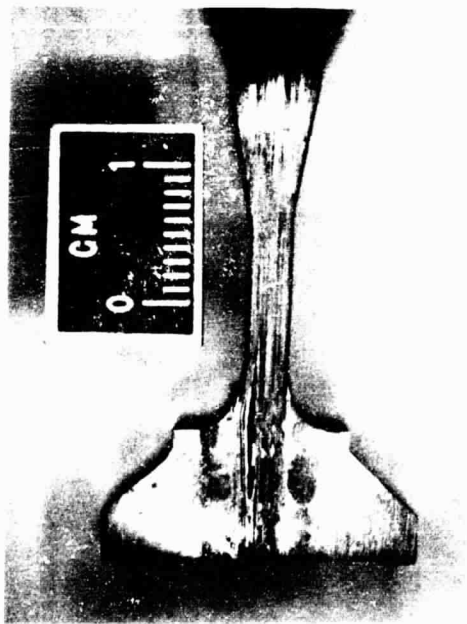

Figure 12. - Typical composite panel delamination due to thermal-mechanical fatigue.

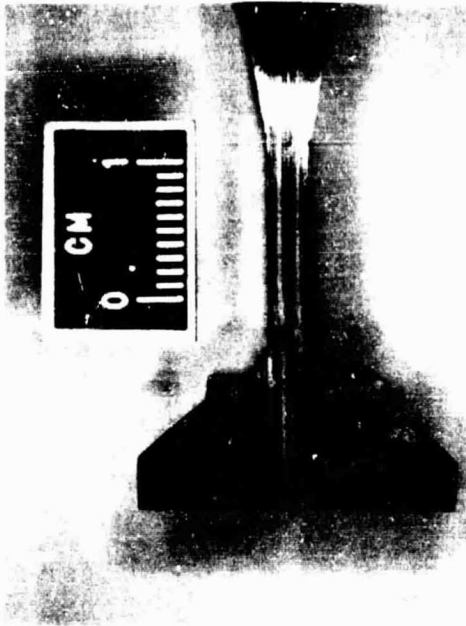

Figure 13. - Typical combination panel and delamination failure due to thermal mechanical fatigue.

**ORIGINAL PAGE IS  
OF POOR QUALITY**

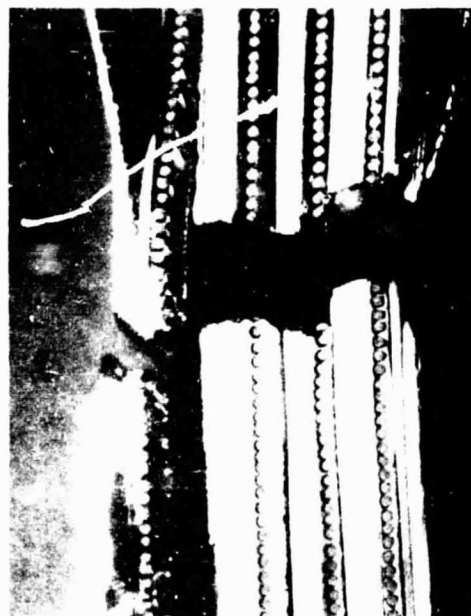
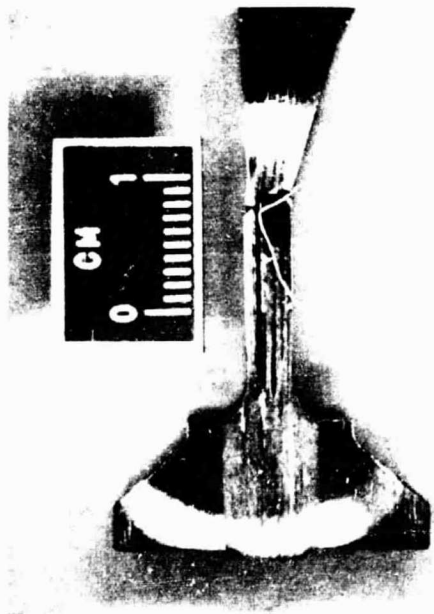

Figure 14. - Typical panel failure due to thermal - mechanical fatigue.

1. Report No. <b>NASA TM-87187</b>	2. Government Accession No.	3. Recipient's Catalog No.	
4. Title and Subtitle <b>Thermal-Mechanical Fatigue Test Apparatus For Metal Matrix Composites and Joint Attachments</b>		5. Report Date	
		6. Performing Organization Code <b>505-33-62</b>	
7. Author(s) <b>Leonard J. Westfall and Donald W. Petrusek</b>		8. Performing Organization Report No. <b>E-2773</b>	
		10. Work Unit No.	
9. Performing Organization Name and Address <b>National Aeronautics and Space Administration Lewis Research Center Cleveland, Ohio 44135</b>		11. Contract or Grant No.	
		13. Type of Report and Period Covered <b>Technical Memorandum</b>	
12. Sponsoring Agency Name and Address <b>National Aeronautics and Space Administration Washington, D.C. 20546</b>		14. Sponsoring Agency Code	
15. Supplementary Notes <b>Prepared for the First Symposium on Testing Technology of Metal Matrix Composites sponsored by the American Society for Testing and Materials, Nashville, Tennessee, November 18-20, 1985.</b>			
16. Abstract <p>Two thermal-mechanical fatigue (TMF) test facilities were designed and developed, one to test tungsten fiber reinforced metal matrix composite specimens at temperature up to 1430 °C (2600 °F) and another to test composite/ metal attachment bond joints at temperatures up to 760 °C (1400 °F). The TMF facility designed for testing tungsten fiber reinforced metal matrix composites permits test specimen temperature excursions from room temperature to 1430 °C (2600 °F) with controlled heating and loading rates. A strain-measuring device measures the strain in the test section of the specimen during each heating and cooling cycle with superimposed loads. Data is collected and recorded by a computer. The second facility was designed to test composite/metal attachment bond joints and to permit heating to a maximum temperature of 760 °C (1400 °F) within 10 min and cooling to 150 °C (300 °F) within 3 min. a computer controls specimen temperature and load cycling.</p>			
17. Key Words (Suggested by Author(s)) <b>Thermal Mechanical Fatigue Apparatus, Composites, Testing, Resistance Heating</b>		18. Distribution Statement <b>Unclassified - unlimited STAR Category 26</b>	
19. Security Classif. (of this report) <b>Unclassified</b>	20. Security Classif. (of this page) <b>Unclassified</b>	21. No. of pages	22. Price