

Larry Kieffling ED23

LMSC-HEC TR F042668

SSME STRUCTURAL DYNAMIC MODEL DEVELOPMENT - PHASE II

FINAL REPORT

1 November 1985

(NASA-CR-178708) SSME STRUCTURAL DYNAMIC
MODEL DEVELOPMENT, PHASE 2 Final Report
(Lockheed Missiles and Space Co.) 234 p
HC A11/MF A01

N86-20496

CSSL 21H

Unclas

G3/20 05444

Contract NAS8-34973

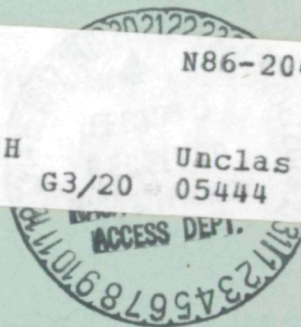

Prepared for

**NATIONAL AERONAUTICS AND SPACE ADMINISTRATION
MARSHALL SPACE FLIGHT CENTER, AL 35812**

by M. J. Foley and V. L. Wilson

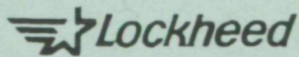

*Missiles & Space Company, Inc
Huntsville Engineering Center*

4800 Bradford Drive, Huntsville, AL 35807

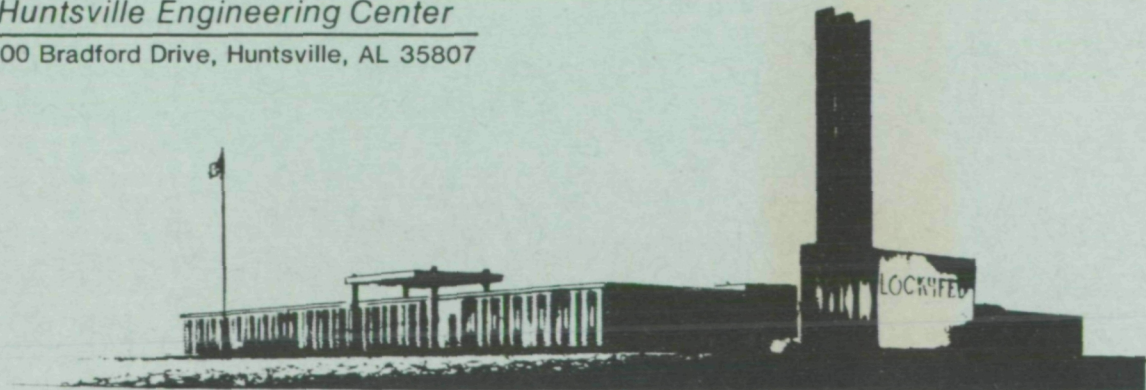

FOREWORD

This technical report summarizes the efforts to produce a set of test correlated dynamic math models of the various components that comprise the Space Shuttle Main Engine (SSME) powerhead. The work was performed by personnel of the Dynamics & Loads Group, Mechanical Systems Section of the Lockheed-Huntsville Engineering Center under Contract NAS8-34973 for the MSFC Systems Dynamics Laboratory, Systems Analysis Branch. All technical activities were monitored by Mr. Larry A. Kiefling and Mr. M. Shane Swint, ED22.

CONTENTS

<u>Section</u>		<u>Page</u>
	FOREWORD	ii
1	INTRODUCTION	1
2	HPOTP ROTOR ASSEMBLY	3
3	HPOTP PUMP HOUSING	9
4	COMPONENT MODE ANALYSIS	33
5	CONCLUSIONS AND RECOMMENDATIONS	44
6	REFERENCES	46

Appendixes

A	LOX Pump Rotor Assembly Data Listing
B	LOX Pump Housing Data Listing
C	Craig-Bampton Procedure Listing

LIST OF TABLES

<u>Table</u>		<u>Page</u>
1	HPOTP Frequency Comparison	11
2	LOX Pump Computed Frequencies with the Flange Constrained	12
3	Natural Frequencies for Truss Sample Problem	38
4	Natural Frequencies for Plate Sample Problem	38

LIST OF FIGURES

<u>Figure</u>		<u>Page</u>
1	HPOTP Rotor Free-Free Bending Modes	4
2	HPOTP Rotor Free-Free Bending Modes	4
3	HPOTP Rotor Free-Free Bending Modes	5
4	HPOTP Rotor Free-Free Bending Modes	5
5	HPOTP Rotor Free-Free Bending Modes	6
6	HPOTP Rotor Free-Free Bending Modes	6
7	HPOTP Rotor Free-Free Bending Modes	7
8	HPOTP Rotor Free-Free Bending Modes	7
9	HPOTP Rotor Free-Free Bending Modes	8
10	HPOTP Rotor Free-Free Bending Modes	8
11	HPOTP Test Article - Coordinate System	13
12	First Elastic Mode	14
13	Second Elastic Mode	15
14	Third Elastic Mode	16
15	Fourth Elastic Mode	17
16	Fifth Elastic Mode	18
17	Sixth Elastic Mode	19
18	Seventh Elastic Mode	20
19	Eighth Elastic Mode	21
20	Ninth Elastic Mode	22
21	Tenth Elastic Mode	23
22	Constrained Nodes on the Flange at the Bolt Circle Joints 643 Through 649	24
23	Vibrational Mode, Freq. (Hz)	25
24	Vibrational Mode, Freq. (Hz)	26
25	Vibrational Mode, Freq. (Hz)	27
26	Vibrational Mode, Freq. (Hz)	28
27	Vibrational Mode, Freq. (Hz)	29

LIST OF FIGURES (Concluded)

<u>Figure</u>		<u>Page</u>
28	Vibrational Mode, Freq. (Hz)	30
29	Vibrational Mode, Freq. (Hz)	31
30	Vibrational Mode, Freq. (Hz)	32
31	Truss Undeformed Structure	39
32	Truss Substructure (ME1)	40
33	Truss Residual Structure	41
34	Annular Plate Macro-Element	42
35	Annular Plate System Joints	43

1. INTRODUCTION

Considerable interest has been focused by the engineering staff at NASA-MSFC Systems Dynamics Laboratory on the performance of the SSME powerhead. In particular, a new design (two-duct) Hot Gas Manifold, single crystal blades for the rotating equipment, and detailed knowledge of the dynamic behavior of the turbopumps have all received attention for the development engine program. The objective of the work described in this report was to produce a set of test correlated mathematical models of the SSME High Pressure Oxygen Turbopump (HPOTP) housing and rotor assembly. Because this effort was in support of a dynamic test program, there were several delays while awaiting tooling and other hardware from the pump manufacturer. This time was used to investigate new analysis methods within the EISI/EAL (Ref. 1) and SPAR (Ref. 2) systems and develop runstreams for future use.

The LOX pump models have undergone extensive modification since the first phase of this effort was completed in December 1983 (Ref. 3). The rotor assembly from the original model was abandoned and a new, more detailed model constructed. A description of the new rotor math model is presented in Section 2 of this report. Also, the pump housing model has been continually modified as additional test data have become available. This model is documented in Section 3 along with measured test results.

During the contract period many of the more advanced features of the EAL/SPAR finite element analysis system were exercised. These included the cyclic symmetry option, the macro-element procedures, and the fluid analysis capability. In addition, a new tool was developed that allows an automated analysis of a disjoint structure in terms of its component modes. A complete description of the implementation of the Craig-Bampton method (Ref. 4) is given in Section 4 along with two worked examples.

Finally, Conclusions and Recommendations are presented in Section 5 along with a brief description of some ideas for future analysis efforts. The tasks suggested are consistent with previous work in that their ultimate goal is to provide a more thorough understanding of the SSME powerhead via detailed finite element analysis and test correlation.

2. HPOTP ROTOR ASSEMBLY

The first component to undergo vibration testing during this analysis effort was the HPOTP rotor assembly. After extracting the rotor assembly from the existing LOX pump model developed during the first phase of this contract, it became apparent that sufficient detail was not present with the simple beam representation. A new rotor model was then constructed with the necessary fidelity to provide correlation with the shaft twist measurements. In addition, an improved load path into the turbine hub was obtained along with a needed reduction of the impeller inertia. Symmetric and anti-symmetric constraints were applied to a 180-deg model to compute the free vibration frequencies and mode shapes. The results of this model agreed with the measured test data to within 20 Hz for the first and second elastic modes. The first five bending modes are shown in Figs. 1 through 5 with an expanded view of the turbine hub plotted in Figs. 6 through 10. These frequencies cover the zero to 1500 Hz range.

VIBRATIONAL MODE, FREQ (HZ) $.449952 \times 10^{+03}$

ID-3/2/3

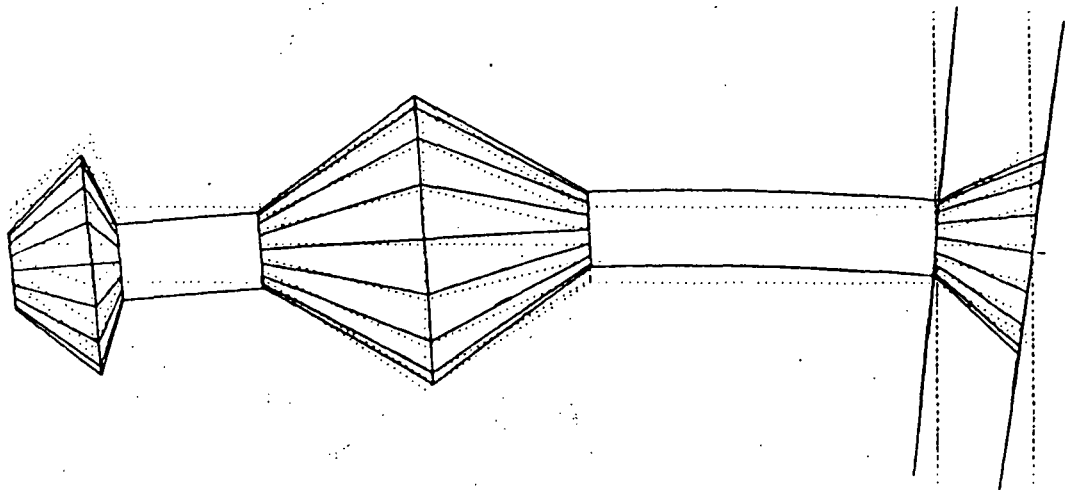

Fig. 1 HPOTP Rotor Free-Free Bending Modes

VIBRATIONAL MODE, FREQ (HZ) $.831339 \times 10^{+03}$

ID-3/2/4

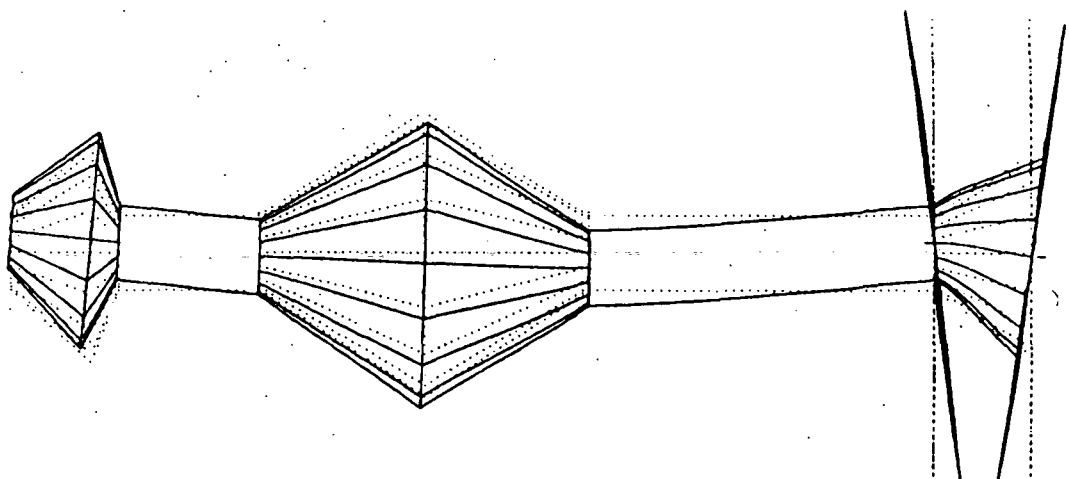

Fig. 2 HPOTP Rotor Free-Free Bending Modes

VIBRATIONAL MODE, FREQ (HZ) $.938738 \times 10^{+03}$

ID-3/2/5

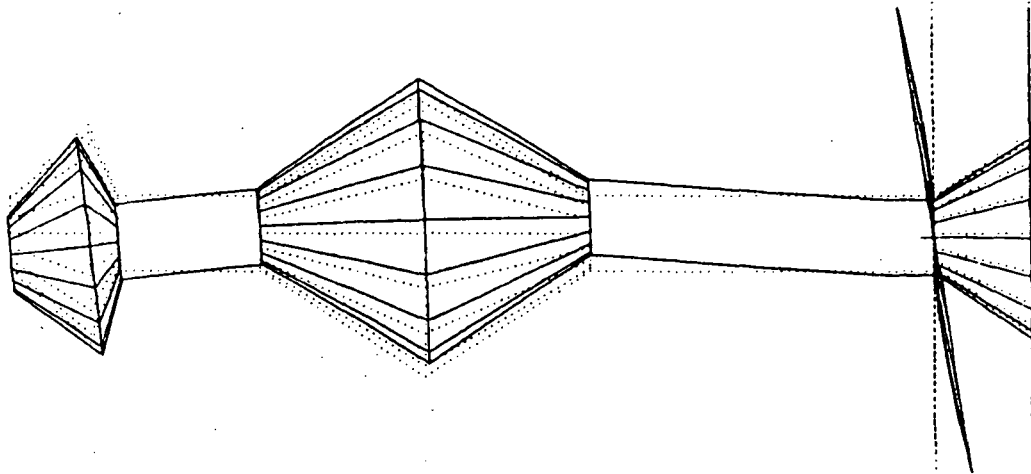

Fig. 3 HPOTP Rotor Free-Free Bending Modes

VIBRATIONAL MODE, FREQ (HZ) $.119896 \times 10^{+04}$

ID-3/2/6

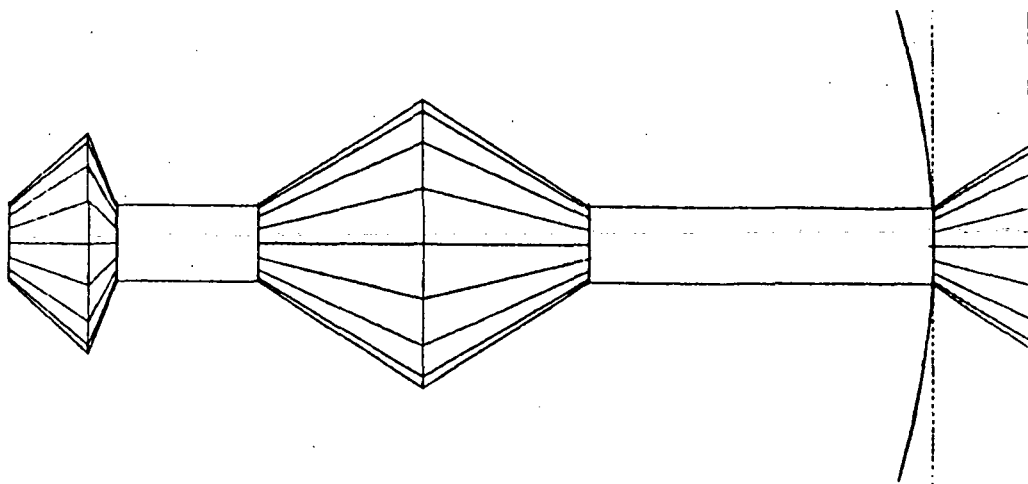

Fig. 4 HPOTP Rotor Free-Free Bending Modes

VIBRATIONAL MODE, FREQ (HZ) $.163291 \times 10^{+04}$

ID-3/2/7

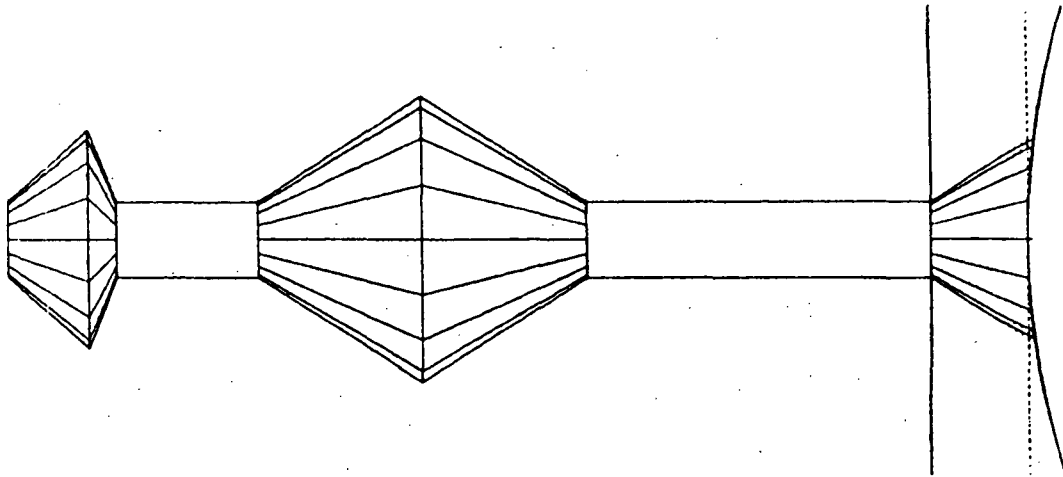

Fig. 5 HPOTP Rotor Free-Free Bending Modes

VIBRATIONAL MODE, FREQ (HZ) $.449952 \times 10^{+03}$

ID-3/2/3

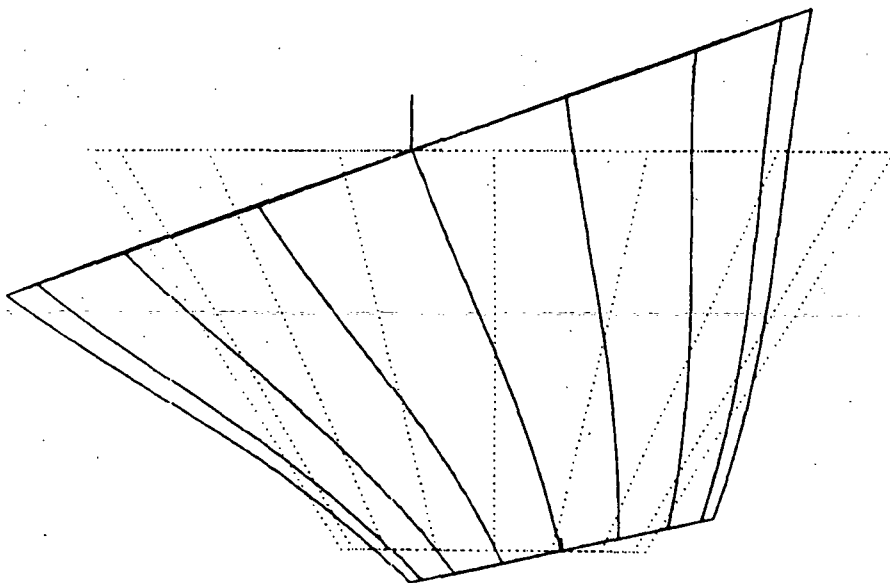

Fig. 6 HPOTP Rotor Free-Free Bending Modes

VIBRATIONAL MODE, FREQ (HZ) .831339X10⁺⁰³

ID-3/2/4

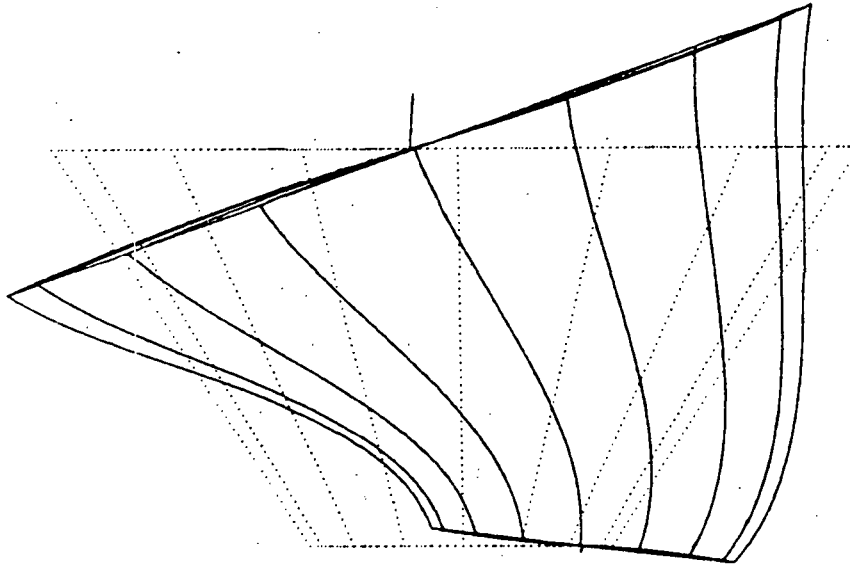

Fig. 7 HPOTP Rotor Free-Free Bending Modes

VIBRATIONAL MODE, FREQ (HZ) .938738X10⁺⁰³

ID-3/2/5

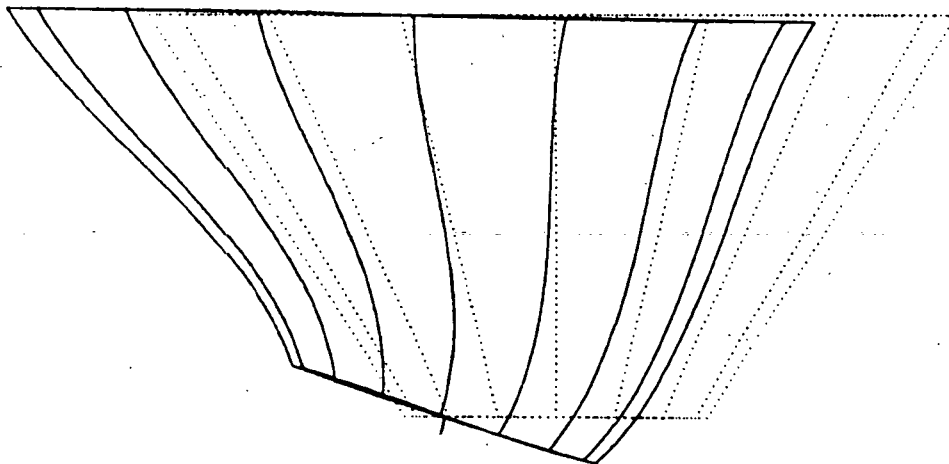

Fig. 8 HPOTP Rotor Free-Free Bending Modes

VIBRATIONAL MODE, FREQ (HZ) .119896X10⁺⁰⁴

ID-3/2/6

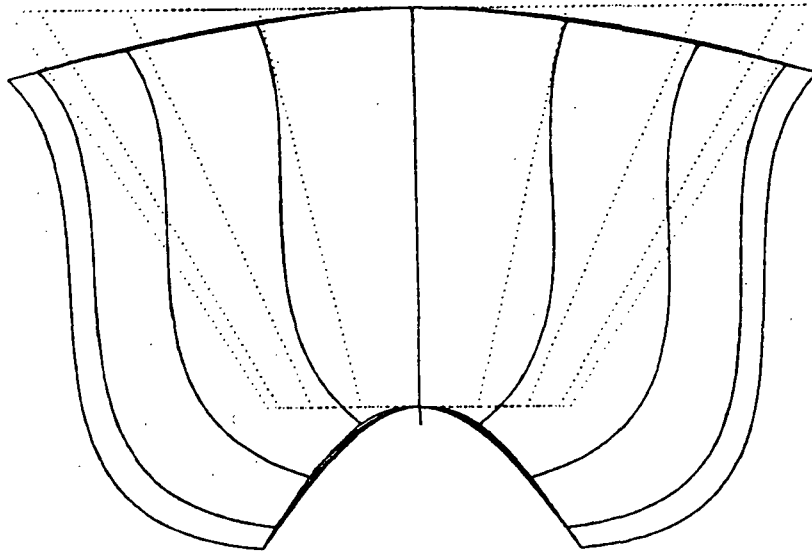

Fig. 9 HPOTP Rotor Free-Free Bending Modes

VIBRATIONAL MODE, FREQ (HZ) .163291X10⁺⁰⁴

ID-3/2/7

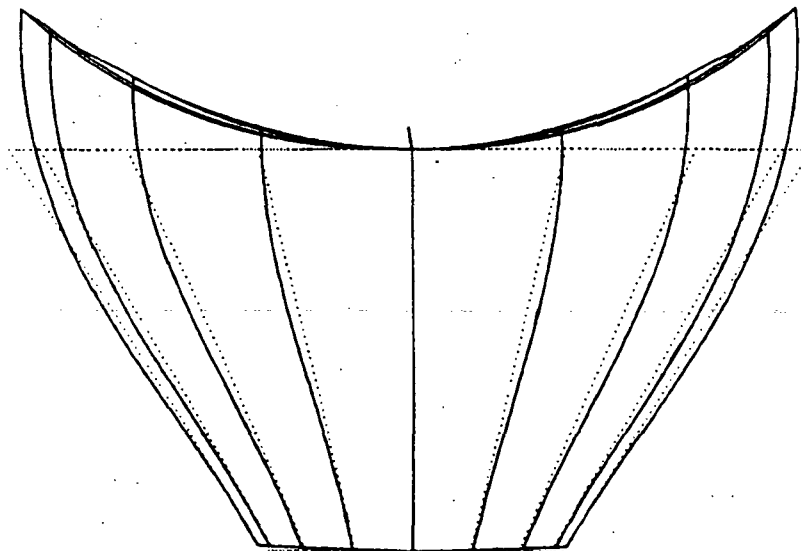

Fig. 10 HPOTP Rotor Free-Free Bending Modes

3. HPOTP PUMP HOUSING

The High Pressure Oxygen Turbopump (HPOTP) is an extremely complex and important component of the SSME powerhead. Dynamic analysis of this pump has required a considerable amount of modifications to the model developed during the first phase of this contract. The existing LOX pump SPAR model appears to be providing a reasonable prediction of the vibration behavior for both free and fixed boundary conditions. This section describes the development of the existing finite element model and the tuning of the model to correlate with measured test data.

Since the test article was the pump housing alone, the first modification to the HPOTP model was the removal of the rotor assembly, oxidizer preburner, and turbine housing. The turbine housing flange was modified to match more closely the local stiffness and provide constraint points at the bolt locations. Unfortunately, the high connectivity of this model was causing excessively long computer run times which soon became a problem. This long run time became significant while flight data reduction was being done on the NASA-MSFC Sperry computer. An effort was then made to run the model on Lockheed's in-house VAX 11/780 computer using EISI/EAL. Although this conversion was successful, no real gains were realized since the CPU time for the VAX was much higher and disk space requirements for this model quickly began to tax the local system resources. The decision was then made to abandon any further efforts on the in-house computer and resume the analysis on the GFE computer.

Measured test results from the "free-free" vibration tests correlated poorly with the initial pretest analysis. Reevaluation of the shell section properties used in some areas of the model revealed unrealistic stiffness and inertia inputs. The model was again modified in several local areas

until the weight and balance calculations agreed closely with the measured data. Also, the total number of system joints was reduced from over 800 to 665 during the process and the joint elimination sequence rewritten by hand. Overnight computer turnaround was then possible for a complete eigenvalue analysis of the math model. The results of the "free-free" test along with the analytical calculations are shown in Table 1. Figure 11 shows the global axes of the model superimposed on the undeformed geometry. The mode shapes for the first 10 elastic modes are shown in Figs. 12 through 21.

Current effort in the NASA Test Lab includes vibration testing of the LOX pump housing with the flange bolted to a rigid fixture. Pretest analysis was provided for this configuration by constraining the joints that represent the flange bolt locations as shown in Fig. 22. Computed frequencies for the "fixed" case are shown in Table 2; the corresponding vibration mode shapes are shown in Figs. 23 through 30.

Table 1 HPOTP FREQUENCY COMPARISON

Mode Number	Computed Freq. (Hz)	Measured Freq. (Hz)	Percent Difference	Description	Match (Y/N)
1	510	490	+4	Discharge Volute Bending in the X-Z Plane	Yes
2	699	689	+1	Discharge Volute to LPOTP Bending in the Y-Z Plane	Yes
3	805	764	+5	Discharge Volute to LPOTP Bending in the X-Y Plane	Yes
4	1106	964	+14	First Case Bending Mode (Y-Z Plane)	Yes
5	1133	986	+14	First Case Bending Mode (X-Z Plane)	Yes
6	1172	1086	+8	First Case Axial Mode in the Global X-Direction	Yes
7	1277	1216	+5	Second Case Bending Mode (Y-Z Plane)	Yes
8	1367	1361	+0.4	Torsion about the Global X-Axis	Yes
9	1487	1426	+4.2	Second Case Bending Mode (X-Z Plane)	Yes
10	1619	1611	+0.5	Discharge Volute Breathing Mode	Yes
11	1654	No Data			
12	1795	No Data			
13	1843	No Data			
14	1881	No Data			
15	1976	No Data			
16	2009	No Data			
17	2140	No Data			

SPAR Model Computed Weight = 255 lb

HPOTP Test Article Measured Weight = 251 lb

Percent Difference = +1.6

Table 2 LOX PUMP COMPUTED FREQUENCIES WITH THE
FLANGE CONSTRAINED

MODE	EIGENVALUE	FREQ (HZ)
1	.46396451+07	342.817146
2	.67877898+07	414.652554
3	.11258535+08	534.024399
4	.13957347+08	594.595459
5	.18679277+08	687.860207
6	.36078368+08	955.968529
7	.48622751+08	1109.787720
8	.60418840+08	1237.104385
9	.72960656+08	1359.454010
10	.90613981+08	1515.017868
11	.10460507+09	1627.783081
12	.11431131+09	1701.628510
13	.13639630+09	1858.751968
14	.14205290+09	1896.903336
15	.15516206+09	1982.498718
16	.16053853+09	2016.553711
17	.18082719+09	2140.188477
18	.18840222+09	2184.555878
19	.21348396+09	2325.427338
20	.21868624+09	2353.590393

18 = NO. OF EIGENVALUES BELOW LAST SHIFT POINT.

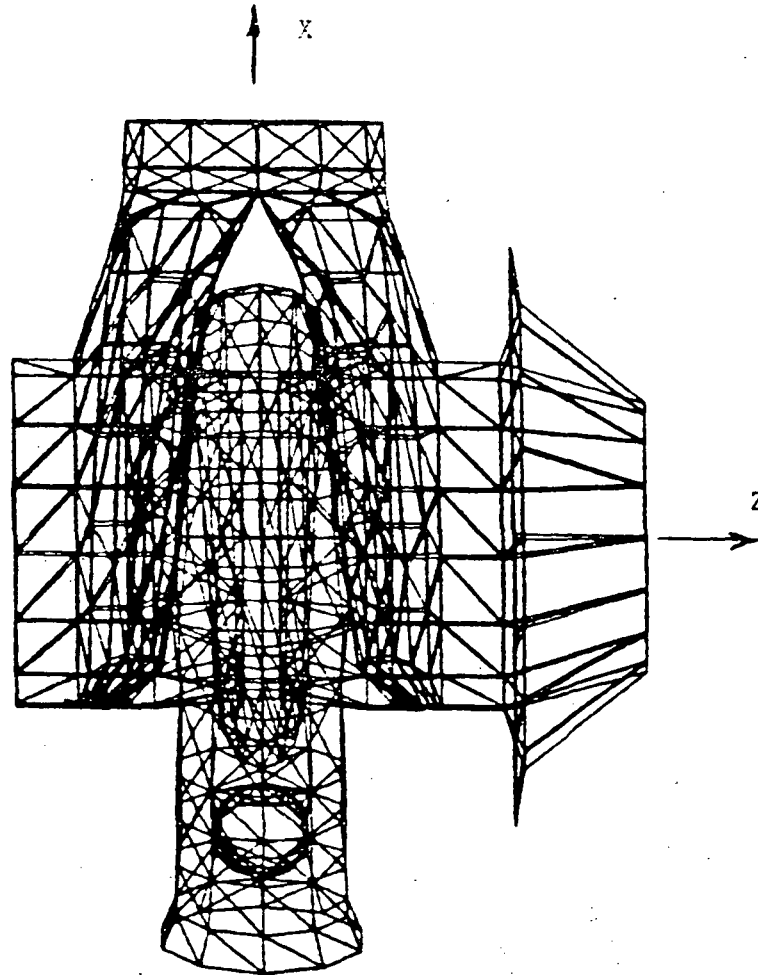

Fig. 11 - HPOTP Test Article - Coordinate System

VIBRATIONAL MODE, FREQ (HZ) $.510390 \times 10^{+03}$

ID-2/1/1

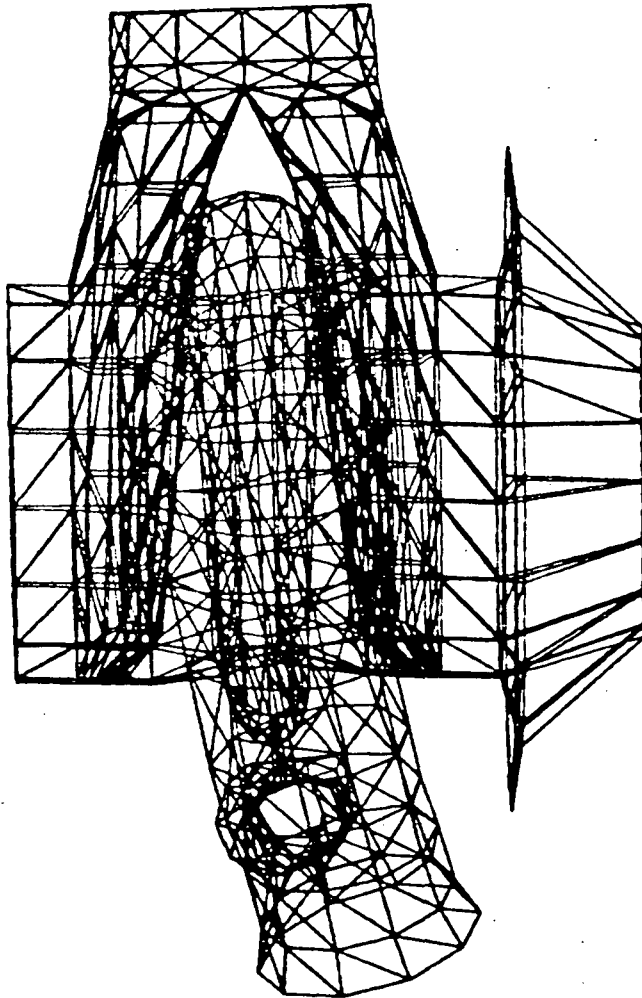

Fig. 12 First Elastic Mode

VIBRATIONAL MODE, FREQ (HZ) $.698794 \times 10^{+03}$

ID=2/1/2

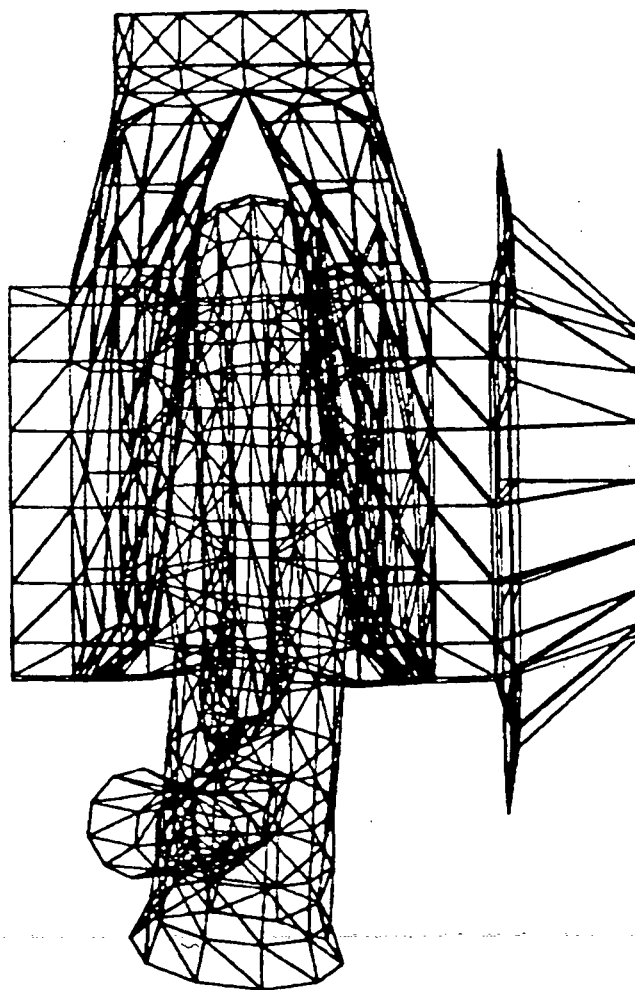

Fig. 13 Second Elastic Mode

VIBRATIONAL MODE, FREQ (HZ) $.804819 \times 10^{+03}$

ID-2/1/3

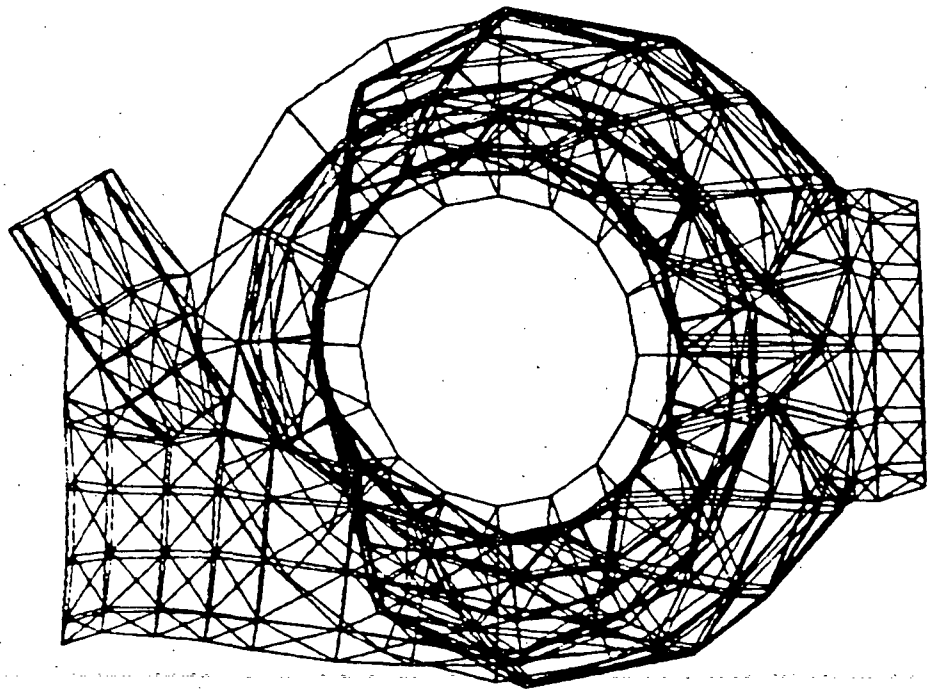

Fig. 14 Third Elastic Mode

VIBRATIONAL MODE, FREQ (HZ) $.110597 \times 10^{+04}$

ID=2/1/4

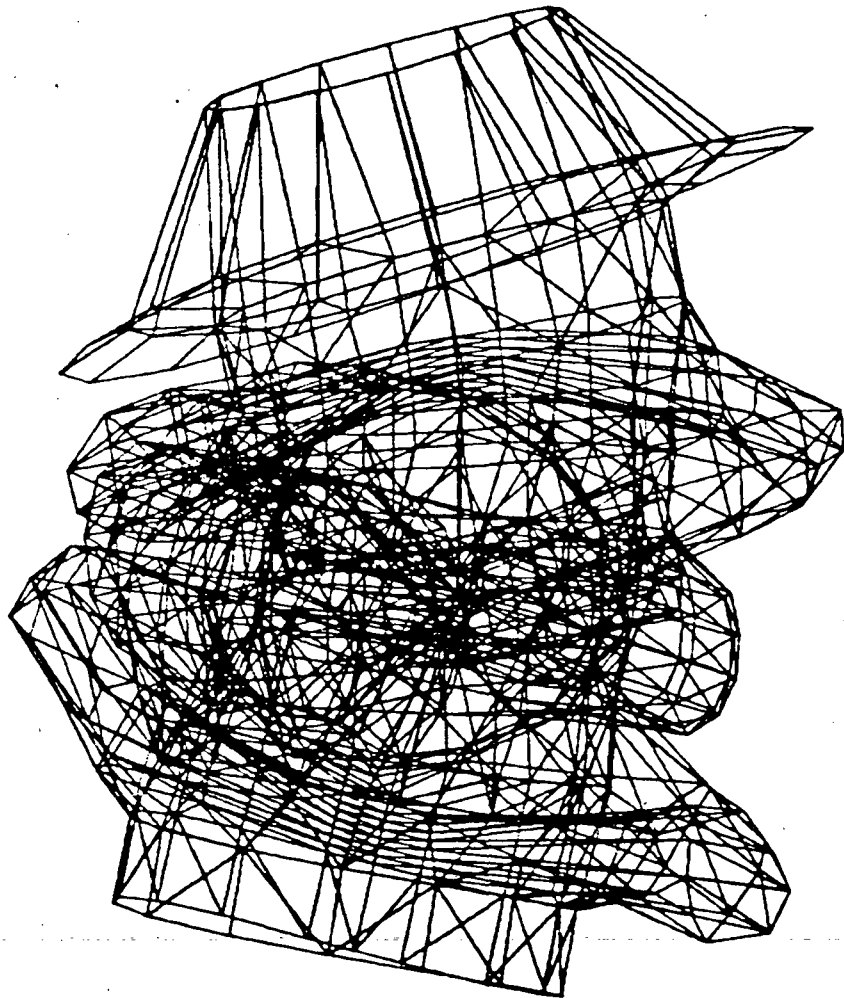

Fig. 15 Fourth Elastic Mode

VIBRATIONAL MODE, FREQ (HZ) . . .113259X10⁺⁰⁴

ID-2/1/5

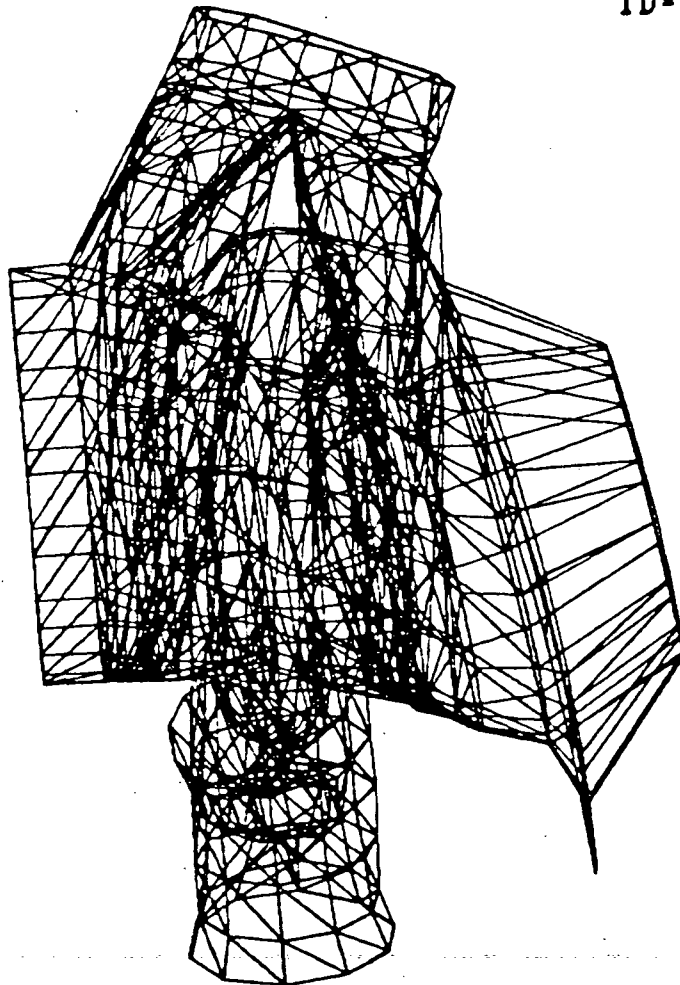

Fig. 16 Fifth Elastic Mode

VIBRATIONAL MODE, FREQ (HZ) $.117281 \times 10^{+04}$

ID=2/1/6

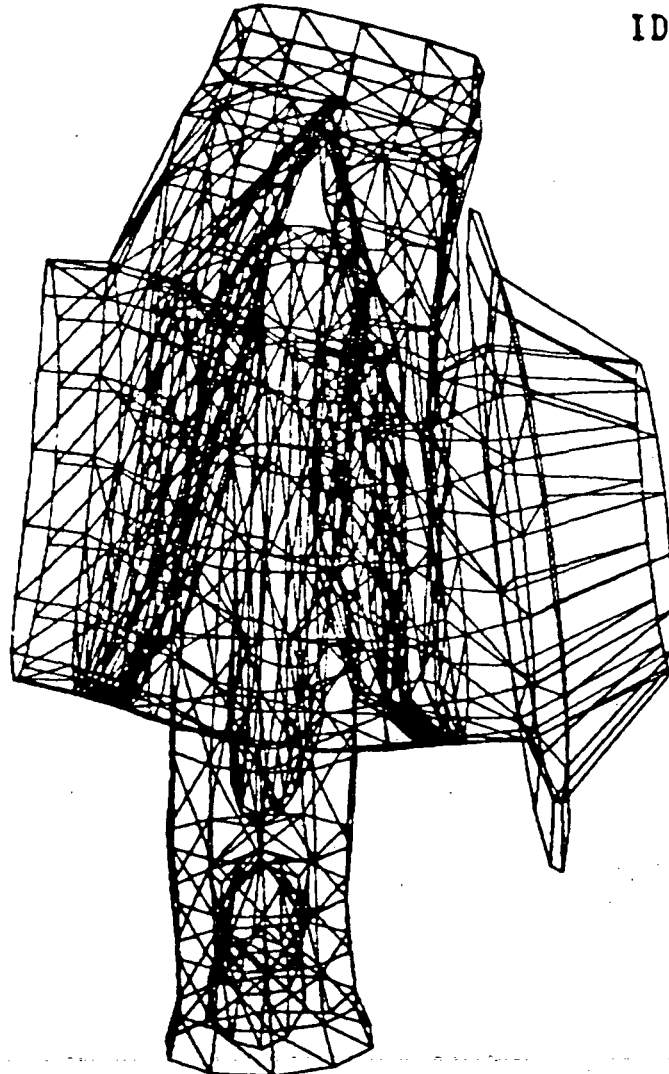

Fig. 17 Sixth Elastic Mode

VIBRATIONAL MODE, FREQ (HZ) .127668X10⁺⁰⁴

ID=2/1/7

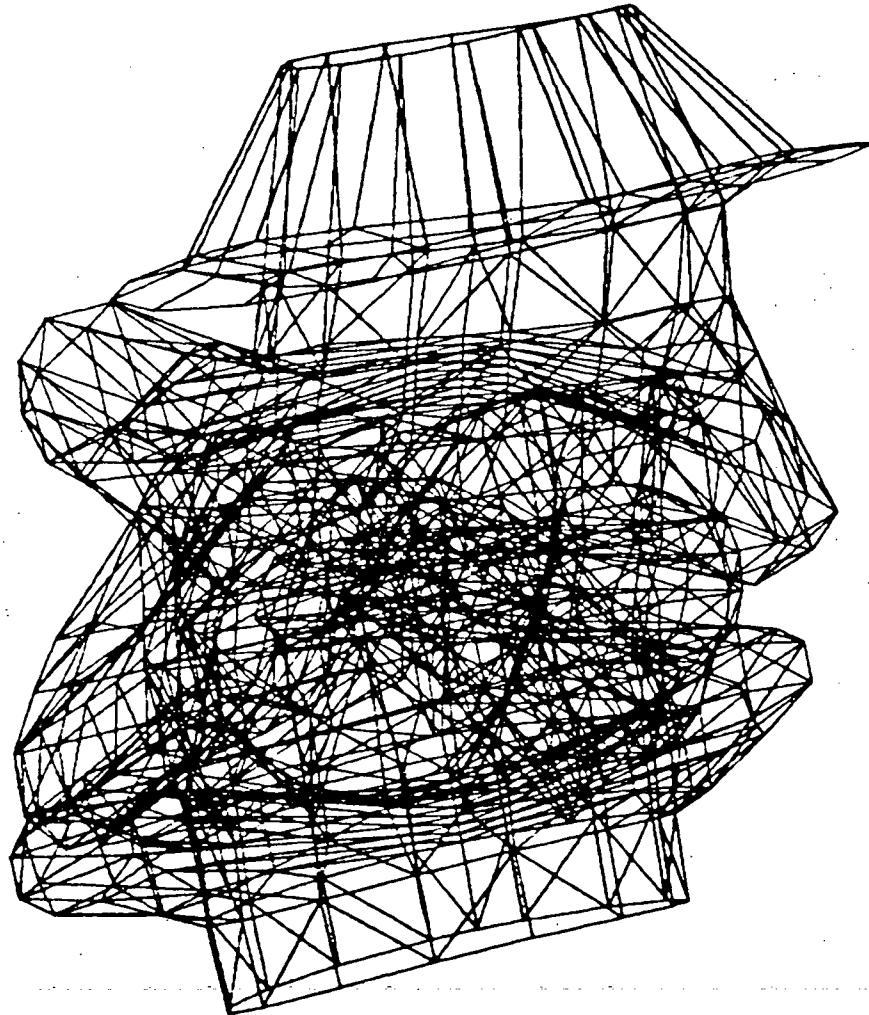

Fig. 18 Seventh Elastic Mode

VIBRATIONAL MODE, FREQ (HZ) $.136683 \times 10^{+04}$

ID=2/1/8

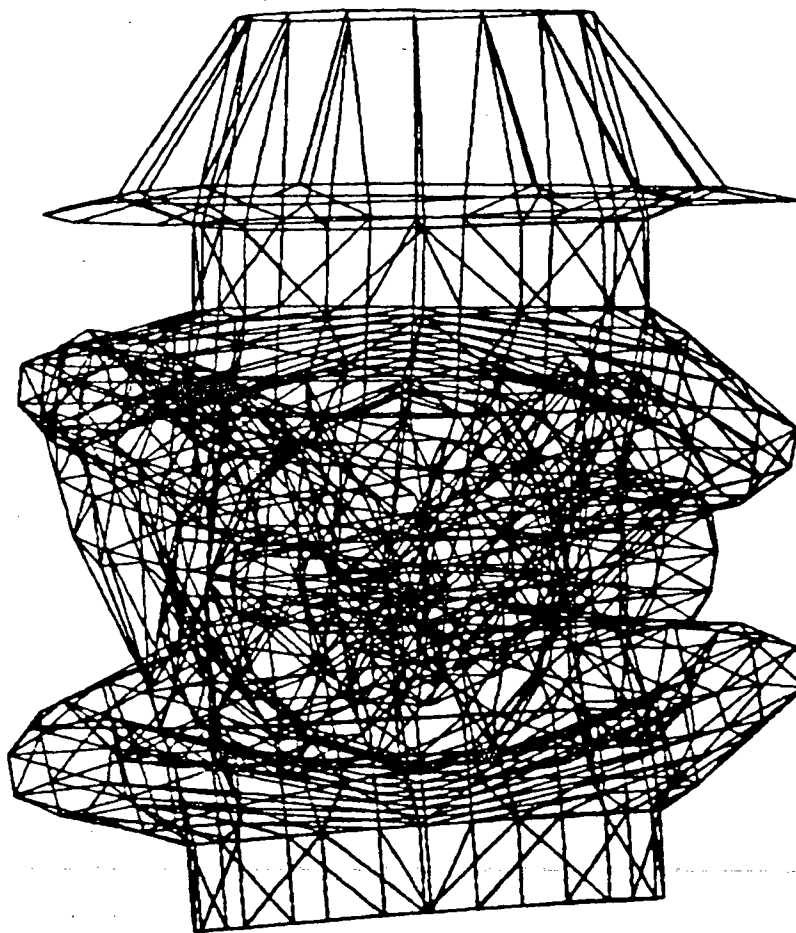

Fig. 19 Eighth Elastic Mode

VIBRATIONAL MODE, FREQ (HZ) .148727X10⁺⁰⁴

ID-2/1/9

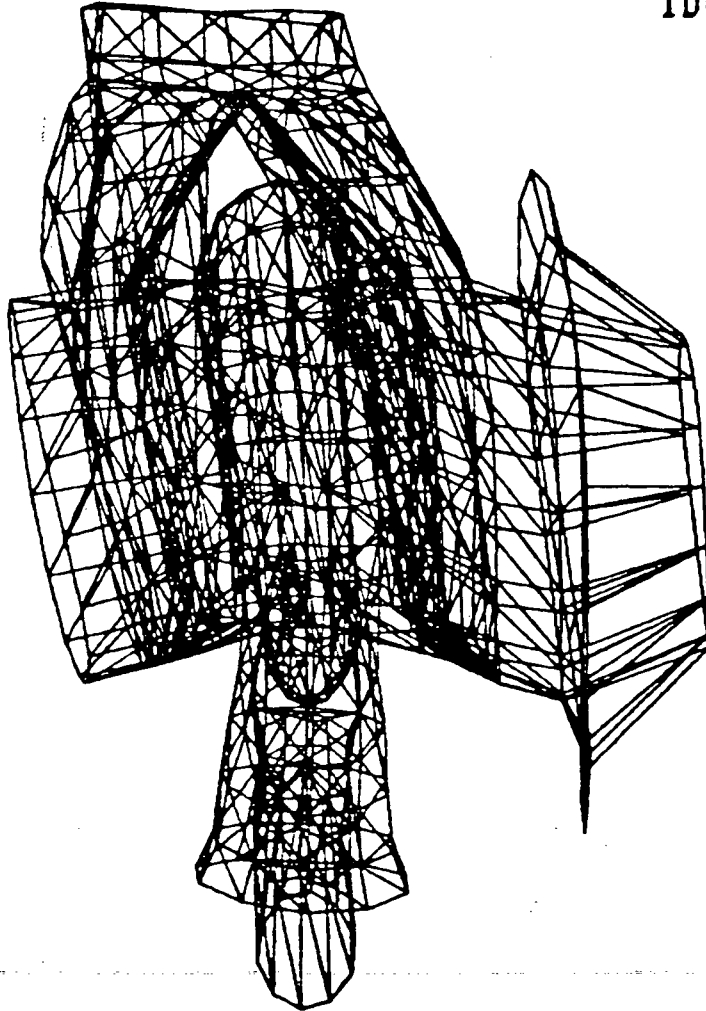

Fig. 20 Ninth Elastic Mode

VIBRATIONAL MODE, FREQ (HZ) .161883X10⁺⁰⁴

ID=2/1/10

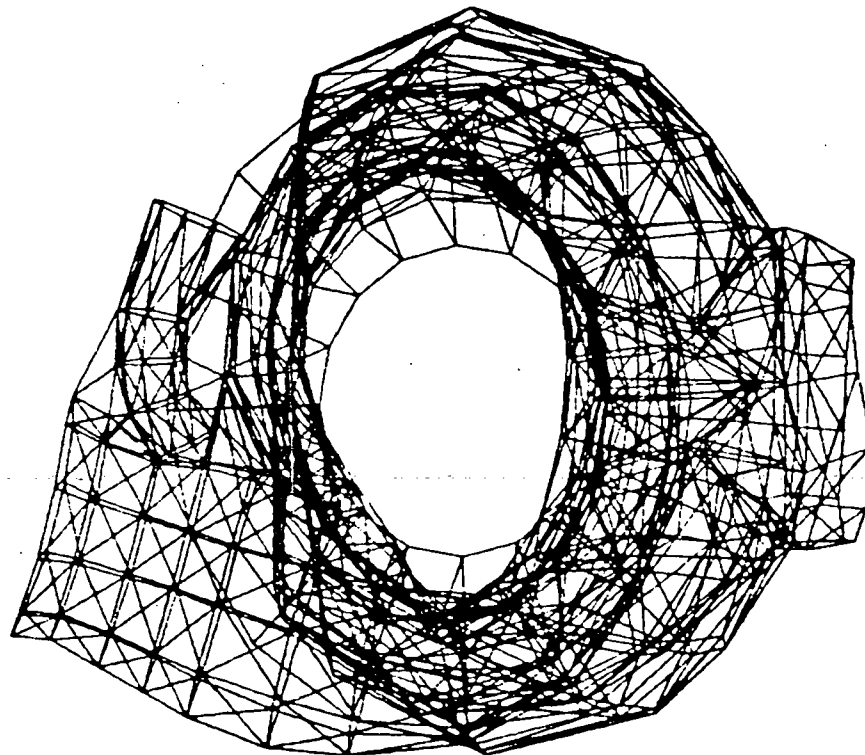
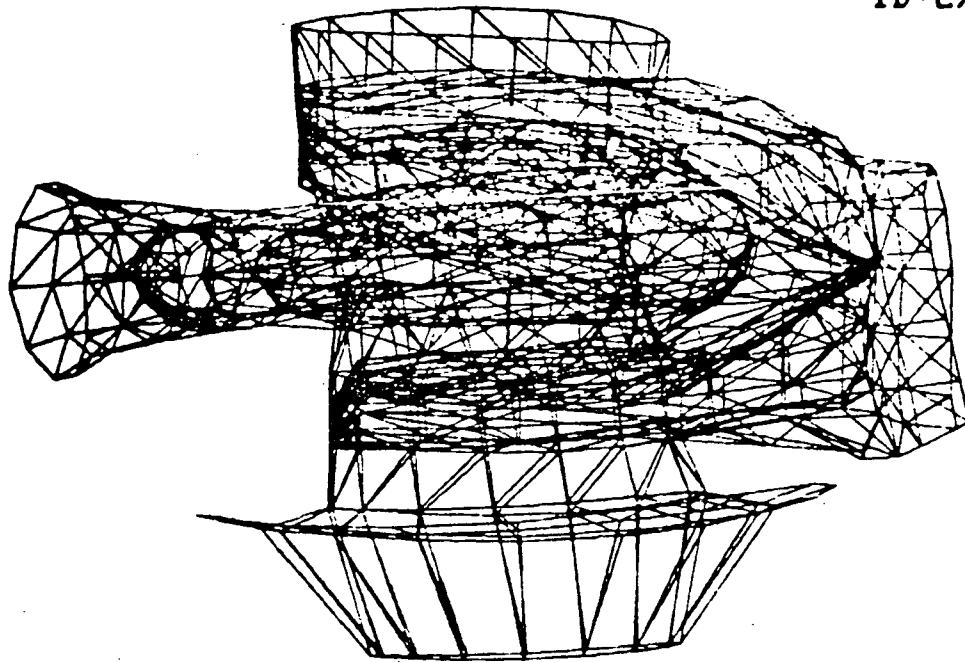
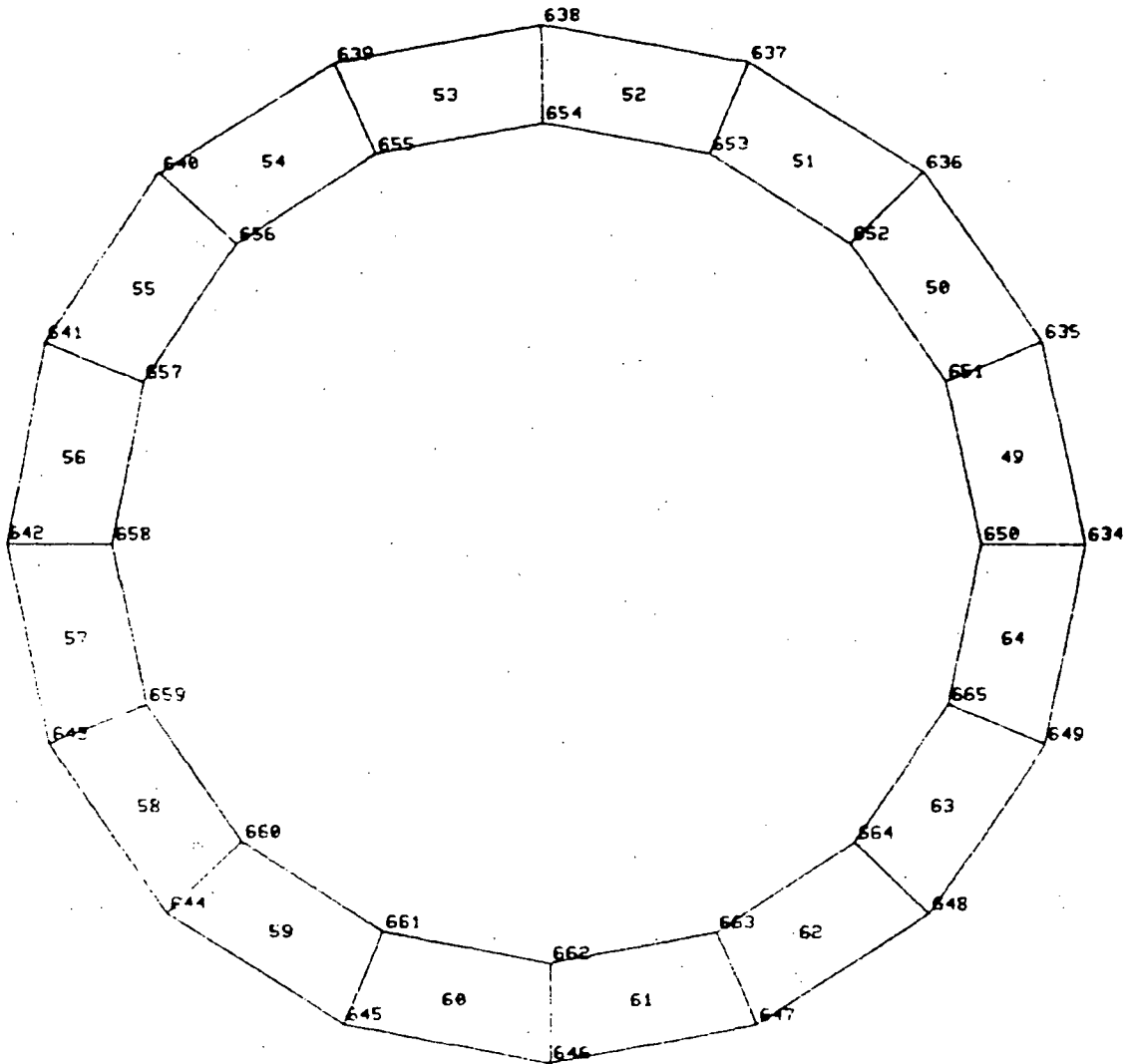

Fig. 21 Tenth Elastic Mode

ORIGINAL PAGE IS
OF POOR QUALITY



HPOTP PUMP HOUSING
CLAMPED BOUNDARY CONDITIONS ON THE FLANGE

Fig. 22 Constrained Nodes on the Flange at the Bolt Circle
Joints 634 Through 649

VIBRATIONAL MODE, FREQ (HZ) .342817X10⁺⁰³

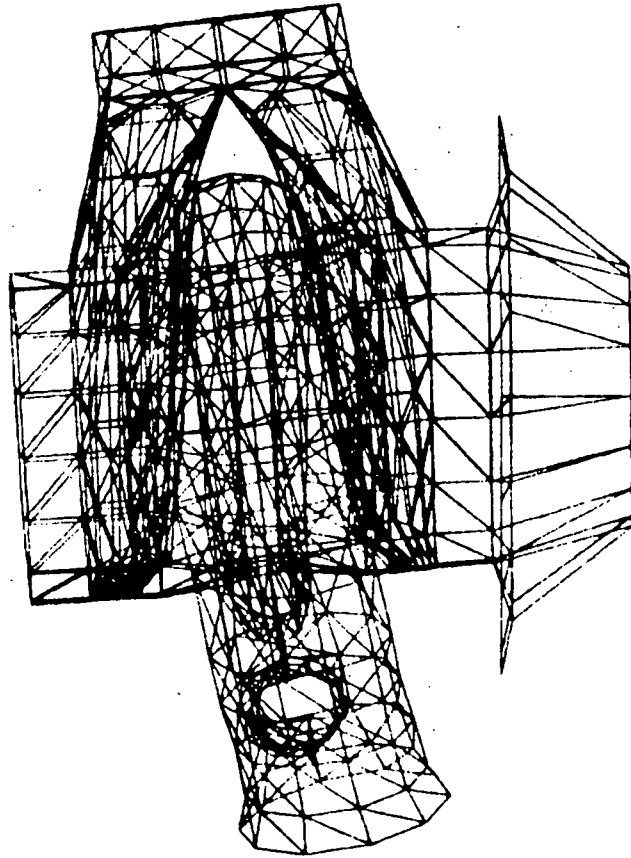

Fig. 23 Vibrational Mode, Freq. (Hz)

VIBRATIONAL MODE, FREQ (HZ) .414653X10⁺⁰³

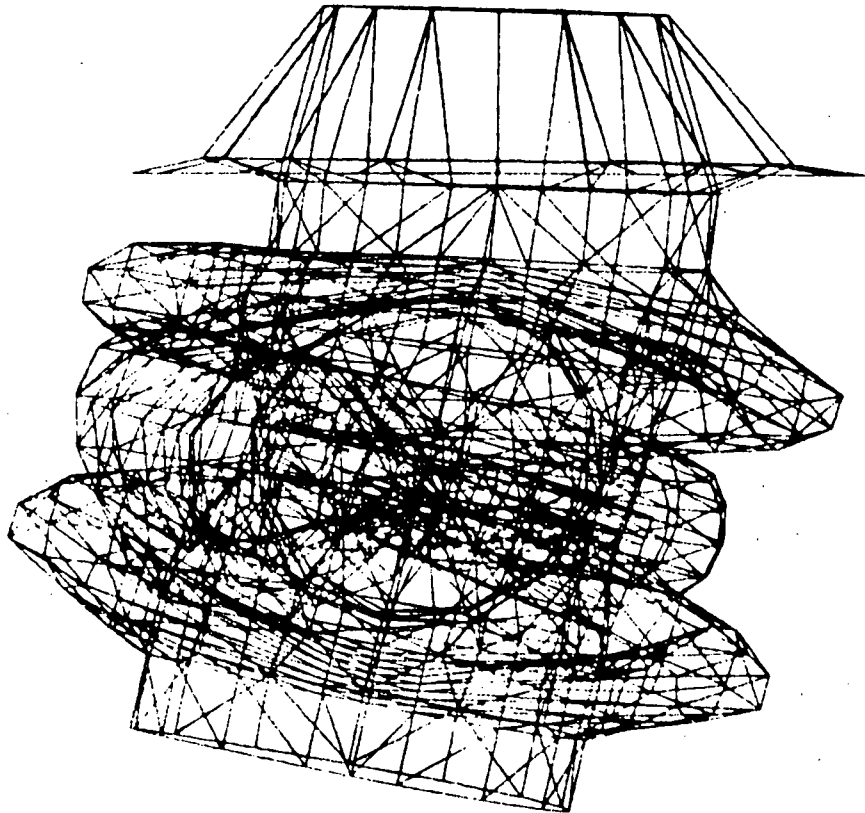

Fig. 24 Vibrational Mode, Freq. (Hz)

ORIGINAL PAGE IS
OF POOR QUALITY

VIBRATIONAL MODE, FREQ (HZ) $.534024 \times 10^{+03}$

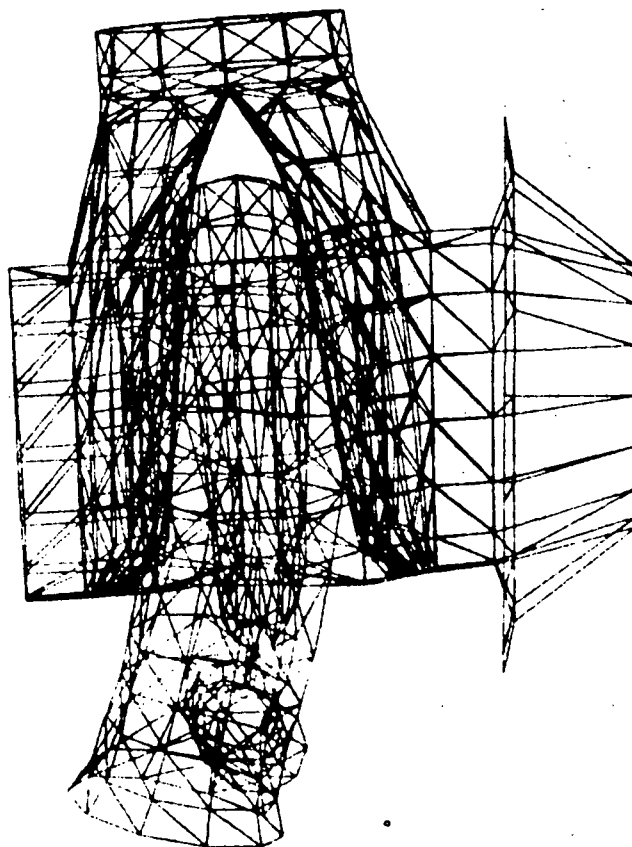

Fig. 25 Vibrational Mode, Freq. (Hz)

VIBRATIONAL MODE, FREQ (HZ) .594595X10⁺⁰³

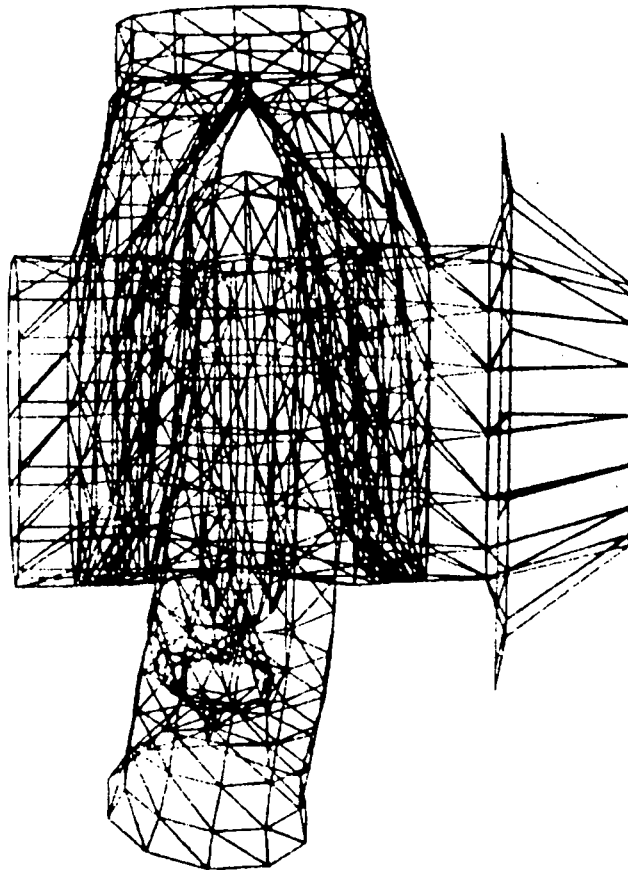

Fig. 26 Vibrational Mode, Freq. (Hz)

VIBRATIONAL MODE, FREQ (HZ) $.687860 \times 10^{+03}$

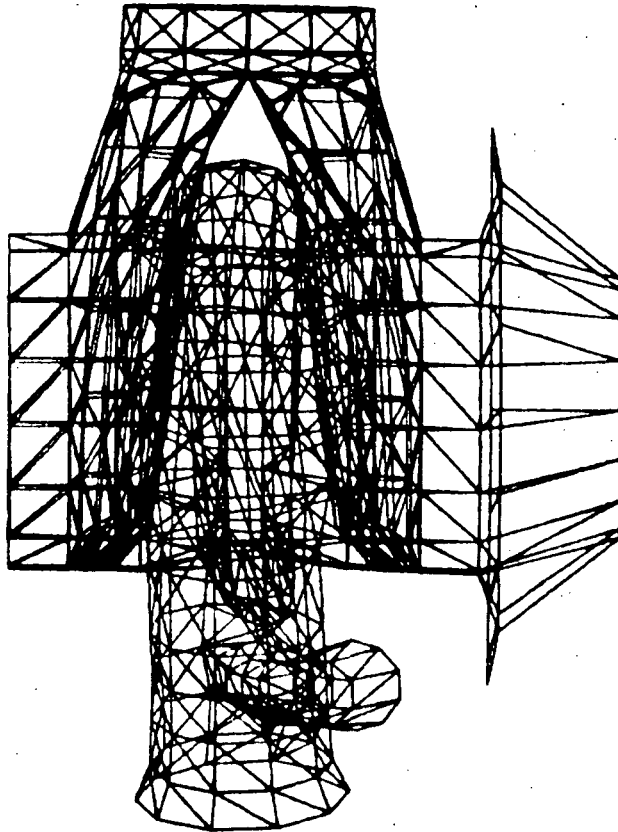

Fig. 27 Vibrational Mode, Freq. (Hz)

VIBRATIONAL MODE, FREQ (HZ) $.955968 \times 10^{+03}$

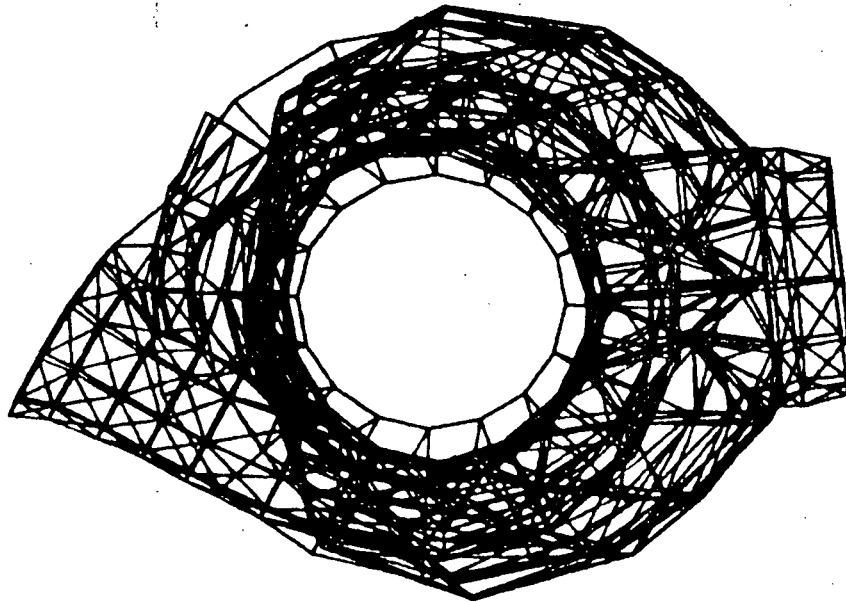

Fig. 28 Vibrational Mode, Freq. (Hz)

VIBRATIONAL MODE, FREQ (HZ) $.110979 \times 10^{+04}$

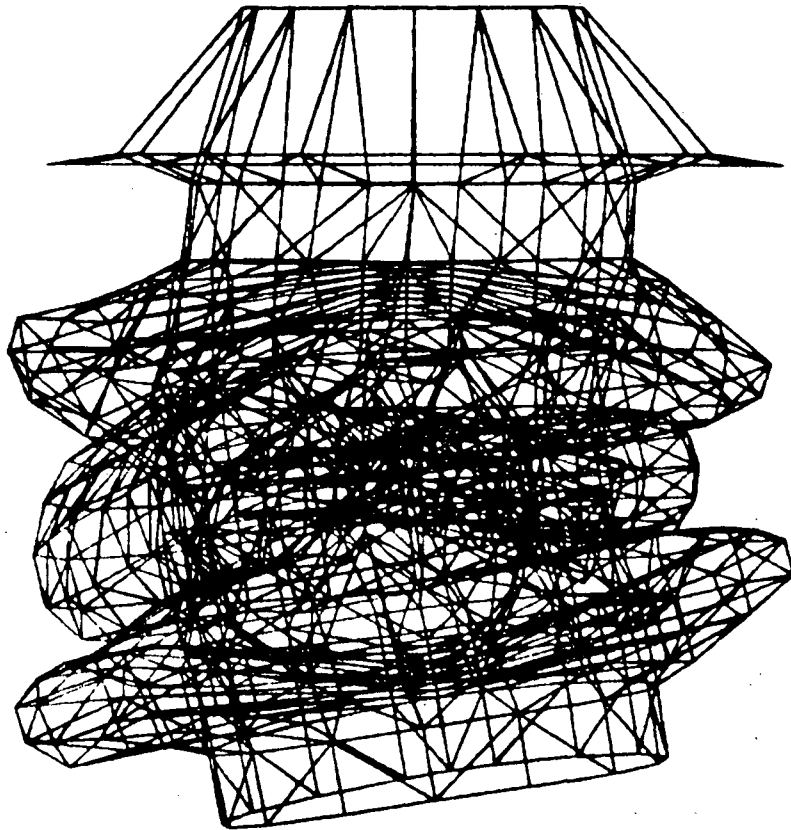

Fig. 29 Vibrational Mode, Freq. (Hz)

VIBRATIONAL MODE, FREQ (HZ) $.123710 \times 10^{+04}$

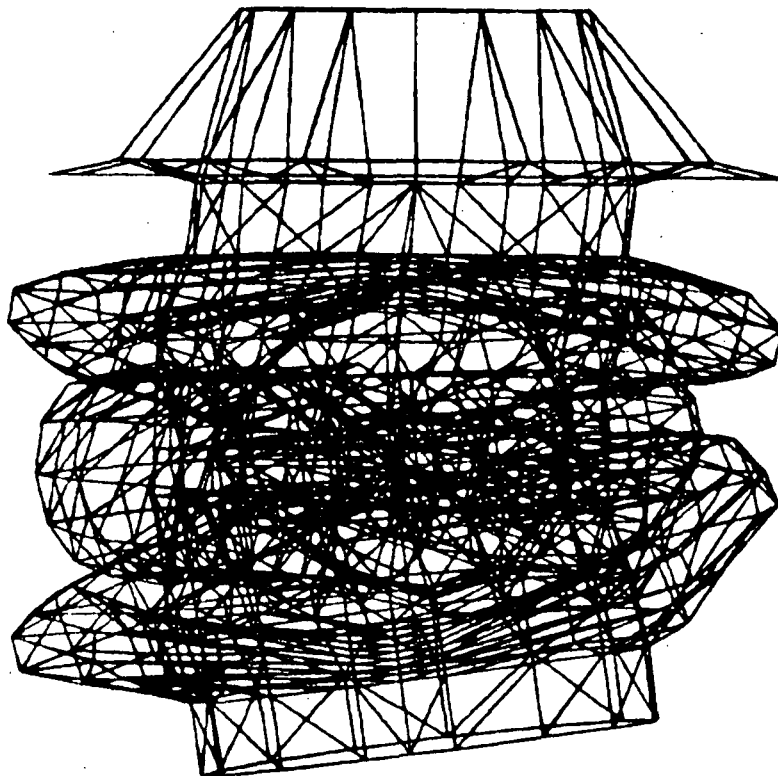

Fig. 30 Vibrational Mode, Freq. (Hz)

4. COMPONENT MODE ANALYSIS

This section describes the implementation of the Craig-Bampton method for the automated analysis of a disjoint structure in terms of its component modes. Derivation of the governing equations are given in Ref. 4, while a complete listing of the EAL runstreams are provided in Appendix C. An examination of the runstreams will show that they were modeled after the existing macro-element procedures with extensive use made of the older substructure routines. Two example problems are worked which demonstrate the procedures.

The seven procedures for exercising the Craig-Bampton analysis method are summarized below:

- (CB JCL 0) - Sets up CB and utility procedure indirect libraries.
- (CB SYS 0) - Inputs system geometry to TAB processor and executes calls to remaining CB procedures for an automated runstream analysis.
- (CB SUBS 1) - Builds substructure finite element models and constructs substructure mass and stiffness matrices using boundary attachment and normal modes.
- (CB ASSE 0) - Assembles substructure mass and stiffness into system mass and stiffness matrices using the SYN processor.
- (CB STRP 0) - Executes the substructure system eigensolver, STRP processor.
- (CB SSBT 0) - Executes the substructure back transformation, SSBT processor.
- (CB VPRT 0) - Prints system eigenvectors for selected substructures in LIB 10.

These procedures were written using the EAL macro-element (ME) procedures as templates and should be compatible with existing ME data sets identified by *(29 cbi DATA 1) where cbi is the macro-element or substructure identifier (SSID). The additional data cards in a CB data set which control the (CB SUBS 1) procedure are all optional and only the NMCB register initialization is actually required to generate a set or normal modes for a substructure. The NMCB register, which specifies the number of eigenvectors extracted by either the EIG or E4 processor, must immediately follow the *(29 cbi DATA 1) card with other register initializations. The default value, NMCB=0, results in substructure data sets equivalent to those generated by the macro-element procedure, (ME MACR 1). The selection of the eigensolver is dependent upon the SPDP register initialization of single (SPDP=1) or double (SPDP=2) precision. For single precision, EIG is used for the eigensolver, while E4 is used for double precision. The default fixed end functions, FEF "SSID" nset ncon, are the AUS processor NORM of the NMCB eigenvectors extracted by EIG or E4. However, the user can select subsets of these eigenvectors via the *(AUS OPTIONS) in data set *(29 cbi DATA 1), e.g.,

```

*(AUS OPTIONS)
  DEFINE X1=V1BR MODE "NEWS" "CONR" 1,1
  DEFINE X2=V1BR MODE "NEWS" "CONR" 4,4
  X=UNION(X1,X2)
  FEF "SSID" "NEWS" "CONR"=NORM(X)

```

selects the first and fourth modes for fixed end functions. Both FEF "SSID" nset ncon and the substructure boundary, mass and stiffness data sets constructed by the AUS processor are stored on LIB 9. This library avoids conflict with libraries assigned by the SYN and SSBT processors without the need for DCU library retrievals. Similar to the ME procedure, (ME MACR 1), the substructure's SPAR finite element data base on LIB 1 is packed into a single data set on LIB 3.

The (CB SYS 0) procedure provides four options to control the remaining CB procedures in an automated runstream mode. These options are selected by the following register initialization within (CB SYS 0) and are called in the following sequence:

ASSM = 1, assembles system mass and stiffness matrices or
 = 0, skip remainder of procedure.

STRP = 1, perform system eigenvalue analysis or
 = 0, skip remainder of procedure.

SSBT = 1, perform substructure back substitution or
 = 0, skip remainder of procedure.

VPRT = 1, print substructure eigenvectors or
 = 0, skip remainder of procedure.

The initializations must immediately follow the *(29 SYS DATA 0) card. System geometry including joint locations, alternate reference frames and constraints is input via *(TAB) similar to the ME procedure. However, no residual structure is allowed within this Craig-Bampton implementation and any *(ELD) data set will not be processed. Thus, the current method requires that the structural system is described by combining only substructures defined in the (CB SUBS 1) procedure. This limitation is invoked since the SYN processor is used to form the system mass and stiffness matrices.

The assembly of the structural system is performed by the (CB ASSE 0) procedure. Each substructure identified by a *(10 SJC cbi nref) data set is assembled within the SYN processor using the substructure data stored by (CB SUBS 1) on LIB 9. Relative constraint vectors may be optionally input to the SYN processor via a *(29 RELC OPTIONS) data set in the form of an AUS processor TABLE. In addition, resets for the SYN processor may be input via *(29 SYN RESETS) to control the mass, stiffness and relative constraint tolerances. However, there is no provision to input mass and stiffness submatrices as residual structure within this implementation.

The (CB STRP 0) procedure is a straightforward implementation of SPAR's STRP processor, a substructure system eigensolver. Lower and upper frequency bounds are controlled respectively, by the FRQ1 and FRQ2 resets input via *(29 STRP RESETS). The procedure uses the U3 processor RP2 to document system modes, eigenvalues, and frequencies.

The (CB SSBT 0) procedure is a straightforward implementation of SPAR's SSBT processor, a substructure back transformation. Lower and upper mode number bounds are controlled respectively by the NM1 and NM2 register initialization input via *(29 SSBT OPTIONS). The procedure stores the system eigenvalues, frequencies, and substructure eigenvectors (USB cbi 0 nref) on LIB 10.

System eigenvectors for selected substructures are printed using the (CB VPRT 0) procedure. To avoid excessive printout for a large number of substructures, only substructures which have a *(10 VPRT cbi nref) data set will have eigenvector printouts. For example,

```
*(10 VPRT ME1 1)
#
*(10 VPRT ME2 2)
#
```

will print the system eigenvectors for substructure ME1 at reference frame 1 and ME2 at reference frame 2. The comment card (# is EAL's comment symbol on the VAX) is required to avoid a null entry in the data set.

Two sample problems were selected for analysis using the Craig-Bampton procedures described above. the first problem is a simple truss structure with 10 identical bays as shown in Fig. 31. A typical substructure for this truss is shown in Fig. 32 with the system joints for the residual structure shown in Fig. 33. Results for this problem-are presented in Table 3 along with similar analysis using macro-elements and a continuous structure. The natural frequencies predicted using the Craig-Bampton method use a single mode (first torsion) for a fixed end function, and the results show improvement over the existing macro-element method for this problem.

The second example problem is a simply supported annular plate vibrating with a normal displacement and two rotations at each node. This problem was chosen so that the EAL cyclic symmetry option could also be verified for a 60-deg segment. The one-sixth segment model is shown in Fig. 34 with the joint numbers and element numbers for the E42 quads. Figure 35 shows the system joint numbers for the corresponding macro-element model. The Craig-Bampton results are shown in Table 4 along with the results from the macro-element and cyclic symmetry models. For this problem substantial improvement in accuracy was attained over the macro-element methods. The frequencies are within 1.06 percent for the 15th and 16th mode pair when six modes were carried in the summation, and within 0.03 percent when 12 modes were used.

Table 3 NATURAL FREQUENCIES FOR TRUSS SAMPLE PROBLEM

Mode Number	SPAR Frequency (Hz)	CB (1 mode) Frequency (Hz)	ME Frequency (Hz)
1	3.38	3.39	3.39
2	3.38	3.39	3.39
3	5.99	5.99	6.06
4	8.57	8.68	8.86
5	8.57	8.68	8.86
6	11.84	11.84	12.38
7	15.23	15.78	15.78
8	15.23	15.78	15.78
9	17.39	17.40	18.89
10	22.52	22.52	23.36
11	22.54	23.36	23.63
12	22.54	23.36	23.63
13	23.11	23.63	24.61

Table 4 NATURAL FREQUENCIES FOR PLATE SAMPLE PROBLEM

Mode Number	CS (60 deg) Frequency (Hz)	CB (12 modes) Frequency (Hz)	CB (6 modes) Frequency (Hz)	ME Frequency (Hz)
1	563.0	563.0	563.0	571.0
2	725.3	725.3	725.3	744.7
3	725.3	725.3	725.3	744.7
4	1028.8	1028.8	1029.0	1081.6
5	1028.8	1028.8	1029.0	1081.6
6	1561.7	1561.7	1561.8	1597.5
7	1561.7	1562.0	1563.1	1984.6
8	2017.5	2017.8	2018.7	2186.9
9	2224.6	2225.0	2226.9	2700.8
10	2224.6	2225.0	2226.9	2700.8
11	2458.4	2459.0	2460.6	2747.6
12	2458.4	2459.0	2460.6	2747.6
13	2931.7	2933.3	2939.8	3561.7
14	2931.7	2933.3	2936.8	3561.7
15	2986.3	2986.9	2991.0	4533.1
16	2986.3	2986.9	2991.0	4533.1

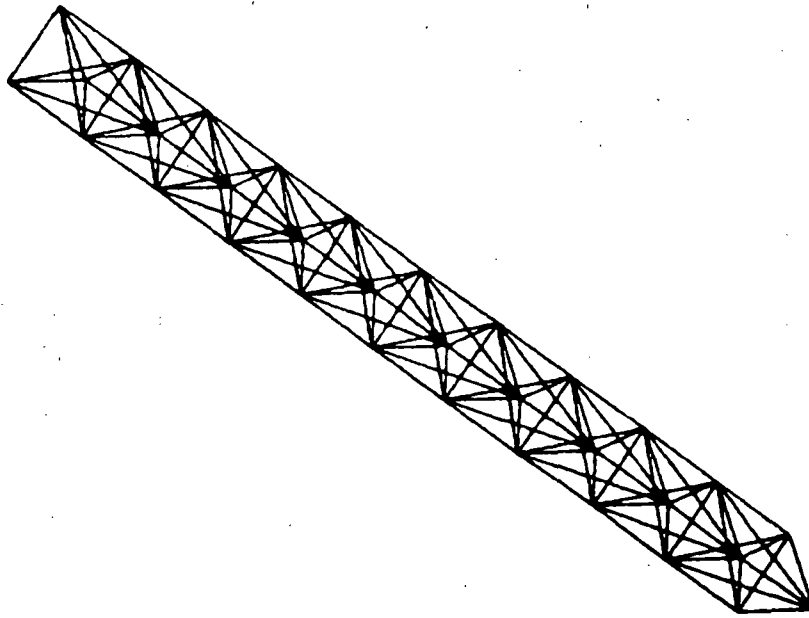

Fig. 31 Truss Undeformed Structure

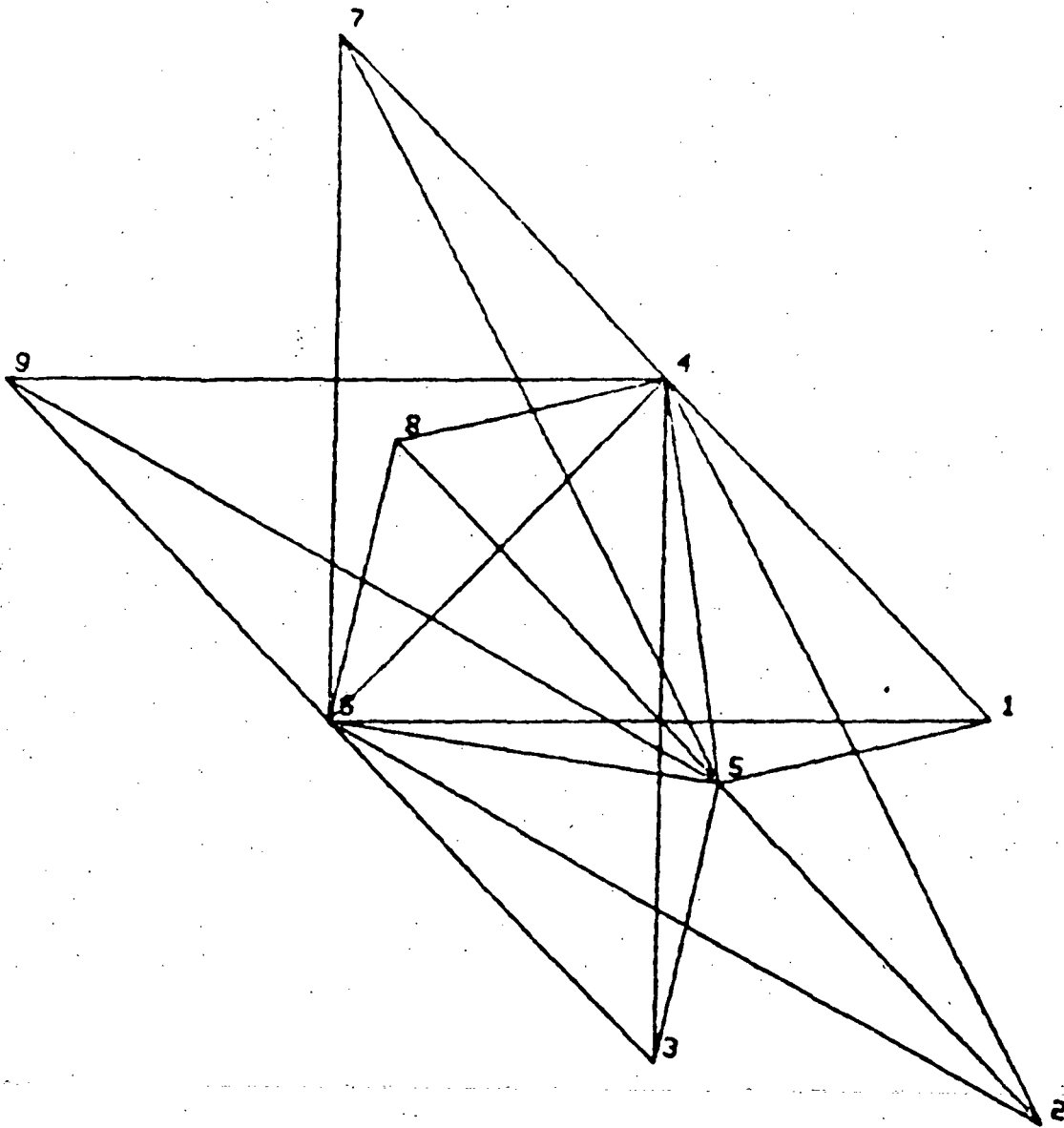

Fig. 32 Truss Substructure (ME1)

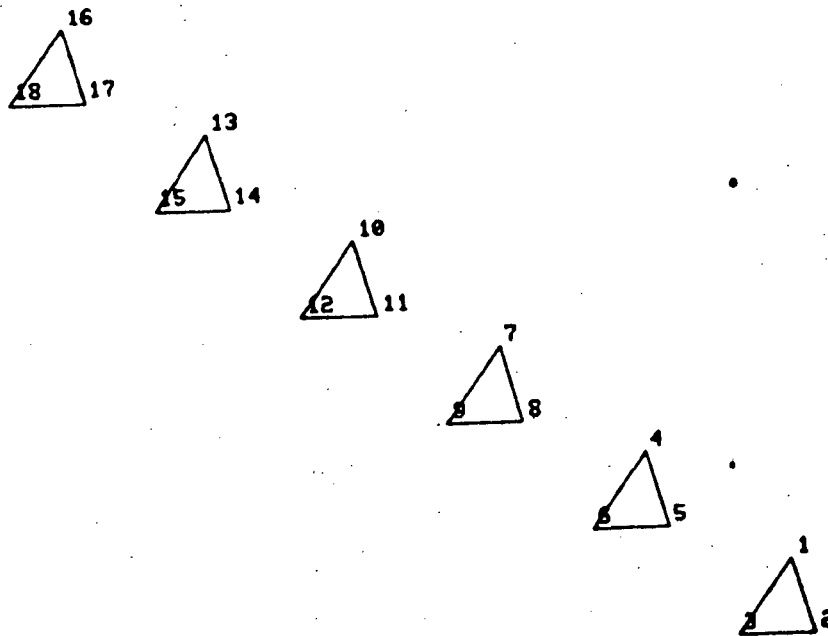

Fig. 33 Truss Residual Structure

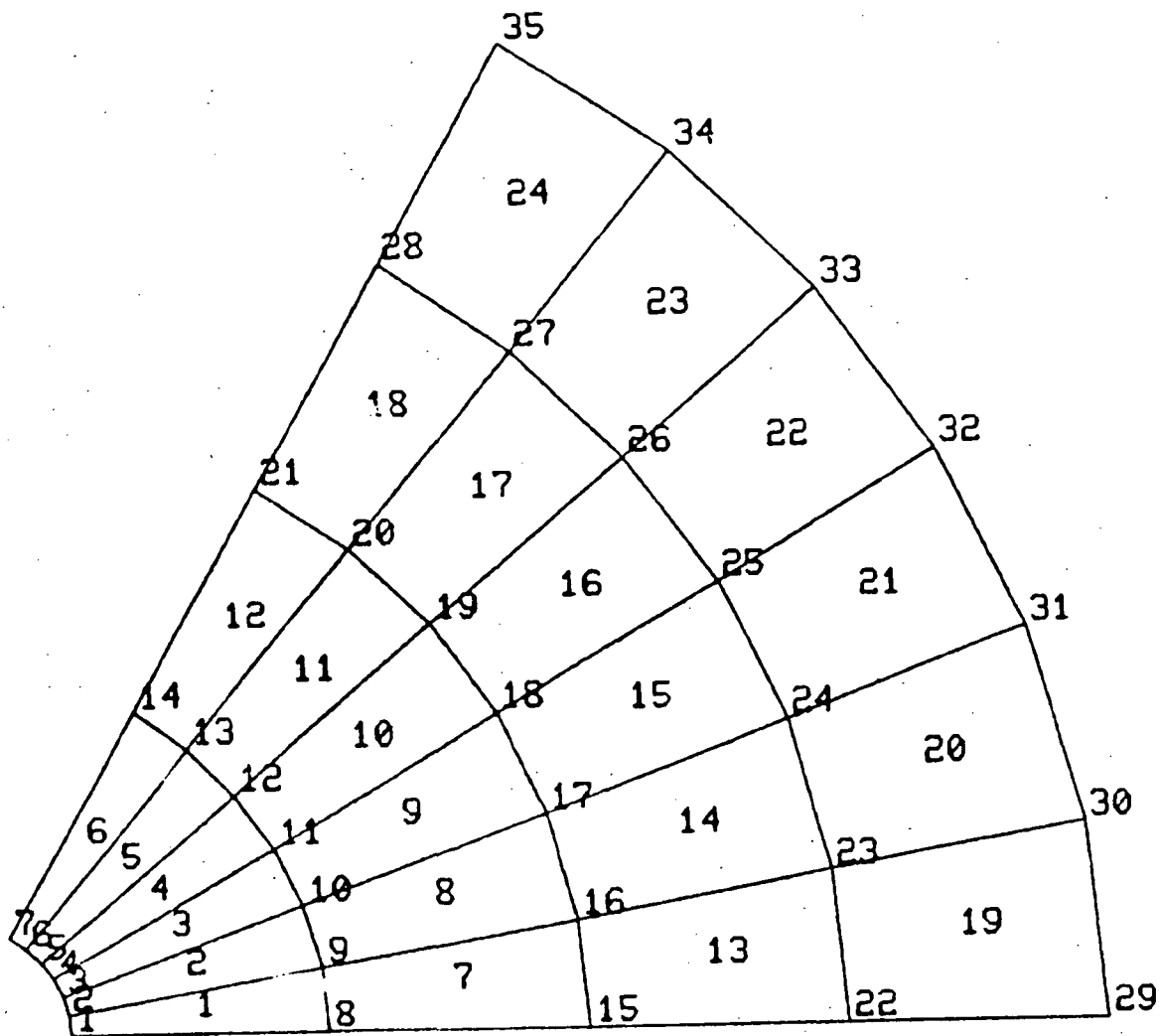

Fig. 34 Annular Plate Macro-Element

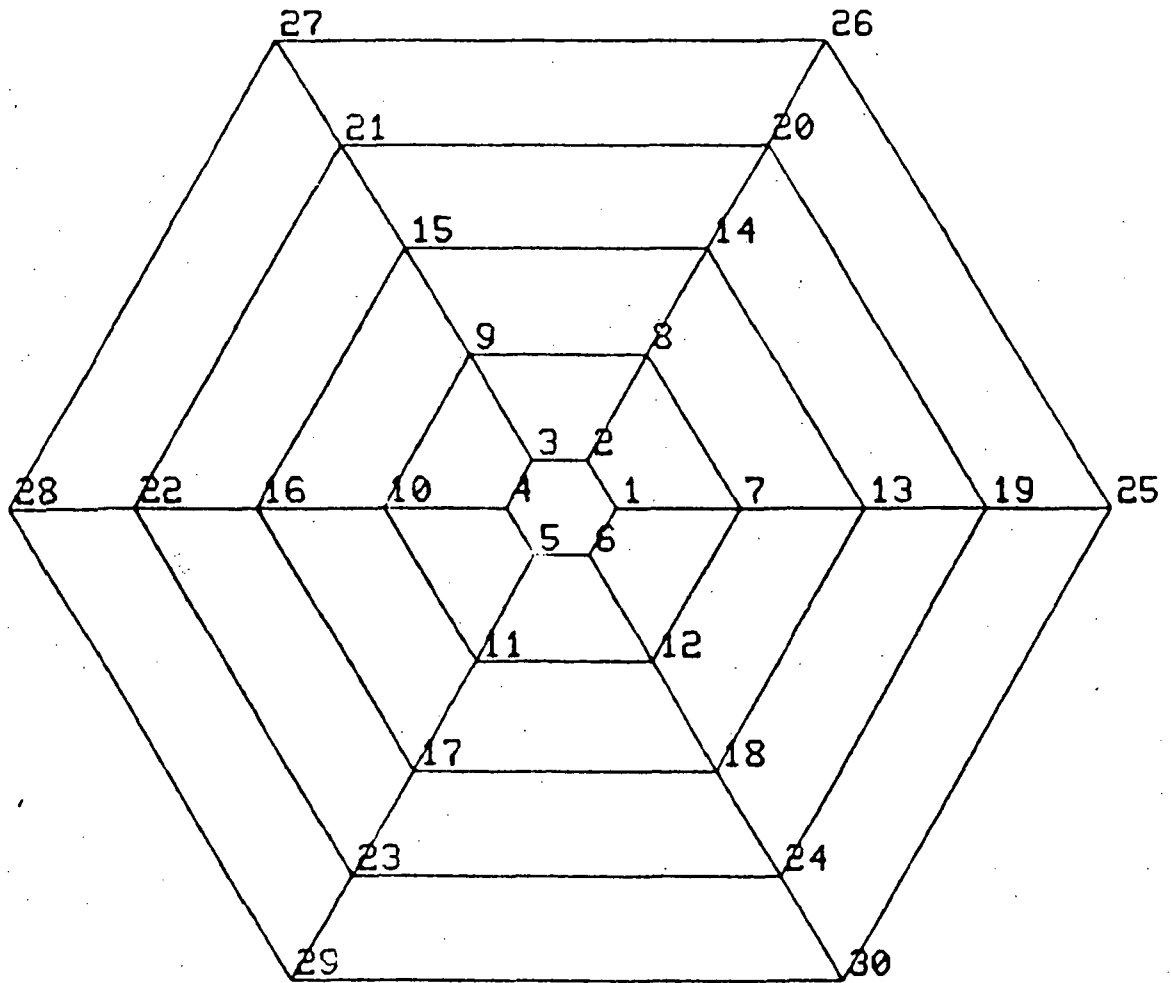

Fig. 35 Annular Plate System Joints

5. CONCLUSIONS AND RECOMMENDATIONS

This effort has provided engineering analysis data in support of the SSME powerhead component testing currently being performed at NASA-MSFC. In addition, the cyclic symmetry, fluid analysis capability, and the macro-element methods were all exercised and a new component mode analysis method was implemented while working under this contract. During the year, several ideas were discussed that might be of interest to engineers involved with finite element methods in general and in particular those responsible for the component test effort.

The test correlation via finite element analysis described in this report is ideally suited for the Structural Modification (SM) processor which currently exists within the SPAR system. Considerable engineering manhours were spent attempting to manually adjust the structural parameters to correlate with measured test data. This hit-or-miss approach was not only time consuming, but required that the work be done by the person who actually constructed the model since he was the only one with the detailed knowledge of its assembly. By using the SM processor, future model correlation efforts can be done faster and, perhaps, be done by someone other than the one who actually constructed the model, thus allowing more flexibility in task assignments for the engineering group. Lockheed suggests that the test correlation for the High Pressure Fuel Turbopump (HPFTP) be used as a benchmark to determine the effectiveness of the SM processor to fine tune the model to obtain agreement with dynamic test results.

During the contract period, a detailed finite element structural model was built of the recently proposed two-duct hot gas manifold (HGM). A COSMIC/NASTRAN and a SPAR version of this same model currently exist on

magnetic tape; both are completely checked out and debugged and have been run for a static load case. CFD calculations published recently in the literature suggest that this new two-duct design exhibits an improved, more uniform flow into the main injector by eliminating the ineffective center transfer tube. Thus, Lockheed feels that some time should be spent comparing the vibration characteristics of these two designs for the engine upgrade effort.

Another recommendation for future work which was discussed during an informal meeting last summer at NASA concerns the development of a common finite element data base. Lockheed has successfully used the Lockheed Dynamic Analysis Language Processor (DALPRO) system to transfer structural and aerodynamic matrices and tables between NASTRAN (via OUTPUT2), SPAR, and FORMA to complete an aeroelastic stability and response analysis funded by a Lockheed Internal Research program. Lockheed feels that extensive use could be made of a set of application tools allowing the analyst to transfer results to and from the large scale, general purpose finite element codes and the many smaller, user written routines designed to perform some specific function.

Finally, the test correlated component math models must eventually be reassembled to obtain the dynamic response behavior of the complete SSME powerhead. Having constructed the models ourselves and having worked with NASA personnel on the model test correlations, Lockheed is confident that our personnel can perform this analysis in the most efficient, cost effective manner.

REFERENCES

1. Whetstone, W.D., "EISI-EAL Engineering Analysis Language Reference Manual," Engineering Information Systems, Inc., San Jose, Calif., July 1983.
2. Whetstone, W.D., and C. E. Jones, "SPAR Reference Manual - Level 13," Engineering Information Systems, Inc., San Jose, Calif., June 1978.
3. Foley, M.J., D.M. Tilley, and C.T. Welch, "SSME Structural Dynamic Model Development - Final Report," IMSC-HREC TR D867307, Lockheed Missiles and Space Company, Huntsville, Ala., December 1983.
4. Craig, R.R., and M.C.C. Bampton, " Coupling of Substructures for Dynamic Analysis," AIAA Journal, Vol. 6, No. 7, July 1968, pp. 1313-1319.

Appendix A
LOX PUMP ROTOR ASSEMBLY
DATA LISTING

ORIGINAL PAGE IS
OF POOR QUALITY

ALTERNATE REFERENCE FRAME DEFINITIONS

REFERENCE FRAME 2
INPUT OPTION 1

ROTATE	.00000000	DEGRS ABOUT AXIS 1
ROTATE	.00000000	DEGRS ABOUT AXIS 2
ROTATE	.00000000	DEGRS ABOUT AXIS 3
Q=	.10000000+01	.00000000
	.00000000	.10000000+01
	.00000000	.00000000
X1=	.00000000	.10000000+01
X2=	.00000000	
X3=	.10075000+02	

REFERENCE FRAME 3
INPUT OPTION 1

ROTATE	-.90000000+02	DEGRS ABOUT AXIS 1
ROTATE	-.90000000+02	DEGRS ABOUT AXIS 2
ROTATE	-.90000000+02	DEGRS ABOUT AXIS 3
Q=	.83002928-15	.00000000
	-.28810229-07	.10000000+01
	-.10000000+01	-.28810229-07
X1=	.10150000+02	.83002928-15
X2=	.00000000	
X3=	.10075000+02	

JOINT LOCATIONS

GLOBAL JOINT NO.	LOCAL JOINT NO.	LOCAL RECTANGULAR COORDINATES			LOCAL CYLINDRICAL COORDINATES		
		X1	X2	X3	R	T	Z
1	1	.790000+00	.000000	.108500+02	.790000+00	.000000	.108500+02
2	2	.729865+00	.302320+00	.108500+02	.790000+00	.225000+02	.108500+02
3	3	.558614+00	.558614+00	.108500+02	.790700+00	.450000+02	.108500+02
4	4	.302320+00	.729865+00	.108500+02	.790000+00	.675000+02	.108500+02
5	5	.125557-07	.790000+00	.108500+02	.790000+00	.900000+02	.108500+02
6	6	-.302320+00	.729865+00	.108500+02	.790000+00	.112500+03	.108500+02
7	7	-.558614+00	.558614+00	.108500+02	.790000+00	.135000+03	.108500+02
8	8	-.729865+00	.302320+00	.108500+02	.790000+00	.157500+03	.108500+02
9	9	-.790000+00	.251113-07	.108500+02	.790000+00	.180000+03	.108500+02
10	10	-.729865+00	-.302320+00	.108500+02	.790000+00	.202500+03	.108500+02
11	11	-.558614+00	-.558614+00	.108500+02	.790000+00	.225000+03	.108500+02
12	12	-.302320+00	-.729865+00	.108500+02	.790000+00	.247500+03	.108500+02
13	13	-.847547-07	.790000+00	.108500+02	.790000+00	.270000+03	.108500+02
14	14	.302320+00	.729865+00	.108500+02	.790000+00	.292500+03	.108500+02
15	15	.558614+00	-.558614+00	.108500+02	.790000+00	.315000+03	.108500+02
16	16	.729865+00	-.302320+00	.108500+02	.790000+00	.337500+03	.108500+02
17	17	.000000	.000000	.108500+02	.000000	.000000	.108500+02
18	18	.790000+00	.000000	.775000+01	.790000+00	.000000	.775000+01
19	19	.729865+00	.302320+00	.775000+01	.790000+00	.225000+02	.775000+01
20	20	.558614+00	.558614+00	.775000+01	.790000+00	.450000+02	.775000+01
21	21	.302320+00	.729865+00	.775000+01	.790000+00	.675000+02	.775000+01
22	22	.125557-07	.790000+00	.775000+01	.790000+00	.900000+02	.775000+01
23	23	-.302320+00	.729865+00	.775000+01	.790000+00	.112500+03	.775000+01
24	24	-.558614+00	.558614+00	.775000+01	.790000+00	.135000+03	.775000+01
25	25	-.729865+00	.302320+00	.775000+01	.790000+00	.157500+03	.775000+01
26	26	-.790000+00	.251113-07	.775000+01	.790000+00	.180000+03	.775000+01
27	27	-.729865+00	-.302320+00	.775000+01	.790000+00	.202500+03	.775000+01
28	28	-.558614+00	-.558614+00	.775000+01	.790000+00	.225000+03	.775000+01
29	29	-.302320+00	-.729865+00	.775000+01	.790000+00	.247500+03	.775000+01
30	30	-.847547-07	.790000+00	.775000+01	.790000+00	.270000+03	.775000+01
31	31	.302320+00	.729865+00	.775000+01	.790000+00	.292500+03	.775000+01
32	32	.558614+00	-.558614+00	.775000+01	.790000+00	.315000+03	.775000+01
33	33	.729865+00	-.302320+00	.775000+01	.790000+00	.337500+03	.775000+01
34	34	.000000	.000000	.775000+01	.000000	.000000	.775000+01
35	35	.790000+00	.000000	.588000+01	.790000+00	.000000	.588000+01
36	36	.729865+00	.302320+00	.588000+01	.790000+00	.225000+02	.588000+01
37	37	.558614+00	.558614+00	.588000+01	.790000+00	.450000+02	.588000+01
38	38	.302320+00	.729865+00	.588000+01	.790000+00	.675000+02	.588000+01
39	39	.125557-07	.790000+00	.588000+01	.790000+00	.900000+02	.588000+01
40	40	-.302320+00	.729865+00	.588000+01	.790000+00	.112500+03	.588000+01
41	41	-.558614+00	.558614+00	.588000+01	.790000+00	.135000+03	.588000+01
42	42	-.729865+00	.302320+00	.588000+01	.790000+00	.157500+03	.588000+01
43	43	-.790000+00	.251113-07	.588000+01	.790000+00	.180000+03	.588000+01
44	44	-.729865+00	-.302320+00	.588000+01	.790000+00	.202500+03	.588000+01
45	45	-.558614+00	-.558614+00	.588000+01	.790000+00	.225000+03	.588000+01
46	46	-.302320+00	-.729865+00	.588000+01	.790000+00	.247500+03	.588000+01
47	47	-.847547-07	.790000+00	.588000+01	.790000+00	.270000+03	.588000+01
48	48	.302320+00	.729865+00	.588000+01	.790000+00	.292500+03	.588000+01
49	49	.558614+00	-.558614+00	.588000+01	.790000+00	.315000+03	.588000+01
50	50	.729865+00	-.302320+00	.588000+01	.790000+00	.337500+03	.588000+01
51	51	.000000	.000000	.588000+01	.000000	.000000	.588000+01
52	52	.790000+00	.000000	.350000+01	.790000+00	.000000	.350000+01
53	53	.729865+00	.302320+00	.350000+01	.790000+00	.225000+02	.350000+01

ORIGINAL PAGE IS
OF POOR QUALITY

54	.559614+00	.558614+00	.350000+01	.790000+00	.450000+02	.350000+01
55	.302320+00	.729865+00	.350000+01	.790000+00	.675000+02	.350000+01
56	.125557-07	.790000+00	.350000+01	.790000+00	.900000+02	.350000+01
57	.302320+00	.790000+00	.350000+01	.790000+00	.112500+03	.350000+01
58	.558614+00	.558614+00	.350000+01	.790000+00	.135000+03	.350000+01
59	.729865+00	.302320+00	.350000+01	.790000+00	.157500+03	.350000+01
60	.790000+00	.251113-07	.350000+01	.790000+00	.180000+03	.350000+01
61	.729865+00	.302320+00	.350000+01	.790000+00	.202500+03	.350000+01
62	.558614+00	.558614+00	.350000+01	.790000+00	.225000+03	.350000+01
63	.302320+00	.729865+00	.350000+01	.790000+00	.247500+03	.350000+01
64	.847547-07	.790000+00	.350000+01	.790000+00	.270000+03	.350000+01
65	.302320+00	.729865+00	.350000+01	.790000+00	.292500+03	.350000+01
66	.558614+00	.558614+00	.350000+01	.790000+00	.315000+03	.350000+01
67	.729865+00	.302320+00	.350000+01	.790000+00	.337500+03	.350000+01
68	.000000	.000000	.350000+01	.000000	.000000	.350000+01
69	.790000+00	.000000	.000000	.790000+00	.000000	.000000
70	.729865+00	.302320+00	.000000	.790000+00	.225000+02	.000000
71	.558614+00	.558614+00	.000000	.790000+00	.450000+02	.000000
72	.302320+00	.729865+00	.000000	.790000+00	.675000+02	.000000
73	.125557-07	.790000+00	.000000	.790000+00	.900000+02	.000000
74	.302320+00	.729865+00	.000000	.790000+00	.112500+03	.000000
75	.558614+00	.558614+00	.000000	.790000+00	.135000+03	.000000
76	.729865+00	.302320+00	.000000	.790000+00	.157500+03	.000000
77	.790000+00	.251113-07	.000000	.790000+00	.180000+03	.000000
78	.729865+00	.302320+00	.000000	.790000+00	.202500+03	.000000
79	.558614+00	.558614+00	.000000	.790000+00	.225000+03	.000000
80	.302320+00	.729865+00	.000000	.790000+00	.247500+03	.000000
81	.847547-07	.790000+00	.000000	.790000+00	.270000+03	.000000
82	.302320+00	.729865+00	.000000	.790000+00	.292500+03	.000000
83	.558614+00	.558614+00	.000000	.790000+00	.315000+03	.000000
84	.729865+00	.302320+00	.000000	.790000+00	.337500+03	.000000
85	.000000	.000000	.000000	.000000	.000000	.000000
86	.790000+00	.000000	.350000+01	.790000+00	.000000	.350000+01
87	.729865+00	.302320+00	.350000+01	.790000+00	.225000+02	.350000+01
88	.558614+00	.558614+00	.350000+01	.790000+00	.450000+02	.350000+01
89	.302320+00	.729865+00	.350000+01	.790000+00	.675000+02	.350000+01
90	.125557-07	.790000+00	.350000+01	.790000+00	.900000+02	.350000+01
91	.302320+00	.729865+00	.350000+01	.790000+00	.112500+03	.350000+01
92	.558614+00	.558614+00	.350000+01	.790000+00	.135000+03	.350000+01
93	.729865+00	.302320+00	.350000+01	.790000+00	.157500+03	.350000+01
94	.790000+00	.251113-07	.350000+01	.790000+00	.180000+03	.350000+01
95	.729865+00	.302320+00	.350000+01	.790000+00	.202500+03	.350000+01
96	.558614+00	.558614+00	.350000+01	.790000+00	.225000+03	.350000+01
97	.302320+00	.729865+00	.350000+01	.790000+00	.247500+03	.350000+01
98	.847547-07	.790000+00	.350000+01	.790000+00	.270000+03	.350000+01
99	.302320+00	.729865+00	.350000+01	.790000+00	.292500+03	.350000+01
100	.558614+00	.558614+00	.350000+01	.790000+00	.315000+03	.350000+01
101	.729865+00	.302320+00	.350000+01	.790000+00	.337500+03	.350000+01
102	.000000	.000000	.350000+01	.000000	.000000	.350000+01
103	.790000+00	.000000	.650000+01	.790000+00	.000000	.650000+01
104	.729865+00	.302320+00	.650000+01	.790000+00	.225000+02	.650000+01
105	.558614+00	.558614+00	.650000+01	.790000+00	.450000+02	.650000+01
106	.302320+00	.729865+00	.650000+01	.790000+00	.675000+02	.650000+01
107	.125557-07	.790000+00	.650000+01	.790000+00	.900000+02	.650000+01
108	.302320+00	.729865+00	.650000+01	.790000+00	.112500+03	.650000+01
109	.558614+00	.558614+00	.650000+01	.790000+00	.135000+03	.650000+01
110	.729865+00	.302320+00	.650000+01	.790000+00	.157500+03	.650000+01

111	-.790000+00	.251113-07	-.650000+01	.790000+00	.180000+03	-.650000+01
112	-.729865+00	-.302320+00	-.650000+01	.790000+00	.202500+03	-.650000+01
113	-.558614+00	-.558614+00	-.650000+01	.790000+00	.225000+03	-.650000+01
114	-.302320+00	-.729865+00	-.650000+01	.790000+00	.247500+03	-.650000+01
115	-.847547-07	-.790000+00	-.650000+01	.790000+00	.270000+03	-.650000+01
116	.302320+00	-.729865+00	-.650000+01	.790000+00	.292500+03	-.650000+01
117	.558614+00	-.558614+00	-.650000+01	.790000+00	.315000+03	-.650000+01
118	.729865+00	-.302320+00	-.650000+01	.790000+00	.337500+03	-.650000+01
119	.000000	.000000	-.650000+01	.000000	.000000	-.650000+01
120	.790000+00	.000000	-.880000+01	.790000+00	.000000	-.880000+01
121	.729865+00	.302320+00	-.880000+01	.790000+00	.225000+02	-.880000+01
122	.558614+00	.558614+00	-.880000+01	.790000+00	.450000+02	-.880000+01
123	.302320+00	.729865+00	-.880000+01	.790000+00	.675000+02	-.880000+01
124	.125557-07	.790000+00	-.880000+01	.790000+00	.900000+02	-.880000+01
125	-.302320+00	.729865+00	-.880000+01	.790000+00	.112500+03	-.880000+01
126	-.558614+00	.558614+00	-.880000+01	.790000+00	.135000+03	-.880000+01
127	-.729865+00	.302320+00	-.880000+01	.790000+00	.157500+03	-.880000+01
128	-.790000+00	.251113-07	-.880000+01	.790000+00	.180000+03	-.880000+01
129	-.729865+00	-.302320+00	-.880000+01	.790000+00	.202500+03	-.880000+01
130	-.558614+00	-.558614+00	-.880000+01	.790000+00	.225000+03	-.880000+01
131	-.302320+00	.729865+00	-.880000+01	.790000+00	.247500+03	-.880000+01
132	-.847547-07	-.790000+00	-.880000+01	.790000+00	.270000+03	-.880000+01
133	.302320+00	-.729865+00	-.880000+01	.790000+00	.292500+03	-.880000+01
134	.558614+00	-.558614+00	-.880000+01	.790000+00	.315000+03	-.880000+01
135	.729865+00	-.302320+00	-.880000+01	.790000+00	.337500+03	-.880000+01
136	.000000	.000000	-.880000+01	.000000	.000000	-.880000+01

JOINT REFERENCE FRAME ASSIGNMENTS

NREF	J1	J2	INC
2	1	136	1

ENTRY	E	NU	G	SP	WT
1	.29600+08	.30000+00	.11385+08	.32596+00	
2	.29600+08	.30000+00	.11385+08	.10000-05	

ENTRY	ALPHA1	ALPHA2	THETA
1	.00000	.00000	.00000
2	.00000	.00000	.00000

ORIGINAL PAGE IS
OF POOR QUALITY

ENTRY	E	NU	G	SP	WT
1	.29600+08	.30000+00	.11385+08	.00000	.32596+00
2	.29600+08	.30000+00	.11385+08	.00000	.10000-05

ENTRY	ALPHA1	ALPHA2	THEIA
1	.00000	.00000	.00000
2	.00000	.00000	.00000

SUMMARY OF CONSTRAINT CONDITIONS AND JOINT REFERENCE FRAME ASSIGNMENTS. (CONSTRAINT SET 1)

JOINT	JREF	CONSTRAINT	JOINT	JREF	CONSTRAINT	JOINT	JREF	CONSTRAINT	JOINT	JREF	CONSTRAINT	JOINT	JREF	CONSTRAINT
1	2	000000	2	2	000000	3	2	000000	4	2	000000	5	2	000000
6	2	000000	7	2	000000	8	2	000000	9	2	000000	10	2	000000
11	2	000000	12	2	000000	13	2	000000	14	2	000000	15	2	000000
16	2	000000	17	2	000000	18	2	000000	19	2	000000	20	2	000000
21	2	000000	22	2	000000	23	2	000000	24	2	000000	25	2	000000
26	2	000000	27	2	000000	28	2	000000	29	2	000000	30	2	000000
31	2	000000	32	2	000000	33	2	000000	34	2	000000	35	2	000000
36	2	000000	37	2	000000	38	2	000000	39	2	000000	40	2	000000
41	2	000000	42	2	000000	43	2	000000	44	2	000000	45	2	000000
46	2	000000	47	2	000000	48	2	000000	49	2	000000	50	2	000000
51	2	000000	52	2	000000	53	2	000000	54	2	000000	55	2	000000
56	2	000000	57	2	000000	58	2	000000	59	2	000000	60	2	000000
61	2	000000	62	2	000000	63	2	000000	64	2	000000	65	2	000000
66	2	000000	67	2	000000	68	2	000000	69	2	000000	70	2	000000
71	2	000000	72	2	000000	73	2	000000	74	2	000000	75	2	000000
76	2	000000	77	2	000000	78	2	000000	79	2	000000	80	2	000000
81	2	000000	82	2	000000	83	2	000000	84	2	000000	85	2	000000
86	2	000000	87	2	000000	88	2	000000	89	2	000000	90	2	000000
91	2	000000	92	2	000000	93	2	000000	94	2	000000	95	2	000000
96	2	000000	97	2	000000	98	2	000000	99	2	000000	100	2	000000
101	2	000000	102	2	000000	103	2	000000	104	2	000000	105	2	000000
106	2	000000	107	2	000000	108	2	000000	109	2	000000	110	2	000000
111	2	000000	112	2	000000	113	2	000000	114	2	000000	115	2	000000
116	2	000000	117	2	000000	118	2	000000	119	2	000000	120	2	000000
121	2	000000	122	2	000000	123	2	000000	124	2	000000	125	2	000000
126	2	000000	127	2	000000	128	2	000000	129	2	000000	130	2	000000
131	2	000000	132	2	000000	133	2	000000	134	2	000000	135	2	000000
136	2	000000												

GLOBAL PLANE (2,3) IS AN ANTI-SYMMETRY PLANE
 APPROPRIATE CONSTRAINT HAS BEEN IMPOSED AT THE FOLLOWING JOINTS

JOINT CONSTRAINT

5	011101
13	011101
17	111111
22	011101
30	011101
34	111111
39	011101
47	011101
51	111111
56	011101
64	011101
68	111111
73	011101
81	011101
85	111111
90	011101
98	011101
102	111111
107	011101
115	011101
119	111111
124	011101
132	011101
136	111111
120	010101
128	010101
136	111111

GLOBAL PLANE (1,3) IS A SYMMETRY PLANE
 APPROPRIATE CONSTRAINT HAS BEEN IMPOSED AT THE FOLLOWING JOINTS

JOINT CONSTRAINT

1	010101
9	010101
17	111111
18	010101
26	010101
34	111111
35	010101
43	010101
51	111111
52	010101
60	010101
68	111111
69	010101
77	010101
85	111111
86	010101
94	010101
102	111111
103	010101
111	010101
119	111111

LIBRARY OF MEMBER (BEAM) ELEMENT REFERENCE FRAME ORIENTATION SPECIFICATIONS

ENTRY

NO. 1 R11= 1.0000000 R21 IS POSITIVE
 NO. 2 R23= 1.0000000 R13 IS POSITIVE
 NO. 3, 11= 1, THIRD POINT COORDINATES RELATIVE TO ALTERNATE FRAME, 2= 1, THIRD POINT COORDINATES RELATIVE TO GLOBAL REFERENCE FRAME
 .00000000 .00000000 .00000000
 .00000000 .00000000 .10075000*02

SUMMARY OF CONSTRAINT CONDITIONS AND JOINT REFERENCE FRAME ASSIGNMENTS. (CONSTRAINT SET 2)

JOINT	JREF	CONSTRAINT	JOINT	JREF	CONSTRAINT	JOINT	JREF	CONSTRAINT	JOINT	JREF	CONSTRAINT	JOINT	JREF	CONSTRAINT
1	2	010101	2	2	010101	3	2	010101	4	2	010101	5	2	011101
6	2	010101	7	2	010101	8	2	010101	9	2	010101	10	2	010101
11	2	010101	12	2	010101	13	2	011101	14	2	010101	15	2	010101
16	2	010101	17	2	111111	18	2	010101	19	2	010101	20	2	010101
21	2	010101	22	2	011101	23	2	010101	24	2	010101	25	2	010101
26	2	010101	27	2	010101	28	2	010101	29	2	010101	30	2	011101
31	2	010101	32	2	010101	33	2	010101	34	2	111111	35	2	010101
36	2	010101	37	2	010101	38	2	010101	39	2	011101	40	2	010101
41	2	010101	42	2	010101	43	2	010101	44	2	010101	45	2	010101
46	2	010101	47	2	011101	48	2	010101	49	2	010101	50	2	010101
51	2	111111	52	2	010101	53	2	010101	54	2	010101	55	2	010101
56	2	011101	57	2	010101	58	2	010101	59	2	010101	60	2	010101
61	2	010101	62	2	010101	63	2	010101	64	2	011101	65	2	010101
66	2	010101	67	2	010101	68	2	111111	69	2	010101	70	2	010101
71	2	010101	72	2	010101	73	2	011101	74	2	010101	75	2	010101
76	2	010101	77	2	010101	78	2	010101	79	2	010101	80	2	010101
81	2	011101	82	2	010101	83	2	010101	84	2	010101	85	2	111111
86	2	010101	87	2	010101	88	2	010101	89	2	010101	90	2	011101
91	2	010101	92	2	010101	93	2	010101	94	2	010101	95	2	010101
96	2	010101	97	2	010101	98	2	011101	99	2	010101	100	2	010101
101	2	010101	102	2	111111	103	2	010101	104	2	010101	105	2	010101
106	2	010101	107	2	011101	108	2	010101	109	2	010101	110	2	010101
111	2	010101	112	2	010101	113	2	010101	114	2	010101	115	2	011101
116	2	010101	117	2	010101	118	2	010101	119	2	111111	120	2	010101
121	2	010101	122	2	010101	123	2	010101	124	2	011101	125	2	010101
126	2	010101	127	2	010101	128	2	010101	129	2	011101	130	2	010101
131	2	010101	132	2	011101	133	2	010101	134	2	010101	135	2	010101
136	2	111111												

KCA= 0 1 0 1 0 1

TABLE BA: E21 BEAM SECTION PROPERTIES

SET	F1	F2	Z1	Z2	THETA
1	.20389+01	.00700	.00000	.00000	.00000
2	.20000+01	.00000	.00000	.00000	.00000

TABLE BA: E21 BEAM SECTION PROPERTIES

SET	Q1	Q2	Q3
1	.00000	.00000	.00000
2	.00000	.00000	.00000

TABLE BA: E21 BEAM SECTION PROPERTIES

SECTION	DATA SET	TYPE	B1	B2	T2	B3	T3	H1	H2	H3	18AR12
1	1	TUBE	.5000+00	.1080+01	.0000	.0070	.0000	.0000	.0000	.0000	.0000

TABLE BA: L21 BEAM SECTION PROPERTIES

SET	T1	ALPHA1	T2	ALPHA2	AREA
1	.10194+01	.10000+01	.10194+01	.10000+01	.28790+01
2	.14400-02	.10000+01	.11725+00	.10000+01	.17980+00

ORIGINAL PAGE IS
OF POOR QUALITY

ELIMINATION ORDER =	1	2	3	4	5	6	7	8	9	10	11	12	13	14	15	16	17	18	19	20
JOINT INDEX =	1	2	3	4	5	6	7	8	9	10	11	12	13	14	15	16	17	18	19	20
ELIMINATION ORDER =	21	22	23	24	25	26	27	28	29	30	31	32	33	34	35	36	37	38	39	40
JOINT INDEX =	21	22	23	24	25	26	27	28	29	30	31	32	33	34	35	36	37	38	39	40
ELIMINATION ORDER =	41	42	43	44	45	46	47	48	49	50	51	52	53	54	55	56	57	58	59	60
JOINT INDEX =	41	42	43	44	45	46	47	48	49	50	51	52	53	54	55	56	57	58	59	60
ELIMINATION ORDER =	61	62	63	64	65	66	67	68	69	70	71	72	73	74	75	76	77	78	79	80
JOINT INDEX =	61	62	63	64	65	66	67	68	69	70	71	72	73	74	75	76	77	78	79	80
ELIMINATION ORDER =	81	82	83	84	85	86	87	88	89	90	91	92	93	94	95	96	97	98	99	100
JOINT INDEX =	81	82	83	84	85	86	87	88	89	90	91	92	93	94	95	96	97	98	99	100
ELIMINATION ORDER =	101	102	103	104	105	106	107	108	109	110	111	112	113	114	115	116	117	118	119	120
JOINT INDEX =	101	102	103	104	105	106	107	108	109	110	111	112	113	114	115	116	117	118	119	120
ELIMINATION ORDER =	121	122	123	124	125	126	127	128	129	130	131	132	133	134	135	136				
JOINT INDEX =	121	122	123	124	125	126	127	128	129	130	131	132	133	134	135	136				

JOINT INDEX =	1	2	3	4	5	6	7	8	9	10	11	12	13	14	15	16	17	18	19	20
ELIMINATION_ORDER =	1	2	3	4	5	6	7	8	9	10	11	12	13	14	15	16	17	18	19	20
JOINT INDEX =	21	22	23	24	25	26	27	28	29	30	31	32	33	34	35	36	37	38	39	40
ELIMINATION_ORDER =	21	22	23	24	25	26	27	28	29	30	31	32	33	34	35	36	37	38	39	40
JOINT INDEX =	41	42	43	44	45	46	47	48	49	50	51	52	53	54	55	56	57	58	59	60
ELIMINATION_ORDER =	41	42	43	44	45	46	47	48	49	50	51	52	53	54	55	56	57	58	59	60
JOINT INDEX =	61	62	63	64	65	66	67	68	69	70	71	72	73	74	75	76	77	78	79	80
ELIMINATION_ORDER =	61	62	63	64	65	66	67	68	69	70	71	72	73	74	75	76	77	78	79	80
JOINT INDEX =	81	82	83	84	85	86	87	88	89	90	91	92	93	94	95	96	97	98	99	100
ELIMINATION_ORDER =	81	82	83	84	85	86	87	88	89	90	91	92	93	94	95	96	97	98	99	100
JOINT INDEX =	101	102	103	104	105	106	107	108	109	110	111	112	113	114	115	116	117	118	119	120
ELIMINATION_ORDER =	101	102	103	104	105	106	107	108	109	110	111	112	113	114	115	116	117	118	119	120
JOINT INDEX =	121	122	123	124	125	126	127	128	129	130	131	132	133	134	135	136				
ELIMINATION_ORDER =	121	122	123	124	125	126	127	128	129	130	131	132	133	134	135	136				
EXII	67.629	20	10																	

NORMAL EXIT. CPU TIME: 638 TOTAL SUPS: 4196 (MILLISECONDS)

EX01 .ELD
DATA SPACE= 20000

E21 GROUP		CONNECTED JOINTS			J4 MATERIAL		SECTION NON-SIR WT		INTENSITY		NOFF. NREF	
INDEX	J1	J2	J3	J4	PROPS	INTENSITY	NOFF.	NREF	NOFF.	NREF	NOFF.	NREF
1	1	18			1	2	0	0	0	3		
2	2	19			1	2	0	0	0	3		
3	3	20			1	2	0	0	0	3		
4	4	21			1	2	0	0	0	3		
5	5	22			1	2	0	0	0	3		
6	6	23			1	2	0	0	0	3		
7	7	24			1	2	0	0	0	3		
8	8	25			1	2	0	0	0	3		
9	9	26			1	2	0	0	0	3		
10	10	27			1	2	0	0	0	3		
11	11	28			1	2	0	0	0	3		
12	12	29			1	2	0	0	0	3		
13	13	30			1	2	0	0	0	3		
14	14	31			1	2	0	0	0	3		
15	15	32			1	2	0	0	0	3		
16	16	33			1	2	0	0	0	3		
17	17	35			1	2	0	0	0	3		
18	18	36			1	2	0	0	0	3		
19	19	37			1	2	0	0	0	3		
20	20	38			1	2	0	0	0	3		
21	21	39			1	2	0	0	0	3		
22	22	40			1	2	0	0	0	3		
23	23	41			1	2	0	0	0	3		
24	24	42			1	2	0	0	0	3		
25	25	43			1	2	0	0	0	3		
26	26	44			1	2	0	0	0	3		
27	27	45			1	2	0	0	0	3		
28	28	46			1	2	0	0	0	3		
29	29	47			1	2	0	0	0	3		
30	30	48			1	2	0	0	0	3		
31	31	49			1	2	0	0	0	3		
32	32	50			1	2	0	0	0	3		
33	33	52			1	2	0	0	0	3		
34	34	53			1	2	0	0	0	3		
35	35	54			1	2	0	0	0	3		
36	36	55			1	2	0	0	0	3		
37	37	56			1	2	0	0	0	3		
38	38	57			1	2	0	0	0	3		
39	39	58			1	2	0	0	0	3		
40	40	59			1	2	0	0	0	3		
41	41	60			1	2	0	0	0	3		
42	42	61			1	2	0	0	0	3		
43	43	62			1	2	0	0	0	3		
44	44	63			1	2	0	0	0	3		
45	45	64			1	2	0	0	0	3		
46	46	65			1	2	0	0	0	3		
47	47	66			1	2	0	0	0	3		
48	48	67			1	2	0	0	0	3		

E21 GROUP 1		CONNECTED JOINTS			J4 MATERIAL		SECTION NON-STR WT		INTENSITY		NOFF		NREF	
INDEX	J1	J2	J3	J4	MATERIAL	PROPS	INTENSITY	NON-STR	WT	NOFF	NREF	NOFF	NREF	
49	52	69			1		2	0	0	0	3			
50	53	70			1		2	0	0	0	3			
51	54	71			1		2	0	0	0	3			
52	55	72			1		2	0	0	0	3			
53	56	73			1		2	0	0	0	3			
54	57	74			1		2	0	0	0	3			
55	58	75			1		2	0	0	0	3			
56	59	76			1		2	0	0	0	3			
57	60	77			1		2	0	0	0	3			
58	61	78			1		2	0	0	0	3			
59	62	79			1		2	0	0	0	3			
60	63	80			1		2	0	0	0	3			
61	64	81			1		2	0	0	0	3			
62	65	82			1		2	0	0	0	3			
63	66	83			1		2	0	0	0	3			
64	67	84			1		2	0	0	0	3			
65	69	86			1		2	0	0	0	3			
66	70	87			1		2	0	0	0	3			
67	71	88			1		2	0	0	0	3			
68	72	89			1		2	0	0	0	3			
69	73	90			1		2	0	0	0	3			
70	74	91			1		2	0	0	0	3			
71	75	92			1		2	0	0	0	3			
72	76	93			1		2	0	0	0	3			
73	77	94			1		2	0	0	0	3			
74	78	95			1		2	0	0	0	3			
75	79	96			1		2	0	0	0	3			
76	80	97			1		2	0	0	0	3			
77	81	98			1		2	0	0	0	3			
78	82	99			1		2	0	0	0	3			
79	83	100			1		2	0	0	0	3			
80	84	101			1		2	0	0	0	3			
81	86	103			1		2	0	0	0	3			
82	87	104			1		2	0	0	0	3			
83	88	105			1		2	0	0	0	3			
84	89	106			1		2	0	0	0	3			
85	90	107			1		2	0	0	0	3			
86	91	108			1		2	0	0	0	3			
87	92	109			1		2	0	0	0	3			
88	93	110			1		2	0	0	0	3			
89	94	111			1		2	0	0	0	3			
90	95	112			1		2	0	0	0	3			
91	96	113			1		2	0	0	0	3			
92	97	114			1		2	0	0	0	3			
93	98	115			1		2	0	0	0	3			
94	99	116			1		2	0	0	0	3			
95	100	117			1		2	0	0	0	3			
96	101	118			1		2	0	0	0	3			

ORIGINAL PAGE IS
OF POOR QUALITY

E21 GROUP	CONNECTED JOINTS			SECTION	NON-STR	WT	INTENSITY	NOFF	NREF
	J1	J2	J3						
97	103	120		1	2	0	0	0	3
98	104	121		1	2	0	0	0	3
99	105	122		1	2	0	0	0	3
100	106	123		1	2	0	0	0	3
101	107	124		1	2	0	0	0	3
102	108	125		1	2	0	0	0	3
103	109	126		1	2	0	0	0	3
104	110	127		1	2	0	0	0	3
105	111	128		1	2	0	0	0	3
106	112	129		1	2	0	0	0	3
107	113	130		1	2	0	0	0	3
108	114	131		1	2	0	0	0	3
109	115	132		1	2	0	0	0	3
110	116	133		1	2	0	0	0	3
111	117	134		1	2	0	0	0	3
112	118	135		1	2	0	0	0	3

E22 GROUP	CONNECTED JOINTS				J4 MATERIAL	SECTION PROPS	NON-STR WT	INTENSITY	NOFF	NRLE
	J1	J2	J3	J4						
1	1	2			1	1	0	0	0	2
2	2	3			1	1	0	0	0	2
3	3	4			1	1	0	0	0	2
4	4	5			1	1	0	0	0	2
5	5	6			1	1	0	0	0	2
6	6	7			1	1	0	0	0	2
7	7	8			1	1	0	0	0	2
8	8	9			1	1	0	0	0	2
9	9	10			1	1	0	0	0	2
10	10	11			1	1	0	0	0	2
11	11	12			1	1	0	0	0	2
12	12	13			1	1	0	0	0	2
13	13	14			1	1	0	0	0	2
14	14	15			1	1	0	0	0	2
15	15	16			1	1	0	0	0	2
16	16	17			1	1	0	0	0	2
17	17	18			1	1	0	0	0	2
18	18	19			1	1	0	0	0	2
19	19	20			1	1	0	0	0	2
20	20	21			1	1	0	0	0	2
21	21	22			1	1	0	0	0	2
22	22	23			1	1	0	0	0	2
23	23	24			1	1	0	0	0	2
24	24	25			1	1	0	0	0	2
25	25	26			1	1	0	0	0	2
26	26	27			1	1	0	0	0	2
27	27	28			1	1	0	0	0	2
28	28	29			1	1	0	0	0	2
29	29	30			1	1	0	0	0	2
30	30	31			1	1	0	0	0	2
31	31	32			1	1	0	0	0	2
32	32	33			1	1	0	0	0	2
33	33	34			1	1	0	0	0	2
34	34	35			1	1	0	0	0	2
35	35	36			1	1	0	0	0	2
36	36	37			1	1	0	0	0	2
37	37	38			1	1	0	0	0	2
38	38	39			1	1	0	0	0	2
39	39	40			1	1	0	0	0	2
40	40	41			1	1	0	0	0	2
41	41	42			1	1	0	0	0	2
42	42	43			1	1	0	0	0	2
43	43	44			1	1	0	0	0	2
44	44	45			1	1	0	0	0	2
45	45	46			1	1	0	0	0	2
46	46	47			1	1	0	0	0	2
47	47	48			1	1	0	0	0	2
48	48	49			1	1	0	0	0	2
49	49	50			1	1	0	0	0	2
50	50	51			1	1	0	0	0	2

E22 GROUP		CONNECTED JOINTS			SECTION NON-STR WT		MATERIAL PROPS.		INTENSITY		NOFF		NREF	
INDEX	J1	J2	J3	J4	J5	J6	J7	J8	J9	J10	J11	J12	J13	J14
49	52	53	1	1	1	0	0	0	0	0	0	0	0	2
50	53	54	1	1	1	0	0	0	0	0	0	0	0	2
51	54	55	1	1	1	0	0	0	0	0	0	0	0	2
52	55	56	1	1	1	0	0	0	0	0	0	0	0	2
53	56	57	1	1	1	0	0	0	0	0	0	0	0	2
54	57	58	1	1	1	0	0	0	0	0	0	0	0	2
55	58	59	1	1	1	0	0	0	0	0	0	0	0	2
56	59	60	1	1	1	0	0	0	0	0	0	0	0	2
57	60	61	1	1	1	0	0	0	0	0	0	0	0	2
58	61	62	1	1	1	0	0	0	0	0	0	0	0	2
59	62	63	1	1	1	0	0	0	0	0	0	0	0	2
60	63	64	1	1	1	0	0	0	0	0	0	0	0	2
61	64	65	1	1	1	0	0	0	0	0	0	0	0	2
62	65	66	1	1	1	0	0	0	0	0	0	0	0	2
63	66	67	1	1	1	0	0	0	0	0	0	0	0	2
64	67	68	1	1	1	0	0	0	0	0	0	0	0	2
65	69	70	1	1	1	0	0	0	0	0	0	0	0	2
66	70	71	1	1	1	0	0	0	0	0	0	0	0	2
67	71	72	1	1	1	0	0	0	0	0	0	0	0	2
68	72	73	1	1	1	0	0	0	0	0	0	0	0	2
69	73	74	1	1	1	0	0	0	0	0	0	0	0	2
70	74	75	1	1	1	0	0	0	0	0	0	0	0	2
71	75	76	1	1	1	0	0	0	0	0	0	0	0	2
72	76	77	1	1	1	0	0	0	0	0	0	0	0	2
73	77	78	1	1	1	0	0	0	0	0	0	0	0	2
74	78	79	1	1	1	0	0	0	0	0	0	0	0	2
75	79	80	1	1	1	0	0	0	0	0	0	0	0	2
76	80	81	1	1	1	0	0	0	0	0	0	0	0	2
77	81	82	1	1	1	0	0	0	0	0	0	0	0	2
78	82	83	1	1	1	0	0	0	0	0	0	0	0	2
79	83	84	1	1	1	0	0	0	0	0	0	0	0	2
80	84	85	1	1	1	0	0	0	0	0	0	0	0	2
81	86	87	1	1	1	0	0	0	0	0	0	0	0	2
82	87	88	1	1	1	0	0	0	0	0	0	0	0	2
83	88	89	1	1	1	0	0	0	0	0	0	0	0	2
84	89	90	1	1	1	0	0	0	0	0	0	0	0	2
85	90	91	1	1	1	0	0	0	0	0	0	0	0	2
86	91	92	1	1	1	0	0	0	0	0	0	0	0	2
87	92	93	1	1	1	0	0	0	0	0	0	0	0	2
88	93	94	1	1	1	0	0	0	0	0	0	0	0	2
89	94	95	1	1	1	0	0	0	0	0	0	0	0	2
90	95	96	1	1	1	0	0	0	0	0	0	0	0	2
91	96	97	1	1	1	0	0	0	0	0	0	0	0	2
92	97	98	1	1	1	0	0	0	0	0	0	0	0	2
93	98	99	1	1	1	0	0	0	0	0	0	0	0	2
94	99	100	1	1	1	0	0	0	0	0	0	0	0	2
95	100	101	1	1	1	0	0	0	0	0	0	0	0	2
96	101	86	1	1	1	0	0	0	0	0	0	0	0	2

E22 GROUP 1		CONNECTED JOINTS				SECTION NON-STR WT			
INDEX	J1	J2	J3	J4	MATERIAL	PROPS	INTENSITY	NOFF	NPLF
97	103	104			1	1	0	0	2
98	104	105			1	1	0	0	2
99	105	106			1	1	0	0	2
100	106	107			1	1	0	0	2
101	107	108			1	1	0	0	2
102	108	109			1	1	0	0	2
103	109	110			1	1	0	0	2
104	110	111			1	1	0	0	2
105	111	112			1	1	0	0	2
106	112	113			1	1	0	0	2
107	113	114			1	1	0	0	2
108	114	115			1	1	0	0	2
109	115	116			1	1	0	0	2
110	116	117			1	1	0	0	2
111	117	118			1	1	0	0	2
112	118	103			1	1	0	0	2
113	120	121			1	1	0	0	2
114	121	122			1	1	0	0	2
115	122	123			1	1	0	0	2
116	123	124			1	1	0	0	2
117	124	125			1	1	0	0	2
118	125	126			1	1	0	0	2
119	126	127			1	1	0	0	2
120	127	128			1	1	0	0	2
121	128	129			1	1	0	0	2
122	129	130			1	1	0	0	2
123	130	131			1	1	0	0	2
124	131	132			1	1	0	0	2
125	132	133			1	1	0	0	2
126	133	134			1	1	0	0	2
127	134	135			1	1	0	0	2
128	135	120			1	1	0	0	2

EXIT 68.306 18 4

ORIGINAL PAGE IS
OF POOR QUALITY

NORMAL EXIT. CPU TIME: 501 TOTAL SUPS: 2201 (MILLISECONDS)

DATA SPACE= 23000

TABLE OF CONTENTS, LIBRARY 1

HPOTP ROTOR MODAL ANALYSIS CHECKOUT

SEQ	RR	DATE	TIME	R	WORDS	NJ	NI	NU	Y	T	DATA	SFT	N3	N4
1	17	062184	134300	0	18	1	18	0	JDFI	BTAR	2	1	8	8
2	-18	062184	134300	0	136	136	136	0	JREF	BTAR	2	2	4	4
3	-23	062184	134300	0	12	1	12	1	ALR	BTAR	2	4	4	4
4	24	062184	134300	0	18	1	18	4	NUAL		0	0	0	0
5	25	062184	134300	0	36	3	36	1	ALTR	BTAR	2	2	4	4
6	27	062184	134300	0	408	136	408	1	JLOC	BTAR	2	2	5	5
7	42	062184	134300	0	136	136	136	0	JREF	BTAR	2	2	6	6
8	47	062184	134300	0	20	2	20	1	MATC	BTAR	2	2	2	2
9	48	062184	134300	0	136	136	136	0	CON		1	0	0	0
10	53	062184	134300	0	136	136	136	0	CON		2	0	0	0
11	58	062184	134300	0	15	3	15	1	MREF	BTAB	2	2	7	7
12	59	062184	134300	0	70	2	70	1	RA	BTAR	2	2	9	9
13	62	062184	134300	0	42	2	42	1	BB	BTAR	2	2	10	10
14	64	062184	134300	0	344	8	344	1	SA	BTAR	2	2	13	13
15	77	062184	134300	0	136	136	136	0	JSEQ	BTAR	2	2	17	17
16	82	062184	134300	0	1224	136	1224	1	OJTT	BTAR	2	2	19	19
17	126	062184	134307	0	2016	49	882	0	DEF	E21	1	2	2	2
18	222	062184	134307	0	2	1	2	0	GO	E21	1	2	2	2
19	223	062184	134307	0	15	1	15	4	GIIT	E21	1	2	2	2
20	224	062184	134307	0	20	1	20	0	DIR	E21	1	2	2	2
21	225	062184	134307	0	2304	49	882	0	DEF	E22	2	2	2	2
22	321	062184	134307	0	2	1	2	0	GO	E22	2	2	2	2
23	322	062184	134307	0	15	1	15	4	GIIT	E22	2	2	2	2
24	323	062184	134307	0	20	1	20	0	DIR	E22	2	2	2	2
25	324	062184	134307	0	2	2	2	4	ELIS	NAMF	0	0	0	0
26	325	062184	134307	0	2	2	2	0	ELIS	NNON	0	0	0	0
27	326	062184	134307	0	2	2	2	0	ELIS	ISCT	0	0	0	0
28	327	062184	134307	0	30	2	30	0	NS		0	0	0	0

EXIT 68.312 0 3

NORMAL EXIT. CPU TIME: 0 TOTAL SUPS: 0 (MILLISECONDS)

@XQT .E
 G .38600000+03
 DATA SPACE= 20000
 T= .10000-19 -.10000-02 .10000-04 .10000+01
 .20000+03 .10000-03 .10000-03 .10000-03
 ERROR LEVELS= 2 2 0 2 2 2 2 2

TYPE GROUP	L, VOL OR	AREA SUM	STRUCTURAL WEIGHT	NON-STRUCTURAL WEIGHT
E21	1	.314400+03	.184263+02	.000000
E22	1	.394550+02	.000000	.000000

TOTAL .184263+02 .000000

EXIT 68.356 5 25

NORMAL EXIT. CPU TIME: 0 TOTAL SUPS: 0 (MILLISECONDS)

@XQT .EKS
 DATA SPACE= 16000
 E21 COMPLETED
 E22 COMPLETED
 EXIT 68.551 4 8

NORMAL EXIT. CPU TIME: 0 TOTAL SUPS: 0 (MILLISECONDS)
 @XQI .TOPO
 CORE = 40000
 DATA SPACE = 27601
 NO. OF 2-NODE ELEMENTS = 240
 TOTAL NO. OF ELEMENTS = 240
 TIME .000 69.027
 MAXCON, MAXSUB, ILMAX = 227 1400 52
 TIME .074 69.101
 KSIZE, NRS, LRS = 20 4 896
 MAXCON, MAXSUB, ILMAX = 219 1400 52
 TIME .550 69.652
 SIZE INDEX = 153, IC1, IC2 = 16777 1957, NR4 = 12
 EXIT 69.652 25 18

NORMAL EXIT. CPU TIME: 625 TOTAL SUPS: 4171 (MILLISECONDS)
 @XQI .K
 DATA SPACE = 16000
 EXIT 70.590 10 252

ORIGINAL PAGE IS
OF POOR QUALITY

NORMAL EXIT. CPU TIME: 792 TOTAL SUPS: 11906 (MILLISECONDS)
@XQI .AUS
DATA SPACE= 20000
SUM COMPLETED.
EXIT 70.591 9 14

NORMAL EXIT. CPU TIME: 0 TOTAL SUPS: 0 (MILLISECONDS)
@XQI .INV
CORE= 8000
CON = 2
K =MS
DATA SPACE= 69013
NSING,NNEG= 0 0
EXIT 76.173 14 28

NORMAL EXIT. CPU TIME: 5539 TOTAL SUPS: 10354 (MILLISECONDS)
@XQI .DCU
DATA SPACE= 23000

TABLE OF CONTENTS, LIBRARY 1

HPOTP ROTOR MODAL ANALYSIS CHECKOUT

SEQ	RR	DATE	TIME	R	WORDS	NJ	NI	NJ	Y	T	DATA SET NAME			
				E							N1	N2	N3	N4
1	17	062184	134300	0	18	1	18	0	JUFI	BTAB	1	2	1	8
2	-18	062184	134300	0	136	136	136	0	JREF	BTAB	2	6	2	6
3	-23	062184	134300	0	12	1	12	1	ALIR	BTAB	2	4	2	4
4	24	062184	134300	0	16	1	18	4	NDAL		0	0	0	0
5	25	062184	134300	0	36	3	36	1	ALIR	BTAB	2	4	2	4
6	27	062184	134300	0	408	136	408	1	JLOC	BTAB	2	5	2	5
7	42	062184	134300	0	136	136	136	0	JREF	BTAB	2	6	2	6
8	47	062184	134300	0	20	2	20	1	MATC	BTAB	2	2	2	2
9	48	062184	134300	0	136	136	136	0	CON		2	0	0	0
10	53	062184	134300	0	136	136	136	0	CON		2	0	0	0
11	58	062184	134300	0	15	3	15	1	MREF	BTAB	2	7	2	7
12	59	062184	134300	0	70	2	70	1	RA	BTAB	2	9	2	9
13	62	062184	134300	0	42	2	42	1	RB	BTAB	2	10	2	10
14	64	062184	134300	0	344	8	344	1	SA	BTAB	2	13	2	13
15	77	062184	134300	0	136	136	136	0	JSEQ	BTAB	2	17	2	17
16	82	062184	134300	0	1224	136	1224	1	OJUT	BTAB	2	19	2	19
17	126	062184	134307	0	2016	49	882	0	DEF	E21	1	2	1	2
18	222	062184	134307	0	2	1	2	0	GO	E21	2	1	2	2
19	223	062184	134307	0	15	1	15	4	GJIT	E21	1	2	1	2
20	224	062184	134307	0	20	1	20	0	DIR	E21	1	2	1	2
21	225	062184	134307	0	2304	49	882	0	DEF	E22	2	2	2	2
22	321	062184	134307	0	2	1	2	0	GO	E22	2	2	2	2
23	322	062184	134307	0	15	1	15	4	GJIT	E22	2	2	2	2
24	323	062184	134307	0	20	1	20	0	DIR	E22	2	2	2	2
25	324	062184	134307	0	2	2	2	4	ELIS	NAMF	0	0	0	0
26	325	062184	134307	0	2	2	2	0	ELTS	MNON	0	0	0	0
27	326	062184	134307	0	2	2	2	0	ELTS	ISCT	0	0	0	0
28	327	062184	134307	0	30	2	30	0	NS		0	0	0	0
29	329	062184	134314	0	15680	112	440	4	E21	EFIL	1	2	1	2
30	889	062184	134314	0	14336	128	112	4	E22	EFIL	2	2	2	2
31	1401	062184	134311	0	816	136	816	-1	DEM	DIAG	0	0	0	0
32	1431	062184	134316	0	3584	136	896	0	KNAP		376	20	2	20
33	1573	062184	134316	0	21504	136	1792	0	AMAP	000A	1957	153	2	153
34	2341	062184	134320	0	15680	136	2240	1	K	SPAR	36	0	2	36
35	2901	062184	134327	0	15680	136	2240	1	K	SPAR	36	0	2	36
36	3461	062184	134329	0	39424	136	3594	1	INV	KS	2	0	2	0

EXIT 76.258 0

6

NORMAL EXIT. CPU TIME: 0 TOTAL SUPS: 0 (MILLISECONDS)

EXIT .AUS.
 DATA SPACE= 20000

TABL COMPLETED.
 RIGI COMPLETED.
 DEFI COMPLETED.
 DEFI COMPLETED.
 DEFI COMPLETED.
 DEFI COMPLETED.
 DEFI COMPLETED.
 UNIO COMPLETED.
 NORM COMPLETED.

EXIT 76.376 25 26

NORMAL EXIT. CPU TIME: 63 TOTAL SUPS: 2688 (MILLISECONDS)

EXIT .VPRT
 DATA SPACE= 20000

IO= 1 / 2 / 2

VIBRATIONAL MODE. EIGENVALUE = -.8000000+07, FREQ = -450.1582 HZ

JOINT	1	2	3	4	5	6
1	.0000000	.0000000	.0000000	.0000000	.5089059-01	.0000000
2	.0000000	.0000000	.3060314-02	.0000000	.5089059-01	.0000000
3	.0000000	.0000000	.1177535-01	.0000000	.5089059-01	.0000000
4	.0000000	.0000000	.2481832-01	.0000000	.5089059-01	.0000000
5	.0000000	.0000000	.4020356-01*	.0000000	.5089059-01	.0000000
6	.0000000	.0000000	.5558880-01	.0000000	.5089059-01	.0000000
7	.0000000	.0000000	.6863177-01	.0000000	.5089059-01	.0000000
8	.0000000	.0000000	.7734681-01	.0000000	.5089059-01	.0000000
9	.0000000	.0000000	.8040712-01	.0000000	.5089059-01	.0000000
10	.0000000	.0000000	.7734681-01	.0000000	.5089059-01	.0000000
11	.0000000	.0000000	.6863177-01	.0000000	.5089059-01	.0000000
12	.0000000	.0000000	.5558880-01	.0000000	.5089059-01	.0000000
13	.0000000	.0000000	.4020357-01*	.0000000	.5089059-01	.0000000
14	.0000000	.0000000	.2481833-01	.0000000	.5089059-01	.0000000
15	.0000000	.0000000	.1177535-01	.0000000	.5089059-01	.0000000
16	.0000000	.0000000	.3060316-02	.0000000	.5089059-01	.0000000
17	.0000000	.0000000	.4020356-01*	.0000000	.5089059-01*	.0000000
18	-.1577608+00	.0000000	.0000000	.0000000	.5089059-01	.0000000
19	-.1577608+00	.0000000	.3060314-02	.0000000	.5089059-01	.0000000
20	-.1577608+00	.0000000	.1177535-01	.0000000	.5089059-01	.0000000
21	-.1577608+00	.0000000	.2481832-01	.0000000	.5089059-01	.0000000
22	-.1577608+00	.0000000	.4020356-01*	.0000000	.5089059-01	.0000000
23	-.1577608+00	.0000000	.5558880-01	.0000000	.5089059-01	.0000000
24	-.1577608+00	.0000000	.6863177-01	.0000000	.5089059-01	.0000000
25	-.1577608+00	.0000000	.7734681-01	.0000000	.5089059-01	.0000000
26	-.1577608+00	.0000000	.8040712-01	.0000000	.5089059-01	.0000000
27	-.1577608+00	.0000000	.7734681-01	.0000000	.5089059-01	.0000000
28	-.1577608+00	.0000000	.6863177-01	.0000000	.5089059-01	.0000000
29	-.1577608+00	.0000000	.5558880-01	.0000000	.5089059-01	.0000000
30	-.1577608+00	.0000000	.4020357-01*	.0000000	.5089059-01	.0000000
31	-.1577608+00	.0000000	.2481833-01	.0000000	.5089059-01	.0000000
32	-.1577608+00	.0000000	.1177535-01	.0000000	.5089059-01	.0000000
33	-.1577608+00	.0000000	.3060316-02	.0000000	.5089059-01	.0000000
34	-.1577608+00*	.0000000	.4020356-01*	.0000000	.5089059-01*	.0000000
35	-.2529262+00	.0000000	.0000000	.0000000	.5089059-01	.0000000
36	-.2529262+00	.0000000	.3060314-02	.0000000	.5089059-01	.0000000
37	-.2529262+00	.0000000	.1177535-01	.0000000	.5089059-01	.0000000
38	-.2529262+00	.0000000	.2481832-01	.0000000	.5089059-01	.0000000
39	-.2529262+00	.0000000	.4020356-01*	.0000000	.5089059-01	.0000000
40	-.2529262+00	.0000000	.5558880-01	.0000000	.5089059-01	.0000000
41	-.2529262+00	.0000000	.6863177-01	.0000000	.5089059-01	.0000000
42	-.2529262+00	.0000000	.7734681-01	.0000000	.5089059-01	.0000000
43	-.2529262+00	.0000000	.8040712-01	.0000000	.5089059-01	.0000000
44	-.2529262+00	.0000000	.7734681-01	.0000000	.5089059-01	.0000000
45	-.2529262+00	.0000000	.6863177-01	.0000000	.5089059-01	.0000000
46	-.2529262+00	.0000000	.5558880-01	.0000000	.5089059-01	.0000000
47	-.2529262+00	.0000000	.4020357-01*	.0000000	.5089059-01	.0000000
48	-.2529262+00	.0000000	.2481833-01	.0000000	.5089059-01	.0000000
49	-.2529262+00	.0000000	.1177535-01	.0000000	.5089059-01	.0000000
50	-.2529262+00	.0000000	.3060316-02	.0000000	.5089059-01	.0000000

51	-	2529262+00*	.000000	*	.4020356-01*	.000000	*	.5089059-01*	.000000	*	.000000	*
52	-	3740458+00	.000000	*	.000000	.000000	*	.5089059-01	.000000	*	.000000	*
53	-	3740458+00	.000000	*	.3060314-02	.000000	*	.5089059-01	.000000	*	.000000	*
54	-	3740458+00	.000000	*	.1177535-01	.000000	*	.5089059-01	.000000	*	.000000	*
55	-	3740458+00	.000000	*	.2481832-01	.000000	*	.5089059-01	.000000	*	.000000	*
56	-	3740458+00	.000000	*	.4020356-01*	.000000	*	.5089059-01	.000000	*	.000000	*
57	-	3740458+00	.000000	*	.5558880-01	.000000	*	.5089059-01	.000000	*	.000000	*
58	-	3740458+00	.000000	*	.6863177-01	.000000	*	.5089059-01	.000000	*	.000000	*
59	-	3740458+00	.000000	*	.7734681-01	.000000	*	.5089059-01	.000000	*	.000000	*
60	-	3740458+00	.000000	*	.8040712-01	.000000	*	.5089059-01	.000000	*	.000000	*
61	-	3740458+00	.000000	*	.7734681-01	.000000	*	.5089059-01	.000000	*	.000000	*
62	-	3740458+00	.000000	*	.6863177-01	.000000	*	.5089059-01	.000000	*	.000000	*
63	-	3740458+00	.000000	*	.5558880-01	.000000	*	.5089059-01	.000000	*	.000000	*
64	-	3740458+00	.000000	*	.4020357-01*	.000000	*	.5089059-01	.000000	*	.000000	*
65	-	3740458+00	.000000	*	.2481833-01	.000000	*	.5089059-01	.000000	*	.000000	*
66	-	3740458+00	.000000	*	.1177535-01	.000000	*	.5089059-01	.000000	*	.000000	*
67	-	3740458+00	.000000	*	.3060316-02	.000000	*	.5089059-01	.000000	*	.000000	*
68	-	3740458+00*	.000000	*	.4020356-01*	.000000	*	.5089059-01*	.000000	*	.000000	*
69	-	5521628+00	.000000	*	.000000	.000000	*	.5089059-01	.000000	*	.000000	*
70	-	5521628+00	.000000	*	.3060314-02	.000000	*	.5089059-01	.000000	*	.000000	*
71	-	5521628+00	.000000	*	.1177535-01	.000000	*	.5089059-01	.000000	*	.000000	*
72	-	5521628+00	.000000	*	.2481832-01	.000000	*	.5089059-01	.000000	*	.000000	*
73	-	5521628+00	.000000	*	.4020356-01*	.000000	*	.5089059-01	.000000	*	.000000	*
74	-	5521628+00	.000000	*	.5558880-01	.000000	*	.5089059-01	.000000	*	.000000	*
75	-	5521628+00	.000000	*	.6863177-01	.000000	*	.5089059-01	.000000	*	.000000	*
76	-	5521628+00	.000000	*	.7734681-01	.000000	*	.5089059-01	.000000	*	.000000	*
77	-	5521628+00	.000000	*	.8040712-01	.000000	*	.5089059-01	.000000	*	.000000	*
78	-	5521628+00	.000000	*	.7734681-01	.000000	*	.5089059-01	.000000	*	.000000	*
79	-	5521628+00	.000000	*	.6863177-01	.000000	*	.5089059-01	.000000	*	.000000	*
80	-	5521628+00	.000000	*	.5558880-01	.000000	*	.5089059-01	.000000	*	.000000	*
81	-	5521628+00	.000000	*	.4020357-01*	.000000	*	.5089059-01	.000000	*	.000000	*
82	-	5521628+00	.000000	*	.2481833-01	.000000	*	.5089059-01	.000000	*	.000000	*
83	-	5521628+00	.000000	*	.1177535-01	.000000	*	.5089059-01	.000000	*	.000000	*
84	-	5521628+00	.000000	*	.3060316-02	.000000	*	.5089059-01	.000000	*	.000000	*
85	-	5521628+00*	.000000	*	.4020356-01*	.000000	*	.5089059-01*	.000000	*	.000000	*
86	-	7302799+00	.000000	*	.000000	.000000	*	.5089059-01	.000000	*	.000000	*
87	-	7302799+00	.000000	*	.3060314-02	.000000	*	.5089059-01	.000000	*	.000000	*
88	-	7302799+00	.000000	*	.1177535-01	.000000	*	.5089059-01	.000000	*	.000000	*
89	-	7302799+00	.000000	*	.2481832-01	.000000	*	.5089059-01	.000000	*	.000000	*
90	-	7302799+00	.000000	*	.4020356-01*	.000000	*	.5089059-01	.000000	*	.000000	*
91	-	7302799+00	.000000	*	.5558880-01	.000000	*	.5089059-01	.000000	*	.000000	*
92	-	7302799+00	.000000	*	.6863177-01	.000000	*	.5089059-01	.000000	*	.000000	*
93	-	7302799+00	.000000	*	.7734681-01	.000000	*	.5089059-01	.000000	*	.000000	*
94	-	7302799+00	.000000	*	.8040712-01	.000000	*	.5089059-01	.000000	*	.000000	*
95	-	7302799+00	.000000	*	.7734681-01	.000000	*	.5089059-01	.000000	*	.000000	*
96	-	7302799+00	.000000	*	.6863177-01	.000000	*	.5089059-01	.000000	*	.000000	*
97	-	7302799+00	.000000	*	.5558880-01	.000000	*	.5089059-01	.000000	*	.000000	*
98	-	7302799+00	.000000	*	.4020357-01*	.000000	*	.5089059-01	.000000	*	.000000	*
99	-	7302799+00	.000000	*	.2481833-01	.000000	*	.5089059-01	.000000	*	.000000	*
100	-	7302799+00	.000000	*	.1177535-01	.000000	*	.5089059-01	.000000	*	.000000	*

101	--.7302799+00	.0000000	*.3060316-02	.0000000	*.5089059-01	.0000000	*.0000000
102	--.7302799+00*	.0000000	*.4020356-01*	.0000000	*.5089059-01*	.0000000	*.0000000
103	--.8829516+00	.0000000	.0000000	.0000000	*.5089059-01	.0000000	*.0000000
104	--.8829516+00	.0000000	*.3060314-02	.0000000	*.5089059-01	.0000000	*.0000000
105	--.8829516+00	.0000000	*.1171535-01	.0000000	*.5089059-01	.0000000	*.0000000
106	--.8829516+00	.0000000	*.2481832-01	.0000000	*.5089059-01	.0000000	*.0000000
107	--.8829516+00	.0000000	*.4020356-01*	.0000000	*.5089059-01	.0000000	*.0000000
108	--.8829516+00	.0000000	*.5558880-01	.0000000	*.5089059-01	.0000000	*.0000000
109	--.8829516+00	.0000000	*.6863177-01	.0000000	*.5089059-01	.0000000	*.0000000
110	--.8829516+00	.0000000	*.7734681-01	.0000000	*.5089059-01	.0000000	*.0000000
111	--.8829516+00	.0000000	*.8040712-01	.0000000	*.5089059-01	.0000000	*.0000000
112	--.8829516+00	.0000000	*.7734681-01	.0000000	*.5089059-01	.0000000	*.0000000
113	--.8829516+00	.0000000	*.6863177-01	.0000000	*.5089059-01	.0000000	*.0000000
114	--.8829516+00	.0000000	*.5558880-01	.0000000	*.5089059-01	.0000000	*.0000000
115	--.8829516+00	.0000000	*.4020357-01*	.0000000	*.5089059-01	.0000000	*.0000000
116	--.8829516+00	.0000000	*.2481833-01	.0000000	*.5089059-01	.0000000	*.0000000
117	--.8829516+00	.0000000	*.1171535-01	.0000000	*.5089059-01	.0000000	*.0000000
118	--.8829516+00	.0000000	*.3060316-02	.0000000	*.5089059-01	.0000000	*.0000000
119	--.8829516+00*	.0000000	*.4020356-01*	.0000000	*.5089059-01*	.0000000	*.0000000
120	--.1000000+01	.0000000	*.0000000	.0000000	*.5089059-01	.0000000	*.0000000
121	--.1000000+01	.0000000	*.3060314-02	.0000000	*.5089059-01	.0000000	*.0000000
122	--.1000000+01	.0000000	*.1171535-01	.0000000	*.5089059-01	.0000000	*.0000000
123	--.1000000+01	.0000000	*.2481832-01	.0000000	*.5089059-01	.0000000	*.0000000
124	--.1000000+01	.0000000	*.4020356-01*	.0000000	*.5089059-01	.0000000	*.0000000
125	--.1000000+01	.0000000	*.5558880-01	.0000000	*.5089059-01	.0000000	*.0000000
126	--.1000000+01	.0000000	*.6863177-01	.0000000	*.5089059-01	.0000000	*.0000000
127	--.1000000+01	.0000000	*.7734681-01	.0000000	*.5089059-01	.0000000	*.0000000
128	--.1000000+01	.0000000	*.8040712-01	.0000000	*.5089059-01	.0000000	*.0000000
129	--.1000000+01	.0000000	*.7734681-01	.0000000	*.5089059-01	.0000000	*.0000000
130	--.1000000+01	.0000000	*.6863177-01	.0000000	*.5089059-01	.0000000	*.0000000
131	--.1000000+01	.0000000	*.5558880-01	.0000000	*.5089059-01	.0000000	*.0000000
132	--.1000000+01	.0000000	*.4020357-01*	.0000000	*.5089059-01	.0000000	*.0000000
133	--.1000000+01	.0000000	*.2481833-01	.0000000	*.5089059-01	.0000000	*.0000000
134	--.1000000+01	.0000000	*.1171535-01	.0000000	*.5089059-01	.0000000	*.0000000
135	--.1000000+01	.0000000	*.3060316-02	.0000000	*.5089059-01	.0000000	*.0000000
136	--.1000000+01*	.0000000	*.4020356-01*	.0000000	*.5089059-01*	.0000000	*.0000000

ORIGINAL PAGE IS
OF POOR QUALITY

JOE 1/2/3

VIBRATIONAL MODE.
EIGENVALUE = -.8000000+07, FREQ = -450.1582 HZ

JOINT	1	2	3	4	5	6
1	.0000000	.0000000	*.1000000+01	.0000000	.0000000	.0000000
2	.0000000	.0000000	*.1000000+01	.0000000	.0000000	.0000000
3	.0000000	.0000000	*.1000000+01	.0000000	.0000000	.0000000
4	.0000000	.0000000	*.1000000+01	.0000000	.0000000	.0000000
5	.0000000	.0000000	*.1000000+01*	.0000000	.0000000	.0000000
6	.0000000	.0000000	*.1000000+01	.0000000	.0000000	.0000000
7	.0000000	.0000000	*.1000000+01	.0000000	.0000000	.0000000
8	.0000000	.0000000	*.1000000+01	.0000000	.0000000	.0000000
9	.0000000	.0000000	*.1000000+01	.0000000	.0000000	.0000000
10	.0000000	.0000000	*.1000000+01	.0000000	.0000000	.0000000
11	.0000000	.0000000	*.1000000+01	.0000000	.0000000	.0000000
12	.0000000	.0000000	*.1000000+01	.0000000	.0000000	.0000000
13	.0000000	.0000000	*.1000000+01*	.0000000	.0000000	.0000000
14	.0000000	.0000000	*.1000000+01	.0000000	.0000000	.0000000
15	.0000000	.0000000	*.1000000+01	.0000000	.0000000	.0000000
16	.0000000	.0000000	*.1000000+01	.0000000	.0000000	.0000000
17	.0000000	*.0000000	*.1000000+01*	.0000000	.0000000	.0000000
18	.0000000	.0000000	*.1000000+01	.0000000	.0000000	.0000000
19	.0000000	.0000000	*.1000000+01	.0000000	.0000000	.0000000
20	.0000000	.0000000	*.1000000+01	.0000000	.0000000	.0000000
21	.0000000	.0000000	*.1000000+01	.0000000	.0000000	.0000000
22	.0000000	.0000000	*.1000000+01*	.0000000	.0000000	.0000000
23	.0000000	.0000000	*.1000000+01	.0000000	.0000000	.0000000
24	.0000000	.0000000	*.1000000+01	.0000000	.0000000	.0000000
25	.0000000	.0000000	*.1000000+01	.0000000	.0000000	.0000000
26	.0000000	.0000000	*.1000000+01	.0000000	.0000000	.0000000
27	.0000000	.0000000	*.1000000+01	.0000000	.0000000	.0000000
28	.0000000	.0000000	*.1000000+01	.0000000	.0000000	.0000000
29	.0000000	.0000000	*.1000000+01	.0000000	.0000000	.0000000
30	.0000000	.0000000	*.1000000+01*	.0000000	.0000000	.0000000
31	.0000000	.0000000	*.1000000+01	.0000000	.0000000	.0000000
32	.0000000	.0000000	*.1000000+01	.0000000	.0000000	.0000000
33	.0000000	.0000000	*.1000000+01	.0000000	.0000000	.0000000
34	.0000000	*.0000000	*.1000000+01*	.0000000	.0000000	.0000000
35	.0000000	.0000000	*.1000000+01	.0000000	.0000000	.0000000
36	.0000000	.0000000	*.1000000+01	.0000000	.0000000	.0000000
37	.0000000	.0000000	*.1000000+01	.0000000	.0000000	.0000000
38	.0000000	.0000000	*.1000000+01	.0000000	.0000000	.0000000
39	.0000000	.0000000	*.1000000+01*	.0000000	.0000000	.0000000
40	.0000000	.0000000	*.1000000+01	.0000000	.0000000	.0000000
41	.0000000	.0000000	*.1000000+01	.0000000	.0000000	.0000000
42	.0000000	.0000000	*.1000000+01	.0000000	.0000000	.0000000
43	.0000000	.0000000	*.1000000+01	.0000000	.0000000	.0000000
44	.0000000	.0000000	*.1000000+01	.0000000	.0000000	.0000000
45	.0000000	.0000000	*.1000000+01	.0000000	.0000000	.0000000
46	.0000000	.0000000	*.1000000+01	.0000000	.0000000	.0000000
47	.0000000	.0000000	*.1000000+01*	.0000000	.0000000	.0000000
48	.0000000	.0000000	*.1000000+01	.0000000	.0000000	.0000000
49	.0000000	.0000000	*.1000000+01	.0000000	.0000000	.0000000
50	.0000000	.0000000	*.1000000+01	.0000000	.0000000	.0000000

ORIGINAL PAGE IS
OF POOR QUALITY

10E 1 / 2 / 4

VIBRATIONAL MODE.
EIGENVALUE = -.8000000+07, FREQ = -450.1582 HZ

JOINT	1	2	3	4	5	6
1	.0000000	.1000000+01*	.0000000	.0000000	.0000000	.0000000
2	.0000000	.1000000+01*	.0000000	.0000000	.0000000	.0000000
3	.0000000	.1000000+01*	.0000000	.0000000	.0000000	.0000000
4	.0000000	.1000000+01*	.0000000	.0000000	.0000000	.0000000
5	.0000000	.1000000+01*	.0000000	.0000000	.0000000	.0000000
6	.0000000	.1000000+01*	.0000000	.0000000	.0000000	.0000000
7	.0000000	.1000000+01*	.0000000	.0000000	.0000000	.0000000
8	.0000000	.1000000+01*	.0000000	.0000000	.0000000	.0000000
9	.0000000	.1000000+01*	.0000000	.0000000	.0000000	.0000000
10	.0000000	.1000000+01*	.0000000	.0000000	.0000000	.0000000
11	.0000000	.1000000+01*	.0000000	.0000000	.0000000	.0000000
12	.0000000	.1000000+01*	.0000000	.0000000	.0000000	.0000000
13	.0000000	.1000000+01*	.0000000	.0000000	.0000000	.0000000
14	.0000000	.1000000+01*	.0000000	.0000000	.0000000	.0000000
15	.0000000	.1000000+01*	.0000000	.0000000	.0000000	.0000000
16	.0000000	.1000000+01*	.0000000	.0000000	.0000000	.0000000
17	.0000000	.1000000+01*	.0000000	.0000000	.0000000	.0000000
18	.0000000	.1000000+01*	.0000000	.0000000	.0000000	.0000000
19	.0000000	.1000000+01*	.0000000	.0000000	.0000000	.0000000
20	.0000000	.1000000+01*	.0000000	.0000000	.0000000	.0000000
21	.0000000	.1000000+01*	.0000000	.0000000	.0000000	.0000000
22	.0000000	.1000000+01*	.0000000	.0000000	.0000000	.0000000
23	.0000000	.1000000+01*	.0000000	.0000000	.0000000	.0000000
24	.0000000	.1000000+01*	.0000000	.0000000	.0000000	.0000000
25	.0000000	.1000000+01*	.0000000	.0000000	.0000000	.0000000
26	.0000000	.1000000+01*	.0000000	.0000000	.0000000	.0000000
27	.0000000	.1000000+01*	.0000000	.0000000	.0000000	.0000000
28	.0000000	.1000000+01*	.0000000	.0000000	.0000000	.0000000
29	.0000000	.1000000+01*	.0000000	.0000000	.0000000	.0000000
30	.0000000	.1000000+01*	.0000000	.0000000	.0000000	.0000000
31	.0000000	.1000000+01*	.0000000	.0000000	.0000000	.0000000
32	.0000000	.1000000+01*	.0000000	.0000000	.0000000	.0000000
33	.0000000	.1000000+01*	.0000000	.0000000	.0000000	.0000000
34	.0000000	.1000000+01*	.0000000	.0000000	.0000000	.0000000
35	.0000000	.1000000+01*	.0000000	.0000000	.0000000	.0000000
36	.0000000	.1000000+01*	.0000000	.0000000	.0000000	.0000000
37	.0000000	.1000000+01*	.0000000	.0000000	.0000000	.0000000
38	.0000000	.1000000+01*	.0000000	.0000000	.0000000	.0000000
39	.0000000	.1000000+01*	.0000000	.0000000	.0000000	.0000000
40	.0000000	.1000000+01*	.0000000	.0000000	.0000000	.0000000
41	.0000000	.1000000+01*	.0000000	.0000000	.0000000	.0000000
42	.0000000	.1000000+01*	.0000000	.0000000	.0000000	.0000000
43	.0000000	.1000000+01*	.0000000	.0000000	.0000000	.0000000
44	.0000000	.1000000+01*	.0000000	.0000000	.0000000	.0000000
45	.0000000	.1000000+01*	.0000000	.0000000	.0000000	.0000000
46	.0000000	.1000000+01*	.0000000	.0000000	.0000000	.0000000
47	.0000000	.1000000+01*	.0000000	.0000000	.0000000	.0000000
48	.0000000	.1000000+01*	.0000000	.0000000	.0000000	.0000000
49	.0000000	.1000000+01*	.0000000	.0000000	.0000000	.0000000
50	.0000000	.1000000+01*	.0000000	.0000000	.0000000	.0000000

IO= 1 / 2 / 5

VIBRATIONAL MODE,
EIGENVALUE= .8000000+07, FREQ= -450.1582 HZ

JOINT	1	2	3	4	5	6
1	.000000	.000000	.000000	.509059-01*	.000000	.000000
2	.000000	.000000	.1536524-01	.509059-01*	.000000	.000000
3	.000000	.000000	.2842821-01	.509059-01*	.000000	.000000
4	.000000	.000000	.3714325-01	.509059-01*	.000000	.000000
5	.000000	.000000	.4020356-01*	.509059-01*	.000000	.000000
6	.000000	.000000	.3714325-01	.509059-01*	.000000	.000000
7	.000000	.000000	.2842821-01	.509059-01*	.000000	.000000
8	.000000	.000000	.1536524-01	.509059-01*	.000000	.000000
9	.000000	.000000	.1277931-08	.509059-01*	.000000	.000000
10	.000000	.000000	.1536523-01	.509059-01*	.000000	.000000
11	.000000	.000000	.2842821-01	.509059-01*	.000000	.000000
12	.000000	.000000	.3714325-01	.509059-01*	.000000	.000000
13	.000000	.000000	.4020356-01*	.509059-01*	.000000	.000000
14	.000000	.000000	.3714325-01	.509059-01*	.000000	.000000
15	.000000	.000000	.2842821-01	.509059-01*	.000000	.000000
16	.000000	.000000	.1536524-01	.509059-01*	.000000	.000000
17	.000000	.000000	.000000	.509059-01*	.000000	.000000
18	.000000	.1577608+00*	.000000	.509059-01*	.000000	.000000
19	.000000	.1577608+00*	.1536524-01	.509059-01*	.000000	.000000
20	.000000	.1577608+00*	.2842821-01	.509059-01*	.000000	.000000
21	.000000	.1577608+00*	.3714325-01	.509059-01*	.000000	.000000
22	.000000	.1577608+00*	.4020356-01*	.509059-01*	.000000	.000000
23	.000000	.1577608+00*	.3714325-01	.509059-01*	.000000	.000000
24	.000000	.1577608+00*	.2842821-01	.509059-01*	.000000	.000000
25	.000000	.1577608+00*	.1536524-01	.509059-01*	.000000	.000000
26	.000000	.1577608+00*	.1277931-08	.509059-01*	.000000	.000000
27	.000000	.1577608+00*	.1536523-01	.509059-01*	.000000	.000000
28	.000000	.1577608+00*	.2842821-01	.509059-01*	.000000	.000000
29	.000000	.1577608+00*	.3714325-01	.509059-01*	.000000	.000000
30	.000000	.1577608+00*	.4020356-01*	.509059-01*	.000000	.000000
31	.000000	.1577608+00*	.3714325-01	.509059-01*	.000000	.000000
32	.000000	.1577608+00*	.2842821-01	.509059-01*	.000000	.000000
33	.000000	.1577608+00*	.1536524-01	.509059-01*	.000000	.000000
34	.000000	.1577608+00*	.000000	.509059-01*	.000000	.000000
35	.000000	.2529262+00*	.000000	.509059-01*	.000000	.000000
36	.000000	.2529262+00*	.1536524-01	.509059-01*	.000000	.000000
37	.000000	.2529262+00*	.2842821-01	.509059-01*	.000000	.000000
38	.000000	.2529262+00*	.3714325-01	.509059-01*	.000000	.000000
39	.000000	.2529262+00*	.4020356-01*	.509059-01*	.000000	.000000
40	.000000	.2529262+00*	.3714325-01	.509059-01*	.000000	.000000
41	.000000	.2529262+00*	.2842821-01	.509059-01*	.000000	.000000
42	.000000	.2529262+00*	.1536524-01	.509059-01*	.000000	.000000
43	.000000	.2529262+00*	.1277931-08	.509059-01*	.000000	.000000
44	.000000	.2529262+00*	.1536523-01	.509059-01*	.000000	.000000
45	.000000	.2529262+00*	.2842821-01	.509059-01*	.000000	.000000
46	.000000	.2529262+00*	.3714325-01	.509059-01*	.000000	.000000
47	.000000	.2529262+00*	.4020356-01*	.509059-01*	.000000	.000000
48	.000000	.2529262+00*	.3714325-01	.509059-01*	.000000	.000000
49	.000000	.2529262+00*	.2842821-01	.509059-01*	.000000	.000000
50	.000000	.2529262+00*	.1536524-01	.509059-01*	.000000	.000000

ORIGINAL PAGE IS
OF POOR QUALITY

51	.000000	.2529262+00*	.000000	.000000	.509059-01*	.000000	.000000	.000000
52	.000000	.3740458+00*	.000000	.000000	.509059-01*	.000000	.000000	.000000
53	.000000	.3740458+00*	.1536524-01	.000000	.509059-01*	.000000	.000000	.000000
54	.000000	.3740458+00*	.2842821-01	.000000	.509059-01*	.000000	.000000	.000000
55	.000000	.3740458+00*	.3714325-01	.000000	.509059-01*	.000000	.000000	.000000
56	.000000	.3740458+00*	.4020356-01*	.000000	.509059-01*	.000000	.000000	.000000
57	.000000	.3740458+00*	.3714325-01	.000000	.509059-01*	.000000	.000000	.000000
58	.000000	.3740458+00*	.2842821-01	.000000	.509059-01*	.000000	.000000	.000000
59	.000000	.3740458+00*	.1536524-01	.000000	.509059-01*	.000000	.000000	.000000
60	.000000	.3740458+00*	.1277931-08	.000000	.5089059-01*	.000000	.000000	.000000
61	.000000	.3740458+00*	.1536523-01	.000000	.509059-01*	.000000	.000000	.000000
62	.000000	.3740458+00*	.2842821-01	.000000	.509059-01*	.000000	.000000	.000000
63	.000000	.3740458+00*	.3714325-01	.000000	.509059-01*	.000000	.000000	.000000
64	.000000	.3740458+00*	.4020356-01*	.000000	.5089059-01*	.000000	.000000	.000000
65	.000000	.3740458+00*	.3714325-01	.000000	.509059-01*	.000000	.000000	.000000
66	.000000	.3740458+00*	.2842821-01	.000000	.509059-01*	.000000	.000000	.000000
67	.000000	.3740458+00*	.1536524-01	.000000	.509059-01*	.000000	.000000	.000000
68	.000000	.3740458+00*	.000000	.000000	.5089059-01*	.000000	.000000	.000000
69	.000000	.5521628+00*	.000000	.000000	.509059-01*	.000000	.000000	.000000
70	.000000	.5521628+00*	.1536524-01	.000000	.509059-01*	.000000	.000000	.000000
71	.000000	.5521628+00*	.2842821-01	.000000	.509059-01*	.000000	.000000	.000000
72	.000000	.5521628+00*	.3714325-01	.000000	.509059-01*	.000000	.000000	.000000
73	.000000	.5521628+00*	.4020356-01*	.000000	.5089059-01*	.000000	.000000	.000000
74	.000000	.5521628+00*	.3714325-01	.000000	.5089059-01*	.000000	.000000	.000000
75	.000000	.5521628+00*	.2842821-01	.000000	.509059-01*	.000000	.000000	.000000
76	.000000	.5521628+00*	.1536524-01	.000000	.5089059-01*	.000000	.000000	.000000
77	.000000	.5521628+00*	.1277931-08	.000000	.509059-01*	.000000	.000000	.000000
78	.000000	.5521628+00*	.1536523-01	.000000	.509059-01*	.000000	.000000	.000000
79	.000000	.5521628+00*	.2842821-01	.000000	.5089059-01*	.000000	.000000	.000000
80	.000000	.5521628+00*	.3714325-01	.000000	.5089059-01*	.000000	.000000	.000000
81	.000000	.5521628+00*	.4020356-01*	.000000	.509059-01*	.000000	.000000	.000000
82	.000000	.5521628+00*	.3714325-01	.000000	.5089059-01*	.000000	.000000	.000000
83	.000000	.5521628+00*	.2842821-01	.000000	.509059-01*	.000000	.000000	.000000
84	.000000	.5521628+00*	.1536524-01	.000000	.509059-01*	.000000	.000000	.000000
85	.000000	.5521628+00*	.000000	.000000	.5089059-01*	.000000	.000000	.000000
86	.000000	.7302799+00*	.000000	.000000	.509059-01*	.000000	.000000	.000000
87	.000000	.7302799+00*	.1536524-01	.000000	.509059-01*	.000000	.000000	.000000
88	.000000	.7302799+00*	.2842821-01	.000000	.509059-01*	.000000	.000000	.000000
89	.000000	.7302799+00*	.3714325-01	.000000	.509059-01*	.000000	.000000	.000000
90	.000000	.7302799+00*	.4020356-01*	.000000	.509059-01*	.000000	.000000	.000000
91	.000000	.7302799+00*	.3714325-01	.000000	.5089059-01*	.000000	.000000	.000000
92	.000000	.7302799+00*	.2842821-01	.000000	.509059-01*	.000000	.000000	.000000
93	.000000	.7302799+00*	.1536524-01	.000000	.509059-01*	.000000	.000000	.000000
94	.000000	.7302799+00*	.1277931-08	.000000	.5089059-01*	.000000	.000000	.000000
95	.000000	.7302799+00*	.1536523-01	.000000	.509059-01*	.000000	.000000	.000000
96	.000000	.7302799+00*	.2842821-01	.000000	.5089059-01*	.000000	.000000	.000000
97	.000000	.7302799+00*	.3714325-01	.000000	.509059-01*	.000000	.000000	.000000
98	.000000	.7302799+00*	.4020356-01*	.000000	.5089059-01*	.000000	.000000	.000000
99	.000000	.7302799+00*	.3714325-01	.000000	.5089059-01*	.000000	.000000	.000000
100	.000000	.7302799+00*	.2842821-01	.000000	.5089059-01*	.000000	.000000	.000000

101	.000000	.7302799+00*	-.1536524-01	.509059-01*	.000000	.000000
102	.000000	.7302799+00*	.000000	.5089059-01*	.000000	.000000
103	.000000	.8829516+00*	.000000	.5089059-01*	.000000	.000000
104	.000000	.8829516+00*	.1538524-01	.509059-01*	.000000	.000000
105	.000000	.8829516+00*	.2842821-01	.509059-01*	.000000	.000000
106	.000000	.8829516+00*	.3714325-01	.5089059-01*	.000000	.000000
107	.000000	.8829516+00*	.4020356-01*	.509059-01*	.000000	.000000
108	.000000	.8829516+00*	.3714325-01	.509059-01*	.000000	.000000
109	.000000	.8829516+00*	.2842821-01	.5089059-01*	.000000	.000000
110	.000000	.8829516+00*	.1536524-01	.509059-01*	.000000	.000000
111	.000000	.8829516+00*	.1277931-08	.5089059-01*	.000000	.000000
112	.000000	.8829516+00*	-.1538523-01	.509059-01*	.000000	.000000
113	.000000	.8829516+00*	-.2842821-01	.5089059-01*	.000000	.000000
114	.000000	.8829516+00*	-.3714325-01	.5089059-01*	.000000	.000000
115	.000000	.8829516+00*	-.4020356-01*	.509059-01*	.000000	.000000
116	.000000	.8829516+00*	-.3714325-01	.509059-01*	.000000	.000000
117	.000000	.8829516+00*	-.2842821-01	.509059-01*	.000000	.000000
118	.000000	.8829516+00*	-.1536524-01	.5089059-01*	.000000	.000000
119	.000000	.8829516+00*	.000000	.509059-01*	.000000	.000000
120	.000000	.1000000+01*	.000000	.5089059-01*	.000000	.000000
121	.000000	.1000000+01*	.1538524-01	.509059-01*	.000000	.000000
122	.000000	.1000000+01*	.2842821-01	.509059-01*	.000000	.000000
123	.000000	.1000000+01*	.3714325-01	.509059-01*	.000000	.000000
124	.000000	.1000000+01*	.4020356-01*	.5089059-01*	.000000	.000000
125	.000000	.1000000+01*	.3714325-01	.5089059-01*	.000000	.000000
126	.000000	.1000000+01*	.2842821-01	.509059-01*	.000000	.000000
127	.000000	.1000000+01*	.1538524-01	.5089059-01*	.000000	.000000
128	.000000	.1000000+01*	.1277931-08	.5089059-01*	.000000	.000000
129	.000000	.1000000+01*	-.1538523-01	.509059-01*	.000000	.000000
130	.000000	.1000000+01*	-.2842821-01	.5089059-01*	.000000	.000000
131	.000000	.1000000+01*	-.3714325-01	.509059-01*	.000000	.000000
132	.000000	.1000000+01*	-.4020356-01*	.5089059-01*	.000000	.000000
133	.000000	.1000000+01*	-.3714325-01	.509059-01*	.000000	.000000
134	.000000	.1000000+01*	-.2842821-01	.5089059-01*	.000000	.000000
135	.000000	.1000000+01*	-.1538524-01	.509059-01*	.000000	.000000
136	.000000	.1000000+01*	.000000	.5089059-01*	.000000	.000000

IO= 1 / 2 / 6

VIBRATIONAL MODE.
EIGENVALUE= -.8000000+07, FREQ= -450.1582 HZ

JOINT	1	2	3	4	5	6
1	.0000000	.0000000	.0000000	.0000000	.0000000	.6329114+00*
2	-.1913417+00	-.3806023-01*	.0000000	.0000000	.0000000	.6329114+00*
3	-.3535534+00	-.1464466+00*	.0000000	.0000000	.0000000	.6329114+00*
4	-.4619398+00	-.3086583+00*	.0000000	.0000000	.0000000	.6329114+00*
5	-.5000000+00	-.5000000+00*	.0000000	.0000000	.0000000	.6329114+00*
6	-.4619398+00	-.6913417+00*	.0000000	.0000000	.0000000	.6329114+00*
7	-.3535534+00	-.8535534+00*	.0000000	.0000000	.0000000	.6329114+00*
8	-.1913417+00	-.9619398+00*	.0000000	.0000000	.0000000	.6329114+00*
9	-.1589325-07	-.1000000+01*	.0000000	.0000000	.0000000	.6329114+00*
10	.1913417+00	-.9619398+00*	.0000000	.0000000	.0000000	.6329114+00*
11	.3535534+00	-.8535534+00*	.0000000	.0000000	.0000000	.6329114+00*
12	.4619398+00	-.6913417+00*	.0000000	.0000000	.0000000	.6329114+00*
13	.5000000+00	-.5000000+00*	.0000000	.0000000	.0000000	.6329114+00*
14	.4619398+00	-.3086583+00*	.0000000	.0000000	.0000000	.6329114+00*
15	.3535534+00	-.1464466+00*	.0000000	.0000000	.0000000	.6329114+00*
16	.1913418+00	-.3806026-01*	.0000000	.0000000	.0000000	.6329114+00*
17	.0000000	-.5000000+00*	.0000000	.0000000	.0000000	.6329114+00*
18	.0000000	.0000000	.0000000	.0000000	.0000000	.6329114+00*
19	-.1913417+00	-.3806023-01*	.0000000	.0000000	.0000000	.6329114+00*
20	-.3535534+00	-.1464466+00*	.0000000	.0000000	.0000000	.6329114+00*
21	-.4619398+00	-.3086583+00*	.0000000	.0000000	.0000000	.6329114+00*
22	-.5000000+00	-.5000000+00*	.0000000	.0000000	.0000000	.6329114+00*
23	-.4619398+00	-.6913417+00*	.0000000	.0000000	.0000000	.6329114+00*
24	-.3535534+00	-.8535534+00*	.0000000	.0000000	.0000000	.6329114+00*
25	-.1913417+00	-.9619398+00*	.0000000	.0000000	.0000000	.6329114+00*
26	-.1589325-07	-.1000000+01*	.0000000	.0000000	.0000000	.6329114+00*
27	.1913417+00	-.9619398+00*	.0000000	.0000000	.0000000	.6329114+00*
28	.3535534+00	-.8535534+00*	.0000000	.0000000	.0000000	.6329114+00*
29	.4619398+00	-.6913417+00*	.0000000	.0000000	.0000000	.6329114+00*
30	.5000000+00	-.5000000+00*	.0000000	.0000000	.0000000	.6329114+00*
31	.4619398+00	-.3086583+00*	.0000000	.0000000	.0000000	.6329114+00*
32	.3535534+00	-.1464466+00*	.0000000	.0000000	.0000000	.6329114+00*
33	.1913418+00	-.3806026-01*	.0000000	.0000000	.0000000	.6329114+00*
34	.0000000	-.5000000+00*	.0000000	.0000000	.0000000	.6329114+00*
35	.0000000	.0000000	.0000000	.0000000	.0000000	.6329114+00*
36	-.1913417+00	-.3806023-01*	.0000000	.0000000	.0000000	.6329114+00*
37	-.3535534+00	-.1464466+00*	.0000000	.0000000	.0000000	.6329114+00*
38	-.4619398+00	-.3086583+00*	.0000000	.0000000	.0000000	.6329114+00*
39	-.5000000+00	-.5000000+00*	.0000000	.0000000	.0000000	.6329114+00*
40	-.4619398+00	-.6913417+00*	.0000000	.0000000	.0000000	.6329114+00*
41	-.3535534+00	-.8535534+00*	.0000000	.0000000	.0000000	.6329114+00*
42	-.1913417+00	-.9619398+00*	.0000000	.0000000	.0000000	.6329114+00*
43	-.1589325-07	-.1000000+01*	.0000000	.0000000	.0000000	.6329114+00*
44	.1913417+00	-.9619398+00*	.0000000	.0000000	.0000000	.6329114+00*
45	.3535534+00	-.8535534+00*	.0000000	.0000000	.0000000	.6329114+00*
46	.4619398+00	-.6913417+00*	.0000000	.0000000	.0000000	.6329114+00*
47	.5000000+00	-.5000000+00*	.0000000	.0000000	.0000000	.6329114+00*
48	.4619398+00	-.3086583+00*	.0000000	.0000000	.0000000	.6329114+00*
49	.3535534+00	-.1464466+00*	.0000000	.0000000	.0000000	.6329114+00*
50	.1913418+00	-.3806026-01*	.0000000	.0000000	.0000000	.6329114+00*

ORIGINAL PAGE IS
OF POOR QUALITY

51	.000000	*	-.500000	*000000	*	.000000	*	.000000	*	.6329114+00*
52	.000000		.000000			.000000		.000000		.6329114+00*
53	-.1913417+00		-.3806023-01*			.000000		.000000		.6329114+00*
54	-.3535534+00		-.1464466+00*			.000000		.000000		.6329114+00*
55	-.4619398+00		-.3086583+00*			.000000		.000000		.6329114+00*
56	-.5000000+00		-.5000000+00*			.000000		.000000		.6329114+00*
57	-.4619398+00		-.6913417+00*			.000000		.000000		.6329114+00*
58	-.3535534+00		-.8535534+00*			.000000		.000000		.6329114+00*
59	-.1913417+00		-.9619398+00*			.000000		.000000		.6329114+00*
60	-.1589325-07		-.1000000+01*			.000000		.000000		.6329114+00*
61	.1913417+00		-.9619398+00*			.000000		.000000		.6329114+00*
62	.3535534+00		-.8535534+00*			.000000		.000000		.6329114+00*
63	.4619398+00		-.6913417+00*			.000000		.000000		.6329114+00*
64	.5000000+00		-.5000000+00*			.000000		.000000		.6329114+00*
65	.4619398+00		-.3086583+00*			.000000		.000000		.6329114+00*
66	.3535534+00		-.1464466+00*			.000000		.000000		.6329114+00*
67	.1913418+00		-.3806026-01*			.000000		.000000		.6329114+00*
68	.0000000	*	-.5000000+00*			.000000	*	.000000	*	.6329114+00*
69	.0000000		.0000000			.000000		.000000		.6329114+00*
70	-.1913417+00		-.3806023-01*			.000000		.000000		.6329114+00*
71	-.3535534+00		-.1464466+00*			.000000		.000000		.6329114+00*
72	-.4619398+00		-.3086583+00*			.000000		.000000		.6329114+00*
73	-.5000000+00		-.5000000+00*			.000000	*	.000000	*	.6329114+00*
74	-.4619398+00		-.6913417+00*			.000000		.000000		.6329114+00*
75	-.3535534+00		-.8535534+00*			.000000		.000000		.6329114+00*
76	-.1913417+00		-.9619398+00*			.000000		.000000		.6329114+00*
77	-.1589325-07		-.1000000+01*			.000000		.000000		.6329114+00*
78	.1913417+00		-.9619398+00*			.000000		.000000		.6329114+00*
79	.3535534+00		-.8535534+00*			.000000		.000000		.6329114+00*
80	.4619398+00		-.6913417+00*			.000000		.000000		.6329114+00*
81	.5000000+00		-.5000000+00*			.000000	*	.000000	*	.6329114+00*
82	.4619398+00		-.3086583+00*			.000000		.000000		.6329114+00*
83	.3535534+00		-.1464466+00*			.000000		.000000		.6329114+00*
84	.1913418+00		-.3806026-01*			.000000		.000000		.6329114+00*
85	.0000000	*	-.5000000+00*			.000000	*	.000000	*	.6329114+00*
86	.0000000		.0000000			.000000		.000000		.6329114+00*
87	-.1913417+00		-.3806023-01*			.000000		.000000		.6329114+00*
88	-.3535534+00		-.1464466+00*			.000000		.000000		.6329114+00*
89	-.4619398+00		-.3086583+00*			.000000		.000000		.6329114+00*
90	-.5000000+00		-.5000000+00*			.000000	*	.000000	*	.6329114+00*
91	-.4619398+00		-.6913417+00*			.000000		.000000		.6329114+00*
92	-.3535534+00		-.8535534+00*			.000000		.000000		.6329114+00*
93	-.1913417+00		-.9619398+00*			.000000		.000000		.6329114+00*
94	-.1589325-07		-.1000000+01*			.000000		.000000		.6329114+00*
95	.1913417+00		-.9619398+00*			.000000		.000000		.6329114+00*
96	.3535534+00		-.8535534+00*			.000000		.000000		.6329114+00*
97	.4619398+00		-.6913417+00*			.000000		.000000		.6329114+00*
98	.5000000+00		-.5000000+00*			.000000	*	.000000	*	.6329114+00*
99	.4619398+00		-.3086583+00*			.000000		.000000		.6329114+00*
100	.3535534+00		-.1464466+00*			.000000		.000000		.6329114+00*

101	.1913418+00	-.3806026-01*	.0000000	.0000000	.0000000	.0000000	.6329114+00*
102	.0000000	-.5000000+00*	.0000000	.0000000	.0000000	.0000000	.6329114+00*
103	.0000000	.0000000	.0000000	.0000000	.0000000	.0000000	.6329114+00*
104	-.1913417+00	-.3806023-01*	.0000000	.0000000	.0000000	.0000000	.6329114+00*
105	-.3535534+00	-.1464466+00*	.0000000	.0000000	.0000000	.0000000	.6329114+00*
106	-.4619398+00	-.3086583+00*	.0000000	.0000000	.0000000	.0000000	.6329114+00*
107	-.5000000+00	-.5000000+00*	.0000000	.0000000	.0000000	.0000000	.6329114+00*
108	-.4619398+00	-.6913417+00*	.0000000	.0000000	.0000000	.0000000	.6329114+00*
109	-.3535534+00	-.8535534+00*	.0000000	.0000000	.0000000	.0000000	.6329114+00*
110	-.1913417+00	-.9619398+00*	.0000000	.0000000	.0000000	.0000000	.6329114+00*
111	-.1589325-07	-.1000000+01*	.0000000	.0000000	.0000000	.0000000	.6329114+00*
112	.1913417+00	-.9619398+00*	.0000000	.0000000	.0000000	.0000000	.6329114+00*
113	.3535534+00	-.8535534+00*	.0000000	.0000000	.0000000	.0000000	.6329114+00*
114	.4619398+00	-.6913417+00*	.0000000	.0000000	.0000000	.0000000	.6329114+00*
115	.5000000+00	-.5000000+00*	.0000000	.0000000	.0000000	.0000000	.6329114+00*
116	.4619398+00	-.3086583+00*	.0000000	.0000000	.0000000	.0000000	.6329114+00*
117	.3535534+00	-.1464466+00*	.0000000	.0000000	.0000000	.0000000	.6329114+00*
118	.1913418+00	-.3806026-01*	.0000000	.0000000	.0000000	.0000000	.6329114+00*
119	.0000000	-.5000000+00*	.0000000	.0000000	.0000000	.0000000	.6329114+00*
120	.0000000	.0000000	.0000000	.0000000	.0000000	.0000000	.6329114+00*
121	-.1913417+00	-.3806023-01*	.0000000	.0000000	.0000000	.0000000	.6329114+00*
122	-.3535534+00	-.1464466+00*	.0000000	.0000000	.0000000	.0000000	.6329114+00*
123	-.4619398+00	-.3086583+00*	.0000000	.0000000	.0000000	.0000000	.6329114+00*
124	-.5000000+00	-.5000000+00*	.0000000	.0000000	.0000000	.0000000	.6329114+00*
125	-.4619398+00	-.6913417+00*	.0000000	.0000000	.0000000	.0000000	.6329114+00*
126	-.3535534+00	-.8535534+00*	.0000000	.0000000	.0000000	.0000000	.6329114+00*
127	-.1913417+00	-.9619398+00*	.0000000	.0000000	.0000000	.0000000	.6329114+00*
128	-.1589325-07	-.1000000+01*	.0000000	.0000000	.0000000	.0000000	.6329114+00*
129	.1913417+00	-.9619398+00*	.0000000	.0000000	.0000000	.0000000	.6329114+00*
130	.3535534+00	-.8535534+00*	.0000000	.0000000	.0000000	.0000000	.6329114+00*
131	.4619398+00	-.6913417+00*	.0000000	.0000000	.0000000	.0000000	.6329114+00*
132	.5000000+00	-.5000000+00*	.0000000	.0000000	.0000000	.0000000	.6329114+00*
133	.4619398+00	-.3086583+00*	.0000000	.0000000	.0000000	.0000000	.6329114+00*
134	.3535534+00	-.1464466+00*	.0000000	.0000000	.0000000	.0000000	.6329114+00*
135	.1913418+00	-.3806026-01*	.0000000	.0000000	.0000000	.0000000	.6329114+00*
136	.0000000	-.5000000+00*	.0000000	.0000000	.0000000	.0000000	.6329114+00*

EX17 77.977 0 14

NORMAL EXIT. CPU TIME: 1590 TOTAL SUPS: 5251 (MILLISECONDS)

3XQT .EIG
 CURE= 40000
 NREQ= 7
 K =KS
 NEWS= 2
 INITE= 9
 L1= 1
 L2= 2
 OLUSE= 1
 SHIF= .80000000*07
 CON= 2
 DATA SPACE= 26262
 ACTIVITY COUNT= 11
 ACTIVITY COUNT= 22
 ROOTS CONVERGED, ITERATION 2
 1 .64939916*08
 ACTIVITY COUNT= 32
 ROOTS CONVERGED, ITERATION 3
 1 .64939916*08
 2 .84074311*08
 3 .15478356*09
 4 .39774553*09
 5 .86291048*09
 6 .14561690*10
 ACTIVITY COUNT= 37
 ROOTS CONVERGED, ITERATION 4
 1 .64939916*08
 2 .84074311*08
 3 .15478356*09
 4 .39774553*09
 5 .86291048*09
 6 .14561690*10
 7 .22455569*10
 ACTIVITY COUNT= 37

ORIGINAL PAGE IS
OF POOR QUALITY

EIGENVALUES

SEV	11	4	11	3	ERR
1	.64939916+08	.64939916+08	.64939916+08	.00000000	1282.555078
2	.84074311+08	.84074311+08	.84074311+08	.00000000	1459.324280
3	.15478356+09	.15478356+09	.15478356+09	.00000000	1980.079254
4	.39774553+09	.39774553+09	.39774553+09	.00000000	3174.116089
5	.86291048+09	.86291048+09	.86291048+09	.00000000	4675.230469
6	.14561690+10	.14561690+10	.14561690+10	.21975471-07	6073.318359
7	.22455569+10	.22455569+10	.22455569+10	.29070739-05	7541.924672
8	.37858873+10	.37858873+10	.37858873+10	.11615348-03	9792.734741
9	.16300893+11	.16635476+11	.16635476+11	.20525402-01	20320.100546
10	.20517714+11	.21975187+11	.21975187+11	.71034851-01	22797.364502
11	.21945969+11	.25543483+11	.25543483+11	.16392594+00	23577.488291

EIGENVALUE ITERATION HISTORY

11	1	2	3	4
1	.56946033+08	.76082971+08	.14781192+09	.39237985+09
2	.56939916+08	.76074299+08	.14678360+09	.38974634+09
3	.56939916+08	.76074311+08	.14678356+09	.38974553+09
4	.56939916+08	.76074311+08	.14678356+09	.38974553+09

EIGENVALUE ITERATION HISTORY

11	5	6	7	8
1	.89061537+09	.14636608+10	.23267289+10	.44650877+10
2	.85496434+09	.14482248+10	.22383704+10	.37956809+10
3	.85491048+09	.14481690+10	.22375635+10	.37783270+10
4	.85491048+09	.14481690+10	.22375569+10	.37778873+10

EIGENVALUE ITERATION HISTORY

11	9	10	11
1	.19095321+11	.24655260+11	.48467300+11
2	.17278433+11	.23048247+11	.3559702+11
3	.16627476+11	.21967187+11	.2553583+11
4	.16292893+11	.20509714+11	.21937969+11
EXIT	91.175	107	162

NORMAL EXIT. CPU TIME: 13111 TOTAL SUPS: 31377 (MILLISECONDS)

@XQT .AUS
DATA SPACE= 20000

DEFI COMPLETED.
TABL COMPLETED.
DEFI COMPLETED.
DEFI COMPLETED.
UNIO COMPLETED.
NORM COMPLETED.

EXIT 91.220 19 22

NORMAL EXIT. CPU TIME: 35 TOTAL SUPS: 2008 (MILLISECONDS)

@XQT .VPRT
DATA SPACE= 20000

ORIGINAL PAGE IS
OF POOR QUALITY

IDENT 3 / 2 / 1

VIBRATIONAL MODE .
EIGENVALUE .00000000 . FREQ= .0000 HZ

JOINT	1	2	3	4	5	6
1	.100J000+01	.0000000	.0000000	.0000000	.0000000	.0000000
2	.1000000+01	.0000000	.0000000	.0000000	.0000000	.0000000
3	.1000000+01	.0000000	.0000000	.0000000	.0000000	.0000000
4	.1000000+01	.0000000	.0000000	.0000000	.0000000	.0000000
5	.1000000+01	.0000000	.0000000	.0000000	.0000000	.0000000
6	.1000000+01	.0000000	.0000000	.0000000	.0000000	.0000000
7	.1000000+01	.0000000	.0000000	.0000000	.0000000	.0000000
8	.1000000+01	.0000000	.0000000	.0000000	.0000000	.0000000
9	.1000000+01	.0000000	.0000000	.0000000	.0000000	.0000000
10	.1000000+01	.0000000	.0000000	.0000000	.0000000	.0000000
11	.1000000+01	.0000000	.0000000	.0000000	.0000000	.0000000
12	.1000000+01	.0000000	.0000000	.0000000	.0000000	.0000000
13	.1000000+01	.0000000	.0000000	.0000000	.0000000	.0000000
14	.1000000+01	.0000000	.0000000	.0000000	.0000000	.0000000
15	.1000000+01	.0000000	.0000000	.0000000	.0000000	.0000000
16	.1000000+01	.0000000	.0000000	.0000000	.0000000	.0000000
17	.1000000+01*	.0000000	.0000000	.0000000	.0000000	.0000000
18	.1000000+01	.0000000	.0000000	.0000000	.0000000	.0000000
19	.1000000+01	.0000000	.0000000	.0000000	.0000000	.0000000
20	.1000000+01	.0000000	.0000000	.0000000	.0000000	.0000000
21	.1000000+01	.0000000	.0000000	.0000000	.0000000	.0000000
22	.1000000+01	.0000000	.0000000	.0000000	.0000000	.0000000
23	.1000000+01	.0000000	.0000000	.0000000	.0000000	.0000000
24	.1000000+01	.0000000	.0000000	.0000000	.0000000	.0000000
25	.1000000+01	.0000000	.0000000	.0000000	.0000000	.0000000
26	.1000000+01	.0000000	.0000000	.0000000	.0000000	.0000000
27	.1000000+01	.0000000	.0000000	.0000000	.0000000	.0000000
28	.1000000+01	.0000000	.0000000	.0000000	.0000000	.0000000
29	.1000000+01	.0000000	.0000000	.0000000	.0000000	.0000000
30	.1000000+01	.0000000	.0000000	.0000000	.0000000	.0000000
31	.1000000+01	.0000000	.0000000	.0000000	.0000000	.0000000
32	.1000000+01	.0000000	.0000000	.0000000	.0000000	.0000000
33	.1000000+01	.0000000	.0000000	.0000000	.0000000	.0000000
34	.1000000+01*	.0000000	.0000000	.0000000	.0000000	.0000000
35	.1000000+01	.0000000	.0000000	.0000000	.0000000	.0000000
36	.1000000+01	.0000000	.0000000	.0000000	.0000000	.0000000
37	.1000000+01	.0000000	.0000000	.0000000	.0000000	.0000000
38	.1000000+01	.0000000	.0000000	.0000000	.0000000	.0000000
39	.1000000+01	.0000000	.0000000	.0000000	.0000000	.0000000
40	.1000000+01	.0000000	.0000000	.0000000	.0000000	.0000000
41	.1000000+01	.0000000	.0000000	.0000000	.0000000	.0000000
42	.1000000+01	.0000000	.0000000	.0000000	.0000000	.0000000
43	.1000000+01	.0000000	.0000000	.0000000	.0000000	.0000000
44	.1000000+01	.0000000	.0000000	.0000000	.0000000	.0000000
45	.1000000+01	.0000000	.0000000	.0000000	.0000000	.0000000
46	.1000000+01	.0000000	.0000000	.0000000	.0000000	.0000000
47	.1000000+01	.0000000	.0000000	.0000000	.0000000	.0000000
48	.1000000+01	.0000000	.0000000	.0000000	.0000000	.0000000
49	.1000000+01	.0000000	.0000000	.0000000	.0000000	.0000000
50	.1000000+01	.0000000	.0000000	.0000000	.0000000	.0000000

ORIGINAL PAGE IS
OF POOR QUALITY

10= 31.2 / 2

VIBRATIONAL MODE	EIGENVALUE	FREQ	Hz	1	2	3	4	5	6
JOINT 1	.000000	.000000	.0000 Hz						
1	.000000	.000000	.0000 Hz						
2	.000000	.000000	.0000 Hz						
3	.000000	.000000	.0000 Hz						
4	.000000	.000000	.0000 Hz						
5	.000000	.000000	.0000 Hz						
6	.000000	.000000	.0000 Hz						
7	.000000	.000000	.0000 Hz						
8	.000000	.000000	.0000 Hz						
9	.000000	.000000	.0000 Hz						
10	.000000	.000000	.0000 Hz						
11	.000000	.000000	.0000 Hz						
12	.000000	.000000	.0000 Hz						
13	.000000	.000000	.0000 Hz						
14	.000000	.000000	.0000 Hz						
15	.000000	.000000	.0000 Hz						
16	.000000	.000000	.0000 Hz						
17	.000000	.000000	.0000 Hz						
18	.1577608+00	.000000	.0000 Hz						
19	.1577608+00	.000000	.0000 Hz						
20	.1577608+00	.000000	.0000 Hz						
21	.1577608+00	.000000	.0000 Hz						
22	.1577608+00	.000000	.0000 Hz						
23	.1577608+00	.000000	.0000 Hz						
24	.1577608+00	.000000	.0000 Hz						
25	.1577608+00	.000000	.0000 Hz						
26	.1577608+00	.000000	.0000 Hz						
27	.1577608+00	.000000	.0000 Hz						
28	.1577608+00	.000000	.0000 Hz						
29	.1577608+00	.000000	.0000 Hz						
30	.1577608+00	.000000	.0000 Hz						
31	.1577608+00	.000000	.0000 Hz						
32	.1577608+00	.000000	.0000 Hz						
33	.1577608+00	.000000	.0000 Hz						
34	.1577608+00	.000000	.0000 Hz						
35	.2529262+00	.000000	.0000 Hz						
36	.2529262+00	.000000	.0000 Hz						
37	.2529262+00	.000000	.0000 Hz						
38	.2529262+00	.000000	.0000 Hz						
39	.2529262+00	.000000	.0000 Hz						
40	.2529262+00	.000000	.0000 Hz						
41	.2529262+00	.000000	.0000 Hz						
42	.2529262+00	.000000	.0000 Hz						
43	.2529262+00	.000000	.0000 Hz						
44	.2529262+00	.000000	.0000 Hz						
45	.2529262+00	.000000	.0000 Hz						
46	.2529262+00	.000000	.0000 Hz						
47	.2529262+00	.000000	.0000 Hz						
48	.2529262+00	.000000	.0000 Hz						
49	.2529262+00	.000000	.0000 Hz						
50	.2529262+00	.000000	.0000 Hz						

51	-	2529262+00*	.000000	*	.4020356-01*	.000000	*	.5089059-01*	.000000	*
52	-	3740458+00	.000000	*	.000000	.000000	*	.5089059-01	.000000	*
53	-	3740458+00	.000000	*	.3060314-02	.000000	*	.5089059-01	.000000	*
54	-	3740458+00	.000000	*	.117535-01	.000000	*	.5089059-01	.000000	*
55	-	3740458+00	.000000	*	.2481832-01	.000000	*	.5089059-01	.000000	*
56	-	3740458+00	.000000	*	.4020356-01*	.000000	*	.5089059-01	.000000	*
57	-	3740458+00	.000000	*	.5558880-01	.000000	*	.5089059-01	.000000	*
58	-	3740458+00	.000000	*	.6863177-01	.000000	*	.5089059-01	.000000	*
59	-	3740458+00	.000000	*	.7734681-01	.000000	*	.5089059-01	.000000	*
60	-	3740458+00	.000000	*	.8040712-01	.000000	*	.5089059-01	.000000	*
61	-	3740458+00	.000000	*	.7734681-01	.000000	*	.5089059-01	.000000	*
62	-	3740458+00	.000000	*	.6863177-01	.000000	*	.5089059-01	.000000	*
63	-	3740458+00	.000000	*	.5558880-01	.000000	*	.5089059-01	.000000	*
64	-	3740458+00	.000000	*	.4020357-01*	.000000	*	.5089059-01	.000000	*
65	-	3740458+00	.000000	*	.2481833-01	.000000	*	.5089059-01	.000000	*
66	-	3740458+00	.000000	*	.117535-01	.000000	*	.5089059-01	.000000	*
67	-	3740458+00	.000000	*	.3060316-02	.000000	*	.5089059-01	.000000	*
68	-	3740458+00*	.000000	*	.4020356-01*	.000000	*	.5089059-01*	.000000	*
69	-	5521628+00	.000000	*	.000000	.000000	*	.5089059-01	.000000	*
70	-	5521628+00	.000000	*	.3060314-02	.000000	*	.5089059-01	.000000	*
71	-	5521628+00	.000000	*	.117535-01	.000000	*	.5089059-01	.000000	*
72	-	5521628+00	.000000	*	.2481832-01	.000000	*	.5089059-01	.000000	*
73	-	5521628+00	.000000	*	.4020356-01*	.000000	*	.5089059-01	.000000	*
74	-	5521628+00	.000000	*	.5558880-01	.000000	*	.5089059-01	.000000	*
75	-	5521628+00	.000000	*	.6863177-01	.000000	*	.5089059-01	.000000	*
76	-	5521628+00	.000000	*	.7734681-01	.000000	*	.5089059-01	.000000	*
77	-	5521628+00	.000000	*	.8040712-01	.000000	*	.5089059-01	.000000	*
78	-	5521628+00	.000000	*	.7734681-01	.000000	*	.5089059-01	.000000	*
79	-	5521628+00	.000000	*	.6863177-01	.000000	*	.5089059-01	.000000	*
80	-	5521628+00	.000000	*	.5558880-01	.000000	*	.5089059-01	.000000	*
81	-	5521628+00	.000000	*	.4020357-01*	.000000	*	.5089059-01	.000000	*
82	-	5521628+00	.000000	*	.2481833-01	.000000	*	.5089059-01	.000000	*
83	-	5521628+00	.000000	*	.117535-01	.000000	*	.5089059-01	.000000	*
84	-	5521628+00	.000000	*	.3060316-02	.000000	*	.5089059-01	.000000	*
85	-	5521628+00*	.000000	*	.4020356-01*	.000000	*	.5089059-01*	.000000	*
86	-	7302799+00	.000000	*	.000000	.000000	*	.5089059-01	.000000	*
87	-	7302799+00	.000000	*	.3060314-02	.000000	*	.5089059-01	.000000	*
88	-	7302799+00	.000000	*	.117535-01	.000000	*	.5089059-01	.000000	*
89	-	7302799+00	.000000	*	.2481832-01	.000000	*	.5089059-01	.000000	*
90	-	7302799+00	.000000	*	.4020356-01*	.000000	*	.5089059-01	.000000	*
91	-	7302799+00	.000000	*	.5558880-01	.000000	*	.5089059-01	.000000	*
92	-	7302799+00	.000000	*	.6863177-01	.000000	*	.5089059-01	.000000	*
93	-	7302799+00	.000000	*	.7734681-01	.000000	*	.5089059-01	.000000	*
94	-	7302799+00	.000000	*	.8040712-01	.000000	*	.5089059-01	.000000	*
95	-	7302799+00	.000000	*	.7734681-01	.000000	*	.5089059-01	.000000	*
96	-	7302799+00	.000000	*	.6863177-01	.000000	*	.5089059-01	.000000	*
97	-	7302799+00	.000000	*	.5558880-01	.000000	*	.5089059-01	.000000	*
98	-	7302799+00	.000000	*	.4020357-01*	.000000	*	.5089059-01	.000000	*
99	-	7302799+00	.000000	*	.2481833-01	.000000	*	.5089059-01	.000000	*
100	-	7302799+00	.000000	*	.117535-01	.000000	*	.5089059-01	.000000	*

101	- .7302799+00	.000000	*	.3060316-02	.000000	*	.5089059-01	.000000	*
102	- .7302799+00*	.000000	*	.4020356-01*	.000000	*	.5089059-01*	.000000	*
103	- .8829516+00	.000000	*	.000000	.000000	*	.5089059-01	.000000	*
104	- .8829516+00	.000000	*	.3060314-02	.000000	*	.5089059-01	.000000	*
105	- .8829516+00	.000000	*	.1177535-01	.000000	*	.5089059-01	.000000	*
106	- .8829516+00	.000000	*	.2481832-01	.000000	*	.5089059-01	.000000	*
107	- .8829516+00	.000000	*	.4020356-01*	.000000	*	.5089059-01	.000000	*
108	- .8829516+00	.000000	*	.5550880-01	.000000	*	.5089059-01	.000000	*
109	- .8829516+00	.000000	*	.6863177-01	.000000	*	.5089059-01	.000000	*
110	- .8829516+00	.000000	*	.7734681-01	.000000	*	.5089059-01	.000000	*
111	- .8829516+00	.000000	*	.8040712-01	.000000	*	.5089059-01	.000000	*
112	- .8829516+00	.000000	*	.7734681-01	.000000	*	.5089059-01	.000000	*
113	- .8829516+00	.000000	*	.6863177-01	.000000	*	.5089059-01	.000000	*
114	- .8829516+00	.000000	*	.5550880-01	.000000	*	.5089059-01	.000000	*
115	- .8829516+00	.000000	*	.4020357-01*	.000000	*	.5089059-01	.000000	*
116	- .8829516+00	.000000	*	.2481833-01	.000000	*	.5089059-01	.000000	*
117	- .8829516+00	.000000	*	.1177535-01	.000000	*	.5089059-01	.000000	*
118	- .8829516+00	.000000	*	.3060316-02	.000000	*	.5089059-01	.000000	*
119	- .8829516+00*	.000000	*	.4020356-01*	.000000	*	.5089059-01*	.000000	*
120	- .1000000+01	.000000	*	.000000	.000000	*	.5089059-01	.000000	*
121	- .1000000+01	.000000	*	.3060314-02	.000000	*	.5089059-01	.000000	*
122	- .1000000+01	.000000	*	.1177535-01	.000000	*	.5089059-01	.000000	*
123	- .1000000+01	.000000	*	.2481832-01	.000000	*	.5089059-01	.000000	*
124	- .1000000+01	.000000	*	.4020356-01*	.000000	*	.5089059-01	.000000	*
125	- .1000000+01	.000000	*	.5550880-01	.000000	*	.5089059-01	.000000	*
126	- .1000000+01	.000000	*	.6863177-01	.000000	*	.5089059-01	.000000	*
127	- .1000000+01	.000000	*	.7734681-01	.000000	*	.5089059-01	.000000	*
128	- .1000000+01	.000000	*	.8040712-01	.000000	*	.5089059-01	.000000	*
129	- .1000000+01	.000000	*	.7734681-01	.000000	*	.5089059-01	.000000	*
130	- .1000000+01	.000000	*	.6863177-01	.000000	*	.5089059-01	.000000	*
131	- .1000000+01	.000000	*	.5550880-01	.000000	*	.5089059-01	.000000	*
132	- .1000000+01	.000000	*	.4020357-01*	.000000	*	.5089059-01	.000000	*
133	- .1000000+01	.000000	*	.2481833-01	.000000	*	.5089059-01	.000000	*
134	- .1000000+01	.000000	*	.1177535-01	.000000	*	.5089059-01	.000000	*
135	- .1000000+01	.000000	*	.3060316-02	.000000	*	.5089059-01	.000000	*
136	- .1000000+01*	.000000	*	.4020356-01*	.000000	*	.5089059-01*	.000000	*

3/21/3

VIBRATIONAL MODE. FREQ=1980.0792 HZ
EIGENVALUE= .1547836+09i

JOINT	1	2	3	4	5	6
1	-.8892737+00	.0000000	* .1545516+00	.0000000	* -.1956352+00	.0000000
2	-.8892736+00	.0000000	* .1427871+00	.0000000	* -.1956357+00	.0000000
3	-.8892736+00	.0000000	* .1092845+00	.0000000	* -.1956352+00	.0000000
4	-.8892735+00	.0000000	* .5914434-01	.0000000	* -.1956351+00	.0000000
5	-.8892735+00	.0000000	* .0000000	.0000000	* -.1956351+00	.0000000
6	-.8892735+00	.0000000	* -.5914434-01	.0000000	* -.1956351+00	.0000000
7	-.8892735+00	.0000000	* .1092845+00	.0000000	* -.1956352+00	.0000000
8	-.8892735+00	.0000000	* .1427871+00	.0000000	* -.1956352+00	.0000000
9	-.8892735+00	.0000000	* .1545516+00	.0000000	* -.1956352+00	.0000000
10	-.8892735+00	.0000000	* .1427871+00	.0000000	* -.1956352+00	.0000000
11	-.8892735+00	.0000000	* .1092845+00	.0000000	* -.1956352+00	.0000000
12	-.8892736+00	.0000000	* -.5914434-01	.0000000	* -.1956352+00	.0000000
13	-.8892737+00	.0000000	* .0000000	.0000000	* -.1956351+00	.0000000
14	-.8892737+00	.0000000	* .5914434-01	.0000000	* -.1956351+00	.0000000
15	-.8892738+00	.0000000	* .1092845+00	.0000000	* -.1956352+00	.0000000
16	-.8892739+00	.0000000	* .1427871+00	.0000000	* -.1956352+00	.0000000
17	.0000000	* .0000000	* .0000000	.0000000	* .0000000	.0000000
18	-.2449571+00	.0000000	* .1401499+00	.0000000	* -.1774053+00	.0000000
19	-.2449572+00	.0000000	* .1294816+00	.0000000	* -.1774053+00	.0000000
20	-.2449572+00	.0000000	* .9910088-01	.0000000	* -.1774052+00	.0000000
21	-.2449572+00	.0000000	* .5363301-01	.0000000	* -.1774052+00	.0000000
22	-.2449572+00	.0000000	* .0000000	.0000000	* -.1774051+00	.0000000
23	-.2449572+00	.0000000	* .5363296-01	.0000000	* -.1774051+00	.0000000
24	-.2449572+00	.0000000	* .9910081-01	.0000000	* -.1774052+00	.0000000
25	-.2449572+00	.0000000	* .1294815+00	.0000000	* -.1774052+00	.0000000
26	-.2449572+00	.0000000	* .1401498+00	.0000000	* -.1774053+00	.0000000
27	-.2449572+00	.0000000	* .1294815+00	.0000000	* -.1774053+00	.0000000
28	-.2449572+00	.0000000	* .9910088-01	.0000000	* -.1774053+00	.0000000
29	-.2449572+00	.0000000	* .5363301-01	.0000000	* -.1774053+00	.0000000
30	-.2449572+00	.0000000	* .0000000	.0000000	* -.1774052+00	.0000000
31	-.2449572+00	.0000000	* .5363302-01	.0000000	* -.1774053+00	.0000000
32	-.2449572+00	.0000000	* .9910091-01	.0000000	* -.1774053+00	.0000000
33	-.2449572+00	.0000000	* .1294816+00	.0000000	* -.1774054+00	.0000000
34	.0000000	* .0000000	* .0000000	.0000000	* .0000000	.0000000
35	.1014500+00	.0000000	* .1141143+00	.0000000	* -.1444490+00	.0000000
36	.1014500+00	.0000000	* .1054279+00	.0000000	* -.1444490+00	.0000000
37	.1014500+00	.0000000	* .8069098-01	.0000000	* -.1444489+00	.0000000
38	.1014500+00	.0000000	* .4366964-01	.0000000	* -.1444489+00	.0000000
39	.1014500+00	.0000000	* .0000000	.0000000	* -.1444488+00	.0000000
40	.1014500+00	.0000000	* -.4366962-01	.0000000	* -.1444488+00	.0000000
41	.1014500+00	.0000000	* .8069094-01	.0000000	* -.1444488+00	.0000000
42	.1014500+00	.0000000	* .1054278+00	.0000000	* -.1444489+00	.0000000
43	.1014500+00	.0000000	* .1141143+00	.0000000	* -.1444489+00	.0000000
44	.1014500+00	.0000000	* .1054278+00	.0000000	* -.1444489+00	.0000000
45	.1014500+00	.0000000	* .8069097-01	.0000000	* -.1444489+00	.0000000
46	.1014500+00	.0000000	* .4366964-01	.0000000	* -.1444489+00	.0000000
47	.1014500+00	.0000000	* .0000000	.0000000	* -.1444489+00	.0000000
48	.1014500+00	.0000000	* .4366964-01	.0000000	* -.1444489+00	.0000000
49	.1014500+00	.0000000	* .8069099-01	.0000000	* -.1444490+00	.0000000
50	.1014500+00	.0000000	* .1054279+00	.0000000	* -.1444490+00	.0000000

101	-.3818033-01	.0000000	-.1117315+00	.0000000	.1530860+00	.0000000
102	.0000000	.0000000	.0000000	.0000000	.0000000	.0000000
103	-.6140031+00	.0000000	-.1351313+00	.0000000	.1710526+00	.0000000
104	-.6140031+00	.0000000	-.1248450+00	.0000000	.1710526+00	.0000000
105	-.6140031+00	.0000000	-.9555223-01	.0000000	.1710526+00	.0000000
106	-.6140031+00	.0000000	-.5171249-01	.0000000	.1710525+00	.0000000
107	-.6140032+00	.0000000	.0000000	.0000000	.1710525+00	.0000000
108	-.6140032+00	.0000000	.5171245-01	.0000000	.1710525+00	.0000000
109	-.6140031+00	.0000000	.9555217-01	.0000000	.1710525+00	.0000000
110	-.6140031+00	.0000000	.1248450+00	.0000000	.1710525+00	.0000000
111	-.6140031+00	.0000000	.1351312+00	.0000000	.1710525+00	.0000000
112	-.6140031+00	.0000000	.1248450+00	.0000000	.1710526+00	.0000000
113	-.6140031+00	.0000000	.9555223-01	.0000000	.1710525+00	.0000000
114	-.6140031+00	.0000000	.5171249-01	.0000000	.1710525+00	.0000000
115	-.6140031+00	.0000000	.0000000	.0000000	.1710525+00	.0000000
116	-.6140031+00	.0000000	-.5171250-01	.0000000	.1710525+00	.0000000
117	-.6140031+00	.0000000	-.9555225-01	.0000000	.1710526+00	.0000000
118	-.6140031+00	.0000000	-.1248451+00	.0000000	.1710527+00	.0000000
119	.0000000	.0000000	.0000000	.0000000	.0000000	.0000000
120	-.9999998+00	.0000000	-.1310114+00	.0000000	.1658372+00	.0000000
121	-.9999998+00	.0000000	-.1210388+00	.0000000	.1658372+00	.0000000
122	-.9999998+00	.0000000	-.9263905-01	.0000000	.1658372+00	.0000000
123	-.9999998+00	.0000000	-.5013590-01	.0000000	.1658372+00	.0000000
124	-.9999998+00	.0000000	.0000000	.0000000	.1658372+00	.0000000
125	-.9999998+00	.0000000	.5013589-01	.0000000	.1658372+00	.0000000
126	-.9999998+00	.0000000	.9263905-01	.0000000	.1658372+00	.0000000
127	-.9999999+00	.0000000	.1210388+00	.0000000	.1658372+00	.0000000
128	-.9999999+00	.0000000	.1310114+00	.0000000	.1658372+00	.0000000
129	-.9999999+00	.0000000	.1210388+00	.0000000	.1658372+00	.0000000
130	-.9999999+00	.0000000	.9263909-01	.0000000	.1658372+00	.0000000
131	-.1000000+01	.0000000	.5013590-01	.0000000	.1658372+00	.0000000
132	-.1000000+01	.0000000	.0000000	.0000000	.1658372+00	.0000000
133	-.1000000+01	.0000000	-.5013591-01	.0000000	.1658372+00	.0000000
134	-.1000000+01	.0000000	-.9263907-01	.0000000	.1658372+00	.0000000
135	-.9999999+00	.0000000	-.1210388+00	.0000000	.1658372+00	.0000000
136	.0000000	.0000000	.0000000	.0000000	.0000000	.0000000

ORIGINAL PAGE IS OF POOR QUALITY

ID= 5/ 2/ 4

VIBRATIONAL MODE. FREQ= 3174.1159 HZ
EIGENVALUE= .3977455+09, 2

JOINT	1	2	3	4	5	6
1	-.9767642+00	.0000000	.2733225+00	.0000000	-.3459791+00	.0000000
2	-.9767643+00	.0000000	.2525171+00	.0000000	-.3459791+00	.0000000
3	-.9767643+00	.0000000	.1932682+00	.0000000	-.3459790+00	.0000000
4	-.9767644+00	.0000000	.1045960+00	.0000000	-.3459788+00	.0000000
5	-.9767644+00	.0000000	.0000000	.0000000	-.3459787+00	.0000000
6	-.9767644+00	.0000000	-.1045959+00	.0000000	-.3459787+00	.0000000
7	-.9767644+00	.0000000	-.1932681+00	.0000000	-.3459788+00	.0000000
8	-.9767644+00	.0000000	-.2525170+00	.0000000	-.3459789+00	.0000000
9	-.9767643+00	.0000000	-.2733224+00	.0000000	-.3459790+00	.0000000
10	-.9767643+00	.0000000	-.2525170+00	.0000000	-.3459790+00	.0000000
11	-.9767644+00	.0000000	-.1932681+00	.0000000	-.3459789+00	.0000000
12	-.9767645+00	.0000000	-.1045960+00	.0000000	-.3459788+00	.0000000
13	-.9767645+00	.0000000	.0000000	.0000000	-.3459788+00	.0000000
14	-.9767645+00	.0000000	.1045960+00	.0000000	-.3459789+00	.0000000
15	-.9767644+00	.0000000	.1932682+00	.0000000	-.3459790+00	.0000000
16	-.9767643+00	.0000000	.2525171+00	.0000000	-.3459791+00	.0000000
17	.0000000	.0000000	.0000000	.0000000	.0000000	.0000000
18	.2505597+00	.0000000	.1928345+00	.0000000	-.2440961+00	.0000000
19	.2505597+00	.0000000	.1781559+00	.0000000	-.2440960+00	.0000000
20	.2505598+00	.0000000	.1363546+00	.0000000	-.2440958+00	.0000000
21	.2505598+00	.0000000	.7372454-01	.0000000	-.2440957+00	.0000000
22	.2505599+00	.0000000	.0000000	.0000000	-.2440955+00	.0000000
23	.2505598+00	.0000000	-.7372449-01	.0000000	-.2440955+00	.0000000
24	.2505598+00	.0000000	-.1363545+00	.0000000	-.2440956+00	.0000000
25	.2505598+00	.0000000	-.1781558+00	.0000000	-.2440958+00	.0000000
26	.2505598+00	.0000000	-.1928344+00	.0000000	-.2440959+00	.0000000
27	.2505598+00	.0000000	-.1781558+00	.0000000	-.2440959+00	.0000000
28	.2505598+00	.0000000	-.1363545+00	.0000000	-.2440958+00	.0000000
29	.2505598+00	.0000000	-.7372453-01	.0000000	-.2440957+00	.0000000
30	.2505599+00	.0000000	.0000000	.0000000	-.2440956+00	.0000000
31	.2505598+00	.0000000	.7372455-01	.0000000	-.2440957+00	.0000000
32	.2505598+00	.0000000	.1363546+00	.0000000	-.2440958+00	.0000000
33	.2505597+00	.0000000	.1781559+00	.0000000	-.2440961+00	.0000000
34	.0000000	.0000000	.0000000	.0000000	.0000000	.0000000
35	.6553304+00	.0000000	.7855690-01	.0000000	-.9943916-01	.0000000
36	.6553303+00	.0000000	.7257711-01	.0000000	-.9943916-01	.0000000
37	.6553303+00	.0000000	.5554812-01	.0000000	-.9943917-01	.0000000
38	.6553304+00	.0000000	.3006243-01	.0000000	-.9943917-01	.0000000
39	.6553304+00	.0000000	.0000000	.0000000	-.9943918-01	.0000000
40	.6553304+00	.0000000	-.3006243-01	.0000000	-.9943918-01	.0000000
41	.6553303+00	.0000000	-.5554814-01	.0000000	-.9943919-01	.0000000
42	.6553302+00	.0000000	-.7257715-01	.0000000	-.9943920-01	.0000000
43	.6553302+00	.0000000	-.7855695-01	.0000000	-.9943920-01	.0000000
44	.6553302+00	.0000000	-.7257715-01	.0000000	-.9943920-01	.0000000
45	.6553303+00	.0000000	-.5554815-01	.0000000	-.9943920-01	.0000000
46	.6553304+00	.0000000	-.3006243-01	.0000000	-.9943919-01	.0000000
47	.6553305+00	.0000000	.0000000	.0000000	-.9943918-01	.0000000
48	.6553305+00	.0000000	.3006243-01	.0000000	-.9943918-01	.0000000
49	.6553305+00	.0000000	.5554812-01	.0000000	-.9943917-01	.0000000
50	.6553305+00	.0000000	.7257711-01	.0000000	-.9943916-01	.0000000

ORIGINAL PAGE IS
OF POOR QUALITY

101	-.6554518+00	.0000000	*.7914419-01	.0070000	*-.1084371+00	.0000000
102	.0000000	.0000000	.0070000	.0000000	*.0000000	.0000000
103	.2144307+00	.0000000	.2208918+00	.0070000	*-.2796116+00	.0000000
104	.2144307+00	.0000000	.2094774+00	.0000000	*-.2796116+00	.0000000
105	.2144307+00	.0000000	.1561940+00	.0070000	*-.2796114+00	.0000000
106	.2144308+00	.0000000	.8453160-01	.0070000	*-.2796112+00	.0000000
107	.2144308+00	.0000000	.0000000	.0000000	*-.2796111+00	.0000000
108	.2144308+00	.0000000	-.8453153-01	.0070000	*-.2796111+00	.0000000
109	.2144307+00	.0000000	-.1561940+00	.0070000	*-.2796112+00	.0000000
110	.2144307+00	.0000000	-.2094773+00	.0000000	*-.2796114+00	.0000000
111	.2144307+00	.0000000	-.2206917+00	.0070000	*-.2796115+00	.0000000
112	.2144307+00	.0000000	-.2094774+00	.0000000	*-.2796115+00	.0000000
113	.2144307+00	.0000000	-.1561940+00	.0070000	*-.2796114+00	.0000000
114	.2144308+00	.0000000	-.8453159-01	.0000000	*-.2796112+00	.0000000
115	.2144308+00	.0000000	.0000000	.0070000	*-.2796112+00	.0000000
116	.2144308+00	.0000000	.8453161-01	.0000000	*-.2796112+00	.0000000
117	.2144307+00	.0000000	.1561941+00	.0070000	*-.2796114+00	.0000000
118	.2144307+00	.0000000	.2094775+00	.0070000	*-.2796116+00	.0000000
119	.0000000	.0000000	.0000000	.0000000	*.0000000	.0000000
120	.9999997+00	.0000000	.2416602+00	.0070000	*-.3058995+00	.0000000
121	.9999997+00	.0000000	.2232650+00	.0070000	*-.3058995+00	.0000000
122	.9999997+00	.0000000	.1708796+00	.0000000	*-.3058995+00	.0000000
123	.9999998+00	.0000000	.9247937-01	.0070000	*-.3058994+00	.0000000
124	.9999999+00	.0000000	.0000000	.0000000	*-.3058995+00	.0000000
125	.9999998+00	.0000000	-.9247936-01	.0000000	*-.3058994+00	.0000000
126	.9999998+00	.0000000	-.1708796+00	.0070000	*-.3058995+00	.0000000
127	.9999998+00	.0000000	.2232650+00	.0070000	*-.3058996+00	.0000000
128	.9999998+00	.0000000	-.2416603+00	.0000000	*-.3058996+00	.0000000
129	.9999998+00	.0000000	-.2232650+00	.0070000	*-.3058996+00	.0000000
130	.9999999+00	.0000000	-.1708796+00	.0000000	*-.3058996+00	.0000000
131	.1000000+01	.0000000	-.9247939-01	.0070000	*-.3058995+00	.0000000
132	.1000000+01	.0000000	.0000000	.0070000	*-.3058995+00	.0000000
133	.1000000+01	.0000000	.9247939-01	.0070000	*-.3058995+00	.0000000
134	.9999999+00	.0000000	.1708796+00	.0000000	*-.3058995+00	.0000000
135	.9999998+00	.0000000	.2232650+00	.0070000	*-.3058995+00	.0000000
136	.0000000	.0000000	.0000000	.0000000	*.0000000	.0000000

10= 3 / 2 / 5

VIBRATIONAL MODE.
EIGENVALUE = .8629105+09, FREQ = 4675.2302 HZ

JOINT	1	2	3	4	5	6
1	-.6922691+00	.000000	.2543912+00	.000000	-.3220163+00	.000000
2	-.6922692+00	.000000	.2350268+00	.000000	-.3220163+00	.000000
3	-.6922693+00	.000000	.1798817+00	.000000	-.3220161+00	.000000
4	-.6922695+00	.000000	.9735125-01	.000000	-.3220158+00	.000000
5	-.6922695+00	.000000	.000000	.000000	-.3220157+00	.000000
6	-.6922695+00	.000000	-.9735121-01	.000000	-.3220157+00	.000000
7	-.6922694+00	.000000	-.1798816+00	.000000	-.3220158+00	.000000
8	-.6922692+00	.000000	-.2350267+00	.000000	-.3220160+00	.000000
9	-.6922692+00	.000000	-.2543911+00	.000000	-.3220162+00	.000000
10	-.6922692+00	.000000	-.2350267+00	.000000	-.3220161+00	.000000
11	-.6922694+00	.000000	-.1798817+00	.000000	-.3220160+00	.000000
12	-.6922695+00	.000000	-.9735124-01	.000000	-.3220158+00	.000000
13	-.6922696+00	.000000	.000000	.000000	-.3220157+00	.000000
14	-.6922695+00	.000000	.9735125-01	.000000	-.3220158+00	.000000
15	-.6922693+00	.000000	.1798817+00	.000000	-.3220160+00	.000000
16	-.6922692+00	.000000	.2350268+00	.000000	-.3220163+00	.000000
17	.0000000	.000000	.000000	.000000	.0000000	.000000
18	.5607158+00	.000000	.1052871+00	.000000	-.1332766+00	.000000
19	.5607158+00	.000000	.9727258-01	.000000	-.1332766+00	.000000
20	.5607159+00	.000000	.7444919-01	.000000	-.1332764+00	.000000
21	.5607160+00	.000000	.4029160-01	.000000	-.1332763+00	.000000
22	.5607161+00	.000000	.000000	.000000	-.1332762+00	.000000
23	.5607160+00	.000000	-.4029160-01	.000000	-.1332762+00	.000000
24	.5607158+00	.000000	-.7444921-01	.000000	-.1332764+00	.000000
25	.5607156+00	.000000	-.9727263-01	.000000	-.1332765+00	.000000
26	.5607155+00	.000000	-.1052871+00	.000000	-.1332766+00	.000000
27	.5607156+00	.000000	-.9727262-01	.000000	-.1332766+00	.000000
28	.5607158+00	.000000	-.7444920-01	.000000	-.1332765+00	.000000
29	.5607160+00	.000000	-.4029160-01	.000000	-.1332763+00	.000000
30	.5607161+00	.000000	.000000	.000000	-.1332762+00	.000000
31	.5607161+00	.000000	.4029160-01	.000000	-.1332762+00	.000000
32	.5607160+00	.000000	.7444921-01	.000000	-.1332763+00	.000000
33	.5607159+00	.000000	.9727261-01	.000000	-.1332765+00	.000000
34	.0000000	.000000	.000000	.000000	.0000000	.000000
35	.5388535+00	.000000	-.5705383-01	.000000	.7222294-01	.000000
36	.5388535+00	.000000	-.5271083-01	.000000	.7222288-01	.000000
37	.5388536+00	.000000	-.4034307-01	.000000	.7222265-01	.000000
38	.5388537+00	.000000	-.2183349-01	.000000	.7222237-01	.000000
39	.5388538+00	.000000	.000000	.000000	.7222221-01	.000000
40	.5388537+00	.000000	.2183348-01	.000000	.7222224-01	.000000
41	.5388536+00	.000000	.4034305-01	.000000	.7222246-01	.000000
42	.5388535+00	.000000	.5271081-01	.000000	.7222273-01	.000000
43	.5388535+00	.000000	.5705381-01	.000000	.7222289-01	.000000
44	.5388535+00	.000000	.5271082-01	.000000	.7222286-01	.000000
45	.5388537+00	.000000	.4034307-01	.000000	.7222265-01	.000000
46	.5388539+00	.000000	-.2183349-01	.000000	.7222240-01	.000000
47	.5388540+00	.000000	.000000	.000000	.7222225-01	.000000
48	.5388540+00	.000000	-.2183349-01	.000000	.7222231-01	.000000
49	.5388538+00	.000000	-.4034309-01	.000000	.7222254-01	.000000
50	.5388537+00	.000000	-.5271086-01	.000000	.7222287-01	.000000

ID= 3 / 2 / 6

VIBRATIONAL MODE.
EIGENVALUE= .1456169+10I, FREQ= 6073.3181 HZ

JOINT	1	2	3	4	5	6
1	.6116963+00	.0000000	-.2706120+00	.0000000	.3425501+00	.0000000
2	.6116964+00	.0000000	-.2500128+00	.0000000	.3425500+00	.0000000
3	.6116966+00	.0000000	-.1913515+00	.0000000	.3425497+00	.0000000
4	.6116969+00	.0000000	-.1035587+00	.0000000	.3425494+00	.0000000
5	.6116970+00	.0000000	.0000000	.0000000	.3425492+00	.0000000
6	.6116969+00	.0000000	.1035586+00	.0000000	.3425492+00	.0000000
7	.6116967+00	.0000000	.1913514+00	.0000000	.3425495+00	.0000000
8	.6116965+00	.0000000	.2500128+00	.0000000	.3425498+00	.0000000
9	.6116964+00	.0000000	.2706119+00	.0000000	.3425500+00	.0000000
10	.6116965+00	.0000000	.2500128+00	.0000000	.3425499+00	.0000000
11	.6116967+00	.0000000	.1913515+00	.0000000	.3425497+00	.0000000
12	.6116969+00	.0000000	.1035586+00	.0000000	.3425494+00	.0000000
13	.6116970+00	.0000000	.0000000	.0000000	.3425493+00	.0000000
14	.6116969+00	.0000000	-.1035586+00	.0000000	.3425493+00	.0000000
15	.6116967+00	.0000000	-.1913515+00	.0000000	.3425496+00	.0000000
16	.6116964+00	.0000000	-.2500129+00	.0000000	.3425500+00	.0000000
17	.0000000	.0000000	.0000000	.0000000	.0000000	.0000000
18	-.8327204+00	.0000000	-.3190257-01	.0000000	.4038398-01	.0000000
19	-.8327204+00	.0000000	-.2947411-01	.0000000	.4038396-01	.0000000
20	-.8327208+00	.0000000	-.2255849-01	.0000000	.4038387-01	.0000000
21	-.8327212+00	.0000000	-.1220856-01	.0000000	.4038376-01	.0000000
22	-.8327213+00	.0000000	.0000000	.0000000	.4038370-01	.0000000
23	-.8327210+00	.0000000	.1220856-01	.0000000	.4038373-01	.0000000
24	-.8327205+00	.0000000	.2255850-01	.0000000	.4038382-01	.0000000
25	-.8327201+00	.0000000	.2947413-01	.0000000	.4038393-01	.0000000
26	-.8327199+00	.0000000	.3190258-01	.0000000	.4038399-01	.0000000
27	-.8327202+00	.0000000	.2947412-01	.0000000	.4038397-01	.0000000
28	-.8327207+00	.0000000	.2255850-01	.0000000	.4038388-01	.0000000
29	-.8327212+00	.0000000	.1220856-01	.0000000	.4038377-01	.0000000
30	-.8327215+00	.0000000	.0000000	.0000000	.4038370-01	.0000000
31	-.8327214+00	.0000000	-.1220856-01	.0000000	.4038373-01	.0000000
32	-.8327211+00	.0000000	-.2255850-01	.0000000	.4038382-01	.0000000
33	-.8327208+00	.0000000	-.2947412-01	.0000000	.4038392-01	.0000000
34	.0000000	.0000000	.0000000	.0000000	.0000000	.0000000
35	-.2217825+00	.0000000	.1514913+00	.0000000	-.1913758+00	.0000000
36	-.2217826+00	.0000000	.1396732+00	.0000000	-.1913757+00	.0000000
37	-.2217827+00	.0000000	.1069011+00	.0000000	-.1913751+00	.0000000
38	-.2217828+00	.0000000	.5785440-01	.0000000	-.1913744+00	.0000000
39	-.2217828+00	.0000000	.0000000	.0000000	-.1913740+00	.0000000
40	-.2217828+00	.0000000	-.5785436-01	.0000000	-.1913741+00	.0000000
41	-.2217827+00	.0000000	.1069010+00	.0000000	-.1913746+00	.0000000
42	-.2217826+00	.0000000	-.1396731+00	.0000000	-.1913753+00	.0000000
43	-.2217825+00	.0000000	-.1514812+00	.0000000	-.1913757+00	.0000000
44	-.2217826+00	.0000000	-.1396731+00	.0000000	-.1913756+00	.0000000
45	-.2217827+00	.0000000	-.1069011+00	.0000000	-.1913751+00	.0000000
46	-.2217828+00	.0000000	-.5785440-01	.0000000	-.1913745+00	.0000000
47	-.2217829+00	.0000000	.0000000	.0000000	-.1913741+00	.0000000
48	-.2217829+00	.0000000	.5785441-01	.0000000	-.1913743+00	.0000000
49	-.2217827+00	.0000000	.1069011+00	.0000000	-.1913748+00	.0000000
50	-.2217826+00	.0000000	.1396733+00	.0000000	-.1913755+00	.0000000

101	.198884*00	.000000	* .3854229-01	.000000	* .5291086-01	.000000	*
102	.000000	.000000	* .000000	.000000	* .000000	.000000	*
103	.1920324*00	.000000	* -.8965213-01	.000000	* .1134842+00	.000000	*
104	.1920324*00	.000000	* -.8284775-01	.000000	* .1134842+00	.000000	*
105	.1920325*00	.000000	* -.6339360-01	.000000	* .1134842+00	.000000	*
106	.1920326*00	.000000	* -.3434836-01	.000000	* .1134841+00	.000000	*
107	.1920327*00	.000000	* .000000	.000000	* .1134840+00	.000000	*
108	.1920327*00	.000000	* .3434834-01	.000000	* .1134840+00	.000000	*
109	.1920325*00	.000000	* .6339356-01	.000000	* .1134841+00	.000000	*
110	.1920324*00	.000000	* .8284770-01	.000000	* .1134841+00	.000000	*
111	.1920324*00	.000000	* .8965208-01	.000000	* .1134842+00	.000000	*
112	.1920324*00	.000000	* .8284773-01	.000000	* .1134842+00	.000000	*
113	.1920325*00	.000000	* .6339359-01	.000000	* .1134842+00	.000000	*
114	.1920327*00	.000000	* .3434836-01	.000000	* .1134841+00	.000000	*
115	.1920327*00	.000000	* .000000	.000000	* .1134841+00	.000000	*
116	.1920327*00	.000000	* -.3434837-01	.000000	* .1134841+00	.000000	*
117	.1920326*00	.000000	* -.6339362-01	.000000	* .1134842+00	.000000	*
118	.1920324*00	.000000	* -.8284772-01	.000000	* .1134843+00	.000000	*
119	.000000	.000000	* .000000	.000000	* .000000	.000000	*
120	.3831274*00	.000000	* -.1454420+00	.000000	* .1841048+00	.000000	*
121	.3831274*00	.000000	* -.1343708+00	.000000	* .1841047+00	.000000	*
122	.3831275*00	.000000	* -.1028430+00	.000000	* .1841047+00	.000000	*
123	.3831276*00	.000000	* -.5565822-01	.000000	* .1841046+00	.000000	*
124	.3831277*00	.000000	* .000000	.000000	* .1841045+00	.000000	*
125	.3831276*00	.000000	* .5565820-01	.000000	* .1841046+00	.000000	*
126	.3831275*00	.000000	* .1028430+00	.000000	* .1841046+00	.000000	*
127	.3831275*00	.000000	* .1343709+00	.000000	* .1841047+00	.000000	*
128	.3831274*00	.000000	* .1454420+00	.000000	* .1841048+00	.000000	*
129	.3831275*00	.000000	* .1343709+00	.000000	* .1841048+00	.000000	*
130	.3831276*00	.000000	* .1028430+00	.000000	* .1841047+00	.000000	*
131	.3831277*00	.000000	* .5565822-01	.000000	* .1841046+00	.000000	*
132	.3831277*00	.000000	* .000000	.000000	* .1841046+00	.000000	*
133	.3831277*00	.000000	* -.5565822-01	.000000	* .1841046+00	.000000	*
134	.3831276*00	.000000	* -.1028430+00	.000000	* .1841046+00	.000000	*
135	.3831275*00	.000000	* -.1343709+00	.000000	* .1841047+00	.000000	*
136	.000000	.000000	* .000000	.000000	* .000000	.000000	*

ORIGINAL PAGE IS
OF POOR QUALITY

LMSC-HEC TR F042668

ID= 3/ 2/ 7

VIBRATIONAL MODE .2245557+17, FREQ= 7541.9243 HZ

JOINT	1	2	3	4	5	6
1	.2677173-01	.0000000	-.1349970-01	.0000000	.1708844-01	.0000000
2	.2677174-01	.0000000	-.1247209-01	.0000000	.1708844-01	.0000000
3	.2677176-01	.0000000	-.9545721-02	.0000000	.1708842-01	.0000000
4	.2677178-01	.0000000	-.5166105-02	.0000000	.1708840-01	.0000000
5	.2677179-01	.0000000	.0000000	.0000000	.1708839-01	.0000000
6	.2677178-01	.0000000	.5166105-02	.0000000	.1708839-01	.0000000
7	.2677177-01	.0000000	.9545721-02	.0000000	.1708841-01	.0000000
8	.2677176-01	.0000000	.1247209-01	.0000000	.1708843-01	.0000000
9	.2677175-01	.0000000	.1349970-01	.0000000	.1708844-01	.0000000
10	.2677176-01	.0000000	.1247209-01	.0000000	.1708844-01	.0000000
11	.2677177-01	.0000000	.9545720-02	.0000000	.1708842-01	.0000000
12	.2677178-01	.0000000	.5166105-02	.0000000	.1708840-01	.0000000
13	.2677178-01	.0000000	.0000000	.0000000	.1708839-01	.0000000
14	.2677177-01	.0000000	-.5166105-02	.0000000	.1708839-01	.0000000
15	.2677175-01	.0000000	-.9545721-02	.0000000	.1708841-01	.0000000
16	.2677173-01	.0000000	-.1247209-01	.0000000	.1708843-01	.0000000
17	.0000000	.0000000	.0000000	.0000000	.0000000	.0000000
18	-.5194282-01	.0000000	.3260351-02	.0000000	-.4127081-02	.0000000
19	-.5194283-01	.0000000	.3012171-02	.0000000	-.4127080-02	.0000000
20	-.5194287-01	.0000000	.2305415-02	.0000000	-.4127077-02	.0000000
21	-.5194292-01	.0000000	.1247681-02	.0000000	-.4127074-02	.0000000
22	-.5194294-01	.0000000	.0000000	.0000000	-.4127071-02	.0000000
23	-.5194292-01	.0000000	-.1247680-02	.0000000	-.4127070-02	.0000000
24	-.5194288-01	.0000000	-.2305414-02	.0000000	-.4127072-02	.0000000
25	-.5194284-01	.0000000	-.3012169-02	.0000000	-.4127076-02	.0000000
26	-.5194282-01	.0000000	.3260349-02	.0000000	-.4127079-02	.0000000
27	-.5194284-01	.0000000	-.3012170-02	.0000000	-.4127079-02	.0000000
28	-.5194288-01	.0000000	-.2305415-02	.0000000	-.4127078-02	.0000000
29	-.5194293-01	.0000000	-.1247681-02	.0000000	-.4127075-02	.0000000
30	-.5194295-01	.0000000	.0000000	.0000000	-.4127074-02	.0000000
31	-.5194293-01	.0000000	.1247682-02	.0000000	-.4127074-02	.0000000
32	-.5194289-01	.0000000	.2305416-02	.0000000	-.4127077-02	.0000000
33	-.5194284-01	.0000000	.3012172-02	.0000000	-.4127081-02	.0000000
34	.0000000	.0000000	.0000000	.0000000	.0000000	.0000000
35	.2178339-01	.0000000	.1047261-01	.0000000	-.1325695-01	.0000000
36	.2178340-01	.0000000	.9675422-02	.0000000	-.1325694-01	.0000000
37	.2178341-01	.0000000	.7405240-02	.0000000	-.1325691-01	.0000000
38	.2178342-01	.0000000	.4007684-02	.0000000	-.1325686-01	.0000000
39	.2178343-01	.0000000	.0000000	.0000000	-.1325684-01	.0000000
40	.2178342-01	.0000000	-.4007683-02	.0000000	-.1325685-01	.0000000
41	.2178341-01	.0000000	-.7405243-02	.0000000	-.1325688-01	.0000000
42	.2178339-01	.0000000	-.9675428-02	.0000000	-.1325693-01	.0000000
43	.2178339-01	.0000000	-.1047261-01	.0000000	-.1325695-01	.0000000
44	.2178339-01	.0000000	-.9675427-02	.0000000	-.1325694-01	.0000000
45	.2178341-01	.0000000	-.7405243-02	.0000000	-.1325691-01	.0000000
46	.2178343-01	.0000000	-.4007685-02	.0000000	-.1325687-01	.0000000
47	.2178343-01	.0000000	.0000000	.0000000	-.1325684-01	.0000000
48	.2178343-01	.0000000	.4007684-02	.0000000	-.1325685-01	.0000000
49	.2178342-01	.0000000	.7405242-02	.0000000	-.1325688-01	.0000000
50	.2178340-01	.0000000	.9675425-02	.0000000	-.1325692-01	.0000000

ORIGINAL PAGE IS
OF POOR QUALITY

101	4889957+00	.0000000	*	-.340923-01	.0000000	*	.4671570-01	.0000000	*
102	.0000000	.0000000	*	.0000000	.0000000	*	.0000000	.0000000	*
103	-.8780973+00	.0000000	*	.187456+00	.0000000	*	-.2377752+00	.0000000	*
104	-.8780976+00	.0000000	*	.173542+00	.0000000	*	-.2377752+00	.0000000	*
105	-.8780984+00	.0000000	*	.1328265+00	.0000000	*	-.2377755+00	.0000000	*
106	-.8780993+00	.0000000	*	.7188523-01	.0000000	*	-.2377757+00	.0000000	*
107	-.8780997+00	.0000000	*	.0000000	.0000000	*	-.2377759+00	.0000000	*
108	-.8780993+00	.0000000	*	-.7188519-01	.0000000	*	-.2377758+00	.0000000	*
109	-.8780985+00	.0000000	*	-.1328264+00	.0000000	*	-.2377755+00	.0000000	*
110	-.8780977+00	.0000000	*	-.1735461+00	.0000000	*	-.2377752+00	.0000000	*
111	-.8780973+00	.0000000	*	-.1878449+00	.0000000	*	-.2377751+00	.0000000	*
112	-.8780976+00	.0000000	*	-.1735461+00	.0000000	*	-.2377751+00	.0000000	*
113	-.8780985+00	.0000000	*	-.1328265+00	.0000000	*	-.2377755+00	.0000000	*
114	-.8780993+00	.0000000	*	-.7188523-01	.0000000	*	-.2377758+00	.0000000	*
115	-.8780997+00	.0000000	*	.0000000	.0000000	*	-.2377761+00	.0000000	*
116	-.8780994+00	.0000000	*	.7188525-01	.0000000	*	-.2377760+00	.0000000	*
117	-.8780986+00	.0000000	*	.1328266+00	.0000000	*	-.2377758+00	.0000000	*
118	-.8780978+00	.0000000	*	.1735462+00	.0000000	*	-.2377755+00	.0000000	*
119	.0000000	.0000000	*	.0000000	.0000000	*	.0000000	.0000000	*
120	.9999987+00	.0000000	*	.4313244+00	.0000000	*	-.5459844+00	.0000000	*
121	.9999988+00	.0000000	*	.3984918+00	.0000000	*	-.5459844+00	.0000000	*
122	.9999991+00	.0000000	*	.3049223+00	.0000000	*	-.5459841+00	.0000000	*
123	.9999996+00	.0000000	*	.1656606+00	.0000000	*	-.5459837+00	.0000000	*
124	.9999927+00	.0000000	*	.0000000	.0000000	*	-.5459834+00	.0000000	*
125	.9999996+00	.0000000	*	-.1656606+00	.0000000	*	-.5459835+00	.0000000	*
126	.9999992+00	.0000000	*	-.3049224+00	.0000000	*	-.5459839+00	.0000000	*
127	.9999989+00	.0000000	*	-.3984919+00	.0000000	*	-.5459843+00	.0000000	*
128	.9999987+00	.0000000	*	-.4313245+00	.0000000	*	-.5459846+00	.0000000	*
129	.9999989+00	.0000000	*	-.3984919+00	.0000000	*	-.5459845+00	.0000000	*
130	.9999994+00	.0000000	*	-.3049224+00	.0000000	*	-.5459842+00	.0000000	*
131	.9999998+00	.0000000	*	-.1656607+00	.0000000	*	-.5459838+00	.0000000	*
132	.1000000+01	.0000000	*	.0000000	.0000000	*	-.5459836+00	.0000000	*
133	.9999998+00	.0000000	*	.1656607+00	.0000000	*	-.5459836+00	.0000000	*
134	.9999994+00	.0000000	*	.3049224+00	.0000000	*	-.5459839+00	.0000000	*
135	.9999990+00	.0000000	*	.3984918+00	.0000000	*	-.5459843+00	.0000000	*
136	.0000000	.0000000	*	.0000000	.0000000	*	.0000000	.0000000	*

EX11 93.124 0 15

ORIGINAL PAGE IS
OF POOR QUALITY

TABLE OF CONTENTS, LIBRARY 1
HPOTP ROTOR MODAL ANALYSIS CHECKOUT

SEQ	RR	DATE	TIME	E	WORDS	NJ	NI	NJ	Y	T	DATA	SFT	NAME
1	17	062184	134300	0	18	1	18	0	JUFI	BTAR	N3	N4	8
2	-18	062184	134300	0	136	136	136	0	JREF	BTAB	2	6	
3	-23	062184	134300	0	12	1	12	1	ALTR	BTAR	2	4	
4	24	062184	134300	0	18	1	18	4	NDAL		0	0	
5	25	062184	134300	0	36	3	36	1	ALTR	BTAR	2	4	
6	27	062184	134300	0	408	136	408	1	JLOC	BTAR	2	5	
7	42	062184	134300	0	136	136	136	0	JREF	BTAR	2	6	
8	47	062184	134300	0	20	2	20	1	MAIC	BTAB	2	2	
9	48	062184	134300	0	136	136	136	0	CON		1	0	
10	53	062184	134300	0	136	136	136	0	CON		2	0	
11	58	062184	134300	0	15	3	15	1	MREF	BTAR	2	7	
12	59	062184	134300	0	70	2	70	1	BA	BTAR	2	9	
13	62	062184	134300	0	42	2	42	1	BB	BTAR	2	10	
14	64	062184	134300	0	344	8	344	1	SA	BTAR	2	13	
15	77	062184	134300	0	136	136	136	0	JSEQ	BTAB	2	17	
16	82	062184	134300	0	1224	136	1224	1	OJJT	BTAR	2	19	
17	126	062184	134307	0	2016	49	882	0	DEF	E21	1	2	
18	222	062184	134307	0	2	1	2	0	GU	E21	1	2	
19	223	062184	134307	0	15	1	15	4	GIII	E21	1	2	
20	224	062184	134307	0	20	1	20	0	DIR	E21	1	2	
21	225	062184	134307	0	2304	49	682	0	DEF	E22	2	2	
22	321	062184	134307	0	2	1	2	0	GU	E22	2	2	
23	322	062184	134307	0	15	1	15	4	GIII	E22	2	2	
24	323	062184	134307	0	20	1	20	0	DIR	E22	2	2	
25	324	062184	134307	0	2	2	2	4	ELTS	NAME	0	0	
26	325	062184	134307	0	2	2	2	0	ELTS	NNOD	0	0	
27	326	062184	134307	0	2	2	2	0	ELTS	ISCT	0	0	
28	327	062184	134307	0	30	2	30	0	NS		0	0	
29	329	062184	134314	0	15680	112	149	4	E21	EFIL	1	2	
30	889	062184	134314	0	14336	128	112	4	E22	EFIL	2	2	
31	1401	062184	134311	0	816	136	816	-1	DEM	DIAG	0	0	
32	1431	062184	134316	0	3584	136	696	0	KMAP		376	20	
33	1573	062184	134316	0	21504	136	1792	0	AMAP	000A	1957	153	
34	2341	062184	134320	0	15680	136	2440	1	K	SPAC	36	0	
35	2901	062184	134327	0	15680	136	2440	1	K	SPAC	36	0	
36	3461	062184	134329	0	39424	136	3584	1	INV	KS	2	0	
37	4869	062184	134356	0	6	1	6	-1	VIBR	EVAL	1	2	
38	4870	062184	134356	0	4896	136	816	-1	A	AUS	1	1	
39	-5050	062184	134356	0	4896	136	816	-1	VEC	AUS	1	1	
40	5430	062184	134356	0	4896	136	816	-1	VIBR	MODF	1	2	
41	5410	062184	134408	0	11	11	11	-1	VIBR	EVAL	2	2	
42	5411	062184	134408	0	8976	136	816	-1	VIBR	MODF	2	2	
43	5741	062184	134459	0	7	1	7	-1	VIBR	EVAL	3	2	
44	5742	062184	134459	0	5712	136	616	-1	VEC	AUS	1	1	
45	5952	062184	134459	0	5712	136	616	-1	VIBR	MODF	3	2	

EXIT 93.212 0 6

ORIGINAL PAGE IS
OF POOR QUALITY

NORMAL EXIT. CPU TIME: 0 TOTAL SUPS: 0 (MILLISECONDS)

68KPT PRINTS

NORMAL EXIT. CPU TIME: 1987 TOTAL SUPS: 6083 (MILLISECONDS)

8XQT .DCU
DATA SPACE: 23000

* * * UNIVAC 1100 TIME/SHARING EXEC --- MULTI-PROCESSOR SYSTEM --- LEV. AY385AHOS11 SITE * MOSI 1

Appendix B
LOX PUMP HOUSING
DATA LISTING

MFOLEYBIN202*HPOTP(1).NEW

1 @RUN./R LOXPMP,6EP553450032,MFOLEYBIN202,240,900/9000
 2 @FREE TPF\$.
 3 @ASG,A KIFLINBIN196*EAL211/
 4 @USE TPF\$.,KIFLINBIN196*EAL211.
 5 @DELETE,C HPOTPDB.
 6 @ASG,UP HPOTPDB.,F/10/POS/300
 7 @FREE HPOTPDB.
 8 @EXTEND HPOTPDB.8
 9 @ASG,A HPOTPDB.
 10 @USE EAL001.,HPOTPDB.
 11 @ASG,A HPOTP.
 12 @PRT,S HPOTP.NEW
 13 @XQT TAB

14 START 665 \$ HPOTP
 15 TITLE' HPOTP TEST ARTICLE
 16 ALTRF

17 FORMAT=1
 18 2 1 -90.0000 2 109.2029 3 180.0000 -1.811045 -4.76761 10.07
 19 3 1 180.0000 2 180.0000 3 220.1999 .000 .000 .000
 20 4 1 180.0000 2 180.0000 3 220.1999 .000 .000 10.075
 21 5 1 .0000 2 180.0000 3 180.0000 .000 .000 10.075
 22 6 1 .0000 2 .0000 3 .0000 .000 .000 10.075

23 JL0C
 24 NREF= 2

25	1	.265000+01	.000000	-.924000+01\$
26	2	.214390+01	.155763+01	-.924000+01\$
27	3	.818895+00	.252030+01	-.924000+01\$
28	4	-.818895+00	.252030+01	-.924000+01\$
29	5	-.214390+01	.155763+01	-.924000+01\$
30	6	-.265000+01	.842342-07	-.924000+01\$
31	7	-.214390+01	-.155763+01	-.924000+01\$
32	8	-.818895+00	-.252030+01	-.924000+01\$
33	9	.818895+00	-.252030+01	-.924000+01\$
34	10	.214390+01	-.155763+01	-.924000+01\$
35	11	.228000+01	.000000	-.830900+01\$
36	12	.184456+01	.134015+01	-.830900+01\$
37	13	.704559+00	.216841+01	-.830900+01\$
38	14	-.704559+00	.216841+01	-.830900+01\$
39	15	-.184456+01	.134015+01	-.830900+01\$
40	16	-.228000+01	.724732-07	-.830900+01\$
41	17	-.184456+01	-.134015+01	-.830900+01\$
42	18	-.704559+00	-.216841+01	-.830900+01\$
43	19	.704559+00	-.216841+01	-.830900+01\$
44	20	.184456+01	-.134015+01	-.830900+01\$
45	21	.150000+01	.000000	-.695900+01\$
46	22	.149668+01	.108740+01	-.695900+01\$
47	23	.686018+00	.211135+01	-.695900+01\$
48	24	-.686018+00	.211135+01	-.695900+01\$
49	25	-.173939+01	.126374+01	-.695900+01\$
50	26	-.218000+01	.692946-07	-.695900+01\$
51	27	-.173939+01	-.126374+01	-.695900+01\$
52	28	-.686018+00	-.211135+01	-.695900+01\$
53	29	.686018+00	-.211135+01	-.695900+01\$
54	30	.149668+01	-.108740+01	-.695900+01\$
55	31	.250000+01	.000000	-.570900+01\$
56	32	.173939+01	.126374+01	-.570900+01\$
57	33	.695288+00	.213988+01	-.570900+01\$
58	34	-.655116+00	.201624+01	-.570900+01\$
59	35	-.173939+01	.126374+01	-.570900+01\$

60	36	- .211000+01	.670695-07	- .570900+01\$
61	37	- .173939+01	- .126374+01	- .570900+01\$
62	38	- .655116+00	- .201624+01	- .570900+01\$
63	39	.695288+00	- .213988+01	- .570900+01\$
64	40	.173939+01	- .126374+01	- .570900+01\$
65	41	.156000+01	.000000	- .435000+01\$
66	42	.161803+01	.117557+01	- .445900+01\$
67	43	.686018+00	.211135+01	- .445900+01\$
68	44	- .664387+00	.204477+01	- .445900+01\$
69	45	- .173939+01	.126374+01	- .445900+01\$
70	46	- .215000+01	.683410-07	- .445900+01\$
71	47	- .173939+01	- .126374+01	- .445900+01\$
72	48	- .664387+00	- .204477+01	- .445900+01\$
73	49	.686018+00	- .211135+01	- .445900+01\$
74	50	.161803+01	- .117557+01	- .445900+01\$
75	51	.117820+01	.549404+00	- .233900+01\$
76	52	.123780+01	.899311+00	- .233900+01\$
77	53	.820388+00	.203053+01	- .233900+01\$
78	54	- .652026+00	.200673+01	- .233900+01\$
79	55	- .170703+01	.124023+01	- .233900+01\$
80	56	- .215000+01	.683410-07	- .233900+01\$
81	57	- .170703+01	- .124023+01	- .233900+01\$
82	58	- .652026+00	- .200673+01	- .233900+01\$
83	59	.820388+00	- .203053+01	- .233900+01\$
84	60	.123780+01	- .899311+00	- .233900+01\$
85	61	.102413+01	.477559+00	- .220000+00\$
86	62	.661530+00	.230703+01	- .250000+00\$
87	63	- .679837+00	.209232+01	- .330000+00\$
88	64	- .161803+01	.117557+01	- .380000+00\$
89	65	- .198000+01	.629373-07	- .420000+00\$
90	66	- .161803+01	- .117557+01	- .380000+00\$
91	67	- .679837+00	- .209232+01	- .310000+00\$
92	68	.661530+00	- .230703+01	- .250000+00\$
93	69	.102413+01	- .477559+00	- .220000+00\$
94	70	.728115+00	.529007+00	- .233900+01\$
95	71	.650000+00	.000000	- .233900+01\$
96	72	.728115+00	- .529007+00	- .233900+01\$
97	73	.117820+01	- .549404+00	- .233900+01\$
98	74	.700000+01	.000000	- .742000+01\$
99	75	.695483+01	.700315+00	- .765000+01\$
100	76	.679849+01	.117919+01	- .825000+01\$
101	77	.659535+01	.117956+01	- .900000+01\$
102	78	.645216+01	.699790+00	- .960000+01\$
103	79	.640000+01	.000000	- .982000+01\$
104	80	.645216+01	- .699790+00	- .960000+01\$
105	81	.659535+01	- .117956+01	- .900000+01\$
106	82	.679849+01	- .117919+01	- .825000+01\$
107	83	.695483+01	- .700315+00	- .765000+01\$
108	84	.490000+01	.000000	- .715000+01\$
109	85	.486944+01	.629837+00	- .722000+01\$
110	86	.470409+01	.118071+01	- .768000+01\$
111	87	.444636+01	.117893+01	- .840000+01\$
112	88	.429399+01	.630253+00	- .885000+01\$
113	89	.428000+01	.000000	- .890000+01\$
114	90	.429399+01	- .630253+00	- .885000+01\$
115	91	.444636+01	- .117893+01	- .840000+01\$
116	92	.470409+01	- .118071+01	- .768000+01\$
117	93	.486944+01	- .629837+00	- .722000+01\$
118	94	.405000+01	.000000	- .690000+01\$
119	95	.404869+01	.579819+00	- .690000+01\$

120	96	.384147+01	.115030+01	-.728000+01\$
121	97	.349610+01	.114878+01	-.796000+01\$
122	98	.329941+01	.579994+00	-.838000+01\$
123	99	.330000+01	.000000	-.838000+01\$
124	100	.329941+01	-.579994+00	-.838000+01\$
125	101	.349610+01	-.114878+01	-.796000+01\$
126	102	.384147+01	-.115030+01	-.728000+01\$
127	103	.404869+01	-.579819+00	-.690000+01\$
128	104	.320000+01	.000000	-.655000+01\$
129	105	.320306+01	.550386+00	-.655000+01\$
130	106	.300396+01	.113151+01	-.688000+01\$
131	107	.259548+01	.112801+01	-.748000+01\$
132	108	.239782+01	.549614+00	-.778000+01\$
133	109	.239780+01	.000000	-.778000+01\$
134	110	.239782+01	-.549614+00	-.778000+01\$
135	111	.259548+01	-.112801+01	-.748000+01\$
136	112	.300396+01	-.113151+01	-.688000+01\$
137	113	.320306+01	-.550386+00	-.655000+01\$
138	114	.234747+01	.499398+00	-.583900+01\$
139	115	.211771+01	.101873+01	-.616900+01\$
140	116	.172024+01	.102019+01	-.670900+01\$
141	117	.172024+01	-.102019+01	-.670900+01\$
142	118	.211771+01	-.101873+01	-.616900+01\$
143	119	.234747+01	-.499398+00	-.583900+01\$
144	120	.145171+01	.450490+00	-.188000+01\$
145	121	.145171+01	-.450490+00	-.188000+01\$
146	122	.246932+01	.450087+00	-.315000+01\$
147	123	.241659+01	.748985+00	-.320000+01\$
148	124	.174244+01	.650778+00	-.395000+01\$
149	125	.154424+01	.378729+00	-.415000+01\$
150	126	.154424+01	-.378729+00	-.415000+01\$
151	127	.174244+01	-.650778+00	-.395000+01\$
152	128	.241659+01	-.748985+00	-.320000+01\$
153	129	.246932+01	-.450087+00	-.315000+01\$
154	130	.402484+01	.450747+00	-.396000+01\$
155	131	.400159+01	.980663+00	-.407000+01\$
156	132	.372179+01	.860612+00	-.500000+01\$
157	133	.359546+01	.499551+00	-.552000+01\$
158	134	.355000+01	.000000	-.572000+01\$
159	135	.359546+01	-.499551+00	-.552000+01\$
160	136	.372179+01	-.860612+00	-.500000+01\$
161	137	.400159+01	-.980663+00	-.407000+01\$
162	138	.402484+01	-.450747+00	-.396000+01\$
163	139	.578008+01	.480288+00	-.407000+01\$
164	140	.580115+01	.118026+01	-.418000+01\$
165	141	.598358+01	.102064+01	-.522000+01\$
166	142	.607037+01	.600553+00	-.572000+01\$
167	143	.608000+01	.000000	-.586000+01\$
168	144	.607037+01	-.600553+00	-.572000+01\$
169	145	.598358+01	-.102064+01	-.522000+01\$
170	146	.580115+01	-.118026+01	-.418000+01\$
171	147	.578008+01	-.480288+00	-.407000+01\$
172				
	NREF=	4		
173	148	-.281211+01	-.329256+01	-.470000+00\$
174	149	-.281211+01	-.329256+01	-.214000+01\$
175	150	-.398761+01	-.466889+01	-.185000+01\$
176	151	-.437079+01	-.511753+01	-.107000+01\$
177	152	-.450068+01	-.526961+01	.000000 \$
178	153	-.437079+01	-.511753+01	.107000+01\$
179	154	-.398761+01	-.466889+01	.185000+01\$

180	155	-.281211+01	-.329256+01	.214000+01\$
181	156	-.281211+01	-.329256+01	.470000+00\$
182	157	-.122411+01	-.413251+01	-.470000+00\$
183	158	-.122411+01	-.413251+01	-.204000+01\$
184	159	-.172397+01	-.582004+01	-.177000+01\$
185	160	-.188302+01	-.635697+01	-.102000+01\$
186	161	-.194835+01	-.657750+01	.000000 \$
187	162	-.188302+01	-.635697+01	.102000+01\$
188	163	-.172397+01	-.582004+01	.177000+01\$
189	164	-.122411+01	-.413251+01	.204000+01\$
190	165	-.122411+01	-.413251+01	.470000+00\$
191	166	.597052+00	-.424825+01	-.470000+00\$
192	167	.597052+00	-.424825+01	-.194000+01\$
193	168	.835038+00	-.594161+01	-.168000+01\$
194	169	.910192+00	-.647635+01	-.970000+00\$
195	170	.936635+00	-.666450+01	.000000 \$
196	171	.910192+00	-.647635+01	.970000+00\$
197	172	.835038+00	-.594161+01	.168000+01\$
198	173	.597052+00	-.424825+01	.194000+01\$
199	174	.597052+00	-.424825+01	.470000+00\$
200	175	.229427+01	-.360128+01	-.470000+00\$
201	176	.229427+01	-.360128+01	-.184000+01\$
202	177	.318619+01	-.500131+01	-.159000+01\$
203	178	.346558+01	-.543987+01	-.920000+00\$
204	179	.356230+01	-.559169+01	.000000 \$
205	180	.346558+01	-.543987+01	.920000+00\$
206	181	.318619+01	-.500131+01	.159000+01\$
207	182	.229427+01	-.360128+01	.184000+01\$
208	183	.230683+01	-.359325+01	.470000+00\$
209	184	.354401+01	-.234573+01	-.470000+00\$
210	185	.354401+01	-.234573+01	-.174000+01\$
211	186	.488657+01	-.323435+01	-.151000+01\$
212	187	.530351+01	-.351032+01	-.870000+00\$
213	188	.544527+01	-.360415+01	.000000 \$
214	189	.530351+01	-.351032+01	.870000+00\$
215	190	.488657+01	-.323435+01	.151000+01\$
216	191	.354401+01	-.234573+01	.174000+01\$
217	192	.354401+01	-.234573+01	.470000+00\$
218	193	.417558+01	-.736268+00	-.470000+00\$
219	194	.417558+01	-.736268+00	-.164000+01\$
220	195	.570204+01	-.100542+01	-.142000+01\$
221	196	.616490+01	-.108704+01	-.820000+00\$
222	197	.633231+01	-.111656+01	.000000 \$
223	198	.616490+01	-.108704+01	.820000+00\$
224	199	.570204+01	-.100542+01	.142000+01\$
225	200	.417558+01	-.736268+00	.164000+01\$
226	201	.417558+01	-.736268+00	.470000+00\$
227	202	.409465+01	.102091+01	-.470000+00\$
228	203	.409465+01	.102091+01	-.154000+01\$
229	204	.555009+01	.138379+01	-.133000+01\$
230	205	.598672+01	.149266+01	-.770000+00\$
231	206	.614197+01	.153137+01	.000000 \$
232	207	.598672+01	.149266+01	.770000+00\$
233	208	.555009+01	.138379+01	.133000+01\$
234	209	.409465+01	.102091+01	.154000+01\$
235	210	.409465+01	.102091+01	.470000+00\$
236	211	.331753+01	.259193+01	-.470000+00\$
237	212	.331753+01	.259193+01	-.143000+01\$
238	213	.444438+01	.347233+01	-.124000+01\$
239	214	.478323+01	.373707+01	-.720000+00\$

240	215	.490143+01	.382941+01	.000000	\$
241	216	.478323+01	.373707+01	.720000+00\$	
242	217	.444438+01	.347233+01	.124000+01\$	
243	218	.331753+01	.259193+01	.143000+01\$	
244	219	.331753+01	.259193+01	.470000+00\$	
245	220	.199525+01	.375253+01	-.470000+00\$	
246	221	.199525+01	.375253+01	-.132000+01\$	
247	222	.261496+01	.491802+01	-.114000+01\$	
248	223	.280275+01	.527120+01	-.660000+00\$	
249	224	.286847+01	.539481+01	.000000	\$
250	225	.280275+01	.527120+01	.660000+00\$	
251	226	.261496+01	.491802+01	.114000+01\$	
252	227	.199525+01	.375253+01	.132000+01\$	
253	228	.199525+01	.375253+01	.470000+00\$	
254	229	.300650+00	.429950+01	-.470000+00\$	
255	230	.300650+00	.429950+01	-.122000+01\$	
256	231	.383661+00	.548660+01	-.106000+01\$	
257	232	.410168+00	.586568+01	-.610000+00\$	
258	233	.419236+00	.599536+01	.000000	\$
259	234	.410168+00	.586568+01	.610000+00\$	
260	235	.383661+00	.548660+01	.106000+01\$	
261	236	.300650+00	.429950+01	.122000+01\$	
262	237	.300650+00	.429950+01	.470000+00\$	
263	NREF =	3			
264	238	-.442560+01	-.253457+01	.100750+02\$	
265	239	.143279+00	-.102610+02	.100750+02\$	
266	240	.000000	.000000	.100750+02\$	
267	NREF =	2			
268	241	.000000	.000000	-.924000+01\$	
269	242	.670000+01	.000000	-.865000+01\$	
270	NREF =	5			
271	243	.407838+01	-.190178+01	.612000+01\$	
272	244	.407838+01	-.190178+01	.457000+01\$	
273	245	.676859+01	-.134022+01	.370000+01\$	
274	246	.811670+01	-.313197+01	.330000+01\$	
275	247	.856892+01	-.361437+01	.230000+01\$	
276	248	.850880+01	-.357677+01	.128000+01\$	
277	249	.801376+01	-.298029+01	.600000+00\$	
278	250	.740171+01	-.212241+01	.700000+00\$	
279	251	.676859+01	-.134022+01	.150000+01\$	
280	252	.407838+01	-.190178+01	.335000+01\$	
281	253	.407838+01	-.190178+01	.270000+01\$	
282	254	.279517+01	-.352662+01	.612000+01\$	
283	255	.279517+01	-.352662+01	.457000+01\$	
284	256	.492690+01	-.342428+01	.390000+01\$	
285	257	.798309+01	-.365495+01	.315000+01\$	
286	258	.758867+01	-.355479+01	.780000+00\$	
287	259	.668472+01	-.350956+01	.105000+01\$	
288	260	.492690+01	-.342428+01	.225000+01\$	
289	261	.279517+01	-.352662+01	.335000+01\$	
290	262	.279517+01	-.352662+01	.270000+01\$	
291	263	.118743+01	-.434051+01	.612000+01\$	
292	264	.118743+01	-.434051+01	.457000+01\$	
293	265	.255411+01	-.492738+01	.405000+01\$	
294	266	.581510+01	-.553764+01	.337000+01\$	
295	267	.660684+01	-.558321+01	.270000+01\$	
296	268	.655895+01	-.556239+01	.183000+01\$	
297	269	.555079+01	-.555079+01	.138000+01\$	
298	270	.446197+01	-.539359+01	.148000+01\$	
299	271	.255411+01	-.492738+01	.265000+01\$	

300	272	.118743+01	-.434051+01	.335000+01\$
301	273	.118743+01	-.434051+01	.270000+01\$
302	274	-.548412+00	-.446646+01	.612000+01\$
303	275	-.548412+00	-.446646+01	.457000+01\$
304	276	.248722+00	-.527414+01	.420000+01\$
305	277	.392500+01	-.679830+01	.345000+01\$
306	278	.471816+01	-.686497+01	.282000+01\$
307	279	.464130+01	-.688101+01	.200000+01\$
308	280	.369772+01	-.675403+01	.172000+01\$
309	281	.198466+01	-.629453+01	.176000+01\$
310	282	.248722+00	-.527414+01	.290000+01\$
311	283	-.548412+00	-.446646+01	.335000+01\$
312	284	-.548412+00	-.446646+01	.270000+01\$
313	285	-.228392+01	-.387733+01	.612000+01\$
314	286	-.228392+01	-.387733+01	.457000+01\$
315	287	-.194403+01	-.469331+01	.425000+01\$
316	288	-.897667+00	-.638723+01	.368000+01\$
317	289	.535032+00	-.765132+01	.307000+01\$
318	290	.332815+00	-.762274+01	.236000+01\$
319	291	-.198244+00	-.709723+01	.205000+01\$
320	292	-.149597+01	-.558305+01	.225000+01\$
321	293	-.194403+01	-.469331+01	.300000+01\$
322	294	-.228392+01	-.387733+01	.335000+01\$
323	295	-.228392+01	-.387733+01	.270000+01\$
324	296	-.364519+01	-.263868+01	.612000+01\$
325	297	-.364519+01	-.263868+01	.457000+01\$
326	298	-.368490+01	-.349684+01	.428000+01\$
327	299	-.337878+01	-.547072+01	.383000+01\$
328	300	-.319241+01	-.600404+01	.340000+01\$
329	301	-.325792+01	-.587744+01	.279000+01\$
330	302	-.344212+01	-.530040+01	.249000+01\$
331	303	-.360532+01	-.449213+01	.266000+01\$
332	304	-.368490+01	-.349684+01	.298000+01\$
333	305	-.364519+01	-.263868+01	.335000+01\$
334	306	-.364519+01	-.263868+01	.270000+01\$
335	307	-.440490+01	-.920232+00	.612000+01\$
336	308	-.440490+01	-.920232+00	.457000+01\$
337	309	-.440490+01	-.920232+00	.442000+01\$
338	310	-.440490+01	-.920232+00	.427000+01\$
339	311	-.440490+01	-.920232+00	.411000+01\$
340	312	-.440490+01	-.920232+00	.396000+01\$
341	313	-.440490+01	-.920232+00	.381000+01\$
342	314	-.440490+01	-.920232+00	.366000+01\$
343	315	-.440490+01	-.920232+00	.350000+01\$
344	316	-.440490+01	-.920232+00	.335000+01\$
345	317	-.440490+01	-.920232+00	.270000+01\$
346	318	-.450000+01	.143039-06	.612000+01\$
347	319	-.450000+01	.143039-06	.457000+01\$
348	320	-.450000+01	.143039-06	.442000+01\$
349	321	-.450000+01	.143039-06	.427000+01\$
350	322	-.450000+01	.143039-06	.411000+01\$
351	323	-.450000+01	.143039-06	.396000+01\$
352	324	-.450000+01	.143039-06	.381000+01\$
353	325	-.450000+01	.143039-06	.366000+01\$
354	326	-.450000+01	.143039-06	.350000+01\$
355	327	-.450000+01	.143039-06	.335000+01\$
356	328	-.450000+01	.143039-06	.270000+01\$
357	329	-.440490+01	.920232+00	.612000+01\$
358	330	-.440490+01	.920232+00	.457000+01\$
359	331	-.440490+01	.920232+00	.442000+01\$

360	332	- .440490+01	.920232+00	.427000+01\$
361	333	- .440490+01	.920232+00	.411000+01\$
362	334	- .440490+01	.920232+00	.396000+01\$
363	335	- .440490+01	.920232+00	.381000+01\$
364	336	- .440490+01	.920232+00	.366000+01\$
365	337	- .440490+01	.920232+00	.350000+01\$
366	338	- .440490+01	.920232+00	.335000+01\$
367	339	- .440490+01	.920232+00	.270000+01\$
368	340	- .364519+01	.263868+01	.612000+01\$
369	341	- .364519+01	.263868+01	.457000+01\$
370	342	- .368490+01	.349684+01	.428000+01\$
371	343	- .337878+01	.547072+01	.383000+01\$
372	344	- .319241+01	.600404+01	.340000+01\$
373	345	- .325792+01	.587744+01	.279000+01\$
374	346	- .344212+01	.530040+01	.249000+01\$
375	347	- .360532+01	.449213+01	.266000+01\$
376	348	- .368490+01	.349684+01	.298000+01\$
377	349	- .364519+01	.263868+01	.335000+01\$
378	350	- .364519+01	.263868+01	.270000+01\$
379	351	- .228392+01	.387733+01	.612000+01\$
380	352	- .228392+01	.387733+01	.457000+01\$
381	353	- .194403+01	.469331+01	.425000+01\$
382	354	- .897666+00	.638723+01	.368000+01\$
383	355	.535032+00	.765132+01	.307000+01\$
384	356	.465800+00	.761577+01	.236000+01\$
385	357	- .198244+00	.709723+01	.205000+01\$
386	358	- .149597+01	.558305+01	.225000+01\$
387	359	- .194403+01	.469331+01	.300000+01\$
388	360	- .228392+01	.387733+01	.335000+01\$
389	361	- .228392+01	.387733+01	.270000+01\$
390	362	- .548412+00	.446646+01	.612000+01\$
391	363	- .548412+00	.446646+01	.457000+01\$
392	364	.248722+00	.527414+01	.420000+01\$
393	365	.392500+01	.679830+01	.345000+01\$
394	366	.471816+01	.686497+01	.282000+01\$
395	367	.464130+01	.688101+01	.200000+01\$
396	368	.369772+01	.675403+01	.172000+01\$
397	369	.198466+01	.629453+01	.176000+01\$
398	370	.248722+00	.527414+01	.290000+01\$
399	371	- .548412+00	.446646+01	.335000+01\$
400	372	- .548412+00	.446646+01	.270000+01\$
401	373	.118743+01	.434051+01	.612000+01\$
402	374	.118743+01	.434051+01	.457000+01\$
403	375	.255411+01	.492738+01	.405000+01\$
404	376	.581510+01	.553764+01	.337000+01\$
405	377	.660684+01	.558321+01	.270000+01\$
406	378	.655895+01	.556239+01	.183000+01\$
407	379	.555079+01	.555079+01	.138000+01\$
408	380	.446197+01	.539359+01	.148000+01\$
409	381	.255411+01	.492738+01	.265000+01\$
410	382	.118743+01	.434051+01	.335000+01\$
411	383	.118743+01	.434051+01	.270000+01\$
412	384	.279517+01	.352662+01	.612000+01\$
413	385	.279517+01	.352662+01	.457000+01\$
414	386	.492690+01	.342428+01	.390000+01\$
415	387	.798309+01	.365495+01	.315000+01\$
416	388	.758867+01	.355479+01	.780000+00\$
417	389	.668472+01	.350956+01	.105000+01\$
418	390	.492690+01	.342428+01	.225000+01\$
419	391	.279517+01	.352662+01	.335000+01\$

**ORIGINAL PAGE IS
OF POOR QUALITY**

420	392	.279517+01	.352662+01	.270000+01\$
421	393	.407838+01	.190178+01	.612000+01\$
422	394	.407838+01	.190178+01	.457000+01\$
423	395	.676859+01	.134022+01	.370000+01\$
424	396	.811670+01	.313197+01	.330000+01\$
425	397	.856892+01	.361437+01	.230000+01\$
426	398	.850880+01	.357677+01	.128000+01\$
427	399	.801376+01	.298029+01	.600000+00\$
428	400	.740172+01	.212241+01	.700000+00\$
429	401	.676859+01	.134022+01	.150000+01\$
430	402	.407838+01	.190178+01	.335000+01\$
431	403	.407838+01	.190178+01	.270000+01\$
432	404	.450000+01	.000000	.612000+01\$
433	405	.450000+01	.000000	.457000+01\$
434	406	.813000+01	.000000	.344000+01\$
435	407	.813000+01	.000000	.460000+00\$
436	408	.450000+01	.000000	.335000+01\$
437	409	.450000+01	.000000	.270000+01\$
438	410	.885000+01	.000000	.330000+01\$
439	411	.885278+01	.178021+01	.303000+01\$
440	412	.884632+01	.305813+01	.160000+01\$
441	413	.885269+01	.350146+01	.000000 \$
442	414	.884632+01	.305813+01	.000000 \$
443	415	.885278+01	.178021+01	.000000 \$
444	416	.885000+01	.000000	.000000 \$
445	417	.885278+01	-.178021+01	.303000+01\$
446	418	.884632+01	-.305813+01	.160000+01\$
447	419	.885269+01	-.350146+01	.000000 \$
448	420	.884632+01	-.305813+01	.000000 \$
449	421	.885278+01	-.178021+01	.000000 \$
450	422	.945226+01	.353029+01	.000000 \$
451	423	.944974+01	.284945+01	.165000+01\$
452	424	.945035+01	.163066+01	.288000+01\$
453	425	.945000+01	.000000	.330000+01\$
454	426	.945035+01	-.163066+01	.288000+01\$
455	427	.944974+01	-.284945+01	.165000+01\$
456	428	.945226+01	-.353029+01	.000000 \$
457	429	.106522+02	.322622+01	.000000 \$
458	430	.106501+02	.279202+01	.161000+01\$
459	431	.106486+02	.161235+01	.279000+01\$
460	432	.106500+02	.000000	.323000+01\$
461	433	.106486+02	-.161235+01	.279000+01\$
462	434	.106452+02	-.281060+01	.161000+01\$
463	435	.106522+02	-.322622+01	.000000 \$
464	NREF= 6			
465	436	.407838+01	-.190178+01	.612000+01\$
466	437	.407838+01	-.190178+01	.457000+01\$
467	438	.676859+01	-.134022+01	.370000+01\$
468	439	.811670+01	-.313197+01	.330000+01\$
469	440	.856892+01	-.361437+01	.230000+01\$
470	441	.850880+01	-.357677+01	.128000+01\$
471	442	.801376+01	-.298029+01	.600000+00\$
472	443	.740171+01	-.212241+01	.700000+00\$
473	444	.676859+01	-.134022+01	.150000+01\$
474	445	.407838+01	-.190178+01	.335000+01\$
475	446	.407838+01	-.190178+01	.270000+01\$
476	447	.279517+01	-.352662+01	.612000+01\$
477	448	.279517+01	-.352662+01	.457000+01\$
478	449	.492690+01	-.342428+01	.390000+01\$
479	450	.798309+01	-.365495+01	.315000+01\$

480	451	.758867+01	-.355479+01	.780000+00\$
481	452	.668472+01	-.350956+01	.105000+01\$
482	453	.492690+01	-.342428+01	.225000+01\$
483	454	.279517+01	-.352662+01	.335000+01\$
484	455	.279517+01	-.352662+01	.270000+01\$
485	456	.118743+01	-.434051+01	.612000+01\$
486	457	.118743+01	-.434051+01	.457000+01\$
487	458	.255411+01	-.492738+01	.405000+01\$
488	459	.581510+01	-.553764+01	.337000+01\$
489	460	.660684+01	-.558321+01	.270000+01\$
490	461	.655895+01	-.556239+01	.183000+01\$
491	462	.555079+01	-.555079+01	.138000+01\$
492	463	.446197+01	-.539359+01	.148000+01\$
493	464	.255411+01	-.492738+01	.265000+01\$
494	465	.118743+01	-.434051+01	.335000+01\$
495	466	.118743+01	-.434051+01	.270000+01\$
496	467	-.548412+00	-.446646+01	.612000+01\$
497	468	-.548412+00	-.446646+01	.457000+01\$
498	469	.248722+00	-.527414+01	.420000+01\$
499	470	.392500+01	-.679830+01	.345000+01\$
500	471	.471816+01	-.686497+01	.282000+01\$
501	472	.464130+01	-.688101+01	.200000+01\$
502	473	.369772+01	-.675403+01	.172000+01\$
503	474	.198466+01	-.629453+01	.176000+01\$
504	475	.248722+00	-.527414+01	.290000+01\$
505	476	-.548412+00	-.446646+01	.335000+01\$
506	477	-.548412+00	-.446646+01	.270000+01\$
507	478	-.228392+01	-.387733+01	.612000+01\$
508	479	-.228392+01	-.387733+01	.457000+01\$
509	480	-.194403+01	-.469331+01	.425000+01\$
510	481	-.897667+00	-.638723+01	.368000+01\$
511	482	.535032+00	-.765132+01	.307000+01\$
512	483	.332815+00	-.762274+01	.236000+01\$
513	484	-.198244+00	-.709723+01	.205000+01\$
514	485	-.149597+01	-.558305+01	.225000+01\$
515	486	-.194403+01	-.469331+01	.300000+01\$
516	487	-.228392+01	-.387733+01	.335000+01\$
517	488	-.228392+01	-.387733+01	.270000+01\$
518	489	-.364519+01	-.263868+01	.612000+01\$
519	490	-.364519+01	-.263868+01	.457000+01\$
520	491	-.368490+01	-.349684+01	.428000+01\$
521	492	-.337878+01	-.547072+01	.383000+01\$
522	493	-.319241+01	-.600404+01	.340000+01\$
523	494	-.325792+01	-.587744+01	.279000+01\$
524	495	-.344212+01	-.530040+01	.249000+01\$
525	496	-.360532+01	-.449213+01	.266000+01\$
526	497	-.368490+01	-.349684+01	.298000+01\$
527	498	-.364519+01	-.263868+01	.335000+01\$
528	499	-.364519+01	-.263868+01	.270000+01\$
529	500	-.440490+01	-.920232+00	.612000+01\$
530	501	-.440490+01	-.920232+00	.457000+01\$
531	502	-.440490+01	-.920232+00	.442000+01\$
532	503	-.440490+01	-.920232+00	.427000+01\$
533	504	-.440490+01	-.920232+00	.411000+01\$
534	505	-.440490+01	-.920232+00	.396000+01\$
535	506	-.440490+01	-.920232+00	.381000+01\$
536	507	-.440490+01	-.920232+00	.366000+01\$
537	508	-.440490+01	-.920232+00	.350000+01\$
538	509	-.440490+01	-.920232+00	.335000+01\$
539	510	-.440490+01	-.920232+00	.270000+01\$

540	511	-.450000+01	.143039-06	.612000+01\$
541	512	-.450000+01	.143039-06	.457000+01\$
542	513	-.450000+01	.143039-06	.442000+01\$
543	514	-.450000+01	.143039-06	.427000+01\$
544	515	-.450000+01	.143039-06	.411000+01\$
545	516	-.450000+01	.143039-06	.396000+01\$
546	517	-.450000+01	.143039-06	.381000+01\$
547	518	-.450000+01	.143039-06	.366000+01\$
548	519	-.450000+01	.143039-06	.350000+01\$
549	520	-.450000+01	.143039-06	.335000+01\$
550	521	-.450000+01	.143039-06	.270000+01\$
551	522	-.440490+01	.920232+00	.612000+01\$
552	523	-.440490+01	.920232+00	.457000+01\$
553	524	-.440490+01	.920232+00	.442000+01\$
554	525	-.440490+01	.920232+00	.427000+01\$
555	526	-.440490+01	.920232+00	.411000+01\$
556	527	-.440490+01	.920232+00	.396000+01\$
557	528	-.440490+01	.920232+00	.381000+01\$
558	529	-.440490+01	.920232+00	.366000+01\$
559	530	-.440490+01	.920232+00	.350000+01\$
560	531	-.440490+01	.920232+00	.335000+01\$
561	532	-.440490+01	.920232+00	.270000+01\$
562	533	-.364519+01	.263868+01	.612000+01\$
563	534	-.364519+01	.263868+01	.457000+01\$
564	535	-.368490+01	.349684+01	.428000+01\$
565	536	-.337878+01	.547072+01	.383000+01\$
566	537	-.319241+01	.600404+01	.340000+01\$
567	538	-.325792+01	.587744+01	.279000+01\$
568	539	-.344212+01	.530040+01	.249000+01\$
569	540	-.360532+01	.449213+01	.266000+01\$
570	541	-.368490+01	.349684+01	.298000+01\$
571	542	-.364519+01	.263868+01	.335000+01\$
572	543	-.364519+01	.263868+01	.270000+01\$
573	544	-.228392+01	.387733+01	.612000+01\$
574	545	-.228392+01	.387733+01	.457000+01\$
575	546	-.194403+01	.469331+01	.425000+01\$
576	547	-.897666+00	.638723+01	.368000+01\$
577	548	.535032+00	.765132+01	.307000+01\$
578	549	.465800+00	.761577+01	.236000+01\$
579	550	-.198244+00	.709723+01	.205000+01\$
580	551	-.149597+01	.558305+01	.225000+01\$
581	552	-.194403+01	.469331+01	.300000+01\$
582	553	-.228392+01	.387733+01	.335000+01\$
583	554	-.228392+01	.387733+01	.270000+01\$
584	555	-.548412+00	.446646+01	.612000+01\$
585	556	-.548412+00	.446646+01	.457000+01\$
586	557	.248722+00	.527414+01	.420000+01\$
587	558	.392500+01	.679830+01	.345000+01\$
588	559	.471816+01	.686497+01	.282000+01\$
589	560	.464130+01	.688101+01	.200000+01\$
590	561	.369772+01	.675403+01	.172000+01\$
591	562	.198466+01	.629453+01	.176000+01\$
592	563	.248722+00	.527414+01	.290000+01\$
593	564	-.548412+00	.446646+01	.335000+01\$
594	565	-.548412+00	.446646+01	.270000+01\$
595	566	.118743+01	.434051+01	.612000+01\$
596	567	.118743+01	.434051+01	.457000+01\$
597	568	.255411+01	.492738+01	.405000+01\$
598	569	.581510+01	.553764+01	.337000+01\$
599	570	.660684+01	.558321+01	.270000+01\$

600	571	.655895+01	.556239+01	.183000+01\$	
601	572	.555079+01	.555079+01	.138000+01\$	
602	573	.446197+01	.539359+01	.148000+01\$	
603	574	.255411+01	.492738+01	.265000+01\$	
604	575	.118743+01	.434051+01	.335000+01\$	
605	576	.118743+01	.434051+01	.270000+01\$	
606	577	.279517+01	.352662+01	.612000+01\$	
607	578	.279517+01	.352662+01	.457000+01\$	
608	579	.492690+01	.342428+01	.390000+01\$	
609	580	.798309+01	.365495+01	.315000+01\$	
610	581	.758867+01	.355479+01	.780000+00\$	
611	582	.668472+01	.350956+01	.105000+01\$	
612	583	.492690+01	.342428+01	.225000+01\$	
613	584	.279517+01	.352662+01	.335000+01\$	
614	585	.279517+01	.352662+01	.270000+01\$	
615	586	.407838+01	.190178+01	.612000+01\$	
616	587	.407838+01	.190178+01	.457000+01\$	
617	588	.676859+01	.134022+01	.370000+01\$	
618	589	.811670+01	.313197+01	.330000+01\$	
619	590	.856892+01	.361437+01	.230000+01\$	
620	591	.850880+01	.357677+01	.128000+01\$	
621	592	.801376+01	.298029+01	.600000+00\$	
622	593	.740172+01	.212241+01	.700000+00\$	
623	594	.676859+01	.134022+01	.150000+01\$	
624	595	.407838+01	.190178+01	.335000+01\$	
625	596	.407838+01	.190178+01	.270000+01\$	
626	597	.450000+01	.000000	.612000+01\$	
627	598	.450000+01	.000000	.457000+01\$	
628	599	.813000+01	.000000	.344000+01\$	
629	600	.813000+01	.000000	.460000+00\$	
630	601	.450000+01	.000000	.335000+01\$	
631	602	.450000+01	.000000	.270000+01\$	
632	603	.885000+01	.000000	.330000+01\$	
633	604	.885278+01	.178021+01	.303000+01\$	
634	605	.884632+01	.305813+01	.160000+01\$	
635	606	.885278+01	.178021+01	.303000+01\$	
636	607	.884632+01	.305813+01	.160000+01\$	
637	608	.944974+01	.284945+01	.165000+01\$	
638	609	.945035+01	.163066+01	.288000+01\$	
639	610	.945000+01	.000000	.330000+01\$	
640	611	.945035+01	.163066+01	.288000+01\$	
641	612	.944974+01	.284945+01	.165000+01\$	
642	613	.106501+02	.279202+01	.161000+01\$	
643	614	.106486+02	.161235+01	.279000+01\$	
644	615	.106500+02	.000000	.323000+01\$	
645	616	.106486+02	.161235+01	.279000+01\$	
646	617	.106452+02	.281060+01	.161000+01\$	
647	FORMAT= 2				
648	NREF= 6				
649	618	3.5	0. 9.8 3.5	337.5 9.8 16 1	
650	650	6.	0. 6.65 6.	337.5 6.65 16 1	
651	634	7.4625	0. 6.4 7.4625	337.5 6.4 16 1	
652	JREF				
653	NREF= -2				
654	1:	2:	3:	4:	5\$
655	6:	7:	8:	9:	10\$
656	11:	12:	13:	14:	15\$
657	16:	17:	18:	19:	20\$
658	21:	22:	23:	24:	25\$
659	26:	27:	28:	29:	30\$

660	31:	32:	33:	34:	35\$
661	36:	37:	38:	39:	40\$
662	41:	42:	43:	44:	45\$
663	46:	47:	48:	49:	50\$
664	51:	52:	53:	54:	55\$
665	56:	57:	58:	59:	60\$
666	NREF= -4				
667	61\$				
668	NREF= -2				
669	62:	63:	64:	65:	66\$
670	67:	68\$			
671	NREF= -4				
672	69\$				
673	NREF= -2				
674	70:	71:	72:	73:	74\$
675	75:	76:	77:	78:	79\$
676	80:	81:	82:	83:	84\$
677	85:	86:	87:	88:	89\$
678	90:	91:	92:	93:	94\$
679	95:	96:	97:	98:	99\$
680	100:	101:	102:	103:	104\$
681	105:	106:	107:	108:	109\$
682	110:	111:	112:	113:	114\$
683	115:	116:	117:	118:	119\$
684	NREF= -4				
685	120:	121:	122:	123:	124\$
686	125:	126:	127:	128:	129\$
687	130:	131:	132:	133:	134\$
688	135:	136:	137:	138:	139\$
689	140:	141:	142:	143:	144\$
690	145:	146:	147:	148:	149\$
691	150:	151:	152:	153:	154\$
692	155:	156:	157:	158:	159\$
693	160:	161:	162:	163:	164\$
694	165:	166:	167:	168:	169\$
695	170:	171:	172:	173:	174\$
696	175:	176:	177:	178:	179\$
697	180:	181:	182:	183:	184\$
698	185:	186:	187:	188:	189\$
699	190:	191:	192:	193:	194\$
700	195:	196:	197:	198:	199\$
701	200:	201:	202:	203:	204\$
702	205:	206:	207:	208:	209\$
703	210:	211:	212:	213:	214\$
704	215:	216:	217:	218:	219\$
705	220:	221:	222:	223:	224\$
706	225:	226:	227:	228:	229\$
707	230:	231:	232:	233:	234\$
708	235:	236:	237\$		
709	NREF= -3				
710	238:	239:	240\$		
711	NREF= -2				
712	241:	242\$			
713	NREF= -4				
714	243\$				
715	NREF= -5				
716	244:	245:	246:	247:	248\$
717	249:	250:	251:	252\$	
718	NREF= -4				
719	253:	254\$			

720	NREF= -5				
721	255:	256:	257:	258:	259\$
722	260:	261\$			
723	NREF= -4				
724	262:	263\$			
725	NREF= -5				
726	264:	265:	266:	267:	268\$
727	269:	270:	271:	272\$	
728	NREF= -4				
729	273:	274\$			
730	NREF= -5				
731	275:	276:	277:	278:	279\$
732	280:	281:	282:	283\$	
733	NREF= -4				
734	284:	285\$			
735	NREF= -5				
736	286:	287:	288:	289:	290\$
737	291:	292:	293:	294\$	
738	NREF= -4				
739	295:	296\$			
740	NREF= -5				
741	297:	298:	299:	300:	301\$
742	302:	303:	304:	305\$	
743	NREF= -4				
744	306:	307\$			
745	NREF= -5				
746	308:	309:	310:	311:	312\$
747	313:	314:	315:	316\$	
748	NREF= -4				
749	317:	318\$			
750	NREF= -5				
751	319:	320:	321:	322:	323\$
752	324:	325:	326:	327\$	
753	NREF= -4				
754	328:	329\$			
755	NREF= -5				
756	330:	331:	332:	333:	334\$
757	335:	336:	337:	338\$	
758	NREF= -4				
759	339:	340\$			
760	NREF= -5				
761	341:	342:	343:	344:	345\$
762	346:	347:	348:	349\$	
763	NREF= -4				
764	350:	351\$			
765	NREF= -5				
766	352:	353:	354:	355:	356\$
767	357:	358:	359:	360\$	
768	NREF= -4				
769	361:	362\$			
770	NREF= -5				
771	363:	364:	365:	366:	367\$
772	368:	369:	370:	371\$	
773	NREF= -4				
774	372:	373\$			
775	NREF= -5				
776	374:	375:	376:	377:	378\$
777	379:	380:	381:	382\$	
778	NREF= -4				
779	383:	384\$			

780	NREF= -5				
781	385:	386:	387:	388:	389\$
782	390:	391\$			
783	NREF= -4				
784	392:	393\$			
785	NREF= -5				
786	394:	395:	396:	397:	398\$
787	399:	400:	401:	402\$	
788	NREF= -4				
789	403:	404\$			
790	NREF= -5				
791	405:	406:	407:	408\$	
792	NREF= -4				
793	409\$				
794	NREF= -5				
795	410:	411:	412\$		
796	NREF= -4				
797	413:	414:	415:	416\$	
798	NREF= -5				
799	417:	418\$			
800	NREF= -4				
801	419:	420:	421:	422\$	
802	NREF= -5				
803	423:	424:	425:	426:	427\$
804	NREF= -4				
805	428:	429:	430:	431:	432\$
806	433:	434:	435:	436\$	
807	NREF= -6				
808	437:	438:	439:	440:	441\$
809	442:	443:	444:	445\$	
810	NREF= -4				
811	446:	447\$			
812	NREF= -6				
813	448:	449:	450:	451:	452\$
814	453:	454\$			
815	NREF= -4				
816	455:	456\$			
817	NREF= -6				
818	457:	458:	459:	460:	461\$
819	462:	463:	464:	465\$	
820	NREF= -4				
821	466:	467\$			
822	NREF= -6				
823	468:	469:	470:	471:	472\$
824	473:	474:	475:	476\$	
825	NREF= -4				
826	477:	478\$			
827	NREF= -6				
828	479:	480:	481:	482:	483\$
829	484:	485:	486:	487\$	
830	NREF= -4				
831	488:	489\$			
832	NREF= -6				
833	490:	491:	492:	493:	494\$
834	495:	496:	497:	498\$	
835	NREF= -4				
836	499:	500\$			
837	NREF= -6				
838	501:	502:	503:	504:	505\$
839	506:	507:	508:	509\$	

840	NREF= -4				
841	510:	511\$			
842	NREF= -6				
843	512:	513:	514:	515:	516\$
844	517:	518:	519:	520\$	
845	NREF= -4				
846	521:	522\$			
847	NREF= -6				
848	523:	524:	525:	526:	527\$
849	528:	529:	530:	531\$	
850	NREF= -4				
851	532:	533\$			
852	NREF= -6				
853	534:	535:	536:	537:	538\$
854	539:	540:	541:	542\$	
855	NREF= -4				
856	543:	544\$			
857	NREF= -6				
858	545:	546:	547:	548:	549\$
859	550:	551:	552:	553\$	
860	NREF= -4				
861	554:	555\$			
862	NREF= -6				
863	556:	557:	558:	559:	560\$
864	561:	562:	563:	564\$	
865	NREF= -4				
866	565:	566\$			
867	NREF= -6				
868	567:	568:	569:	570:	571\$
869	572:	573:	574:	575\$	
870	NREF= -4				
871	576:	577\$			
872	NREF= -6				
873	578:	579:	580:	581:	582\$
874	583:	584\$			
875	NREF= -4				
876	585:	586\$			
877	NREF= -6				
878	587:	588:	589:	590:	591\$
879	592:	593:	594:	595\$	
880	NREF= -4				
881	596:	597\$			
882	NREF= -6				
883	598:	599:	600:	601\$	
884	NREF= -4				
885	602\$				
886	NREF= -6				
887	603:	604:	605:	606:	607\$
888	608:	609:	610:	611:	612\$
889	613:	614:	615:	616\$	
890	NREF= -6				
891	617\$				
892	NREF= -6				
893	618,665				
894	MATC				
895	1 30.+6 .3 .325961				
896	2 30.+6 .3 .325961				
897	3 29.6+6 .3 .325961				
898	4 29.6+6 .3 .325961				
899	CON 1				

```

900      ZERO 1 2 3 4 5 6 : 634,649
901      MREF
902      FORMAT=2 : NREF=      3:      1 1 -.44256+01 -.25346+01 .10075+02
903      FORMAT=2 : NREF=      2:      2 1 .67000+01 .00000      -.86500+01
904      FORMAT=2 : NREF=      2:      3 1 .00000      .00000      -.92400+01
905      FORMAT=2 : NREF=      3:      4 1 -.44256+01 -.25346+01 .10075+02
906      FORMAT=2 : NREF=      5:      5 1 .10652+02 -.32262+01 .00000
907      FORMAT=2 : NREF=      5:      6 1 .10652+02 .32262+01 .00000
908      FORMAT=2 : NREF=      5:      7 1 .10652+02 -.32262+01 .00000
909      FORMAT= 1
910      NREF= 6
911      8 1 1 +1 1.0
912      BA
913      GIVN      1 .85100-01 .00000      .90000-03 .00000      >
914      .32200+00 .86000-01
915      GIVN      2 .92860-01 .00000      .98420-01 .00000      >
916      .10710+01 .19126+00
917      GIVN      3 .28089+00 .00000      .28930+00 .00000      >
918      .18495+01 .57019+00
919      GIVN      4 .85100-01 .00000      .90000-03 .00000      >
920      .32200+00 .86000-01
921      GIVN      5 .23720-01 .00000      .98550-01 .00000      >
922      .58100+00 .57070-01
923      TUBE 6 .5 1.08
924      SA
925      FORMAT=1: NMAT=      1:      1      .13000+00
926      FORMAT=1: NMAT=      1:      2      .13000+00
927      FORMAT=1: NMAT=      1:      3      .15000+00
928      FORMAT=1: NMAT=      1:      4      .19000+00
929      FORMAT=1: NMAT=      1:      5      .20000+00
930      FORMAT=1: NMAT=      1:      6      .20000+00
931      FORMAT=1: NMAT=      1:      7      .40000+00
932      FORMAT=1: NMAT=      2:      8      .40000+00
933      FORMAT=1: NMAT=      2:      9      .40000+00
934      FORMAT=1: NMAT=      2:     10      .28000+00
935      FORMAT=1: NMAT=      2:     11      .35000+00
936      FORMAT=1: NMAT=      2:     12      .28500+00
937      FORMAT=1: NMAT=      2:     13      .50000+00
938      FORMAT=1: NMAT=      2:     14      .25800+00
939      FORMAT=1: NMAT=      2:     15      .22300+00
940      FORMAT=1: NMAT=      2:     16      .20000+00
941      FORMAT=1: NMAT=      2:     17      .18000+00
942      FORMAT=1: NMAT=      2:     18      .50000+00
943      FORMAT=1: NMAT=      2:     19      .78000+00
944      FORMAT=1: NMAT=      2:     20      .40000+00
945      FORMAT=1: NMAT=      2:     21      .20000+00
946      FORMAT=1: NMAT=      2:     22      .20000+00
947      FORMAT=1: NMAT=      2:     23      .20000+00
948      FORMAT=1: NMAT=      2:     24      .20000+00
949      FORMAT=1: NMAT=      2:     25      .20000+00
950      FORMAT=1: NMAT=      2:     26      .20000+00
951      FORMAT=1: NMAT=      2:     27      .20000+00
952      FORMAT=1: NMAT=      2:     28      .90000+00
953      FORMAT=1: NMAT=      2:     29      .20000+00
954      FORMAT=1: NMAT=      2:     30      .20000+00
955      FORMAT=1: NMAT=      2:     31      .20000+00
956      FORMAT=1: NMAT=      2:     32      .20000+00
957      FORMAT=1: NMAT=      2:     33      .20000+00
958      FORMAT=1: NMAT=      2:     34      .20000+00
959      FORMAT=1: NMAT=      2:     35      .20000+00

```

960	FORMAT=1: NMAT=	2:	36	.20000+00					
961	FORMAT=1: NMAT=	2:	37	.20000+00					
962	FORMAT=1: NMAT=	2:	38	.20000+00					
963	FORMAT=1: NMAT=	2:	39	.20000+00					
964	FORMAT=1: NMAT=	2:	40	.20000+00					
965	FORMAT=1: NMAT=	2:	41	.20000+00					
966	FORMAT=1: NMAT=	2:	42	.20000+00					
967	FORMAT=1: NMAT=	2:	43	.24000+00					
968	FORMAT=1: NMAT=	2:	44	.20000+00					
969	FORMAT=1: NMAT=	2:	45	.39000+00					
970	FORMAT=1: NMAT=	2:	46	.20000+00					
971	FORMAT=1: NMAT=	2:	47	.65000+00					
972	FORMAT=1: NMAT=	2:	48	.20000+00					
973	FORMAT=1: NMAT=	2:	49	.30000+00					
974	FORMAT=1: NMAT=	2:	50	.15500+01					
975	FORMAT=1: NMAT=	2:	51	.22000+00					
976	FORMAT=1: NMAT=	1:	52	.35000+00					
977	FORMAT=1: NMAT=	2:	53	.22000+00					
978	FORMAT=1: NMAT=	2:	54	.30000+00					
979	55	1.0							
980	56	1.2							
981	57	1.05							
982	58	.8							
983	59	.1							
984	@XOT ELD								
985	E21								
986	GROUP 1								
987	NMAT= 2: NSECT=	1: NNSW=	0: NOFF=	0: NREF=	1:	120	121		
988	NMAT= 2: NSECT=	1: NNSW=	0: NOFF=	0: NREF=	1:	122	129		
989	NMAT= 2: NSECT=	1: NNSW=	0: NOFF=	0: NREF=	1:	130	138		
990	NMAT= 2: NSECT=	1: NNSW=	0: NOFF=	0: NREF=	1:	139	147		
991	NMAT= 2: NSECT=	1: NNSW=	0: NOFF=	0: NREF=	1:	148	156		
992	NMAT= 2: NSECT=	1: NNSW=	0: NOFF=	0: NREF=	1:	157	165		
993	NMAT= 2: NSECT=	1: NNSW=	0: NOFF=	0: NREF=	1:	166	174		
994	NMAT= 2: NSECT=	1: NNSW=	0: NOFF=	0: NREF=	1:	175	183		
995	NMAT= 2: NSECT=	1: NNSW=	0: NOFF=	0: NREF=	1:	184	192		
996	NMAT= 2: NSECT=	1: NNSW=	0: NOFF=	0: NREF=	1:	193	201		
997	NMAT= 2: NSECT=	1: NNSW=	0: NOFF=	0: NREF=	1:	210	202		
998	NMAT= 2: NSECT=	1: NNSW=	0: NOFF=	0: NREF=	1:	219	211		
999	NMAT= 2: NSECT=	1: NNSW=	0: NOFF=	0: NREF=	1:	228	220		
1000	NMAT= 2: NSECT=	1: NNSW=	0: NOFF=	0: NREF=	1:	237	229		
1001	NMAT= 2: NSECT=	2: NNSW=	0: NOFF=	0: NREF=	2:	83	74		
1002	NMAT= 2: NSECT=	2: NNSW=	0: NOFF=	0: NREF=	2:	74	75		
1003	NMAT= 2: NSECT=	2: NNSW=	0: NOFF=	0: NREF=	2:	75	76		
1004	NMAT= 2: NSECT=	2: NNSW=	0: NOFF=	0: NREF=	2:	76	77		
1005	NMAT= 2: NSECT=	2: NNSW=	0: NOFF=	0: NREF=	2:	77	78		
1006	NMAT= 2: NSECT=	2: NNSW=	0: NOFF=	0: NREF=	2:	78	79		
1007	NMAT= 2: NSECT=	2: NNSW=	0: NOFF=	0: NREF=	2:	79	80		
1008	NMAT= 2: NSECT=	2: NNSW=	0: NOFF=	0: NREF=	2:	80	81		
1009	NMAT= 2: NSECT=	2: NNSW=	0: NOFF=	0: NREF=	2:	81	82		
1010	NMAT= 2: NSECT=	2: NNSW=	0: NOFF=	0: NREF=	2:	82	83		
1011	NMAT= 2: NSECT=	3: NNSW=	0: NOFF=	0: NREF=	3:	10	1		
1012	NMAT= 2: NSECT=	3: NNSW=	0: NOFF=	0: NREF=	3:	1	2		
1013	NMAT= 2: NSECT=	3: NNSW=	0: NOFF=	0: NREF=	3:	2	3		
1014	NMAT= 2: NSECT=	3: NNSW=	0: NOFF=	0: NREF=	3:	3	4		
1015	NMAT= 2: NSECT=	3: NNSW=	0: NOFF=	0: NREF=	3:	4	5		
1016	NMAT= 2: NSECT=	3: NNSW=	0: NOFF=	0: NREF=	3:	5	6		
1017	NMAT= 2: NSECT=	3: NNSW=	0: NOFF=	0: NREF=	3:	6	7		
1018	NMAT= 2: NSECT=	3: NNSW=	0: NOFF=	0: NREF=	3:	7	8		
1019	NMAT= 2: NSECT=	3: NNSW=	0: NOFF=	0: NREF=	3:	8	9		

1020	NMAT= 2: NSECT= 3: NNSW= 0: NOFF= 0: NREF= 3: 9 10
1021	NMAT= 2: NSECT= 1: NNSW= 0: NOFF= 0: NREF= 4: 61 69
1022	NMAT= 1: NSECT= 5: NNSW= 0: NOFF= 0: NREF= 5: 430 429
1023	NMAT= 1: NSECT= 5: NNSW= 0: NOFF= 0: NREF= 5: 431 430
1024	NMAT= 1: NSECT= 5: NNSW= 0: NOFF= 0: NREF= 5: 432 431
1025	NMAT= 1: NSECT= 5: NNSW= 0: NOFF= 0: NREF= 5: 433 432
1026	NMAT= 1: NSECT= 5: NNSW= 0: NOFF= 0: NREF= 5: 434 433
1027	NMAT= 1: NSECT= 5: NNSW= 0: NOFF= 0: NREF= 6: 435 434
1028	NMAT= 1: NSECT= 5: NNSW= 0: NOFF= 0: NREF= 6: 613 435
1029	NMAT= 1: NSECT= 5: NNSW= 0: NOFF= 0: NREF= 6: 614 613
1030	NMAT= 1: NSECT= 5: NNSW= 0: NOFF= 0: NREF= 6: 615 614
1031	NMAT= 1: NSECT= 5: NNSW= 0: NOFF= 0: NREF= 6: 616 615
1032	NMAT= 1: NSECT= 5: NNSW= 0: NOFF= 0: NREF= 6: 617 616
1033	NMAT= 1: NSECT= 5: NNSW= 0: NOFF= 0: NREF= 7: 429 617
1034	E43
1035	GROUP 1
1036	NMAT= 1: NSECT= 1: NNSW= 0: 256 255 261 260
1037	NMAT= 1: NSECT= 2: NNSW= 0: 265 264 272 271
1038	NMAT= 1: NSECT= 3: NNSW= 0: 276 275 283 282
1039	NMAT= 1: NSECT= 4: NNSW= 0: 287 286 294 293
1040	NMAT= 1: NSECT= 5: NNSW= 0: 298 297 305 304
1041	NMAT= 1: NSECT= 6: NNSW= 0: 245 244 252 251
1042	NMAT= 1: NSECT= 1: NNSW= 0: 375 374 382 381
1043	NMAT= 1: NSECT= 2: NNSW= 0: 386 385 391 390
1044	NMAT= 1: NSECT= 3: NNSW= 0: 342 341 349 348
1045	NMAT= 1: NSECT= 4: NNSW= 0: 353 352 360 359
1046	NMAT= 1: NSECT= 5: NNSW= 0: 364 363 371 370
1047	NMAT= 1: NSECT= 6: NNSW= 0: 395 394 402 401
1048	NMAT= 1: NSECT= 7: NNSW= 0: 406 405 408 407
1049	NMAT= 1: NSECT= 1: NNSW= 0: 449 448 454 453
1050	NMAT= 1: NSECT= 2: NNSW= 0: 458 457 465 464
1051	NMAT= 1: NSECT= 3: NNSW= 0: 469 468 476 475
1052	NMAT= 1: NSECT= 4: NNSW= 0: 480 479 487 486
1053	NMAT= 1: NSECT= 5: NNSW= 0: 491 490 498 497
1054	NMAT= 1: NSECT= 6: NNSW= 0: 438 437 445 444
1055	NMAT= 1: NSECT= 1: NNSW= 0: 568 567 575 574
1056	NMAT= 1: NSECT= 2: NNSW= 0: 579 578 584 583
1057	NMAT= 1: NSECT= 3: NNSW= 0: 535 534 542 541
1058	NMAT= 1: NSECT= 4: NNSW= 0: 546 545 553 552
1059	NMAT= 1: NSECT= 5: NNSW= 0: 557 556 564 563
1060	NMAT= 1: NSECT= 6: NNSW= 0: 588 587 595 594
1061	NMAT= 1: NSECT= 7: NNSW= 0: 599 598 601 600
1062	GROUP 2
1063	NMAT= 4
1064	NSECT= 56
1065	597 586 651 650
1066	586 577 652 651
1067	577 566 653 652
1068	566 555 654 653
1069	555 544 655 654
1070	544 533 656 655
1071	533 522 657 656
1072	522 511 658 657
1073	511 500 659 658
1074	500 489 660 659
1075	489 478 661 660
1076	478 467 662 661
1077	467 456 663 662
1078	456 447 664 663
1079	447 436 665 664

1080	436 597 650 665						
1081	NSECT=55						
1082	597 586 619 618						
1083	586 577 620 619						
1084	577 566 621 620						
1085	566 555 622 621						
1086	555 544 623 622						
1087	544 533 624 623						
1088	533 522 625 624						
1089	522 511 626 625						
1090	511 500 627 626						
1091	500 489 628 627						
1092	489 478 629 628						
1093	478 467 630 629						
1094	467 456 631 630						
1095	456 447 632 631						
1096	447 436 633 632						
1097	436 597 618 633						
1098	NSECT=56						
1099	650 618 619 651 2 16						
1100	NSECT=57						
1101	634 650 651 635 2 16						
1102	E33						
1103	GROUP 1						
1104	NMAT=	2: NSECT=	8: NNSW=	0:	1	2	12
1105	NMAT=	2: NSECT=	9: NNSW=	0:	2	3	13
1106	NMAT=	2: NSECT=	9: NNSW=	0:	3	4	14
1107	NMAT=	2: NSECT=	9: NNSW=	0:	4	5	15
1108	NMAT=	2: NSECT=	9: NNSW=	0:	5	6	16
1109	NMAT=	2: NSECT=	9: NNSW=	0:	6	7	17
1110	NMAT=	2: NSECT=	9: NNSW=	0:	7	8	18
1111	NMAT=	2: NSECT=	9: NNSW=	0:	8	9	19
1112	NMAT=	2: NSECT=	9: NNSW=	0:	9	10	20
1113	NMAT=	2: NSECT=	8: NNSW=	0:	10	11	11
1114	NMAT=	2: NSECT=	8: NNSW=	0:	12	1	1
1115	NMAT=	2: NSECT=	9: NNSW=	0:	13	12	2
1116	NMAT=	2: NSECT=	9: NNSW=	0:	14	13	3
1117	NMAT=	2: NSECT=	9: NNSW=	0:	15	14	4
1118	NMAT=	2: NSECT=	9: NNSW=	0:	16	15	5
1119	NMAT=	2: NSECT=	9: NNSW=	0:	17	16	6
1120	NMAT=	2: NSECT=	9: NNSW=	0:	18	17	7
1121	NMAT=	2: NSECT=	9: NNSW=	0:	19	18	8
1122	NMAT=	2: NSECT=	9: NNSW=	0:	20	19	9
1123	NMAT=	2: NSECT=	8: NNSW=	0:	11	20	10
1124	NMAT=	2: NSECT=	10: NNSW=	0:	11	12	22
1125	NMAT=	2: NSECT=	11: NNSW=	0:	12	13	23
1126	NMAT=	2: NSECT=	11: NNSW=	0:	13	14	24
1127	NMAT=	2: NSECT=	11: NNSW=	0:	14	15	25
1128	NMAT=	2: NSECT=	11: NNSW=	0:	15	16	26
1129	NMAT=	2: NSECT=	11: NNSW=	0:	16	17	27
1130	NMAT=	2: NSECT=	11: NNSW=	0:	17	18	28
1131	NMAT=	2: NSECT=	11: NNSW=	0:	18	19	29
1132	NMAT=	2: NSECT=	11: NNSW=	0:	19	20	30
1133	NMAT=	2: NSECT=	10: NNSW=	0:	20	11	21
1134	NMAT=	2: NSECT=	10: NNSW=	0:	22	21	11
1135	NMAT=	2: NSECT=	11: NNSW=	0:	23	22	12
1136	NMAT=	2: NSECT=	11: NNSW=	0:	24	23	13
1137	NMAT=	2: NSECT=	11: NNSW=	0:	25	24	14
1138	NMAT=	2: NSECT=	11: NNSW=	0:	26	25	15
1139	NMAT=	2: NSECT=	11: NNSW=	0:	27	26	16

1140	NMAT=	2:	NSECT=	11:	NNSW=	0:	28	27	17
1141	NMAT=	2:	NSECT=	11:	NNSW=	0:	29	28	18
1142	NMAT=	2:	NSECT=	11:	NNSW=	0:	30	29	19
1143	NMAT=	2:	NSECT=	10:	NNSW=	0:	21	30	20
1144	NMAT=	2:	NSECT=	12:	NNSW=	0:	22	23	33
1145	NMAT=	2:	NSECT=	12:	NNSW=	0:	23	24	34
1146	NMAT=	2:	NSECT=	12:	NNSW=	0:	24	25	35
1147	NMAT=	2:	NSECT=	12:	NNSW=	0:	25	26	36
1148	NMAT=	2:	NSECT=	12:	NNSW=	0:	26	27	37
1149	NMAT=	2:	NSECT=	12:	NNSW=	0:	27	28	38
1150	NMAT=	2:	NSECT=	12:	NNSW=	0:	28	29	39
1151	NMAT=	2:	NSECT=	12:	NNSW=	0:	29	30	40
1152	NMAT=	2:	NSECT=	12:	NNSW=	0:	33	32	22
1153	NMAT=	2:	NSECT=	12:	NNSW=	0:	34	33	23
1154	NMAT=	2:	NSECT=	12:	NNSW=	0:	35	34	24
1155	NMAT=	2:	NSECT=	12:	NNSW=	0:	36	35	25
1156	NMAT=	2:	NSECT=	12:	NNSW=	0:	37	36	26
1157	NMAT=	2:	NSECT=	12:	NNSW=	0:	38	37	27
1158	NMAT=	2:	NSECT=	12:	NNSW=	0:	39	38	28
1159	NMAT=	2:	NSECT=	12:	NNSW=	0:	40	39	29
1160	NMAT=	2:	NSECT=	13:	NNSW=	0:	31	32	42
1161	NMAT=	2:	NSECT=	12:	NNSW=	0:	32	33	43
1162	NMAT=	2:	NSECT=	14:	NNSW=	0:	33	34	44
1163	NMAT=	2:	NSECT=	14:	NNSW=	0:	34	35	45
1164	NMAT=	2:	NSECT=	14:	NNSW=	0:	35	36	46
1165	NMAT=	2:	NSECT=	14:	NNSW=	0:	36	37	47
1166	NMAT=	2:	NSECT=	14:	NNSW=	0:	37	38	48
1167	NMAT=	2:	NSECT=	14:	NNSW=	0:	38	39	49
1168	NMAT=	2:	NSECT=	12:	NNSW=	0:	39	40	50
1169	NMAT=	2:	NSECT=	13:	NNSW=	0:	40	31	41
1170	NMAT=	2:	NSECT=	13:	NNSW=	0:	42	41	31
1171	NMAT=	2:	NSECT=	12:	NNSW=	0:	43	42	32
1172	NMAT=	2:	NSECT=	14:	NNSW=	0:	44	43	33
1173	NMAT=	2:	NSECT=	14:	NNSW=	0:	45	44	34
1174	NMAT=	2:	NSECT=	14:	NNSW=	0:	46	45	35
1175	NMAT=	2:	NSECT=	14:	NNSW=	0:	47	46	36
1176	NMAT=	2:	NSECT=	14:	NNSW=	0:	48	47	37
1177	NMAT=	2:	NSECT=	14:	NNSW=	0:	49	48	38
1178	NMAT=	2:	NSECT=	12:	NNSW=	0:	50	49	39
1179	NMAT=	2:	NSECT=	13:	NNSW=	0:	41	50	40
1180	NMAT=	2:	NSECT=	15:	NNSW=	0:	42	43	53
1181	NMAT=	2:	NSECT=	15:	NNSW=	0:	43	44	54
1182	NMAT=	2:	NSECT=	15:	NNSW=	0:	44	45	55
1183	NMAT=	2:	NSECT=	15:	NNSW=	0:	45	46	56
1184	NMAT=	2:	NSECT=	15:	NNSW=	0:	46	47	57
1185	NMAT=	2:	NSECT=	15:	NNSW=	0:	47	48	58
1186	NMAT=	2:	NSECT=	15:	NNSW=	0:	48	49	59
1187	NMAT=	2:	NSECT=	15:	NNSW=	0:	49	50	60
1188	NMAT=	2:	NSECT=	15:	NNSW=	0:	53	52	42
1189	NMAT=	2:	NSECT=	15:	NNSW=	0:	54	53	43
1190	NMAT=	2:	NSECT=	15:	NNSW=	0:	55	54	44
1191	NMAT=	2:	NSECT=	15:	NNSW=	0:	56	55	45
1192	NMAT=	2:	NSECT=	15:	NNSW=	0:	57	56	46
1193	NMAT=	2:	NSECT=	15:	NNSW=	0:	58	57	47
1194	NMAT=	2:	NSECT=	15:	NNSW=	0:	59	58	48
1195	NMAT=	2:	NSECT=	15:	NNSW=	0:	60	59	49
1196	NMAT=	2:	NSECT=	16:	NNSW=	0:	122	123	51
1197	NMAT=	2:	NSECT=	16:	NNSW=	0:	124	122	70
1198	NMAT=	2:	NSECT=	16:	NNSW=	0:	125	124	70
1199	NMAT=	2:	NSECT=	16:	NNSW=	0:	41	125	71

1200	NMAT=	2: NSECT=	16: NNSW=	0:	126	41	71
1201	NMAT=	2: NSECT=	16: NNSW=	0:	127	126	72
1202	NMAT=	2: NSECT=	16: NNSW=	0:	129	127	72
1203	NMAT=	2: NSECT=	16: NNSW=	0:	128	129	60
1204	NMAT=	2: NSECT=	16: NNSW=	0:	52	51	123
1205	NMAT=	2: NSECT=	16: NNSW=	0:	51	70	122
1206	NMAT=	2: NSECT=	16: NNSW=	0:	70	71	125
1207	NMAT=	2: NSECT=	16: NNSW=	0:	71	72	126
1208	NMAT=	2: NSECT=	16: NNSW=	0:	72	73	129
1209	NMAT=	2: NSECT=	16: NNSW=	0:	73	60	129
1210	NMAT=	2: NSECT=	16: NNSW=	0:	51	52	120
1211	NMAT=	2: NSECT=	16: NNSW=	0:	52	53	62
1212	NMAT=	2: NSECT=	16: NNSW=	0:	53	54	63
1213	NMAT=	2: NSECT=	16: NNSW=	0:	54	55	64
1214	NMAT=	2: NSECT=	16: NNSW=	0:	55	56	65
1215	NMAT=	2: NSECT=	16: NNSW=	0:	56	57	66
1216	NMAT=	2: NSECT=	16: NNSW=	0:	57	58	67
1217	NMAT=	2: NSECT=	16: NNSW=	0:	58	59	68
1218	NMAT=	2: NSECT=	16: NNSW=	0:	59	60	69
1219	NMAT=	2: NSECT=	16: NNSW=	0:	60	73	121
1220	NMAT=	2: NSECT=	16: NNSW=	0:	61	120	52
1221	NMAT=	2: NSECT=	16: NNSW=	0:	62	61	52
1222	NMAT=	2: NSECT=	16: NNSW=	0:	63	62	53
1223	NMAT=	2: NSECT=	16: NNSW=	0:	64	63	54
1224	NMAT=	2: NSECT=	16: NNSW=	0:	65	64	55
1225	NMAT=	2: NSECT=	16: NNSW=	0:	66	65	56
1226	NMAT=	2: NSECT=	16: NNSW=	0:	67	66	57
1227	NMAT=	2: NSECT=	16: NNSW=	0:	68	67	58
1228	NMAT=	2: NSECT=	16: NNSW=	0:	69	68	59
1229	NMAT=	2: NSECT=	16: NNSW=	0:	60	121	69
1230	NMAT=	2: NSECT=	16: NNSW=	0:	61	62	155
1231	NMAT=	2: NSECT=	16: NNSW=	0:	62	63	154
1232	NMAT=	2: NSECT=	16: NNSW=	0:	63	64	153
1233	NMAT=	2: NSECT=	16: NNSW=	0:	64	65	152
1234	NMAT=	2: NSECT=	16: NNSW=	0:	65	66	151
1235	NMAT=	2: NSECT=	16: NNSW=	0:	66	67	150
1236	NMAT=	2: NSECT=	16: NNSW=	0:	67	68	149
1237	NMAT=	2: NSECT=	16: NNSW=	0:	68	69	148
1238	NMAT=	2: NSECT=	16: NNSW=	0:	155	156	61
1239	NMAT=	2: NSECT=	16: NNSW=	0:	154	155	62
1240	NMAT=	2: NSECT=	16: NNSW=	0:	153	154	63
1241	NMAT=	2: NSECT=	16: NNSW=	0:	152	153	64
1242	NMAT=	2: NSECT=	16: NNSW=	0:	151	152	65
1243	NMAT=	2: NSECT=	16: NNSW=	0:	150	151	66
1244	NMAT=	2: NSECT=	16: NNSW=	0:	149	150	67
1245	NMAT=	2: NSECT=	16: NNSW=	0:	148	149	68
1246	NMAT=	2: NSECT=	17: NNSW=	0:	1	89	99
1247	NMAT=	2: NSECT=	17: NNSW=	0:	99	11	1
1248	NMAT=	2: NSECT=	17: NNSW=	0:	11	99	109
1249	NMAT=	2: NSECT=	19: NNSW=	0:	12	108	22
1250	NMAT=	2: NSECT=	19: NNSW=	0:	11	109	21
1251	NMAT=	2: NSECT=	19: NNSW=	0:	20	110	30
1252	NMAT=	2: NSECT=	17: NNSW=	0:	84	143	94
1253	NMAT=	2: NSECT=	17: NNSW=	0:	94	143	134
1254	NMAT=	2: NSECT=	17: NNSW=	0:	94	134	104
1255	NMAT=	2: NSECT=	18: NNSW=	0:	104	134	31
1256	NMAT=	2: NSECT=	20: NNSW=	0:	31	134	41
1257	NMAT=	2: NSECT=	29: NNSW=	0:	20	11	110
1258	NMAT=	2: NSECT=	29: NNSW=	0:	109	110	11
1259	NMAT=	2: NSECT=	29: NNSW=	0:	108	109	11

1260	NMAT=	2:	NSECT=	29:	NNSW=	0:	11	12	108
1261	NMAT=	2:	NSECT=	25:	NNSW=	0:	40	117	118
1262	NMAT=	2:	NSECT=	25:	NNSW=	0:	40	30	117
1263	NMAT=	2:	NSECT=	25:	NNSW=	0:	32	116	115
1264	NMAT=	2:	NSECT=	25:	NNSW=	0:	32	22	116
1265	NMAT=	2:	NSECT=	26:	NNSW=	0:	118	119	40
1266	NMAT=	2:	NSECT=	26:	NNSW=	0:	119	31	40
1267	NMAT=	2:	NSECT=	26:	NNSW=	0:	114	32	31
1268	NMAT=	2:	NSECT=	26:	NNSW=	0:	114	115	32
1269	NMAT=	2:	NSECT=	20:	NNSW=	0:	40	134	50
1270	NMAT=	2:	NSECT=	20:	NNSW=	0:	32	134	42
1271	NMAT=	2:	NSECT=	16:	NNSW=	0:	73	72	121
1272	NMAT=	2:	NSECT=	16:	NNSW=	0:	73	121	129
1273	NMAT=	2:	NSECT=	16:	NNSW=	0:	70	51	120
1274	NMAT=	2:	NSECT=	16:	NNSW=	0:	51	120	122
1275	NMAT=	2:	NSECT=	21:	NNSW=	0:	74	75	85
1276	NMAT=	2:	NSECT=	21:	NNSW=	0:	75	76	86
1277	NMAT=	2:	NSECT=	21:	NNSW=	0:	76	77	87
1278	NMAT=	2:	NSECT=	21:	NNSW=	0:	77	78	88
1279	NMAT=	2:	NSECT=	21:	NNSW=	0:	78	79	89
1280	NMAT=	2:	NSECT=	21:	NNSW=	0:	79	80	90
1281	NMAT=	2:	NSECT=	21:	NNSW=	0:	80	81	91
1282	NMAT=	2:	NSECT=	21:	NNSW=	0:	81	82	92
1283	NMAT=	2:	NSECT=	21:	NNSW=	0:	82	83	93
1284	NMAT=	2:	NSECT=	21:	NNSW=	0:	83	74	84
1285	NMAT=	2:	NSECT=	21:	NNSW=	0:	85	84	74
1286	NMAT=	2:	NSECT=	21:	NNSW=	0:	86	85	75
1287	NMAT=	2:	NSECT=	21:	NNSW=	0:	87	86	76
1288	NMAT=	2:	NSECT=	21:	NNSW=	0:	88	87	77
1289	NMAT=	2:	NSECT=	21:	NNSW=	0:	89	88	78
1290	NMAT=	2:	NSECT=	21:	NNSW=	0:	90	89	79
1291	NMAT=	2:	NSECT=	21:	NNSW=	0:	91	90	80
1292	NMAT=	2:	NSECT=	21:	NNSW=	0:	92	91	81
1293	NMAT=	2:	NSECT=	21:	NNSW=	0:	93	92	82
1294	NMAT=	2:	NSECT=	21:	NNSW=	0:	84	93	83
1295	NMAT=	2:	NSECT=	22:	NNSW=	0:	84	85	95
1296	NMAT=	2:	NSECT=	22:	NNSW=	0:	85	86	96
1297	NMAT=	2:	NSECT=	22:	NNSW=	0:	86	87	97
1298	NMAT=	2:	NSECT=	22:	NNSW=	0:	87	88	98
1299	NMAT=	2:	NSECT=	22:	NNSW=	0:	88	89	99
1300	NMAT=	2:	NSECT=	22:	NNSW=	0:	89	90	100
1301	NMAT=	2:	NSECT=	22:	NNSW=	0:	90	91	101
1302	NMAT=	2:	NSECT=	22:	NNSW=	0:	91	92	102
1303	NMAT=	2:	NSECT=	22:	NNSW=	0:	92	93	103
1304	NMAT=	2:	NSECT=	22:	NNSW=	0:	93	84	94
1305	NMAT=	2:	NSECT=	22:	NNSW=	0:	95	94	84
1306	NMAT=	2:	NSECT=	22:	NNSW=	0:	96	95	85
1307	NMAT=	2:	NSECT=	22:	NNSW=	0:	97	96	86
1308	NMAT=	2:	NSECT=	22:	NNSW=	0:	98	97	87
1309	NMAT=	2:	NSECT=	22:	NNSW=	0:	99	98	88
1310	NMAT=	2:	NSECT=	22:	NNSW=	0:	100	99	89
1311	NMAT=	2:	NSECT=	22:	NNSW=	0:	101	100	90
1312	NMAT=	2:	NSECT=	22:	NNSW=	0:	102	101	91
1313	NMAT=	2:	NSECT=	22:	NNSW=	0:	103	102	92
1314	NMAT=	2:	NSECT=	22:	NNSW=	0:	94	103	93
1315	NMAT=	2:	NSECT=	23:	NNSW=	0:	94	95	105
1316	NMAT=	2:	NSECT=	23:	NNSW=	0:	95	96	106
1317	NMAT=	2:	NSECT=	23:	NNSW=	0:	96	97	107
1318	NMAT=	2:	NSECT=	23:	NNSW=	0:	97	98	108
1319	NMAT=	2:	NSECT=	23:	NNSW=	0:	98	99	109

1320	NMAT=	2: NSECT=	23: NNSW=	0:	99	100	110
1321	NMAT=	2: NSECT=	23: NNSW=	0:	100	101	111
1322	NMAT=	2: NSECT=	23: NNSW=	0:	101	102	112
1323	NMAT=	2: NSECT=	23: NNSW=	0:	102	103	113
1324	NMAT=	2: NSECT=	23: NNSW=	0:	103	94	104
1325	NMAT=	2: NSECT=	23: NNSW=	0:	105	104	94
1326	NMAT=	2: NSECT=	23: NNSW=	0:	106	105	95
1327	NMAT=	2: NSECT=	23: NNSW=	0:	107	106	96
1328	NMAT=	2: NSECT=	23: NNSW=	0:	108	107	97
1329	NMAT=	2: NSECT=	23: NNSW=	0:	109	108	98
1330	NMAT=	2: NSECT=	23: NNSW=	0:	110	109	99
1331	NMAT=	2: NSECT=	23: NNSW=	0:	111	110	100
1332	NMAT=	2: NSECT=	23: NNSW=	0:	112	111	101
1333	NMAT=	2: NSECT=	23: NNSW=	0:	113	112	102
1334	NMAT=	2: NSECT=	23: NNSW=	0:	104	113	103
1335	NMAT=	2: NSECT=	24: NNSW=	0:	104	105	114
1336	NMAT=	2: NSECT=	24: NNSW=	0:	105	106	115
1337	NMAT=	2: NSECT=	24: NNSW=	0:	106	107	116
1338	NMAT=	2: NSECT=	24: NNSW=	0:	107	108	22
1339	NMAT=	2: NSECT=	25: NNSW=	0:	108	109	21
1340	NMAT=	2: NSECT=	24: NNSW=	0:	109	110	30
1341	NMAT=	2: NSECT=	24: NNSW=	0:	110	111	117
1342	NMAT=	2: NSECT=	24: NNSW=	0:	111	112	118
1343	NMAT=	2: NSECT=	24: NNSW=	0:	112	113	119
1344	NMAT=	2: NSECT=	24: NNSW=	0:	113	104	31
1345	NMAT=	2: NSECT=	24: NNSW=	0:	114	31	104
1346	NMAT=	2: NSECT=	24: NNSW=	0:	115	114	105
1347	NMAT=	2: NSECT=	24: NNSW=	0:	116	115	106
1348	NMAT=	2: NSECT=	24: NNSW=	0:	22	116	107
1349	NMAT=	2: NSECT=	24: NNSW=	0:	21	22	108
1350	NMAT=	2: NSECT=	24: NNSW=	0:	30	21	109
1351	NMAT=	2: NSECT=	24: NNSW=	0:	117	30	110
1352	NMAT=	2: NSECT=	24: NNSW=	0:	118	117	111
1353	NMAT=	2: NSECT=	24: NNSW=	0:	119	118	112
1354	NMAT=	2: NSECT=	24: NNSW=	0:	31	119	113
1355	NMAT=	2: NSECT=	28: NNSW=	0:	122	123	131
1356	NMAT=	2: NSECT=	27: NNSW=	0:	123	124	132
1357	NMAT=	2: NSECT=	27: NNSW=	0:	124	125	133
1358	NMAT=	2: NSECT=	27: NNSW=	0:	125	41	134
1359	NMAT=	2: NSECT=	27: NNSW=	0:	41	126	135
1360	NMAT=	2: NSECT=	27: NNSW=	0:	126	127	136
1361	NMAT=	2: NSECT=	27: NNSW=	0:	127	128	137
1362	NMAT=	2: NSECT=	28: NNSW=	0:	128	129	138
1363	NMAT=	2: NSECT=	28: NNSW=	0:	131	130	122
1364	NMAT=	2: NSECT=	27: NNSW=	0:	132	131	123
1365	NMAT=	2: NSECT=	27: NNSW=	0:	133	132	124
1366	NMAT=	2: NSECT=	27: NNSW=	0:	134	133	125
1367	NMAT=	2: NSECT=	27: NNSW=	0:	135	134	41
1368	NMAT=	2: NSECT=	27: NNSW=	0:	136	135	126
1369	NMAT=	2: NSECT=	27: NNSW=	0:	137	136	127
1370	NMAT=	2: NSECT=	28: NNSW=	0:	138	137	128
1371	NMAT=	2: NSECT=	28: NNSW=	0:	130	131	140
1372	NMAT=	2: NSECT=	27: NNSW=	0:	131	132	141
1373	NMAT=	2: NSECT=	27: NNSW=	0:	132	133	142
1374	NMAT=	2: NSECT=	27: NNSW=	0:	133	134	143
1375	NMAT=	2: NSECT=	27: NNSW=	0:	134	135	144
1376	NMAT=	2: NSECT=	27: NNSW=	0:	135	136	145
1377	NMAT=	2: NSECT=	27: NNSW=	0:	136	137	146
1378	NMAT=	2: NSECT=	28: NNSW=	0:	137	138	147
1379	NMAT=	2: NSECT=	28: NNSW=	0:	140	139	130

1380	NMAT=	2:	NSECT=	27:	NNSW=	0:	141	140	131
1381	NMAT=	2:	NSECT=	27:	NNSW=	0:	142	141	132
1382	NMAT=	2:	NSECT=	27:	NNSW=	0:	143	142	133
1383	NMAT=	2:	NSECT=	27:	NNSW=	0:	144	143	134
1384	NMAT=	2:	NSECT=	27:	NNSW=	0:	145	144	135
1385	NMAT=	2:	NSECT=	27:	NNSW=	0:	146	145	136
1386	NMAT=	2:	NSECT=	28:	NNSW=	0:	147	146	137
1387	NMAT=	2:	NSECT=	29:	NNSW=	0:	148	149	158
1388	NMAT=	2:	NSECT=	30:	NNSW=	0:	149	150	159
1389	NMAT=	2:	NSECT=	30:	NNSW=	0:	150	151	160
1390	NMAT=	2:	NSECT=	30:	NNSW=	0:	151	152	161
1391	NMAT=	2:	NSECT=	30:	NNSW=	0:	152	153	162
1392	NMAT=	2:	NSECT=	30:	NNSW=	0:	153	154	163
1393	NMAT=	2:	NSECT=	30:	NNSW=	0:	154	155	164
1394	NMAT=	2:	NSECT=	29:	NNSW=	0:	155	156	165
1395	NMAT=	2:	NSECT=	29:	NNSW=	0:	158	157	148
1396	NMAT=	2:	NSECT=	30:	NNSW=	0:	159	158	149
1397	NMAT=	2:	NSECT=	30:	NNSW=	0:	160	159	150
1398	NMAT=	2:	NSECT=	30:	NNSW=	0:	161	160	151
1399	NMAT=	2:	NSECT=	30:	NNSW=	0:	162	161	152
1400	NMAT=	2:	NSECT=	30:	NNSW=	0:	163	162	153
1401	NMAT=	2:	NSECT=	30:	NNSW=	0:	164	163	154
1402	NMAT=	2:	NSECT=	29:	NNSW=	0:	165	164	155
1403	NMAT=	2:	NSECT=	31:	NNSW=	0:	157	158	167
1404	NMAT=	2:	NSECT=	32:	NNSW=	0:	158	159	168
1405	NMAT=	2:	NSECT=	32:	NNSW=	0:	159	160	169
1406	NMAT=	2:	NSECT=	32:	NNSW=	0:	160	161	170
1407	NMAT=	2:	NSECT=	32:	NNSW=	0:	161	162	171
1408	NMAT=	2:	NSECT=	32:	NNSW=	0:	162	163	172
1409	NMAT=	2:	NSECT=	32:	NNSW=	0:	163	164	173
1410	NMAT=	2:	NSECT=	31:	NNSW=	0:	164	165	174
1411	NMAT=	2:	NSECT=	31:	NNSW=	0:	167	166	157
1412	NMAT=	2:	NSECT=	32:	NNSW=	0:	168	167	158
1413	NMAT=	2:	NSECT=	32:	NNSW=	0:	169	168	159
1414	NMAT=	2:	NSECT=	32:	NNSW=	0:	170	169	160
1415	NMAT=	2:	NSECT=	32:	NNSW=	0:	171	170	161
1416	NMAT=	2:	NSECT=	32:	NNSW=	0:	172	171	162
1417	NMAT=	2:	NSECT=	32:	NNSW=	0:	173	172	163
1418	NMAT=	2:	NSECT=	31:	NNSW=	0:	174	173	164
1419	NMAT=	2:	NSECT=	33:	NNSW=	0:	166	167	176
1420	NMAT=	2:	NSECT=	34:	NNSW=	0:	167	168	177
1421	NMAT=	2:	NSECT=	34:	NNSW=	0:	168	169	178
1422	NMAT=	2:	NSECT=	34:	NNSW=	0:	169	170	179
1423	NMAT=	2:	NSECT=	34:	NNSW=	0:	170	171	180
1424	NMAT=	2:	NSECT=	34:	NNSW=	0:	171	172	181
1425	NMAT=	2:	NSECT=	34:	NNSW=	0:	172	173	182
1426	NMAT=	2:	NSECT=	33:	NNSW=	0:	173	174	183
1427	NMAT=	2:	NSECT=	33:	NNSW=	0:	176	175	166
1428	NMAT=	2:	NSECT=	34:	NNSW=	0:	177	176	167
1429	NMAT=	2:	NSECT=	34:	NNSW=	0:	178	177	168
1430	NMAT=	2:	NSECT=	34:	NNSW=	0:	179	178	169
1431	NMAT=	2:	NSECT=	34:	NNSW=	0:	180	179	170
1432	NMAT=	2:	NSECT=	34:	NNSW=	0:	181	180	171
1433	NMAT=	2:	NSECT=	34:	NNSW=	0:	182	181	172
1434	NMAT=	2:	NSECT=	33:	NNSW=	0:	183	182	173
1435	NMAT=	2:	NSECT=	35:	NNSW=	0:	175	176	185
1436	NMAT=	2:	NSECT=	36:	NNSW=	0:	176	177	186
1437	NMAT=	2:	NSECT=	36:	NNSW=	0:	177	178	187
1438	NMAT=	2:	NSECT=	36:	NNSW=	0:	178	179	188
1439	NMAT=	2:	NSECT=	36:	NNSW=	0:	179	180	189

1440	NMAT =	2: NSECT =	36: NNSW =	0:	180	181	190
1441	NMAT =	2: NSECT =	36: NNSW =	0:	181	182	191
1442	NMAT =	2: NSECT =	35: NNSW =	0:	182	183	192
1443	NMAT =	2: NSECT =	35: NNSW =	0:	185	184	175
1444	NMAT =	2: NSECT =	36: NNSW =	0:	186	185	176
1445	NMAT =	2: NSECT =	36: NNSW =	0:	187	186	177
1446	NMAT =	2: NSECT =	36: NNSW =	0:	188	187	178
1447	NMAT =	2: NSECT =	36: NNSW =	0:	189	188	179
1448	NMAT =	2: NSECT =	36: NNSW =	0:	190	189	180
1449	NMAT =	2: NSECT =	36: NNSW =	0:	191	190	181
1450	NMAT =	2: NSECT =	35: NNSW =	0:	192	191	182
1451	NMAT =	2: NSECT =	37: NNSW =	0:	184	185	194
1452	NMAT =	2: NSECT =	38: NNSW =	0:	185	186	195
1453	NMAT =	2: NSECT =	38: NNSW =	0:	186	187	196
1454	NMAT =	2: NSECT =	38: NNSW =	0:	187	188	197
1455	NMAT =	2: NSECT =	38: NNSW =	0:	188	189	198
1456	NMAT =	2: NSECT =	38: NNSW =	0:	189	190	199
1457	NMAT =	2: NSECT =	38: NNSW =	0:	190	191	200
1458	NMAT =	2: NSECT =	37: NNSW =	0:	191	192	201
1459	NMAT =	2: NSECT =	37: NNSW =	0:	194	193	184
1460	NMAT =	2: NSECT =	38: NNSW =	0:	195	194	185
1461	NMAT =	2: NSECT =	38: NNSW =	0:	196	195	186
1462	NMAT =	2: NSECT =	38: NNSW =	0:	197	196	187
1463	NMAT =	2: NSECT =	38: NNSW =	0:	198	197	188
1464	NMAT =	2: NSECT =	38: NNSW =	0:	199	198	189
1465	NMAT =	2: NSECT =	38: NNSW =	0:	200	199	190
1466	NMAT =	2: NSECT =	37: NNSW =	0:	201	200	191
1467	NMAT =	2: NSECT =	39: NNSW =	0:	193	194	203
1468	NMAT =	2: NSECT =	40: NNSW =	0:	194	195	204
1469	NMAT =	2: NSECT =	40: NNSW =	0:	195	196	205
1470	NMAT =	2: NSECT =	40: NNSW =	0:	196	197	206
1471	NMAT =	2: NSECT =	40: NNSW =	0:	197	198	207
1472	NMAT =	2: NSECT =	40: NNSW =	0:	198	199	208
1473	NMAT =	2: NSECT =	40: NNSW =	0:	199	200	209
1474	NMAT =	2: NSECT =	39: NNSW =	0:	200	201	210
1475	NMAT =	2: NSECT =	40: NNSW =	0:	203	202	193
1476	NMAT =	2: NSECT =	40: NNSW =	0:	204	203	194
1477	NMAT =	2: NSECT =	40: NNSW =	0:	205	204	195
1478	NMAT =	2: NSECT =	40: NNSW =	0:	206	205	196
1479	NMAT =	2: NSECT =	40: NNSW =	0:	207	206	197
1480	NMAT =	2: NSECT =	40: NNSW =	0:	208	207	198
1481	NMAT =	2: NSECT =	40: NNSW =	0:	209	208	199
1482	NMAT =	2: NSECT =	39: NNSW =	0:	210	209	200
1483	NMAT =	2: NSECT =	41: NNSW =	0:	202	203	212
1484	NMAT =	2: NSECT =	42: NNSW =	0:	203	204	213
1485	NMAT =	2: NSECT =	42: NNSW =	0:	204	205	214
1486	NMAT =	2: NSECT =	42: NNSW =	0:	205	206	215
1487	NMAT =	2: NSECT =	42: NNSW =	0:	206	207	216
1488	NMAT =	2: NSECT =	42: NNSW =	0:	207	208	217
1489	NMAT =	2: NSECT =	42: NNSW =	0:	208	209	218
1490	NMAT =	2: NSECT =	41: NNSW =	0:	209	210	219
1491	NMAT =	2: NSECT =	41: NNSW =	0:	212	211	202
1492	NMAT =	2: NSECT =	42: NNSW =	0:	213	212	203
1493	NMAT =	2: NSECT =	42: NNSW =	0:	214	213	204
1494	NMAT =	2: NSECT =	42: NNSW =	0:	215	214	205
1495	NMAT =	2: NSECT =	42: NNSW =	0:	216	215	206
1496	NMAT =	2: NSECT =	42: NNSW =	0:	217	216	207
1497	NMAT =	2: NSECT =	42: NNSW =	0:	218	217	208
1498	NMAT =	2: NSECT =	41: NNSW =	0:	219	218	209
1499	NMAT =	2: NSECT =	43: NNSW =	0:	211	212	221

1500	NMAT=	2:	NSECT=	44:	NNSW=	O:	212	213	222
1501	NMAT=	2:	NSECT=	44:	NNSW=	O:	213	214	223
1502	NMAT=	2:	NSECT=	44:	NNSW=	O:	214	215	224
1503	NMAT=	2:	NSECT=	44:	NNSW=	O:	215	216	225
1504	NMAT=	2:	NSECT=	44:	NNSW=	O:	216	217	226
1505	NMAT=	2:	NSECT=	44:	NNSW=	O:	217	218	227
1506	NMAT=	2:	NSECT=	43:	NNSW=	O:	218	219	228
1507	NMAT=	2:	NSECT=	43:	NNSW=	O:	221	220	211
1508	NMAT=	2:	NSECT=	44:	NNSW=	O:	222	221	212
1509	NMAT=	2:	NSECT=	44:	NNSW=	O:	223	222	213
1510	NMAT=	2:	NSECT=	44:	NNSW=	O:	224	223	214
1511	NMAT=	2:	NSECT=	44:	NNSW=	O:	225	224	215
1512	NMAT=	2:	NSECT=	44:	NNSW=	O:	226	225	216
1513	NMAT=	2:	NSECT=	44:	NNSW=	O:	227	226	217
1514	NMAT=	2:	NSECT=	43:	NNSW=	O:	228	227	218
1515	NMAT=	2:	NSECT=	45:	NNSW=	O:	220	221	230
1516	NMAT=	2:	NSECT=	46:	NNSW=	O:	221	222	231
1517	NMAT=	2:	NSECT=	46:	NNSW=	O:	222	223	232
1518	NMAT=	2:	NSECT=	46:	NNSW=	O:	223	224	233
1519	NMAT=	2:	NSECT=	46:	NNSW=	O:	224	225	234
1520	NMAT=	2:	NSECT=	46:	NNSW=	O:	225	226	235
1521	NMAT=	2:	NSECT=	46:	NNSW=	O:	226	227	236
1522	NMAT=	2:	NSECT=	45:	NNSW=	O:	227	228	237
1523	NMAT=	2:	NSECT=	45:	NNSW=	O:	230	229	220
1524	NMAT=	2:	NSECT=	46:	NNSW=	O:	231	230	221
1525	NMAT=	2:	NSECT=	46:	NNSW=	O:	232	231	222
1526	NMAT=	2:	NSECT=	46:	NNSW=	O:	233	232	223
1527	NMAT=	2:	NSECT=	46:	NNSW=	O:	234	233	224
1528	NMAT=	2:	NSECT=	46:	NNSW=	O:	235	234	225
1529	NMAT=	2:	NSECT=	46:	NNSW=	O:	236	235	226
1530	NMAT=	2:	NSECT=	45:	NNSW=	O:	237	236	227
1531	NMAT=	2:	NSECT=	47:	NNSW=	O:	139	140	236
1532	NMAT=	2:	NSECT=	48:	NNSW=	O:	140	141	235
1533	NMAT=	2:	NSECT=	48:	NNSW=	O:	141	142	234
1534	NMAT=	2:	NSECT=	48:	NNSW=	O:	142	143	233
1535	NMAT=	2:	NSECT=	48:	NNSW=	O:	143	144	232
1536	NMAT=	2:	NSECT=	48:	NNSW=	O:	144	145	231
1537	NMAT=	2:	NSECT=	48:	NNSW=	O:	145	146	230
1538	NMAT=	2:	NSECT=	47:	NNSW=	O:	146	147	229
1539	NMAT=	2:	NSECT=	47:	NNSW=	O:	236	237	139
1540	NMAT=	2:	NSECT=	48:	NNSW=	O:	235	236	140
1541	NMAT=	2:	NSECT=	48:	NNSW=	O:	234	235	141
1542	NMAT=	2:	NSECT=	48:	NNSW=	O:	233	234	142
1543	NMAT=	2:	NSECT=	48:	NNSW=	O:	232	233	143
1544	NMAT=	2:	NSECT=	48:	NNSW=	O:	231	232	144
1545	NMAT=	2:	NSECT=	48:	NNSW=	O:	230	231	145
1546	NMAT=	2:	NSECT=	47:	NNSW=	O:	229	230	146
1547	NMAT=	2:	NSECT=	49:	NNSW=	O:	403	409	176
1548	NMAT=	2:	NSECT=	49:	NNSW=	O:	176	167	403
1549	NMAT=	2:	NSECT=	49:	NNSW=	O:	392	403	167
1550	NMAT=	2:	NSECT=	49:	NNSW=	O:	167	158	392
1551	NMAT=	2:	NSECT=	49:	NNSW=	O:	383	392	158
1552	NMAT=	2:	NSECT=	49:	NNSW=	O:	158	149	383
1553	NMAT=	2:	NSECT=	49:	NNSW=	O:	372	383	149
1554	NMAT=	2:	NSECT=	49:	NNSW=	O:	149	69	372
1555	NMAT=	2:	NSECT=	49:	NNSW=	O:	361	372	69
1556	NMAT=	2:	NSECT=	49:	NNSW=	O:	69	121	361
1557	NMAT=	2:	NSECT=	49:	NNSW=	O:	350	361	121
1558	NMAT=	2:	NSECT=	49:	NNSW=	O:	121	128	350
1559	NMAT=	2:	NSECT=	49:	NNSW=	O:	339	350	128

1560	NMAT=	2: NSECT=	49: NNSW=	0:	328	339	128
1561	NMAT=	2: NSECT=	49: NNSW=	0:	128	137	328
1562	NMAT=	2: NSECT=	49: NNSW=	0:	317	328	137
1563	NMAT=	2: NSECT=	49: NNSW=	0:	137	146	317
1564	NMAT=	2: NSECT=	49: NNSW=	0:	306	317	146
1565	NMAT=	2: NSECT=	49: NNSW=	0:	146	230	306
1566	NMAT=	2: NSECT=	49: NNSW=	0:	295	306	230
1567	NMAT=	2: NSECT=	49: NNSW=	0:	230	221	295
1568	NMAT=	2: NSECT=	49: NNSW=	0:	284	295	221
1569	NMAT=	2: NSECT=	49: NNSW=	0:	221	212	284
1570	NMAT=	2: NSECT=	49: NNSW=	0:	273	284	212
1571	NMAT=	2: NSECT=	49: NNSW=	0:	212	203	273
1572	NMAT=	2: NSECT=	49: NNSW=	0:	262	273	203
1573	NMAT=	2: NSECT=	49: NNSW=	0:	203	194	262
1574	NMAT=	2: NSECT=	49: NNSW=	0:	253	262	194
1575	NMAT=	2: NSECT=	49: NNSW=	0:	194	185	253
1576	NMAT=	2: NSECT=	49: NNSW=	0:	409	253	185
1577	NMAT=	2: NSECT=	49: NNSW=	0:	596	602	191
1578	NMAT=	2: NSECT=	49: NNSW=	0:	191	200	596
1579	NMAT=	2: NSECT=	49: NNSW=	0:	585	596	200
1580	NMAT=	2: NSECT=	49: NNSW=	0:	200	209	585
1581	NMAT=	2: NSECT=	49: NNSW=	0:	576	585	209
1582	NMAT=	2: NSECT=	49: NNSW=	0:	209	218	576
1583	NMAT=	2: NSECT=	49: NNSW=	0:	565	576	218
1584	NMAT=	2: NSECT=	49: NNSW=	0:	218	227	565
1585	NMAT=	2: NSECT=	49: NNSW=	0:	554	565	227
1586	NMAT=	2: NSECT=	49: NNSW=	0:	227	236	554
1587	NMAT=	2: NSECT=	49: NNSW=	0:	543	554	236
1588	NMAT=	2: NSECT=	49: NNSW=	0:	236	140	543
1589	NMAT=	2: NSECT=	49: NNSW=	0:	532	543	140
1590	NMAT=	2: NSECT=	49: NNSW=	0:	140	131	532
1591	NMAT=	2: NSECT=	49: NNSW=	0:	521	532	131
1592	NMAT=	2: NSECT=	49: NNSW=	0:	131	123	521
1593	NMAT=	2: NSECT=	49: NNSW=	0:	510	521	123
1594	NMAT=	2: NSECT=	49: NNSW=	0:	499	510	123
1595	NMAT=	2: NSECT=	49: NNSW=	0:	123	120	499
1596	NMAT=	2: NSECT=	49: NNSW=	0:	488	499	120
1597	NMAT=	2: NSECT=	49: NNSW=	0:	120	61	488
1598	NMAT=	2: NSECT=	49: NNSW=	0:	477	488	61
1599	NMAT=	2: NSECT=	49: NNSW=	0:	61	155	477
1600	NMAT=	2: NSECT=	49: NNSW=	0:	466	477	155
1601	NMAT=	2: NSECT=	49: NNSW=	0:	155	164	466
1602	NMAT=	2: NSECT=	49: NNSW=	0:	455	466	164
1603	NMAT=	2: NSECT=	49: NNSW=	0:	164	173	455
1604	NMAT=	2: NSECT=	49: NNSW=	0:	446	455	173
1605	NMAT=	2: NSECT=	49: NNSW=	0:	173	182	446
1606	NMAT=	2: NSECT=	49: NNSW=	0:	602	446	182
1607	NMAT=	2: NSECT=	49: NNSW=	0:	182	191	602
1608	NMAT=	2: NSECT=	49: NNSW=	0:	185	176	409
1609	NMAT=	2: NSECT=	50: NNSW=	0:	243	244	254
1610	NMAT=	2: NSECT=	51: NNSW=	0:	256	245	244
1611	NMAT=	2: NSECT=	51: NNSW=	0:	257	246	245
1612	NMAT=	2: NSECT=	51: NNSW=	0:	246	247	257
1613	NMAT=	2: NSECT=	51: NNSW=	0:	249	250	258
1614	NMAT=	2: NSECT=	51: NNSW=	0:	250	251	259
1615	NMAT=	2: NSECT=	51: NNSW=	0:	251	252	260
1616	NMAT=	1: NSECT=	52: NNSW=	0:	252	253	261
1617	NMAT=	2: NSECT=	50: NNSW=	0:	255	254	244
1618	NMAT=	2: NSECT=	51: NNSW=	0:	255	256	244
1619	NMAT=	2: NSECT=	51: NNSW=	0:	256	257	245

1620	NMAT=	2:	NSECT=	51:	NNSW=	0:	258	248	249
1621	NMAT=	2:	NSECT=	51:	NNSW=	0:	259	258	250
1622	NMAT=	2:	NSECT=	51:	NNSW=	0:	260	259	251
1623	NMAT=	2:	NSECT=	51:	NNSW=	0:	261	260	252
1624	NMAT=	1:	NSECT=	52:	NNSW=	0:	262	261	253
1625	NMAT=	2:	NSECT=	50:	NNSW=	0:	254	255	263
1626	NMAT=	2:	NSECT=	51:	NNSW=	0:	255	265	256
1627	NMAT=	2:	NSECT=	51:	NNSW=	0:	256	266	257
1628	NMAT=	2:	NSECT=	51:	NNSW=	0:	257	267	247
1629	NMAT=	2:	NSECT=	51:	NNSW=	0:	247	248	267
1630	NMAT=	2:	NSECT=	51:	NNSW=	0:	248	258	268
1631	NMAT=	2:	NSECT=	51:	NNSW=	0:	258	259	269
1632	NMAT=	2:	NSECT=	51:	NNSW=	0:	259	260	270
1633	NMAT=	2:	NSECT=	51:	NNSW=	0:	260	261	271
1634	NMAT=	1:	NSECT=	52:	NNSW=	0:	261	262	272
1635	NMAT=	2:	NSECT=	50:	NNSW=	0:	264	263	255
1636	NMAT=	2:	NSECT=	51:	NNSW=	0:	264	265	255
1637	NMAT=	2:	NSECT=	51:	NNSW=	0:	265	266	256
1638	NMAT=	2:	NSECT=	51:	NNSW=	0:	266	267	257
1639	NMAT=	2:	NSECT=	51:	NNSW=	0:	268	267	248
1640	NMAT=	2:	NSECT=	51:	NNSW=	0:	269	268	258
1641	NMAT=	2:	NSECT=	51:	NNSW=	0:	270	269	259
1642	NMAT=	2:	NSECT=	51:	NNSW=	0:	271	270	260
1643	NMAT=	2:	NSECT=	51:	NNSW=	0:	272	271	261
1644	NMAT=	1:	NSECT=	52:	NNSW=	0:	273	272	262
1645	NMAT=	2:	NSECT=	50:	NNSW=	0:	263	264	274
1646	NMAT=	2:	NSECT=	51:	NNSW=	0:	264	276	265
1647	NMAT=	2:	NSECT=	51:	NNSW=	0:	265	277	266
1648	NMAT=	2:	NSECT=	51:	NNSW=	0:	266	278	267
1649	NMAT=	2:	NSECT=	51:	NNSW=	0:	267	268	278
1650	NMAT=	2:	NSECT=	51:	NNSW=	0:	268	269	279
1651	NMAT=	2:	NSECT=	51:	NNSW=	0:	269	270	280
1652	NMAT=	2:	NSECT=	51:	NNSW=	0:	270	271	281
1653	NMAT=	2:	NSECT=	51:	NNSW=	0:	271	272	282
1654	NMAT=	1:	NSECT=	52:	NNSW=	0:	272	273	283
1655	NMAT=	2:	NSECT=	50:	NNSW=	0:	275	274	264
1656	NMAT=	2:	NSECT=	51:	NNSW=	0:	275	276	264
1657	NMAT=	2:	NSECT=	51:	NNSW=	0:	276	277	265
1658	NMAT=	2:	NSECT=	51:	NNSW=	0:	277	278	266
1659	NMAT=	2:	NSECT=	51:	NNSW=	0:	279	278	268
1660	NMAT=	2:	NSECT=	51:	NNSW=	0:	280	279	269
1661	NMAT=	2:	NSECT=	51:	NNSW=	0:	281	280	270
1662	NMAT=	2:	NSECT=	51:	NNSW=	0:	282	281	271
1663	NMAT=	2:	NSECT=	51:	NNSW=	0:	283	282	272
1664	NMAT=	1:	NSECT=	52:	NNSW=	0:	284	283	273
1665	NMAT=	2:	NSECT=	50:	NNSW=	0:	274	275	285
1666	NMAT=	2:	NSECT=	51:	NNSW=	0:	287	276	275
1667	NMAT=	2:	NSECT=	51:	NNSW=	0:	288	277	276
1668	NMAT=	2:	NSECT=	51:	NNSW=	0:	289	278	277
1669	NMAT=	2:	NSECT=	51:	NNSW=	0:	278	279	289
1670	NMAT=	2:	NSECT=	51:	NNSW=	0:	279	280	290
1671	NMAT=	2:	NSECT=	51:	NNSW=	0:	280	281	291
1672	NMAT=	2:	NSECT=	51:	NNSW=	0:	281	282	292
1673	NMAT=	2:	NSECT=	51:	NNSW=	0:	282	283	293
1674	NMAT=	1:	NSECT=	52:	NNSW=	0:	283	284	294
1675	NMAT=	2:	NSECT=	50:	NNSW=	0:	286	285	275
1676	NMAT=	2:	NSECT=	51:	NNSW=	0:	286	287	275
1677	NMAT=	2:	NSECT=	51:	NNSW=	0:	287	288	276
1678	NMAT=	2:	NSECT=	51:	NNSW=	0:	288	289	277
1679	NMAT=	2:	NSECT=	51:	NNSW=	0:	290	289	279

1680	NMAT =	2:	NSECT =	51: NNSW =	0:	291	290	280
1681	NMAT =	2:	NSECT =	51: NNSW =	0:	292	291	281
1682	NMAT =	2:	NSECT =	51: NNSW =	0:	293	292	282
1683	NMAT =	2:	NSECT =	51: NNSW =	0:	294	293	283
1684	NMAT =	1:	NSECT =	52: NNSW =	0:	295	294	284
1685	NMAT =	2:	NSECT =	50: NNSW =	0:	285	286	296
1686	NMAT =	2:	NSECT =	51: NNSW =	0:	298	287	286
1687	NMAT =	2:	NSECT =	51: NNSW =	0:	299	288	287
1688	NMAT =	2:	NSECT =	51: NNSW =	0:	300	289	288
1689	NMAT =	2:	NSECT =	51: NNSW =	0:	289	290	300
1690	NMAT =	2:	NSECT =	51: NNSW =	0:	290	291	301
1691	NMAT =	2:	NSECT =	51: NNSW =	0:	291	292	302
1692	NMAT =	2:	NSECT =	51: NNSW =	0:	292	293	303
1693	NMAT =	2:	NSECT =	51: NNSW =	0:	293	294	304
1694	NMAT =	1:	NSECT =	52: NNSW =	0:	294	295	305
1695	NMAT =	2:	NSECT =	50: NNSW =	0:	297	296	286
1696	NMAT =	2:	NSECT =	51: NNSW =	0:	297	298	286
1697	NMAT =	2:	NSECT =	51: NNSW =	0:	298	299	287
1698	NMAT =	2:	NSECT =	51: NNSW =	0:	299	300	288
1699	NMAT =	2:	NSECT =	51: NNSW =	0:	301	300	290
1700	NMAT =	2:	NSECT =	51: NNSW =	0:	302	301	291
1701	NMAT =	2:	NSECT =	51: NNSW =	0:	303	302	292
1702	NMAT =	2:	NSECT =	51: NNSW =	0:	304	303	293
1703	NMAT =	2:	NSECT =	51: NNSW =	0:	305	304	294
1704	NMAT =	1:	NSECT =	52: NNSW =	0:	306	305	295
1705	NMAT =	2:	NSECT =	50: NNSW =	0:	296	297	307
1706	NMAT =	2:	NSECT =	51: NNSW =	0:	297	298	308
1707	NMAT =	2:	NSECT =	51: NNSW =	0:	298	299	309
1708	NMAT =	2:	NSECT =	51: NNSW =	0:	299	300	310
1709	NMAT =	2:	NSECT =	51: NNSW =	0:	300	301	311
1710	NMAT =	2:	NSECT =	51: NNSW =	0:	301	302	312
1711	NMAT =	2:	NSECT =	51: NNSW =	0:	302	303	313
1712	NMAT =	2:	NSECT =	51: NNSW =	0:	303	304	314
1713	NMAT =	2:	NSECT =	51: NNSW =	0:	304	305	315
1714	NMAT =	1:	NSECT =	52: NNSW =	0:	305	306	316
1715	NMAT =	2:	NSECT =	50: NNSW =	0:	308	307	297
1716	NMAT =	2:	NSECT =	51: NNSW =	0:	309	308	298
1717	NMAT =	2:	NSECT =	51: NNSW =	0:	310	309	299
1718	NMAT =	2:	NSECT =	51: NNSW =	0:	311	310	300
1719	NMAT =	2:	NSECT =	51: NNSW =	0:	312	311	301
1720	NMAT =	2:	NSECT =	51: NNSW =	0:	313	312	302
1721	NMAT =	2:	NSECT =	51: NNSW =	0:	314	313	303
1722	NMAT =	2:	NSECT =	51: NNSW =	0:	315	314	304
1723	NMAT =	2:	NSECT =	51: NNSW =	0:	316	315	305
1724	NMAT =	1:	NSECT =	52: NNSW =	0:	317	316	306
1725	NMAT =	2:	NSECT =	50: NNSW =	0:	307	308	318
1726	NMAT =	2:	NSECT =	50: NNSW =	0:	308	309	319
1727	NMAT =	2:	NSECT =	50: NNSW =	0:	309	310	320
1728	NMAT =	2:	NSECT =	50: NNSW =	0:	310	311	321
1729	NMAT =	2:	NSECT =	50: NNSW =	0:	311	312	322
1730	NMAT =	2:	NSECT =	50: NNSW =	0:	312	313	323
1731	NMAT =	2:	NSECT =	50: NNSW =	0:	313	314	324
1732	NMAT =	2:	NSECT =	50: NNSW =	0:	314	315	325
1733	NMAT =	2:	NSECT =	50: NNSW =	0:	315	316	326
1734	NMAT =	1:	NSECT =	52: NNSW =	0:	316	317	327
1735	NMAT =	2:	NSECT =	50: NNSW =	0:	319	318	308
1736	NMAT =	2:	NSECT =	50: NNSW =	0:	320	319	309
1737	NMAT =	2:	NSECT =	50: NNSW =	0:	321	320	310
1738	NMAT =	2:	NSECT =	50: NNSW =	0:	322	321	311
1739	NMAT =	2:	NSECT =	50: NNSW =	0:	323	322	312

1740	NMAT=	2:	NSECT=	50:	NNSW=	0:	324	323	313
1741	NMAT=	2:	NSECT=	50:	NNSW=	0:	325	324	314
1742	NMAT=	2:	NSECT=	50:	NNSW=	0:	326	325	315
1743	NMAT=	2:	NSECT=	50:	NNSW=	0:	327	326	316
1744	NMAT=	1:	NSECT=	52:	NNSW=	0:	328	327	317
1745	NMAT=	2:	NSECT=	50:	NNSW=	0:	329	330	318
1746	NMAT=	2:	NSECT=	50:	NNSW=	0:	330	331	319
1747	NMAT=	2:	NSECT=	50:	NNSW=	0:	331	332	320
1748	NMAT=	2:	NSECT=	50:	NNSW=	0:	332	333	321
1749	NMAT=	2:	NSECT=	50:	NNSW=	0:	333	334	322
1750	NMAT=	2:	NSECT=	50:	NNSW=	0:	334	335	323
1751	NMAT=	2:	NSECT=	50:	NNSW=	0:	335	336	324
1752	NMAT=	2:	NSECT=	50:	NNSW=	0:	336	337	325
1753	NMAT=	2:	NSECT=	50:	NNSW=	0:	337	338	326
1754	NMAT=	1:	NSECT=	52:	NNSW=	0:	338	339	327
1755	NMAT=	2:	NSECT=	50:	NNSW=	0:	319	318	330
1756	NMAT=	2:	NSECT=	50:	NNSW=	0:	320	319	331
1757	NMAT=	2:	NSECT=	50:	NNSW=	0:	321	320	332
1758	NMAT=	2:	NSECT=	50:	NNSW=	0:	322	321	333
1759	NMAT=	2:	NSECT=	50:	NNSW=	0:	323	322	334
1760	NMAT=	2:	NSECT=	50:	NNSW=	0:	324	323	335
1761	NMAT=	2:	NSECT=	50:	NNSW=	0:	325	324	336
1762	NMAT=	2:	NSECT=	50:	NNSW=	0:	326	325	337
1763	NMAT=	2:	NSECT=	50:	NNSW=	0:	327	326	338
1764	NMAT=	1:	NSECT=	52:	NNSW=	0:	328	327	339
1765	NMAT=	2:	NSECT=	50:	NNSW=	0:	340	341	329
1766	NMAT=	2:	NSECT=	51:	NNSW=	0:	341	342	330
1767	NMAT=	2:	NSECT=	51:	NNSW=	0:	342	343	331
1768	NMAT=	2:	NSECT=	51:	NNSW=	0:	343	344	332
1769	NMAT=	2:	NSECT=	51:	NNSW=	0:	344	345	333
1770	NMAT=	2:	NSECT=	51:	NNSW=	0:	345	346	334
1771	NMAT=	2:	NSECT=	51:	NNSW=	0:	346	347	335
1772	NMAT=	2:	NSECT=	51:	NNSW=	0:	347	348	336
1773	NMAT=	2:	NSECT=	51:	NNSW=	0:	348	349	337
1774	NMAT=	1:	NSECT=	52:	NNSW=	0:	349	350	338
1775	NMAT=	2:	NSECT=	50:	NNSW=	0:	330	329	341
1776	NMAT=	2:	NSECT=	51:	NNSW=	0:	331	330	342
1777	NMAT=	2:	NSECT=	51:	NNSW=	0:	332	331	343
1778	NMAT=	2:	NSECT=	51:	NNSW=	0:	333	332	344
1779	NMAT=	2:	NSECT=	51:	NNSW=	0:	334	333	345
1780	NMAT=	2:	NSECT=	51:	NNSW=	0:	335	334	346
1781	NMAT=	2:	NSECT=	51:	NNSW=	0:	336	335	347
1782	NMAT=	2:	NSECT=	51:	NNSW=	0:	337	336	348
1783	NMAT=	2:	NSECT=	51:	NNSW=	0:	338	337	349
1784	NMAT=	1:	NSECT=	52:	NNSW=	0:	339	338	350
1785	NMAT=	2:	NSECT=	50:	NNSW=	0:	351	352	340
1786	NMAT=	2:	NSECT=	51:	NNSW=	0:	342	341	352
1787	NMAT=	2:	NSECT=	51:	NNSW=	0:	342	353	343
1788	NMAT=	2:	NSECT=	51:	NNSW=	0:	343	354	344
1789	NMAT=	2:	NSECT=	51:	NNSW=	0:	355	356	344
1790	NMAT=	2:	NSECT=	51:	NNSW=	0:	356	357	345
1791	NMAT=	2:	NSECT=	51:	NNSW=	0:	357	358	346
1792	NMAT=	2:	NSECT=	51:	NNSW=	0:	358	359	347
1793	NMAT=	2:	NSECT=	51:	NNSW=	0:	359	360	348
1794	NMAT=	1:	NSECT=	52:	NNSW=	0:	360	361	349
1795	NMAT=	2:	NSECT=	50:	NNSW=	0:	341	340	352
1796	NMAT=	2:	NSECT=	51:	NNSW=	0:	342	352	353
1797	NMAT=	2:	NSECT=	51:	NNSW=	0:	343	353	354
1798	NMAT=	2:	NSECT=	51:	NNSW=	0:	344	354	355
1799	NMAT=	2:	NSECT=	51:	NNSW=	0:	345	344	356

1800	NMAT=	2:	NSECT=	51:	NNSW=	0:	346	345	357
1801	NMAT=	2:	NSECT=	51:	NNSW=	0:	347	346	358
1802	NMAT=	2:	NSECT=	51:	NNSW=	0:	348	347	359
1803	NMAT=	2:	NSECT=	51:	NNSW=	0:	349	348	360
1804	NMAT=	1:	NSECT=	52:	NNSW=	0:	350	349	361
1805	NMAT=	2:	NSECT=	50:	NNSW=	0:	362	363	351
1806	NMAT=	2:	NSECT=	51:	NNSW=	0:	353	352	363
1807	NMAT=	2:	NSECT=	51:	NNSW=	0:	353	364	354
1808	NMAT=	2:	NSECT=	51:	NNSW=	0:	354	365	355
1809	NMAT=	2:	NSECT=	51:	NNSW=	0:	366	367	355
1810	NMAT=	2:	NSECT=	51:	NNSW=	0:	367	368	356
1811	NMAT=	2:	NSECT=	51:	NNSW=	0:	368	369	357
1812	NMAT=	2:	NSECT=	51:	NNSW=	0:	369	370	358
1813	NMAT=	2:	NSECT=	51:	NNSW=	0:	370	371	359
1814	NMAT=	1:	NSECT=	52:	NNSW=	0:	371	372	360
1815	NMAT=	2:	NSECT=	50:	NNSW=	0:	352	351	363
1816	NMAT=	2:	NSECT=	51:	NNSW=	0:	353	363	364
1817	NMAT=	2:	NSECT=	51:	NNSW=	0:	354	364	365
1818	NMAT=	2:	NSECT=	51:	NNSW=	0:	355	365	366
1819	NMAT=	2:	NSECT=	51:	NNSW=	0:	356	355	367
1820	NMAT=	2:	NSECT=	51:	NNSW=	0:	357	356	368
1821	NMAT=	2:	NSECT=	51:	NNSW=	0:	358	357	369
1822	NMAT=	2:	NSECT=	51:	NNSW=	0:	359	358	370
1823	NMAT=	2:	NSECT=	51:	NNSW=	0:	360	359	371
1824	NMAT=	1:	NSECT=	52:	NNSW=	0:	361	360	372
1825	NMAT=	2:	NSECT=	50:	NNSW=	0:	373	374	362
1826	NMAT=	2:	NSECT=	51:	NNSW=	0:	364	363	374
1827	NMAT=	2:	NSECT=	51:	NNSW=	0:	365	364	375
1828	NMAT=	2:	NSECT=	51:	NNSW=	0:	366	365	376
1829	NMAT=	2:	NSECT=	51:	NNSW=	0:	377	378	366
1830	NMAT=	2:	NSECT=	51:	NNSW=	0:	378	379	367
1831	NMAT=	2:	NSECT=	51:	NNSW=	0:	379	380	368
1832	NMAT=	2:	NSECT=	51:	NNSW=	0:	380	381	369
1833	NMAT=	2:	NSECT=	51:	NNSW=	0:	381	382	370
1834	NMAT=	1:	NSECT=	52:	NNSW=	0:	382	383	371
1835	NMAT=	2:	NSECT=	50:	NNSW=	0:	363	362	374
1836	NMAT=	2:	NSECT=	51:	NNSW=	0:	364	374	375
1837	NMAT=	2:	NSECT=	51:	NNSW=	0:	365	375	376
1838	NMAT=	2:	NSECT=	51:	NNSW=	0:	366	376	377
1839	NMAT=	2:	NSECT=	51:	NNSW=	0:	367	366	378
1840	NMAT=	2:	NSECT=	51:	NNSW=	0:	368	367	379
1841	NMAT=	2:	NSECT=	51:	NNSW=	0:	369	368	380
1842	NMAT=	2:	NSECT=	51:	NNSW=	0:	370	369	381
1843	NMAT=	2:	NSECT=	51:	NNSW=	0:	371	370	382
1844	NMAT=	1:	NSECT=	52:	NNSW=	0:	372	371	383
1845	NMAT=	2:	NSECT=	50:	NNSW=	0:	384	385	373
1846	NMAT=	2:	NSECT=	51:	NNSW=	0:	375	374	385
1847	NMAT=	2:	NSECT=	51:	NNSW=	0:	376	375	386
1848	NMAT=	2:	NSECT=	51:	NNSW=	0:	377	376	387
1849	NMAT=	2:	NSECT=	51:	NNSW=	0:	397	398	377
1850	NMAT=	2:	NSECT=	51:	NNSW=	0:	398	388	378
1851	NMAT=	2:	NSECT=	51:	NNSW=	0:	388	389	379
1852	NMAT=	2:	NSECT=	51:	NNSW=	0:	389	390	380
1853	NMAT=	2:	NSECT=	51:	NNSW=	0:	390	391	381
1854	NMAT=	1:	NSECT=	52:	NNSW=	0:	391	392	382
1855	NMAT=	2:	NSECT=	50:	NNSW=	0:	374	373	385
1856	NMAT=	2:	NSECT=	51:	NNSW=	0:	375	385	386
1857	NMAT=	2:	NSECT=	51:	NNSW=	0:	376	386	387
1858	NMAT=	2:	NSECT=	51:	NNSW=	0:	377	387	397
1859	NMAT=	2:	NSECT=	51:	NNSW=	0:	378	377	398

1860	NMAT=	2:	NSECT=	51:	NNSW=	0:	379	378	388
1861	NMAT=	2:	NSECT=	51:	NNSW=	0:	380	379	389
1862	NMAT=	2:	NSECT=	51:	NNSW=	0:	381	380	390
1863	NMAT=	2:	NSECT=	51:	NNSW=	0:	382	381	391
1864	NMAT=	1:	NSECT=	52:	NNSW=	0:	383	382	392
1865	NMAT=	2:	NSECT=	50:	NNSW=	0:	393	394	384
1866	NMAT=	2:	NSECT=	51:	NNSW=	0:	386	385	394
1867	NMAT=	2:	NSECT=	51:	NNSW=	0:	387	386	395
1868	NMAT=	2:	NSECT=	51:	NNSW=	0:	396	397	387
1869	NMAT=	2:	NSECT=	51:	NNSW=	0:	399	400	388
1870	NMAT=	2:	NSECT=	51:	NNSW=	0:	400	401	389
1871	NMAT=	2:	NSECT=	51:	NNSW=	0:	401	402	390
1872	NMAT=	1:	NSECT=	52:	NNSW=	0:	402	403	391
1873	NMAT=	2:	NSECT=	50:	NNSW=	0:	385	384	394
1874	NMAT=	2:	NSECT=	51:	NNSW=	0:	386	394	395
1875	NMAT=	2:	NSECT=	51:	NNSW=	0:	387	395	396
1876	NMAT=	2:	NSECT=	51:	NNSW=	0:	388	398	399
1877	NMAT=	2:	NSECT=	51:	NNSW=	0:	389	388	400
1878	NMAT=	2:	NSECT=	51:	NNSW=	0:	390	389	401
1879	NMAT=	2:	NSECT=	51:	NNSW=	0:	391	390	402
1880	NMAT=	1:	NSECT=	52:	NNSW=	0:	392	391	403
1881	NMAT=	2:	NSECT=	50:	NNSW=	0:	393	394	404
1882	NMAT=	2:	NSECT=	51:	NNSW=	0:	394	395	405
1883	NMAT=	2:	NSECT=	51:	NNSW=	0:	401	402	407
1884	NMAT=	1:	NSECT=	52:	NNSW=	0:	402	403	408
1885	NMAT=	2:	NSECT=	50:	NNSW=	0:	405	404	394
1886	NMAT=	2:	NSECT=	51:	NNSW=	0:	406	405	395
1887	NMAT=	2:	NSECT=	51:	NNSW=	0:	408	407	402
1888	NMAT=	1:	NSECT=	52:	NNSW=	0:	409	408	403
1889	NMAT=	2:	NSECT=	50:	NNSW=	0:	244	243	404
1890	NMAT=	2:	NSECT=	51:	NNSW=	0:	245	244	405
1891	NMAT=	2:	NSECT=	51:	NNSW=	0:	252	251	407
1892	NMAT=	1:	NSECT=	52:	NNSW=	0:	253	252	408
1893	NMAT=	2:	NSECT=	50:	NNSW=	0:	404	405	244
1894	NMAT=	2:	NSECT=	51:	NNSW=	0:	405	406	245
1895	NMAT=	2:	NSECT=	51:	NNSW=	0:	407	408	252
1896	NMAT=	1:	NSECT=	52:	NNSW=	0:	408	409	253
1897	NMAT=	2:	NSECT=	51:	NNSW=	0:	395	396	411
1898	NMAT=	2:	NSECT=	51:	NNSW=	0:	411	406	395
1899	NMAT=	2:	NSECT=	51:	NNSW=	0:	406	411	410
1900	NMAT=	2:	NSECT=	51:	NNSW=	0:	396	397	411
1901	NMAT=	2:	NSECT=	51:	NNSW=	0:	412	411	397
1902	NMAT=	2:	NSECT=	51:	NNSW=	0:	397	398	412
1903	NMAT=	2:	NSECT=	51:	NNSW=	0:	413	412	398
1904	NMAT=	2:	NSECT=	51:	NNSW=	0:	398	399	413
1905	NMAT=	2:	NSECT=	51:	NNSW=	0:	414	413	399
1906	NMAT=	2:	NSECT=	51:	NNSW=	0:	399	400	414
1907	NMAT=	2:	NSECT=	51:	NNSW=	0:	415	414	400
1908	NMAT=	2:	NSECT=	51:	NNSW=	0:	400	401	415
1909	NMAT=	2:	NSECT=	51:	NNSW=	0:	416	415	401
1910	NMAT=	2:	NSECT=	51:	NNSW=	0:	407	416	401
1911	NMAT=	2:	NSECT=	51:	NNSW=	0:	410	417	406
1912	NMAT=	2:	NSECT=	51:	NNSW=	0:	406	417	245
1913	NMAT=	2:	NSECT=	51:	NNSW=	0:	245	417	246
1914	NMAT=	2:	NSECT=	51:	NNSW=	0:	247	246	417
1915	NMAT=	2:	NSECT=	51:	NNSW=	0:	417	418	247
1916	NMAT=	2:	NSECT=	51:	NNSW=	0:	248	247	418
1917	NMAT=	2:	NSECT=	51:	NNSW=	0:	418	419	248
1918	NMAT=	2:	NSECT=	51:	NNSW=	0:	249	248	419
1919	NMAT=	2:	NSECT=	51:	NNSW=	0:	419	420	249

1920	NMAT=	2: NSECT=	51: NNSW=	0:	250	249	420
1921	NMAT=	2: NSECT=	51: NNSW=	0:	420	421	250
1922	NMAT=	2: NSECT=	51: NNSW=	0:	251	250	421
1923	NMAT=	2: NSECT=	51: NNSW=	0:	421	416	251
1924	NMAT=	2: NSECT=	51: NNSW=	0:	416	407	251
1925	NMAT=	2: NSECT=	53: NNSW=	0:	422	429	423
1926	NMAT=	2: NSECT=	53: NNSW=	0:	423	430	424
1927	NMAT=	2: NSECT=	53: NNSW=	0:	424	431	425
1928	NMAT=	2: NSECT=	53: NNSW=	0:	425	432	426
1929	NMAT=	2: NSECT=	53: NNSW=	0:	426	433	427
1930	NMAT=	2: NSECT=	53: NNSW=	0:	427	434	428
1931	NMAT=	2: NSECT=	53: NNSW=	0:	430	423	429
1932	NMAT=	2: NSECT=	53: NNSW=	0:	431	424	430
1933	NMAT=	2: NSECT=	53: NNSW=	0:	432	425	431
1934	NMAT=	2: NSECT=	53: NNSW=	0:	433	426	432
1935	NMAT=	2: NSECT=	53: NNSW=	0:	434	427	433
1936	NMAT=	2: NSECT=	53: NNSW=	0:	435	428	434
1937	NMAT=	2: NSECT=	53: NNSW=	0:	423	412	422
1938	NMAT=	2: NSECT=	53: NNSW=	0:	424	411	423
1939	NMAT=	2: NSECT=	53: NNSW=	0:	425	410	424
1940	NMAT=	2: NSECT=	53: NNSW=	0:	426	417	425
1941	NMAT=	2: NSECT=	53: NNSW=	0:	427	418	426
1942	NMAT=	2: NSECT=	53: NNSW=	0:	428	419	427
1943	NMAT=	2: NSECT=	53: NNSW=	0:	413	422	412
1944	NMAT=	2: NSECT=	53: NNSW=	0:	412	423	411
1945	NMAT=	2: NSECT=	53: NNSW=	0:	411	424	410
1946	NMAT=	2: NSECT=	53: NNSW=	0:	410	425	417
1947	NMAT=	2: NSECT=	53: NNSW=	0:	417	426	418
1948	NMAT=	2: NSECT=	53: NNSW=	0:	418	427	419
1949	NMAT=	2: NSECT=	54: NNSW=	0:	436	437	447
1950	NMAT=	2: NSECT=	51: NNSW=	0:	449	438	437
1951	NMAT=	2: NSECT=	51: NNSW=	0:	450	439	438
1952	NMAT=	2: NSECT=	51: NNSW=	0:	439	440	450
1953	NMAT=	2: NSECT=	51: NNSW=	0:	442	443	451
1954	NMAT=	2: NSECT=	51: NNSW=	0:	443	444	452
1955	NMAT=	2: NSECT=	51: NNSW=	0:	444	445	453
1956	NMAT=	1: NSECT=	52: NNSW=	0:	445	446	454
1957	NMAT=	2: NSECT=	54: NNSW=	0:	448	447	437
1958	NMAT=	2: NSECT=	51: NNSW=	0:	448	449	437
1959	NMAT=	2: NSECT=	51: NNSW=	0:	449	450	438
1960	NMAT=	2: NSECT=	51: NNSW=	0:	451	441	442
1961	NMAT=	2: NSECT=	51: NNSW=	0:	452	451	443
1962	NMAT=	2: NSECT=	51: NNSW=	0:	453	452	444
1963	NMAT=	2: NSECT=	51: NNSW=	0:	454	453	445
1964	NMAT=	1: NSECT=	52: NNSW=	0:	455	454	446
1965	NMAT=	2: NSECT=	54: NNSW=	0:	447	448	456
1966	NMAT=	2: NSECT=	51: NNSW=	0:	448	458	449
1967	NMAT=	2: NSECT=	51: NNSW=	0:	449	459	450
1968	NMAT=	2: NSECT=	51: NNSW=	0:	450	460	440
1969	NMAT=	2: NSECT=	51: NNSW=	0:	440	441	460
1970	NMAT=	2: NSECT=	51: NNSW=	0:	441	451	461
1971	NMAT=	2: NSECT=	51: NNSW=	0:	451	452	462
1972	NMAT=	2: NSECT=	51: NNSW=	0:	452	453	463
1973	NMAT=	2: NSECT=	51: NNSW=	0:	453	454	464
1974	NMAT=	1: NSECT=	52: NNSW=	0:	454	455	465
1975	NMAT=	2: NSECT=	54: NNSW=	0:	457	456	448
1976	NMAT=	2: NSECT=	51: NNSW=	0:	457	458	448
1977	NMAT=	2: NSECT=	51: NNSW=	0:	458	459	449
1978	NMAT=	2: NSECT=	51: NNSW=	0:	459	460	450
1979	NMAT=	2: NSECT=	51: NNSW=	0:	461	460	441

1980	NMAT=	2: NSECT=	51: NNSW=	0:	462	461	451
1981	NMAT=	2: NSECT=	51: NNSW=	0:	463	462	452
1982	NMAT=	2: NSECT=	51: NNSW=	0:	464	463	453
1983	NMAT=	2: NSECT=	51: NNSW=	0:	465	464	454
1984	NMAT=	1: NSECT=	52: NNSW=	0:	466	465	455
1985	NMAT=	2: NSECT=	54: NNSW=	0:	456	457	467
1986	NMAT=	2: NSECT=	51: NNSW=	0:	457	469	458
1987	NMAT=	2: NSECT=	51: NNSW=	0:	458	470	459
1988	NMAT=	2: NSECT=	51: NNSW=	0:	459	471	460
1989	NMAT=	2: NSECT=	51: NNSW=	0:	460	461	471
1990	NMAT=	2: NSECT=	51: NNSW=	0:	461	462	472
1991	NMAT=	2: NSECT=	51: NNSW=	0:	462	463	473
1992	NMAT=	2: NSECT=	51: NNSW=	0:	463	464	474
1993	NMAT=	2: NSECT=	51: NNSW=	0:	464	465	475
1994	NMAT=	1: NSECT=	52: NNSW=	0:	465	466	476
1995	NMAT=	2: NSECT=	54: NNSW=	0:	468	467	457
1996	NMAT=	2: NSECT=	51: NNSW=	0:	468	469	457
1997	NMAT=	2: NSECT=	51: NNSW=	0:	469	470	458
1998	NMAT=	2: NSECT=	51: NNSW=	0:	470	471	459
1999	NMAT=	2: NSECT=	51: NNSW=	0:	472	471	461
2000	NMAT=	2: NSECT=	51: NNSW=	0:	473	472	462
2001	NMAT=	2: NSECT=	51: NNSW=	0:	474	473	463
2002	NMAT=	2: NSECT=	51: NNSW=	0:	475	474	464
2003	NMAT=	2: NSECT=	51: NNSW=	0:	476	475	465
2004	NMAT=	1: NSECT=	52: NNSW=	0:	477	476	466
2005	NMAT=	2: NSECT=	54: NNSW=	0:	467	468	478
2006	NMAT=	2: NSECT=	51: NNSW=	0:	480	469	468
2007	NMAT=	2: NSECT=	51: NNSW=	0:	481	470	469
2008	NMAT=	2: NSECT=	51: NNSW=	0:	482	471	470
2009	NMAT=	2: NSECT=	51: NNSW=	0:	471	472	482
2010	NMAT=	2: NSECT=	51: NNSW=	0:	472	473	483
2011	NMAT=	2: NSECT=	51: NNSW=	0:	473	474	484
2012	NMAT=	2: NSECT=	51: NNSW=	0:	474	475	485
2013	NMAT=	2: NSECT=	51: NNSW=	0:	475	476	486
2014	NMAT=	1: NSECT=	52: NNSW=	0:	476	477	487
2015	NMAT=	2: NSECT=	54: NNSW=	0:	479	478	468
2016	NMAT=	2: NSECT=	51: NNSW=	0:	479	480	468
2017	NMAT=	2: NSECT=	51: NNSW=	0:	480	481	469
2018	NMAT=	2: NSECT=	51: NNSW=	0:	481	482	470
2019	NMAT=	2: NSECT=	51: NNSW=	0:	483	482	472
2020	NMAT=	2: NSECT=	51: NNSW=	0:	484	483	473
2021	NMAT=	2: NSECT=	51: NNSW=	0:	485	484	474
2022	NMAT=	2: NSECT=	51: NNSW=	0:	486	485	475
2023	NMAT=	2: NSECT=	51: NNSW=	0:	487	486	476
2024	NMAT=	1: NSECT=	52: NNSW=	0:	488	487	477
2025	NMAT=	2: NSECT=	54: NNSW=	0:	478	479	489
2026	NMAT=	2: NSECT=	51: NNSW=	0:	491	480	479
2027	NMAT=	2: NSECT=	51: NNSW=	0:	492	481	480
2028	NMAT=	2: NSECT=	51: NNSW=	0:	493	482	481
2029	NMAT=	2: NSECT=	51: NNSW=	0:	482	483	493
2030	NMAT=	2: NSECT=	51: NNSW=	0:	483	484	494
2031	NMAT=	2: NSECT=	51: NNSW=	0:	484	485	495
2032	NMAT=	2: NSECT=	51: NNSW=	0:	485	486	496
2033	NMAT=	2: NSECT=	51: NNSW=	0:	486	487	497
2034	NMAT=	1: NSECT=	52: NNSW=	0:	487	488	498
2035	NMAT=	2: NSECT=	54: NNSW=	0:	490	489	479
2036	NMAT=	2: NSECT=	51: NNSW=	0:	490	491	479
2037	NMAT=	2: NSECT=	51: NNSW=	0:	491	492	480
2038	NMAT=	2: NSECT=	51: NNSW=	0:	492	493	481
2039	NMAT=	2: NSECT=	51: NNSW=	0:	494	493	483

2040	NMAT=	2:	NSECT=	51:	NNSW=	0:	495	494	484
2041	NMAT=	2:	NSECT=	51:	NNSW=	0:	496	495	485
2042	NMAT=	2:	NSECT=	51:	NNSW=	0:	497	496	486
2043	NMAT=	2:	NSECT=	51:	NNSW=	0:	498	497	487
2044	NMAT=	1:	NSECT=	52:	NNSW=	0:	499	498	488
2045	NMAT=	2:	NSECT=	54:	NNSW=	0:	489	490	500
2046	NMAT=	2:	NSECT=	51:	NNSW=	0:	490	491	501
2047	NMAT=	2:	NSECT=	51:	NNSW=	0:	491	492	502
2048	NMAT=	2:	NSECT=	51:	NNSW=	0:	492	493	503
2049	NMAT=	2:	NSECT=	51:	NNSW=	0:	493	494	504
2050	NMAT=	2:	NSECT=	51:	NNSW=	0:	494	495	505
2051	NMAT=	2:	NSECT=	51:	NNSW=	0:	495	496	506
2052	NMAT=	2:	NSECT=	51:	NNSW=	0:	496	497	507
2053	NMAT=	2:	NSECT=	51:	NNSW=	0:	497	498	508
2054	NMAT=	1:	NSECT=	52:	NNSW=	0:	498	499	509
2055	NMAT=	2:	NSECT=	54:	NNSW=	0:	501	500	490
2056	NMAT=	2:	NSECT=	51:	NNSW=	0:	502	501	491
2057	NMAT=	2:	NSECT=	51:	NNSW=	0:	503	502	492
2058	NMAT=	2:	NSECT=	51:	NNSW=	0:	504	503	493
2059	NMAT=	2:	NSECT=	51:	NNSW=	0:	505	504	494
2060	NMAT=	2:	NSECT=	51:	NNSW=	0:	506	505	495
2061	NMAT=	2:	NSECT=	51:	NNSW=	0:	507	506	496
2062	NMAT=	2:	NSECT=	51:	NNSW=	0:	508	507	497
2063	NMAT=	2:	NSECT=	51:	NNSW=	0:	509	508	498
2064	NMAT=	1:	NSECT=	52:	NNSW=	0:	510	509	499
2065	NMAT=	2:	NSECT=	54:	NNSW=	0:	500	501	511
2066	NMAT=	2:	NSECT=	50:	NNSW=	0:	501	502	512
2067	NMAT=	2:	NSECT=	50:	NNSW=	0:	502	503	513
2068	NMAT=	2:	NSECT=	50:	NNSW=	0:	503	504	514
2069	NMAT=	2:	NSECT=	50:	NNSW=	0:	504	505	515
2070	NMAT=	2:	NSECT=	50:	NNSW=	0:	505	506	516
2071	NMAT=	2:	NSECT=	50:	NNSW=	0:	506	507	517
2072	NMAT=	2:	NSECT=	50:	NNSW=	0:	507	508	518
2073	NMAT=	2:	NSECT=	50:	NNSW=	0:	508	509	519
2074	NMAT=	1:	NSECT=	52:	NNSW=	0:	509	510	520
2075	NMAT=	2:	NSECT=	54:	NNSW=	0:	512	511	501
2076	NMAT=	2:	NSECT=	50:	NNSW=	0:	513	512	502
2077	NMAT=	2:	NSECT=	50:	NNSW=	0:	514	513	503
2078	NMAT=	2:	NSECT=	50:	NNSW=	0:	515	514	504
2079	NMAT=	2:	NSECT=	50:	NNSW=	0:	516	515	505
2080	NMAT=	2:	NSECT=	50:	NNSW=	0:	517	516	506
2081	NMAT=	2:	NSECT=	50:	NNSW=	0:	518	517	507
2082	NMAT=	2:	NSECT=	50:	NNSW=	0:	519	518	508
2083	NMAT=	2:	NSECT=	50:	NNSW=	0:	520	519	509
2084	NMAT=	1:	NSECT=	52:	NNSW=	0:	521	520	510
2085	NMAT=	2:	NSECT=	54:	NNSW=	0:	522	523	511
2086	NMAT=	2:	NSECT=	50:	NNSW=	0:	523	524	512
2087	NMAT=	2:	NSECT=	50:	NNSW=	0:	524	525	513
2088	NMAT=	2:	NSECT=	50:	NNSW=	0:	525	526	514
2089	NMAT=	2:	NSECT=	50:	NNSW=	0:	526	527	515
2090	NMAT=	2:	NSECT=	50:	NNSW=	0:	527	528	516
2091	NMAT=	2:	NSECT=	50:	NNSW=	0:	528	529	517
2092	NMAT=	2:	NSECT=	50:	NNSW=	0:	529	530	518
2093	NMAT=	2:	NSECT=	50:	NNSW=	0:	530	531	519
2094	NMAT=	1:	NSECT=	52:	NNSW=	0:	531	532	520
2095	NMAT=	2:	NSECT=	54:	NNSW=	0:	512	511	523
2096	NMAT=	2:	NSECT=	50:	NNSW=	0:	513	512	524
2097	NMAT=	2:	NSECT=	50:	NNSW=	0:	514	513	525
2098	NMAT=	2:	NSECT=	50:	NNSW=	0:	515	514	526
2099	NMAT=	2:	NSECT=	50:	NNSW=	0:	516	515	527

2100	NMAT=	2:	NSECT=	50:	NNSW=	0:	517	516	528
2101	NMAT=	2:	NSECT=	50:	NNSW=	0:	518	517	529
2102	NMAT=	2:	NSECT=	50:	NNSW=	0:	519	518	530
2103	NMAT=	2:	NSECT=	50:	NNSW=	0:	520	519	531
2104	NMAT=	1:	NSECT=	52:	NNSW=	0:	521	520	532
2105	NMAT=	2:	NSECT=	54:	NNSW=	0:	533	534	522
2106	NMAT=	2:	NSECT=	51:	NNSW=	0:	534	535	523
2107	NMAT=	2:	NSECT=	51:	NNSW=	0:	535	536	524
2108	NMAT=	2:	NSECT=	51:	NNSW=	0:	536	537	525
2109	NMAT=	2:	NSECT=	51:	NNSW=	0:	537	538	526
2110	NMAT=	2:	NSECT=	51:	NNSW=	0:	538	539	527
2111	NMAT=	2:	NSECT=	51:	NNSW=	0:	539	540	528
2112	NMAT=	2:	NSECT=	51:	NNSW=	0:	540	541	529
2113	NMAT=	2:	NSECT=	51:	NNSW=	0:	541	542	530
2114	NMAT=	1:	NSECT=	52:	NNSW=	0:	542	543	531
2115	NMAT=	2:	NSECT=	54:	NNSW=	0:	523	522	534
2116	NMAT=	2:	NSECT=	51:	NNSW=	0:	524	523	535
2117	NMAT=	2:	NSECT=	51:	NNSW=	0:	525	524	536
2118	NMAT=	2:	NSECT=	51:	NNSW=	0:	526	525	537
2119	NMAT=	2:	NSECT=	51:	NNSW=	0:	527	526	538
2120	NMAT=	2:	NSECT=	51:	NNSW=	0:	528	527	539
2121	NMAT=	2:	NSECT=	51:	NNSW=	0:	529	528	540
2122	NMAT=	2:	NSECT=	51:	NNSW=	0:	530	529	541
2123	NMAT=	2:	NSECT=	51:	NNSW=	0:	531	530	542
2124	NMAT=	1:	NSECT=	52:	NNSW=	0:	532	531	543
2125	NMAT=	2:	NSECT=	54:	NNSW=	0:	544	545	533
2126	NMAT=	2:	NSECT=	51:	NNSW=	0:	535	534	545
2127	NMAT=	2:	NSECT=	51:	NNSW=	0:	535	546	536
2128	NMAT=	2:	NSECT=	51:	NNSW=	0:	536	547	537
2129	NMAT=	2:	NSECT=	51:	NNSW=	0:	548	549	537
2130	NMAT=	2:	NSECT=	51:	NNSW=	0:	549	550	538
2131	NMAT=	2:	NSECT=	51:	NNSW=	0:	550	551	539
2132	NMAT=	2:	NSECT=	51:	NNSW=	0:	551	552	540
2133	NMAT=	2:	NSECT=	51:	NNSW=	0:	552	553	541
2134	NMAT=	1:	NSECT=	52:	NNSW=	0:	553	554	542
2135	NMAT=	2:	NSECT=	54:	NNSW=	0:	534	533	545
2136	NMAT=	2:	NSECT=	51:	NNSW=	0:	535	545	546
2137	NMAT=	2:	NSECT=	51:	NNSW=	0:	536	546	547
2138	NMAT=	2:	NSECT=	51:	NNSW=	0:	537	547	548
2139	NMAT=	2:	NSECT=	51:	NNSW=	0:	538	537	549
2140	NMAT=	2:	NSECT=	51:	NNSW=	0:	539	538	550
2141	NMAT=	2:	NSECT=	51:	NNSW=	0:	540	539	551
2142	NMAT=	2:	NSECT=	51:	NNSW=	0:	541	540	552
2143	NMAT=	2:	NSECT=	51:	NNSW=	0:	542	541	553
2144	NMAT=	1:	NSECT=	52:	NNSW=	0:	543	542	554
2145	NMAT=	2:	NSECT=	54:	NNSW=	0:	555	556	544
2146	NMAT=	2:	NSECT=	51:	NNSW=	0:	546	545	556
2147	NMAT=	2:	NSECT=	51:	NNSW=	0:	546	557	547
2148	NMAT=	2:	NSECT=	51:	NNSW=	0:	547	558	548
2149	NMAT=	2:	NSECT=	51:	NNSW=	0:	559	560	548
2150	NMAT=	2:	NSECT=	51:	NNSW=	0:	560	561	549
2151	NMAT=	2:	NSECT=	51:	NNSW=	0:	561	562	550
2152	NMAT=	2:	NSECT=	51:	NNSW=	0:	562	563	551
2153	NMAT=	2:	NSECT=	51:	NNSW=	0:	563	564	552
2154	NMAT=	1:	NSECT=	52:	NNSW=	0:	564	565	553
2155	NMAT=	2:	NSECT=	54:	NNSW=	0:	545	544	556
2156	NMAT=	2:	NSECT=	51:	NNSW=	0:	546	556	557
2157	NMAT=	2:	NSECT=	51:	NNSW=	0:	547	557	558
2158	NMAT=	2:	NSECT=	51:	NNSW=	0:	548	558	559
2159	NMAT=	2:	NSECT=	51:	NNSW=	0:	549	548	560

2160	NMAT=	2:	NSECT=	51:	NNSW=	0:	550	549	561
2161	NMAT=	2:	NSECT=	51:	NNSW=	0:	551	550	562
2162	NMAT=	2:	NSECT=	51:	NNSW=	0:	552	551	563
2163	NMAT=	2:	NSECT=	51:	NNSW=	0:	553	552	564
2164	NMAT=	1:	NSECT=	52:	NNSW=	0:	554	553	565
2165	NMAT=	2:	NSECT=	54:	NNSW=	0:	566	567	555
2166	NMAT=	2:	NSECT=	51:	NNSW=	0:	557	556	567
2167	NMAT=	2:	NSECT=	51:	NNSW=	0:	558	557	568
2168	NMAT=	2:	NSECT=	51:	NNSW=	0:	559	558	569
2169	NMAT=	2:	NSECT=	51:	NNSW=	0:	570	571	559
2170	NMAT=	2:	NSECT=	51:	NNSW=	0:	571	572	560
2171	NMAT=	2:	NSECT=	51:	NNSW=	0:	572	573	561
2172	NMAT=	2:	NSECT=	51:	NNSW=	0:	573	574	562
2173	NMAT=	2:	NSECT=	51:	NNSW=	0:	574	575	563
2174	NMAT=	1:	NSECT=	52:	NNSW=	0:	575	576	564
2175	NMAT=	2:	NSECT=	54:	NNSW=	0:	556	555	567
2176	NMAT=	2:	NSECT=	51:	NNSW=	0:	557	567	568
2177	NMAT=	2:	NSECT=	51:	NNSW=	0:	558	568	569
2178	NMAT=	2:	NSECT=	51:	NNSW=	0:	559	569	570
2179	NMAT=	2:	NSECT=	51:	NNSW=	0:	560	559	571
2180	NMAT=	2:	NSECT=	51:	NNSW=	0:	561	560	572
2181	NMAT=	2:	NSECT=	51:	NNSW=	0:	562	561	573
2182	NMAT=	2:	NSECT=	51:	NNSW=	0:	563	562	574
2183	NMAT=	2:	NSECT=	51:	NNSW=	0:	564	563	575
2184	NMAT=	1:	NSECT=	52:	NNSW=	0:	565	564	576
2185	NMAT=	2:	NSECT=	54:	NNSW=	0:	577	578	566
2186	NMAT=	2:	NSECT=	51:	NNSW=	0:	568	567	578
2187	NMAT=	2:	NSECT=	51:	NNSW=	0:	569	568	579
2188	NMAT=	2:	NSECT=	51:	NNSW=	0:	570	569	580
2189	NMAT=	2:	NSECT=	51:	NNSW=	0:	590	591	570
2190	NMAT=	2:	NSECT=	51:	NNSW=	0:	591	581	571
2191	NMAT=	2:	NSECT=	51:	NNSW=	0:	581	582	572
2192	NMAT=	2:	NSECT=	51:	NNSW=	0:	582	583	573
2193	NMAT=	2:	NSECT=	51:	NNSW=	0:	583	584	574
2194	NMAT=	1:	NSECT=	52:	NNSW=	0:	584	585	575
2195	NMAT=	2:	NSECT=	54:	NNSW=	0:	567	566	578
2196	NMAT=	2:	NSECT=	51:	NNSW=	0:	568	578	579
2197	NMAT=	2:	NSECT=	51:	NNSW=	0:	569	579	580
2198	NMAT=	2:	NSECT=	51:	NNSW=	0:	570	580	590
2199	NMAT=	2:	NSECT=	51:	NNSW=	0:	571	570	591
2200	NMAT=	2:	NSECT=	51:	NNSW=	0:	572	571	581
2201	NMAT=	2:	NSECT=	51:	NNSW=	0:	573	572	582
2202	NMAT=	2:	NSECT=	51:	NNSW=	0:	574	573	583
2203	NMAT=	2:	NSECT=	51:	NNSW=	0:	575	574	584
2204	NMAT=	1:	NSECT=	52:	NNSW=	0:	576	575	585
2205	NMAT=	2:	NSECT=	54:	NNSW=	0:	586	587	577
2206	NMAT=	2:	NSECT=	51:	NNSW=	0:	579	578	587
2207	NMAT=	2:	NSECT=	51:	NNSW=	0:	580	579	588
2208	NMAT=	2:	NSECT=	51:	NNSW=	0:	589	590	580
2209	NMAT=	2:	NSECT=	51:	NNSW=	0:	592	593	581
2210	NMAT=	2:	NSECT=	51:	NNSW=	0:	593	594	582
2211	NMAT=	2:	NSECT=	51:	NNSW=	0:	594	595	583
2212	NMAT=	1:	NSECT=	52:	NNSW=	0:	595	596	584
2213	NMAT=	2:	NSECT=	54:	NNSW=	0:	578	577	587
2214	NMAT=	2:	NSECT=	51:	NNSW=	0:	579	587	588
2215	NMAT=	2:	NSECT=	51:	NNSW=	0:	580	588	589
2216	NMAT=	2:	NSECT=	51:	NNSW=	0:	581	591	592
2217	NMAT=	2:	NSECT=	51:	NNSW=	0:	582	581	593
2218	NMAT=	2:	NSECT=	51:	NNSW=	0:	583	582	594
2219	NMAT=	2:	NSECT=	51:	NNSW=	0:	584	583	595

2220	NMAT=	1: NSECT=	52: NNSW=	0:	585	584	596
2221	NMAT=	2: NSECT=	54: NNSW=	0:	586	587	597
2222	NMAT=	2: NSECT=	51: NNSW=	0:	587	588	598
2223	NMAT=	2: NSECT=	51: NNSW=	0:	594	595	600
2224	NMAT=	1: NSECT=	52: NNSW=	0:	595	596	601
2225	NMAT=	2: NSECT=	54: NNSW=	0:	598	597	587
2226	NMAT=	2: NSECT=	51: NNSW=	0:	599	598	588
2227	NMAT=	2: NSECT=	51: NNSW=	0:	601	600	595
2228	NMAT=	1: NSECT=	52: NNSW=	0:	602	601	596
2229	NMAT=	2: NSECT=	54: NNSW=	0:	437	436	597
2230	NMAT=	2: NSECT=	51: NNSW=	0:	438	437	598
2231	NMAT=	2: NSECT=	51: NNSW=	0:	445	444	600
2232	NMAT=	1: NSECT=	52: NNSW=	0:	446	445	601
2233	NMAT=	2: NSECT=	54: NNSW=	0:	597	598	437
2234	NMAT=	2: NSECT=	51: NNSW=	0:	598	599	438
2235	NMAT=	2: NSECT=	51: NNSW=	0:	600	601	445
2236	NMAT=	1: NSECT=	52: NNSW=	0:	601	602	446
2237	NMAT=	2: NSECT=	51: NNSW=	0:	588	589	604
2238	NMAT=	2: NSECT=	51: NNSW=	0:	604	599	588
2239	NMAT=	2: NSECT=	51: NNSW=	0:	599	604	603
2240	NMAT=	2: NSECT=	51: NNSW=	0:	589	590	604
2241	NMAT=	2: NSECT=	51: NNSW=	0:	605	604	590
2242	NMAT=	2: NSECT=	51: NNSW=	0:	590	591	605
2243	NMAT=	2: NSECT=	51: NNSW=	0:	419	605	591
2244	NMAT=	2: NSECT=	51: NNSW=	0:	591	592	419
2245	NMAT=	2: NSECT=	51: NNSW=	0:	420	419	592
2246	NMAT=	2: NSECT=	51: NNSW=	0:	592	593	420
2247	NMAT=	2: NSECT=	51: NNSW=	0:	421	420	593
2248	NMAT=	2: NSECT=	51: NNSW=	0:	593	594	421
2249	NMAT=	2: NSECT=	51: NNSW=	0:	416	421	594
2250	NMAT=	2: NSECT=	51: NNSW=	0:	600	416	594
2251	NMAT=	2: NSECT=	51: NNSW=	0:	603	606	599
2252	NMAT=	2: NSECT=	51: NNSW=	0:	599	606	438
2253	NMAT=	2: NSECT=	51: NNSW=	0:	438	606	439
2254	NMAT=	2: NSECT=	51: NNSW=	0:	440	439	606
2255	NMAT=	2: NSECT=	51: NNSW=	0:	606	607	440
2256	NMAT=	2: NSECT=	51: NNSW=	0:	441	440	607
2257	NMAT=	2: NSECT=	51: NNSW=	0:	607	413	441
2258	NMAT=	2: NSECT=	51: NNSW=	0:	442	441	413
2259	NMAT=	2: NSECT=	51: NNSW=	0:	413	414	442
2260	NMAT=	2: NSECT=	51: NNSW=	0:	443	442	414
2261	NMAT=	2: NSECT=	51: NNSW=	0:	414	415	443
2262	NMAT=	2: NSECT=	51: NNSW=	0:	444	443	415
2263	NMAT=	2: NSECT=	51: NNSW=	0:	415	416	444
2264	NMAT=	2: NSECT=	51: NNSW=	0:	416	600	444
2265	NMAT=	2: NSECT=	53: NNSW=	0:	428	435	608
2266	NMAT=	2: NSECT=	53: NNSW=	0:	608	613	609
2267	NMAT=	2: NSECT=	53: NNSW=	0:	609	614	610
2268	NMAT=	2: NSECT=	53: NNSW=	0:	610	615	611
2269	NMAT=	2: NSECT=	53: NNSW=	0:	611	616	612
2270	NMAT=	2: NSECT=	53: NNSW=	0:	612	617	422
2271	NMAT=	2: NSECT=	53: NNSW=	0:	613	608	435
2272	NMAT=	2: NSECT=	53: NNSW=	0:	614	609	613
2273	NMAT=	2: NSECT=	53: NNSW=	0:	615	610	614
2274	NMAT=	2: NSECT=	53: NNSW=	0:	616	611	615
2275	NMAT=	2: NSECT=	53: NNSW=	0:	617	612	616
2276	NMAT=	2: NSECT=	53: NNSW=	0:	429	422	617
2277	NMAT=	2: NSECT=	53: NNSW=	0:	608	605	428
2278	NMAT=	2: NSECT=	53: NNSW=	0:	609	604	608
2279	NMAT=	2: NSECT=	53: NNSW=	0:	610	603	609

2280	NMAT=	2: NSECT=	53: NNSW=	0:	611	606	610
2281	NMAT=	2: NSECT=	53: NNSW=	0:	612	607	611
2282	NMAT=	2: NSECT=	53: NNSW=	0:	422	413	612
2283	NMAT=	2: NSECT=	53: NNSW=	0:	419	428	605
2284	NMAT=	2: NSECT=	53: NNSW=	0:	605	608	604
2285	NMAT=	2: NSECT=	53: NNSW=	0:	604	609	603
2286	NMAT=	2: NSECT=	53: NNSW=	0:	603	610	606
2287	NMAT=	2: NSECT=	53: NNSW=	0:	606	611	607
2288	NMAT=	2: NSECT=	53: NNSW=	0:	607	612	413
2289	@XQT E						
2290	RESET G=386.						
2291	T=. 1-19 -. 1-2 . 1-4 1. 200. . 1-3 . 1-3 . 1-3						
2292	@XQT TAN						
2293	@XQT EKS						
2294	@XQT K						
2295	RESET SPDP=2, CORE=30000						
2296	@XQT E4						
2297	RESET NMODES=20, NREQ=15						
2298	@XQT DCU						
2299	TOC 1						
2300	@FIN						

@XQT TAB
 TAB 211 DATA SPACE= 20000, DATE/TIME= 851008 180022

665 JOINTS.

ACTIVE JOINT MOTION COMPONENTS= 1 2 3 4 5 6

ALTERNATE REFERENCE FRAME DEFINITIONS

REFERENCE FRAME 2
INPUT OPTION 1

ROTATE -.9000000+02 DEGREES ABOUT AXIS 1
 ROTATE .10920290+03 DEGREES ABOUT AXIS 2
 ROTATE .1800000+03 DEGREES ABOUT AXIS 3
 Q= .32891447+00 .94435971+00 .30413239-07
 -.18952202-07 -.25604210-07 .10000000+01
 .94435971+00 -.32891447+00 .94761012-08
 X1= -.18110450+01
 X2= -.47676100+01
 X3= .10070000+02

REFERENCE FRAME 3
INPUT OPTION 1

ROTATE .1800000+03 DEGREES ABOUT AXIS 1
 ROTATE .1800000+03 DEGREES ABOUT AXIS 2
 ROTATE .22019990+03 DEGREES ABOUT AXIS 3
 Q= .76379712+00 .64545640+00 .81201832-07
 -.64545640+00 .76379712+00 .68188468-08
 -.57620458-07 -.57620458-07 .10000000+01
 X1= .00000000
 X2= .00000000
 X3= .00000000

REFERENCE FRAME 4
INPUT OPTION 1

ROTATE .1800000+03 DEGREES ABOUT AXIS 1
 ROTATE .1800000+03 DEGREES ABOUT AXIS 2
 ROTATE .22019990+03 DEGREES ABOUT AXIS 3
 Q= .76379712+00 .64545640+00 .81201832-07
 -.64545640+00 .76379712+00 .68188468-08
 -.57620458-07 -.57620458-07 .10000000+01
 X1= .00000000
 X2= .00000000
 X3= .10075000+02

REFERENCE FRAME 5
INPUT OPTION 1

ROTATE .00000000 DEGREES ABOUT AXIS 1
 ROTATE .1800000+03 DEGREES ABOUT AXIS 2
 ROTATE .1800000+03 DEGREES ABOUT AXIS 3
 Q= .10000000+01 -.57620458-07 -.57620458-07

```

      -.57620458-07  -.10000000+01  .33201171-14
      -.57620458-07  .00000000  -.10000000+01
X1= .00000000
X2= .00000000
X3= .10075000+02
    
```

REFERENCE FRAME 6
INPUT OPTION 1

```

ROTATE .00000000  DEGREES ABOUT AXIS 1
ROTATE .00000000  DEGREES ABOUT AXIS 2
ROTATE .00000000  DEGREES ABOUT AXIS 3
Q= .10000000+01  .00000000  .00000000
   .00000000  .10000000+01  .00000000
   .00000000  .00000000  .10000000+01
X1= .00000000
X2= .00000000
X3= .10075000+02
    
```

JOINT LOCATIONS

LOCAL JOINT NO.	GLOBAL JOINT NO.	LOCAL RECTANGULAR COORDINATES			LOCAL CYLINDRICAL COORDINATES	
		X1	X2	X3	R	THETA(DEG.) Z
1	1	.265000+01	.000000	-.924000+01		
2	2	.214390+01	.155763+01	-.924000+01		
3	3	.818895+00	.252030+01	-.924000+01		
4	4	-.818895+00	.252030+01	-.924000+01		
5	5	-.214390+01	.155763+01	-.924000+01		
6	6	-.265000+01	.842342-07	-.924000+01		
7	7	-.214390+01	-.155763+01	-.924000+01		
8	8	-.818895+00	-.252030+01	-.924000+01		
9	9	.818895+00	-.252030+01	-.924000+01		
10	10	.214390+01	-.155763+01	-.924000+01		
11	11	.228000+01	.000000	-.830900+01		
12	12	.184456+01	.134015+01	-.830900+01		
13	13	.704559+00	.216841+01	-.830900+01		
14	14	-.704559+00	.216841+01	-.830900+01		
15	15	-.184456+01	.134015+01	-.830900+01		
16	16	-.228000+01	.724732-07	-.830900+01		
17	17	-.184456+01	-.134015+01	-.830900+01		
18	18	-.704559+00	-.216841+01	-.830900+01		
19	19	.704559+00	-.216841+01	-.830900+01		
20	20	.184456+01	-.134015+01	-.830900+01		
21	21	.150000+01	.000000	-.695900+01		
22	22	.149668+01	.108740+01	-.695900+01		
23	23	.686018+00	.211135+01	-.695900+01		
24	24	-.686018+00	.211135+01	-.695900+01		
25	25	-.173939+01	.126374+01	-.695900+01		
26	26	-.218000+01	.692946-07	-.695900+01		
27	27	-.173939+01	-.126374+01	-.695900+01		
28	28	-.686018+00	-.211135+01	-.695900+01		
29	29	.686018+00	-.211135+01	-.695900+01		
30	30	.149668+01	-.108740+01	-.695900+01		
31	31	.250000+01	.000000	-.570900+01		
32	32	.173939+01	.126374+01	-.570900+01		
33	33	.695288+00	.213988+01	-.570900+01		
34	34	-.655116+00	.201624+01	-.570900+01		
35	35	-.173939+01	.126374+01	-.570900+01		
36	36	-.211000+01	.670695-07	-.570900+01		
37	37	-.173939+01	-.126374+01	-.570900+01		
38	38	-.655116+00	-.201624+01	-.570900+01		
39	39	.695288+00	-.213988+01	-.570900+01		
40	40	.173939+01	-.126374+01	-.570900+01		
41	41	.156000+01	.000000	-.435000+01		
42	42	.161803+01	.117557+01	-.445900+01		
43	43	.686018+00	.211135+01	-.445900+01		
44	44	-.664387+00	.204477+01	-.445900+01		
45	45	-.173939+01	.126374+01	-.445900+01		
46	46	-.215000+01	.683410-07	-.445900+01		
47	47	-.173939+01	-.126374+01	-.445900+01		
48	48	-.664387+00	-.204477+01	-.445900+01		
49	49	.686018+00	-.211135+01	-.445900+01		
50	50	.161803+01	-.117557+01	-.445900+01		
51	51	.117820+01	.549404+00	-.233900+01		
52	52	.123780+01	.899311+00	-.233900+01		
53	53	.820388+00	.203053+01	-.233900+01		
54	54	-.652026+00	.200673+01	-.233900+01		
55	55	-.170703+01	.124023+01	-.233900+01		
56	56	-.215000+01	.683410-07	-.233900+01		

57	57	-.170703+01	-.124023+01	-.233900+01
58	58	-.652026+00	-.200673+01	-.233900+01
59	59	.820388+00	-.203053+01	-.233900+01
60	60	.123780+01	-.899311+00	-.233900+01
61	61	.102413+01	.477559+00	-.220000+00
62	62	.661530+00	.230703+01	-.250000+00
63	63	-.679837+00	.209232+01	-.330000+00
64	64	-.161803+01	.117557+01	-.380000+00
65	65	-.198000+01	.629373-07	-.420000+00
66	66	-.161803+01	-.117557+01	-.380000+00
67	67	-.679837+00	-.209232+01	-.310000+00
68	68	.661530+00	-.230703+01	-.250000+00
69	69	.102413+01	-.477559+00	-.220000+00
70	70	.728115+00	.529007+00	-.233900+01
71	71	.650000+00	.000000	-.233900+01
72	72	.728115+00	-.529007+00	-.233900+01
73	73	.117820+01	-.549404+00	-.233900+01
74	74	.700000+01	.000000	-.742000+01
75	75	.695483+01	.700315+00	-.765000+01
76	76	.679849+01	.117919+01	-.825000+01
77	77	.659535+01	.117956+01	-.900000+01
78	78	.645216+01	.699790+00	-.960000+01
79	79	.640000+01	.000000	-.982000+01
80	80	.645216+01	-.699790+00	-.960000+01
81	81	.659535+01	-.117956+01	-.900000+01
82	82	.679849+01	-.117919+01	-.825000+01
83	83	.695483+01	-.700315+00	-.765000+01
84	84	.490000+01	.000000	-.715000+01
85	85	.486944+01	.629837+00	-.722000+01
86	86	.470409+01	.118071+01	-.768000+01
87	87	.444636+01	.117893+01	-.840000+01
88	88	.429399+01	.630253+00	-.885000+01
89	89	.428000+01	.000000	-.890000+01
90	90	.429399+01	-.630253+00	-.885000+01
91	91	.444636+01	-.117893+01	-.840000+01
92	92	.470409+01	-.118071+01	-.768000+01
93	93	.486944+01	-.629837+00	-.722000+01
94	94	.405000+01	.000000	-.690000+01
95	95	.404869+01	.579819+00	-.690000+01
96	96	.384147+01	.115030+01	-.728000+01
97	97	.349610+01	.114878+01	-.796000+01
98	98	.329941+01	.579994+00	-.838000+01
99	99	.330000+01	.000000	-.838000+01
100	100	.329941+01	-.579994+00	-.838000+01
101	101	.349610+01	-.114878+01	-.796000+01
102	102	.384147+01	-.115030+01	-.728000+01
103	103	.404869+01	-.579819+00	-.690000+01
104	104	.320000+01	.000000	-.655000+01
105	105	.320306+01	.550386+00	-.655000+01
106	106	.300396+01	.113151+01	-.688000+01
107	107	.259548+01	.112801+01	-.748000+01
108	108	.239782+01	.549614+00	-.778000+01
109	109	.239780+01	.000000	-.778000+01
110	110	.239782+01	-.549614+00	-.778000+01
111	111	.259548+01	-.112801+01	-.748000+01
112	112	.300396+01	-.113151+01	-.688000+01
113	113	.320306+01	-.550386+00	-.655000+01
114	114	.234747+01	.499398+00	-.583900+01
115	115	.211771+01	.101873+01	-.616900+01
116	116	.172024+01	.102019+01	-.670900+01

117	117	.172024+01	-.102019+01	-.670900+01
118	118	.211771+01	-.101873+01	-.616900+01
119	119	.234747+01	-.499398+00	-.583900+01
120	120	.145171+01	.450490+00	-.188000+01
121	121	.145171+01	-.450490+00	-.188000+01
122	122	.246932+01	.450087+00	-.315000+01
123	123	.241659+01	.748985+00	-.320000+01
124	124	.174244+01	.650778+00	-.395000+01
125	125	.154424+01	.378729+00	-.415000+01
126	126	.154424+01	-.378729+00	-.415000+01
127	127	.174244+01	-.650778+00	-.395000+01
128	128	.241659+01	-.748985+00	-.320000+01
129	129	.246932+01	-.450087+00	-.315000+01
130	130	.402484+01	.450747+00	-.396000+01
131	131	.400159+01	.980663+00	-.407000+01
132	132	.372179+01	.860612+00	-.500000+01
133	133	.359546+01	.499551+00	-.552000+01
134	134	.355000+01	.000000	-.572000+01
135	135	.359546+01	-.499551+00	-.552000+01
136	136	.372179+01	-.860612+00	-.500000+01
137	137	.400159+01	-.980663+00	-.407000+01
138	138	.402484+01	-.450747+00	-.396000+01
139	139	.578008+01	.480288+00	-.407000+01
140	140	.580115+01	.118026+01	-.418000+01
141	141	.598358+01	.102064+01	-.522000+01
142	142	.607037+01	.600553+00	-.572000+01
143	143	.608000+01	.000000	-.586000+01
144	144	.607037+01	-.600553+00	-.572000+01
145	145	.598358+01	-.102064+01	-.522000+01
146	146	.580115+01	-.118026+01	-.418000+01
147	147	.578008+01	-.480288+00	-.407000+01
148	148	-.281211+01	-.329256+01	-.470000+00
149	149	-.281211+01	-.329256+01	-.214000+01
150	150	-.398761+01	-.466889+01	-.185000+01
151	151	-.437079+01	-.511753+01	-.107000+01
152	152	-.450068+01	-.526961+01	.000000
153	153	-.437079+01	-.511753+01	.107000+01
154	154	-.398761+01	-.466889+01	.185000+01
155	155	-.281211+01	-.329256+01	.214000+01
156	156	-.281211+01	-.329256+01	.470000+00
157	157	-.122411+01	-.413251+01	-.470000+00
158	158	-.122411+01	-.413251+01	-.204000+01
159	159	-.172397+01	-.582004+01	-.177000+01
160	160	-.188302+01	-.635697+01	-.102000+01
161	161	-.194835+01	-.657750+01	.000000
162	162	-.188302+01	-.635697+01	.102000+01
163	163	-.172397+01	-.582004+01	.177000+01
164	164	-.122411+01	-.413251+01	.204000+01
165	165	-.122411+01	-.413251+01	.470000+00
166	166	.597052+00	-.424825+01	-.470000+00
167	167	.597052+00	-.424825+01	-.194000+01
168	168	.835038+00	-.594161+01	-.168000+01
169	169	.910192+00	-.647635+01	-.970000+00
170	170	.936635+00	-.666450+01	.000000
171	171	.910192+00	-.647635+01	.970000+00
172	172	.835038+00	-.594161+01	.168000+01
173	173	.597052+00	-.424825+01	.194000+01
174	174	.597052+00	-.424825+01	.470000+00
175	175	.229427+01	-.360128+01	-.470000+00
176	176	.229427+01	-.360128+01	-.184000+01

177	177	.318619+01	-.500131+01	-.159000+01
178	178	.346558+01	-.543987+01	-.920000+00
179	179	.356230+01	-.559169+01	.000000
180	180	.346558+01	-.543987+01	.920000+00
181	181	.318619+01	-.500131+01	.159000+01
182	182	.229427+01	-.360128+01	.184000+01
183	183	.230683+01	-.359325+01	.470000+00
184	184	.354401+01	-.234573+01	-.470000+00
185	185	.354401+01	-.234573+01	-.174000+01
186	186	.488657+01	-.323435+01	-.151000+01
187	187	.530351+01	-.351032+01	-.870000+00
188	188	.544527+01	-.360415+01	.000000
189	189	.530351+01	-.351032+01	.870000+00
190	190	.488657+01	-.323435+01	.151000+01
191	191	.354401+01	-.234573+01	.174000+01
192	192	.354401+01	-.234573+01	.470000+00
193	193	.417558+01	-.736268+00	-.470000+00
194	194	.417558+01	-.736268+00	-.164000+01
195	195	.570204+01	-.100542+01	-.142000+01
196	196	.616490+01	-.108704+01	-.820000+00
197	197	.633231+01	-.111656+01	.000000
198	198	.616490+01	-.108704+01	.820000+00
199	199	.570204+01	-.100542+01	.142000+01
200	200	.417558+01	-.736268+00	.164000+01
201	201	.417558+01	-.736268+00	.470000+00
202	202	.409465+01	.102091+01	-.470000+00
203	203	.409465+01	.102091+01	-.154000+01
204	204	.555009+01	.138379+01	-.133000+01
205	205	.598672+01	.149266+01	-.770000+00
206	206	.614197+01	.153137+01	.000000
207	207	.598672+01	.149266+01	.770000+00
208	208	.555009+01	.138379+01	.133000+01
209	209	.409465+01	.102091+01	.154000+01
210	210	.409465+01	.102091+01	.470000+00
211	211	.331753+01	.259193+01	-.470000+00
212	212	.331753+01	.259193+01	-.143000+01
213	213	.444438+01	.347233+01	-.124000+01
214	214	.478323+01	.373707+01	-.720000+00
215	215	.490143+01	.382941+01	.000000
216	216	.478323+01	.373707+01	.720000+00
217	217	.444438+01	.347233+01	.124000+01
218	218	.331753+01	.259193+01	.143000+01
219	219	.331753+01	.259193+01	.470000+00
220	220	.199525+01	.375253+01	-.470000+00
221	221	.199525+01	.375253+01	-.132000+01
222	222	.261496+01	.491802+01	-.114000+01
223	223	.280275+01	.527120+01	-.660000+00
224	224	.286847+01	.539481+01	.000000
225	225	.280275+01	.527120+01	.660000+00
226	226	.261496+01	.491802+01	.114000+01
227	227	.199525+01	.375253+01	.132000+01
228	228	.199525+01	.375253+01	.470000+00
229	229	.300650+00	.429950+01	-.470000+00
230	230	.300650+00	.429950+01	-.122000+01
231	231	.383661+00	.548660+01	-.106000+01
232	232	.410168+00	.586568+01	-.610000+00
233	233	.419236+00	.599536+01	.000000
234	234	.410168+00	.586568+01	.610000+00
235	235	.383661+00	.548660+01	.106000+01
236	236	.300650+00	.429950+01	.122000+01

237	237	.300650+00	.429950+01	.470000+00
238	238	-.442560+01	-.253457+01	.100750+02
239	239	.143279+00	-.102610+02	.100750+02
240	240	.000000	.000000	.100750+02
241	241	.000000	.000000	-.924000+01
242	242	.670000+01	.000000	-.865000+01
243	243	.407838+01	-.190178+01	.612000+01
244	244	.407838+01	-.190178+01	.457000+01
245	245	.676859+01	-.134022+01	.370000+01
246	246	.811670+01	-.313197+01	.330000+01
247	247	.856892+01	-.361437+01	.230000+01
248	248	.850880+01	-.357677+01	.128000+01
249	249	.801376+01	-.298029+01	.600000+00
250	250	.740171+01	-.212241+01	.700000+00
251	251	.676859+01	-.134022+01	.150000+01
252	252	.407838+01	-.190178+01	.335000+01
253	253	.407838+01	-.190178+01	.270000+01
254	254	.279517+01	-.352662+01	.612000+01
255	255	.279517+01	-.352662+01	.457000+01
256	256	.492690+01	-.342428+01	.390000+01
257	257	.798309+01	-.365495+01	.315000+01
258	258	.758867+01	-.355479+01	.780000+00
259	259	.668472+01	-.350956+01	.105000+01
260	260	.492690+01	-.342428+01	.225000+01
261	261	.279517+01	-.352662+01	.335000+01
262	262	.279517+01	-.352662+01	.270000+01
263	263	.118743+01	-.434051+01	.612000+01
264	264	.118743+01	-.434051+01	.457000+01
265	265	.255411+01	-.492738+01	.405000+01
266	266	.581510+01	-.553764+01	.337000+01
267	267	.660684+01	-.558321+01	.270000+01
268	268	.655895+01	-.556239+01	.183000+01
269	269	.555079+01	-.555079+01	.138000+01
270	270	.446197+01	-.539359+01	.148000+01
271	271	.255411+01	-.492738+01	.265000+01
272	272	.118743+01	-.434051+01	.335000+01
273	273	.118743+01	-.434051+01	.270000+01
274	274	-.548412+00	-.446646+01	.612000+01
275	275	-.548412+00	-.446646+01	.457000+01
276	276	.248722+00	-.527414+01	.420000+01
277	277	.392500+01	-.679830+01	.345000+01
278	278	.471816+01	-.686497+01	.282000+01
279	279	.464130+01	-.688101+01	.200000+01
280	280	.369772+01	-.675403+01	.172000+01
281	281	.198466+01	-.629453+01	.176000+01
282	282	.248722+00	-.527414+01	.290000+01
283	283	-.548412+00	-.446646+01	.335000+01
284	284	-.548412+00	-.446646+01	.270000+01
285	285	-.228392+01	-.387733+01	.612000+01
286	286	-.228392+01	-.387733+01	.457000+01
287	287	-.194403+01	-.469331+01	.425000+01
288	288	-.897667+00	-.638723+01	.368000+01
289	289	.535032+00	-.765132+01	.307000+01
290	290	.332815+00	-.762274+01	.236000+01
291	291	-.198244+00	-.709723+01	.205000+01
292	292	-.149597+01	-.558305+01	.225000+01
293	293	-.194403+01	-.469331+01	.300000+01
294	294	-.228392+01	-.387733+01	.335000+01
295	295	-.228392+01	-.387733+01	.270000+01
296	296	-.364519+01	-.263868+01	.612000+01

297	297	-.364519+01	-.263868+01	.457000+01
298	298	-.368490+01	-.349684+01	.428000+01
299	299	-.337878+01	-.547072+01	.383000+01
300	300	-.319241+01	-.600404+01	.340000+01
301	301	-.325792+01	-.587744+01	.279000+01
302	302	-.344212+01	-.530040+01	.249000+01
303	303	-.360532+01	-.449213+01	.266000+01
304	304	-.368490+01	-.349684+01	.298000+01
305	305	-.364519+01	-.263868+01	.335000+01
306	306	-.364519+01	-.263868+01	.270000+01
307	307	-.440490+01	-.920232+00	.612000+01
308	308	-.440490+01	-.920232+00	.457000+01
309	309	-.440490+01	-.920232+00	.442000+01
310	310	-.440490+01	-.920232+00	.427000+01
311	311	-.440490+01	-.920232+00	.411000+01
312	312	-.440490+01	-.920232+00	.396000+01
313	313	-.440490+01	-.920232+00	.381000+01
314	314	-.440490+01	-.920232+00	.366000+01
315	315	-.440490+01	-.920232+00	.350000+01
316	316	-.440490+01	-.920232+00	.335000+01
317	317	-.440490+01	-.920232+00	.270000+01
318	318	-.450000+01	.143039-06	.612000+01
319	319	-.450000+01	.143039-06	.457000+01
320	320	-.450000+01	.143039-06	.442000+01
321	321	-.450000+01	.143039-06	.427000+01
322	322	-.450000+01	.143039-06	.411000+01
323	323	-.450000+01	.143039-06	.396000+01
324	324	-.450000+01	.143039-06	.381000+01
325	325	-.450000+01	.143039-06	.366000+01
326	326	-.450000+01	.143039-06	.350000+01
327	327	-.450000+01	.143039-06	.335000+01
328	328	-.450000+01	.143039-06	.270000+01
329	329	-.440490+01	.920232+00	.612000+01
330	330	-.440490+01	.920232+00	.457000+01
331	331	-.440490+01	.920232+00	.442000+01
332	332	-.440490+01	.920232+00	.427000+01
333	333	-.440490+01	.920232+00	.411000+01
334	334	-.440490+01	.920232+00	.396000+01
335	335	-.440490+01	.920232+00	.381000+01
336	336	-.440490+01	.920232+00	.366000+01
337	337	-.440490+01	.920232+00	.350000+01
338	338	-.440490+01	.920232+00	.335000+01
339	339	-.440490+01	.920232+00	.270000+01
340	340	-.364519+01	.263868+01	.612000+01
341	341	-.364519+01	.263868+01	.457000+01
342	342	-.368490+01	.349684+01	.428000+01
343	343	-.337878+01	.547072+01	.383000+01
344	344	-.319241+01	.600404+01	.340000+01
345	345	-.325792+01	.587744+01	.279000+01
346	346	-.344212+01	.530040+01	.249000+01
347	347	-.360532+01	.449213+01	.266000+01
348	348	-.368490+01	.349684+01	.298000+01
349	349	-.364519+01	.263868+01	.335000+01
350	350	-.364519+01	.263868+01	.270000+01
351	351	-.228392+01	.387733+01	.612000+01
352	352	-.228392+01	.387733+01	.457000+01
353	353	-.194403+01	.469331+01	.425000+01
354	354	-.897666+00	.638723+01	.368000+01
355	355	.535032+00	.765132+01	.307000+01
356	356	.465800+00	.761577+01	.236000+01

357	357	- .198244+00	.709723+01	.205000+01
358	358	- .149597+01	.558305+01	.225000+01
359	359	- .194403+01	.469331+01	.300000+01
360	360	- .228392+01	.387733+01	.335000+01
361	361	- .228392+01	.387733+01	.270000+01
362	362	- .548412+00	.446646+01	.612000+01
363	363	- .548412+00	.446646+01	.457000+01
364	364	.248722+00	.527414+01	.420000+01
365	365	.392500+01	.679830+01	.345000+01
366	366	.471816+01	.686497+01	.282000+01
367	367	.464130+01	.688101+01	.200000+01
368	368	.369772+01	.675403+01	.172000+01
369	369	.198466+01	.629453+01	.176000+01
370	370	.248722+00	.527414+01	.290000+01
371	371	- .548412+00	.446646+01	.335000+01
372	372	- .548412+00	.446646+01	.270000+01
373	373	.118743+01	.434051+01	.612000+01
374	374	.118743+01	.434051+01	.457000+01
375	375	.255411+01	.492738+01	.405000+01
376	376	.581510+01	.553764+01	.337000+01
377	377	.660684+01	.558321+01	.270000+01
378	378	.655895+01	.556239+01	.183000+01
379	379	.555079+01	.555079+01	.138000+01
380	380	.446197+01	.539359+01	.148000+01
381	381	.255411+01	.492738+01	.265000+01
382	382	.118743+01	.434051+01	.335000+01
383	383	.118743+01	.434051+01	.270000+01
384	384	.279517+01	.352662+01	.612000+01
385	385	.279517+01	.352662+01	.457000+01
386	386	.492690+01	.342428+01	.390000+01
387	387	.798309+01	.365495+01	.315000+01
388	388	.758867+01	.355479+01	.780000+00
389	389	.668472+01	.350956+01	.105000+01
390	390	.492690+01	.342428+01	.225000+01
391	391	.279517+01	.352662+01	.335000+01
392	392	.279517+01	.352662+01	.270000+01
393	393	.407838+01	.190178+01	.612000+01
394	394	.407838+01	.190178+01	.457000+01
395	395	.676859+01	.134022+01	.370000+01
396	396	.811670+01	.313197+01	.330000+01
397	397	.856892+01	.361437+01	.230000+01
398	398	.850880+01	.357677+01	.128000+01
399	399	.801376+01	.298029+01	.600000+00
400	400	.740172+01	.212241+01	.700000+00
401	401	.676859+01	.134022+01	.150000+01
402	402	.407838+01	.190178+01	.335000+01
403	403	.407838+01	.190178+01	.270000+01
404	404	.450000+01	.000000	.612000+01
405	405	.450000+01	.000000	.457000+01
406	406	.813000+01	.000000	.344000+01
407	407	.813000+01	.000000	.460000+00
408	408	.450000+01	.000000	.335000+01
409	409	.450000+01	.000000	.270000+01
410	410	.885000+01	.000000	.330000+01
411	411	.885278+01	.178021+01	.303000+01
412	412	.884632+01	.305813+01	.160000+01
413	413	.885269+01	.350146+01	.000000
414	414	.884632+01	.305813+01	.000000
415	415	.885278+01	.178021+01	.000000
416	416	.885000+01	.000000	.000000

417	417	.885278+01	-.178021+01	.303000+01
418	418	.884632+01	-.305813+01	.160000+01
419	419	.885269+01	-.350146+01	.000000
420	420	.884632+01	-.305813+01	.000000
421	421	.885278+01	-.178021+01	.000000
422	422	.945226+01	.353029+01	.000000
423	423	.944974+01	.284945+01	.165000+01
424	424	.945035+01	.163066+01	.288000+01
425	425	.945000+01	.000000	.330000+01
426	426	.945035+01	-.163066+01	.288000+01
427	427	.944974+01	-.284945+01	.165000+01
428	428	.945226+01	-.353029+01	.000000
429	429	.106522+02	.322622+01	.000000
430	430	.106501+02	.279202+01	.161000+01
431	431	.106486+02	.161235+01	.279000+01
432	432	.106500+02	.000000	.323000+01
433	433	.106486+02	-.161235+01	.279000+01
434	434	.106452+02	-.281060+01	.161000+01
435	435	.106522+02	-.322622+01	.000000
436	436	.407838+01	-.190178+01	.612000+01
437	437	.407838+01	-.190178+01	.457000+01
438	438	.676859+01	-.134022+01	.370000+01
439	439	.811670+01	-.313197+01	.330000+01
440	440	.856892+01	-.361437+01	.230000+01
441	441	.850880+01	-.357677+01	.128000+01
442	442	.801376+01	-.298029+01	.600000+00
443	443	.740171+01	-.212241+01	.700000+00
444	444	.676859+01	-.134022+01	.150000+01
445	445	.407838+01	-.190178+01	.335000+01
446	446	.407838+01	-.190178+01	.270000+01
447	447	.279517+01	-.352662+01	.612000+01
448	448	.279517+01	-.352662+01	.457000+01
449	449	.492690+01	-.342428+01	.390000+01
450	450	.798309+01	-.365495+01	.315000+01
451	451	.758867+01	-.355479+01	.780000+00
452	452	.668472+01	-.350956+01	.105000+01
453	453	.492690+01	-.342428+01	.225000+01
454	454	.279517+01	-.352662+01	.335000+01
455	455	.279517+01	-.352662+01	.270000+01
456	456	.118743+01	-.434051+01	.612000+01
457	457	.118743+01	-.434051+01	.457000+01
458	458	.255411+01	-.492738+01	.405000+01
459	459	.581510+01	-.553764+01	.337000+01
460	460	.660684+01	-.558321+01	.270000+01
461	461	.655895+01	-.556239+01	.183000+01
462	462	.555079+01	-.555079+01	.138000+01
463	463	.446197+01	-.539359+01	.148000+01
464	464	.255411+01	-.492738+01	.265000+01
465	465	.118743+01	-.434051+01	.335000+01
466	466	.118743+01	-.434051+01	.270000+01
467	467	-.548412+00	-.446646+01	.612000+01
468	468	-.548412+00	-.446646+01	.457000+01
469	469	.248722+00	-.527414+01	.420000+01
470	470	.392500+01	-.679830+01	.345000+01
471	471	.471816+01	-.686497+01	.282000+01
472	472	.464130+01	-.688101+01	.200000+01
473	473	.369772+01	-.675403+01	.172000+01
474	474	.198466+01	-.629453+01	.176000+01
475	475	.248722+00	-.527414+01	.290000+01
476	476	-.548412+00	-.446646+01	.335000+01

477	477	- .548412+00	- .446646+01	.270000+01
478	478	- .228392+01	- .387733+01	.612000+01
479	479	- .228392+01	- .387733+01	.457000+01
480	480	- .194403+01	- .469331+01	.425000+01
481	481	- .897667+00	- .638723+01	.368000+01
482	482	.535032+00	- .765132+01	.307000+01
483	483	.332815+00	- .762274+01	.236000+01
484	484	- .198244+00	- .709723+01	.205000+01
485	485	- .149597+01	- .558305+01	.225000+01
486	486	- .194403+01	- .469331+01	.300000+01
487	487	- .228392+01	- .387733+01	.335000+01
488	488	- .228392+01	- .387733+01	.270000+01
489	489	- .364519+01	- .263868+01	.612000+01
490	490	- .364519+01	- .263868+01	.457000+01
491	491	- .368490+01	- .349684+01	.428000+01
492	492	- .337878+01	- .547072+01	.383000+01
493	493	- .319241+01	- .600404+01	.340000+01
494	494	- .325792+01	- .587744+01	.279000+01
495	495	- .344212+01	- .530040+01	.249000+01
496	496	- .360532+01	- .449213+01	.266000+01
497	497	- .368490+01	- .349684+01	.298000+01
498	498	- .364519+01	- .263868+01	.335000+01
499	499	- .364519+01	- .263868+01	.270000+01
500	500	- .440490+01	- .920232+00	.612000+01
501	501	- .440490+01	- .920232+00	.457000+01
502	502	- .440490+01	- .920232+00	.442000+01
503	503	- .440490+01	- .920232+00	.427000+01
504	504	- .440490+01	- .920232+00	.411000+01
505	505	- .440490+01	- .920232+00	.396000+01
506	506	- .440490+01	- .920232+00	.381000+01
507	507	- .440490+01	- .920232+00	.366000+01
508	508	- .440490+01	- .920232+00	.350000+01
509	509	- .440490+01	- .920232+00	.335000+01
510	510	- .440490+01	- .920232+00	.270000+01
511	511	- .450000+01	.143039-06	.612000+01
512	512	- .450000+01	.143039-06	.457000+01
513	513	- .450000+01	.143039-06	.442000+01
514	514	- .450000+01	.143039-06	.427000+01
515	515	- .450000+01	.143039-06	.411000+01
516	516	- .450000+01	.143039-06	.396000+01
517	517	- .450000+01	.143039-06	.381000+01
518	518	- .450000+01	.143039-06	.366000+01
519	519	- .450000+01	.143039-06	.350000+01
520	520	- .450000+01	.143039-06	.335000+01
521	521	- .450000+01	.143039-06	.270000+01
522	522	- .440490+01	.920232+00	.612000+01
523	523	- .440490+01	.920232+00	.457000+01
524	524	- .440490+01	.920232+00	.442000+01
525	525	- .440490+01	.920232+00	.427000+01
526	526	- .440490+01	.920232+00	.411000+01
527	527	- .440490+01	.920232+00	.396000+01
528	528	- .440490+01	.920232+00	.381000+01
529	529	- .440490+01	.920232+00	.366000+01
530	530	- .440490+01	.920232+00	.350000+01
531	531	- .440490+01	.920232+00	.335000+01
532	532	- .440490+01	.920232+00	.270000+01
533	533	- .364519+01	.263868+01	.612000+01
534	534	- .364519+01	.263868+01	.457000+01
535	535	- .368490+01	.349684+01	.428000+01
536	536	- .337878+01	.547072+01	.383000+01

537	537	- .319241+01	.600404+01	.340000+01
538	538	- .325792+01	.587744+01	.279000+01
539	539	- .344212+01	.530040+01	.249000+01
540	540	- .360532+01	.449213+01	.266000+01
541	541	- .368490+01	.349684+01	.298000+01
542	542	- .364519+01	.263868+01	.335000+01
543	543	- .364519+01	.263868+01	.270000+01
544	544	- .228392+01	.387733+01	.612000+01
545	545	- .228392+01	.387733+01	.457000+01
546	546	- .194403+01	.469331+01	.425000+01
547	547	- .897666+00	.638723+01	.368000+01
548	548	.535032+00	.765132+01	.307000+01
549	549	.465800+00	.761577+01	.236000+01
550	550	- .198244+00	.709723+01	.205000+01
551	551	- .149597+01	.558305+01	.225000+01
552	552	- .194403+01	.469331+01	.300000+01
553	553	- .228392+01	.387733+01	.335000+01
554	554	- .228392+01	.387733+01	.270000+01
555	555	- .548412+00	.446646+01	.612000+01
556	556	- .548412+00	.446646+01	.457000+01
557	557	.248722+00	.527414+01	.420000+01
558	558	.392500+01	.679830+01	.345000+01
559	559	.471816+01	.686497+01	.282000+01
560	560	.464130+01	.688101+01	.200000+01
561	561	.369772+01	.675403+01	.172000+01
562	562	.198466+01	.629453+01	.176000+01
563	563	.248722+00	.527414+01	.290000+01
564	564	- .548412+00	.446646+01	.335000+01
565	565	- .548412+00	.446646+01	.270000+01
566	566	.118743+01	.434051+01	.612000+01
567	567	.118743+01	.434051+01	.457000+01
568	568	.255411+01	.492738+01	.405000+01
569	569	.581510+01	.553764+01	.337000+01
570	570	.660684+01	.558321+01	.270000+01
571	571	.655895+01	.556239+01	.183000+01
572	572	.555079+01	.555079+01	.138000+01
573	573	.446197+01	.539359+01	.148000+01
574	574	.255411+01	.492738+01	.265000+01
575	575	.118743+01	.434051+01	.335000+01
576	576	.118743+01	.434051+01	.270000+01
577	577	.279517+01	.352662+01	.612000+01
578	578	.279517+01	.352662+01	.457000+01
579	579	.492690+01	.342428+01	.390000+01
580	580	.798309+01	.365495+01	.315000+01
581	581	.758867+01	.355479+01	.780000+00
582	582	.668472+01	.350956+01	.105000+01
583	583	.492690+01	.342428+01	.225000+01
584	584	.279517+01	.352662+01	.335000+01
585	585	.279517+01	.352662+01	.270000+01
586	586	.407838+01	.190178+01	.612000+01
587	587	.407838+01	.190178+01	.457000+01
588	588	.676859+01	.134022+01	.370000+01
589	589	.811670+01	.313197+01	.330000+01
590	590	.856892+01	.361437+01	.230000+01
591	591	.850880+01	.357677+01	.128000+01
592	592	.801376+01	.298029+01	.600000+00
593	593	.740172+01	.212241+01	.700000+00
594	594	.676859+01	.134022+01	.150000+01
595	595	.407838+01	.190178+01	.335000+01
596	596	.407838+01	.190178+01	.270000+01

597	597	.450000+01	.000000	.612000+01			
598	598	.450000+01	.000000	.457000+01			
599	599	.813000+01	.000000	.344000+01			
600	600	.813000+01	.000000	.460000+00			
601	601	.450000+01	.000000	.335000+01			
602	602	.450000+01	.000000	.270000+01			
603	603	.885000+01	.000000	.330000+01			
604	604	.885278+01	.178021+01	.303000+01			
605	605	.884632+01	.305813+01	.160000+01			
606	606	.885278+01	-.178021+01	.303000+01			
607	607	.884632+01	-.305813+01	.160000+01			
608	608	.944974+01	.284945+01	.165000+01			
609	609	.945035+01	.163066+01	.288000+01			
610	610	.945000+01	.000000	.330000+01			
611	611	.945035+01	-.163066+01	.288000+01			
612	612	.944974+01	-.284945+01	.165000+01			
613	613	.106501+02	.279202+01	.161000+01			
614	614	.106486+02	.161235+01	.279000+01			
615	615	.106500+02	.000000	.323000+01			
616	616	.106486+02	-.161235+01	.279000+01			
617	617	.106452+02	-.281060+01	.161000+01			
618	618	.350000+01	.000000	.980000+01	.350000+01	.000000	.980000+01
619	619	.323358+01	.133939+01	.980000+01	.350000+01	.225000+02	.980000+01
620	620	.247487+01	.247487+01	.980000+01	.350000+01	.450000+02	.980000+01
621	621	.133939+01	.323358+01	.980000+01	.350000+01	.675000+02	.980000+01
622	622	.556264-07	.350000+01	.980000+01	.350000+01	.900000+02	.980000+01
623	623	-.133939+01	.323358+01	.980000+01	.350000+01	.112500+03	.980000+01
624	624	-.247487+01	.247487+01	.980000+01	.350000+01	.135000+03	.980000+01
625	625	-.323358+01	.133939+01	.980000+01	.350000+01	.157500+03	.980000+01
626	626	-.350000+01	.111253-06	.980000+01	.350000+01	.180000+03	.980000+01
627	627	-.323358+01	-.133939+01	.980000+01	.350000+01	.202500+03	.980000+01
628	628	-.247487+01	-.247487+01	.980000+01	.350000+01	.225000+03	.980000+01
629	629	-.133939+01	-.323358+01	.980000+01	.350000+01	.247500+03	.980000+01
630	630	-.375495-06	-.350000+01	.980000+01	.350000+01	.270000+03	.980000+01
631	631	.133939+01	-.323358+01	.980000+01	.350000+01	.292500+03	.980000+01
632	632	.247487+01	-.247487+01	.980000+01	.350000+01	.315000+03	.980000+01
633	633	.323358+01	-.133939+01	.980000+01	.350000+01	.337500+03	.980000+01
650	650	.600000+01	.000000	.665000+01	.600000+01	.000000	.665000+01
651	651	.554328+01	.229610+01	.665000+01	.600000+01	.225000+02	.665000+01
652	652	.424264+01	.424264+01	.665000+01	.600000+01	.450000+02	.665000+01
653	653	.229610+01	.554328+01	.665000+01	.600000+01	.675000+02	.665000+01
654	654	.953595-07	.600000+01	.665000+01	.600000+01	.900000+02	.665000+01
655	655	-.229610+01	.554328+01	.665000+01	.600000+01	.112500+03	.665000+01
656	656	-.424264+01	.424264+01	.665000+01	.600000+01	.135000+03	.665000+01
657	657	-.554328+01	.229610+01	.665000+01	.600000+01	.157500+03	.665000+01
658	658	-.600000+01	.190719-06	.665000+01	.600000+01	.180000+03	.665000+01
659	659	-.554328+01	-.229610+01	.665000+01	.600000+01	.202500+03	.665000+01
660	660	-.424264+01	-.424264+01	.665000+01	.600000+01	.225000+03	.665000+01
661	661	-.229610+01	-.554328+01	.665000+01	.600000+01	.247500+03	.665000+01
662	662	-.643706-06	-.600000+01	.665000+01	.600000+01	.270000+03	.665000+01
663	663	.229610+01	-.554328+01	.665000+01	.600000+01	.292500+03	.665000+01
664	664	.424264+01	-.424264+01	.665000+01	.600000+01	.315000+03	.665000+01
665	665	.554328+01	-.229610+01	.665000+01	.600000+01	.337500+03	.665000+01
634	634	.746250+01	.000000	.640000+01	.746250+01	.000000	.640000+01
635	635	.689445+01	.285578+01	.640000+01	.746250+01	.225000+02	.640000+01
636	636	.527678+01	.527678+01	.640000+01	.746250+01	.450000+02	.640000+01
637	637	.285578+01	.689445+01	.640000+01	.746250+01	.675000+02	.640000+01
638	638	.118603-06	.746250+01	.640000+01	.746250+01	.900000+02	.640000+01
639	639	-.285578+01	.689445+01	.640000+01	.746250+01	.112500+03	.640000+01
640	640	-.527678+01	.527678+01	.640000+01	.746250+01	.135000+03	.640000+01

641	641	-.689445+01	.285578+01	.640000+01	.746250+01	.157500+03	.640000+01
642	642	-.746250+01	.237207-06	.640000+01	.746250+01	.180000+03	.640000+01
643	643	-.689445+01	-.285577+01	.640000+01	.746250+01	.202500+03	.640000+01
644	644	-.527678+01	-.527678+01	.640000+01	.746250+01	.225000+03	.640000+01
645	645	-.285578+01	-.689445+01	.640000+01	.746250+01	.247500+03	.640000+01
646	646	-.800610-06	-.746250+01	.640000+01	.746250+01	.270000+03	.640000+01
647	647	.285577+01	-.689445+01	.640000+01	.746250+01	.292500+03	.640000+01
648	648	.527678+01	-.527678+01	.640000+01	.746250+01	.315000+03	.640000+01
649	649	.689445+01	-.285578+01	.640000+01	.746250+01	.337500+03	.640000+01

JOINT REFERENCE FRAME ASSIGNMENTS

NREF	J1	J2	INC				
-2	1	1	1	-2	57	57	1
-2	2	2	1	-2	58	58	1
-2	3	3	1	-2	59	59	1
-2	4	4	1	-2	60	60	1
-2	5	5	1	-4	61	61	1
-2	6	6	1	-2	62	62	1
-2	7	7	1	-2	63	63	1
-2	8	8	1	-2	64	64	1
-2	9	9	1	-2	65	65	1
-2	10	10	1	-2	66	66	1
-2	11	11	1	-2	67	67	1
-2	12	12	1	-2	68	68	1
-2	13	13	1	-4	69	69	1
-2	14	14	1	-2	70	70	1
-2	15	15	1	-2	71	71	1
-2	16	16	1	-2	72	72	1
-2	17	17	1	-2	73	73	1
-2	18	18	1	-2	74	74	1
-2	19	19	1	-2	75	75	1
-2	20	20	1	-2	76	76	1
-2	21	21	1	-2	77	77	1
-2	22	22	1	-2	78	78	1
-2	23	23	1	-2	79	79	1
-2	24	24	1	-2	80	80	1
-2	25	25	1	-2	81	81	1
-2	26	26	1	-2	82	82	1
-2	27	27	1	-2	83	83	1
-2	28	28	1	-2	84	84	1
-2	29	29	1	-2	85	85	1
-2	30	30	1	-2	86	86	1
-2	31	31	1	-2	87	87	1
-2	32	32	1	-2	88	88	1
-2	33	33	1	-2	89	89	1
-2	34	34	1	-2	90	90	1
-2	35	35	1	-2	91	91	1
-2	36	36	1	-2	92	92	1
-2	37	37	1	-2	93	93	1
-2	38	38	1	-2	94	94	1
-2	39	39	1	-2	95	95	1
-2	40	40	1	-2	96	96	1
-2	41	41	1	-2	97	97	1
-2	42	42	1	-2	98	98	1
-2	43	43	1	-2	99	99	1
-2	44	44	1	-2	100	100	1
-2	45	45	1	-2	101	101	1
-2	46	46	1	-2	102	102	1
-2	47	47	1	-2	103	103	1
-2	48	48	1	-2	104	104	1
-2	49	49	1	-2	105	105	1
-2	50	50	1	-2	106	106	1
-2	51	51	1	-2	107	107	1
-2	52	52	1	-2	108	108	1
-2	53	53	1	-2	109	109	1
-2	54	54	1	-2	110	110	1
-2	55	55	1	-2	111	111	1
-2	56	56	1	-2	112	112	1
				-2	113	113	1
				-2	114	114	1
				-2	115	115	1
				-2	116	116	1

-2	117	117	1	-4	177	177	1
-2	118	118	1	-4	178	178	1
-2	119	119	1	-4	179	179	1
-4	120	120	1	-4	180	180	1
-4	121	121	1	-4	181	181	1
-4	122	122	1	-4	182	182	1
-4	123	123	1	-4	183	183	1
-4	124	124	1	-4	184	184	1
-4	125	125	1	-4	185	185	1
-4	126	126	1	-4	186	186	1
-4	127	127	1	-4	187	187	1
-4	128	128	1	-4	188	188	1
-4	129	129	1	-4	189	189	1
-4	130	130	1	-4	190	190	1
-4	131	131	1	-4	191	191	1
-4	132	132	1	-4	192	192	1
-4	133	133	1	-4	193	193	1
-4	134	134	1	-4	194	194	1
-4	135	135	1	-4	195	195	1
-4	136	136	1	-4	196	196	1
-4	137	137	1	-4	197	197	1
-4	138	138	1	-4	198	198	1
-4	139	139	1	-4	199	199	1
-4	140	140	1	-4	200	200	1
-4	141	141	1	-4	201	201	1
-4	142	142	1	-4	202	202	1
-4	143	143	1	-4	203	203	1
-4	144	144	1	-4	204	204	1
-4	145	145	1	-4	205	205	1
-4	146	146	1	-4	206	206	1
-4	147	147	1	-4	207	207	1
-4	148	148	1	-4	208	208	1
-4	149	149	1	-4	209	209	1
-4	150	150	1	-4	210	210	1
-4	151	151	1	-4	211	211	1
-4	152	152	1	-4	212	212	1
-4	153	153	1	-4	213	213	1
-4	154	154	1	-4	214	214	1
-4	155	155	1	-4	215	215	1
-4	156	156	1	-4	216	216	1
-4	157	157	1	-4	217	217	1
-4	158	158	1	-4	218	218	1
-4	159	159	1	-4	219	219	1
-4	160	160	1	-4	220	220	1
-4	161	161	1	-4	221	221	1
-4	162	162	1	-4	222	222	1
-4	163	163	1	-4	223	223	1
-4	164	164	1	-4	224	224	1
-4	165	165	1	-4	225	225	1
-4	166	166	1	-4	226	226	1
-4	167	167	1	-4	227	227	1
-4	168	168	1	-4	228	228	1
-4	169	169	1	-4	229	229	1
-4	170	170	1	-4	230	230	1
-4	171	171	1	-4	231	231	1
-4	172	172	1	-4	232	232	1
-4	173	173	1	-4	233	233	1
-4	174	174	1	-4	234	234	1
-4	175	175	1	-4	235	235	1
-4	176	176	1	-4	236	236	1

-4 237 237 1
 -3 238 238 1
 -3 239 239 1
 -3 240 240 1
 -2 241 241 1
 -2 242 242 1
 -4 243 243 1
 -5 244 244 1
 -5 245 245 1
 -5 246 246 1
 -5 247 247 1
 -5 248 248 1
 -5 249 249 1
 -5 250 250 1
 -5 251 251 1
 -5 252 252 1
 -4 253 253 1
 -4 254 254 1
 -5 255 255 1
 -5 256 256 1
 -5 257 257 1
 -5 258 258 1
 -5 259 259 1
 -5 260 260 1
 -5 261 261 1
 -4 262 262 1
 -4 263 263 1
 -5 264 264 1
 -5 265 265 1
 -5 266 266 1
 -5 267 267 1
 -5 268 268 1
 -5 269 269 1
 -5 270 270 1
 -5 271 271 1
 -5 272 272 1
 -4 273 273 1
 -4 274 274 1
 -5 275 275 1
 -5 276 276 1
 -5 277 277 1
 -5 278 278 1
 -5 279 279 1
 -5 280 280 1
 -5 281 281 1
 -5 282 282 1
 -5 283 283 1
 -4 284 284 1
 -4 285 285 1
 -5 286 286 1
 -5 287 287 1
 -5 288 288 1
 -5 289 289 1
 -5 290 290 1
 -5 291 291 1
 -5 292 292 1
 -5 293 293 1
 -5 294 294 1
 -4 295 295 1
 -4 296 296 1

-5 297 297 1
 -5 298 298 1
 -5 299 299 1
 -5 300 300 1
 -5 301 301 1
 -5 302 302 1
 -5 303 303 1
 -5 304 304 1
 -5 305 305 1
 -4 306 306 1
 -4 307 307 1
 -5 308 308 1
 -5 309 309 1
 -5 310 310 1
 -5 311 311 1
 -5 312 312 1
 -5 313 313 1
 -5 314 314 1
 -5 315 315 1
 -5 316 316 1
 -4 317 317 1
 -4 318 318 1
 -5 319 319 1
 -5 320 320 1
 -5 321 321 1
 -5 322 322 1
 -5 323 323 1
 -5 324 324 1
 -5 325 325 1
 -5 326 326 1
 -5 327 327 1
 -4 328 328 1
 -4 329 329 1
 -5 330 330 1
 -5 331 331 1
 -5 332 332 1
 -5 333 333 1
 -5 334 334 1
 -5 335 335 1
 -5 336 336 1
 -5 337 337 1
 -5 338 338 1
 -4 339 339 1
 -4 340 340 1
 -5 341 341 1
 -5 342 342 1
 -5 343 343 1
 -5 344 344 1
 -5 345 345 1
 -5 346 346 1
 -5 347 347 1
 -5 348 348 1
 -5 349 349 1
 -4 350 350 1
 -4 351 351 1
 -5 352 352 1
 -5 353 353 1
 -5 354 354 1
 -5 355 355 1
 -5 356 356 1

-5	357	357	1
-5	358	358	1
-5	359	359	1
-5	360	360	1
-4	361	361	1
-4	362	362	1
-5	363	363	1
-5	364	364	1
-5	365	365	1
-5	366	366	1
-5	367	367	1
-5	368	368	1
-5	369	369	1
-5	370	370	1
-5	371	371	1
-4	372	372	1
-4	373	373	1
-5	374	374	1
-5	375	375	1
-5	376	376	1
-5	377	377	1
-5	378	378	1
-5	379	379	1
-5	380	380	1
-5	381	381	1
-5	382	382	1
-4	383	383	1
-4	384	384	1
-5	385	385	1
-5	386	386	1
-5	387	387	1
-5	388	388	1
-5	389	389	1
-5	390	390	1
-5	391	391	1
-4	392	392	1
-4	393	393	1
-5	394	394	1
-5	395	395	1
-5	396	396	1
-5	397	397	1
-5	398	398	1
-5	399	399	1
-5	400	400	1
-5	401	401	1
-5	402	402	1
-4	403	403	1
-4	404	404	1
-5	405	405	1
-5	406	406	1
-5	407	407	1
-5	408	408	1
-4	409	409	1
-5	410	410	1
-5	411	411	1
-5	412	412	1
-4	413	413	1
-4	414	414	1
-4	415	415	1
-4	416	416	1

-5	417	417	1
-5	418	418	1
-4	419	419	1
-4	420	420	1
-4	421	421	1
-4	422	422	1
-5	423	423	1
-5	424	424	1
-5	425	425	1
-5	426	426	1
-5	427	427	1
-4	428	428	1
-4	429	429	1
-4	430	430	1
-4	431	431	1
-4	432	432	1
-4	433	433	1
-4	434	434	1
-4	435	435	1
-4	436	436	1
-6	437	437	1
-6	438	438	1
-6	439	439	1
-6	440	440	1
-6	441	441	1
-6	442	442	1
-6	443	443	1
-6	444	444	1
-6	445	445	1
-4	446	446	1
-4	447	447	1
-6	448	448	1
-6	449	449	1
-6	450	450	1
-6	451	451	1
-6	452	452	1
-6	453	453	1
-6	454	454	1
-4	455	455	1
-4	456	456	1
-6	457	457	1
-6	458	458	1
-6	459	459	1
-6	460	460	1
-6	461	461	1
-6	462	462	1
-6	463	463	1
-6	464	464	1
-6	465	465	1
-4	466	466	1
-4	467	467	1
-6	468	468	1
-6	469	469	1
-6	470	470	1
-6	471	471	1
-6	472	472	1
-6	473	473	1
-6	474	474	1
-6	475	475	1
-6	476	476	1

-4	477	477	1	-6	537	537	1	-4	597	597	1
-4	478	478	1	-6	538	538	1	-6	598	598	1
-6	479	479	1	-6	539	539	1	-6	599	599	1
-6	480	480	1	-6	540	540	1	-6	600	600	1
-6	481	481	1	-6	541	541	1	-6	601	601	1
-6	482	482	1	-6	542	542	1	-4	602	602	1
-6	483	483	1	-4	543	543	1	-6	603	603	1
-6	484	484	1	-4	544	544	1	-6	604	604	1
-6	485	485	1	-6	545	545	1	-6	605	605	1
-6	486	486	1	-6	546	546	1	-6	606	606	1
-6	487	487	1	-6	547	547	1	-6	607	607	1
-4	488	488	1	-6	548	548	1	-6	608	608	1
-4	489	489	1	-6	549	549	1	-6	609	609	1
-6	490	490	1	-6	550	550	1	-6	610	610	1
-6	491	491	1	-6	551	551	1	-6	611	611	1
-6	492	492	1	-6	552	552	1	-6	612	612	1
-6	493	493	1	-6	553	553	1	-6	613	613	1
-6	494	494	1	-4	554	554	1	-6	614	614	1
-6	495	495	1	-4	555	555	1	-6	615	615	1
-6	496	496	1	-6	556	556	1	-6	616	616	1
-6	497	497	1	-6	557	557	1	-6	617	617	1
-6	498	498	1	-6	558	558	1	-6	618	665	1
-4	499	499	1	-6	559	559	1				
-4	500	500	1	-6	560	560	1				
-6	501	501	1	-6	561	561	1				
-6	502	502	1	-6	562	562	1				
-6	503	503	1	-6	563	563	1				
-6	504	504	1	-6	564	564	1				
-6	505	505	1	-4	565	565	1				
-6	506	506	1	-4	566	566	1				
-6	507	507	1	-6	567	567	1				
-6	508	508	1	-6	568	568	1				
-6	509	509	1	-6	569	569	1				
-4	510	510	1	-6	570	570	1				
-4	511	511	1	-6	571	571	1				
-6	512	512	1	-6	572	572	1				
-6	513	513	1	-6	573	573	1				
-6	514	514	1	-6	574	574	1				
-6	515	515	1	-6	575	575	1				
-6	516	516	1	-4	576	576	1				
-6	517	517	1	-4	577	577	1				
-6	518	518	1	-6	578	578	1				
-6	519	519	1	-6	579	579	1				
-6	520	520	1	-6	580	580	1				
-4	521	521	1	-6	581	581	1				
-4	522	522	1	-6	582	582	1				
-6	523	523	1	-6	583	583	1				
-6	524	524	1	-6	584	584	1				
-6	525	525	1	-4	585	585	1				
-6	526	526	1	-4	586	586	1				
-6	527	527	1	-6	587	587	1				
-6	528	528	1	-6	588	588	1				
-6	529	529	1	-6	589	589	1				
-6	530	530	1	-6	590	590	1				
-6	531	531	1	-6	591	591	1				
-4	532	532	1	-6	592	592	1				
-4	533	533	1	-6	593	593	1				
-6	534	534	1	-6	594	594	1				
-6	535	535	1	-6	595	595	1				
-6	536	536	1	-4	596	596	1				

ENTRY	E	NU	G	SP WI
1	.30000+08	.30000+00	.11538+08	.32596+00
2	.30000+08	.30000+00	.11538+08	.32596+00
3	.29600+08	.30000+00	.11385+08	.32596+00
4	.29600+08	.30000+00	.11385+08	.32596+00

ENTRY	ALPHA1	ALPHA2	THETA
1	.00000	.00000	.00000
2	.00000	.00000	.00000
3	.00000	.00000	.00000
4	.00000	.00000	.00000

SUMMARY OF CONSTRAINT CONDITIONS AND JOINT REFERENCE FRAME ASSIGNMENTS. (CONSTRAINT SET 1)

JOINT	JREF	CONSTRAINT	JOINT	JREF	CONSTRAINT	JOINT	JREF	CONSTRAINT	JOINT	JREF	CONSTRAINT	JOINT	JREF	CONSTRAINT
1	-2	000000	2	-2	000000	3	-2	000000	4	-2	000000	5	-2	000000
6	-2	000000	7	-2	000000	8	-2	000000	9	-2	000000	10	-2	000000
11	-2	000000	12	-2	000000	13	-2	000000	14	-2	000000	15	-2	000000
16	-2	000000	17	-2	000000	18	-2	000000	19	-2	000000	20	-2	000000
21	-2	000000	22	-2	000000	23	-2	000000	24	-2	000000	25	-2	000000
26	-2	000000	27	-2	000000	28	-2	000000	29	-2	000000	30	-2	000000
31	-2	000000	32	-2	000000	33	-2	000000	34	-2	000000	35	-2	000000
36	-2	000000	37	-2	000000	38	-2	000000	39	-2	000000	40	-2	000000
41	-2	000000	42	-2	000000	43	-2	000000	44	-2	000000	45	-2	000000
46	-2	000000	47	-2	000000	48	-2	000000	49	-2	000000	50	-2	000000
51	-2	000000	52	-2	000000	53	-2	000000	54	-2	000000	55	-2	000000
56	-2	000000	57	-2	000000	58	-2	000000	59	-2	000000	60	-2	000000
61	-4	000000	62	-2	000000	63	-2	000000	64	-2	000000	65	-2	000000
66	-2	000000	67	-2	000000	68	-2	000000	69	-4	000000	70	-2	000000
71	-2	000000	72	-2	000000	73	-2	000000	74	-2	000000	75	-2	000000
76	-2	000000	77	-2	000000	78	-2	000000	79	-2	000000	80	-2	000000
81	-2	000000	82	-2	000000	83	-2	000000	84	-2	000000	85	-2	000000
86	-2	000000	87	-2	000000	88	-2	000000	89	-2	000000	90	-2	000000
91	-2	000000	92	-2	000000	93	-2	000000	94	-2	000000	95	-2	000000
96	-2	000000	97	-2	000000	98	-2	000000	99	-2	000000	100	-2	000000
101	-2	000000	102	-2	000000	103	-2	000000	104	-2	000000	105	-2	000000
106	-2	000000	107	-2	000000	108	-2	000000	109	-2	000000	110	-2	000000
111	-2	000000	112	-2	000000	113	-2	000000	114	-2	000000	115	-2	000000
116	-2	000000	117	-2	000000	118	-2	000000	119	-2	000000	120	-4	000000
121	-4	000000	122	-4	000000	123	-4	000000	124	-4	000000	125	-4	000000
126	-4	000000	127	-4	000000	128	-4	000000	129	-4	000000	130	-4	000000
131	-4	000000	132	-4	000000	133	-4	000000	134	-4	000000	135	-4	000000
136	-4	000000	137	-4	000000	138	-4	000000	139	-4	000000	140	-4	000000
141	-4	000000	142	-4	000000	143	-4	000000	144	-4	000000	145	-4	000000
146	-4	000000	147	-4	000000	148	-4	000000	149	-4	000000	150	-4	000000
151	-4	000000	152	-4	000000	153	-4	000000	154	-4	000000	155	-4	000000
156	-4	000000	157	-4	000000	158	-4	000000	159	-4	000000	160	-4	000000
161	-4	000000	162	-4	000000	163	-4	000000	164	-4	000000	165	-4	000000
166	-4	000000	167	-4	000000	168	-4	000000	169	-4	000000	170	-4	000000
171	-4	000000	172	-4	000000	173	-4	000000	174	-4	000000	175	-4	000000
176	-4	000000	177	-4	000000	178	-4	000000	179	-4	000000	180	-4	000000
181	-4	000000	182	-4	000000	183	-4	000000	184	-4	000000	185	-4	000000
186	-4	000000	187	-4	000000	188	-4	000000	189	-4	000000	190	-4	000000
191	-4	000000	192	-4	000000	193	-4	000000	194	-4	000000	195	-4	000000
196	-4	000000	197	-4	000000	198	-4	000000	199	-4	000000	200	-4	000000
201	-4	000000	202	-4	000000	203	-4	000000	204	-4	000000	205	-4	000000
206	-4	000000	207	-4	000000	208	-4	000000	209	-4	000000	210	-4	000000
211	-4	000000	212	-4	000000	213	-4	000000	214	-4	000000	215	-4	000000
216	-4	000000	217	-4	000000	218	-4	000000	219	-4	000000	220	-4	000000
221	-4	000000	222	-4	000000	223	-4	000000	224	-4	000000	225	-4	000000
226	-4	000000	227	-4	000000	228	-4	000000	229	-4	000000	230	-4	000000
231	-4	000000	232	-4	000000	233	-4	000000	234	-4	000000	235	-4	000000
236	-4	000000	237	-4	000000	238	-3	000000	239	-3	000000	240	-3	000000
241	-2	000000	242	-2	000000	243	-4	000000	244	-5	000000	245	-5	000000
246	-5	000000	247	-5	000000	248	-5	000000	249	-5	000000	250	-5	000000
251	-5	000000	252	-5	000000	253	-4	000000	254	-4	000000	255	-5	000000
256	-5	000000	257	-5	000000	258	-5	000000	259	-5	000000	260	-5	000000
261	-5	000000	262	-4	000000	263	-4	000000	264	-5	000000	265	-5	000000
266	-5	000000	267	-5	000000	268	-5	000000	269	-5	000000	270	-5	000000
271	-5	000000	272	-5	000000	273	-4	000000	274	-4	000000	275	-5	000000
276	-5	000000	277	-5	000000	278	-5	000000	279	-5	000000	280	-5	000000
281	-5	000000	282	-5	000000	283	-5	000000	284	-4	000000	285	-4	000000

LIBRARY OF MEMBER (BEAM) ELEMENT REFERENCE FRAME ORIENTATION SPECIFICATIONS

ENTRY

NO.	1.	11=	1.	THIRD POINT COORDINATES RELATIVE TO ALTERNATE FRAME'	3'	-.44256000+01	-.25346000+01	.10075000+02
				THIRD POINT COORDINATES RELATIVE TO GLOBAL REFERENCE FRAME=		-.17442873+01	-.47924525+01	.10075000+02
NO.	2.	11=	1.	THIRD POINT COORDINATES RELATIVE TO ALTERNATE FRAME'	2'	.67000000+01	.00000000	.86500000+01
				THIRD POINT COORDINATES RELATIVE TO GLOBAL REFERENCE FRAME=		-.77760295+01	.44047102+01	.10070000+02
NO.	3.	11=	1.	THIRD POINT COORDINATES RELATIVE TO ALTERNATE FRAME'	2'	.00000000	.00000000	-.92400000+01
				THIRD POINT COORDINATES RELATIVE TO GLOBAL REFERENCE FRAME=		-.10536929+02	-.17284402+01	.10070000+02
NO.	4.	11=	1.	THIRD POINT COORDINATES RELATIVE TO ALTERNATE FRAME'	3'	-.44256000+01	-.25346000+01	.10075000+02
				THIRD POINT COORDINATES RELATIVE TO GLOBAL REFERENCE FRAME=		-.17442873+01	-.47924525+01	.10075000+02
NO.	5.	11=	1.	THIRD POINT COORDINATES RELATIVE TO ALTERNATE FRAME'	5'	.10652000+02	-.32262000+01	.00000000
				THIRD POINT COORDINATES RELATIVE TO GLOBAL REFERENCE FRAME=		.10652000+02	.32261994+01	.10074999+02
NO.	6.	11=	1.	THIRD POINT COORDINATES RELATIVE TO ALTERNATE FRAME'	5'	.10652000+02	.32262000+01	.00000000
				THIRD POINT COORDINATES RELATIVE TO GLOBAL REFERENCE FRAME=		.10652000+02	-.32262006+01	.10074999+02
NO.	7.	11=	1.	THIRD POINT COORDINATES RELATIVE TO ALTERNATE FRAME'	5'	.10652000+02	-.32262000+01	.00000000
				THIRD POINT COORDINATES RELATIVE TO GLOBAL REFERENCE FRAME=		.10652000+02	.32261994+01	.10074999+02
NO.	8	R11=	.99999999	R21 IS POSITIVE				

LIBRARY OF MEMBER (BEAM) ELEMENT REFERENCE FRAME ORIENTATION SPECIFICATIONS
ENTRY

NO.	1.	I1=	1.	THIRD POINT COORDINATES RELATIVE TO ALTERNATE FRAME'	3' =	-.44256000+01	-.25346000+01	.10075000+02
				THIRD POINT COORDINATES RELATIVE TO GLOBAL REFERENCE FRAME =		-.17442873+01	-.47924525+01	.10075000+02
NO.	2.	I1=	1.	THIRD POINT COORDINATES RELATIVE TO ALTERNATE FRAME'	2' =	.87000000+01	.00000000	-.86500000+01
				THIRD POINT COORDINATES RELATIVE TO GLOBAL REFERENCE FRAME =		-.77760295+01	.44047102+01	.10070000+02
NO.	3.	I1=	1.	THIRD POINT COORDINATES RELATIVE TO ALTERNATE FRAME'	2' =	.00000000	.00000000	-.92400000+01
				THIRD POINT COORDINATES RELATIVE TO GLOBAL REFERENCE FRAME =		-.10536929+02	-.17284402+01	.10070000+02
NO.	4.	I1=	1.	THIRD POINT COORDINATES RELATIVE TO ALTERNATE FRAME'	3' =	-.44256000+01	-.25346000+01	.10075000+02
				THIRD POINT COORDINATES RELATIVE TO GLOBAL REFERENCE FRAME =		-.17442873+01	-.47924525+01	.10075000+02
NO.	5.	I1=	1.	THIRD POINT COORDINATES RELATIVE TO ALTERNATE FRAME'	5' =	.10652000+02	-.32262000+01	.00000000
				THIRD POINT COORDINATES RELATIVE TO GLOBAL REFERENCE FRAME =		.10652000+02	.32261994+01	.10074999+02
NO.	6.	I1=	1.	THIRD POINT COORDINATES RELATIVE TO ALTERNATE FRAME'	5' =	.10652000+02	.32262000+01	.00000000
				THIRD POINT COORDINATES RELATIVE TO GLOBAL REFERENCE FRAME =		.10652000+02	-.32262006+01	.10074999+02
NO.	7.	I1=	1.	THIRD POINT COORDINATES RELATIVE TO ALTERNATE FRAME'	5' =	.10652000+02	-.32262000+01	.00000000
				THIRD POINT COORDINATES RELATIVE TO GLOBAL REFERENCE FRAME =		.10652000+02	.32261994+01	.10074999+02
NO.	8	R11=	.99999999	R21 IS POSITIVE				

TABLE DA: E21 BEAM SECTION PROPERTIES

SECTION DATA SET	TYPE TUBE	B1	T1	B2	T2	B3	T3	H1	H2	IBAR12
6		.5000+00	.1080+01	.0000	.0000	.0000	.0000	.0000	.0000	.0000

TABLE BA: E21 BEAM SECTION PROPERTIES

SET	I1	ALPHA1	I2	ALPHA2	AREA
1	.85100-01	.00000	.90000-03	.00000	.32200+00
2	.92860-01	.00000	.98420-01	.00000	.10710+01
3	.28089+00	.00000	.28930+00	.00000	.18495+01
4	.85100-01	.00000	.90000-03	.00000	.32200+00
5	.23720-01	.00000	.98550-01	.00000	.58100+00
6	.10194+01	.10000+01	.10194+01	.10000+01	.28790+01

TABLE BA: E21 BEAM SECTION PROPERTIES

SET	F1	F2	Z1	Z2	THETA
1	.86000-01	.00000	.00000	.00000	.00000
2	.19126+00	.00000	.00000	.00000	.00000
3	.57019+00	.00000	.00000	.00000	.00000
4	.86000-01	.00000	.00000	.00000	.00000
5	.57070-01	.00000	.00000	.00000	.00000
6	.20389+01	.00000	.00000	.00000	.00000

TABLE BA: E21 BEAM SECTION PROPERTIES

SET	Q1	Q2	Q3
1	.00000	.00000	.00000
2	.00000	.00000	.00000
3	.00000	.00000	.00000
4	.00000	.00000	.00000
5	.00000	.00000	.00000
6	.00000	.00000	.00000

TABLE BA: E21 BEAM SECTION PROPERTIES

SET	Y11	Y12	Y21	Y22
1	.00000	.00000	.00000	.00000
2	.00000	.00000	.00000	.00000
3	.00000	.00000	.00000	.00000
4	.00000	.00000	.00000	.00000
5	.00000	.00000	.00000	.00000
6	.10800+01	.00000	.00000	.10800+01

TABLE BA: E21 BEAM SECTION PROPERTIES

SET	Y31	Y32	Y41	Y42
1	.00000	.00000	.00000	.00000
2	.00000	.00000	.00000	.00000
3	.00000	.00000	.00000	.00000
4	.00000	.00000	.00000	.00000
5	.00000	.00000	.00000	.00000
6	.10800+01	.00000	.00000	.10800+01
STOP TAB	3.603	24	8	8
				0

*XOT ELD
 ELD 211 DATA SPACE= 20000, DATE/TIME= 851008 180041

E21 GROUP 1

INDEX	CONNECTS		NMAT	NSECT	NNSW	NOFF	NREF
	J1	J2					
1	120	121	2	1	0	0	1
2	122	129	2	1	0	0	1
3	130	138	2	1	0	0	1
4	139	147	2	1	0	0	1
5	148	156	2	1	0	0	1
6	157	165	2	1	0	0	1
7	166	174	2	1	0	0	1
8	175	183	2	1	0	0	1
9	184	192	2	1	0	0	1
10	193	201	2	1	0	0	1
11	210	202	2	1	0	0	1
12	219	211	2	1	0	0	1
13	228	220	2	1	0	0	1
14	237	229	2	1	0	0	1
15	83	74	2	2	0	0	2
16	74	75	2	2	0	0	2
17	75	76	2	2	0	0	2
18	76	77	2	2	0	0	2
19	77	78	2	2	0	0	2
20	78	79	2	2	0	0	2
21	79	80	2	2	0	0	2
22	80	81	2	2	0	0	2
23	81	82	2	2	0	0	2
24	82	83	2	2	0	0	2
25	10	1	2	3	0	0	3
26	1	2	2	3	0	0	3
27	2	3	2	3	0	0	3
28	3	4	2	3	0	0	3
29	4	5	2	3	0	0	3
30	5	6	2	3	0	0	3
31	6	7	2	3	0	0	3
32	7	8	2	3	0	0	3
33	8	9	2	3	0	0	3
34	9	10	2	3	0	0	3
35	61	69	2	1	0	0	4
36	430	429	1	5	0	0	5
37	431	430	1	5	0	0	5
38	432	431	1	5	0	0	5
39	433	432	1	5	0	0	5
40	434	433	1	5	0	0	5
41	435	434	1	5	0	0	6
42	613	435	1	5	0	0	6
43	614	613	1	5	0	0	6
44	615	614	1	5	0	0	6
45	616	615	1	5	0	0	6
46	617	616	1	5	0	0	6
47	429	617	1	5	0	0	7

E43 GROUP 1

INDEX	CONNECTED JOINTS				NMAT	NSECT	NNSW	NREF	SREF
	J1	J2	J3	J4					
1	256	255	261	260	1	1	0	1	0
2	265	264	272	271	1	2	0	1	0
3	276	275	283	282	1	3	0	1	0
4	287	286	294	293	1	4	0	1	0
5	298	297	305	304	1	5	0	1	0
6	245	244	252	251	1	6	0	1	0
7	375	374	382	381	1	1	0	1	0
8	386	385	391	390	1	2	0	1	0
9	342	341	349	348	1	3	0	1	0
10	353	352	360	359	1	4	0	1	0
11	364	363	371	370	1	5	0	1	0
12	395	394	402	401	1	6	0	1	0
13	406	405	408	407	1	7	0	1	0
14	449	448	454	453	1	1	0	1	0
15	458	457	465	464	1	2	0	1	0
16	469	468	476	475	1	3	0	1	0
17	480	479	487	486	1	4	0	1	0
18	491	490	498	497	1	5	0	1	0
19	438	437	445	444	1	6	0	1	0
20	568	567	575	574	1	1	0	1	0
21	579	578	584	583	1	2	0	1	0
22	535	534	542	541	1	3	0	1	0
23	546	545	553	552	1	4	0	1	0
24	557	556	564	563	1	5	0	1	0
25	588	587	595	594	1	6	0	1	0
26	599	598	601	600	1	7	0	1	0

E43 GROUP 2

CONNECTED JOINTS									
INDEX	J1	J2	J3	J4	NMAT	NSECT	NNSW	NREF	SREF
1	597	586	651	650	4	56	0	1	0
2	586	577	652	651	4	56	0	1	0
3	577	566	653	652	4	56	0	1	0
4	566	555	654	653	4	56	0	1	0
5	555	544	655	654	4	56	0	1	0
6	544	533	656	655	4	56	0	1	0
7	533	522	657	656	4	56	0	1	0
8	522	511	658	657	4	56	0	1	0
9	511	500	659	658	4	56	0	1	0
10	500	489	660	659	4	56	0	1	0
11	489	478	661	660	4	56	0	1	0
12	478	467	662	661	4	56	0	1	0
13	467	456	663	662	4	56	0	1	0
14	456	447	664	663	4	56	0	1	0
15	447	436	665	664	4	56	0	1	0
16	436	597	650	665	4	56	0	1	0
17	597	586	619	618	4	55	0	1	0
18	586	577	620	619	4	55	0	1	0
19	577	566	621	620	4	55	0	1	0
20	566	555	622	621	4	55	0	1	0
21	555	544	623	622	4	55	0	1	0
22	544	533	624	623	4	55	0	1	0
23	533	522	625	624	4	55	0	1	0
24	522	511	626	625	4	55	0	1	0
25	511	500	627	626	4	55	0	1	0
26	500	489	628	627	4	55	0	1	0
27	489	478	629	628	4	55	0	1	0
28	478	467	630	629	4	55	0	1	0
29	467	456	631	630	4	55	0	1	0
30	456	447	632	631	4	55	0	1	0
31	447	436	633	632	4	55	0	1	0
32	436	597	618	633	4	55	0	1	0
33	650	618	619	651	4	56	0	1	0
34	651	619	620	652	4	56	0	1	0
35	652	620	621	653	4	56	0	1	0
36	653	621	622	654	4	56	0	1	0
37	654	622	623	655	4	56	0	1	0
38	655	623	624	656	4	56	0	1	0
39	656	624	625	657	4	56	0	1	0
40	657	625	626	658	4	56	0	1	0
41	658	626	627	659	4	56	0	1	0
42	659	627	628	660	4	56	0	1	0
43	660	628	629	661	4	56	0	1	0
44	661	629	630	662	4	56	0	1	0
45	662	630	631	663	4	56	0	1	0
46	663	631	632	664	4	56	0	1	0
47	664	632	633	665	4	56	0	1	0
48	665	633	618	650	4	56	0	1	0

E43 GROUP 2		CONNECTED JOINTS							
INDEX	J1	J2	J3	J4	NMAT	NSECT	NNSW	NREF	SREF
49	634	650	651	635	4	57	0	1	0
50	635	651	652	636	4	57	0	1	0
51	636	652	653	637	4	57	0	1	0
52	637	653	654	638	4	57	0	1	0
53	638	654	655	639	4	57	0	1	0
54	639	655	656	640	4	57	0	1	0
55	640	656	657	641	4	57	0	1	0
56	641	657	658	642	4	57	0	1	0
57	642	658	659	643	4	57	0	1	0
58	643	659	660	644	4	57	0	1	0
59	644	660	661	645	4	57	0	1	0
60	645	661	662	646	4	57	0	1	0
61	646	662	663	647	4	57	0	1	0
62	647	663	664	648	4	57	0	1	0
63	648	664	665	649	4	57	0	1	0
64	649	665	650	634	4	57	0	1	0

E33 GROUP 1

INDEX	CONNECTED JOINTS			NMAT	NSECT	NNSW	NREF	SREF
	J1	J2	J3					
1	1	2	12	2	8	0	1	0
2	2	3	13	2	9	0	1	0
3	3	4	14	2	9	0	1	0
4	4	5	15	2	9	0	1	0
5	5	6	16	2	9	0	1	0
6	6	7	17	2	9	0	1	0
7	7	8	18	2	9	0	1	0
8	8	9	19	2	9	0	1	0
9	9	10	20	2	9	0	1	0
10	10	1	11	2	8	0	1	0
11	12	11	1	2	8	0	1	0
12	13	12	2	2	9	0	1	0
13	14	13	3	2	9	0	1	0
14	15	14	4	2	9	0	1	0
15	16	15	5	2	9	0	1	0
16	17	16	6	2	9	0	1	0
17	18	17	7	2	9	0	1	0
18	19	18	8	2	9	0	1	0
19	20	19	9	2	9	0	1	0
20	11	20	10	2	8	0	1	0
21	11	12	22	2	10	0	1	0
22	12	13	23	2	11	0	1	0
23	13	14	24	2	11	0	1	0
24	14	15	25	2	11	0	1	0
25	15	16	26	2	11	0	1	0
26	16	17	27	2	11	0	1	0
27	17	18	28	2	11	0	1	0
28	18	19	29	2	11	0	1	0
29	19	20	30	2	11	0	1	0
30	20	11	21	2	10	0	1	0
31	22	21	11	2	10	0	1	0
32	23	22	12	2	11	0	1	0
33	24	23	13	2	11	0	1	0
34	25	24	14	2	11	0	1	0
35	26	25	15	2	11	0	1	0
36	27	26	16	2	11	0	1	0
37	28	27	17	2	11	0	1	0
38	29	28	18	2	11	0	1	0
39	30	29	19	2	11	0	1	0
40	21	30	20	2	10	0	1	0
41	22	23	33	2	12	0	1	0
42	23	24	34	2	12	0	1	0
43	24	25	35	2	12	0	1	0
44	25	26	36	2	12	0	1	0
45	26	27	37	2	12	0	1	0
46	27	28	38	2	12	0	1	0
47	28	29	39	2	12	0	1	0
48	29	30	40	2	12	0	1	0

E33 GROUP 1

INDEX	CONNECTED JOINTS			NMAT	NSECT	NNSW	NREF	SREF
	J1	J2	J3					
49	33	32	22	2	12	0	1	0
50	34	33	23	2	12	0	1	0
51	35	34	24	2	12	0	1	0
52	36	35	25	2	12	0	1	0
53	37	36	26	2	12	0	1	0
54	38	37	27	2	12	0	1	0
55	39	38	28	2	12	0	1	0
56	40	39	29	2	12	0	1	0
57	31	32	42	2	13	0	1	0
58	32	33	43	2	12	0	1	0
59	33	34	44	2	14	0	1	0
60	34	35	45	2	14	0	1	0
61	35	36	46	2	14	0	1	0
62	36	37	47	2	14	0	1	0
63	37	38	48	2	14	0	1	0
64	38	39	49	2	14	0	1	0
65	39	40	50	2	12	0	1	0
66	40	31	41	2	13	0	1	0
67	42	41	31	2	13	0	1	0
68	43	42	32	2	12	0	1	0
69	44	43	33	2	14	0	1	0
70	45	44	34	2	14	0	1	0
71	46	45	35	2	14	0	1	0
72	47	46	36	2	14	0	1	0
73	48	47	37	2	14	0	1	0
74	49	48	38	2	14	0	1	0
75	50	49	39	2	12	0	1	0
76	41	50	40	2	13	0	1	0
77	42	43	53	2	15	0	1	0
78	43	44	54	2	15	0	1	0
79	44	45	55	2	15	0	1	0
80	45	46	56	2	15	0	1	0
81	46	47	57	2	15	0	1	0
82	47	48	58	2	15	0	1	0
83	48	49	59	2	15	0	1	0
84	49	50	60	2	15	0	1	0
85	53	52	42	2	15	0	1	0
86	54	53	43	2	15	0	1	0
87	55	54	44	2	15	0	1	0
88	56	55	45	2	15	0	1	0
89	57	56	46	2	15	0	1	0
90	58	57	47	2	15	0	1	0
91	59	58	48	2	15	0	1	0
92	60	59	49	2	15	0	1	0
93	122	123	51	2	16	0	1	0
94	124	122	70	2	16	0	1	0
95	125	124	70	2	16	0	1	0
96	41	125	71	2	16	0	1	0

C-3

E33 GROUP 1

CONNECTED JOINTS								
INDEX	J1	J2	J3	NMAT	NSECT	NNSW	NREF	SREF
97	126	41	71	2	16	0	1	0
98	127	126	72	2	16	0	1	0
99	129	127	72	2	16	0	1	0
100	128	129	60	2	16	0	1	0
101	52	51	123	2	16	0	1	0
102	51	70	122	2	16	0	1	0
103	70	71	125	2	16	0	1	0
104	71	72	126	2	16	0	1	0
105	72	73	129	2	16	0	1	0
106	73	60	129	2	16	0	1	0
107	51	52	120	2	16	0	1	0
108	52	53	62	2	16	0	1	0
109	53	54	63	2	16	0	1	0
110	54	55	64	2	16	0	1	0
111	55	56	65	2	16	0	1	0
112	56	57	66	2	16	0	1	0
113	57	58	67	2	16	0	1	0
114	58	59	68	2	16	0	1	0
115	59	60	69	2	16	0	1	0
116	60	73	121	2	16	0	1	0
117	61	120	52	2	16	0	1	0
118	62	61	52	2	16	0	1	0
119	63	62	53	2	16	0	1	0
120	64	63	54	2	16	0	1	0
121	65	64	55	2	16	0	1	0
122	66	65	56	2	16	0	1	0
123	67	66	57	2	16	0	1	0
124	68	67	58	2	16	0	1	0
125	69	68	59	2	16	0	1	0
126	60	121	69	2	16	0	1	0
127	61	62	155	2	16	0	1	0
128	62	63	154	2	16	0	1	0
129	63	64	153	2	16	0	1	0
130	64	65	152	2	16	0	1	0
131	65	66	151	2	16	0	1	0
132	66	67	150	2	16	0	1	0
133	67	68	149	2	16	0	1	0
134	68	69	148	2	16	0	1	0
135	155	156	61	2	16	0	1	0
136	154	155	62	2	16	0	1	0
137	153	154	63	2	16	0	1	0
138	152	153	64	2	16	0	1	0
139	151	152	65	2	16	0	1	0
140	150	151	66	2	16	0	1	0
141	149	150	67	2	16	0	1	0
142	148	149	68	2	16	0	1	0
143	1	89	99	2	17	0	1	0
144	99	11	1	2	17	0	1	0

E33 GROUP 1

INDEX	CONNECTED JOINTS			NMAT	NSECT	NNSW	NREF	SREF
	J1	J2	J3					
145	11	99	109	2	17	0	1	0
146	12	108	22	2	19	0	1	0
147	11	109	21	2	19	0	1	0
148	20	110	30	2	19	0	1	0
149	84	143	94	2	17	0	1	0
150	94	143	134	2	17	0	1	0
151	94	134	104	2	17	0	1	0
152	104	134	31	2	18	0	1	0
153	31	134	41	2	20	0	1	0
154	20	11	110	2	29	0	1	0
155	109	110	11	2	29	0	1	0
156	108	109	11	2	29	0	1	0
157	11	12	108	2	29	0	1	0
158	40	117	118	2	25	0	1	0
159	40	30	117	2	25	0	1	0
160	32	116	115	2	25	0	1	0
161	32	22	116	2	25	0	1	0
162	118	119	40	2	26	0	1	0
163	119	31	40	2	26	0	1	0
164	114	32	31	2	26	0	1	0
165	114	115	32	2	26	0	1	0
166	40	134	50	2	20	0	1	0
167	32	134	42	2	20	0	1	0
168	73	72	121	2	16	0	1	0
169	73	121	129	2	16	0	1	0
170	70	51	120	2	16	0	1	0
171	51	120	122	2	16	0	1	0
172	74	75	85	2	21	0	1	0
173	75	76	86	2	21	0	1	0
174	76	77	87	2	21	0	1	0
175	77	78	88	2	21	0	1	0
176	78	79	89	2	21	0	1	0
177	79	80	90	2	21	0	1	0
178	80	81	91	2	21	0	1	0
179	81	82	92	2	21	0	1	0
180	82	83	93	2	21	0	1	0
181	83	74	84	2	21	0	1	0
182	85	84	74	2	21	0	1	0
183	86	85	75	2	21	0	1	0
184	87	86	76	2	21	0	1	0
185	88	87	77	2	21	0	1	0
186	89	88	78	2	21	0	1	0
187	90	89	79	2	21	0	1	0
188	91	90	80	2	21	0	1	0
189	92	91	81	2	21	0	1	0
190	93	92	82	2	21	0	1	0
191	84	93	83	2	21	0	1	0
192	84	85	95	2	22	0	1	0

E33 GROUP 1
CONNECTED JOINTS

INDEX	J1	J2	J3	NMAT	NSECT	NNSW	NREF	SREF
193	85	86	96	2	22	0	1	0
194	86	87	97	2	22	0	1	0
195	87	88	98	2	22	0	1	0
196	88	89	99	2	22	0	1	0
197	89	90	100	2	22	0	1	0
198	90	91	101	2	22	0	1	0
199	91	92	102	2	22	0	1	0
200	92	93	103	2	22	0	1	0
201	93	84	94	2	22	0	1	0
202	95	94	84	2	22	0	1	0
203	96	95	85	2	22	0	1	0
204	97	96	86	2	22	0	1	0
205	98	97	87	2	22	0	1	0
206	99	98	88	2	22	0	1	0
207	100	99	89	2	22	0	1	0
208	101	100	90	2	22	0	1	0
209	102	101	91	2	22	0	1	0
210	103	102	92	2	22	0	1	0
211	94	103	93	2	22	0	1	0
212	94	95	105	2	23	0	1	0
213	95	96	106	2	23	0	1	0
214	96	97	107	2	23	0	1	0
215	97	98	108	2	23	0	1	0
216	98	99	109	2	23	0	1	0
217	99	100	110	2	23	0	1	0
218	100	101	111	2	23	0	1	0
219	101	102	112	2	23	0	1	0
220	102	103	113	2	23	0	1	0
221	103	94	104	2	23	0	1	0
222	105	104	94	2	23	0	1	0
223	106	105	95	2	23	0	1	0
224	107	106	96	2	23	0	1	0
225	108	107	97	2	23	0	1	0
226	109	108	98	2	23	0	1	0
227	110	109	99	2	23	0	1	0
228	111	110	100	2	23	0	1	0
229	112	111	101	2	23	0	1	0
230	113	112	102	2	23	0	1	0
231	104	113	103	2	23	0	1	0
232	104	105	114	2	24	0	1	0
233	105	106	115	2	24	0	1	0
234	106	107	116	2	24	0	1	0
235	107	108	22	2	24	0	1	0
236	108	109	21	2	25	0	1	0
237	109	110	30	2	24	0	1	0
238	110	111	117	2	24	0	1	0
239	111	112	118	2	24	0	1	0
240	112	113	119	2	24	0	1	0

E33 GROUP 1

CONNECTED JOINTS								
INDEX	J1	J2	J3	NMAT	NSECT	NNSW	NREF	SREF
241	113	104	31	2	24	0	1	0
242	114	31	104	2	24	0	1	0
243	115	114	105	2	24	0	1	0
244	116	115	106	2	24	0	1	0
245	22	116	107	2	24	0	1	0
246	21	22	108	2	24	0	1	0
247	30	21	109	2	24	0	1	0
248	117	30	110	2	24	0	1	0
249	118	117	111	2	24	0	1	0
250	119	118	112	2	24	0	1	0
251	31	119	113	2	24	0	1	0
252	122	123	131	2	28	0	1	0
253	123	124	132	2	27	0	1	0
254	124	125	133	2	27	0	1	0
255	125	41	134	2	27	0	1	0
256	41	126	135	2	27	0	1	0
257	126	127	136	2	27	0	1	0
258	127	128	137	2	27	0	1	0
259	128	129	138	2	28	0	1	0
260	131	130	122	2	28	0	1	0
261	132	131	123	2	27	0	1	0
262	133	132	124	2	27	0	1	0
263	134	133	125	2	27	0	1	0
264	135	134	41	2	27	0	1	0
265	136	135	126	2	27	0	1	0
266	137	136	127	2	27	0	1	0
267	138	137	128	2	28	0	1	0
268	130	131	140	2	28	0	1	0
269	131	132	141	2	27	0	1	0
270	132	133	142	2	27	0	1	0
271	133	134	143	2	27	0	1	0
272	134	135	144	2	27	0	1	0
273	135	136	145	2	27	0	1	0
274	136	137	146	2	27	0	1	0
275	137	138	147	2	28	0	1	0
276	140	139	130	2	28	0	1	0
277	141	140	131	2	27	0	1	0
278	142	141	132	2	27	0	1	0
279	143	142	133	2	27	0	1	0
280	144	143	134	2	27	0	1	0
281	145	144	135	2	27	0	1	0
282	146	145	136	2	27	0	1	0
283	147	146	137	2	28	0	1	0
284	148	149	158	2	29	0	1	0
285	149	150	159	2	30	0	1	0
286	150	151	160	2	30	0	1	0
287	151	152	161	2	30	0	1	0
288	152	153	162	2	30	0	1	0

E33 GROUP 1
CONNECTED JOINTS

INDEX	J1	J2	J3	NMAT	NSECT	NNSW	NREF	SREF
289	153	154	163	2	30	0	1	0
290	154	155	164	2	30	0	1	0
291	155	156	165	2	29	0	1	0
292	158	157	148	2	29	0	1	0
293	159	158	149	2	30	0	1	0
294	160	159	150	2	30	0	1	0
295	161	160	151	2	30	0	1	0
296	162	161	152	2	30	0	1	0
297	163	162	153	2	30	0	1	0
298	164	163	154	2	30	0	1	0
299	165	164	155	2	29	0	1	0
300	157	158	167	2	31	0	1	0
301	158	159	168	2	32	0	1	0
302	159	160	169	2	32	0	1	0
303	160	161	170	2	32	0	1	0
304	161	162	171	2	32	0	1	0
305	162	163	172	2	32	0	1	0
306	163	164	173	2	32	0	1	0
307	164	165	174	2	31	0	1	0
308	167	166	157	2	31	0	1	0
309	168	167	158	2	32	0	1	0
310	169	168	159	2	32	0	1	0
311	170	169	160	2	32	0	1	0
312	171	170	161	2	32	0	1	0
313	172	171	162	2	32	0	1	0
314	173	172	163	2	32	0	1	0
315	174	173	164	2	31	0	1	0
316	166	167	176	2	33	0	1	0
317	167	168	177	2	34	0	1	0
318	168	169	178	2	34	0	1	0
319	169	170	179	2	34	0	1	0
320	170	171	180	2	34	0	1	0
321	171	172	181	2	34	0	1	0
322	172	173	182	2	34	0	1	0
323	173	174	183	2	33	0	1	0
324	176	175	166	2	33	0	1	0
325	177	176	167	2	34	0	1	0
326	178	177	168	2	34	0	1	0
327	179	178	169	2	34	0	1	0
328	180	179	170	2	34	0	1	0
329	181	180	171	2	34	0	1	0
330	182	181	172	2	34	0	1	0
331	183	182	173	2	33	0	1	0
332	175	176	185	2	35	0	1	0
333	176	177	186	2	36	0	1	0
334	177	178	187	2	36	0	1	0
335	178	179	188	2	36	0	1	0
336	179	180	189	2	36	0	1	0

E33 GROUP 1

CONNECTED JOINTS				NMAT	NSECT	NNSW	NREF	SREF
INDEX	J1	J2	J3					
337	180	181	190	2	36	0	1	0
338	181	182	191	2	36	0	1	0
339	182	183	192	2	35	0	1	0
340	185	184	175	2	35	0	1	0
341	186	185	176	2	36	0	1	0
342	187	186	177	2	36	0	1	0
343	188	187	178	2	36	0	1	0
344	189	188	179	2	36	0	1	0
345	190	189	180	2	36	0	1	0
346	191	190	181	2	36	0	1	0
347	192	191	182	2	35	0	1	0
348	184	185	194	2	37	0	1	0
349	185	186	195	2	38	0	1	0
350	186	187	196	2	38	0	1	0
351	187	188	197	2	38	0	1	0
352	188	189	198	2	38	0	1	0
353	189	190	199	2	38	0	1	0
354	190	191	200	2	38	0	1	0
355	191	192	201	2	37	0	1	0
356	194	193	184	2	37	0	1	0
357	195	194	185	2	38	0	1	0
358	196	195	186	2	38	0	1	0
359	197	196	187	2	38	0	1	0
360	198	197	188	2	38	0	1	0
361	199	198	189	2	38	0	1	0
362	200	199	190	2	38	0	1	0
363	201	200	191	2	37	0	1	0
364	193	194	203	2	39	0	1	0
365	194	195	204	2	40	0	1	0
366	195	196	205	2	40	0	1	0
367	196	197	206	2	40	0	1	0
368	197	198	207	2	40	0	1	0
369	198	199	208	2	40	0	1	0
370	199	200	209	2	40	0	1	0
371	200	201	210	2	39	0	1	0
372	203	202	193	2	40	0	1	0
373	204	203	194	2	40	0	1	0
374	205	204	195	2	40	0	1	0
375	206	205	196	2	40	0	1	0
376	207	206	197	2	40	0	1	0
377	208	207	198	2	40	0	1	0
378	209	208	199	2	40	0	1	0
379	210	209	200	2	39	0	1	0
380	202	203	212	2	41	0	1	0
381	203	204	213	2	42	0	1	0
382	204	205	214	2	42	0	1	0
383	205	206	215	2	42	0	1	0
384	206	207	216	2	42	0	1	0

E33 GROUP 1

CONNECTED JOINTS

INDEX	J1	J2	J3	NMAT	NSECT	NNSW	NREF	SREF
385	207	208	217	2	42	0	1	0
386	208	209	218	2	42	0	1	0
387	209	210	219	2	41	0	1	0
388	212	211	202	2	41	0	1	0
389	213	212	203	2	42	0	1	0
390	214	213	204	2	42	0	1	0
391	215	214	205	2	42	0	1	0
392	216	215	206	2	42	0	1	0
393	217	216	207	2	42	0	1	0
394	218	217	208	2	42	0	1	0
395	219	218	209	2	41	0	1	0
396	211	212	221	2	43	0	1	0
397	212	213	222	2	44	0	1	0
398	213	214	223	2	44	0	1	0
399	214	215	224	2	44	0	1	0
400	215	216	225	2	44	0	1	0
401	216	217	226	2	44	0	1	0
402	217	218	227	2	44	0	1	0
403	218	219	228	2	43	0	1	0
404	221	220	211	2	43	0	1	0
405	222	221	212	2	44	0	1	0
406	223	222	213	2	44	0	1	0
407	224	223	214	2	44	0	1	0
408	225	224	215	2	44	0	1	0
409	226	225	216	2	44	0	1	0
410	227	226	217	2	44	0	1	0
411	228	227	218	2	43	0	1	0
412	220	221	230	2	45	0	1	0
413	221	222	231	2	46	0	1	0
414	222	223	232	2	46	0	1	0
415	223	224	233	2	46	0	1	0
416	224	225	234	2	46	0	1	0
417	225	226	235	2	46	0	1	0
418	226	227	236	2	46	0	1	0
419	227	228	237	2	45	0	1	0
420	230	229	220	2	45	0	1	0
421	231	230	221	2	46	0	1	0
422	232	231	222	2	46	0	1	0
423	233	232	223	2	46	0	1	0
424	234	233	224	2	46	0	1	0
425	235	234	225	2	46	0	1	0
426	236	235	226	2	46	0	1	0
427	237	236	227	2	45	0	1	0
428	139	140	236	2	47	0	1	0
429	140	141	235	2	48	0	1	0
430	141	142	234	2	48	0	1	0
431	142	143	233	2	48	0	1	0
432	143	144	232	2	48	0	1	0

E33 GROUP 1

CONNECTED JOINTS								
INDEX	J1	J2	J3	NMAT	NSECT	NNSW	NREF	SREF
433	144	145	231	2	48	0	1	0
434	145	146	230	2	48	0	1	0
435	146	147	229	2	47	0	1	0
436	236	237	139	2	47	0	1	0
437	235	236	140	2	48	0	1	0
438	234	235	141	2	48	0	1	0
439	233	234	142	2	48	0	1	0
440	232	233	143	2	48	0	1	0
441	231	232	144	2	48	0	1	0
442	230	231	145	2	48	0	1	0
443	229	230	146	2	47	0	1	0
444	403	409	176	2	49	0	1	0
445	176	167	403	2	49	0	1	0
446	392	403	167	2	49	0	1	0
447	167	158	392	2	49	0	1	0
448	383	392	158	2	49	0	1	0
449	158	149	383	2	49	0	1	0
450	372	383	149	2	49	0	1	0
451	149	69	372	2	49	0	1	0
452	361	372	69	2	49	0	1	0
453	69	121	361	2	49	0	1	0
454	350	361	121	2	49	0	1	0
455	121	128	350	2	49	0	1	0
456	339	350	128	2	49	0	1	0
457	328	339	128	2	49	0	1	0
458	128	137	328	2	49	0	1	0
459	317	328	137	2	49	0	1	0
460	137	146	317	2	49	0	1	0
461	306	317	146	2	49	0	1	0
462	146	230	306	2	49	0	1	0
463	295	306	230	2	49	0	1	0
464	230	221	295	2	49	0	1	0
465	284	295	221	2	49	0	1	0
466	221	212	284	2	49	0	1	0
467	273	284	212	2	49	0	1	0
468	212	203	273	2	49	0	1	0
469	262	273	203	2	49	0	1	0
470	203	194	262	2	49	0	1	0
471	253	262	194	2	49	0	1	0
472	194	185	253	2	49	0	1	0
473	409	253	185	2	49	0	1	0
474	596	602	191	2	49	0	1	0
475	191	200	596	2	49	0	1	0
476	585	596	200	2	49	0	1	0
477	200	209	585	2	49	0	1	0
478	576	585	209	2	49	0	1	0
479	209	218	576	2	49	0	1	0
480	565	576	218	2	49	0	1	0

E33 GROUP 1

CONNECTED JOINTS				NMAT	NSECT	NNSW	NREF	SREF
INDEX	J1	J2	J3					
481	218	227	565	2	49	0	1	0
482	554	565	227	2	49	0	1	0
483	227	236	554	2	49	0	1	0
484	543	554	236	2	49	0	1	0
485	236	140	543	2	49	0	1	0
486	532	543	140	2	49	0	1	0
487	140	131	532	2	49	0	1	0
488	521	532	131	2	49	0	1	0
489	131	123	521	2	49	0	1	0
490	510	521	123	2	49	0	1	0
491	499	510	123	2	49	0	1	0
492	123	120	499	2	49	0	1	0
493	488	499	120	2	49	0	1	0
494	120	61	488	2	49	0	1	0
495	477	488	61	2	49	0	1	0
496	61	155	477	2	49	0	1	0
497	466	477	155	2	49	0	1	0
498	155	164	466	2	49	0	1	0
499	455	466	164	2	49	0	1	0
500	164	173	455	2	49	0	1	0
501	446	455	173	2	49	0	1	0
502	173	182	446	2	49	0	1	0
503	602	446	182	2	49	0	1	0
504	182	191	602	2	49	0	1	0
505	185	176	409	2	49	0	1	0
506	243	244	254	2	50	0	1	0
507	256	245	244	2	51	0	1	0
508	257	246	245	2	51	0	1	0
509	246	247	257	2	51	0	1	0
510	249	250	258	2	51	0	1	0
511	250	251	259	2	51	0	1	0
512	251	252	260	2	51	0	1	0
513	252	253	261	1	52	0	1	0
514	255	254	244	2	50	0	1	0
515	255	256	244	2	51	0	1	0
516	256	257	245	2	51	0	1	0
517	258	248	249	2	51	0	1	0
518	259	258	250	2	51	0	1	0
519	260	259	251	2	51	0	1	0
520	261	260	252	2	51	0	1	0
521	262	261	253	1	52	0	1	0
522	254	255	263	2	50	0	1	0
523	255	265	256	2	51	0	1	0
524	256	266	257	2	51	0	1	0
525	257	267	247	2	51	0	1	0
526	247	248	267	2	51	0	1	0
527	248	258	268	2	51	0	1	0
528	258	259	269	2	51	0	1	0

E33 GROUP 1

CONNECTED JOINTS								
INDEX	J1	J2	J3	NMAT	NSECT	NNSW	NREF	SREF
529	259	260	270	2	51	0	1	0
530	260	261	271	2	51	0	1	0
531	261	262	272	1	52	0	1	0
532	264	263	255	2	50	0	1	0
533	264	265	255	2	51	0	1	0
534	265	266	256	2	51	0	1	0
535	266	267	257	2	51	0	1	0
536	268	267	248	2	51	0	1	0
537	269	268	258	2	51	0	1	0
538	270	269	259	2	51	0	1	0
539	271	270	260	2	51	0	1	0
540	272	271	261	2	51	0	1	0
541	273	272	262	1	52	0	1	0
542	263	264	274	2	50	0	1	0
543	264	276	265	2	51	0	1	0
544	265	277	266	2	51	0	1	0
545	266	278	267	2	51	0	1	0
546	267	268	278	2	51	0	1	0
547	268	269	279	2	51	0	1	0
548	269	270	280	2	51	0	1	0
549	270	271	281	2	51	0	1	0
550	271	272	282	2	51	0	1	0
551	272	273	283	1	52	0	1	0
552	275	274	264	2	50	0	1	0
553	275	276	264	2	51	0	1	0
554	276	277	265	2	51	0	1	0
555	277	278	266	2	51	0	1	0
556	279	278	268	2	51	0	1	0
557	280	279	269	2	51	0	1	0
558	281	280	270	2	51	0	1	0
559	282	281	271	2	51	0	1	0
560	283	282	272	2	51	0	1	0
561	284	283	273	1	52	0	1	0
562	274	275	285	2	50	0	1	0
563	287	276	275	2	51	0	1	0
564	288	277	276	2	51	0	1	0
565	289	278	277	2	51	0	1	0
566	278	279	289	2	51	0	1	0
567	279	280	290	2	51	0	1	0
568	280	281	291	2	51	0	1	0
569	281	282	292	2	51	0	1	0
570	282	283	293	2	51	0	1	0
571	283	284	294	1	52	0	1	0
572	286	285	275	2	50	0	1	0
573	286	287	275	2	51	0	1	0
574	287	288	276	2	51	0	1	0
575	288	289	277	2	51	0	1	0
576	290	289	279	2	51	0	1	0

E33 GROUP 1

INDEX	CONNECTED JOINTS			NMAT	NSECT	NNSW	NREF	SREF
	J1	J2	J3					
577	291	290	280	2	51	0	1	0
578	292	291	281	2	51	0	1	0
579	293	292	282	2	51	0	1	0
580	294	293	283	2	51	0	1	0
581	295	294	284	1	52	0	1	0
582	285	286	296	2	50	0	1	0
583	298	287	286	2	51	0	1	0
584	299	288	287	2	51	0	1	0
585	300	289	288	2	51	0	1	0
586	289	290	300	2	51	0	1	0
587	290	291	301	2	51	0	1	0
588	291	292	302	2	51	0	1	0
589	292	293	303	2	51	0	1	0
590	293	294	304	2	51	0	1	0
591	294	295	305	1	52	0	1	0
592	297	296	286	2	50	0	1	0
593	297	298	286	2	51	0	1	0
594	298	299	287	2	51	0	1	0
595	299	300	288	2	51	0	1	0
596	301	300	290	2	51	0	1	0
597	302	301	291	2	51	0	1	0
598	303	302	292	2	51	0	1	0
599	304	303	293	2	51	0	1	0
600	305	304	294	2	51	0	1	0
601	306	305	295	1	52	0	1	0
602	296	297	307	2	50	0	1	0
603	297	298	308	2	51	0	1	0
604	298	299	309	2	51	0	1	0
605	299	300	310	2	51	0	1	0
606	300	301	311	2	51	0	1	0
607	301	302	312	2	51	0	1	0
608	302	303	313	2	51	0	1	0
609	303	304	314	2	51	0	1	0
610	304	305	315	2	51	0	1	0
611	305	306	316	1	52	0	1	0
612	308	307	297	2	50	0	1	0
613	309	308	298	2	51	0	1	0
614	310	309	299	2	51	0	1	0
615	311	310	300	2	51	0	1	0
616	312	311	301	2	51	0	1	0
617	313	312	302	2	51	0	1	0
618	314	313	303	2	51	0	1	0
619	315	314	304	2	51	0	1	0
620	316	315	305	2	51	0	1	0
621	317	316	306	1	52	0	1	0
622	307	308	318	2	50	0	1	0
623	308	309	319	2	50	0	1	0
624	309	310	320	2	50	0	1	0

E33 GROUP 1

INDEX	CONNECTED JOINTS			NMAT	NSECT	NNSW	NREF	SREF
	J1	J2	J3					
625	310	311	321	2	50	0	1	0
626	311	312	322	2	50	0	1	0
627	312	313	323	2	50	0	1	0
628	313	314	324	2	50	0	1	0
629	314	315	325	2	50	0	1	0
630	315	316	326	2	50	0	1	0
631	316	317	327	1	52	0	1	0
632	319	318	308	2	50	0	1	0
633	320	319	309	2	50	0	1	0
634	321	320	310	2	50	0	1	0
635	322	321	311	2	50	0	1	0
636	323	322	312	2	50	0	1	0
637	324	323	313	2	50	0	1	0
638	325	324	314	2	50	0	1	0
639	326	325	315	2	50	0	1	0
640	327	326	316	2	50	0	1	0
641	328	327	317	1	52	0	1	0
642	329	330	318	2	50	0	1	0
643	330	331	319	2	50	0	1	0
644	331	332	320	2	50	0	1	0
645	332	333	321	2	50	0	1	0
646	333	334	322	2	50	0	1	0
647	334	335	323	2	50	0	1	0
648	335	336	324	2	50	0	1	0
649	336	337	325	2	50	0	1	0
650	337	338	326	2	50	0	1	0
651	338	339	327	1	52	0	1	0
652	319	318	330	2	50	0	1	0
653	320	319	331	2	50	0	1	0
654	321	320	332	2	50	0	1	0
655	322	321	333	2	50	0	1	0
656	323	322	334	2	50	0	1	0
657	324	323	335	2	50	0	1	0
658	325	324	336	2	50	0	1	0
659	326	325	337	2	50	0	1	0
660	327	326	338	2	50	0	1	0
661	328	327	339	1	52	0	1	0
662	340	341	329	2	50	0	1	0
663	341	342	330	2	51	0	1	0
664	342	343	331	2	51	0	1	0
665	343	344	332	2	51	0	1	0
666	344	345	333	2	51	0	1	0
667	345	346	334	2	51	0	1	0
668	346	347	335	2	51	0	1	0
669	347	348	336	2	51	0	1	0
670	348	349	337	2	51	0	1	0
671	349	350	338	1	52	0	1	0
672	330	329	341	2	50	0	1	0

E33 GROUP 1

CONNECTED JOINTS								
INDEX	J1	J2	J3	NMAT	NSECT	NNSW	NREF	SREF
673	331	330	342	2	51	0	1	0
674	332	331	343	2	51	0	1	0
675	333	332	344	2	51	0	1	0
676	334	333	345	2	51	0	1	0
677	335	334	346	2	51	0	1	0
678	336	335	347	2	51	0	1	0
679	337	336	348	2	51	0	1	0
680	338	337	349	2	51	0	1	0
681	339	338	350	1	52	0	1	0
682	351	352	340	2	50	0	1	0
683	342	341	352	2	51	0	1	0
684	342	353	343	2	51	0	1	0
685	343	354	344	2	51	0	1	0
686	355	356	344	2	51	0	1	0
687	356	357	345	2	51	0	1	0
688	357	358	346	2	51	0	1	0
689	358	359	347	2	51	0	1	0
690	359	360	348	2	51	0	1	0
691	360	361	349	1	52	0	1	0
692	341	340	352	2	50	0	1	0
693	342	352	353	2	51	0	1	0
694	343	353	354	2	51	0	1	0
695	344	354	355	2	51	0	1	0
696	345	344	356	2	51	0	1	0
697	346	345	357	2	51	0	1	0
698	347	346	358	2	51	0	1	0
699	348	347	359	2	51	0	1	0
700	349	348	360	2	51	0	1	0
701	350	349	361	1	52	0	1	0
702	362	363	351	2	50	0	1	0
703	353	352	363	2	51	0	1	0
704	353	364	354	2	51	0	1	0
705	354	365	355	2	51	0	1	0
706	366	367	355	2	51	0	1	0
707	367	368	356	2	51	0	1	0
708	368	369	357	2	51	0	1	0
709	369	370	358	2	51	0	1	0
710	370	371	359	2	51	0	1	0
711	371	372	360	1	52	0	1	0
712	352	351	363	2	50	0	1	0
713	353	363	364	2	51	0	1	0
714	354	364	365	2	51	0	1	0
715	355	365	366	2	51	0	1	0
716	356	355	367	2	51	0	1	0
717	357	356	368	2	51	0	1	0
718	358	357	369	2	51	0	1	0
719	359	358	370	2	51	0	1	0
720	360	359	371	2	51	0	1	0

E33 GROUP 1									
CONNECTED JOINTS									
INDEX	J1	J2	J3	NMAT	NSECT	NNSW	NREF	SREF	
721	361	360	372	1	52	0	1	0	
722	373	374	362	2	50	0	1	0	
723	364	363	374	2	51	0	1	0	
724	365	364	375	2	51	0	1	0	
725	366	365	376	2	51	0	1	0	
726	377	378	366	2	51	0	1	0	
727	378	379	367	2	51	0	1	0	
728	379	380	368	2	51	0	1	0	
729	380	381	369	2	51	0	1	0	
730	381	382	370	2	51	0	1	0	
731	382	383	371	1	52	0	1	0	
732	363	362	374	2	50	0	1	0	
733	364	374	375	2	51	0	1	0	
734	365	375	376	2	51	0	1	0	
735	366	376	377	2	51	0	1	0	
736	367	366	378	2	51	0	1	0	
737	368	367	379	2	51	0	1	0	
738	369	368	380	2	51	0	1	0	
739	370	369	381	2	51	0	1	0	
740	371	370	382	2	51	0	1	0	
741	372	371	383	1	52	0	1	0	
742	384	385	373	2	50	0	1	0	
743	375	374	385	2	51	0	1	0	
744	376	375	386	2	51	0	1	0	
745	377	376	387	2	51	0	1	0	
746	397	398	377	2	51	0	1	0	
747	398	388	378	2	51	0	1	0	
748	388	389	379	2	51	0	1	0	
749	389	390	380	2	51	0	1	0	
750	390	391	381	2	51	0	1	0	
751	391	392	382	1	52	0	1	0	
752	374	373	385	2	50	0	1	0	
753	375	385	386	2	51	0	1	0	
754	376	386	387	2	51	0	1	0	
755	377	387	397	2	51	0	1	0	
756	378	377	398	2	51	0	1	0	
757	379	378	388	2	51	0	1	0	
758	380	379	389	2	51	0	1	0	
759	381	380	390	2	51	0	1	0	
760	382	381	391	2	51	0	1	0	
761	383	382	392	1	52	0	1	0	
762	393	394	384	2	50	0	1	0	
763	386	385	394	2	51	0	1	0	
764	387	386	395	2	51	0	1	0	
765	396	397	387	2	51	0	1	0	
766	399	400	388	2	51	0	1	0	
767	400	401	389	2	51	0	1	0	
768	401	402	390	2	51	0	1	0	

ORIGINAL PAGE IS
OF POOR QUALITY

E33 GROUP 1

INDEX	CONNECTED JOINTS			NMAT	NSECT	NNSW	NREF	SREF
	J1	J2	J3					
769	402	403	391	1	52	0	1	0
770	385	384	394	2	50	0	1	0
771	386	394	395	2	51	0	1	0
772	387	395	396	2	51	0	1	0
773	388	398	399	2	51	0	1	0
774	389	388	400	2	51	0	1	0
775	390	389	401	2	51	0	1	0
776	391	390	402	2	51	0	1	0
777	392	391	403	1	52	0	1	0
778	393	394	404	2	50	0	1	0
779	394	395	405	2	51	0	1	0
780	401	402	407	2	51	0	1	0
781	402	403	408	1	52	0	1	0
782	405	404	394	2	50	0	1	0
783	406	405	395	2	51	0	1	0
784	408	407	402	2	51	0	1	0
785	409	408	403	1	52	0	1	0
786	244	243	404	2	50	0	1	0
787	245	244	405	2	51	0	1	0
788	252	251	407	2	51	0	1	0
789	253	252	408	1	52	0	1	0
790	404	405	244	2	50	0	1	0
791	405	406	245	2	51	0	1	0
792	407	408	252	2	51	0	1	0
793	408	409	253	1	52	0	1	0
794	395	396	411	2	51	0	1	0
795	411	406	395	2	51	0	1	0
796	406	411	410	2	51	0	1	0
797	396	397	411	2	51	0	1	0
798	412	411	397	2	51	0	1	0
799	397	398	412	2	51	0	1	0
800	413	412	398	2	51	0	1	0
801	398	399	413	2	51	0	1	0
802	414	413	399	2	51	0	1	0
803	399	400	414	2	51	0	1	0
804	415	414	400	2	51	0	1	0
805	400	401	415	2	51	0	1	0
806	416	415	401	2	51	0	1	0
807	407	416	401	2	51	0	1	0
808	410	417	406	2	51	0	1	0
809	406	417	245	2	51	0	1	0
810	245	417	246	2	51	0	1	0
811	247	246	417	2	51	0	1	0
812	417	418	247	2	51	0	1	0
813	248	247	418	2	51	0	1	0
814	418	419	248	2	51	0	1	0
815	249	248	419	2	51	0	1	0
816	419	420	249	2	51	0	1	0

E33 GROUP 1

CONNECTED JOINTS								
INDEX	J1	J2	J3	NMAT	NSECT	NNSW	NREF	SREF
817	250	249	420	2	51	0	1	0
818	420	421	250	2	51	0	1	0
819	251	250	421	2	51	0	1	0
820	421	416	251	2	51	0	1	0
821	416	407	251	2	51	0	1	0
822	422	429	423	2	53	0	1	0
823	423	430	424	2	53	0	1	0
824	424	431	425	2	53	0	1	0
825	425	432	426	2	53	0	1	0
826	426	433	427	2	53	0	1	0
827	427	434	428	2	53	0	1	0
828	430	423	429	2	53	0	1	0
829	431	424	430	2	53	0	1	0
830	432	425	431	2	53	0	1	0
831	433	426	432	2	53	0	1	0
832	434	427	433	2	53	0	1	0
833	435	428	434	2	53	0	1	0
834	423	412	422	2	53	0	1	0
835	424	411	423	2	53	0	1	0
836	425	410	424	2	53	0	1	0
837	426	417	425	2	53	0	1	0
838	427	418	426	2	53	0	1	0
839	428	419	427	2	53	0	1	0
840	413	422	412	2	53	0	1	0
841	412	423	411	2	53	0	1	0
842	411	424	410	2	53	0	1	0
843	410	425	417	2	53	0	1	0
844	417	426	418	2	53	0	1	0
845	418	427	419	2	53	0	1	0
846	436	437	447	2	54	0	1	0
847	449	438	437	2	51	0	1	0
848	450	439	438	2	51	0	1	0
849	439	440	450	2	51	0	1	0
850	442	443	451	2	51	0	1	0
851	443	444	452	2	51	0	1	0
852	444	445	453	2	51	0	1	0
853	445	446	454	1	52	0	1	0
854	448	447	437	2	54	0	1	0
855	448	449	437	2	51	0	1	0
856	449	450	438	2	51	0	1	0
857	451	441	442	2	51	0	1	0
858	452	451	443	2	51	0	1	0
859	453	452	444	2	51	0	1	0
860	454	453	445	2	51	0	1	0
861	455	454	446	1	52	0	1	0
862	447	448	456	2	54	0	1	0
863	448	458	449	2	51	0	1	0
864	449	459	450	2	51	0	1	0

E33 GROUP 1
CONNECTED JOINTS

INDEX	J1	J2	J3	NMAT	NSECT	NNSW	NREF	SREF
913	479	480	468	2	51	0	1	0
914	480	481	469	2	51	0	1	0
915	481	482	470	2	51	0	1	0
916	483	482	472	2	51	0	1	0
917	484	483	473	2	51	0	1	0
918	485	484	474	2	51	0	1	0
919	486	485	475	2	51	0	1	0
920	487	486	476	2	51	0	1	0
921	488	477	477	1	52	0	1	0
922	478	479	489	2	54	0	1	0
923	491	480	479	2	51	0	1	0
924	492	481	480	2	51	0	1	0
925	493	482	481	2	51	0	1	0
926	482	483	493	2	51	0	1	0
927	483	484	494	2	51	0	1	0
928	484	485	495	2	51	0	1	0
929	485	486	496	2	51	0	1	0
930	486	487	497	2	51	0	1	0
931	487	488	498	1	52	0	1	0
932	490	489	479	2	54	0	1	0
933	490	491	479	2	51	0	1	0
934	491	492	480	2	51	0	1	0
935	492	493	481	2	51	0	1	0
936	494	493	483	2	51	0	1	0
937	495	494	484	2	51	0	1	0
938	496	495	485	2	51	0	1	0
939	497	496	486	2	51	0	1	0
940	498	497	487	2	51	0	1	0
941	499	498	488	1	52	0	1	0
942	489	490	500	2	54	0	1	0
943	490	491	501	2	51	0	1	0
944	491	492	502	2	51	0	1	0
945	492	493	503	2	51	0	1	0
946	493	494	504	2	51	0	1	0
947	494	495	505	2	51	0	1	0
948	495	496	506	2	51	0	1	0
949	496	497	507	2	51	0	1	0
950	497	498	508	2	51	0	1	0
951	498	499	509	1	52	0	1	0
952	501	500	490	2	54	0	1	0
953	502	501	491	2	51	0	1	0
954	503	502	492	2	51	0	1	0
955	504	503	493	2	51	0	1	0
956	505	504	494	2	51	0	1	0
957	506	505	495	2	51	0	1	0
958	507	506	496	2	51	0	1	0
959	508	507	497	2	51	0	1	0
960	509	508	498	2	51	0	1	0

E33 GROUP 1

CONNECTED JOINTS				NMAT	NSECT	NNSW	NREF	SREF
INDEX	J1	J2	J3					
913	479	480	468	2	51	0	1	0
914	480	481	469	2	51	0	1	0
915	481	482	470	2	51	0	1	0
916	483	482	472	2	51	0	1	0
917	484	483	473	2	51	0	1	0
918	485	484	474	2	51	0	1	0
919	486	485	475	2	51	0	1	0
920	487	486	476	2	51	0	1	0
921	488	487	477	1	52	0	1	0
922	478	479	489	2	54	0	1	0
923	491	480	479	2	51	0	1	0
924	492	481	480	2	51	0	1	0
925	493	482	481	2	51	0	1	0
926	482	483	493	2	51	0	1	0
927	483	484	494	2	51	0	1	0
928	484	485	495	2	51	0	1	0
929	485	486	496	2	51	0	1	0
930	486	487	497	2	51	0	1	0
931	487	488	498	1	52	0	1	0
932	490	489	479	2	54	0	1	0
933	490	491	479	2	51	0	1	0
934	491	492	480	2	51	0	1	0
935	492	493	481	2	51	0	1	0
936	494	493	483	2	51	0	1	0
937	495	494	484	2	51	0	1	0
938	496	495	485	2	51	0	1	0
939	497	496	486	2	51	0	1	0
940	498	497	487	2	51	0	1	0
941	499	498	488	1	52	0	1	0
942	489	490	500	2	54	0	1	0
943	490	491	501	2	51	0	1	0
944	491	492	502	2	51	0	1	0
945	492	493	503	2	51	0	1	0
946	493	494	504	2	51	0	1	0
947	494	495	505	2	51	0	1	0
948	495	496	506	2	51	0	1	0
949	496	497	507	2	51	0	1	0
950	497	498	508	2	51	0	1	0
951	498	499	509	1	52	0	1	0
952	501	500	490	2	54	0	1	0
953	502	501	491	2	51	0	1	0
954	503	502	492	2	51	0	1	0
955	504	503	493	2	51	0	1	0
956	505	504	494	2	51	0	1	0
957	506	505	495	2	51	0	1	0
958	507	506	496	2	51	0	1	0
959	508	507	497	2	51	0	1	0
960	509	508	498	2	51	0	1	0

E33 GROUP 1

CONNECTED JOINTS									
INDEX	J1	J2	J3	NMAT	NSECT	NNSW	NREF	SREF	
961	510	509	499	1	52	0	1	0	
962	500	501	511	2	54	0	1	0	
963	501	502	512	2	50	0	1	0	
964	502	503	513	2	50	0	1	0	
965	503	504	514	2	50	0	1	0	
966	504	505	515	2	50	0	1	0	
967	505	506	516	2	50	0	1	0	
968	506	507	517	2	50	0	1	0	
969	507	508	518	2	50	0	1	0	
970	508	509	519	2	50	0	1	0	
971	509	510	520	1	52	0	1	0	
972	512	511	501	2	54	0	1	0	
973	513	512	502	2	50	0	1	0	
974	514	513	503	2	50	0	1	0	
975	515	514	504	2	50	0	1	0	
976	516	515	505	2	50	0	1	0	
977	517	516	506	2	50	0	1	0	
978	518	517	507	2	50	0	1	0	
979	519	518	508	2	50	0	1	0	
980	520	519	509	2	50	0	1	0	
981	521	520	510	1	52	0	1	0	
982	522	523	511	2	54	0	1	0	
983	523	524	512	2	50	0	1	0	
984	524	525	513	2	50	0	1	0	
985	525	526	514	2	50	0	1	0	
986	526	527	515	2	50	0	1	0	
987	527	528	516	2	50	0	1	0	
988	528	529	517	2	50	0	1	0	
989	529	530	518	2	50	0	1	0	
990	530	531	519	2	50	0	1	0	
991	531	532	520	1	52	0	1	0	
992	512	511	523	2	54	0	1	0	
993	513	512	524	2	50	0	1	0	
994	514	513	525	2	50	0	1	0	
995	515	514	526	2	50	0	1	0	
996	516	515	527	2	50	0	1	0	
997	517	516	528	2	50	0	1	0	
998	518	517	529	2	50	0	1	0	
999	519	518	530	2	50	0	1	0	
1000	520	519	531	2	50	0	1	0	
1001	521	520	532	1	52	0	1	0	
1002	533	534	522	2	54	0	1	0	
1003	534	535	523	2	51	0	1	0	
1004	535	536	524	2	51	0	1	0	
1005	536	537	525	2	51	0	1	0	
1006	537	538	526	2	51	0	1	0	
1007	538	539	527	2	51	0	1	0	
1008	539	540	528	2	51	0	1	0	

E33 GROUP 1

INDEX	CONNECTED JOINTS			NMAT	NSECT	NNSW	NREF	SREF
	J1	J2	J3					
1009	540	541	529	2	51	0	1	0
1010	541	542	530	2	51	0	1	0
1011	542	543	531	1	52	0	1	0
1012	523	522	534	2	54	0	1	0
1013	524	523	535	2	51	0	1	0
1014	525	524	536	2	51	0	1	0
1015	526	525	537	2	51	0	1	0
1016	527	526	538	2	51	0	1	0
1017	528	527	539	2	51	0	1	0
1018	529	528	540	2	51	0	1	0
1019	530	529	541	2	51	0	1	0
1020	531	530	542	2	51	0	1	0
1021	532	531	543	1	52	0	1	0
1022	544	545	533	2	54	0	1	0
1023	535	534	545	2	51	0	1	0
1024	535	546	536	2	51	0	1	0
1025	536	547	537	2	51	0	1	0
1026	548	549	537	2	51	0	1	0
1027	549	550	538	2	51	0	1	0
1028	550	551	539	2	51	0	1	0
1029	551	552	540	2	51	0	1	0
1030	552	553	541	2	51	0	1	0
1031	553	554	542	1	52	0	1	0
1032	534	533	545	2	54	0	1	0
1033	535	545	546	2	51	0	1	0
1034	536	546	547	2	51	0	1	0
1035	537	547	548	2	51	0	1	0
1036	538	537	549	2	51	0	1	0
1037	539	538	550	2	51	0	1	0
1038	540	539	551	2	51	0	1	0
1039	541	540	552	2	51	0	1	0
1040	542	541	553	2	51	0	1	0
1041	543	542	554	1	52	0	1	0
1042	555	556	544	2	54	0	1	0
1043	546	545	556	2	51	0	1	0
1044	546	557	547	2	51	0	1	0
1045	547	558	548	2	51	0	1	0
1046	559	560	548	2	51	0	1	0
1047	560	561	549	2	51	0	1	0
1048	561	562	550	2	51	0	1	0
1049	562	563	551	2	51	0	1	0
1050	563	564	552	2	51	0	1	0
1051	564	565	553	1	52	0	1	0
1052	545	544	556	2	54	0	1	0
1053	546	556	557	2	51	0	1	0
1054	547	557	558	2	51	0	1	0
1055	548	558	559	2	51	0	1	0
1056	549	548	560	2	51	0	1	0

E33 GROUP 1

CONNECTED JOINTS								
INDEX	J1	J2	J3	NMAT	NSECT	NNSW	NREF	SREF
1057	550	549	561	2	51	0	1	0
1058	551	550	562	2	51	0	1	0
1059	552	551	563	2	51	0	1	0
1060	553	552	564	2	51	0	1	0
1061	554	553	565	1	52	0	1	0
1062	566	567	555	2	54	0	1	0
1063	557	556	567	2	51	0	1	0
1064	558	557	568	2	51	0	1	0
1065	559	558	569	2	51	0	1	0
1066	570	571	559	2	51	0	1	0
1067	571	572	560	2	51	0	1	0
1068	572	573	561	2	51	0	1	0
1069	573	574	562	2	51	0	1	0
1070	574	575	563	2	51	0	1	0
1071	575	576	564	1	52	0	1	0
1072	556	555	567	2	54	0	1	0
1073	557	567	568	2	51	0	1	0
1074	558	568	569	2	51	0	1	0
1075	559	569	570	2	51	0	1	0
1076	560	559	571	2	51	0	1	0
1077	561	560	572	2	51	0	1	0
1078	562	561	573	2	51	0	1	0
1079	563	562	574	2	51	0	1	0
1080	564	563	575	2	51	0	1	0
1081	565	564	576	1	52	0	1	0
1082	577	578	566	2	54	0	1	0
1083	568	567	578	2	51	0	1	0
1084	569	568	579	2	51	0	1	0
1085	570	569	580	2	51	0	1	0
1086	590	591	570	2	51	0	1	0
1087	591	581	571	2	51	0	1	0
1088	581	582	572	2	51	0	1	0
1089	582	583	573	2	51	0	1	0
1090	583	584	574	2	51	0	1	0
1091	584	585	575	1	52	0	1	0
1092	567	566	578	2	54	0	1	0
1093	568	578	579	2	51	0	1	0
1094	569	579	580	2	51	0	1	0
1095	570	580	590	2	51	0	1	0
1096	571	570	591	2	51	0	1	0
1097	572	571	581	2	51	0	1	0
1098	573	572	582	2	51	0	1	0
1099	574	573	583	2	51	0	1	0
1100	575	574	584	2	51	0	1	0
1101	576	575	585	1	52	0	1	0
1102	586	587	577	2	54	0	1	0
1103	579	578	587	2	51	0	1	0
1104	580	579	588	2	51	0	1	0

E33 GROUP 1

CONNECTED JOINTS								
INDEX	J1	J2	J3	NMAT	NSECT	NNSW	NREF	SREF
1105	589	590	580	2	51	0	1	0
1106	592	593	581	2	51	0	1	0
1107	593	594	582	2	51	0	1	0
1108	594	595	583	2	51	0	1	0
1109	595	596	584	1	52	0	1	0
1110	578	577	587	2	54	0	1	0
1111	579	587	588	2	51	0	1	0
1112	580	588	589	2	51	0	1	0
1113	581	591	592	2	51	0	1	0
1114	582	581	593	2	51	0	1	0
1115	583	582	594	2	51	0	1	0
1116	584	583	595	2	51	0	1	0
1117	585	584	596	1	52	0	1	0
1118	586	587	597	2	54	0	1	0
1119	587	588	598	2	51	0	1	0
1120	594	595	600	2	51	0	1	0
1121	595	596	601	1	52	0	1	0
1122	598	597	587	2	54	0	1	0
1123	599	598	588	2	51	0	1	0
1124	601	600	595	2	51	0	1	0
1125	602	601	596	1	52	0	1	0
1126	437	436	597	2	54	0	1	0
1127	438	437	598	2	51	0	1	0
1128	445	444	600	2	51	0	1	0
1129	446	445	601	1	52	0	1	0
1130	597	598	437	2	54	0	1	0
1131	598	599	438	2	51	0	1	0
1132	600	601	445	2	51	0	1	0
1133	601	602	446	1	52	0	1	0
1134	588	589	604	2	51	0	1	0
1135	604	599	588	2	51	0	1	0
1136	599	604	603	2	51	0	1	0
1137	589	590	604	2	51	0	1	0
1138	605	604	590	2	51	0	1	0
1139	590	591	605	2	51	0	1	0
1140	419	605	591	2	51	0	1	0
1141	591	592	419	2	51	0	1	0
1142	420	419	592	2	51	0	1	0
1143	592	593	420	2	51	0	1	0
1144	421	420	593	2	51	0	1	0
1145	593	594	421	2	51	0	1	0
1146	416	421	594	2	51	0	1	0
1147	600	416	594	2	51	0	1	0
1148	603	606	599	2	51	0	1	0
1149	599	606	438	2	51	0	1	0
1150	438	606	439	2	51	0	1	0
1151	440	439	606	2	51	0	1	0
1152	606	607	440	2	51	0	1	0

E33 GROUP 1

CONNECTED JOINTS								
INDEX	J1	J2	J3	NMAT	NSECT	NNSW	NREF	SREF
1153	441	440	607	2	51	0	1	0
1154	607	413	441	2	51	0	1	0
1155	442	441	413	2	51	0	1	0
1156	413	414	442	2	51	0	1	0
1157	443	442	414	2	51	0	1	0
1158	414	415	443	2	51	0	1	0
1159	444	443	415	2	51	0	1	0
1160	415	416	444	2	51	0	1	0
1161	416	600	444	2	51	0	1	0
1162	428	435	608	2	53	0	1	0
1163	608	613	609	2	53	0	1	0
1164	609	614	610	2	53	0	1	0
1165	610	615	611	2	53	0	1	0
1166	611	616	612	2	53	0	1	0
1167	612	617	422	2	53	0	1	0
1168	613	608	435	2	53	0	1	0
1169	614	609	613	2	53	0	1	0
1170	615	610	614	2	53	0	1	0
1171	616	611	615	2	53	0	1	0
1172	617	612	616	2	53	0	1	0
1173	429	422	617	2	53	0	1	0
1174	608	605	428	2	53	0	1	0
1175	609	604	608	2	53	0	1	0
1176	610	603	609	2	53	0	1	0
1177	611	606	610	2	53	0	1	0
1178	612	607	611	2	53	0	1	0
1179	422	413	612	2	53	0	1	0
1180	419	428	605	2	53	0	1	0
1181	605	608	604	2	53	0	1	0
1182	604	609	603	2	53	0	1	0
1183	603	610	606	2	53	0	1	0
1184	606	611	607	2	53	0	1	0
1185	607	612	413	2	53	0	1	0
STOP ELD			8.636		42	8	4	4

@XQT E

G .38600000+03
 E 211 DATA SPACE= 20000, DATE/TIME= 851008.180054
 T= .10000-19 -.10000-02 .10000-04 .10000+01
 .20000+03 .10000-03 .10000-03 .10000-03
 ERROR LEVELS= 2 2 0 2 2 2 2 2

ELEMENT GEOMETRY ERROR SUMMARY

ERROR CODE	ERROR FLAG	TEST VALUE	ERROR COUNT	TEST DESCRIPTION
3	0	.100-04	32	WARPED 4-NODE SURFACE

TYPE	GROUP	L. VOL OR AREA SUM	STRUCTURAL WEIGHT	NON-STRUCTURAL WEIGHT
E21	1	.580744+02	.178057+02	.000000
E43	1	.685034+02	.490634+01	.000000
E43	2	.325628+03	.118203+03	.000000
E43	ALL	.394131+03	.123109+03	.000000
E33	1	.119831+04	.113772+03	.000000

TOTAL .254686+03 .000000

TOTAL 2-NODE: .5807442+02
 TOTAL 3-NODE: .1198308+04
 TOTAL 4-NODE: .3941312+03
 STOP E 11.933 39 82 11 16

EXQT TAN

TAN 211 DATA SPACE= 30000, DATE/TIME= 851008 180107
 NO. OF 2-NODE ELEMENTS= 47
 NO. OF 3-NODE ELEMENTS= 1185
 NO. OF 4-NODE ELEMENTS= 90
 TOTAL NO. OF ELEMENTS= 1322
 MAXCON, MAXSUB, ILMAX= 181 2000 62
 TSIZE, IC3= 137 2833
 TANY: LMAP, LAST, F= 4292 8992 .678
 IC1, IC2, IC3= 612419 26477 2833
 INV BLOCK SIZE, TOTAL SIZE= 7168 1132544 P 1
 MAX, AVERAGE JOINT CONNECTIVITY= 62, 39.8
 STOP TAN 16.039 94 156 12 21

EXQT EKS

EKS 211 DATA SPACE= 16000, DATE/TIME= 851008 180126
 E21 COMPLETED
 E43 COMPLETED
 E33 COMPLETED
 STOP EKS 69.364 30 35 6 7

EXQT K

SPDP= 2
 CORE= 30000
 CM CHANGED TO 30000
 K 211 DATA SPACE= 30000, DATE/TIME= 851008 180605
 STOP K 82.858 55 1349 5 9

@XQT E4

NMOD= 20
 NREQ= 15
 E4 211 DATA SPACE= 12000, DATE/TIME= 851008 180710

SHIFT 1, C= .0000000
 CM CHANGED TO 35000

NO. OF SINGULARITIES= 0
 NO. OF NEGATIVE DIAG. TERMS= 0
 CM CHANGED TO 140000
 CONV: 4 1 1 .46396451+07
 CONV: 4 2 2 .67877898+07

SHIFT 2, C= .1233815+08
 CM CHANGED TO 30629

NO. OF SINGULARITIES= 0
 NO. OF NEGATIVE DIAG. TERMS= 3
 CM CHANGED TO 140000
 CONV: 6 1 3 .11258535+08
 CONV: 6 2 4 .13957347+08
 CONV: 6 3 5 .18679277+08
 CONV: 6 4 6 .36078368+08
 CONV: 8 1 7 .48622751+08
 CONV: 8 2 8 .60418840+08
 CONV: 10 1 9 .72960656+08
 CONV: 10 4 10 .11431131+09
 CONV: 12 1 11 .90613981+08
 CONV: 14 1 12 .10460507+09
 CONV: 16 1 13 .13639630+09
 CONV: 18 1 14 .14205290+09
 CONV: 20 1 15 .15516206+09
 CONV: 22 1 16 .16053853+09
 CONV: 24 1 17 .18082719+09

SHIFT 3, C= .1984349+09
 CM CHANGED TO 30629

NO. OF SINGULARITIES= 0
 NO. OF NEGATIVE DIAG. TERMS= 18
 CM CHANGED TO 140000
 ** NMODES TOO SMALL FOR CONVERGED ROOT TO BE STORED: 4 .22285587+09
 ** NMODES TOO SMALL FOR CONVERGED ROOT TO BE STORED: 5 .22779943+09
 ** NMODES TOO SMALL FOR CONVERGED ROOT TO BE STORED: 6 .23885036+09
 ** NMODES TOO SMALL FOR CONVERGED ROOT TO BE STORED: 7 .25652900+09
 CONV: 26 1 18 .18840222+09
 CONV: 26 2 19 .21348396+09
 CONV: 26 3 20 .21868624+09

EIGENVALUE APPROXIMATION STATUS, LAST WORKING SET:

ITERATION= 26 ITERATION= 25 CONVERGED

1	.18840222+09	.18840222+09	YES
2	.21348396+09	.21348396+09	YES
3	.21868624+09	.21868624+09	YES

4	.22285587+09	.22285587+09	NO
5	.22779943+09	.22779943+09	NO
6	.23885036+09	.23885041+09	NO
7	.25652900+09	.25652924+09	NO
8	.27720319+09	.27720424+09	NO
9	.29863986+09	.29866452+09	NO
10	.30787816+09	.30843207+09	NO
11	.31389218+09	.31403715+09	NO
12	.34670257+09	.34770100+09	NO
13	.35928047+09	.36510712+09	NO
14	.39767076+09	.40229721+09	NO
15	.42395186+09	.46496490+09	NO
16	.47659819+09	.10268169+10	NO

MODE	EIGENVALUE	FREQ (HZ)
1	.46396451+07	342.817146
2	.67877898+07	414.652554
3	.11258535+08	534.024399
4	.13957347+08	594.595459
5	.18679277+08	687.860207
6	.36078368+08	955.968529
7	.48622751+08	1109.787720
8	.60418840+08	1237.104385
9	.72960656+08	1359.454010
10	.90613981+08	1515.017868
11	.10460507+09	1627.783081
12	.11431131+09	1701.628510
13	.13639630+09	1858.751968
14	.14205290+09	1896.903336
15	.15516206+09	1982.498718
16	.16053853+09	2016.553711
17	.18082719+09	2140.188477
18	.18840222+09	2184.555878
19	.21348396+09	2325.427338
20	.21868624+09	2353.590393

18 = NO. OF EIGENVALUES BELOW LAST SHIFT POINT.

XI*M*XJ ACCURACY TEST:

AVERAGE ERROR= .56069654-08
 MAXIMUM ERROR= .74505806-07, I,J= 5 5
 TOTAL NUMBER OF QUALIFYING ERROR TERMS= 0
 LOWEST QUALIFYING MODE= 0
 CM CHANGED TO 12000
 STOP E4 4807.427 2161 22530 26 41

⊙XOT DCU
 DCU 211 DATA SPACE= 20000, DATE/TIME= 851008 214637

TABLE OF CONTENTS, LIBRARY 1

HPOTP TEST ARTICLE

SEQ	RR	DATE	TIME	E	WORDS	NJ	NI*NJ	T	DATA SET	NAME	N3	N4
1	17	851008	180022	0	18	1	18	0	JDF1	BTAB	1	8
2	-18	851008	180022	0	665	665	665	0	JREF	BTAB	2	6
3	-42	851008	180022	0	12	1	12	-1	ALTR	BTAB	2	4
4	43	851008	180022	0	665	1	665	0	JSEQ	BTAB	2	17
5	67	851008	180022	0	665	1	665	0	SEQ	BTAB	2	170
6	91	851008	180022	0	18	1	18	4	NDAL		0	0
7	92	851008	180022	0	72	6	72	-1	ALTR	BTAB	2	4
8	95	851008	180022	0	1995	665	1995	-1	JLOC	BTAB	2	5
9	167	851008	180022	0	665	665	665	0	JREF	BTAB	2	6
10	191	851008	180022	0	40	4	40	-1	MATC	BTAB	2	2
11	193	851008	180022	0	665	665	665	0	CON		1	0
12	217	851008	180022	0	40	8	40	-1	MREF	BTAB	2	7
13	219	851008	180022	0	210	6	210	-1	BA	BTAB	2	9
14	227	851008	180022	0	2537	59	2537	-1	SA	BTAB	2	13
15	318	851008	180022	0	5985	665	5985	-1	QJUT	BTAB	2	19
16	532	851008	180041	0	846	49	882	0	DEF	E21	1	2
17	564	851008	180041	0	2	1	2	0	GD	E21	1	2
18	565	851008	180041	0	15	1	15	4	GTIT	E21	1	2
19	566	851008	180041	0	20	1	20	0	DIR	E21	1	2
20	567	851008	180041	0	1440	56	896	0	DEF	E43	11	4
21	631	851008	180041	0	4	2	4	0	GD	E43	11	4
22	632	851008	180041	0	30	2	30	4	GTIT	E43	11	4
23	634	851008	180041	0	20	1	20	0	DIR	E43	11	4
24	635	851008	180041	0	17775	59	885	0	DEF	E33	8	3
25	1307	851008	180041	0	2	1	2	0	GD	E33	8	3
26	1308	851008	180041	0	15	1	15	4	GTIT	E33	8	3
27	1309	851008	180041	0	20	1	20	0	DIR	E33	8	3
28	1310	851008	180041	0	3	3	3	4	ELTS	NAME	0	0
29	1311	851008	180041	0	3	3	3	0	ELTS	NNOD	0	0
30	1312	851008	180041	0	3	3	3	0	ELTS	ISCT	0	0
31	1313	851008	180041	0	45	3	45	0	NS		0	0
32	1315	851008	180126	0	6580	47	140	4	E21	EFIL	1	2
33	1564	851008	180126	0	40320	90	448	4	E43	EFIL	11	4
34	3004	851008	180126	0	298620	1185	252	4	E33	EFIL	8	3
35	13669	851008	180054	0	3990	665	3990	-1	DEM	DIAG	0	0
36	13812	851008	180107	0	25088	665	1792	0	KMAP	TOPO	2833	137
37	14708	851008	180107	0	28672	1	1792	0	TAN	IMAP	0	0
38	15732	851008	180107	0	9	9	9	0	TAN	STAT	0	0
39	15733	851008	180107	0	18960	10	1200	0	TAN	TBCT	0	0
40	16413	851008	180107	0	8	8	8	0	TAN	PBCT	0	0
41	16414	851008	180605	0	109760	665	2240	2	K	SPAR	36	0
42	24254	851008	180710	0	79800	665	3990	-1	VIBR	MODE	1	1
43	27114	851008	180710	0	79800	665	3990	-1	VIBR	MMOD	1	1
44	29974	851008	180710	0	20	1	20	-1	VIBR	EVAL	1	1
45	29975	851008	180710	0	13	1	13	0	VIBR	STAT	1	1
STOP	DCU		4807.503		3	9		2		7		

⊙FIN

RUNID: LOXPMP ACCT: 6EP553450032 PROJECT: MFOLEYBIN202

LOXPMP FIN

TIME: TOTAL: 02:05:30.390 CBSUPS: 9445837578
CPU: 01:20:07.504 I/O: 00:44:11.606
CC/ER: 00:01:11.279 WAIT: 00:00:00.000

IMAGES READ: 2306 PAGES: 117

START: 18:00:06 OCT 08, 1985 FIN: 21:46:39 OCT 08, 1985

*****ATTENTION ALL USERS*****

***** TENTATIVE SPERRY HOLIDAY SHUTDOWN *****
* FROM 1600 HRS ON SAT OCT 12 UNTIL 0700 TUES OCT 15. ANY QUESTIONS OR *
* PROBLEMS WITH THIS SCHEDULE, PLEASE CONTACT DENNIS CLEM AT 453-4974 *

** FOR USER PROBLEM ON THE SPERRY 1100 SYSTEM CALL SPERRY PERSONNEL AT 3-3762 **

Appendix C
CRAIG-BAMPTON PROCEDURE LISTING

```

NMCB=0
VPRT=NO
NEWS=1
CONR=1
*DATA(29 "SSID" DATA 1)
#
!BLANK='
!TNAM='DEM
!TEST=EQUAL(MNAM,TNAM): !CEM=0
*
!CEM=1# CONRISTENT MASS MATRIX
*
!E4CB="EIG"
!TEST=EQUAL(SPDP,TWO)
*
!E4CB="E4"
*
JNZ(TEST,1100)
LABEL 1100
JZ(TEST,1200)
LABEL 1200
*XQT AUS
TABLE(NI=1,NJ=1): "SSID" CB
*XQT TAB
*DATA(TAB)
UPDATE=1: CON="CONR": NONZERO 1 2 3 4 5 6
*DATA(BN)
DC FLAG CON "BLANK",*,B
*XQT ELD
*DATA(ELD)
#
# FORM THE SUBSTRUCTURE K AND M MATRICES:
#
*CALL("LPLA" SPREP)
!KNAM='K
*CALL("LPLA" FACTOR)
*
JZ(NMCB,1800)
#
# SUBSTRUCTURE EIGENVALUE ANALYSIS FOR CRAIG-BAMPTON METHOD.
#
!TEST=EQUAL(E4CB,EIG)
*
JZ(TEST,1400)
*XQT U1
*REGISTER EXCEPTIONS OPT, MNAM, KNAM, CONR, NEWS, NMCB
*REGISTER STORE(29 REGI CB 1 1)
!IZER=0
*RGI
NDYN=8
INIT=0
L1=0
L2=0
INLI=0
OLDS=1
*DATA,OPT(EIG RESETS)
*XQT EIG
RESET NDYN="NDYN", K="KNAM", M="MNAM", CON="CONR"
RESET NEWSSET="NEWS"
!TEST=EQUAL(INLIB, IZER)

```



```

*FREE 1,20
*
*
* (29 CB ASSE 0 0)
#
# THIS PROCEDURE IS DRIVEN BY THE DATA SETS RESIDING IN LIBRARY 10.
# SUBSTRUCTURE M AND K MATRICES RESIDING IN LIB 9 ARE ASSEMBLED BY
# SYN INTO SYSTEM M AND K MATRICES ON LIB 1.
#
*XQTC U1
*REGISTER EXCEPTIONS
*REGISTER STORE( 29 REGI HOUSE 1 1)
#
!OPT=0
*RGI
  CON=1
  TOLM=1.E-30
  TOLK=1.E-30
  TOLR=1.E-5
*DATA,OPT(29 SYN RESETS)
*XQT SYN
  RESET LIBA=10, CON="CON", TOLM="TOLM", TOLK="TOLK"
  RESET TOLR="TOLR"
  !ISEQ=0
*
!SSID=TOC,N2(10 SJC MASK MASK MASK),ISEQ: !JSEQ=ISEQ-1
*
!NREF=TOC,N3(10 SJC "SSID" MASK MASK),JSEQ
#
# SUBSTRUCTURE DEFINED BY SSID AND NREF.
#
"SSID" 9 "NREF"
*DATA(10 SJC "SSID" "NREF" MASK)
*
*
*QTC U1
*REGISTER RETRIEVE(29 REGI HOUSE 1 1)
*
*
* (29 CB STRP 0 0)
#
# SYSTEM EIGENVALUE ANALYSIS
#
*XQTC U1
*REGISTER EXCEPTIONS
*REGISTER STORE( 29 REGI HOUSE 1 1)
#
!OPT=0
*RGI
  FRQ1=-1.E+10
  FRQ2=1.E+10
  PRT=0
*DATA,OPT(29 STRP RESETS)
*XQT STRP

```

RETURN
ENDSUBS
ENDASSE

LABEL 1000
JLZ(ISEQ,2000)

JUMP 1000
LABEL 2000

RETURN
ENDASSE
ENDSTRP

```

      RESET FRQ1="FRQ1", FRQ2="FRQ2", PRT="PRT"
*XQT U3
  RP2
  !TWOP=ATAN(1.): !TWOP=8.*TWOP
  !NMAX=TOC,NI(1 SYS EVAL MASK MASK)
  NUMBER OF FORMATS=3
#
  FORMAT 1'(33H1MODE          EIGENVALUE  FREQ (HZ))
  FORMAT 2'(1H )
  FORMAT 3'(1X,I4,1X,E15.8,1X,F13.6)
#
  PRINT(1)
  PRINT(2)
  !MODE=1
*
  !VAL=DS,"MODE",1,1(1 SYS EVAL 0 0)
  !HZ=VAL**.5/TWOP
#
  PRINT(3) "MODE", "VAL", "HZ"
  !MODE=MODE+1
*
  PRINT(2)
#
*XQT U1
*REGISTER RETRIEVE(29 REGI HOUSE 1 1)
*
*
* (29 CB SSBT 0 0)
#
# THIS PROCEDURE BACK TRANSFORMS FROM SYSTEM EIGENVECTORS
# (LABELED ELEMENT FORMAT) TO SUBSTRUCTURE EIGENVECTORS
# (SYSVEC FORMAT) EACH SUBSTRUCTURE FOR WHICH A DATA SET
# NAMED (SJC "SSID" "NREF") RESIDES IN LIB 10 IS PROCESSED.
#
*XQTC U1
*REGISTER EXCEPTIONS
*REGISTER STORE(29 REGI HOUSE 1 1)
#
# DEFAULT REGISTERS:
  !OPT=0
  !ISEQ=0
  !NMAX=TOC,NI(1 SYS EVAL MASK MASK),ISEQ
  !NM2="NMAX"
#
# RGI
  NM1=      1 # MODE START NUMBER
#
  NM2=      NMAX # MODE STOP NUMBER
*DATA,OPT(SSBT OPTIONS)
  !NM1=ABS(NM1)
  !NM2=ABS(NM2)
  !NTMP=NMAX-NM2
*
  !NM2=NMAX
*
  !NTMP=NM2-NM1

```

LABEL 1000

JGZ,-1(NMAX,1000)

RETURN
ENDSTRP
ENDSSBT

JGZ(NTMP,100)

LABEL 100

```

*
*           !NM1=NM2
*
*           JGZ(NTMP,200)
*
*           LABEL 200
*XQT AUS
  DEFINE VAL=SYS EVAL 0 0 "NM1","NM2"
  10 VIBR EVAL 0 0=UNION(VAL)
  10 VIBR FREQ 0 0= SQRT(.0253303 VAL)
*XQT SSBT
  MODES="NM1","NM2"
  !ISEQ=0
*
*           LABEL 1000
*           !SSID=TOC,N2(10 SJC MASK MASK MASK),ISEQ: !JSEQ=ISEQ-1
*           JLZ( ISEQ,2000)
*
*           !NREF=TOC,N3(10 SJC "SSID" MASK MASK),JSEQ
#
# SUBSTRUCTURE DEFINED VIA SSID AND NREF:
#
#           "SSID" 9 10 "NREF" 10
*
*           JUMP 1000
*           LABEL 2000
*XQT U1
*REGISTER RETRIEVE(29 REGI HOUSE 1 1)
*
*           RETURN
*           ENDSBT
*           ENDVPRT
*
* (29 CB VPRT 0 0)
#
# THIS PROCEDURE SIMULATES VPRT PRINTOUT FOR EACH SUBSTRUCTURE
# FOR WHICH A DATA SET NAMED (VPRT "SSID" "NREF") RESIDES IN
# LIB 10.
#
*XQT U1
*REGISTER EXCEPTIONS
*REGISTER STORE(29 REGI HOUSE 1 1)
*LIBS 2 1 3 4 5 6 7 8 9 10 11 12 13 14 15 16 17 18 19 20
#
# DEFAULT REGISTERS:
  !OPT=0
*RGI
  CONR=      1 # CONSTRAINT CONDITION
*DATA,OPT(VPRT PARAMETERS)
  !BLANK='
  !IFMT=1: !ISEQ=0: !CBOL=0
*
*           LABEL 1000
*           !SSID=TOC,N2(10 VPRT MASK MASK MASK),ISEQ: !JSEQ=ISEQ-1
*           JLZ( ISEQ,2000)
*
*           !TEST=EQUAL(SSID,CBOL)# =0 FOR NO EQUALITY
*           JNZ( TEST,1100)
#
# NEW SUBSTRUCTURE SSID:
#
*XQT DCU
  LIBLIB=3: RETRIEVE 1 LIB "SSID" 1 1: !CBOL=SSID
  !IERR=TOC,IERR(1 FLAG CON "CONR" 0)
*
*           JZ( IERR,1100)

```

