

PRELIMINARY FLOOR, SEAT,
AND DUMMY DATA

Mark R. Cannon
Richard E. Zimmerman
Simula Inc.
Phoenix, Arizona

NASA/FAA Government/Industry CID Workshop
NASA Langley Research Center
April 10, 1985

SUMMARY OF SEAT EXPERIMENTS

The seats installed by Simula numbered 23 total, and figure 1 shows that 10 seats were installed in the "as is" condition and 13 were modified. Both groups included a variety of seat experiments. The table also shows a brief summary of the types of seats and modifications that were performed. The presentation given by Dick Johnson (ref. 1) outlined what some of these typical modifications were.

STANDARD SEATS

PILOT SEAT	1
TRIPLE PAX, FORWARD-FACING	6
DUAL PAX, AFT-FACING	2
WALL-MOUNTED, FOLD DOWN, FLIGHT ATTENDANT	1
	10

MODIFIED SEATS

	{	LAP BELT E/A	2
		REAR LEG E/A	4
TRIPLE PAX		PROTOTYPE TRACK FITTINGS	1
FWD FACING		COMPRESSION E/A	2
		REAR LEG AND BRACE E/A	2
AFT-FACING WITH COMPRESSION E/A			1
WALL-MOUNTED, FOLD DOWN, FLIGHT ATTENDANT			1
			13

Figure 1.

SEAT MODIFICATIONS

In general, the modifications were concerned with improving the retention of the occupant and seat structure to the existing aircraft structure. The designs were matched to the strength that the floor structure was believed to have. There were no energy absorbers introduced for the purpose of reducing the loads on the occupant such as is done in some crashworthy seat systems for small aircraft. This was assumed to be inappropriate for a transport seat. The energy absorbers were simply to limit the loads applied to the floor of the aircraft. Other things done to improve seat retention included releases built into the structure to allow it to deform rather than break and separate. Legs and seat pans were reinforced, with emphasis placed on lateral bracing. The track fittings were changed. A report on the design of these experiments is in preparation.

POSITION OF SEAT EXPERIMENTS ABOARD AIRCRAFT

Figure 2 shows where various seating experiments were in the aircraft; they were arranged in two sets. There was a set of eight seats up front, a couple of seats in between, and then another set of eight in the aft part of the aircraft. The experiment was reproduced in this way because the G loading might have been quite different in the aft portion of the cabin from that in the forward part of the cabin. It was thought that data for two different crash environments might be obtained. The pitch (seat spacing) on these seat experiments was very large compared to a commercial transport. It was felt that if seats with the dummies in them were put as close together as they would be in a commercial transport, the different seat designs would interact with one another in an unpredictable and uncontrolled manner. It was believed that if the seats interacted with the dummies striking seats ahead of them it would not be possible to interpret the data. For example, it might be impossible to differentiate between acceleration due to floor input and dummy impact. Also, stroking seats mounted behind nonstroking seats could be a problem with a small pitch. Therefore, the seats were isolated as much as possible in the available cabin space. The placing of the seats also considered the proximity of modified and unmodified seats of the same type and the probability of failure.

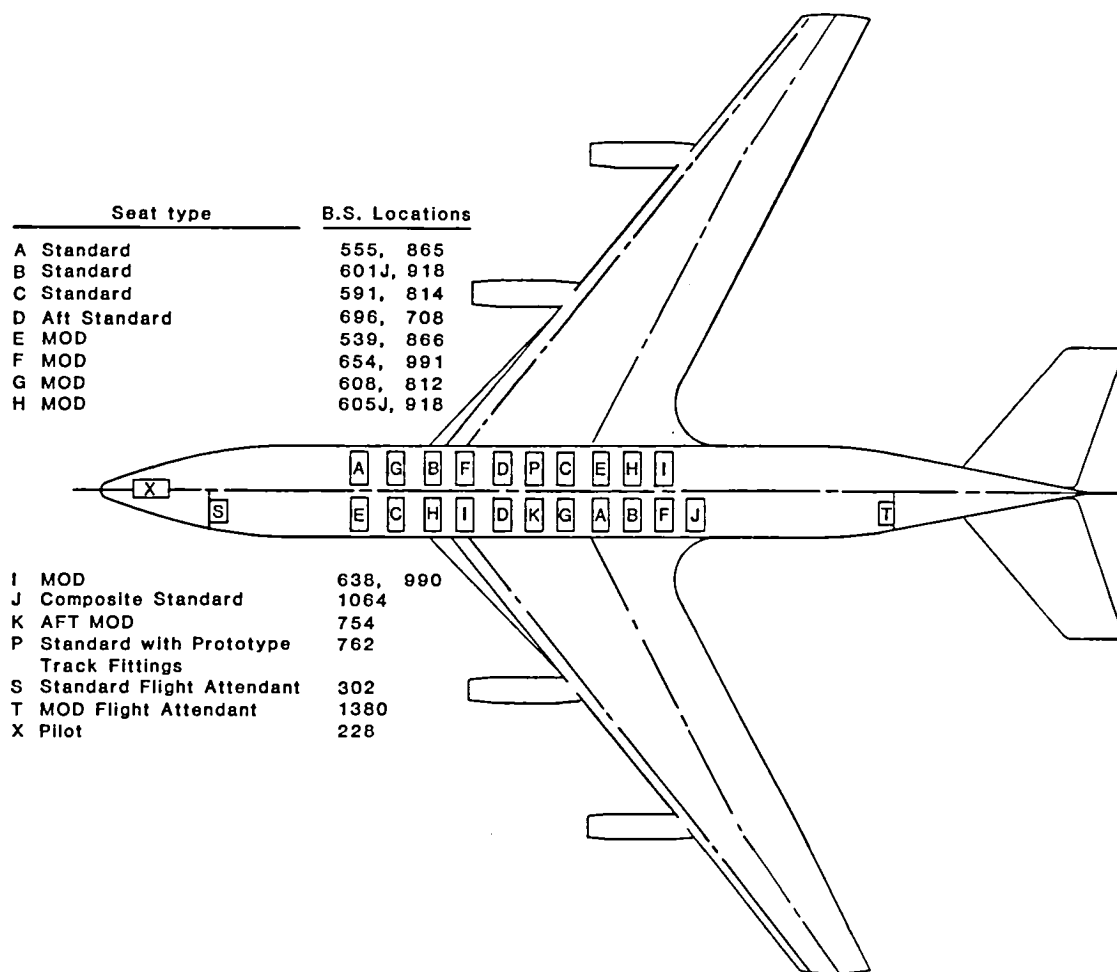

Figure 2.

LOCATION OF FLOOR ACCELEROMETERS

Figure 3 shows where the accelerometers were placed on the floor plan. There were vertical accelerometers at all locations because the floor was not anticipated to have much rigidity in that direction and the acceleration could easily vary with location. Because of the limitations of data channels, the decision was made to infer that the lateral acceleration on one side of the aircraft would be similar to data obtainable on the other side. It was reasoned that acceleration could not vary much in the lateral direction because the structure had much greater rigidity in that direction. The same reasoning was applied to the longitudinal direction. The lateral and longitudinal accelerations were measured only at selected locations. Accelerometers were also placed on the seat pan and in the dummy. There were also tensiometers on the lap belts of the instrumented dummies and on the pilot and flight attendant restraint harnesses.

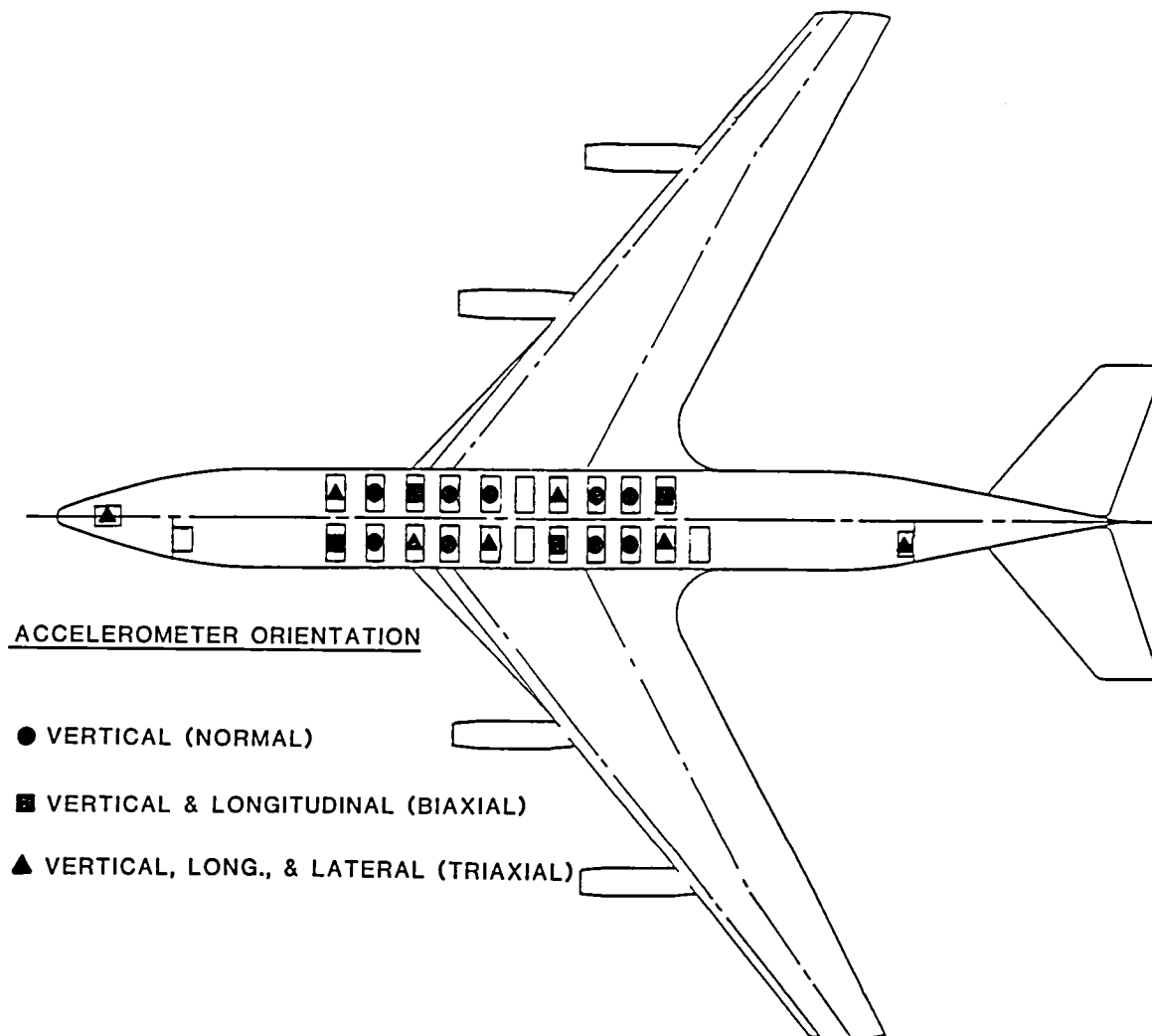

Figure 3.

TYPICAL MOUNTING LOCATION OF BIAXIAL
AND TRIAXIAL ACCELEROMETERS IN THE FLOOR

The floor accelerometers were mounted on the floor beams under the aisle end legs of the seat structure, as shown in figure 4.

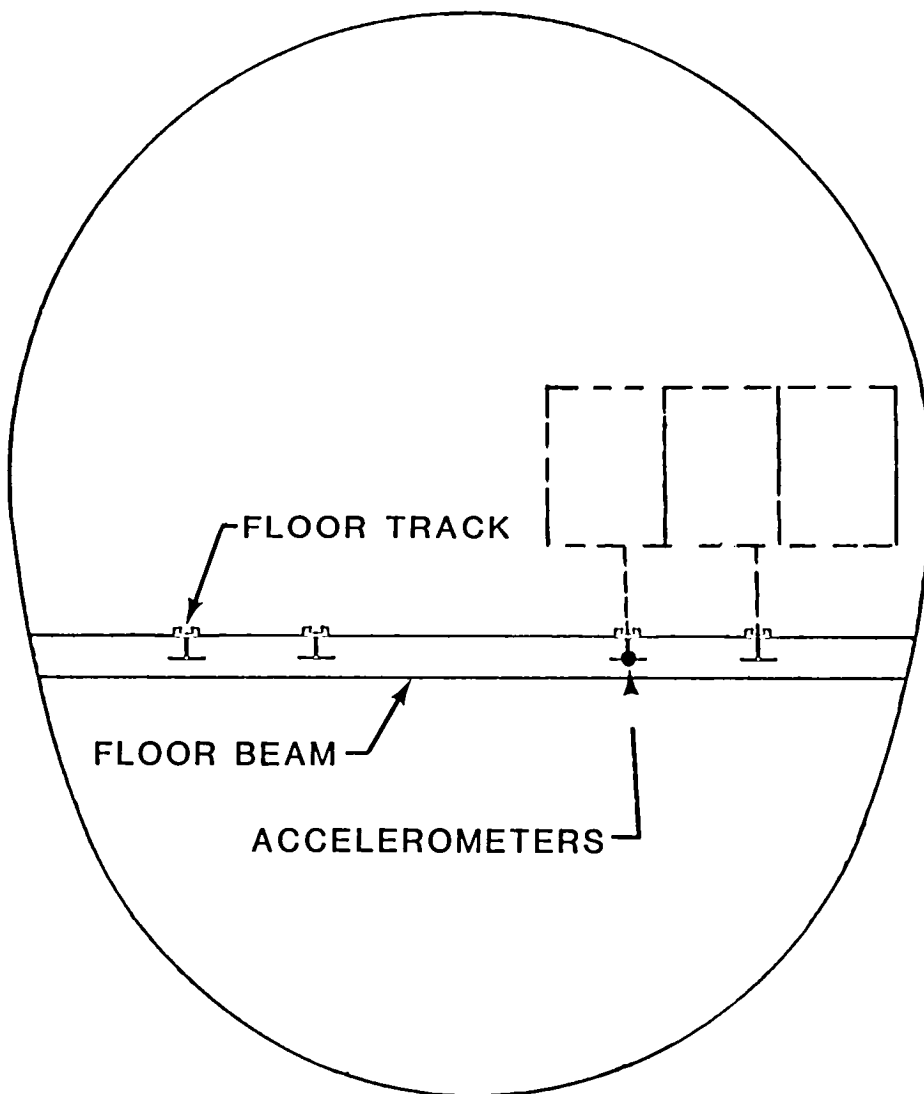

Figure 4.

POSITION OF ACCELEROMETERS ON THE SEAT

All of the seats had an accelerometer mounted at the hardest point on the seat structure, on the seat pan near the rear leg (fig. 5). The leg that was closest to the aisle was selected because it was likely to experience the highest deceleration due to the assymetry of the seat structure. This was based on the assumption that the more heavily loaded window-end of the seat would yield first. On some of the seats there was a second accelerometer near the window end (a uniaxial longitudinal accelerometer only). It was placed there because the two ends of an assymmetric stroking seat would probably experience quite different longitudinal accelerations.

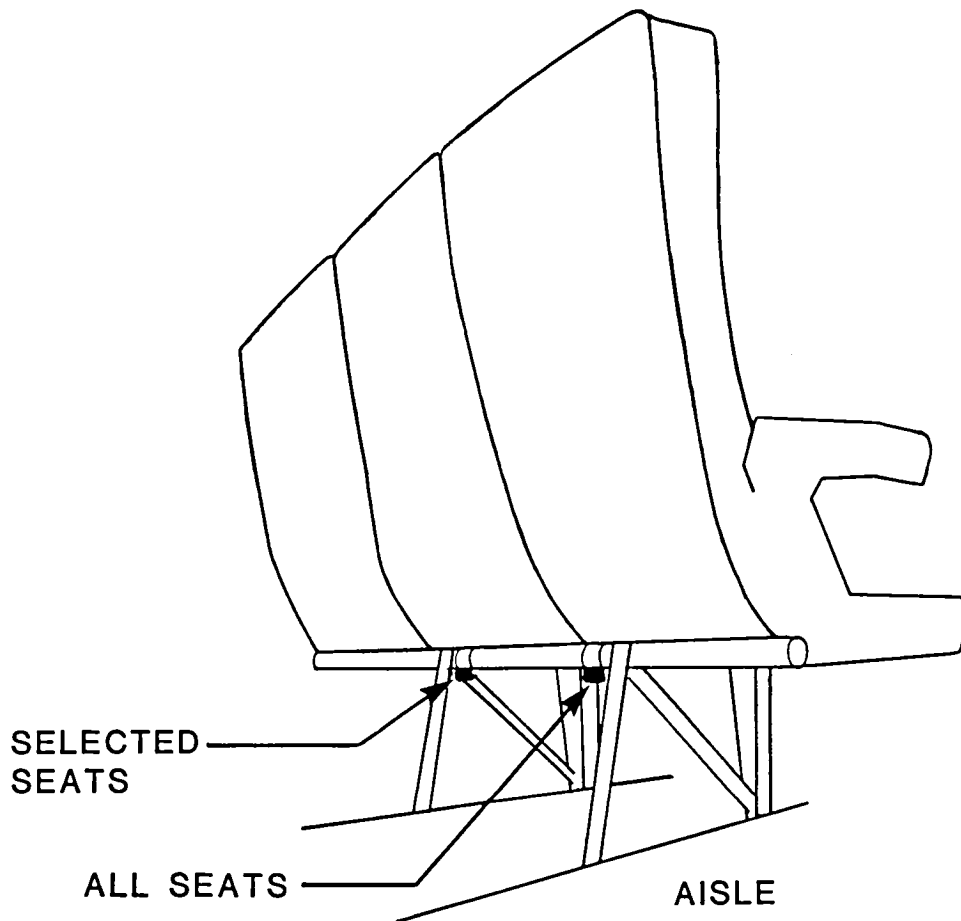

Figure 5.

SEAT LOCATIONS WITH ACCELEROMETERS

Figure 6 shows which seats were equipped with the two different arrangements of seat pan accelerometers.

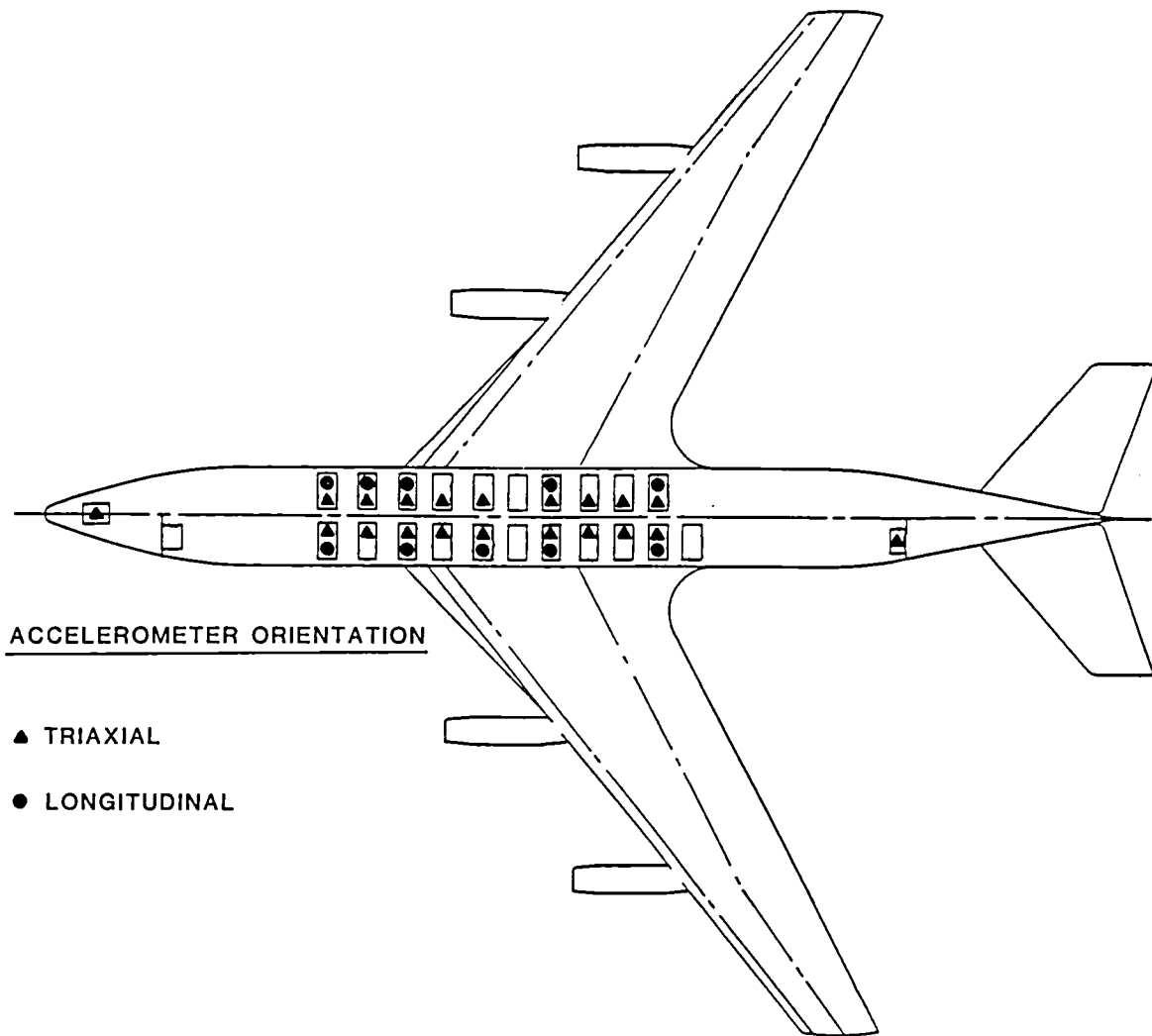

Figure 6.

LOCATION OF DUMMY INSTRUMENTATION

The pelvis, thorax, and head of selected dummies were instrumented. All had at least a triaxial pelvis accelerometer and lap belt tensiometers. Tensiometers were also placed on the pilot and flight attendant restraint harnesses. Three dummies had biaxial head accelerometers and either biaxial or triaxial thorax accelerometers. (See fig. 7.)

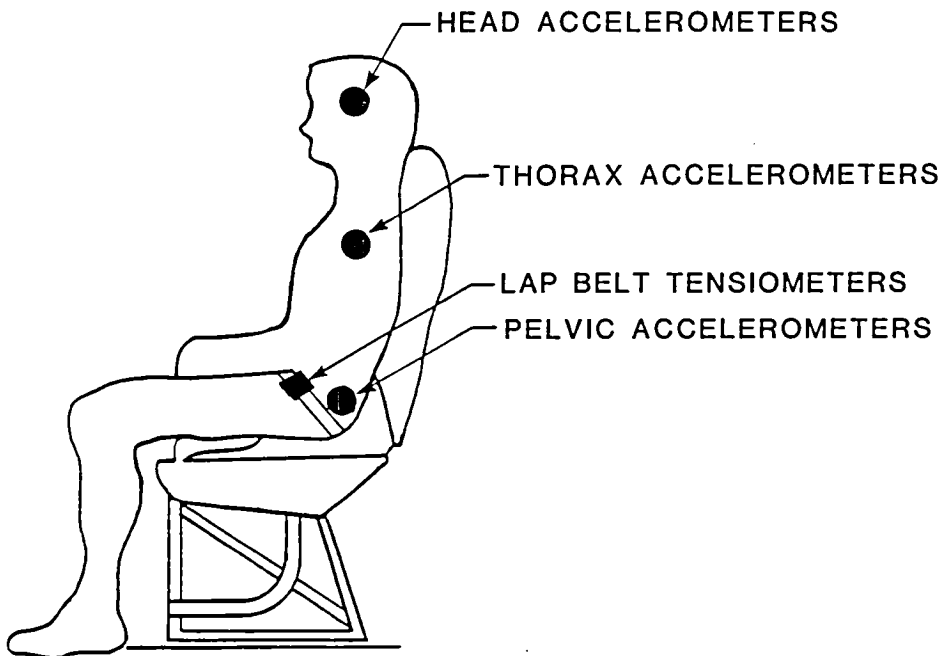

Figure 7.

DUMMY LOCATIONS WITH ACCELEROMETERS

Figure 8 shows where the various dummy instrumentation configurations were placed in the aircraft.

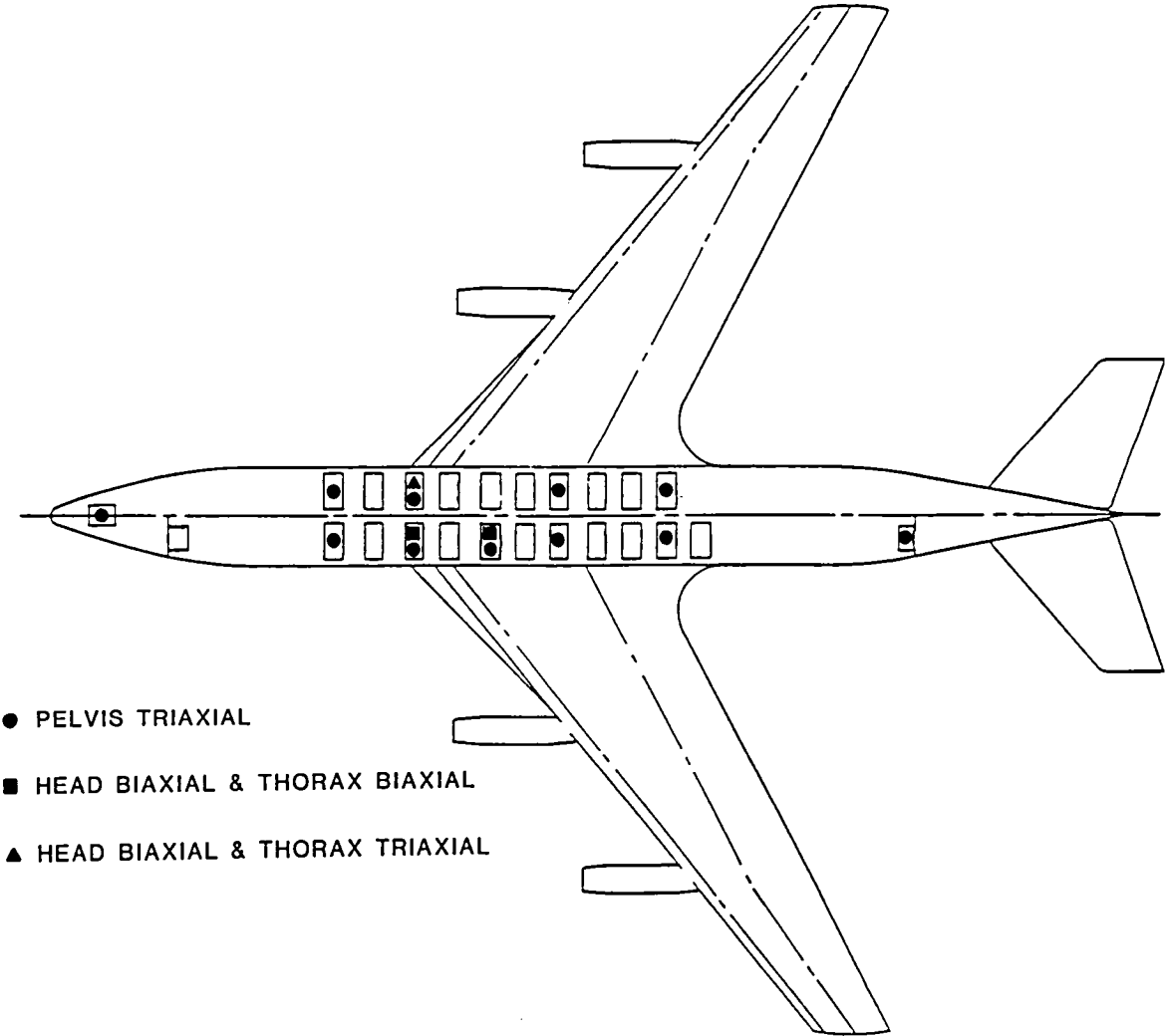

Figure 8.

POSTTEST OBSERVATIONS

Posttest observations revealed several occurrences. None of the energy absorbers was stroked in any way, due to the fact that there was not enough loading on the modified seats. It was also observed that none of the dummies jackknifed over the lap belts, indicating there was not a very high forward G loading. In a laboratory test with a 9-G forward impact with appreciable velocity, the dummies will fold over; they did not in this test. The only impact damage that we observed on the seat structures occurred where the landing gear destroyed the floor structure. There was some very slight seat pan deformation on some seats. There was a little lateral deformation on seats near the area of floor damage. There was no damage to any track fittings, but one seat, just behind where the floor was ripped, did have one front leg fitting come out of the track.

FLOOR ACCELERATIONS

The floor acceleration data of interest occurred when the aircraft struck the ground, and also when the aircraft struck the obstacles that were to cut the wings. Obstacle impact is of some interest for the crashworthiness experiments because somewhat larger accelerations occurred at this time. This is true in all axes. The times associated with these events were as follows:

- Wing/ground impact at approximately 33731.06 sec (2200 msec)*
- Fuselage/ground impact at approximately 33731.46 sec (2600 msec)
- Fuselage/obstacle impact at approximately 33732.91 sec (4050 msec)

The obstacle impact appears most severe in all axes.

*Data received begins at 33728.86 sec (used as starting time of 0 msec).

VERTICAL FLOOR ACCELERATIONS (G) - GROUND IMPACT

Figure 9 shows vertical acceleration during ground impact. This includes the engine, and then the fuselage, striking the ground. Accelerations are shown for four different points in the aircraft, at the aft flight attendant seat and at three other points along the length of the cabin. There are accelerations similar to those shown in reference 2: 2-4 G accelerations at most locations and somewhat higher at the flight attendant seat. The data is consistent with the physical observations made after the test. Figures 10 and 11 show the longitudinal and lateral components of accelerations at the same locations.

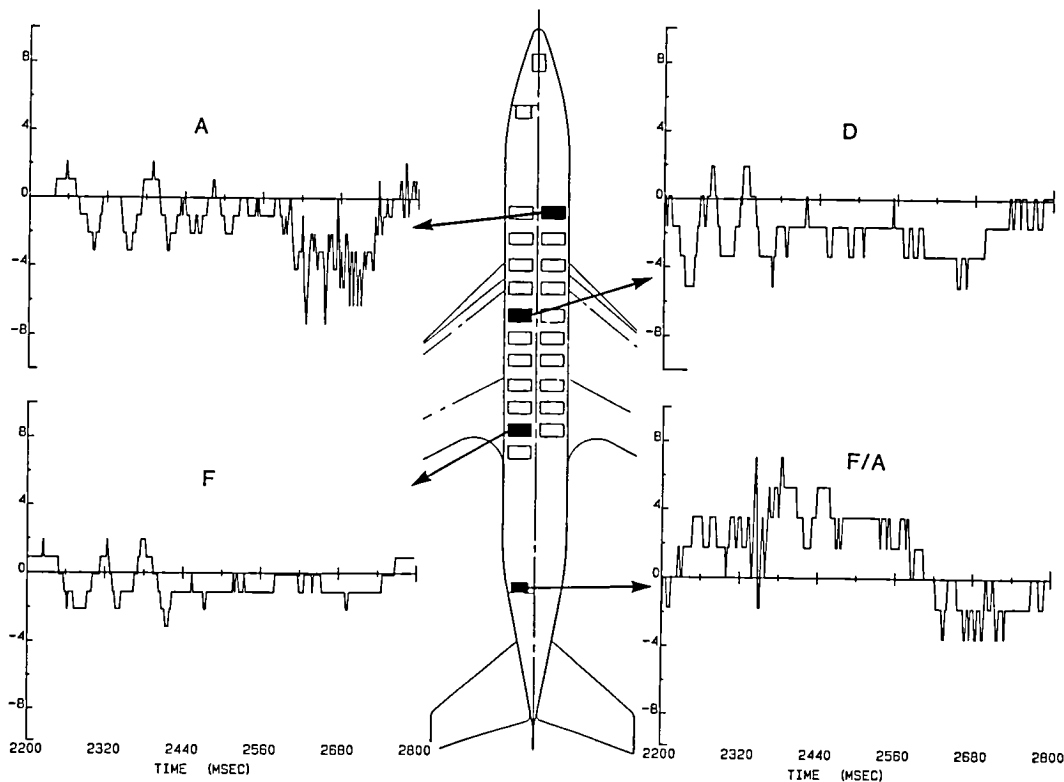

Figure 9.

LONGITUDINAL FLOOR ACCELERATIONS (G) - GROUND IMPACT

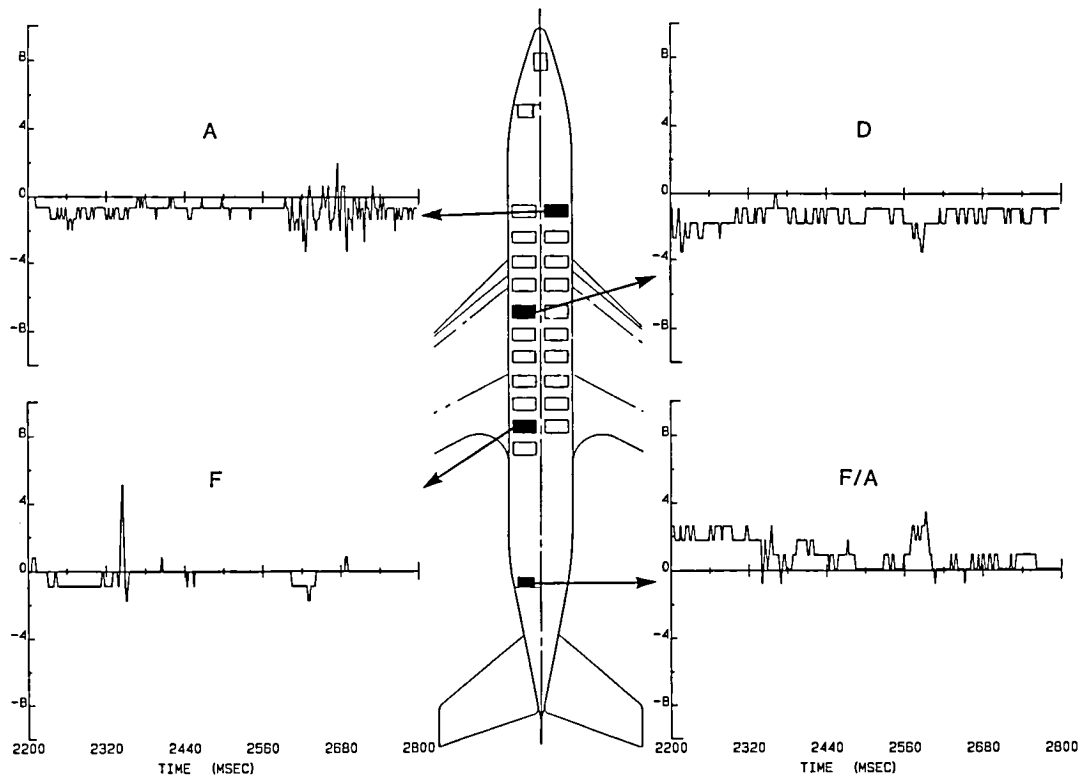

Figure 10.

LATERAL FLOOR ACCELERATIONS (G) - GROUND IMPACT

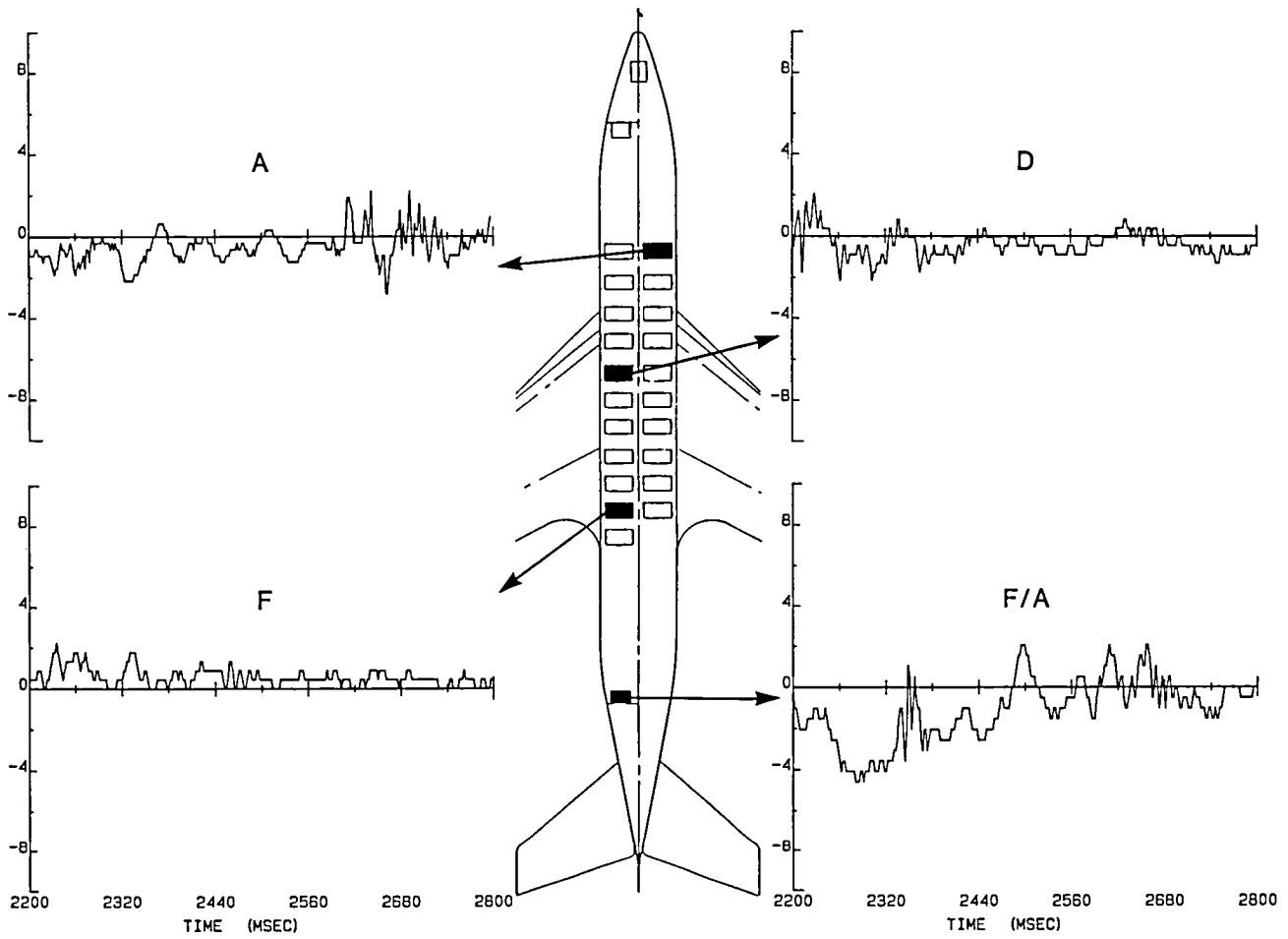

Figure 11.

VERTICAL FLOOR ACCELERATIONS (G) - OBSTACLE IMPACT

When the aircraft hit the obstacles there were some 15- to 20-G vertical acceleration peaks. (See fig. 12.) They were very sharp peaks, with little energy. That is typical of data for all three coordinate axes. The channel for seat F shows a higher acceleration, but it is not really consistent with the other channels. (Apparently an instrumentation problem existed.) This channel behaved well during ground impact, but not after the aircraft hit the obstacle. Serious doubt exists that there were accelerations of such magnitude. Figures 13 and 14 show the longitudinal and lateral acceleration components at the same locations.

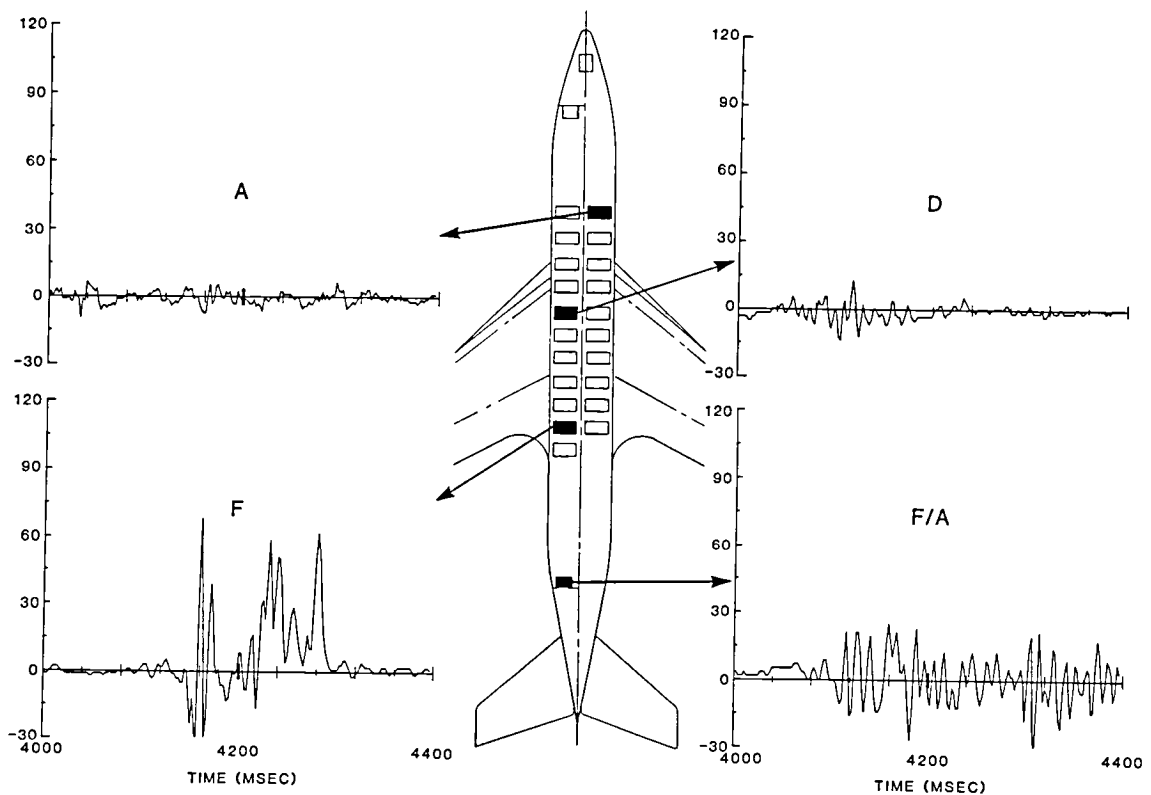

Figure 12.

LONGITUDINAL FLOOR ACCELERATIONS (G) - OBSTACLE IMPACT

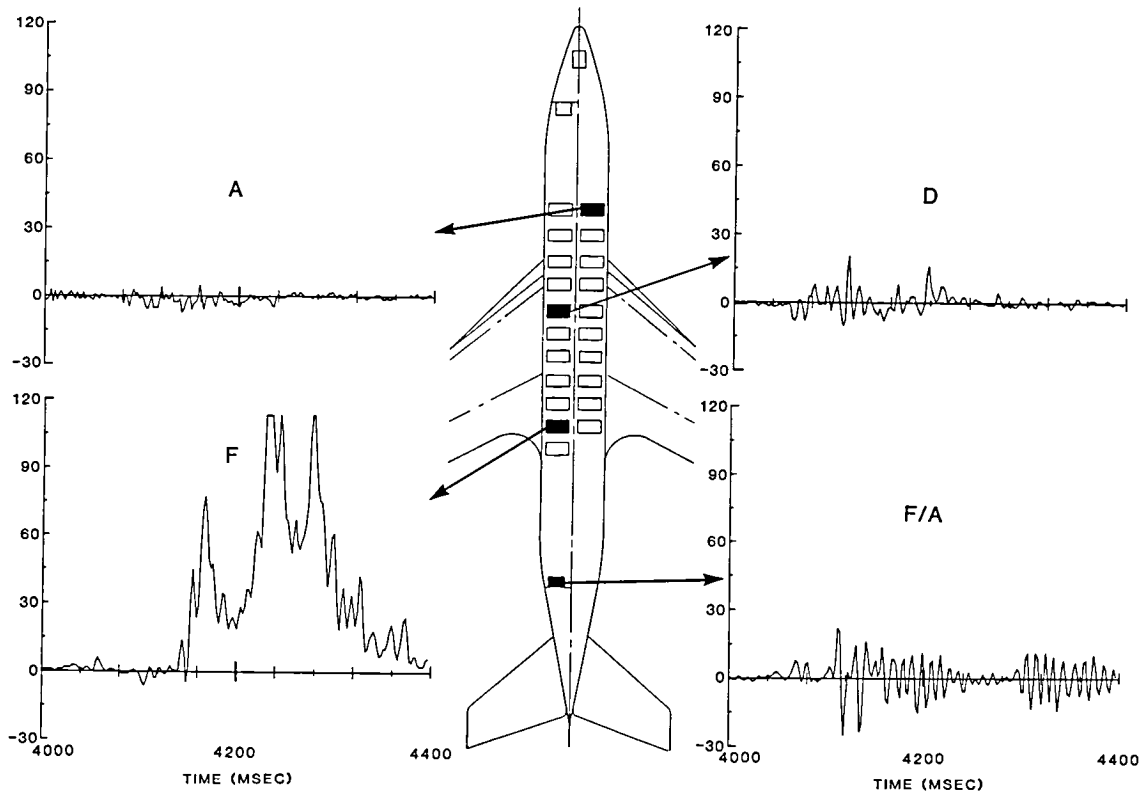

Figure 13.

LATERAL FLOOR ACCELERATIONS (G) - OBSTACLE IMPACT

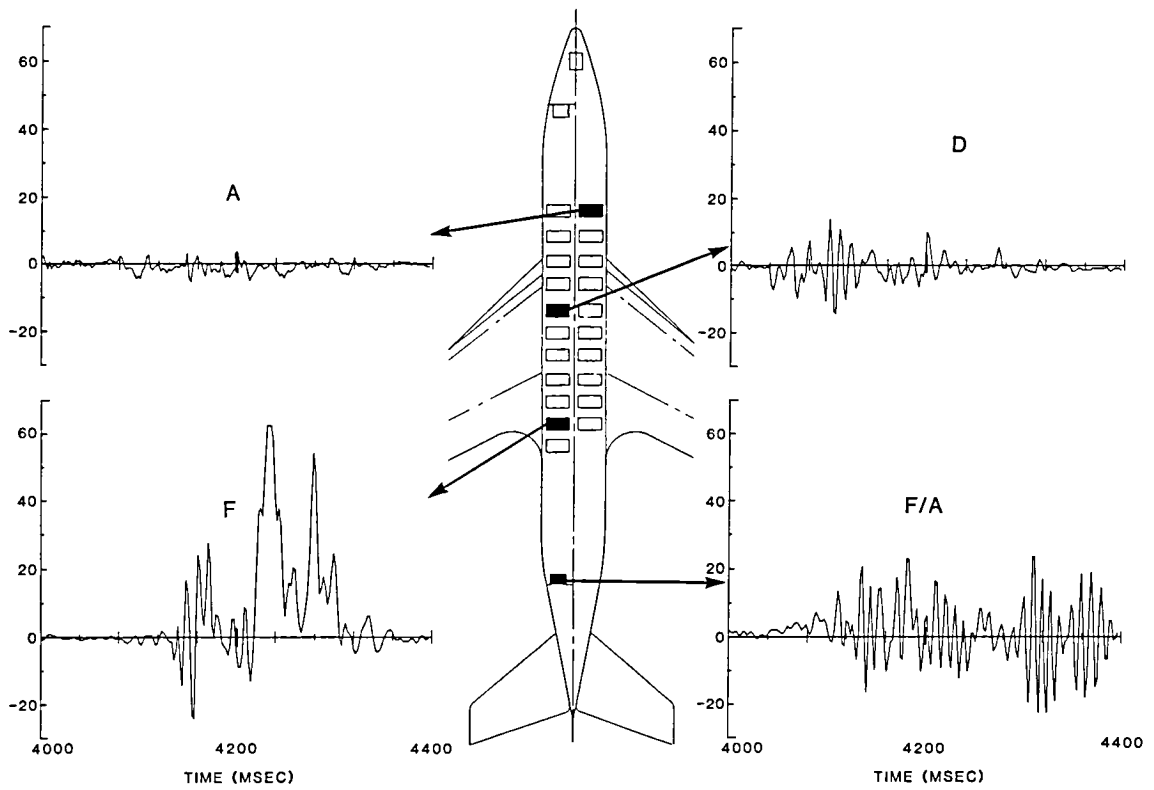

Figure 14.

FLOOR, SEAT, AND PELVIS ACCELERATIONS - GROUND IMPACT

The next three figures (Figures 15-17) show vertical, longitudinal, and lateral accelerations for the floor, seat, and dummy pelvis at Seat A. They are arranged so that the floor accelerations near the bottom end of the seat leg, the seat pan acceleration near the top end of the leg, and the dummy pelvis accelerations above this leg can be viewed simultaneously. The figures therefore display how the floor accelerations were transmitted through the seat/occupant system. The seat pan acceleration is reasonably similar to the floor acceleration. This would be expected in view of the relatively rigid seat leg structure and the fact that nothing deformed. Therefore, this is a good indication that the data is probably valid. The pelvis of the dummy responded somewhat differently, as expected. Approximate velocity changes are shown for the three accelerations; they are not identical. But when the resolution of the data as indicated by the steps in the pelvis data is considered along with other potential instrumentation errors, the correlation between the velocity changes shown here is reasonably good. Also, note that these velocity changes are reasonably consistent with the velocity changes that were demonstrated in references 2 and 3. For the longitudinal acceleration components (fig. 16), the seat pan response again reflects the floor response fairly closely. For the lateral accelerations (fig. 17), the seat pan acceleration is not nearly as similar to the floor acceleration. This is as expected, because the seat is much less rigid in the lateral direction.

VERTICAL ACCELERATIONS - SEAT A (R.H.) GROUND IMPACT

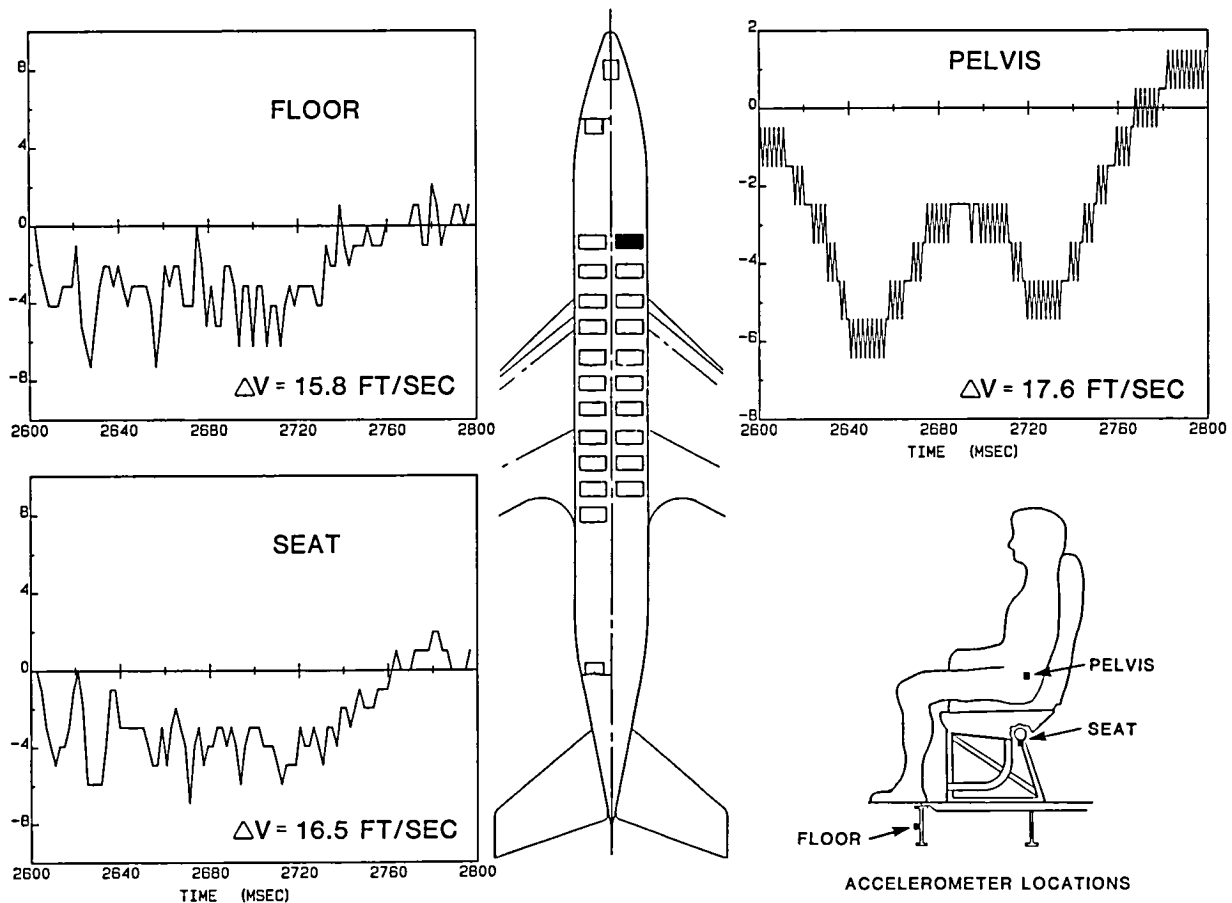

Figure 15.

LONGITUDINAL ACCELERATIONS - SEAT A (R.H.), GROUND IMPACT

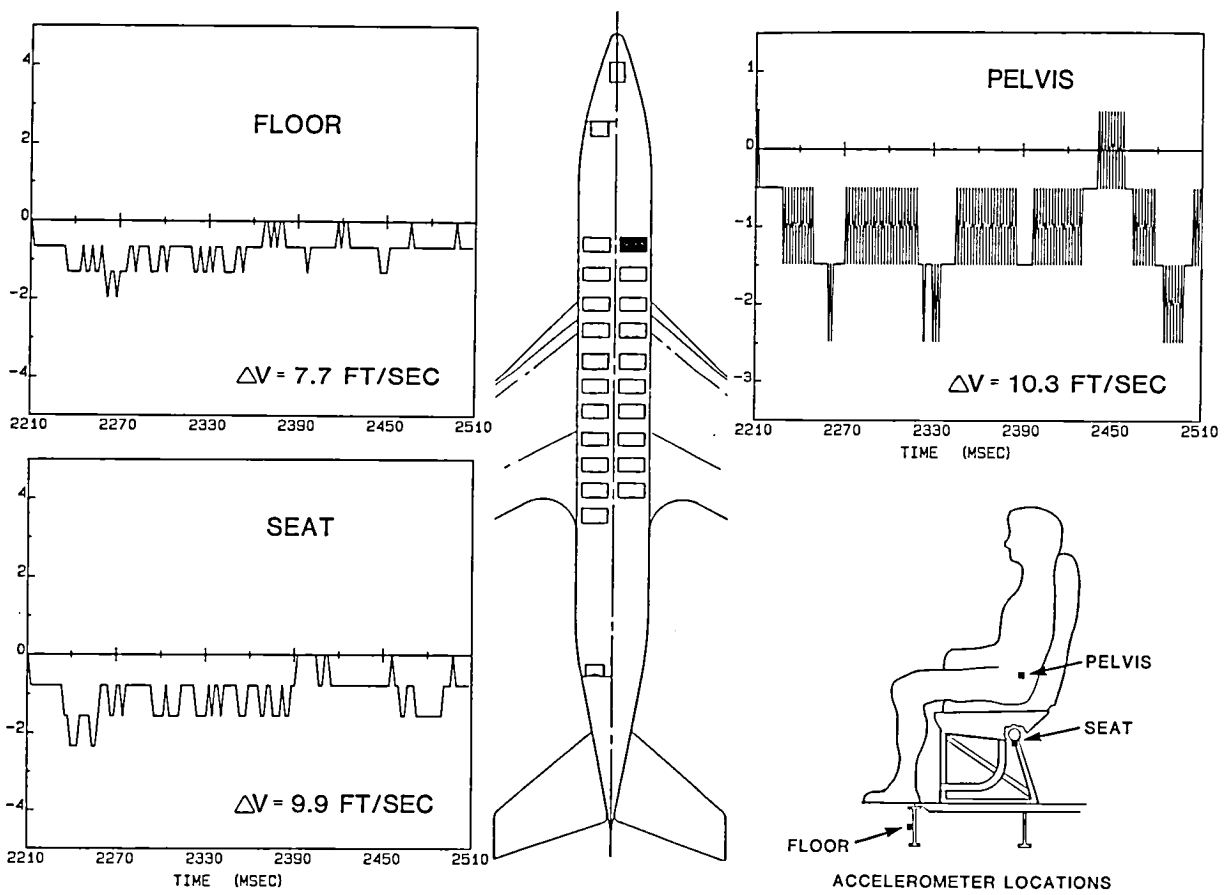

Figure 16.

LATERAL ACCELERATIONS - SEAT A (R.H.), GROUND IMPACT

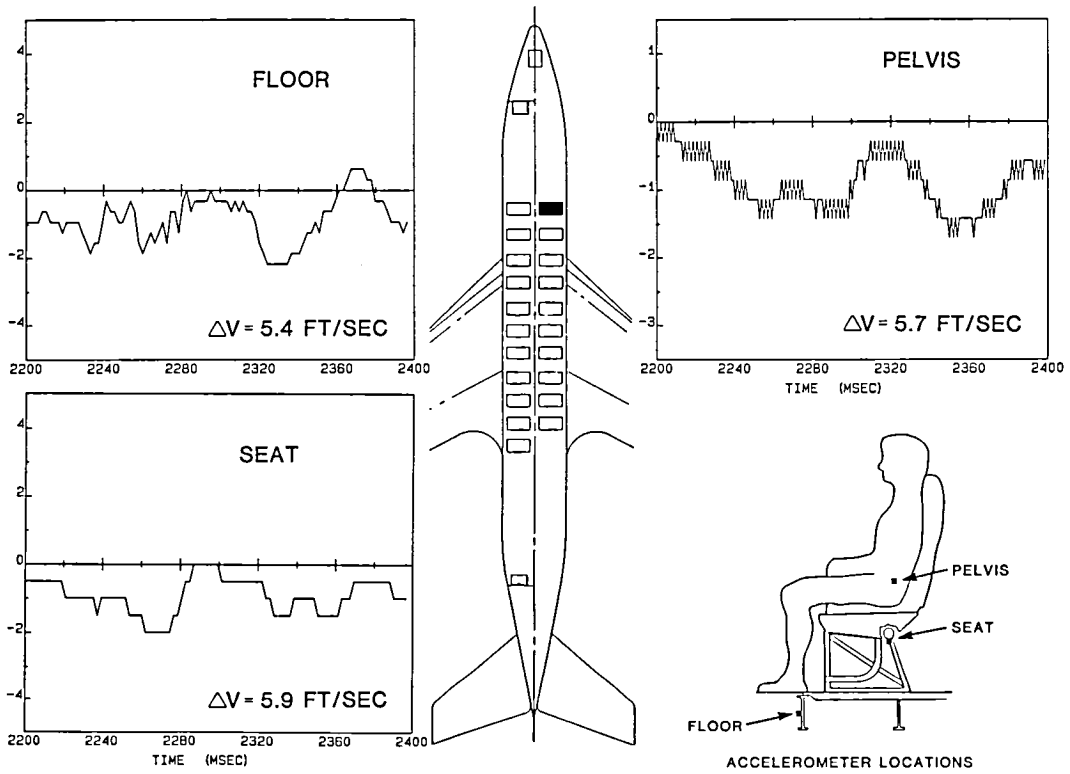

Figure 17.

FLOOR, SEAT, AND PELVIS ACCELERATIONS - OBSTACLE IMPACT

The following three figures (figures 18-20) show floor, seat, and pelvis data for obstacle impact. This includes four seat accelerations along the length of the cabin, and seat and pelvis accelerations for Seat A.

The vertical seat accelerations for four seats along the length of the aircraft are shown in figure 18, which shows that the accelerations on those seat pans during obstacle impact are a function of position along the aircraft. There are some higher values than were seen on ground impact. There are very brief and occasional accelerations of over 20 G; sometimes there is a sharp spike up to 40 G. However, they are extremely steep and narrow and represent very little energy. It therefore does not appear unusual for unmodified seats to have survived this impact.

Figure 19 shows the longitudinal data during obstacle impact for the same four seats. Again, the response is shown to be most severe in the aft portion of the aircraft.

Figure 20 shows the lateral acceleration component. Note that the main pulses are wider. This is probably consistent with the cutter tearing through the aircraft as it slid sideways.

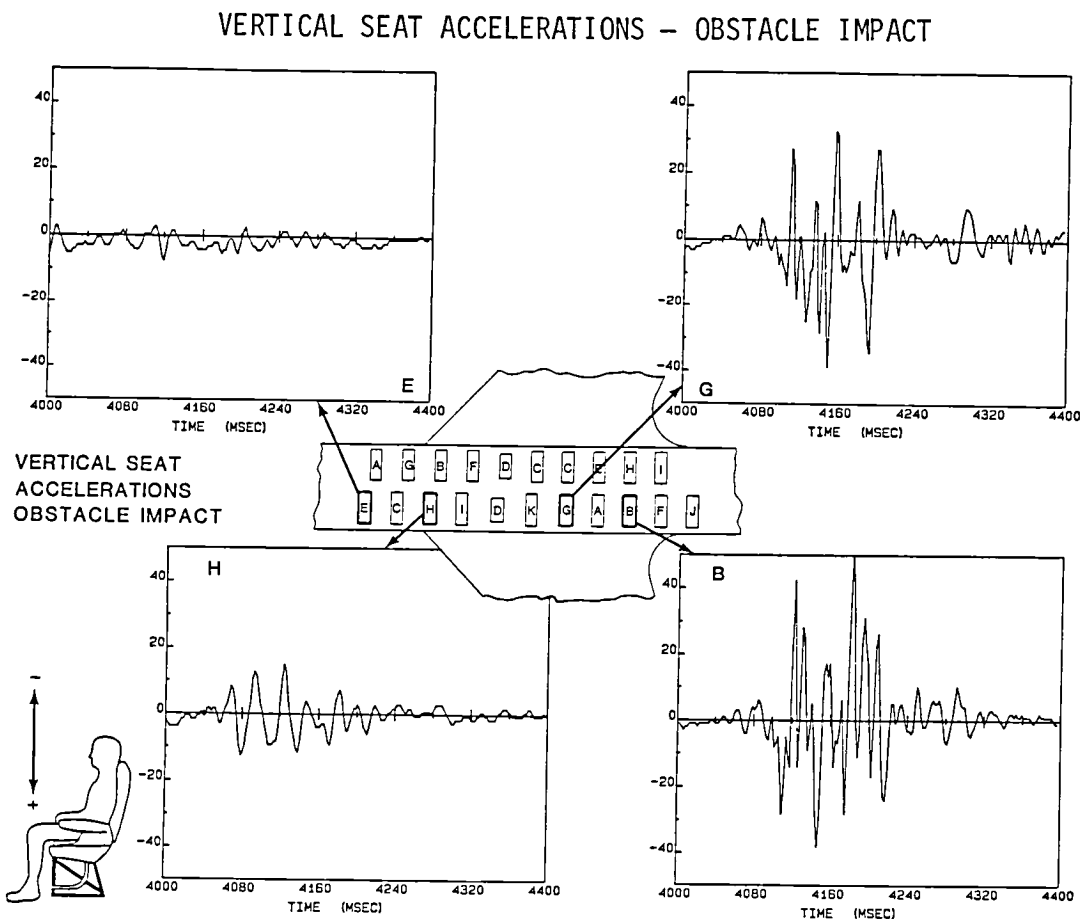

Figure 18.

LONGITUDINAL SEAT ACCELERATIONS - OBSTACLE IMPACT

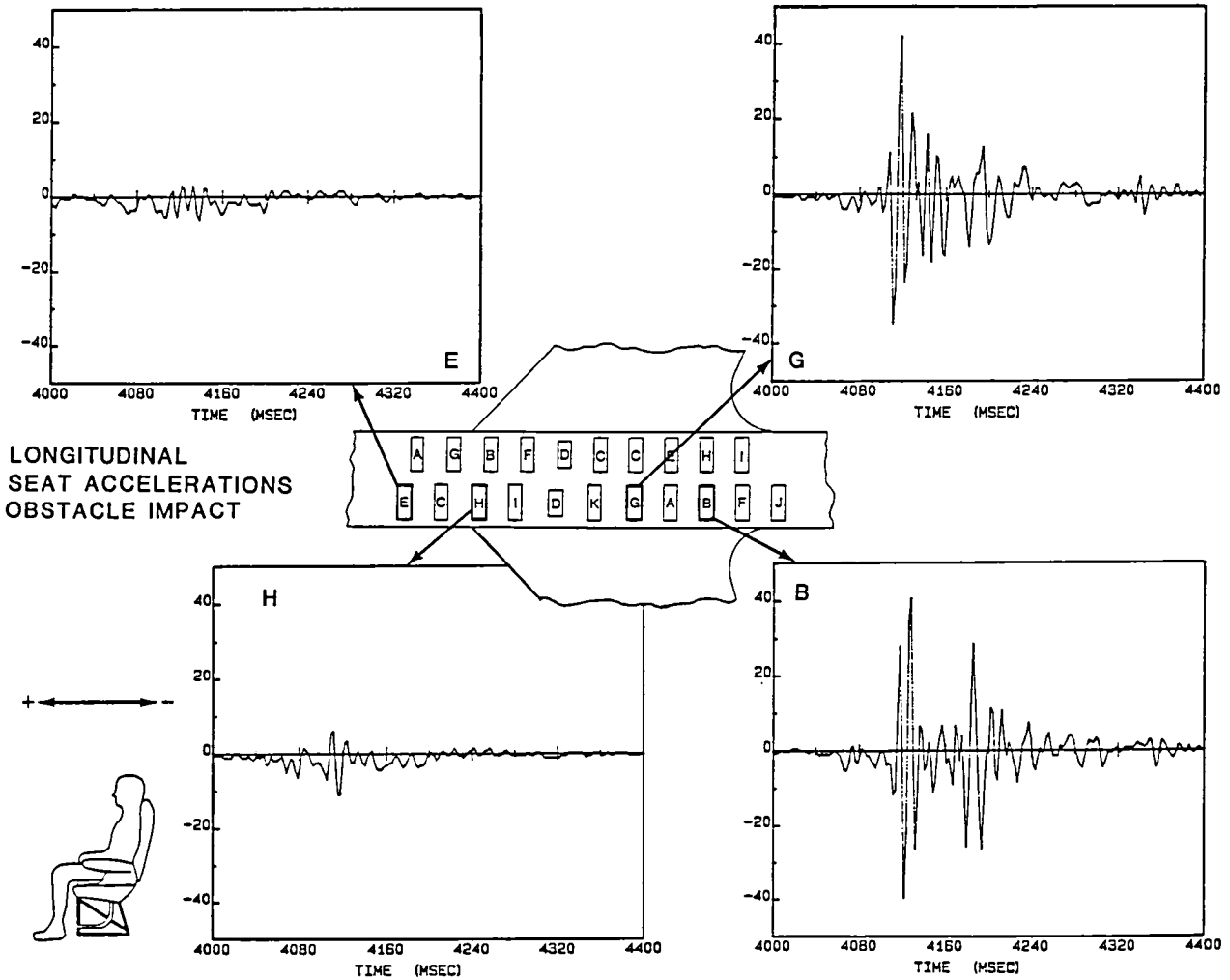

Figure 19.

LATERAL SEAT ACCELERATIONS - OBSTACLE IMPACT

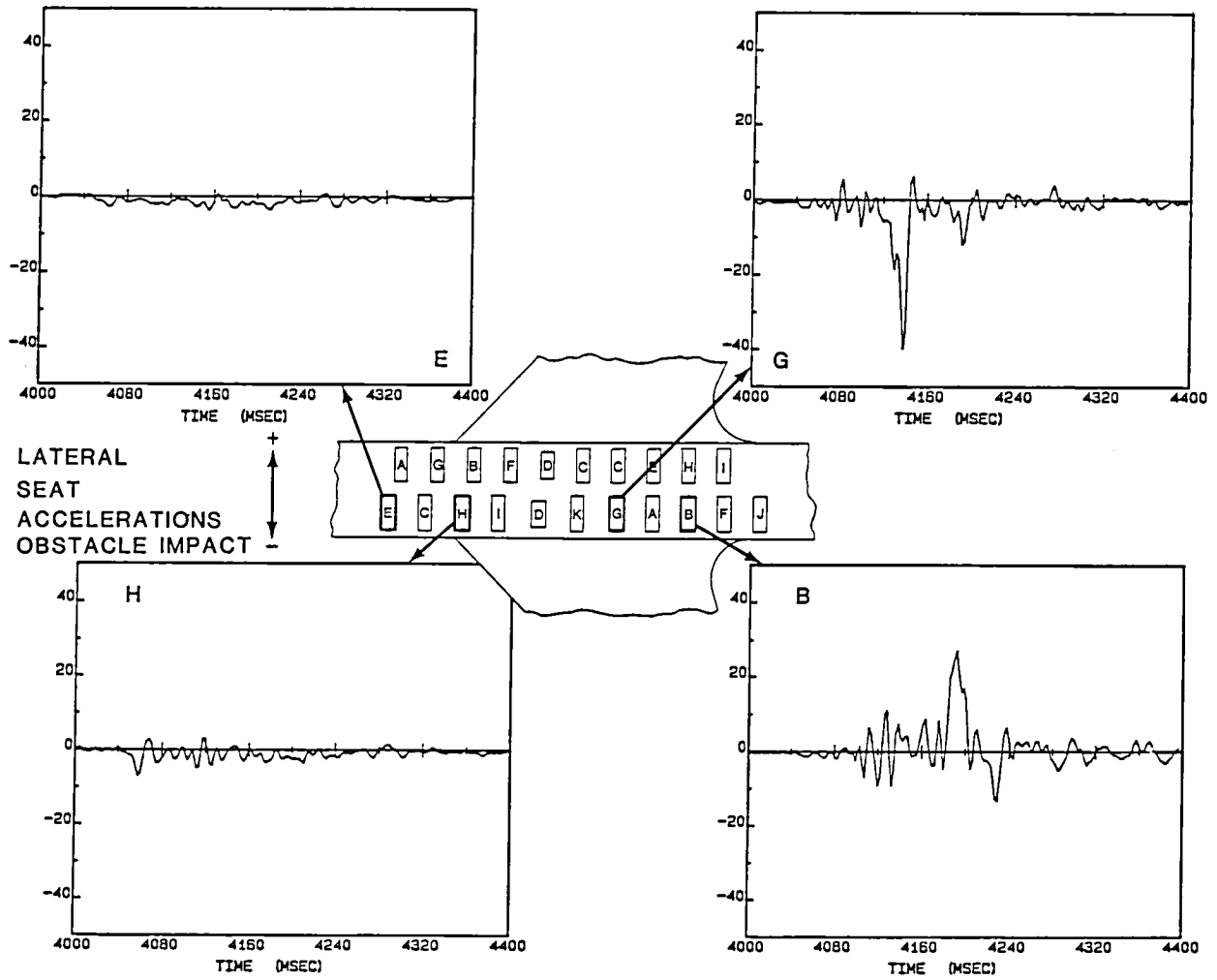

Figure 20.

VERTICAL ACCELERATIONS - SEAT A (R.H.), OBSTACLE IMPACT

The next three figures (figures 21-23) show seat and dummy response during obstacle impact. Figure 21 shows comparisons of the floor, seat, and pelvis response for Seat A. This was the most forward seat in the cabin, and similar data for this seat during ground impact has already been shown. Again, the data is consistent. The fact that the floor and seat pan accelerations matched fairly well gives confidence that the transducers were performing properly. This is particularly true of the vertical acceleration. The dummy response is quite different, as would be expected. However, the velocity change for the dummy is also quite different, and this is not so encouraging.

The longitudinal data seen in figure 22 also shows reasonable correlation between floor and seat pan. Here, the dummy velocity change is more nearly matched to that of the seat pan.

Figure 23 shows the lateral component of acceleration during ground impact. The lesser stiffness of the seat in this direction causes more of a disparity between floor and seat pan accelerations.

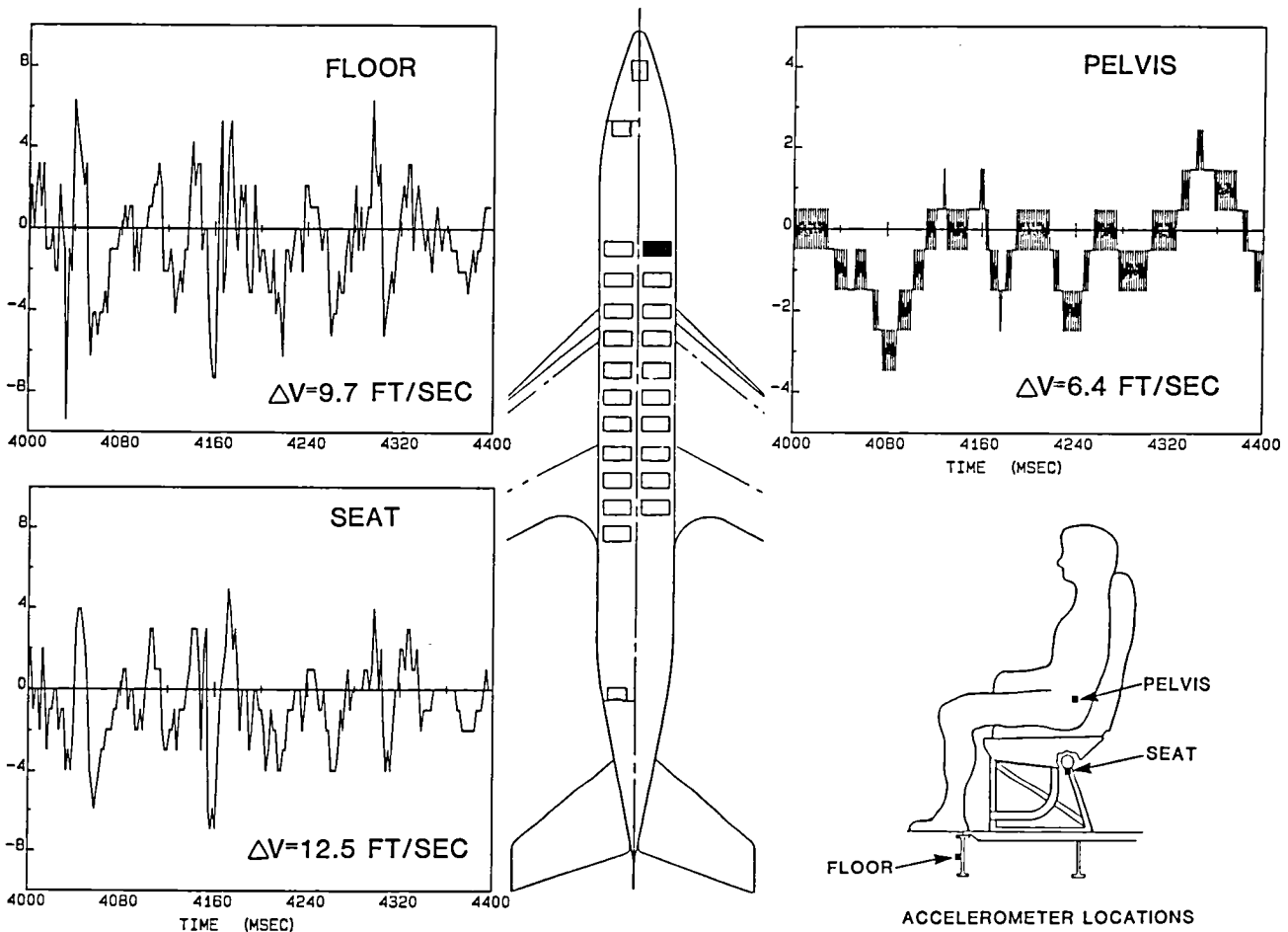

Figure 21.

LONGITUDINAL ACCELERATIONS - SEAT A (R.H.), OBSTACLE IMPACT

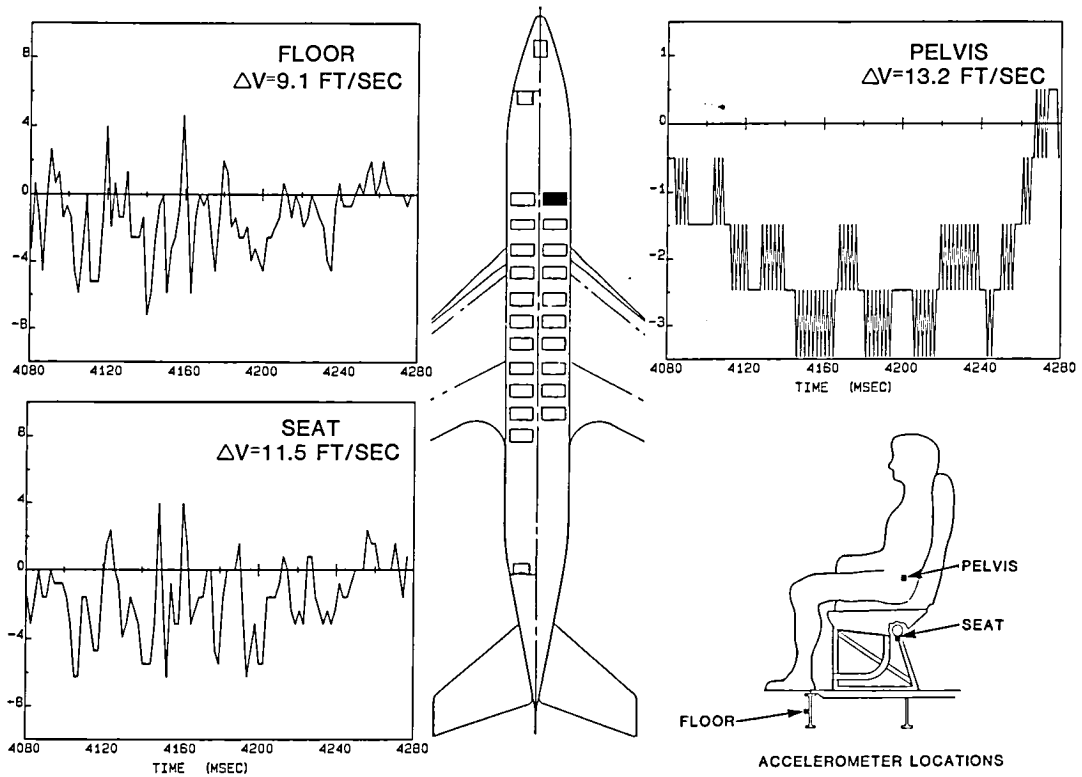

Figure 22.

LATERAL ACCELERATIONS - SEAT A (R.H.), OBSTACLE IMPACT

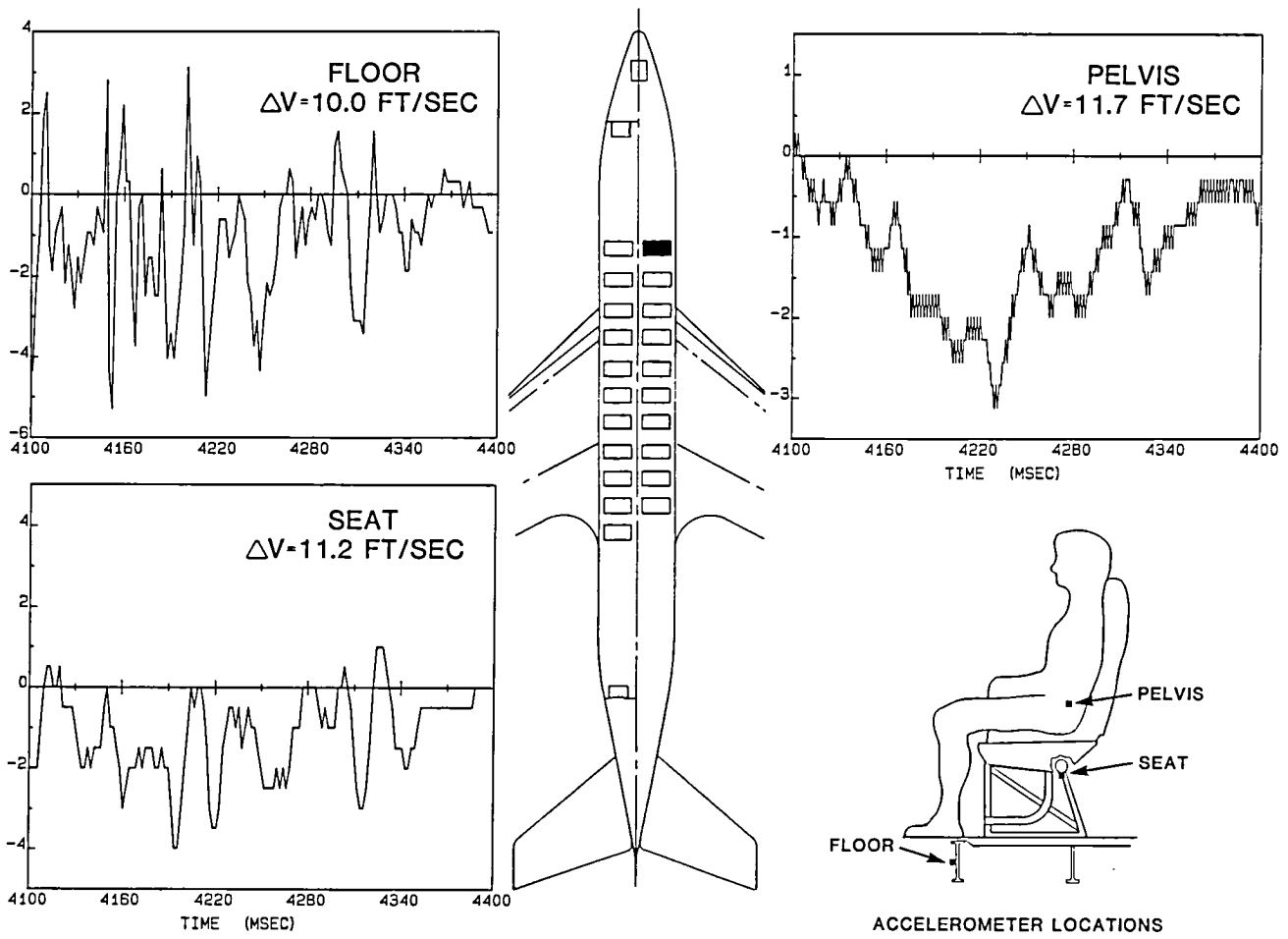
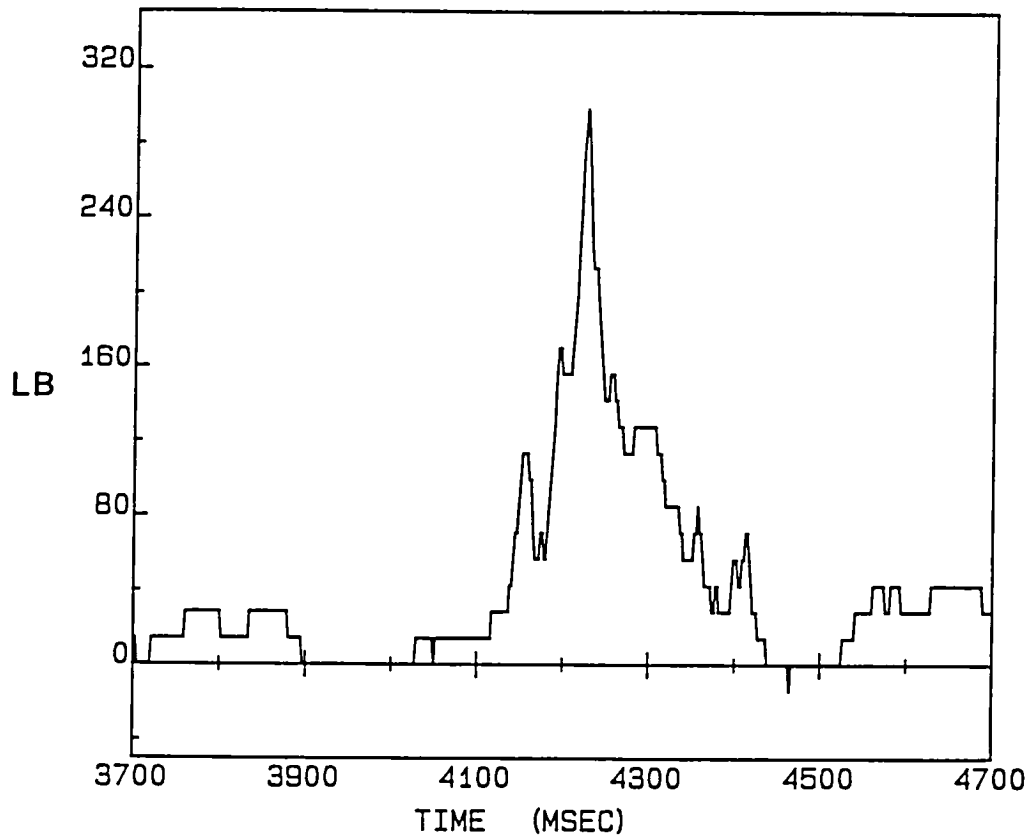

Figure 23.

TYPICAL LAP BELT LOAD

Figure 24 shows a typical lap belt tensile load, with about a 300-lb peak. This is a low load for a lap belt, and most of the lap belt data reviewed is similar. It is relatively consistent with the measured G loads and the film data which shows that the dummies did not jackknife.



OBSTACLE IMPACT

Figure 24.

OVERHEAD BIN ACCELERATIONS (G) - OBSTACLE IMPACT

Figure 25 shows overhead bin data. The FAA had a few accelerometers on an overhead bin that was placed in the aircraft. There was a mass attached to the door of the bin and the accelerometer was mounted to its back. There are peaks of 6 G or more in the vertical and longitudinal directions. Higher values are seen in the lateral direction. This data is from the time of obstacle impact.

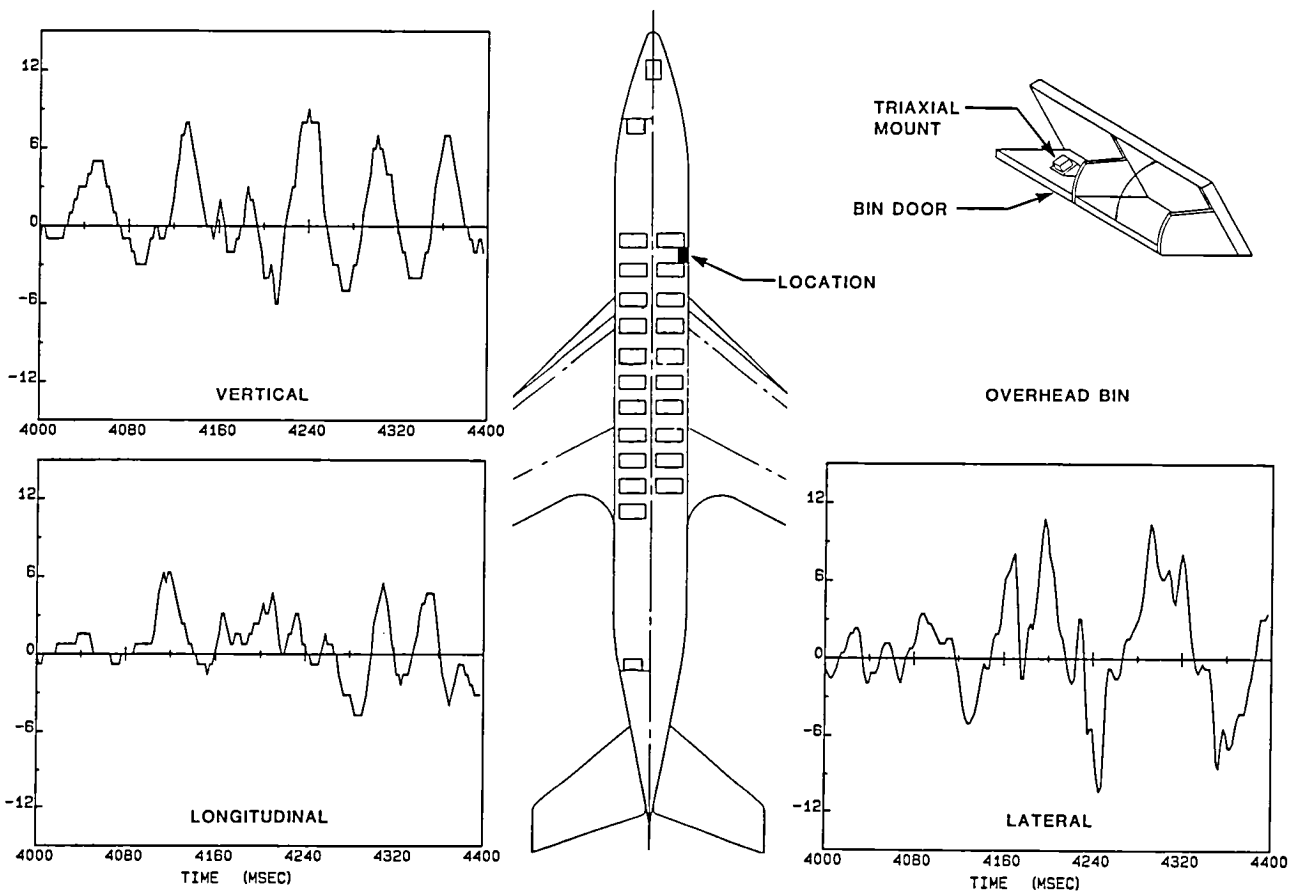

Figure 25.

CONCLUSIONS

According to preliminary examination of the data, out of 179 data channels that were onboard the aircraft in support of the seat experiments, there is data from 168. There was a somewhat more severe environment imposed in the structure by the obstacles than by the ground impact. Therefore, both ground impact and obstacle impact are of interest for crashworthiness experiments. Most of the data channels that were studied are fairly consistent with the physical evidence: they show acceleration levels that are reasonable, and in many cases these integrate out to a reasonable velocity change.

Finally, from observation thus far, the ground impact did not fail or significantly damage any seat. Nor did any of the energy absorbers in the modified seats extend. The accelerations do not appear high enough and/or energetic enough to cause this to happen. Of course, at this time, the onboard films have not been studied; only some videotapes have been viewed. Some of the seats were so badly damaged by the fire that any failures which might have occurred were obscured. A close examination of the onboard films using a stop-action projector will allow a more thorough evaluation.

REFERENCES

1. Johnson, Richard A.: Controlled Impact Demonstration Seat/Cabin Restraint Systems - FAA. Full-Scale Transport Controlled Impact Demonstration, NASA CP-2395, 1986, pp. 49-60.
2. Fasanella, E. L.: Digital Filtering and Acceleration Pulse Interpretation. Full-Scale Transport Controlled Impact Demonstration, NASA CP-2395, 1986, pp. 103-123.
3. Alfaro-Bou, Emilio: Structural Loads Preliminary Results. Full-Scale Transport Controlled Impact Demonstration, NASA CP-2395, 1986, pp. 91-102.