

111 5700

---

*Report to the President*

---

AD-A71402

*By The*  
**PRESIDENTIAL  
COMMISSION**  
*on the Space Shuttle  
Challenger Accident*

REPORT OF THE PRESIDENTIAL COMMISSION ON THE  
SPACE SHUTTLE CHALLENGER ACCIDENT, VOLUME 1  
(Presidential Commission on the Space  
Shuttle) 260 p MF A01; also available GPO  
HC \$18.00

N86-24726

H2/16    Unclas  
43598

*By The*

**PRESIDENTIAL  
COMMISSION**

*on the Space Shuttle  
Challenger Accident*

June 6th, 1986  
Washington, D.C.

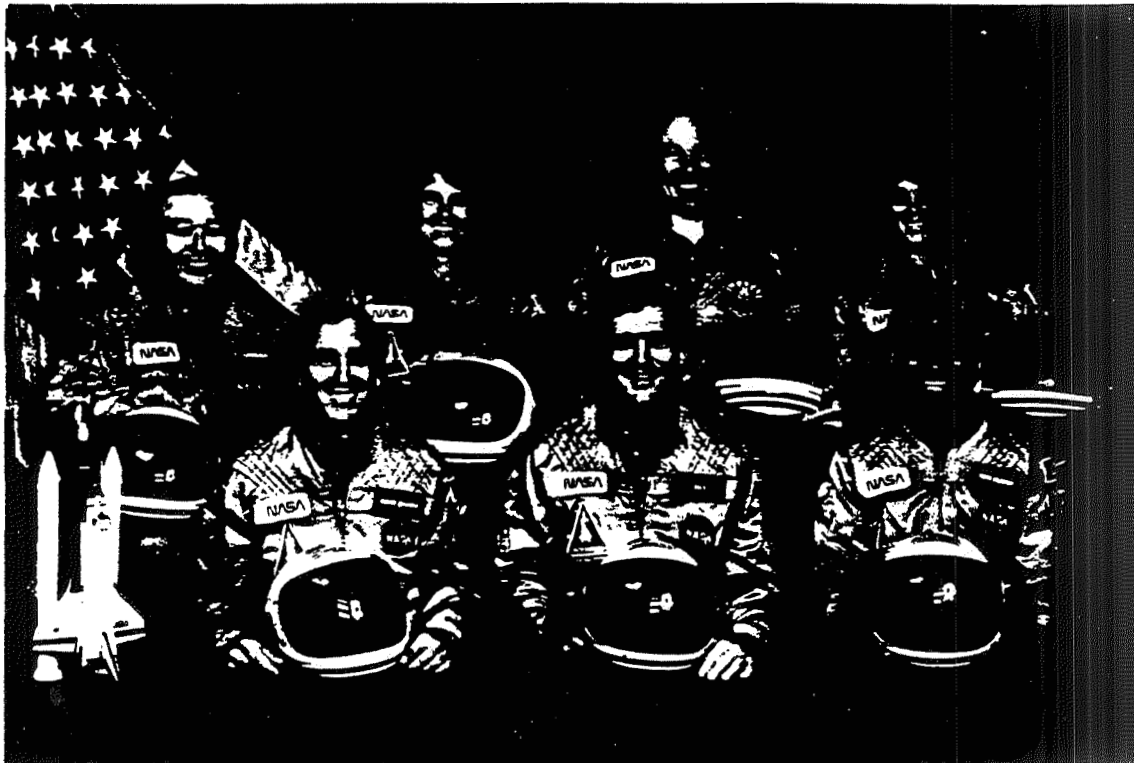

## IN MEMORIAM

*"The future is not free: the story of all human progress is one of a struggle against all odds. We learned again that this America, which Abraham Lincoln called the last, best hope of man on Earth, was built on heroism and noble sacrifice. It was built by men and women like our seven star voyagers, who answered a call beyond duty, who gave more than was expected or required and who gave it little thought of worldly reward."*

—President Ronald Reagan January 31, 1986

---

Francis R. (Dick) Scobee  
*Commander*

Michael John Smith  
*Pilot*

Ellison S. Onizuka  
*Mission Specialist One*

Judith Arlene Resnik  
*Mission Specialist Two*

Ronald Erwin McNair  
*Mission Specialist Three*

S. Christa McAuliffe  
*Payload Specialist One*

Gregory Bruce Jarvis  
*Payload Specialist Two*

---

ORIGINAL PAGE IS  
OF POOR QUALITY



Presidential Commission  
on the  
Space Shuttle Challenger Accident

June 6, 1986

Dear Mr. President:

On behalf of the Commission, it is my privilege to present the report of the Presidential Commission on the Space Shuttle Challenger Accident.

Since being sworn in on February 6, 1986, the Commission has been able to conduct a comprehensive investigation of the Challenger accident. This report documents our findings and makes recommendations for your consideration.

Our objective has been not only to prevent any recurrence of the failure related to this accident, but to the extent possible to reduce other risks in future flights. However, the Commission did not construe its mandate to require a detailed evaluation of the entire Shuttle system. It fully recognizes that the risk associated with space flight cannot be totally eliminated.

Each member of the Commission shared the pain and anguish the nation felt at the loss of seven brave Americans in the Challenger accident on January 28, 1986.

The nation's task now is to move ahead to return to safe space flight and to its recognized position of leadership in space. There could be no more fitting tribute to the Challenger crew than to do so.

Sincerely,

A handwritten signature in black ink, appearing to read "William P. Rogers", written in a cursive style.

William P. Rogers  
Chairman

The President of the United States  
The White House  
Washington, D. C. 20500



In compliance with the Executive Order 12546 of February 3, 1986,  
the undersigned present the report of the  
Presidential Commission on the Space Shuttle Challenger Accident.

  
William P. Rogers  
Chairman, Maryland

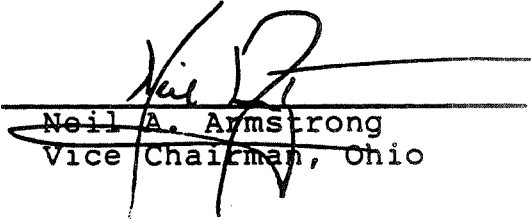
  
Neil A. Armstrong  
Vice Chairman, Ohio

  
David C. Acheson  
District of Columbia

  
Eugene E. Covert  
Massachusetts

  
Richard P. Feynman  
California

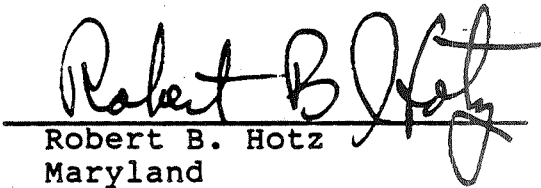
  
Robert B. Hotz  
Maryland

  
Donald J. Kutyna  
Illinois

  
Sally K. Ride  
California

  
Robert W. Rummel  
Arizona

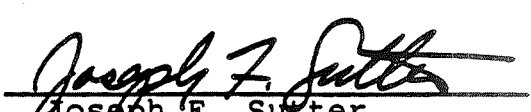
  
Joseph F. Sutter  
Washington

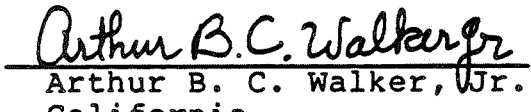
  
Arthur B. C. Walker, Jr.  
California

  
Albert D. Wheelon  
California

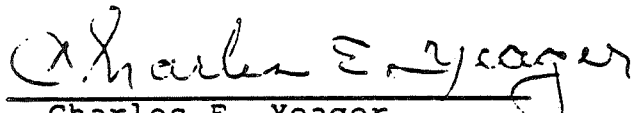
  
Charles E. Yeager  
California

---

*Volume I*

---

**Report of the Presidential Commission on the Space Shuttle Challenger Accident**

*with*

<i>Appendix A</i>	Commission Activities
<i>Appendix B</i>	Commission Documentation System
<i>Appendix C</i>	Observations Concerning the Processing and Assembly of Flight 51-L
<i>Appendix D</i>	Supporting Charts and Documents

---

*Volume II*

---

<i>Appendix E</i>	Independent Test Team Report to the Commission
<i>Appendix F</i>	Personal Observations on Reliability of Shuttle
<i>Appendix G</i>	Human Factors Analysis
<i>Appendix H</i>	Flight Readiness Review Treatment of O-ring Problems
<i>Appendix I</i>	NASA Pre-Launch Activities Team Report
<i>Appendix J</i>	NASA Mission Planning and Operations Team Report
<i>Appendix K</i>	NASA Development and Production Team Report
<i>Appendix L</i>	NASA Accident Analysis Team Report
<i>Appendix M</i>	Comments by Morton Thiokol on NASA Report

---

*Volume III*

---

<i>Appendix N</i>	NASA Photo and TV Support Team Report
<i>Appendix O</i>	NASA Search, Recovery and Reconstruction Task Force Team Report

---

*Volume IV*

---

Hearings of the Presidential Commission on the Space Shuttle  
Challenger Accident: February 6, 1986 to February 25, 1986

---

*Volume V*

---

Hearings of the Presidential Commission on the Space Shuttle  
Challenger Accident: February 26, 1986 to May 2, 1986

# Table of Contents

---

	Preface .....	1
<i>Chapter I</i>	Introduction .....	2
<i>Chapter II</i>	Events Leading Up to the Challenger Mission .....	10
<i>Chapter III</i>	The Accident .....	19
<i>Chapter IV</i>	The Cause of the Accident .....	40
<i>Chapter V</i>	The Contributing Cause of the Accident .....	82
<i>Chapter VI</i>	An Accident Rooted in History .....	120
<i>Chapter VII</i>	The Silent Safety Program .....	152
<i>Chapter VIII</i>	Pressures on the System .....	164
<i>Chapter IX</i>	Other Safety Considerations .....	178
	Recommendations .....	198
	The Commission .....	202
	The Staff .....	204
<i>Appendix A</i>	Commission Activities .....	206
<i>Appendix B</i>	Commission Documentation System .....	214
<i>Appendix C</i>	Observations Concerning the Processing and Assembly of Flight 51-L .....	219
<i>Appendix D</i>	Supporting Charts and Documents .....	225

---

# Preface

**T**he accident of Space Shuttle Challenger, mission 51-L, interrupting for a time one of the most productive engineering, scientific and exploratory programs in history, evoked a wide range of deeply felt public responses. There was grief and sadness for the loss of seven brave members of the crew; firm national resolve that those men and women be forever enshrined in the annals of American heroes, and a determination, based on that resolve and in their memory, to strengthen the Space Shuttle program so that this tragic event will become a milestone on the way to achieving the full potential that space offers to mankind.

The President, who was moved and troubled by this accident in a very personal way, appointed an independent Commission made up of persons not connected with the mission to investigate it. The mandate of the Commission was to:

1. Review the circumstances surrounding the accident to establish the probable cause or causes of the accident; and
2. Develop recommendations for corrective or other action based upon the Commission's findings and determinations.

Immediately after being appointed, the Commission moved forward with its investigation and, with the full support of the White House, held public hearings dealing with the facts leading up to the accident. In a closed society other options are available; in an open society—unless classified matters are involved—other options are not, either as matter of law or as a practical matter.

In this case a vigorous investigation and full disclosure of the facts were necessary. The way to deal with a failure of this magnitude is to disclose all the facts fully and openly; to take immediate steps to correct mistakes that led to the failure; and to continue the program with renewed confidence and determination.

The Commission construed its mandate somewhat broadly to include recommendations on safety matters not necessarily involved in this

accident but which require attention to make future flights safer. Careful attention was given to concerns expressed by astronauts because the Space Shuttle program will only succeed if the highly qualified men and women who fly the Shuttle have confidence in the system.

However, the Commission did not construe its mandate to require a detailed investigation of all aspects of the Space Shuttle program; to review budgetary matters; or to interfere with or supersede Congress in any way in the performance of its duties. Rather, the Commission focused its attention on the safety aspects of future flights based on the lessons learned from the investigation with the objective being to return to safe flight.

Congress recognized the desirability, in the first instance, of having a single investigation of this national tragedy. It very responsibly agreed to await the Commission's findings before deciding what further action might be necessary to carry out its responsibilities.

For the first several days after the accident—possibly because of the trauma resulting from the accident—NASA appeared to be withholding information about the accident from the public. After the Commission began its work, and at its suggestion, NASA began releasing a great deal of information that helped to reassure the public that all aspects of the accident were being investigated and that the full story was being told in an orderly and thorough manner.

Following the suggestion of the Commission, NASA established several teams of persons not involved in the mission 51-L launch process to support the Commission and its panels. These NASA teams have cooperated with the Commission in every aspect of its work. The result has been a comprehensive and complete investigation.

The Commission believes that its investigation and report have been responsive to the request of the President and hopes that they will serve the best interests of the nation in restoring the United States space program to its preeminent position in the world. ■

# Introduction

**T**he Space Shuttle concept had its genesis in the 1960s, when the Apollo lunar landing spacecraft was in full development but had not yet flown.

From the earliest days of the space program, it seemed logical that the goal of frequent, economical access to space might best be served by a reusable launch system. In February, 1967, the President's Science Advisory Committee lent weight to the idea of a reusable spacecraft by recommending that studies be made "of more economical ferrying systems, presumably involving partial or total recovery and use."

In September, 1969, two months after the initial lunar landing, a Space Task Group chaired by the Vice President offered a choice of three long-range plans:

- A \$8-\$10 billion per year program involving a manned Mars expedition, a space station in lunar orbit and a 50-person Earth-orbiting station serviced by a reusable ferry, or Space Shuttle.
- An intermediate program, costing less than \$8 billion annually, that would include the Mars mission.
- A relatively modest \$4-\$5.7 billion a year program that would embrace an Earth-orbiting space station and the Space Shuttle as its link to Earth.<sup>1</sup>

In March, 1970, President Nixon made it clear that, while he favored a continuing active space program, funding on the order of Apollo was not in the cards. He opted for the shuttle-tended space base as a long-range goal but deferred going ahead with the space station pending development of the shuttle vehicle. Thus the reusable

Space Shuttle, earlier considered only the transport element of a broad, multi-objective space plan, became the focus of NASA's near-term future.

## The Space Shuttle Design

The embryo Shuttle program faced a number of evolutionary design changes before it would become a system in being. The first design was based on a "fly back" concept in which two stages, each manned, would fly back to a horizontal, airplane-like landing. The first stage was a huge, winged, rocket-powered vehicle that would carry the smaller second stage piggyback; the carrier would provide the thrust for liftoff and flight through the atmosphere, then release its passenger—the orbiting vehicle—and return to Earth. The Orbiter, containing the crew and payload, would continue into space under its own rocket power, complete its mission and then fly back to Earth.

The second-stage craft, conceived prior to 1970 as a space station ferry, was a vehicle considerably larger than the later Space Shuttle Orbiter. It carried its rocket propellants internally, had a flight deck sufficiently large to seat 12 space station-bound passengers and a cargo bay big enough to accommodate space station modules. The Orbiter's size put enormous weightlifting and thrust-generating demands on the first-stage design.

This two-stage, fully reusable design represented the optimum Space Shuttle in terms of "routine, economical access to space," the catchphrase that was becoming the primary guideline for development of Earth-to-orbit systems. It was,

however, less than optimum in terms of the development investment required: an estimated \$10-13 billion, a figure that met with disfavor in both Congress and the Office of Management and Budget.

In 1971, NASA went back to the drawing board, aware that development cost rather than system capability would probably be the determining factor in getting a green light for Shuttle development. Government and industry studies sought developmental economies in the configuration. One proposal found acceptance: eliminate the Orbiter's internal tanks and carry the propellant in a single, disposable External Tank. It provided a smaller, cheaper Orbiter without substantial performance loss.

For the launch system, NASA examined a number of possibilities. One was a winged but unmanned recoverable liquid-fuel vehicle based on the eminently successful Saturn 5 rocket from the Apollo Program. Other plans envisioned simpler but also recoverable liquid-fuel systems, expendable solid rockets and the reusable Solid Rocket Booster. NASA had been using solid-fuel vehicles for launching some small unmanned spacecraft, but solids as boosters for manned flight was a technology new to the agency. Mercury, Gemini and Apollo astronauts had all been rocketed into space by liquid-fuel systems. Nonetheless, the recoverable Solid Rocket Booster won the nod, even though the liquid rocket offered potentially lower operating costs.

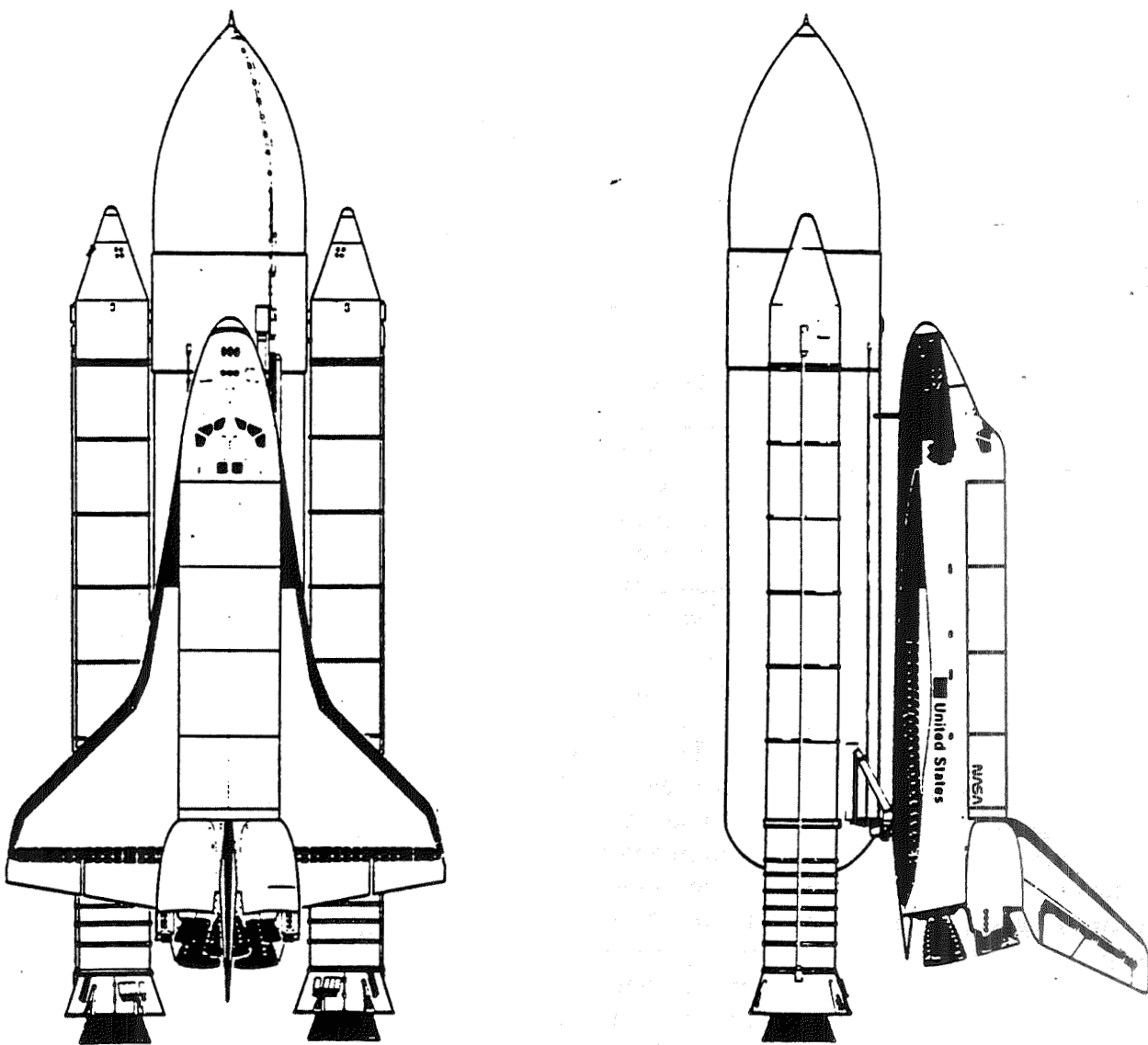

Artist's drawing depicts Space Shuttle stacked for launch in view from dorsal side of Orbiter (left) and from the left side of stack.

The overriding reason was that pricing estimates indicated a lower cost of development for the solid booster.

Emerging from this round of design decision making was the Space Shuttle: a three-element system composed of the Orbiter, an expendable external fuel tank carrying liquid propellants for the Orbiter's engines, and two recoverable Solid Rocket Boosters. It would cost, NASA estimated early in 1972, \$6.2 billion to develop and test a five-Orbiter Space Shuttle system, about half what the two-stage "fly back" design would have cost. To achieve that reduction, NASA had to accept somewhat higher system operating costs and sacrifice full reusability. The compromise design retained recoverability and reuse of two of the three elements and still promised to trim substantially the cost of delivering payloads to orbit.

The final configuration was selected in March, 1972.

## The Space Shuttle Development

In August, 1972, NASA awarded a contract to Rockwell International Corporation's Space Transportation Systems Division for design and development of the Space Shuttle Orbiter. Martin Marietta Denver Aerospace was assigned development and fabrication of the External Tank, Morton Thiokol Corporation was awarded the contract for the Solid Rocket Boosters, and Rocketdyne, a division of Rockwell, was selected to develop the Orbiter main engines.

NASA divided managerial responsibility for the program among three of its field centers. Johnson Space Center, Houston, Texas, was assigned management of the Orbiter. Marshall Space Flight Center, Huntsville, Alabama, was made responsible for the Orbiter's main engines, the External Tank and the Solid Rocket Boosters. Kennedy Space Center, Merritt Island, Florida, was given the job of assembling the Space Shuttle components, checking them out and conducting launches. Because these three centers will be mentioned repeatedly in this report, they will hereafter be identified simply as Johnson, Marshall and Kennedy.

It was in an increasingly austere fiscal environ-

ment that NASA struggled through the Shuttle development years of the 1970s. The planned five-Orbiter fleet was reduced to four. Budgetary difficulties were compounded by engineering problems and, inevitably in a major new system whose development pushes the frontiers of technology, there was cost growth. This combination of factors induced schedule slippage. The initial orbital test flights were delayed by more than two years.

The first Shuttle test flights were conducted at Dryden Flight Research Facility, California, in 1977. The test craft was the Orbiter Enterprise, a full-size vehicle that lacked engines and other systems needed for orbital flight. The purpose of these tests was to check out the aerodynamic and flight control characteristics of the Orbiter in atmospheric flight. Mounted piggyback atop a modified Boeing 747, the Enterprise was carried to altitude and released for a gliding approach and landing at the Mojave Desert test center. Five such flights were made. They served to validate the Orbiter's computers and other systems. They also demonstrated the craft's subsonic handling qualities, in particular its performance in the precise unpowered landings that would be required on all Shuttle flights.

The Enterprise test flights were followed—in 1977-80—by extensive ground tests of Shuttle systems, including vibration tests of the entire assembly—Orbiter, External Tank and Solid Rocket Boosters—at Marshall. Main engine test firings were conducted at National Space Technology Laboratories at Bay St. Louis, Mississippi, and on the launch pad at Kennedy.

By early 1981, the Space Shuttle was ready for an orbital flight test program. This was carefully crafted to include more than 1,000 tests and data collection procedures. All flights were to be launched from Kennedy and terminate at Edwards Air Force Base, where the Dryden Flight Research Facility is located (actually the third flight landed at White Sands Test Facility, New Mexico, because the normally dry lakebed at Edwards was flooded). Originally intended as a six-mission program, the orbital test series was reduced to four flights:

- STS-1 (Space Transportation System—1), April 12-14, 1981, Orbiter Columbia, was a two-day demonstration of the Orbiter's ability to go into orbit and return safely. Its



main payload was a flight instrumentation pallet containing equipment for recording temperatures, pressures and acceleration levels at various points around the Orbiter. In addition, there were checkouts of the cargo bay doors, attitude control system and orbital maneuvering system.

- STS-2, November 12-14, 1981, Orbiter Columbia, marked the first test of the Remote Manipulator System and carried a payload of Earth survey instruments. This was the first time any spacecraft had flown twice. Failure of a fuel cell shortened the flight by about three days.
- STS-3, March 22-30, 1982, Orbiter Columbia, was the longest of the initial test series, staying aloft eight days. Activities included a special test of the manipulator in which the robot arm removed a package of instruments from the payload bay but did not release it into space. The flight included experiments in materials processing.
- STS-4, June 27-July 4, 1982, Orbiter Columbia, featured another test of the robot arm, which extended a scientific payload over the side of the payload bay, then reberthed it. Materials processing experiments were conducted, as were a number of scientific investigations. This flight carried the first Department of Defense payload.

With the landing of STS-4, the orbital flight test program came to an end with 95 percent of its objectives accomplished. The interval between flights had been trimmed from seven months to four, then three. NASA declared the Space Shuttle "operational," a term that has encountered some criticism because it erroneously suggests that the Shuttle had attained an airline-like degree of routine operation. In any event, NASA regarded all flights after STS-4 operational in the sense that payload requirements would take precedence over spacecraft testing, requiring larger crews.

After completing the orbital test in mid-1982, NASA began the "operational phase" of the Space Shuttle program, beginning with STS-5. The STS—for Space Transportation System—sequential numbering was still in effect at that time; after STS-9 NASA changed the method of numbering missions. Thereafter each flight was designated by two numbers and a letter, such as 41-B. The first digit indicates the fiscal year of the scheduled launch (4 for 1984). The second

digit identifies the launch site (1 is Kennedy, 2 Vandenberg Air Force Base, California). The letter corresponds to the alphabetical sequence for the fiscal year, B being the second mission scheduled. Here is a brief summary of the 21 missions launched from late 1982 to January, 1986:

- STS-5, November 11-16, 1982, Orbiter Columbia, launched two communications satellites, which later were boosted to geosynchronous orbit by attached propulsion systems.
- STS-6, April 4-9, 1983, Orbiter Challenger, was highlighted by the first Shuttle-based spacewalk, or extravehicular activity. The crew successfully deployed the 5,000-pound Tracking and Data Relay Satellite, first of three planned NASA communications satellites.
- STS-7, June 18-24, 1983, Orbiter Challenger, delivered a second pair of commercial communications satellites. The mission also included additional payload release and recapture tests using the Remote Manipulator System. This flight marked the first retrieval of an object from orbit.
- STS-8, August 30-September 6, 1983, Orbiter Challenger, included more robot arm tests plus deployment of a commercial/public service communications satellite.
- STS-9, November 28-December 8, 1983, Orbiter Columbia, carried the first Spacelab in the payload bay. The mission marked Columbia's return to service after a year's hiatus, during which it had been extensively modified.
- Flight 10 (41-B), February 3-11, 1984, Orbiter Challenger, was highlighted by the introduction of the Manned Maneuvering Unit, a backpack propulsion unit that allows astronauts to maneuver in space independent of the Orbiter. The mission also launched two communications satellites, but their boosters failed to put them into geosynchronous orbit. For the first time, the Shuttle landed on the concrete runway at Kennedy Space Center.
- Flight 11 (41-C), April 6-13, 1984, Orbiter Challenger, featured an important demonstration of Shuttle ability: the retrieval, repair and redeployment of the malfunctioning Solar Maximum Mission spacecraft with the help of a Manned

Maneuvering Unit. Other activity included deployment of the Long Duration Exposure Facility, a large cylinder containing materials samples to be retrieved and examined after long exposure to the space environment.

- Flight 12 (41-D), August 30-September 5, 1984, Orbiter Discovery, was devoted primarily to launch of three communications satellites. The mission demonstrated repeated deployment and retraction of a large, foldable solar array to investigate the practicability of using such solar wings as power sources for extended Shuttle missions, space platforms or the space station.
- Flight 13 (41-G), October 5-13, 1984, Orbiter Challenger, launched the NASA Earth Radiation Budget Explorer. A cargo bay pallet carried instruments for Earth observations, including an advanced imaging radar.
- Flight 14 (51-A), November 8-16, 1984, Orbiter Discovery, launched two communications satellites and retrieved two others that had been sent into unusable orbits after deployment on Flight 10.
- Flight 15 (51-C), January 24-27, 1985, Orbiter Discovery, carried a Department of Defense payload.
- Flight 16 (51-D), April 12-19, 1985, Orbiter Discovery, deployed two commercial satellites; one, Leasat-3, remained in low orbit when the upper stage booster failed to activate.
- Flight 17 (51-B), April 29-May 6, 1985, Orbiter Challenger, carried a second Spacelab mission and materials processing experiments.
- Flight 18 (51-G), June 17-24, 1985, Orbiter Discovery, delivered three communications satellites, deployed a low-cost Spartan scientific satellite and retrieved it after a period of free flight.
- Flight 19 (51-F), July 29-August 6, 1985, Orbiter Challenger, carried the third Spacelab mission, which covered a broad range of experiments in plasma physics, astrophysics, solar astronomy and materials processing.
- Flight 20 (51-I), August 27-September 3, 1985, Orbiter Discovery, deployed three communications satellites. The Leasat-3

satellite which failed to activate after deployment on Flight 16 was retrieved, repaired and successfully redeployed.

- Flight 21 (51-J), October 3-10, 1985, Orbiter Atlantis was devoted to another Department of Defense mission.
- Flight 22 (61-A), October 30-November 6, 1985, Orbiter Challenger, carried the fourth Spacelab mission, devoted to materials processing experimentation.
- Flight 23 (61-B), November 26-December 3, 1985, Orbiter Atlantis, was highlighted by an experiment in astronaut assembly of structures in orbit and attendant study of extravehicular dynamics and human factors. The mission also deployed three communications satellites.
- Flight 24 (61-C), January 12-18, 1986, Orbiter Columbia, launched a commercial communications satellite, deployed a Hitchhiker secondary payload, conducted experiments in infrared imaging, acquired photos and spectral images of Comet Halley.
- Flight 25 (51-L), January 28, 1986, Orbiter Challenger. The accident.

Including the initial orbital tests, the Space Shuttle flew 24 successful missions over a 57-month period. Columbia made seven trips into space, Discovery six and Atlantis two. Challenger flew most frequently—nine times prior to its fateful last flight.

In those 24 flights, the Shuttle demonstrated its ability to deliver a wide variety of payloads; its ability to serve as an orbital laboratory; its utility as a platform for erection of large structures; and its use for retrieval and repair of orbiting satellites.

## Elements of the Space Shuttle

---

The Space Shuttle is the principal component of a national Space Transportation System designed to accommodate not only NASA's predictable needs but also those of the Department of Defense and commercial payload sponsors. Technically speaking, transportation system hardware embraces not only the Shuttle but its Spacelab laboratory component, the upper stage propulsion units, contemplated heavy lift vehicles

and space tugs for moving payloads from one orbit to another. To provide for the broadest possible spectrum of civil/military missions, the Space Shuttle was designed to deliver 65,000 pounds of payload to an easterly low Earth orbit or 32,000 pounds to polar orbit. The following sections describe the main elements of the Shuttle system.

## The Orbiter

The Orbiter is as large as a mid-size airline transport and has a structure like that of an aircraft: an aluminum alloy skin stiffened with stringers to form a shell over frames and bulkheads of aluminum or aluminum alloy. The major structural sections of the Orbiter are the forward fuselage, which encompasses the pressurized crew compartment; the mid fuselage, which contains the payload bay; the payload bay doors; the aft fuselage, from which the main engine nozzles project; and the vertical tail, which splits open along the trailing edge to provide a speed brake used during entry and landing.

The crew compartment is divided into two levels—the flight deck on top and the middeck below. Besides working space, the crew compartment contains the systems needed to provide a habitable environment (atmosphere, temperature, food, water, the crew sleep facilities and waste management). It also houses the electronic, guidance and navigation systems.

The Orbiter crew may include as many as eight people, although generally the limit is seven. The crew consists of the commander, the captain of the ship; the pilot, second in command; and two or more mission specialists. One or more payload specialists can also be accommodated. A mission specialist coordinates activities of the Orbiter and crew in support of a given payload objective. A payload specialist may manage specific experiments. The commander, pilot and mission specialists are career astronauts assigned to the mission by NASA. Payload specialists do not come from the Astronaut Office. They are assigned, by payload sponsors in coordination with NASA.

Cargoes up to 24 tons have been carried in the payload bay. Clamshell doors on the top of the Orbiter meet along the craft's spine to enclose the bay, which is 15 feet wide and 60 feet long.

The payload bay is designed to hold securely a wide range of objects. They may include one or more communications satellites to be launched from orbit, an autonomous Spacelab for ex-

periments in space, or cargo disposed on special pallets. To handle cargo in orbital flight, the payload bay has the 50-foot mechanical arm that is controlled from within the crew compartment. A television camera and lights mounted near the end of the arm enable the operator to see what the "hand" is doing.

Just as important as delivering cargo to orbit is recovering a satellite and bringing it back to Earth—retrieving a satellite in need of refurbishment, for example. The Orbiter can carry 16 tons of cargo back from space.

The feasibility of a reusable Space Shuttle hinges on a particularly vital requirement: protecting the Orbiter from the searing heat generated by friction with the atmosphere when the craft returns to Earth. Temperatures during entry may rise as high as 2,750 degrees Fahrenheit on the leading edge of the wing and 600 degrees on the upper fuselage, the "coolest" area. The thermal protection system devised for the Orbiter must prevent the temperature of the aluminum skin from rising above 350 degrees during either ascent or entry.

The Orbiter has four kinds of external insulation that are applied to various parts of the structure according to the temperature each is likely to experience. The craft's nose cap and the leading edges of the wings are protected with an all-carbon composite consisting of layers of graphite cloth in a carbon matrix. The outer layers are converted chemically to silicon carbide, the same material that has long been used as an abrasive in grindstones. Areas subjected to the next greatest heat are shielded with high-temperature ceramic tiles about six inches square and varying in thickness from one to five inches, depending on the protection needed. So-called "low-temperature" tiles are of the same material—nearly pure glass, of which 90 percent of the volume is "air"—for use on areas requiring less protection. (Low-temperature is relative; tiles so designated can withstand a temperature of 1,200 degrees Fahrenheit.) About 30,000 tiles, each different, are installed on each Orbiter.

## Space Shuttle Main Engines

The three high-performance rocket engines in the aft section of the Orbiter fire for about the first 8½ minutes of flight after liftoff. At sea level, each engine generates 375,000 pounds of thrust at 100 percent throttle.

The propellants for the engines are the fuel (liq-

uid hydrogen) and the oxidizer (liquid oxygen) carried in the External Tank. Combustion takes place in two stages. First, the propellants are mixed and partly burned in pre-burners. Hot gases from the pre-burners drive the high-pressure turbopumps which deliver propellants to the main injector. Combustion, once initiated by electrical igniters, is self-sustaining. Before firing, the very cold liquid propellant is allowed to flow into the system as far as the pre-burners and combustion chamber to cool the pumps and ducts so that the hydrogen and oxygen in the system will remain liquid when the engine is started.

The main engines have been throttled over a range of 65 to 104 percent of the thrust at sea level. At liftoff, they are thrusting at 100 percent. Computers command engine thrust to 104 percent as soon as the Shuttle clears the tower. They throttle to 65 percent to reduce the maximum aerodynamic loads that occur at an altitude of about 34,000 feet. Thereafter, the thrust is again increased to provide an acceleration of three times that of gravity in the last minute or so of powered flight.

### **External Tank**

The External Tank carries the propellants for the Orbiter's main engines—143,000 gallons of liquid oxygen and 383,000 gallons of liquid hydrogen, which is much lighter than a comparable volume of oxygen. Together, the propellants weigh a little more than 790 tons. Martin Marietta Denver Aerospace, Michoud, Louisiana, builds the tank, a welded aluminum alloy cylinder with an ogive nose and a hemispherical tail. It is 154 feet long and 27½ feet in diameter.

Because the Orbiter and the two Solid Rocket Boosters are attached to it at liftoff, the External Tank absorbs the thrust of the combined propulsion system. It withstands complex load effects and pressures from the propellants.

The liquid oxygen tank forms the nose of the External Tank. It contains oxidizer kept liquid at a temperature of -297 degrees Fahrenheit. A removable conical nose cap acts as an aerodynamic fairing. Inside the tank, baffles reduce sloshing and the associated control problems. The liquid hydrogen tank does not need baffles because the fuel is so light that sloshing does not induce significant forces. The liquid hydrogen tank accounts for the greater part of the External Tank. Its contents are even colder than the LOX: -423 degrees Fahrenheit.

The intertank structure or "intertank" connects the two propellant tanks. It is a cylindrical structural section that houses instruments and receives and distributes most of the thrust load from the Solid Rocket Boosters. The front end of each booster is connected to the External Tank at the intertank midsection.

A multilayered thermal coating covers the outside of the External Tank to protect it from extreme temperature variations during pre-launch, launch, and the first 8½ minutes of flight. That insulation reduces the boil-off rate of the propellants, which must be kept at very low temperatures to remain liquid. It also is meant to minimize ice that might form from condensation on the outside of the propellant tanks.

In addition to the Solid Rocket Booster forward attachment points on either side of the intertank, three other attachment points link each booster to the aft major ring frame of the External Tank. The boosters are thus connected to the tank at four points, one forward and three aft.

Three structural elements link the Orbiter to the External Tank. A "wishbone" attachment beneath the crew compartment connects the forward end of the Orbiter to the tank. The two aft connections are tripods at the base of the External Tank.

A command from the Orbiter computer jettisons the External Tank 18 seconds after main engine cutoff, about 8½ minutes after liftoff. To ensure that it will travel a predictable path, a tumble system rotates the tank end-over-end at a minimum rate of two revolutions per minute. The tank breaks up upon atmospheric entry, falling into the planned area of the Indian or Pacific Ocean about an hour after liftoff. The External Tank is the only main component of the Space Shuttle that is not recovered and reused.

### **Solid Rocket Boosters**

The two solid-propellant rocket boosters are almost as long as the External Tank and attached to each side of it. They contribute about 80 percent of the total thrust at liftoff; the rest comes from the Orbiter's three main engines. Roughly two minutes after liftoff and 24 miles down range, the solid rockets have exhausted their fuel. Explosives separate the boosters from the External Tank. Small rocket motors move them away from the External Tank and the Orbiter, which continue toward orbit under thrust of the Shuttle's main engines.

The Solid Rocket Booster is made up of several subassemblies: the nose cone, Solid Rocket Motor and the nozzle assembly. Marshall is responsible for the Solid Rocket Booster; Morton Thiokol, Inc., Wasatch Division, Brigham City, Utah, is the contractor for the Solid Rocket Motors. Each Solid Rocket Motor case is made of 11 individual cylindrical weld free steel sections about 12 feet in diameter. When assembled, they form a tube almost 116 feet long. The 11 sections are the forward dome section, six cylindrical sections, the aft External Tank-attach ring section, two stiffener sections, and the aft dome section.

The 11 sections of the motor case are joined by tang-and-clevis joints held together by 177 steel pins around the circumference of each joint.

After the sections have been machined to fine tolerances and fitted, they are partly assembled at the factory into four casting segments. Those four cylindrical segments are the parts of the motor case into which the propellant is poured (or cast). They are shipped by rail in separate pieces to Kennedy.

Joints assembled before the booster is shipped are known as factory joints. Joints between the four casting segments are called field joints; they are connected at Kennedy when the booster segments are stacked for final assembly.

### **Orbital Maneuvering System**

The two engine pods on the aft fuselage of the Orbiter contain maneuvering engines and their propellant — monomethyl hydrazine (the fuel) and nitrogen tetroxide (the oxidizer). Helium pressurizes the propellant tanks, and the fuel and the oxidizer ignite on contact.

Forty-four small rocket motors in the Orbiter's nose and aft section maneuvering system pods allow adjustments of the vehicle's attitude in pitch, yaw, and roll axes. They also may be used to make small changes of velocity along one of the Orbiter's three axes.

### **Flight of a Shuttle**

Except for ascent and entry, all of the Shuttle's typical seven-day mission is in orbit. That is where the goals of a given mission are accomplished: scientific experiments carried out;

satellites deployed into orbit, retrieved or repaired; observations made of the Earth and the solar system. The Shuttle makes one revolution of the Earth approximately every 90 minutes during the satellite mission.

When it comes out of orbit, the Shuttle is moving at about 17,500 miles an hour. Reaction engines position the Orbiter nose forward again for entry into the atmosphere. Those thrusters continue to control the Orbiter's attitude until the atmosphere becomes dense enough for the aerodynamic surfaces to take effect.

The Shuttle enters the ever-thickening blanket of atmosphere at 400,000 feet of altitude and a speed of more than 17,000 miles an hour (about Mach 25). The Orbiter's nose is positioned 40 degrees above its flight path. That attitude increases aerodynamic drag, thus helping to dissipate the tremendous amount of energy that the spacecraft has when it enters the atmosphere. Friction heats the surface of the Orbiter, which is protected by thermal tiles, and ionizes the surrounding air, preventing radio communication with Earth for the next 13 minutes.

The flight control system's computer program allows use of the reaction thrusters and aerodynamic surfaces in combination to control the spacecraft. At Mach 4.2, the rudder is activated, and the last reaction thrusters are deactivated at Mach 1. Thereafter, the craft is entirely maneuvered like an airplane by movement of the aerodynamic control surfaces: elevons, rudder, speed brake, and body flap.

In the landing approach, the Orbiter has no propulsion. It has only its velocity and altitude. Its energy must be carefully managed to maneuver the Shuttle aerodynamically to a safe landing. Beginning this terminal phase, the glide slope is steep—19 degrees—as the Orbiter descends toward the runway. Half a minute before touchdown and two miles from the runway, the craft flares to a shallow, almost flat 1.5 degree glide slope. Touchdown occurs at 225 miles per hour. On the runway, the Orbiter rolls to a stop, and the mission is complete. ■

### **References**

<sup>1</sup> Space Task Group Report to the President. "The Post-Apollo Space Program: Directions for the Future." September, 1969. pages 20 and 21.

# Events Leading Up to the Challenger Mission

**P**reparations for the launch of mission 51-L were not unusual, though they were complicated by changes in the launch schedule. The sequence of complex, interrelated steps involved in producing the detailed schedule and supporting logistics necessary for a successful mission always requires intense effort and close coordination.

Flight 51-L of the Challenger was originally scheduled for July, 1985, but by the time the crew was assigned in January, 1985, launch had been postponed to late November to accommodate changes in payloads. The launch was subsequently delayed further and finally rescheduled for late January, 1986.

After the series of payload changes, the Challenger cargo included two satellites in the cargo bay and equipment in the crew compartment for experiments that would be carried out during the mission. The payloads flown on mission 51-L are listed in this table:

---

## Mission 51-L Payloads

Tracking and Data Relay Satellite-B  
Spartan-Halley Satellite  
Comet Halley Active Monitoring Program  
Fluid Dynamics Experiment  
Phase Partitioning Experiment  
Teacher in Space Project  
Shuttle Student Involvement Program  
Radiation Monitoring Experiment

---

The primary payloads were the Tracking and Data Relay Satellite (a NASA communications satellite) and the Spartan satellite that would be deployed into orbit carrying special instruments

for the observation of Halley's Comet.

The NASA communications satellite was to have been placed in a geosynchronous orbit with the aid of a booster called the Inertial Upper Stage. The satellite would have supported communications with the Space Shuttle and up to 23 other spacecraft.

The Spartan satellite was to have been deployed into low Earth orbit using the remote manipulator system. The Spartan instruments would have watched Halley's Comet when it was too close to the Sun for other observatories to do so. Subsequently, the satellite would have been retrieved and returned to Earth in the Shuttle payload bay.

---

## Crew Assignments

On January 27, 1985, one year before launch, NASA announced the names of the astronauts assigned to mission 51-L:

Commander	Francis R. Scobee
Pilot	Michael J. Smith
Mission Specialist	Ellison S. Onizuka
One	
Mission Specialist	Judith A. Resnik
Two	
Mission Specialist	Ronald E. McNair
Three	

The mission commander, Francis R. (Dick) Scobee, first flew on the Space Shuttle as the pilot of mission 41-C in April, 1984. Mr. Scobee, a native of Auburn, Washington, received his bachelor's degree in aerospace engineering from the University of Arizona. A former Air Force



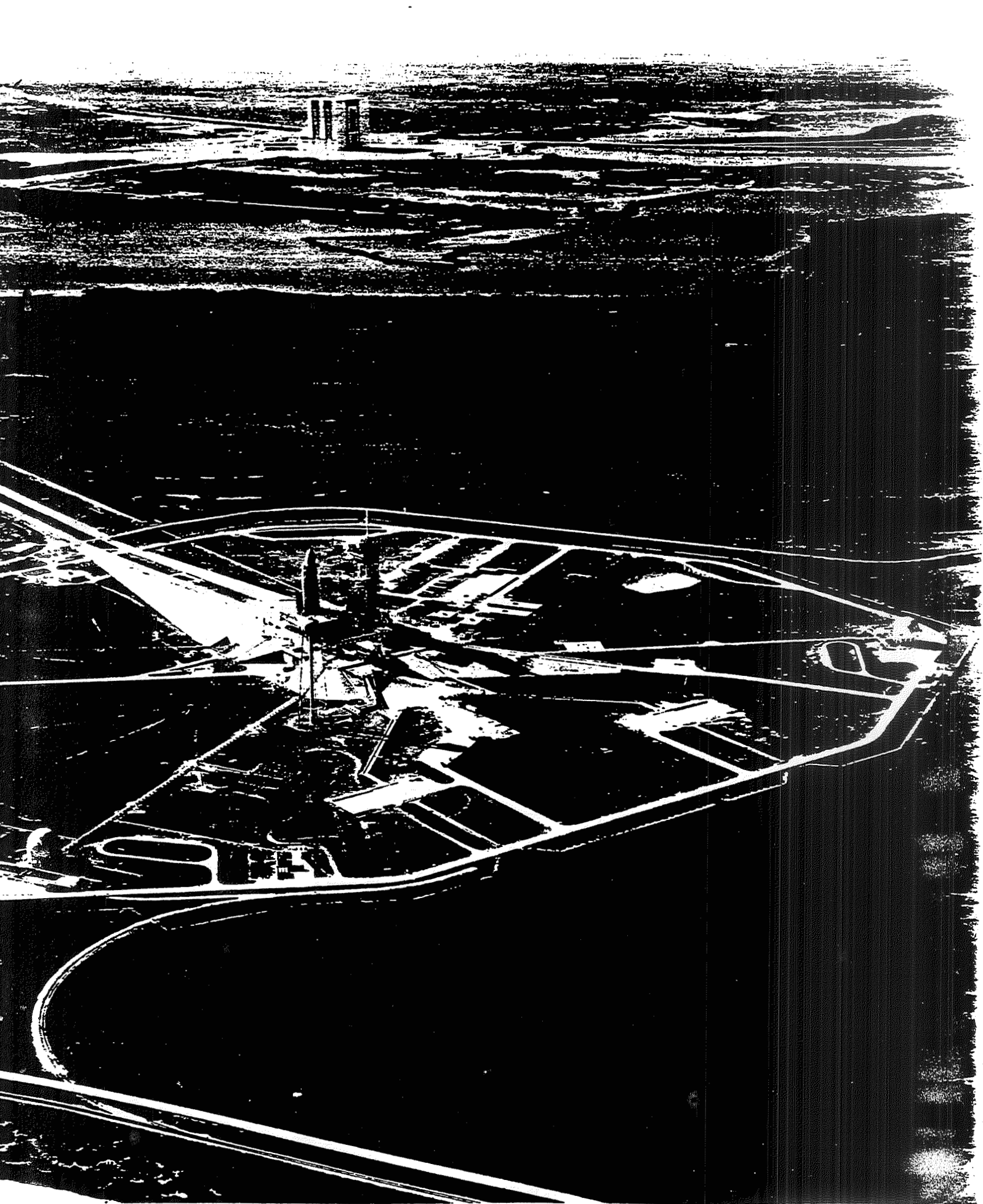

Space Shuttle 51-L on Pad 39B of Kennedy Space Center's launch complex.

ORIGINAL PAGE IS  
OF POOR QUALITY



test pilot with 7,000 hours in 45 aircraft types, he became an astronaut in 1978.

The mission pilot, Captain Michael J. Smith, USN, was on his first Shuttle flight after being selected as an astronaut in 1980. A native of Beaufort, North Carolina, Captain Smith, a 1967 graduate of the United States Naval Academy, received a master's degree from the Naval Postgraduate School. He was a Navy test pilot with extensive experience in a variety of aircraft.

Mission specialist Lieutenant Colonel Ellison S. Onizuka, USAF, from Kealahou, Kona, Hawaii, received his master's degree in aerospace engineering at the University of Colorado. A flight test engineer in the Air Force, he became

an astronaut in 1978 and flew on the first military mission (51-C) in January, 1985, aboard the Space Shuttle Discovery.

Mission specialist Judith A. Resnik, Ph.D., flew on the first flight of the Orbiter Discovery on mission 41-D in August, 1984. Born in Akron, Ohio, Dr. Resnik received her doctorate in electrical engineering from the University of Maryland in 1976. After working for several industrial firms, she became an astronaut in 1978.

Mission specialist Ronald E. McNair, Ph.D., a native of Lake City, South Carolina, received his doctorate in physics from the Massachusetts Institute of Technology in 1976. After working as a research physicist in civilian industry, he

### Mission 51-L Major Milestone Summary

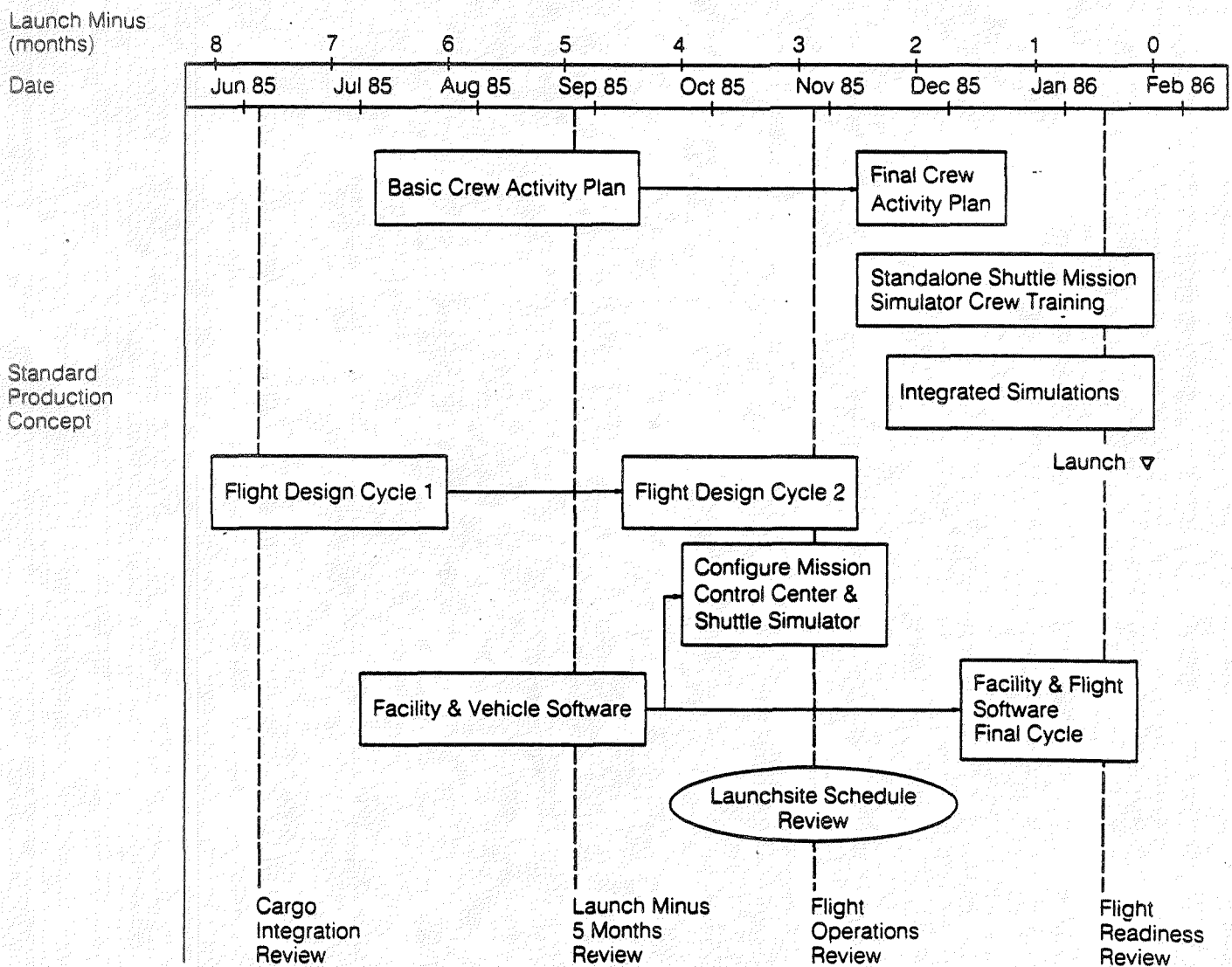

Diagram shows the scheduling of various preparatory milestones in the months that preceded the launching of the Mission 51-L Shuttle.

became an astronaut in 1978 and first flew on mission 41-B in February, 1984, aboard the Space Shuttle Challenger.

Payload specialists are members of a Space Shuttle crew who are not career astronauts. Two such specialists, Christa McAuliffe and Gregory B. Jarvis, were added to the crew of mission 51-L.

Ms. McAuliffe was born in Boston and raised in Framingham, Massachusetts, where she graduated from Framingham State College. After teaching a variety of junior high and high school subjects in Maryland and New Hampshire, she was selected as the Teacher in Space. She was assigned to the 51-L crew in July, 1985.

Mr. Jarvis was a former Air Force engineer who specialized in satellite design. He was born in Detroit, Michigan, and received his master's degree in electrical engineering from Northeastern University in Boston. He was assigned to the 51-L crew in October, 1985, as a representative of the Hughes Aircraft Company.

The payload specialists each had responsibilities for mission 51-L. Ms. McAuliffe was to conduct a series of classroom lessons from orbit and conduct several basic classroom experiments. Mr. Jarvis was to perform a series of fluid dynamics experiments that would support satellite redesign.

## Preparations for Flight

Planning for mission 51-L began in 1984, but 10 major change documents adding or deleting payload items caused some disruption in the preparation process. Because the 12- to 18-month process is a series of repetitive cycles that define a flight design in progressively more specific detail, significant changes can require extensive time and effort to incorporate. The closer to the planned launch date the changes occur, the more difficult and disruptive it becomes to repeat the cycles necessary to complete a mission plan. (See the Mission 51-L Milestone Summary chart.) Although there were several significant changes to the cargo manifest, most occurred early enough in the planning cycle to minimize their impact on the flight preparation.

The cargo integration review is one of the crucial coordination meetings in the flight preparation process. At that meeting, requirements for all payloads are examined to ensure that, collectively, they are within the capabilities of the vehicle and crew.

For mission 51-L, the cargo integration review was rescheduled six times, primarily because of payload changes. All major payload changes were made, however, before the review eventually took place on June 18, 1985, seven months before the launch. Until the cargo integration review for a mission is completed, the development of the final flight design products cannot really get underway. Because the mission 51-L payload changes were made before the cargo integration review, however, changes to the manifest did not seriously disrupt the preparation cycle.

Once the principal payload items were determined and the cargo integration review was completed, the flight design process became relatively straightforward. The flight design process is the central element in flight preparation. The process transforms the broad objectives of the flight into a detailed sequence of events from launch to landing. For mission 51-L, the objectives consisted of placing one satellite in orbit, deploying and retrieving Spartan, and conducting the six experiments. From that base, the flight design process produced a detailed schedule of events, trajectory data, requirements for consumable items, communications requirements and the necessary computer programming for the Orbiter, the Mission Control Center, and the Shuttle simulator used to train the crew for this particular mission.

The launch minus five months Flight Planning and Stowage Review was conducted on August 20, 1985, to address any unresolved issues and any changes to the plan that had developed to that point. Ideally, the mission events are firmly determined before the review takes place. For mission 51-L, however, Mr. Jarvis was not added to the crew until October 25, 1985, and his activities could not be incorporated into mission planning until that time. The crew activity plan, the formal flight requirements and the flight design status were reviewed as well as the current status of the engineering integration, the photo and TV requirements, and crew compartment stowage. The Flight Planning and Stowage Review did identify the need for further consideration of the launch window and of the then undefined requirements for the Teacher-in-Space program.

There were changes to middeck payloads, resulting from the addition of Mr. Jarvis, that occurred less than three months before launch. The most negative result of the changes was a

delay in publishing the crew activity plan. The crew activity plan specifies the in-flight schedule for all crew members, which in turn affects other aspects of flight preparation. Because the NASA communications satellite training requirements were quite similar to those for a previous flight, the crew training began using that existing crew activity plan and associated checklists. Considerable time was saved as a result. The requirements unique to Spartan did not involve major departures from the standard satellite deployment and rendezvous techniques that had been developed on mission 51-G, the experiment packages did not require any new Orbiter procedures, and the ascent and entry techniques were

standard. Thus, mission 51-L did not involve radical departures from previous flight patterns.

The crew began training 37 weeks before launch. Preparation in the Shuttle Mission Simulator, a fully instrumented mock-up of the Shuttle interior, began at launch minus 36 weeks. Integrated training in the simulator, which allows the crew to train with the flight controllers who will be controlling the flight in both the Mission Control Center and remote centers, began at launch minus nine weeks. For the crew, Shuttle simulator training included preparation for the use of the robot arm, a rendezvous in space, Inertial Upper Stage deployment, ascent and entry procedures, and a variety of other activities

### Crew Workload Comparison

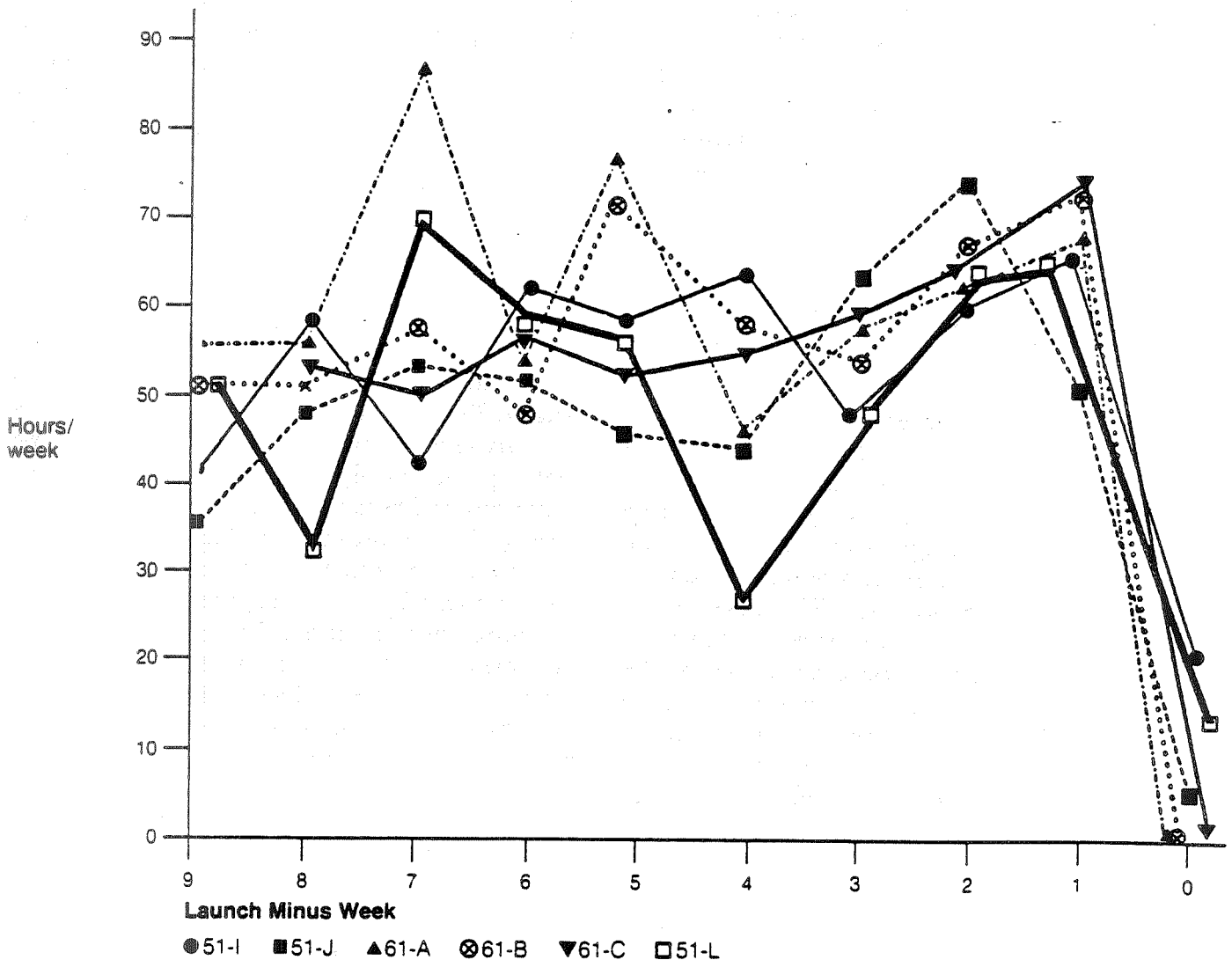

Graph compares training workloads of crews for six Shuttle missions in the nine weeks that preceded the launching of the space flights.

that must be practiced repeatedly if a Shuttle mission is to be carried out successfully.

All NASA crew members exceeded the number of training hours required and were certified proficient in all mission tasks. The two payload specialists also fulfilled their training requirements. All mission 51-L astronauts and flight controllers were certified ready for flight.

From a flight design process point of view, mission 51-L was a fairly typical mission. The most noticeable effect of the delays in the production process was a delay in the start of Shuttle Mission Simulator training specific to the flight. That training began at launch minus nine weeks for the crew of 51-L, two weeks later than the original schedule required.

Compressed training time was becoming a concern in late 1985. The crew of mission 51-L trained for an average of 48.7 hours per week during those nine weeks before launch, with peaks reaching 65 to 70 hours per week. Much more compression in their training schedule would not have been possible. (See the Crew Workload Comparisons graph.)

Launch date delays for mission 61-C also became a scheduling factor for the integrated simulations for mission 51-L. Originally scheduled for the third week in December, the 61-C launch was delayed until January 12, 1986. During the last six weeks before the Challenger launch, the 51-L schedule was changed several times as a result of launch delays of 61-C. The final impact on the Challenger crew training was reduced spacing between the ascent and entry simulations during the last two weeks before launch, but no training time was lost.

## **Flight Readiness Review**

---

The Level I Flight Readiness Review for mission 51-L took place on January 15, 1986. The Flight Readiness Review should address all aspects of flight preparation about which any questions have arisen. In addition, attendees confirm that all equipment and operational plans have been certified ready by the responsible manager within NASA. Solid Rocket Booster joints were not discussed during the review on January 15.

The period during the day when a particular

flight can be launched is determined by the requirements of the Orbiter and the payloads. The launch period for mission 51-L was limited in order to provide the best lighting conditions for Spartan's observations of Halley's Comet. The resulting "launch window" was a topic of some discussion at the Flight Readiness Review. The Challenger launch originally had been scheduled for a morning lift off. When Spartan was added to the mission, the launch window was changed to the afternoon. This change would have required a landing at night if a transatlantic abort landing had become necessary. Because the alternate transatlantic site, Casablanca, was not equipped for a night landing, the afternoon launch eliminated that back-up site. As January drew to a close, however, the conditions for optimum telescopic viewing of the comet could not be met. The launch window was shifted back to the morning hours so that the transatlantic abort site would be in daylight and a back-up site (Casablanca) would be available.

The results of the flight design process were summarized at the Flight Readiness Review. The predicted ascent performance, including expected trajectory, main engine throttling profile, expected dynamic pressure and the amount of propellant reserve expected at main engine cutoff, were presented and discussed. The expected landing parameters, weight and center of gravity figures were also presented for a variety of contingencies. It should be noted that a waiver was required because the weight of the Orbiter exceeded the allowable limits for an abort landing. The flight design data presented at the Flight Readiness Review are available in the Appendix in the NASA Mission Planning and Operations Team Report. No outstanding concerns were identified in the discussion of flight design.

The detailed flight plan and schedule of crew activities also were presented at the Flight Readiness Review. The Challenger was to circle the Earth for six days at an orbital altitude of approximately 153 nautical miles, landing early on the seventh day at Kennedy in Florida.

The major activities were to include deployment of the tracking and data relay satellite 10 hours after launch, deployment of the Spartan satellite on the third day of the flight and subsequent retrieval of the Spartan two days later. A summary of the planned activities is provided in the table that follows.

---

## Mission 51-L Orbital Activity Schedule

- Day One** After arriving in orbit, the crew had two periods of scheduled high activity. First, they were to check the readiness of the NASA satellite prior to planned deployment. After a lunch break, they were to deploy the satellite and Inertial Upper Stage and to perform a series of separation maneuvers. The first sleep period was scheduled to be eight hours long starting about 18 hours after crew wake-up on launch morning.
- 
- Day Two** The Comet Halley Active Monitoring Program experiment was scheduled to begin on the second day. Also scheduled were the initial teacher-in-space video taping and a firing of the orbital maneuvering engines to place the Orbiter at the 152-mile orbital altitude from which the Spartan would be deployed.
- 
- Day Three** The third day was to start with the crew programming the Spartan satellite with data sent from Johnson. The satellite was to be deployed using the remote manipulator system (the robot arm), and then the Orbiter would be maneuvered to produce, by day four, a 90-mile separation from Spartan.
- 
- Day Four** The Orbiter was to begin closing on Spartan while Jarvis continued the fluid dynamics experiments started on day two and day three. In addition, two lessons telecast live were to be conducted by Ms. McAuliffe.
- 
- Day Five** After rendezvous with Spartan, the crew was to use the robot arm to capture the satellite and re-stow it in the payload bay.
- 
- Day Six** Entry preparations were to dominate the last full day in space: flight control system checks, test firing of maneuvering jets needed for entry, and cabin stowage. A crew news conference also was scheduled following the lunch period, if requested by the NASA Public Affairs Office.
- 
- Day Seven** The seventh day would have been spent preparing the Space Shuttle for deorbit and entry into the atmosphere. The Challenger was scheduled to land at Kennedy 144 hours and 34 minutes after launch.
-

## Launch Delays

---

The launch of mission 51-L was postponed three times and scrubbed once from the planned date of January 22, 1986. The first postponement was announced on December 23, 1985. That change established the launch date as January 23, 1986, in order to accommodate the final integrated simulation schedule that resulted from the slip in the launch date of mission 61-C.

On January 22, 1986, the Program Requirements Change Board first slipped the launch from January 23 to January 25. That date subsequently was changed to January 26, 1986, primarily because of Kennedy work requirements produced by the late launch of mission 61-C.

The third postponement of the launch date occurred during an evening management conference on January 25, 1986, to review the weather forecast for the Kennedy area. Because the forecast was for unacceptable weather throughout the launch window on January 26, early countdown activities that had already started were terminated.

The launch attempt of January 27 began the day before as the complex sequence of events leading to lift off commenced. Fueling of the External Tank began at 12:30 a.m. Eastern Standard Time. The crew was awakened at 05:07 a.m., and events proceeded normally with the crew strapped into the Shuttle at 07:56 a.m. At 09:10, however, the countdown was halted when the ground crew reported a problem with an exterior hatch handle. By the time the hatch handle problem was solved at 10:30 a.m., winds at the Kennedy runway designated for a return-to-launch-site abort had increased and exceeded the allowable velocity for crosswinds. The launch attempt for January 27 was canceled at 12:35 p.m. Eastern Standard Time; the Challenger countdown was rescheduled for January 28.

The weather was forecast to be clear and very cold, with temperatures dropping into the low twenties overnight. The management team directed engineers to assess the possible effects of temperature on the launch. No critical issues were identified to management officials, and while evaluation continued, it was decided to proceed with the countdown and the fueling of the External Tank.

Ice had accumulated in the launch pad area

during the night and it caused considerable concern for the launch team. In reaction, the ice inspection team was sent to the launch pad at 01:35 a.m., January 28, and returned to the Launch Control Center at 03:00 a.m. After a meeting to consider the team's report, the Space Shuttle program manager decided to continue the countdown. Another ice inspection was scheduled at launch minus three hours.

Also, during the night, prior to fueling, a problem developed with a fire detector in the ground liquid hydrogen storage tank. Though it was ultimately tracked to a hardware fault and repaired, fueling was delayed by two and one-half hours. By continuing past a planned hold at launch minus three hours, however, the launch delay was reduced to one hour. Crew wake-up was rescheduled for 06:18 a.m., January 28, but by that time the crew was already up.

Because of forecast rain and low ceilings at Casablanca, the alternate abort site, that site was declared a "no-go" at 07:30 a.m. The change had no mission impact, however, because the weather at the primary transatlantic abort landing site at Dakar, Senegal, was acceptable. The abort-once-around site was Edwards Air Force Base, California.

With an extra hour, the crew had more than sufficient time to eat breakfast, get a weather briefing and put on flight gear. At the weather briefing, the temperature and ice on the pad were discussed, but neither then nor in earlier weather discussions was the crew told of any concern about the effects of low temperature on the Shuttle System. The seven crew members left the crew quarters and rode the astronaut van to launch pad B, arriving at 08:03. They were in their seats in the Challenger at 08:36 a.m.

At 08:44 a.m. the ice team completed its second inspection. After hearing the team's report, the program manager decided to allow additional time for ice to melt on the pad. He also decided to send the ice team to perform one final ice assessment at launch minus 20 minutes. When the count was resumed, launch had been delayed a second hour beyond the original lift off time of 09:38 a.m., Eastern Standard Time.

At 11:15 the ice inspection was completed, and during the hold at launch minus nine minutes, the mission 51-L crew and all members of the launch team gave their "go" for launch. The final flight of the Challenger began at 11:38:00.010 a.m., Eastern Standard Time, January 28, 1986.

## The Flight of the Challenger

---

The events that followed lift off were brief:

---

<i>Launch Time</i>	<i>Event</i>
- 6.6 sec.	Space Shuttle engines ignition
0 sec.	Solid Rocket Booster ignition
+ 7 sec.	"Roll program." (Challenger) "Roger, roll, Challenger." (Houston)
+ 24 sec.	Main engines throttled down to 94%
+ 42 sec.	Main engines throttled down to 65%
+ 59 sec.	Main engines throttled up to 104%
+ 65 sec.	"Challenger, go at throttle up." (Houston) "Roger. Go at throttle up." (Challenger)
+ 73 sec.	Loss of signal from Challenger

---

From lift off until the signal from the Shuttle was lost, no flight controller observed any indication of a problem. The Shuttle's main engines throttled down to limit the maximum dynamic pressure, then throttled up to full thrust as ex-

pected. Voice communications with the crew were normal. The crew called to indicate the Shuttle had begun its roll to head due east and to establish communication after launch. Fifty-seven seconds later, Mission Control informed the crew that the engines had successfully throttled up and all other systems were satisfactory. The commander's acknowledgment of this call was the last voice communication from the Challenger.

There were no alarms sounded in the cockpit. The crew apparently had no indication of a problem before the rapid break-up of the Space Shuttle system. The first evidence of an accident came from live video coverage. Radar then began to track multiple objects. The flight dynamics officer in Houston confirmed to the flight director that "RSO [range safety officer] reports vehicle exploded," and 30 seconds later he added that the range safety officer had sent the destruct signal to the Solid Rocket Boosters.

During the period of the flight when the Solid Rocket Boosters are thrusting, there are no survivable abort options. There was nothing that either the crew or the ground controllers could have done to avert the catastrophe. ■



# The Accident

**F**light of the Space Shuttle Challenger on Mission 51-L began at 11:38 a.m. Eastern Standard Time on January 28, 1986. It ended 73 seconds later in an explosive burn of hydrogen and oxygen propellants that destroyed the External Tank and exposed the Orbiter to severe aerodynamic loads that caused complete structural breakup. All seven crew members perished. The two Solid Rocket Boosters flew out of the fireball and were destroyed by the Air Force range safety officer 110 seconds after launch.

The ambient air temperature at launch was 36 degrees Fahrenheit measured at ground level approximately 1,000 feet from the 51-L mission launch pad 39B. This temperature was 15 degrees colder than that of any previous launch.

The following description of the flight events is based on visual examination and image enhancement of film from NASA operated cameras and telemetry data transmitted from the Space Shuttle to ground stations. The last telemetry data from the Challenger was received 73.618 seconds after launch.

At 6.6 seconds before launch, the Challenger's liquid fueled main engines were ignited in sequence and run up to full thrust while the entire Shuttle structure was bolted to the launch pad. Thrust of the main engines bends the Shuttle assembly forward from the bolts anchoring it to the pad. When the Shuttle assembly springs back to the vertical, the Solid Rocket Boosters' restraining bolts are explosively released. During this pre-release "twang" motion, structural loads are stored in the assembled structure. These loads are released during the first few seconds of flight in a structural vibration mode at a frequency of about

3 cycles per second. The maximum structural loads on the aft field joints of the Solid Rocket Boosters occur during the "twang," exceeding even those of the maximum dynamic pressure period experienced later in flight.

Just after liftoff at .678 seconds into the flight, photographic data show a strong puff of gray smoke was spurting from the vicinity of the aft field joint on the right Solid Rocket Booster. The two pad 39B cameras that would have recorded the precise location of the puff were inoperative. Computer graphic analysis of film from other cameras indicated the initial smoke came from the 270 to 310-degree sector of the circumference of the aft field joint of the right Solid Rocket Booster. This area of the solid booster faces the External Tank. The vaporized material streaming from the joint indicated there was not complete sealing action within the joint.

Eight more distinctive puffs of increasingly blacker smoke were recorded between .836 and 2.500 seconds. The smoke appeared to puff upwards from the joint. While each smoke puff was being left behind by the upward flight of the Shuttle, the next fresh puff could be seen near the level of the joint. The multiple smoke puffs in this sequence occurred at about four times per second, approximating the frequency of the structural load dynamics and resultant joint flexing. Computer graphics applied to NASA photos from a variety of cameras in this sequence again placed the smoke puffs' origin in the 270-to 310-degree sector of the original smoke spurt.

As the Shuttle increased its upward velocity, it flew past the emerging and expanding smoke puffs. The last smoke was seen above the field joint at 2.733 seconds. At 3.375 seconds the last

smoke was visible below the Solid Rocket Boosters and became indiscernible as it mixed with rocket plumes and surrounding atmosphere.

The black color and dense composition of the smoke puffs suggest that the grease, joint insulation and rubber O-rings in the joint seal were being burned and eroded by the hot propellant gases.

Launch sequence films from previous missions were examined in detail to determine if there were any prior indications of smoke of the color and composition that appeared during the first few seconds of the 51-L mission. None were found. Other vapors in this area were determined to be melting frost from the bottom of the External Tank or steam from the rocket exhaust in the pad's sound suppression water trays.

Shuttle main engines were throttled up to 104 percent of their rated thrust level, the Challenger executed a programmed roll maneuver and the engines were throttled back to 94 percent.

At approximately 37 seconds, Challenger encountered the first of several high-altitude wind shear conditions, which lasted until about 64 seconds. The wind shear created forces on the vehicle with relatively large fluctuations. These were immediately sensed and countered by the guidance, navigation and control system. Although flight 51-L loads exceeded prior experience in both yaw and pitch planes at certain instants, the maxima had been encountered on previous flights and were within design limits.

The steering system (thrust vector control) of the Solid Rocket Booster responded to all commands and wind shear effects. The wind shear caused the steering system to be more active than on any previous flight.

At 45 seconds into the flight, three bright flashes appeared downstream of the Challenger's right wing. Each flash lasted less than one-thirtieth of a second. Similar flashes have been seen on other flights. Another appearance of a separate bright spot was diagnosed by film analysis to be a reflection of main engine exhaust on the Orbital Maneuvering System pods located at the upper rear section of the Orbiter. The flashes were unrelated to the later appearance of the flame plume from the right Solid Rocket Booster.

Both the Shuttle main engines and the solid rockets operated at reduced thrust approaching and passing through the area of maximum

dynamic pressure of 720 pounds per square foot. Main engines had been throttled up to 104 percent thrust and the Solid Rocket Boosters were increasing their thrust when the first flickering flame appeared on the right Solid Rocket Booster in the area of the aft field joint. This first very small flame was detected on image enhanced film at 58.788 seconds into the flight. It appeared to originate at about 305 degrees around the booster circumference at or near the aft field joint.

One film frame later from the same camera, the flame was visible without image enhancement. It grew into a continuous, well-defined plume at 59.262 seconds. At about the same time (60 seconds), telemetry showed a pressure differential between the chamber pressures in the right and left boosters. The right booster chamber pressure was lower, confirming the growing leak in the area of the field joint.

As the flame plume increased in size, it was deflected rearward by the aerodynamic slipstream and circumferentially by the protruding structure of the upper ring attaching the booster to the External Tank. These deflections directed the flame plume onto the surface of the External Tank. This sequence of flame spreading is confirmed by analysis of the recovered wreckage. The growing flame also impinged on the strut attaching the Solid Rocket Booster to the External Tank.

At about 62 seconds into the flight, the control system began to react to counter the forces caused by the plume and its effects. The left Solid Rocket Booster thrust vector control moved to counter the yaw caused by reduced thrust from the leaking right Solid Rocket Booster. During the next nine seconds, Space Shuttle control systems worked to correct anomalies in pitch and yaw rates.

The first visual indication that swirling flame from the right Solid Rocket Booster breached the External Tank was at 64.660 seconds when there was an abrupt change in the shape and color of the plume. This indicated that it was mixing with leaking hydrogen from the External Tank. Telemetered changes in the hydrogen tank pressurization confirmed the leak. Within 45 milliseconds of the breach of the External Tank, a bright sustained glow developed on the black-tiled underside of the Challenger between it and the External Tank.

Beginning at about 72 seconds, a series of events occurred extremely rapidly that terminated

the flight. Telemetered data indicate a wide variety of flight system actions that support the visual evidence of the photos as the Shuttle struggled futilely against the forces that were destroying it.

At about 72.20 seconds the lower strut linking the Solid Rocket Booster and the External Tank was severed or pulled away from the weakened hydrogen tank permitting the right Solid Rocket Booster to rotate around the upper attachment strut. This rotation is indicated by divergent yaw and pitch rates between the left and right Solid Rocket Boosters.

At 73.124 seconds, a circumferential white vapor pattern was observed blooming from the side of the External Tank bottom dome. This was the beginning of the structural failure of the hydrogen tank that culminated in the entire aft dome dropping away. This released massive amounts of liquid hydrogen from the tank and created a sudden forward thrust of about 2.8 million pounds, pushing the hydrogen tank upward into the intertank structure. At about the same time, the rotating right Solid Rocket Booster impacted the intertank structure and the lower part of the liquid oxygen tank. These structures

failed at 73.137 seconds as evidenced by the white vapors appearing in the intertank region.

Within milliseconds there was massive, almost explosive, burning of the hydrogen streaming from the failed tank bottom and the liquid oxygen breach in the area of the intertank.

At this point in its trajectory, while traveling at a Mach number of 1.92 at an altitude of 46,000 feet, the Challenger was totally enveloped in the explosive burn. The Challenger's reaction control system ruptured and a hypergolic burn of its propellants occurred as it exited the oxygen-hydrogen flames. The reddish brown colors of the hypergolic fuel burn are visible on the edge of the main fireball. The Orbiter, under severe aerodynamic loads, broke into several large sections which emerged from the fireball. Separate sections that can be identified on film include the main engine/tail section with the engines still burning, one wing of the Orbiter, and the forward fuselage trailing a mass of umbilical lines pulled loose from the payload bay.

Evidence in the recovered wreckage from the 51-L mission hardware supports this final sequence of events. ■

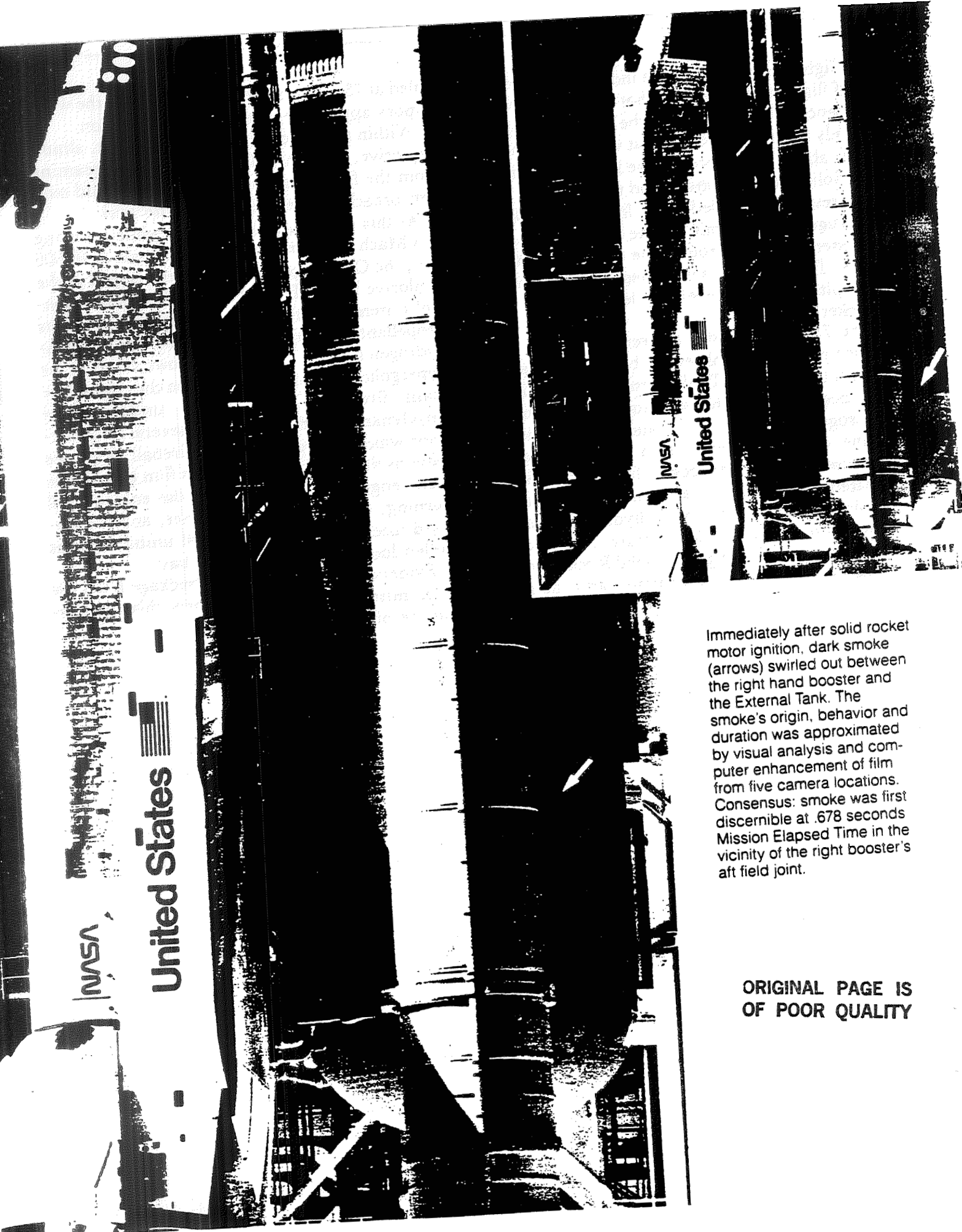

Immediately after solid rocket motor ignition, dark smoke (arrows) swirled out between the right hand booster and the External Tank. The smoke's origin, behavior and duration was approximated by visual analysis and computer enhancement of film from five camera locations. Consensus: smoke was first discernible at .678 seconds Mission Elapsed Time in the vicinity of the right booster's aft field joint.

ORIGINAL PAGE IS  
OF POOR QUALITY

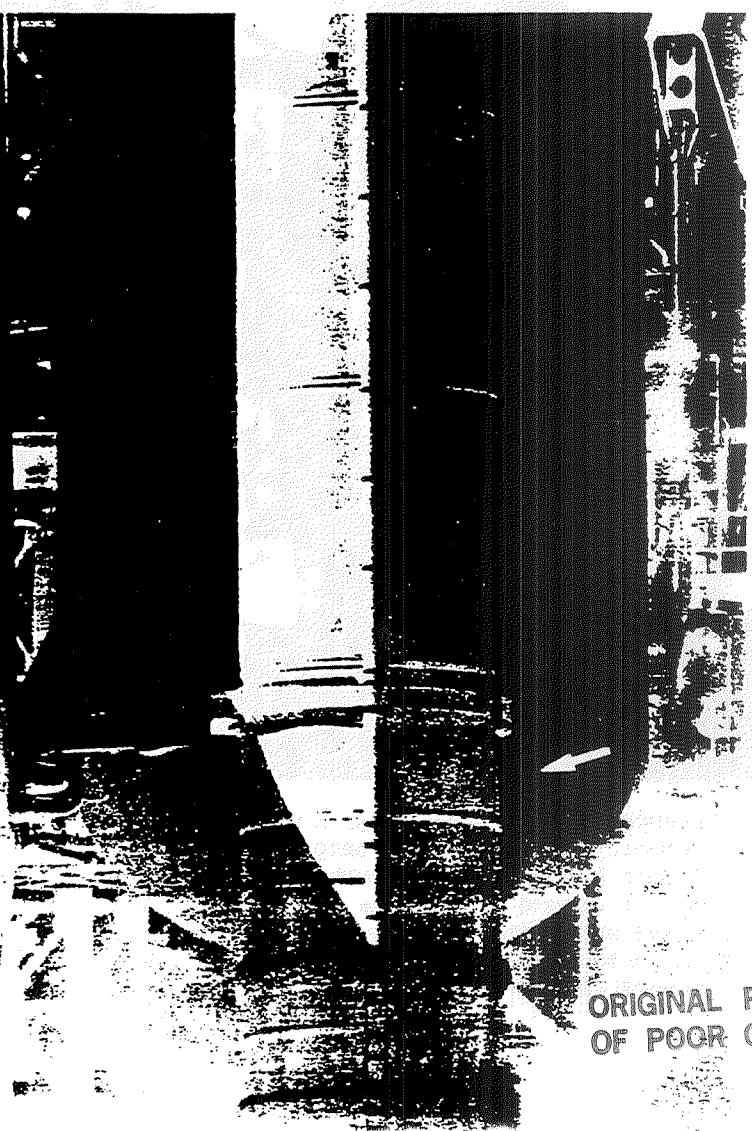
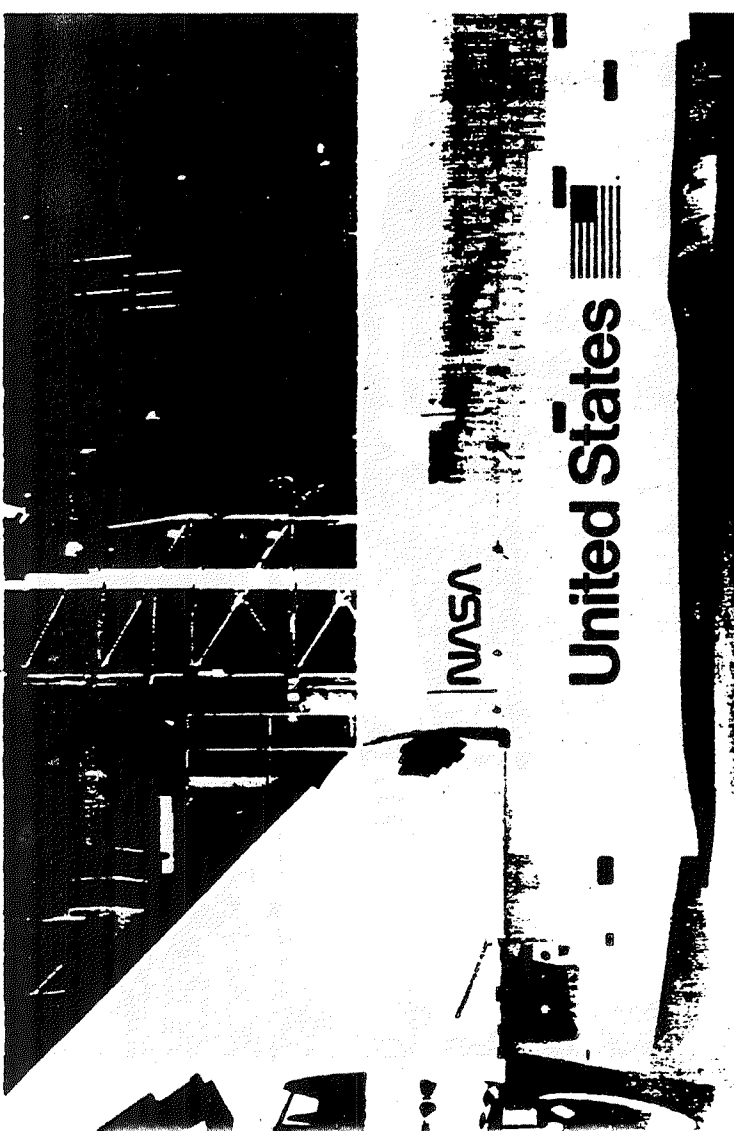
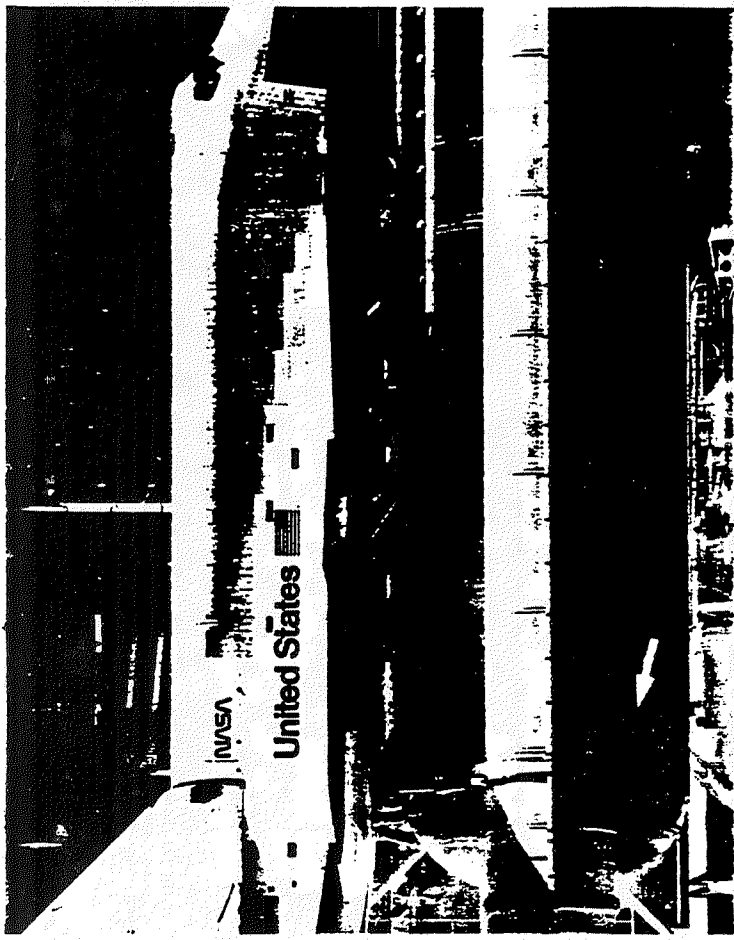

ORIGINAL PAGE IS  
OF POOR QUALITY

ORIGINAL PAGE IS  
OF POOR QUALITY

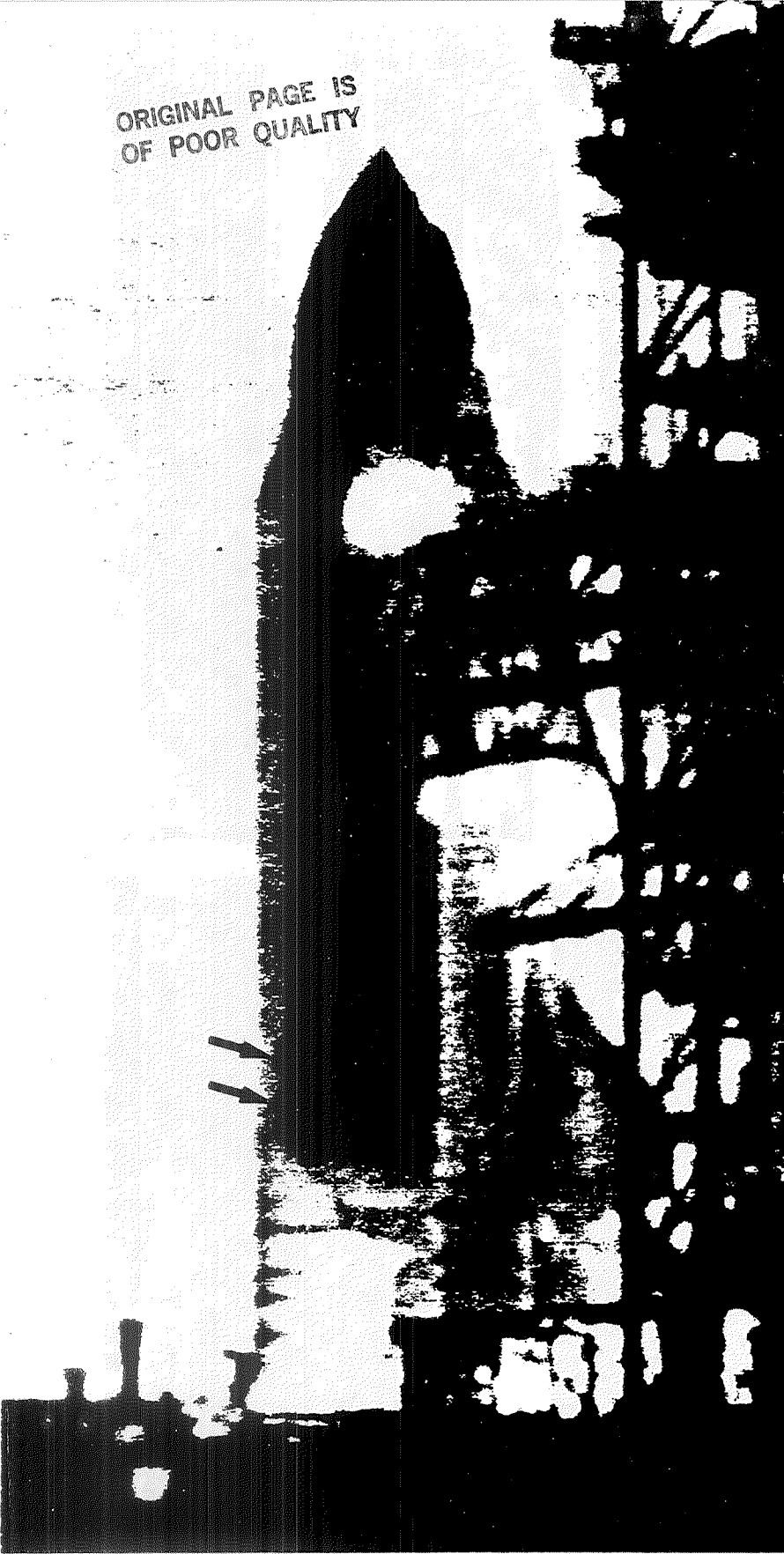

Multiple smoke puffs are visible in the photo above (arrows). They began at .836 seconds and continued through 2.500 seconds, occurring about 4 times a second. Upward motion of the vehicle caused the smoke to drift downward and blur into a single cloud. Smoke source is shown in the computer generated drawing (far right).



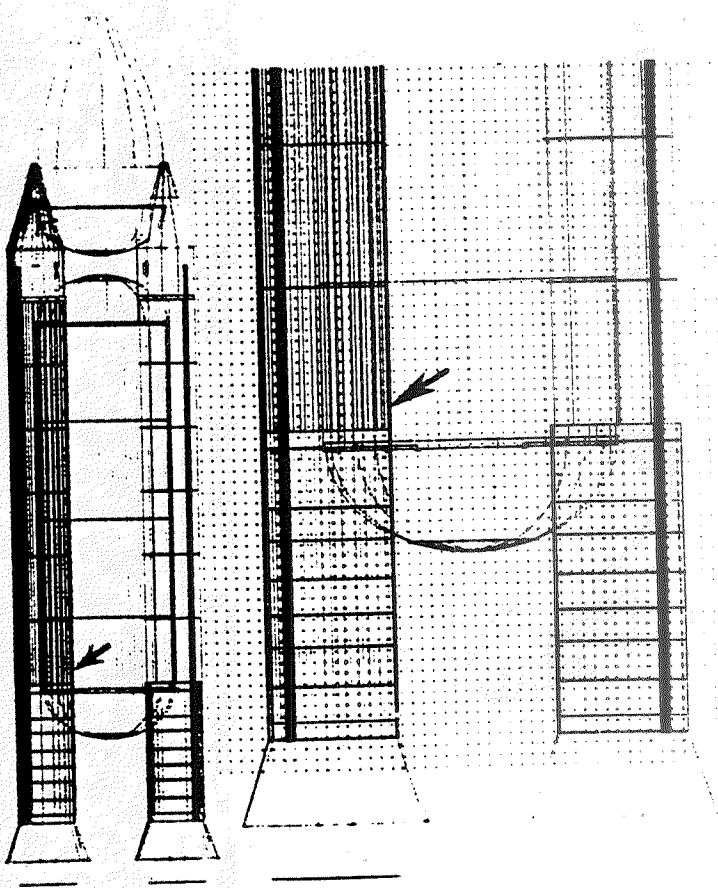
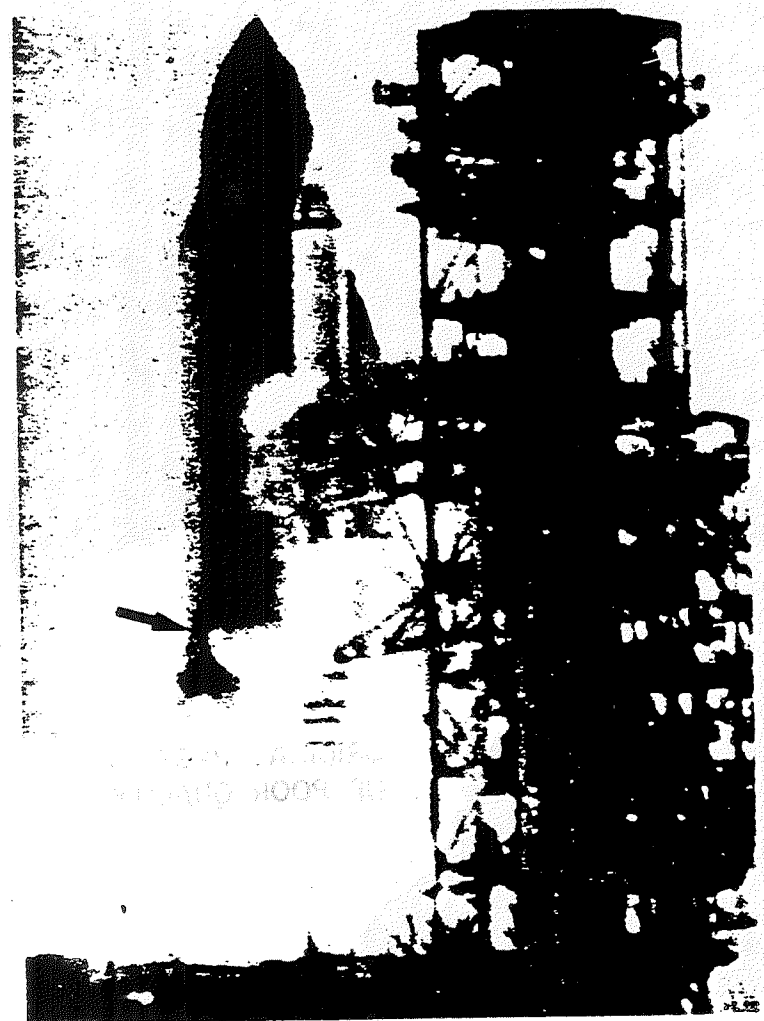
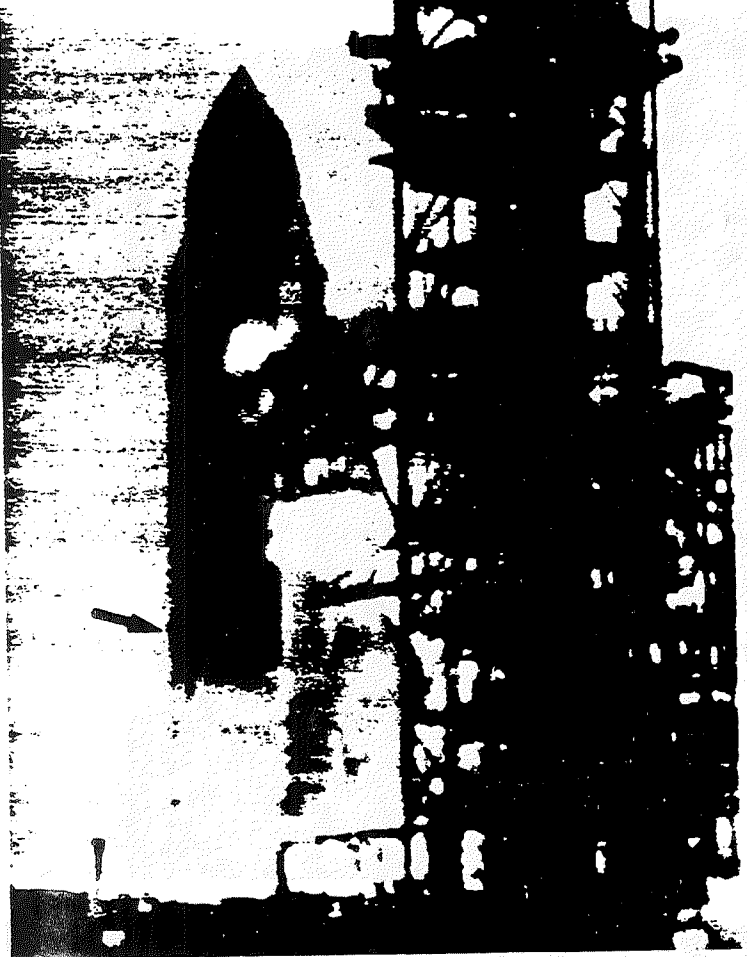





At 58.788 seconds, the first flicker of flame appeared. Barely visible above, it grew into a large plume and began to impinge on the External Tank at about 60 seconds. Flame is pinpointed in the computer drawing between the right booster and the tank, as in the case of earlier smoke puffs. At far right (arrow), vapor is seen escaping from the apparently breached External Tank.

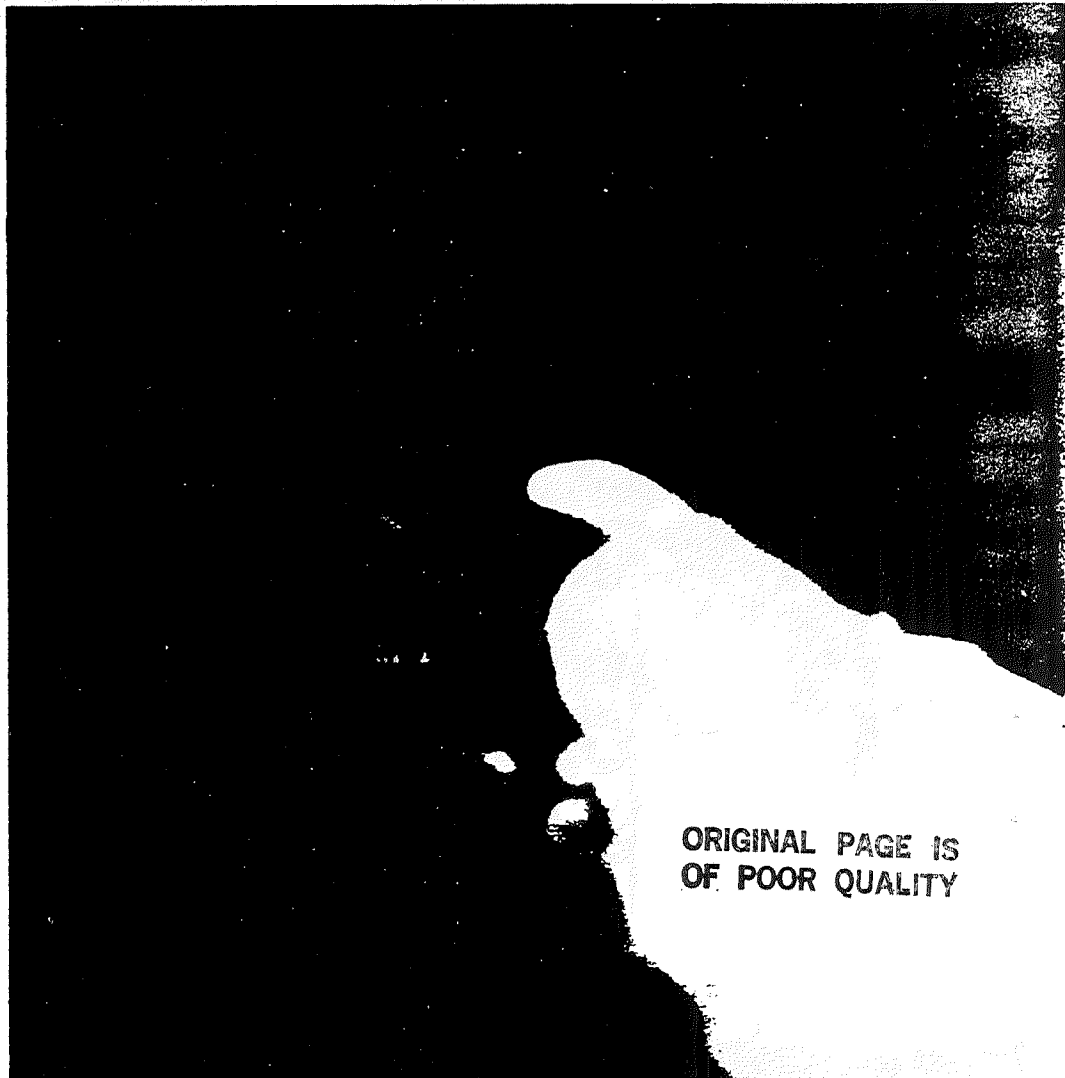
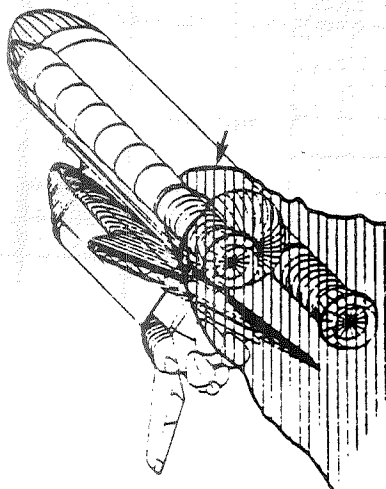

ORIGINAL PAGE IS  
OF POOR QUALITY



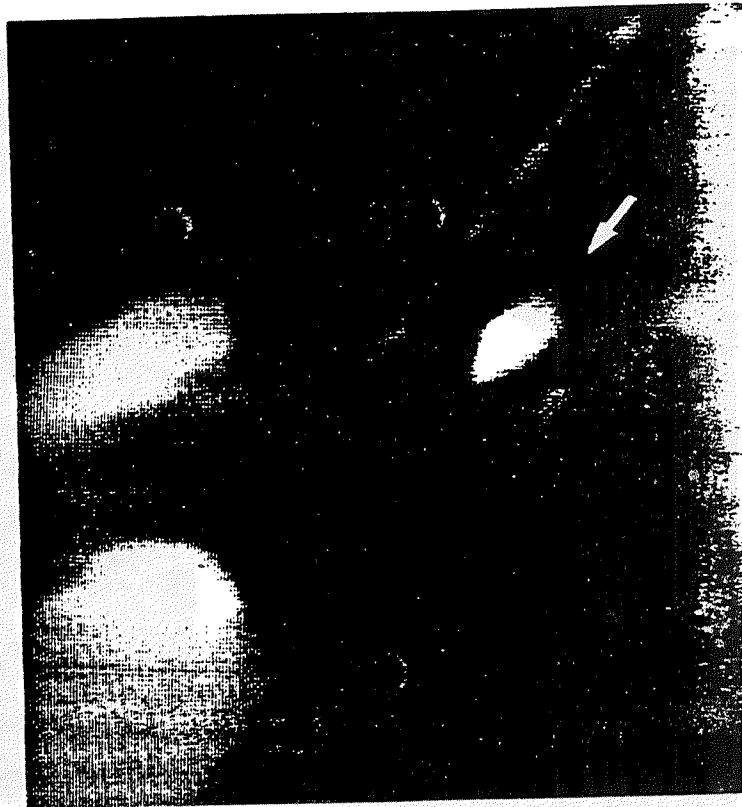
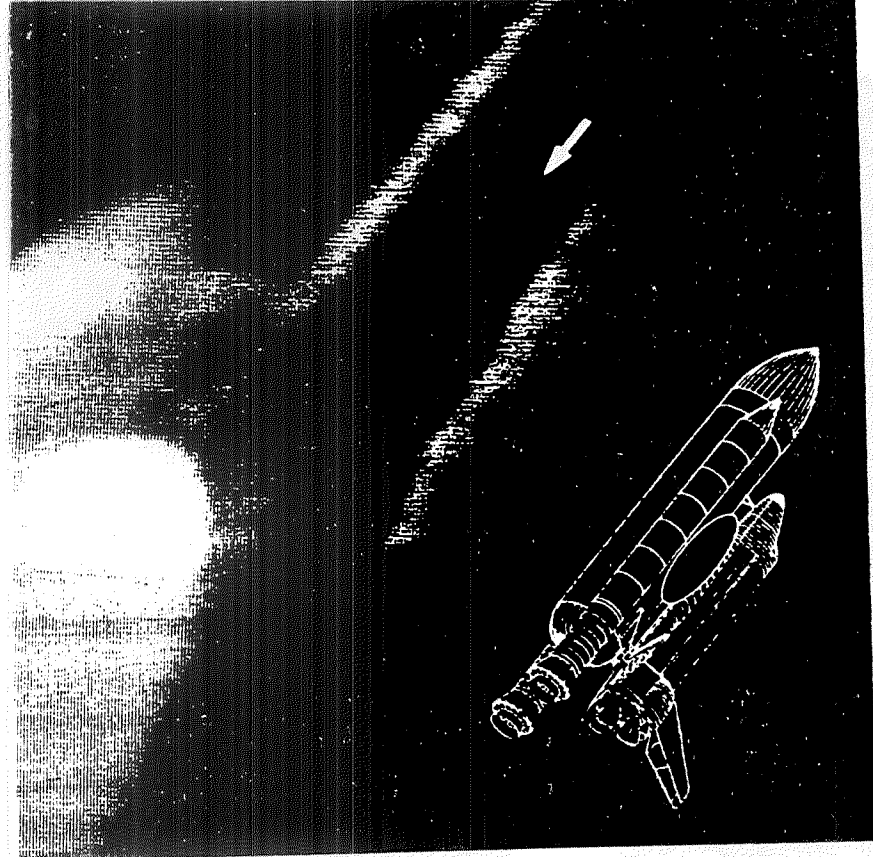

Camera views indicate the beginning of rupture of the liquid hydrogen and liquid oxygen tanks within the External Tank. A small flash (arrows above) intensified rapidly, then diminished. A second flash,

attributed to rupture of the liquid oxygen tank, occurred above the booster/tank forward attachment (below left) and grew in milliseconds to the maximum size indicated in the computer drawing.

ORIGINAL PAGE IS  
OF POOR QUALITY

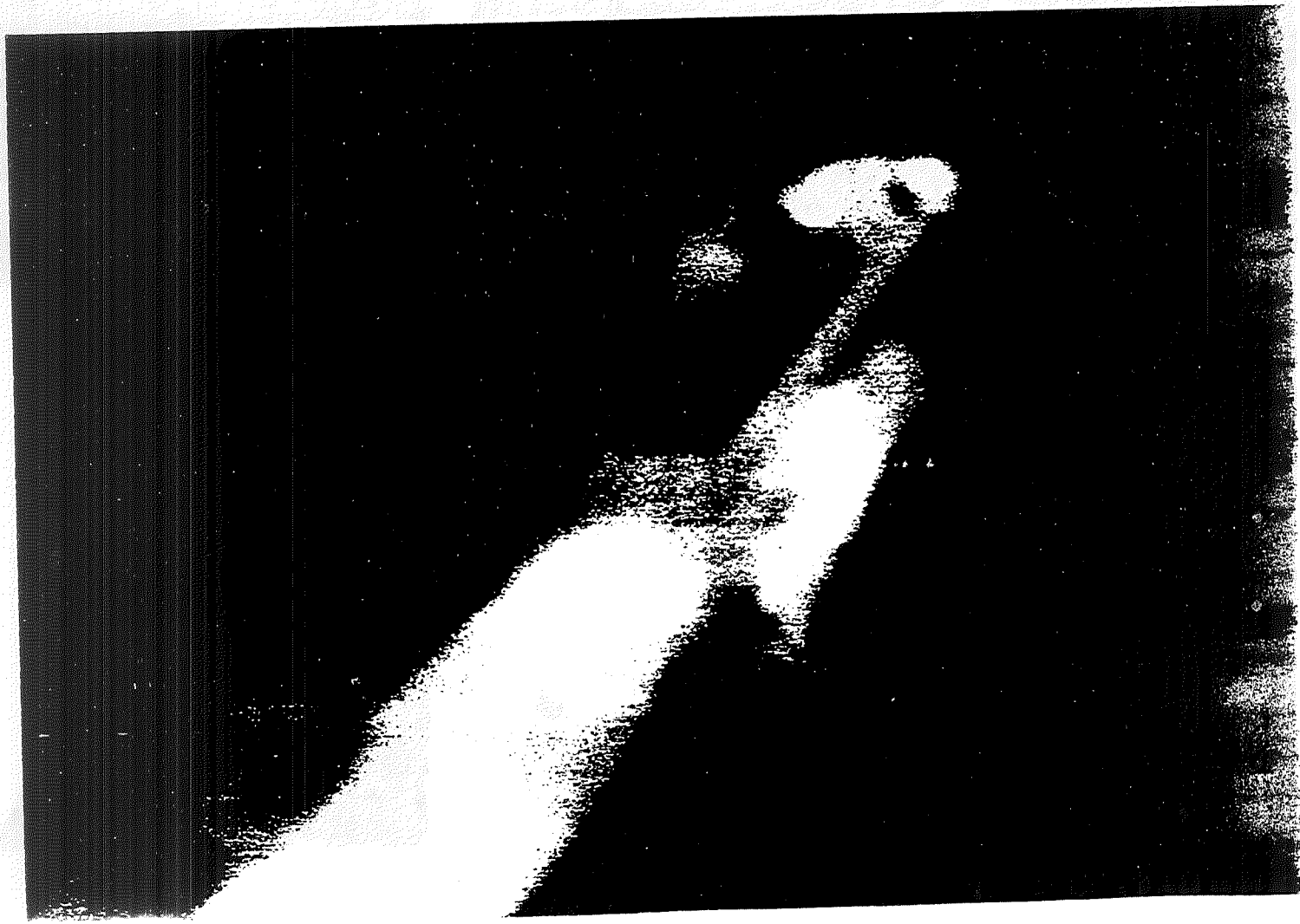

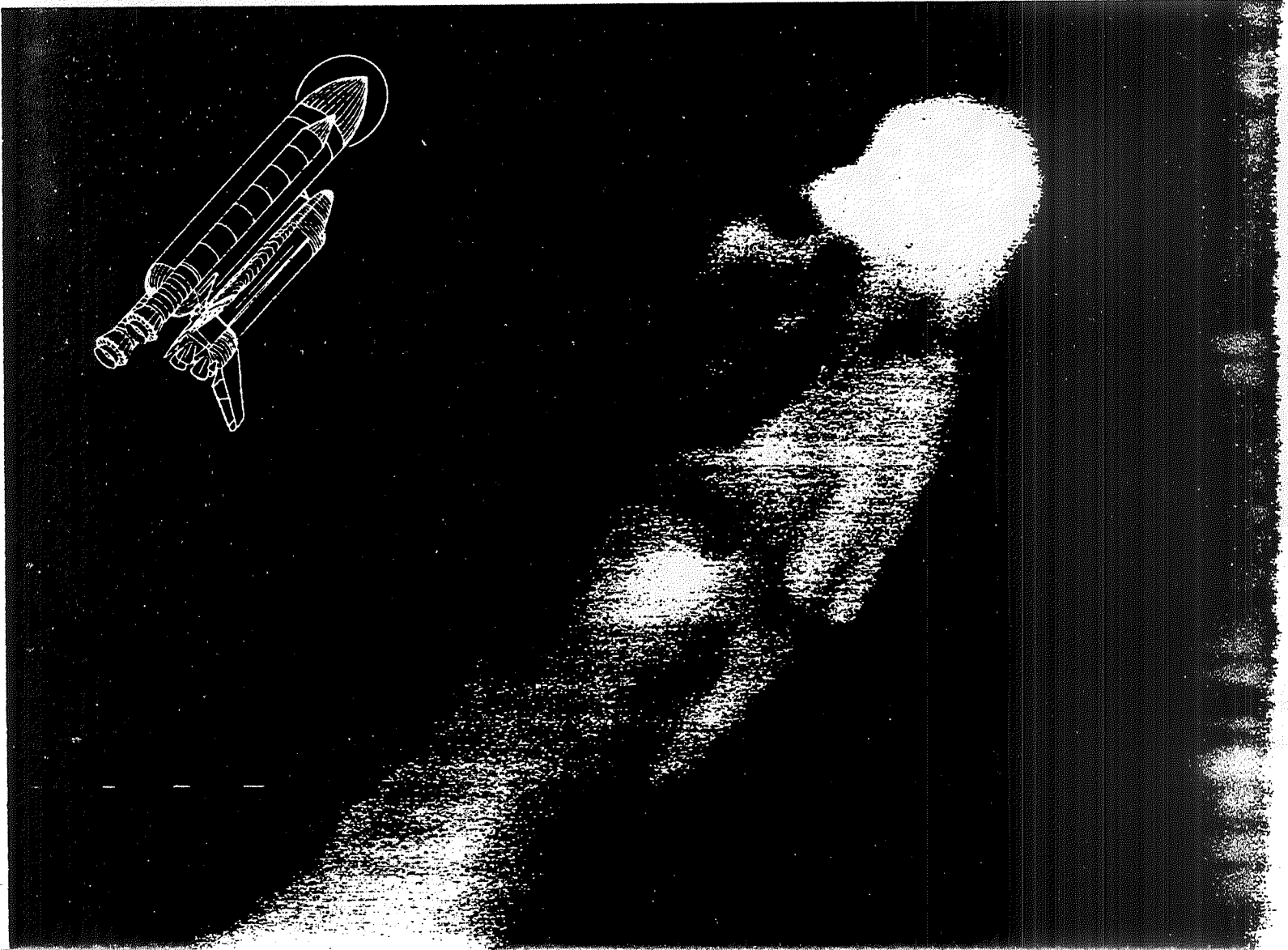
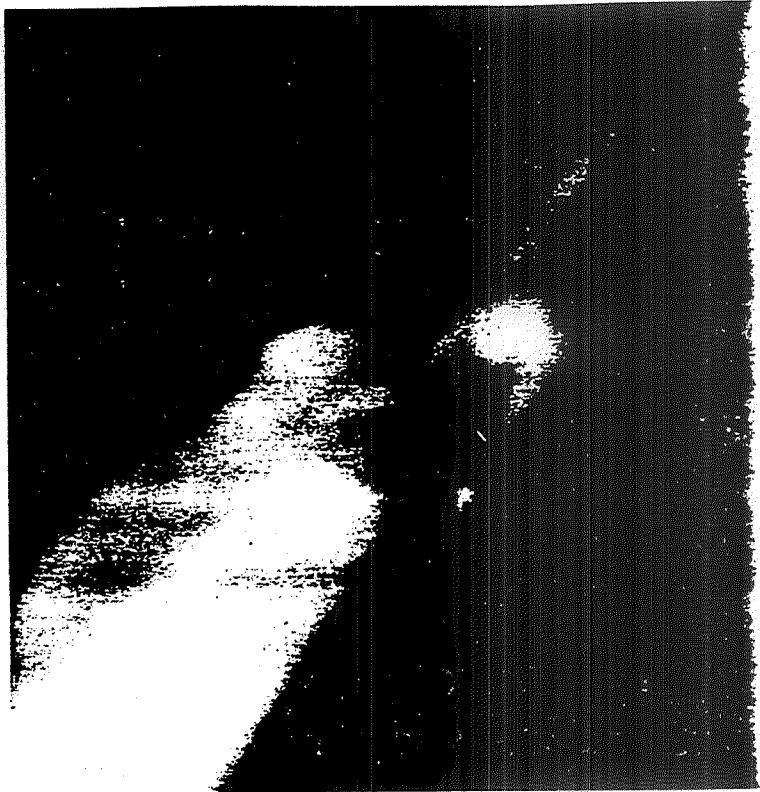
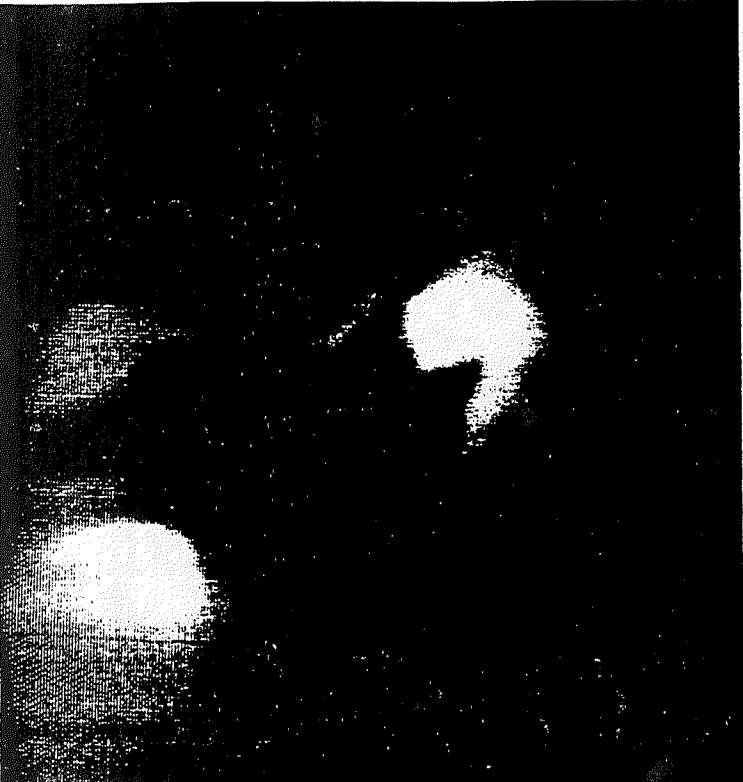



Structural breakup of the vehicle began at approximately 73 seconds. Fire spread very rapidly. Above, a bright flash (arrow) is evident near the nose of the Orbiter, suggesting spillage and ignition of the spacecraft's reaction control system propellants. At left, the two Solid Rocket Boosters thrust away from the fire, crisscrossing to form a "V." The right booster—identifiable by its failure plume—now to the left of its counterpart. At right, the boosters diverge farther; the External Tank wreckage is obscured by smoke and vapor. The Orbiter engines still firing, is visible at bottom center.

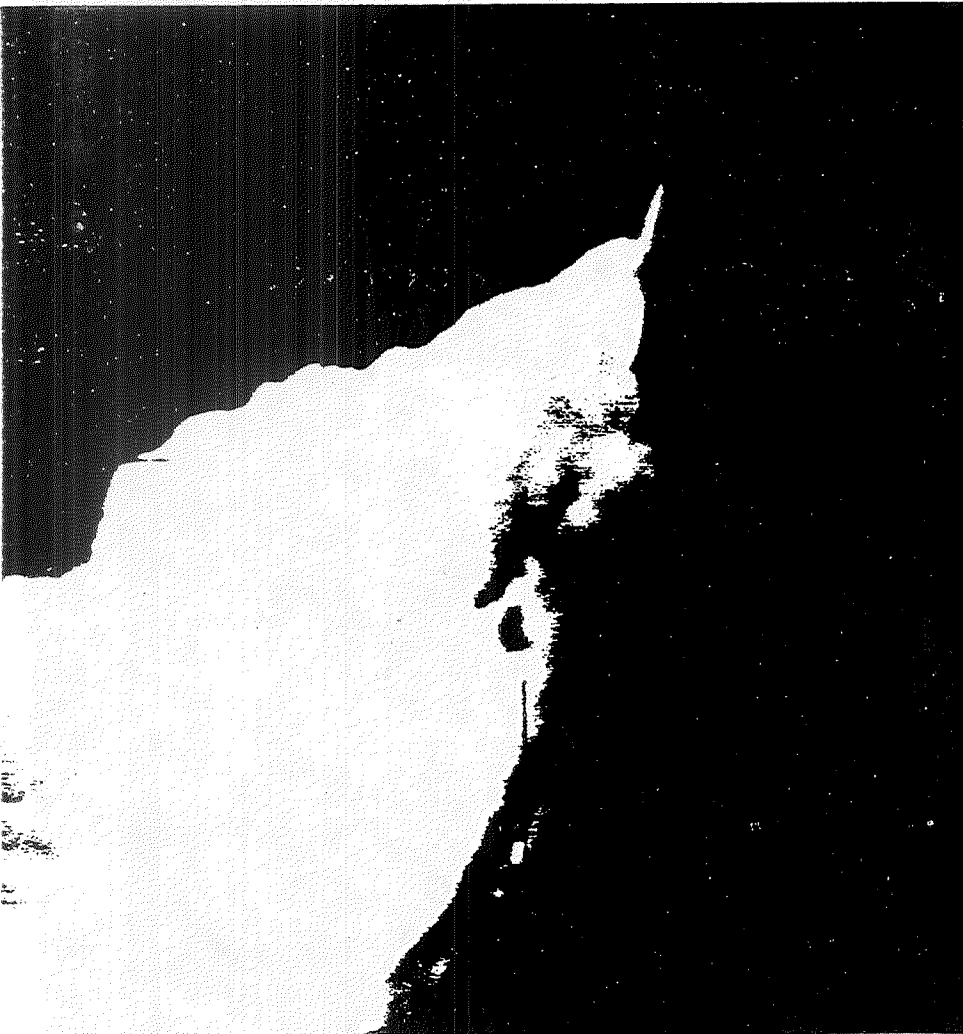

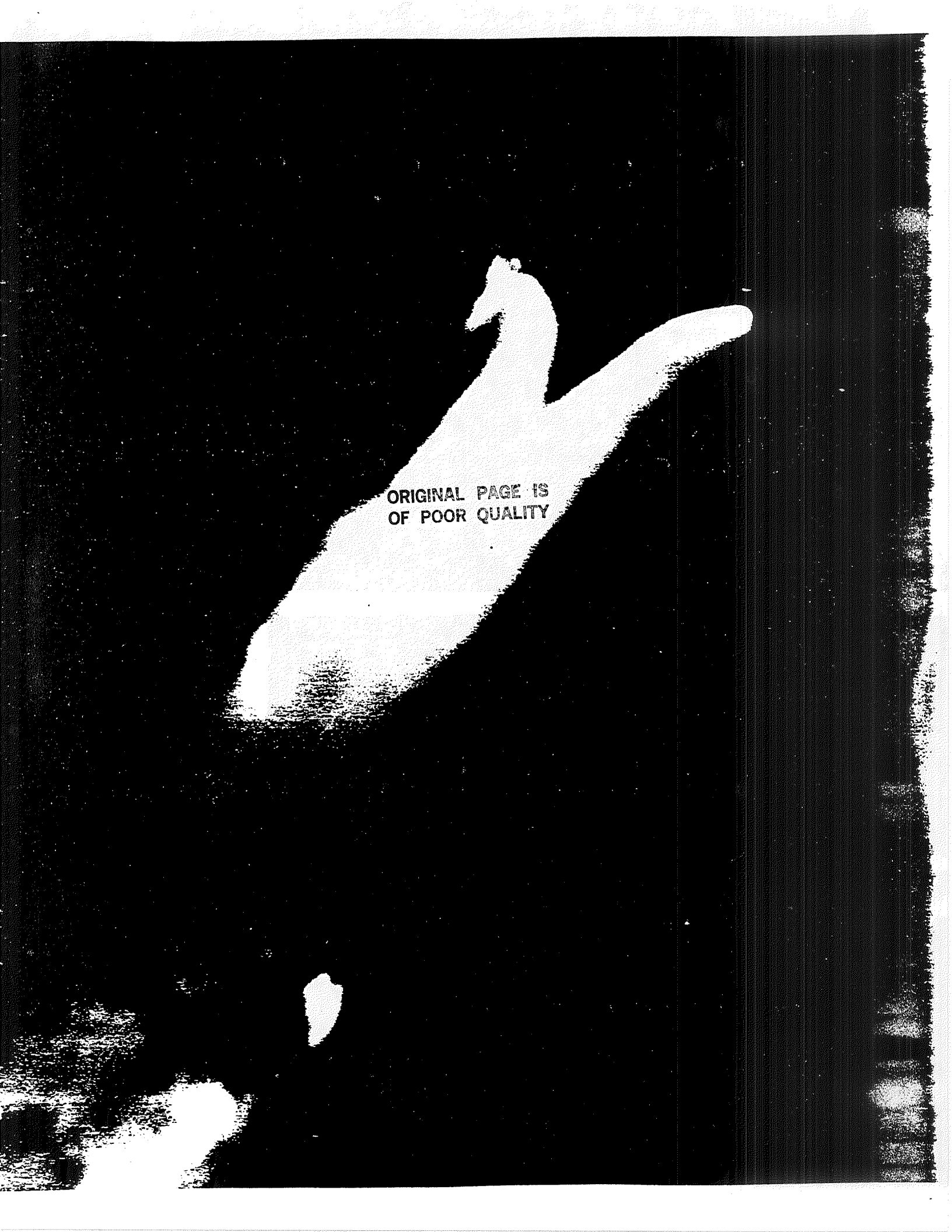

ORIGINAL PAGE IS  
OF POOR QUALITY



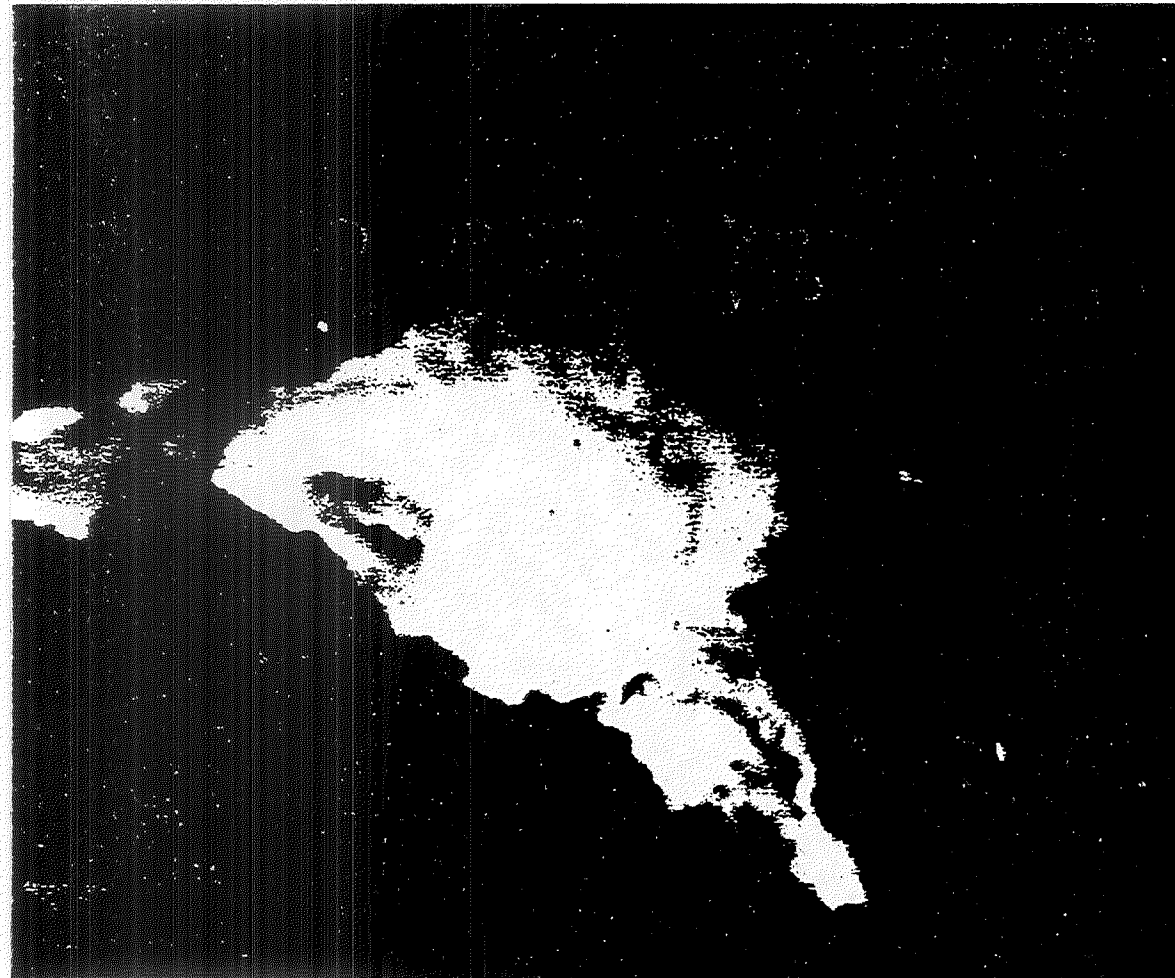
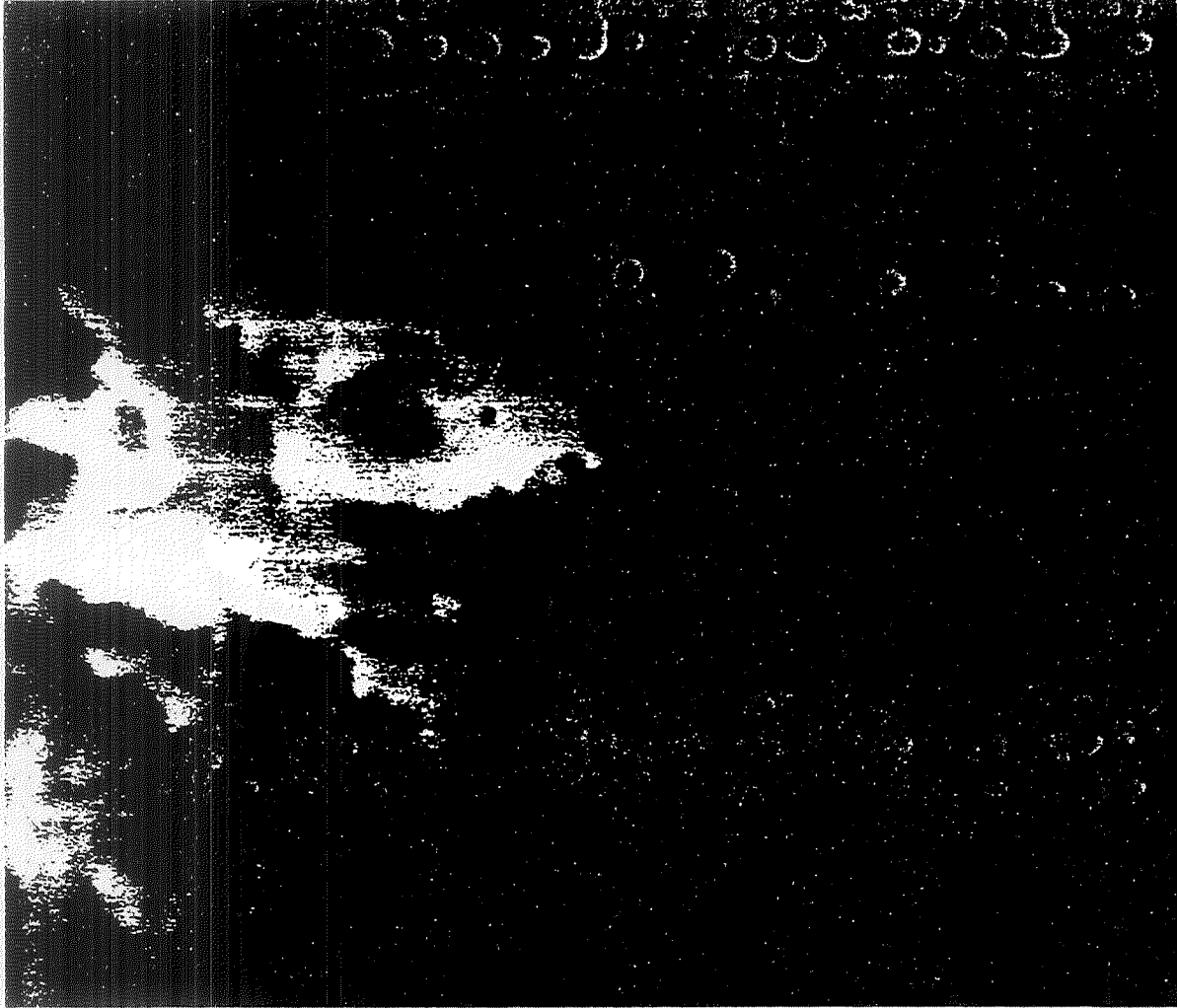



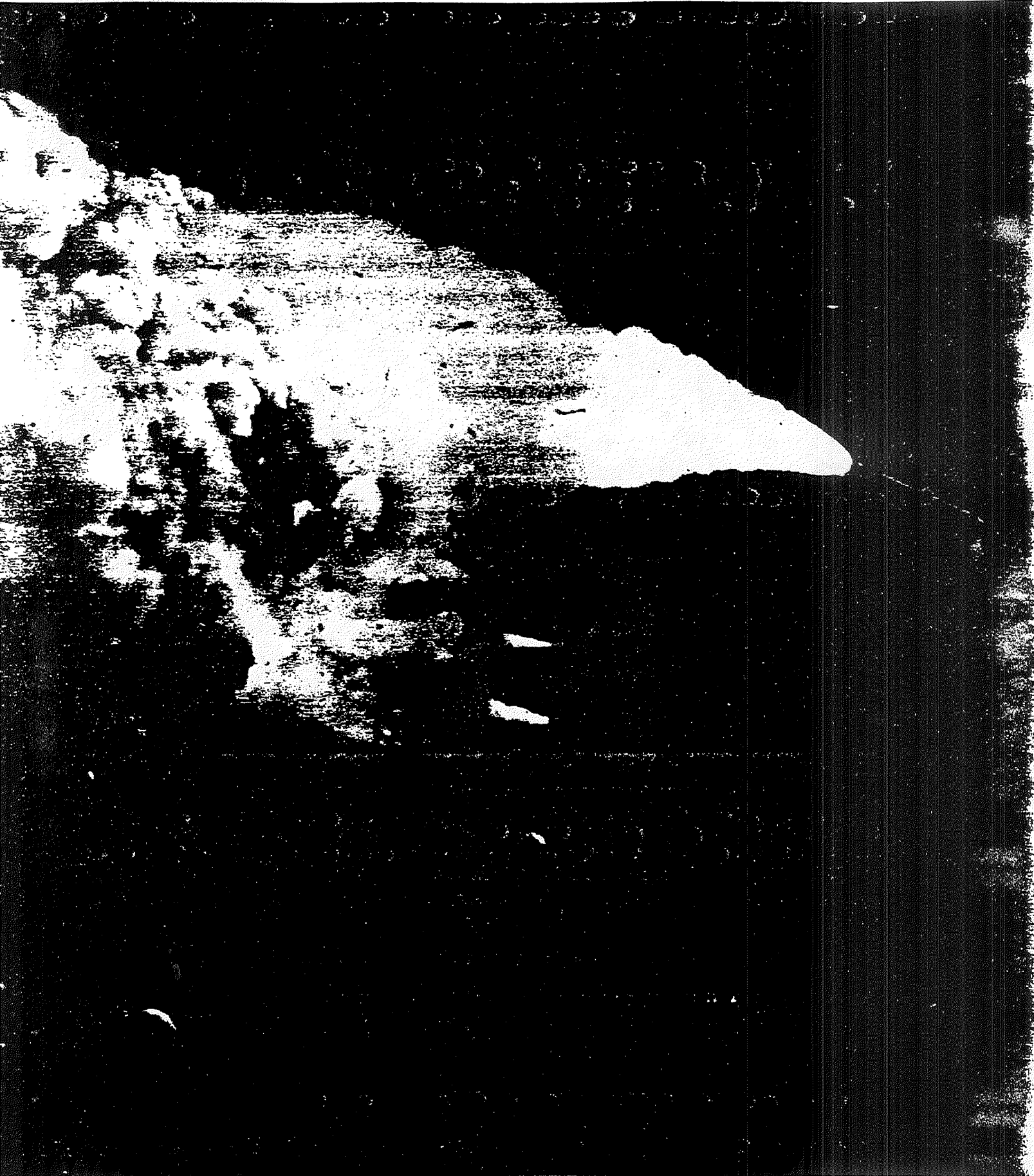

At about 76 seconds, unidentifiable fragments of the Shuttle vehicle can be seen tumbling against a background of fire, smoke and vaporized propellants from the External Tank (left). In the photo at right, the left booster (far right)

soars away, still thrusting. The reddish-brown cloud envelops the disintegrating Orbiter. The color is characteristic of the nitrogen tetroxide oxidizer in the Orbiter Reaction Control System propellant.

**ORIGINAL PAGE IS  
OF POOR QUALITY**



ORIGINAL PAGE IS  
OF POOR QUALITY

Hurling out of the fireball at 78 seconds (left) are the Orbiter's left wing (top arrow), the main engines (center arrow) and the forward fuselage (bottom arrow). In the photo below, it plummets Earthward, trailed by smoking fragments of Challenger.

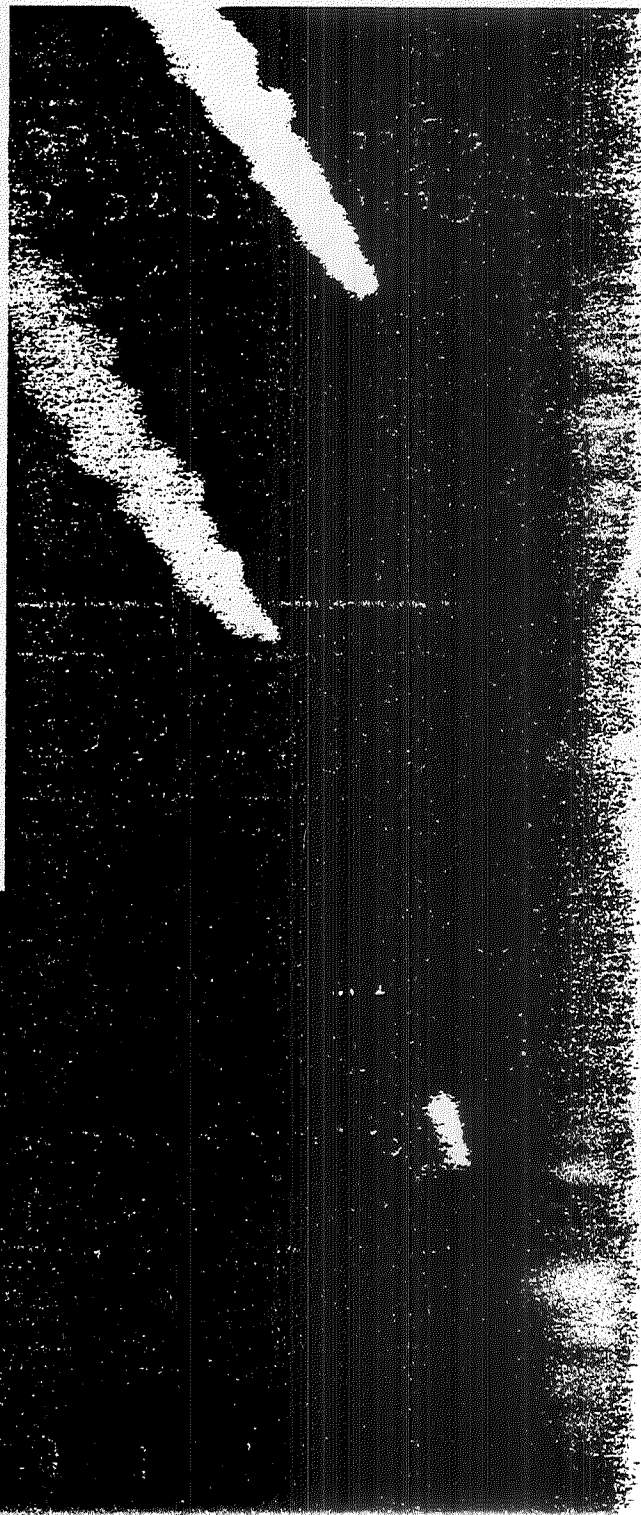

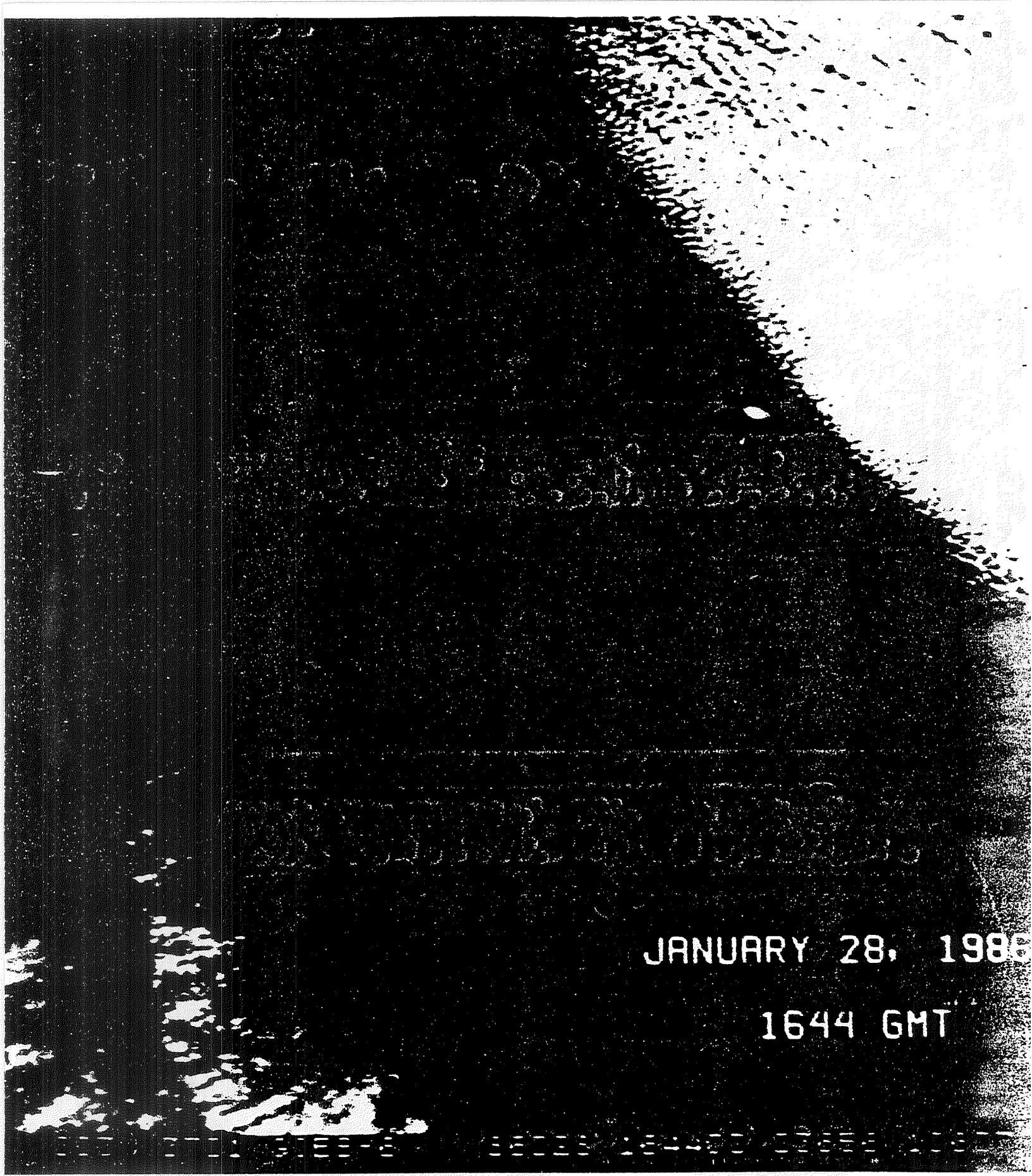

JANUARY 28, 1986

1644 GMT

At 11:44 a.m. Eastern Standard Time, a GOES environment-monitoring satellite operated by the National Oceanic and Atmospheric Administration acquired this image of the smoke and vapor cloud from the 51-L accident. The coast of Florida is outlined in red.

## STS 51-L Sequence of Major Events

Mission Time (GMT, in hr:min:sec)	Event	Elapsed Time (secs.)	Source
16:37:53.444	ME - 3 Ignition Command	- 6.566	GPC
37:53.564	ME - 2 Ignition Command	- 6.446	GPC
37:53.684	ME - 1 Ignition Command	- 6.326	GPC
38:00.010	SRM Ignition Command (T = 0)	0.000	GPC
38:00.018	Holddown Post 2 PIC firing	0.008	E8 Camera
38:00.260	First Continuous Vertical Motion	0.250	E9 Camera
38:00.688	Confirmed smoke above field joint on RH SRM	0.678	E60 Camera
38:00.846	Eight puffs of smoke (from 0.836 thru 2.500 sec MET)	0.836	E63 Camera
38:02.743	Last positive evidence of smoke above right aft SRB/ET attach ring	2.733	CZR-1 Camera
38:03.385	Last positive visual indication of smoke	3.375	E60 Camera
38:04.349	SSME 104% Command	4.339	E41M2076D
38:05.684	RH SRM pressure 11.8 psi above nominal	5.674	B47P2302C
38:07.734	Roll maneuver initiated	7.724	V90R5301C
38:19.869	SSME 94% Command	19.859	E41M2076D
38:21.134	Roll maneuver completed	21.124	V90R5301C
38:35.389	SSME 65% Command	35.379	E41M2076D
38:37.000	Roll and Yaw Attitude Response to Wind (36.990 to 62.990 sec)	36.990	V95H352nC
38:51.870	SSME 104% Command	51.860	E41M2076D
38:58.798	First evidence of flame on RH SRM	58.788	E207 Camera
38:59.010	Reconstructed Max Q (720 psf)	59.000	BET
38:59.272	Continuous well defined plume on RH SRM	59.262	E207 Camera
38:59.763	Flame from RH SRM in + Z direction (seen from south side of vehicle)	59.753	E204 Camera
39:00.014	SRM pressure divergence (RH vs. LH)	60.004	B47P2302
39:00.248	First evidence of plume deflection, intermittent	60.238	E207 Camera
39:00.258	First evidence of SRB plume attaching to ET ring frame	60.248	E203 Camera
39:00.998	First evidence of plume deflection, continuous	60.988	E207 Camera
39:01.734	Peak roll rate response to wind	61.724	V90R5301C

ACT	POS - Actuator Position	MEC	- Main Engine Controller
APU	- Auxiliary Power Unit	MET	- Mission Elapsed Time
BET	- Best Estimated Trajectory	MPS	- Main Propulsion System
CH	- Channel	PC	- Chamber Pressure
DISC	- Discharge	PIC	- Pyrotechnics Initiator Controller
ET	- External Tank	psf	- Pounds per square foot
GG	- Gas Generator	RCS	- Reaction Control System
GPC	- General Purpose Computer	RGA	- Rate Gyro Assembly
GMT	- Greenwich Mean Time	RH	- Righthand
HPFT	- High Pressure Fuel Turbopump	RSS	- Range Safety System
LH	- Lethand	SRB	- Solid Rocket Booster
LH <sub>2</sub>	- Liquid Hydrogen	SRM	- Solid Rocket Motor
LO <sub>2</sub>	- Liquid Oxygen (same as LOX)	SSME	- Space Shuttle Main Engine
MAX Q	- Maximum Dynamic Pressure	TEMP	- Temperature
ME	- Main Engine (same as SSME)	TVC	- Thrust Vector Control

NOTE: The Shuttle coordinate system used in Chapter 3 is, relative to the Orbiter, as follows:

- + X direction = forward (tail to nose)
- X direction = rearward (nose to tail)
- + Y direction = right (toward the right wing tip)
- Y direction = left (toward the left wing up)
- + Z direction = down
- Z direction = up

<i>Mission Time</i> (GMT. in hr:min:sec)	<i>Event</i>	<i>Elapsed</i> <i>Time (secs.)</i>	<i>Source</i>
39:02.094	Peak TVC response to wind	62.084	B58H1150C
39:02.414	Peak yaw rate response to wind	62.404	V90R5341C
39:02.494	RH outboard elevon actuator hinge moment spike	62.484	V58P0966C
39:03.934	RH outboard elevon actuator delta pressure change	63.924	V58P0966C
39:03.974	Start of planned pitch rate maneuver	63.964	V90R5321C
39:04.670	Change in anomalous plume shape (LH <sub>2</sub> tank leak near 2058 ring frame)	64.660	E204 Camera
39:04.715	Bright sustained glow on sides of ET	64.705	E204 Camera
39:04.947	Start SSME gimbal angle large pitch variations	64.937	V58H1100A
39:05.174	Beginning of transient motion due to changes in aero forces due to plume	65.164	V90R5321C
39:05.534	LH outboard elevon actuator delta pressure change	65.524	V58P0866C
39:06.774	Start ET LH <sub>2</sub> ullage pressure deviations	66.764	T41P1700C
39:12.214	Start divergent yaw rates (RH vs. LH SRB)	72.204	V90R2528C
39:12.294	Start divergent pitch rates (RH vs. LH SRB)	72.284	V90R2525C
39:12.488	SRB major high-rate actuator command	72.478	V79H2111A
39:12.507	SSME roll gimbal rates 5 deg/sec	72.497	V58H1100A
39:12.535	Vehicle max + Y lateral acceleration (+ .227 g)	72.525	V98A1581C
39:12.574	SRB major high-rate actuator motion	72.564	B58H1151C
39:12.574	Start of H <sub>2</sub> tank pressure decrease with 2 flow control valves open	72.564	T41P1700C
39:12.634	Last state vector downlinked	72.624	Data reduction
39:12.974	Start of sharp MPS LOX inlet pressure drop	72.964	V41P1330C
39:13.020	Last full computer frame of TDRS data	73.010	Data reduction
39:13.054	Start of sharp MPS LH <sub>2</sub> inlet pressure drop	73.044	V41P1100C
39:13.055	Vehicle max - Y lateral acceleration (- .254 g)	73.045	V98A1581C
39:13.134	Circumferential white pattern on ET aft dome (LH <sub>2</sub> tank failure)	73.124	E204 Camera
39:13.134	RH SRM pressure 19 psi lower than LH SRM	73.124	B47P2302C
39:13.147	First hint of vapor at intertank	73.137	E207 Camera
39:13.153	All engine systems start responding to loss of fuel and LOX inlet pressure	73.143	SSME team
39:13.172	Sudden cloud along ET between intertank and aft dome	73.162	E207 Camera
39:13.201	Flash between Orbiter and LH <sub>2</sub> tank	73.191	E204 Camera
39:13.221	SSME telemetry data interference from 73.211 to 73.303	73.211	



Mission Time (GMT. in hr:min:sec)	Event	Elapsed Time (secs.)	Source
39:13.223	Flash near SRB fwd attach and brightening of flash between Orbiter and ET	73.213	E204 Camera
39:13.292	First indication intense white flash at SRB fwd attach point	73.282	E204 Camera
39:13.337	Greatly increased intensity of white flash	73.327	E204 Camera
39:13.387	Start RCS jet chamber pressure fluctuations	73.377	V42P1552A
39:13.393	All engines approaching HPFT discharge temp redline limits	73.383	E41Tn010D
39:13.492	ME-2 HPFT disch. temp Chan. A vote for shutdown; 2 strikes on Chan. B	73.482	MEC data
39:13.492	ME-2 controller last time word update	73.482	MEC data
39:13.513	ME-3 in shutdown due to HPFT discharge temperature redline exceedance	73.503	MEC data
39:13.513	ME-3 controller last time word update	73.503	MEC data
39:13.533	ME-1 in shutdown due to HPFT discharge temperature redline exceedance	73.523	Calculation
39:13.553	ME-1 last telemetered data point	73.543	Calculation
39:13.628	Last validated Orbiter telemetry measurement	73.618	V46P0120A
39:13.641	End of last reconstructed data frame with valid synchronization and frame count	73.631	Data reduction
39:14.140	Last radio frequency signal from Orbiter	74.130	Data reduction
39:14.597	Bright flash in vicinity of Orbiter nose	74.587	E204 Camera
39:16.447	RH SRB nose cap sep/chute deployment	76.437	E207 Camera
39:50.260	RH SRB RSS destruct	110.250	E202 Camera
39:50.262	LH SRB RSS destruct	110.252	E230 Camera

#### Shuttle to Ground Telemetry Channels

Channel Identifier	Sample Rate (Samples/sec)	Sample Period (sec)	Description
B47P1302C	12.5	.080	LH SRM CHAMBER PRESSURE
B47P2302C	12.5	.080	RH SRM CHAMBER PRESSURE
B58H1150C	25	.040	LH SRB TVC TILT ACT POS
B58H1151C	25	.040	LH SRB TVC ROCK ACT POS
E41M2076D	25	.040	ME-3 VEHICLE COMMAND
E41T1010D	25	.040	ME-1 HPFT DISC TEMP-CH A
E41T2010D	25	.040	ME-2 HPFT DISC TEMP-CH A
E41T3010D	25	.040	ME-3 HPFT DISC TEMP-CH A
T41P1700C	5	.200	ET LH <sub>2</sub> ULLAGE PRESSURE
V41P1100C	12.5	.080	MPS LH <sub>2</sub> INLET PRESS (ME-1)
V41P1330C	12.5	.080	MPS LO <sub>2</sub> INLET PRESS (ME-3)
V42P1552A	25	.040	RCS THRUSTER PC
V46P0120A	100	.010	APU-1 GG CHAMBER PRESS

#### Shuttle to Ground Telemetry Channels

Channel Identifier	Sample Rate (Samples/sec)	Sample Period (sec)	Description
V58H1100A	25	.040	ME-PITCH ACTUATOR POS
V58P0866C	12.5	.080	LH OB ELEVON PRI DELTA P
V58P0966C	12.5	.080	RH OB ELEVON PRI DELTA P
V79H2111A	25	.040	LH SRB TILT ACT DRIVER
V90R2525C	5	.200	SEL LH SRB PITCH RATE
V90R2528C	5	.200	SEL RH SRB YAW RATE
V90R5301C	5	.200	SELECTED RGA ROLL RATE
V90R5321C	5	.200	SELECTED RGA PITCH RATE
V90R5341C	5	.200	SELECTED RGA YAW RATE
V95H3522C	12.5	.080	BODY YAW ATTITUDE ERROR
V95H3523C	12.5	.080	BODY ROLL ATTITUDE ERROR
V98A1581C	25	.040	LATERAL ACCELERATION



# The Cause of the Accident

**T**he consensus of the Commission and participating investigative agencies is that the loss of the Space Shuttle Challenger was caused by a failure in the joint between the two lower segments of the right Solid Rocket Motor. The specific failure was the destruction of the seals that are intended to prevent hot gases from leaking through the joint during the propellant burn of the rocket motor. The evidence assembled by the Commission indicates that no other element of the Space Shuttle system contributed to this failure.

In arriving at this conclusion, the Commission reviewed in detail all available data, reports and records; directed and supervised numerous tests, analyses, and experiments by NASA, civilian contractors and various government agencies; and then developed specific failure scenarios and the range of most probable causative factors. The sections that follow discuss the results of the investigation.

---

## Analysis of the Accident

The results of the accident investigation and analysis will be presented in this and the following sections. Throughout the investigation three critical questions were central to the inquiry, namely:

- What were the circumstances surrounding mission 51-L that contributed to the catastrophic termination of that flight in contrast to 24 successful flights preceding it?
- What evidence pointed to the right Solid Rocket Booster as the source of the accident as opposed to other elements of the Space Shuttle?
- Finally, what was the mechanism of failure?

Using mission data, subsequently completed tests and analyses, and recovered wreckage, the

Commission identified all possible faults that could originate in the respective flight elements of the Space Shuttle which might have the potential to lead to loss of the Challenger. Potential contributors to the accident examined by the Commission were the launch pad (exonerated in Chapter IX of this report), the External Tank, the Space Shuttle Main Engines, the Orbiter and related equipment, payload/Orbiter interfaces, the payload, Solid Rocket Boosters and Solid Rocket Motors.

In a parallel effort, the question of sabotage was examined in detail and reviewed by the Commission in executive session. *There is no evidence of sabotage, either at the launch pad or during other processes prior to or during launch.*

## External Tank

The External Tank contains propellants used by the Orbiter's three main engines during Shuttle launch and ascent to orbit. Structurally the tank is attached to and serves as the backbone of the Orbiter and the two Solid Rocket Boosters. Three primary structures—the liquid oxygen tank, the intertank and the liquid hydrogen tank—comprise the configuration. (Figure 1)

The External Tank delivers oxidizer and fuel from the propellant tanks to the Orbiter. The electrical subsystem includes instrumentation sensors, heaters, range safety electronics and explosives, and lightning protection and associated cabling. All flight instrumentation and electrical power are wired directly to the Orbiter. The thermal protection subsystem is the insulation applied to the tank's exterior. Its function is to prevent heat leakage into the propellants, to protect the External Tank from overheating during flight and to minimize ice formation while the Shuttle is on the pad.

Approximately 20 percent of the External Tank structure was recovered after the accident and the majority of the pieces were from the intertank and liquid hydrogen tank.<sup>1</sup> The Commission initially considered all External Tank systems and subsystems in identifying possible faults or failures

potentially contributing to the Challenger accident. Those potential contributors were:

- Premature detonation of the External Tank range safety system
- Structural flaw
- Damage at lift-off
- Load exceedance
- Overheating

The Commission examined the possibility that the STS 51-L accident could have been triggered by accidental detonation of the range safety system explosives. This potential fault was assessed using flight data, observed events, and recovered hardware. Most of the explosive charges for the External Tank emergency destruction system were recovered.<sup>2</sup> Examination of this material established that none of it had exploded and thus could not have contributed to the accident (Photo C & D). Flight data verified that the External Tank range safety system was not activated.

The possibility of an imperfection existing in either the pressurized or nonpressurized External Tank structural elements that could grow to a sufficient size to cause structural failure was examined in detail. All construction history, structural qualification test data, proof test inspection records and x-rays were reviewed. One previously

Figure 1

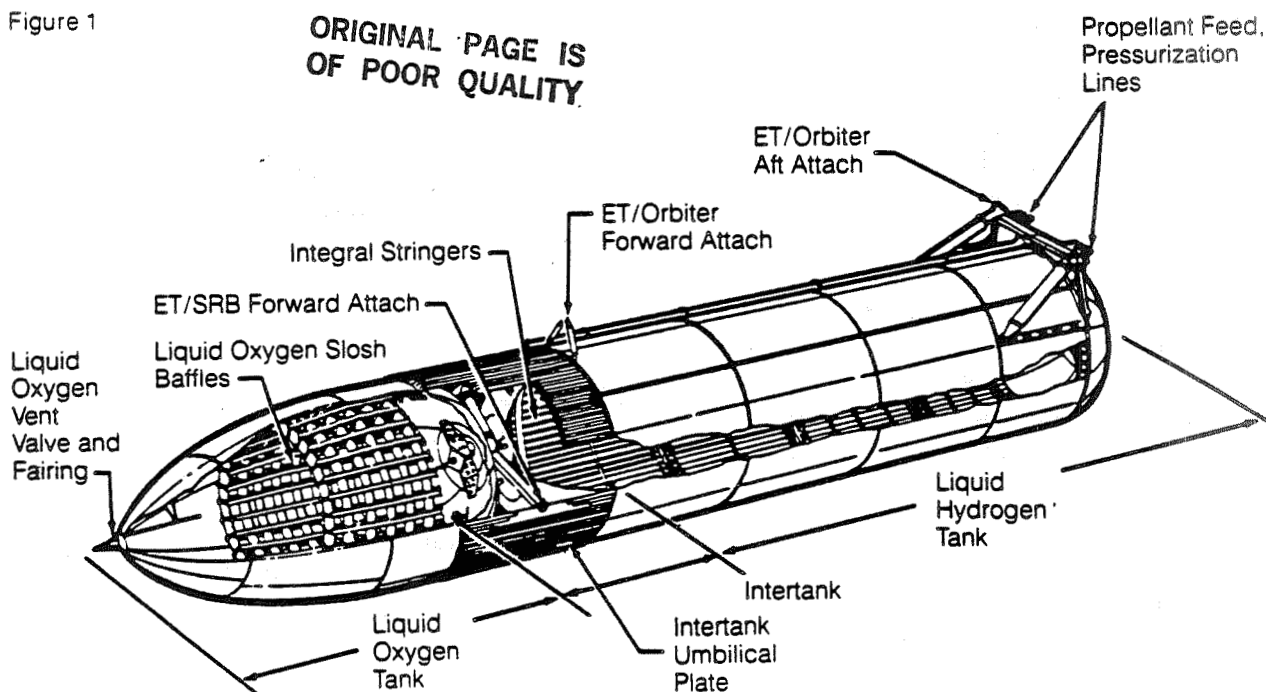

Partial cutaway drawing of External Tank shows oxygen tank at left, intertank to its right and hydrogen tank at right.

undetected imperfection that was discovered during a reexamination of the x-rays was found in recovered hardware with no propagation indicated.<sup>3</sup> Other data from the pre-launch ice and frost team inspections, film and video coverage, pressurization records and flight data revealed no evidence of leakage. The Commission concluded that no structural imperfections existed that could have grown to a size to create a leak or cause catastrophic failure of the External Tank.

Possible damage to the liquid hydrogen tank at lift off was considered. The ice and frost team observed no vapor or frost that would indicate a leak. The liquid hydrogen vent arm retracted as expected during launch and did not recontact the tank or solid booster.<sup>4</sup> Photo analysis and television monitoring did not indicate that any debris contacted the tank. Therefore, damage to the liquid hydrogen tank at lift off was determined to be highly improbable.

The possibility that abnormally high structural loads caused an External Tank failure was examined. Analysis indicated that there were no excessive loading conditions based on lift off and flight data prior to the explosion. The maximum structural load produced was less than 80 percent of the allowable design load.<sup>5</sup> The structural implications of vent and flow control valve operation was examined and found not to be a factor.

The possibility of a structural failure due to overheating was assessed with several causes postulated: high heating due to abnormal trajectory, loss of the thermal protection system, a hot gas leak from the Solid Rocket Motor and a liquid hydrogen leak from the External Tank. The trajectory was normal until well after the Solid Rocket Motor leak was observed at 58 seconds. Maximum aerodynamic heating would not have occurred until approximately 90 seconds.<sup>6</sup> At 73 seconds, heating was well within tank component structural capability. Based on careful review of pre-launch and flight films and data, the Commission found no evidence that any thermal protection foam was lost during the launch and ascent.

The possibility of a leak from the hydrogen tank resulting in overheating was addressed. Tests indicated that small leaks (0.037 lbs/second) would have been visible. In addition, if there was a liquid hydrogen leak at lift off, it would have been ignited by either the Solid Rocket Booster ignition or Space Shuttle Main Engine ignition.<sup>7</sup>

The resultant flame would have ignited the Solid Rocket Booster attach ring foam insulation almost immediately. Copious quantities of dense black smoke and open flames would be evident in such a case and would have continued for as long as the leak burned. Smoke and flames in these quantities were not observed at lift off nor anytime throughout the flight. It is therefore concluded that an initial liquid hydrogen tank leak was improbable, and that the only possible cause for overheating the tank was the impingement of leaking Solid Rocket Motor gases. This resulted in the ultimate breakup of the External Tank.

The recovered external foam insulation on the External Tank was scorched and discolored in various locations.<sup>8</sup> Burn patterns across the pieces of insulation on the External Tank indicate that various areas were subjected to fire both before and after the External Tank broke up in flight.

*The Commission reviewed the External Tank's construction records, acceptance testing, pre-launch and flight data, and recovered hardware and found nothing relating to the External Tank that caused or contributed to the cause of the accident.*

## Space Shuttle Main Engines

A cluster of three Space Shuttle Main Engines operates simultaneously with the Solid Rocket Boosters during the initial ascent phase of flight and provides primary propulsion until the Shuttle has attained orbital velocity. These engines use liquid hydrogen as the fuel and liquid oxygen as the oxidizer. Both the liquid hydrogen and oxygen are stored in the External Tank and are transferred to the engines under pressure. During the mission the engines operate for about 8.5 minutes.

Engine thrust is controlled by throttling and has ranged from 65 to 104 percent of a specified thrust level. At sea level, 100 percent equals 375,000 pounds of thrust per engine.

Pitch, yaw and roll control of the Orbiter is provided by gimbals on each engine. Gimbaling is operated by two hydraulic servoactuators, one for pitch motion and the other for yaw motion, with roll controlled by a combination of both pitch and yaw. These servoactuators are commanded by the Orbiter's computer.

An electronic controller is attached to the forward end of each engine. Each controller is a self-

Figure 2

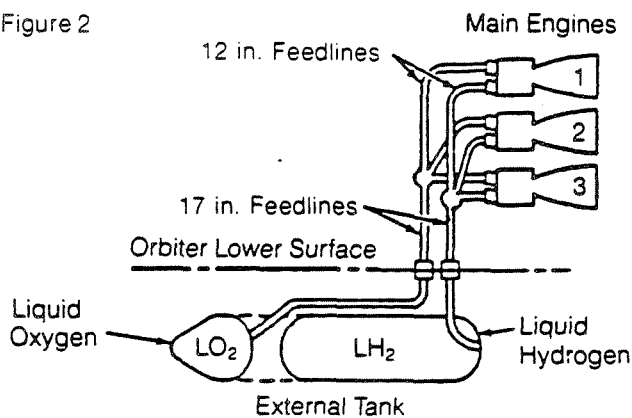

Schematic drawing depicts liquid oxygen and liquid hydrogen tanks and the feedlines connecting them to the Space Shuttle Main Engines.

Figure 3

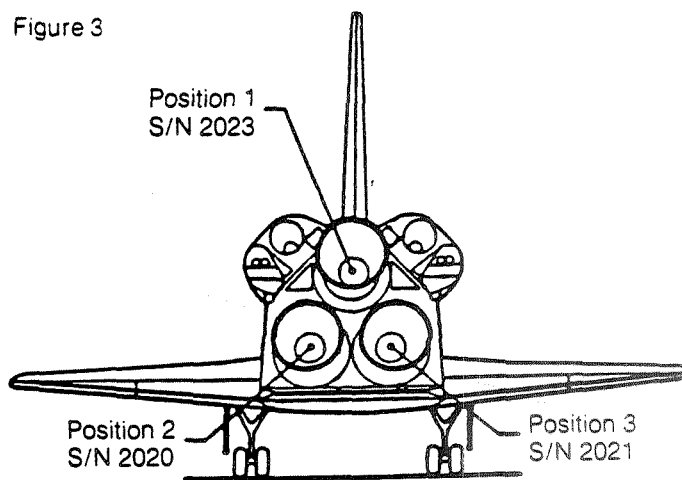

Rear view drawing identifies the positions and numbers of the engines mounted on the Orbiter Challenger for the flight of Mission 51-L.

contained system that monitors engine checkout, control and status, and sends the data to the Orbiter. Each of the three engine interface units in turn sends its data to the Orbiter computers and relays commands from the computers to the engines.

A propellant management subsystem of manifolds, distribution lines and valves controls the flow of liquids from the External Tank to the engines, and the flow of gaseous hydrogen and oxygen from the engines into the External Tank to maintain pressurization.

All three main engines from the Challenger, No. 2020 in position 2, No. 2021 in position 3, and No. 2023 in position 1, were recovered in large part on February 23, 1986, off the Florida coast in about 85 feet of water. All parts were recovered close to one another, and the engines were still attached to the thrust structure.<sup>9</sup> All engine gimbal bearings had failed, apparently because of overload on water impact.

All metallic surfaces were damaged by marine life, except titanium surfaces or those parts that were buried under the ocean bottom. The metal fractures, examined at 3x magnification, showed rough texture and shear lips, which appeared to be caused by overloads due to water impact.<sup>10</sup> No pre-accident material defects were noted.

The engine nozzles were sheared at the manifolds. The main combustion chambers, main injectors and preburners of each engine were attached to one another. The six hydraulic servoactuators used to control engine gimbaling

were attached to segments of the Orbiter thrust structure.<sup>11</sup>

Sections of the main propulsion system fuel and liquid oxygen feedlines and feedline manifolds were recovered, as well as the External Tank/Orbiter disconnect assembly in the mated configuration. A portion of the oxidizer inlet duct was attached to the interface of engine 2020. All preburner valves were recovered.<sup>12</sup>

The main engine controllers for both engines 2020 and 2021 were recovered. One controller was broken open on one side, and both were severely corroded and damaged by marine life. Both units were disassembled and the memory units flushed with deionized water. After they were dried and vacuum baked, data from these units were retrieved.<sup>13</sup>

All engines had burn damage caused by internal overtemperature typical of oxygen-rich shutdown. Thus, the loss of hydrogen fuel appears to have initiated the shutdown. The Commission reviewed engine and ground measurements made while the three engines were prepared for launch. Ambient temperature during pre-launch was the coldest to date, but preflight engine data were normal.<sup>14</sup> These data were also compared with Challenger engine data during the flight 61-A pre-flight period. All differences seen between the two missions were due either to planned variations in the pre-launch sequence or the cold ambient conditions during the preflight period for flight 51-L. These differences did not affect engine

evidence of any pro-  
 zer) in the aft compart-  
 1 flight phase all the  
 e aft compartment that  
 n of a leak were selected  
 51-L measurement list.  
 e parameters were either  
 ts or those recorded during  
 e metered to the ground.<sup>15</sup>  
 that were telemetered during  
 n temperature measurements  
 ation of a hot gas or other leak  
 mpartment.

the final section  
 dent was compared  
 flights of the Challenger engine  
 showed the engine performance on  
 was consistent with previous flights.<sup>16</sup>  
 The first abnormal engine indication was a  
 drop in engine fuel tank pressure at 72.564  
 seconds. As fuel pressure dropped, the control  
 system automatically responded by opening the  
 fuel flowrate valve. The turbine temperatures  
 then increased because of the leaner fuel mixture.

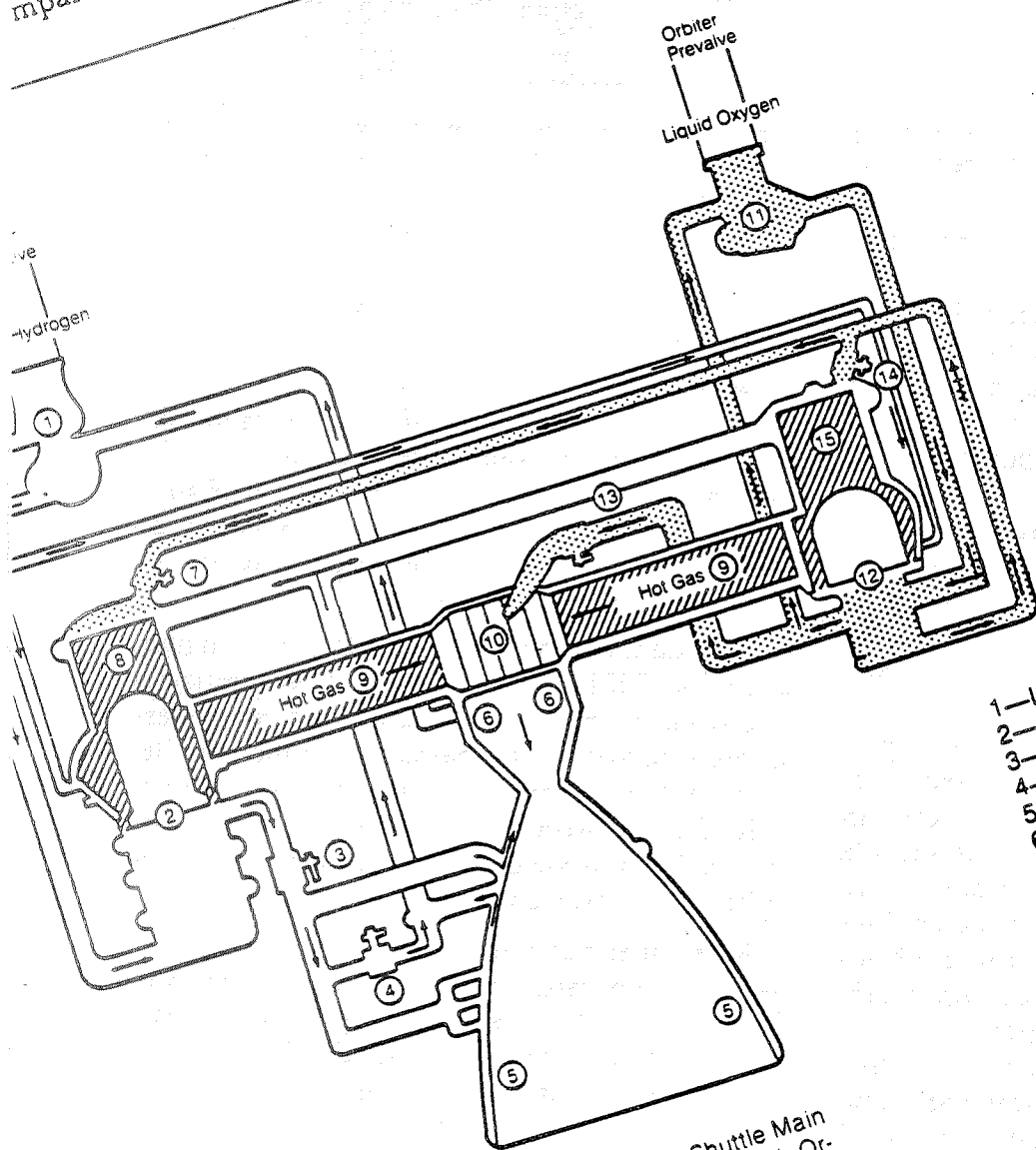

ORIGINAL PAGE IS  
 OF POOR QUALITY

- 1—Low-Pressure Fuel Turbopump
- 2—High-Pressure Fuel Turbopump
- 3—Main Fuel Valve
- 4—Coolant Control Valve
- 5—Nozzle Tube
- 6—Main Combustion Chamber
- 7—Fuel Preburner
- 8—Hot-Gas Manifold
- 9—Main Injector
- 10—Low-Pressure Oxidizer Turbopump
- 11—High-Pressure Oxidizer Turbopump
- 12—Main Oxidizer Valve
- 13—Oxidizer Preburner Valve
- 14—Oxidizer Preburner
- 15—Oxidizer Preburner

Drawing identifies principal elements in Space Shuttle Main Engines, three of which are mounted on the aft of each Or-  
 biter.

The increased temperature caused an increase in pump speed. This could not, however, increase the fuel pressure because of a decrease in fuel tank top (ullage) pressure resulting from the burned through hydrogen tank leakage. When the fuel pump pressures dropped below 140 pounds per square inch, the programmed control system disqualified the measured data because it was past reasonable limits. This caused the fuel flowrate and high-pressure fuel pump discharge pressure to decrease, while the lack of load allowed the pump's speed to increase. The decreased fuel flow caused a drop in fuel preburner chamber pressure, though the fuel preburner oxygen valve was then advancing toward a more open position. The mixture ratio in the fuel preburner became leaner, which raised high-pressure fuel turbine discharge temperatures above the redline limits. This caused the engine control system to start automatic shutdown of the engine.

The engine flight history showed that engine 2023 flew four previous times while engines 2020 and 2021 had flown five previous missions.<sup>17</sup> The flight data from flight 51-L compared well with flight data from all previous flights.

The analysis of flight data confirmed that the Space Shuttle Main Engines operated properly while reacting to changing external conditions. Previous engine tests suggest that the high-pressure pumps are the most likely components to fail, because of either bearing or turbine blade failure. There was no evidence of either in flight 51-L. Engine operation was normal until the fuel inlet pressure dropped. As the pressure decreased, the engine responded in a predictable manner. Automatic shutdown of engine 2023 was verified by telemetry data. Data recovered from the salvaged engine 2021 control computer verify that this engine also had begun shutdown. Salvaged control computer data from engine 2020 showed that this engine was within 20 milliseconds of shutdown when the computer stopped.<sup>18</sup> Inspection of recovered engine hardware verified that all engines were shut down in a fuel-lean or oxygen-rich condition which resulted in burn through and erosion of the engine hot gas circuits.

*The Commission concluded that the Space Shuttle Main Engines did not cause or contribute to the cause of the Challenger accident.*

## **Orbiter and Related Equipment**

The Orbiter subsystems include propulsion and power, avionics, structures, thermal and environmental control and life support, mechanical

and interface, and other government furnished essential equipment. Onboard government furnished equipment for STS 51-L included the remote manipulator arm system, extravehicular mobility units, extravehicular activity hardware, television, equipment worn by the crew, storage provisions and communication equipment.

The significant pieces of Orbiter structure recovered included all three Space Shuttle Main Engines, the forward fuselage including the crew module, the right inboard and outboard elevons, a large portion of the right wing, a lower portion of the vertical stabilizer, three rudder speed brake panels and portions of mid-fuselage side walls from both the left and right sides.<sup>19</sup> This represents about 30 percent of the Orbiter but does not provide sufficient evidence to establish conclusively the complete failure sequence of the entire Orbiter spacecraft. However, there was sufficient evidence to establish some of the structural failure modes that resulted in the Orbiter's destruction.

All fractures and material failures examined on the Orbiter, with the exception of the main engines, were the result of overload forces, and they exhibited no evidence of internal burn damage or exposure to explosive forces. This indicated that the destruction of the Orbiter occurred predominantly from aerodynamic and inertial forces that exceeded design limits. There was evidence that during the breakup sequence, the right Solid Rocket Booster struck the outboard end of the Orbiter's right wing and right outboard elevon. Additionally, chemical analysis indicated that the right side of the Orbiter was sprayed by hot propellant gases exhausting from the hole in the inboard circumference of the right Solid Rocket Booster. Evaluation of the Orbiter main engines showed extensive internal thermal damage to the engines as a consequence of oxygen-rich shutdown that resulted from a depletion of the hydrogen fuel supply. The supply of hydrogen fuel to the main engines would have been abruptly discontinued when the liquid hydrogen tank in the External Tank disintegrated.

The crew module wreckage was found submerged in about 90 feet of ocean water concentrated in an area of about 20 feet by 80 feet. Portions of the forward fuselage outer shell structure were found among the pieces of crew module recovered.<sup>20</sup> There was no evidence of an internal explosion, heat or fire damage on the forward

Figure 5

**1 Orbital Maneuvering System**

Two engines  
Thrust level = 6,000 pounds each

Propellants  
Monomethyl hydrazine (fuel) and  
nitrogen tetroxide (oxidizer)

**2 Reaction Control System**

One forward module, two aft pods  
38 primary thrusters (14 forward, 12 per aft pod)  
Thrust level = 870 pounds each

Six vernier thrusters (two forward, four aft)  
Thrust level = 25 pounds each

Propellants  
Monomethyl hydrazine (fuel) and  
nitrogen tetroxide (oxidizer)

**3 Main Propulsion**

Three engines  
Thrust level = 375,000 pounds each

Propellants  
Liquid hydrogen (fuel) and  
liquid oxygen (oxidizer)

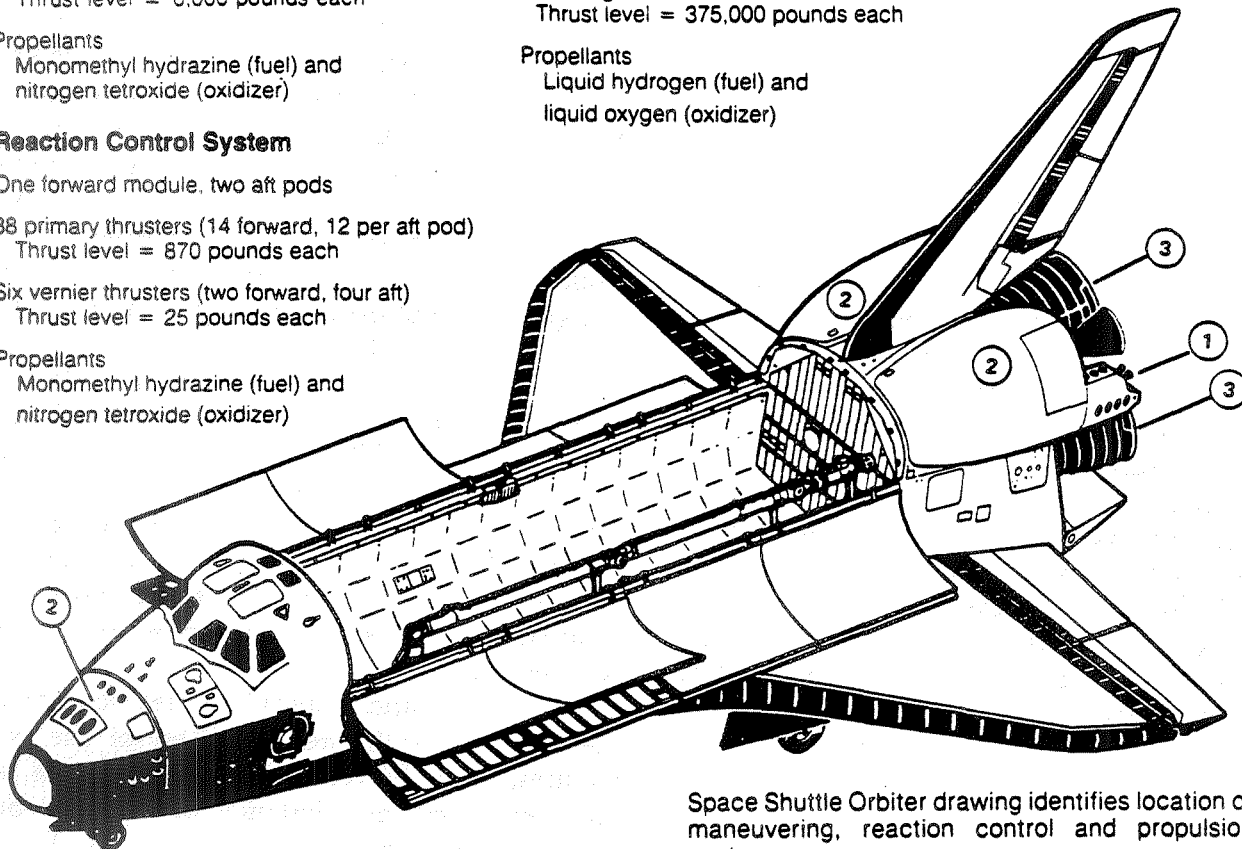

Space Shuttle Orbiter drawing identifies location of principal maneuvering, reaction control and propulsion system engines.

fuselage/crew module pieces. The crew module was disintegrated, with the heaviest fragmentation and crash damage on the left side. The fractures examined were typical of overload breaks and appeared to be the result of high forces generated by impact with the surface of the water. The sections of lower forward fuselage outer shell found floating on the ocean surface were recovered shortly after the accident. They also contained crush damage indicative of an impact on the left side. The consistency of damage to the left side of the outer fuselage shell and crew module indicates that these structures remained attached to each other until impact with the water.

The Orbiter investigation consisted of a review of all Orbiter data and vehicle parts retrieved. Also reviewed were vehicle and equipment processing records and pre-mission analyses.

All orbital maneuvering system measurements such as temperatures, pressures, events, commands, stimuli, and switch positions were reviewed with all related computer data. There

were no indications of abnormal behavior. All temperature and pressure transducers active during ascent for the reaction control system were reviewed, including thruster chamber pressure, leak temperature, line temperature, propellant tank, helium tank and propellant line transducers. Nothing was found that could have contributed to the accident.

Auxiliary power unit pressures and temperatures were reviewed, and no abnormal conditions were observed during ascent. Selected hydraulic measurements, including system pressures, fluid quantities and most temperatures in the aft compartment and in the wing cavity containing the elevon actuator supply lines, were reviewed by the Commission, and no abnormality was found. All fuel cells and power reactant storage and distribution subsystem measurements were reviewed and found to be normal during all phases of ground and flight operation prior to the accident. All available pyrotechnic firing control circuit measurements were reviewed, along with radiography, shear bolt review and debris reports,



Figure 6

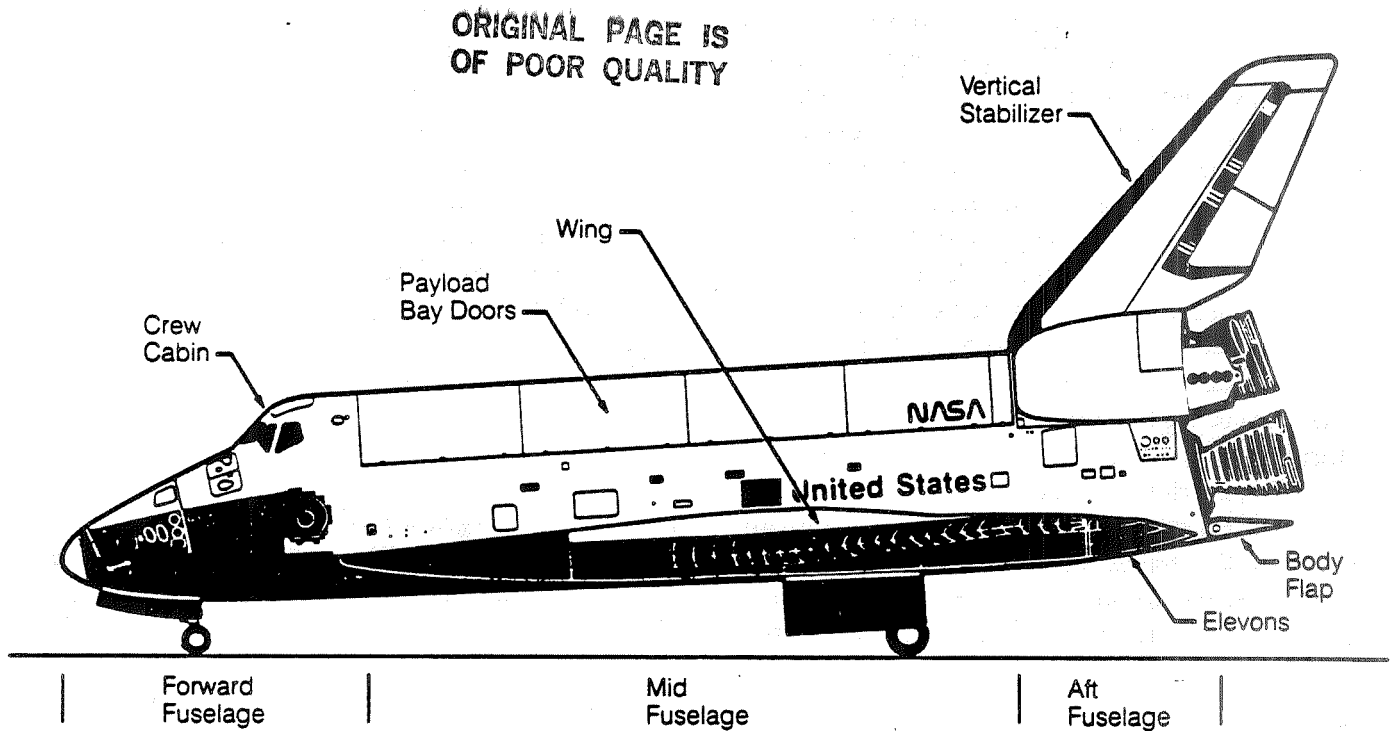

Sketch of Space Shuttle Orbiter in the landing configuration viewed from -Y position identifies aerodynamic flight surfaces.

and there were no unintentional firing command indications.<sup>21</sup> All available data regarding range safety and recovery system batteries were reviewed, and no indications were found that the batteries were involved in initiating the accident.

Guidance, navigation and control subsystems data were reviewed, and it appears that the subsystems performed properly. All subsystem sensors and software apparently performed as designed until data loss. Inertial measurement unit data from the preflight calibration through signal loss were found to be normal. All data processing system related data were reviewed, and nothing significant was found. Data review of the electrical power distribution and control subsystem indicated that its performance was normal until the time of the accident.<sup>22</sup> All communication and tracking system parameters active during launch were evaluated and found to be normal. No instrumentation abnormalities were observed during the pre-launch and launch period before signal loss.

Structures evaluation included analysis of

ground and flight data (loads, temperatures, pressures and purge flows), hardware changes and discrepancy reports since the last Challenger flight, and wreckage. The Commission found that no Orbiter structural elements contributed to the accident.

Orbiter structural pre-launch temperature measurements were evaluated and found to be within specified limits.

Data related to the atmospheric revitalization system, which maintains cabin atmosphere, were evaluated.<sup>23</sup> During pre-launch, launch and until signal loss, data indicated that both of the water coolant loops were normal, the pressure control system functioned normally, all fans functioned normally, and all switches and valve positions were proper.

Active thermal control subsystem data indicated that both of the freon coolant loops functioned normally, the ammonia boiler system was normal, and all switch and valve positions were proper.<sup>24</sup>

The water management subsystem functioned

normally during the flight. The smoke detection and fire suppression subsystem and airlock support subsystem both functioned normally. The waste collection subsystem is inoperative during the launch phase, and no data were available.<sup>25</sup>

No mechanical system abnormalities were identified. The vent doors remained open throughout the launch. The payload bay doors remained latched. All landing gear were up and locked, all doors remained closed and locked, and the remote manipulator system and payload retention system remained latched. Film and Orbiter interface data showed that there was no premature Orbiter/External Tank separation.

Video tapes and photographs indicated the crew egress hatch, which caused the launch delay on the preceding day, operated properly.

The onboard government furnished equipment configuration and pre-launch processing were reviewed and determined to have been flight-ready with no unusual or abnormal conditions.

*Based on this review and assessment, the Commission concluded that neither the Orbiter nor related equipment caused or contributed to the cause of the accident.*

## **Payload/Orbiter Interfaces**

Interfaces between the Orbiter and the payload serve to attach the cargo to the Orbiter or provide services from the Orbiter to cargo items. These interfaces are mechanical, thermal, avionics, power and fluid systems.

The Spartan-Halley payload was located in the front of the payload bay, attached to the equipment support structure carrier. The Tracking and Data Relay Satellite (TDRS) was attached to the Inertial Upper Stage (IUS) booster rocket used to move the TDRS into geosynchronous orbit. In the aft flight deck, payload interfaces consisted of a standard switch panel, a payload deployment and retention system, and display and control panels for use with the payload. Payloads in the middeck area were in the stowage lockers. These were radiation monitoring, phase partitioning, fluid dynamics experiments, three student experiments, the Teacher in Space Project and the Comet Halley monitoring program.

Thermal interfaces between the Orbiter and the payload in the aft flight deck and middeck consisted of the Orbiter's purge, vent and fluid heat exchanger systems. Thermal interface for TDRS/IUS, Spartan-Halley, and the experiments and projects were provided by the Or-

biter environment control and life support system.

Electrical power and avionics were provided to the payload through standard interface panels along both side of the cargo bay. In the aft flight deck, the control and display panels supplied by the Orbiter provided the avionics and power interfaces for TDRS/IUS. The experiments and projects constituting the middeck payload had no interfaces with avionics and power systems.

The only direct payload loads data from STS 51-L were accelerometer data recorded through the Orbiter umbilical prior to lift off. Accelerometer data from the payload bay and the crew cabin compared favorably with previous flights. Results indicate that payload loads on STS 51-L were similar to those of STS-6 and were within design levels and pre-launch predictions.

The Commission found that all payload elements had been certified safe for flight, and records for integration of hardware met engineering requirements. Temperatures during pre-launch and ascent were normal. Reconstructed lift off loads were below those used in the flight readiness certification. The relay satellite's rate gyro data correlated with those for the Orbiter and boosters during ascent. Fittings attaching the payloads to the Orbiter remained in operation, as shown by telemetered data from monitoring microswitches.

*The Commission found no discrepancies in the Orbiter/payload interface performance that might have contributed to the Challenger accident.*

## **Payloads, Inertial Upper Stage, and Support Equipment**

The payload bay of the Orbiter Challenger contained a Tracking and Data Relay Satellite (TDRS) attached to an Inertial Upper Stage (IUS) booster rocket, and associated airborne support equipment. The IUS contained two solid rocket motors (SRMs): SRM-1 and SRM-2. The combined weight of these components was about 40,000 pounds. About five percent of the payload, IUS, and support equipment package was recovered from the ocean. Components recovered included segments of the cases of both IUS SRMs, the ignition safe/arm device for each SRM, the igniter for SRM-2, fragments of unburned propellant from each SRM, five explosive

Figure 7  
**STS 51-L Payload  
 Configuration**

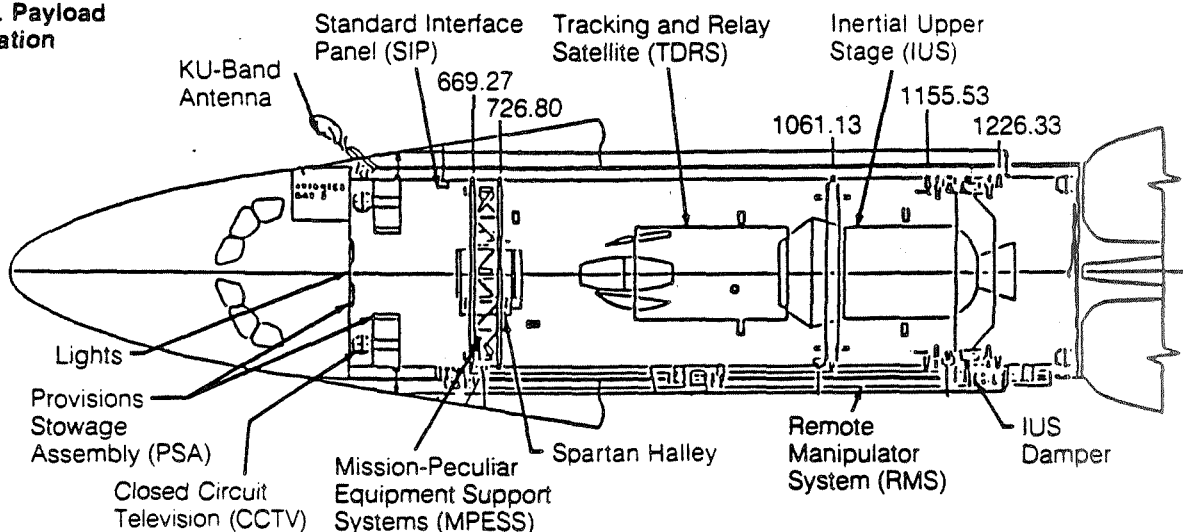

Overhead drawing of the Orbiter shows position of payload and other elements within the payload bay of the Challenger 51-L mission.

separation bolts that secure the two SRMs together, the forward support equipment trunnions, the aft trunnions with spreader beams, and an undetonated section of explosive fasteners.

There was no evidence of scorching, burning, or melting on any of the components and structure recovered, and all fractures were typical overload fractures. The safe arm device for each IUS SRM was in the safe position, the five explosive SRM-1/SRM-2 separation bolts were intact, and pieces of propellant were not burned, indicating that the SRMs had not ignited. The two aft trunnion spreader beams were intact but were bent in the downward direction relative to the Orbiter. The right spreader beam was cracked and deformed about 7.5 inches, and the left spreader beam was cracked and deformed about 1.5 inches.<sup>26</sup> These deformations indicate that the payload and upper stage package was intact and secure in the cargo bay while being subjected to significant inertial flight loads.

The inertial upper stage is a two-stage, solid-rocket-propelled, three-axis controlled, inertially navigated upper stage rocket used to deliver spacecraft weighing up to approximately 5,000 pounds from the Shuttle parking orbit to geosynchronous orbit. It includes the stage structure; solid rocket motors; a reaction control subsystem; avionics for telemetry, tracking and command; guidance, navigation and control; data management; thrust vector control; electrical

power sources and electrical cabling; and airborne software.

Assessment of possible upper stage contribution to the accident centered on the elimination of three possible scenarios: Premature upper stage rocket ignition, explosion/fire in the payload bay, and payload shift in the payload bay.

Premature ignition of either the upper stage stage 1 and/or stage 2 motor while still in the Orbiter bay would have resulted in catastrophic failure of the Orbiter. Potential causes for premature ignition were electrostatic discharge, inadvertent ignition command and auto-ignition. Each would have caused a rapid increase in the Orbiter payload bay temperature and pressure, and would have been immediately followed by structural damage to the payload bay doors. The payload bay temperatures remained essentially constant, and the Orbiter photographic and telemetry data indicated the payload doors remained closed and latched from lift off until signal loss.<sup>27</sup> Both indications verified that there was no ignition of the IUS solid rocket motors.

An IUS component explosion or fire could have damaged critical systems in the Orbiter by overheating or impact. Five sources other than an upper stage motor pre-ignition were identified as potential origins of a fire or explosion in the payload bay: (1) release and ignition of IUS hydrazine from the reaction control system tanks, (2) fire or explosion from an IUS battery, (3) im-

impact or rupture of a motor case and subsequent ignition of exposed propellant, (4) fire of electrical origin due to a short, and (5) fire or inadvertent ignition of pyrotechnic devices due to radio frequency radiation. Thermal measurements in the propellant tank and in components adjacent to the propellant tanks indicated no abnormalities. Pre-launch and thermal measurements in the Orbiter payload bay and in TDRS near the reaction control system were stable throughout the ascent period. A fire and/or explosion resulting in shrapnel from an IUS battery was eliminated based on pre-launch monitoring of open circuit voltages on all batteries, except the support equipment batteries. Location of these batteries made the potential for damage to critical systems very small if they burned or exploded. Motor case impact or rupture and resulting exposure and propellant ignition was determined improbable because batteries and reaction control system burning or explosion were eliminated by flight data analysis. They were the only potential sources for IUS heating and high velocity shrapnel. Propellant burning was not indicated by payload bay thermal measurements. Electrical shorting was eliminated as a fire source in the payload bay because IUS electrical and Orbiter voltage monitors were normal at launch and during STS 51-L ascent. Fires initiated by radio frequency radiation due to inadvertent IUS, TDRS, or ground emittance were eliminated because data showed worst case radio frequency radiation during ascent was less than ground-emitted radiation to the payload bay during pre-launch check-out. The ground-emitted radiation was within specified limits.

IUS/TDRS payload shifting or breaking free within the Orbiter due to structural failure or premature separation was investigated. Such a shift could have resulted in severe Orbiter damage from a direct impact, or could have induced a significant shift in the Challenger vehicle center of gravity and possibly affected flight control.<sup>28</sup> Four possible faults that could have led to Orbiter damage or substantial payload shift were considered: IUS stage 2/TDRS separation, IUS stage 1/stage 2 separation, IUS/TDRS separation from the airborne support equipment and IUS/airborne support equipment separation from Orbiter. All were eliminated because dynamic response data conclusively showed that IUS/TDRS responded normally until the final loss of data. Further, TDRS data, which pass

through the IUS stage 1/stage 2 and support equipment, were continuous until data loss, verifying that these elements did not separate.

The TDRS spacecraft weighs approximately 4,905 pounds and is 9.5 feet in diameter and 19.5 feet long. The forward 11 feet contain six deployable appendages, two solar arrays, one space-ground link antenna, and two single access antennas. The spacecraft body structure consists of a payload structure and a spacecraft structure. These structures house the tracking and telemetry and command subsystem, power subsystem, thermal control subsystem, ordnance subsystem, reaction control subsystem and attitude control subsystem.

Telemetry data were transmitted from TDRS from approximately 48 hours prior to launch through signal loss. The telemetry system was functioning properly, and the data indicated that the telemetry processor was in its normal operational mode and all power supply voltages and calibration voltages were normal. There were no changes through the countdown to the time of structural breakup, when all telemetry abruptly halted. The telemetry tracking and control subsystems command and tracking elements were inactive during the countdown through ascent, and no changes were noted, indicating that the TDRS was not commanded to alter its launch configuration.

The TDRS power subsystem had a total of 138 telemetry indications. These were the main data source used to determine the power subsystem activity. Analyzing this telemetry showed all subsystem elements performed normally.

The TDRS thermal control subsystem was designed to maintain proper temperatures primarily by passive means. Also, there is a thermostatically controlled heater system to ensure minimum required temperatures are maintained. The thermal subsystem was monitored by 82 configuration status indicators and 137 analog temperature channels. This telemetry showed that the TDRS remained in its normal thermal configuration and experienced normal temperatures until signal loss.

No data indicated that the IUS separated from TDRS, that any deployable appendage ordnance had been fired or that any appendage motion had begun.

The TDRS reaction control system was inactive at launch and required an IUS command and two ground commands to activate any propellant.

Telemetry indicated no valve actuation, changes in tank pressures or temperatures, or propellant line temperature violations. Further, there was no telemetry that would suggest a hydrazine leakage or abnormality and no indications that the TDRS reaction control system contributed to the accident.

During the launch phase, the attitude control subsystem was disabled except for the gyros and associated electronics necessary to provide the telemetry. All telemetry parameters reflecting attitude control subsystem configuration remained normal and unchanged during the STS 51-L pre-launch and post-launch periods.

The TDRS was mounted in a cantilevered fashion to the IUS by an adapter ring that provided structural, communications and power interfaces. Structural integrity loss indications would have been observed by interruptions in telemetry or electrical power. TDRS telemetry during the launch phase was transmitted by electrical cable to the IUS and interleaved with upper stage data. If separation had occurred at either the TDRS/IUS interface or the IUS/support equipment interface, TDRS data would have stopped. There was no abnormal telemetry until signal loss of all vehicle telemetry. TDRS also received power from the Shuttle via the IUS through the same interfaces. There were no indications of TDRS batteries coming on line. This indicates that structural integrity at the TDRS and IUS interfaces was maintained until the structural breakup. Additionally, an inspection of the recovered debris gives the following indications that the TDRS/IUS remained intact until the structural breakup. First, the separation bank lanyards frayed at the end where they attached to the band, indicating that the spacecraft was pulled forcefully from the adapter. Second, the V-groove ring structure at the top of the adapter was torn from its riveted connection to the adapter, indicating that a strong shear existed between the spacecraft and IUS which would only be generated if the two were still attached. Finally, the adapter base was torn where it attached to the IUS, again indicating high tension and shear forces. There were no indications from telemetry or recovered debris that showed that the structural integrity of the satellite or the satellite/stage interface had been compromised.

The TDRS records at Kennedy were reviewed for technical correctness and to verify that no open safety related issues existed. There were no

findings that revealed unsafe conditions or that any safety requirements had been violated or compromised.

A review and assessment of Spartan Halley performance was conducted to establish any possible contributions to the STS 51-L accident. The Spartan Halley was unpowered except for the release/engage mechanism latch monitor. Its electrical current was in the order of milliamps and the telemetry records obtained from the Orbiter indicated that the latches were in the proper configuration and thus Spartan Halley remained firmly attached during flight. In addition, the TDRS spacecraft data indicated there was no interaction from Spartan. Therefore, the Spartan Halley and its support structure remained intact. The payload bay temperature in the vicinity of Spartan was 55 degrees Fahrenheit indicating no abnormal thermal conditions.

As a result of detailed analyses of the STS 51-L Orbiter, the payload flight data, payload recovered hardware, flight film, available payload pre-launch data and applicable hardware processing documentation, *the Commission concluded that the payload did not cause or contribute to the cause of the accident.*

## **Solid Rocket Booster**

The Solid Rocket Booster comprises seven subsystems: structures, thrust vector control, range safety, separation, electrical and instrumentation, recovery, and the Solid Rocket Motor.

All recovered Solid Rocket Booster pieces were visually examined, and selected areas were extracted for chemical and metallurgical analysis.

The exterior surfaces of the Solid Rocket Boosters are normally protected from corrosion by an epoxy resin compound. There were several small areas where this protective coating was gouged or missing on the pieces recovered and, as a result, the exposed metallic surfaces in the areas were corroded. The damage to the protective coating was most likely the result of detonation of the linear shaped charges and water impact. There was no obvious evidence of major external flame impingement or molten metal found on any of the pieces recovered. All fracture surfaces exhibited either the characteristic markings of rapid tensile overload, a complete bending failure due to overload, or a separation fracture due to the detonation of the linear shaped charges.

Other pieces of the right Solid Rocket Motor aft field joint showed extensive burn damage, centered at the 307 degree position.

Most of the Solid Rocket Motor case material recovered contained pieces of residual unburned propellant still attached to the inner lining of the case structure.<sup>29</sup> The severed propellant edges were sharp, with no unusual burn patterns. Propellant recovered with a forward segment of the booster exhibited the star pattern associated with the receding shape of the propellant at the front end of the Solid Rocket Motor. There was no evidence found of propellant grain cracking or debonding on the pieces recovered. Casting flow lines could be distinguished on the propellant surfaces in several areas. This is a normal occurrence due to minor differences in the propellant cast during the installation of the propellant in the motor case structure.

Hardness tests of each piece of the steel casing material were taken before the propellant was burned from the piece. All of the tests showed normal hardness values.

One of the pieces of casing showed evidence

of O-ring seal tracks on the tang of the field joint. The tracks were cleaned with hexane to remove the grease preservative that had been applied after recovery of the piece, and samples of the track material were removed for analysis. Chemical analysis of the track material showed that the tracks were not composed of degraded O-ring seal material.

The possible Solid Rocket Booster faults or failures assessed were: structural overload, Solid Rocket Motor pressure integrity violation, and premature linear shaped charge detonation.

Reconstructed lift off and flight loads were compared with design loads to determine if a structural failure may have caused the accident. The STS 51-L loads were within the bounds of design and capability and were not a factor. Photographic and video imagery confirmed that both Solid Rocket Boosters remained structurally intact until the time of the explosion except for the leak observed on right Solid Rocket Motor.

The possibility that the range safety system prematurely operated, detonating the linear shaped charges was investigated. The linear

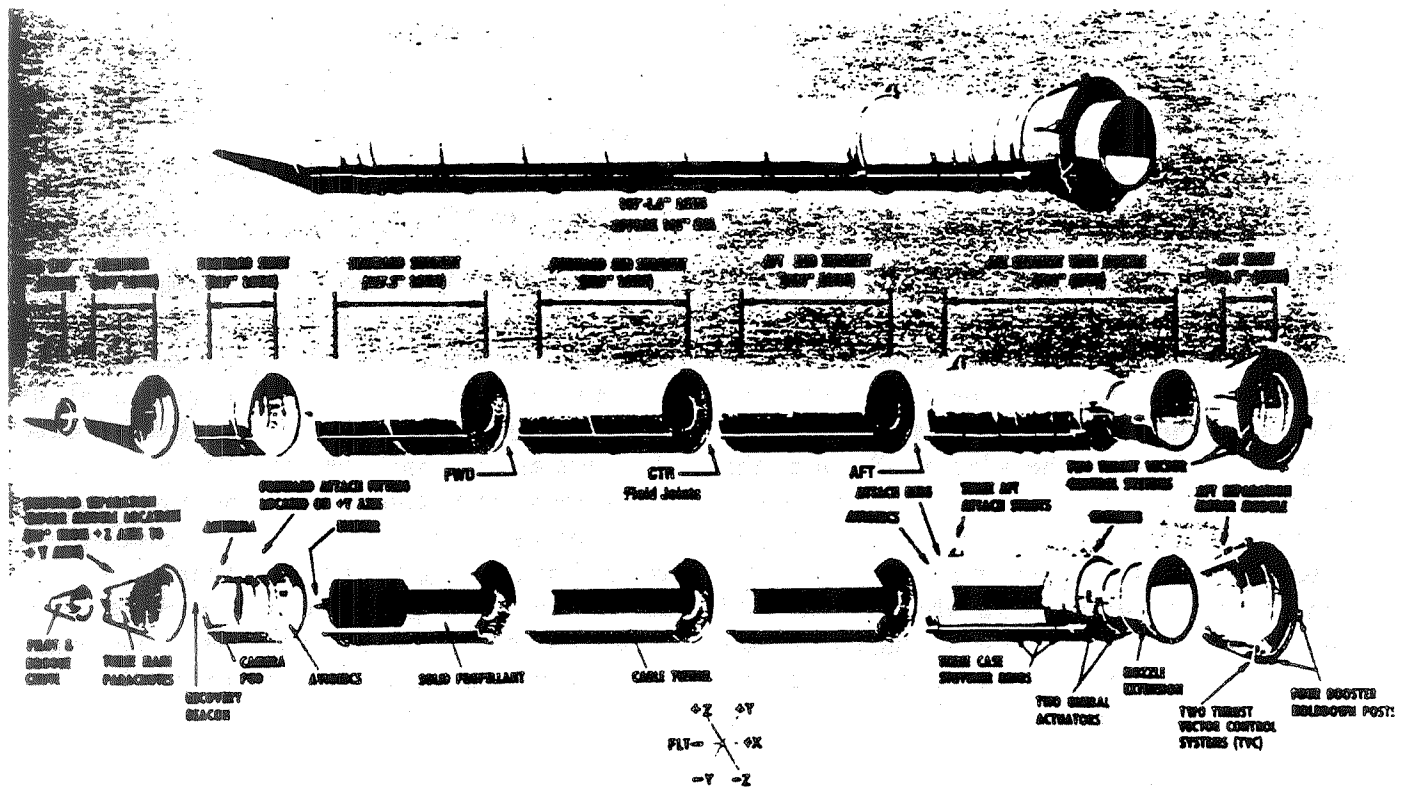

Figure 8  
Solid Rocket Booster drawing at top is exploded in lower drawings to show motor segments and other elements at forward and aft ends of booster.

ORIGINAL PAGE IS  
OF POOR QUALITY



Aft ET/SRB Struts	Measured Net Load						Recon-structed	Design Loads
	STS 1 (LB <sub>f</sub> × 10 <sup>-3</sup> )	STS 2 (LB <sub>f</sub> × 10 <sup>-3</sup> )	STS 3 (LB <sub>f</sub> × 10 <sup>-3</sup> )	STS 5 (LB <sub>f</sub> × 10 <sup>-3</sup> )	STS 6 (LB <sub>f</sub> × 10 <sup>-3</sup> )	STS 7 (LB <sub>f</sub> × 10 <sup>-3</sup> )	STS 51-L (LB <sub>f</sub> × 10 <sup>-3</sup> )	(LB <sub>f</sub> × 10 <sup>-3</sup> )
P8	-86	-93	-78	-55	-76	-76	-139	-306
P9	142	126	141	120	122	120	138	393
P10	-150	-128	-105	-94	-105	-116	-108	-306
P11	-93	-75	-71	-58	-85	-71	-141	-306
P12*	137	138	124	116	116	121	140	393
P13	-172	-108	-111	-111	-102	-106	-94	-306

\*Strut Nearest Point of Failure  
LB<sub>f</sub> = Pounds Force

#### Aft External Tank/Solid Rocket Booster Liftoff Strut Loads

Table compares External Tank/Solid Rocket Booster strut loads for first seven Shuttle flights with those for the mission 51-L launch and the strut design loads for the vehicle.

shaped charges were photographically observed to destroy both Solid Rocket Boosters at 110 seconds after launch when commanded to do so by the Range Safety Officer and therefore could not have discharged at 73 seconds after launch causing the accident. The possibilities of the Solid Rocket Boosters separating prematurely from the External Tank, the nozzle exit cone prematurely separating or early deployment of the recovery system were examined. Premature activation of the separation system was eliminated as a cause of failure based on telemetry that showed no separation commands. There were no indications that the nozzle exit cone separated. The recovery system was observed photographically to activate only after the Solid Rocket Boosters had exited the explosion.

In addition to the possible faults or failures, STS 51-L Solid Rocket Booster hardware manufacturing records were examined in detail to identify and evaluate any deviations from the design, any handling abnormalities or incidents, any material usage issues, and/or other indication of problems that might have importance in the investigation. *Based on these observations, the Commission concluded that the left Solid Rocket Booster, and all components of the right Solid Rocket Booster, except the right Solid Rocket Motor, did not contribute to or cause the accident.*

### The Right Solid Rocket Motor

As the investigation progressed, elements assessed as being improbable contributors to the accident were eliminated from further considera-

tion. This process of elimination brought focus to the right Solid Rocket Motor. As a result, four areas related to the functioning of that motor received detailed analysis to determine their part in the accident:

- Structural Loads Evaluation
- Failure of the Case Wall, (Case Membrane)
- Propellant Anomalies
- Loss of the Pressure Seal at the Case Joint

Where appropriate, the investigation considered the potential for interaction between the areas.

### Structural Loads Evaluation

Structural loads for all STS 51-L launch and flight phases were reconstructed using test-verified models to determine if any loading condition exceeded design limits.

Seconds prior to lift off, the Space Shuttle Main Engines start while the Solid Rocket Boosters are still bolted to the launch pad. The resultant thrust loads on the Solid Rocket Boosters prior to lift off were derived in two ways: (1) through strain gauges on the hold-down posts, and (2) from photographic coverage of Solid Rocket Booster and External Tank tip deflections. These showed that the hold-down post strain data were within design limits. The Solid Rocket Booster tip deflection ("twang") was about four inches less than seen on a previous flight, STS-6, which carried the same general payload weight and distribution as STS 51-L. The period of oscillation was normal. These data indicate that the Space Shuttle Main



## Shuttle Strut Identification

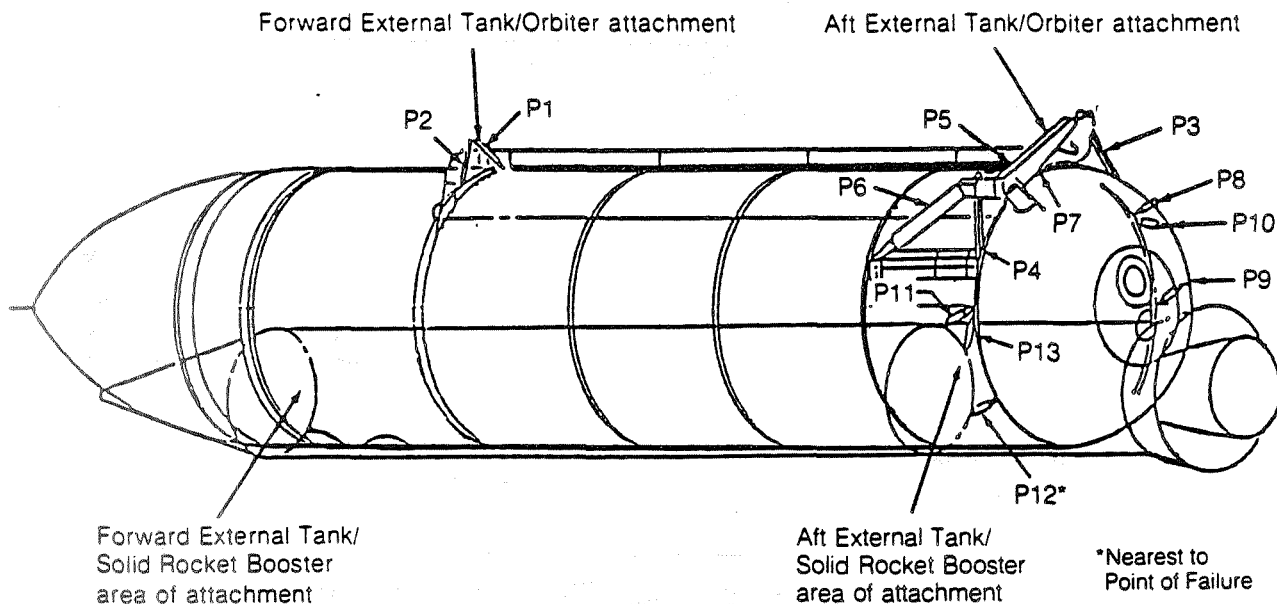

Figure 10  
Drawing of transparent External Tank, with right Solid Rocket Booster on far side, shows location of struts measured in table of strut loads. (Figure 9)

Engine thrust buildup, the resulting forces and moments, vehicle and pad stiffness, and clearances were as expected. The resultant total bending moment experienced by STS 51-L was  $291 \times 10^6$  inch-pounds, which is within the design allowable limit of  $347 \times 10^6$  inch-pounds.

The STS 51-L lift off loads were compared to design loads and flight measured loads for STS-1 through STS-7 (Figure 9). The Shuttle strut identification is shown in Figure 10. The loads measured on the struts are good indicators of stress since all loads between Shuttle elements are carried through the struts. The STS 51-L lift off loads were within the design limit.

Because the Solid Rocket Motor field joints were the major concern, the reconstructed joint loads were compared to design loads. Most of the joint load is due to the booster's internal pressure, but external loads and the effects of inertia (dynamics) also contribute. The Solid Rocket Motor field joint axial tension loads at lift off were within the design load limit ( $17.2 \times 10^6$  pounds). The highest load occurred at the forward field joint,  $15.2 \times 10^6$  pounds. The mid-joint load was

$13.9 \times 10^6$  pounds, while the aft joint showed  $13.8 \times 10^6$  pounds load.

Loads were constructed for all in-flight events, including the roll maneuver and the region of maximum dynamic pressure. A representative measure of these loads is the product of dynamic pressure ( $q$ ) and the angle of attack ( $\alpha$ ). Since the Shuttle is designed to climb out at a negative angle of attack, the product is a negative number. The loads in the  $q \times \alpha$  pitch plane are shown in Figure 11. Although the  $q \times \alpha$  variations in loads due to wind shear were larger than expected, they were well within the design limit loads.

The Solid Rocket Motor field joint axial tension loads were substantially lower at maximum dynamic pressure than at lift off:  $11.6 \times 10^6$  pounds for the forward field joint and  $10.6 \times 10^6$  pounds for the aft field joint. Compared to the internal pressure loads, the dynamic variations due to wind shear were small—about  $\frac{1}{15}$  those of the pressure loads. *These loads were well below the design limit loads and were not considered the cause of the accident.*

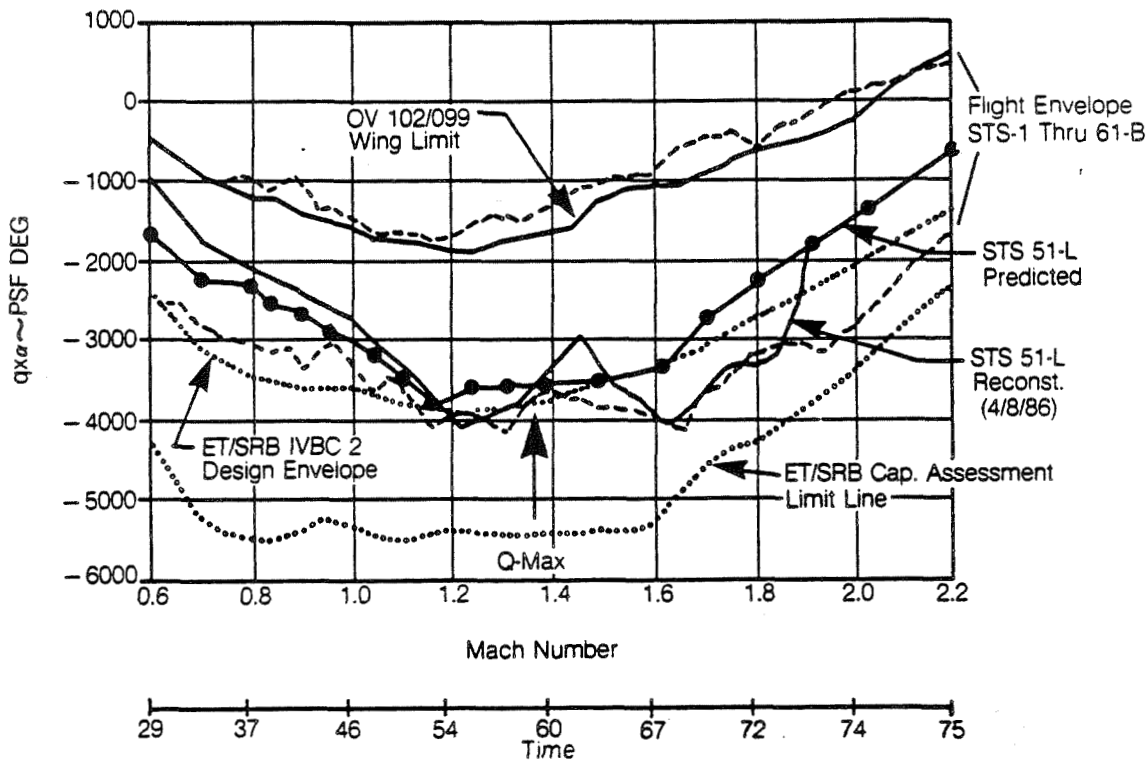

Figure 11  
The loads in the pitch plane are shown by the solid line marked "STS 51-L RECONST." The curve "STS 51-L PREDICTED" give the loads expected before the flight. The dashed lines show the limit of experience from STS-1 through 61-B. The present design limits are the two lines marked "OV

102/099 WING LIMIT" above, and "ET/SRB CAP. ASSESSMENT LIMIT LINE" below. (After STS-6, the wing was strengthened. The previous design limits were "ET/SRB IVBC 2 DESIGN ENVELOPE" below, and a curve in the positive region of  $q \times \alpha$  above)

### Assumed Inhibitor Flaw

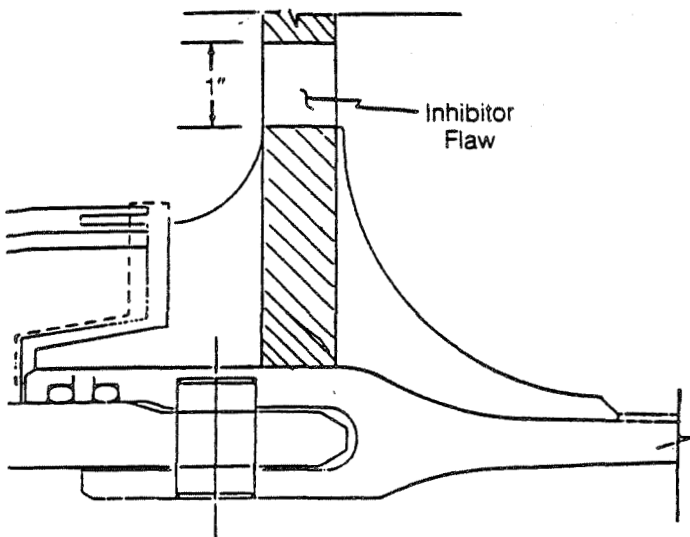

Figure 12  
Sketch shows location of assumed inhibitor flaw used in eliminating such a problem as a possible cause.

### Case Membrane Failure

The case membrane is the half-inch thick steel wall of the rocket between the joints. The possibility that the failure was initiated by anomalies associated with the case membrane was evaluated by analysis of design and test criteria. Potential failure modes were constrained by the following flight data and photographic observations:

- (1) A burn through the membrane would have to occur at or near the aft field joint.
- (2) The failure could have little or no influence on motor internal pressure since no deviation in pressure occurred prior to 60 seconds.
- (3) The failure must cause a burn through the membrane in 58 seconds.

The hypothesis of a membrane failure requires that the initial smoke observed at 0.678 seconds was an independent occurrence. It is an unlikely hypothesis for initiation of the accident. Fracture mechanics analysis indicates that a hole in the

Cutaway view of the Solid Rocket Booster showing Solid Rocket Motor propellant and aft field joint  
Figure 13

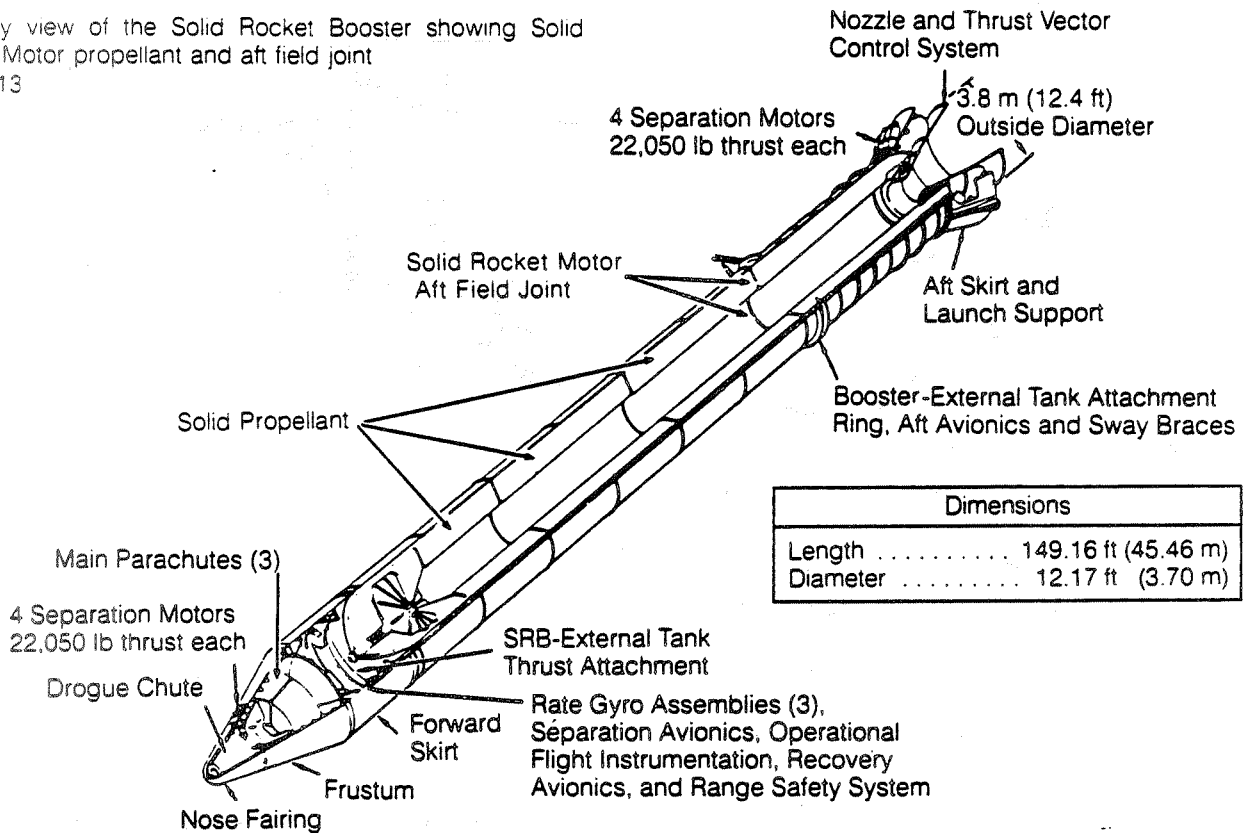

case larger than one inch would cause the entire case to rupture in a few milliseconds. This would give rise to the appearance of a large longitudinal flame, an event that is contrary to the flight films.

Evaluation of potential insulation or inhibitor (see Figure 12) flaws against the three criteria above resulted in elimination of all candidates except a defect in the forward-facing inhibitor. This potential failure mode was evaluated by assuming a 1-inch-diameter hole in the inhibitor. Analysis indicated that the change in motor internal pressure resulting from this failure would probably not be detected. However, an erosion rate substantially higher than the observed values would be required to burn through the membrane by 58 seconds. In addition, the assumed flaw is unlikely since the inhibitor is constructed by vulcanizing eight individual plies of the material. Subsequent damage of the magnitude required is improbable and would be easily detected.

A review of the segment inspection and of proof tests was conducted. Prior to vehicle assembly, each segment was pressurized to 112 percent of the maximum design operational pressure. A magnetic particle inspection of each membrane was then conducted. These procedures are designed to screen critical flaws, and are capable of detecting cracks greater than 0.1 inches. Frac-

ture mechanics analysis indicates that a flaw 0.1 inch long and 0.050 inch deep would grow to only 0.122 inches long and 0.061 inches deep in 80 uses of the segment. This flaw would be less than the critical size required to cause case rupture. Furthermore, as noted previously, a failure resulting in a case rupture is not consistent with photographic observations.

Subsequent to these evaluations, sections of the right Solid Rocket Motor case containing holes burned through in the area of the aft field joint were recovered. *Assessments of the sections do not support a failure that started in the membrane and progressed slowly to the joint; or one that started in the membrane and grew rapidly the length of the Solid Rocket Motor segment.*

### Propellant

An examination of propellant characteristics and flight data was accomplished to determine if any anomalous conditions were present in the STS 51-L right Solid Rocket Motor. Propellant cracking and propellant mean bulk temperatures were evaluated.

Historically, the propellant family used in the Solid Rocket Motor (TP-H1148) has exhibited good mechanical properties and an absence of grain structural problems. Should a crack occur,

however, the effects would be evident by changes in chamber pressure. Shortly after lift off, the STS 51-L right Solid Rocket Motor chamber pressure was 22 pounds per square inch higher than that of the left solid. This would correlate to a postulated radial crack through the grain spanning a 90-degree, pie-shaped wedge of the solid. However, with a crack of this nature, the chamber pressure would have remained high for approximately 60 seconds. Telemetry shows that the right Solid Rocket Motor chamber pressure did not remain high past 20-24 seconds and, therefore, the existence of a propellant crack was ruled out.

Propellant mean bulk temperature calculations were made using the ambient temperature over the two-week period prior to launch. The lowest bulk temperature experienced was 57 degrees Fahrenheit on the day of the launch. This was 17 degrees Fahrenheit above the minimum specified.

Based on this assessment and subscale lot-acceptance motor-firing evaluations, *it is improbable that propellant anomalies contributed to the STS 51-L accident.*

### Joint Seal Failure

Enhanced photographic and computer-graphic positioning determined that the flame from the right Solid Rocket Booster near the aft field joint emanated at about the 305-degree circumferential position. The smoke at lift off appeared in the same general location. Thus, early in the investigation the right Solid Rocket Booster aft field joint seal became the prime failure suspect. This supposition was confirmed when the Salvage Team recovered portions of both sides of the aft joint containing large holes extending from 291 degrees to 318 degrees. Several possible causes could have resulted in this failure. These possible causes are treated in the following paragraphs of this report.

During stacking operations at the launch site, four segments are assembled to form the Solid Rocket Motor. The resulting joints are referred to as field joints, located as depicted in Figures 8 and 13. Joint sealing is provided by two rubber O-rings with diameters of 0.280 inches (+0.005, -0.003), which are installed, as received from Morton Thiokol, during motor assembly. O-ring static compression during and after assembly is dictated by the width of the gap

between the tang and the inside leg of the clevis. This gap between the tang and clevis at any location after assembly is influenced by the size and shape (concentricity) of the segments as well as the loads on the segments. Zinc chromate putty is applied to the composition rubber (NBR) insulation face prior to assembly. In the assembled configuration the putty was intended to act as a thermal barrier to prevent direct contact of combustion gas with the O-rings. It was also intended that the O-rings be actuated and sealed by combustion gas pressure displacing the putty in the space between the motor segments (Figure 14). The displacement of the putty would act like a piston and compress the air ahead of the primary O-ring, and force it into the gap between the tang and clevis. This process is known as pressure actuation of the O-ring seal. This pressure actuated sealing is required to occur very early during the Solid Rocket Motor ignition transient, because the gap between the tang and clevis increases as

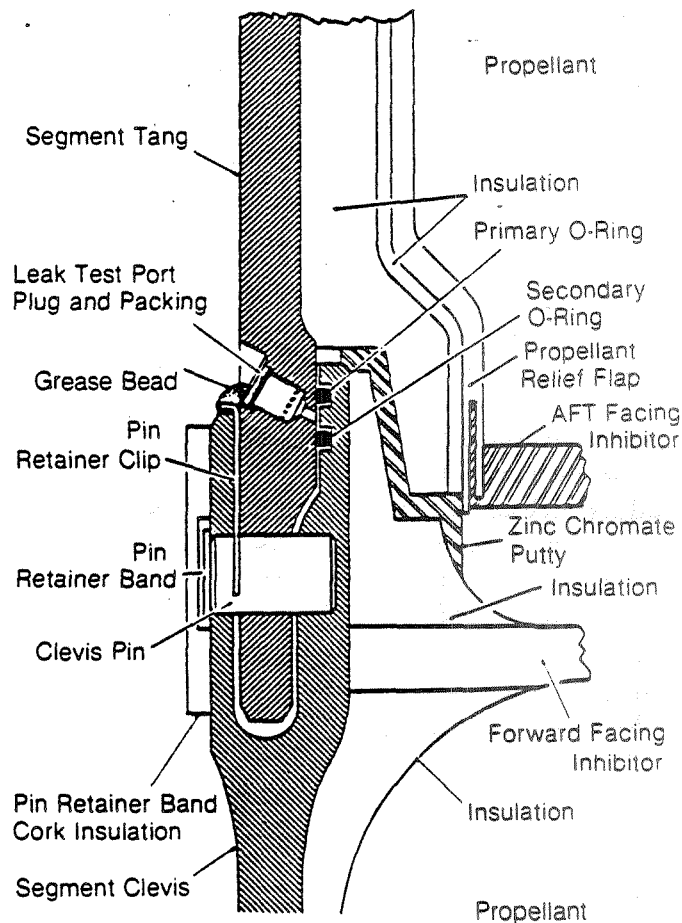

Figure 14  
Solid Rocket Motor cross section shows positions of tang, clevis and O-rings. Putty lines the joint on the side toward the propellant.

pressure loads are applied to the joint during ignition. Should pressure actuation be delayed to the extent that the gap has opened considerably, the possibility exists that the rocket's combustion gases will blow by the O-ring and damage or destroy the seals. The principal factor influencing the size of the gap opening is motor pressure; but, gap opening is also influenced by external loads and other joint dynamics. The investigation has shown that the joint sealing performance is sensitive to the following factors, either independently or in combination:

- (a) Damage to the joints/seals or generation of contaminants as joints are assembled as influenced by:
  - (1) Manufacturing tolerances.
  - (2) Out of round due to handling.
  - (3) Effects of reuse.
- (b) Tang/clevis gap opening due to motor pressure and other loads.
- (c) Static O-ring compression.
- (d) Joint temperature as it affects O-ring response under dynamic conditions (resiliency) and hardness.
- (e) Joint temperature as it relates to forming ice from water intrusion in the joint.
- (f) Putty performance effects on:
  - (1) O-ring pressure actuation timing.
  - (2) O-ring erosion.

The sensitivity of the O-ring sealing performance to these factors has been investigated in extensive tests and analyses. The sensitivity to each factor was evaluated independently and in appropriate combinations to assess the potential to cause or contribute to the 51-L aft field joint failure. Most of the testing was done on either laboratory or subscale equipment. In many cases, the data from these tests are considered to be directly applicable to the seal performance in full scale. However, in some cases there is considerable uncertainty in extrapolating the data to full-scale seal performance. Where such is the case, it is noted in the following discussions.

#### Assembly Damage/Contamination

It is possible that the assembly operation could influence joint sealing performance by damaging the O-rings or by generating contamination. The shapes of the solid rocket segments which include the tang and clevis, are not perfect circles because of dimensional tolerances, stresses, distortions

#### SRB Joint Tang/Clevis Interference

Premate Measurements of the Tang and Clevis  
(Not to Scale)

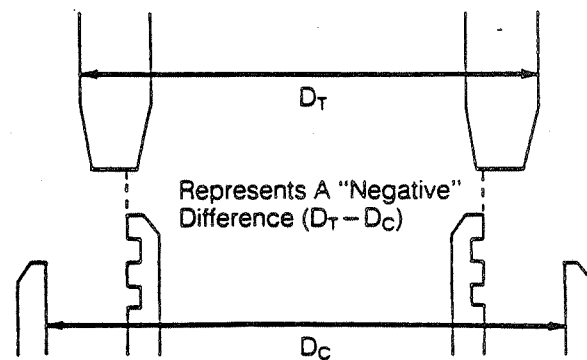
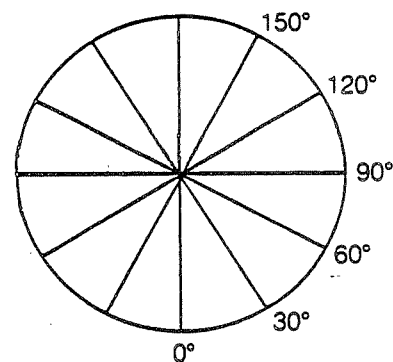
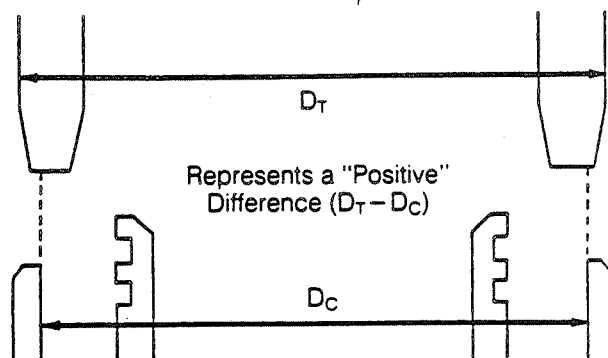

Measurements Made on Both Segments  
(Tang & Clevis) at Six Locations

$D_T$  = Outside Diameter of Tang

$D_C$  = Inside Diameter of  
Clevis Outer Leg

Figure 15  
Sketch shows how diameters of tang and clevis are measured to assure proper fit of two Solid Rocket Motor segments.

from previous use, and the effects of shipping and handling. The most important effect is from the load of propellant, a plastic and rubbery material, which can take a set that relaxes very slowly. For example, since the segments are shipped in a horizontal position on railroad cars, their weight can make them somewhat elliptical—a shape they can maintain for some time. At assembly, after the lower segment (with the clevis on top) is placed vertically, the tang of the next segment is lowered into it. To make the fit easier, the upper segment is purposely reshaped by connecting the lifting crane in an appropriate position and, on occasion (51-L was one of these), directly squeezing the tang section with a special tool. To monitor the fit, the diameters of the clevis,  $D_C$ , and the tang,  $D_T$  (Figure 15) are measured at six positions 30 degrees apart, and difference of these measurements ( $D_T - D_C$ ) are noted. When these differences are such that the tang encroaches somewhat into the outer clevis, slanted edges (chamfers) permit the pieces to slide together. If the difference is too great, flat areas of the tang meet flat areas of the clevis. What really counts, of course, are differences of radii, which diameter measurements alone do not determine, for one does not know during the assembly how far off the centers are. This is a circumstance to be avoided, but one that can be detected during assembly. Experience has shown that a diameter difference of less than +0.25 inches usually permits assembly without a flat-on-flat condition arising. A negative diameter difference means the tang encroaches on the inside of the clevis. The possibility was noted that contaminants from sliding metal and direct O-ring pinching might occur if this overlap is large. If it is too great, a flat-on-flat condition can arise inside the joint where it is very difficult to see. These dimensions shift as the pieces slide together and they change further as the propellant stresses relax during the period between assembly and launch. Therefore, a condition such as that which occurred during assembly of the aft segment for flight 51-L, wherein the maximum interference between tang and clevis at the O-rings was at approximately 300 degrees, may or may not have persisted until launch—seven weeks after assembly.

The O-rings are heavily greased to prevent damage. This grease adds another element of uncertainty to the configuration and action of the seal under pressurization, especially at low temperatures.

Testing was conducted during the investigation to evaluate the potential for assembly damage and contaminant generation, and its effect on seal performance. A sub-scale section of a field joint was configured in a test fixture and simulated assembly operations were conducted. This section was much stiffer than the full-scale booster segments and did not fully simulate actual assembly conditions. However, under these test circumstances, metal slivers were generated during situations wherein the tang flat overlapped the flat end of the clevis leg by 0.005 to 0.010 inches. The metal slivers in turn were carried into the joint and deposited on and around the O-rings. A second finding from this test series was that the O-ring section increased in length as the tang entered the clevis and compressed the O-ring diameter. The implication of this finding is that canted tang entry in a full diameter segment, while unlikely, could chase the O-ring around the circumference, resulting in gathering (bulging from the groove) on the opposite side. This could make the O-ring more vulnerable to damage. There is no known experience of such bulging during previous assemblies.

To understand the effects of potential contaminants on sealing performance, tests were conducted employing metal contaminants simulating those generated in the segment assembly tests. The tests were to determine if joints with metal shavings positioned between the O-ring and sealing surface could pass a static leak check but fail under dynamic conditions. The contaminants that passed the 50 pounds per square inch leak check were between 0.001 and 0.003 inches thick. Testing to determine seal performance under dynamic conditions with these representative contaminations is not complete. However, the possibility cannot be dismissed that contamination generated under some assembly conditions could pass a leak check and yet cause the seal to leak under dynamic conditions.

A second concern was structural damage to the clevis due to abnormal loading during assembly. An analysis was made to determine the deflections and stresses experienced during assembly of the right Solid Rocket Motor aft center segment to the aft segment. These stresses were then used in a fracture mechanics analysis of the O-ring groove to determine the maximum flaw size that would not fail under the 51-L case segment life cycle history. Included in this analysis was the single point load needed to deflect a suspended

segment to the side by 0.200 inches, and the maximum stress on the case clevis that this causes. The analysis further addressed a condition that has been encountered, where the tang sits on top of the inner clevis leg on one side and slips down into the clevis groove on the opposite side.

The result of this analysis is that the stresses induced during the operation were low and would not have resulted in hardware damage. Also, the stresses would have resulted in significant growth of an undetected flaw, which then would be detectable by inspection on its next use.

### Gap Opening

The gap to be sealed between the tang and the inside leg of the clevis opens as the combustion gas pressure rises. This gap opening was calculated as a function of pressure and time by an analysis that was calibrated to joint deflections measured on a structural test article. The analysis extended the results beyond test calibration conditions to include propellant effects and external loads. The initial static gap dimensions combined

with the time history of the gap opening determined the minimum and maximum gap conditions used for testing the capability of the O-rings to seal.

The joint deflection analysis established time histories for gap openings for primary and secondary O-rings for all field joints. For the aft field joints these data indicate gap opening increases of approximately 0.029 inches and 0.017 inches for the primary and secondary O-rings respectively. These values were used for sub-scale dynamic tests. Due to differences in motor pressure and loads, the gap opening increases for forward field joints are approximately 0.008 inches greater than for the aft field joints. Gap opening changes (called delta gap openings) versus time are shown in Figure 17 for the aft field joints. The total gap at any time also depends on the initial static gap, on rounding effects during segment pressurization, and on loadings due to struts and airloads. Sub-scale tests were run containing combinations of the above variables, but did not include the effects of the struts and airloads.

### Pressurized Joint Deflection

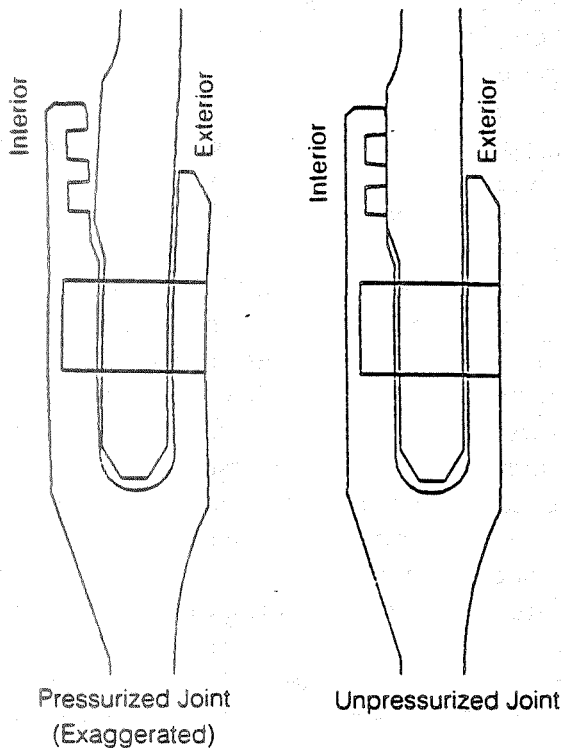

Figure 16  
Drawings show how tang/clevis joint deflects during pressurization to open gap at location of O-ring slots. Inside of motor case and propellant are to left in sketches.

### Right Hand SRM Aft Field Joint Primary And Secondary Delta Gap Opening

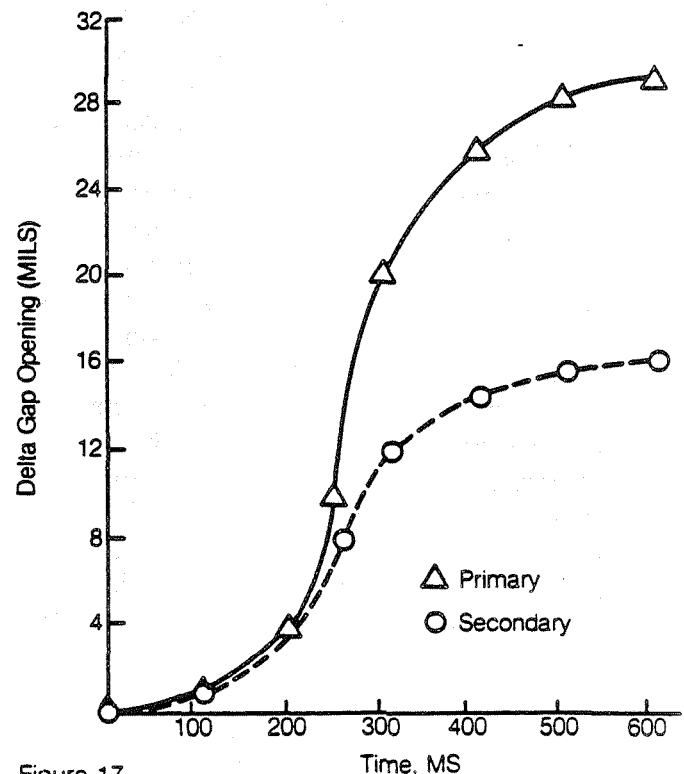

Figure 17  
Graph plots changes in right booster's aft field joint primary and secondary gap openings. Horizontal scale is time in milliseconds from ignition.



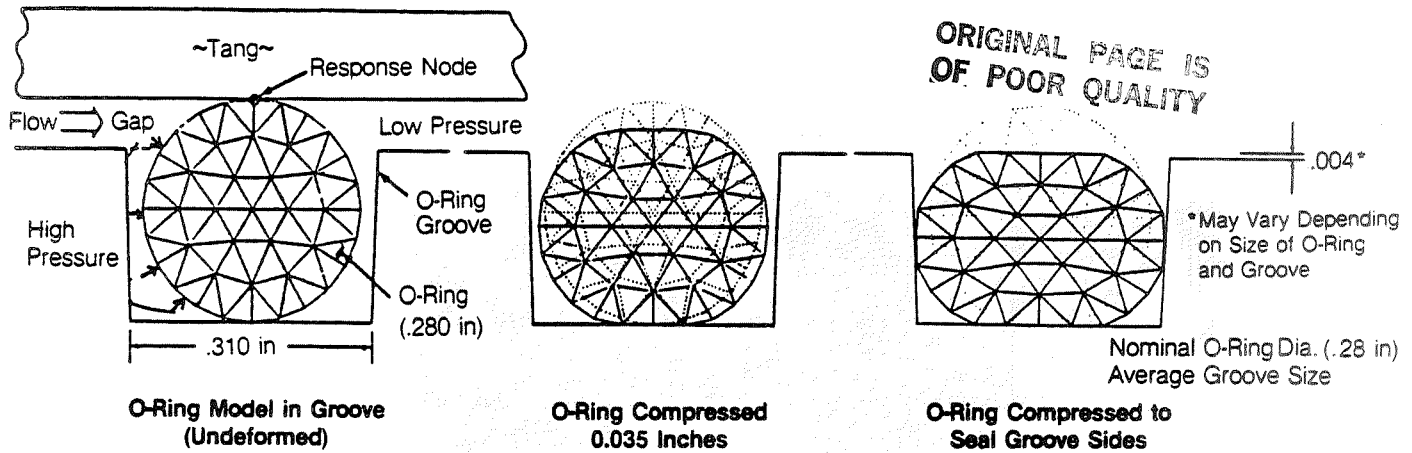

Figure 18  
 Drawings show how progressive reduction of gap between tang and clevis can inhibit and eventually block motor cavity's high-pressure flow from getting behind O-ring.

### O-Ring Compression at Launch (Static)

As noted previously, diameters measured just prior to assembly do not permit determination of conditions at launch because, among other things, the propellant slowly relaxes. For STS 51-L, the difference in the true diameters of the surfaces of tang and clevis measured at the factory was 0.008 inches. Thus, the average gap at the O-rings between the tang and clevis was 0.004 inches. The minimum gap could be somewhat less, and possibly metal-to-metal contact (zero gap) could exist at some locations.

During the investigation, measurements were made on segments that had been refurbished and reused. The data indicate that segment circumferences at the sealing surfaces change with repeated use. This expectation was not unique to this joint.

Recent analysis has shown and tests tend to confirm that O-ring sealing performance is significantly improved when actuating pressure can get behind the entire face of the O-ring on the upstream side of the groove within which the O-ring sits (Figure 18). If the groove is too narrow or if the initial squeeze is so great as to compress the O-ring to the extent that it fills the entire groove and contacts all groove surfaces, pressure actuation of the seal could be inhibited. This latter condition is relieved as the joint gap opens and the O-ring attempts to return to its uncompressed shape. However, if the temperature is low, resiliency is severely reduced and the O-ring is very slow in returning towards its original shape. Thus, it may remain compressed in the

groove, contact all three surfaces of that groove, and inhibit pressure actuation of the seal. In addition, as the gap opens between the O-ring and tang surface allowing pressure bypass, O-ring actuation is further inhibited.

Two sub-scale dynamic test fixtures were designed and built that simulated the initial static gap, gap opening rate, maximum gap opening and ignition transient pressures. These fixtures were tested over a temperature range with varying initial static gap openings. A summary of results with initial gap openings of 0.020 and 0.004 inches is provided in Figure 19. The results indicate that with a 0.020-inch maximum initial gap, sealing can be achieved in most instances at temperatures as low as 25 degrees Fahrenheit, while with the 0.004-inch initial gap, sealing is not achieved at 25 degrees Fahrenheit and is marginal even in the 40 and 50 degree Fahrenheit temperature range. For the 0.004-inch initial gap condition, sealing without any gas blow-by, did not occur consistently until the temperature was raised to 55 degrees Fahrenheit. To evaluate the sensitivity to initial gap opening, four tests were conducted at 25 degrees Fahrenheit with an initial gap of 0.010 inch. In contrast to the tests at a 0.004 inch gap, these tests resulted in sealing with some minimal O-ring blow-by observed during the sealing process.



These tests indicate the sensitivity of the O-ring seals to temperature and O-ring squeeze in a joint with the gap opening characteristics of the Solid Rocket Motors.

It should be noted that the test fixture placed

**Summary of Dynamic Test Results**

GAP (MILS)	Initial Δ	MTI		MSFC	
		4	20	4	20
Temp(°F)	Final	27	20	27	16
70					
60					
55					
50					
40					
25		(4) PL/SL-1 TEST PL/SB-3 TESTS		(4) PL/SL-4 TESTS	
10		(2) PL/SL-1 TEST PL/SB-1 TEST	(3) PL/SB-3 TESTS		
0			(3) PL/SB-1 TEST		
-10			(4) PL/SL-3 TESTS PB/SB-1 TEST		

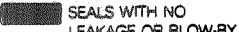
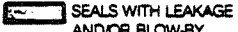
 SEALS WITH NO LEAKAGE OR BLOW-BY	 SEALS WITH LEAKAGE AND/OR BLOW-BY	 DOES NOT SEAL
--	---	--

( )	—Number of Tests
BLANK	—No Apparent Leakage or Blow-By
PL	—Primary O-Ring Leak
PB	—Primary O-Ring Blow-By
SL	—Secondary O-Ring Leak
SB	—Secondary O-Ring Blow-By
*	—Data Under Evaluation

Figure 19  
Table plots results of tests of .004 and .020 inch initial gap openings over the range of temperatures in left hand vertical column.

the O-rings at a specific initial gap and squeeze condition uniformly around the circumference. It is not certain what the effect of differences in circumferential gaps might be in full size joints. Such effects could not be simulated in the sub-scale test results reported above.

**Joint Temperature**

Analyses were conducted to establish STS 51-L joint temperatures at launch. Some differences existed among the six 51-L field joints. The joints on the right Solid Rocket Motor had larger circumferential gradients than those on the left motor at launch. It is possible that the aft field joint of the right Solid Rocket Booster was at the lowest temperature at launch, although all joints had calculated local temperatures as low as  $28 \pm 5$  degrees Fahrenheit. Estimated transient temperature for several circumferential locations on the joints are shown for the right Solid Rocket Motor aft field joint and the left motor aft field

joint in Figures 20 and 21. These data are representative of other joints on the respective Solid Rocket Motors.

The investigation has shown that the low launch temperatures had two effects that could potentially affect the seal performance: (1) O-ring resiliency degradation, the effects of which are explained above; and (2) the potential for ice in the joints. O-ring hardness is also a function of temperature and may have been another factor in joint performance.

Consistent results from numerous O-ring tests have shown a resiliency degradation with reduced temperatures. Figure 23 provides O-ring recovery from 0.040 inches of initial compression versus time. This shows how quickly an O-ring will move back towards its uncompressed shape at temperatures ranging from 10 to 75 degrees Fahrenheit. When these data are compared with the gap openings versus time from Figure 17, it can be seen that the O-rings will not track or

**Aft Right Segment Temperatures for STS 51-L**

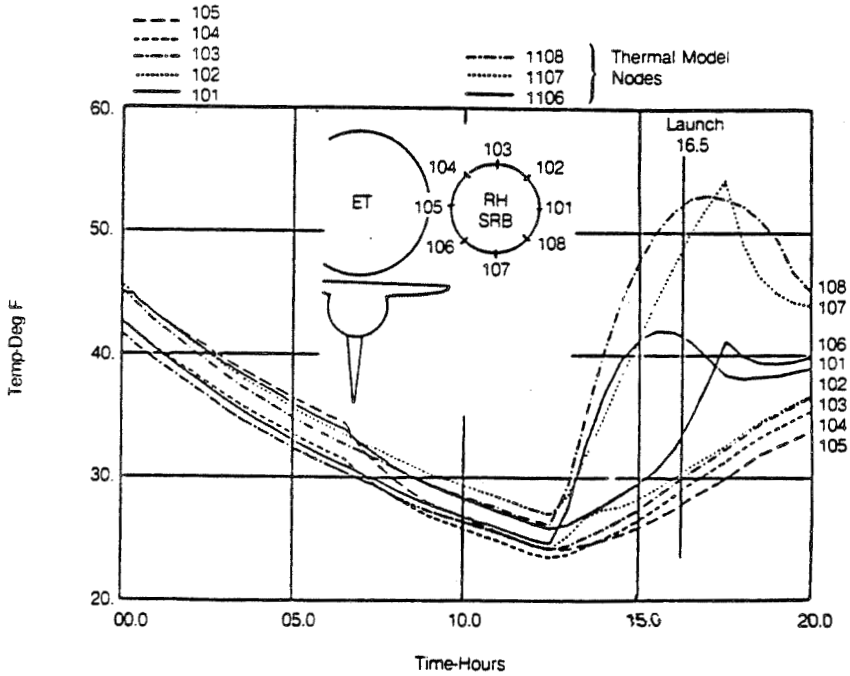

Figure 20  
Temperature model for 51-L right solid booster aft segment circumferential positions from 16.5 hours prior to launch to 3.5 hours after launch.

**Aft Left Segment Temperatures for STS 51-L**

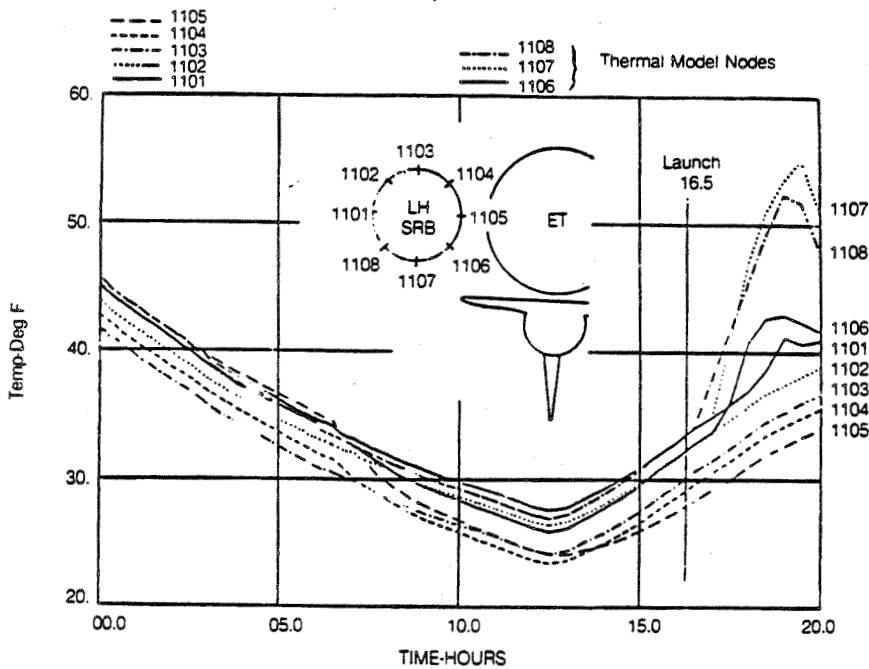

Figure 21  
Temperature model for 51-L left solid booster aft segment circumferential positions from 16.5 hours prior to launch until 3.5 hours after launch.

## Field Joint Distress

<i>Flight</i>	<i>Joint</i>	<i>SRB (right or left)</i>	<i>Angular location</i>	<i>Joint Temp (°F)</i>	<i>Previous Use of Segments (2)</i>	<i>Type of Distress</i>
STS-2	AFT	RH	090	70	none/none	Erosion
41-B	FWD	LH	351	57	1/none	Erosion
41-C	AFT	LH	N/A	63	1/1	O-ring heat
41-D	FWD	RH	275/110	70	2/none	Erosion
51-C	FWD	LH	163	53	1/none	Erosion
51-C (3)	MID	RH	354	53	1/1	Erosion
61-A	MID	LH	36-66	75	none/none	Blow-by
61-A	AFT	LH	338/018	75	none/none	Blow-by
61-C	AFT	LH	154	58	1/none	Erosion
51-L	AFT	RH	307	28	1/2	Flame

(1) Mean calculated ( $\pm 5^\circ\text{F}$ )

(2) Refurbished after recovery

(3) Both primary and secondary O-rings affected

Examination of the records shows that if one defines any sort of damage around the O-ring as "distress", then there have been 10 "distressed" field joints, including the aft field joint on the right-hand booster of 51-L. These data, which are tabulated above, show 10 instances of distress in a total of 150 flight exposures. One-half of the instances occurred in the aft joint, one-third in the forward joint, and one-fifth in the mid-joint. Sixty percent of the distress occurred in the left Solid Rocket Motor.

recover to the gap opening by 600 milliseconds (gap full open) at low to moderate temperatures. These data show the importance of timely O-ring pressure actuation to achieve proper sealing.

It is possible that water got into some, if not all STS 51-L field joints. Subsequent to the Challenger accident, it was learned that water had been observed in the STS-9 joints during restacking operations following exposure to less rain than that experienced by STS 51-L. It was reported that water had drained from the STS-9 joint when the pins were removed and that approximately 0.5 inch of water was present in the clevis well. While on the pad for 38 days, STS 51-L was exposed to approximately seven inches of rain. Analyses and tests conducted show that water will freeze under the environmental conditions experienced prior to the 51-L launch and could unseat the secondary O-ring. To determine the effects of unseating, tests were conducted on the sub-scale dynamic test fixture at Thiokol to further evaluate seal performance. For these tests, water was frozen downstream of the secondary O-ring. With ice present, there were conditions under which the O-ring failed to seal.

### Putty Performance

The significance of the possibility that putty could keep the motor pressure from promptly reaching the O-rings to pressure actuate and seal them was apparently not fully appreciated prior to the Challenger accident. During the investigation, it became evident that several variables may affect the putty performance and, in turn, seal performance. However, limited test data and lack of fidelity in full scale joint simulation prevented a complete engineering assessment of putty performance. Tests were conducted over a range of putty conditions, including temperature at ignition, pretest conditioning to simulate the environmental effects, and dimensional variations within the joint. These test results demonstrated that putty performance as a pressure seal is highly variable. The results may be interpreted to indicate that the putty can maintain pressure during the ignition transient and prevent O-ring sealing. For example, one test conducted with putty, which had been conditioned for 10 hours at 80 percent relative humidity and 75 degrees Fahrenheit, delayed the pressure rise at the primary O-ring for 530 milliseconds at a

## O-Ring Recovery vs. Time

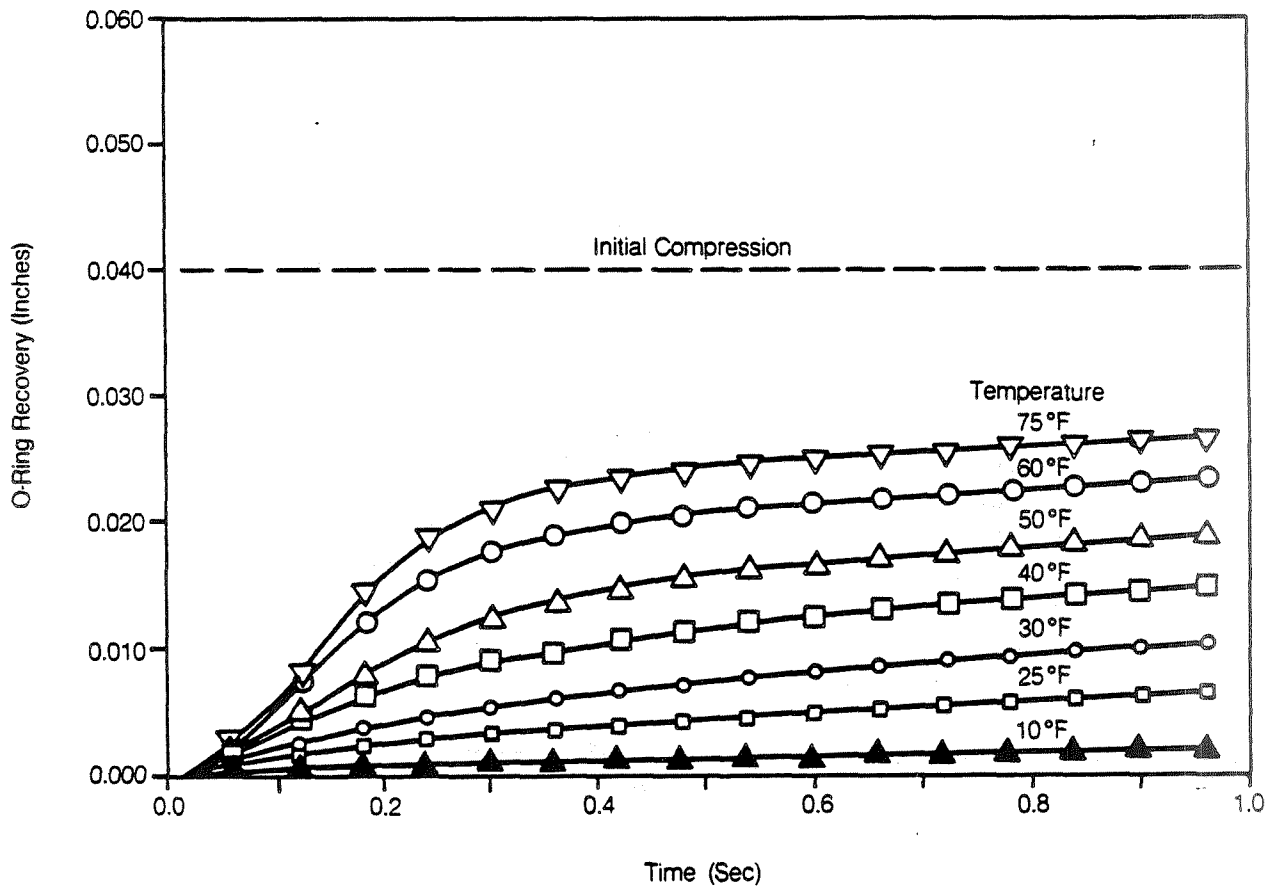

Figure 23  
Graph plots O-ring shape recovery in inches against time in seconds for a variety of temperatures.

Note: Average O-Ring Recovery at Various Test Temperatures During First Second After Load Release. Initial Compression of 40 Mills Was Maintained for 2 Hours.

temperature of 75 degrees. Tests at 20 degrees Fahrenheit with similarly conditioned putty delayed the pressurization time by 1.9 seconds. Such delays would allow full joint gap opening before a seal could pressure actuate.

To evaluate this effect, a sub-scale test fixture was fabricated that effectively simulated gap opening at the time of putty rupture and pressure application. The tests simulate the O-ring pressure actuation delay due to the putty temporarily holding the motor pressure. They were conducted over a range of temperatures, putty rupture time and initial O-ring squeeze. Test results (Appendix L, Fig. 6.5.1) demonstrated that sealing performance is dependent on temperature and initial squeeze, both of which affect the pressure actuation capability of the O-rings. The tests indicate that sealing capability is marginal for maximum squeeze conditions,

i.e., a 0.004-inch gap, at 50 degrees Fahrenheit with a pressure delay of 500 milliseconds. For the temperature and O-ring squeeze conditions that existed for several of the STS 51-L field joints, O-ring sealing was not achieved in these tests with simulated putty rupture times delayed to 250 to 500 milliseconds.

Note that the sub-scale tests do not faithfully reproduce what happens in the real joint. These data do indicate, however, that the potential exists for O-rings not to seal as a result of variables related to the putty.

The seal is checked by pressurizing the volume between the primary and secondary O-rings. This action seats the secondary seal and drives the primary seal upstream into its groove. Because of concern that the putty could mask a leaking primary seal, the pressure was first increased from

50 psi to 100 psi and then to 200 psi. The consequence of increasing the pressure is shown below.

	Stabilization Pressure, psi	Number Of Flights	Percentage of Flights With O-ring Anomalies
Field Joint	50	7	14
	100	2	0
	200	15	56
Nozzle Joint	50	8	12
	100	8	56
	200	8	88

Clearly the increased pressure used in the leak check increased the likelihood of a gas path through the putty to the primary seal. That is, with increased pressure, blow holes in the putty are more likely with a resulting greater potential for erosion damage to the O-ring. On the positive side the blow holes tend to prevent the delay in pressurization discussed in the previous paragraphs. This further illustrates the influence of putty variables on the performance of the Solid Rocket Motor seals.

#### *The Dynamic Characteristics of the Field Joint Seal*

The discussion of static factors which affect joint performance is based on the assumption that motor segments remain perfectly round, and that stacked segments are always a perfectly straight column. At launch the boosters are subjected to forces which bend and twist them. These forces cause physical changes in the shape of the boosters, actually squashing them out-of-round and bending them along their entire length. The dynamic effects of this out-of-roundness are most significant just after booster ignition when the hold-down bolts have been released because in the previous 6.6 seconds the boosters have actually been bent forward by the thrust from the main engines. The elastic energy stored in the entire system is then released, inducing a bending vibration in the boosters. This bending causes the case to change its shape from circular to elliptical, the maximum out-of-roundness occurring on the 045-315 degree line on the outside of the right booster. This deflection is a consequence of a vibration and occurs at a frequency of about 3 cycles per second. The same occurs in the left booster, only the deflection axis is oriented differently, being a mirror image of that which takes

place in the right side. The dynamic effects cause an increase in the joint rotation, and, hence, increase the gap between the tang and clevis by about 10 percent. Another dynamic load results from the geometry of the struts which attach the booster to the external tank. Strut P12 is attached to the booster at about the 314 degree point and imposes additional inertial forces on the booster which tend to additionally increase the gap by 10 to 21 percent.

## Analysis of the Wreckage

The investigation of the sequence of events that led to the final breakup of the Challenger rests upon three primary sources of data: launch photographs, telemetry and tracking data, and the recovered pieces of the Shuttle wreckage. The third source of data is presented here, which is largely descriptive. It provides support for the conclusions reached through use of the data from the other two sources. A more detailed analysis that provides technical details to be used for subsequent redesign or accident analysis is available in the appendix.

Figure 24 shows an overview of the search areas with the general location of parts of both the left and the right Solid Rocket Boosters indicated. The area is at the edge of the Gulf Stream in water depth that ranged from 100 to 1,200 feet. Pertinent pieces were examined by use of a remotely controlled submarine containing a flood light and a television camera. The television picture was available on ship board and was transmitted to Kennedy and to Marshall. The arrangement allowed a number of people who were familiar with the Solid Rocket Booster to comment upon the merit of recovering a particular piece.

The aft left side of the Orbiter contained its original paint markings and showed no apparent sign of heat damage (photo A. All photo references are to color section, pp. 74-81). Thermal distress, however, was apparent on the right rudder speed brake panel and elevon (photo B). The paint was scorched and blackened on the right side panels of the aft part of the fuselage and vertical fin. The remaining recovered parts of the Orbiter did not seem to be affected by a hydrogen fire. The bottom side of the right wing showed some indentation on the tiles that make up the Thermal Protection System. This indentation was

## Expanded Search Area

Figure 24

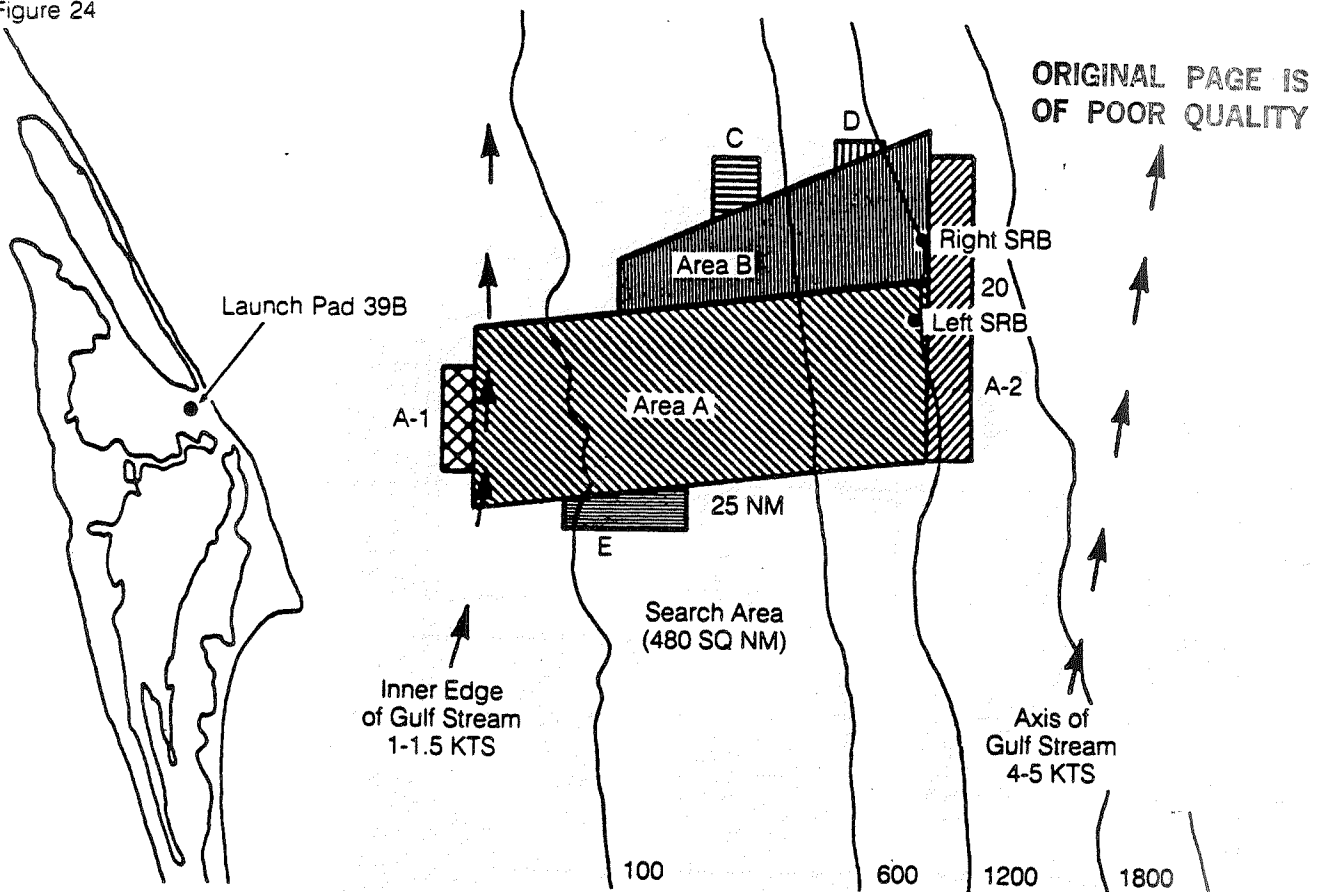

Map shows ocean areas searched for Shuttle wreckage in relation to Cape Canaveral and Launch Pad 39B. Wavy vertical lines indicate water depths.

consistent with impact with the right booster as it rotated following loss of restraint of one or more of its lower struts.

The frustum of the nose cone of the right Solid Rocket Booster was damaged (photo E) as if it had struck the External Tank, but there were no signs of thermal distress. The frustum of the nose cone of the left Solid Rocket Booster (photo F) was essentially undamaged.

A substantial part of the External Tank was recovered. Analysis of this recovered structure showed some interesting features. Interpretation of the photographs suggests that the flame from the right hand Solid Rocket Booster encircled the External Tank. A short time later the dome at the base of the External Tank was thought to break free. Since the internal pressure of the liquid hydrogen tank is at approximately 33 pounds per square inch, a sudden venting at the aft section will produce a large initial thrust that tails off as the pressure drops. The intertank region of the wreckage contained buckling in the fore and aft direction consistent with this impulsive

thrust. Similarly, the right side of the intertank showed signs of crushing. This crushing is consistent with the rotational impact of the frustum of the right Solid Rocket Booster with the External Tank following complete loss of restraint at the aft lower strut attachment area.

The telemetered signals from the rate gyros in the right Solid Rocket Booster clearly show a change in angular velocity of the booster with respect to the Orbiter. It is believed that this velocity change was initiated by a failure at or near the P12 strut connecting the booster to the External Tank. Photographs of the flight could not define the failure point and none of the connecting struts to the right Solid Rocket Booster or the corresponding area on the External Tank in this region were recovered. Therefore the exact location of initial separation could not be determined by the evidence. At the time of relative booster movement, the hole in the shell of the right Solid Rocket Booster was calculated to be six to eight inches in diameter located 12 to 15 inches forward and adjacent to the P12



RH SRB Recovered Debris  
Aft Segment

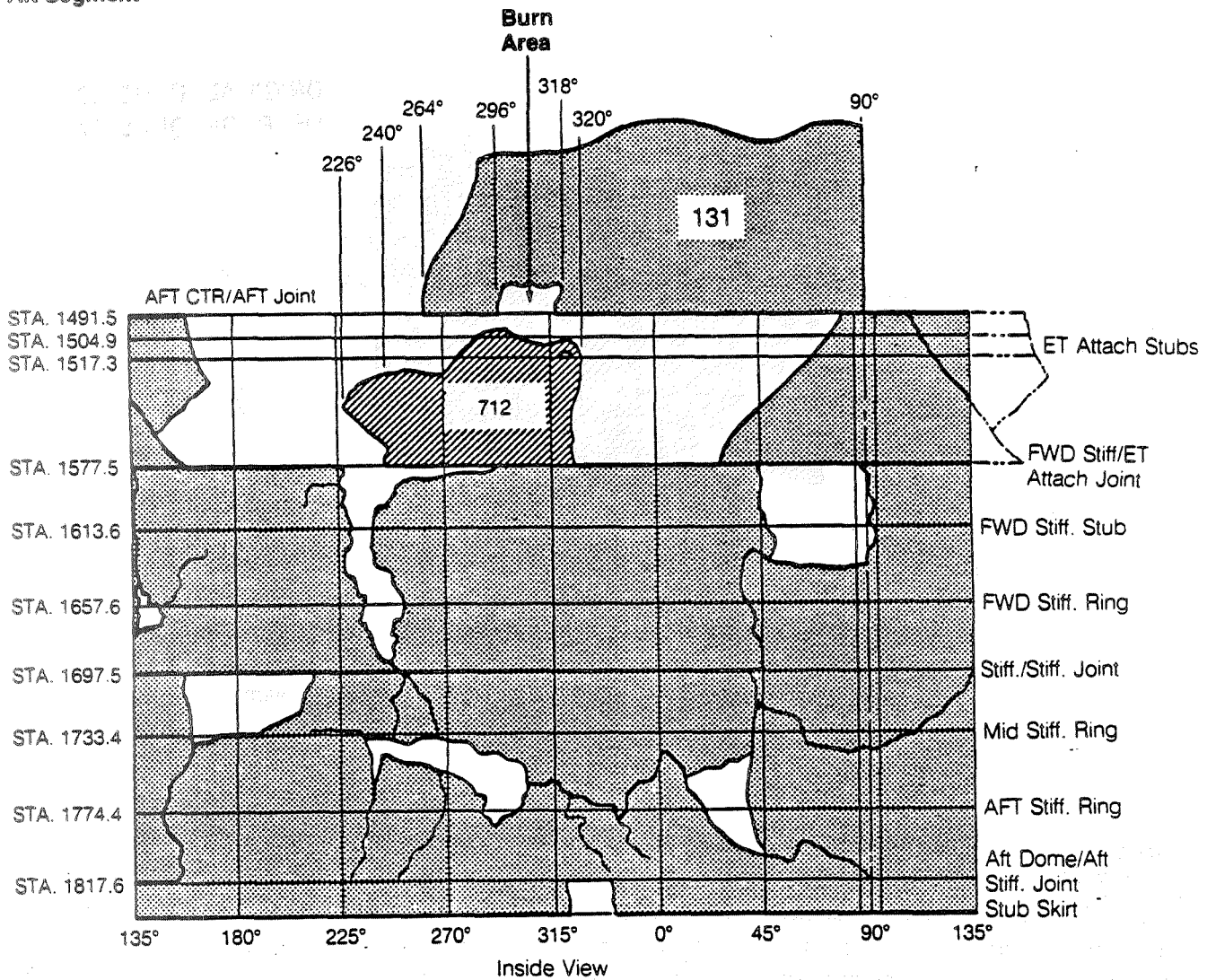

Figure 25  
Drawing depicts pieces of right Solid Rocket Booster aft segment recovered. At top is piece of aft center segment.

strut. This location was within the center of the burned out zone on the right Solid Rocket Booster (photo G). As a matter of interest, the P12 strut is located close to the point on the circumference where the booster case experiences maximum radial deflection due to flight loads. It seems likely that the plume from the hole in the booster would impact near the location of the P12 strut connection and the External Tank. Using geometric considerations alone suggests this strut separated from the External Tank before it separated from the right hand Solid Rocket Booster.

Figure 25 shows a sketch of an interior unrolled view of the aft part of the right hand Solid Rocket Booster with the recovered burned pieces 131 and 712 noted. The critical region is between

parts 131, the upper segment tang region, and part 712, the lower clevis region of the joint. This burned area extends roughly from station 1476, in the upper section, to 1517 on the lower region. In a circumferential direction (see figure 26) the lower end of the eroded region extends from roughly 291 degrees to 320 degrees and the upper eroded section extends between 296 and 318 degrees. Note that the region at about 314 degrees includes the attachment region of the strut to the attachment ring on the right Solid Rocket Booster.

Some observations were made from a detailed examination of the aft center section of the joint, contact 131. This piece (photo I) shows a large hole that is approximately centered on the

**Angular Coordinate System  
For Solid Rocket Boosters/Motors**  
Figure 26

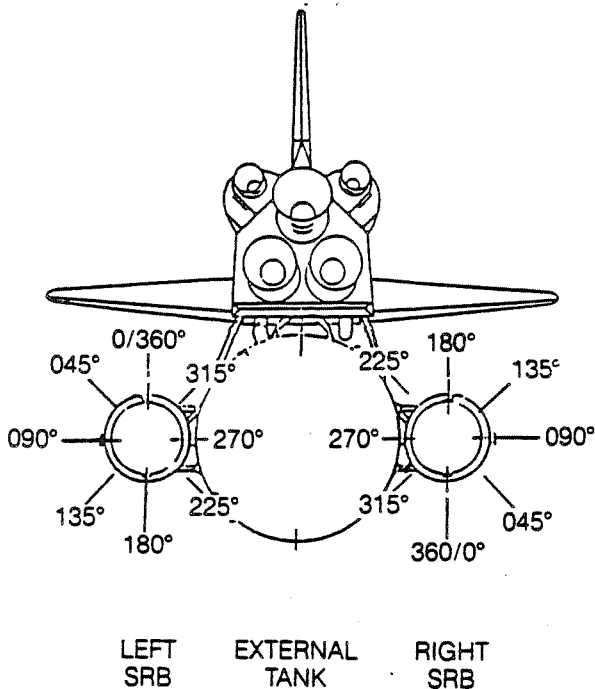

- (1) View Is Forward (Direction of Flight)  
or "Up" When Vehicle Is On Launch Pad  
(2) Angles Increase *Counterclockwise*

307-degree circumferential position. Although irregular, the hole is roughly rectangular in shape, extending approximately 27 inches circumferentially along the tang (296 to 318 degrees) with total burnout extension approximately 15 inches forward of the tang. At either side in the interior of the hole (photo K) the insulation and steel case material showed evidence of hot gas erosion that beveled these surfaces (indicative of combustion products flowing through the hole from the interior of the Solid Rocket Motor). The top surface of the hole was hardly beveled at all. The

tang O-ring sealing surface next to either side of the hole showed distinct erosion grooves starting from the O-ring locations (photo J). These erosion grooves indicate the O-rings were sealing the joint away from the central area during the later stages of the trajectory. No other evidence of thermal distress, melting or burning was noted in the tang section of the joint.

The part of the aft section of the right Solid Rocket Booster in the circumferential position of the hole was recovered (photos L and N). This piece, contact 712, showed evidence of a burned hole edge extending from 291 degrees to 318 degrees, approximately 33 inches long (see bracket, photo L). The burned surface extended into the aft attach stub region of the case adjacent to the P 12 strut attach point. The box structure of the aft attachment ring was missing from the attach stubs. The piece displayed fractures which led circumferentially or aft from the hole and the burned surface. Booster pieces on either side have not been recovered. Thus in the burn area no portion of the clevis or attachment ring other than the stubs was available for examination.

The exterior surface of the aft case piece also contained a large heat affected area (photo M). The shape and location of this area indicates a plume impingement from the escaping gases. The light colored material at the downstream edge of the area is probably asbestos from the insulator. The rust colored line more or less parallel to the stubs may be a stagnation line produced in the gas flow when the gases passed around the attachment ring. Secondary flow of metal from the aft attach stub ring also shows this feature. There was a small burn hole in the case wall (arrow, photo O) which appeared to have penetrated the case from the exterior toward the interior. This may also have been due to a swirling flow of hot gases within the attachment ring box structure. The shadow of the insulation downstream of the attach box can also be seen. This evidence suggests strongly that a hot gas plume impinged against the attachment ring, passed around and through it, and ultimately destroyed its structural integrity, probably late in the flight of the Solid Rocket Booster.

The photographs L, M, N, and O view the lower case piece in the inverted position. A correct orientation of this piece is shown in a composite view of the burn area located in photo P.

## Findings

1. A combustion gas leak through the right Solid Rocket Motor aft field joint initiated at or shortly after ignition eventually weakened and/or penetrated the External Tank initiating vehicle structural breakup and loss of the Space Shuttle Challenger during STS Mission 51-L.
2. The evidence shows that no other STS 51-L Shuttle element or the payload contributed to the causes of the right Solid Rocket Motor aft field joint combustion gas leak. Sabotage was not a factor.
3. Evidence examined in the review of Space Shuttle material, manufacturing, assembly, quality control, and processing of non-conformance reports found no flight hardware shipped to the launch site that fell outside the limits of Shuttle design specifications.
4. Launch site activities, including assembly and preparation, from receipt of the flight hardware to launch were generally in accord with established procedures and were not considered a factor in the accident.
5. Launch site records show that the right Solid Rocket Motor segments were assembled using approved procedures. However, significant out-of-round conditions existed between the two segments joined at the right Solid Rocket Motor aft field joint (the joint that failed).
  - a. While the assembly conditions had the potential of generating debris or damage that could cause O-ring seal failure, these were not considered factors in this accident.
  - b. The diameters of the two Solid Rocket Motor segments had grown as a result of prior use.
  - c. The growth resulted in a condition at time of launch wherein the maximum gap between the tang and clevis in the region of the joint's O-rings was no more than .008 inches and the average gap would have been .004 inches.
  - d. With a tang-to-clevis gap of .004 inches, the O-ring in the joint would be compressed to the extent that it pressed against all three walls of the O-ring retaining channel.
  - e. The lack of roundness of the segments
6. The ambient temperature at time of launch was 36 degrees Fahrenheit, or 15 degrees lower than the next coldest previous launch.
  - a. The temperature at the 300 degree position on the right aft field joint circumference was estimated to be 28 degrees  $\pm$  5 degrees Fahrenheit. This was the coldest point on the joint.
  - b. Temperature on the opposite side of the right Solid Rocket Booster facing the sun was estimated to be about 50 degrees Fahrenheit.
7. Other joints on the left and right Solid Rocket Boosters experienced similar combinations of tang-to-clevis gap clearance and temperature. It is not known whether these joints experienced distress during the flight of 51-L.
8. Experimental evidence indicates that due to several effects associated with the Solid Rocket Booster's ignition and combustion pressures and associated vehicle motions, the gap between the tang and the clevis will open as much as .017 and .029 inches at the secondary and primary O-rings, respectively.
  - a. This opening begins upon ignition, reaches its maximum rate of opening at about 200-300 milliseconds, and is essentially complete at 600 milliseconds when the Solid Rocket Booster reaches its operating pressure.
  - b. The External Tank and right Solid Rocket Booster are connected by several struts, including one at 310 degrees near the aft field joint that failed. This strut's effect on the joint dynamics is to enhance the opening of the gap between the tang and clevis by about 10-20 percent in the region of 300-320 degrees.
9. O-ring resiliency is directly related to its temperature.
  - a. A warm O-ring that has been com-

- pressed will return to its original shape much quicker than will a cold O-ring when compression is relieved. Thus, a warm O-ring will follow the opening of the tang-to-clevis gap. A cold O-ring may not.
- b. A compressed O-ring at 75 degrees Fahrenheit is five times more responsive in returning to its uncompressed shape than a cold O-ring at 30 degrees Fahrenheit.
  - c. As a result it is probable that the O-rings in the right solid booster aft field joint were not following the opening of the gap between the tang and clevis at time of ignition.
10. Experiments indicate that the primary mechanism that actuates O-ring sealing is the application of gas pressure to the upstream (high-pressure) side of the O-ring as it sits in its groove or channel.
    - a. For this pressure actuation to work most effectively, a space between the O-ring and its upstream channel wall should exist during pressurization.
    - b. A tang-to-clevis gap of .004 inches, as probably existed in the failed joint, would have initially compressed the O-ring to the degree that no clearance existed between the O-ring and its upstream channel wall and the other two surfaces of the channel.
    - c. At the cold launch temperature experienced, the O-ring would be very slow in returning to its normal rounded shape. It would not follow the opening of the tang-to-clevis gap. It would remain in its compressed position in the O-ring channel and not provide a space between itself and the upstream channel wall. Thus, it is probable the O-ring would not be pressure actuated to seal the gap in time to preclude joint failure due to blow-by and erosion from hot combustion gases.
  11. The sealing characteristics of the Solid Rocket Booster O-rings are enhanced by timely application of motor pressure.
    - a. Ideally, motor pressure should be applied to actuate the O-ring and seal the joint prior to significant opening of the tang-to-clevis gap (100 to 200 milliseconds after motor ignition).
    - b. Experimental evidence indicates that temperature, humidity and other variables in the putty compound used to seal the joint can delay pressure application to the joint by 500 milliseconds or more.
    - c. This delay in pressure could be a factor in initial joint failure.
  12. Of 21 launches with ambient temperatures of 61 degrees Fahrenheit or greater, only four showed signs of O-ring thermal distress: i.e., erosion or blow-by and soot. Each of the launches below 61 degrees Fahrenheit resulted in one or more O-rings showing signs of thermal distress.
    - a. Of these improper joint sealing actions, one-half occurred in the aft field joints, 20 percent in the center field joints, and 30 percent in the upper field joints. The division between left and right Solid Rocket Boosters was roughly equal.
    - b. Each instance of thermal O-ring distress was accompanied by a leak path in the insulating putty. The leak path connects the rocket's combustion chamber with the O-ring region of the tang and clevis. Joints that actuated without incident may also have had these leak paths.
  13. There is a possibility that there was water in the clevis of the STS 51-L joints since water was found in the STS-9 joints during a destack operation after exposure to less rainfall than STS 51-L. At time of launch, it was cold enough that water present in the joint would freeze. Tests show that ice in the joint can inhibit proper secondary seal performance.
  14. A series of puffs of smoke were observed emanating from the 51-L aft field joint area of the right Solid Rocket Booster between 0.678 and 2.500 seconds after ignition of the Shuttle Solid Rocket Motors.
    - a. The puffs appeared at a frequency of about three puffs per second. This roughly matches the natural structural frequency of the solids at lift off and is reflected in slight cyclic changes of the tang-to-clevis gap opening.

- b. The puffs were seen to be moving upward along the surface of the booster above the aft field joint.
  - c. The smoke was estimated to originate at a circumferential position of between 270 degrees and 315 degrees on the booster aft field joint, emerging from the top of the joint.
15. This smoke from the aft field joint at Shuttle lift off was the first sign of the failure of the Solid Rocket Booster O-ring seals on STS 51-L.
16. The leak was again clearly evident as a flame at approximately 58 seconds into the flight. It is possible that the leak was continuous but unobservable or non-existent in portions of the intervening period. It is possible in either case that thrust vectoring and normal vehicle response to wind shear as well as planned maneuvers reinitiated or magnified the leakage from a degraded seal in the period preceding the observed flames. The estimated position of the flame, centered at a point 307 degrees around the circumference of the aft field joint, was confirmed by the recovery of two fragments of the right Solid Rocket Booster.
- a. A small leak could have been present that may have grown to breach the joint in flame at a time on the order of 58 to 60 seconds after lift off.
  - b. Alternatively, the O-ring gap could have been resealed by deposition of a fragile buildup of aluminum oxide and other combustion debris. This resealed section of the joint could have been disturbed by thrust vectoring, Space Shuttle motion and flight loads induced by changing winds aloft.
  - c. The winds aloft caused control actions in the time interval of 32 seconds to 62 seconds into the flight that were typical of the largest values experienced on previous missions.

## Conclusion

---

*In view of the findings, the Commission concluded that the cause of the Challenger accident was the failure of the pressure seal in the aft field joint of the right Solid Rocket Motor. The failure was due to a faulty design unacceptably sensitive to a number of factors. These factors were the effects of temperature, physical dimensions, the character of materials, the effects of reusability, processing, and the reaction of the joint to dynamic loading. ■*

## References

---

<sup>1</sup> 51-L Structural Reconstruction and Evaluation Report, National Transportation Safety Board, page 55. This document is subsequently referred to as reference A.

<sup>2</sup> 51-L Data and Design Analysis Task Force (DDATF) External Tank Working Group Final Report, NASA, page 65. This document is subsequently referred to as reference B.

<sup>3</sup> Reference B, page 20, 21

<sup>4</sup> Reference B, page 66

<sup>5</sup> Reference B, page 66

<sup>6</sup> Reference B, page 65

<sup>7</sup> DDATF Accident Analysis Team Report, NASA, page 23. This document is subsequently referred to as reference C.

<sup>8</sup> Reference A, page 60

<sup>9</sup> DDATF Space Shuttle Main Engine (SSME) Working Group Final Report, NASA, page 77. This document is subsequently referred to as reference D.

<sup>10</sup> Reference D, page 77, 81

<sup>11</sup> Reference D, page 77, 81

<sup>12</sup> Reference D, page 81

<sup>13</sup> Reference D, page 81

<sup>14</sup> Reference D, page 19

<sup>15</sup> Reference D, page 30

<sup>16</sup> Reference D, page 38

<sup>17</sup> Reference D, page 91

<sup>18</sup> Reference D, page 77, 91

<sup>19</sup> Reference A, page 16

<sup>20</sup> Reference A, page 38

<sup>21</sup> DDAFT Orbiter and Government Furnished Equipment (GFE) Working Group Final Report, NASA, page 6. This document is subsequently referred to as reference E.

<sup>22</sup> Reference E, page 7, 8

<sup>23</sup> Reference E, page 13

<sup>24</sup> Reference E, page 13

<sup>25</sup> Reference E, page 14

<sup>26</sup> Reference E, page 50

<sup>27</sup> DDATF IUS/TDRS Systems Working Group Report, NASA, page 52. This document is subsequently referred to as reference F.

<sup>28</sup> Reference F, page 53

<sup>29</sup> Reference A, page 68

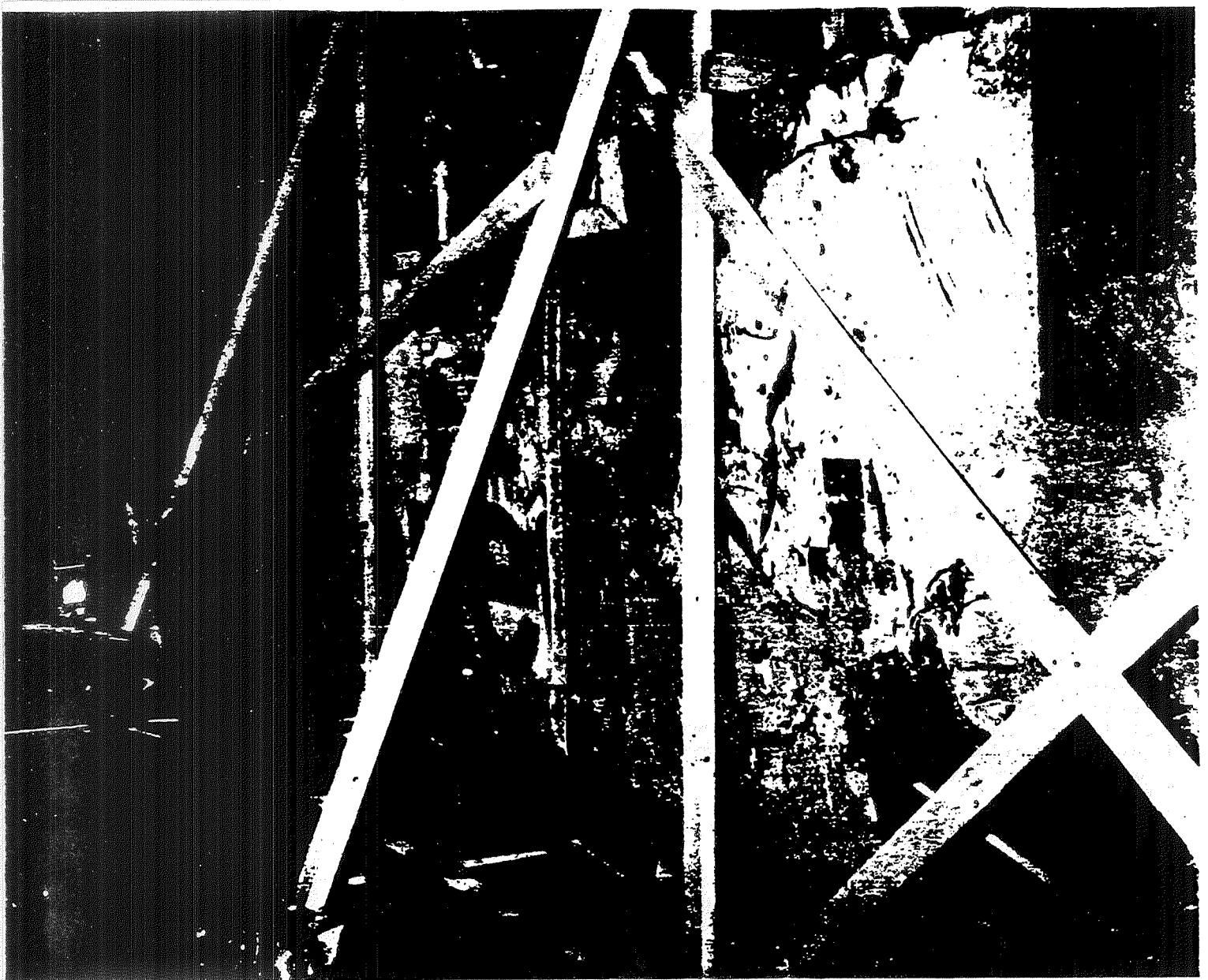

A The upper photos show, from left to right, the left side of the Orbiter (unburned), the right lower and upper rudder speed brake (both burn damaged) and left upper speed brake (unburned), confirmation that the fire was on the

right side of the Shuttle stack. The lower photos show the range safety destruct charges in the External Tank. These charges were exonerated when they were recovered intact and undetonated.

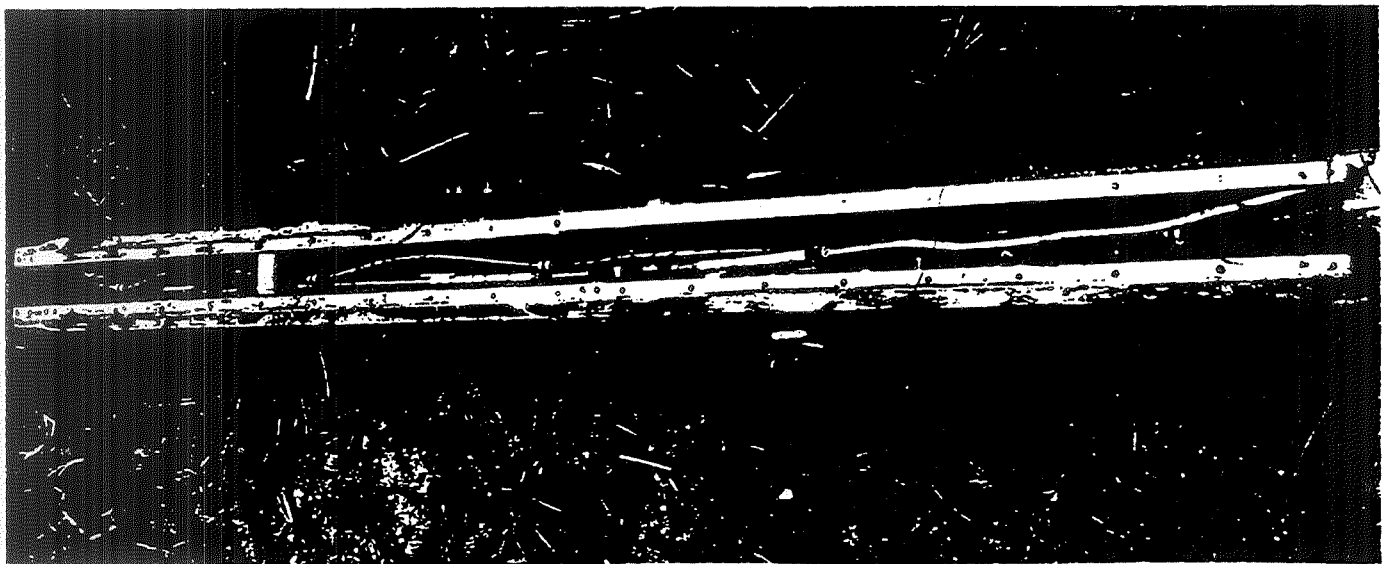

C



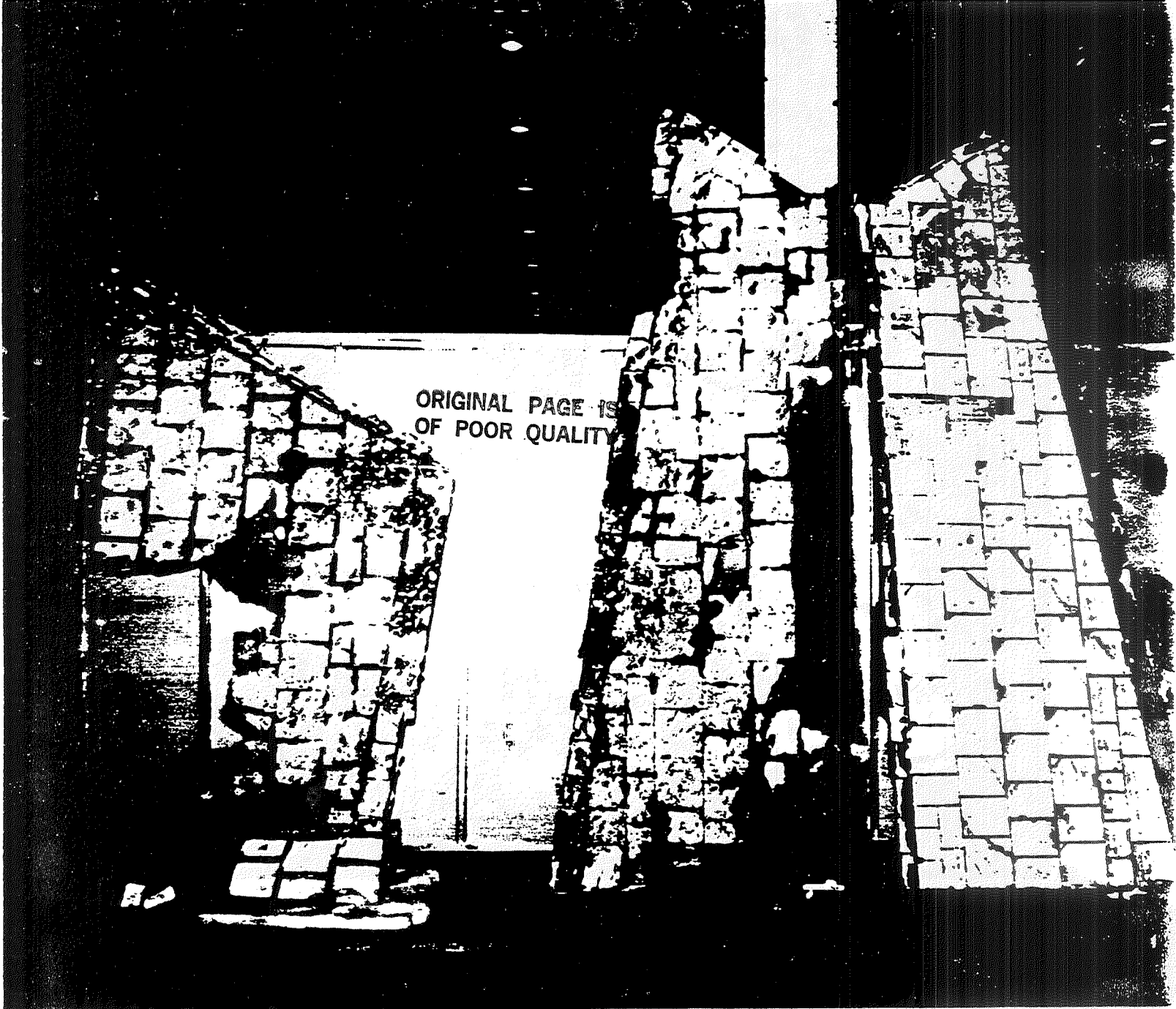

ORIGINAL PAGE IS  
OF POOR QUALITY

B



DEGC  
ALLAS 29.12.9 8023

D

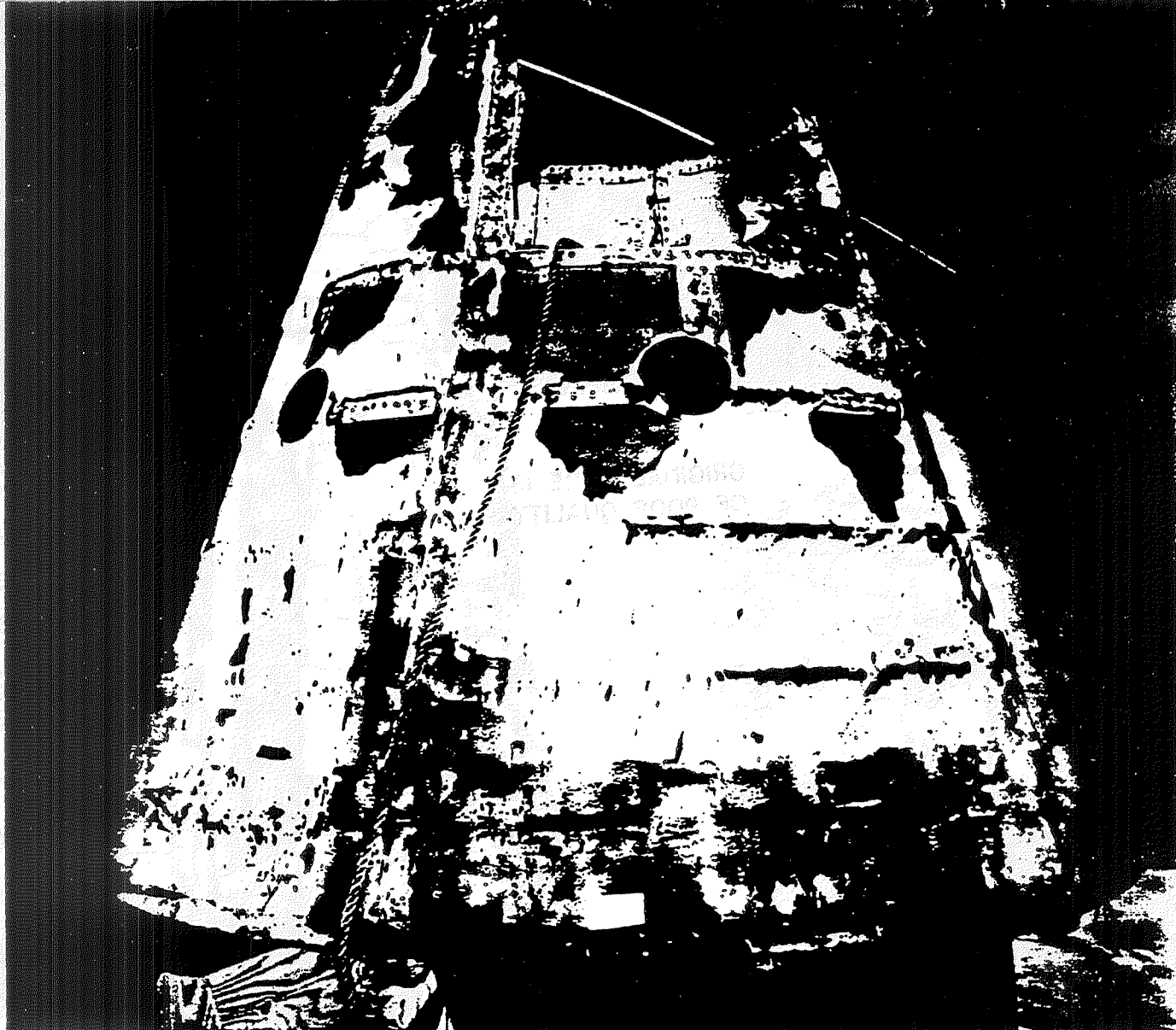

E

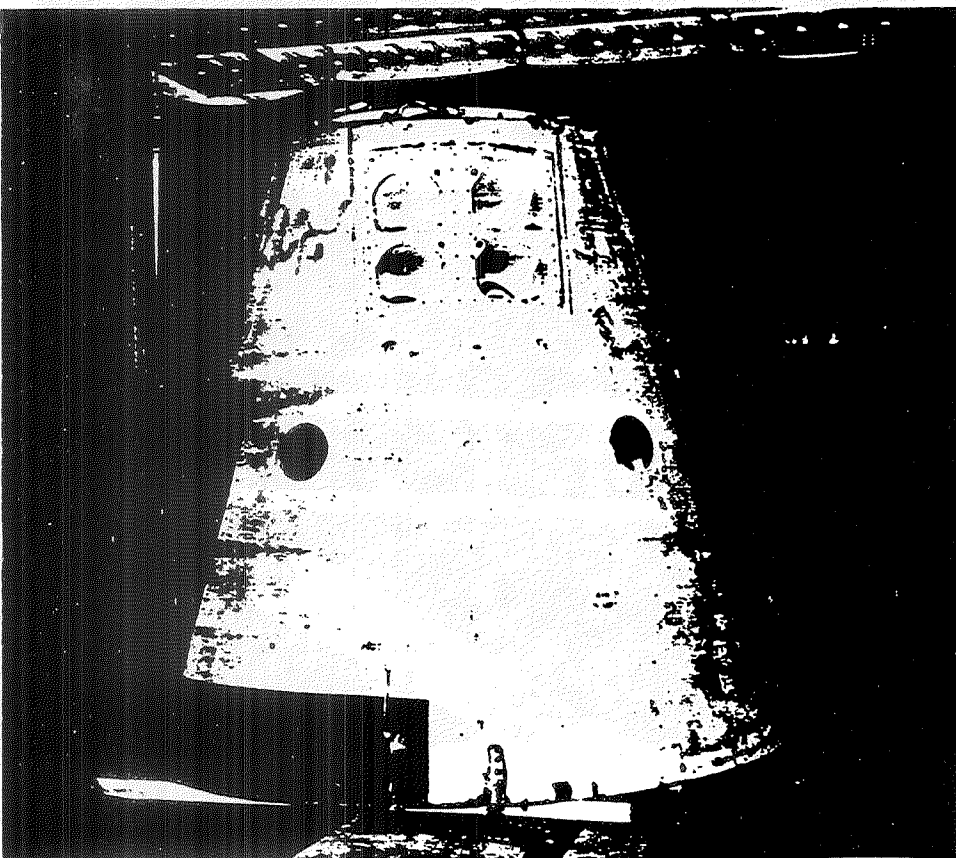

F

The frustums on the left page are parts of the Solid Rocket Booster forward assemblies that contain recovery parachutes, location aids and flotation devices. The frustum of the left hand booster (lower left) is virtually undamaged. The right frustum shows impact damage at top and burns along the base of the cone; evidence indicates it was damaged when it impacted with the External Tank. Shown at right above is another Solid Rocket Motor stack crosshatched to show the burned area of the right booster's aft joint (diagram at right). The flame from the hole impinged on the External Tank and caused a failure at the aft connection at the External Tank.



H G

**AFT SEGMENT/AFT CENTER SEGMENT FIELD JOINT CONFIGURATION**

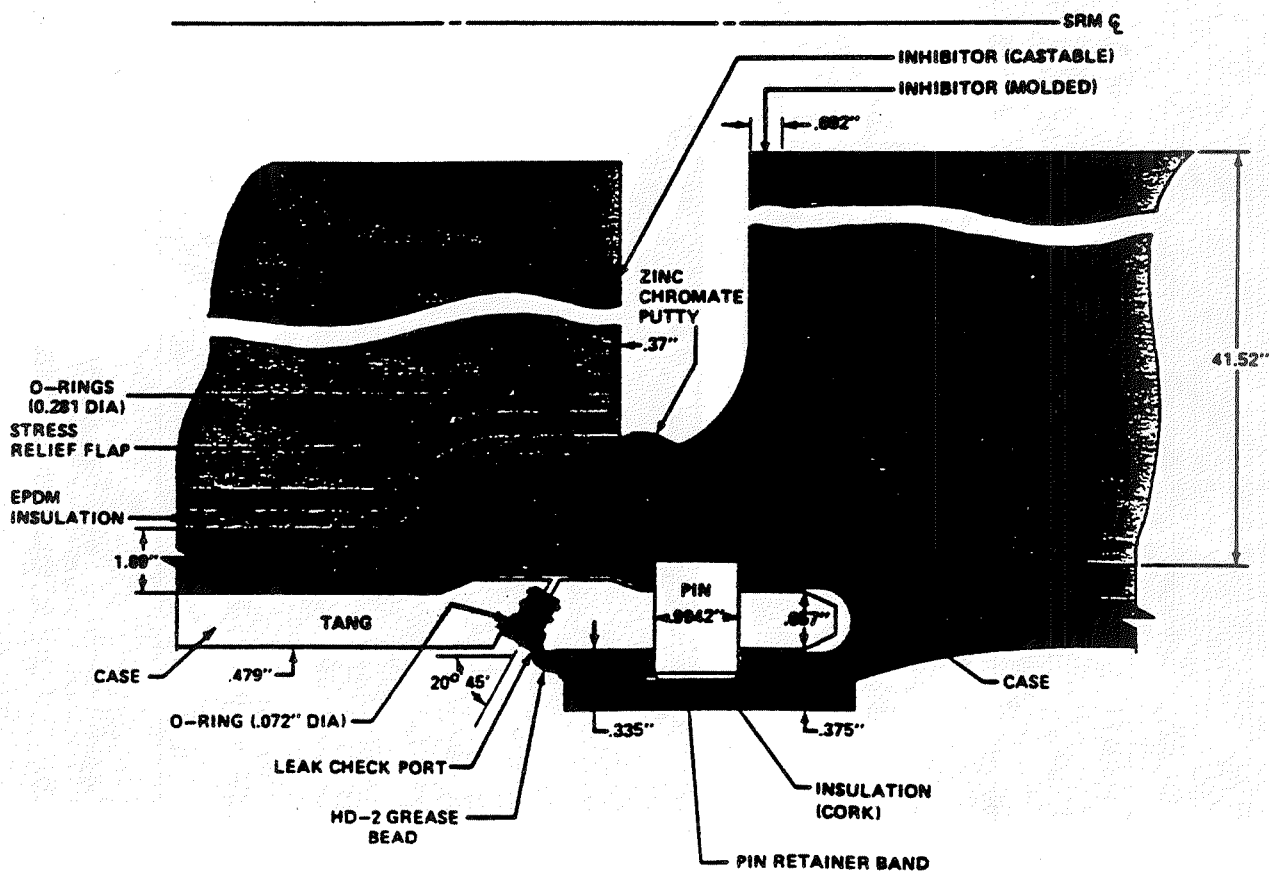

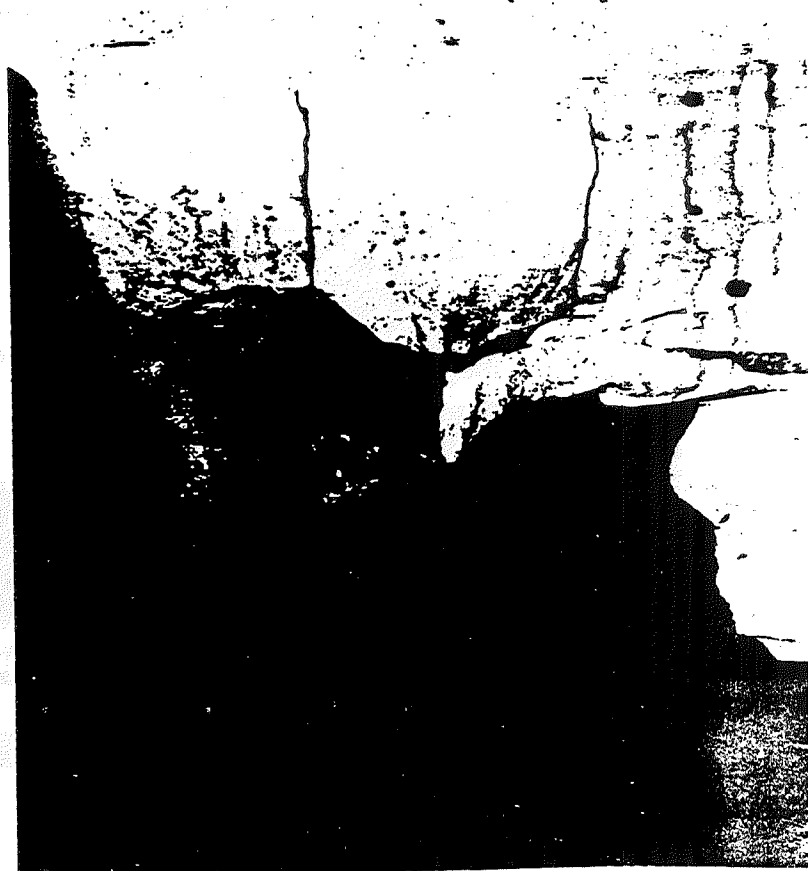
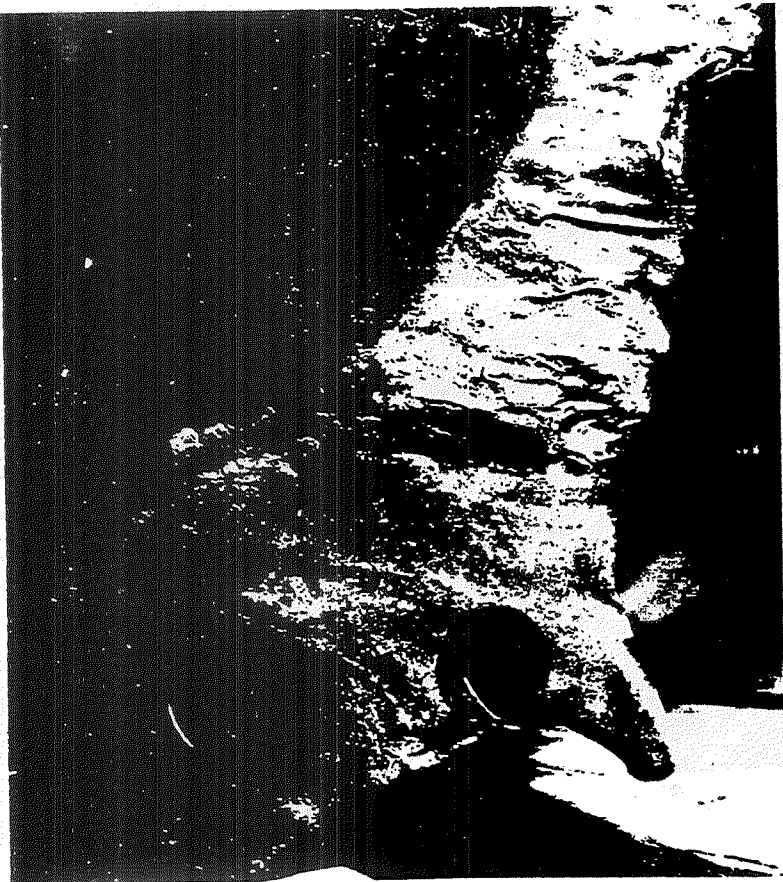
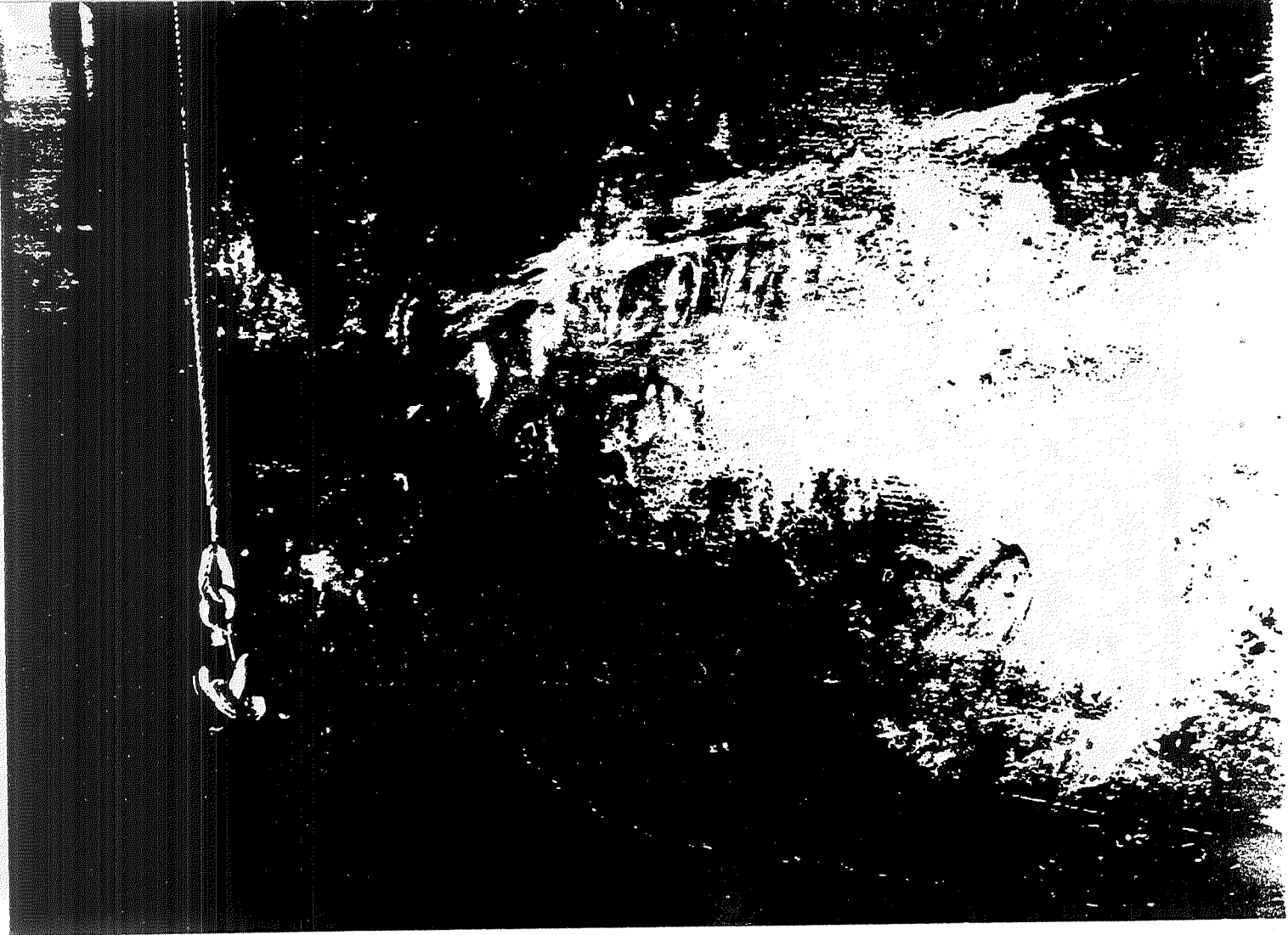

J K



L

Examined at Kennedy Space Center after their recovery from the ocean, these fragments show the extent of burn through the right hand booster's aft field joint. On the left page are sections of the aft center motor segment above the joint. On the right page are sections (inverted) of the aft motor segment showing burn-hole below the joint (bracket). Except for the interior views on lower left, the camera is viewing the parts from outside the casing.

ORIGINAL PAGE IS  
OF POOR QUALITY

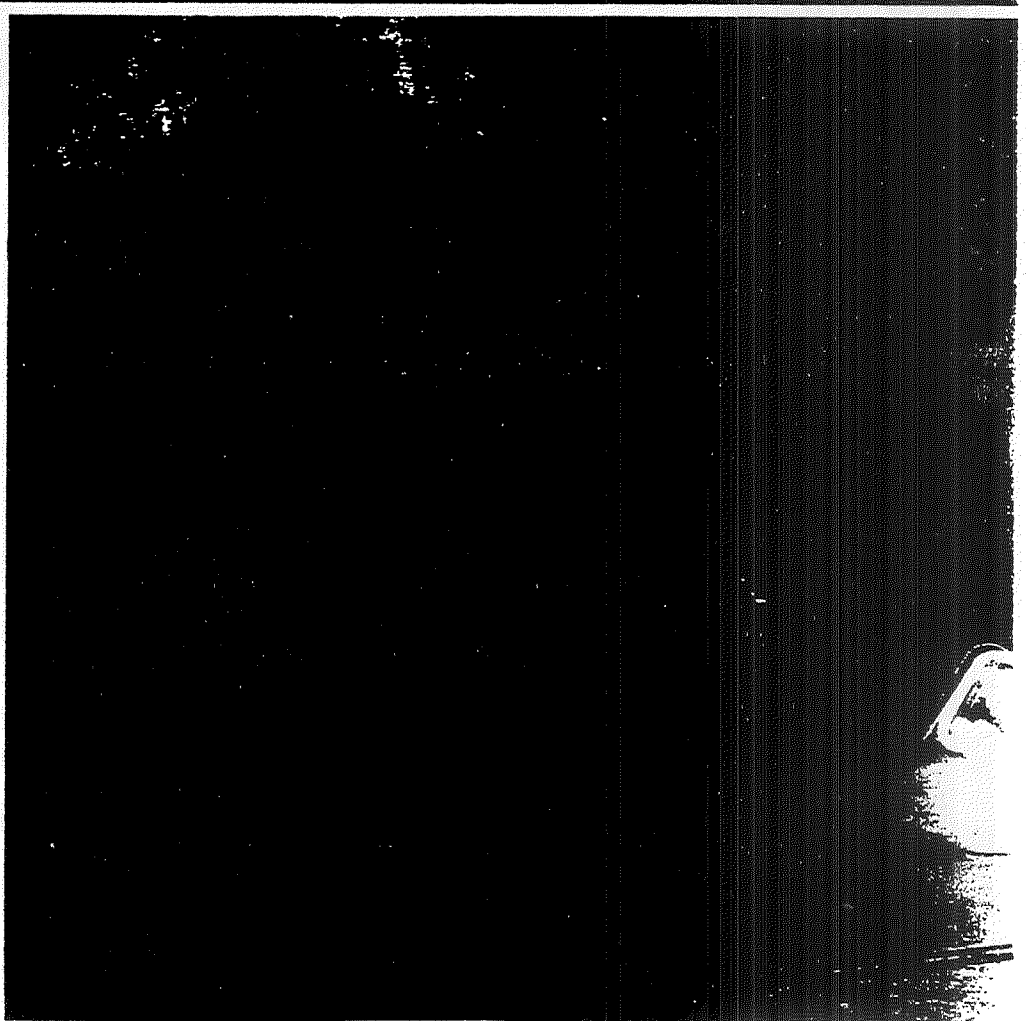

M



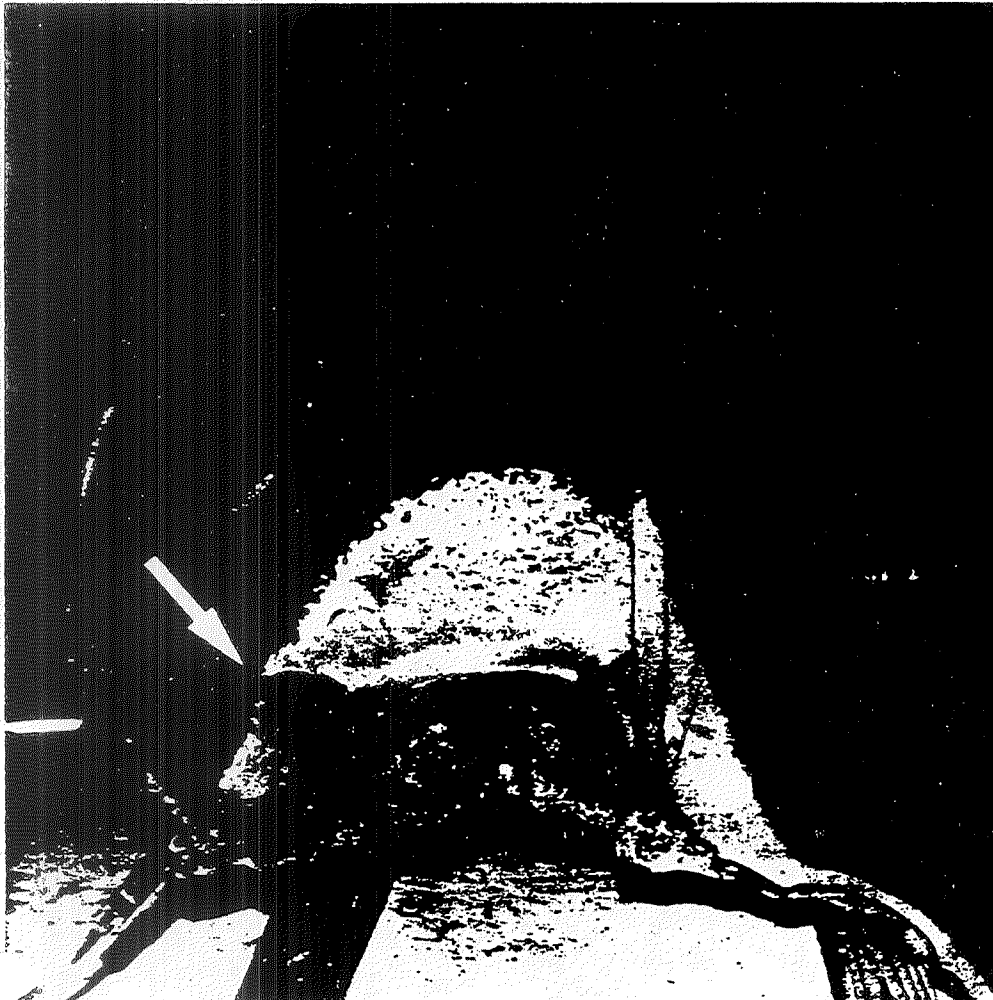
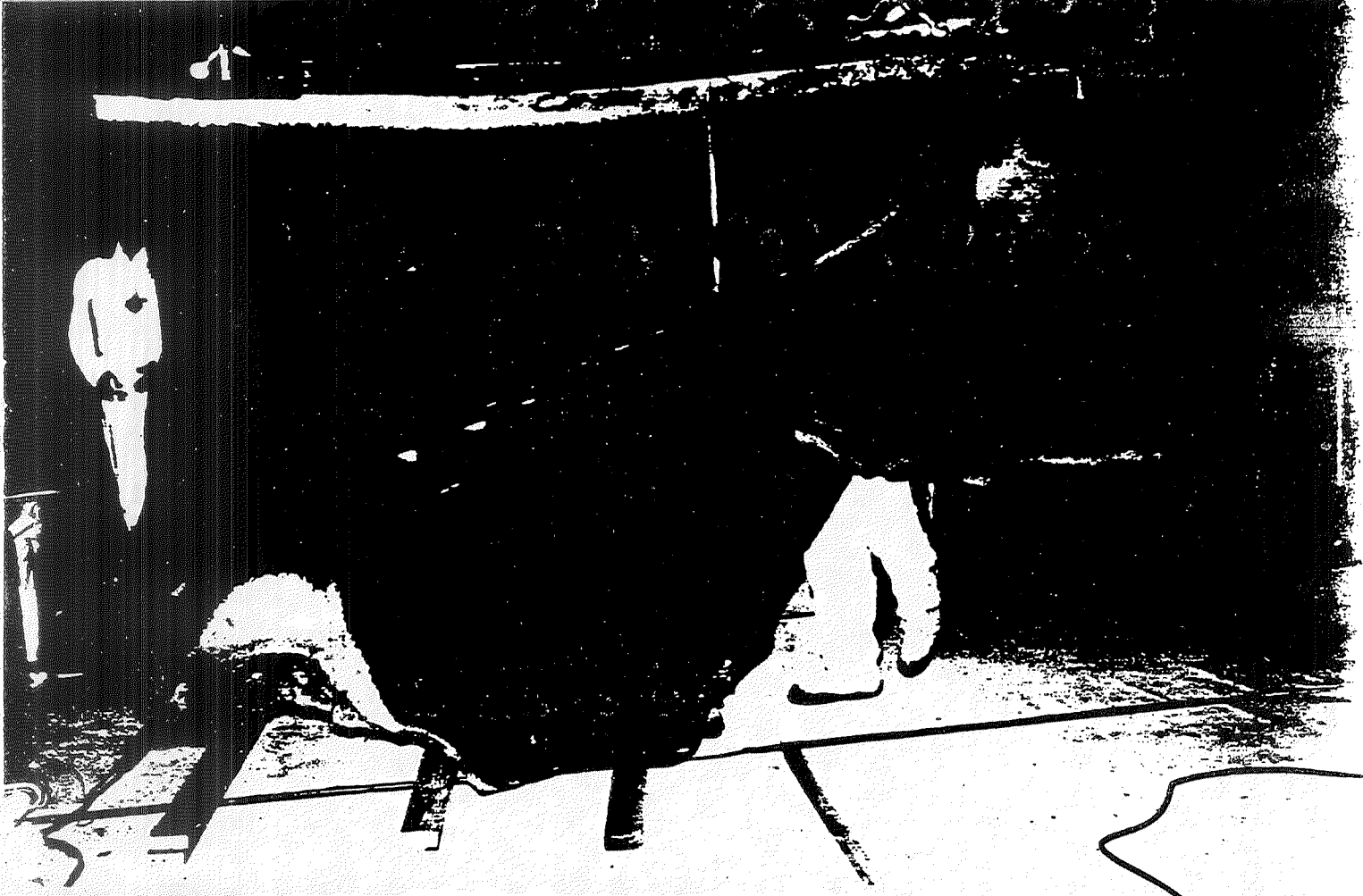

At upper left is the aft segment burn viewed from inside the casing; the lower photo is a closeup of the same section. The latter photo shows a hole (arrow) where the flame plume may have burned through the casing from the outside. At right is a composite view of the burn above and below the aft field joint.

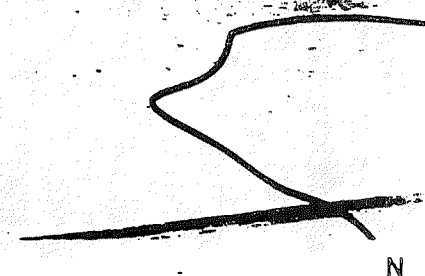

ORIGINAL PAGE IS  
OF POOR QUALITY

# 131

↑  
318°

↑  
307°

↑  
291°

51-L SRB R.H.  
# 712  
240°-300°-320°  
ATTACH SEGMENT  
1450716-02  
SN CCCCC06R2  
4-29-86



# The Contributing Cause Of The Accident

**T**he decision to launch the Challenger was flawed. Those who made that decision were unaware of the recent history of problems concerning the O-rings and the joint and were unaware of the initial written recommendation of the contractor advising against the launch at temperatures below 53 degrees Fahrenheit and the continuing opposition of the engineers at Thiokol after the management reversed its position. They did not have a clear understanding of Rockwell's concern that it was not safe to launch because of ice on the pad. If the decisionmakers had known all of the facts, it is highly unlikely that they would have decided to launch 51-L on January 28, 1986.

## Flaws In The Decision Making Process

In addition to analyzing all available evidence concerning the material causes of the accident on January 28, the Commission examined the chain of decisions that culminated in approval of the launch. It concluded that the decision making process was flawed in several ways. The actual events that produced the information upon which the approval of launch was based are recounted and appraised in the sections of this chapter. The discussion that follows relies heavily on excerpts from the testimony of those involved in the management judgments that led to the launch of the Challenger under conditions described.

That testimony reveals failures in communication that resulted in a decision to launch 51-L based on incomplete and sometimes misleading information, a conflict between engineering data

and management judgments, and a NASA management structure that permitted internal flight safety problems to bypass key Shuttle managers.

The Shuttle Flight Readiness Review is a carefully planned, step-by-step activity, established by NASA program directive SPO-PD 710.5A,<sup>1</sup> designed to certify the readiness of all components of the Space Shuttle assembly. The process is focused upon the Level I Flight Readiness Review, held approximately two weeks before a launch. The Level I review is a conference chaired by the NASA Associate Administrator for Space Flight and supported by the NASA Chief Engineer, the Program Manager, the center directors and project managers from Johnson, Marshall and Kennedy, along with senior contractor representatives.

The formal portion of the process is initiated by directive from the Associate Administrator for Space Flight. The directive outlines the schedule for the Level I Flight Readiness Review and for the steps that precede it. The process begins at Level IV with the contractors formally certifying—in writing—the flight readiness of the elements for which they are responsible. Certification is made to the appropriate Level III NASA project managers at Johnson and Marshall. Additionally, at Marshall the review is followed by a presentation directly to the Center Director. At Kennedy the Level III review, chaired by the Center Director, verifies readiness of the launch support elements.

The next step in the process is the Certification of Flight Readiness to the Level II Program Manager at Johnson. In this review each Space Shuttle program element endorses that it has satisfactorily completed the manufacture,

assembly, test and checkout of the pertinent element, including the contractors' certification that design and performance are up to standard. The Flight Readiness Review process culminates in the Level I review.

In the initial notice of the review, the Level I directive establishes a Mission Management Team for the particular mission. The team assumes responsibility for each Shuttle's readiness for a period commencing 48 hours before launch and continuing through post-landing crew egress and the safing of the Orbiter. On call throughout the entire period, the Mission Management Team supports the Associate Administrator for Space Flight and the Program Manager.

A structured Mission Management Team meeting—called L-1—is held 24 hours, or one day, prior to each scheduled launch. Its agenda includes closeout of any open work, a closeout of any Flight Readiness Review action items, a discussion of new or continuing anomalies, and an updated briefing on anticipated weather conditions at the launch site and at the abort landing sites in different parts of the world. It is standard practice of Level I and II officials to encourage the reporting of new problems or concerns that might develop in the interval between the Flight Readiness Review and the L-1 meeting, and between the L-1 and launch.

In a procedural sense, the process described

### Readiness Reviews

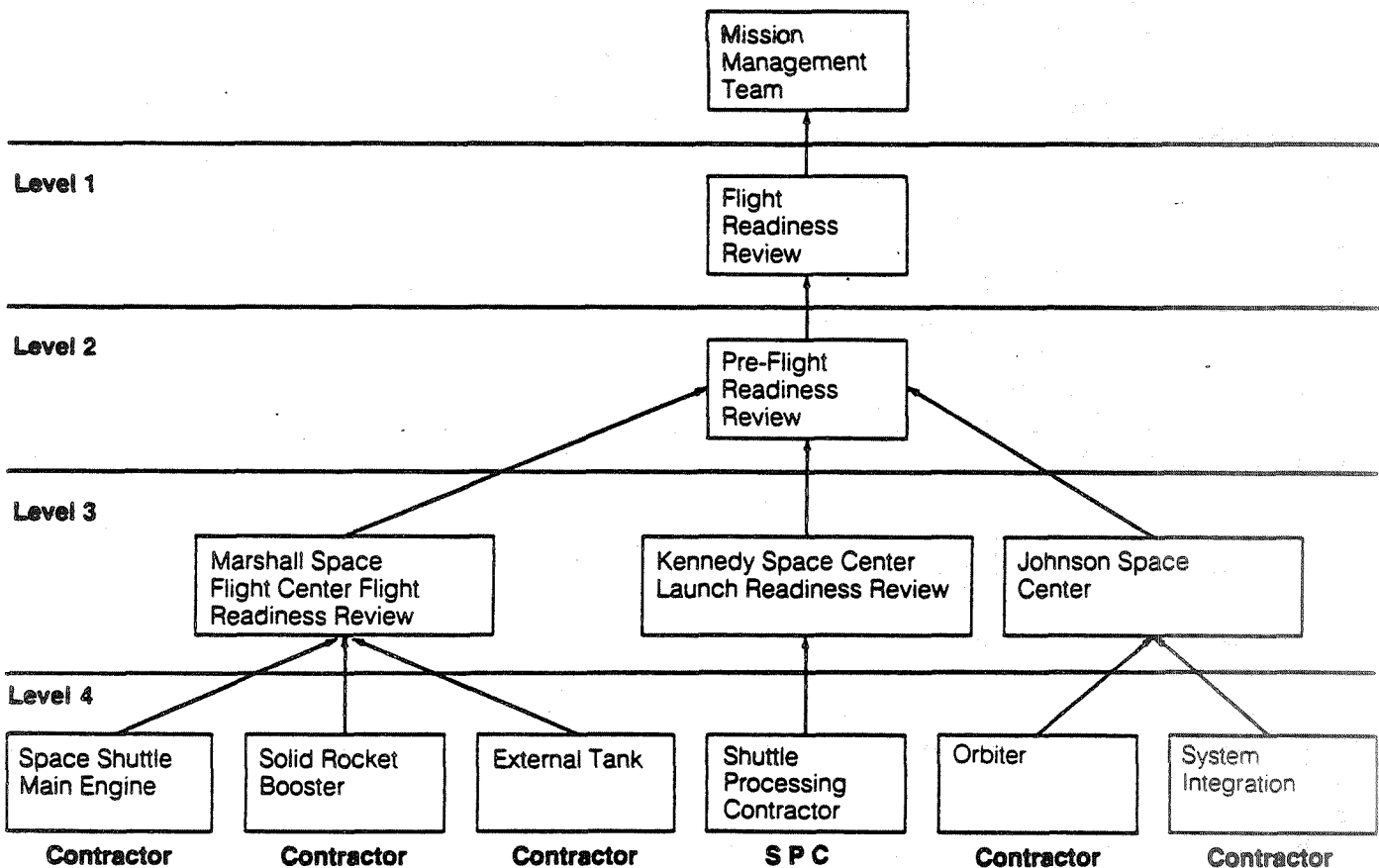

Readiness reviews for both the launch and the flight of a Shuttle mission are conducted at ascending levels that begin with contractors.

NOTE: See Chart on page 102 for description of management "levels" and organization chain of command.

was followed in the case of flight 51-L. However, in the launch preparation for 51-L relevant concerns of Level III NASA personnel and element contractors were not, in the following crucial areas, adequately communicated to the NASA Level I and II management responsible for the launch:

- The objections to launch voiced by Morton Thiokol engineers about the detrimental effect of cold temperatures on the performance of the Solid Rocket Motor joint seal.
- The degree of concern of Thiokol and Marshall about the erosion of the joint seals in prior Shuttle flights, notably 51-C (January, 1985) and 51-B (April, 1985).

On December 13, 1985, the Associate Administrator for Space flight, Jesse Moore, sent out a message distributed among NASA Headquarters, NASA field centers, and U.S. Air Force units, that scheduled the Flight Readiness Review for January 15, 1986, and prescribed the dates for the other steps in the standard procedure.

The message was followed by directives from James A. (Gene) Thomas, Deputy Director of Launch and Landing Operations at Kennedy on January 2, 1986; by the National Space Transportation System Program Manager, Arnold Aldrich, on January 3; by William R. Lucas, the Marshall Center Director, on January 7; and by the Marshall Shuttle Projects Office on January 8. Each of these implementing directives prescribed for Level III the preparatory steps for the Flight Readiness Review.

The Flight Readiness Review was held, as scheduled, on January 15. On the following day, Aldrich issued the schedule for the combined Level I/Mission Management Team meetings; he also announced plans for the Mission Management Team meetings continuing throughout the mission and included the schedule for the L-1 review.

On January 23, Moore issued a directive stating that the Flight Readiness Review had been conducted on the 15th and that 51-L was ready to fly pending closeout of open work, satisfactory countdown, and completion of remaining Flight Readiness Review action items, which were to be closed out during the L-1 meeting. No problems with the Solid Rocket Booster were identified.

Since December, 1982, the O-rings had been designated a "Criticality 1" feature of the Solid

TELEGRAPHIC MESSAGE

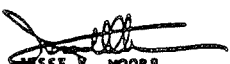
NASA HEADQUARTERS DEC 13 1 33 PM '85		UNCLASSIFIED
PER INFORMATION CALL		12-9-85
EDGAR L. MARLEROAD	433-2380	353
TO:		
DISTRIBUTION		
SUBJECT: STS 51-L FLIGHT READINESS REVIEW		
THE STS 51-L FLIGHT READINESS REVIEW (FRR) IS SCHEDULED FOR JANUARY 15, 1986 FROM 2:00-4:30 PM EST. THE LEVEL III NSTS OFFICE IS RESPONSIBLE FOR IMPLEMENTING THIS REVIEW. HEADQUARTERS 4-WIRE NUMBER 211 WILL BE USED FOR THIS TELECON. TELEVISION WILL BE USED AS BEFORE.		
THE INITIAL MEETING OF THE MISSION MANAGEMENT TEAM (MMT) WILL SERVE THE FUNCTION OF THE L-1 DAY REVIEW.		
 JESSE V. MOORE ASSOCIATE ADMINISTRATOR FOR SPACE FLIGHT		
		UNCLASSIFIED

The NASA Associate Administrator for Space Flight issued this notice of scheduling of the Flight Readiness Review for mission 51-L.

Rocket Booster design, a term denoting a failure point — without back-up — that could cause a loss of life or vehicle if the component fails. In July, 1985, after a nozzle joint on STS 51-B showed erosion of a secondary O-ring, indicating that the primary seal failed, a launch constraint was placed on flight 51-F and subsequent launches. These constraints had been imposed and regularly waived by the Solid Rocket Booster Project Manager at Marshall, Lawrence B. Mulloy.

Neither the launch constraint, the reason for it, or the six consecutive waivers prior to 51-L were known to Moore (Level I) or Aldrich (Level II) or Thomas at the time of the Flight Readiness Review process for 51-L.

It should be noted that there were other and independent paths of system reporting that were designed to bring forward information about the Solid Rocket Booster joint anomalies. One path was the task force of Thiokol engineers and Mar-

shall engineers who had been conducting subscale pressure tests at Wasatch during 1985, a source of documented rising concern and frustration on the part of some of the Thiokol participants and a few of the Marshall participants. But Level II was not in the line of reporting for this activity. Another path was the examination at each Flight Readiness Review of evidence of earlier flight anomalies. For 51-L, the data presented in this latter path, while it reached Levels I and II, never referred to either test anomalies or flight anomalies with O-rings.

In any event, no mention of the O-ring problems in the Solid Rocket Booster joint appeared in the Certification of Flight Readiness, signed for Thiokol on January 9, 1986, by Joseph Kilminster, for the Solid Rocket Booster set designated BI026.<sup>2</sup>

Similarly, no mention appeared in the certification endorsement, signed on January 15, 1986, by Kilminster and by Mulloy,<sup>3</sup> No mention appears in several inches of paper comprising the entire chain of readiness reviews for 51-L.<sup>4</sup>

In the 51-L readiness reviews, it appears that neither Thiokol management nor the Marshall Level III project managers believed that the O-ring blow-by and erosion risk was critical. The testimony and contemporary correspondence show that Level III believed there was ample margin to fly with O-ring erosion, provided the leak check was performed at 200 pounds per square inch.

Following the January 15 Flight Readiness Review each element of the Shuttle was certified as flight-ready.

The L-1 Mission Management Team meeting took place as scheduled at 11:00 a.m. Eastern Standard Time January 25. No technical issues appeared at this meeting or in the documentation and all Flight Readiness Review actions were reported closed out.

Mr. Mulloy testified as follows regarding the Flight Readiness Review record about O-ring concerns:<sup>5</sup>

**Chairman Rogers:** . . . Why wasn't that a cause for concern on the part of the whole NASA organization?

**Mr. Mulloy:** It was cause for concern, sir.

**Chairman Rogers:** Who did you tell about this?

**Mr. Mulloy:** Everyone, sir.

**Chairman Rogers:** And they all knew about it at the time of 51-L?

**Mr. Mulloy:** Yes, sir. You will find in the Flight Readiness Review record that went all the way to the L-1 review.

It is disturbing to the Commission that contrary to the testimony of the Solid Rocket Booster Project Manager, the seriousness of concern was not conveyed in Flight Readiness Review to Level I and the 51-L readiness review was silent.

The only remaining issue facing the Mission Management Team at the L-1 review was the approaching cold front, with forecasts of rain showers and temperatures in the mid-sixties. There had also been heavy rain since 51-L had been rolled out to the launch pad, approximately seven inches compared with the 2.5 inches that would have been normal for that season and length of exposure (35 days).

At 12:36 p.m. on the 27th, the Mission Management Team scrubbed the launch for that day due to high cross winds at the launch site. In the accompanying discussion that ran for about half an hour, all appropriate personnel were polled as to the feasibility of a launch within 24 hours. Participants were requested to identify any constraints. This meeting, aimed at launch at 9:38 a.m. on January 28, produced no constraints or concerns about the performance of the Solid Rocket Boosters.

At 2:00 p.m. on the 27th, the Mission Management Team met again. At that time, the weather was expected to clear, but it appeared that temperatures would be in the low twenties for about 11 hours. Issues were raised with regard to the cold weather effects on the launch facility, including the water drains, the eye wash and shower water, fire suppression system, and overpressure water trays. It was decided to activate heaters in the Orbiter, but no concerns were expressed about the O-rings in the Solid Rocket Boosters. The decision was to proceed with the countdown and with fueling, but all members of the team were asked to review the situation and call if any problems arose.

At approximately 2:30 p.m. EST, at Thiokol's Wasatch plant, Robert Ebeling, after learning of the predicted low temperature for launch, convened a meeting with Roger Boisjoly and with other Thiokol engineers. A brief chronology of the subsequent chain of events begins on page 104. Ebeling was concerned about predicted cold

temperatures at Kennedy Space Center. In a post-accident interview, Mr. Ebeling recalled the substance of the meeting.<sup>6</sup>

"The meeting lasted one hour, but the conclusion of that meeting was Engineering—especially Arnie, Roger Boisjoly, Brian Russell, myself, Jerry Burns, they come to mind—were very adamant about their concerns on this lower temperature, because we were way below our data base and we were way below what we qualified for."

Later in the afternoon on the same day, Allan McDonald—Thiokol's liaison for the Solid Rocket Booster project at Kennedy Space Center—received a telephone call from Ebeling, expressing concern about the performance of the Solid Rocket Booster field joints at low temperatures. During testimony before the Commission on February 27, McDonald recounted that conversation:<sup>7</sup>

**Mr. McDonald:** Well, I had first become aware of the concern of the low temperatures that were projected for the Cape, it was late in the afternoon of the 27th. I was at Carver Kennedy's house. He is a vice president of, as I mentioned, our space operations center at the Cape, and supports the stacking of the SRMs [Solid Rocket Motors].

And I had a call from Bob Ebeling. He is the manager of our ignition system and final assembly, and he worked for me as program manager at Thiokol in Utah. And he called me and said that they had just received some word earlier that the weatherman was projecting temperatures as low as 18 degrees Fahrenheit some time in the early morning hours of the 28th, and that they had some meetings with some of the engineering people and had some concerns about the O-rings getting to those kinds of temperatures.

And he wanted to make me aware of that and also wanted to get some more updated and better information on what the actual temperature was going to be depicted, so that they could make some calculations on what they expected the real temperature the O-rings may see. . . .

I told him that I would get that temperature data for him and call him back. Carver Kennedy then, when I hung up, called the launch operations center to get the

predicted temperatures from pad B, as well as what the temperature history had been during the day up until that time.

. . . He obtained those temperatures from the launch operations center, and they basically said that they felt it was going to get near freezing or freezing before midnight. It would get as low as 22 degrees as a minimum in the early morning hours, probably around 6:00 o'clock, and that they were predicting a temperature of about 26 degrees at the intended time, about 9:38 the next morning.

I took that data and called back to the plant and sent it to Bob Ebeling and relayed that to him, and told him he ought to use this temperature data for his predictions, but I thought this was very serious and to make sure that he had the vice president, engineering, involved in this and all of his people; that I wanted them to put together some calculations and a presentation of material.

**Chairman Rogers:** Who's the Vice President, Engineering?

**Mr. McDonald:** Mr. Bob Lund is our Vice President, Engineering, at our Morton Thiokol facility in Utah.

To make sure he was involved in this, and that this decision should be an engineering decision, not a program management decision. And I told him that I would like him to make sure they prepared some charts and were in a position to recommend the launch temperature and to have the rationale for supporting that launch temperature.

I then hung up and I called Mr. Mulloy. He was staying at the Holiday Inn in Merritt Island and they couldn't reach him, and so I called Cecil Houston—Cecil Houston is the resident manager for the Marshall Space Flight Center office at KSC [Kennedy Space Center]-- and told him about our concerns with the low temperatures and the potential problem with the O-rings.

And he said that he would set up a teleconference. He had a four-wire system next to his office. His office is right across from the VAB [Vehicle Assembly Building] in the trailer complex C over there. And he would set up a four-wire teleconference involving the engineering people at Marshall Space Flight Center at Huntsville, our people back at Thiokol in Utah; and that I

should come down to his office and participate at Kennedy from there, and that he would get back with me and let me know when that time would be.

Soon thereafter Cecil Houston called Dr. Judson Lovingood, Deputy Shuttle Project Manager at Marshall Space Flight Center, to inform him of the concerns about the O-rings and asked Lovingood to set up a teleconference with senior project management personnel, with George Hardy, Marshall's Deputy Director of Science and Engineering, and with Morton Thiokol personnel. Lovingood called Stanley Reinartz, Shuttle Project Manager, a few minutes later and informed him of the planned telecon.

The first phase of the teleconference began at 5:45 p.m. Eastern Standard Time; participants included Reinartz, Lovingood, Hardy, and numerous people at Kennedy, Marshall and Thiokol-Wasatch. (Allan McDonald missed this phase; he did not arrive at Kennedy until after 8:00 p.m.) Concerns for the effect of low temperature on the O-rings and the joint seal were presented by Morton Thiokol, along with an opinion that launch should be delayed. A recommendation was also made that Aldrich, Program Manager at Johnson (Level II), be informed of these concerns.

The following are excerpts from testimony before the Commission relating to the teleconference:<sup>8</sup>

**Dr. Keel:** You just indicated earlier that, based upon that teleconference, you thought there was a good possibility of delay. Is that what Thiokol was recommending then, was delay?

**Dr. Lovingood:** That is the way I heard it, and they were talking about the 51-C experience and the fact that they had experienced the worst case blow-by as far as the arc and the soot and so forth. And also, they talked about the resiliency data that they had.

So it appeared to me — and we didn't have all of the proper people there. That was another aspect of this. It appeared to me that we had better sit down and get the data so that we could understand exactly what they were talking about and assess that data.

And that is why I suggested that we go ahead and have a telecon within the center, so that we could review that.

**Dr. Keel:** So as early as after that first afternoon conference at 5:45, it appeared that Thiokol was basically saying delay. Is that right?

**Dr. Lovingood:** That is the way it came across to me. I don't know how other people perceived it, but that's the way it came across to me.

**Dr. Keel:** Mr. Reinartz, how did you perceive it?

**Mr. Reinartz:** I did not perceive it that way. I perceived that they were raising some questions and issues which required looking into by all the right parties, but I did not perceive it as a recommendation delay.

**Dr. Keel:** Some prospects for delay?

**Mr. Reinartz:** Yes, sir, that possibility is always there.

**Dr. Keel:** Did you convey that to Mr. Mulloy and Mr. Hardy before the 8:15 conference?

**Mr. Reinartz:** Yes, I did. And as a matter of fact, we had a discussion. Mr. Mulloy was just out of communication for about an hour, and then after that I got in contact with him, and we both had a short discussion relating to the general nature of the concerns with Dr. Lucas and Mr. Kingsbury at the motel before we both departed for the telecon that we had set up out at the Cape.

**Dr. Keel:** But based upon that, Mr. Lovingood, that impression, you thought it was a significant enough possibility that Mr. Aldrich should have been contacted?

**Dr. Lovingood:** Yes.

**Dr. Keel:** In addition, did you recommend that Mr. Lucas, who is director of Marshall, of course, and Mr. Kingsbury, who is Mr. Hardy's boss, participate in the 8:15 conference?

**Dr. Lovingood:** Yes, I did.

**Dr. Keel:** And you recommended that to whom?

**Dr. Lovingood:** I believe I said that over the net. I said that I thought we ought to have an inter-center meeting involving Dr. Lucas and Mr. Kingsbury, and then plan to go on up the line to Level II and Level I.

And then it was after we broke off that first telecon I called Stan at the motel and told



him that he ought to go ahead and alert Arnie to that possibility.

**Dr. Keel:** And Mr. Reinartz, you then visited the motel room of Mr. Lucas with Mr. Kingsbury, and also was Mr. Mulloy with you then?

**Mr. Reinartz:** Yes, sir, he was. In the first couple of minutes I believe I was there by myself, and then Mr. Mulloy joined us.

**Dr. Keel:** And did you discuss with them Mr. Lovingood's recommendation that the two of them, Lucas and Kingsbury, participate?

**Mr. Reinartz:** No, sir. I don't recall discussing Mr. Lovingood's recommendations. I discussed with them the nature of the telecon, the nature of the concerns raised by Thiokol, and the plans to gather the proper technical support people at Marshall for examination of the data. And I believe that was the essence of the discussion.

**Chairman Rogers:** But you didn't recommend that the information be given to Level II or Level I?

**Mr. Reinartz:** I don't recall that I raised that issue with Dr. Lucas. I told him what the plans were for proceeding. I don't recall, Mr. Chairman, making any statement regarding that.

**Mr. Hotz:** Mr. Reinartz, are you telling us that you in fact are the person who made the decision not to escalate this to a Level II item?

**Mr. Reinartz:** That is correct, sir.

At approximately 8:45 p.m. Eastern Standard Time, Phase 2 of the teleconference commenced, the Thiokol charts and written data having arrived at Kennedy Space Center by telefax. (A table of teleconference participants is included with Chronology of Events.) The charts presented a history of the O-ring erosion and blow-by in the Solid Rocket Booster joints of previous flights, presented the results of subscale testing at Thiokol and the results of static tests of Solid Rocket Motors. In the following testimony, Roger Boisjoly, Allan McDonald and Larry Mulloy expressed their recollections of this teleconference up to the point when an off-net caucus was requested:<sup>9</sup>

**Mr. Boisjoly:** I expressed deep concern about launching at low temperature. I presented Chart 2-1 with emphasis—now, 2-1, if you want to see it, I have it, but basically that was the chart that summarized the primary concerns, and that was the chart that I pulled right out of the Washington presentation without changing one word of it because it was still applicable, and it addresses the highest concern of the field joint in both the ignition transient condition and the steady state condition, and it really sets down the rationale for why we were continuing to fly. Basically, if erosion penetrates the primary O-ring seal, there is a higher probability of no secondary seal capability in the steady state condition. And I had two sub-bullets under that which stated bench testing showed O-ring not capable of maintaining contact with metal parts, gap, opening rate to maximum operating pressure. I had another bullet which stated bench testing showed capability to maintain O-ring contact during initial phase (0 to 170 milliseconds of transient). That was my comfort basis of continuing to fly under normal circumstances, normal being within the data base we had.

I emphasized, when I presented that chart about the changing of the timing function of the O-ring as it attempted to seal. I was concerned that we may go from that first beginning region into that intermediate region, from 0 to 170 being the first region, and 170 to 330 being the intermediate region where we didn't have a high probability of sealing or seating.

I then presented Chart 2-2 with added concerns related to the timing function. And basically on that chart, I started off talking about a lower temperature than current data base results in changing the primary O-ring sealing timing function, and I discussed the SRM-15 [Flight 51-C, January, 1985] observations, namely, the 15A [Left SRM, Flight 51-C] motor had 80 degrees arc black grease between the O-rings, and make no mistake about it, when I say black, I mean black just like coal. It was jet black. And SRM-15B [Right SRM, Flight 51-C] had a 110 degree arc of black grease between the O-rings. We would have low O-ring squeeze due to low



PRIMARY CONCERNS	
o	FIELD JOINT - HIGHEST CONCERN
o	EROSION PENETRATION OF PRIMARY SEAL REQUIRES RELIABLE SECONDARY SEAL FOR PRESSURE INTEGRITY
o	IGNITION TRANSIENT - (0-600 MS)
o	(0-170 MS) HIGH PROBABILITY OF RELIABLE SECONDARY SEAL
o	(170-330 MS) REDUCED PROBABILITY OF RELIABLE SECONDARY SEAL
o	(330-600 MS) HIGH PROBABILITY OF NO SECONDARY SEAL CAPABILITY
o	STEADY STATE - (600 MS - 2 MINUTES)
o	IF EROSION PENETRATES PRIMARY O-RING SEAL - HIGH PROBABILITY OF NO SECONDARY SEAL CAPABILITY
o	BENCH TESTING SHOWED O-RING NOT CAPABLE OF MAINTAINING CONTACT WITH METAL PARTS GAP OPENING RATE TO NEOP
o	BENCH TESTING SHOWED CAPABILITY TO MAINTAIN O-RING CONTACT DURING INITIAL PHASE (0-170 MS) OF TRANSIENT

Chart 2-1 presented by Thiokol's Roger Boisjoly summarizing primary concerns with the field joint and its O-ring seals on the boosters.

Joint Primary Concerns	SRM 25
■ A Temperature Lower Than Current Data Base Results in Changing Primary O-Ring Sealing Timing Function	
■ SRM 15A - 80° ARC Black Grease Between O-Rings	
■ SRM 15B - 110° ARC Black Grease Between O-Rings	
■ Lower O-Ring squeeze due to lower temp.	
■ Higher O-Ring shore hardness	
■ Thicker grease viscosity	
■ Higher O-Ring pressure actuation time	
■ If actuation time increases, threshold of secondary seal pressurization capability is approached	
■ If threshold is reached then secondary seal may not be capable of being pressurized	

Boisjoly's Chart 2-2 indicating concern about temperature effect on seal actuation time (handwritten).

temperature which I calculated earlier in the day. We should have higher O-ring Shore hardness. . . .

Now, that would be harder. And what that material really is, it would be likened to trying to shove a brick into a crack versus a sponge. That is a good analogy for purposes of this discussion. I also mentioned that thicker grease, as a result of lower temperatures, would have a higher viscosity. It wouldn't be as slick and slippery as it would be at room temperature. And so it would be a little bit more difficult to move across it.

We would have higher O-ring pressure actuation time, in my opinion, and that is what I presented. . . . These are the sum and substance of what I just presented. If action time increases, then the threshold of secondary seal pressurization capability is approached. That was my fear. If the threshold is reached, then secondary seal may not be capable of being pressurized, and that was the bottom line of everything that had been presented up to that point.

**Chairman Rogers:** Did anybody take issue with you?

**Mr. Boisjoly:** Well, I am coming to that. I also showed a chart of the joint with an exaggerated cross section to show the seal

lifted off, which has been shown to everybody. I was asked, yes, at that point in time I was asked to quantify my concerns, and I said I couldn't. I couldn't quantify it. I had no data to quantify it, but I did say I knew that it was away from goodness in the current data base. Someone on the net commented that we had soot blow-by on SRM-22 [Flight 61-A, October, 1985] which was launched at 75 degrees. I don't remember who made the comment, but that is where the first comment came in about the disparity between my conclusion and the observed data because SRM-22 [Flight 61-A, October, 1985] had blow-by at essentially a room temperature launch.

I then said that SRM-15 [Flight 51-C, January, 1985] had much more blow-by indication and that it was indeed telling us that lower temperature was a factor. This was supported by inspection of flown hardware by myself. I was asked again for data to support my claim, and I said I have none other than what is being presented, and I had been trying to get resilience data, Arnie and I both, since last October, and that statement was mentioned on the net.

Others in the room presented their charts, and the main telecon session concluded with Bob Lund, who is our Vice President of

## RECOMMENDATIONS :

- ° O-RING TEMP MUST BE  $\geq 53^{\circ}\text{F}$  AT LAUNCH  
DEVELOPMENT MOTORS AT  $47^{\circ}$  TO  $52^{\circ}\text{F}$  WITH  
PUTTY PACKING HAD NO BLOW-BY  
SRM 15 (THE BEST SIMULATION) WORKED AT  $53^{\circ}\text{F}$
- ° PROJECT AMBIENT CONDITIONS (TEMP & WIND)  
TO DETERMINE LAUNCH TIME

Initial Thiokol recommendation Chart presented by Robert K. Lund at second teleconference prior to Thiokol caucus.

Engineering, presenting his conclusions and recommendations charts which were based on our data input up to that point. Listeners on the telecon were not pleased with the conclusions and the recommendations.

**Chairman Rogers:** What was the conclusion?

**Mr. Boisjoly:** The conclusion was we should not fly outside of our data base, which was 53 degrees. Those were the conclusions. And we were quite pleased because we knew in advance, having participated in the preparation, what the conclusions were, and we felt very comfortable with that.

**Mr. Acheson:** Who presented that conclusion?

**Mr. Boisjoly:** Mr. Bob Lund. He had prepared those charts. He had input from other people. He had actually physically prepared the charts. It was about that time that Mr. Hardy from Marshall was asked what he thought about the MTI [Morton Thiokol] recommendation, and he said he was appalled at the MTI decision. Mr. Hardy was also asked about launching, and he said no, not if the contractor recommended not launching, he would not go against the contractor and launch.

There was a short discussion that ensued about temperature not being a discriminator between SRM-15 [Flight 51-C] and SRM-22 [Flight 61-A], and shortly after, I believe it was Mr. Kilminster asked if—excuse me. I'm getting confused here. Mr. Kilminster was asked by NASA if he would launch, and he said no because the engineering recommendation was not to launch.

Then MTI management then asked for a five-minute caucus. I'm not sure exactly who asked for that, but it was asked in such a manner that I remember it was asked for, a five-minute caucus, which we put on—the line on mute and went off-line with the rest of the net.

**Chairman Rogers:** Mr. Boisjoly, at the time that you made the—that Thiokol made the recommendation not to launch, was that the unanimous recommendation as far as you knew?

**Mr. Boisjoly:** Yes. I have to make something clear. I have been distressed by the things that have been appearing in the paper and things that have been said in general, and there was never one positive, pro-launch statement ever made by anybody. There have been some feelings since then that folks have expressed that they would support the decision, but there was not one positive statement for launch ever made in that room.

**Mr. McDonald's testimony:**<sup>10</sup>

**Mr. McDonald:** I arrived at the Kennedy Space Center at about 8:15 [p.m.], and when I arrived there at the Kennedy Space Center the others that had already arrived were Larry Mulloy, who was there—he is the manager, the project manager for the SRB for Marshall. Stan Reinartz was there and he is the manager of the Shuttle Project Office. He's Larry Mulloy's boss.

Cecil Houston was there, the resident manager for Marshall. And Jack Buchanan was there. He happens to be our manager, Morton Thiokol's manager of our launch support services office at Kennedy.

The telecon hadn't started yet. It came on

the network shortly after I got there. . . .

**Chairman Rogers:** Was it essentially a telephone conference or was there actually a network of pictures?

**Mr. McDonald:** It was a telephone conference. . . .

But I will relay . . . what I heard at the conference as best I can. The teleconference started I guess close to 9:00 o'clock and, even though all the charts weren't there, we were told to begin and that Morton Thiokol should take the lead and go through the charts that they had sent to both centers.

The charts were presented by the engineering people from Thiokol, in fact by the people that had made those particular charts. Some of them were typed, some of them were handwritten. And they discussed their concerns with the low temperatures relative to the possible effects on the O-rings, primarily the timing function to seal the O-rings.

They presented a history of some of the data that we had accumulated both in static test and in flight tests relative to temperatures and the performance of the O-rings, and reviewed the history of all of our erosion studies of the O-rings, in the field joints, any blow-by of the primary O-ring with soot or products of combustion or decomposition that we had noted, and the performance of the secondary O-rings.

And there was an exchange amongst the technical people on that data as to what it meant . . . But the real exchange never really came until the conclusions and recommendations came in.

At that point in time, our vice president, Mr. Bob Lund, presented those charts and he presented the charts on the conclusions and recommendations. And the bottom line was that the engineering people would not recommend a launch below 53 degrees Fahrenheit. The basis for that recommendation was primarily our concern with the launch that had occurred about a year earlier, in January of 1985, I believe it was 51-C.

Mr. Mulloy's testimony:<sup>11</sup>

**Mr. Mulloy:** That telecon was a little late starting. It was intended to be set up at 8:15

. . . and the telecon was begun at 8:45.

And Thiokol will then present to you today the data that they presented to us in that telecon. I will not do that. The bottom line of that, though, initially was that Thiokol engineering, Bob Lund, who is the Vice President and Director of Engineering, who is here today, recommended that 51-L not be launched if the O-ring temperatures predicted at launch time would be lower than any previous launch, and that was 53 degrees.

**Dr. Walker:** May I ask a question? I wish you would distinguish between the predicted bulk temperatures and the O-ring temperatures. In fact, as I understand it, you really don't have any official O-ring temperature prediction in your models, and it seems that the assumption has been that the O-ring temperature is the same as the bulk temperature, which we know is not the case.

**Mr. Mulloy:** You will see, sir, in the Thiokol presentation today that that is not the case. This was a specific calculation of what the O-ring temperature was on the day of the January 1985 launch. It is not the bulk temperature of the propellant, nor is it the ambient temperature of the air.

It was Thiokol's calculation of what the lowest temperature an O-ring had seen in previous flights, and the engineering recommendation was that we should not move outside of that experience base.

I asked Joe Kilminster, who is the program manager for the booster program at Thiokol, what his recommendation was, because he is the gentleman that I get my recommendations from in the program office. He stated that, based on that engineering recommendation, that he could not recommend launch.

At that point I restated, as I have testified to, the rationale that was essentially documented in the 1982 Critical Items List, that stated that the rationale had been that we were flying with a simplex joint seal. And you will see in the Thiokol presentation that the context of their presentation is that the primary ring, with the reduced temperatures and reduced resiliency, may not function as

C-2

a primary seal and we would be relying on secondary.

And without getting into their rationale and getting ahead, the point, the bottom line, is that we were continuing—the assessment was, my assessment at that time was, that we would have an effective simplex seal, based upon the engineering data that Thiokol had presented, and that none of those engineering data seemed to change that basic rationale.

Stan Reinartz then asked George Hardy, the Deputy Director of Science and Engineering at Marshall, what his opinion was. George stated that he agreed that the engineering data did not seem to change this basic rationale, but also stated on the telecon that he certainly would not recommend launching if Thiokol did not.

At that time Joe Kilminster requested a five minute off-net caucus, and that caucus lasted approximately 30 minutes.

The teleconference was recessed at approximately 10:30 p.m. Eastern Standard Time. The off-net caucus of Thiokol personnel started and continued for about 30 minutes at the Wasatch office. The major issues, according to the testimony of Jerry Mason, Senior Vice President for Wasatch Operations, were the effect of temperature upon the O-rings and the history of erosion of the O-rings:<sup>12</sup>

**Mr. Mason:** Now, in the caucus we revisited all of our previous discussions, and the important things that came out of that was that, as we had recognized, we did have the possibility that the primary O-ring might be slower to move into the seating position and that was our concern, and that is what we had focused on originally.

The fact that we couldn't show direct correlation with the O-ring temperature was discussed, but we still felt that there was some concern about it being colder.

We then recognized that, if the primary did move more slowly, that we could get some blow-by and erosion on the primary. But we had pointed out to us in that caucus a point that had not come across clearly in our earlier discussions, and that is that we had run tests where we deliberately cut large pieces out of the O-rings to see what the threshold of sealing was, and we found we

could go to 125 thousandths of a cut out of the O-ring and it would still seal.

Approximately 10 engineers participated in the caucus, along with Mason, Kilminster, C. G. Wiggins (Vice President, Space Division), and Lund. Arnold Thompson and Boisjoly voiced very strong objections to launch, and the suggestion in their testimony was that Lund was also reluctant to launch:<sup>13</sup>

**Mr. Boisjoly:** Okay, the caucus started by Mr. Mason stating a management decision was necessary. Those of us who opposed the launch continued to speak out, and I am specifically speaking of Mr. Thompson and myself because in my recollection he and I were the only ones that vigorously continued to oppose the launch. And we were attempting to go back and rereview and try to make clear what we were trying to get across, and we couldn't understand why it was going to be reversed. So we spoke out and tried to explain once again the effects of low temperature. Arnie actually got up from his position which was down the table, and walked up the table and put a quarter pad down in front of the table, in front of the management folks, and tried to sketch out once again what his concern was with the joint, and when he realized he wasn't getting through, he just stopped.

I tried one more time with the photos. I grabbed the photos, and I went up and discussed the photos once again and tried to make the point that it was my opinion from actual observations that temperature was indeed a discriminator and we should not ignore the physical evidence that we had observed.

And again, I brought up the point that SRM-15 [Flight 51-C, January, 1985] had a 110 degree arc of black grease while SRM-22 [Flight 61-A, October, 1985] had a relatively different amount, which was less and wasn't quite as black. I also stopped when it was apparent that I couldn't get anybody to listen.

**Dr. Walker:** At this point did anyone else speak up in favor of the launch?

**Mr. Boisjoly:** No, sir. No one said anything, in my recollection, nobody said a word. It was then being discussed amongst the management folks. After Arnie and I had

our last say, Mr. Mason said we have to make a management decision. He turned to Bob Lund and asked him to take off his engineering hat and put on his management hat. From this point on, management formulated the points to base their decision on. There was never one comment in favor, as I have said, of launching by any engineer or other nonmanagement person in the room before or after the caucus. I was not even asked to participate in giving any input to the final decision charts.

I went back on the net with the final charts or final chart, which was the rationale for launching, and that was presented by Mr. Kilminster. It was hand written on a notepad, and he read from that notepad. I did not agree with some of the statements that were being made to support the decision. I was never asked nor polled, and it was clearly a management decision from that point.

I must emphasize, I had my say, and I never [would] take [away] any management right to take the input of an engineer and then make a decision based upon that input, and I truly believe that. I have worked at a lot of companies, and that has been done from time to time, and I truly believe that, and so there was no point in me doing anything any further than I had already attempted to do.

I did not see the final version of the chart until the next day. I just heard it read. I left the room feeling badly defeated, but I felt I really did all I could to stop the launch.

I felt personally that management was under a lot of pressure to launch and that they made a very tough decision, but I didn't agree with it.

One of my colleagues that was in the meeting summed it up best. This was a meeting where the determination was to launch, and it was up to us to prove beyond a shadow of a doubt that it was not safe to do so. This is in total reverse to what the position usually is in a preflight conversation or a flight readiness review. It is usually exactly opposite that.

**Dr. Walker:** Do you know the source of the pressure on management that you alluded to?

**Mr. Boisjoly:** Well, the comments made over the [net] is what I felt, I can't speak for them, but I felt it—I felt the tone of the meeting exactly as I summed up, that we were being put in a position to prove that we should not launch rather than being put in the position and prove that we had enough data to launch. And I felt that very real.

**Dr. Walker:** These were the comments from the NASA people at Marshall and at Kennedy Space Center?

**Mr. Boisjoly:** Yes.

**Dr. Feynman:** I take it you were trying to find proof that the seal would fail?

**Mr. Boisjoly:** Yes.

**Dr. Feynman:** And of course, you didn't, you couldn't, because five of them didn't, and if you had proved that they would have all failed, you would have found yourself incorrect because five of them didn't fail.

**Mr. Boisjoly:** That is right. I was very concerned that the cold temperatures would change that timing and put us in another regime, and that was the whole basis of my fighting that night.

As appears from the foregoing, after the discussion between Morton Thiokol management and the engineers, a final management review was conducted by Mason, Lund, Kilminster, and Wiggins. Lund and Mason recall this review as an unemotional, rational discussion of the engineering facts as they knew them at that time; differences of opinion as to the impact of those facts, however, had to be resolved as a judgment call and therefore a management decision. The testimony of Lund taken by Commission staff investigators is as follows:<sup>14</sup>

**Mr. Lund:** We tried to have the telecon, as I remember it was about 6:00 o'clock [MST], but we didn't quite get things in order, and we started transmitting charts down to Marshall around 6:00 or 6:30 [MST], something like that, and we were making charts in real time and seeing the data, and we were discussing them with the Marshall folks who went along.

We finally got the—all the charts in, and when we got all the charts in I stood at the board and tried to draw the conclusions that we had out of the charts that had been presented, and we came up with a conclu-

sions chart and said that we didn't feel like it was a wise thing to fly.

**Question:** What were some of the conclusions?

**Mr. Lund:** I had better look at the chart.

Well, we were concerned the temperature was going to be lower than the 50 or the 53 that had flown the previous January, and we had experienced some blow-by, and so we were concerned about that, and although the erosion on the O-rings, and it wasn't critical, that, you know, there had obviously been some little puff go through. It had been caught.

There was no real extensive erosion of that O-ring, so it wasn't a major concern, but we said, gee, you know, we just don't know how much further we can go below the 51 or 53 degrees or whatever it was. So we were concerned with the unknown. And we presented that to Marshall, and that rationale was rejected. They said that they didn't accept that rationale, and they would like us to consider some other thoughts that they had had.

. . . Mr. Mulloy said he did not accept that, and Mr. Hardy said he was appalled that we would make such a recommendation. And that made me ponder of what I'd missed, and so we said, what did we miss, and Mr. Mulloy said, well, I would like you to consider these other thoughts that we have had down here. And he presented a very strong and forthright rationale of what they thought was going on in that joint and how they thought that the thing was happening, and they said, we'd like you to consider that when they had some thoughts that we had not considered.

. . . So after the discussion with Mr. Mulloy, and he presented that, we said, well, let's ponder that a little bit, so we went off-line to talk about what we—

**Question:** Who requested to go off-line?

**Mr. Lund:** I guess it was Joe Kilminster. . . .

And so we went off line on the telecon . . . so we could have a roundtable discussion here.

**Question:** Who were the management people that were there?

**Mr. Lund:** Jerry Mason, Cal Wiggins, Joe, I, manager of engineering design, the

manager of applied mechanics. On the chart.

Before the Commission on February 25, 1986, Mr. Lund testified as follows regarding why he changed his position on launching Challenger during the management caucus when he was asked by Mr. Mason "To take off his engineering hat and put on his management hat":<sup>15</sup>

**Chairman Rogers:** How do you explain the fact that you seemed to change your mind when you changed your hat?

**Mr. Lund:** I guess we have got to go back a little further in the conversation than that. We have dealt with Marshall for a long time and have always been in the position of defending our position to make sure that we were ready to fly, and I guess I didn't realize until after that meeting and after several days that we had absolutely changed our position from what we had been before. But that evening I guess I had never had those kinds of things come from the people at Marshall. We had to prove to them that we weren't ready, and so we got ourselves in the thought process that we were trying to find some way to prove to them it wouldn't work, and we were unable to do that. We couldn't prove absolutely that that motor wouldn't work.

**Chairman Rogers:** In other words, you honestly believed that you had a duty to prove that it would not work?

**Mr. Lund:** Well, that is kind of the mode we got ourselves into that evening. It seems like we have always been in the opposite mode. I should have detected that, but I did not, but the roles kind of switched. . . .

Supplemental testimony of Mr. Mason obtained in a Commission staff interview is as follows:<sup>16</sup>

**Question:** Do you recall Mr. Hardy and Mr. Mulloy's comments after—I think after Mr. Kilminster had got done, or Mr. Lund got done presenting the charts? They had some comments. Do you recall—

**Mr. Mason:** Oh, yes, it was over and over. Hardy said that, "I'm appalled at your recommendation." . . .

**Question:** Well, did Mr. Hardy's "appalled" remark and Mr. Mulloy's "can't launch, we won't be able to launch until April"

remark, how did that affect your thinking and affect your decision?

**Mr. Mason:** My personal thinking, I just, you know, it didn't make that much difference. . . .

And the comments that they made, in my view, probably had got more reaction from the engineer[s] at the lower level than they would from the manager[s], because we deal with people, and managers all the time. . . .

Mr. McDonald indicated that during the period of the internal Morton Thiokol caucus he continued to argue for delay with Mulloy, challenging, among other things, the rationale that the rocket motor was qualified down to 40 degrees Fahrenheit. Present were Reinartz, Jack Buchanan, the manager of Morton Thiokol Launch Support Services at Kennedy, and Cecil Houston. McDonald's testimony described that conversation:<sup>17</sup>

**Mr. McDonald:** . . . while they were off-line, reevaluating or reassessing this data . . . I got into a dialogue with the NASA people about such things as qualification and launch commit criteria.

The comment I made was it is my understanding that the motor was supposedly qualified to 40 to 90 degrees.

I've only been on the program less than three years, but I don't believe it was. I don't believe that all of those systems, elements, and subsystems were qualified to that temperature.

And Mr. Mulloy said well, 40 degrees is propellant mean bulk temperature, and we're well within that. That is a requirement. We're at 55 degrees for that—and that the other elements can be below that . . . that, as long as we don't fall out of the propellant mean bulk temperature. I told him I thought that was asinine because you could expose that large Solid Rocket Motor to extremely low temperatures—I don't care if it's 100 below zero for several hours—with that massive amount of propellant, which is a great insulator, and not change that propellant mean bulk temperature but only a few degrees, and I don't think the spec really meant that.

But that was my interpretation because I had been working quite a bit on the filament wound case Solid Rocket Motor. It was my

impression that the qualification temperature was 40 to 90, and I knew everything wasn't qualified to that temperature, in my opinion. But we were trying to qualify that case itself at 40 to 90 degrees for the filament wound case.

I then said I may be naive about what generates launch commit criteria, but it was my impression that launch commit criteria was based upon whatever the lowest temperature, or whatever loads, or whatever environment was imposed on any element or subsystem of the Shuttle. And if you are operating outside of those, no matter which one it was, then you had violated some launch commit criteria.

That was my impression of what that was. And I still didn't understand how NASA could accept a recommendation to fly below 40 degrees. I could see why they took issue with the 53, but I could never see why they would . . . of accept a recommendation below 40 degrees, even though I didn't agree that the motor was fully qualified to 40. I made the statement that if we're wrong and something goes wrong on this flight, I wouldn't want to have to be the person to stand up in front of board of inquiry and say that I went ahead and told them to go ahead and fly this thing outside what the motor was qualified to.

I made that very statement.

Mr. Mulloy's recollections of these discussions are as follows:<sup>18</sup>

**Mr. Mulloy:** Mr. Kilminster then requested an off-net caucus. It has been suggested, implied, or stated that we directed Thiokol to go reconsider these data. That is not true. Thiokol asked for a caucus so that they could consider the discussions that had ensued and the comments that Mr. Hardy and I and others had made.

That caucus, as has been stated, was going to start at that point, and Mr. McDonald interjected into the teleconference. At that point, he made the first comment that he had made during this entire teleconference.

Mr. McDonald testified for quite a while yesterday about his thoughts on this, but he did not say any of them until this point. At that point, he stated that he thought what George Hardy said was a very important



consideration, and that consideration was, and he asked Mr. Kilminster to be sure and consider the comment made by George Hardy during the course of the discussions, that the concerns expressed were for primary O-ring blow-by and that the secondary O-ring was in a position to seal during the time of blow-by and would do so before significant joint rotation had occurred.

They then went into their caucus, having asked for five minutes—

**Mr. Hotz:** . . . It figures quite prominently in the discussion that you were quoted as saying, do you expect us to wait till April to launch?

**Mr. Mulloy:** Yes, sir.

**Dr. Walker:** Is that an accurate statement or not?

**Mr. Mulloy:** It is certainly a statement that is out of context, and the way I read the quote, sir—and I have seen it many times, too many times—the quote I read was: My God, Thiokol, when do you want me to launch, next April?

Mr. McDonald testified to another quote that says: You guys are generating new Launch Commit Criteria.

Now, both of those I think kind of go together, and that is what I was saying. I don't know whether that occurred during the caucus or subsequent to. I just simply can't remember that.

**Mr. Hotz:** Well, never mind the timing.

**Mr. Mulloy:** Well, yes, sir. I'm going to answer your question now. I think those quotes derive from a single thought that may have been expressed by me using some of those words.

I have not yet encountered anyone other than those at KSC who heard those words, so I don't believe they were transmitted over the net. The total context I think in which those words may have been used is, there are currently no Launch Commit Criteria [LCC] for joint temperature. What you are proposing to do is to generate a new Launch Commit Criteria on the eve of launch, after we have successfully flown with the existing Launch Commit Criteria 24 previous times. With this LCC, i.e., do not launch with a temperature greater [sic] than 53 degrees, we may not be able to launch until next

April. We need to consider this carefully before we jump to any conclusions.

It is all in the context, again, with challenging your interpretation of the data, what does it mean and is it logical, is it truly logical that we really have a system that has to be 53 degrees to fly?

At approximately 11 p.m. Eastern Standard Time, the Thiokol/NASA teleconference resumed, the Thiokol management stating that they had reassessed the problem, that the temperature effects were a concern, but that the data were admittedly inconclusive. Kilminster read the rationale recommending launch and stated that that was Morton Thiokol's recommendation. Hardy requested that it be sent in writing by telefax both to Kennedy and to Marshall, and it was. The testimony of Mulloy and Hardy regarding the remainder of the teleconference and their rationale for recommending launch follows:<sup>19</sup>

**Mr. Mulloy:** Okay, sir. At the completion of the caucus, of course, Mr. Kilminster came back on the loop and stated they had assessed all the data and considered the discussions that had ensued for the past couple of hours and the discussions that occurred during their caucus.

**Chairman Rogers:** Was it a couple of hours?

**Mr. Mulloy:** Yes, sir. We started at 8:45 and I believe it was probably 11:00 o'clock before he came back on the loop. It was a long discussion. And I must emphasize that I had no knowledge of what interchange occurred during the caucus at Thiokol, because all sites were on mute. We were on mute at KSC. No communications occurred between myself and Mr. Hardy at Huntsville, nor did any communication occur between KSC and Thiokol during that caucus.

After Mr. Kilminster made that recommendation, Mr. Reinartz then asked if there were any further comments, and to my recollection there were none. There were no further comments made.

I then asked Mr. Kilminster to send me a copy of his flight readiness rationale and recommendation. The conference was then terminated at approximately 11:15.

I have no knowledge of, as has been testified, of Mr. McDonald being asked to sign that documentation. That would have

MTI ASSESSMENT OF TEMPERATURE CONCERN ON SRM-25 (51L) LAUNCH

- 0 CALCULATIONS SHOW THAT SRM-25 O-RINGS WILL BE 20° COLDER THAN SRM-15 O-RINGS
- 0 TEMPERATURE DATA NOT CONCLUSIVE ON PREDICTING PRIMARY O-RING BLOW-BY
- 0 ENGINEERING ASSESSMENT IS THAT:
  - 0 COLDER O-RINGS WILL HAVE INCREASED EFFECTIVE DUROMETER ("HARDER")
  - 0 "HARDER" O-RINGS WILL TAKE LONGER TO "SEAT"
    - 0 MORE GAS MAY PASS PRIMARY O-RING BEFORE THE PRIMARY SEAL SEATS (RELATIVE TO SRM-15)
    - 0 DEMONSTRATED SEALING THRESHOLD IS 3 TIMES GREATER THAN 0.038" EROSION EXPERIENCED ON SRM-15
  - 0 IF THE PRIMARY SEAL DOES NOT SEAT, THE SECONDARY SEAL WILL SEAT
    - 0 PRESSURE WILL GET TO SECONDARY SEAL BEFORE THE METAL PARTS ROTATE
    - 0 O-RING PRESSURE LEAK CHECK PLACES SECONDARY SEAL IN OUTBOARD POSITION WHICH MINIMIZES SEALING TIME
- 0 MTI RECOMMENDS STS-51L LAUNCH PROCEED ON 28 JANUARY 1986
  - 0 SRM-25 WILL NOT BE SIGNIFICANTLY DIFFERENT FROM SRM-15

  
JOE C. KILMINSTER, VICE PRESIDENT  
SPACE BOOSTER PROGRAMS

MORTON THIOKOL INC  
Wasatch Division

Copy of telefax sent Kennedy and Marshall centers by Thiokol detailing the company's final position on the January 28 launch of mission 51-L.

been unusual, because Mr. Kilminster signs all flight readiness documentation.

Now, after the teleconference was complete, Mr. McDonald informed Mr. Reinartz and me that if the Thiokol engineering concern for the effect of cold was not sufficient cause to recommend not launching, there were two other considerations, launch pad ice and recovery area weather.

I stated that launch pad ice had been considered by the Mission Management Team —

**Chairman Rogers:** Excuse me. Could you identify that discussion, where that took place?

**Mr. Mulloy:** That was after the teleconference was completed, after Mr. Kilminster made his recommendation, after Mr. Reinartz asked are there any other comments. There were no other comments on the telecon from anyone. . . .

I stated that launch pad ice had been con-

sidered by the Mission Management Team before deciding to proceed and that a further periodic monitoring of that condition was planned. I further stated that I had been made aware of the recovery area weather previously and planned to place a call to Mr. Aldrich and advise him that the weather in the recovery area exceeded the Launch Commit Criteria.

So I stated earlier, when you asked what were the Launch Commit Criteria, one of them was that the recovery area weather has limitations on it. The report we had, that Mr. McDonald confirmed, was that we were outside of those limits.

Now, I must point out that that is not a hard Launch Commit Criteria. That is an advisory call, and the LCC so states that. It does require that we discuss the condition.

So at about 11:30 p.m., Mr. Cecil Houston established a teleconference with Mr. Aldrich and Mr. Sestile at KSC. I informed Mr. Aldrich that the weather in the

recovery area could preclude immediate recovery of the SRBs, since the ships were in a survival mode and they were moving back toward Cape Kennedy at about three knots, and the estimate provided to us by Mr. Sestile was that they would be probably 40 miles from the SRB impact area at the time of launch, at 9:38; and then, continuing at three knots, it was going to be some period of time before they could get back and locate the boosters.

The concern I had for that was not loss of the total booster, but loss of the main parachutes for the booster, which are separated at water impact, and loss of the frustum of the boosters, which has the drogue parachute on it, which comes down separately, because with the 50 knot winds we had out there and with the kind of sea states we had, by the time the recovery ships got back out there, there was little probability of being able to recover those.

I informed Mr. Aldrich of that, and he decided to proceed with the launch after that information. I did not discuss with Mr. Aldrich the conversations that we had just completed with Morton Thiokol.

**Chairman Rogers:** Could you explain why?

**Mr. Mulloy:** Yes, sir. At that time, and I still consider today, that was a Level III issue, Level III being an SRB element or an external tank element or Space Shuttle main engine element or an Orbiter. There was no violation of Launch Commit Criteria. There was no waiver required in my judgment at that time and still today.

And we work many problems at the Orbiter and the SRB and the External Tank level that never get communicated to Mr. Aldrich or Mr. Moore. It was clearly a Level III issue that had been resolved.

... There were 27 full-scale seal tests with an O-ring groove damage tolerances, damage in the grooves and damage tolerance on O-rings. And then there were two cold gas tests.

And these data were presented on the night of the 27th. All of that was at ambient temperature. And then we did discuss what is a development qualification motor experience range, and that is shown on the

chart. We had experience everywhere from 40 to 85 degrees.

There then were data presented on two cold gas tests at 30 degrees, where the O-ring was pressurized at the motor pressurization rate at 30 degrees, which would indicate that an O-ring would operate before joint rotation at 30 degrees.

**Dr. Ride:** Was that actually in a joint?

**Mr. Mulloy:** No, it is not. It is a full-scale O-ring, full-scale groove, in a scaled test device, where the pressurize rate on that O-ring is zero to 900 psi [pounds per square inch] in 600 milliseconds at a temperature of 30 degrees.

**Dr. Walker:** You would say, then, the O-ring was qualified to a temperature of 30 degrees? Would that be an accurate statement?

**Mr. Mulloy:** The day that we were looking at it, on the 27th, these two tests that we did indicated that it would perform at 30 degrees under the motor pressurization rate before the joint rotated.

**Dr. Walker:** What about, let's consider the putty and the O-ring, because that is really the system that responds to the pressure surge. What temperature was the putty/O-ring system qualified to?

**Mr. Mulloy:** The lowest that I'm aware of—and we're still flushing this out, because this is kind of what we talked about on the 27th, but the lowest that I'm aware of is the 40-degree test on one of the development motors.

**Dr. Walker:** And, of course, during those tests the putty was modified before the test. The putty was not just laid up and then the seal made. The putty was then smoothed out or some attempt was made to remove the volcanoes, I think.

**Mr. Mulloy:** Because the horizontal assembly caused that.

Now, there's one other significant point on this chart that we did discuss, that we didn't have the quantities on on the 27th. and I mentioned this earlier. We have 150 case segment proof tests, with a large number of joints with a simulation of a cold O-ring. That is the 90 durometer with a .275, and that was at about 35 degrees.

So those are the certification data that we kind of discussed, all of which we didn't discuss. The two cold gas tests we did, the segment proof tests we did, the development and qualification motor test we did, as a basis for understanding what we could expect to happen at colder temperatures on the joints.

Mr. Hardy testified as follows:<sup>20</sup>

**Mr. Hardy:** At the teleconference on the evening of January 27, 1986, Thiokol engineering personnel in Utah reviewed charts that had been datafaxed to Huntsville and KSC participants just prior to the beginning of the conference. Now, I am not going to repeat a lot of what you have already heard, but I will give you some of my views on the whole matter.

The presentations were professional in nature. There were numerous questions and answers. There was a discussion of various data and points raised by individuals at Thiokol or at Marshall or at Kennedy. I think it was a rather full discussion. There were some 14 charts presented, and as has been mentioned earlier, we spent about two, two and a half hours reviewing this. To my knowledge, anyone who desired to make a point, ask a question or express a view was in no way restrained from doing so.

As others have mentioned, I have heard this particular teleconference characterized as a heated discussion. I acknowledge that there were penetrating questions that were asked, I think, from both, from all people involved. There were various points of view and an interpretation of the data that was exchanged. The discussion was not, in my view, uncharacteristic of discussions on many flight readiness issues on many previous occasions. Thiokol engineering concluded their presentation with recommendation that the launch time be determined consistent with flight experience to date, and that is the launch with the O-ring temperatures at or greater than 53 degrees Fahrenheit.

Mr. Kilminster at Thiokol stated . . . to the best of my recollection, that with that engineering assessment, he recommended we not launch on Tuesday morning as scheduled. After some short discussion, Mr.

Mulloy at KSC summarized his assessment of the data and his rationale with that data, and I think he has testified to that.

Mr. Reinartz, who was at KSC, asked me for comment, and I stated I was somewhat appalled, and that was referring specifically to some of the data or the interpretation of some of the data that Thiokol had presented with respect to its influence on the joint seal performance relative to the issue under discussion, which specifically was the possibility that the primary seal may take longer to actuate and therefore to blow by the primary seal. The blow-by of the primary seal may be longer, and I am going to elaborate on that a little further in this statement.

Then I went on to say that I supported the assessment of data presented essentially as summarized by Mr. Mulloy, but I would not recommend launch over Thiokol's objections.

Somewhere about this time, Mr. Kilminster at Utah stated that he wanted to go off the loop to caucus for about five minutes. I believe at this point Mr. McDonald, the senior Thiokol representative at KSC for this launch suggested to Mr. Kilminster that he consider a point that I think I had made earlier, that the secondary O-ring is in the proper position to seal if blow-by of the primary O-ring occurred.

I clearly interpreted this as a somewhat positive statement of supporting rationale for launch. . . . The status of the caucus by Thiokol lasted some 30, 35 minutes. At Huntsville during this Thiokol caucus, we continued to discuss the data presented. We were off the loop, we were on mute. We were around a table in small groups. It was not an organized type discussion. But I did take that opportunity to discuss my assessment and understanding of the data with several of my key advisors, and none of us had any disagreement or differences in our interpretation of what we believed the data was telling us with regard to the primary issue at hand.

When Thiokol came back on line, Mr. Kilminster reviewed rationale that supported proceeding with the launch and so recommended.

Mr. Reinartz asked if anyone in the loop had a different position or disagreed or something to that effect, with the Thiokol recommendation as presented by Mr. Kilminster. There were no dissenting responses.

The telecon was terminated shortly after, and I have no knowledge of any subsequent events or discussions between personnel at KSC or at Thiokol on this matter.

At about 5:00 a.m. on January 28, a discussion took place among Messrs. Mulloy, Lucas, and Reinartz in which Mulloy reported to Lucas only that there had been a discussion with Thiokol over their concerns about temperature effects on the O-rings, and that it had been resolved in favor of launch. The following testimony of Mr. Mulloy and Dr. Lucas recount that discussion:<sup>21</sup>

**General Kutyna:** . . . Larry, let me follow through on that, and I am kind of aware of the launch decision process, and you said you made the decision at your level on this thing.

If this were an airplane, an airliner, and I just had a two-hour argument with Boeing on whether the wing was going to fall off or not, I think I would tell the pilot, at least mention it.

Why didn't we escalate a decision of this importance?

**Mr. Mulloy:** I did, sir.

**General Kutyna:** You did?

**Mr. Mulloy:** Yes, sir.

**General Kutyna:** Tell me what levels above you.

**Mr. Mulloy:** As I stated earlier, Mr. Reinartz, who is my manager, was at the meeting, and on the morning, about 5:00 o'clock in the operations support room where we all were I informed Dr. Lucas of the content of the discussion.

**General Kutyna:** But this is not in the launch decision chain.

**Mr. Mulloy:** No, sir. Mr. Reinartz is in the launch decision chain, though.

**General Kutyna:** And is he the highest level in that chain?

**Mr. Mulloy:** No. Normally it would go from me to Mr. Reinartz to Mr. Aldrich to Mr. Moore.

Dr. Lucas' testimony is as follows:<sup>22</sup>

**Chairman Rogers:** Would you please tell the Commission when you first heard about the problem of the O-rings and the seals insofar as it involves launch 51-L? And I don't want you to go way back, but go back to when you first heard. I guess it was on January 27th, was it?

**Dr. Lucas:** Yes, sir. It was on the early evening of the 27th, I think about 7:00 p.m., when I was in my motel room along with Mr. Kingsbury. And about that time, Mr. Reinartz and Mr. Mulloy came to my room and told me that they had heard that some members of Thiokol had raised a concern about the performance of the Solid Rocket Boosters in the low temperature that was anticipated for the next day, specifically on the seals, and that they were going out to the Kennedy Space Center to engage in a telecon with the appropriate engineers back at Marshall Space Flight Center in Huntsville and with corresponding people back at the Wasatch division of Thiokol in Utah.

And we discussed it a few moments and I said, fine, keep me informed, let me know what happens.

**Chairman Rogers:** And when was the next time you heard something about that?

**Dr. Lucas:** The next time was about 5:00 a.m. on the following morning, when I went to the Kennedy Space Center and went to the launch control center. I immediately saw Mr. Reinartz and Mr. Mulloy and asked them how the matter of the previous evening was dispositioned.

**Chairman Rogers:** You had heard nothing at all in between?

**Dr. Lucas:** No, sir.

**Chairman Rogers:** So from 8:00 o'clock that evening until 5:00 o'clock in the morning, you had not heard a thing?

**Dr. Lucas:** It was about 7:00, I believe, sir. But for that period of time, I heard nothing in the interim. . .

**Chairman Rogers:** . . . And you heard Mr. Reinartz say he didn't think he had to notify you, or did he notify you?

**Dr. Lucas:** He told me, as I testified, when I went into the control room, that an issue had been resolved, that there were some peo-

ple at Thiokol who had a concern about the weather, that that had been discussed very thoroughly by the Thiokol people and by the Marshall Space Flight Center people, and it had been concluded agreeably that there was no problem, that he had a recommendation by Thiokol to launch and our most knowledgeable people and engineering talent agreed with that. So from my perspective, I didn't have—I didn't see that as an issue.

**Chairman Rogers:** And if you had known that Thiokol engineers almost to a man opposed the flight, would that have changed your view?

**Dr. Lucas:** I'm certain that it would.

**Chairman Rogers:** So your testimony is the same as Mr. Hardy's. Had he known, he would not have recommended the flight be launched on that day.

**Dr. Lucas:** I didn't make a recommendation one way or the other. But had I known that, I would have then interposed an objection, yes.

**Chairman Rogers:** I gather you didn't tell Mr. Aldrich or Mr. Moore what Mr. Reinartz had told you?

**Dr. Lucas:** No, sir. That is not the reporting channel. Mr. Reinartz reports directly to Mr. Aldrich. In a sense, Mr. Reinartz informs me as the institutional manager of the progress that he is making in implementing his program, but that I have never on any occasion reported to Mr. Aldrich.

**Chairman Rogers:** And you had subsequent conversations with Mr. Moore and Mr. Aldrich prior to the flight and you never mentioned what Mr. Reinartz had told you?

**Dr. Lucas:** I did not mention what Mr. Reinartz told me, because Mr. Reinartz had indicated to me there was not an issue, that we had a unanimous position between Thiokol and the Marshall Space Flight Center, and there was no issue in his judgment, nor in mine as he explained it to me.

**Chairman Rogers:** But had you known, your attitude would have been totally different?

**Dr. Lucas:** Had I had the advantage at that time of the testimony that I have heard here this week, I would have had a different attitude, certainly.

**Chairman Rogers:** In view of the fact that you were running tests to improve the joint, didn't the fact that the weather was so bad and Reinartz had told you about the questions that had been raised by Thiokol, at least, didn't that cause you serious concern?

**Dr. Lucas:** I would have been concerned if Thiokol had come in and said, we don't think you should launch because we've got bad weather.

**Chairman Rogers:** Well, that's what they did, of course, first. That is exactly what they did. You didn't know that?

**Dr. Lucas:** I knew only that Thiokol had raised a concern.

**Chairman Rogers:** Did you know they came and recommended against the launch, is the question?

**Dr. Lucas:** I knew that I was told on the morning of the launch that the initial position of some members of Thiokol—and I don't know who it was—had recommended that one not launch with the temperature less than 53 degrees Fahrenheit.

**Chairman Rogers:** And that didn't cause you enough concern so you passed that information on to either Mr. Moore or Mr. Aldrich?

**Dr. Lucas:** No, sir, because I was shown a document signed by Mr. Kilminster that indicated that that would not be significant, that the temperature would not be—that it would be that much lower, as I recall it.

It is clear that crucial information about the O-ring damage in prior flights and about the Thiokol engineers' argument with the NASA telecon participants never reached Jesse Moore or Arnold Aldrich, the Levels I and II program officials, or J.A. (Gene) Thomas, the Launch Director for 51-L. The testimony of Aldrich describes this failure of the communication system very aptly:<sup>23</sup>

**Dr. Feynman:** . . . have you collected your thoughts yet on what you think is the cause—I wouldn't call it of the accident but the lack of communication which we have seen and which everybody is worried about from one level to another? . . .

**Mr. Aldrich:** Well, there were two specific breakdowns at least, in my impression,

about that situation. One is the situation that occurred the night before the launch and leading up to the launch where there was a significant review that has been characterized in a number of ways before the Commission and the Commission's Subpanels and the fact that that was not passed forward.

And I can only conclude what has been reported, and that is that the people responsible for that work in the Solid Rocket Booster project at Marshall believed that the concern was not of a significance that would be required to be brought forward because clearly the program requirements specify that critical problems should be brought forward to Level II and not only to Level II but through myself to Level I.

The second breakdown in communications, however, and one that I personally am concerned about is the situation of the variety of reviews that were conducted last summer between the NASA Headquarters Organization and the Marshall Organization on the same technical area and the fact that that was not brought through my office in either direction—that is, it was not worked through—by the NASA Headquarters Organization nor when the Marshall Organization brought these concerns to be reported were we involved.

And I believe that is a critical breakdown in process and I think it is also against the documented reporting channels that the program is supposed to operate to.

Now, it in fact did occur in that matter. In fact, there is a third area of concern to me in the way the program has operated. There is yet one other way that could have come to me, given a different program structure. I'm sure you've had it reported to you as it has been reported to me that in August or I think or at least at some time late in the summer or early fall the Marshall SRB project went forward to procure some additional Solid Rocket Motor casings to be machined and new configurations for testing of the joints.

Now it turns out that the budget for that kind of work does not come through my Level II office. It is worked directly between the Marshall Center in NASA Headquarters and there again had I been responsible for

## Shuttle Program Management Structure

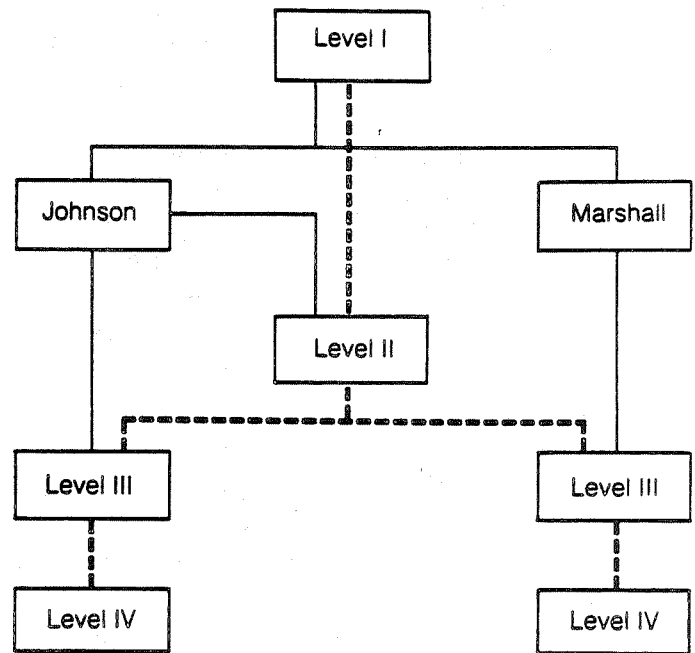

— Institutional Chain  
 - - - - - Program Chain

- Level I:** The associate administrator for Space Flight. Oversees budgets for Johnson, Marshall and Kennedy. Responsible for policy, budgetary and top-level technical matters for Shuttle program.
- Level II:** Manager, National Space Transportation Program. Responsible for Shuttle program baseline and requirements. Provides technical oversight on behalf of Level I.
- Level III:** Program managers for Orbiter, Solid Rocket Booster, External Tank and Space Shuttle Main Engine. Responsible for development, testing and delivery of hardware to launch site.
- Level IV:** Contractors for Shuttle elements. Responsible for design and production of hardware.



the budget for that sort of work, it would have to come through me, and it would have been clear that something was going on here that I ought to know about.

And so there are three areas of breakdown, and I haven't exactly answered your question. But I have explained it in the way that I best know it and—well, I can say a fourth thing.

There was some discussion earlier about the amount of material that was or was not reported on O-ring erosion in the FRRs [Flight Readiness Reviews] and I researched the FRR back reports and also the flight anomaly reports that were forwarded to my center—to my office—by the SRB [Solid Rocket Booster] project and as was indicated, there is a treatment of the Solid Rocket Motor O-ring erosion, I believe, for the STS 41-C FRR, which quantifies it and indicates some limited amount of concern.

The next time that is mentioned, I believe it is the STS 51-E, FRR in January 1985 or early in February, and that indicates, again, a reference to it but refers back to the 41-C as the only technical data.

And then from there forward the comment on O-ring erosion only is that there was another instance and it is not of concern.

Clearly the amount of reporting in the FRR is of concern to me, but in parallel with that, each of the flight anomalies in the STS program are required to be logged and reviewed by each of the projects and then submitted through the Level II system for formal close-out.

And in looking back and reviewing the anomaly close-outs that were submitted to Level II from the SRB project, you find that O-ring erosion was not considered to be an anomaly and, therefore, it was not logged and, therefore, there are not anomaly reports that progress from one flight to the other.

Yet, that is another way that that information could have flagged the system, and the system is set up to use that technique for flagging.

But if the erosion is classified as not an anomaly, it then is in some other category and the system did not force it in that direction. None of those are very focused answers, but they were all factors.

The Commission Chairman, Mr. Rogers, asked four key officials about their knowledge of the Thiokol objections to launch:<sup>24</sup>

**Chairman Rogers:** . . . By way of a question, could I ask, did any of your gentlemen prior to launch know about the objections of Thiokol to the launch?

**Mr. Smith** [Kennedy Space Center Director]: I did not.

**Mr. Thomas** [Launch Director]: No, sir.

**Mr. Aldrich** [Shuttle Program Director]: I did not.

**Mr. Moore** [Associate Administrator for Space Flight]: I did not.

Additionally, in further testimony J.A. (Gene) Thomas commented on the launch.<sup>25</sup>

**Mr. Hotz:** . . . Mr. Thomas, you are familiar with the testimony that this Commission has taken in the last several days on the relationship of temperature to the seals in the Solid Rocket Booster?

**Mr. Thomas:** Yes, sir, I have been here all week.

**Mr. Hotz:** Is this the type of information that you feel that you should have as Launch Director to make a launch decision?

**Mr. Thomas:** If you refer to the fact that the temperature according to the Launch Commit Criteria should have been 53 degrees, as has been testified, rather than 31, yes, I expect that to be in the LCC. That is a controlling document that we use in most cases to make a decision for launch.

**Mr. Hotz:** But you are not really very happy about not having had this information before the launch?

**Mr. Thomas:** No, sir. I can assure you that if we had had that information, we wouldn't have launched if it hadn't been 53 degrees.

## Findings

1. The Commission concluded that there was a serious flaw in the decision making process leading up to the launch of flight 51-L. A well structured and managed system emphasizing safety would have flagged the rising doubts about the Solid Rocket Booster joint seal. Had these matters been clearly stated and emphasized in the flight readiness process in terms reflecting the views of most of the Thiokol engineers and at least some of the Marshall engineers, it seems likely that the launch of 51-L might not have occurred when it did.

2. The waiving of launch constraints appears to have been at the expense of flight safety. There was no system which made it imperative that launch constraints and waivers of launch constraints be considered by all levels of management.

3. The Commission is troubled by what appears to be a propensity of management at Marshall to contain potentially serious problems and to attempt to resolve them internally rather than communicate them forward. This tendency is altogether at odds with the need for Marshall to function as part of a system working toward successful flight missions, interfacing and communicating with the other parts of the system that work to the same end.

4. The Commission concluded that the Thiokol Management reversed its position and recommended the launch of 51-L, at the urging of Marshall and contrary to the views of its engineers in order to accommodate a major customer. ■

---

## Chronology of Events Related to Temperature Concerns Prior to Launch of Challenger (STS 51-L)

<i>Time</i>	<i>Key Participants</i>	<i>Event</i>
12:36 PM (EST) January 27, 1986	<i>NASA Project Managers and Contractor Support Personnel (including Morton Thiokol).</i>	■ <i>Launch Scrub.</i> Decision is made to scrub due to high crosswinds at launch site.
Approximately 1:00 PM (EST)	<i>Same as above.</i>	■ <i>Post-Scrub Discussion.</i> All appropriate personnel are polled as to feasibility to launch again with 24-hour cycle and it results in no SRB constraints for launch at 9:38 AM, 28 January 1986. ■ Request is made for all participants to report any constraints.
Approximately 1:00 PM (EST)	<i>Kennedy Space Center</i> (1) Boyd C. Brinton, Manager, Space Booster Project, MTI; (2) Lawrence O. Wear, Manager, SRM Project Office, Marshall.  <i>Morton Thiokol, Utah</i> (1) Arnold R. Thompson, Supervisor, Rocket Motor Cases; (2) Robert Ebeling, Manager, Ignition System and Final Assembly, SRM Project.	■ <i>Conversation.</i> Wear asks Brinton if Thiokol had any concerns about predicted low temperatures and about what Thiokol had said about cold temperature effects following January 1985 flight 51-C. ■ Brinton telephones Thompson and other MTI personnel to ask them to determine if there were concerns based on predicted weather conditions. Ebeling and other engineers are notified and asked for evaluation.

<i>Time</i>	<i>Key Participants</i>	<i>Event</i>
Approximately 2:00 PM (EST)	<p><i>NASA Levels I and II Management With Appropriate Program Managers and Contract Personnel</i></p> <p>(1) Jesse W. Moore, Associate Administrator, Space Flight, NASA HQ, and Director, JSC;  (2) Arnold D. Aldrich, Manager, Space Transportation Systems Program, JSC;  (3) Lawrence B. Mulloy, Manager, SRB Project, Marshall Space Flight Center (MSFC);  (4) Dr. William Lucas, Director, MSFC.</p>	<p>■ <i>Mission Management Team Meeting.</i> Discussion is centered around the temperature at the launch facility and weather conditions predicted for launch at 9:38 AM on 28 January 1986.</p>
Approximately 2:30 PM (EST)	<p><i>At Thiokol, Utah</i></p> <p>(1) R. Boisjoly, Seal Task Force, Morton Thiokol, Utah;  (2) Robert Ebeling, Manager, Ignition System and Final Assembly, SRM Project.</p>	<p>■ Boisjoly learns of cold temperatures at Cape at meeting convened by Ebeling</p>
Approximately 4:00 PM (EST)	<p><i>At Kennedy Space Center</i></p> <p>(1) Allan J. McDonald, Director, SRM Project, Morton Thiokol;  (2) Carver Kennedy, Director of Vehicle Assembly Building Operations, and Vice President of Space Operations at KSC, for Morton Thiokol.</p> <p><i>At Thiokol, Utah</i></p> <p>Robert Ebeling, Department Manager, Ignition System and Final Assembly, SRM Project.</p>	<p>■ <i>Telephone Conversation.</i> McDonald receives call at Carver Kennedy's residence from Ebeling expressing concern about performance of SRB field joints at low temperatures.</p> <p>■ McDonald indicates he will call back latest temperature predictions up to launch time.</p> <p>■ Carver Kennedy calls Launch Operations Center and received latest temperature information.</p> <p>■ McDonald transmits data to Utah and indicates will set up telecon and asks engineering to prepare.</p>
Approximately 5:15 PM (EST)	<p><i>At Kennedy Space Center</i></p> <p>(1) Allan J. McDonald, Director, SRM Project, Morton Thiokol, Inc.;  (2) Cecil Houston, MSFC Resident Manager, at KSC.</p>	<p>■ <i>Telephone Conversation.</i> McDonald calls Cecil Houston informing him that Morton Thiokol engineering had concerns regarding O-ring temperatures.</p> <p>■ Cecil Houston indicates he will set up teleconference with Marshall Space Flight Center and Morton Thiokol.</p>

<i>Time</i>	<i>Key Participants</i>	<i>Event</i>
Approximately 5:25 PM (EST)	<p><i>At Kennedy Space Center</i> Cecil Houston, MSFC Resident Manager, at KSC.</p> <p><i>At Marshall Space Flight Center</i> Judson A. Lovingood, Deputy Manager, Shuttle Projects Office, MSFC.</p>	<p>■ <i>Telephone Conversation.</i> Cecil Houston calls Lovingood, informing him of the concerns of temperature on the O-rings and asks him to establish a telecon with:</p> <p>(1) Stanley R. Reinartz, Manager, Shuttle Projects Office, MSFC (at Kennedy);</p> <p>(2) Lawrence B. Mulloy, Manager, SRB Project, MSFC (at Kennedy);</p> <p>(3) George Hardy, Deputy Director, Science and Engineering (at Marshall);</p> <p>(4) Thiokol Wasatch Division personnel.</p>
Approximately 5:30 PM (EST)	<p><i>At Kennedy Space Center</i> Stanley R. Reinartz, Manager, Shuttle Projects Office, MSFC</p> <p><i>At Marshall Space Flight Center</i> Judson A. Lovingood, Deputy Manager, Shuttle Projects Office, MSFC.</p>	<p>■ <i>Telephone Conversation.</i> Lovingood calls Reinartz to inform him of planned 5:45 PM (EST) teleconference.</p> <p>■ Lovingood proposes that Kingsbury (Director of Science and Engineering, MSFC), participate in teleconference.</p>
Approximately 5:45 PM (EST)	<p><i>At Kennedy Space Center</i> Stanley R. Reinartz, Manager, Shuttle Projects Office (MSFC).</p> <p><i>At Marshall Space Flight Center</i> Judson A. Lovingood, Deputy Manager, Shuttle Projects Office, MSFC.</p> <p><i>Plus other personnel at Kennedy, Marshall, and Thiokol, Utah.</i></p>	<p>■ <i>First Teleconference.</i> Concerns regarding temperature effects on the O-rings are discussed.</p> <p>■ MTI is of the opinion launch should be delayed until Noon or afternoon.</p> <p>■ It is decided that another telecon at 8:15 PM will be set up to transmit the data to all of the parties and to have more personnel involved.</p> <p>■ Lovingood recommends to Reinartz to include Lucas, Director, MSFC and Kingsbury in 8:45 PM conference and to plan to go to Level II if MTI recommends not launching.</p>
Approximately 6:30 PM (EST)	<p><i>At Marshall Space Flight Center</i> Judson A. Lovingood, Deputy Manager, Shuttle Projects Office, MSFC.</p> <p><i>At Kennedy Space Center</i> Stanley R. Reinartz, Manager, Shuttle Projects Office, MSFC.</p>	<p>■ <i>Telephone Conversation.</i> Lovingood calls Reinartz and tells him that if Thiokol persists, they should not launch.</p> <p>■ Lovingood also suggests advising Aldrich, Manager, National Transportation System (Level II), of teleconference to prepare him for Level I meeting to inform of possible recommendation to delay.</p>

<i>Time</i>	<i>Key Participants</i>	<i>Event</i>
Approximately 7:00 PM (EST)	<i>At Kennedy Space Center</i> (1) Lawrence B. Mulloy, Manager, SRB Project, MSFC. (2) Stanley R. Reinartz, Manager, Shuttle Projects Office, MSFC; (3) Dr. William Lucas, Director, MSFC; (4) Jim Kingsbury, Director of Science and Engineering, MSFC.	<ul style="list-style-type: none"> <li>■ <i>Conversation.</i> Reinartz and Mulloy visit Lucas and Kingsbury in their motel rooms to inform them of Thiokol concern and planned teleconference.</li> </ul>
Approximately 8:45 PM (EST)	<i>At Morton Thiokol, Utah</i> (1) Jerald Mason, Senior Vice President, Wasatch Operations; (2) Calvin Wiggins, Vice President and General Manager, Space Division, Wasatch; (3) Joe C. Kilminster, Vice President, Space Booster Programs, Wasatch; (4) Robert K. Lund, Vice President, Engineering; (5) Roger Boisjoly, Member Seal Task Force; (6) Arnold R. Thompson, Supervisor, Rocket Motor Cases. <i>At Kennedy Space Center</i> (1) Stanley R. Reinartz, Manager, Shuttle Projects Office, MSFC; (2) Lawrence B. Mulloy, Manager, SRB Project, MSFC; (3) Allan J. McDonald, Director, SRM Project, MTI. <i>At Marshall Space Flight Center</i> (1) George B. Hardy, Deputy Director, Science and Engineering; (2) Judson A. Lovingood, Deputy Manager, Shuttle Project Office; (3) Ben Powers, Engineering Structures and Propulsion. <i>Plus other personnel (see table page 111).</i>	<ul style="list-style-type: none"> <li>■ <i>Second Teleconference.</i> Charts present a history of the O-ring erosion and blow-by for the primary seal in the field joints, including results of subscale tests, previous flights and static tests of Solid Rocket Motors.</li> <li>■ The data shows that the timing function of the O-rings will be slower due to lower temperatures and that the worst blow-by occurred on SRM 15 (STS 51-C) in January 1985 with O-ring temperatures of 53 degrees Fahrenheit.</li> <li>■ Recommendation by Thiokol (Lund) is not to fly STS 51-L (SRM-25) until the temperature of the O-ring reached 53 degrees Fahrenheit, which was the lowest temperature of any previous flight.</li> <li>■ Mulloy asks for recommendation from Kilminster.</li> <li>■ Kilminster states that based upon the engineering recommendation, he can <i>not</i> recommend launch.</li> <li>■ Hardy is reported by both McDonald and Boisjoly to have said he is "appalled" by Thiokol's recommendation.</li> <li>■ Reinartz comments that he is under the impression that SRM is qualified from 40 degrees Fahrenheit to 90 degrees Fahrenheit.</li> <li>■ NASA personnel challenge conclusions and recommendations.</li> <li>■ Kilminster asks for five minutes off-net to caucus.</li> </ul>

Approximately  
10:30 PM (EST)

*Thiokol Personnel*

- (1) Jerald Mason, Senior Vice President, Wasatch Operations;
- (2) Joe C. Kilminster, Vice President, Space Booster Program;
- (3) Calvin Wiggins, Vice President and General Manager, Space Division;
- (4) Robert K. Lund, Vice President, Engineering;
- (5) Arnold R. Thompson, Supervisor, Rocket Motor Cases;
- (6) Roger Boisjoly, Member, Seal Task Force;
- (7) Brian Russell, Special Projects, SRM Program Office;
- (8) Robert Ebeling, Manager, Ignition System and Final Assembly, SRM Project.

*Plus other personnel*

- *Thiokol Caucus.* Caucus continues for about 30 minutes at Thiokol, Wasatch, Utah.
- Major issues are (1) temperature effects on O-ring, and (2) erosion of the O-ring.
- Thompson and Boisjoly voice objections to launch and indication is that Lund also is reluctant to launch.
- A final management review is conducted with only Mason, Lund, Kilminster, and Wiggins.
- Lund is asked to put on management hat by Mason.
- Final agreement is: (1) there is a substantial margin to erode the primary O-ring by a factor of three times the previous worst case, and (2) even if the primary O-ring does not seal, the secondary is in position and will.

Approximately  
10:30 PM to  
11:00 PM (EST)

*At Kennedy Space Center*

- (1) Allan J. McDonald, Manager, Space Booster Project, Morton Thiokol, Inc. (MTI);
- (2) Lawrence B. Mulloy, Manager, SRB Projects, MSFC;
- (3) Stanley R. Reinartz, Manager, Shuttle Projects, MSFC;
- (4) Jack Buchanan, Manager, KSC Operations, for MTI;
- (5) Cecil Houston, MSFC Resident manager, at KSC.

- *Conversation at Kennedy.* McDonald continues to argue for delay.
- McDonald challenges Reinartz's rationale that SRM is qualified at 40 degrees F. to 90 degrees F., and Mulloy's explanation that Propellant Mean Bulk Temperatures are within specifications.

Approximately  
11:00 PM (EST)

*Same participants as 8:45 PM Teleconference.*

- *Second Teleconference (Cont'd).* Thiokol indicates it had reassessed; temperature effects are concern, but data is inconclusive.
- Kilminster reads the rationale for recommending launch.
- Thiokol recommends launch.
- Hardy requests that Thiokol put in writing their recommendation and send it by fax to both Kennedy and Marshall.

<i>Time</i>	<i>Key Participants</i>	<i>Event</i>
Approximately 11:15 to 11:30 PM (EST)	<i>At Kennedy Space Center</i> (1) Allan J. McDonald, Manager, Space Booster Project, MTI; (2) Lawrence Mulloy, Manager, SRB Projects Office, MSFC; (3) Stanley R. Reinartz, Manager, Shuttle Projects Office, MSFC; (4) Jack Buchanan, Manager, KSC Operations, for MTI; (5) Cecil Houston, Manager, MSFC Resident Office at KSC.	<ul style="list-style-type: none"> <li>■ <i>Conversation at Kennedy.</i> McDonald argues again for delay asking how NASA could rationalize launching below qualification temperature.</li> <li>■ McDonald indicates if anything happened, he would not want to have to explain to Board of Inquiry.</li> <li>■ McDonald indicates he would cancel launch since (1) O-ring problem at low temperatures; (2) booster recovery ships heading into wind toward shore due to high seas, and (3) icing conditions on launch pad.</li> <li>■ McDonald is told it is not his concern and that his above concerns will be passed on in advisory capacity.</li> </ul>
Approximately 11:45 PM (EST)		<ul style="list-style-type: none"> <li>■ <i>Telefax.</i> Kilminster faxes Thiokol's recommendation to launch at 9:45 MST, 27 January 1986 (11:45 EST).</li> <li>■ Fax is signed by Kilminster.</li> <li>■ McDonald retrieves fax at KSC.</li> </ul>
Approximately 11:30 PM to 12:00 AM (EST)	<i>At Kennedy Space Center</i> (1) Lawrence B. Mulloy, Manager, SRB Projects Office, MSFC; (2) Stanley R. Reinartz, Manager, Shuttle Projects, MSFC; (3) Arnold D. Aldrich, Manager, National Space Transportation System Program Office, JSC.	<ul style="list-style-type: none"> <li>■ <i>Teleconference.</i> Discussion centers around the recovery ships' activities and brief discussion of the ice issue on the launch complex area.</li> <li>■ Reinartz and Mulloy place call to Aldrich.</li> <li>■ McDonald delivers fax to Jack Buchanan's office at Kennedy Space Center and overhears part of conversation.</li> <li>■ Aldrich is apparently not informed of the O-ring concerns.</li> </ul>
Approximately 12:01 AM (EST) January 28		<ul style="list-style-type: none"> <li>■ Kennedy Space Center meeting breaks up.</li> </ul>
Approximately 1:30 to 3:00 AM (EST)	<i>At Kennedy Space Center</i> (1) Charles Stevenson, Supervisor of Ice Crew; KSC (2) B.K. Davis, Ice Team Member, MSFC	<ul style="list-style-type: none"> <li>■ <i>Ice Crew Inspection of Launch Pad B.</i> Ice crew finds large quantity of ice on Fixed Service Structure, mobile launch platform, and pad apron; and reports conditions.</li> </ul>
Approximately 5:00 AM (EST)	<i>At Kennedy Space Center</i> (1) Lawrence B. Mulloy, Manager, SRB Project, MSFC; (2) Dr. William Lucas, Director, (MSFC); (3) Jim Kingsbury, Director of Science and Engineering, MSFC.	<ul style="list-style-type: none"> <li>■ <i>Conversation.</i> Mulloy tells Lucas of Thiokol's concerns over temperature effects on O-rings and final resolution.</li> <li>■ Lucas is shown copy of Thiokol telefax.</li> </ul>



<i>Time</i>	<i>Key Participants</i>	<i>Event</i>
Approximately 7:00-9:00 AM (EST)	<i>At Kennedy Space Center</i> (1) Charles Stevenson, Supervisor of Ice Crew, KSC; (2) B. K. Davis, Ice Team Member, MSFC.	<ul style="list-style-type: none"> <li>■ <i>Ice Crew Inspection of Launch Pad B.</i> Ice crew inspects Launch Pad B and Challenger for ice formation.</li> <li>■ Davis measures temperatures on SRBs, External Tank, Orbiter, and launch pad with infrared pyrometer.</li> <li>■ Left-hand SRB appears to be about 25 degrees F. and right-hand SRB appears to be about 8 degrees F. near the aft region.</li> <li>■ Ice crew is not concerned since there is no Launch Commit Criteria on surface temperatures and does not report.</li> <li>■ Crew reports patches of sheet ice on lower segment and skirt of left Solid Rocket Booster</li> </ul>
Approximately 8:00 AM (EST)	<i>At Marshall Space Flight Center</i> (1) Judson A. Lovingood, Deputy Manager, Shuttle Projects Office, MSFC; (2) Jack Lee, Deputy Director, MSFC.	<ul style="list-style-type: none"> <li>■ <i>Conversation.</i> Lovingood informs Lee of previous night's discussions.</li> <li>■ He indicates that Thiokol had at first recommended not launching, and then after Wasatch conference recommended launching.</li> <li>■ He also informs Lee that Thiokol is providing in writing their recommendation for launch.</li> </ul>
Approximately 9:00 AM (EST)	<i>NASA Levels I and Level II Management With Appropriate Project Managers and Contract Personnel.</i>	<ul style="list-style-type: none"> <li>■ <i>Mission Management Team Meeting.</i> Ice conditions at launch complex are discussed. There is no apparent discussion of temperature effects on O-ring seal.</li> </ul>
Approximately 10:30 AM (EST)	<i>At Kennedy Space Center</i> (1) Charles Stevenson, Supervisor of Ice Crew; (2) B.K. Davis, Ice Team Member	<ul style="list-style-type: none"> <li>■ <i>Ice Crew Inspection of Launch Pad B.</i> Ice crew inspects Launch Pad B for third time.</li> <li>■ Crew removes ice from water troughs, returns to Launch Control Center at T-20 minutes, reports conditions to Mission Management Team, including fact that ice is still on left Solid Rocket Booster.</li> </ul>
11:38 AM (EST)		<ul style="list-style-type: none"> <li>■ <i>Launch.</i> Challenger (STS 51-L) is launched.</li> </ul>

---

## Final Teleconference Participants

### NASA Marshall Space Flight Center

1. George B. Hardy, Deputy Director, Science and Engineering, MSFC
2. Judson A. Lovingood, Deputy Manager, Shuttle Projects Office, MSFC
3. Leslie F. Adams, Deputy Manager, SRB Project, MSFC
4. Lawrence O. Wear, Manager, SRM Project Office, MSFC
5. John Q. Miller, Technical Assistant, SRM Project, MSFC
6. J. Wayne Littles, Associate Director for Engineering, MSFC
7. Robert J. Schwinghamer, Director, Material and Processes Laboratory, MSFC
8. Wilbur A. Riehl, Chief, Nonmetallic Materials Division, MSFC
9. John P. McCarty, Deputy Director, Structures and Propulsion Laboratory, MSFC
10. Ben Powers, Engineering Structures and Propulsion Laboratory, MSFC
11. James Smith, Chief Engineer, SRB Program, MSFC
12. Keith E. Coates, Chief Engineer, Special Projects Office, MSFC
13. John Schell, Retired Engineer, Materials Laboratory, MSFC

#### Present at KSC

14. Cecil Houston, MSFC Resident Manager, at KSC
15. Stanley R. Reinartz, Manager, Shuttle Projects Office, MSFC
16. Lawrence B. Mulloy, Manager, SRB Project, MSFC

### Morton Thiokol Wasatch Division

1. Jerald Mason, Senior Vice President, Wasatch Operations, MTI
2. Calvin Wiggins, Vice President and General Manager, Space Division, MTI
3. Joe C. Kilminster, Vice President, Space Booster Programs, MTI
4. Robert K. Lund, Vice President, Engineering, MTI
5. Larry H. Sayer, Director, Engineering and Design, MTI
6. William Macbeth, Manager, Case Projects, Space Booster Project Engineering, Wasatch Division, MTI
7. Donald M. Ketner, Supervisor, Gas Dynamics Section and Head Seal Task Force, MTI
8. Roger Boisjoly, Member, Seal Task Force, MTI
9. Arnold R. Thompson, Supervisor, Rocket Motor Cases, MTI
10. Jack R. Kapp, Manager, Applied Mechanics Department, MTI
11. Jerry Burn, Associate Engineer, Applied Mechanics, MTI
12. Joel Maw, Associate Scientist, Heat Transfer Section, MTI
13. Brian Russell, Manager, Special Projects, SRM Project, MTI
14. Robert Ebeling, Manager, Ignition System and Final Assembly, SRB Project, MTI

#### Present at MSFC

15. Boyd C. Brinton, Manager, Space Booster Project, MTI
16. Kyle Speas, Ballistics Engineer, MTI

#### Present at KSC

17. Allan J. McDonald, Director, SRM Project, MTI
18. Jack Buchanan, Manager, KSC Operations, MTI

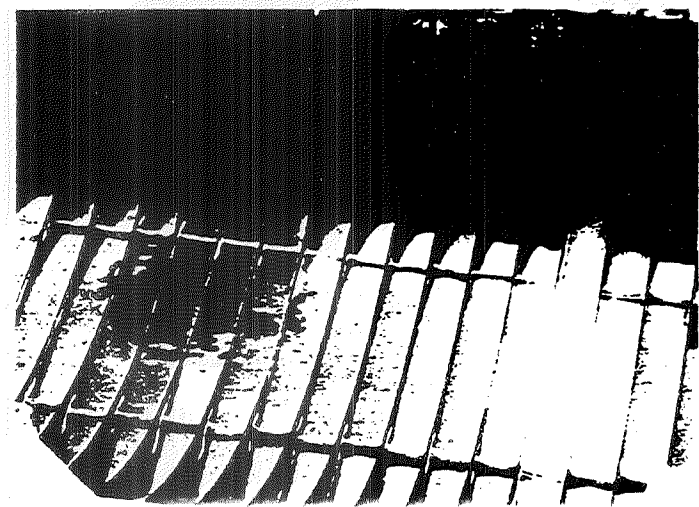
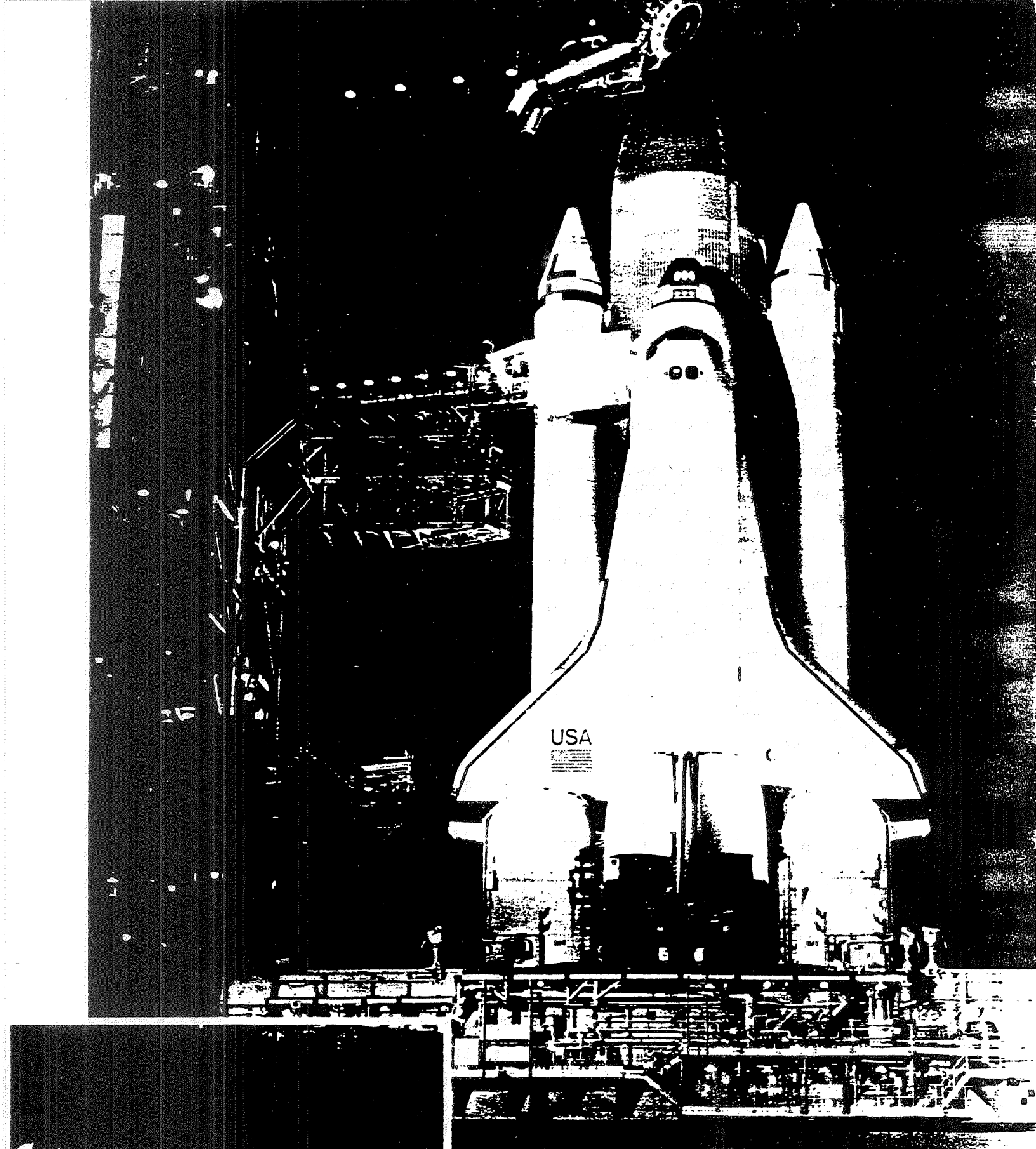

Above, Shuttle 51-L on Kennedy Space Center Pad 39B in the early morning of launch day. Temperatures were well below freezing, as indicated by the lower left photo, which shows thick ice in a water trough despite use of an anti-freeze solution.

**ORIGINAL PAGE IS  
OF POOR QUALITY**

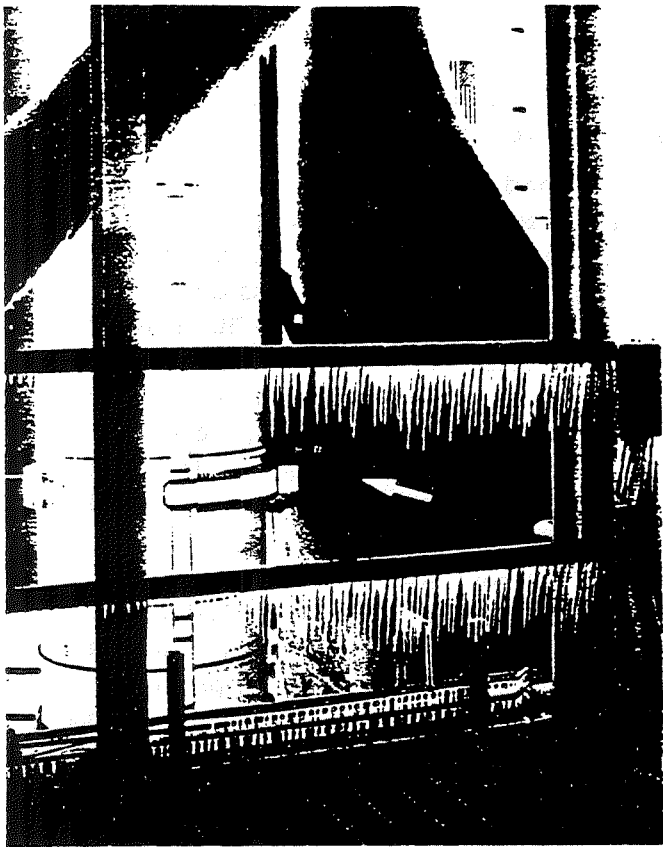

Above, foot long icicles on a lower level of the Fixed Service Structure frame the attachment point where the Orbiter is attached to the external tank (arrow). Icing was even more extensive at upper levels of the service structure (upper right and below). At right below is a ground communications box (not used during launch) rendered inoperable by heavy ice.

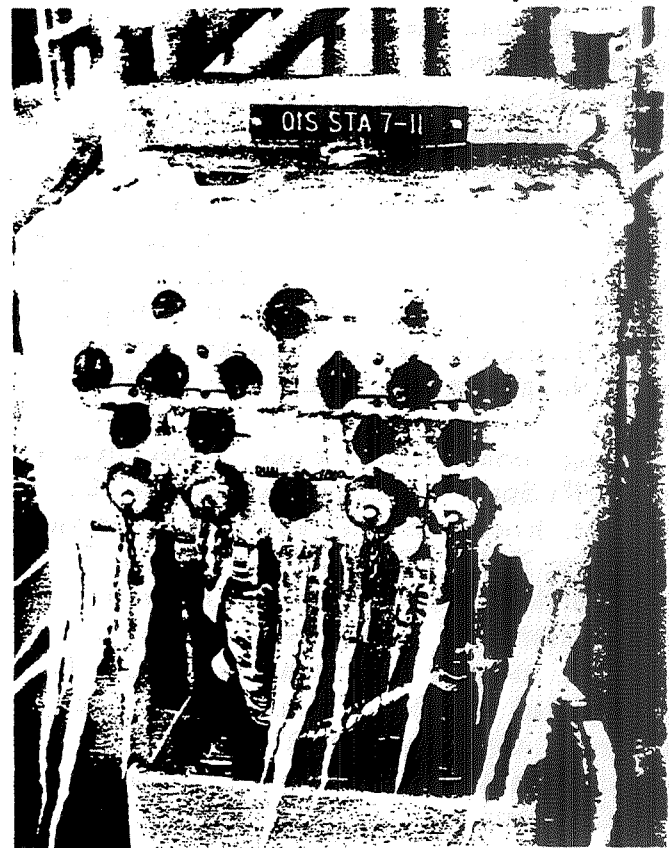
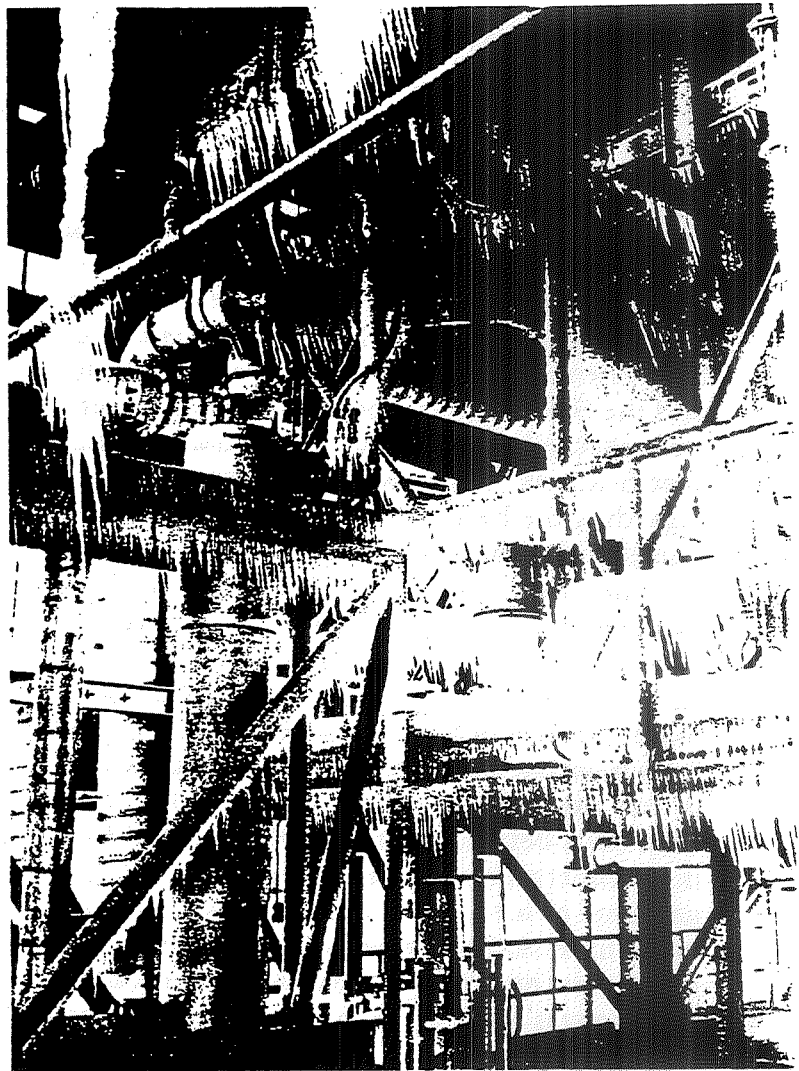

## Ambiguities In The Decision Making Process

During the night and early morning of January 28, another problem was developing due to the extreme cold weather, predicted to be in the low 20s for approximately 11 hours. Reaction control system heaters on the Orbiter were activated and the Solid Rocket Booster recovery batteries were checked and found to be functioning within specifications. There were no serious concerns regarding the External Tank. The freeze protection plan for the launch pad was implemented, but the results were not what had been anticipated. The freeze protection plan usually involves completely draining the water system. However, this was not possible because of the imminent launch of 51-L. In order to prevent pipes from freezing, a decision was made to allow water to run slowly from the system. This had never been done before, and the combination of freezing temperatures and stiff winds caused large amounts of ice to form below the 240-foot level of the fixed service structure including the access to the crew emergency egress slide wire baskets. Ice also was forming in the water trays beneath the vehicle.

These conditions were first identified by the Ice Team at approximately 2:00 a.m. on January 28 and were assessed by management and engineering throughout the night, culminating with a Mission Management Team meeting at 9:00 a.m. At this meeting, representatives for the Orbiter prime contractor, Rockwell International, expressed their concern about what effects the ice might have on the Orbiter during launch. Rockwell had been alerted about the icing conditions during the early morning and was working on the problem at its Downey, California, facility.

During Commission hearings, the president of Rockwell's Space Transportation Systems Division, Dr. Rocco Petrone, and two of his vice presidents, Robert Glaysher and Martin Cioffoletti, all described the work done regarding the ice conditions and the Rockwell position at the 9:00 a.m. meeting with regard to launch. Dr. Petrone had arrived at Kennedy on Friday, January 24. On Monday the 27th he left to return to Rockwell's facility in California, but Glaysher and Cioffoletti remained at Kennedy. Dr. Petrone testified that he first heard about the ice

at 4:00 a.m. Pacific Standard Time. He explained what followed:<sup>26</sup>

"I had gotten up and went to the support room to support this launch. We have people monitoring consoles, and I checked in, and they told me there was a concern, and when I arrived at about 4:30, 4:40 (PST), I was informed we were working the problem with our aerodynamicist and debris people, but very importantly, we would have to make an input to Kennedy for a meeting scheduled at 6:00 o'clock our time and 9:00 o'clock Florida time.

"We had approximately an hour of work to bring together. The work had been underway when I arrived and was continuing.

"At that time I got on the phone with my Orbiter program managers just to discuss background of where we were, how things stood, and what their concerns were locally. They described what they knew in Florida, and we also in Downey did television input, and we could see some of the ice scenes that were shown here this morning.

"We arrived through a series of meetings to a top level discussion at approximately 5:30 Pacific Standard Time, from which we drew the following conclusions: Ice on the mobile launcher itself, it could be debris. We were very concerned with debris of any kind at the time of launch. With this particular ice, one, could it hit the Orbiter? There was wind blowing from the west. That appeared not to be so, that it wouldn't hit the Orbiter but would land on the mobile launcher. The second concern was what happens to that ice at the time you light your liquid fuel engines, the SSMEs, and would it throw it around and ricochet and potentially hit the Orbiter.

"The third aspect is the one that has been discussed here of aspiration, what would happen when the large SRM [Solid Rocket Motors] motors ignite and in effect suck in air, referred to as aspiration, and ice additionally would come down, how much unknown.

"The prime thing we were concerned about was the unknown base line. We had not launched in conditions of that nature, and we just felt we had an unknown.

"I then called my program managers over in Florida at 5:45 (PST) and said we could

not recommend launching from here, from what we see. We think the tiles would be endangered, and we had a very short conversation. We had a meeting to go through, and I said let's make sure that NASA understands that Rockwell feels it is not safe to launch, and that was the end of my conversation."

Mr. Glaysher, who was at Kennedy, came to the center at approximately 7:45 a.m. EST. He conferred with Rockwell's Chief Engineer as well as the Vice President of Engineering, Dr. John Peller, at Rockwell's Downey plant. At 9:00 a.m., after the ice debris team had reported back from the pad inspection, Glaysher was asked for Rockwell's position on launch. He discussed aspiration effects, the possible ricochet of ice from the fixed service structure, and what the ice resting on the mobile launch platform would do at ignition. Glaysher said he told the Mission Management Team when it met at 9:00 a.m. that the ice was an unknown condition, and Rockwell was unable to predict where the ice would go or the degree of potential damage to the Orbiter thermal protection system if it were struck by the ice. He testified that his recommendation to NASA was:<sup>27</sup>

"[M]y exact quote — and it comes in two parts. The first one was, Rockwell could not 100 percent assure that it is safe to fly which I quickly changed to Rockwell cannot assure that it is safe to fly . . ."

Rockwell's other vice president at Kennedy, Martin Cioffoletti, described the concern about ice in a slightly different manner:<sup>28</sup>

**Mr. Cioffoletti:** Similarly, I was called in and told about the problem and came into the 6:00 o'clock meeting which you heard about a few minutes ago, and at the conclusion of that meeting I spoke with Mr. Dick Kohrs, the deputy program manager from Johnson Space Flight Center, and he asked if we could get the Downey folks to look at the falling ice and how it might reverse toward the vehicle, and also, did we have any information on aspiration effects.

So I did call back to Downey and got the John Peller folks working on that problem, and they did, as you saw from Charlie Stevenson's sketches, predict that the ice would travel only about halfway to the vehi-

cle, freefalling ice carried by the winds. So we felt that ice was not a problem. However, it would land on the mobile launch platform. That we considered a problem. We also investigated the aspiration data base we had, and we had seen the aspiration effect on previous launches where things were pulled into the SRB [Solid Rocket Booster] hole after ignition, but we had never seen anything out as far as the fixed surface tower. So we felt in fact it was an unknown. We did not have the data base to operate from an aspiration effect.

At the 9:00 o'clock meeting, I was asked by Arnie Aldrich, the program manager, to give him the results of our analysis, and I essentially told him what I just told you and felt that we did not have a sufficient data base to absolutely assure that nothing would strike the vehicle, and so we could not lend our 100 percent credence, if you will, to the fact that it was safe to fly . . .

I said I could not predict the trajectory that the ice on the mobile launch platform would take at SRB ignition."

**Chairman Rogers:** But I think NASA's position probably would be that they thought that you were satisfied with the launch. Did you convey to them in a way that they were able to understand that you were not approving the launch from your standpoint?

**Mr. Cioffoletti:** I felt that by telling them we did not have a sufficient data base and could not analyze the trajectory of the ice, I felt he understood that Rockwell was not giving a positive indication that we were for the launch.

After Cioffoletti's testimony at the Commission hearings, Dr. Petrone was pressed for a more detailed description of Rockwell's launch recommendation:<sup>29</sup>

**General Kutyna:** Dr. Petrone, you've got a lot more experience than I have in this business, but the few launch conferences that I have been on the question is very simple. Are you go or are you no-go for launch, and "maybe" isn't an answer. I hear all kinds of qualifications and cautions and considerations here.

Did someone ask you are you go or no-go? Was that not asked?



**Dr. Petrone:** At this particular meeting, as far as—and I was not in Florida, and so I cannot answer that. It had been done at earlier meetings. This was a technical evaluation of a series of problems, and we talked about debris hitting the TPS [thermal protection system] and the tiles, and the long series of reviews that we had done that morning and all led us to a conclusion that they were not safe to fly.

And we transmitted that to program managers along with the technical evaluation quickly of why we had arrived at that.

So much of it is how the question gets raised because earlier we had aspiration work, ricochet work, a number of things which we did, and then we came up with our recommendation.

**Chairman Rogers:** And your recommendation now you say it was, it was unsafe to fly?

**Dr. Petrone:** Correct, sir.

Two things are apparent from the Rockwell testimony. First, Rockwell did not feel it had sufficient time to research and resolve the ice on the pad problem. Second, even though there was considerable discussion about ice, Rockwell's position on launch described above was not clearly communicated to NASA officials in the launch decision chain during the hours preceding 51-L's launch.

At a meeting with Commission investigators on March 4, 1986, at Kennedy, Horace Lamberth, NASA director of Shuttle Engineering, said he did not interpret Rockwell's position at the 9:00 a.m. Mission Management Team meeting on January 28 as being "no-go." Lamberth said the language used by Rockwell was "we can't give you 100 percent assurance" but there was no feeling in his mind that Rockwell was voicing a no-go recommendation. "It just didn't come across as the normal Rockwell no-go safety of flight issues come across."<sup>30</sup> This conclusion is confirmed in part by an interview of Dr. John Peller, Rockwell's Vice President of Engineering, who was assigned the ice problem early Tuesday morning. Dr. Peller, in describing a telephone conversation with the Johnson Director of Engineering, Tom Moser, stated:<sup>31</sup>

**Dr. Peller:** That was a call from Tom Moser to me, in which he asked again to under-

stand my concerns. And I just repeated the same concerns. And he asked, "Did I think that it was likely that the vehicle would take safety critical damage?"

And I said, "From the possibility that the vehicle would take safety critical damage," I said, "there's a probability in a sense that it was probably an unlikely event, but I could not prove that it wouldn't happen . . ."

. . . I never used the words "no-go" for launch. I did use the words that we cannot prove it is safe. And normally that's what we were asked to do. We were unable to do that in this particular case, although it was a strange case, that we normally don't get involved in.

Arnold Aldrich, NASA Mission Management Team Leader, described NASA's view of the ice situation and his recollection of Rockwell's position. He said that on Tuesday morning the mission management team did a detailed analysis of the ice on the fixed service structure. Representatives from the ice team, Rockwell, and the directors of Engineering (Horace Lamberth) and the Orbiter project (Richard Colonna) all considered the problem. Aldrich reported this discussion as follows:<sup>32</sup>

"Following the discussion of the acceptability of the ice threat to the Orbiter, based upon the conditions described in detail of the fixed service structure—and some of that you've seen here portrayed well this morning—I asked the NASA managers involved for their position on what they felt about the threat of that to the Orbiter.

"Mr. Lamberth reported that KSC [Kennedy Space Center] engineering had calculated the trajectories, as you've heard, of the falling ice from the fixed service structure east side, with current 10-knot winds at 300 degrees, and predicted that none of this ice would contact the Orbiter during its ignition or launch sequence; and that their calculations even showed that if the winds would increase to 15 knots, we still would not have contact with the Orbiter.

"Mr. Colonna, Orbiter project manager, reported that similar calculations had been performed in Houston by the mission evaluation team there. They concurred in this assessment. And further, Mr. Colonna stated that, even if these calculations were



significantly in error, that it was their belief that falling ice from the fixed service structure, if it were in fact to make its way to the Orbiter, it would only be the most lightweight ice that was in that falling stream, and it would impact the Orbiter at a very oblique angle.

"Impacts of this type would have very low probability of causing any serious damage to the Orbiter, and at most would result in post-flight turnaround repairs.

"At this point I placed a phone call to Mr. Moser that I had previously mentioned, director of Engineering at the Johnson Space Center, who was in the mission evaluation room, and he confirmed the detailed agreement with Mr. Lamberth's and Mr. Colonna's position. . . .

"And both Mr. Lamberth and Mr. Colonna reported that their assessment was that the time it took for the ice to fall, to hit the Orbiter and to rebound, and the location of the fixed service structure on the MLP [mobile launch platform] would not cause that ice in their view to be a concern to rebound and come up and impact the rear end of the Orbiter.

"Following these discussions, I asked for a position regarding proceeding with the launch. Mr. Colonna, Mr. Lamberth, and Mr. Moser all recommended that we proceed.

"At that time, I also polled Mr. Robert Glaysher, the vice president, Orbiter project manager, Rockwell International STS Division, and Mr. Marty Cioffoletti, Shuttle Integration Project Manager, Rockwell International STS Division. Mr. Glaysher stated — and he had been listening to this entire discussion and had not been directly involved with it, but had been party to this the whole time.

"His statement to me as best I can reconstruct it to report to you at this time was that, while he did not disagree with the analysis that JSC [Johnson Space Center] and KSC had reported, that they would not give an unqualified go for launch as ice on the launch complex was a condition which had not previously been experienced, and thus this posed a small additional, but un-

quantifiable, risk. Mr. Glaysher did not ask or insist that we not launch, however.

"At the conclusion of the above review, I felt reasonably confident that the launch should proceed."

In addition to Rockwell's input, Mr. Aldrich also had reports from other contractors and the ice, frost and debris team at the 9:00 session. Ice on the vehicle assembly appeared to be of no concern; sheet ice in the noise suppression trays had been broken up and removed; as previously noted the ice team reported that there was ice on the fixed service structure between 95 feet above ground and 215 feet; no ice above 255 feet. The north and west sides had large amounts of ice and icicles. The final assessment was made that the ice on the fixed service structure would not strike or damage the Orbiter tiles or the vehicle assembly during ignition or ascent, owing to the considerable horizontal distance between the service structure and the vehicle assembly. The decision was made to launch pending a final ice team review of the launch complex in order to assess any changes in the situation. This inspection was completed following the Mission Management Team meeting and the ice team report indicated no significant change.

## Findings

The Commission is concerned about three aspects of the ice-on-the-pad issue.

1. An analysis of all of the testimony and interviews establishes that Rockwell's recommendation on launch was ambiguous. The Commission finds it difficult, as did Mr. Aldrich, to conclude that there was a no-launch recommendation. Moreover, all parties were asked specifically to contact Aldrich or Moore about launch objections due to weather. Rockwell made no phone calls or further objections to Aldrich or other NASA officials after the 9:00 Mission Management Team meeting and subsequent to the resumption of the countdown.

2. The Commission is also concerned about the NASA response to the Rockwell position at the 9:00 a.m. meeting. While it is understood that decisions have to be made in launching a Shuttle, the Commission is not convinced Levels I and II appropriately considered Rockwell's concern about the ice. However ambiguous Rockwell's position was, it is clear that they did tell NASA that the ice was an unknown condition. Given

the extent of the ice on the pad (see photos pages 112 and 113), the admitted unknown effect of the Solid Rocket Motor and Space Shuttle Main Engines ignition on the ice, as well as the fact that debris striking the Orbiter was a potential flight safety hazard, the Commission finds the decision to launch questionable under those circumstances. In this situation, NASA appeared to be requiring a contractor to prove that it was not safe to launch, rather than proving it was safe. Nevertheless, the Commission has determined that the ice was not a cause of the 51-L accident and does not conclude that NASA's decision to launch specifically overrode a no-launch recommendation by an element contractor.

3. The Commission concluded that the freeze protection plan for launch pad 39B was inadequate. The Commission believes that the severe cold and presence of so much ice on the fixed service structure made it inadvisable to launch on the morning of January 28, and that margins of safety were whittled down too far.

Additionally, access to the crew emergency slide wire baskets was hazardous due to ice conditions. Had the crew been required to evacuate the Orbiter on the launch pad, they would have been running on an icy surface. The Commission believes the crew should have been made aware of the situation, and based on the seriousness of the condition, greater consideration should have been given to delaying the launch. ■

## References

- <sup>1</sup> NASA Program Directive Shuttle FRR. September 26, 1983, Appendix K. Volume I.
- <sup>2</sup> Shuttle Projects Flight Readiness Review Mission 51-L. January 9, 1986.
- <sup>3</sup> STS 51-L Flight Readiness Review, Solid Rocket Booster, January 15, 1986.
- <sup>4</sup> STS 51-L Flight Readiness Review.
- <sup>5</sup> Commission Hearing Transcript, May 2, 1986, pages 2610-2611.
- <sup>6</sup> Commission Interview Transcript, Ebeling, R., March 19, 1986, page 13.
- <sup>7</sup> Commission Hearing Transcript, February 25, 1986, pages 1264-1268.
- <sup>8</sup> Commission Hearing Transcript, February 26, 1986, pages 1694-1697 and 1681.
- <sup>9</sup> Commission Hearing Transcript, February 25, 1986, pages 1412-1417.
- <sup>10</sup> Commission Hearing Transcript, February 25, 1986, pages 1268-1271.
- <sup>11</sup> Commission Hearing Transcript, February 14, 1986, pages 1078-1080.
- <sup>12</sup> Commission Hearing Transcript, February 25, 1986, pages 1346-1347.
- <sup>13</sup> Commission Hearing Transcript, February 25, 1986, pages 1418-1422.
- <sup>14</sup> Commission Interview Transcript, Lund, R., April 1, 1986, pages 37-53.
- <sup>15</sup> Commission Hearing Transcript, February 25, 1986, pages 1456-1457.
- <sup>16</sup> Commission Interview Transcript, Mason, J., April 2, 1986, pages 24-26.
- <sup>17</sup> Commission Hearing Transcript, February 14, 1986, pages 1234-1236.
- <sup>18</sup> Commission Hearing Transcript, February 26, 1986, pages 1537-1541.
- <sup>19</sup> Commission Hearing Transcript, February 26, 1986, pages 1553-1566 and 1560-1563.
- <sup>20</sup> Commission Hearing Transcript, February 26, 1986, pages 1598-1601.
- <sup>21</sup> Commission Hearing Transcript, February 26, 1986, pages 1588-1589.
- <sup>22</sup> Commission Hearing Transcript, February 27, 1986, pages 1867-1868 and 1876-1879.
- <sup>23</sup> Commission Hearing Transcript, April 3, 1986, pages 2538-2541.
- <sup>24</sup> Commission Hearing Transcript, February 27, 1986, page 1899.
- <sup>25</sup> Commission Hearing Transcript, February 27, 1986, pages 1932-1933.
- <sup>26</sup> Commission Hearing Transcript, February 27, 1986, pages 1798-1800.
- <sup>27</sup> Ibid, page 1802.
- <sup>28</sup> Ibid, pages 1803-1806.
- <sup>29</sup> Ibid, pages 1806 and 1807.
- <sup>30</sup> Commission Work Session, Pre-Launch, March 4, 1986, page 75.
- <sup>31</sup> Commission Interview Transcript, Peller, J., April 10, 1986, pages 13-14.
- <sup>32</sup> Commission Hearing Transcript, February 27, 1986, pages 1833-1836.

# An Accident Rooted in History

## Early Design

**T**he Space Shuttle's Solid Rocket Booster problem began with the faulty design of its joint and increased as both NASA and contractor management first failed to recognize it as a problem, then failed to fix it and finally treated it as an acceptable flight risk.

Morton Thiokol, Inc., the contractor, did not accept the implication of tests early in the program that the design had a serious and unanticipated flaw.<sup>1</sup> NASA did not accept the judgment of its engineers that the design was unacceptable, and as the joint problems grew in number and severity NASA minimized them in management briefings and reports.<sup>2</sup> Thiokol's stated position was that "the condition is not desirable but is acceptable."<sup>3</sup>

Neither Thiokol nor NASA expected the rubber O-rings sealing the joints to be touched by hot gases of motor ignition, much less to be partially burned. However, as tests and then flights confirmed damage to the sealing rings, the reaction by both NASA and Thiokol was to increase the amount of damage considered "acceptable." At no time did management either recommend a redesign of the joint or call for the Shuttle's grounding until the problem was solved.

Thiokol was selected to receive the NASA contract to design and build the Solid Rocket Boosters on November 20, 1973.<sup>4</sup> The booster was the largest Solid Rocket Motor ever produced in the United States; it was also the first solid motor program managed by NASA's Marshall Space Flight Center in Huntsville, Alabama.

Costs were the primary concern of NASA's selection board, particularly those incurred early in the program.

Thiokol's three competitors were Aerojet Solid Propulsion Co., Lockheed Propulsion Co. and United Technologies. The Source Evaluation Board on the proposals rated Thiokol fourth under the design, development and verification factor, second under the manufacturing, refurbishment and product support factor and first under the management factor.<sup>5</sup>

Thiokol received the second highest overall Mission Suitability score, tied with United Technologies.<sup>6</sup>

In a December 12, 1973, report, NASA selection officials said Thiokol's "cost advantages were substantial and consistent throughout all areas evaluated."<sup>7</sup> They also singled out Thiokol's joint design for special mention.

"The Thiokol motor case joints utilized dual O-rings and test ports between seals, enabling a simple leak check without pressurizing the entire motor," the officials' report said. "This innovative design feature increased reliability and decreased operations at the launch site, indicating good attention to low cost (design, development, testing and engineering) and production."<sup>8</sup>

"We noted that the [NASA Source Selection] board's analysis of cost factors indicated that Thiokol could do a more economical job than any of the other proposers in both the development and the production phases of the program; and that, accordingly, the cost per flight to be expected from a Thiokol-built motor would be the lowest," the officials said. "We, therefore, concluded that any selection other than Thiokol would give rise to an additional cost of appreciable size."<sup>9</sup>

The Selection officials said they "found no other

factors bearing upon the selection that ranked in weight with the foregoing."

Cost consideration overrode any other objections, they decided. "We concluded that the main criticisms of the Thiokol proposal in the Mission Suitability evaluation were technical in nature, were readily correctable, and the costs to correct did not negate the sizable Thiokol cost advantage," the selection officials concluded.

The cost-plus-award-fee contract, estimated to be worth \$800 million, was awarded to Thiokol.

The design of the Shuttle Solid Rocket Booster was primarily based on the Air Force's Titan III solid rocket, one of the most reliable ever produced. Thiokol hoped to reduce new design problems, speed up the development program and cut costs by borrowing from the Titan design. In Thiokol's Solid Rocket Motor proposal, the rocket fuel is contained in four forged steel cases which are stacked one on top of the other. The casings were connected by a circumferential tang and clevis, as were the Titans.<sup>10</sup>

Despite their many similarities, the Thiokol Solid Rocket Booster and the Titan motors had some significant design differences. For example, the joints of the Titan were designed so that the insulation of one case fits tightly against the insulation of the adjacent case to form a more gas-tight fit than the Thiokol design. One O-ring bore seal was used in each Titan joint to stop any hot gas pressure that might pass by the insulation overlap,<sup>11</sup> but in the Titan design the O-ring was able but not intended to take the brunt of the combustion pressure. In contrast, the Thiokol O-rings were designed to take the brunt of the combustion pressure, with no other gas barriers present except an insulating putty. Also, the Solid

---

### Comparison of Original Design to Design Used

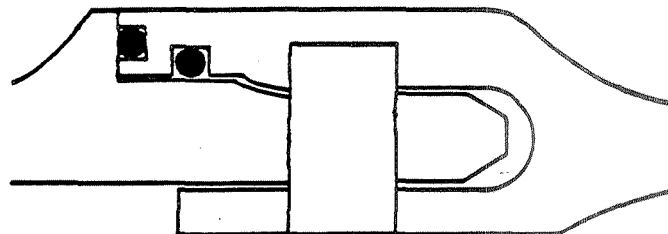

Original design with Face Seal and Bore Seal

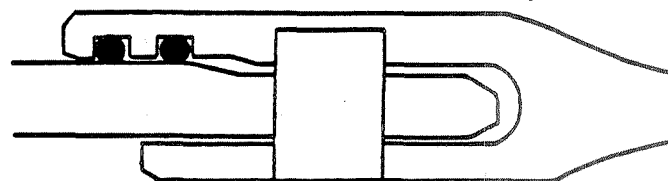

Design used with Double Bore Seal

Figure 1

---

Rocket Motor joint had two O-rings, the second to provide a backup in case the primary seal failed.

Asbestos-filled putty was used in the Solid Rocket Motor to pack the space between the two case segments to prevent O-ring damage from the heat of combustion gases.<sup>12</sup> Thiokol believed the putty was plastic, so when acted on by the combustion pressure at the motor's ignition the putty flow towards the O-ring would compress the air in the gap between the putty and the primary O-ring.<sup>13</sup> The compressed air, in turn, would

cause the primary O-ring to extrude into the gap between the clevis and the tang, behind the primary O-ring groove, thereby sealing the opening. If the primary O-ring did not seal, the intent was that the secondary would pressurize and seal the joint by extruding into the gap behind its groove.<sup>14</sup>

Another difference in the Solid Rocket Motor and the Titan was that the tang portion of the Thiokol joint was longer in order to accommodate two O-rings instead of one. It was more susceptible to bending under combustion pressure than the Titan joint, as post-design tests and later flight experience demonstrated.<sup>15</sup>

The initial Thiokol design proposal was changed before the production motors were manufactured. Originally, the joint seal design incorporated both a face seal and a bore seal.<sup>16</sup> (Figure 1.) However, the motor that was eventually used had double bore O-rings. The original bore seal/face seal design was chosen because it was anticipated that it “provides [better] redundancy over a double bore ring seal since each is controlled by different manufacturing tolerances, and each responds differently during joint assembly.”<sup>17</sup> Because the early design incorporated tolerances similar to the Titan and it also incorporated a face seal, Thiokol believed it possessed “complete, redundant seal capability.”<sup>18</sup>

Nevertheless, as the Solid Rocket Motor program progressed, Thiokol—with NASA’s concurrence—dropped the face/bore seal design for one using a double bore seal (Figure 1). NASA engineers at Marshall said the original design would have required tapered pins to maintain necessary tolerances and assure enough “squeeze” on the face-sealing O-ring.<sup>19</sup> However, design analysis determined that motor ignition would create tension loads on the joint sufficient to cause the tapered pins to pop out. Solving that would have meant designing some type of pin-retainers. Moreover, the rocket assembly was much easier with the dual bore seals. Because inspections and tests had to be conducted on the Solid Rocket Motor stack, horizontal assembly was required. Thiokol engineer, Howard McIntosh, described this in a Commission interview on April 2, 1986:

“We were concerned very much about the horizontal assembly that we had to do to do the static tests. The Titan had always been assembled vertically, and so there had never

been a larger rocket motor to our knowledge that was assembled (horizontally).”<sup>20</sup>

Because of the extremely tight tolerances in the joints caused by horizontal assembly, McIntosh noted, “We . . . put the bore seals in there, and we opened the tolerance in the gaps slightly to accommodate that.”<sup>21</sup> To tighten the joint’s fit and to increase the squeeze in the O-rings to compensate for the larger tolerances, Thiokol subsequently put thin metal shims between the outer walls of the tang and clevis.

Another significant feature of the Thiokol design was a vent, or port, on the side of the motor case used after assembly to check the sealing of the O-rings. As will be noted later, this leak check eventually became a significant aspect of the O-ring erosion phenomenon.<sup>22</sup>

The manufacture of the O-rings themselves constituted another difference between the Titan and the Thiokol Solid Rocket Motor. While both O-rings were Viton rubber, the Titan O-rings were molded in one piece. The Solid Rocket Motor O-rings were made from sections of rubber O-ring material glued together. The specifications allowed five such joints, a number chosen arbitrarily, and the vendor routinely made repairs of voids and inclusions after getting the material supplies. Only surface inspections were performed by Thiokol and by the manufacturer.

Finally, unlike the Titan, the Thiokol Solid Rocket Motor was designed for multiple firings. To reduce program costs, each Thiokol motor case for the Shuttle was to be recovered after flight and reused up to 20 times.<sup>23</sup>

## Early Tests

Thiokol began testing the Solid Rocket Motor in the mid-1970’s. One of the early important tests was a 1977 “hydroburst test.”<sup>24</sup>

Its purpose was to test the strength of the steel cases by simulating a motor firing. The case was pressurized with water to about one and one-half times the pressure of an ignited motor (about 1,500 pounds per square inch) to make certain the case had adequate structural margin.<sup>25</sup> Also, to measure the pressure between the O-rings, engineers attached instruments to the leak test port at a segment joint. Although the test was successful in that it demonstrated the case met strength requirements, test measurements showed that, contrary to design expectations, the joint

tang and inside clevis bent away from each other instead of toward each other and by doing so reduced — instead of increased — pressure on the O-ring in the milliseconds after ignition.<sup>26</sup> This phenomenon was called “joint rotation.” Testifying before the Commission, Arnold Thompson, Thiokol’s supervisor of structures, said,

“We discovered that the joint was opening rather than closing as our original analysis had indicated, and in fact it was quite a bit. I think it was up to 52 one-thousandths of an inch at that time, to the primary O-ring.”<sup>27</sup>

Thiokol reported these initial test findings to the NASA program office at Marshall. Thiokol engineers did not believe the test results really proved that “joint rotation” would cause significant problems,<sup>28</sup> and scheduled no additional tests for the specific purpose of confirming or disproving the joint gap behavior.

## Design Objections

Reaction from Marshall to the early Solid Rocket Motor test results was rapid and totally opposite of Thiokol’s. In a September 2, 1977 memorandum, Glenn Eudy, Marshall’s Chief Engineer of the Solid Rocket Motor Division, informed Alex McCool, Director of the Structures and Propulsion Laboratory, that the assembly of a developmental motor provided early indications that the Thiokol design:

“Allowed O-ring clearance. . . . Some people believe this design deficiency must be corrected by some method such as shimming and perhaps design modification to the case joint for hardware which has not been final machined. . . . I personally believe that our first choice should be to correct the design in a way that eliminates the possibility of O-ring clearance. . . . Since this is a very critical SRM issue, it is requested that the assignment results be compiled in such a manner as to permit review at the S&E Director’s level as well as project manager.”

After seeing the data from the September 1977 hydroburst test, Marshall engineer Leon Ray submitted a report entitled “Solid Rocket Motor Joint Leakage Study” dated October 21, 1977. It characterizes “no change” in the Thiokol design as “unacceptable” — “tang can move outboard and

cause excessive joint clearance resulting in seal leakage. Eccentric tang/clevis interface can cause O-ring extrusion when case is pressurized.” Ray recommended a “redesign of the tang and reduce tolerance on the clevis” as the “best option for a long-term fix.”<sup>29</sup>

After Ray’s 1977 report, John Q. Miller, chief of the Solid Rocket Motor branch at Marshall, signed and sent a memorandum on January 9, 1978 to his superior, Glenn Eudy, describing the problems evident in the Solid Rocket Motor joint seal. “We see no valid reason for not designing to accepted standards,” the memo said, and it emphasized that proper sealing of the joint by use of shims to create necessary O-ring pressure was “mandatory to prevent hot gas leaks and resulting catastrophic failure.”<sup>30</sup>

One year later, not having received a response to his 1978 memo, Miller signed and forwarded a second memo strenuously objecting to Thiokol’s Solid Rocket Motor joint seal design. This memo, dated January 19, 1979, opened with: “We find the Thiokol position regarding design adequacy of the clevis joint to be completely unacceptable. . . .”<sup>31</sup> The memorandum made three principal objections to Thiokol’s joint design. The first was the “large sealing surface gap created by extensive tang/clevis relative movement.” The memo said this movement, the so-called “joint rotation,” caused the primary O-ring to extrude into the gap, “forcing the seal to function in a way which violates industry and government O-ring application practices.”<sup>32</sup> Moreover, joint rotation allowed the secondary O-ring to “become completely disengaged from its sealing surface on the tang.” Finally, the memorandum noted that although Thiokol’s contract required all high pressure case seals to be verifiable, “the clevis joint secondary O-ring seal has been verified by tests to be unsatisfactory.”<sup>33</sup> A copy of the second memorandum was sent to George Hardy, then Solid Rocket Booster project manager at Marshall. Thiokol apparently did not receive copies of either Miller memorandum, and no reply from Eudy to Miller has been found.

The Commission has learned that Leon Ray actually authored the Miller memos to Eudy, although Miller signed them and concurred in the objections raised.<sup>34</sup> During February, 1979, Ray also reported on a visit he made to two O-ring manufacturers — the Precision Rubber Products Corporation at Lebanon Tennessee, and the Parker Seal Co. at Lexington, Kentucky.<sup>35</sup> Eudy



accompanied Ray on the Precision visit. The purpose of the trips was to give the manufacturers the data on the O-ring experiences at Thiokol and to "seek opinions regarding potential risks involved," Ray wrote in a February 9, 1979, memo describing the visit. Officials at Precision did "voice concern for the design, stating that the Solid Rocket Motor O-ring extrusion gap was larger than that covered by their experience," Ray reported. "Their first thought was that the O-ring was being asked to perform beyond its intended design and that a different type of seal should be considered." Ray added.<sup>36</sup>

During the Commission hearing on May 2, 1986, Ray was asked why the 1978 and 1979 memoranda were written:

Mr. Ray: The reason they were written was as a result of test data that we had, and I have to go back to, I guess, a little bit further back in time than these memos. When the joint was first designed, the analysis produced by Thiokol says the joint would close, the extrusion gap would actually close.

We had quite a debate about that until we did a test on the first couple of segments that we received from the manufacturer, which in fact showed that the joint did open. Later on we did some tests with the structural test article, and this is mentioned in the memo as STA-1 [Structural Test Article].

At that time, we really nailed it down. We got some very accurate numbers on joint rotation, and we know for a fact that during these tests that, just what the memo says, the joint rotated. The primary O-ring was extruded up into the joint. The secondary O-ring did in fact detach from the seat.<sup>37</sup>

No records show Thiokol was informed of the visits, and the O-ring design was not changed.

Thiokol's phase 1 certification review on March 23, 1979, mentioned leak check failures, and forces during case joint assembly that resulted in clevis O-ring grooves not conforming with tang sealing surfaces. However, this was not listed as a problem or a failure.<sup>38</sup>

## Verification and Certification Committee

---

While Ray was warning of problems with joint rotation, static motor tests in July 1978 and April

1980 again were demonstrating that inner tang/clevis relative movement was greater than originally predicted.<sup>39</sup> Thiokol continued to question the validity of these joint rotation measurements and their effect on the availability of the secondary O-ring.

In 1980, NASA empanelled a Space Shuttle Verification/Certification Committee to study the flight worthiness of the entire Shuttle system. A subdivision of that group, the Propulsion Committee, met with NASA Solid Rocket Motor program personnel and raised several concerns about the joint design.<sup>40</sup> The Committee pointed out that the booster's leak test pressurized the primary O-ring in the wrong direction so that the motor ignition would have to move the ring across its groove before it sealed. The Committee added that the effect of the insulation putty was not certain. Redundancy of the O-rings was also listed as a verification concern. The same report, however, said "the Committee understands from a telecon that the primary purpose of the second O-ring is to test the primary and that redundancy is not a requirement." George Hardy testified that the Committee's statement conflicted with his understanding:

"The discussion there or the reference there to a telecon — and I don't know who that was with — that implies there was no intent for the joint to be redundant is totally foreign to me. I don't know where they would have gotten that information because that was the design requirement for the joint."<sup>41</sup>

In May 1980, the Verification/Certification Committee recommended that NASA conduct full-scale tests to verify the field joint integrity, including firing motors at a mean bulk propellant temperature range of 40–90 degrees Fahrenheit. The panel also asked NASA to:

"Perform case burst test with one O-ring removed. During the burst test for final verification of the motor case safety factor, one of the two O-rings failed by extrusion and leaked. The analysis used for additional verification did not include further gap openings caused by joint deflection at pressurization or any deflections caused by bending loads. The panel considers the above to be inadequate to provide operational program reliability, and marginal to provide adequate

safety factor confidence on [Shuttle flight] one.”<sup>42</sup>

The NASA program response to these issues was included in the final Committee report in September 1980. It said that the original hydroburst tests and the lightweight case tests, being conducted at the time, satisfied the intent of the Committee's recommendations. Moreover, the response stated: “NASA specialists have reviewed the field joint design, updated with larger O-rings and thicker shims and found the safety factors to be adequate for the current design. Re-analysis of the joint with larger O-rings and thicker shims is being accomplished as part of the lightweight case program. . . . The joint has been sufficiently verified with the testing accomplished to date (joint lab tests, structural test article, and seven static firings and the two case configuration burst tests) and currently scheduled for lightweight case program.”<sup>43</sup>

## Criticality Classification and Changes

The Solid Rocket Motor certification was deemed satisfactory by the Propulsion Committee of the Verification/Certification Group on September 15, 1980. Shortly thereafter, on November 24, 1980, the Solid Rocket Booster joint was classified on the Solid Rocket Booster Critical Items List as criticality category 1R. NASA defines “Criticality 1R” as any subsystem of the Shuttle that contains “redundant hardware, total element failure of which could cause loss of life or vehicle.”<sup>44</sup> The use of “R”, representing redundancy, meant that NASA believed the secondary O-ring would pressurize and seal if the primary O-ring did not. Nonetheless, the 1980 Critical Items List (CIL) states:

“Redundancy of the secondary field joint seal cannot be verified after motor case pressure reaches approximately 40 percent of maximum expected operating pressure. It is known that joint rotation occurring at this pressure level with a resulting enlarged extrusion gap causes the secondary O-ring to lose compression as a seal. It is not known if the secondary O-ring would successfully reseal if the primary O-ring should fail after motor case pressure reaches or exceeds 40

percent of maximum expected operating pressure.”

When asked about the text of the 1980 Criticality 1R classification, Arnold Aldrich, NASA Manager of the National Space Transportation System, said,

“The way that . . . language [reads], I would call it [criticality] 1.”<sup>45</sup>

Notwithstanding this apparent contradiction in the classification 1R and the questionable status of the secondary described in the text of the CIL, the joint carried a 1R classification from November 1980 through the flight of STS-5 (November 1982).

The Space Shuttle first flew on April 12-14, 1981. After the second flight, STS-2, in November 1981, inspection revealed the first in-flight erosion of the primary O-ring.<sup>46</sup> It occurred in the right Solid Rocket Booster's aft field joint and was caused by hot motor gases.<sup>47</sup> The damage to the ring proved to be the worst ever found on a primary O-ring in a field joint on any recovered Solid Rocket Booster.<sup>48</sup> Post-flight examination found an erosion depth of .053 inches on the primary O-ring; nonetheless, the anomaly was not reported in the Level I Flight Readiness Review for STS-3 held on March 9, 1982. Furthermore, in 1982 the STS-2 O-ring erosion was not reported on the Marshall problem assessment system and given a tracking number as were other flight anomalies.<sup>49</sup>

In mid-1982, two significant developments took place. Because Thiokol believed blow holes in the insulating putty were a cause of the erosion on STS-2,<sup>50</sup> they began tests of the method of putty layup and the effect of the assembly of the rocket stages on the integrity of the putty. The manufacturer of the original putty, Fuller-O'Brien, discontinued the product and a new putty, from the Randolph Products Company, was tested and selected in May 1982.<sup>51</sup> The new Randolph putty was eventually substituted for the old putty in the summer of 1983, for the STS-8 Solid Rocket Motor flow.<sup>52</sup>

A second major event regarding the joint seal occurred in the summer of 1982. As noted before, in 1977-78, Leon Ray had concluded that joint rotation caused the loss of the secondary O-ring as a backup seal. Because of May 1982 high pressure O-ring tests and tests of the new lightweight motor case, Marshall management

finally accepted the conclusion that the secondary O-ring was no longer functional after the joints rotated when the Solid Rocket Motor reached 40 percent of its maximum expected operating pressure. It obviously followed that the dual O-rings were not a completely redundant system, so the Criticality 1R had to be changed to Criticality 1.<sup>53</sup> This was done at Marshall on December 17, 1982. The revised Critical Items List read (See pages 157 and 158):

“Criticality Category 1. . . .

“Failure Mode and Causes: Leakage at case assembly joints due to redundant O-ring seal failures or primary seal and leak check port O-ring failure.

*“Note: Leakage of the primary O-ring seal is classified as a single failure point due to possibility of loss of sealing at the secondary O-ring because of joint rotation after motor pressurization.*

“Failure Effect Summary: *Actual Loss — Loss of mission, vehicle and crew due to metal erosion, burn through, and probable case burst resulting in fire and deflagration.* . . .

“Rationale for Retention:

“The Solid Rocket Motor case joint design is common in the lightweight and regular weight cases having identical dimensions. The joint concept is basically the same as the single O-ring joint successfully employed on the Titan III Solid Rocket Motor. . . . On the Shuttle Solid Rocket Motor, the secondary O-ring was designed to provide redundancy and to permit a leak check, ensuring proper installation of the O-rings. Full redundancy exists at the moment of initial pressurization. However, test data shows that a phenomenon called joint rotation occurs as the pressure rises, opening up the O-ring extrusion gap and permitting the energized ring to protrude into the gap. This condition has been shown by test to be well within that required for safe primary O-ring sealing. This gap may, however, in some cases, increase sufficiently to cause the unenergized secondary O-ring to lose compression, raising question as to its ability to energize and seal if called upon to do so by primary seal failure. Since, under this latter condition only the single O-ring is sealing, a rationale for retention is provided for the simplex mode where

only one O-ring is acting” [emphasis added].<sup>54</sup>

The retention rationale for the “simplex” or single O-ring seal was written on December 1, 1982, by Howard McIntosh, a Thiokol engineer.<sup>55</sup> This document gave the justification for flight with the single functional O-ring. It reported that tests showed the Thiokol design should be retained, citing the Titan history, the leak and hydroburst tests, and static motor firings as justification. However, it also contained the following rationale which appeared to conflict with the Criticality 1 classification that the secondary O-ring was not redundant:

“Initial information generated in a lightweight cylinder-to-cylinder proof test shows a total movement of only .030 inch at 1,004 pounds per square inch, gauge pressure in the center joint. This . . . indicates that the tang-to-clevis movement will not unseat the secondary O-ring at operating pressures.”<sup>56</sup>

Testimony in hearings and statements given in Commission interviews support the view that NASA management and Thiokol still considered the joint to be a redundant seal even after the change from Criticality 1R to 1. For example, McIntosh’s interview states:

**Question:** [After the Criticality I classification], what did you think it would take to make [the joint seal] 1R?

**Mr. McIntosh:** I thought it was already 1R. I thought that after those tests that would have been enough to do it.

**Question:** Well, you knew it was 1 but you were hoping for 1R?

**Mr. McIntosh:** Yeah, I was hoping for 1R, and I thought this test data would do it, but it didn’t.<sup>57</sup>

At the time (in 1982-83), the redundancy of the secondary O-ring was analyzed in terms of joint or hardware geometry, with no consideration being given to the resiliency of the ring as affected by temperatures.<sup>58</sup> Moreover, Marshall engineers like Ray and Miller disagreed with Thiokol’s calculations on the measurement of joint opening.<sup>59</sup> That engineering debate eventually went to a “referee” for testing which was not concluded until after the 51-L accident.

Notwithstanding the view of some of Marshall engineers that the secondary ring was not redundant, even at the time of the Criticality revision, Marshall Solid Rocket Motor program management appeared to believe the seal was redundant in all but exceptional cases. Dr. Judson Lovingood told the Commission:

“... [T]here are two conditions you have to have before you don't have redundancy. One of them is what I call a spatial condition which says that the dimensional tolerances have to be such that you get a bad stackup, you don't have proper squeeze, etc. on the O-ring so that when you get joint rotation, you will lift the metal surfaces off the O-ring. All right, that's the one condition, and that is a worst case condition involving dimensional tolerances.

“The other condition is a temporal condition which says that you have to be past a point of joint rotation, and of course, that relates back to what I just said.

“So first of all, if you don't have this bad stackup, then you have full redundancy. Now, secondly, if you do have the bad stackup, you had redundancy during the ignition transient up to the 170 millisecond point, whatever it is, but that is the way I understand the [Critical Items List].”<sup>60</sup>

George Hardy and Lawrence Mulloy shared Lovingood's view that the secondary seal was redundant in all but situations of worst case tolerances.<sup>61</sup> However, there is no mention of this caveat in the Critical Items List itself, nor does it appear in the subsequent “waiver” of the Criticality 1 status granted by NASA Levels I and II in March, 1983.<sup>62</sup> This waiver was approved to avoid the obligations imposed on the Shuttle Program by Paragraph 2.8 of the Space Shuttle Program Requirements Document, Level I, dated June 30, 1977. That paragraph states:

“The redundancy requirements for all flight vehicle subsystems (except primary structure, thermal protection system, and pressure vessels) shall be established on an individual subsystems basis, but shall not be less than fail-safe. ‘Fail-safe’ is defined as the ability to sustain a failure and retain the capability to successfully terminate the mission. Redundant systems shall be designed so that their operational status can be

verified during ground turnaround and to the maximum extent possible while in flight.”<sup>63</sup>

Glynn Lunney, the former manager of the STS Program (Level II at JSC) described the Criticality 1 change and resulting waiver to the Commission on May 2:

**Mr. Lunney:** Well, the approval of the waiver in March of '83, at the time I was involved in that. I was operating on the assumption that there really would be redundancy most of the time except when the secondary O-ring had a set of dimensional tolerances add up, and in that extreme case there would not be a secondary seal.

So I was dealing with what I thought was a case where there were two seals unless the dimensional tolerances were such that there might only be one seal in certain cases.

**Chairman Rogers:** Now, to me, if you will excuse the expression, that sounds almost contradictory, what you just said. What you first said was you came to the conclusion that you could only rely on the primary seal and therefore you removed the R.

**Mr. Lunney:** Yes, sir.

**Chairman Rogers:** And now you're saying, if I understand it, that experience showed that there was redundancy after all.

**Mr. Lunney:** No, I don't know of any experience showing that. What I'm saying is that the removal of the R is an indicator that under all circumstances we did not have redundancy. There were a certain number of cases under which we would not have redundancy of the secondary O-ring.

Recognizing that, even though there were a lot of cases where we expected we would have redundancy we changed the criticality designation.

**Chairman Rogers:** It was saying to everybody else you can't necessarily rely on the primary seal, and if the primary seal fails, as you've said here, there may be loss of vehicle, mission and crew.

**Mr. Lunney:** I would adjust that to only say you cannot rely on the secondary O-ring

but we would expect the primary O-ring to always be there.<sup>64</sup>

The criticality waiver was processed outside the formal NASA Program Requirements Control Board, however, representatives of that group "signed off" on the document.<sup>65</sup> It was forwarded to Level I and approved by Associate Administrator for Space Flight (Technical), L. Michael Weeks on March 28, 1983. Weeks told the Commission he signed the waiver because of the Certification/Verification Review of the Propulsion Committee in 1980. Weeks explained, "We felt at the time — all of the people in the program I think felt that this Solid Rocket Motor in particular or the Solid Rocket Booster was probably one of the least worrisome things we had in the program."<sup>66</sup> The waiver was signed less than one week prior to the launch of STS-6 on April 4. According to interviews of Arnold Aldrich and of Richard Kohrs, the latter having been involved with the waiver review at Johnson Level II, the waiver was approved so that STS-6 could fly.<sup>67</sup> However, Weeks denied any connection between the Level I waiver approval and the flight of STS-6.<sup>68</sup>

Although some Thiokol engineers and officials claimed that they had no notice of the Criticality change and waiver in December, 1982 and in March, 1983, from the approval signatures (including Thiokol's Operations Manager at Marshall, Maurice Parker) and the distribution of the Criticality and Waiver documents, apparently Thiokol officials were sent copies and were involved in the criticality reclassification.<sup>69</sup> Nonetheless, the Commission has also determined that several documents tracking the O-ring erosion at Thiokol and Marshall refer to the Solid Rocket Motor field joint seal as Criticality 1-R, long after the status was changed to Criticality 1.<sup>70</sup>

## **STS 41-B O-Ring Erosion**

As Figure 2 shows,<sup>71</sup> prior to STS 41-B, the O-ring erosion/blow-by problem was infrequent, occurring on a field joint of STS-2 (November, 1981), nozzles of STS-6 (April, 1983) and a nozzle of QM-4 (March, 1983), a qualification test motor fired by Thiokol.<sup>72</sup> However, when STS 41-B flew on February 3, 1984, the left Solid Rocket Booster forward field joint and the right

nozzle joint primary O-rings both suffered erosion damage. Thiokol engineers reacted to this discovery by filing a problem report on the O-ring erosion found on STS 41-B. Thiokol presented a series of charts to the Marshall Solid Rocket Booster Engineering Office about the 41-B O-ring erosion. Thiokol told Marshall that recent joint rotation measurements in tests indicated the secondary O-ring will not unseat, providing confidence that the secondary was an adequate backup. Keith Coates described his view about Thiokol's data in a February 29, 1984 memorandum to George Hardy:

"We have two problems with their rationale. The effect of 0.065 inch erosion on O-ring sealing capability is not addressed. We have asked Thiokol to provide their data to justify their confidence in the degraded O-ring. The second concern is the amount of joint rotation. L. Ray does not agree with Thiokol numbers, and he has action to discuss his concern with R. Boisjoly (Thiokol) and reach agreement.

"Thiokol definition of their plans on resolution of the problem is very weak."

The erosion problem was identified and tracked by the Marshall Problem Assessment System as Marshall Record A07934 and by Thiokol as Thiokol Contractor Record DR4-5/30, "Slight char condition on primary O-ring seal in forward field joint on SRM A57 of STS-11 flight, Mission 41B."<sup>73</sup> The Marshall Problem Assessment System Report states:

"Remedial action — none required; problem occurred during flight. The primary O-ring seal in the forward field joint exhibited a charred area approximately 1 inch long .03-.050 inches deep and .100 inches wide. This was discovered during post-flight segment disassembly at KSC."

A March 8, 1984 entry on the same report continues:

"Possibility exists for some O-ring erosion on future flights. Analysis indicates max. erosion possible is .090 inches according to Flight Readiness Review findings for STS-13. Laboratory test shows sealing integrity at 3,000 psi using an O-ring with a simulated erosion depth of .095 inches. Therefore, this is not a constraint to future launches."<sup>74</sup>

Figure 2

## O-Ring Anomalies Compared with Joint Temperature and Leak Check Pressure

Flight or Motor	Date	(Solid Rocket Booster)	Joint/ O-Ring	Pressure (in psi)		Erosion	Blow-by	Joint Temp °F
				Field	Nozzle			
DM-1	07/18/77	—	—	NA	NA	—	—	84
DM-2	01/18/78	—	—	NA	NA	—	—	49
DM-3	10/19/78	—	—	NA	NA	—	—	61
DM-4	02/17/79	—	—	NA	NA	—	—	40
QM-1	07/13/79	—	—	NA	NA	—	—	83
QM-2	09/27/79	—	—	NA	NA	—	—	67
QM-3	02/13/80	—	—	NA	NA	—	—	45
STS-1	04/12/81	—	—	50	50	—	—	66
STS-2	11/12/81	(Right)	Aft Field/Primary	50	50	X	—	70
STS-3	03/22/82	—	—	50	50	—	—	69
STS-4	06/27/82	unknown: hardware lost at sea		50	50	NA	NA	80
DM-5	10/21/82	—	—	NA	NA	—	—	58
STS-5	11/11/82	—	—	50	50	—	—	68
QM-4	03/21/83	—	Nozzle/ Primary	NA	NA	X	—	60
STS-6	04/04/83	(Right)	Nozzle/ Primary	50	50	(1)	—	67
		(Left)	Nozzle/ Primary	50	50	(1)	—	67
STS-7	06/18/83	—	—	50	50	—	—	72
STS-8	08/30/83	—	—	100	50	—	—	73
STS-9	11/28/83	—	—	100 <sup>2</sup>	100	—	—	70
STS 41-B	02/03/84	(Right)	Nozzle/ Primary	200	100	X	—	57
		(Left)	Forward Field/ Primary	200	100	X	—	57
STS 41-C	04/06/84	(Right)	Nozzle/ Primary	200	100	X	—	63

Dash (—) denotes no anomaly.

NA denotes not applicable.

NOTE: A list of the sequence of launches (1-25), identified by STS mission designation, is provided on pages 4 thru 6.

<sup>1</sup> On STS-6, both nozzles had a hot gas path detected in the putty with an indication of heat on the primary O-ring.

<sup>2</sup> On STS-9, one of the right Solid Rocket Booster field joints was pressurized at 200 psi after a destack.

Flight or Motor	Date	(Solid Rocket Booster)	Joint/ O-Ring	Pressure (in psi)		Erosion	Blow-by	Joint Temp °F
				Field	Nozzle			
STS 41-C (cont'd)		(Left)	Aft Field/ Primary	200	100	( <sup>3</sup> )	—	63
		(Right)	Igniter/ Primary	NA	NA	—	X	63
STS 41-D	08/30/84	(Right)	Forward Field/Primary	200	100	X	—	70
		(Left)	Nozzle/ Primary	200	100	X	X	70
		(Right)	Igniter/ Primary	NA	NA	—	X	70
STS 41-G	10/05/84	—	—	200	100	—	—	78
DM-6	10/25/84	—	Inner Gasket/ Primary	NA	NA	X	X	52
STS 51-A	11/08/84	—	—	200	100	—	—	67
STS 51-C	01/24/85	(Right)	Center Field/Primary	200	100	X	X	53
		(Right)	Center Field/ Secondary	200	100	( <sup>4</sup> )	—	53
		(Right)	Nozzle/ Primary	200	100	—	X	53
		(Left)	Forward Field/Primary	200	100	X	X	53
		(Left)	Nozzle/ Primary	200	100	—	X	53
STS 51-D	04/12/85	(Right)	Nozzle/ Primary	200	200	X	—	67
		(Right)	Igniter/ Primary	NA	NA	—	X	67
		(Left)	Nozzle/ Primary	200	200	X	—	67
		(Left)	Igniter/ Primary	NA	NA	—	X	67
STS 51-B	04/29/85	(Right)	Nozzle/ Primary	200	100	X	—	75
		(Left)	Nozzle/ Primary	200	100	X	X	75

Dash (—) denotes no anomaly.

NA denotes not applicable.

NOTE: A list of the sequence of launches (1-25), identified by STS mission designation, is provided on pages 4 thru 6.

<sup>3</sup> On STS 41-C, left aft field had a hot gas path detected in the putty with an indication of heat on the primary O-ring.

<sup>4</sup> On a center field joint of STS 51-C, soot was blown by the primary and there was a heat effect on the secondary.



Flight or Motor	Date	(Solid Rocket Booster)	Joint: O-Ring	Pressur (in psi)		Erosion	Blow-by	Joint Temp °F
				Field	Nozzle			
STS 51-B (cont'd)		(Left)	Nozzle/ Secondary	200	100	X	—	75
DM-7	05/09/85		Nozzle/ Primary	NA	NA	X	—	61
STS 51-G	06/17/85	(Right)	Nozzle/ Primary	200	200	X <sup>5</sup>	X	70
		(Left)	Nozzle/ Primary	200	200	X	X	70
		(Left)	Igniter/ Primary	NA	NA	—	X	70
STS 51-F	07/29/85	(Right)	Nozzle/ Primary	200	200	( <sup>6</sup> )	—	81
STS 51-I	08/27/85	(Left)	Nozzle/ Primary	200	200	X <sup>7</sup>	—	76
STS 51-J	10/03/85		—	200	200	—	—	79
STS 61-A	10/30/85	(Right)	Nozzle/ Primary	200	200	X	—	75
		(Left)	Aft Field/Primary	200	200	—	X	75
		(Left)	Center Field/ Primary	200	200	—	X	75
STS 61-B	11/26/85	(Right)	Nozzle/ Primary	200	200	X	—	76
		(Left)	Nozzle/ Primary	200	200	X	X	76
STS 61-C	01/12/86	(Right)	Nozzle/ Primary	200	200	X	—	58
		(Left)	Aft Field/Primary	200	200	X	—	58
		(Left)	Nozzle/ Primary	200	200	—	X	58
STS 51-L	01/28/86			200	200			31

Dash (—) denotes no anomaly.

NA denotes not applicable.

NOTE: A list of the sequence of launches (1-25), identified by STS mission designation, is provided on pages 4 thru 6.

<sup>5</sup> On STS 51-G, right nozzle had erosion in two places on the primary O-ring.

<sup>6</sup> On STS 51-F, right nozzle had hot gas path detected in putty with an indication of heat on the primary O-ring.

<sup>7</sup> On STS 51-I, left nozzle had erosion in two places on the primary O-ring.

This last entry is also a summary of the briefing given by Thiokol to Lawrence Mulloy about the 41-B erosion at the Level III Flight Readiness Review for STS 41-C held at Marshall on March 8, 1984. At that same briefing, the Chief Engineer for United Space Boosters, George Morefield, raised prior Titan experience with O-ring problems. He explained in a memorandum to Mulloy the following day:

"I alluded to the Titan III SRM history which is quite similar to the current STS Solid Rocket Motor experience. Post-fire inspection of Titan Solid Rocket Motor static test motors showed that pressurization of the single O-rings in the pressure vessel routinely occurred via a single break-down path across the joint putty. There was also evidence that some O-rings never see pressure in the Titan motor. The segment-to-segment case insulation design results in a compression butt joint which apparently is often sufficient to withstand P, . . . .

"Your review showed that there was sufficient margin of O-ring remaining to do the job. I'm sure you have considered that if it does burn through, the secondary O-ring will then be similarly pressurized through a single port. So, some concern remains.

"I recommend that you set up a panel to study the use of putty and consider some alternatives:

- "1) Is putty needed at all?
- "2) If the tradition can't be broken, can the putty be applied with multiple (6 or 8) pressurization paths built in?

"I think that the primary seal should be allowed to work in its classical design mode. Both the Titan and STS Solid Rocket Motors have been designed for this not to happen. Titan has flown over a thousand pressure joints with no failure. My opinion is that the potential for failure of the joint is higher for the STS Solid Rocket Motor, especially when occasionally the secondary seal may not be totally effective."<sup>75</sup>

When the 41-B erosion was taken to the Level I Flight Readiness Review for 41-C on March 30, 1984, it was briefed as a "technical issue". A recommendation to fly 41-C was approved by Level I "accepting the possibility of some O-ring

erosion due to the hot gas impingement."<sup>76</sup> The rationale for acceptance was the same as that given at the Level III Flight Readiness Review and entered into the Marshall problem assessment report. An outgrowth of this review was an April 5, 1984, directive from NASA Deputy Administrator Dr. Hans Mark to Lawrence Mulloy at Marshall. This "Programmatic Action Item" was signed by Weeks and asked Mulloy to conduct a "formal review of the Solid Rocket Motor case-to-case and case-to-nozzle joint sealing procedures to ensure satisfactory consistent close-outs."<sup>77</sup> This action item had been preceded by a letter written from NASA Associate Administrator for Space Flight General Abrahamson to Marshall Center Director Lucas.<sup>78</sup> That letter, sent January 18, 1984, requested that Marshall develop a plan of action to make improvement in NASA's ability to design, manufacture and fly Solid Rocket Motors. Abrahamson pointed out that NASA was flying motors where basic design and test results were not well understood. The letter addressed the overall general Solid Rocket Motor design but did not specifically mention O-ring erosion.

After Mulloy received the April 5, 1984 STS 41-C action item on the O-rings, he had Lawrence Wear forward a letter to Thiokol which asked for a formal review of the booster field joint and nozzle joint sealing procedures. Thiokol was to identify the cause of the erosion, determine whether it was acceptable, define necessary changes, and reevaluate the putty then in use. The Wear letter also requested small motor tests reflecting joint dynamics as well as analysis of the booster assembly process.<sup>79</sup>

Thiokol replied to the Marshall STS 41-C action item on May 4, 1984, with a program plan entitled "Protection of SRM Primary Motor Seals." The plan was prepared by Brian Russell, then Thiokol's Manager of Systems Engineering. It outlined a systematic program to isolate the O-ring erosion and charring problem and to eliminate damage to the joint seals.<sup>80</sup> Proposed areas of inquiry included the leak check pressures, assembly loads, case eccentricity and putty layup. The Thiokol response in May 1984 was merely a proposal. The actual final response to the directive from Marshall was not completed until the August 19, 1985 briefing on the Solid Rocket Motor seal held at NASA headquarters some 15 months later.<sup>81</sup>

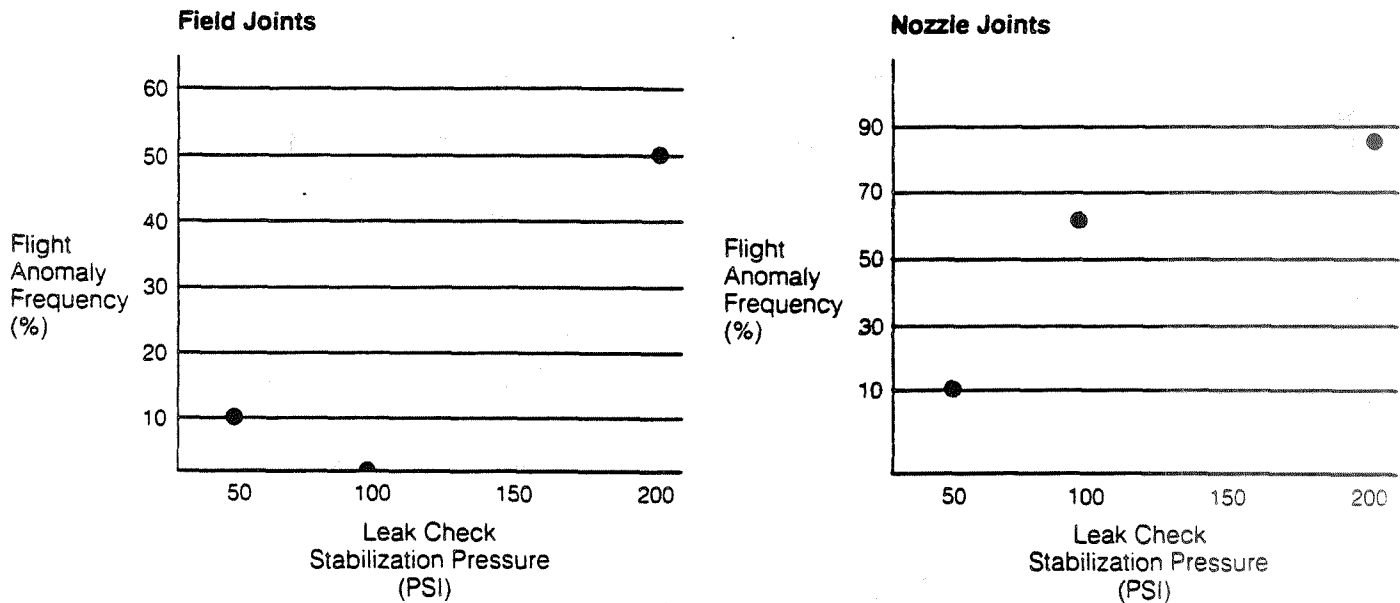

Graphs depict flight anomaly frequency for both field and nozzle joint of solid motors for a variety of leak check pressures. Figure 3

## Leak Check and Putty

In addition to the action item from NASA Headquarters, another result of the 41-B erosion was a warning written by John Q. Miller, Marshall chief of the solid motor branch, to George Hardy, through Keith Coates.<sup>82</sup> Miller was worried about the two charred rings on 41-B and the "missing putty" found when the Solid Rocket Boosters were recovered and disassembled. He specifically identified the putty's sensitivity to humidity and temperature as potential sources of problems. "The thermal design of the [Solid Rocket Motor] joints depends on thermal protection of the O-ring by the [putty]," Miller said. Failure of the putty to "provide a thermal barrier can lead to burning both O-rings and subsequent catastrophic failure." The memorandum also said that "the O-ring leak check procedure and its potential effect on the (putty) installation and possible displacement is also an urgent concern which requires expedition of previously identified full scale tests."

From the beginning, Thiokol had suspected the putty was a contributing factor in O-ring erosion, even after STS-2.<sup>83</sup> In April 1983, Thiokol reported on tests conducted to study the behavior of the joint putty. One conclusion of the report was that the STS-2 erosion was probably caused by blow holes in the putty, which allowed a jet

of hot gas to focus on a point on the primary O-ring. Thiokol discovered the focused jet ate away or "impinged" on portions of the O-ring. Thiokol calculated that the maximum possible impingement erosion was .090 inch, and that lab test proved that an O-ring would seal at 3,000 psi when erosion of .095 inches was simulated. This "safety margin" was the basis for approving Shuttle flights while accepting the possibility of O-ring erosion.<sup>84</sup>

Shortly after Miller's routing slip to Hardy about the "urgent concern" of the missing putty on 41-B, at Thiokol, Brian Russell authored a letter to Robert Ebeling which analyzed the erosion history and the test data. Russell's April 9, 1984 conclusion was that the putty itself and its layup were not at fault but that the higher stabilization pressure adopted in leak check procedures, first implemented in one field joint on STS-9, may increase the chances of O-ring erosion. The conclusion by Miller and Russell was that the air pressure forced through the joint during the O-ring leak check was creating more putty blow holes, allowing more focused jets on the primary O-ring, thereby increasing the frequency of erosion.<sup>85</sup>

This hypothesis that O-ring erosion is related to putty blow holes is substantiated by the leak check history (Figure 3). Prior to January, 1984, and STS 41-B, when the leak check pressure was

50 or 100 psi, only one field joint O-ring anomaly had been found during the first nine flights. However, when the leak check stabilization pressure was officially boosted to 200 psi for STS 41-B, over half the Shuttle missions experienced field joint O-ring blow-by or erosion of some kind.<sup>86</sup>

Moreover, the nozzle O-ring history of problems is similar. The nozzle joint leak check was changed from 50 psi to 100 psi before STS-9 launched in November 1983. After this change, the incidence of O-ring anomalies in the nozzle joint increased from 12 percent to 56 percent of all Shuttle flights. The nozzle pressure was increased to 200 psi for mission 51-D in April, 1985, and 51-G in June, 1985, and all subsequent missions. Following the implementation of the 200 psi check on the nozzle, 88 percent of all flights experienced erosion or blow-by.<sup>87</sup>

Both Thiokol and NASA witnesses agreed that they were aware that the increase in blow holes in the putty could contribute to O-ring erosion. The Commission testimony of May 2, 1986, reads:

**Dr. Walker:** The analysis that some of our staff has done suggests that after you increase the test pressure to 200 pounds, the incidence of blow-by and erosion actually increased.

**Mr. Russell:** We realized that.

Lawrence Mulloy was also questioned about the blow holes in the putty:

**Dr. Walker:** Do you agree that the primary cause of the erosion is the blow holes in the putty?

**Mr. Mulloy:** I believe it is. Yes.

**Dr. Walker:** And so your leak check procedure created blow holes in the putty?

**Mr. Mulloy:** That is one cause of blow holes in the putty.

**Dr. Walker:** But in other words, your leak check procedure could indeed cause what was your primary problem. Didn't that concern you?

**Mr. Mulloy:** Yes, sir.<sup>88</sup>

Notwithstanding the knowledge that putty blow holes caused erosion and that higher pressure in the leak check caused more blow holes, Thiokol recommended and NASA ac-

cepted the increased pressure to ensure that the joint actually passed the integrity tests.<sup>89</sup>

The documentary evidence produced by NASA and Thiokol demonstrates that Marshall was very concerned about the putty erosion/blow hole problem after STS 41-B. In addition to John Miller's routing slip about putty on STS 41-B discussed above, there is a report of a June 7, 1984, telephone conference between Messrs. Thompson, Coates and Ray (Marshall) and Messrs. Sayer, Boisjoly, Russell and Parker (Thiokol), among others.<sup>90</sup> Marshall told Thiokol that NASA was very concerned about the O-ring erosion problem and that design changes were necessary, including possible putty changes. The Thiokol engineers discussed Marshall's suggestions after the telephone conference, but decided they could not agree a change was mandatory. A follow-up telephone conference was held between Ben Powers of Marshall and Lawrence Sayer of Thiokol on July 2. Powers told Sayer that NASA would not accept the removal of the putty from the joint and that everyone expected the tests to show that gas jets would damage an O-ring. However, Powers expressly stated that Marshall would not accept Thiokol's opinion that no further tests were necessary.

In mid-1984, the early tests after NASA's action item for 41-C led Thiokol to the conclusion that O-ring erosion was a function of the putty blow hole size and the amount of free volume between the putty orifice and the O-ring. The damage to the O-ring was judged to be worse when the blow hole was smaller and the free volume was larger.<sup>91</sup>

While Thiokol did establish plans for putty tests to determine how it was affected by the leak check in response to the 41-C action item, their progress in completing the tests was slow. The action item was supposed to be completed by May 30, 1984, but as late as March 6, 1985, there are Marshall internal memos that complain that Thiokol had not taken any action on Marshall's December 1983 directive to provide data on putty behavior as affected by the joint leak check stabilization pressure.<sup>92</sup>

## STS 51-C and Cold Temperature

On January 24, 1985, STS 51-C was launched. The temperature of the O-rings at launch was 53

<i>NASA Official</i>	<i>Position</i>	<i>Description of Awareness of O-Ring Problems</i>
John Young	Chief, Astronaut Office	"The secret seal, which no one that we know knew about." <sup>93</sup>
Milton Silveira	Chief Engineer	". . . If I had known' . . . I'm sure in the '82 time period when we first came to that conclusion [that the seal was not redundant], I would have insisted that we get busy right now on a design change and also look for any temporary fix we could do to improve the operation of the seal." <sup>94</sup>
James Beggs	(Former) NASA Administrator	"I had no specific concerns with the joint, the O-rings or the putty. . . ." <sup>95</sup>
Arnold Aldrich	Manager, National Space Transportation System	None were aware of Thiokol's concern about negative effect of cold temperature on O-ring performance, nor were they informed of the same concern raised after STS 51-C. <sup>96</sup>
Jesse Moore	(Former) Associate Administrator for Space Flight	
Richard Smith	Director, Kennedy Space Center	
James A. Thomas	Deputy Director, Kennedy Launch and Landing Operations	

Figure 4

degrees, the coldest to that date. O-ring erosion occurred in both solid boosters. The right and left nozzle joint showed evidence of blow-by between the primary and secondary O-rings. The primary O-ring in the left booster's forward field joint was eroded and had blow-by, or soot behind the ring.<sup>97</sup> The right booster's damage was in the center field joint—the first time that field joint seal was damaged. Both its primary and secondary O-rings were affected by heat, and the primary ring also had evidence of blow-by of soot behind it. This was also the first flight where a secondary O-ring showed the effect of heat.

STS 51-C was the second example of O-ring damage in flight where there was evidence of blow-by erosion as well as impingement erosion. As noted previously, impingement erosion occurs where the O-ring has already sealed and a focused jet of hot gas strikes the surface of the ring and removes a portion of it. Blow-by erosion happens

when the O-ring has not yet sealed the joint gap and the edge of the ring erodes as the hot gas flows around it.

Roger Boisjoly described the blow-by erosion seen in 51-C:

"SRM 15 [STS 51-C] actually increased [our] concern because that was the first time we had actually penetrated a primary O-ring on a field joint with hot gas, and we had a witness of that event because the grease between the O-rings was blackened just like coal . . . and that was so much more significant than had ever been seen before on any blow-by on any joint . . . the fact was that now you introduced another phenomenon. You have impingement erosion and bypass erosion, and the O-ring material gets removed from the cross section of the O-ring much, much faster when you have bypass erosion or blow-by."<sup>98</sup>

Boisjoly also said blow-by erosion was where the primary O-ring "at the beginning of the transient cycle . . . is still being attacked by hot gas, and it is eroding at the same time it is trying to seal, and it is a race between, will it erode more than the time allowed to have it seal." He described the blow-by on 51-C as "over 100 degrees of arc, and the blow-by was absolutely jet black. It was totally intermixed in a homogeneous mixture in the grease." When the blow-by material was chemically analyzed, Boisjoly said, "we found the products of putty in it, we found the products of O-ring in it."<sup>99</sup>

On the Marshall problem assessment report that was started to track field joint erosion after STS 41-B, the STS 51-C O-ring anomaly was described as "O-ring burns were as bad or worse than previously experienced . . . Design changes are pending test results."<sup>100</sup> The changes being considered included modifying the O-rings and adding grease around the O-rings to fill the void left by putty blow holes.

On January 31, 1985, Marshall Solid Rocket Booster Project Manager Mulloy sent an urgent message to Lawrence Wear with the stated subject: "51-C O-Ring Erosion Re: 51-E FRR." The message ordered that the Flight Readiness Review for the upcoming flight:

"Should recap all incidents of O-ring erosion, whether nozzle or case joint, and all incidents where there is evidence of flow past the primary O-ring. Also, the rationale used for accepting the condition on the nozzle O-ring. Also, the most probable scenario and limiting mechanism for flow past the primary on the 51-C case joints. If [Thiokol] does not have all this for today I would like to see the logic on a chart with blanks [to be filled in]."<sup>101</sup>

On February 8, 1985, Thiokol presented its most detailed analysis to date of the erosion problems to the Solid Rocket Motor project office at Marshall for what was then called Shuttle mission 51-E, but later changed to 51-D. Thiokol included a report on damage incurred by the O-rings during flight 51-C at the left forward and right center field joints. The right center joint had hot gas past the primary O-ring. Thiokol said that caused a concern that the gas seal could be lost, but its resolution was "accept risk."<sup>102</sup>

Thiokol presented test results showing "maximum expected erosion" and "maximum erosion

experienced" for both primary and secondary O-rings for the field and nozzle joints. Accepting damage to the primary O-ring was being justified, in part, based on an assumption of the secondary O-ring working even with erosion. However, the Criticality classification indicated the primary seal was a "single point failure." During this flight readiness assessment at Marshall, for the first time Thiokol mentioned temperature as a factor in O-ring erosion and blow-by. Thiokol said in its conclusions that "low temperature enhanced probability of blow-by — [flight] 51-C experienced worst case temperature change in Florida history." Thiokol concluded that while the next Shuttle flight "could exhibit same behavior," nonetheless "the condition is not desirable but is acceptable."<sup>103</sup>

At the Level I Flight Readiness Review conducted on February 21, there was no detailed analysis of O-ring problems presented or any reference made to low temperature effects. Instead, a single reference indicated the O-ring erosion and blow-by experienced was "acceptable" because of "limited exposure time and redundancy."

## **STS 51-B and the Launch Constraint**

---

Joint seal problems occurred in each of the next four Shuttle flights. Flight 51-D, launched April 12, 1985 had nozzle O-ring erosion and blow-by on an igniter joint. STS 51-B, launched 17 days later, experienced both nozzle O-ring erosion and blow-by as did 51-G, which flew on the following June 17. STS 51-F, launched July 29, 1985 had nozzle O-ring blow-by.<sup>104</sup>

In reponse to the apparent negative effect of cold leading to the extensive O-ring problems on flight 51-C in January, Thiokol conducted some O-ring resiliency tests in early 1985.<sup>105</sup> The tests were conducted to quantify the seal timing function of the secondary O-ring and the effect of joint rotation on its ability to back up the primary ring. The key variable was temperature. The June 3 test report, which was described in an August 9, 1985 letter from Brian Russell at Thiokol to Jim Thomas at Marshall, showed:

"Bench test data indicates that the O-ring resiliency (its capability to follow the metal) is a function of temperature and rate of case expansion. [Thiokol] measured the force of the O-ring against Instron platens, which

simulated the nominal squeeze on the O-ring and approximated the case expansion distance and rate.

"At 100°F, the O-ring maintained contact. At 75°F the O-ring lost contact for 2.4 seconds. At 50°F, the O-ring did not re-establish contact in ten minutes at which time the test was terminated."<sup>106</sup>

On June 25, 1985, the left nozzle joint of STS 51-B (launched April 29) was disassembled and inspected after it had been shipped back to Thiokol. What Thiokol found was alarming. The primary O-ring seal had been compromised because it eroded .171 inches and it did not seal. The secondary O-ring did seal, but it had eroded .032 inches. Lawrence Mulloy described the 51-B problem as follows:

"This erosion of a secondary O-ring was a new and significant event . . . that we certainly did not understand. Everything up to that point had been the primary O-ring, even though it had experienced some erosion does seal. What we had evidence of was that here was a case where the primary O-ring was violated and the secondary O-ring was eroded, and that was considered to be a more serious observation than previously observed . . ."<sup>107</sup>

"What we saw [in 51-B], it was evident that the primary ring never sealed at all, and we saw erosion all the way around that O-ring, and that is where the .171 came from, and that was not in the model that predicated a maximum of .090, the maximum of .090 is the maximum erosion that can occur if the primary O-ring seals.

"But in this case, the primary O-ring did not seal; therefore, you had another volume to fill, and the flow was longer and it was blow-by and you got more erosion."<sup>108</sup>

Upon receiving the report of the 51-B primary ring failure, Solid Rocket Booster Project Manager Mulloy and the Marshall Problem Assessment Committee placed a "launch constraint" on the Shuttle system.<sup>109</sup> A 1980 Marshall letter which references "Assigning Launch Constraints on Open Problems Submitted to MSFC PAS" defines launch constraint as:

"All open problems coded Criticality 1, 1R, 2, or 2R will be considered launch constraints until resolved (recurrence control

established and its implementation effectivity determined) or sufficient rationale, i.e., different configuration, etc., exists to conclude that this problem will not occur on the flight vehicle during pre-launch, launch, or flight."<sup>110</sup>

Lawrence Mulloy told the Commission that the launch constraint was "put on after we saw the secondary O-ring erosion on the [51-B] nozzle." "Based on the amount of charring," the problem report listing the constraint said, "the erosion paths on the primary O-ring and what is understood about the erosion phenomenon, it is believed that the primary O-ring [of the joint] never sealed."<sup>111</sup> The constraint applied to STS 51-F and all flights subsequent, including STS 51-L. Although one Marshall document says that the constraint applied to all O-ring anomalies,<sup>112</sup> no similar launch constraint was noted on the Marshall Problem Assessment Report that started tracking the field joint erosion after STS 41-B. Thiokol officials who testified before the Commission all claimed they were not aware of the July 1985 launch constraint;<sup>113</sup> however, Thiokol letters referenced Marshall Record number A09288, the report that expressly identified the constraint.<sup>114</sup>

After the launch constraint was imposed, Project Manager Mulloy waived it for each Shuttle flight after July 10, 1985. Mr. Mulloy and Mr. Lawrence Wear outlined the procedure in the following manner:

**Chairman Rogers:** To you, what does a constraint mean, then?

**Mr. Mulloy:** A launch constraint means that we have to address the observations, see if we have seen anything on the previous flight that changes our previous rationale, and address that at the Flight Readiness Review.

**Chairman Rogers:** When you say "address it," I always get confused by the word. Do you mean think about it? Is that what you mean?

**Mr. Mulloy:** No, sir. I mean present the data as to whether or not what we have seen in our most recent observation, which may not be the last flight, it may be the flight before that, is within our experience base and whether or not the previous analysis and



tests that previously concluded that was an acceptable situation is still valid, based upon later observations. . . .

The constraint was put on after we saw the secondary O-ring erosion on the nozzle, I believe.

**Chairman Rogers:** Who decided that?

**Mr. Mulloy:** I decided that, that that would be addressed, until that problem was resolved, it would be considered a launch constraint, and addressed at Flight Readiness Reviews to assure that we were staying within our test experience base. . . .

**Chairman Rogers:** Do you have ultimate responsibility for waiving the launch constraints?

**Mr. Mulloy:** Yes, sir, I have ultimate responsibility for the launch readiness of the Solid Rocket Boosters.

**Chairman Rogers:** So there was a launch constraint, and you waived it.

**Mr. Mulloy:** Yes, sir, all flights subsequent to. . . .

**Dr. Ride:** I'm trying to understand how you deal with the launch constraint. How important do you think a launch constraint is and how unusual is it in your system?

**Mr. Wear:** I think a launch constraint is a significant event in our system, and it is one that has to be addressed within the Flight Readiness cycle because I don't have the authority to not do that. . . .

**Dr. Ride:** Why didn't you put a launch constraint on the field joint at the same time?

**Mr. Mulloy:** I think at that point, and I will react to that question in real time, because I haven't really thought about it, but I think the logic was that we had been observing the field joint, the field and nozzle joint primary O-ring erosion. This erosion of a secondary O-ring was a new and significant event, very new and significant even that we certainly did not understand. Everything up to that point had been that the primary O-ring, even though it had experienced some erosion, does seal. What we had evidence of was that here was a case where the primary O-ring was violated and the secondary O-

ring was eroded, and that was considered to be a more serious observation than previously observed.

**Dr. Ride:** Correct me if I am wrong, but weren't you basing most of your decisions on the field joint on analysis of what was the maximum, what you believed to be the maximum possible erosion, and you had that analysis for the field joint and for the nozzle joint. When you saw the complete erosion of the primary O-ring on the nozzle joint, that showed you that your analysis on the nozzle joint wasn't any good, I would think. That would indicate to you that your analysis on the field joint wasn't very good, either, or at least should be suspect.

**Mr. Mulloy:** The conclusion, rightly or wrongly, for the cause of the secondary O-ring erosion on the nozzle joint, it was concluded from test data we had that 100 psi pressurization leak check, that the putty could mask a primary O-ring that was not sealing. The conclusion was — and that one was done at 100 psi. The conclusion was that in order to get that type of erosion that we saw on the primary O-ring, that that O-ring never sealed, and therefore the conclusion was that it never was capable of sealing. The leak check on subsequent nozzles, all subsequent nozzles was run at 200 psi, which the test data indicated would always blow through the putty, and in always blowing through the putty we were guaranteed that we had a primary O-ring seal that was capable of sealing, and then we further did, and we already had that on the field joints at that time.<sup>115</sup>

While Mulloy and Wear both testified that the constraint was still in effect and waived for Challenger's flight, they told the Commission that there had been two erroneous entries on the O-ring erosion nozzle problem assessment report stating the O-ring erosion problem had been resolved or closed.<sup>116</sup> Thiokol had suggested this closure on December 10, 1985 (at Marshall's request according to Brian Russell) but Wear and Mulloy told the Commission they rejected that recommendation and the problem was still being addressed in Flight Readiness Reviews.<sup>117</sup> NASA Levels I and II apparently did not realize Marshall had assigned a launch constraint within the Problem Assessment System.<sup>118</sup> This com-

### General Conclusions

- All O-ring erosion has occurred where gas paths in the vacuum putty are formed
- Gas paths in the vacuum putty can occur during assembly, leak check, or during motor pressurization
- Improved filler materials or layup configurations which still allow a valid leak check of the primary O-rings may reduce frequency of O-ring erosion but will probably not eliminate it or reduce the severity of erosion
- Elimination of vacuum putty in a tighter joint area will eliminate O-ring erosion if circumferential flow is not present—if it is present, some baffle arrangement may be required
- Erosion in the nozzle joint is more severe due to eccentricity; however, the secondary seal in the nozzle will seal and will not erode through
- The primary O-ring in the field joint should not erode through but if it leaks due to erosion or lack of sealing the secondary seal may not seal the motor
- The igniter Gask-O-Seal design is adequate providing proper quality inspections are made to eliminate overfill conditions

Figure 5

munication failure was contrary to the requirement, contained in the NASA Problem Reporting and Corrective Action Requirements System, that launch constraints were to be taken to Level II.

### Escalating Concerns

When the burn through of the primary nozzle O-ring on the left Solid Rocket Booster of STS 51-B was discovered in Utah on June 25, 1985, an engineer from the NASA headquarters Shuttle Propulsion Group was on the scene. Three days after the 51-B inspection, a memorandum was written to Michael Weeks, also at Headquarters, reporting on the primary O-ring burn through.<sup>119</sup> The memo blamed the problem on the faulty 100 psi leak check and reminded Weeks that Thiokol had not yet responded to the O-ring erosion action item sent out after STS 41-B one year earlier.

Engineers at Thiokol also were increasingly concerned about the problem. On July 22, 1985, Roger Boisjoly of the structures section wrote a memorandum predicting NASA might give the motor contract to a competitor or there might be a flight failure if Thiokol did not come up with a timely solution.<sup>120</sup>

Nine days later (July 31) Boisjoly wrote another memorandum titled "O-ring Erosion/Potential

### Recommendations

- The lack of a good secondary seal in the field joint is most critical and ways to reduce joint rotation should be incorporated as soon as possible to reduce criticality
- The flow conditions in the joint areas during ignition and motor operation need to be established through cold flow modeling to eliminate O-ring erosion
- QM-5 static test should be used to qualify a second source of the only flight certified joint filler material (asbestos-filled vacuum putty) to protect the flight program schedule
- VLS-1 should use the only flight certified joint filler material (Randolph asbestos-filled vacuum putty) in all joints
- Additional hot and cold subscale tests need to be conducted to improve analytical modeling of O-ring erosion problem and for establishing margins of safety for eroded O-rings
- Analysis of existing data indicates that it is safe to continue flying existing design as long as all joints are leak checked with a 200 psig stabilization pressure, are free of contamination in the seal areas and meet O-ring squeeze requirements
- Efforts need to continue at an accelerated pace to eliminate SRM seal erosion

Failure Criticality" to R. K. Lund, Thiokol's Vice President of Engineering:

"The mistakenly accepted position on the joint problem was to fly without fear of failure and to run a series of design evaluations which would ultimately lead to a solution or at least a significant reduction of the erosion problem. This position is now changed as a result of the [51-B] nozzle joint erosion which eroded a secondary O-ring with the primary O-ring never sealing. If the same scenario should occur in a field joint (and it could), then it is a jump ball whether as to the success or failure of the joint because the secondary O-ring cannot respond to the clevis opening rate and may not be capable of pressurization. The result would be a catastrophe of the highest order—loss of human life."

Boisjoly recommended setting up a team to solve the O-ring problem, and concluded by stating:

"It is my honest and very real fear that if we do not take immediate action to dedicate a team to solve the problem, with the field joint having the number one priority, then we stand in jeopardy of losing a flight along with all the launch pad facilities."<sup>121</sup>

In reply to specific questions from Marshall on August 9, Thiokol's Brian Russell reported the test data on the June 3 resiliency tests. As noted previously, he indicated O-ring resiliency was a function of the temperature and case expansion. Also, he wrote, Thiokol had no reason to suspect that the primary O-ring would fail after motor ignition transient. He said the secondary O-ring would seal within the period after ignition from 0 to 170 milliseconds.<sup>122</sup> From 170 to 330 milliseconds, the probability of the sealing of the secondary O-ring was reduced. From 330 to 600 milliseconds, there was only a slight chance the secondary seal would hold.

On August 19, 1985, Thiokol and Marshall program managers briefed NASA Headquarters on erosion of the motor pressure seals.<sup>123</sup> The briefing paper concluded that the O-ring seal was a critical matter, but it was safe to fly. The briefing was detailed, identifying all prior instances of field joint, nozzle joint and igniter O-ring erosion. It recommended an "accelerated pace" to eliminate seal erosion but concluded with the recommendation that "it is safe to continue flying existing design as long as all joints are leak checked with a 200 psig stabilization pressure, are free of contamination in the seal areas and meet O-ring squeeze requirements." The briefing conclusions and recommendations appear in Figure 5.<sup>124</sup>

Thiokol's Robert Lund, Vice President — Engineering, noting that "the result of a leak at any of the joints would be catastrophic," announced the establishment of a Thiokol O-ring task force on August 20, 1985, to "investigate the Solid Rocket Motor case and nozzle joints, both materials and configurations, and recommend both short-term and long-term solutions."<sup>125</sup>

Two days later, A. R. Thompson, Thiokol's supervisor of structures design, said in a memorandum to S. R. Stein, project engineer, that the "O-ring seal problem has lately become acute." Thompson recommended near-term solutions of increasing the thickness of shims used at the tang and clevis mating, and increasing the diameter of the O-ring. "Several long-term solutions look good; but, several years are required to incorporate some of them," Thompson wrote. "The simple short-term measures should be taken to reduce flight risks."<sup>126</sup> During a Commission hearing, Thompson was asked about the larger diameter O-ring solution:

**Dr. Walker:** Why didn't you go to the larger O-ring, then?

**Mr. Thompson:** One problem in going to larger O-rings is in field joints — plant joints, excuse me. In the plant joints, if you put in the 295 and you take the worst on worst, when the joint is raised to a temperature of 325 degrees during the curing of the insulation, it is an overfill condition because of the alpha problems with the case, and the rubber.

**Dr. Walker:** There is no reason why a field joint and a plant joint had to have the same O-ring, is there?

**Mr. Thompson:** There were some that were afraid of the QC people, that were afraid of the confusion that might be developed between two nearly the same sized O-ring.<sup>127</sup>

Thiokol's revised O-ring protection plan, dated August 30, 1985, indicated that NASA and Thiokol were still not in agreement on the magnitude of the joint rotation phenomenon. It said that "presently there are conflicting data from Solid Rocket Motor case hydrotest and [static tests] concerning the magnitude of case field joint rotation under motor pressure. A referee test will be devised, which is mutually acceptable to NASA and Thiokol, to determine joint opening characteristics."<sup>128</sup>

## Design Questions Resurface

Also in late August, Thiokol submitted "Preliminary Solid Rocket Motor Nozzle/Field Joint Seal Concepts" to NASA, which were "formulated to solve the [Solid Rocket Motor] sealing problems." The document contained 43 possible design concepts for field joints and 20 for nozzle joints. The report said Thiokol "feels the case field joint poses the greatest potential risk in that its secondary seal may not maintain metal contact throughout motor operation. The nozzle joint is also of major concern because the frequency and severity of seal damage experienced has been greater than any other joint."

In September 1985, Thiokol's plans called for test-firing a static motor with various O-ring configurations. In a September 10 presentation to Marshall, Thiokol discussed erosion predictions, and evaluated primary engineering concerns including joint deflection and secondary O-ring resiliency. Temperature was not mentioned.<sup>129</sup>

Prior to that Thiokol presentation, Marshall Science and Engineering Director Kingsbury had informed Solid Rocket Booster Program Manager Mulloy:

"I am most anxious to be briefed on plans for improving the Solid Rocket Motor O-ring seals. Specifically, I want to review plans which lead to flight qualifications and the attendant schedules. I have been apprised of general ongoing activities but these do not appear to carry the priority which I attach to this situation. I consider the O-ring seal problem on the Solid Rocket Motor to require priority attention of both Morton Thiokol/Wasatch and MSFC."<sup>130</sup>

Early in October, internal warnings about the lack of results from the O-ring task force came when Thiokol's management got two separate memoranda complaining about administrative delays and lack of cooperation. One memorandum was written by Roger Boisjoly on October 4, 1985, and it warned Thiokol management about lack of management support of the O-ring team's efforts.<sup>131</sup> He said that "even NASA perceives that the team is being blocked in its engineering efforts to accomplish its task. NASA is sending an engineering representative to stay with us starting October 14th. We feel that this is the direct result of their feeling that we [Thiokol] are not responding quickly enough on the seal problem."

R. V. Ebeling, manager of Thiokol's Solid Rocket Motor ignition system, began his October 1, 1985, report to McDonald with the alarming word "HELP!" Ebeling said the seal task force was "constantly being delayed by every possible means." "Marshall Space Flight Center," he said, "is correct in stating that we do not know how to run a development program." Ebeling continued:

"The allegiance to the O-ring investigation task force is very limited to a group of engineers numbering 8-10. Our assigned people in manufacturing and quality have the desire, but are encumbered with other significant work. Others in manufacturing, quality, procurement who are not involved directly, but whose help we need, are generating plenty of resistance. We are creating more instructional paper than engineering data. We wish we could get ac-

tion by verbal request, but such is not the case. This is a red flag."<sup>132</sup>

Shuttle flight 61-A was launched October 30, 1985. It experienced nozzle O-ring erosion and field joint O-ring blow-by.<sup>133</sup> These anomalies were not mentioned at the Level I Flight Readiness Review for flight 61-B. That flight was launched on November 26, 1985, and sustained nozzle O-ring erosion and blow-by.<sup>134</sup>

The following month (December) Thiokol's problem status report which tracked the field joint erosion anomaly stated that the O-ring task force had made one hot gas test and preliminary results indicated the test chamber needed to be redesigned.<sup>135</sup> Mr. Ebeling of Thiokol became so concerned about the gravity of the O-ring problem that he told fellow members of the seal task force that he believed Thiokol should not ship any more motors until the problem was fixed.

In testimony before the Commission, Ebeling said:

**Mr. Ebeling:** Well, I am a hydraulics engineer by profession, and O-rings and seals and hydraulics are very sacred, but for the most part, a hydraulics or pneumatics engineer controls the structure, the structural design, the structural deformation to make sure that this neat little part that is so critical is given every thing it needs to operate. In Solid Rocket Motors I have been there now pushing 25 years. They had a different attitude on O-rings when I came there, and it is not just Thiokol, it is universal.

**Dr. Covert:** By universal, you mean the solid rocket industry?

**Mr. Ebeling:** The entire solid rocket industry. It gets around from one, the competitors' information eventually gets to me by one track or another, and mine to them, but my experience on O-rings was and is to this date that the O-ring is not a mechanism and never should be a mechanism that sees the heat of the magnitude of our motors, and I think before I do retire, I'm going to make sure that we discontinue to fly with round seals which I am against round seals anyway. I think seals with memories, not pressure-activated, but energized through mechanical means, and in all cases, keep the heat of our rocket

motors away from those seals. Whatever it is, you do not need chamber pressure to energize a seal.

**Dr. Covert:** In this regard, then, did you have an increasing concern as you saw the tendency first to accept thermal distress and then to say, well, we can model this reasonably and we can accept a little bit of erosion, and then etc., etc.? Did this cause you a feeling of if not distress, then betrayal in terms of your feeling about O-rings?

**Mr. Ebeling:** I'm sure sorry you asked that question.

**Mr. Covert:** I'm sorry I had to.

**Mr. Ebeling:** To answer your question, yes. In fact, I have been an advocate, I used to sit in on the O-ring task force and was involved in the seals since Brian Russell worked directly for me, and I had a certain allegiance to this type of thing anyway, that I felt that we shouldn't ship any more rocket motors until we got it fixed.

**Dr. Covert:** Did you voice this concern?

**Mr. Ebeling:** Unfortunately, not to the right people.<sup>136</sup>

## The Closure Issue

On December 6, 1985, Thiokol's Brian Russell wrote Al McDonald, Thiokol Solid Rocket Motor Project Director, requesting "closure of the Solid Rocket Motor O-ring erosion critical problems."<sup>137</sup> He gave 17 reasons for the closure, including test results, future test plans and the work to date of Thiokol's task force. Four days later (December 10) McDonald wrote a memorandum to NASA's Wear asking for closure of the O-ring problem. All O-ring erosion problems, including the problem containing the July 1985 launch constraint, were among the referenced matters that Thiokol suggested should be closed. McDonald noted that the O-ring problem would not be fully resolved for some time, and he enclosed a copy of Thiokol's August 30 plan for improving the motor seals.<sup>138</sup>

Brian Russell described the problem tracking process and gave the reason for the closure recommendation during the following exchange:

**Mr. Russell:** We have our reliability engineering department, who is responsible

to complete the monthly problem report, and in addition to that we have our monthly problem review board telephone conference with NASA and the contractors, of which we are a part, and the monthly problem review or the monthly problem report that reliability prepares, they get the information from engineering or from the office as necessary to complete their status of what has happened during that month, whether the problem originated that month or what has been done to close the problem out, and that is submitted every month, and I for one do review that before it is submitted to the Marshall Space Flight Center, and so much of the information that I would read in these reports would be the same information that we had given in that monthly problem report or over the telephone on the teleconference.

**Chairman Rogers:** Mr. Russell, when you say close the problem out, what do you mean by that? How do you close it out normally?

**Mr. Russell:** Normally, whether it takes engineering analysis or tests or some corrective action, a closeout to the problem would occur after an adequate corrective action had been taken to satisfy those on the problem review board that the problem had indeed been closed out. That is the way that that happens; for example, we had found a loose bolt on the recovery one time, and we had to take corrective action in our procedures and in the engineering to make sure that that wouldn't happen again, and then to verify that corrective action, and at that point that problem would be ready to be closed out. It generally involves a report or at least a mention by the review board stating what had been done to adequately close it out, and then it is agreed upon by the parties involved. . . .

**Question:** What do you understand a launch constraint to mean?

**Mr. Russell:** My understanding of a launch constraint is that the launch cannot proceed without adequately—without everyone's agreement that the problem is under control.

**Chairman Rogers:** Under control meaning what? You just said a moment ago that you would expect some corrective action to be taken.

**Mr. Russell:** That is correct, and in this particular case on this 51-B nozzle O-ring erosion problem there had been some corrective action taken, and that was included in the presentation made as a special addendum to the next Flight Readiness Review, and at the time we did agree to continue to launch, which apparently had lifted the launch constraint, would be my understanding. . . .

**Chairman Rogers:** But really my question is: Did you gentlemen realize that it was a launch constraint?

**Mr. Russell:** I would like to answer for myself. I didn't realize that there was a formal launch constraint on this one, any different than some of the other erosion and blow-by that we had seen in the past.

**Mr. Ebeling:** I agree. . . .

**Question:** . . . Mr. Russell, you wrote a letter; did you not, or a memorandum indicating that the problem should be closed.

Could you explain to the Commission what you meant by that?

**Mr. Russell:** Yes. In our December telephone call on the Problem Review Board—and I can't remember the date—it was around the 9th or so—there was a request to close the problems out and particularly the ones that had been open for a long time, of which this was one, and a long time meaning six months or more.

There was a request from the Director of Engineering, as I recall it, that we close these problems out. . . .

**Dr. Walker:** That was the Director of Engineering at Marshall?

**Mr. Russell:** Yes, at Marshall Space Flight Center. Now, he wasn't in that call. My understanding is what they told us and my recollection was that Mr. Kingsbury would like to see these problems closed out.

Now, the normal method of closing them out is to implement the corrective action, verify the corrective action, and then the

problem is closed, it comes off the board and is no longer under active review. . . .

**Chairman Rogers:** What was being done to fix it?

**Mr. Russell:** Well, we had a task force created of full-time people at Thiokol, of which I was a member of that task team, and we had done some engineering tests. We were trying to develop concepts. We had developed some concepts to block the flow of hot gas against the O-ring to the point where the O-ring would no longer be damaged in a new configuration.

And we had run some cold gas tests and some hot gas motor firing tests and were working toward a solution of the problem and we had some meetings scheduled with the Marshall Space Flight Center. We had weekly telephone calls where we statused our progress and there was a team at Marshall also of engineering people who were monitoring the things that we were doing to fix the problem with the goal of implementing a fix in our qualification motor No. 5, which was scheduled at that time in January, this timeframe being about the December timeframe of last year.

**Chairman Rogers:** Can I interrupt? So you're trying to figure out how to fix it, right? And you're doing some things to try to help you figure out how to fix it.

Now, why at that point would you close it out? . . .

**Mr. Russell:** Because I was asked to do it.

**Chairman Rogers:** I see. Well, that explains it.

**Mr. Rummel:** It explains it, but really doesn't make any sense. On one hand you close out items that you've been reviewing flight by flight, that have obviously critical implications, on the basis that after you close it out, you're going to continue to try to fix it.

So I think what you're really saying is, you're closing it out because you don't want to be bothered. Somebody doesn't want to be bothered with flight-by-flight reviews, but you're going to continue to work on it after it's closed out.<sup>139</sup>



Marshall received the Thiokol letter asking for the closure and an entry was placed on all Marshall Problem Reports referenced in McDonald's December 10 letter indicating "contractor closure received" on December 18, 1985.<sup>140</sup> On January 23, 1986, another entry was placed on the same reports indicating the "problem is considered closed."<sup>141</sup> Lawrence Mulloy and Lawrence Wear testified those entries were "in error." They said:

**Mr. Mulloy:** The problem assessment system was put in place to provide visibility throughout the Shuttle system for the types of problems that do occur, not just in flight, but also in qualification tests, and in failure of hardware that is back for refurbishment at a vendor or whatever. And it is a closed loop tracking system that lists the anomaly. . . .

Now, the entry that is shown in there that the problem was closed prior to 51-L is in error. What happened there was, one of your documents here which we did not discuss is the letter from Mr. McDonald to Mr. Wear which proposed that this problem be dropped from the problem assessment system and no longer be tracked for the reasons stated in Mr. McDonald's letter.

That letter was in the review cycle. The letter, I believe, was dated 10 December 1985. It came into the center, it was in the review cycle. After Mr. Wear brought this letter to my attention, my reaction was, we are not going to drop this from the problem assessment system because the problem is not resolved and it has to be dealt with on a flight-by-flight basis.

Since that was going through the review cycle, the people who run this problem assessment system erroneously entered a closure for the problem on the basis of this submittal from Thiokol. Having done that then for the 51-L review, this did not come up in the Flight Readiness Review as an open launch constraint, so you won't find a project signature because the PAS system showed the problem was closed, and that was an error.

**Chairman Rogers:** Who made the error? Do you know?

**Mr. Mulloy:** The people who do the problem assessment system.

**Mr. Wear:** Mr. Fletcher, and he reports within our quality organization at the Flight Readiness Reviews, . . . as I think have been described to you before. There is one from Thiokol to me, and there is one from my group to Larry, and then Larry, of course, does one with the Shuttle project office, and so forth, on up the line. At my review and at Larry's review, here is a heads up given to the quality representative at that board for what problems the system has open, and they cross-check to make sure that we address that problem in the readiness review.

On this particular occasion, there was no heads up given because their Problem Assessment System considered that action closed. That is unfortunate.<sup>142</sup>

Project Manager Mulloy was asked during Commission hearings about the original response to O-ring erosion:

**Mr. Hotz:** Mr. Mulloy, I would like to try to understand this in somewhat simpler terms than you people are used to using.

Is it correct to state that when you originally designed this joint and looked at it, that you did not anticipate erosion of any of the O-ring during flights?

**Mr. Mulloy:** That is my understanding. I entered this program in November of 1982 and I wasn't there on the original design of the joint, but when I took over the program there was no O-ring erosion anticipated.

**Mr. Hotz:** So that when you did run into signs of O-ring erosion, this was a bad sign.

**Mr. Mulloy:** Yes, sir. . . .

**Mr. Hotz:** So then you decided to introduce a standard based on the measurement or the possibility of the limits of O-ring erosion. And as those limits, as the experience went up, your criteria for, say, flight went up too.

In other words, when you experienced more than maximum anticipated O-ring erosion, you waived the flight and said "Well, it's possible to tolerate that. We still have a margin left."

**Mr. Mulloy:** Are you speaking of the case where we did not have a primary seal.

**Mr. Hotz:** Yes.



**Mr. Mulloy:** Yes, sir. That is correct. . . .

**Mr. Hotz:** Then you finally, you're talking about these margins of safety, and I wonder if you could express in either percentages or actual measurement terms — you have used the term "wide margin." I wonder if you could give us a quantitative measurement as to what you consider a wide margin?

**Mr. Mulloy:** Yes, sir. Well, as I said we had demonstrated that we could stand 125 thousandths of erosion and still seat. The maximum erosion that we had seen in the case joint was on STS-2, which was 53 thousandths, so that is a factor of two and a half . . .

**Dr. Keel:** . . . I think, Larry, if you go back and look at your Flight Readiness Reviews, that you were relying on less margins than that.

You were arguing in the Flight Readiness Reviews where you briefed the problems of primary O-ring erosion that for the worst case for the field joint also that it would be 90 thousandths.

**Mr. Mulloy:** That is correct.

**Dr. Keel:** At that point you were pointing out that's okay, because you can seal at 95, not at 125 but at 95. It wasn't until later on during the process that you determined you could seal at 125.

**Mr. Mulloy:** That is when we got the hot gas test data.

**Dr. Keel:** So that's a five percent margin, roughly, five and a half.

**Mr. Mulloy:** On the 90 to 95 on a max predictable, yes.<sup>143</sup>

## Temperature Effects

The record of the fateful series of NASA and Thiokol meetings, telephone conferences, notes, and facsimile transmissions on January 27th, the night before the launch of flight 51-L, shows that only limited consideration was given to the past history of O-ring damage in terms of temperature. The managers compared as a function of temperature the flights for which thermal distress of O-rings had been observed — not the frequen-

cy of occurrence based on all flights (Figure 6). In such a comparison, there is nothing irregular in the distribution of O-ring "distress" over the spectrum of joint temperatures at launch between 53 degrees Fahrenheit and 75 degrees Fahrenheit. When the entire history of flight experience is considered, including "normal" flights with no erosion or blow-by, the comparison is substantially different (Figure 7).

This comparison of flight history indicates that only three incidents of O-ring thermal distress occurred out of twenty flights with O-ring temperatures at 66 degrees Fahrenheit or above, whereas, all four flights with O-ring temperatures at 63 degrees Fahrenheit or below experienced O-ring thermal distress.

Consideration of the entire launch temperature history indicates that the probability of O-ring distress is increased to almost a certainty if the temperature of the joint is less than 65.

## Flight Readiness Reviews

It is clear that contractor and NASA program personnel all believed that the O-ring erosion/blow-by anomaly, and even the launch constraint, were problems that should be addressed in NASA's Flight Readiness Review process. The Flight Readiness Review is a multi-tiered review that is designed to create an information flow from the contractor up through Level III at Marshall, then to Level II officials from Johnson and Level I at Headquarters. With regard to the Solid Rocket Booster, the process begins at the element level and culminates in a coordinated Marshall position at the subsequent Levels II and I Flight Readiness Review.<sup>144</sup>

NASA policy manuals list four objectives of the Shuttle Projects Flight Readiness Review, an intermediate review between Level III and Level I, when contractors and Level III program personnel consider the upcoming launch. The stated objectives are:

1. To provide the review team with sufficient information necessary for them to make an independent judgment regarding flight readiness.
2. Review solved problems and previous flight anomalies and establish confidence in solution rationale.

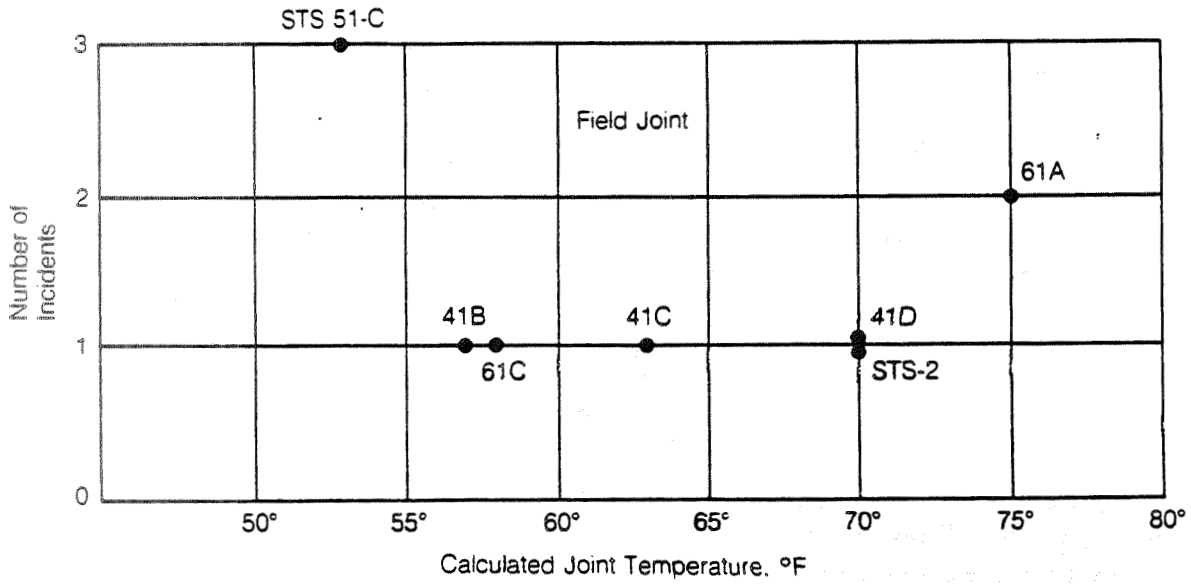

Figure 6  
Plot of flights with incidents of O-ring thermal distress as function of temperature

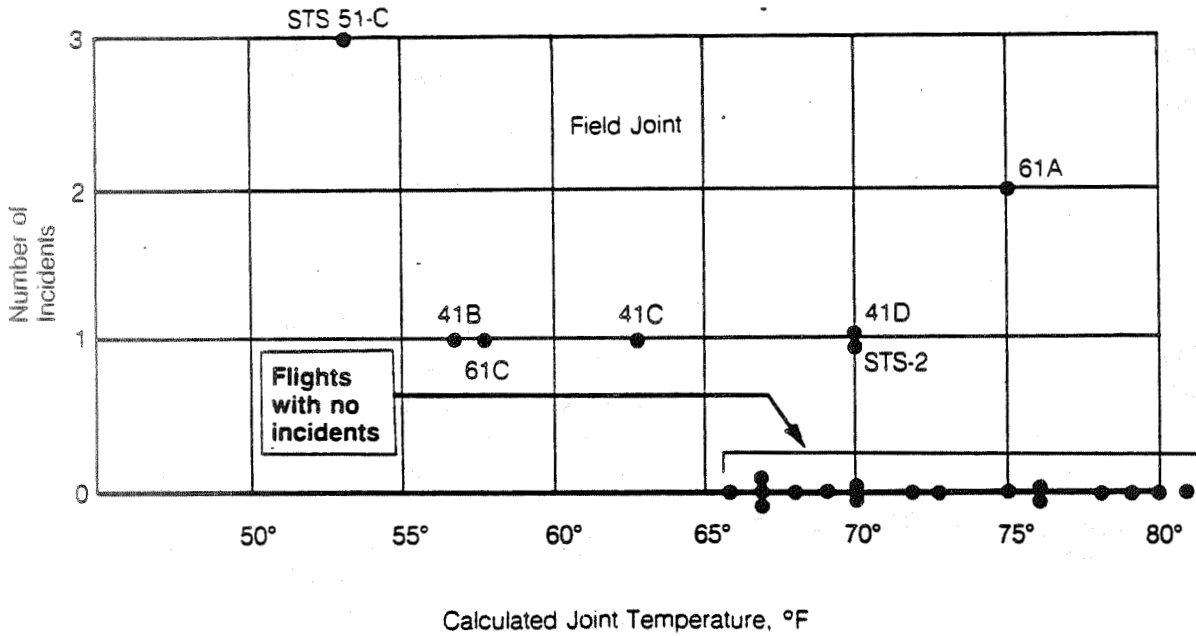

Figure 7  
Plot of flights with and without incidents of O-ring thermal distress

NOTE: Thermal distress defined as O-ring erosion, blow-by, or excessive heating

- “3. Address all problems, technical issues, open items and constraints requiring resolution before flight.
- “4. Establish the flight baseline configuration particularly as it differs from previous missions.”<sup>145</sup>

The Commission has reviewed the various documentary presentations made by Thiokol and NASA program people for Flight Readiness Reviews on all Shuttle flights. The O-ring presentations in those Flight Readiness Reviews have been summarized in an Appendix to this report.

The erosion on STS-2 was not considered on any level of the Flight Readiness Review for STS-3.<sup>146</sup> Similarly the heat effect on STS-6's primary O-ring in the nozzle was not mentioned on the STS-7 Flight Readiness Review in 1983. However, the rationale for acceptance of the “secondary seal condition” for the lightweight case first flown on STS-6 contained the observation that an O-ring sealed during a Thiokol test under 3,000 psi where .125 inches had been cut out of the O-ring.<sup>147</sup>

The inattention to erosion and blow-by anomaly changed when Thiokol filed a problem report on the field joint erosion after STS 41-B. The O-ring problems (field and nozzle) on 41-B were briefed as a “technical issue” in the 41-C Flight Readiness Review. “Probable causes” were defined as:

“Putty blow-through at ignition causes cavity between putty and primary O-ring to fill during pressurization. Inability of putty to withstand motor pressure. Air entrapment in putty during mating. Blow holes in putty during joint leak test.”

Thiokol presented the question at its 41-C pre-board to Marshall, “If primary O-ring allowed a hot gas jet to pass through, would the secondary O-ring survive impingement?”<sup>148</sup> At the 41-C Level I Flight Readiness Review, on March 30, 1984, Marshall said the erosion phenomenon was “acceptable” and that blow holes in the putty were the “most probable cause.” The rationale for the acceptance of the possibility of erosion on STS 41-C was:

“Conservative analysis indicates max erosion possible:

- “.090 in. (field joint)
- “.090 in. (nozzle joint)

“Laboratory test of full scale O-ring/joint cross section shows capability to sustain joint

sealing integrity at 3,000 psi pressure using an O-ring with a simulated .095 in. erosion depth.

“Recommendation:

“Fly STS 41-C accepting possibility of some O-ring gas impingement.”<sup>149</sup>

The next significant treatment of the problem occurred after the coldest flight, 51-C at 53 degrees in January 1985. In part, Thiokol's extensive analysis for the 51-E Flight Readiness Review was due to the fact that four joints on 51-C had problems.<sup>150</sup> Additionally, Mr. Mulloy's specific request for a recap of the O-ring history undoubtedly prompted a full treatment. Temperature was highlighted as a concern when Mulloy took Thiokol's analysis up to the Shuttle Projects Office Flight Readiness Review. That 18-page briefing concluded with the statement that: “STS 51-C consistent with erosion data based. Low temperature enhanced probability of blow-by. STS-51-C experienced worst case temperature change in Florida history. STS 51-E could exhibit the same behavior. Condition is acceptable.”<sup>151</sup>

At the Level I Flight Readiness Review for 51-E on February 21, 1985, the previous 18-page analysis had been reduced to a one page chart with the resolution: “acceptable risk because of limited exposure and redundancy (Ref. STS 41-C FRR).”<sup>152</sup> No mention of temperature was found in the Level I report.

The last major discussion of erosion was at the Level I Flight Readiness Review for STS 51-F (July 2, 1985).<sup>153</sup> An analysis of the failure of the nozzle primary O-ring to seal due to erosion on flight STS 51-B (April 29, 1985) was presented. This serious erosion was attributed to leak check procedures. An increase in the nozzle leak check to 200 psi was proposed to be a cure. There was no mention of the fact that .171 inches of erosion on the primary O-ring far exceeded a more recent analysis model prediction of .070 inches maximum possible erosion. This was a revision of the former prediction of .090 inches. The launch constraint activated after STS 51-B was not specifically listed in the Level I Flight Readiness Review for 51-F. The Commission has also not found any mention of the July 1985 constraint, or its waiver for subsequent Shuttle flights, in any Flight Readiness Review briefing documents.

The Commission's review of the Marshall and Thiokol documentary presentations at the various Flight Readiness Reviews revealed several significant trends. First, O-ring erosion was not considered early in the program when it first occurred. Second, when the problem grew worse after STS 41-B, the initial analysis of the problem did not produce much research: instead, there was an early acceptance of the phenomenon. Third, because of a belief that in-flight O-ring erosion was "within the data base" of prior experience, later Flight Readiness Reviews gave a cursory review and often dismissed the recurring erosion as within "acceptable" or "allowable" limits. Fourth, both Thiokol and Marshall continued to rely on the redundancy of the secondary O-ring long after NASA had officially declared that the seal was a non-redundant single point failure. Finally, in 1985 when temperature became a major concern after STS 51-C and when the launch constraint was applied after 51-B, NASA Levels I and II were not informed of these developments in the Flight Readiness Review process.

## Findings

The genesis of the Challenger accident—the failure of the joint of the right Solid Rocket Motor—began with decisions made in the design of the joint and in the failure by both Thiokol and NASA's Solid Rocket Booster project office to understand and respond to facts obtained during testing.

The Commission has concluded that neither Thiokol nor NASA responded adequately to internal warnings about the faulty seal design. Furthermore, Thiokol and NASA did not make a timely attempt to develop and verify a new seal after the initial design was shown to be deficient. Neither organization developed a solution to the unexpected occurrences of O-ring erosion and blow-by even though this problem was experienced frequently during the Shuttle flight history. Instead, Thiokol and NASA management came to accept erosion and blow-by as unavoidable and an acceptable flight risk. Specifically, the Commission has found that:

1. The joint test and certification program was inadequate. There was no require-

ment to configure the qualifications test motor as it would be in flight, and the motors were static tested in a horizontal position, not in the vertical flight position.

2. Prior to the accident, neither NASA nor Thiokol fully understood the mechanism by which the joint sealing action took place.
3. NASA and Thiokol accepted escalating risk apparently because they "got away with it last time." As Commissioner Feynman observed, the decision making was:

"a kind of Russian roulette. . . . [The Shuttle] flies [with O-ring erosion] and nothing happens. Then it is suggested, therefore, that the risk is *no longer* so high for the next flights. We can lower our standards a little bit because we got away with it last time. . . . You got away with it, but it shouldn't be done over and over again like that."<sup>154</sup>

4. NASA's system for tracking anomalies for Flight Readiness Reviews failed in that, despite a history of persistent O-ring erosion and blow-by, flight was still permitted. It failed again in the strange sequence of six consecutive launch constraint waivers prior to 51-L, permitting it to fly without any record of a waiver, or even of an explicit constraint. Tracking and continuing only anomalies that are "outside the data base" of prior flight allowed major problems to be removed from, and lost by, the reporting system.
5. The O-ring erosion history presented to Level I at NASA Headquarters in August 1985 was sufficiently detailed to require corrective action prior to the next flight.
6. A careful analysis of the flight history of O-ring performance would have revealed the correlation of O-ring damage and low temperature. Neither NASA nor Thiokol carried out such an analysis; consequently, they were unprepared to properly evaluate the risks of launching the 51-L mission in conditions more extreme than they had encountered before. ■

## References

- <sup>1</sup> Letter, Dorsey to Hardy, November 7, 1978.
- <sup>2</sup> Report, "STS-3 through STS-25 Flight Readiness Reviews to Level III Center Board." NASA.
- <sup>3</sup> Ibid.
- <sup>4</sup> Report, "Selection of Contractor for Space Shuttle Program SRM," NASA, December 12, 1973; GAO Report B-17367, page 339.
- <sup>5</sup> Ibid., page 6.
- <sup>6</sup> Ibid., pages 21 and 22.
- <sup>7</sup> Ibid., page 18.
- <sup>8</sup> Ibid., page 7.
- <sup>9</sup> Ibid., page 20.
- <sup>10</sup> Chart, "SRM and Titan III Clevis Joint Comparison," from Pelham presentation to Commission Development and Production Subcommittee, March 17, 1986, page 3. PC 73978.
- <sup>11</sup> Chart, "Segment/Segment Interface," from Pelham presentation to Commission Development and Production Subcommittee, March 17, 1986, page 2, PC 73977.
- <sup>12</sup> Report, "Thiokol Space Shuttle Joint Review," Thiokol, February 25, 1986, PC 021453.
- <sup>13</sup> Ibid.
- <sup>14</sup> Ibid.
- <sup>15</sup> Report, "Presidential Commission Development and Production Panel, Response to Panel Question/Special Actions—SRM and Titan III Clevis Joint Comparison," Thiokol, April 3, 1986, PC 073979.
- <sup>16</sup> Report, "Original Design of Joint Assembly SRB Morton Thiokol," Thiokol, July 13, 1973, PC 009350; and Commission Work Session, Panel on Development and Production, April 17, 1986, page 18.
- <sup>17</sup> Report, "1974 Proposal Write Up On Case Design," Thiokol, 1974, page 4, 3-3, PC 010957.
- <sup>18</sup> Ibid., page 4, 3-19, PC 010973.
- <sup>19</sup> Commission Work Session, Development and Production Panel, April 7, 1986, page 118.
- <sup>20</sup> Commission Interview Transcript, McIntosh, H., April 2, 1986, page 5.
- <sup>21</sup> Ibid.
- <sup>22</sup> Letter, Brian Russell to Bob Ebeling, Thiokol, April 9, 1986, PC 091702 and Commission Hearing Transcript, May 2, 1986, pages 2653-2658.
- <sup>23</sup> Commission Hearing Transcript, February 6, 1986, page 30.
- <sup>24</sup> Report, "Space Shuttle Case Burst Test Report," Thiokol, December 21, 1977, PC 049551-049648, TWR-11664.
- <sup>25</sup> Ibid.
- <sup>26</sup> Report, "Analytical Evaluation of the Space Shuttle Solid Rocket Motor Tang/Clevis Joint Behavior," Thiokol, October 6, 1978, TWR-12019; and Report, "SRM Clevis Joint Leakage Study," NASA, October 21, 1977.
- <sup>27</sup> Commission Hearing Transcript, February 25, 1986, page 1435.
- <sup>28</sup> Commission Hearing Transcript, May 2, 1986, page 2784.
- <sup>29</sup> Report, "SRM Clevis Joint Leakage Study," NASA, October 21, 1977, PC 102337.
- <sup>30</sup> Letter, Miller to Eudy, January 9, 1978, PC 009923.
- <sup>31</sup> Letter, Miller to Eudy, January 19, 1979, PC 009921.
- <sup>32</sup> Ibid.
- <sup>33</sup> Ibid., footnote 31.
- <sup>34</sup> Commission Hearing Transcript, May 2, 1986, page 2782.
- <sup>35</sup> Report, "Visit to Precision Rubber Products Corporation and Parker Seal Company," NASA, February 6, 1979.
- <sup>36</sup> Ibid.
- <sup>37</sup> Commission Hearing Transcript, May 2, 1986, page 2782.
- <sup>38</sup> Report, "Phase I Design Certification Review," Thiokol, March 23, 1979, TWR-12230.
- <sup>39</sup> Report, "Analytical Evaluation of the Space Shuttle SRM Tang/Clevis Joint Behavior," Thiokol, October 6, 1978, PC 102302.
- <sup>40</sup> Report, "Space Shuttle Verification/Certification Review Propulsion Committee Cognizant Engineers 5th Meeting," NASA, July 10, 1980, pages C-7-22.
- <sup>41</sup> Commission Hearing Transcript, May 2, 1986, page 2807.
- <sup>42</sup> Report, "Verification/Certification Space Shuttle Program Response to Assessment," NASA, September 1980, page 59, PC 094010.
- <sup>43</sup> Report, "SRM Program Response," NASA, August 15, 1980, PC 102359.
- <sup>44</sup> NASA Handbook, NASA, 5300.4 (1D-2), Appendix A, page a-1.
- <sup>45</sup> Commission Interview Transcript, A. Aldrich, April 8, 1986, page 13.
- <sup>46</sup> Memorandum, Abrahamson to Beggs, December 8, 1981.
- <sup>47</sup> Ibid.
- <sup>48</sup> Report, "Erosion of SRM Pressure Seals," Thiokol, August 19, 1985, Rev. A (February 10, 1986), page A-4a.
- <sup>49</sup> Commission Interview Transcript, Thomas, J.W., April 10, 1986, pages 64-66; and Reports, Marshall Space Flight Center Problem Assessment Reports, NASA.
- <sup>50</sup> Report, "Post-flight Evaluation of STS-2 SRM Components," Thiokol, January, 1983, part 1, page 2, TWR 13286.
- <sup>51</sup> Report, "NASA Response to Commission Request DP-006," NASA, March 17, 1986, PC 074021.
- <sup>52</sup> Report, "STS-8, SRB Pre-Board Flight Readiness Review," Thiokol, July 29, 1983.
- <sup>53</sup> Report, "Retention Rationale, SRM Simplex Seal," Thiokol, December 1, 1982, page 4; and Report, "Critical Items List," NASA, December 17, 1982.
- <sup>54</sup> Report, "SRB Critical Items List," NASA, December 17, 1982.
- <sup>55</sup> Report, "Retention Rationale, SRM Simplex Seal," Thiokol, December 1, 1982, page 5.
- <sup>56</sup> Ibid., page 4.
- <sup>57</sup> Commission Interview Transcript, McIntosh, H., April 2, 1986, page 66.
- <sup>58</sup> Commission Hearing Transcript, May 2, 1986, pages 2729-30.
- <sup>59</sup> Ibid., footnote 31, page 1.
- <sup>60</sup> Commission Hearing Transcript, February 26, 1986, pages 1700-1701.
- <sup>61</sup> Commission Hearing Transcript, February 26, 1986, pages 1514-1516.
- <sup>62</sup> Report, "Space Transportation System Level I Change Request—Report, SRB Critical Items List Requirements," NASA, March 2, 1983, page 1; and Report, "Space Shuttle Program Requirements Control Board Directive—Level II—SRB Critical Item List Requirements for SRM Case Joint Assemblies," NASA, March 2, 1983, page 1.
- <sup>63</sup> Report, "Space Shuttle Program Requirements Document Level I," NASA, June 30, 1977, page A-8.
- <sup>64</sup> Commission Hearing Transcript, May 2, 1986, pages 2842-2844.
- <sup>65</sup> Commission Hearing Transcript, May 2, 1986, page 2845; and Report, "Space Shuttle Program Requirements Control Board Directive—Level II, SRB Critical Item List Requirements for SRM Case Joint Assemblies," NASA, March 2, 1983, page 1.
- <sup>66</sup> Commission Hearing Transcript, May 2, 1986, page 2852.
- <sup>67</sup> Commission Interview Transcript, A. Aldrich, and R. Kohrs, April 8, 1986, pages 19-20.
- <sup>68</sup> Commission Interview Transcript, L. Weeks, April 7, 1986, page 16.
- <sup>69</sup> Ibid., footnote 54.

- <sup>70</sup> Report, "MSFC Problem Assessment Report—O-Ring Erosion in the Case to Nozzle Joint." NASA, February 26, 1986, page 1 of 3; and Commission Interview Transcript, W. Hankins, April 2, 1986, page 11.
- <sup>71</sup> Report, "Erosion of SRM Pressure Seals." Thiokol, February 10, 1986, TWR-15150 Revision A; and Chart, "History of O-Ring Damage in Field Joints" from Thiokol's presentation on February 25, 1986 to Commission, PC 072076 and PC 072077.
- <sup>72</sup> Report, "Case and Nozzle Joint Configuration Review," Thiokol, July 2, 1980, pages 2 and 5; and Report, "Erosion of SRM Pressure Seals." Thiokol, August 19, 1986, pages A-4 and A-6, TWR-15150.
- <sup>73</sup> Report, "Char Condition on O-Ring Seal in Forward Field Joint of SRM A57 of STS-11 Flight Mission 41-B." Thiokol, entry of March 12, 1984, page 5, TWR-14283; and Report, "MSFC Problem Assessment System—Segment Joint Primary O-Ring Charred." NASA, February 17, 1984.
- <sup>74</sup> Report, "MSFC Problem Assessment System—Segment Joint Primary O-Ring Charred." NASA, entry of March 12, 1984, page 5, TWR-14283.
- <sup>75</sup> Letter, Morefield to Mulloy, March 9, 1984.
- <sup>76</sup> Report, "Flight Readiness Review—41C Level I." NASA, March 30, 1984.
- <sup>77</sup> Hans Mark 41-C Programmatic Action Item, NASA, March 30, 1984.
- <sup>78</sup> Letter, Abrahamson to Lucas, January 18, 1984, PC 008191.
- <sup>79</sup> Letter, Wear to Kilminster, April 13, 1984, pages 1 and 2.
- <sup>80</sup> Report, "Protection of Space Shuttle SRM Primary Motor Seals." Thiokol, May 4, 1984, PC 014053.
- <sup>81</sup> Report, "Erosion of SRM Pressure Seals Presentation to NASA HQ." Thiokol, August 19, 1985, page 1, and "STS 41-C Action Item Closeout." L. Mulloy, S. Reinartz, NASA, February 20, 1986.
- <sup>82</sup> Routing slip, Miller to Hardy, NASA, February 28, 1984, PC 0266494.
- <sup>83</sup> Report, "SRM Field Joint Zinc Chromate Vacuum Putty Test Report." Thiokol, April 21, 1983, page 13.
- <sup>84</sup> Report, "SRM Joint Putty, O-Ring, and Leak History." Thiokol, April 9, 1984, page 1, TWR-13484.
- <sup>85</sup> *Ibid.*; and Report, "Erosion of SRM Pressure Seals." Thiokol, TWR-15150, page D-16, PC 002963.
- <sup>86</sup> *Ibid.*; and Report, "SRB STS 9 Flight Readiness Review." NASA, November 4, 1983, page 35.
- <sup>87</sup> Report, "Erosion of Solid Rocket Motor Pressure Seals." Thiokol, August 19, 1985, TWR-15150, PC 021767.
- <sup>88</sup> Commission Hearing Transcript, May 2, 1986, page 2687.
- <sup>89</sup> Commission Hearing Transcript, May 2, 1986, page 2621.
- <sup>90</sup> Memorandum, B. Russell, Thiokol, June 13, 1984, "Minutes of Telecon with NASA MSFC on June 7, 1984," page 1, PC 102463.
- <sup>91</sup> Memorandum, B. Russell, Thiokol, June 1, 1984, "Vacuum Putty/O-Ring Test Results," page 1, PC 102460.
- <sup>92</sup> Memorandum, J. Miller, March 6, 1985, NASA.
- <sup>93</sup> Memorandum, Young to Director, Flight Crew Operations, March 3, 1986.
- <sup>94</sup> Commission Interview Transcript, M. Silveira, April 16, 1986, page 30.
- <sup>95</sup> Commission Interview Transcript, J. Beggs, May 1, 1986, pages 5-6.
- <sup>96</sup> Commission Hearing Transcript, February 27, 1986, page 1899.
- <sup>97</sup> Report, "Flight Readiness Review STS 51-E SRM-16," Thiokol, February 12, 1985, pages 3-1 through 3-17.
- <sup>98</sup> Commission Hearing Transcript, February 25, 1986, page 1392.
- <sup>99</sup> Commission Hearing Transcript, February 14, 1986, page 1202.
- <sup>100</sup> Report, "Problem Assessment System Record #A07934." NASA, page 3, PC 037598.
- <sup>101</sup> Memorandum, "51-C O-Ring Erosion Re: 51-E FRR." Mulloy to Wear, 01/31/85, PC 102482.
- <sup>102</sup> Report, "STS 51-E Flight Readiness Review," Thiokol, February 8, 1984, TWR-14740 Rev. B Section 1, page 4.
- <sup>103</sup> *Ibid.*, Section 6, page 4.
- <sup>104</sup> Report, "SRM Seal Erosion Problems," NASA, March 19, 1986, PC 10235.
- <sup>105</sup> Report, "O-Ring Resiliency Testing," Thiokol, June 3, 1985, PC 102509; and Memorandum, "Actions Pertaining to Field Joint Secondary Seal," B. Russell, Thiokol, August 9, 1985, PC 102543.
- <sup>106</sup> *Ibid.*
- <sup>107</sup> Commission Hearing Transcript, May 2, 1986, page 2591.
- <sup>108</sup> Commission Hearing Transcript, May 2, 1986, pages 2606-2607.
- <sup>109</sup> Commission Hearing Transcript, May 2, 1986, page 2591.
- <sup>110</sup> Memorandum, Lindstrom to Distribution, NASA, September 15, 1980, page 1.
- <sup>111</sup> Report, "MSFC Problem Assessment System." February 26, 1986, PC 037710.
- <sup>112</sup> Report, "SRM Seal Erosion Problem, Revised," March 19, 1986, PC 037593.
- <sup>113</sup> Commission Hearing Transcript, May 2, 1986, page 2735.
- <sup>114</sup> Letter, McDonald to Wear, Thiokol, December 10, 1985, PC 49701.
- <sup>115</sup> Commission Hearing Transcript, May 2, 1986, excerpt beginning pages 2590 through 2646.
- <sup>116</sup> Commission Hearing Transcript, May 2, 1986, page 2589.
- <sup>117</sup> Commission Hearing Transcript, May 2, 1986, page 2635.
- <sup>118</sup> Commission Hearing Transcript, May 2, 1986, page 2867.
- <sup>119</sup> Memorandum, Winterhalter to Weeks, June 28, 1985.
- <sup>120</sup> Memorandum, R. Boisjoly, July 22, 1985.
- <sup>121</sup> Memorandum, R. Boisjoly, July 31, 1985.
- <sup>122</sup> Letter, "Actions Pertaining to SRM Field Joint Secondary Seal." Russell to Thomas, August 9, 1985.
- <sup>123</sup> Report, "Erosion of Solid Rocket Motor Pressure Seal Updated from August 19, 1985—Revised February 10, 1986." Thiokol, TWR-15150, PC 000769.
- <sup>124</sup> *Ibid.*
- <sup>125</sup> Memorandum, Lund to Sayer, August 20, 1985.
- <sup>126</sup> Memorandum, "SRM Flight Seal Recommendation." Thompson to Stein, August 22, 1985.
- <sup>127</sup> Commission Hearing Transcript, February 14, 1986, page 1220.
- <sup>128</sup> Report, "Program Plan Improvement of Space Shuttle SRM Motor Seal," Thiokol, August 30, 1985, page 6.
- <sup>129</sup> Report, "Erosion of SRM Pressure Seals." Thiokol, September 10, 1985, pages A-1 to C-5.
- <sup>130</sup> Letter, Kingsbury to Mulloy, September 5, 1985.
- <sup>131</sup> Report, "Activity Report—Solid Rocket Motor Seal Problem Task Team Status," Thiokol, October 4, 1985.
- <sup>132</sup> Memorandum, Ebeling to McDonald, October 1, 1985, page 1.
- <sup>133</sup> *Ibid.*, page 2; and Report, "Erosion of SRM Pressure Seals. Update," February 10, 1986, pages A-4a, A-6a, TWR-1510, PC000760.
- <sup>134</sup> Report, "Level I STS 61-C Flight Readiness Review." NASA, December 11, 1985.
- <sup>135</sup> *Ibid.*, footnote 133; and Report, "Solid Rocket Motor Branch Significant Events," NASA, December 12, 1985.
- <sup>136</sup> Commission Hearing Transcript, May 2, 1986, pages 2746-2747.
- <sup>137</sup> Memorandum, "Closure of SRM O-Ring Erosion Critical Problems." Russell to McDonald, December 6, 1985.
- <sup>138</sup> Letter, McDonald to Wear, December 10, 1985.

<sup>139</sup> Commission Hearing Transcript, May 2, 1986, pages 2682-2695.

<sup>140</sup> Report, "Problem Assessment System," NASA, entry dated December 18, 1985.

<sup>141</sup> Ibid., entry January 23, 1986.

<sup>142</sup> Commission Hearing Transcript, May 2, 1986, pages 2589-2590.

<sup>143</sup> Ibid., pages 2619-2623.

<sup>144</sup> Commission Hearing Transcript, February 11, 1986, pages 650-653.

<sup>145</sup> Report, "Shuttle Project Flight Readiness Review (Pre-launch Activities Team Report)," NASA, December 29, 1983, page 75.

<sup>146</sup> Reports, "STS-3 Flight Readiness Review for Levels I, II, III and Contractor."

<sup>147</sup> Commission Hearing Transcript, February 26, 1986, page 1639.

<sup>148</sup> Report, "STS-13 Solid (41-C) Rocket Motor Flight Readiness Review," Thiokol, March 2, 1984, page 2, TWR-14231.

<sup>149</sup> Report, "STS 41-C Flight Readiness Review Solid Rocket Booster," NASA, March 30, 1984, page 39.

<sup>150</sup> Report, "O-Ring Erosion on SRM-15," Thiokol, February 12, 1985, pages 1 through 17.

<sup>151</sup> Report, "STS 51-E Flight Readiness Review," Thiokol, February 12, 1985, TWR-14740 Rev. D., Section 3, page 17.

<sup>152</sup> Report, "STS 51-E Flight Readiness Review, Level I," NASA, February 21, 1985, page 4.

<sup>153</sup> Report, "STS 51-F Flight Readiness Review, Level I," NASA, July 2, 1985, page 5.

<sup>154</sup> Commission Hearing Transcript, April 3, 1986, page 2469.



# The Silent Safety Program

The Commission was surprised to realize after many hours of testimony that NASA's safety staff was never mentioned. No witness related the approval or disapproval of the reliability engineers, and none expressed the satisfaction or dissatisfaction of the quality assurance staff. No one thought to invite a safety representative or a reliability and quality assurance engineer to the January 27, 1986, teleconference between Marshall and Thiokol. Similarly, there was no representative of safety on the Mission Management Team that made key decisions during the countdown on January 28, 1986. The Commission is concerned about the symptoms that it sees.

The unrelenting pressure to meet the demands of an accelerating flight schedule might have been adequately handled by NASA if it had insisted upon the exactingly thorough procedures that were its hallmark during the Apollo program. An extensive and redundant safety program comprising interdependent safety, reliability and quality assurance functions existed during and after the lunar program to discover any potential safety problems. Between that period and 1986, however, the program became ineffective. This loss of effectiveness seriously degraded the checks and balances essential for maintaining flight safety.

On April 3, 1986, Arnold Aldrich, the Space Shuttle program manager, appeared before the Commission at a public hearing in Washington, D.C. He described five different communication or organization failures that affected the launch decision on January 28, 1986.<sup>1</sup> Four of those failures relate directly to faults within the safety program. These faults include a lack of problem

reporting requirements, inadequate trend analysis, misrepresentation of criticality and lack of involvement in critical discussions.<sup>2</sup> A properly staffed, supported, and robust safety organization might well have avoided these faults and thus eliminated the communication failures.

NASA has a safety program to ensure that the communication failures to which Mr. Aldrich referred do not occur. In the case of mission 51-L, that program fell short.

## NASA's Safety Program

The NASA Safety, Reliability and Quality Assurance Program should play an important role in agency activities, for the three concerns indicated in the program title are its functions. In general terms, the program monitors the status of equipment, validation of design, problem analysis and system acceptability. Each of these has flight safety implications.

More specifically, safety includes the preparation and execution of plans for accident prevention, flight system safety and industrial safety requirements. Within the Shuttle program, safety analyses focus on potential hazards and the assessment of acceptable risks.

Reliability refers to processes for determining that particular components and systems can be relied on to work as planned. One product of such processes is a Critical Items List that identifies how serious the failure of a particular item or system would be.

Quality assurance is closely related to both safety and reliability. All NASA elements prepare

plans and institute procedures to insure that high standards of quality are maintained. To accomplish that goal, elements charged with responsibility for quality assurance establish procedural controls, assess inspection programs, and participate in a problem identification and reporting system.

The Chief Engineer at NASA Headquarters, has overall responsibility for safety, reliability and quality assurance. The ability of the Chief Engineer to manage NASA's safety program is limited by the structure of safety, reliability and quality assurance organizations within the agency. His limited staff of 20 persons<sup>3</sup> includes only one who spends 25 percent of his time on Shuttle maintainability, reliability and quality assurance and another who spends 10 percent of his time on these vital aspects of flight safety.<sup>4</sup>

At Johnson, a large number of government and contractor engineers support the safety, reliability and quality assurance program, but needed expertise concerning Marshall hardware is absent. Thus the effectiveness of the oversight responsibilities at Level II was limited.<sup>5</sup>

Kennedy has a myriad of safety, reliability and quality assurance organizations. In most cases, these organizations report to supervisors who are responsible for processing. The clear implication of such a management structure is that it fails to provide the kind of independent role necessary for flight safety.

At Marshall, the director of Reliability and Quality Assurance reports to the director of Science and Engineering who oversees the development of Shuttle hardware. Again, this results in a lack of independence from the producer of hardware and is compounded by reductions in manpower,<sup>6</sup> the net bringing about a decrease in effectiveness which has direct implications for flight safety.

## Monitoring Safety Critical Items

As part of the safety, reliability and quality assurance effort, components of the Shuttle system are assigned to criticality categories as follows:

- Criticality 1 Loss of life or vehicle if the component fails.
- Criticality 2 Loss of mission if the component fails.

Criticality 3 All others.

Criticality 1R Redundant components, the failure of both could cause loss of life or vehicle.

Criticality 2R Redundant components, the failure of both could cause loss of mission.

The assignment of criticality follows a highly detailed analysis of each Space Shuttle component to determine the effect of various ways the component could fail. This analysis always assumes the most adverse conditions with the most conservative assumptions. Any component that does not meet the fail-safe design requirement is designated a Criticality 1 item and must receive a waiver for use. A Critical Items List is produced that contains information about all Criticality 1 components. The Solid Rocket Booster Critical Items List entry for the field joint, dated December 17, 1982 is an example of this process.

Component criticality is related to test requirements in the Operational Maintenance Requirements and Specifications Document published and maintained by Level II at Johnson. For the Orbiter, the references from the Critical Items List to the requirements and specifications document are complete and traceable in both directions. The Solid Rocket Booster Critical Items List, however, does not include references to the requirements and specifications document.<sup>7</sup> Such references would make the Critical Items List a more efficient management tool for tracking activities concerned with items critical for flight safety.

The next step in procedures documentation is the Operations and Maintenance Instruction, which develops the directives into step-by-step procedures used at Kennedy by technicians, inspectors and test personnel to accomplish each step of the hardware preparations for flight. The current Operations and Maintenance Instruction does not indicate the criticality level of components.

If the Operations and Maintenance Instruction clearly indicated when the work to be performed related to a Criticality 1 component, all concerned would be alerted that a higher than normal level of care should be used. The same point applies to production activities at Thiokol where criticality should be directly incorporated into manufacturing quality planning.

## Problem Reporting

Prior to 1983, Level III was required to report all problems, trends, and problem closeout actions to Level II unless the problem was associated with hardware that was not flight-critical.<sup>8</sup> Unfortunately, this requirement was substantially reduced to include only those problems which dealt with common hardware items or physical interface elements. The revision eliminated reporting on flight safety problems, flight schedule problems, and problem trends.

The change to the reporting requirements was signed by James B. Jackson, Jr., for Glynn Lunney, who was at that time manager of the National Space Transportation System (Level II manager). The change was submitted by Martin Raines, director of Safety, Reliability and Quality Assurance at Johnson.<sup>9</sup> With this action, Level II lost all insight into safety, operational and flight schedule issues resulting from Level III problems.

On May 19, 1986, Mr. Raines wrote a memo in which he explained that the documentation change was made in an attempt to streamline the system since the old requirements were not productive for the operational phase of the Shuttle program.<sup>10</sup> In retrospect, it is still difficult to understand why the director of Safety, Reliability and Quality Assurance at Johnson initiated this action, and it is even more difficult to understand why Level II approved it.

A review of all Level III monthly problem reports (Open Problem List) issued by Marshall during 1984 and 1985 indicates that none was distributed to Level II management. From a lengthy list of recipients, only a single copy was sent to Johnson, and that one was sent to an engineer in the flight control division. Mr. Aldrich's office and the entire Johnson safety, reliability and quality assurance directorate were not on the distribution list for the problem reports. A Rockwell International safety, reliability and quality assurance contractor at Johnson received a statistical summary of problem status, but not the actual problems descriptions.

### **Reporting of In-flight Anomalies**

A second method of notifying Level II of problems would have been through the in-flight anomaly reporting channels. The identification and resolution of anomalies that occur during

flight are addressed in Space Shuttle Program Directive 34E. For the Solid Rocket Booster, the Huntsville Operations Support Center is charged with these activities as well as other evaluations and documentation of mission results.

"The Space Shuttle Project Managers at Kennedy, Johnson, and Marshall, and the Manager for Systems Integration are responsible for the implementation of this directive in their respective areas."<sup>11</sup>

A letter dated October 20, 1981, from the manager of the National Space Transportation System (Level II) addressed flight anomaly resolution:

"Beginning with the STS-2 evaluations, the enclosed new form and instructions, outlined in enclosure 1, will be utilized for all official flight anomaly closeouts. Flight anomalies will be presented for review and closeout at the Noon Special PRCB [Program Requirements Change Board]. The briefing charts will be prepared by the Project elements, and should include a schematic/graph/sketch of the problem area. This material, along with the closeout form and appropriate signatures, will become a part of the permanent closeout record. Enclosure 2 provides a sample of closeout material from STS-1 that would be acceptable.

"Your cooperation in this activity will be appreciated."<sup>12</sup>

Since O-ring erosion and blow-by were considered by Marshall to be flight anomalies,<sup>13</sup> the letter above would appear to require reporting by the Solid Rocket Booster Project Office to Level II. However, the sample closeout material attached to the 1981 letter was identified as pertaining to "Flight Test" (the first four flights). The 1983 change might well have been interpreted as superseding the 1981 Lunney letter, particularly since the program officially became "operational" in late 1982.

The reporting of anomalies (unexpected events or unexplained departures from past experience) that occur during mission performance is a key ingredient in any reliability and quality assurance program. Through accurate reporting, careful analysis and thorough testing, problems or recurrence of problems can be prevented. In an effective program, reporting, analysis, testing and im-

plementation of corrective measures must be fully documented.

The level of management that should be informed is a function of the seriousness of the problem. For Criticality 1 equipment anomalies, the communications must reach all levels of management. Highly detailed and specific procedures for reporting anomalies and problems are essential to the entire process. The procedures must be understood and followed by all.

Unfortunately, NASA does not have a concise set of problem reporting requirements. Those in effect are found in numerous individual documents, and there is little agreement about which document applies to a given level of management under a given set of circumstances for a given anomaly.

## Safety Program Failures

The safety, reliability and quality assurance program at Marshall serves a dual role. It is responsible for assuring that the hardware delivered for use on the Space Shuttle meets design specifications. In addition, it acts as a "watch dog" on the system to assure that sound engineering judgment is exercised in the use of hardware and in appraising hardware problems. Limited human resources and an organization that placed reliability and quality assurance functions under the director of Science and Engineering reduced the capability of the "watch dog" role.

Much of what follows concerns engineering judgments and decisions by engineers and managers at Marshall and Morton Thiokol. It is the validity of these judgments that the Commission has examined closely. In its "watch dog" role, an effectively functioning safety, reliability and quality assurance organization could have taken action to prevent the 51-L accident.

In the discussion that follows, various aspects of the Solid Rocket Booster joint design issue discussed earlier will be reviewed in the context of safety, reliability and quality assurance. The critical issue, discussed in detail elsewhere, involves the O-rings installed to seal the booster joints.

### Trend Data

Development of trend data and the possible relationships between problems is a standard and

expected function of any reliability and quality assurance program. As previously noted, the history of problems with the Solid Rocket Booster O-ring took an abrupt turn in January, 1984, when an ominous trend began. Until that date, only one field joint O-ring anomaly had been found during the first nine flights of the Shuttle. Beginning with the tenth mission, however, and concluding with the twenty-fifth, the Challenger flight, more than half of the missions experienced field joint O-ring blow-by or erosion of some kind.

In retrospect, this trend is easily recognizable. According to Wiley Bunn, director of Reliability and Quality Assurance at Marshall:

"I agree with you from my purview in quality, but we had that data. It was a matter of assembling that data and looking at it in the proper fashion. Had we done that, the data just jumps off the page at you."<sup>14</sup>

This striking change in performance should have been observed and perhaps traced to a root cause. No such trend analysis was conducted. While flight anomalies involving the O-rings received considerable attention at Morton Thiokol and at Marshall, the significance of the developing trend went unnoticed. The safety, reliability and quality assurance program, of course, exists to ensure that such trends are recognized when they occur.

A series of changes to Solid Rocket Booster processing procedures at Kennedy may be significant: on-site O-ring inspections were discontinued; O-ring leak check stabilization pressure on the field joint was increased to 200 pound per square inch from 100, sometimes blowing holes through the protective putty; the patterns for positioning the putty were changed; the putty type was changed; re-use of motor segment casings increased; and a new government contractor began management of Solid Rocket Booster assembly. One of these developments or a combination of them was probably the cause of the higher anomaly rate. The safety, reliability and quality assurance program should have tracked and discovered the reason for the increasing erosion and blow-by.

The history of problems in the nozzle joint is similar to that of the Solid Rocket Booster field joint. While several of the changes mentioned above also could have influenced the frequency



Pressure tests at 200 pounds per square inch of the Solid Rocket Booster joints produced bubbles in putty used to line the joints.

of nozzle O-ring problems, the frequency correlates with leak check pressure to a remarkable degree.

Again, development of trend data is a standard and expected function of any reliability and quality assurance program. Even the most cursory examination of failure rate should have indicated that a serious and potentially disastrous situation was developing on all Solid Rocket Booster joints. Not recognizing and reporting this trend can only be described, in NASA terms, as a "quality escape," a failure of the program to preclude an avoidable problem. If the program had functioned properly, the Challenger accident might have been avoided. The trend should have been identified and analyzed to discover the physical processes damaging the O-ring and thus jeopardizing the integrity of the joint.

A likely cause of the O-ring erosion appears to have been the increased leak check pressure that caused hazardous blow holes in the putty. Such holes at booster ignition provide a ready path for combustion gases directly to the O-ring. The blow holes were known to be created by the higher pressure used in the leak check. The phenomenon was observed and even photographed prior to a test firing in Utah on May 9, 1985. In that particular case, the grease from the O-ring was actually blown through the putty and

was visible on the inside core of the Solid Rocket Booster.

The trends of flight anomalies in relation to leak check stabilization pressure are illustrated for the field joint and the nozzle joint in Figure 3, on page 133. While the data point concerning the 100 pound per square inch field joint leak check is not conclusive since it is based on only two flights, the trend is apparent.

### Management Awareness

During its investigation, the Commission repeatedly heard witnesses refer to redundancy in the Solid Rocket Motor joint and argue over the criticality of the joint. While the field joint has been categorized as a Criticality 1 item since 1982 (page 157), most of the problem reporting paperwork generated by Thiokol and Marshall listed it as Criticality 1R, perhaps leading some managers to believe—wrongly—that redundancy existed. The Problem Assessment System operated by Rockwell contractors at Marshall, which routinely updates the problem status still listed the field joint as Criticality 1R on March 7, 1986, more than five weeks after the accident. Such misrepresentation of criticality must also be categorized as a failure of the safety, reliability and quality assurance program. As a result, informed decision making by key managers was impossible.

**ORIGINAL PAGE IS  
OF POOR QUALITY**

# SRB CRITICAL ITEMS LIST

Sheet 1 of 2

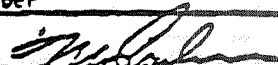
Subsystem <u>SOLID ROCKET BOOSTER</u>	Criticality Category <u>1</u> Reaction Time <u>10 Sec.</u>
Code <u>10-01-01</u> Case, P/N (See Retention Rationale) Item Name <u>(Joint Assys, Factory P/N 1U50147 Field: 1U50747)</u>	Page: <u>A-6A</u> Revision: _____
No. Required: <u>1 (11 segments, 3 Field joints, 7 plant joints)</u> FMEA Page No. <u>A-4 of MSFC-RPT-724</u>	Date: <u>December 17, 1982</u> Analyst: <u>Garber</u>
Critical Phases: <u>BOOST</u>	Approved: 

**Failure Mode & Causes:** Leakage at case assembly joints due to redundant O-ring seal failures or primary seal and leak check port O-ring failure.

**NOTE:** Leakage of the primary O-ring seal is classified as a single failure point due to possibility of loss of sealing at the secondary O-ring because of joint rotation after motor pressurization.

**Failure Effect Summary:** Actual Loss - Loss of mission, vehicle, and crew due to metal erosion, burnthrough, and probable case burst resulting in fire and deflagration.

## RATIONALE FOR RETENTION

Case, P/N 1U50129, 1U50131, 1U50130, 1U50185, 1U50147, 1U50715, 1U50716, 1U50717

### A. DESIGN

The SRM case joint design is common in the lightweight and regular weight cases having identical dimensions. The joint concept is basically the same as the single O-ring joint successfully employed on the Titan III solid rocket motor. The SRM joint uses centering clips which are installed in the gap between the tang O.D. and the outside clevis leg to compensate for the loss of concentricity due to gathering and to reduce the total clevis gap which has been provided for ease of assembly. On the shuttle SRM, the secondary O-ring was designed to provide redundancy and to permit a leak check, ensuring proper installation of the O-rings. Full redundancy exists at the moment of initial pressurization. However, test data shows that a phenomenon called joint rotation occurs as the pressure rises, opening up the O-ring extrusion gap and permitting the energized O-ring to protrude into the gap. This condition has been shown by test to be well within that required for safe primary O-ring sealing. This gap may, however, in some cases, increase sufficiently to cause the unenergized secondary O-ring to lose compression, raising question as to its ability to energize and seal if called upon to do so by primary seal failure. Since, under this latter condition only the single O-ring is sealing, a rationale for retention is provided for the simplex mode where only one O-ring is acting.

The surface finish requirement for the O-ring grooves is 63 and the finish of the O-ring contacting portion of the tang, which slices across the O-ring during joint assembly, is 32. The joint design provides an CD for the O-ring installation, which facilitates retention during joint assembly. The tang has a large shallow angle chamfer on the tip to prevent the cutting of the O-ring at assembly. The design drawing specifies application of O-ring lubricant prior to the installation. The factory assembled joints have NBR rubber material vulcanized across the internal joint faying surfaces as a part of the case internal insulation subsystem.

A small MS port leading to the annular cavity between the redundant seals permits a leak check of the seals immediately after joining segments. The MS plug, installed after leak test, has a retaining groove and compression face for its O-ring seal. A means to test the seal of the installed MS plug has not been established.

The O-rings for the case joints are mold formed and ground to close tolerance and the O-rings for the test port are mold formed to net dimensions. Both O-rings are made for high temperature, low compression set fluorocarbon elastomer. The design permits five scarf joints for the case joint seal rings. The O-ring joint strength must equal or exceed 40% of the parent material strength.

### B. TESTING

To date, eight static firings and five flights have resulted in 180 (54 field and 126 factory) joints tested with no evidence of leakage. The Titan III program using a similar joint concept has tested a total of 1076 joints successfully.



# SRB CRITICAL ITEMS LIST

Page 2 of 2

Subsystem: <u>SOLID ROCKET BOOSTER</u>	Criticality Category: <u>1</u> Reaction Time: <u>Immediate</u>
Item Code: <u>10-01-01</u>	Page: <u>A-6B</u>
Item Name: <u>"Case, P/N (See Retention Rationale) 1019R Assy. Factory P/N 1148787 Field: 1148737</u>	Revision: _____

## RATIONALE FOR RETENTION (CONT'D)

A laboratory test program demonstrated the ability of the O-ring to operate successfully when extruded into gaps well over those encountered in this O-ring application. Uniform gaps of 1/8-inch and over (TWR-13486) successfully withstood pressures of 1600 psi. The Microburst Program (TWR-11664) and the Structural Test Program (STA-1) for the standard weight case (TWR-12051) and the Lightweight Case Joint Certification Test (TWR-12829) all have shown that the O-ring can withstand a minimum of four pressurizations before damage to the ring can permit any leakage.

Further demonstration of the capability of joint sealing is found in the hydro-proof testing of new and refurbished case segments. Over 540 joints have been exposed to liquid pressurizations at levels exceeding motor MEGP with no leakage experienced past the primary O-ring. The only occasions where leakage was experienced was during refurbishment of STS-1 where two stiffener segments were severely damaged during cavity collapse at water impact.

A more detailed description of SRM joint testing history is contained in TWR-13520, Revision A.

### C. INSPECTION

The tang -A- diameter and clevis -C- diameter are measured and recorded. The depth, width and surface finish of the O-rings grooves are verified. The surface finish of the tang is also verified. Characteristics are inspected on each O-ring to assure conformance to the standards to include:

- o Surface conditions
- o Mold flashing
- o Scuff joint mismatch or separation
- o Cross section
- o Circumference
- o Diameter

Each assembled joint seal is tested per STW-2747 via pressurizing the annular cavity between seals to 50 psi and monitoring for 10 minutes. A pressure decay of 1 psig or greater is not acceptable. Following seal verification by QC, the leak test port plug is installed with QC verifying installation and torquing.

### D. FAILURE HISTORY

No failures have been experienced in the static firing of three qualification motors, five development motors and ten flight motors.

ORIGINAL PAGE IS  
OF POOR QUALITY



Mr. Bunn, the director of Reliability and Quality Assurance at Marshall, stated on April 17, 1986:

“But the other thing you will notice on those problem reports is that for some reason on the individual problem reports we kept sticking [Criticality] 1-R on them and that is just a sheer quality escape.”<sup>15</sup>

### **The Impact of Misinformation**

The manner in which misinformation influences top management has been illustrated by former Associate Administrator for Space Flight Jesse Moore.

“And then we had a Flight Readiness Review, I guess, in July, getting ready for a mid-July or a late July flight, and the action had come back from the project office. I guess the Level III had reported to the Level II Flight Readiness Review, and then they reported up to me that — they reported the two erosions on the primary (O-ring) and some 10 or 12 percent erosion on the secondary (O-ring) on that flight in April, and the corrective actions, I guess, that had been put in place was to increase the test pressure, I think, from 50 psi [pounds per square inch] to 200 psi or 100 psi — I guess it was 200 psi is the number — and they felt that they had run a bunch of laboratory tests and analyses that showed that by increasing the pressure up to 200 psi, this would minimize or eliminate the erosion, and that there would be a fairly good degree of safety factor margin on the erosion as a result of increasing this pressure and ensuring that the secondary seal had been seated. And so we left that FRR [Flight Readiness Review] with that particular action closed by the project. . . .”<sup>16</sup>

Not only was Mr. Moore misinformed about the effectiveness and potential hazards associated with the long-used “new” procedure, he also was misinformed about the issue of joint redundancy. Apparently, no one told (or reminded) Mr. Moore that while the Solid Rocket Booster nozzle joint was Criticality 1R, the field joint was Criticality 1. No one told him about blow holes in the putty, probably resulting from the increased stabilization pressure, and no one told him that this “new” procedure had been in use

since the exact time that field joint anomalies had become dangerously frequent. At the time of this briefing, the increased pressure already had been used on four Solid Rocket Motor nozzle joints, and all four had erosion. Erosion was the enemy, and increased pressure was its ally.

While Mr. Moore was not being intentionally deceived, he was obviously misled. The reporting system simply was not making trends, status and problems visible with sufficient accuracy and emphasis.

### **Reporting Launch Constraints**

The Commission was surprised to learn that a launch constraint had been imposed on the Solid Rocket Booster. It was further surprised to learn that those outside of Marshall were not notified. Because of the seriousness of the mission 51-B nozzle O-ring erosion incident, launch constraints were placed against the next six Shuttle flights. A launch constraint arises from a flight safety issue of sufficient seriousness to justify a decision not to launch. The initial problem description stated that, “based on the amount of charring, the erosion paths on the primary O-ring and what is understood about the erosion phenomenon, it is believed that the primary O-ring of SRM 16A [the Solid Rocket Motor on flight 51-B] never seated.”<sup>17</sup> The maximum erosion depth was 0.171 inches on the primary O-ring and 0.032 inches on the secondary. On February 12, at a Level III Flight Readiness Review, maximum expected erosion on nozzle joint O-rings had been projected as 0.070 inches for the primary and 0.004 inches for the secondary. Thus, the results far exceeded the maximum expected. If this same ratio of actual to projected erosion were to occur on a field joint, the erosion would be 0.225 inches. With secondary seal inadequacy, as indicated by Criticality 1 status, that degree of erosion could result in joint failure and loss of vehicle and crew.

The Problem Reporting and Corrective Action document (JSC 08126A, paragraph 3.2d) requires project offices to inform Level II of launch constraints. That requirement was not met. Neither Level II nor Level I was informed.

### **Implications of an Operational Program**

Following successful completion of the orbital flight test phase of the Shuttle program, the system was declared to be operational. Subse-

quently, several safety, reliability and quality assurance organizations found themselves with reduced and/or reorganized functional capability. Included, notably, were the Marshall offices where there was net attrition<sup>18</sup> and NASA Headquarters where there were several reorganizations and transfers.

The apparent reason for such actions was a perception that less safety, reliability and quality assurance activity would be required during "routine" Shuttle operations. This reasoning was faulty. The machinery is highly complex, and the requirements are exacting. The Space Shuttle remains a totally new system with little or no history. As the system matures and the experience changes, careful tracking will be required to prevent premature failures. As the flight rate increased, more hardware operations were involved, and more total in-flight anomalies occurred.<sup>19</sup> Tracking requirements became more rather than less critical because of implications for the next flight in an accelerating program.

Two problems on mission 61-C were not evaluated as part of the review process for the next flight, 51-L. A serious failure of the Orbiter wheel brake was not known to the crew as mission 51-L lifted off with a plan to make the first Kennedy landing since a similar problem halted such operations in April, 1985.<sup>20</sup> Secondly, an O-ring erosion problem had occurred on mission 61-C, and while it had been discovered, it had not been incorporated into the Problem Assessment System when mission 51-L was launched.<sup>21</sup> If the program cannot come to grips with such critical safety aspects before subsequent flights are scheduled to occur, it obviously is moving too fast, or its safety, reliability and quality assurance programs must be strengthened to provide more rapid response.

The inherent risk of the Space Shuttle program is defined by the combination of a highly dynamic environment, enormous energies, mechanical complexities, time consuming preparations and extremely time-critical decision making. Complacency and failures in supervision and reporting seriously aggravate these risks.

Rather than weaken safety, reliability and quality assurance programs through attrition and reorganization, NASA must elevate and strengthen these vital functions. In addition, NASA's traditional safety, reliability and quality assurance efforts need to be augmented by an

alert and vigorous organization that oversees the flight safety program.

## Aerospace Safety Advisory Panel

The Aerospace Safety Advisory Panel (the "panel" in what follows) was established in the aftermath of the Apollo spacecraft fire January 27, 1967. Shortly thereafter the United States Congress enacted legislation (Section 6 of the NASA Authorization Act, 1968; 42 U.S.C. 2477) to establish the panel as a senior advisory committee to NASA. The statutory duties of the panel are:

"The panel shall review safety studies and operations plans referred to it and shall make reports thereon, shall advise the Administrator with respect to the hazards of proposed operations and with respect to the adequacy of proposed or existing safety standards, and shall perform such other duties as the Administrator may request."

The panel membership is set by statute at no more than nine members, of whom up to four may come from NASA. The NASA Chief Engineer is an ex-officio member. The staff consists of full-time NASA employees, and the staff director serves as both executive secretary and technical assistant to the panel.

The role of the panel has been defined and redefined by the members themselves, NASA senior management and members of the House and Senate of the U.S. Congress. The panel began to review the Space Shuttle program in 1971, and in its 1974 annual report, it documented a shift in focus:

"The panel feels that [a] broader examination of the programs and their management gives them more confidence than in limiting their inquiry to safety alone."<sup>22</sup>

Over ensuing years, the panel continued to examine the Space Shuttle program including safety, reliability and quality assurance; systems redundancy; flight controls; and ground processing and handling, though management issues continued to dominate their concerns. Following the first flight of the Shuttle, the panel investigated a wide variety of specific subjects, to include the lightweight External Tank, the Cen-

taur and Inertial Upper Stage programs, Shuttle logistics and spare parts, landing gear, tires, brakes, Solid Rocket Motor nozzles and the Solid Rocket Motor using the filament-wound case. There is no indication, however, that the details of Solid Rocket Booster joint design or in-flight problems were ever the subject of a panel activity. The efforts of this panel were not sufficiently specific and immediate to prevent the 51-L accident.

## Space Shuttle Program Crew Safety Panel

---

The Space Shuttle Crew Safety Panel, established by Space Shuttle Program Directive 4A dated April 17, 1974, served an important function in NASA flight safety activities, until it went out of existence in 1981. If it were still in existence, it might have identified the kinds of problems now associated with the 51-L mission. The purpose of the panel was twofold: (1) to identify possible hazards to Shuttle crews and (2) to provide guidance and advice to Shuttle program management concerning the resolution of such conditions.

The membership of the panel comprised 10 representatives from Johnson and a single representative each from Dryden (the NASA facility at Edwards Air Force Base, California), Kennedy, Marshall and the Air Force.

The panel was to support the Level II Program Requirements Control Board chaired by the project manager, and recommendations were subject to Control Board approval.

From 1974 through 1978, the panel met on a regular basis (24 times) and considered vital issues ranging from mission abort contingencies to equipment acceptability. The membership of the panel from engineering, project management and astronaut offices ensured a minimum level of safety communications among those organizations. This ceased to exist when the panel effectively ceased to exist in 1980.<sup>23</sup> NASA had expected the panel to be functional only "during the design, development and flight test phases" and to "concern itself with all vehicle systems and operating modes."<sup>24</sup> When the original chairman, Scott H. Simpkinson, retired in 1981, the panel was merged with a safety subpanel that assumed neither the membership nor the functions of the

safety panel. After that time, the NASA Shuttle program had no focal point for flight safety.

## The Need for a New Safety Organization

---

The Aerospace Safety Advisory Panel unquestionably has provided NASA a valuable service, which has contributed to the safety of NASA's operations. Because of its breadth of activities, however, it cannot be expected to uncover all of the potential problems nor can it be charged with failure when accidents occur that in hindsight were clearly probable. The ability of any panel to function effectively depends on a focused scope of responsibilities. An acceptable level of operational safety coverage requires the total combination of NASA and contractor organizations, working more effectively on a coordinated basis at all levels. The Commission believes, therefore, that a top-to-bottom emphasis on safety can best be achieved by a combination of a strong central authority and a working level panel devoted to the operational aspects of Shuttle flight safety.

## Findings

---

1. Reductions in the safety, reliability and quality assurance work force at Marshall and NASA Headquarters have seriously limited capability in those vital functions.
2. Organizational structures at Kennedy and Marshall have placed safety, reliability and quality assurance offices under the supervision of the very organizations and activities whose efforts they are to check.
3. Problem reporting requirements are not concise and fail to get critical information to the proper levels of management.
4. Little or no trend analysis was performed on O-ring erosion and blow-by problems.
5. As the flight rate increased, the Marshall safety, reliability and quality assurance work force was decreasing, which adversely affected mission safety.
6. Five weeks after the 51-L accident, the criticality of the Solid Rocket Motor field joint was still not properly documented in the problem reporting system at Marshall. ■

## References

- <sup>1</sup> Commission Hearing Transcript, April 3, 1986, page 2538.
- <sup>2</sup> Commission Interview Transcript, Bunn, W., April 17, 1986, Washington, D.C., pages 42-43.
- <sup>3</sup> Commission Interview Transcript, Silveira, M., April 16, 1986, Washington, D.C., page 4.
- <sup>4</sup> Commission Interview Transcript, Quong, H., April 11, 1986, Washington, D.C., pages 29-30.
- <sup>5</sup> Commission Work Session, March 25, 1986, JSC, page 84.
- <sup>6</sup> Commission Interview Transcript, Bunn, W., April 17, 1986, Washington, D.C., page 89.
- <sup>7</sup> SRB Critical Items List, Change 2, November 30, 1983, page A6-A.
- <sup>8</sup> Space Shuttle Program Requirements Control Board Directive—Level II, PRCBD Number 501152A, JSC, April 4, 1975, pages 2-4.
- <sup>9</sup> Space Shuttle Program Requirements Control Board Directive—Level II, PRCBD Number 521701R2, JSC, March 7, 1983, pages 1-6.
- <sup>10</sup> Letter from Martin L. Raines, JSC, ND5/86-M 121, May 19, 1986.
- <sup>11</sup> Space Shuttle Program Manager Directive 34E, September 3, 1982, page 2.
- <sup>12</sup> Letter from Glynn Lunney, JSC, WA-81-LO38, October 20, 1981.
- <sup>13</sup> Commission Interview Transcript, Bunn, W., April 17, 1986, Washington, D.C., page 4.
- <sup>14</sup> Commission Interview Transcript, Bunn, W., April 17, 1986, Washington, D.C., page 41.
- <sup>15</sup> Commission Interview Transcript, Bunn, W., April 17, 1986, Washington, D.C., page 13.
- <sup>16</sup> Commission Interview Transcript, Moore, J., April 8, 1986, NASA Headquarters, page 19.
- <sup>17</sup> Marshall Space Flight Center Record Number AO9288, February 26, 1986, page 2.
- <sup>18</sup> Commission Interview Transcript, Bunn, W., April 17, 1986, Washington, D.C., pages 85-86.
- <sup>19</sup> Commission Interview Transcript, Bunn, W., April 17, 1986, Washington, D.C., pages 78-79.
- <sup>20</sup> Commission Hearing Transcript, April 3, 1986, page 2552.
- <sup>21</sup> Marshall Space Flight Center Record Number A07934, March 7, 1986, page 6.
- <sup>22</sup> Annual Report, Aerospace Safety Advisory Panel, 1974, page 4.
- <sup>23</sup> Report, "Space Shuttle Crew Safety Panel History," JSC, April 16, 1986, pages 4-6.
- <sup>24</sup> Space Shuttle Program Directive 4A, JSC, April 17, 1974, page 1.

# Pressures on the System

With the 1982 completion of the orbital flight test series, NASA began a planned acceleration of the Space Shuttle launch schedule. One early plan contemplated an eventual rate of a mission a week, but realism forced several downward revisions. In 1985, NASA published a projection calling for an annual rate of 24 flights by 1990. Long before the Challenger accident, however, it was becoming obvious that even the modified goal of two flights a month was overambitious.

In establishing the schedule, NASA had not provided adequate resources for its attainment. As a result, the capabilities of the system were strained by the modest nine-mission rate of 1985, and the evidence suggests that NASA would not have been able to accomplish the 15 flights scheduled for 1986. These are the major conclusions of a Commission examination of the pressures and problems attendant upon the accelerated launch schedule.

On the same day that the initial orbital tests concluded—July 4, 1982—President Reagan announced a national policy to set the direction of the U.S. space program during the following decade. As part of that policy, the President stated that:

“The United States Space Transportation System (STS) is the primary space launch system for both national security and civil government missions.”

Additionally, he said:

“The first priority of the STS program is to make the system fully operational and

cost-effective in providing routine access to space.”

From the inception of the Shuttle, NASA had been advertising a vehicle that would make space operations “routine and economical.” The greater the annual number of flights, the greater the degree of routinization and economy, so heavy emphasis was placed on the schedule. However, the attempt to build up to 24 missions a year brought a number of difficulties, among them the compression of training schedules, the lack of spare parts, and the focusing of resources on near-term problems.

One effect of NASA’s accelerated flight rate and the agency’s determination to meet it was the dilution of the human and material resources that could be applied to any particular flight.

The part of the system responsible for turning the mission requirements and objectives into flight software, flight trajectory information and crew training materials was struggling to keep up with the flight rate in late 1985, and forecasts showed it would be unable to meet its milestones for 1986. It was falling behind because its resources were strained to the limit, strained by the flight rate itself and by the constant changes it was forced to respond to within that accelerating schedule. Compounding the problem was the fact that NASA had difficulty evolving from its single-flight focus to a system that could efficiently support the projected flight rate. It was slow in developing a hardware maintenance plan for its reusable fleet and slow in developing the capabilities that would allow it to handle the higher volume of work and training associated with the increased flight frequency.

Pressures developed because of the need to meet customer commitments, which translated into a requirement to launch a certain number of flights per year and to launch them on time. Such considerations may occasionally have obscured engineering concerns. Managers may have forgotten — partly because of past success, partly because of their own well-nurtured image of the program — that the Shuttle was still in a research and development phase. In his testimony before a U.S. Senate Appropriations subcommittee on May 5, 1982, following the third flight of the Space Shuttle, James Beggs, then the NASA Administrator, expressed NASA's commitment:

"The highest priority we have set for NASA is to complete development of the Shuttle and turn it into an operational system. Safety and reliability of flight and the control of operational costs are primary objectives as we move forward with the Shuttle program."<sup>1</sup>

Sixteen months later, arguing in support of the Space Station, Mr. Beggs said, "We can start anytime. . . . There's no compelling reason [why] it has to be 1985 rather than '86 or '87. The point that we have made is that the Shuttle is now operational."<sup>2</sup> The prevalent attitude in the program appeared to be that the Shuttle should be ready to emerge from the developmental stage, and managers were determined to prove it "operational."

Various aspects of the mission design and development process were directly affected by that determination. The sections that follow will discuss the pressures exerted on the system by the flight rate, the reluctance to relax the optimistic schedule, and the attempt to assume an operational status.

## Planning of a Mission

The planning and preparation for a Space Shuttle flight require close coordination among those making the flight manifest, those designing the flight and the customers contracting NASA's services. The goals are to establish the manifest; define the objectives, constraints and capabilities of the mission; and translate those into hardware, software and flight procedures.

There are major program decision points in the development of every Shuttle flight. At each of

these points, sometimes called freeze points, decisions are made that form the basis for further engineering and product development. The disciplines affected by these freeze points include integration hardware, engineering, crew timeline, flight design and crew training.

The first major freeze point is at launch minus 15 months. At that time the flight is officially defined: the launch date, Orbiter and major payloads are all specified, and initial design and engineering are begun based on this information.

The second major freeze point is at launch minus 7.7 months, the cargo integration review. During this review, the integration hardware design, Orbiter vehicle configuration, flight design and software requirements are agreed to and specified. Further design and engineering can then proceed.

Another major freeze point is the flight planning and stowage review at launch minus five months. At that time, the crew activity timeline and the crew compartment configuration, which includes middeck payloads and payload specialist assignments, are established. Final design, engineering and training are based on these products.

## Development of Flight Products

The "production process" begins by collecting all mission objectives, requirements and constraints specified by the payload and Space Shuttle communities at the milestones described above. That information is interpreted and assimilated as various groups generate products required for a Space Shuttle flight: trajectory data, consumables requirements, Orbiter flight software, Mission Control Center software and the crew activity plan, to name just a few.

Some of these activities can be done in parallel, but many are serial. Once a particular process has started, if a substantial change is made to the flight, not only does that process have to be started again, but the process that preceded it and supplied its data may also need to be repeated. If one group fails to meet its due date, the group that is next in the chain will start late. The delay then cascades through the system.

Were the elements of the system meeting their schedules? Although each group believed it had an adequate amount of time allotted to perform its function, the system as a whole was falling

## Shuttle Mission Simulator Training

When Shuttle Mission Simulator Training Began in  
Comparison With the Normal Launch-minus-77-Days  
Training Start Date

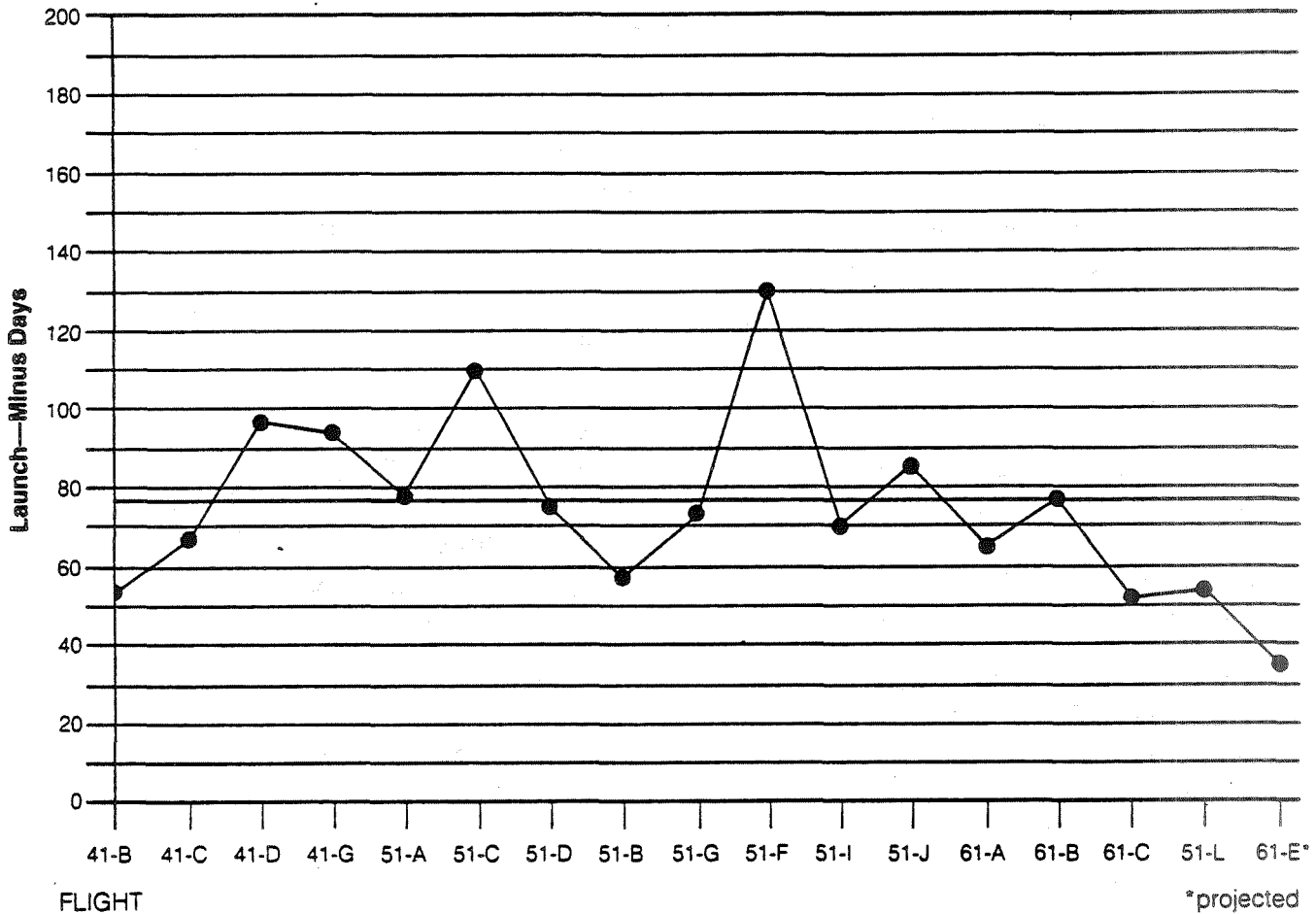

Graph depicts beginning of simulator training for Shuttle crews in days before launch for missions 41-B through 61-E.

behind. An assessment of the system's overall performance is best made by studying the process at the end of the production chain: crew training. Analysis of training schedules for previous flights and projected training schedules for flights in the spring and summer of 1986 reveals a clear trend: less and less time was going to be available for crew members to accomplish their required training. (See the Shuttle mission simulator training chart.)

The production system was disrupted by several factors including increased flight rate, lack of efficient production processing and manifest changes.

## Changes in the Manifest

Each process in the production cycle is based on information agreed upon at one of the freeze points. If that information is later changed, the process may have to be repeated. The change could be a change in manifest or a change to the Orbiter hardware or software. The hardware and software changes in 1985 usually were mandatory changes; perhaps some of the manifest changes were not.

The changes in the manifest were caused by factors that fall into four general categories: hardware problems, customer requests, operational



constraints and external factors. The significant changes made in 1985 are shown in the accompanying table. The following examples illustrate that a single proposed change can have extensive impact, not because the change itself is particularly difficult to accommodate (though it may be), but because each change necessitates four or five other changes. The cumulative effect can be substantial. (See the Impact of Manifest Changes chart.)

When a change occurs, the program must choose a response and accept the consequences of that response. The options are usually either to maximize the benefit to the customer or to minimize the adverse impact on Space Shuttle operations. If the first option is selected, the consequences will include short-term and/or long-term effects.

Hardware problems can cause extensive changes in the payload manifest. The 51-E mission was on the launch pad, only days from launch, with a Tracking and Data Relay Satellite and Telesat satellite in the cargo bay, when a hardware problem in the tracking satellite was discovered. That flight was canceled and the payload reassigned. The cancellation resulted in major changes to several succeeding flights. Mission 51-D, scheduled to fly two months later, was changed to add the Telesat and delete the retrieval of the Long Duration Exposure Facility. The retrieval mission was then added to mission 61-I, replacing another satellite. A new mission (61-M) was scheduled for July, 1986, to accommodate the Tracking and Data Relay Satellite and the displaced satellite, and all flights scheduled later in 1986 slipped to make room for 61-M.

Customers occasionally have notified NASA Headquarters of a desire to change their scheduled launch date because of development problems, financial difficulties or changing market conditions. NASA generally accedes to these requests and has never imposed the penalties available. An example is the request made to delay the flight of the Westar satellite from mission 61-C (December, 1985) to a flight in March, 1986. Westar was added to flight 61-E, and the Getaway Special bridge assembly was removed to make room for it; the HS-376 satellite slot was deleted from 51-L and added to 61-C; the Spartan-Halley satellite was deleted from 61-D and added to 51-L. Thus, four flights experienced major payload changes as a result of one customer's request.

---

## 1985 Changes in the Manifest

---

### *Hardware Problems*

Tracking and Data Relay Satellite (canceled 51-E, added 61-M).

Synchronous Communication Satellite (added to 61-C).

Synchronous Communication Satellite (removed from 61-C).

OV-102 late delivery from Palmdale (changed to 51-G, 51-I, and 61-A).

### *Customer Requests*

HS-376 (removed from 51-I).

G-Star (removed from 61-C).

Satellite Television Corporation—Direct Broadcast Satellite (removed from 61-E).

Westar (removed from 61-C).

Satellite Television Corporation—Direct Broadcast Satellite (removed from 61-H).

Electrophoresis Operations in Space (removed from 61-B).

Electrophoresis Operations in Space (removed from 61-H).

Hubble Space Telescope (swap with Earth Observation Mission).

### *Operational Constraints*

No launch window for Skynet/Indian Satellite Combination (61-H).

Unacceptable structural loads for Tracking and Data Relay Satellite/Indian Satellite (61-H).

Landing weight above allowable limits for each of the following missions: 61-A, 61-E, 71-A, 61-K.

### *External Factors*

Late addition of Senator Jake Garn (R-Utah) (51-D).

Late addition of Representative Bill Nelson (D-Florida) (61-C).

Late addition of Physical Vapor Transport Organic Solid experiment (51-I).

---

**Impact of Manifest Changes  
on Workload at Johnson Space Center**

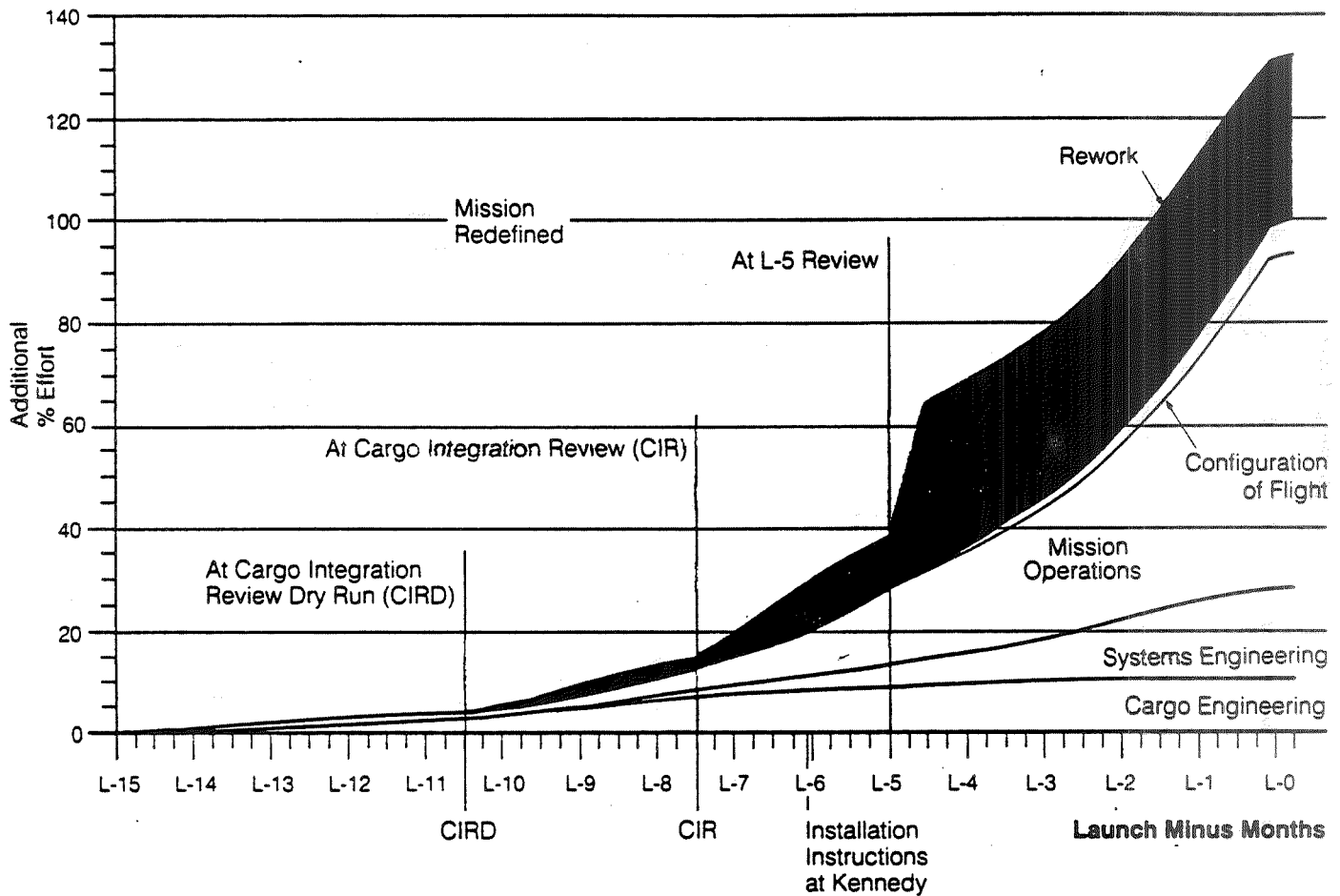

Graph shows that changes to the payload manifest for Shuttle missions can boost Johnson Space Center workload as much as 130 percent.

Operational constraints (for example, a constraint on the total cargo weight) are imposed to insure that the combination of payloads does not exceed the Orbiter's capabilities. An example involving the Earth Observation Mission Spacelab flight is presented in the NASA Mission Planning and Operations Team Report in Appendix J. That case illustrates that changes resulting from a single instance of a weight constraint violation can cascade through the entire schedule.

External factors have been the cause of a number of changes in the manifest as well. The changes discussed above involve major payloads,

but changes to other payloads or to payload specialists can create problems as well. One small change does not come alone; it generates several others. A payload specialist was added to mission 61-C only two months before its scheduled lift off. Because there were already seven crew members assigned to the flight, one had to be removed. The Hughes payload specialist was moved from 61-C to 51-L just three months before 51-L was scheduled to launch. His experiments were also added to 51-L. Two middeck experiments were deleted from 51-L as a result, and the deleted experiments would have reappeared on later flights.

## Simulation Training

When Shuttle Simulator Training Began in Comparison with the Normal Launch-Minus-77-Days Training Start Date

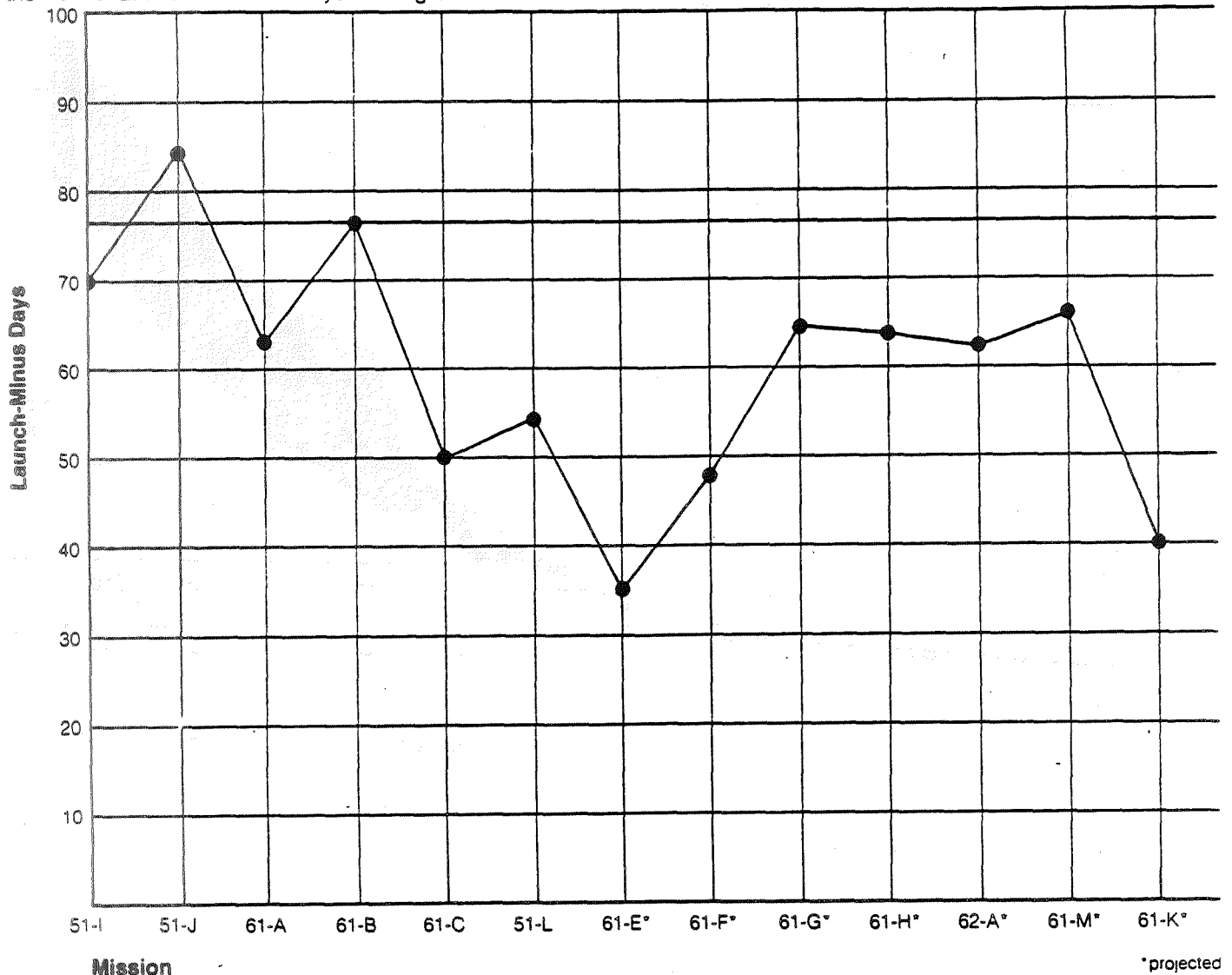

Graph depicts beginning of simulator training for Shuttle crews in days before launch for missions 51-L through 61-K. Launch minus 77 days is normal training date start.

Again, a "single" late change affected at least two flights very late in the planning and preparation cycles.

The effects of such changes in terms of budget, cost and manpower can be significant. In some cases, the allocation of additional resources allows the change to be accommodated with little or no impact to the overall schedule. In those cases, steps that need to be re-done can still be accomplished before their deadlines. The amount of additional resources required depends, of course, on the magnitude of the change and when the change occurs: early changes, those before the

cargo integration review, have only a minimal impact; changes at launch minus five months (two months after the cargo integration review) can carry a major impact, increasing the required resources by approximately 30 percent. In the missions from 41-C to 51-L, only 60 percent of the major changes occurred before the cargo integration review. More than 20 percent occurred after launch minus five months and caused disruptive budget and manpower impacts.<sup>3</sup>

Engineering flight products are generated under a contract that allows for increased expenditures to meet occasional high workloads.

Even with this built-in flexibility, however, the requested changes occasionally saturate facilities and personnel capabilities. The strain on resources can be tremendous. For short periods of two to three months in mid-1985 and early 1986, facilities and personnel were being required to perform at roughly twice the budgeted flight rate.

If a change occurs late enough, it will have an impact on the serial processes. In these cases, additional resources will not alleviate the problem, and the effect of the change is absorbed by all downstream processes, and ultimately by the last element in the chain. In the case of the flight design and software reconfiguration process, that last element is crew training. In January, 1986, the forecasts indicated that crews on flights after 51-L would have significantly less time than desired to train for their flights.<sup>4</sup> (See the Simulation Training chart.)

According to Astronaut Henry Hartsfield:

"Had we not had the accident, we were going to be up against a wall; STS 61-H . . . would have had to average 31 hours in the simulator to accomplish their required training, and STS 61-K would have to average 33 hours. That is ridiculous. For the first time, somebody was going to have to stand up and say we have got to slip the launch because we are not going to have the crew trained."<sup>5</sup>

## **"Operational" Capabilities**

For a long time during Shuttle development, the program focused on a single flight, the first Space Shuttle mission. When the program became "operational," flights came more frequently, and the same resources that had been applied to one flight had to be applied to several flights concurrently. Accomplishing the more pressing immediate requirements diverted attention from what was happening to the system as a whole. That appears to be one of the many telling differences between a "research and development" program and an "operational program." Some of the differences are philosophical, some are attitudinal and some are practical.

Elements within the Shuttle program tried to adapt their philosophy, their attitude and their requirements to the "operational era." But that era came suddenly, and in some cases, there had

not been enough preparation for what "operational" might entail. For example, routine and regular post-flight maintenance and inspections are critical in an operational program; spare parts are critical to flight readiness in an operational fleet; and the software tools and training facilities developed during a test program may not be suitable for the high volume of work required in an operational environment. In many respects, the system was not prepared to meet an "operational" schedule.

As the Space Shuttle system matured, with numerous changes and compromises, a comprehensive set of requirements was developed to ensure the success of a mission. What evolved was a system in which the preflight processing, flight planning, flight control and flight training were accomplished with extreme care applied to every detail. This process checked and rechecked everything, and though it was both labor- and time-intensive, it was appropriate and necessary for a system still in the developmental phase. This process, however, was not capable of meeting the flight rate goals.

After the first series of flights, the system developed plans to accomplish what was required to support the flight rate. The challenge was to streamline the processes through automation, standardization, and centralized management, and to convert from the developmental phase to the mature system without a compromise in quality. It required that experts carefully analyze their areas to determine what could be standardized and automated, then take the time to do it.

But the increasing flight rate had priority—quality products had to be ready on time. Further, schedules and budgets for developing the needed facility improvements were not adequate. Only the time and resources left after supporting the flight schedule could be directed toward efforts to streamline and standardize. In 1985, NASA was attempting to develop the capabilities of a production system. But it was forced to do that while responding—with the same personnel—to a higher flight rate.

At the same time the flight rate was increasing, a variety of factors reduced the number of skilled personnel available to deal with it. These included retirements, hiring freezes, transfers to other programs like the Space Station and transitioning to a single contractor for operations support.

The flight rate did not appear to be based on assessment of available resources and capabilities and was not reduced to accommodate the capacity of the work force. For example, on January 1, 1986, a new contract took effect at Johnson that consolidated the entire contractor work force under a single company. This transition was another disturbance at a time when the work force needed to be performing at full capacity to meet the 1986 flight rate. In some important areas, a significant fraction of workers elected not to change contractors. This reduced the work force and its capabilities, and necessitated intensive training programs to qualify the new personnel. According to projections, the work force would not have been back to full capacity until the summer of 1986. This drain on a critical part of the system came just as NASA was beginning the most challenging phase of its flight schedule.<sup>6</sup>

Similarly, at Kennedy the capabilities of the Shuttle processing and facilities support work force became increasingly strained as the Orbiter turnaround time decreased to accommodate the accelerated launch schedule. This factor has resulted in overtime percentages of almost 28 percent in some directorates. Numerous contract employees have worked 72 hours per week or longer and frequent 12-hour shifts. The potential implications of such overtime for safety were made apparent during the attempted launch of mission 61-C on January 6, 1986, when fatigue and shiftwork were cited as major contributing factors to a serious incident involving a liquid oxygen depletion that occurred less than five minutes before scheduled lift off. The issue of workload at Kennedy is discussed in more detail in Appendix G.

Another example of a system designed during the developmental phase and struggling to keep up with operational requirements is the Shuttle Mission Simulator. There are currently two simulators. They support the bulk of a crew's training for ascent, orbit and entry phases of a Shuttle mission. Studies indicate two simulators can support no more than 12-15 flights per year. The flight rate at the time of the accident was about to saturate the system's capability to provide trained astronauts for those flights. Furthermore, the two existing simulators are out-of-date and require constant attention to keep them operating at capacity to meet even the rate of 12-15 flights per year. Although there are plans to improve capability, funds for those im-

provements are minimal and spread out over a 10-year period. This is another clear demonstration that the system was trying to develop its capabilities to meet an operational schedule but was not given the time, opportunity or resources to do it.<sup>7</sup>

## Responding to Challenges and Changes

---

Another obstacle in the path toward accommodation of a higher flight rate is NASA's legendary "can-do" attitude. The attitude that enabled the agency to put men on the moon and to build the Space Shuttle will not allow it to pass up an exciting challenge—even though accepting the challenge may drain resources from the more mundane (but necessary) aspects of the program.

A recent example is NASA's decision to perform a spectacular retrieval of two communications satellites whose upper stage motors had failed to raise them to the proper geosynchronous orbit. NASA itself then proposed to the insurance companies who owned the failed satellites that the agency design a mission to rendezvous with them in turn and that an astronaut in a jet backpack fly over to escort the satellites into the Shuttle's payload bay for a return to Earth.

The mission generated considerable excitement within NASA and required a substantial effort to develop the necessary techniques, hardware and procedures. The mission was conceived, created, designed and accomplished within 10 months. The result, mission 51-A (November, 1984), was a resounding success, as both failed satellites were successfully returned to Earth. The retrieval mission vividly demonstrated the service that astronauts and the Space Shuttle can perform.

Ten months after the first retrieval mission, NASA launched a mission to repair another communications satellite that had failed in low-Earth orbit. Again, the mission was developed and executed on relatively short notice and was resoundingly successful for both NASA and the satellite insurance industry.

The satellite retrieval missions were not isolated occurrences. Extraordinary efforts on NASA's part in developing and accomplishing missions will, and should, continue, but such efforts will be a substantial additional drain on resources. NASA cannot both accept the relatively spur-of-

the-moment missions that its "can-do" attitude tends to generate and also maintain the planning and scheduling discipline required to operate as a "space truck" on a routine and cost-effective basis. As the flight rate increases, the cost in resources and the accompanying impact on future operations must be considered when infrequent, but extraordinary efforts are undertaken. The system is still not sufficiently developed as a "production line" process in terms of planning or implementation procedures. It cannot routinely or even periodically accept major disruptions without considerable cost. NASA's attitude historically has reflected the position that "We can do anything," and while that may essentially be true, NASA's optimism must be tempered by the realization that it cannot do everything.

NASA has always taken a positive approach to problem solving and has not evolved to the point where its officials are willing to say they no longer have the resources to respond to proposed changes. Harold Draughon, manager of the Mission Integration Office at Johnson, reinforced this point by describing what would have to happen in 1986 to achieve the flight rate:

"The next time the guy came in and said 'I want to get off this flight and want to move down two' . . . [the system would have had to say,] 'We can't do that,' and that would have been the decision."<sup>8</sup>

Even in the event of a hardware problem, after the problem is fixed there is still a choice about how to respond. Flight 41-D had a main engine shutdown on the launch pad. It had a commercial payload on it, and the NASA Customer Services division wanted to put that commercial payload on the next flight (replacing some NASA payloads) to satisfy more customers. Draughon described the effect of that decision to the Commission: "We did that. We did not have to. And the system went out and put that in work, but it paid a price. The next three or four flights all slipped as a result."<sup>9</sup>

NASA was being too bold in shuffling manifests. The total resources available to the Shuttle program for allocation were fixed. As time went on, the agency had to focus those resources more and more on the near term — worrying about today's problem and not focusing on tomorrow's.

NASA also did not have a way to forecast the effect of a change of a manifest. As already indicated, a change to one flight ripples through

the manifest and typically necessitates changes to many other flights, each requiring resources (budget, manpower, facilities) to implement. Some changes are more expensive than others, but all have an impact, and those impacts must be understood.

In fact, Leonard Nicholson, manager of Space Transportation System Integration and Operations at Johnson, in arguing for the development of a forecasting tool, illustrated the fact that the resources were spread thin: "The press of business would have hindered us getting that kind of tool in place, just the fact that all of us were busy . . . ."<sup>10</sup>

The effect of shuffling major payloads can be significant. In addition, as stated earlier, even apparently "easy" changes put demands on the resources of the system. Any middeck or secondary payload has, by itself, a minimal impact compared with major payloads. But when several changes are made, and made late, they put significant stress on the flight preparation process by diverting resources from higher priority problems.

Volume III of JSC 07700, Revision B, specifies that all middeck experiments must be scheduled, and payload specialists assigned, 22 weeks before launch.<sup>11</sup> That rule has not been enforced — in fact, it is more honored in the breach than in the observance. A review of missions 41-G through 61-C revealed that of the 16 payload specialists added to those flights, seven were added after launch minus five months.

Even "secondary" payloads take a lot of time and attention when they are added to a flight late. Harold Draughon:

"I spend more than half of my time working on things that are not very important because they get put in so late. Rather than working on PAM's [Payload Assist Modules] and IUS's [Inertial Upper Stages], I am working on chicken eggs."<sup>12</sup>

Those directing the changes in the manifest were not yet sensitive to the problem. Each change nibbles away at the operational resources, and the changes were occurring frequently, even routinely. Much of the capacity of the system was being used up responding to late changes in lower priority experiments. That flexibility toward secondary experiments tied up the resources that would have been better spent building capability to meet the projected flight rate.



Tommy Holloway, chief of the Johnson Flight Director Office, emphasized that, given finite resources, one must decide: "It's flight rate versus [manifest] flexibility."<sup>13</sup>

The portion of the system forced to respond to the late changes in the manifest tried to bring its concerns to Headquarters. As Mr. Nicholson explained,

"We have done enough complaining about it that I cannot believe there is not a growing awareness, but the political aspects of the decision are so overwhelming that our concerns do not carry much weight. . . . The general argument we gave about distracting the attention of the team late in the process of implementing the flight is a qualitative argument . . . . And in the face of that, political advantages of implementing those late changes outweighed our general objections."<sup>14</sup>

It is important to determine how many flights can be accommodated, and accommodated safely. NASA must establish a realistic level of expectation, then approach it carefully. Mission schedules should be based on a realistic assessment of what NASA can do safely and well, not on what is possible with maximum effort. The ground rules must be established firmly, and then enforced.

The attitude is important, and the word operational can mislead. "Operational" should not imply any less commitment to quality or safety, nor a dilution of resources. The attitude should be, "We are going to fly high risk flights this year; every one is going to be a challenge, and every one is going to involve some risk, so we had better be careful in our approach to each."<sup>15</sup>

## Effect of Flight Rate on Spare Parts

As the flight rate increases, the demand on resources and the demand for spare parts increases. Since 1981, NASA has had logistics plans for Shuttle flight rates of 12 and 24 flights a year. It was originally forecast (in mid-1983) that the supply of spares required to support 12 flights annually could be accomplished in the spring of 1986. Actual inventory of spare parts had run close to plan until the second quarter of fiscal year 1985. At that time, inventory requirements for

spares began to increase faster than deliveries. A year later, when inventory stockage should have been complete, only 32,000 of the required 50,000 items (65 percent) had been delivered.<sup>16</sup>

The spare parts plan to support 24 flights per year had called for completing inventory stockage by June, 1987. By mid-1985, that schedule was in jeopardy.

The logistics plan could not be fully implemented because of budget reductions. In October, 1985, the logistics funding requirement for the Orbiter program, as determined by Level III management at Johnson, was \$285.3 million. That funding was reduced by \$83.3 million — a cut that necessitated major deferrals of spare parts purchases. Purchasing deferrals come at great cost. For example, a reduction due to deferral of \$11.2 million in fiscal year 1986 would cost \$11.2 million in fiscal year 1987, plus an additional \$21.6 million in fiscal year 1988. This three-to-one ratio of future cost to current savings is not uncommon. Indeed, the ratio in many instances is as high as seven to one. This practice cannot make sense by any standard of good financial management.

According to Johnson officials, reductions in spares expenditures provided savings required to meet the revised budgets. As Program Manager Arnold Aldrich reported to the Commission:

"There had been fund contentions in the program for a number of years, at least starting in the mid-seventies and running through into the early to mid-eighties . . . intentional decisions were made to defer the heavy build-up of spare parts procurements in the program so that the funds could be devoted to other more pressing activities. . . . It was a regular occurrence for several annual budget cycles. And once the flight rate really began to rise and it was really clear that spare parts were going to be a problem, significant attention was placed on that problem by all levels of NASA and efforts had been made to catch up. But . . . our parts availability is well behind the flight need. . . ."<sup>17</sup>

Those actions resulted in a critical shortage of serviceable spare components. To provide parts required to support the flight rate, NASA had to resort to cannibalization. Extensive cannibalization of spares, i.e., the removal of components



from one Orbiter for installation in another, became an essential modus operandi in order to maintain flight schedules. Forty-five out of approximately 300 required parts were cannibalized for Challenger before mission 51-L. These parts spanned the spectrum from common bolts to a thrust control actuator for the orbital maneuvering system to a fuel cell. This practice is costly and disruptive, and it introduces opportunities for component damage.

This concern was summarized in testimony before the Commission by Paul Weitz, deputy chief of the Astronaut Office at Johnson:

"It increases the exposure of both Orbiters to intrusion by people. Every time you get people inside and around the Orbiter you stand a chance of inadvertent damage of whatever type, whether you leave a tool behind or whether you, without knowing it, step on a wire bundle or a tube or something along those lines."<sup>18</sup>

Cannibalization is a potential threat to flight safety, as parts are removed from one Orbiter, installed in another Orbiter, and eventually replaced. Each handling introduces another opportunity for imperfections in installation and for damage to the parts and spacecraft.

Cannibalization also drains resources, as one Kennedy official explained to the Commission on March 5, 1986:

"It creates a large expenditure in manpower at KSC. A job that you would have normally used what we will call one unit of effort to do the job now requires two units of effort because you've got two ships [Orbiters] to do the task with."<sup>19</sup>

Prior to the Challenger accident, the shortage of spare parts had no serious impact on flight schedules, but cannibalization is possible only so long as Orbiters from which to borrow are available. In the spring of 1986, there would have been no Orbiters to use as "spare parts bins." Columbia was to fly in March, Discovery was to be sent to Vandenberg, and Atlantis and Challenger were to fly in May. In a Commission interview, Kennedy director of Shuttle Engineering Horace Lamberth predicted the program would have been unable to continue:

"I think we would have been brought to

our knees this spring [1986] by this problem [spare parts] if we had kept trying to fly."<sup>20</sup>

NASA's processes for spares provisioning (determining the appropriate spares inventory levels), procurement and inventory control are complicated and could be streamlined and simplified.

As of spring 1986, the Space Shuttle logistics program was approximately one year behind. Further, the replenishment of all spares (even parts that are not currently available in the system) has been stopped. Unless logistics support is improved, the ability to maintain even a three-Orbiter fleet is in jeopardy.

Spare parts provisioning is yet another illustration that the Shuttle program was not prepared for an operational schedule. The policy was shortsighted and led to cannibalization in order to meet the increasing flight rate.

## **The Importance of Flight Experience**

---

In a developmental program it is important to make use of flight experience, both to understand the system's actual performance and to uncover problems that might not have been discovered in testing. Because Shuttle flights were coming in fairly rapid succession, it was becoming difficult to analyze all the data from one flight before the next was scheduled to launch. In fact, the Flight Readiness Review for 51-L was held while mission 61-C was still in orbit. Obviously, it was impossible to even present, much less analyze and understand, anomalies from that flight.

The point can be emphasized by citing two problems that occurred during mission 61-C but were discovered too late to be considered at the 51-L Flight Readiness Review:

1. The Space Shuttle brakes and tires have long been a source of concern. In particular, after the 51-D Orbiter blew a tire at Kennedy in April, 1985, there was considerable effort (within budgetary constraints) to understand and resolve the problems, and Kennedy landings were suspended until certain improvements were made. (See section "Landing: Another Critical Phase," page 186.) Mission 51-L was to be the first flight to land

in Florida since 51-D had experienced brake problems. STS 61-C landed at Edwards Air Force Base in California on January 19, 1986, four days after the 51-L Flight Readiness Review. The 61-C brakes were removed following landing and shipped to the vendor for further inspection and analysis. That inspection revealed major brake damage. The subsystem manager at Johnson in charge of the brakes did not receive the information until January 27, 1986, one day before 51-L was launched, and did not learn the extent of the problem until January 30, 1986.

2. The inspection of the 61-C Solid Rocket Booster segments was completed on January 19, 1986, four days after the 51-L Level I Flight Readiness Review. The post-recovery inspection of the 61-C Solid Rocket Booster segments revealed that there was O-ring erosion in one of the left booster field joints and additional O-ring anomalies on both booster nozzles. Although the information was available for Marshall's 51-L Level III review at launch minus one day, it was clearly not available in time for consideration in the formal launch preparation process.<sup>21</sup> These examples underscore the need to establish a list of mandatory post-flight inspections that must precede any subsequent launch.

## Effect on Payload Safety

The payload safety process exists to ensure that each Space Shuttle payload is safe to fly and that on a given mission the total integrated cargo does not create a hazard. NASA policy is to minimize its involvement in the payload design process. The payload developer is responsible for producing a safe design, and the developer must verify compliance with NASA safety requirements. The Payload Safety Panel at Johnson conducts a phased series of safety reviews for each payload. At those reviews, the payload developer presents material to enable the panel to assess the payload's compliance with safety requirements.

Problems may be identified late, however, often as a result of late changes in the payload design and late inputs from the payload developer. Obviously, the later a hazard is iden-

tified, the more difficult it will be to correct, but the payload safety process has worked well in identifying and resolving safety hazards.

Unfortunately, pressures to maintain the flight schedule may influence decisions on payload safety provisions and hazard acceptance. This influence was evident in circumstances surrounding the development of two high priority scientific payloads and their associated booster, the Centaur.

Centaur is a Space Shuttle-compatible booster that can be used to carry heavy satellites from the Orbiter's cargo bay to deep space. It was scheduled to fly on two Shuttle missions in May, 1986, sending the NASA Galileo spacecraft to Jupiter and the European Space Agency Ulysses spacecraft first to Jupiter and then out of the planets' orbital plane over the poles of the Sun. The pressure to meet the schedule was substantial because missing launch in May or early June meant a year's wait before planetary alignment would again be satisfactory.

Unfortunately, a number of safety and schedule issues clouded Centaur's use. In particular, Centaur's highly volatile cryogenic propellants created several problems. If a return-to-launch-site abort ever becomes necessary, the propellants will definitely have to be dumped overboard. Continuing safety concerns about the means and feasibility of dumping added pressure to the launch preparation schedule as the program struggled to meet the launch dates.

Of four required payload safety reviews, Centaur had completed three at the time of the Challenger accident, but unresolved issues remained from the last two. In November, 1985, the Payload Safety Panel raised several important safety concerns. The final safety review, though scheduled for late January, 1986, appeared to be slipping to February, only three months before the scheduled launches.

Several safety waivers had been granted, and several others were pending. Late design changes to accommodate possible system failure would probably have required reconsideration of some of the approved waivers. The military version of the Centaur booster, which was not scheduled to fly for some time, was to be modified to provide added safety, but because of the rush to get the 1986 missions launched, these improvements were not approved for the first two Centaur boosters. After the 51-L accident, NASA allotted more than \$75 million to incorporate the opera-

tional and safety improvements to these two vehicles.<sup>22</sup> We will never know whether the payload safety program would have allowed the Centaur missions to fly in 1986. Had they flown, however, they would have done so without the level of protection deemed essential after the accident.

## Outside Pressure to Launch

After the accident, rumors appeared in the press to the effect that persons who made the decision to launch mission 51-L might have been subjected to outside pressure to launch. Such rumors concerning unnamed persons, emanating from anonymous sources about events that may never have happened, are difficult to disprove and dispel. Nonetheless, during the Commission's hearings all persons who played key roles in that decision were questioned. Each one attested, under oath, that there had been no outside intervention or pressure of any kind leading up to the launch.

There was a large number of other persons who were involved to a lesser extent in that decision, and they were questioned. All of those persons provided the Commission with sworn statements that they knew of no outside pressure or intervention.<sup>23</sup>

The Commission and its staff also questioned a large number of other witnesses during the course of the investigation. No evidence was reported to the Commission which indicated that any attempt was ever made by anyone to apply pressure on those making the decision to launch the Challenger.

Although there was total lack of evidence that any outside pressure was ever exerted on those who made the decision to launch 51-L, a few speculative reports persisted.

One rumor was that plans had been made to have a live communication hookup with the 51-L crew during the State of the Union Message. Commission investigators interviewed all of the persons who would have been involved in a hookup if one had been planned, and all stated unequivocally that there was no such plan. Furthermore, to give the crew time to become oriented, NASA does not schedule a communication for at least 48 hours after the launch and no such communication was scheduled in the case of flight 51-L.

The flight activity officer who was responsible for developing the crew activity plan testified that three live telecasts were planned for the Challenger, but they related in no way to the State of the Union Message:<sup>24</sup>

- During the teacher activities on flight day 4.
- During the phase partitioning experiment on flight day 5.
- During the crew conference on flight day 6.

The Commission concluded that the decision to launch the Challenger was made solely by the appropriate NASA officials without any outside intervention or pressure.

## Findings

1. The capabilities of the system were stretched to the limit to support the flight rate in winter 1985/1986. Projections into the spring and summer of 1986 showed a clear trend; the system, as it existed, would have been unable to deliver crew training software for scheduled flights by the designated dates. The result would have been an unacceptable compression of the time available for the crews to accomplish their required training.

2. Spare parts are in critically short supply. The Shuttle program made a conscious decision to postpone spare parts procurements in favor of budget items of perceived higher priority. Lack of spare parts would likely have limited flight operations in 1986.

3. Stated manifesting policies are not enforced. Numerous late manifest changes (after the cargo integration review) have been made to both major payloads and minor payloads throughout the Shuttle program.

- Late changes to major payloads or program requirements can require extensive resources (money, manpower, facilities) to implement.
- If many late changes to "minor" payloads occur, resources are quickly absorbed.
- Payload specialists frequently were added to a flight well after announced deadlines.
- Late changes to a mission adversely affect the training and development of procedures for subsequent missions.

4. The scheduled flight rate did not accurately reflect the capabilities and resources.

- The flight rate was not reduced to accommodate periods of adjustment in the capacity of the work force. There was no margin in the system to accommodate unforeseen hardware problems.
- Resources were primarily directed toward supporting the flights and thus not enough were available to improve and expand facilities needed to support a higher flight rate.

5. Training simulators may be the limiting factor on the flight rate: the two current simulators cannot train crews for more than 12-15 flights per year.

6. When flights come in rapid succession, current requirements do not ensure that critical anomalies occurring during one flight are identified and addressed appropriately before the next flight. ■

## References

- <sup>1</sup> Hearings of the U.S. Senate, Subcommittee of the Committee on Appropriations, May 5, 1982, page 1029.
- <sup>2</sup> "Interview with NASA Administrator James Beggs." Space Business News, September 12, 1983.
- <sup>3</sup> See Appendix, NASA Mission Planning and Operations Team Report (Preliminary), April, 1986, page 86.
- <sup>4</sup> Commission Work Session, Mission Planning and Operations Panel, April 1, 1986, JSC, page 198.
- <sup>5</sup> Commission Work Session, Mission Planning and Operations Panel, April 1, 1986, JSC, page 198.
- <sup>6</sup> NASA Memo, DA-RRR-86-06.
- <sup>7</sup> See Appendix J, NASA Mission Planning and Operations Team Report (Preliminary), April, 1986, pages 58-59.
- <sup>8</sup> Commission Work Session, Mission Planning and Operations Panel, March 24, 1986, JSC, page 130.
- <sup>9</sup> Commission Work Session, Mission Planning and Operations Panel, March 24, 1986, JSC, page 126.
- <sup>10</sup> Commission Work Session, Mission Planning and Operations Panel, April 8, 1986, JSC, page 240.
- <sup>11</sup> Page 12.
- <sup>12</sup> Commission Work Session, Mission Planning and Operations Panel, April 1, 1986, JSC, page 205.
- <sup>13</sup> Commission Work Session, Mission Planning and Operations Panel, April 8, 1986, JSC, pages 216-218.
- <sup>14</sup> Commission Work Session, Mission Planning and Operations Panel, April 8, 1986, JSC, pages 216-218.
- <sup>15</sup> Commission Work Session, Mission Planning and Operations Panel, April 8, 1986, JSC, pages 262-263.
- <sup>16</sup> NASA Memo from Goetz, R., "Logistics Responsibility Transfer from NASA JSC to NASA KSC," February 6, 1986.
- <sup>17</sup> Commission Hearing Transcript, April 3, 1986, page 2544.
- <sup>18</sup> Commission Hearing Transcript, April 3, 1986, page 2445.
- <sup>19</sup> Commission Work Session, Mission Planning and Operations Panel, March 5, 1986, KSC, page 306.
- <sup>20</sup> Commission Work Session, Mission Planning and Operations Panel, March 4, 1986, KSC, page 304.
- <sup>21</sup> Report, "SRM Post-flight Hardware Inspection Report for STS 61-C," Part 1 of 2, January 24, 1986, pages 51-52.
- <sup>22</sup> Cost figures were provided by the Centaur program manager, telephone call, May 16, 1986.
- <sup>23</sup> Twenty-eight Affidavits submitted to the Commission.
- <sup>24</sup> Commission Interview Transcript, Ehlers, K., April 16, 1986, JSC, pages 1-10.

# Other Safety Considerations

In the course of its investigation, the Commission became aware of a number of matters that played no part in the mission 51-L accident but nonetheless hold a potential for safety problems in the future.

Some of these matters, those involving operational concerns, were brought directly to the Commission's attention by the NASA astronaut office. They were the subject of a special hearing.

Other areas of concern came to light as the Commission pursued various lines of investigation in its attempt to isolate the cause of the accident. These inquiries examined such aspects as the development and operation of each of the elements of the Space Shuttle—the Orbiter, its main engines and the External Tank; the procedures employed in the processing and assembly of 51-L, and launch damage.

This chapter examines potential risks in two general areas. The first embraces critical aspects of a Shuttle flight; for example, considerations related to a possible premature mission termination during the ascent phase and the risk factors connected with the demanding approach and landing phase. The other focuses on testing, processing and assembling the various elements of the Shuttle.

## Ascent: A Critical Phase

The events of flight 51-L dramatically illustrated the dangers of the first stage of a Space Shuttle ascent. The accident also focused attention on the issues of Orbiter abort capabilities and crew escape. Of particular concern to the Com-

mission are the current abort capabilities, options to improve those capabilities, options for crew escape and the performance of the range safety system.

It is not the Commission's intent to second-guess the Space Shuttle design or try to depict escape provisions that might have saved the 51-L crew. In fact, the events that led to destruction of the Challenger progressed very rapidly and without warning. Under those circumstances, the Commission believes it is highly unlikely that any of the systems discussed below, or any combination of those systems, would have saved the flight 51-L crew.

## Abort Capabilities

Various unexpected conditions during ascent can require premature termination of a Shuttle mission. The method of termination, or abort, depends upon the nature of the unexpected condition and when it occurs.

The Space Shuttle is lifted to orbit by thrust from its two solid rockets and three main engines. The design criteria for the Shuttle specify that, if a single main engine is lost at any time between lift off and normal main engine cut off, the Shuttle must be able to continue to orbit or to execute an intact abort, that is, make a survivable landing on a runway. That design requirement has been met. If a single main engine is lost early in ascent, the Shuttle can return to make an emergency landing at Kennedy (a return-to-launch-site abort). If the failure occurs later, the Shuttle can make an emergency landing in Africa or Europe (a transatlantic abort landing). If the failure occurs during the last part of the ascent, the Shuttle can proceed around the Earth to a

landing in the continental United States (abort once around), or can continue to a lower-than-planned orbit (abort to orbit). Indeed, if the failure occurs late enough, the Shuttle will achieve the intended orbital conditions.

**Return-to-Launch-Site Abort.** If the termination is necessary because of loss of a main engine during the first four minutes of flight, the Shuttle has the capability to fly back to the launch site. It continues downrange to burn excess propellant, and at the proper point it turns back toward Florida. The computers shutdown the remaining two engines and separate the Orbiter from the External Tank, which falls into the Atlantic

Ocean. The Orbiter then glides to a landing on the runway at the Shuttle Landing Facility at Kennedy.

**Transatlantic Abort.** During ascent there comes a time when the Shuttle is too far downrange to fly back to Kennedy. If it suffers an engine failure after that point, but has not yet achieved enough energy to continue toward orbit, it will have to land on the other side of the Atlantic. It will continue on a special flight path until it achieves the energy necessary to glide to the landing site. At that point the Shuttle computers will cut off the two remaining engines and separate the Orbiter from the External Tank. The

### Shuttle Abort Regions

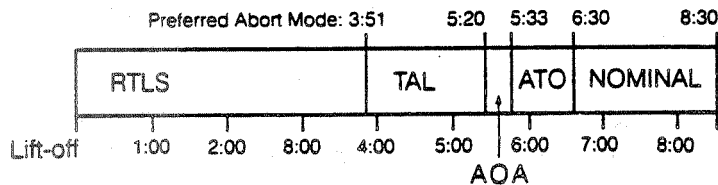
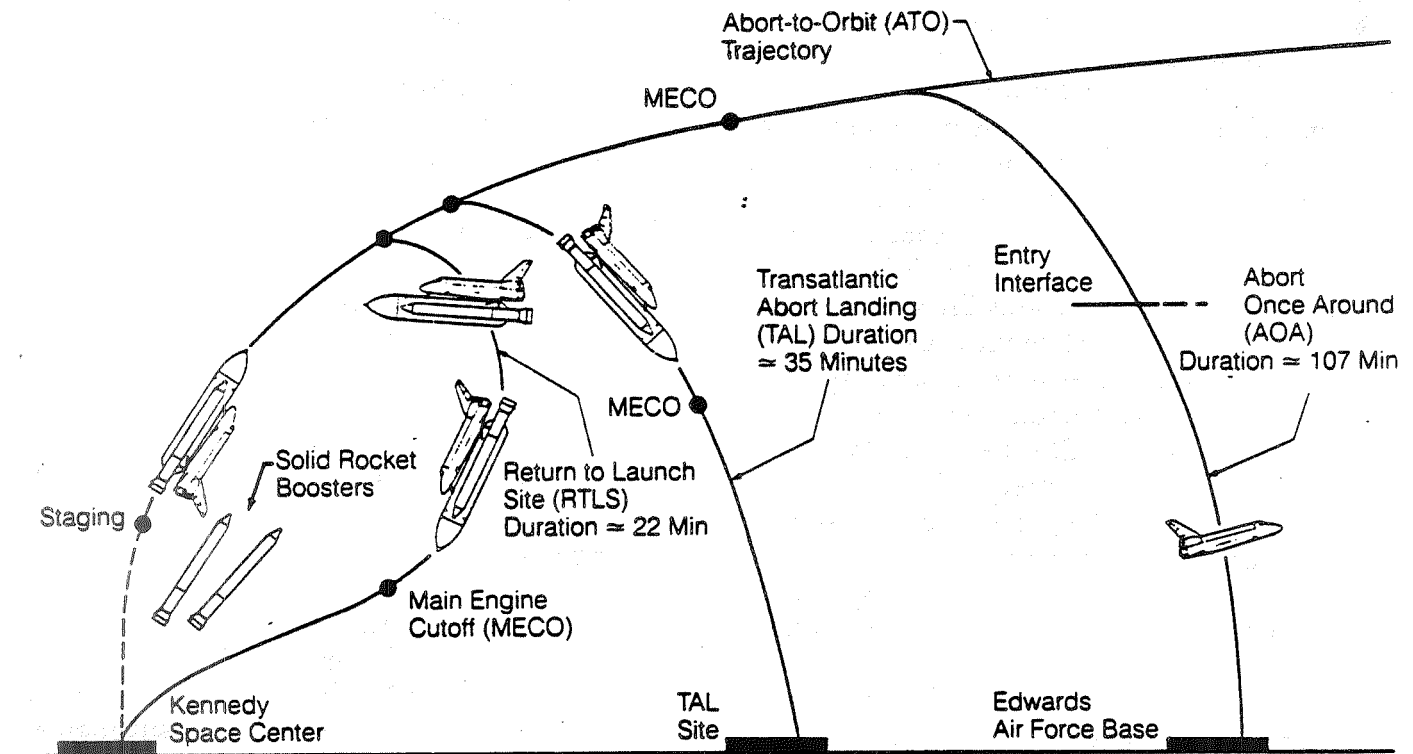

**Mission Elapsed Time (minutes : seconds)**

Note: Times are scaled to the schematic

Schematic shows options available to Space Shuttle crews for aborts in the event of power loss at various stages in the ascent to space.

Shuttle will then re-enter the lower atmosphere much like a normal entry. The landing, however, will be at a pre-selected site in Africa or Europe.

**Design.** The Shuttle design specifications do not require that the Orbiter be able to manage an intact abort (i.e., make it to a runway) if a second main engine should fail. If two (or all three) main engines fail within the first five to six minutes of the flight, the Space Shuttle will land in water. This maneuver is called a "contingency abort" and is not believed to be survivable because of damage incurred at water impact.

The Shuttle design requirements did not specify that the Shuttle should be able to survive a Solid Rocket Booster failure. The system has no way to identify when a booster is about to fail, and no way to get the Orbiter or the crew away from a failing Solid Rocket Booster.

Crew survival during ascent rests on the following assumptions:

1. The Solid Rocket Boosters will work from ignition to planned separation.
2. If more than one main engine fails, the crew must be able to survive a water landing.

### **Shuttle Abort Enhancements**

Between 1973 and 1983, first stage abort provisions were assessed many times by all levels of NASA management. Many methods of saving the Orbiter and/or crew from emergencies during first stage were considered.

Ejection seats (which afforded only limited protection during first stage) were provided for the two-man crews of the Orbital Flight Test program (the first four Shuttle flights). Other options for "operational" flights carrying crews of five or more astronauts were considered, but were not implemented because of limited utility, technical complexity and excessive cost in dollars, weight or schedule delays.

Because of these factors, NASA adopted the philosophy that the reliability of first stage ascent must be assured, and that design and testing must preclude time critical failures that would require emergency action before normal Solid Rocket Booster burnout. That philosophy has been reviewed many times during the Space Shuttle program and is appropriately being reevaluated, as are all first stage abort options, in light of the 51-L accident.

### **Early Orbiter Separation**

If a problem arose that required the Orbiter to get away from failing Solid Rocket Boosters, the separation would have to be performed extremely quickly. Time would be of the essence for two reasons. First, as 51-L demonstrated, if a problem develops in a Solid Rocket Booster, it can escalate very rapidly. Second, the ascent trajectory is carefully designed to control the aerodynamic loads on the vehicle; very small deviation from the normal path will produce excessive loads, so if the vehicle begins to diverge from its path there is very little time (seconds) before structural breakup will occur.

The normal separation sequence to free the Shuttle from the rest of the system takes 18 seconds, far too long to be of use during a first-stage contingency. "Fast-separation" was formally established by Review Item Discrepancy 03.00.151, which stated the requirement to separate the Orbiter from the External Tank at any time. The sequence was referred to as fast-separation because delays required during normal separation were bypassed or drastically shortened in order to achieve separation in approximately three seconds. Some risk was accepted to obtain this contingency capability. Fast-separation was incorporated into the flight software, so that technically this capability does exist. Unfortunately, analysis has shown that, if it is attempted while the Solid Rocket Boosters are still thrusting, the Orbiter will "hang up" on its aft attach points and pitch violently, with probable loss of the Orbiter and crew.

In summary, as long as the Solid Rocket Boosters are still thrusting, fast-separation does not provide a way to escape. It would be useful during first stage only if Solid Rocket Booster thrust could first be terminated.

The current concept of fast-separation does, however, have some use. Contingency aborts resulting from loss of two or three main engines early in ascent are time-critical, and every fraction of a second that can be trimmed from the separation sequence helps. These abort procedures are executed after the Solid Rocket Boosters are expended, and fast-separation is used to reduce the time required for separation as the Shuttle must attain entry attitude very quickly. Unfortunately, all contingency aborts culminate in water impact.



## Thrust Termination

Thrust termination (or thrust neutralization) as originally proposed for the Space Shuttle was a concept conceived for the Titan 3-M booster intended for use in the Manned Orbiting Laboratory Program. The objective of thrust termination is to either extinguish or reduce the thrust of the Solid Rocket Booster in an emergency situation. With this thrust terminated, emergency options such as crew ejection or fast-separation might become feasible during the first two minutes of flight.

The principal drawback is that thrust termination itself introduces high dynamic loads that could cause Shuttle structural components to fail. Early design reviews suggested that to strengthen the Orbiter to withstand the stresses caused by rapid thrust termination would require an additional, prohibitive 19,600 pounds. Thrust termination was deleted from design consideration on April 27, 1973, by Space Shuttle Directive SS00040. Key factors in the decision were that (1) proper design would be stressed to prevent Solid Rocket Booster failure and (2) other first-stage ascent systems provided enough redundancy to allow delaying an abort until after the Solid Rocket Boosters burned out.

The subject arose again in 1979 when Space Shuttle Directive S13141 required the system contractor to determine the time over which thrust reduction must be spread so that the deceleration loads would not destroy the Orbiter. Marshall analyzed the thrust decay curves submitted by the contractor and concluded that achieving the required thrust decay rates was impractical.

On July 12, 1982, the Associate Administrator for Space Transportation Systems requested reconsideration of thrust termination. Gerald Griffin, director of Johnson, responded to the request in a letter dated September 9, 1982, as follows:

"In our opinion, further study of a thrust termination system for the SRB [Solid Rocket Booster] would not be productive. The potential failure modes which could result in a set of conditions requiring SRB thrust termination are either very remote or a result of primary structural failure. The structural failure risk would normally be accepted as a part of the factor of safety verification by analysis or test. In addition, any thrust termination system is going to be

extremely heavy, very costly and, at best, present some risk to the Orbiter and ET [External Tank]. Venting of hot gases and the shock load or pressure spike, have the potential for being as great a hazard as the problem to be corrected. It does not appear that a practical approach exists for achieving the desired pressure decay rate without a major redesign of the motor."<sup>1</sup>

In retrospect, the possibility of Solid Rocket Booster failures was neither very remote nor limited to primary structural failure.

Although it would not have helped on mission 51-L, thrust termination is the key to any successful first-stage abort, and new ideas and technologies should be examined. If a thrust termination system is eventually deemed feasible (that is, the Orbiter/External Tank will still be intact after the rapid deceleration), it cannot have failure modes that would cause an uncommanded neutralization of the thrust of one or both of the Solid Rocket Boosters. If thrust termination were to be implemented, reliable detection mechanisms and reliable decision criteria would be mandatory.

## Ditching

As previously discussed, most contingency aborts (those resulting from failure of two or three main engines during the first five to six minutes of flight) result in a water landing, or ditching. In addition, if the Space Shuttle did have a thrust termination capability to use with fast-separation to allow it to separate from failing solid rockets, the Orbiter would have to ditch in the water unless the failure occurred during a small window 50-70 seconds after launch. Accordingly, whether the crew can survive a water impact is a critical question.

In 1974 and 1975, ditching studies were conducted at Langley Research Center. Although test limitations precluded definitive conclusions, the studies suggested that the loads at water impact would be high. The deceleration would most probably cause structural failure of the crew cabin support ties to the fuselage, which would impede crew egress and possibly flood the cabin. Furthermore, payloads in the cargo bay are not designed to withstand decelerations as high as those expected,<sup>2</sup> and would very possibly break free and travel forward to the crew cabin. The Langley report does state that the Orbiter shape and mass

properties are good for ditching, but given the structural problems and deceleration loads, that is little consolation.

Orbiter ditching was discussed by the Crew Safety Panel and at Orbiter flight techniques meetings before the first Shuttle flight. The consensus of these groups was that (1) ditching is more hazardous than suggested by the early Langley tests, and (2) ditching is probably not survivable.

This view was reiterated in the September 9, 1982, letter from Griffin to Abrahamson:

“We also suggest no further effort be expended to study bailout or ditching. There is considerable doubt that either case is technically feasible with the present Orbiter design. Even if a technical solution can be found, the impact of providing either capability is so severe in terms of cost and schedule as to make them impractical.”

There is no evidence that a Shuttle crew would survive a water impact. Since all contingency aborts and all first stage abort capabilities that are being studied culminate in a water impact, an additional provision for crew escape before impact should also be considered.

Astronaut Paul Weitz expressed this before the Commission on April 3, 1986:

“My feeling is so strong that the Orbiter will not survive a ditching, and that includes land, water or any unprepared surface. . . .

“I think if we put the crew in a position where they’re going to be asked to do a contingency abort, then they need some means to get out of the vehicle before it contacts earth, the surface of the earth.”<sup>3</sup>

## Crew Escape Options

In a study conducted before the Orbiter contract was awarded, Rockwell International evaluated a range of ejection systems (Rockwell International, Incorporated, Phase B Study, 1971). The table shows the results comparing three systems: ejection seats, encapsulated ejection seats and a separable crew compartment. The development costs are in 1971 dollars, and the costs and weights cited were those required to incorporate these systems into the developing Orbiter design, not to modify an existing Orbiter.

The only system that could provide protection for more than the two-man experimental flight crew was the separable crew compartment, which would add substantial weight and development cost. All of these systems had limitations in their ability to provide successful escape, and all would require advance warning of an impending hazard from reliable data sources.

The Request for Proposal, written in April, 1971 (reference paragraph 1.3.6.2.1), states: “Provisions shall be made for rapid emergency egress of the crew during development test flights.” Ejection seats were selected as the emergency escape system. The objective was to offer the crew some protection, though limited, from risks of the test flights. The philosophy was that after the test flights, all unknowns would be resolved, and the vehicle would be certified for “operational” flights.

Conventional ejection seats similar to those installed in the Lockheed F-12/SR-71 were selected shortly after the Orbiter contract was awarded. They were subsequently incorporated into Columbia and were available for the first four flights. The ejection could be initiated by either crew member and would be used in the event of un-

1971 Rockwell Data on Ejection Systems

Type	Altitude (feet)	Velocity (feet/sec)	Weight (pounds)	Development Cost
Open Ejection Seat	< 60,000	< 2,000	1,760	\$10,000,000
B-70 Encapsulated Seat	< 100,000	< 3,000	5,200	\$7,000,000
Separable Crew Compartment	< 100,000	8,000 or more	14,000 to 17,000	\$292,000,000

controlled flight, on-board fire or pending landings on unprepared surfaces. The escape sequence required approximately 15 seconds for the crew to recognize pending disaster, initiate the sequence and get a safe distance away from the vehicle.

Although the seats were originally intended for use during first-stage ascent or during gliding flight below 100,000 feet, analysis showed that the crew would be exposed to the Solid Rocket Booster and main engine exhaust plumes if they ejected during ascent. During descent, the seats provided good protection from about 100,000 feet to landing.

After the Space Shuttle completed the four test flights it was certified for "operational" flights. But missions for the "operational" flights required more crew members, and there were no known ejection systems, other than an entire cabin escape module, that could remove the entire crew within the necessary time. The Orbiter configuration allowed room for only two ejection seats on the flight deck. With alternative ejection concepts and redesign of the flight deck, this number might have been increased slightly, but not to the full crew size. Thus, because of limited utility during first-stage ascent and inability to accommodate a full crew, the ejection seats were eliminated for operational flights.

The present Shuttle has no means for crew escape, either during first-stage ascent or during gliding flight. Conventional ejection seats do not appear to be viable Space Shuttle options because they severely limit the crew size and, therefore, prevent the Space Shuttle from accomplishing its mission objectives. The remaining options fall into three categories:

1. **Escape Module.** The entire crew compartment would be separated from the Orbiter and descend by parachute.
2. **Rocket-assisted Extraction.** Many military aircraft employ a system using a variety of small rocket-assisted devices to boost occupants from the plane. Such a system could be used in the Orbiter.
3. **Bail-Out System.** The crew can exit unassisted through a hatch during controlled, gliding flight.

Only one of these, the escape module, offers the possibility of escape during first-stage ascent.

Its use would probably be practical only after thrust termination. It should be noted that in all cases of crew escape, the Orbiter would be lost, but in cases of Solid Rocket Booster failure or Orbiter ditching the vehicle would be lost anyway. The utility and feasibility of each method are described below.

An escape module can offer an opportunity for crew escape at all altitudes during a first-stage time-critical emergency if the escape system itself is not damaged to the point that it cannot function. The module must be sufficiently far from the vehicle at the time of catastrophe that neither it nor its descent system is destroyed. Incorporation of an escape module would require significant redesign of the Orbiter: some structural reinforcement, pyrotechnic devices to sever the escape module from the rest of the Orbiter, modifications to sever connections that supply power and fluids, separation rockets and a parachute system. An additional weight penalty would result from the requirement to add mass in the rear of the Orbiter to compensate for the forward shift in the center of gravity. Recent estimates indicate this could add as much as 30,000 pounds to the weight of the Orbiter.<sup>4</sup> This increase in weight would reduce payload capacity considerably, perhaps unacceptably. There is no current estimate of the attendant cost.

An escape module does theoretically offer the widest range of crew escape options. The other two options, rocket extraction and bail-out, are only practical during gliding flight. Both methods would be useful when the Orbiter could not reach a prepared runway, for they would allow the crew to escape before a very hazardous landing or a water ditching. Aerodynamic model tests showed that a crew member bailing out through either the side or overhead hatch would subsequently contact the wing, tail or orbital maneuvering system pod unless he or she could exit with sufficient velocity (> 5 to 10 feet per second) to avoid these obstacles. Slides and pendant rocket systems were evaluated as means of providing this velocity, but all concepts of bail-out and rocket extraction that were studied require many minutes to get the entire crew out and would be practical only during controlled gliding flight. The results of these studies were presented at the Program Requirements Change Board session held on May 12, 1983, and subsequently to the NASA administrator, but none of the alternatives was

implemented because of limited capability and resulting program impacts.

There is much discussion and disagreement over which escape systems are feasible, or whether any provide protection against a significant number of failure modes.

The astronauts testifying before the Commission on April 3, 1986, agreed that it does not appear practical to modify the Orbiter to incorporate an escape module. The astronauts disagreed, however, about which of the other two systems would be preferable. As Astronaut Weitz testified:

“John [Astronaut John Young] likes the rocket extraction system because it does cover a wider flight regime and allows you to get out perhaps with the vehicle only under partial control as opposed to complete control; however, any system that adds more parts like rockets gets more complex. . . . The only kind of a system that I think is even somehow feasible would be maybe some kind of a bail-out system that could be used subsonic.”<sup>5</sup>

In its 1982 Annual Report, the Aerospace Safety Advisory Panel listed “crew escape . . . at launch and prior to potential ditching”<sup>6</sup> as a priority item that warranted further study. The Commission fully supports such studies. In particular, the Commission believes that the crew should have a means of escaping the Orbiter in controlled, gliding flight. The Commission thinks it crucial that the vehicle that will carry astronauts into orbit through this decade and the next incorporate systems that provide some chance for crew survival in emergencies. It nonetheless accepts the following point made by Astronaut Robert Crippen:

“I don’t know of an escape system that would have saved the crew from the particular incident that we just went through [the Challenger accident].”<sup>7</sup>

## Range Safety

Television coverage of the Challenger accident vividly showed the Solid Rocket Boosters emerging from the ball of fire and smoke. The erratic and uncontrolled powered flight of such large components could have posed a potential danger to populated areas. The responsible official accordingly destroyed the Solid Rocket Boosters.

To understand how the booster rockets were destroyed, one must understand the purpose of a range safety system, its functions, and the special considerations that apply to Shuttle launches.

The Eastern Space and Missile Center operates a range safety system for all Department of Defense and NASA launch activities in the Cape Canaveral area. The primary responsibility of the range safety system, run by the U.S. Air Force, is to protect people and property from abnormal vehicle flights during first stage ascent.

To fulfill its range safety responsibilities, the Eastern Space and Missile Center staff supervises on-site launch preparations and tracks rockets and vehicles until they are far enough away from populated areas to remove any danger. When such a danger arises during the ascent stage of a launch, the vehicle may have to be destroyed to minimize harm to persons and property on the ground. Every major vehicle flown from the Cape Canaveral area has carried an explosive destruct system that could be armed and fired by the range safety officer.

Range safety procedures in launch activities from Kennedy are governed by Department of Defense and NASA documents. The primary regulatory publication is DOD Document 3200.11, Use, Management, and Operation of DOD Major Ranges and Test Facilities.

## Space Shuttle Range Safety System

Both Space Shuttle Solid Rocket Boosters and the External Tank are fitted with explosive charges. These can be detonated on the command of the range safety officer if the vehicle crosses the limits established by flight analysis before launch and the vehicle is no longer in controlled flight. The determination of controllability is made by the flight director in Mission Control, Houston, who is in communication with the range safety officer. Following an encoded “arm” command, the existing package on the Shuttle System is detonated by a subsequent encoded “fire” command.

The range safety officer who sends the commands is the key decision maker who is finally responsible for preventing loss of life and property that could result if the vehicle or components should fall in populated areas. The destruct criteria are agreed to by NASA and the Eastern Space and Missile Center.

A range safety system for the Shuttle launches was approved in concept in 1974. Under that concept, the capability to destroy the system in flight

#### Range Safety System Components

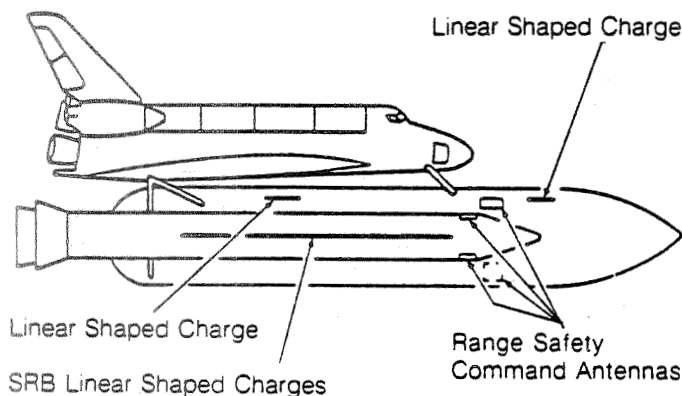

Drawing shows position of linear shaped charges and range safety command antennas on Solid Rocket Boosters and External Tank.

from the ground was to be installed in the form of radio detonated explosive charges triggered by encoded signals. Such a range safety package appeared necessary for a variety of reasons based upon the initial Shuttle design that included ejection seats. If the crew were to eject, the unmanned vehicle would be uncontrollable and thus a much greater danger than a manned system.

After the first four test flights, however, the ejection seats were deactivated. Retaining the range safety package when the crew could no longer escape was an emotional and controversial decision. In retrospect, however, the Challenger accident has demonstrated the need for some type of range safety measure. Since the current range safety system does not allow for selective destruction of components, the Commission believes that NASA and the Air Force should critically re-examine whether the destruct package on the External Tank might be removed.

#### Range Safety Activities, January 28, 1986

The range safety officer for the Challenger flight on January 28 was Maj. Gerald F. Bieringer, U.S. Air Force. He reported that the mission was normal until about 76 seconds after launch. The following description is from Maj.

Bieringer's written statement prepared approximately two hours after the accident:

"Watching the IP [impact point] displays and optics I observed the primary and alternate sources diverge significantly at about T + 76 [76 seconds into the flight]. At about the same time I heard . . . [through monitored communications] the vehicle had exploded. Concurrently, I saw the explosion on the video monitor on my right. A white cloud seemed to envelop the vehicle, small pieces exploded out of it. The IP displays PRI and ALT indications were jumping around wildly. I was about to recommend we do nothing as it appeared the entire vehicle had exploded when I observed what appeared to be an SRB [Solid Rocket Booster] stabilized and flying toward the upper left corner of the display. As it appeared stabilized I felt it might endanger land or shipping and as the ET [External Tank] had apparently exploded I recommended to the SRSO [senior range safety officer] we send functions. I sent ARM, waited about 10 seconds, and sent FIRE. . . . FIRE was sent at about 110 [seconds]."<sup>8</sup>

During the flight and prior to the accident, tracking and control functions performed normally. There were no communications problems throughout the range or with the NASA flight dynamics officer in Mission Control, Houston.

Range safety data displays did not provide useful information immediately after the accident. The range safety officer depended upon the video displays for evidence concerning the performance of the Solid Rocket Boosters. Without that information, the range safety officer would not have sent the destruct signals. Detailed studies from Marshall had indicated that Solid Rocket Boosters would tumble if prematurely separated. That assumption made possible the prediction of impact points. When the Challenger Solid Rocket Boosters separated after the explosion, however, they continued powered, stabilized flight and did not tumble, contrary to the expectations upon which range safety rules had been based. Without the live television pictures, the range safety officer would not have known about the unexpected performance of the boosters.

The Eastern Space and Missile Center and NASA have appropriately initiated a comprehen-

sive review of the Shuttle range safety requirements and their implementation. The events of the Challenger accident demonstrate the need for a range safety package of some type on the Solid Rocket Boosters. However, the review should examine whether technology exists that would allow combining the range safety function for the Solid Rocket Boosters with a thrust termination system, and whether, if technically feasible, it would be desirable.

### **Postflight Analysis**

The Mission Control Center in Houston had no more warning of the impending disaster than the range safety officer had. All information that might be useful in recognizing problems that the crew or the mission control flight team could do something about is available to flight controllers during the launch, but that information constitutes only a fraction of the electronic data being telemetered from the Shuttle. To ensure that nothing was overlooked during the launch, Johnson flight controllers conducted a thorough analysis of the telemetry data on January 29 and 30, 1986.

Their review of the recorded events revealed that the chamber pressure inside the right Solid Rocket Booster began to differ from that of the left booster approximately 60 seconds after lift off. A sampling of that information is available to a flight controller during ascent, but the internal pressures of the boosters are normally not monitored during the first stage. The readings are used only to indicate whether the crew can expect an on-time or slightly delayed separation of the boosters from the Orbiter and External Tank. The difference in pressure during the brief ascent of Challenger was small, and pressures were within acceptable limits.

The replay of the data also indicated that the vehicle flight control system was responding properly to external forces and continued to control the Shuttle until the accident. No unusual motion responses occurred, and inside the cockpit there were no alarms. There are no indications that the crew had any warning of a problem before the fire and the disintegration of the Space Shuttle.

### **Findings**

1. The Space Shuttle System was not designed to survive a failure of the Solid Rocket Boosters. There are no corrective actions that can be taken if the boosters do not operate properly after ignition, i.e., there is no ability to separate an Orbiter safely from thrusting boosters and no ability for the crew to escape the vehicle during first-stage ascent.

- Neither the Mission Control Team nor the 51-L crew had any warning of impending disaster.
- Even if there had been warning, there were no actions available to the crew or the Mission Control Team to avert the disaster.

### **Landing: Another Critical Phase**

The consequences of faulty performance in any dynamic and demanding flight environment can be catastrophic. The Commission was concerned that an insufficient safety margin may have existed in areas other than Shuttle ascent. Entry and landing of the Shuttle are dynamic and demanding with all the risks and complications inherent in flying a heavyweight glider with a very steep glide path. Since the Shuttle crew cannot divert to any alternate landing site after entry, the landing decision must be both timely and accurate. In addition, the landing gear, which includes wheels, tires and brakes, must function properly. These considerations will be discussed for both normal and abort landings.

### **Abort Site Weather**

The acceptability of the weather at abort landing sites, both inside and outside the continental United States, is a critical factor in the launch decision process. The local weather minima for the actual launch are necessarily restrictive. The minima for acceptably safe abort landings are even more restrictive. Of course, the wider the range of acceptable weather conditions, the greater the possibility of launch on any given day. As a result of past efforts to increase the likelihood of launch, abort landing weather criteria are currently less restrictive than the criteria for planned landings.

The program also allows consideration of launching with a light rain shower over the Kennedy runway. Although engineering assessments



indicate that the tile damage that would result would not affect Shuttle controllability, it would be a serious setback to the program in terms of budget and schedule. This rule is designed to allow the program to weigh the probability of a return-to-launch-site abort and decide whether it is worthwhile to launch and accept the risk of a setback because of tile damage should a return-to-launch-site abort be required. This risk appears to be unnecessary.

The programmatic decision to accept worse weather for an abort landing, in a situation where other conditions are also less than optimal, is not consistent with a conservative approach to flight safety. The desire to launch is understandable, and abort landings are indeed improbable. However, if an abort is required, it is irrelevant that it was unlikely. An emergency, the loss of a Space Shuttle Main Engine, has already occurred to produce the necessity. Abort situations will require landing under emergency conditions on limited runways with Orbiter weights higher than normal. The difficulties should not be compounded by high crosswinds or reduced visibility. The Commission recommended that this subject be reviewed, and those reviews are currently underway.

### **Orbiter Tires and Brakes**

The Aerospace Safety Advisory Panel has shared NASA's concern over the Orbiter wheels, tires and brakes since the beginning of the Shuttle program. This is summarized in its 1982 Annual Report.

"The landing gear including wheels, tires, and brakes is vital for safe completion of any mission. With the future flights going to higher weights and lower margins, possibly even negative margins, it is imperative that existing capabilities be fully explored, documented and improved where necessary."<sup>9</sup>

### **Orbiter Tires**

Orbiter tires are manufactured by B.F. Goodrich and are designed to support a Space Shuttle landing up to 240,000 pounds at 225 knots with 20 knots of crosswind. The tires have a 34-ply rating using 16 cords. Though they have successfully passed testing programs, they have shown excessive wear during landings at Kennedy, especially when crosswinds were involved.

The tires are rated as Criticality 1 because loss of a single tire could cause loss of control and subsequent loss of vehicle and crew.

Based upon approach and landing test experience, crosswind testing was added to the Space Shuttle tire certification testing. To date, Orbiters have landed with a maximum of 8 knots of crosswind at the Kennedy runway resulting in heavy tire wear: both spinup wear that occurs initially at touchdown and crosswind wear induced by side forces and differential braking. While dynamometer tests indicated that these tires should withstand conditions well above the design specification, the tests have not been able to simulate runway surface effects accurately. A Langley Research Center test track has been used to give a partial simulation of the strains caused by a landing at Kennedy. This test apparatus will be upgraded for further testing in the summer of 1986 in an attempt to include all the representative flight loads and conditions.

The tires have undergone extensive testing to examine effects of vacuum exposure, temperature extremes, and cuts. They also have undergone leakage, side force, load, storage, and durability tests. The tires have qualified in all these areas.

To date, tests using the simulated Kennedy runway at Langley indicate that spinup wear by itself will not lead to tire failure. Tests using the Kennedy test surface do indicate that spinup wear is worse if the tire is subjected to crosswind. For this reason, the crosswind allowable for normal landings is limited to 10 knots. This restriction also permits a safe stop if the nosewheel steering system fails. The limitation is being reviewed to see if it is too high for abort landings involving nosewheel steering failure. Testing has not been conducted to ensure that excessive crosswind wear will not be a hazard when landing on the various hard surface runways with maximum crosswinds and failed nosewheel steering.

Main tire loads are increased substantially after nosewheel touchdown because of the large downward wing force at its negative angle of attack. The total force on each side can be nearly 200,000 pounds, which exceeds the capability of a single tire. In fact, the touchdown loads alone can exceed the load bearing ability of a single tire. The obvious result is that if a single tire fails before nosegear touchdown, the vehicle will have serious if not catastrophic directional control problems following the expected failure of the ad-



jacent tire. This failure case has led to a Criticality 1 rating on the tires. Before nosegear touchdown, control is maintained through the rudder. However, it loses effectiveness as the speedbrake is opened and the vehicle decelerates. After nosegear touchdown, simulations have shown that directional control is possible using the nosewheel steering system for most subsequent failures, but not for some cases in which crosswinds exceed the current flight rule limits. Because of the consequences of this failure, crew members strongly recommend that the nosewheel steering system be modified to achieve full redundancy.

Tire side loads have been difficult to measure and subsequently model because of test facility limitations. Two mathematical models were developed from early dynamometer tests and extrapolation from nosewheel tire tests. New dynamic tests of main gear tires show a more flexible side response, which has been incorporated into the latest mathematical model. A reasonably accurate model is required both for nosewheel steering engineering studies and for crew training simulators.

The Orbiter tire in use meets specifications and has been certified through testing. However, testing has not reproduced results observed on Kennedy runways. To date, the only blown tire has been caused by a brake lockup and the resulting skid wear.

Several improvements have been considered to increase protection against the high-speed blown-tire case. One would add a skid at the bottom of the main gear strut to take the peak load during nosegear touchdown; another would add a roll-on-rim capability to the main gear wheel. None of the possible improvements has been funded, however, nor has any been seriously studied.

In summary, two blown tires before nosegear touchdown would likely be catastrophic, and the potential for that occurrence should be minimized. NASA has directed testing in the fall of 1986 to examine actual tire, wheel, and strut failures to better understand this failure case.

### **Orbiter Brakes**

The Orbiter brake design chosen in 1973 was based on the Orbiter's design weight. It used beryllium rotors and stators with carbon lining. However, as the actual Orbiter weight grew, the

response from the Shuttle program management was not a redesign of the brakes, but an extension of required runway length from 10,000 to 12,500 feet. Thus, the brakes for many years have been known to have little or no margin, even if they performed as originally designed.

There are four brake assemblies, one for each main landing gear wheel. Each assembly uses four rotors and three stators, the stators being attached to a torque tube. Carbon pads are attached to provide the friction surface. The Orbiter brakes were designed to absorb 36.5 million foot-pounds of energy for normal stops and 55.5 million foot-pounds of energy for one emergency stop. The brakes were tested and qualified using standard dynamometer tests.

Actual flight experience has shown brake damage on most flights. The damage is classified by cause as either dynamic or thermal. The dynamic damage is usually characterized by damage to rotors and carbon lining chipping, plus beryllium and pad retainer cracks. On the other hand, the thermal damage has been due to heating of the stator caused by energy absorption during braking. The beryllium becomes ductile and has a much reduced yield strength at temperatures possible during braking. Both types of damage are typical of early brake development problems experienced in the aviation industry.

Brake damage has required that special crew procedures be developed to assure successful braking. To minimize dynamic damage and to keep any loose parts together, the crews are told to hold the brakes on constantly from the time of first application until their speed slows to about 40 knots. For a normal landing, braking is initiated at about 130 knots. For abort landings, braking would be initiated at about 150 knots. Braking speeds are established to avoid exceeding the temperature limits of the stator. The earlier the brakes are applied, the higher the heat rate. The longer the brakes are applied, the higher the temperature will be, no matter what the heat rate. To minimize problems, the commander must get the brake energy into the brakes at just the right rate and just the right time — before the beryllium yields and causes a low-speed wheel lockup.

At a Commission hearing on April 3, 1986, Astronaut John Young described the problem the Shuttle commander has with the system:

"It is very difficult to use precisely right now. In fact, we're finding out we don't real-

ly have a good technique for applying the brakes. . . . We don't believe that astronauts or pilots should be able to break the brakes." <sup>10</sup>

Missions 5, 51-D and 61-C had forms of thermal stator damage. The mission 51-D case resulted in a low-speed wheel lockup and a subsequent blown tire at Kennedy. The mission 61-C case did not progress to a lockup but came very close. The amount of brake energy that can be obtained using normal braking procedures is about 40 million foot-pounds before the first stator fails. The mission 61-C damage occurred at 34 million foot-pounds but had not progressed to the lockup condition. Inspection of failed stators clearly shows the ductile failure response of the beryllium, and, hence, it appears that this failure mechanism cannot contribute to a high-speed lockup and subsequent tire failure. It should be noted that the brake specification called for a maximum energy of 55 million foot-pounds. Qualification testing of the abort braking profile showed that 55 million foot-pounds was the point of first stator failure. During qualification tests, the brakes continued to operate until all stators failed, providing about another 5 million foot-pounds of energy. Based upon the thermal response of beryllium under load, it appears that the early heavy braking required for transatlantic abort landings produces more than the 40 million foot-pounds that have resulted in thermal failure of the brakes during the normal braking profile. No numbers are certain, however, and clearly the qualification testing did not point out the current thermal problems.

The assumed normal and abort brake energy limits for the current design should be reinvestigated. The 61-C damage resulted from only 34 million foot-pounds of energy. If this same brake design is to continue to fly, the mission 61-C damage should be fully understood, and destructive testing should be accomplished to establish the short runway (transatlantic abort landing) brake limit and appropriate abort landing planning factors.

NASA is considering stator improvements, including steel or thicker beryllium stators, and has undertaken a carbon brake program that would provide a major margin improvement and less dynamic damage because of fewer parts. Additional testing is currently underway, and more is planned, to evaluate these brake modifications

and to perform destructive testing. The testing results are expected to conform more closely to flight conditions because landing gear dynamics have been included. Early tests have confirmed the energy levels for the abort braking profile with a modified brake, and future tests may provide confidence in the normal braking profile.

The Aerospace Safety Advisory Panel recognized NASA's efforts in its 1985 Annual Report:

"A carbon brake review was conducted by NASA in early December, 1985, and resulted in agreement to procure a carbon brake system for the Orbiter. . . . There is concern by the STS [Space Transportation System] management about the availability of resources to support the development of the carbon brakes given the many competing requirements and the projected constrained budget during the 1986 period. The program management considers the development of the carbon brake system to be of the highest priority . . . and the Panel supports this position as it has in the past." <sup>11</sup>

Because of the brake problems encountered in the program, two reviews have been conducted by NASA. The third review will take place during the summer of 1986. The review board members have studied all of the Orbiter brake data and have compared Orbiter problems to industry problems. Improvements suggested have been implemented. It is the consensus of NASA and industry experts that high priority should be placed on correcting Orbiter brake problems, and that brake redesign should proceed with emphasis on developing higher energy and torque capacity.

Concern within the program about the entire deceleration system (landing gear, wheels, tires, brakes and nosewheel steering) has been the subject of numerous reviews, meetings and design efforts. These concerns continued to be expressed by the Aerospace Safety Advisory Panel in 1982:

"Studies of Shuttle landings to date show that tire, wheel and brake stresses are approaching limits." <sup>12</sup>

"Short runways, with inadequate overruns, are cause for concern, for instance, a transatlantic abort to Dakar." <sup>13</sup>

The issues are difficult, and the required technology is challenging, but most agree that it is appropriate and important that NASA resolve

each of these problems. A conservative approach to the landing phase of flight demands reliable performance by all critical systems.

### Kennedy Space Center Landings

The original Space Shuttle plan called for routine landings at Kennedy to minimize turnaround time and cost per flight and to provide an efficient operation for both the Shuttle system and the cargo elements. While those considerations remain important, other concerns, such as the performance of the Orbiter tires and brakes, and the difficulty of accurate weather prediction in Florida, have called the plan into question.

When the Shuttle lands at Edwards Air Force Base, California, approximately six days are added to the turnaround time compared with a landing at Kennedy. That is the time required to load the Orbiter atop the Shuttle carrier aircraft, a specially modified Boeing 747, and to ferry it back to Florida for processing.

Returning the Orbiter to Kennedy from Edwards costs not only time but also money: nearly \$1,000,000, not including the cost of additional ground support equipment, extra security and other support requirements. Further, the people necessary to accomplish the turnaround tasks must be drawn from the staffs at Kennedy and Vandenberg Air Force Base, California. They are the same people needed for the preparation for subsequent flights.

Returning the Orbiter also imposes an additional handling risk to the vehicle in both the loading operation and the ferry flight itself. Encountering light precipitation during the ferry flight has caused substantial damage to the Orbiter thermal protection system. These costs and risks, however, are minimal when compared with those of a Space Shuttle mission.

The Kennedy runway was built to Space Shuttle design requirements that exceeded all Federal Aviation Administration requirements and was coordinated extensively with the Air Force, Dryden Flight Research Center, NASA Headquarters, Johnson, Kennedy, Marshall and the Army Corps of Engineers. The result is a single concrete runway, 15,000 feet long and 300 feet wide. The grooved and coarse brushed surface and the high coefficient of friction provide an all-weather landing facility.

The Kennedy runway easily meets the intent of most of the Air Force, Federal Aviation Ad-

ministration and International Civil Aviation Organization specification requirements. According to NASA, it was the best runway that the world knew how to build when the final design was determined in 1973.

In the past several years, questions about weather predictability and Shuttle systems performance have influenced the Kennedy landing issue. Experience gained in the 24 Shuttle landings has raised concerns about the adequacy of the Shuttle landing and rollout systems: tires, brakes and nosewheel steering. Tires and brakes have been discussed earlier. The tires have shown excessive wear after Kennedy landings, where the rough runway is particularly hard on tires. Tire wear became a serious concern after the landing of mission 51-D at Kennedy. Spinup wear was three cords deep, crosswind wear (in only an 8-knot crosswind) was significant and one tire eventually failed as a result of brake lock-up and skid.

This excessive wear, coupled with brake failure, led NASA to schedule subsequent landings at Edwards while attempting to solve these problems. At the Commission hearing on April 3, 1986, Clifford Charlesworth, director of Space Operations at Johnson, stated his reaction to the blown-tire incident:

“Let me say that following 51-D . . . one of the first things I did was go talk to then program manager, Mr. Lunney, and say we don't want to try that again until we understand that, which he completely agreed with, and we launched into this nosewheel steering development.”<sup>14</sup>

There followed minor improvements to the braking system. The nosewheel steering system was also improved, so that it, rather than differential braking, could be used for directional control to reduce tire wear.

These improvements were made before mission 61-C, and it was deemed safe for that mission and subsequent missions to land at Kennedy. Bad weather in Florida required that 61-C land at Edwards. There were again problems with the brakes, indicating that the Shuttle braking system was still suspect. Mr. Charlesworth provided this assessment to the Commission:

“Given the problem that has come up now with the brakes, I think that whole question still needs some more work before I would

be satisfied that yes, we should go back and try to land at the Cape.”<sup>15</sup>

The nosewheel steering, regarded as fail-safe, might better be described as fail-passive: at worst, a single failure will cause the nosewheel to castor. Thus, a single failure in nosewheel steering, coupled with failure conditions that require its use, could result in departure from the runway. There is a long-range program to improve the nosewheel steering so that a single failure will leave the system operational.

Eight flights have been launched with plans to land in Florida. Of those, three have been diverted to California because of bad weather. Moreover, it is indicative of the dynamic weather environment in Florida that twice in the program's history flights have been waved off for one orbit to allow for weather conditions to improve enough to be acceptable for landing. Thus, even if NASA eventually were to resume routine operations at Kennedy, experience indicates the Orbiter will divert into Edwards more than 30 percent of the time. NASA must therefore plan to use Edwards routinely. This requires reserving six days in the post-landing processing schedule for the Orbiter's ferry trip back to Florida. It also requires redundancy in the ferry aircraft. The single Shuttle carrier aircraft, with some one-of-a-kind support items, is presently the only way to get the Orbiter from California back to its launch site in Florida.

### Landing Site Changes

Mission	Wave-offs	Reason	Scheduled Landing	Actual Landing
STS-3	1	Flooding	Edwards	Northrup Strip, (New Mexico)
STS-7	2	Rain/ceiling	Kennedy	Edwards
STS 41-C	1	Rain/ceiling	Kennedy	Edwards
STS 61-C	5	Rain/ceiling	Kennedy	Edwards

The most serious concern is not that the weather in Florida is bad, but that the atmospheric conditions are frequently unpredictable. Captain Robert Crippen testified before the Commission on April 3, 1986:

“I don't think the astronaut office would disagree with the premise that you are much safer landing at Edwards. There are some things you could do, as was indicated, to make Kennedy better, but you're never

going to overcome the weather unpredictability.”<sup>16</sup>

Once the Shuttle performs the deorbit burn, it is going to land approximately 60 minutes later; there is no way to return to orbit, and there is no option to select another landing site. This means that the weather forecaster must analyze the landing site weather nearly one and one-half hours in advance of landing, and that the forecast must be accurate. Unfortunately, the Florida weather is particularly difficult to forecast at certain times of the year. In the spring and summer, thunderstorms build and dissipate quickly and unpredictably. Early morning fog also is very difficult to predict if the forecast must be made in the hour before sunrise.

In contrast, the stable weather patterns at Edwards make the forecaster's job much easier.

Although NASA has a conservative philosophy, and applies conservative flight rules in evaluating end-of-mission weather, the decision always comes down to evaluating a weather forecast. There is a risk associated with that. If the program requirements put forecasters in the position of predicting weather when weather is unpredictable, it is only a matter of time before the crew is allowed to leave orbit and arrive in Florida to find thunderstorms or rapidly forming ground fog. Either could be disastrous.

The weather at Edwards, of course, is not always acceptable for landing either. In fact, only days prior to the launch of STS-3, NASA was forced to shift the normal landing site from Edwards to Northrup Strip, New Mexico, because of flooding of the Edwards lakebed. This points out the need to support fully both Kennedy and Edwards as potential end-of-mission landing sites.

In summary, although there are valid programmatic reasons to land routinely at Kennedy, there are concerns that suggest that this is not wise under the present circumstances. While planned landings at Edwards carry a cost in dollars and days, the realities of weather cannot be ignored. Shuttle program officials must recognize that Edwards is a permanent, essential part of the program. The cost associated with regular, scheduled landing and turnaround operations at Edwards is thus a necessary program cost.

Decisions governing Space Shuttle operations must be consistent with the philosophy that unnecessary risks have to be eliminated. Such deci-

sions cannot be made without a clear understanding of margins of safety in each part of the system.

Unfortunately, margins of safety cannot be assured if performance characteristics are not thoroughly understood, nor can they be deduced from a previous flight's "success."

The Shuttle Program cannot afford to operate outside its experience in the areas of tires, brakes, and weather, with the capabilities of the system today. Pending a clear understanding of all landing and deceleration systems, and a resolution of the problems encountered to date in Shuttle landings, the most conservative course must be followed in order to minimize risk during this dynamic phase of flight.

## Shuttle Elements

The Space Shuttle Main Engine teams at Marshall and Rocketdyne have developed engines that have achieved their performance goals and have performed extremely well. Nevertheless the main engines continue to be highly complex and critical components of the Shuttle that involve an element of risk principally because important components of the engines degrade more rapidly with flight use than anticipated. Both NASA and Rocketdyne have taken steps to contain that risk. An important aspect of the main engine program has been the extensive "hot fire" ground tests. Unfortunately, the vitality of the test program has been reduced because of budgetary constraints.

The ability of the engine to achieve its programmed design life is verified by two test engines. These "fleet leader" engines are test fired with sufficient frequency that they have twice as much operational experience as any flight engine. Fleet leader tests have demonstrated that most engine components have an equivalent 40-flight service life. As part of the engine test program, major components are inspected periodically and replaced if wear or damage warrants. Fleet leader tests have established that the low-pressure fuel turbopump and the low-pressure oxidizer pump have lives limited to the equivalent of 28 and 22 flights, respectively. The high-pressure fuel turbopump is limited to six flights before overhaul; the high-pressure oxidizer pump is limited to less than six flights.<sup>17</sup> An active program of flight engine inspection and component replacement has been effectively implemented by

Rocketdyne, based on the results of the fleet leader engine test program.

The life-limiting items on the high-pressure pumps are the turbine blades, impellers, seals and bearings. Rocketdyne has identified cracked turbine blades in the high-pressure pumps as a primary concern. The contractor has been working to improve the pumps' reliability by increasing bearing and turbine blade life and improving dynamic stability. While considerable progress has been made, the desired level of turbine blade life has not yet been achieved. A number of improvements achieved as a result of the fleet leader program are now ready for incorporation in the Space Shuttle Main Engines used in future flights, but have not been implemented due to fiscal constraints.<sup>18</sup> Immediate implementation of these improvements would allow incorporation before the next Shuttle flight.

The number of engine test firings per month has decreased over the past two years. Yet this test program has not yet demonstrated the limits of engine operation parameters or included tests over the full operating envelope to show full engine capability. In addition, tests have not yet been deliberately conducted to the point of failure to determine actual engine operating margins.

The Orbiter has also performed well. There is, however, one serious potential failure mode related to the disconnect valves between the Orbiter and the External Tank. The present design includes two 17-inch diameter valves, one controlling the oxygen flow, and the other the hydrogen flow from the tank to the Orbiter's three engines. Each of the disconnect valves has two flappers that close off the flow of the liquid hydrogen and oxygen when the External Tank separates from the Orbiter. An inadvertent closure by any of the four flappers during normal engine operation would cause a catastrophe due to rupture of the supply line and/or tank. New designs are under study, incorporating modifications to prevent inadvertent valve closures. Redesigned valves could be qualified, certified and available for use on the Shuttle's next flight.

While the External Tank has performed flawlessly during all Shuttle flights, one area of concern pertains to the indicators for the two valves which vent the liquid hydrogen and liquid oxygen. These valves can indicate they are closed when they might be partially open. This condi-

tion is potentially hazardous, since leaks of either gaseous oxygen or hydrogen prior to launch, or in flight, could lead to fires. This could, in turn, lead to catastrophic failure of the External Tank. NASA is currently studying design modifications to the valve position indicators. This effort could be expedited and the redesigned indicators installed before the next flight of the Shuttle.

## **Processing and Assembly**

During the processing and assembly of the elements of flight 51-L, various problems were seen in the Commission's review which could bear on the safety of future flights.

### **Structural Inspections**

During the 51-L processing, waivers were granted on 60 of 146 required Orbiter structural inspections. Seven of these waivers were second-time waivers of inspections.

A formal structural inspection plan for the Shuttle fleet had not been fully developed, and not all of the 146 inspections had been scheduled for the 51-L processing. In order to minimize the flight delay until the implementation plan could be fully developed, the waivers were documented, requested and granted by Level II at Johnson.

The structural inspection requirements are relatively new and not completely mature. A working group was formed in December 1985, to expedite a structural inspection plan. A plan now exists for future structural inspections. The Commission believes that these inspections should not be waived. The fleet of Orbiters has no counterpart anywhere in the world. There is no data base relative to reusable spacecraft. The Orbiter's operating environment is totally different from that of airliners, and the program must closely track the effects of the Orbiters' age and use.<sup>19</sup>

### **Records**

Throughout the Commission's review of the accident, a large number of errors were noted in the paperwork for the Space Shuttle Main Engine/Main Propulsion System and for the Orbiter. The review showed, however, that in the vast majority of cases the problem lay in the documentation itself and not in the work that was actually accomplished. The review led the Commission to conclude that the Operations and

Maintenance Instructions are in need of an overall review and update, and the performance of Operations and Maintenance Instructions needs to be improved.

### **Missed Requirements**

At the time of launch, all items called for by the Operational Maintenance Requirements and Specifications Document were to have been met, waived or excepted. The 51-L audit review has revealed additional areas where such requirements were not met and were not formally waived or excepted:

1. A formal post-flight inspection of the forward External Tank attach plate was not documented.
2. A forward avionics bay closeout panel was not verified as installed during Orbiter rollover/stacking operations (the area was properly configured prior to flight with installation of a locker).
3. Flight 51-L was launched with only one of two crew hatch microswitches showing the proper indication. This condition was documented by a Problem Report and was deferred; no waiver was obtained, however.
4. Post-flight hydraulic reservoir sampling was not performed prior to connection of ground hydraulic support equipment at Dryden Flight Research Facility, but was performed in the Orbiter Processing Facility.
5. During Auxiliary Power Unit hypergolic loading operations, the Number 2 tank evacuation prior to loading was not maintained above 20 inches of mercury for five minutes as required (19.8 inches maintained for 2 hours). This incident was documented as an acceptable condition by Kennedy, Johnson and Launch Support Service, but no waiver was submitted.
6. Landing gear voids were not replenished and crew module meters were not verified during final vehicle closeouts. The additional requirement to replenish the landing gear voids during launch countdown was performed.<sup>20</sup>

### **Inspection by Proxy**

Another aspect of the processing activities that warrants particular attention is the Shuttle Processing Contractor's policy of using "designated



verifiers" to supplement the quality assurance force. A designated verifier is a senior technician who is authorized to inspect and approve his own and his fellow technicians' work in specific non-flight areas, instead of NASA quality assurance personnel inspecting the work. The aviation industry follows this practice in performing verifications for the Federal Aviation Administration. The Shuttle Processing Contractor has about 770 designated verifiers (nearly 15% of the work force).<sup>21</sup> The NASA quality assurance inspection program no longer covers 100 percent of the inspection areas. Due to reduced manpower, NASA personnel now inspect only areas that are considered more critical. Thus the system of independent checks that NASA maintained through several programs is declining in effectiveness. The effect of this change requires careful evaluation by NASA.

### **Accidental Damage Reporting**

While not specifically related to the Challenger accident, a serious problem was identified during interviews of technicians who work on the Orbiter. It had been their understanding at one time that employees would not be disciplined for accidental damage done to the Orbiter, provided the damage was fully reported when it occurred. It was their opinion that this forgiveness policy was no longer being followed by the Shuttle Processing Contractor. They cited examples of employees being punished after acknowledging they had accidentally caused damage. The technicians said that accidental damage is not consistently reported, when it occurs, because of lack of confidence in management's forgiveness policy and technicians' consequent fear of losing their jobs. This situation has obvious severe implications if left uncorrected.

### **Launch Pad 39B**

All launch damage and launch measurement data from Pad B ground systems anomalies were considered to be normal or minor with three exceptions: the loss of the springs and plungers on the booster hold-down posts; the failure of the gaseous hydrogen vent arm to latch; and the loss of bricks from the flame trench. These three items are treated in Appendix I, the NASA Pre-Launch Activities Team Report (May, 1986). None contributed to the accident.

Loss of bricks from the flame trench was also experienced during the launch of STS-1 (April, 1981) and STS-2 (November, 1981) from Pad A, though at locations closer to the centerline of the vehicle. Since the brick was blown out of the flame trench and away from the vehicle, there is no evidence to indicate that the loose brick might have endangered the 51-L vehicle, but it may be possible for damage to occur if the condition remains uncorrected. The Pad B fire brick is to be replaced by refractory concrete, as was done on Pad A.

## **Involvement of Development Contractors**

---

The Space Shuttle program, like its predecessors Mercury, Gemini, Apollo, Skylab and Apollo-Soyuz, is clearly a developmental program and must be treated as such by NASA. Indeed, the chief differences between the Shuttle and previous developmental programs are that the Shuttle is principally a transportation system and employs reusable hardware. Reusability implies a new set of functions such as logistics support, maintenance, refurbishment, lifetime concerns and structural inspections that must be addressed by the program.

In order to enhance post-flight "turnaround" schedule and efficiency, NASA is striving to implement processing procedures accepted by the transportation industry. While this effort is useful, there is not an exact industry analogy to the Orbiter vehicles' flight operations, because each successive Shuttle mission expands system and performance requirements. Consequently, the Shuttle configuration is evolving as design changes and improvements are incorporated. The demands of individual payloads can cause significant additional developmental changes.

These developmental aspects make significant demands, which can be met only by the following strategies:

1. Maintain a significant engineering design and development capability among the Shuttle contractors and an ongoing engineering capability within NASA.
2. Maintain an active analytical capability so that the evolving capabilities of the



Shuttle can be matched to the demands on the Shuttle.

The Shuttle's developmental status demands that both NASA and all its contractors maintain a high level of in-house experience and technical ability.

All Shuttle contractors and their corresponding NASA project organizations expressed concern about the organization of contractor services. When Shuttle operations were begun, the prime development contractors had total responsibility for all Shuttle activities. The concept of a single Shuttle Processing Prime Contractor was adopted as NASA policy in 1981, and implemented in 1983 when a team led by Lockheed Space Operations was selected. The Lockheed team includes Lockheed Missiles & Space Company, responsible for processing the Orbiter; Grumman Aerospace Corporation, responsible for operation and maintenance of the launch processing system; Pan American World Airways, charged with introducing and maintaining airline methods and techniques in the processing system; Morton Thiokol, Inc., responsible for processing the Solid Rocket Boosters and External Tank; and Rocketdyne, responsible for processing the Shuttle main engines.

Lockheed's performance as Shuttle Processing Contractor is judged on the basis of a NASA grading system using agreed criteria. In September, 1984, the company was marked down for failure to form a coordinated contractor team. As a result of that grading, Lockheed earned for that period an award fee of about one-quarter of one percent of cost, on a maximum fee scale at that time of one percent of cost. Lockheed reviewed the findings of NASA's grading and did not quarrel with its major thrust.

The award fee presently is a composite of incentives to be earned on mission success and cost control. It can vary along a scale of one to 14 percent of cost. The Shuttle Processing Contractor was earning, at the time of the Challenger accident, about six percent of cost, or nearly mid-point on the scale.

Although the performance of the Shuttle Processing Contractor's team has improved considerably, serious processing problems have occurred, especially with respect to the Orbiter. An example is provided by the handling of the critical 17-inch disconnect valves during the 51-L flight preparations.

During External Tank propellant loading in preparation for launch, the liquid hydrogen 17-inch disconnect valve was opened prior to reducing the pressure in the Orbiter liquid hydrogen manifold, through a procedural error by the console operator. The valve was opened with a six pounds per square inch differential. This was contrary to the critical requirement that the differential be no greater than one pound per square inch. This pressure held the valve closed for approximately 18 seconds before it finally slammed open abruptly. These valves are extremely critical and have very stringent tolerances to preclude inadvertent closure of the valve during mainstage thrusting. Accidental closing of a disconnect valve would mean catastrophic loss of Orbiter and crew. The slamming of this valve (which could have damaged it) was not reported by the operator and was not discovered until the post-accident data review. Although this incident did not contribute to the 51-L incident, this type of error cannot be tolerated in future operations, and a policy of rigorous reporting of anomalies in processing must be strictly enforced.

During the pre-launch processing and post-flight refurbishment of the Orbiter, Rockwell—the development contractor—acts largely as an adviser to the Shuttle Processing Contractor. Martin Marietta has a similar role regarding the pre-launch processing of the External Tank. In contrast, NASA directed the Shuttle Processing Contractor to subcontract with Rocketdyne and Thiokol for the processing and refurbishment of the main engines and the Solid Rocket Motors, respectively. If Rockwell and Martin Marietta, as the development contractor, had a similar direct involvement with their elements of the Shuttle system, the likelihood of difficulties caused by improper processing would probably be decreased. Furthermore, all Shuttle elements would benefit from the advantages of beginning-to-end responsibility vested in individual contractors, each responsible for the design, development, manufacturing, operation, and refurbishment of their respective Shuttle elements.

## References

---

- <sup>1</sup> Letter from Gerald D. Griffin. LO-82-90. September 9, 1982.
- <sup>2</sup> NASA Memo. April 14, 1986, PC 076109-076113.
- <sup>3</sup> Commission Hearing Transcript. April 3, 1986. pages 2439-2440.
- <sup>4</sup> Commission Work Session. Mission Planning and Operations Panel. April 14, 1986. JSC, page 138.
- <sup>5</sup> Commission Hearing Transcript, April 3, 1986, pages 2436-2437.
- <sup>6</sup> Page 28.
- <sup>7</sup> Commission Hearing Transcript, April 3, 1986, page 2429.
- <sup>8</sup> Visual Aid. Range Safety Officer Statement, Commission Work Session. March 24, 1986. JSC, PC 02267-02268.
- <sup>9</sup> Page 15.
- <sup>10</sup> Commission Hearing Transcript. April 3, 1986, page 2474.
- <sup>11</sup> Page 41.
- <sup>12</sup> Pages 7-8.
- <sup>13</sup> Page 8.
- <sup>14</sup> Commission Hearing Transcript. April 3, 1986. page 2554.
- <sup>15</sup> Commission Hearing Transcript. April 3, 1986. page 2555.
- <sup>16</sup> Commission Hearing Transcript. April 13, 1986, page 2485.
- <sup>17</sup> Rocketdyne Report, BC 86-38. President Comments on the Space Shuttle Challenger Accident Development and Production Panel. April 2, 1986, pages 170, 171, 260-268.
- <sup>18</sup> Rocketdyne Report. BC 86-38, pages 315-324.
- <sup>19</sup> NASA Pre-Launch Activities Team Report, Appendix D, page 188.
- <sup>20</sup> NASA Pre-Launch Activities Team Report, Appendix D, page 186.
- <sup>21</sup> Commission Work Session, Pre-Launch. March 4, 1986, page 206.

---

# Recommendations

---

**T**he Commission has conducted an extensive investigation of the Challenger accident to determine the probable cause and necessary corrective actions. Based on the findings and determinations of its investigation, the Commission has unanimously adopted recommendations to help assure the return to safe flight.

The Commission urges that the Administrator of NASA submit, one year from now, a report to the President on the progress that NASA has made in effecting the Commission's recommendations set forth below:

---

## — I —

**Design.** The faulty Solid Rocket Motor joint and seal must be changed. This could be a new design eliminating the joint or a redesign of the current joint and seal. No design options should be prematurely precluded because of schedule, cost or reliance on existing hardware. All Solid Rocket Motor joints should satisfy the following requirements:

- The joints should be fully understood, tested and verified.
- The integrity of the structure and of the seals of all joints should be not less than that of the case walls throughout the design envelope.
- The integrity of the joints should be insensitive to:
  - Dimensional tolerances.
  - Transportation and handling.
  - Assembly procedures.
  - Inspection and test procedures.
  - Environmental effects.
  - Internal case operating pressure.
  - Recovery and reuse effects.
  - Flight and water impact loads.

- The certification of the new design should include:
  - Tests which duplicate the actual launch configuration as closely as possible.
  - Tests over the full range of operating conditions, including temperature.

- Full consideration should be given to conducting static firings of the exact flight configuration in a vertical attitude.

**Independent Oversight.** The Administrator of NASA should request the National Research Council to form an independent Solid Rocket Motor design oversight committee to implement the Commission's design recommendations and oversee the design effort. This committee should:

- Review and evaluate certification requirements.
- Provide technical oversight of the design, test program and certification.
- Report to the Administrator of NASA on the adequacy of the design and make appropriate recommendations.

## — II —

**Shuttle Management Structure.** The Shuttle Program Structure should be reviewed. The project managers for the various elements of the Shuttle program felt more accountable to their center management than to the Shuttle program organization. Shuttle element funding, work package definition, and vital program information frequently bypass the National STS (Shuttle) Program Manager.

A redefinition of the Program Manager's responsibility is essential. This redefinition should give the Program Manager the requisite authority for all ongoing STS operations. Program funding and all Shuttle Program work at the centers should be placed clearly under the Program Manager's authority.

**Astronauts in Management.** The Commission observes that there appears to be a departure from the philosophy of the 1960s and 1970s relating

to the use of astronauts in management positions. These individuals brought to their positions flight experience and a keen appreciation of operations and flight safety.

- NASA should encourage the transition of qualified astronauts into agency management positions.
- The function of the Flight Crew Operations director should be elevated in the NASA organization structure.

**Shuttle Safety Panel.** NASA should establish an STS Safety Advisory Panel reporting to the STS Program Manager. The charter of this panel should include Shuttle operational issues, launch commit criteria, flight rules, flight readiness and risk management. The panel should include representation from the safety organization, mission operations, and the astronaut office.

## — III —

**Criticality Review and Hazard Analysis.** NASA and the primary Shuttle contractors should review all Criticality 1, 1R, 2, and 2R items and hazard analyses. This review should identify those items that must be improved prior

to flight to ensure mission success and flight safety. An Audit Panel, appointed by the National Research Council, should verify the adequacy of the effort and report directly to the Administrator of NASA.

## — IV —

**Safety Organization.** NASA should establish an Office of Safety, Reliability and Quality Assurance to be headed by an Associate Administrator, reporting directly to the NASA Administrator. It would have direct authority for safety, reliability, and quality assurance throughout the agency. The office should be assigned the work force to ensure adequate oversight of its functions and should be independent of other NASA functional and program responsibilities.

The responsibilities of this office should include:

- The safety, reliability and quality assurance functions as they relate to all NASA activities and programs.
- Direction of reporting and documentation of problems, problem resolution and trends associated with flight safety.

---

— V —

**Improved Communications.** The Commission found that Marshall Space Flight Center project managers, because of a tendency at Marshall to management isolation, failed to provide full and timely information bearing on the safety of flight 51-L to other vital elements of Shuttle program management.

■ NASA should take energetic steps to eliminate this tendency at Marshall Space Flight Center, whether by changes of personnel, organization, indoctrination or all three.

■ A policy should be developed which governs the imposition and removal of Shuttle launch constraints.

■ Flight Readiness Reviews and Mission Management Team meetings should be recorded.

■ The flight crew commander, or a designated representative, should attend the Flight Readiness Review, participate in acceptance of the vehicle for flight, and certify that the crew is properly prepared for flight.

---

— VI —

**Landing Safety.** NASA must take actions to improve landing safety.

■ The tire, brake and nosewheel steering systems must be improved. These systems do not have sufficient safety margin, particularly at abort landing sites.

■ The specific conditions under which planned landings at Kennedy would be acceptable should be determined. Criteria must be established for tires, brakes and nosewheel steering. Until the systems meet those criteria in high fidelity testing that is verified at Edwards, landing at Kennedy should not be planned.

■ Committing to a specific landing site requires that landing area weather be forecast more than an hour in advance. During unpredictable weather periods at Kennedy, program officials should plan on Edwards landings. Increased landings at Edwards may necessitate a dual ferry capability.

---

— VII —

**Launch Abort and Crew Escape.** The Shuttle program management considered first-stage abort options and crew escape options several times during the history of the program, but because of limited utility, technical infeasibility, or program cost and schedule, no systems were implemented. The Commission recommends that NASA:

■ Make all efforts to provide a crew escape system for use during controlled gliding flight.

■ Make every effort to increase the range of flight conditions under which an emergency runway landing can be successfully conducted in the event that two or three main engines fail early in ascent.

## — VIII —

**Flight Rate.** The nation's reliance on the Shuttle as its principal space launch capability created a relentless pressure on NASA to increase the flight rate. Such reliance on a single launch capability should be avoided in the future.

NASA must establish a flight rate that is consistent with its resources. A firm payload assignment policy should be established. The policy should include rigorous controls on cargo manifest changes to limit the pressures such changes exert on schedules and crew training.

---

## — IX —

**Maintenance Safeguards.** Installation, test, and maintenance procedures must be especially rigorous for Space Shuttle items designated Criticality 1. NASA should establish a system of analyzing and reporting performance trends of such items.

Maintenance procedures for such items should be specified in the Critical Items List, especially for those such as the liquid-fueled main engines, which require unstinting maintenance and overhaul.

With regard to the Orbiters, NASA should:

- Develop and execute a comprehensive maintenance inspection plan.
- Perform periodic structural inspections when scheduled and not permit them to be waived.
- Restore and support the maintenance and spare parts programs, and stop the practice of removing parts from one Orbiter to supply another.

---

### Concluding Thought

*The Commission urges that NASA continue to receive the support of the Administration and the nation. The agency constitutes a national resource that plays a critical role in space exploration and development. It also provides a symbol of national pride and technological leadership.*

*The Commission applauds NASA's spectacular achievements of the past and anticipates impressive achievements to come. The findings and recommendations presented in this report are intended to contribute to the future NASA successes that the nation both expects and requires as the 21st century approaches. ■*

## Presidential Commission on the Space Shuttle Challenger Accident

### **William P. Rogers, Chairman**

Former Secretary of State under President Nixon (1969-1973), and Attorney General under President Eisenhower (1957-1961), currently a practicing attorney and senior partner in the law firm of Rogers & Wells. Born in Norfolk, New York, he was awarded the Medal of Freedom in 1973. He holds a J.D. from Cornell University (1937) and served as LCDR, U.S. Navy (1942-1946).

### **Neil A. Armstrong, Vice Chairman**

Former astronaut, currently Chairman of the Board of Computing Technologies for Aviation, Inc. Born in Wapakoneta, Ohio, Mr. Armstrong was spacecraft commander for Apollo 11, July 16-24, 1969, the first manned lunar landing mission. He was Professor of Aeronautical Engineering at the University of Cincinnati from 1971 to 1980 and was appointed to the National Commission on Space in 1985.

### **David C. Acheson**

Former Senior Vice President and General Counsel, Communications Satellite Corporation (1967-1974), currently a partner in the law firm of Drinker Biddle & Reath. Born in Washington, DC, he previously served as an attorney with the U.S. Atomic Energy Commission (1948-1950) and was U.S. Attorney for the District of Columbia (1961-1965). He holds an LL.B. from Harvard University (1948) and served as LT, U.S. Navy (1942-1946).

### **Dr. Eugene E. Covert**

Educator and engineer. Born in Rapid City, South Dakota, he is currently Professor and

Head, Department of Aeronautics and Astronautics, at Massachusetts Institute of Technology. Member of the National Academy of Engineering, he was a recipient of the Exceptional Civilian Service Award, USAF, in 1973 and the NASA Public Service Award in 1980. He holds a Doctorate in Science from Massachusetts Institute of Technology.

### **Dr. Richard P. Feynman**

Physicist. Born in New York City, he is Professor of Theoretical Physics at California Institute of Technology. Nobel Prize winner in Physics, 1965, he also received the Einstein Award in 1954, the Oersted Medal in 1972 and the Niels Bohr International Gold Medal in 1973. He holds a Doctorate in Physics from Princeton (1942).

### **Robert B. Hotz**

Editor, publisher. Born in Milwaukee, Wisconsin. He is a graduate of Northwestern University. He was the editor-in-chief of *Aviation Week & Space Technology* magazine (1953-1980). He served in the Air Force in World War II and was awarded the Air Medal with Oak Leaf Cluster. Since 1982, he has been a member of the General Advisory Committee to the Arms Control and Disarmament Agency.

### **Major General Donald J. Kutyna, USAF**

Director of Space Systems and Command, Control, Communications. Born in Chicago, Illinois, and graduate of the U.S. Military Academy, he holds a Master of Science degree from Massachusetts Institute of Technology (1965). A command pilot with over 4,000 flight



hours, he is a recipient of the Distinguished Service Medal, Distinguished Flying Cross, Legion of Merit and nine air medals.

**Dr. Sally K. Ride**

Astronaut. Born in Los Angeles, California, she was a mission specialist on STS-7, launched on June 18, 1983, becoming the first American woman in space. She also flew on mission 41-G launched October 5, 1984. She holds a Doctorate in Physics from Stanford University (1978) and is still an active astronaut.

**Robert W. Rummel**

Space expert and aerospace engineer. Born in Dakota, Illinois, and former Vice President of Trans World Airlines, he is currently President of Robert W. Rummel Associates, Inc., of Mesa, Arizona. He is a member of the National Academy of Engineering and is holder of the NASA Distinguished Public Service Medal.

**Joseph F. Sutter**

Aeronautical engineer. Currently Executive Vice President of the Boeing Commercial Airplane Company. Born in Seattle, he has been with Boeing since 1945 and was a principal figure in the development of three generations of jet aircraft. In 1984, he was elected to the National Academy of Engineering. In 1985, President Reagan conferred on him the U.S. National Medal of Technology.

**Dr. Arthur B. C. Walker, Jr.**

Astronomer. Born in Cleveland, Ohio, he is currently Professor of Applied Physics and was formerly Associate Dean of the Graduate Divi-

sion at Stanford University. Consultant to Aerospace Corporation, Rand Corporation and the National Science Foundation, he is a member of the American Physical Society, American Geophysical Union, and the American Astronomy Society. He holds a Doctorate in Physics from the University of Illinois (1962).

**Dr. Albert D. Wheelon**

Physicist. Born in Moline, Illinois, he is currently Executive Vice President, Hughes Aircraft Company. Also a member of the President's Foreign Intelligence Advisory Board, he served as a consultant to the President's Science Advisory Council from 1961 to 1974. He holds a Doctorate in Physics from Massachusetts Institute of Technology (1952).

**Brigadier General Charles Yeager, USAF (Retired)**

Former experimental test pilot. Born in Myra, West Virginia, he was appointed in 1985 as a member of the National Commission on Space. He was the first person to penetrate the sound barrier and the first to fly at a speed of more than 1,600 miles an hour.

**Dr. Alton G. Keel, Jr., Executive Director**

Detailed to the Commission from his position in the Executive Office of the President, Office of Management and Budget, as Associate Director for National Security and International Affairs; formerly Assistant Secretary of the Air Force for Research, Development and Logistics; and Senate Staff. Born in Newport News, Virginia, he holds a Doctorate in Engineering Physics from the University of Virginia (1970).

---

## Presidential Commission Staff

---

Dr. Alton G. Keel, Jr. Thomas T. Reinhardt	Executive Director Executive Secretary	White House MAJ, USA/OMB
<b>Special Assistants</b> Marie C. Hunter	Executive Assistant to the Chairman	Rogers & Wells
M. M. Black	Personal Secretary to Vice Chairman & Executive Director	OMB
Mark D. Weinberg Herb Hetu John T. Shepherd	Media Relations Media Relations NASA Tasking Coordination.	White House Consultant CAPT, USN (Ret)/Atty.

## Administrative Staff

---

Stephen B. Hyle Patt Sullivan Marilyn Stumpf Joleen A. B. Bottalico Jane M. Green Lorraine K. Walton Vera A. Barnes Virginia A. James	Administrative Officer Administrative Assistant Travel Coordination Travel Coordination Secretary Secretary Secretary Receptionist	LTC, USAF NASA NASA NASA NASA NASA NASA Contract Support
--	---	---

## Investigative Staff

---

William G. Dupree	Investigator, Development and Production	DOD IG
John B. Hungerford, Jr.	Investigator, Development and Production	LTC, USAF
John P. Chase	Investigator, Pre-Launch Activities	MAJ, USMC/DOD IG
Brewster Shaw	Investigator, Pre-Launch Activities	LTC, USAF/NASA Astronaut
John C. Macidull	Investigator, Accident Analysis	FAA/CDR, USNR-R
Ron Waite	Investigator, Accident Analysis	Engineering Consultant
John Fabian	Investigator, Mission Planning and Operations	COL, USAF/Former Astronaut
Emily M. Trapnell	Coordinator, General Investigative Activities	FAA Atty.
Randy R. Kehrli E. Thomas Almon Patrick J. Maley John R. Molesworth, Jr. Robert C. Thompson Dr. R. Curtis Graeber Michael L. Marx	Evidence Analysis Investigator Investigator Investigator Investigator Human Factors Specialist Metallurgist	DOJ Atty. Special Agent, FBI Special Agent, FBI Special Agent, FBI Special Agent, FBI LTC, USA/NASA NTSB

---

**Writing Support**

---

Woods Hansen	Editor	Free Lance
James Haggerty	Writer	Free Lance
Anthony E. Hartle	Writer	COL, USA/USMA
William Bauman	Writer	CAPT, USAF/USAF
Frank Gillen	Word Processing Supervisor	Contract Support
Lawrence J. Herb	Art Layout	Free Lance
Willis Rickert	Printer	NASA
Lynne Komai	Design	Contract Support

---

**Documentation Support**

---

Clarisse Abramidis	Case Manager	DOJ
Fritz Geurtsen	Project Manager	DOJ
John Dunbar	Contract Representative	Contract Support
Valarie Lease	Support Center Supervisor	Contract Support
Stephen M. Croll	Correspondence Support	Contract Support

---

**Independent Test Observers**

---

Eugene G. Haberman	Rocket Propulsion Lab	USAF
Wilbur W. Wells	Rocket Propulsion Lab	USAF
Don E. Kennedy	TRW Ballistic Missile Office	Pro Bono
Laddie E. Dufka	Aerospace Corp	Pro Bono
Mohan Aswani	Aerospace Corp	Pro Bono
Michael L. Marx	Metallurgist	NTSB

## Commission Activities

### An Overview

President Reagan, seeking to ensure a thorough and unbiased investigation of the Challenger accident, announced the formation of the Commission on February 3, 1986. The mandate given by the President, contained in Executive Order 12546, required Commission members to:

- (1) Review the circumstances surrounding the accident to establish the probable cause or causes of the accident; and
- (2) Develop recommendations for corrective or other action based upon the Commission's findings and determinations.

Following their swearing in by Chairman Rogers on February 6th, Commission members immediately began a series of hearings during which NASA officials outlined agency procedures covering the Shuttle program and the status of NASA's investigation of the accident.

Shortly thereafter, on February 10th, Dr. Alton G. Keel, Jr., Associate Director of the Office of Management and Budget, was appointed Executive Director. Dr. Keel began gathering a staff of 15 experienced investigators from various government agencies and the military services, and administrative personnel to support Commission activities.

During a closed session on February 10, 1986, the Commission began to learn of the troubled history of the Solid Rocket Motor joint and seals. Moreover, it discovered the first indication that the contractor, Morton Thiokol, initially recommended against launch on January 27, 1986, the night before the launch of 51-L, because of con-

cerns regarding low temperature effects on the joint and seal. To investigate this disturbing development, additional closed sessions were scheduled for February 13th and 14th at Kennedy. The February 13, 1986, session was an extensive presentation of film, video and telemetry data relating to the Challenger accident. It provided the Commission the first evidence that the Solid Rocket Motor joint and seal may have malfunctioned, initiating the accident.

The session on February 14th included NASA and contractor participants involved in the discussion on January 27, 1986, not to launch 51-L. After testimony was received, an executive session of the Commission was convened. The following statement was subsequently issued by the Chairman on February 15, 1986, reflecting the conclusion and view of the Commission:

"In recent days, the Commission has been investigating all aspects of the decision making process leading up to the launch of the Challenger and has found that the process may have been flawed. The President has been so advised.

"Dr. William Graham, Acting Administrator of NASA, has been asked not to include on the internal investigating teams at NASA, persons involved in that process.

"The Commission will, of course, continue its investigation and will make a full report to the President within 120 days."

The role of the Commissioners thus changed from that of overseers to that of active investigators and analysts of data presented by NASA and its contractors.

The Commission itself divided into four investigative panels:

1. Development and Production, responsible for investigating the acquisition and test and evaluation processes for the Space Shuttle elements;
2. Pre-Launch Activities, responsible for assessing the Shuttle system processing, launch readiness process and pre-launch security;
3. Mission Planning and Operations, responsible for investigating mission planning and operations, schedule pressures and crew safety areas; and
4. Accident Analysis, charged with analyzing the accident data and developing both an anomaly tree and accident scenarios.

By February 17th, the panel organization had been finalized and, on February 18th, Chairman Rogers described the Commission's new approach before Congress. Working groups were sent to Marshall, Kennedy and Thiokol to analyze data relating to the accident and to redirect efforts. NASA's investigation was also reorganized to reflect the structure of the Commission's panels.

A series of public hearings were planned on February 25th, 26th and 27th to assure an orderly and fair presentation of all the facts that the Commission had discovered concerning the launch decision making process for flight 51-L. At these hearings, additional information about the launch decision was obtained from the testimony of Thiokol, Rockwell and NASA officials. Details about the history of problems with the then suspect Solid Rocket Motor joints and seals also began emerging and served to focus the Commission's attention on a need to document fully the extent of knowledge and awareness about the problems within both Thiokol and NASA.

Following these hearings, a substantial portion of the investigative efforts of the Commission was conducted by the separate panels in parallel with full Commission hearings.

The Accident Analysis Panel, chaired by Major General Donald Kutyna, made several trips to both Kennedy and Marshall and traveled to Thiokol facilities in Utah to review photographic and telemetric evidence as well as the results of the salvage operation and to oversee the tests being conducted by NASA and Thiokol engineers.

The Accident Analysis Panel followed standard investigative procedures. An extensive effort

was needed to establish the design, manufacturing and processing baseline configuration of the Shuttle vehicle for STS 51-L. A data base was established for the examination and analysis of information related to all flight elements and segments. From these data and a compilation of possible and observed deviations from the norm, scenarios that might have led to the accident were developed. Tests and analyses were then performed to determine the specific scenarios most likely to have caused loss of Challenger.

Early in March, at the request of the Chairman, this group assembled and directed the Commission's independent team of technical observers with extensive experience in Solid Rocket Motor technology and accident investigation to validate and interpret the tests and analyses performed on the Thiokol motor by NASA and Thiokol.

The Development and Production Panel, chaired by Joseph Sutter, centered its investigation on the production and testing activities of the Shuttle element contractors. Starting at Johnson, the panel and staff investigators looked at how these contractors and their NASA counterparts interact.

They next traveled to the Wasatch plant of Thiokol in Promontory, Utah. Thiokol personnel briefed the group on the details of the design, manufacturing, verification and certification of the Solid Rocket Motors. Similar sessions took place in April in Downey, California, at the headquarters of Rocketdyne, Inc., the Shuttle main engine contractor; in Canoga Park, California, at the facilities of Rockwell International, the Orbiter contractor; in Michoud, Louisiana, at the plant of Martin Marietta, the External Tank contractor; and in Berea, Kentucky, at the facilities of Parker Seal Company, the manufacturers of the O-ring seals of the Thiokol Solid Rocket Motors.

In addition, the panel traveled to Marshall to learn about Marshall's interaction with Thiokol and to discuss issues that had been raised during the visits to the contractors' plants.

The Pre-Launch Activities Panel, chaired by David Acheson, centered its investigation at Kennedy where the Shuttle elements are assembled and all other final launch preparations are completed. This panel, in conjunction with the Mission Planning and Operations Panel, chaired by Dr. Sally Ride, met with its NASA counterparts in early March. This series of meetings identified for the Commission the various aspects of the pre-

launch process that required thorough review, not only for the purpose of the Challenger accident investigation but also to increase safety margins for the future.

Later in March the Pre-Launch Panel again met at Kennedy to receive the NASA Team's preliminary reports and to focus on the spare parts issue and Solid Rocket Booster assembly operations. Panel members also met with contractor personnel involved in Shuttle processing and Kennedy security work.

After the joint meeting at Kennedy with the Pre-Launch Activities Panel, the Mission Planning and Operations Panel traveled to Johnson to begin working with its NASA counterparts and to initiate its own investigative efforts. A specific focus of its work was the mission planning and crew preparation for STS 51-L and details of NASA's safety, reliability and quality assurance programs. Later meetings at both Johnson and Marshall dealt with range safety, weather criteria for launch, flight delays and hardware testing.

While the work of the individual panels and their investigative staffs was ongoing, a general investigative staff began a series of individual interviews to document fully the factual background of various areas of the Commission's interest, including the telecon between NASA and Thiokol officials the night before the launch; the history of joint design and O-ring problems; NASA safe-

ty, reliability and quality assurance functions; and the assembly of the right Solid Rocket Booster for STS 51-L. Subsequent investigative efforts by this group were directed in the area of the effectiveness of NASA's organizational structure, particularly the Shuttle program structure, and allegations that there had been external pressure on NASA to launch on January 28th.

More than 160 individuals were interviewed and more than 35 formal panel investigative sessions were held generating almost 12,000 pages of transcript (Table 1 and Table 2). Almost 6,300 documents, totaling more than 122,000 pages, and hundreds of photographs were examined and made a part of the Commission's permanent data base and archives. These sessions and all the data gathered added to the 2,800 pages of hearing transcript generated by the Commission in both closed and open sessions.

In addition to the work of the Commission and the Commission staff, NASA personnel expended a vast effort in the investigation. More than 1,300 employees from all NASA facilities were involved and were supported by more than 1,600 people from other government agencies and over 3,100 from NASA's contractor organizations. Particularly significant were the activities of the military, the Coast Guard and the NTSB in the salvage and analysis of the Shuttle wreckage.

Table 1

## Commission Investigative Interviews

Interviews of January 27, 1986

Teleconference (8:15 PM EST)

### Participants

Ben Powers	John Schell	William Macbeth	Jerry E. Mason
Frank Adams	Keith Coates	Brian Russell	Robert Lund
Larry Wear	George Hardy	Jack Kapp	Joseph Kilminster
James Smith	Jud Lovingood	Ron Ebeling	Roger Boisjoly
Boyd Brinton	Jack Buchanan	Calvin Wiggins	Arnold Thompson
Robert Schwinghamer	Allan McDonald	Larry Sayer	Jerry Peoples
William Reihl	Carver Kennedy	Joel Maw	James Kingsbury
Wayne Littles	Cecil Houston	Kyle Speas	
John Q. Miller	Lawrence Mulloy	Jerry Burn	
John McCarty	Stanley Reinartz	Don Ketner	

---

**Interviews of Personnel  
Involved in Stacking of  
of Right SRB for Flight 51-L**

Howard Fichtl	Ed O'Neal	Mike Sestile	Jim Gardner
Jack Roberts	Leslie Lake	Granville Goad	John Taris
Curtis J. Newsome	Buddy Rogers	David Mumpower	Kenneth Koby
Mark Vigil	Mario Duran	Robin Nix	Allen R. Hyde
Bob Heinbaugh	Jim St. John	Glenn Charron	Jerry Wilkerson
Howard Christy	Billy Massey	Stewart Dalton	Alex McCool
Jackie Walden	Mike Sieglitz	Sharron Whitaker	Charles D. Newman
Alvie Hicks	Jim Jordan		

---

**Interviews on Ice on Pad**

Thomas Moser  
John Peller

---

**Interviews on Security**

Marvin Jones  
Herbert Weisner

---

**Interviews on History of SRB  
Joint Design and Problem**

Leon Ray	Robert Lindstrom	James Kingsbury	Ben Powers
Alex McCool	James Brier	Sam Lowry	Michael Mann
Jerry Peoples	Jesse Moore	Stanley Reinartz	Richard Kohrs
Glenn Eudy	Joseph Kilminster	Calvin Wiggins	Maurice Parker
Ben Powers	Arnold Thompson	Mark Salita	Keith Coates
John Miller	Irving Davids	Joe Pelham	John Schell
Bill Rice	Arnold Aldrich	Phillip Dykster	James W. Thomas
Bill Horton	Hans Mark	Ed Dorsey	Boyd Brinton
Jerry Cox	Glynn Lunney	Roger Boisjoly	James Abrahamson
Bill Bush	Walt C. Williams	Brian Russel	Jerry Mason
Paul Wetzell	George Hardy	Jack Kemp	Jack Kapp
David Winterhalter	Larry Mulloy	Robert Lund	Ronald Ebeling
William Hamby	Fred Uptagrafft	Howard McIntosh	Arnold Aldrich
Michael Weeks	Richard Cook	Glenn Eudy	Hazel Saunders
Paul Herr	Walter Dankhoff	Robert Gaffin	

---

**Interview on Launch Coverage  
Camera Failures**

Charles Alsworth

---

**Interviews on Outside Pressure  
To Launch**

Michael Weeks	Phil Culbertson	Jerry E. Mason	Karen Ehlers
Jesse Moore	George Hardy	Arnold Aldrich	George Johnson
Charles Kupperman	Larry Mulloy	Lawrence Wear	James Beggs
Shirley Green	Joseph Kilminster	John Q. Miller	William R. Graham
Vera Herschberg	Stanley Reinartz	James Smith	Richard Cook
Richard Smith	Robert Lund	Norman Terrell	Ben Powers



---

### Interviews on Safety, Reliability and Quality Assurance

David Brown  
Richard M. Henritze  
James O. Batte  
Arthur M. Carr  
Wiley C. Bunn  
David Austin

Jackie C. Walker  
Benny Nunnally  
George Butler  
Henry P. Smith  
Wesley Hawkins  
John Maxson

Howard Gittens  
Brian Russell  
Haggai Cohen  
Harry Quong  
Dallas N. Vickers

Wayne Frazier  
Norman R. Schulze  
Stanley Reinartz  
Milton Silveira

---

### Interviews on Management Structure

Dick Kohrs  
Jesse Moore  
Dr. Hans Mark  
William Hamby  
Michael Weeks  
Lawrence Wear  
John Q. Miller  
William Lucas

James Smith  
Arnold Aldrich  
John J. McCarty  
Scott Simpkinson  
James Brier  
Jud A. Lovingood  
Bill Bush

Jerry Cox  
Jerry Griffin  
Stanley Reinartz  
James Kingsbury  
Thomas J. Lee  
William F. Taylor

Richard A. Colonna  
Walt C. Williams  
George Bridwell  
George Johnson  
Richard Cook  
Michael Mann

---

### Interviews on Human Factors

Louis E. Toole  
James B. Hill  
Leonard J. Riche  
Heather M. Mitchell

Jenny Howard  
Greg Oliver  
Robert Yackovetsky  
Morton O'Hare

Ray Hallard  
Ken McCrary  
Joe Kenneth Patterson

Gregory Haywood Williams  
Robert L. Brayant  
Keith Coates

---

### Interview on Wreckage Reconstruction

Terry Armentrout

---

### Interview on Crew Activities

George Abbey

**Table 2****Commission Panel Sessions**

<i>Date</i>	<i>Location</i>	<i>Subject</i>
<b>Accident Analysis Panel</b>		
March 3, 4, 5	Marshall	Accident Data Review, Fault Tree Analysis
March 6, 7	Kennedy	Film & Wreckage Review
March 11	Kennedy	Coordination with NASA Task Force
March 12, 13	Marshall	Accident Data Review, Fault Tree Analysis, Test Requirements
March 19	Thiokol - Utah	Test Coordination
March 26	Marshall	Test Review
April 10, 11	Marshall	Test Review
April 14, 15, 16, 17	Marshall	Final Review
<b>Design, Development and Production Panel</b>		
March 5	Johnson	Preliminary Briefing
March 17	Thiokol - Utah	Fact-Finding Session
March 18	Thiokol - Utah	Design-Production
April 2	Rocketdyne - California	Main Engines
April 3	Rocketdyne & Rockwell - California	Development - Orbiter
April 4	Rockwell - California	Orbiter
April 7	Marshall	Development and Production
April 8, 9	Martin Marietta-Louisiana	Development - External Tank
April 11	Parker Seal - Kentucky	O-rings
<b>Pre-Launch Activities Panel</b>		
March 4, 5, 6	Kennedy	Training, Workload, Schedule, Spares, Pre-Launch Investigation Update, Security
March 17, 18, 19	Kennedy	Manpower, Spare Parts, Shuttle Processing, Security, Hold-down Post Spring 51-L, Booster Flow, Salvage Status, SRB Recovery, Launch Readiness Process
<b>Mission Planning and Operations Panel</b>		
March 4, 5	Kennedy	Preliminary Briefing
March 11, 12	Johnson	Crew Activity Planning, Training, Abort Modes, Safety, Manifesting
March 20	Johnson	Objectives Review
March 24, 25	Johnson	Range Safety, Mission Operations, Landing Operations, Weather, Tile Damage, Main Engines, Safety, Reliability and Quality Assurance
March 31, April 1	Johnson	Payload Safety, Hardware Testing, Training, 51-L Flight Design
April 7	Marshall	Safety, Reliability and Quality Assurance
April 8, 9	Johnson	Workload, Software, Manifesting, Landing Considerations
April 14, 15	Johnson	Ascent/Entry Envelope, Abort Option History, Safety, Reliability and Quality Assurance

Executive Order 12546, dated February 3, 1986, which established  
the Presidential Commission on the Space Shuttle Challenger Accident

EXECUTIVE ORDER

PRESIDENTIAL COMMISSION ON THE  
SPACE SHUTTLE CHALLENGER ACCIDENT

By the authority vested in me as President by the Constitution and statutes of the United States of America, including the Federal Advisory Committee Act, as amended (5 U.S.C. App. I), and in order to establish a commission of distinguished Americans to investigate the accident to the Space Shuttle Challenger, it is hereby ordered as follows:

Section 1. Establishment. (a) There is established the Presidential Commission on the Space Shuttle Challenger Accident. The Commission shall be composed of not more than 20 members appointed or designated by the President. The members shall be drawn from among distinguished leaders of the government, and the scientific, technical, and management communities.

(b) The President shall designate a Chairman and a Vice Chairman from among the members of the Commission.

Sec. 2. Functions. (a) The Commission shall investigate the accident to the Space Shuttle Challenger, which occurred on January 28, 1986.

(b) The Commission shall:

(1) Review the circumstances surrounding the accident to establish the probable cause or causes of the accident; and

(2) Develop recommendations for corrective or other action based upon the Commission's findings and determinations.

(c) The Commission shall submit its final report to the President and the Administrator of the National Aeronautics and Space Administration within one hundred and twenty days of the date of this Order.

Sec. 3. Administration. (a) The heads of Executive departments and agencies shall, to the extent permitted by law, provide the Commission with such information as it may require for purposes of carrying out its functions.

(b) Members of the Commission shall serve without compensation for their work on the Commission. However, members appointed from among private citizens of the United States may be allowed travel expenses, including per diem in lieu of subsistence, to the extent permitted by law for persons serving intermittently in the government service (5 U.S.C. 5701-5707).

(c) To the extent permitted by law, and subject to the availability of appropriations, the Administrator of the National Aeronautics and Space Administration shall provide the Commission with such administrative services, funds, facilities, staff, and other support services as may be necessary for the performance of its functions.

Sec. 4. General Provisions. (a) Notwithstanding the provisions of any other Executive Order, the functions of the President under the Federal Advisory Committee Act which are applicable to the Commission, except that of reporting annually to the Congress, shall be performed by the Administrator of the National Aeronautics and Space Administration, in accordance with guidelines and procedures established by the Administrator of General Services.

(b) The Commission shall terminate 60 days after submitting its final report.

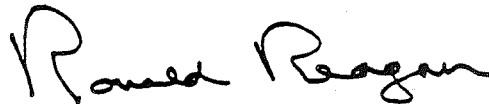

THE WHITE HOUSE,

February 3, 1986.

# Commission Documentation System

## Overview

---

One of the Commission's initial concerns was to make certain that Commission members and staff would have ready access to the tens of thousands of pages of technical information, hearing transcripts, witness interviews, and correspondence relating to the Challenger accident. Several aspects of the investigation made gathering, controlling, and cataloging such information a formidable task. One was the massive volume of information collected. In addition, the fairly short response time required of the Commission made it imperative that all information be immediately and completely accessible. Finally, the Commission needed to make sure that it could account for and retrieve every piece of information that it collected and generated.

To address those issues, the Commission enlisted the support of the Justice Department's Office of Litigation Support, Civil Division.

With existing capabilities, the Office of Litigation Support mounted a rigorous cataloging effort, developed and implemented a document control system, created the automated data bases, and established a Commission documents Support Center for document processing and research activities.

The resulting system enabled the Commission to manage the volume and assortment of information received and generated in the course of the investigation, and provided Commission staff with rapid access to needed information. The system was designed to enable access to either hard copy or microfilm for future research after the Commission completed its work.

The Commission was able to meet its commitment to ensuring the integrity of this extensive collection of information; all information pertaining to the investigation can be easily located and its origin readily traced.

## The Commission Information Management System

---

The Commission developed procedures to assure that it received all documents requested from NASA and other sources and that all documents and other correspondence were properly processed.

### Document Control

The Commission had control procedures and systems to track all types of documents relevant to the investigation. Specific procedures were used to process (1) Commission requests for information from NASA, and NASA's responses; (2) NASA Task Force Reports; (3) other correspondence to and from the Commission; (4) other documents obtained by the Commission; and (5) reports and transcripts generated by the Commission.

The document control system ensured that all requests, documents, transcript and interview tapes, and other source materials were properly accounted for, and became part of the Commission's permanent records and data base.

### Documents Requested from NASA

Most documents relevant to the investigation came directly from NASA in response to Commission requests. The Commission requested documents from NASA in writing or verbally at

hearings. The Commission followed up verbal requests with written requests.

To handle the flow of paper, the Commission assigned a staff member to be document coordinator. The document coordinator assigned every written request a unique control number. The number identified the date of the request and its order of occurrence on that date.

NASA set up a complementary system. The NASA coordinator received and logged Commission request letters, assigned unique NASA tracking numbers to each item or group of documents requested, and followed up to ensure that NASA staff responded promptly and fully.

When documents were received from NASA corresponding to each numbered request, one copy of each was sent to the Support Center for microfilming, analysis (coding), and inclusion in the computer data base.

### **Correspondence**

Each individual piece of nonpersonal mail arriving at the Commission was assigned a correspondence control number. Technical staff evaluated correspondence for investigative value. On a microcomputer-based system, staff captured critical information about each correspondence item, including correspondence control number, date of receipt, addressee, author, type of correspondence, and response date and type.

### **Other Documents**

The Commission also received many documents other than those requested from NASA. These included relevant materials that Commission members themselves had gathered or generated, those from NASA and from the various NASA contractors as a result of Commission investigative activities, and incoming correspondence that staff decided would be of use to the investigation. These documents were also entered into the Commission's data base, and relevant correspondence was also entered into the microcomputer tracking system.

### **Transcripts and Commission-Generated Documents**

The Commission used a court reporting firm to transcribe hearings, interviews, and meetings. The firm created magnetic computer tapes with the full text of the transcripts and delivered the tapes to be loaded into the computer data base.

The firm also provided hard copies of the transcripts to all participants of the hearing, in-

terview, or meeting so that they could correct any mistakes made in transcription.

Quick entry of the transcripts into the data base allowed timely search of transcript records on a word-by-word basis.

### **Processing of Documents and Tapes by the Support Center**

As described in the previous section on document control, the Commission forwarded most documents to the Support Center for microfilming, coding, inclusion in the computer data base, and filing in the library. These documents included NASA reports and documents, selected correspondence, and other documents received by the Commission.

### **Assignment of Control Numbers**

When the Support Center received a document, Center staff immediately applied a unique preliminary control (PC) number to each page of the document. This number was a sequential number to indicate where the original copy of the document would be located in the library files.

### **Microfilming**

After control identifiers were assigned, Center staff microfilmed the document and placed the original hard copy in the library. The Center made daily deliveries of completed microfilm reels to the microfilm processing facility, which produced two copies of each reel.

The Support Center maintained one copy in the microfilm library, and used it to respond to information requests from Commission members and staff.

The second copy was used to produce hard copies of the documents for coding purposes.

### **Coding and Data Entry of Microfilmed Documents**

The purpose of coding was to develop a comprehensive computerized index of all microfilmed documents. Using hard copies produced from microfilm, each document was reviewed and bibliographic, control, and subject matter information was recorded on a coding form designed specifically for the Commission investigation.

The bibliographic information included items such as document title and date, and names and organizations of people mentioned in the documents. The control information included the

preliminary control number, microfilm number and other information useful in identifying and locating documents.

To capture information on subject matter, coders read each document and noted what subjects were mentioned. The coders used a list of "subject terms" developed specifically for Commission purposes. Each subject term had a unique six-character identifier. Every document was assigned at least one such subject code. Documents that covered many subjects were assigned multiple codes.

Data entry operators keyed the index information from the completed coding forms onto magnetic tape to be loaded into the computer data base.

From the date a document was received, it was microfilmed, filed in the hard copy and microfilm libraries, coded, and entered on the computer data base within one week. Throughout the process, there were numerous quality checks to ensure the readability of the microfilm, the accuracy of the document coding, and the overall integrity of the data base.

#### **Creation and Data Entry of Index Information from Transcripts and Commission Generated Documents**

For the Commission generated documents and the transcripts, index information was captured and entered into the computer. This information included date of the hearing or report; names of all attendees, Commission members or witnesses; and other cross-reference data.

The index information was added to the full-text versions on the magnetic computer tapes, and loaded into the computer data base.

#### **Creation of the Computer Data Base**

Through the processes described above, the Commission created two computer data bases. The first—called the document data base, named INQUIRE—contained the index (bibliographic, control, and subject matter information) of all microfilmed documents, representing more than 100,000 pages.

The second—called the full-text data base, named JURIS—contained the full text of (1) transcripts of all Commission hearings, interviews, and panel meetings; and (2) Commission reports, hearing digests, and affidavits.

## **Libraries**

---

### **Documents and Microfilm**

As noted above, the Support Center maintained libraries of Commission documents.

One contained the microfilmed versions of the more than 122,000 pages of materials indexed on the document data base. The microfilm was filed by reel number and cross-referenced to the preliminary control number assigned to the original hard copy of each document. Microfilmed documents could be quickly located through the computer search capability and hard copies printed, if desired.

The second library contained hard copies of transcripts and other Commission generated documents (those documents stored in the full-text data base), plus the originals of the microfilmed documents, which could be located by using the preliminary control number.

### **Other Materials**

The Commission also maintained a library of video tapes of presentations, hearings, photographic and film records relating to the accident itself, and the salvage operations. These tapes were filed chronologically by date received and labeled according to subject. Use of these materials was controlled through a library check-out system.

Audio tapes of interviews were labeled and maintained at the Support Center. These were filed chronologically by interview date and controlled through a library check-out system.

## **Use of the Data Bases**

---

The Support Center provided personnel to perform searches of both the document data base (INQUIRE) and the full-text data base (JURIS). Access to INQUIRE and JURIS was gained from terminals at the Support Center and the Commission offices.

Detailed information on the use of these systems is available in the following OLS documentation: "INQUIRE Users Manual," "JURIS Users Manual," and "Challenger Data Bases—Sample Searches for JURIS and INQUIRE."



## The Document Data Base Accessible Through INQUIRE

The INQUIRE system allowed rapid retrieval and review of the index information that constituted the document data base.

Users who wanted to locate documents on a particular subject (such as O-ring erosion) could search the document data base using the bibliographic information or subject codes captured for each document. INQUIRE provided a listing of all documents matching the criteria specified in the search. The user could then decide which of the listed documents would be useful and, using the document number provided, obtain a copy of the document from the library.

The user could ask INQUIRE to list a variety of information on selected documents, including the preliminary control number (used to locate the material in the library), date, title, and document type. INQUIRE could also print all the subject terms associated with each selected document (not just the subject term(s) that matched the search criteria), and all the names mentioned in the text. Users could also choose the order in which INQUIRE listed the documents (e.g., chronologically by document date, alphabetically by author name, or numerically by document number).

## The Full-Text Data Base Accessible Through JURIS

The Department of Justice developed JURIS specifically for retrieval of full-text information, and designed it for easy use by nontechnical personnel. Users could ask JURIS to locate all documents containing specific words or phrases. Users could specify multiple words or phrases, and could include index information as one of the search criteria. Users could request that JURIS print a list of documents that were selected, or print the full text of the documents.

## Final Disposition of Commission Report and Investigation-Related Materials

---

The entire collection of documents and microfilm is permanently housed in the National Archives. In addition, several different indices and other supporting documentation were com-

plied to assist historians and others in using and gaining access to this large and very important collection.

These materials were provided to the National Archives in accordance with the procedures described in FPMR 101-11.4, "General Records Schedules," published by the National Archives and Records Administration, and specifically Schedule 24 which focuses on "Temporary Commissions, Committees, and Boards Records."

## Materials Provided

The following materials were turned over to the Archives at the conclusion of the investigation:

- The Commission's Report, including all appendices;
- All materials requested and received by the Commission from NASA and its contractors, including the NASA Task Force reports;
- All documents provided to the Commission and its staff at hearings, meetings, presentations, and interviews;
- The entire microfilm collection containing those materials (both in open-reel and cartridge format), as well as a file-level index to each reel;
- All transcripts of hearings, panel meetings and interviews;
- Summaries of all hearing transcripts and significant interview transcripts;
- Indices to the INQUIRE (document) data base, listing all of the documents by document number, date, and subject term;
- All correspondence and respective responses, as well as indices to the entire correspondence collection sorted by author, correspondence type, and date of receipt;
- Computer tapes containing the entire INQUIRE data base prepared for and used by the Commission in the course of its investigation;
- Complete set of the request letters sent by the Commission to NASA, the resulting Action Item forms, and the responsive memoranda that closed out each of those Action Items;
- All press releases produced by the Commission;

- All video and audio tapes received by the Commission, including indices to those two collections; and
- All planning and instructional materials related to the creation and use of the INQUIRE and JURIS data bases.

## Public Access

To gain access to the Commission's documents, requests can be made to:  
**Office of the National Archives  
National Archives and Records  
Administration  
Washington, DC 20408**

## Observations Concerning the Processing and Assembly of Flight 51-L

The following examples of Operational Maintenance Requirements and Specifications Document violations were noted during the Commission's inquiry:<sup>1</sup>

1. The Operational Maintenance Requirements and Specifications Document indicated that the External Tank liquid hydrogen and liquid oxygen ullage pressure control and redundancy verification using simulated transducers was a requirement for this processing. However, the entire sequence was marked "not performed" in the documentation, indicating that it had not been completed. Missing any of these steps has implications for safety of flight.
2. The three requirements that verify the main engine pneumatic isolation valve actuation were not met as specifically called for in the Operational Maintenance Requirements and Specifications Document. The intent of the requirement was met.
3. One requirement (main engine pneumatic isolation check valve individual flow-through test) was not met in the Operations & Maintenance Instructions. The main engine flight readiness tests gave assurance that at least one of two check valves per system was working.
4. A main engine pneumatic regulator functional test, which checks the redundancy of individual regulators, was not verified under flow conditions.
5. The results of helium pneumatic low pressure system decay check (with closing solenoids energized) exceeded the allowable limit. The decay rate was recorded as 0.98 pounds per square inch per minute; however, a recalculation of the data revealed that the decay rate was actually 1.4 pounds per square inch per minute. The calculated allowable decay rate was 1.35 pounds per square inch per minute maximum.
6. The leak check steps for test port Number 4, after installation of the plug, were inadvertently omitted from the Operations & Maintenance Instructions.
7. Main engine protective covers were not installed at times required. A revision to the requirement is needed.
8. Several requirements cannot be satisfied during a 24-hour launch scrub turnaround due to lack of access. A revision to the requirement is needed.
9. The humidity indicator inspection requirement was not met because the engines were not in the controlled environment with a trickle purge on. The requirement needs to be updated.

Representative samples were taken from the Orbiter processing paper. Of 121 Operations & Maintenance Instructions reviewed, 47 percent had paper errors. Incomplete, incorrect or missing data recording points were found in about 13 percent of the cases and 32 percent had Quality Control buy-off stamps missing.

Also reviewed were 479 Work Authorization Documents in the Interim Problem Report, Problem Report and Test Preparation Sheet categories. Of those documents, 70 percent had

anomalies, including inaccurate/inadequate level of detail (36 percent), missing stamps (24 percent), correct signatures not obtained (29 percent), and inaccurately detailed summary for closure or deferral (20 percent).

In addition to normal processing, there were 22 Modification Change Requests applicable to flight 51-L. Those requests generated 51 Work Authorization Documents, all of which were reviewed as part of the post-accident study of flight 51-L processing. Although not accident-related, 96 percent of the Work Authorization Documents were found to have errors of an administrative or format nature. Those examples led to the conclusion that there was a pervasive lack of discipline and lack of proper training with respect to how Work Authorization Documents are written and implemented.<sup>2</sup>

The same lack of completeness and accuracy was discovered in review of nearly all types of paperwork in the processing system. The amount of flawed paper work—approximately 50 percent—is unacceptable. There are several contributing factors, among them signature requirements that are lengthy and require people to travel long distances to accomplish, excessively long times required to close out paper, as compared with doing the actual work; lack of understanding of the paper system; a complicated tiered control and status trail for Quality Assurance personnel; and the fact that no single organization has the responsibility for final review for closure. Basically, the system is not simplified for the originator, performer, or verifier. Therefore, it is not a useful tool, which would be the only reason for its existence. Rather, it is an impediment to good work and good records.<sup>3</sup>

The work control documentation system is cumbersome and difficult to use. Consequently, the work force does not try very hard to use it. The result is that the real-time execution of tasks and their subsequent traceability suffer. The system needs to be simplified so that it becomes "user friendly." Once it is, the work force should be trained to use it and management should place proper emphasis on rigorous observance of the documentation requirements.

### **Flight 51-L Booster Processing**

With Shuttle mission STS-6 in April 1983, NASA introduced the "lightweight" version of the Solid Rocket Booster, about 4,000 pounds lighter

than its 185,000-pound (empty weight) predecessors. The weight reduction was achieved by shaving the thickness of each steel casing by two to four hundredths of an inch. On flight 51-L, all but the forward segments of the two boosters had lightweight casings.

There are 11 separate case components in each Solid Rocket Booster. Only two of the 22 components in the 51-L stack were new. The remaining 20 components had been used a combined total of 29 times previously, in ground tests and in flight.

The new components were the right forward center tang and the left forward dome. The right forward segment (Number 085) had been part of the flight 51-C (January 24-27, 1985) left forward field joint that had experienced O-ring erosion and deposited soot behind the primary O-ring. None of the other 51-L case segments had experienced O-ring problems on previous use.

Segment L-60, the right aft center tang component, had been flown on 41-D (August 30—September 5, 1984) as the left forward center tang component. Segment L-06, the right aft clevis component, had been flown on 51-C as the left aft clevis member. Segment L-06 had undergone another burn in addition to 51-C; it had been used as part of the left aft segment in a static test firing.<sup>4</sup>

The first of the eight motor segments for flight 51-L arrived by rail at Kennedy Space Center on October 11, 1985. The last reached Kennedy on November 4. The segments for 51-L were designated booster integration set BI026.

Grain inspection and offloading began on October 24. Stacking preliminaries for the left booster got under way on October 28 with the mating of the aft segment to the skirt that surrounds the nozzle. The stacking of the right booster began on December 4. During the stacking operation, which involves assembling the components of the Solid Rocket Booster one atop the other on the Mobile Launch Platform (MLP), a number of minor deviations and a few unusual situations were experienced. They were carefully reviewed by the NASA report team and by the Commission. With one possible exception, explained below, these incidents did not have significant impact on the performance of the Solid Rocket Boosters.

Before stacking of the right hand booster, measurements of the right aft center tang and the right aft clevis diameters indicated a potential for

**Vehicle Assembly Building  
AFT Segment to AFT Center Segment Stack**

**Transfer Aisle**

**High Bay**

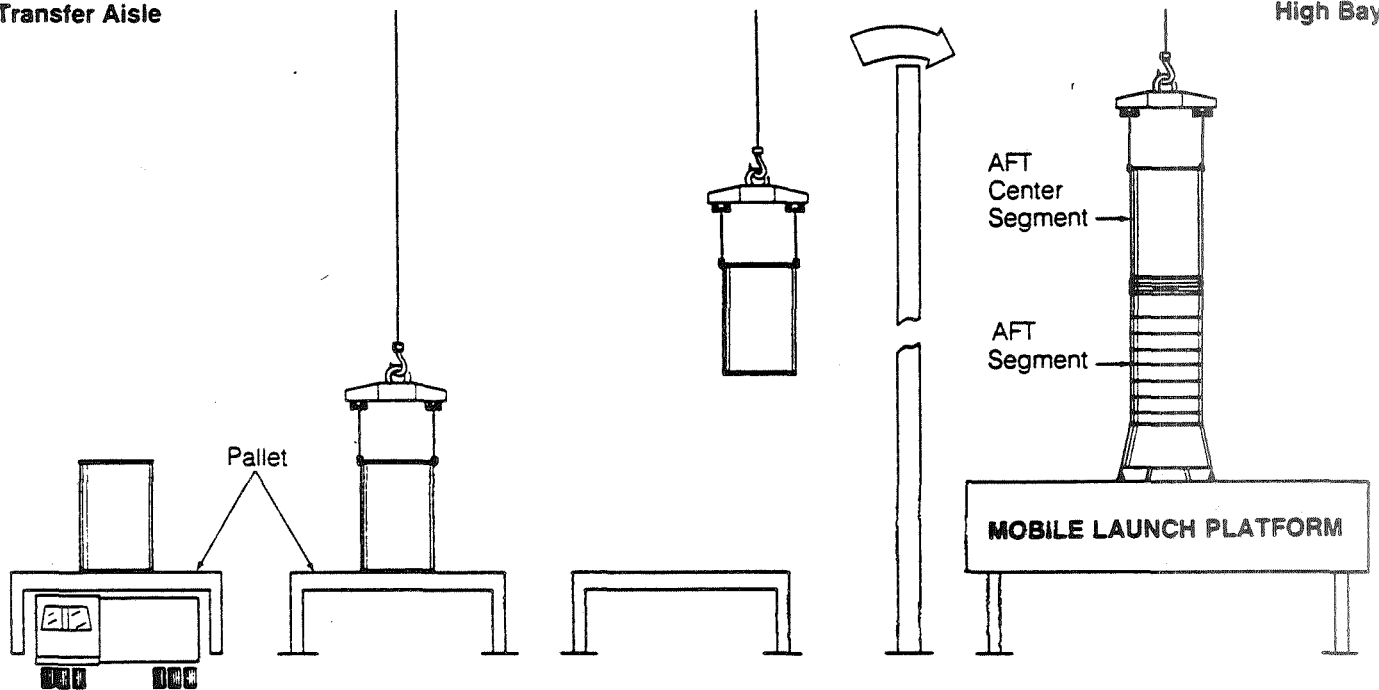

Transport Segment to VAB Transfer Aisle

Install Lifting Beam

Lift off Pallet  
Clean & Inspect Lower End (Tang)  
Measure Diameters

Lift from Transfer Aisle to High Bay & Position Above AFT Segment

- Clean & Inspect Upper End (Clevis) of AFT Segment
- Measure Diameters
- Install Putty & O-Rings
- Engage AFT Center Tang in Clevis
- Install Pins
- Conduct Seal Leak Check
- Install Joint Retention & Insulation

Drawing depicts steps in the stacking of the aft and aft center segments of the Solid Rocket Booster in the Vehicle Assembly Building (VAB).

stacking interference. Taken across the 0-180 degree axis, the tang diameter measurement exceeded the corresponding clevis dimension by +.512 inch. The maximum allowable tang to clevis difference is +.250 inch.

Normal Operations and Maintenance Instructions procedures were followed for bringing the out-of-round segment into allowable tolerances. While the right aft center segment was hanging from four points on a lifting beam, the first step was to adjust the lifting beam to create a two-point lift across the 90-270 degree axis. The weight of the segment itself would decrease the tang diameter across the 0-180 degree axis. This process reduced the excess measurement to

+ .334 inch, but it was still outside the allowable tolerance.

The next step in the procedure was to install the circumferential alignment tool. It was installed across the 16-196 degree axis and maximum allowable pressure of 1,200 pounds per square inch gauge was applied to the tool. This produced a further improvement, but again fell short of the measurement requirements. Additional deflection was obtained by turning the hex nut on the alignment tool. This caused the hydraulic pressure on the tool to increase to 1,300-1,500 pounds per square inch gauge, which exceeded the limit on the tool. The procedure produced a force of 3,254-3,766 pounds on the seg-

Table 1  
 Right Aft Center Segment Tang  
 to Aft Segment Clevis Diameter  
 Measurement Differentials Taken on December 7, 1985  
 (Positive is Tang Larger)

Circumferential Location	4-Point Lift 0145 hrs	Initial 2-Point Lift 0305 hrs	Inter- mediate 2-Point Lift 0354 hrs	Final 2-Point Lift 0415 hrs	Alignment Tool Installed 16°/196° 0925 hrs	Alignment Tool Removed 0945 hrs
0°	+ .512	+ .393	+ .334	+ .334	+ .138	+ .216
30°	+ .158	+ .295	+ .315	+ .315	N/A	+ .158
60°	- .334	- .236	- .157	- .157	- .079	- .118
90°	- .728	- .571	- .531	- .531	- .295	- .334
120°	- .669	- .571	- .531	- .531	- .374	- .393
150°	+ .059	0	+ .020	+ .020	- .39	- .059

NOTE: Measurements to nearest .001 inch are approximate

ment case, which was within manufacturer specifications. Although this procedure was at that time authorized by the Operations and Maintenance Instruction, it has since been deleted because the application of increased pressure on the alignment tool risks damage to the tool.

Following all of these procedures, measurement of the tang showed the differential between the tang and clevis along the 0-180 degree axis to be + .138 inch, which was considered suitable for mate. The right aft center segment was hoisted from the transfer aisle and lowered into position above the aft segment in the Vehicle Assembly Building high bay. The alignment tool was removed and final tang measurements showed a differential of + .216 inch, indicating mating was possible. Installation of both O-rings and successful stacking of the segments then took place without incident. No further problems were identified during engagement of the two segments. Table 1 shows the measurements taken at various stages of the entire procedure.<sup>5</sup>

The several sets of tang/clevis diametric measurements referred to in the foregoing discussion, and presented in Table 1, were reported by the stacking crews at Kennedy.

Two conspicuous aspects of the 51-L right aft field joint warrant comparison with joint history of earlier flights. Those aspects are the use of the

circumferential alignment tool and the large tang-to-clevis negative diameter difference of - .393 inch along the 120-300-degree axis. However, the NASA Operations and Maintenance Instructions do not specify a limit to negative differences between tang and clevis.

The alignment tool had been used five times previously; its usage is shown in Table 2.<sup>6</sup>

Table 2

Alignment Tool Use History		
Mission	Field Joint	O-Ring Damage
51-B	Left Aft	None
51-F	Left Fwd	None
61-B	Left Aft	None
61-C (2 joints)	Left Aft	Erosion
	Right Aft	None

Of the five field joints on which the alignment tool was used, one experienced erosion.

There were 13 Solid Rocket Booster joints on missions 51-C (January 1985) through 61-C (January 1986) that had negative differences greater than - .320 inch. Three of those joints had negative differences greater than the 51-L right aft field joint. None of those 13 earlier joints experienced O-ring damage. Table 3 indicates the joints and missions with negative differences greater than - .320 inch.<sup>7</sup>

Table 3  
Negative Diameter Differences Greater Than .320  
Inches for Field Joints: STS 51-C Through 61-C

Mission		Difference (Inches)	Location (Degrees)
51 - C	Right Fwd	-.360	120
51 - B	Right Aft	-.360	90
		-.372	120
	Right Fwd	-.336	0
51 - D	Left Aft	-.324	120
	Left Fwd	-.372	120
51 - G	Right Aft	-.354	120
51 - F	Right Center	-.385	0
		-.433*	150
51 - I	Left Center	-.335	0
	Right Aft	-.327	30
61 - B	Left Center	-.334	150
	Right Center	-.473*	120
61 - C	Left Center	-.355	150
		-.354	0
	Right Center	-.394*	120

\*Negative diameter differences greater than 51-L.

It was found that the negative dimension differences on 51-L were not the most troublesome ever experienced and that a significant number of joints on other flights had initial negative differences in excess of the worst-case design clearance between the tang and the clevis. One significant uncertainty is the degree to which segments may tend to circularity after being mated.

The procedures used in mating the right side aft and aft center segments were carefully examined and appear normal, properly followed and executed by well-experienced personnel according to specifications.

The 51-L joint negative diameter difference has been examined for the light it may shed on whether this discrepancy may have contributed to the fatal booster joint failure.

The large negative diameter difference indicates a potential for an interference between the tang and inner clevis leg that can lead to a flat on flat condition when the tang section is lowered into the clevis section on assembly.

Subscale test on sections of the full scale joint cross section were performed which purposely produced a flat on flat condition as these sector sections were forced together. Test results showed that metal slivers were sheared from the flats, and

that these slivers could be pulled into the O-ring region during assembly.

However, a flat on flat condition probably did not exist on the STS 51-L lower joint. Past assembly practice has shown that if the difference of all diametrical readings of the mating halves is less than + .250 inches a flat on flat condition will not occur. Furthermore during the mating process the halves are brought slowly together with stacking personnel positioned around the joint. A potential for flat on flat is looked for during this critical period. It has been shown through experience that a flat on flat condition is readily apparent when viewing the mating section while the upper tang section is suspended just above the inner leg of the clevis. Thus both the physical measurements and assembly procedures make a flat on flat condition unlikely during assembly.

While the tang of the 51-L right aft center segment was burned through near the 300 degree arc point where the largest negative dimension occurred, this dimension was an assembly condition only and it is not certain that it persisted until launch. Examination of the STS 61-E destacked segments subsequent to the 51-L accident indicated that their ovality had changed after assembly while awaiting launch.

If the very tight tang-to-clevis assembly gap did persist to time of launch, it could have resulted in near maximum compression of the O-rings. Such compression, in conjunction with cold temperatures, joint dynamics, and the variable performance of the insulating putty has been shown to have detrimental influences on the joint's ability to seal. Several joints on STS 51-L, however, may have had areas where the O-ring was at near maximum compression.

## References

- <sup>1</sup> NASA Pre-Launch Activities Team Report, Appendix D, pages 214 and 215.
- <sup>2</sup> Ibid, pages 179-181
- <sup>3</sup> NASA Pre-Launch Activities Team Report, Appendix I, page 116.
- <sup>4</sup> Morton Thiokol Inc., SRM Steel Case Segment Use Record, April 1, 1986
- <sup>5</sup> NASA Pre-Launch Activities Team Report, Appendix B, pages 5-90 through 5-117
- <sup>6</sup> Ibid, page 6-9
- <sup>7</sup> Ibid, pages 6-1 through 6-3





---

# Supporting Charts and Documents

## Referred to During The Commission Investigation and Report

---

### Table of Contents

---

Relevant Organization Charts of NASA and Morton Thiokol .....	226
Temperature Definitions .....	232
Early Marshall documents and memoranda raising design objections .....	233
Documents relating to the change from Criticality 1R to 1, and the waiver of the redundancy requirements for the Solid Rocket Motor seal .....	239
Memoranda written following the field joint O-ring erosion on STS 41-B (flight 10) .....	245
Marshall urgent request for briefing after the STS 51-C mission (flight 15) .....	247
Internal NASA Headquarters memorandum after visit to Marshall .....	248
Thiokol letters and memoranda written after O-ring concern escalates .....	249
Marshall internal memorandum in the fall of 1985 .....	256

# Relevant Organization Charts of NASA and Morton Thiokol

## NASA Headquarters

Incumbents as of January 28, 1986

ORIGINAL PAGE IS  
OF POOR QUALITY

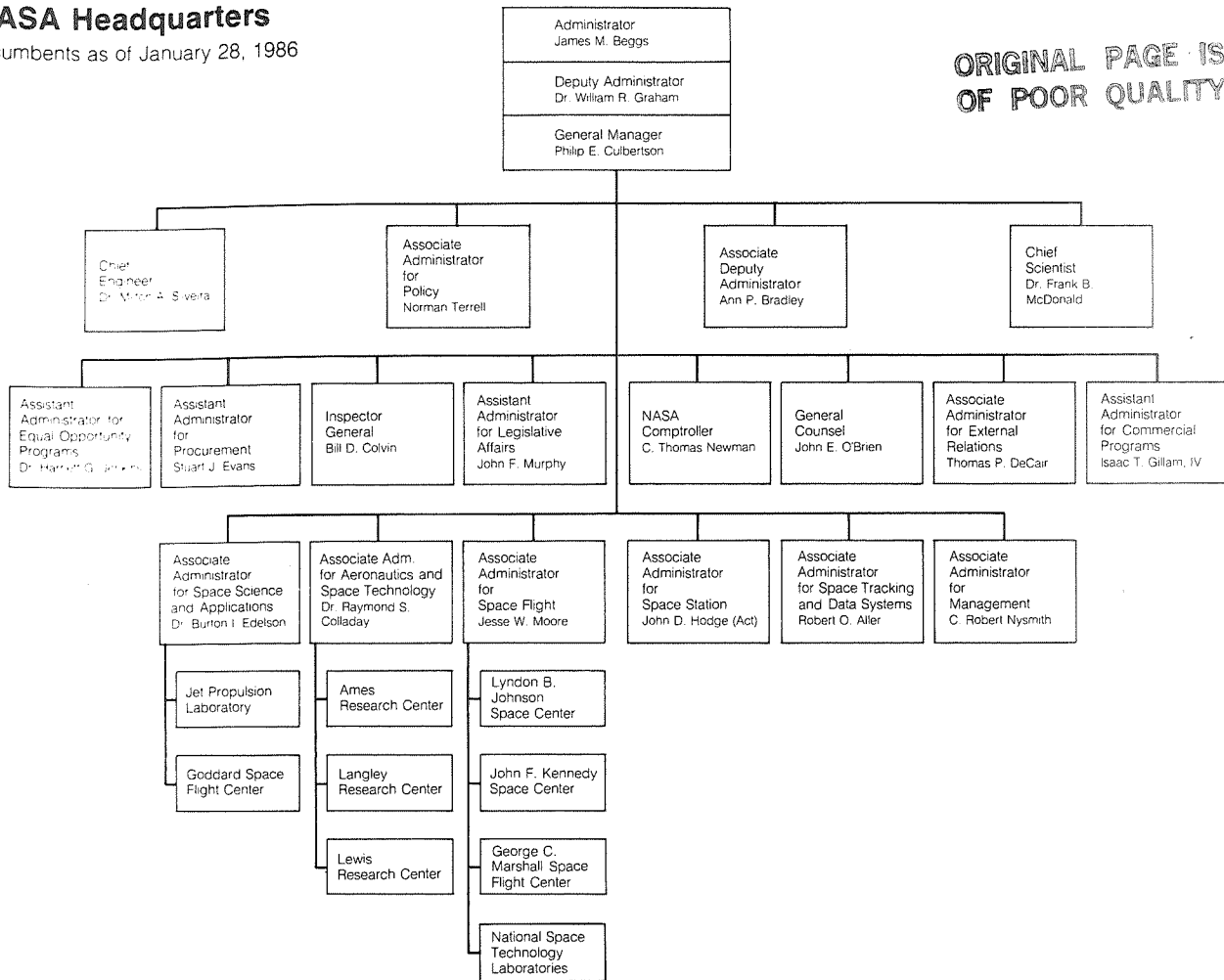

## Office of Space Flight

Incumbents as of January 28, 1986

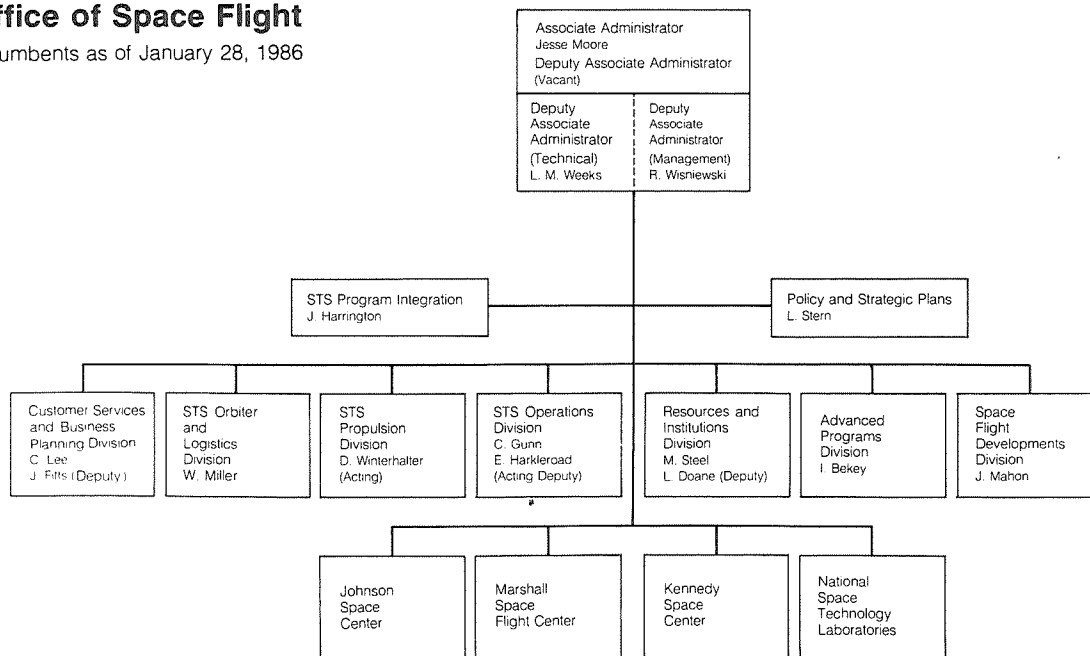

# Lyndon B. Johnson Space Center

Incumbents as of January 28, 1986

ORIGINAL PAGE IS  
OF POOR QUALITY

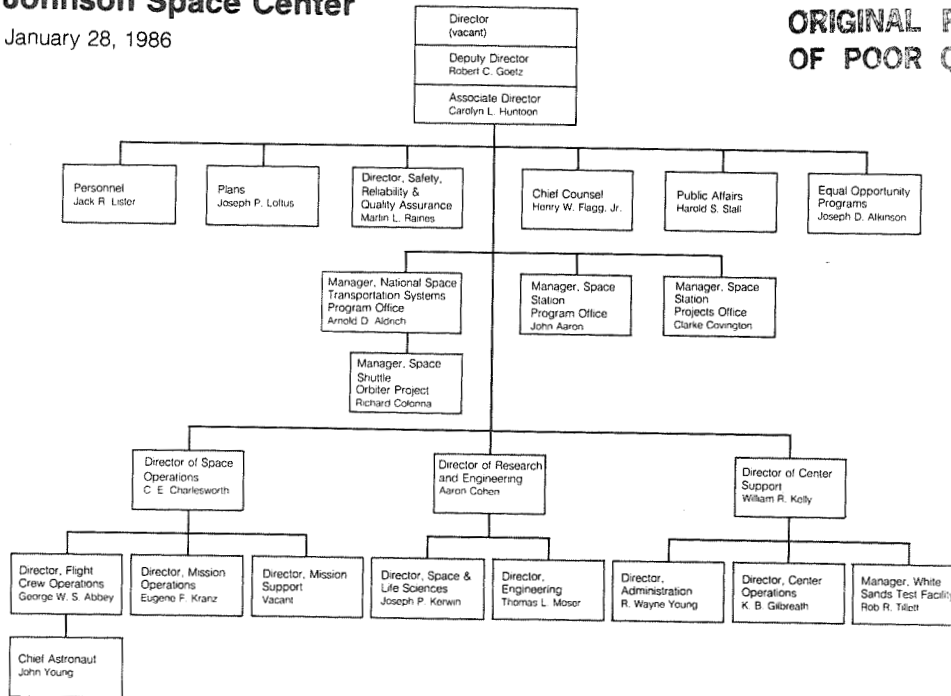

# John F. Kennedy Space Center

Incumbents as of January 28, 1986

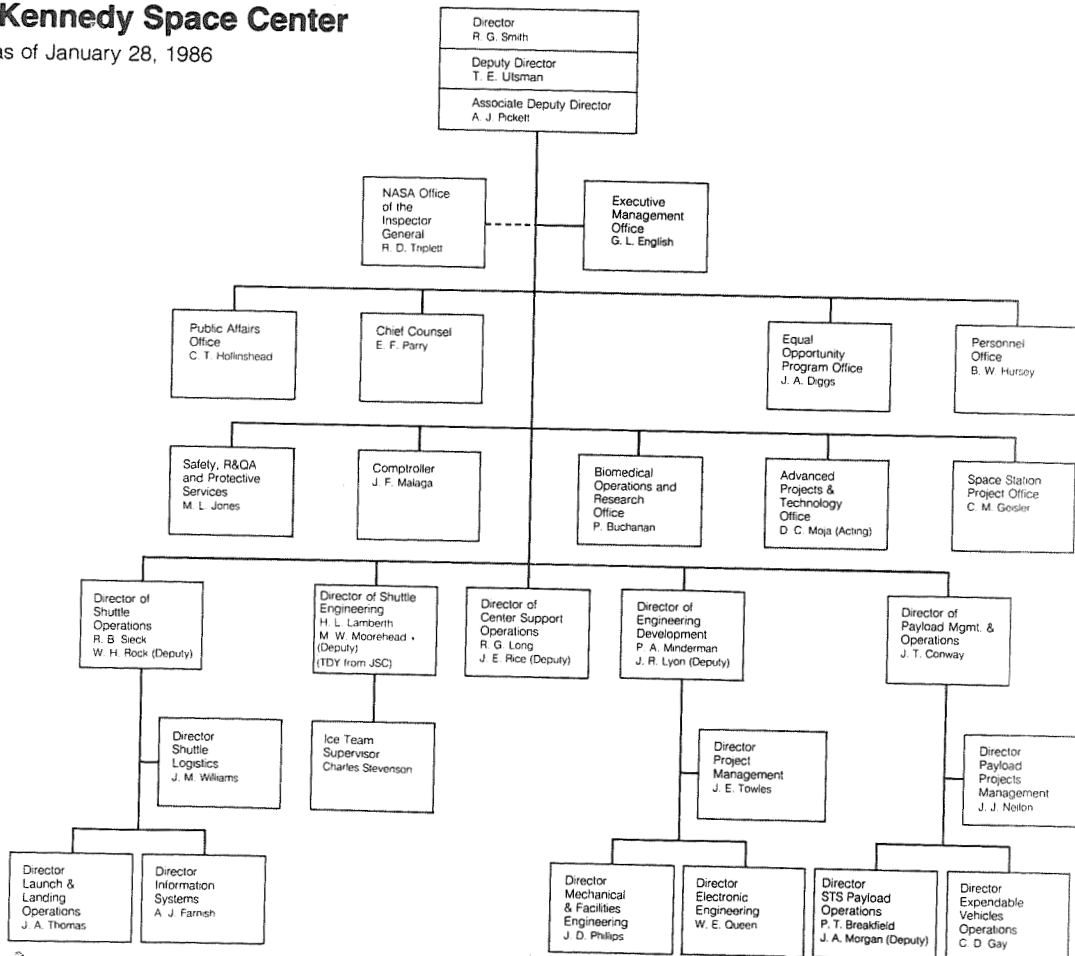

# George C. Marshall Space Flight Center Organization Charts

## Center Organization

Incumbents as of January 28, 1986

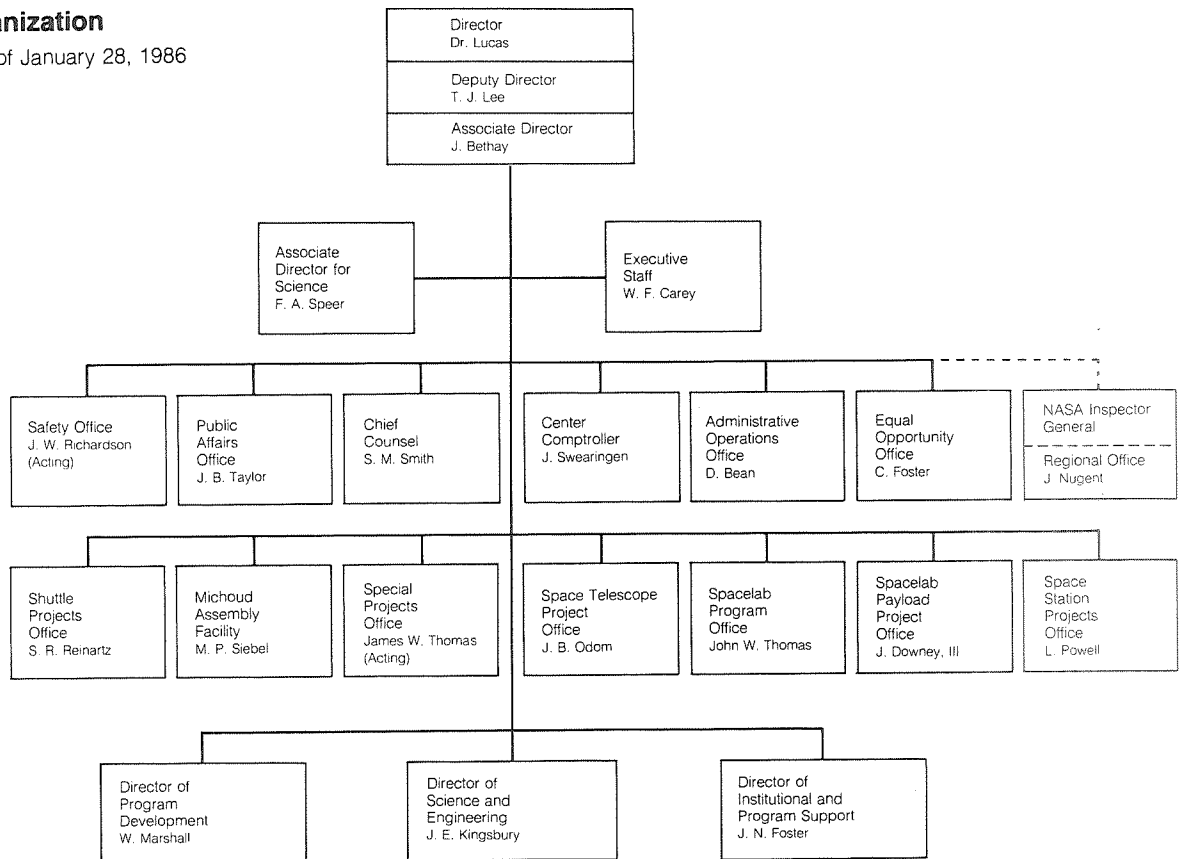

## Science and Engineering Directorate

Incumbents as of January 28, 1986

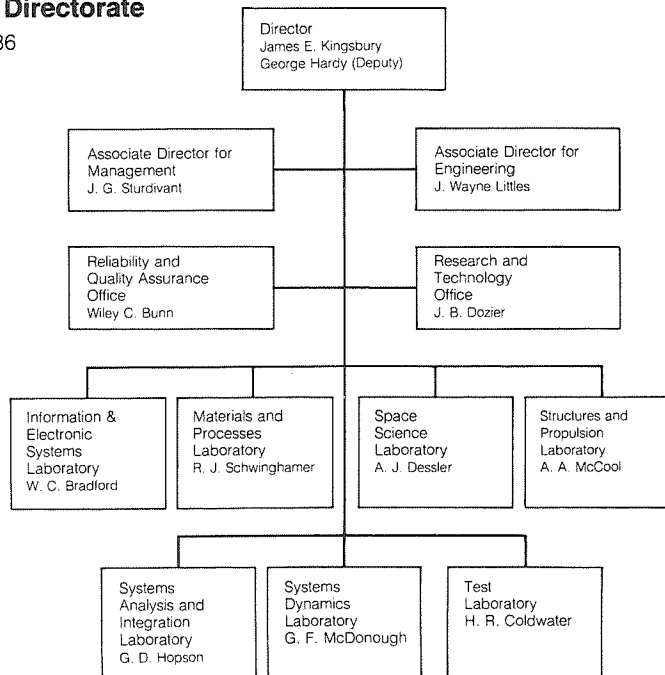

## Shuttle Projects Office

Incumbents as of January 28, 1986

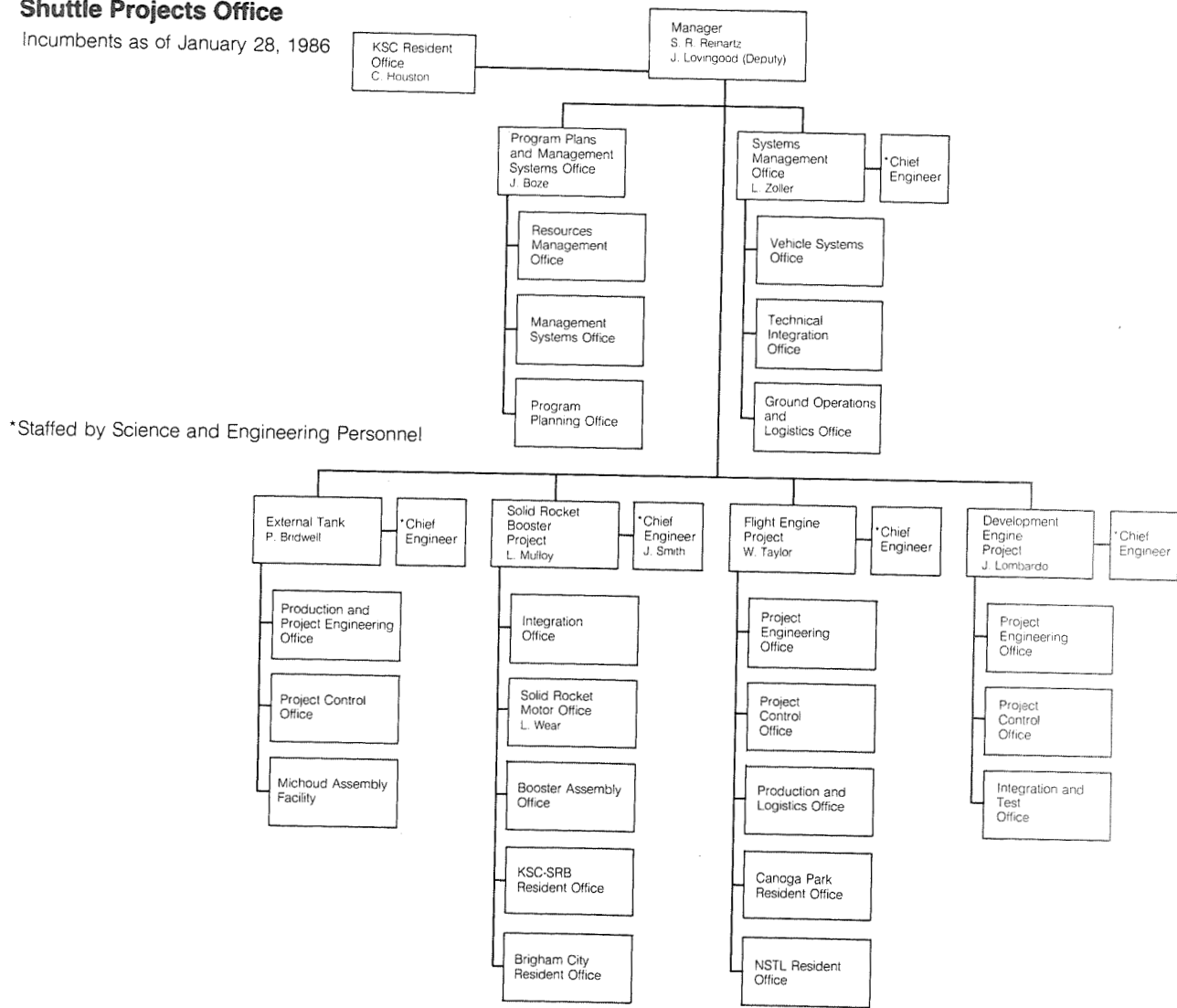

\*Staffed by Science and Engineering Personnel

## Key Marshall Personnel Related to the Solid Rocket Booster

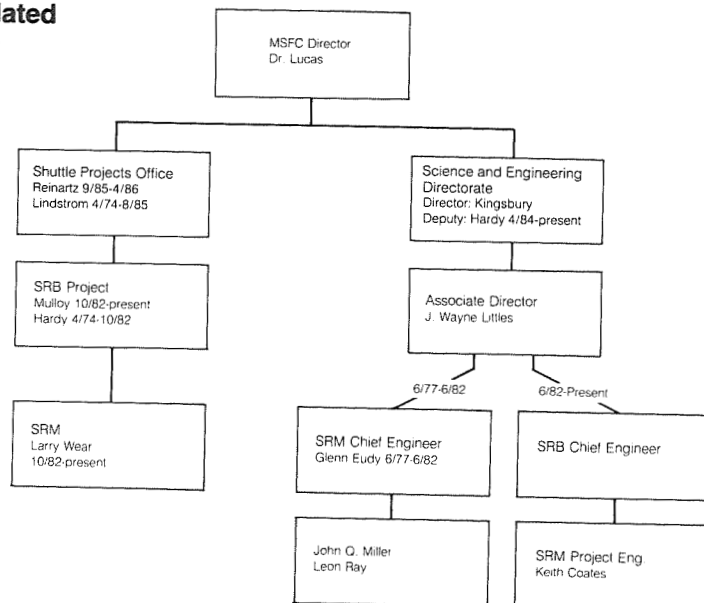

**ORIGINAL PAGE IS  
OF POOR QUALITY**

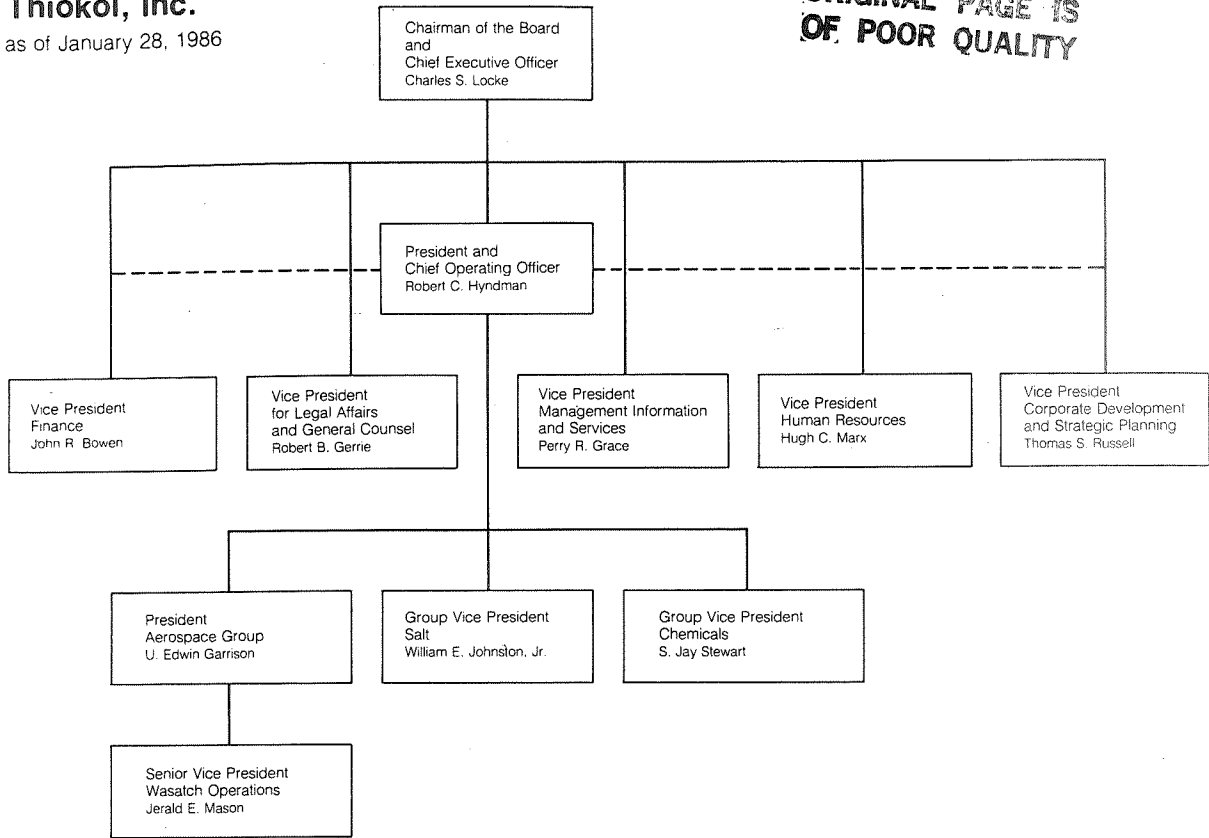



**Morton Thiokol 27 Jan 1986  
Meeting Participants**

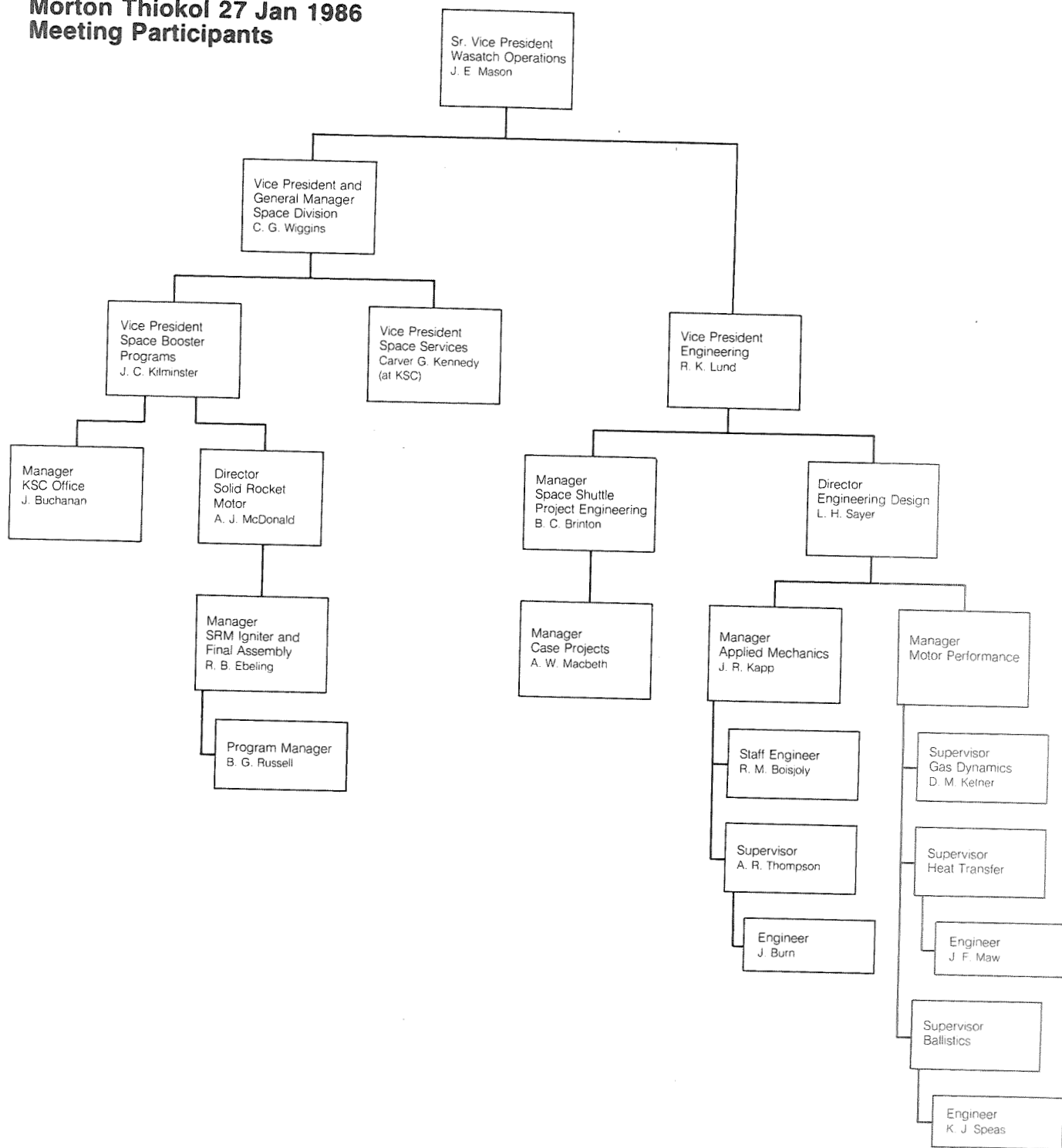

# Temperature Definitions

as applicable to this report

---

Parameter	Definition
Field Joint (O-ring) Temperature	A calculated temperature for the surface of the Solid Rocket Booster in the vicinity of the tang/clevis joint. The O-ring temperature is assumed to be the same. Calculations are based on a thermal model which includes ambient temperature among the variables. (See references 1 and 2.)
Ambient Temperature (at launch)	Measured atmospheric temperature at: (See reference 3) <ul style="list-style-type: none"><li>■ Camera Site 3, approximately 1,000 feet, bearing 150 degrees from Launch Pad 39B (36 degrees Fahrenheit at launch).</li><li>■ At a weather observation site approximately 3,000 feet east of the Kennedy Shuttle Landing Facility; (reported minimum of 24 degrees Fahrenheit and maximum of 43 degrees Fahrenheit for January 28, 1986).</li></ul>

---

## References

---

1. Report, "Accident Analysis Team Report, Solid Rocket Motor Working Group. NASA, April 1986", pages B-105 through B-114.
2. Commission Panel Work Session (Solid Rocket Booster matters) Design and Production Panel; Brigham City, Utah, March 18, 1986, pages 392 through 403.
3. Report, "Accident Analysis Team Report, Space Shuttle Systems Working Group. NASA, April 1986", pages 18 through 23. Tables B.1 and B.2.

Note: A comparison of atmospheric environmental data (wind, temperature, precipitation) for Flights STS-1 through STS 61-C is included in Tables B.5 and B.6 of reference 3.

# Early Marshall documents and memoranda raising design objections

MARSHALL SPACE FLIGHT CENTER		NAME:
EP25	SRM CLEVIS JOINT LEAKAGE STUDY	LEON RAY
		DATE:
		OCTOBER 21, 1977
DESIGN OPTIONS		
OPTIONS	REMARKS	
1. NO CHANGE	<ul style="list-style-type: none"> <li>o UNACCEPTABLE - TANG CAN MOVE OUTBOARD AND CAUSE EXCESSIVE JOINT CLEARANCE RESULTING IN SEAL LEAKAGE.</li> <li>o ECCENTRIC TANG/CLEVIS INTERFACE CAN CAUSE O-RING EXTRUSION WHEN CASE IS PRESSURIZED.</li> </ul>	
2. SHIMS BETWEEN TANG AND CLEVIS (OUTSIDE)	<ul style="list-style-type: none"> <li>o ACCEPTABLE SHORT-TERM FIX IF PROPER SHIM SIZE IS USED.</li> <li>o PROBABILITY OF ERROR IN CALCULATING PROPER SHIM SIZE.</li> <li>o REQUIRES INCREASED ASSEMBLY TIME FOR SHIM INSTALLATION AND JOINT CENTERING.</li> </ul>	
3. OVERSIZED O-RINGS	<ul style="list-style-type: none"> <li>o UNACCEPTABLE SOLUTION - HIGH PROBABILITY OF O-RING DAMAGE OR CLEVIS DISTORTION DURING ASSEMBLY.</li> <li>o DEPARTS FROM RECOMMENDED DESIGN PRACTICES.</li> </ul>	
4. REDESIGN TANG AND REDUCE TOLERANCE ON CLEVIS	<ul style="list-style-type: none"> <li>o BEST OPTION FOR LONG-TERM FIX - ELIMINATES USE OF SHIMS WHEN ALL REDESIGNED HARDWARE IS USED.</li> <li>o PREVENTS THE TYPE OF ERROR WHICH COULD RESULT IN CALCULATING JOINT CLEARANCE FOR SHIM INSTALLATION.</li> </ul>	
5. COMBINATION OF REDESIGN (AS IN OPTION 4) AND USE OF SHIMS	<ul style="list-style-type: none"> <li>o ACCEPTABLE APPROACH. SHIMS WILL BE REQUIRED IN SOME CASES WHEN REDESIGNED HARDWARE AND PRESENT HARDWARE IS JOINTED.</li> <li>o SHIMS WILL BE DISCONTINUED WHEN PRESENT HARDWARE IS PHASED OUT.</li> </ul>	

This briefing chart is the earliest known indication that the joint design was unacceptable. Leon Ray, in a 1977 briefing on a planned Structural Test Article test indicates that not changing the design is unacceptable since the tang can move outboard and cause excessive joint clearance resulting in seal leakage.

EP25 (78-1)

January 9, 1978

TO: EES1/Mr. Eudy  
FROM: EP25/Mr. Miller  
SUBJECT: Restatement of Position on SRM Clevis Joint O-Ring  
Acceptance Criteria and Clevis Joint Shim Requirements

In view of recent events relating to proposals suggesting the relaxation of standards for clevis joint O-ring acceptance and the use of a standard shim thickness for clevis joints which allows O-ring compression to fall below minimum industry accepted values, this office feels obligated to restate its opposition to both proposals. The following paragraphs address each of the related subjects in terms of events leading to such recommendations, risks involved by lowering standards, and recommendations to resolve risks.

a. Relaxation of O-Ring Acceptance Standards - During the latter part of November 1977, this office was requested by memorandum EES1 (77-291) to review Thiokol documents STW-2875, Standard Acceptance Criteria for Preformed Packing (O-Rings) and 171-136, Standard Repair Instructions for O-Rings (see enclosure 1). Our response, which was documented in memorandum EP25 (77-108) dated November 30, 1977 (see enclosure 2), recommended rejection of both documents because of excessive deviations from MIL-STD-413 requirements, "visual inspection for rubber O-rings", and for lack of clarification on several subjects. Our memorandum also outlined recommended allowable flaw sizes per MIL-STD-413 and allowables for other types of defects which were not contained in MIL-STD-413. On December 22, 1977, we were provided with and asked to comment on a draft copy of memorandum EES1 (77-321) to program management (see enclosure 3) which contained EES1 comments and recommendations to Thiokol documents STW-2875 and 171-136 which were not in agreement with our previous assessment. Because of these differences and to further amplify our position concerning O-ring defect allowables, the following recommendations and justifications are restated:

(1) Inclusions - Remove all visible inclusions regardless of size or type of included material. The included material can be detached during O-ring installation and use, creating debris and probable leakage. Repair is required if the resulting void exceeds 0.025 inch diameter by 0.005 inch deep. Deeper voids create a greater risk for leakage with low compression (example: a void .015 inch deep reduces compression effect by 5.5 percent).

(2) Mold Deposit Effects, Pits, and Voids - Each defect must be treated according to defect shape. Defects having sharp edges should be treated as a notch sensitive cut and repaired if the defect exceeds 0.025 inch diameter by 0.002 inch deep. Defects having smooth shapes should be repaired if either the diameter or depth exceeds 0.025 inch and 0.005 inch, respectively.

(3) Cuts - Radial cuts other than superficial cuts (cuts which cannot be felt with the thumbnail) are not allowed and must be repaired or dispositioned by splicing or rejection. The orientation of radial cuts is such that stretching of the O-ring can cause further tearing. Cuts parallel to the O-ring longitudinal axis must not exceed 0.002 inch deep by 0.060 inch long.

(4) Repair Limitations - The limitations on maximum defect size acceptable for repair should be based on results of Thiokol's test program per TWA-11507. Deviations should be approved by EMD1.

b. Below Minimum O-Ring Compression - Prior to the static firing of OM-1 in June 1977, shims were installed in the clevis joints to stop seal leakage caused by tang distortion. Shims of various thicknesses (0.010 to 0.031 in.) were placed around two of the joints according to gap width available (with some exceptions). No leaks were apparent during the test; however, the cavity pressure measurement on clevis joint number 5 (see enclosure 4) showed peculiar behavior (negative pressure to +8.3 psig). Calculations performed by MSFC and agreed to by Thiokol show that distortion of the clevis joint tang for any joint can be sufficient to cause O-ring/tang separation. Data from OM-1 shows that this condition can be created by joint movement (lowering of support chocks) and data from the hydroburst test shows the tang and clevis do not remain concentric during pressure cycling. All situations which could create tang distortion are not known, nor is the magnitude of movement known. Regardless of these unknowns, Thiokol then proposed to use a standard 0.020 inch thick shim for all SRM clevis joints including the STA-1 vehicle (see enclosure 5). Subsequent to arrival of the STA-1 vehicle at MSFC, Structures and Propulsion Laboratory was asked to assess the adequacy of the 0.020 inch shims which had been installed by Thiokol. The response, documented by memorandum EPO1 (77-252) (see enclosure 5) recommended shim sizes ranging from 0.034 inch to 0.046 inch thick in order to maintain the industry recommended minimum compression value of 15 percent. It was, and still is, our desire to test with 15 percent minimum compression since this value is the industry wide minimum and was originally the minimum design value used by Thiokol prior to the tang distortion problem.

After issuance of the Structures and Propulsion Laboratory recommendations, an EES1 decision was made to use a 0.015 inch thick shim in the field joint of STA-1 which results in a minimum compression value of approximately 5.5 percent. This value assumes no compression set. We strongly object to this proposal because it creates unacceptable risks which can and should be avoided.

ORIGINAL PAGE IS  
OF POOR QUALITY

Calculations conducted by this office show that in some instances, O-ring compression on flight vehicles has the potential of being negative by approximately 1.5 percent; these calculations included the effect of O-ring compression set. This test report dated August 15, 1977, per TWR-11507, "O-ring repair verification test plan" (see enclosure 7) shows that the parent O-ring material and splice joints exhibited maximum compression sets of 5.8 and 7.0 percent, respectively. Also, when considering that the SRM process demonstration segment O-ring suffered a compression set value of approximately 11.0 percent, one must treat these values as realistic and include their effects when calculating O-ring compression. It is recognized that O-rings will perform properly at lower values than the 15 to 25 percent range recommended; however, the higher values are used as a design point in order to account for losses such as O-ring compression set and defects in the hardware sealing surfaces and O-rings. Our recommendations to redesign on-coming hardware and custom shim each joint (with a range) on existing hardware as presented to you in October 1977, is still valid (see enclosure 8). The following recommendations and justifications are considered mandatory to provide adequate clevis joint sealing on all SRMs.

- (1) Reshim STA-1 to obtain a minimum compression value of 15 percent in order to verify the design for flight.
- (2) Redesign clevis joints on all on-coming hardware at the earliest possible effectivity to preclude unacceptable, high risk, O-ring compression values. This will eventually negate the use of shims, thereby reducing assembly time and eliminating shimming errors.
- (3) Continue to use shims with existing and sized hardware. Shims should be of sufficient thickness to provide a minimum O-ring compression of 15 percent. This value is used and recommended by Parker, Precision, CSD (Titan), Aerojet, and MSFC Science and Engineering Laboratories. We know of no instance where lower values are recommended.
- (4) Direct the prime contractor and booster assembly contractor to reinstate the design requirements of 15 to 25 percent compression for clevis joint O-rings. We see no valid reason for not designing to accepted standards.

In summary, we believe that the facts presented in the preceding paragraphs should receive your most urgent attention. Proper shim sizing and high quality O-rings are mandatory to prevent hot gas leaks and resulting catastrophic failure. We will be pleased to provide assistance in any way possible.

Questions concerning the contents of this memorandum should be referred to Mr. W. L. Ray, 3-0459;

*John Q. Miller*  
John Q. Miller  
Chief, Solid Motor Branch

6 Enclosures

cc: w/o ENG.  
EP01/Mr. McCool  
EP41/Mr. Hopson  
EP21/Mr. Lombardo

George C. Marshall Space Flight Center  
Marshall Space Flight Center, Alabama  
35812

EP25 (79-13)

January 19, 1979

TO: EE51/Mr. Eudy  
FROM: EP25/Mr. Miller  
SUBJECT: Evaluation of SRM Clevis Joint Behavior

As requested by your memorandum, EE51 (79-10), Thiokol documents TWR-12019 and letter 7000/ED-78-484 have been reevaluated. We find the Thiokol position regarding design adequacy of the clevis joint to be completely unacceptable for the following reasons:

a. The large sealing surface gap created by excessive tang/clevis relative movement causes the primary O-ring seal to extrude into the gap, forcing the seal to function in a way which violates industry and Government O-ring application practices.

b. Excessive tang/clevis movement as explained above also allows the secondary O-ring seal to become completely disengaged from its sealing surface on the tang.

c. Contract End Item Specification, CPW1-2500D, page I-28, paragraph 3.2.1.2 requires that the integrity of all high pressure case seals be verifiable; the clevis joint secondary O-ring seal has been verified by tests to be unsatisfactory.

Questions or comments concerning this memorandum should be referred to Mr. William L. Ray, 3-0459.



John Q. Miller  
Chief, Solid Motor Branch

cc:  
SA41/Messrs. Hardy/Rice  
EE51/Mr. Uptagrafft  
EH02/Mr. Key  
EP01/Mr. McCool  
EP42/Mr. Bianca  
EP21/Mr. Lombardo  
EP25/Mr. Powers  
EP25/Mr. Ray

This memorandum, also written by Leon Ray and signed by John Q. Miller, strongly questions the clevis joint design. It is the earliest known official document which questions the redundancy of the seal.

George C. Marshall Space Flight Center  
Marshall Space Flight Center, Alabama  
35812

Reply to Attn of: EP25 (79-23)

February 6, 1979

**TO:** Distribution  
**FROM:** EP25/Mr. Ray  
**SUBJECT:** Visit to Precision Rubber Products Corporation and  
Parker Seal Company

The purpose of this memorandum is to document the results of a visit to Precision Rubber Products Corporation, Lebanon, TN, by Mr. Eudy, EE51 and Mr. Ray, EP25, on February 1, 1979 and also to inform you of the visit made to Parker Seal Company, Lexington, KY on February 2, 1979 by Mr. Ray. The purpose of the visits was to present the O-ring seal manufacturers with data concerning the large O-ring extrusion gaps being experienced on the Space Shuttle Solid Rocket Motor clevis joints and to seek opinions regarding potential risks involved.

The visit on February 1, 1979, to Precision Rubber Products Corporation by Mr. Eudy and Mr. Ray was very well received. Company officials, Mr. Howard Gillette, Vice President for Technical Direction, Mr. John Hoover, Vice President for Engineering, and Mr. Gene Hale, Design Engineer attended the meeting and were presented with the SRM clevis joint seal test data by Mr. Eudy and Mr. Ray. After considerable discussion, company representatives declined to make immediate recommendations because of the need for more time to study the data. They did, however, voice concern for the design, stating that the SRM O-ring extrusion gap was larger than that covered by their experience. They also stated that more tests should be performed with the present design. Mr. Hoover promised to contact MSFC for further discussions within a few days. Mr. Gillette provided Mr. Eudy and Mr. Ray with the names of two consultants who may be able to help. We are indebted to the Precision Rubber Products Corporation for the time and effort being expended by their people in support of this problem, especially since they have no connection with the project.

The visit to the Parker Seal Company on February 2, 1979, by Mr. Ray, EP25, was also well received; Parker Seal Company supplies the O-rings used in the SRM clevis joint design. Parker representatives, Mr. Bill Collins, Vice President for Sales, Mr. W. B. Green, Manager for Technical Services, Mr. J. W. Kosty, Chief Development Engineer for R&D, Mr. D. P. Thalman, Territory Manager and Mr. Dutch Haddock, Technical Services, met with Mr. Ray, EP25, and were provided with the identical

page 1

This Leon Ray memorandum documents his visits to two O-ring manufacturers, both of whom expressed concern relative to the O-ring performing properly in the joint design.



SRM clevis joint data as was presented to the Precision Rubber Products Company on February 1, 1979. Reaction to the data by Parker officials was essentially the same as that by Precision; the SRM O-ring extrusion gap is larger than they have previously experienced. They also expressed surprise that the seal had performed so well in the present application. Parker experts would make no official statements concerning reliability and potential risk factors associated with the present design; however, their first thought was that the O-ring was being asked to perform beyond its intended design and that a different type of seal should be considered. The need for additional testing of the present design was also discussed and it was agreed that tests which more closely simulate actual conditions should be done. Parker officials will study the data in more detail with other Company experts and contact MSFC for further discussions in approximately one week. Parker Seal has shown a serious interest in assisting MSFC with this problem and their efforts are very much appreciated.

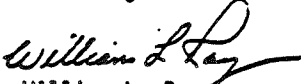

William L. Ray  
Solid Motor Branch, EP25

Distribution:  
SA41/Messrs. Hardy/Rice  
EE51/Mr. Eudy  
EP01/Mr. McCool

Documents relating to the change from Criticality 1R to 1, and the waiver of the redundancy requirements for the Solid Rocket Motor seal

SRB CRITICAL ITEMS LIST	
System: <u>SOLID ROCKET MOTOR</u>	Criticality Category <u>1R</u> Reaction Time <u>Integrate to sec.</u>
Item Case: <u>10-01-01</u> Case, P/N <u>1U50129, 1U50131, 1U50130, 1U50169, 1U50185,</u> Item Name: <u>1U51473 (Joint Assys, Factory P/N 1U51758, Field: 1U50747)</u>	Page: <u>A-35</u> Revision: _____
No. Required: <u>1 (11 segments)</u> PMSA Page No.: <u>A-4 of MSFC-RPT-724</u> Critical Phase: <u>Boost</u>	Date: <u>November 24, 1980</u> Analyst: <u>Moskins</u> Approved: _____
Failure Mode & Cause: <u>Leakage at case assembly joints due to redundant O-ring seal failures or primary seal and leak check port O-ring failure.</u>	
Failure Effect Summary: <u>Actual Loss - Loss of mission, vehicle, and crew due to metal erosion, burnthrough, and probable case burst resulting in fire and deflagration.</u>	
Redundancy Screens & Measurements 1) Fail - Leak test does not verify integrity of leak check port seal. 2) Fail - Not tested. 3) Pass - No known credible causes.	
RATIONALE FOR RETENTION	
<p><b>A. DESIGN</b></p> <p>- Each O-ring of the redundant pair is designed to effect a seal. The design is based upon similar single seal joints used in previous large diameter, segmented motor cases.</p> <p>A small MS port leading to the annular cavity between the redundant seals permits a leak check of the seals immediately after joining segments. The MS plug, installed after leak test, has a retaining groove and compression face for its O-ring seal. A means to test the seal of the installed MS plug has not been established.</p> <p>The surface finish requirement for the O-ring grooves is 63 and the finish of the O-ring contacting portion of the tang, which slides across the O-ring during joint assembly, is 32. The joint design provides an OD for the O-ring installation, which facilitates retention during joint assembly. The entry portion of the tang provides 0.125-inch standoff from the O-rings contact portion of the tang during joint assembly. The design drawing specifies O-ring lubricant prior to the installation. The factory assembled joints (Dwg. 1U51768) have an additional seal provided by the subsequently applied internal case insulation.</p> <p>The field assembled joints (Dwg. 1U50747) and factory assembled joints (Dwg. 1U51768) benefit from the increased O-ring compression resulting from the centering effect of shims of .032-.036 inches between the tang O.D. and clevis I.D. of the case joint. However, redundancy of the secondary field joint seal cannot be verified after motor case pressure reaches approximately 40% MECP. It is known that joint rotation occurring at this pressure level with a resulting enlarged extrusion gap causes the secondary O-ring to lose compression as a seal. It is not known if the secondary O-ring would successfully re-seal if the primary O-ring should fail after motor case pressure reaches or exceeds 40% MECP.</p> <p>The O-ring for the case joint and test port are mold formed of high temperature, compression set resistant, fluorocarbon elastomer. The design permits five scarf joints for the case joint seal. The O-ring joint strength must equal or exceed 40% of the parent material strength.</p> <p><b>B. TESTING</b></p> <p>A full scale clevis joint test verified the structural strength of the case and pins (TAR-1C547). A hydroburst life cycle test (TAR-11564) demonstrated the primary seal's ability to withstand four times the flight requirement of one pressurization cycle and the secondary seal's ability to continue to seal under repeated cycling (54 cycles) with the primary seal failed. The joint seals withstood ultimate pressure of 1683 psi during the burst tests, yielding a safety factor of 1.58. The Structural Test Article (STA-1) verified the seals capability under flight loads and further verified the redundancy of the secondary seal.</p> <p>The joint seals have performed successfully in four developmental and three qualification motor static firings.</p>	

This original Critical Items List entry for the Solid Rocket Motor case joint seals establishes them as Criticality 1R (redundant).

# SRB CRITICAL ITEMS LIST

Sheet 2 of 2

Subsystem: <u>SOLID ROCKET MOTOR</u>	Criticality: <u>1R</u> Reaction Time: <u>Immediate to Sec.</u>
Item Code: <u>10-01-01</u> Case, P/N: <u>1U50129, 1U50131, 1U50130, 1U50169, 1U50155,</u> Item Name: <u>1U51473 (Joint Assys. Factory, P/N 1U51768, Field: 1U50747)</u>	Page: <u>A-2E</u> Revision: _____

## RATIONALE FOR RETENTION (CONT'D)

A lightweight case joint verification test (TWR-12690) has demonstrated the secondary seal performance with a purposely pre-failed primary O-ring and demonstrated three pressure cycles on the primary seal with one cycle to 1.40 times maximum expected operating pressure.

### C. INSPECTION

The tang -A- dia. and clevis -C- dia. are measured and recorded. These diameters control the radial spacing between tang and clevis. The depth, width and surface finish of the O-ring grooves are verified. The segment finish of the tang is also verified. The O-ring seal mating surfaces of the forward and aft segments are verified for flatness and surface finish. The following characteristics are inspected on each O-ring to assure conformance to the standards.

- o Surface voids and inclusions
- o Mold flashing
- o Scarf joint mismatch or separation
- o Cross section
- o Circumference

Each assembled joint seal is tested per STN7-2747 via pressurizing the annular cavity between seals to 50 ± 5 psi and monitoring for 10 minutes. A seal seating pressure of 220 psi, with return to 0 psig, may be used prior to the test. A pressure decay of 1 psig or greater is not acceptable. Following seal verification by QC, the leak test port plug is installed with QC verifying installation and torquing.

### D. FAILURE HISTORY

- No known record of failure due to case joint seal leakage on segmented 156° or Titan IIIC motors.
- No failures in the four development and three qualification SRM motor test firings.

ORIGINAL PAGE IS  
OF POOR QUALITY

# SRB CRITICAL ITEMS LIST

Sheet: 1 of 2

CR  
22  
Add

<b>Subsystem</b> <u>SOLID ROCKET BOOSTER</u>	<b>Criticality Category</b> <u>1</u> <b>Reaction Time</b> <u>Immediate to Sec.</u>
<b>Item Code</b> <u>10-01-01</u>	<b>Page</b> <u>A-6A</u>
<b>Case, P/N (See Retention Rationale)</b> <b>Item Name (Joint Assys. Factory P/N IUS0147 Field: IUS0747)</b>	<b>Revision</b> _____
<b>No. Occured</b> <u>1 (11 segments, 3 field joints, 7 plant joints)</u>	<b>Date</b> <u>December 17, 1982</u>
<b>ROEA Para No.</b> <u>A-4 of MSFC-RPT-724</u>	<b>Analyst</b> <u>GARBER</u>
<b>Critical Phase</b> <u>Boost</u>	<b>Approved:</b> 
<b>Forum Mode &amp; Cause</b> <u>Leakage at case assembly joints due to redundant O-ring seal failures or primary seal and leak check port O-ring failure.</u>	
<b>NOTE:</b> Leakage of the primary O-ring seal is classified as a single failure point due to possibility of loss of sealing at the secondary O-ring because of joint rotation after motor pressurization.	
<b>Failure Effect Summary</b> <u>Actual Loss - Loss of mission, vehicle, and crew due to metal erosion, burnthrough, and probable case burst resulting in fire and deflagration.</u>	

## RATIONALE FOR RETENTION

Case, P/N IUS0129, IUS0131, IUS0130, IUS0185, ~~IUS0147~~, IUS0715, IUS0716, IUS0717  
IUS0473

### A. DESIGN

The SRM case joint design is common in the lightweight and regular weight cases having identical dimensions. The SRM joint uses centering clips which are installed in the gap between the tang O.D. and the outside clevis leg to compensate for the loss of concentricity due to gathering and to reduce the total clevis gap which has been provided for ease of assembly. On the shuttle SRM, the secondary O-ring was designed to provide redundancy and to permit a leak check, ensuring proper installation of the O-rings. Full redundancy exists at the moment of initial pressurization. However, test data shows that a phenomenon called joint rotation occurs as the pressure rises, opening up the O-ring extrusion gap and permitting the energized O-ring to protrude into the gap. This condition has been shown by test to be well within that required for safe primary O-ring sealing. This gap may, however, in some cases, increase sufficiently to cause the un-energized secondary O-ring seal to lose compression, raising question as to its ability to energize and seal if called upon to do so by primary seal failure. Since, under this latter condition only the single O-ring is sealing, a rationale for retention is provided for the simplex mode where only one O-ring is acting.

The surface finish requirement for the O-ring grooves is 63 and the finish of the O-ring contacting portion of the tang, which slides across the O-ring during joint assembly, is 32. The joint design provides an OD for the O-ring installation, which facilitates retention during joint assembly. The tang has a large shallow angle chamfer on the tip to prevent the cutting of the O-ring at assembly. The design drawing specifies application of O-ring lubricant prior to the installation. The factory assembled joints have MSR rubber material vulcanized across the internal joint faying surfaces as a part of the case internal insulation subsystem.

A small MS port leading to the annular cavity between the redundant seals permits a leak check of the seals immediately after joining segments. The MS plug, installed after leak test, has a retaining groove and compression face for its O-ring seal. A means to test the seal of the installed MS plug has not been established.

The O-rings for the case joints are mold formed and ground to close <sup>of</sup> tolerance and the O-rings for the test port are mold formed to net dimensions. Both O-rings are made for high temperature, low compression set fluorocarbon elastomer. The design permits five scarf joints for the case joint seal rings. The O-ring joint strength must equal or exceed 40% of the parent material strength.

### B. TESTING

To date, eight static firings and five flights have resulted in 180 (54 field and 126 factory) joints tested with no evidence of leakage. The Titan III program using a similar joint concept has tested a total of 1076 joints successfully.

In late 1982, Marshall Safety, Reliability and Quality Assurance engineers reviewed test and analysis results and determined that the case joints should be reclassified as Criticality 1 (not redundant). This form was signed by Maurice (Bud) Parker, a local Thiokol Reliability engineer, beginning the process of management approval of the Criticality change.

# SRB CRITICAL ITEMS LIST

Sheet 2 of 2

CY  
23  
Add

Subsystem: <u>SOLID ROCKET BOOSTER</u>	Criticality Category <u>1</u> Reaction Time <u>Immediate to Ser.</u>
Item Code: <u>10-01-01</u> *Case, P/N (See Retention Rationale) Item Name: <u>(Joint Assys. Factory P/N 1150747 Field: 1150747)</u>	Page: <u>A-6B</u> Revision: _____

### RATIONALE FOR RETENTION (CONT'D)

A laboratory test program demonstrated the ability of the O-ring to operate successfully when extruded into gaps well over those encountered in this O-ring application. Uniform gaps of 1/8-inch and over (TWR-13406) successfully withstood pressures of 1600 psi. The Hydroburst Program (TWR-11664) and the Structural Test Program (STA-1) for the standard weight case (TWR-12051) and the Lightweight Case Joint Certification Test (TWR-12829) all have shown that the O-ring can withstand a minimum of four pressurizations before damage to the ring can permit any leakage.

Further demonstration of the capability of joint sealing is found in the hydro-proof testing of new and refurbished case segments. Over 540 joints have been exposed to liquid pressurizations at levels exceeding motor MEDP with no leakage experienced past the primary O-ring. The only occasions where leakage was experienced was during refurbishment of STS-1 where two stiffener segments were severely damaged during cavity collapse at water impact.

A more detailed description of SRM joint testing history is contained in TWR-13520, Revision A.

**C. INSPECTION**

The tang -A- diameter and clevis -C- diameter are measured and recorded. The depth, width and surface finish of the O-rings grooves are verified. The surface finish of the tang is also verified. Characteristics are inspected on each O-ring to assure conformance to the standards to include:

- o Surface conditions
- o Mold flashing
- o Scarf joint mismatch or separation
- o Cross section
- o Circumference
- o Diameter

Each assembled joint seal is tested per STM7-2747 via pressurizing the annular cavity between seals to 50 ± 5 psi and monitoring for 10 minutes. A pressure decay of 1 psig or greater is not acceptable. Following seal verification by QC, the leak test port plug is installed with QC verifying installation and torquing.

**D. FAILURE HISTORY**

No failures have been experienced in the static firing of three qualification motors, five development motors and ten flight motors.

ORIGINAL PAGE IS  
OF POOR QUALITY

FORM NO. (10-8161)	2. CONFIGURATION CONTROL BOARD SRB LEVEL III	3. DATE: 1-21-83
CHANGE NO.: EL54-0141		4. PAGE 1 OF 1
PROGRAM CONTROL NO.: 77761	5. RESPONSIBLE INDIVIDUAL(S)/ORGANIZATION(S): W. Trehitt/EL54 IULT	

CHANGE TITLE:  
SRB and RSCD System CIL  
Change Notice No. 23

UNDER THE AUTHORITY OF CHANGE ORDER 347 TO  
CONTRACT NASS-32000, USBI IS HEREBY AUTHORIZED  
TO INCORPORATE THE REQUIREMENTS OF  
CHANGE EL 54-0141 *John J. Strickland*  
SA43 *J. J. Strickland*

6. EFFECTIVITY:  
A17 thru A18; STS-6

MSFC-RPT-725

CHANGE DISPOSITION: DOCUMENTATION CHANGE

- ECR EL54-0141 is approved with changes
- a. Page A-6A - A. DESIGN - Forward first part of paragraph 1.
  - b. Page A-6A - A. DESIGN - Paragraph 4 reworded.
  - c. Page A-6A - B. TESTING - Paragraph 1 reworded.
  - d. Page A-6B - B. TESTING - Paragraph 1 reworded.
  - e. Page A-6B - C. INSPECTION - Paragraph 1 reworded.
  - f. Page A-6B - D. FAILURE HISTORY - Delete the first paragraph and reword the second paragraph.
- SA43/J. M. Strickland shall take necessary action to inform USBI that ECR EL54-0141 is approved with above changes. Due Date: 2-8-83.

- EL54/W. Trehitt shall submit Change Notice No. 23 to MSFC-RPT-725 through EL65/Release Desk to MSFC Repository. Due Date: 2-8-83.
- EL54/W. Trehitt shall prepare a Level II CR and SCRG Action Request for transmittal via SCRG to Level II PRCB. Due Date: 2-8-83.
- Future correspondence shall reference PCIN 77761.

5114

CCB MEMBERS	CONCUR		CCB MEMBERS	CONCUR		14. CCB CHAIRMAN
	YES	NO		YES	NO	
111/W. P. Horton	<input checked="" type="checkbox"/>	<input type="checkbox"/>	AP44/B. Clough	<input type="checkbox"/>	<input type="checkbox"/>	<i>L. B. Mulloy</i> SA41/L. B. Mulloy
143/J. Strickland	<input checked="" type="checkbox"/>	<input type="checkbox"/>	EG03/P. Madole <i>11:7</i>	<input checked="" type="checkbox"/>	<input type="checkbox"/>	
142/L. Wear	<input checked="" type="checkbox"/>	<input type="checkbox"/>	CS11/R. Hize <i>2:11</i>	<input checked="" type="checkbox"/>	<input type="checkbox"/>	
145/V. Caruso	<input checked="" type="checkbox"/>	<input type="checkbox"/>	SA43/W. Black	<input type="checkbox"/>	<input type="checkbox"/>	
141/R. Mitchell <i>1-17-83</i>	<input checked="" type="checkbox"/>	<input type="checkbox"/>		<input type="checkbox"/>	<input type="checkbox"/>	

On January 21, 1983, the Marshall Configuration Control Board, chaired by Lawrence Mulloy, approved the change from Criticality 1R to Criticality 1 and approved it for forwarding to Level II.

PCRD NO. S22106L	SPACE SHUTTLE PROGRAM REQUIREMENTS CONTROL BOARD DIRECTIVE - LEVEL II	PAGE 1 OF 1 PCRD DATE 0
CHANGE TITLE: SRB Critical Item List (CIL) Requirements for SRM Case Joint Assemblies		
CHANGE PROPOSAL(S) NO. AND SOURCE Level II Change Request S22106L		
DOCUMENTS AFFECTED (NO., TITLE, PARA) JSC 07700, Volume X		
INITIATED BY: NSFC-EL54/W. Trammitt		
SUBMITTED BY: NSFC-S222/D. Xiley		
LEVEL II BASELINE CHANGE DIRECTION: OPP: LA/W 1c/sls		
PCRD S22106L is issued to authorize submittal of Level I Change Request N22106L for waiver of SRB critical failure modes which do not meet the redundancy requirements (paragraph 2.8) of the Space Shuttle Program Requirements Document, Level I, dated June 30, 1977.		
Effectivity: STS-6 and subs.		
Level II impacts authorized by this direction - Cost: none; Weight: none; Schedule: none.		
ACTIONS: JSC-LV: (1-1) Subsequent to Level I approval of Change Request N22106L, revise PCRD S22106L to authorize implementation and update of JSC 07700, Volume X. Action due: Upon receipt of the Level I approved Change Request. Category II		
*This PCRD was processed outside the formal Level II PCRD. In the event a discrepancy or impact is identified, implementation of this change shall be held in abeyance pending further disposition by the Level II PCRD. Such discrepancies and/or impacts shall be immediately identified to the Level II PCRD Secretary and submitted on a Level II Change Request for appropriate action within 60 days after approval of this directive.		
AUTHORIZED BY: <i>[Signature]</i> CHAIRMAN, LEVEL II PCRD	DATE: 3/26/83	CLOSE-OUT DOCUMENTATION (ENTERED BY LEVEL II PCRD SECRETARY)

PCRN S22106	SPACE TRANSPORTATION SYSTEM LEVEL I CHANGE REQUEST	PAGE 1 OF 1 ORIGINATOR LAJ/A. B. Jackson Jr.			
RELATED CHANGES S22106L	TITLE SRB Critical Items List (CIL) Requirements				
SYSTEM/ELEMENT(S) AFFECTED: // Shuttle System // System Software // Payloads // Orbiter // Crew-Related CPU // Operations // Space Shuttle Main Engines // Shuttle Carrier Aircraft // Other(Specify) // External Tank // IUS // Solid Rocket Booster // Specials // Launch and Landing					
DESCRIPTION OF CHANGE: // Mandatory // Improvement // Other(Specify) Waiver					
This change identifies Criticality 1 critical items which do not meet the fail safe requirements of Paragraph 2.8 of the Space Shuttle Program Requirements Document, Level I, dated June 30, 1977. These critical items contain 3 new items and 5 items which were previously approved Criticality 1B by Level II Change Request S021060 and are now being reclassified Criticality 1.					
SUBSYSTEM - SOLID ROCKET MOTOR					
Subsystem - Electrical and Instrumentation					
CRITICALITY	ITEM NUMBER	ITEM	AREA NO.		
1	1U50129	Leak	10-01-01		
1	1U50130		10-01-01		
1	1U50131		10-01-01		
1	1U50173		10-01-01		
1	1U50185		10-01-01		
1	1U50775		10-01-01		
1	1U50776		10-01-01		
1	1U50777		10-01-01		
RECOMMENDED EFFECTIVITY: STS-6 and subs					
WEIGHT IMPACT: None					
SCHEDULE IMPACT: None					
COST PER FLIGHT IMPACT: None					
COST	PROJECT/FT	IFT	IFT	REPAIR/DR	TOTAL
0000					
0000					
0000					
REASONS FOR CHANGE: Critical items which do not meet Level I fail-safe requirements require submittal per NASA Headquarters letter NSM-7 dated February 21, 1979, which states that all waivers to Level I redundancy requirements be submitted to the Level I PCRD for review and approval.					
FORWARDING AUTHORIZATION // Space Shuttle // Other(Specify) PCRD S22106L		SIGNATURE <i>[Signature]</i>	DATE 3/2/83		
LEVEL I ACTION X Approved Approved with Revision. See Page // Disapproved		SIGNATURE <i>[Signature]</i>	DATE 28 MAR '83		

ORIGINAL PAGE IS  
OF POOR QUALITY

After receiving written concurrence from certain Johnson organizations, Glynn Lunney, the Shuttle Program Manager, approved the Criticality change, based on a telephone conversation with Lawrence Mulloy, the Solid Rocket Booster Project Manager. This action was taken without convening a meeting of the Program Requirements Control Board. This action authorized submittal of a waiver of the "fail-safe" design requirement to Level I.

Glynn Lunney signed this request for Level I to approve for the field joint a waiver of the "fail-safe requirement" for Shuttle components, in that the joint had been reclassified as Criticality 1 (no redundancy). The waiver was approved for Level I by L. Michael Weeks on March 28, 1983.



Memoranda written following the field joint O-ring erosion on STS 41-B (flight 10)

NASA National Aeronautics and Space Administration			Routing Slip
Mail Code	Name	Action	
		Approval	
		Call me	
TO: EE01	Mr. Hardy	Concurrence	
		File	
THRU: EE11	Mr. Coates <i>JQC</i>	Information	
		Investigate and Advise	
		Note and Forward	
		Note and Return	
		Per Request	
		Per Phone Conversation	
		Recommendation	
		See me	
		Signature	
		Circulate and Destroy	

**SUBJECT: Burned O-Rings on STS-11**

The recent experience of two burned O-rings (nozzle/case boss and forward/forward center joint) on STS-11 coupled with the "missing putty" finding at disassembly raise concern with STS-13.

Specifically concern is raised about the type II Randolph zinc chromate putty (ZCP) sensitivity to humidity and temperature. The thermal design of the SRM joints depends on thermal protection of the O-ring by the ZCP. ZCP failure to provide a thermal barrier can lead to burning both O-rings and subsequent catastrophic failure. Adhesion service-life and sensitivity to temperature and humidity of the type II ZCP must be reassessed and verified in the light of recent experience. The O-ring leak check procedure and its potential effect on the ZCP installation and possible displacement is also an urgent

Mail Code	Name	Action
		Approval
		Call me
		Concurrence
		File
		Information
		Investigate and Advise
		Note and Forward
		Note and Return
		Per Request
		Per Phone Conversation
		Recommendation
		See me
		Signature
		Circulate and Destroy

concern which requires expedition of previously identified fullscale tests. Effect of cavity volume size (cavity between the ZCP and primary O-ring) on O-ring damage severity must also be assessed.

Your support in this urgent matter is requested.

*John Q. Miller*  
John Q. Miller  
Chief, Solid Motor Branch

cc:  
EH01/Mr. Schwinghamer  
EH43/Mr. Hill..  
SA41/Mr. Mulloy  
SA42/Mr. Wear  
EP01/Mr. McCool  
EP21/Mr. McCarty  
EP25/Messrs. Powers/Ray

Name	Tel. No. (or Code) & Ext.
John Q. Miller	453-3702
Code (or other designation)	Date
EP25	2/28/84

NASA FORM 28 JUN 78 PREVIOUS EDITIONS MAY BE USED.

This internal Marshall note was written by John Q. Miller after the O-ring erosion experience on STS 41-B (flight 10), indicating concern that the leak check procedures may displace putty ("blow-holes") leading to O-ring burning ("erosion"). STS 41-B was the first flight for which a 200 psi leak check stabilization pressure was used.



**UNITED  
TECHNOLOGIES**  
**UNITED SPACE  
BOOSTERS**

84-3-9

INTERNAL CORRESPONDENCE

To: Larry Mulloy  
Fm: George Morefield  
Sj: Zinc Chromate Putty in SRM Joints  
Dt: March 9, 1984  
No: GSM-042-84

Following is an elaboration of my impromptu remarks in yesterday's FRR concerning burned primary pressure vessel "O"-rings.

\* I alluded to the Titan III SRM history which is quite similar to the current STS SRM experience. Post-fire inspection of Titan SRM static test motors showed that pressurization of the single "O"-rings in the pressure vessel routinely occurred via a single break-down path across the joint putty. There was also evidence that some "O"-rings never see pressure in the Titan motor. The segment-to-segment case insulation design results in a compression butt joint which apparently is often sufficient to withstand  $P_c$ .

It should be pointed out that single point pressurization of a Titan "O"-ring annulus is a less severe event than on an STS SRM because, being a smaller diameter motor, the Titan "O"-ring plenum has less volume and comes to pressure equilibrium faster (less time to melt the "O"-ring).

The use of "lucky putty" has always been surrounded by controversy. Its use has become a given, although no one really claims it to be part of either the insulation system or the sealing system. In fact there is evidence that its use can cause problems other than forcing single-point pressurization. On the few occasions when Titan motors were destacked it was found that the high hydraulic forces associated with joint mating actually caused case insulation to peel away from the case. This is of course aggravated by the pressure of the hydraulic medium, putty, which flows into the separation as well as the "O"-ring plenum.

Your review showed that there was sufficient margin of "O"-ring remaining to do the job. I'm sure you have considered that if it does burn through, the secondary "O"-ring will then be similarly pressurized through a single port. So, some concern remains.

page 1

In this memorandum to Lawrence Mulloy, George Morefield compares the Titan joint with the Shuttle joint and assesses a higher failure probability for the Shuttle joint, indicating concern that putty may cause "single point pressurization" of the primary O-ring.

I recommend that you set up a panel to study the use of putty and consider some alternatives:

- 1) Is putty needed at all?
- 2) If the tradition can't be broken, can the putty be applied with multiple (6 or 8) pressurization paths built in?

I think that the primary seal should be allowed to work in its classical design mode. Both the Titan and STS SRM's have been designed for this not to happen. Titan has flown over a thousand pressure joints with no failure. My opinion is that the potential for failure of the joint is higher for the STS SRM, especially when occasionally the secondary seal may not be totally effective.

  
G. S. Morefield  
Chief Engineer

rp

page 2

## Marshall urgent request for briefing after the STS 51-C mission (flight 15)

TO LARRY WEAR

MESSAGE DISPL  
TO SANDY COLEMAN

FROM: Larry Mulloy  
Postmark: Jan 31, 85 7:39 AM  
Status: Certified Urgent  
Subject: 51C O-RING EROSION RE: 51E FRR

RECEIVED  
31 JAN 1985  
Joe C.  
Kilminster

Message:  
FRR DISCUSSION SHOULD RECAP ALL INCIDENTS OF O-RING EROSION, WHETHER NOZZLE OR CASE JOINT AND ALL INCIDENTS WHERE THERE IS EVIDENCE OF FLOW PAST THE PRIMARY O-RING. ALSO, THE RATIONALE USED FOR ACCEPTING THE CONDITION ON THE NOZZLE O-RING. ALSO, THE MOST PROBABLE SCENARIO AND LIMITING MECHANISM FOR FLOW PAST THE PRIMARY ON THE 51C CASE JOINTS. IF MFI DOES NOT HAVE ALL THIS FOR TODAY I WOULD LIKE TO SEE THE LOGIC ON A CHART WITH BLANKS TBD.

-----X-----

Following the discovery of the STS 51-C (flight 15) O-ring erosion and blow-by, Lawrence Mulloy sent this "Certified Urgent" message to the Solid Rocket Motor manager, Larry Wear. This message was passed on to Thiokol as direction to prepare a detailed briefing on O-ring problems for the next Flight Readiness Review.

# Internal NASA Headquarters memorandum after visit to Marshall

**NASA**

National Aeronautics and  
Space Administration  
Washington, D.C.  
20546

ORIGINAL PAGE IS  
OF POOR QUALITY

JL 17 885

MPS

**TO:** M/Associate Administrator for Space Flight  
**FROM:** MPS/Irv Davids  
**SUBJECT:** Case to Case and Nozzle to Case "O" Ring Seal Erosion Problems

As a result of the problems being incurred during flight on both case to case and nozzle to case "O" ring erosion, Mr. Hanby and I visited MSFC on July 11, 1985, to discuss this issue with both project and S&E personnel. Following are some important factors concerning these problems:

#### A. Nozzle to Case "O" ring erosion

There have been twelve (12) instances during flight where there have been some primary "O" ring erosion. In one specific case there was also erosion of the secondary "O" ring seal. There were two (2) primary "O" ring seals that were heat affected (no erosion) and two (2) cases in which soot blew by the primary seals.

The prime suspect as the cause for the erosion on the primary "O" ring seals is the type of putty used. It is Thiokol's position that during assembly, leak check, or ignition, a hole can be formed through the putty which initiates "O" ring erosion due to a jetting effect. It is important to note that after STS-10, the manufacturer of the putty went out of business and a new putty manufacturer was contracted. The new putty is believed to be more susceptible to environmental effects such as moisture which makes the putty more tacky.

There are various options being considered such as removal of putty, varying the putty configuration to prevent the jetting effect, use of a putty made by a Canadian Manufacturer which includes asbestos, and various combination of putty and grease. Thermal analysis and/or tests are underway to assess these options.

Thiokol is seriously considering the deletion of putty on the QM-5 nozzle/case joint since they believe the putty is the prime cause of the erosion. A decision on this change is planned to be made this week. I have reservations about doing it, considering the significance of the QM-5 firing in qualifying the FNC for flight.

It is important to note that the cause and effect of the putty varies. There are some MSFC personnel who are not convinced that the holes in the putty are the source of the problem but feel that it may be a reverse effect in that the hot gases may be leaking through the seal and causing the hole track in the putty.

Considering the fact that there doesn't appear to be a validated resolution as to the effect of putty, I would certainly question the wisdom in removing it on QM-5.

#### B. Case to Case "O" Ring Erosion

There have been five (5) occurrences during flight where there was primary field joint "O" ring erosion. There was one case where the secondary "O" ring was heat affected with no erosion. The erosion with the field joint primary "O" rings is considered by some to be more critical than the nozzle joint due to the fact that during the pressure build up on the primary "O" ring the unpressurized field joint secondary seal unseats due to joint rotation.

The problem with the unseating of the secondary "O" ring during joint rotation has been known for quite some time. In order to eliminate this problem on the FNC field joints a capture feature was designed which prevents the secondary seal from lifting off. During our discussions on this issue with MSFC, an action was assigned for them to identify the timing associated with the unseating of the secondary "O" ring and the seating of the primary "O" ring during rotation. How long it takes the secondary "O" ring to lift off during rotation and when in the pressure cycle it lifts are key factors in the determination of its criticality.

The present consensus is that if the primary "O" ring seats during ignition, and subsequently fails, the unseated secondary "O" ring will not serve its intended purpose as a redundant seal. However, redundancy does exist during the ignition cycle, which is the most critical time.

It is recommended that we arrange for MSFC to provide an overall briefing to you on the SRM "O" rings, including failure history, current status, and options for correcting the problems.

*Irv Davids*  
Irving Davids

cc:  
M/Mr. Weeks  
M/Mr. Hanby  
ML/Mr. Harrington  
MP/Mr. Winterhalter

This memorandum to Level I describes a visit to Marshall by Irving Davids of NASA Headquarters. Davids' visit was prompted by the nozzle O-ring problems suffered on STS 51-B (flight 17).

# Thiokol letters and memoranda written after O-ring concern escalates

**MORTON THIOKOL INC**

COMPANY PRIVATE

Wasatch Division



Interoffice Memo

31 July 1985  
2870:FY86:073

**TO:** R. K. Lund  
Vice President, Engineering

**CC:** B. C. Brinton, A. J. McDonald, L. H. Sayer, J. R. Kapp

**FROM:** R. M. Boisjoly  
Applied Mechanics - Ext. 3525

**SUBJECT:** SRM O-Ring Erosion/Potential Failure Criticality

This letter is written to insure that management is fully aware of the seriousness of the current O-Ring erosion problem in the SRM joints from an engineering standpoint.

The mistakenly accepted position on the joint problem was to fly without fear of failure and to run a series of design evaluations which would ultimately lead to a solution or at least a significant reduction of the erosion problem. This position is now drastically changed as a result of the SRM 16A nozzle joint erosion which eroded a secondary O-Ring with the primary O-Ring never sealing.

If the same scenario should occur in a field joint (and it could), then it is a jump ball as to the success or failure of the joint because the secondary O-Ring cannot respond to the clevis opening rate and may not be capable of pressurization. The result would be a catastrophe of the highest order - loss of human life.

An unofficial team (a memo defining the team and its purpose was never published) with leader was formed on 19 July 1985 and was tasked with solving the problem for both the short and long term. This unofficial team is essentially nonexistent at this time. In my opinion, the team must be officially given the responsibility and the authority to execute the work that needs to be done on a non-interference basis (full time assignment until completed).

page 1

Roger Boisjoly's first attempt after STS 51-B (flight 17) to convince his management of the seriousness of the O-ring erosion problem.

R. K. Lund

31 July 1985

It is my honest and very real fear that if we do not take immediate action to dedicate a team to solve the problem with the field joint having the number one priority, then we stand in jeopardy of losing a flight along with all the launch pad facilities.



R. M. Boisjoly

Concurred by:

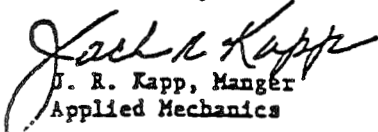
  
J. R. Kapp, Manager  
Applied Mechanics

COMPANY PRIVATE

# MORTON THIOKOL INC

Wasatch Division



Interoffice Memo

2871:FY86:141  
22 August 1985

TO: S.R. Stein,  
Project Engineer

CC: J.R. Kapp, K.M. Sperry, B.G. Russell, R.V. Ebeling, H.H. McIntosh,  
R.M. Boisjoly, M. Salita D.M. Ketner

FROM: A.R. Thompson, Supervisor  
Structures Design

SUBJECT: SRM Flight Seal Recommendation

The O-ring seal problem has lately become acute. Solutions, both long and short term are being sought, in the mean time flights are continuing. It is my recommendation that a near term solution be incorporated for flights following STS-27 which is currently scheduled for 24 August 1985. The near term solution uses the maximum possible shim thickness and a  $.292 +.005/-.003$  inch dia O-ring. The results of these two changes are shown in Table 1. A great deal of effort will be required to incorporate these changes. However, as shown in the Table the O-ring squeeze is nearly doubled for the example (STS-27A). A best effort should be made to include a max shim kit and the  $.292$  dia O-ring as soon as is practical. Much of the initial blow-by during O-ring sealing is controlled by O-ring squeeze. Also more sacrificial O-ring material is available to protect the sealed portion of the O-ring. The added cross-sectional area of the  $.292$  dia O-ring will help the resilience response by added pressure from the groove side wall.

Several long term solutions look good; but, several years are required to incorporate some of them. The simple short term measures should be taken to reduce flight risks.

  
A.R. Thompson

ART/jh

TC 2018 REV 7-841

In this memorandum to S.R. Stein, A.R. Thompson indicates the O-ring seal problem is acute and short-term measures should be taken to reduce flight risk.



**MORTON THIOKOL INC**

Wasatch Division



## Interoffice Memo

1 October 1985  
E150/RVE-86-47

**TO:** A. J. McDonald, Director  
Solid Rocket Motor Project

**FROM:** Manager, SRM Ignition System, Final Assembly, Special Projects and Ground Test

**CC:** B. McDougall, B. Russell, J. McCluskey, D. Cooper, J. Kilminster, B. Brinton, T. O'Grady, B. MacBeth, J. Sutton, J. Elwell, I. Adams, F. Call, J. Lamere, P. Ross, D. Fullmer, E. Bailey, D. Smith, L. Bailey, B. Kuchek, Q. Eskelsen, P. Petty, J. McCall

**SUBJECT:** Weekly Activity Report  
1 October 1985

EXECUTIVE SUMMARY

HELP! The seal task force is constantly being delayed by every possible means. People are quoting policy and systems without work-around. MSFC is correct in stating that we do not know how to run a development program.

GROUND TEST

1. The two (2) GTM center segments were received at T-24 last week. Optical measurements are being taken. Significant work has to be done to clean up the joints. It should be noted that when necessary SICBM takes priority.
2. The DM-6 test report less composite section was released last week.

ELECTRICAL

As a result of the latest engineering analysis of the V-1 case it appears that high stress risers to the case are created by the phenolic DFI housings and fairings. As it presently stands, these will probably have to be modified or removed and if removed will have to be replaced. This could have an impact on the launch schedule.

A. J. McDonald, Director  
1 October 1985  
E150/RVE-86-47  
Page 2

FINAL ASSEMBLY

One SRM 25 and two SRM 26 segments along with two SRM 24 exit cones were completed during this period. Only three segments are presently in work. Availability of igniter components, nozzles and systems tunnel tooling are the present constraining factors in the final assembly area.

IGNITION SYSTEM

1. Engineering is currently rewriting igniter gask-o-seal coating requirements to allow minor flaws and scratches. Bare metal areas will be coated with a thin film of HD-2 grease. Approval is expected within the week.
2. Safe and Arm Device component deliveries is beginning to cause concern. There are five SIA's at KSC on the shelf. Procurement, Program Office representatives visited Consolidated Controls to discuss accelerating scheduled deliveries. CCC has promised 10 A&M's and 30 B-B's no later than 31 October 1985.

O-RINGS AND PUTTY

1. The short stack finally went together after repeated attempts, but one of the o-rings was cut. Efforts to separate the joint were stopped because some do not think they will work. Engineering is designing tools to separate the pieces. The prints should be released tomorrow.
2. The inert segments are at T-24 and are undergoing inspection.
3. The hot flow test rig is in design, which is proving to be difficult. Engineering is planning release of these prints Wednesday or Thursday.
4. Various potential filler materials are on order such as carbon, graphite, quartz, and silica fiber braids; and different putties. They will all be tried in hot flow tests and full scale assembly tests.
5. The allegiance to the o-ring investigation task force is very limited to a group of engineers numbering 8-10. Our assigned people in manufacturing and quality have the desire, but are encumbered with other significant work. Others in manufacturing, quality, procurement who are not involved directly, but whose help we need, are generating plenty of resistance. We are creating more instructional paper than engineering data. We wish we could get action by verbal request but such is not the case. This is a red flag.

R. V. Ebeling

ORIGINAL PAGE IS  
OF POOR QUALITY

In this weekly activity report, Robert Ebeling attempts ("Help!") to draw management attention to the difficulties experienced by the seal task force in getting adequate support, indicating "This is a red flag."

MORTON THIOKOL INC

Wasatch Operations

Interoffice Memo

1 October 1985  
ORTF-FYSG-M002

TO: R. K. Lund, Vice President, Engineering  
A. J. McDonald, Director, Space Booster Programs  
B. C. Brinton, Manager, Project Engineering  
A. W. MacBeth, Manager, Project Engineering  
O-Ring Investigation Task Force Members

FROM: S. R. Stein  
Space Booster Project Engineering

SUBJECT: Potency of O-Ring Investigation Task Force

The task force for investigation of O-ring erosion and related joint problems has now existed for more than a month. We are finally getting enough people aware of our efforts so that in some areas we are receiving full cooperation. In other areas however, it is truly a struggle to get work performed. The O-Ring firing, VLS-1 launch, and safety of every other shuttle launch are all directly related to the work currently underway. Unless drastic improvements in the potency of the task force are realized, the time required to complete the necessary investigations, testing, and analytical work will not support a desirable schedule.

We are currently being hog-tied by paperwork every time we try to accomplish anything. I understand that for production programs, the paperwork is necessary. However, for a priority, short schedule investigation, it makes accomplishment of our goals in a timely manner extremely difficult, if not impossible. We need the authority to bypass some of the paperwork jungle. As a representative example of problems and time that could easily be eliminated, consider assembly or disassembly of test hardware by manufacturing personnel.

Currently an AO must be generated, which triggers the manufacturing engineer to generate detailed planning. Once the planning is released, we must go to scheduling, who puts us on the list of priority work to do. We then wait until our job reaches the top of the list, and a crew begins the work. If any problems arise, we get tangled in more paperwork. In recent operations, we have had full cooperation from all involved parties, but getting all the procedures lined up takes too long. We need the authority to have a "team" formed which could include a Design Engineer, Manufacturing Engineer, Quality Engineer, Safety Engineer, and the Foreman. The crew should perform the work as directed by the team. Paperwork to describe each step in detail should not be necessary. The team engineers should be allowed to take responsibility for the work.

Distribution  
1 October 1985  
Page two

I know the established paperwork procedures can be violated if someone with enough authority dictates it. We did that with the DR system when the FWC hardware "Tiger Team" was established. If changes are not made to allow us to accomplish work in a reasonable amount of time, then the O-ring investigation task force will never have the potency necessary to resolve the problems in a timely manner.

  
S. R. Stein

S.R. Stein echoes the concerns about the seal task force not getting full support.

## ACTIVITY REPORT

The team generally has been experiencing trouble from the business as usual attitude from supporting organizations. Part of this is due to lack of understanding of how important this task team activity is and the rest is due to pure operating procedure inertia which prevents timely results to a specific request.

The team met with Joe Kilminster on 10/3/85 to discuss this problem. He wanted specific examples which he was given and he simply concluded that it was every team members responsibility to flag problems that occurred to organizational supervision and work to remove the road block by getting the required support to solve the problem. The problem was further explained to require almost full time nursing of each task to insure it is taken to completion by a support group. Joe simply agreed and said we should then nurse every task we have.

He plain doesn't understand that there are not enough people to do that kind of nursing of each task, but he doesn't seem to mind directing that the task never-the-less gets done. For example, the team just found out that when we submit a request to purchase an item, that it goes through approximately 6 to 8 people before a purchase order is written and the item actually ordered.

The vendors we are working with on seals and spacer rings have responded to our requests in a timely manner yet we (MTI) cannot get a purchase order to them in a timely manner. Our lab has been waiting for a function generator since 9-25-85. The paperwork authorizing the purchase was finished by engineering on 9-24-85 and placed into the system. We have yet to receive the requested item. This type of

page 1

In this activity report, Roger Boisjoly expresses his frustration with the slow progress of and lack of management attention to the seal task force.

example is typical and results in lost resources that had been planned to do test work for us in a timely manner.

I for one resent working at full capacity all week long and then being required to support activity on the weekend that could have been accomplished during the week. I might add that even NASA perceives that the team is being blocked in its engineering efforts to accomplish its tasks. NASA is sending an engineering representative to stay with us starting Oct 14th. We feel that this is the direct result of their feeling that we (MTI) are not responding quickly enough on the seal problem.

I should add that several of the team members requested that we be given a specific manufacturing engineer, quality engineer, safety engineer and 4 to 6 technicians to allow us to do our tests on a non-interference basis with the rest of the system. This request was deemed not necessary when Joe decided that the nursing of the task approach was directed.

Finally, the basic problem boils down to the fact that ALL MTI problems have #1 priority and that upper management apparently feels that the SRM program is ours for sure and the customer be damned.

  
Roger Boisjoly 10/4/85

Marshall internal memorandum in the fall of 1985

Space Administration

George C. Marshall Space Flight Center  
Marshall Space Flight Center, Alabama  
35812

ORIGINAL PAGE IS  
OF POOR QUALITY

*100*

SEP 5 1985

Reply to Ann of: EA01

TO: SA41/L. M. Mulloy  
FROM: EA01/J. E. Kingsbury  
SUBJECT: O-ring Joint Seals

I am most anxious to be briefed on plans for improving the SRM O-ring seals. Specifically, I want to review plans which lead to flight qualifications and the attendant schedules. I have been apprised of general ongoing activities but these do not appear to carry the priority which I attach to this situation. I consider the o-ring seal problem on the SRM to require priority attention of both Morton Thiokol/Wasatch and MSFC. Please arrange such a briefing no later than September 13, 1985. From my point of view, this can be accomplished by telecon with Morton Thiokol. I would hope such a briefing could be done in two hours or less.

*J. E. Kingsbury*  
J. E. Kingsbury  
Director  
Science and Engineering

cc:  
SA01/Mr. Lindstrom  
SA01/Dr. Lovingood  
EA01/Mr. Hardy  
EE01/Dr. Little 4201/600  
EE11/Mr. Horton  
EPO1/Mr. McCool  
EH01/Mr. Schwinghamer

EE01 Rec'd SEP 5 1985  
Action/ \_\_\_\_\_  
Suspense \_\_\_\_\_  
File 2503  
Copies to Dr. Little  
\_\_\_\_\_  
\_\_\_\_\_

cc  
(EE11/Mr. Smith)

In this memorandum, J. E. Kingsbury informs Lawrence Mulloy that he places high priority on the O-ring seal problem and desires additional information on plans for improving the situation.