

General Disclaimer

One or more of the Following Statements may affect this Document

- This document has been reproduced from the best copy furnished by the organizational source. It is being released in the interest of making available as much information as possible.
- This document may contain data, which exceeds the sheet parameters. It was furnished in this condition by the organizational source and is the best copy available.
- This document may contain tone-on-tone or color graphs, charts and/or pictures, which have been reproduced in black and white.
- This document is paginated as submitted by the original source.
- Portions of this document are not fully legible due to the historical nature of some of the material. However, it is the best reproduction available from the original submission.

79 pages
IN-11575

AR 86-3

Aeronautical Report 86-3

DE-ICING OF THE ALTITUDE WIND TUNNEL TURNING VANES BY ELECTRO-MAGNETIC IMPULSE

by

Glen W. Zumwalt

and

Richard Ross

Aeronautical Engineering Department

Wichita State University

Wichita, Kansas 67208

NO 802171

Final Report

for

NASA Lewis Research Center (NAG 3-607)

NASA Technical Monitor: Roger Svehla

March 1986

(NASA-CR-177260) DE-ICING OF THE ALTITUDE
WIND TUNNEL TURNING VANES BY
ELECTRO-MAGNETIC IMPULSE Final Report
(Wichita State Univ.) 79 p HC A05/MF A01

N86-27291

CSSL 14B G3/09

Unclas
43230

ABSTRACT

DE-ICING OF THE ALTITUDE WIND-TUNNEL TURNING VANES BY ELECTRO-MAGNETIC IMPULSE

This is the Final Technical Report for research and development work done under Grant No. NAG 3-607 from the NASA Lewis Research Center to Wichita State University. The period of the Grant was 16 January, 1985, to 15 January, 1986. The NASA technical monitor was Mr. Roger Svehla and the principal investigator was Professor Glen W. Zumwalt.

The Altitude Wind Tunnel at the NASA-Lewis facility in Cleveland, Ohio, is being proposed for a refurbishment and modernization. Two major changes are (1) the increasing of the test section Mach number to 0.90 and (2) the addition of spray nozzles to provide simulation of flight in icing clouds. Features to be retained are the simulation of atmospheric temperature and pressure to 50,000 foot altitude and provision for full-scale aircraft engine operation by the exhausting of the aircraft combustion gases and ingestion of air to replace that used in combustion.

The first change required a re-design of the turning vanes in the two corners downstream of the test section due to the higher Mach number at the corners. The second change threatens the operation of the turning vanes by the expected ice build-up, particularly on the first-corner vanes. De-icing by heat has two drawbacks: (1) an extremely large amount of heat is required and (2) the melted ice would tend to collect as ice on some other surfaces in the tunnel, namely, the tunnel propellers and the cooling coils. An alternate de-icing method had been under development for three years under NASA-Lewis grants to The Wichita State University.

This report describes the Electro-Impulse De-Icing method and the testing work done to assess its applicability to wind tunnel turning vane de-icing. Tests were conducted in the structural dynamics laboratory and in the NASA Icing Research Tunnel. Good ice protection was achieved at low power consumption and at a wide range of tunnel operating conditions. Recommendations for design and construction of the system for this application of the EIDI method are given.

TABLE OF CONTENTS

	<u>Page No.</u>
Abstract	1
Table of Contents	2
I. The Problem: Turning Vane Icing	3
II. Electro-Impluse De-Icing	5
III. Model Design and Fabrication	7
IV. Laboratory Tests	9
V. Icing Tunnel Tests	10
VI. Results and Conclusions	11
VII. Construction Recommendations	13
VIII. References	14
Figures 1 through 12	15-31
Appendix A. Project Personnel	32
Appendix B. Data from the Icing Wind Tunnel Tests . .	33-45
Appendix C. Design Drawings	46

I. The Problem: Turning Vane Icing

The planned rehabilitation of the Altitude Wind Tunnel (AWT) at the NASA Lewis Research Center includes the need for new corner turning vanes to match its upgraded performance. A plan view of the tunnel and its planned capabilities are shown in Fig. 1. Increasing the test section Mach number to 0.9 results in an approach Mach number for the first corner turning vanes of 0.35. The flow turns 90° in very limited distance, requiring a carefully designed turning vane to avoid separation and high pressure losses, Ref. 1.

In addition to higher speed, the AWT refurbishment calls for an icing capability by the addition of spray nozzles in the plenum chamber. Experience in other icing tunnels has shown that a considerable fraction of the water spray can be expected to freeze on the first corner vanes. This would gradually alter the critical vane shape and result ultimately in transonic flow. A de-icing system was clearly required.

In the existing Icing Research Tunnel (IRT) at NASA Lewis Research Center, steam heating is used to de-ice the vanes. This has three drawbacks: (a) for the AWT, which has nearly six times the flow area of the IRT and nearly four times the velocity, a very large amount of steam would be required; (b) A sophisticated control system would be required to avoid condensate freezing on excessive heating over the wide range of air speed, density and temperature; (c) The ice melted from the turning vane is returned to the tunnel circuit as water droplets to become ice on the next cold surface, thus transferring the icing problem from the corner vanes to the propeller or (more likely) the cooling coils.

An alternative method for de-icing the corner vanes was proposed: de-icing the corner vanes by Electro-Impulse De-Icing (EIDI). For the previous 30 months NASA had sponsored a project to develop the EIDI method for aircraft applications. Wichita State University had been the Grant recipient, charged with performing research on the underlying electrical and physical phenomena, and with coordinating the efforts of ten cooperating industrial partners. These industries include manufacturers of large transport aircraft (Boeing; Douglas), business jets (LearFan; Learjet), small planes (Beech; Cessna), helicopters (Sikorsky), nacelles (Rohr) and electrical equipment (Simmonds-Precision; Electro-Delta). The project had resulted in seven test periods in the Icing Wind Tunnel at Lewis, and two sets of flight tests (NASA's DHC-6 Icing Research Aircraft and Cessna 206). Flight tests (NASA's DHC-6 Icing Research Aircraft and Cessna 206). (See Ref. 2 for a summary). The technology had been advanced to the point where a full prototype was being installed in a Cessna 206 aircraft, and the Cessna company had stated its intention to pursue certification after successful prototype refinement. For a wide range of aircraft wings, struts, and an engine inlet, with skin thicknesses up to 0.088 inches, the EIDI system had been shown to be able to expel ice reliably for various tunnel icing conditions. This was done with very small power consumption and no aerodynamic surface intrusion.

The basic principles of the EIDI system will be given in Section II. Consideration of the use of the EIDI system for the turning vanes involved an application to a very different situation from those previously tested. In all previous tests, lifting surfaces or engine inlets were the ice collectors, and small amounts of ice formed on the leading edges only. For the turning vanes, due to their function of turning the air a full 90

degrees, it was expected that ice will form on the entire concave surface as well as the leading edge. This is a streamwise length of nearly five feet for 64 vanes with span lengths from 10 to 28 feet. Thus, much more ice and larger surfaces must be considered than ever before.

On the other hand, previous applications were dominated by low weight and power requirements and these will not be of such high concern for the AWT. In both cases, high reliability with a minimum of maintenance are expected. The degree of aerodynamic cleanliness required in the AWT is likely to be somewhat less than that for an aircraft wing. The compact, light-weight power supply and sequencing boxes developed for aircraft would probably be changed considerably for this application to optimize economy and reliability.

Thus, in principle, no barriers were seen to the successful de-icing of the AWT corner vanes by the electro-impulse method. But to design a system which is near optimum for vanes which are so large, curved, highly loaded aerodynamically and inaccessible, required a major study, test and development program.

II. Electro-Impulse De-Icing

Electromagnetic impulse is the force on an electrically conducting material in the presence of a rapidly changing magnetic field. Figure 2 shows a thin metallic sheet ("skin") and a nearby flat-wound coil. The magnetic field forming around the coil induces eddy currents in the skin. The field produced by the eddy currents interacts with the coil's field to produce a repulsive force. Figure 3 shows a simple circuit to produce such an impulse, using a capacitor as the source of transient current. The rapidly acting solid-state switch, the "thyristor" or silicon controlled

rectifier (SCR), shorts the capacitor through the coil. The diode acts as a one-way valve to prevent reverse charging of the capacitor. Figure 4 shows the typical resulting current and skin displacement.

This impulse phenomenon can be used to de-ice a surface due to the brittle character of ice. When used to de-ice the leading edge of an aircraft wing or engine inlet, an installation such as the one shown in Figure 5 is used. The coil, constructed of flat ribbon wire wound spirally, is rigidly mounted to the nearby spar, to a beam supported by ribs or even to the skin itself. Peak currents of 2 to 3 kA at 1000 to 1500 volts discharge in a fraction of a millisecond resulting in a peak force of 400 to 500 lbs. (1780-2237N). Aircraft skin displacements of a few milli-inches (a fraction of millimeter) are typical. Coils are placed along a wing's span, spaced about 18 inches (0.46m) apart. These are all supplied by a single power unit, with two or three impulses at each coil location, separated by the time required to recharge the capacitor. Ice is then allowed to accumulate at that location while the impulses are sequenced around the aircraft, returning to the original position after 3 or 4 minutes. The energy required to constantly recharge the capacitor is small; it is less than 1% of the energy needed to continuously melt the ice. For aircraft, the rule-of-thumb is that the power required for Electro-Impulse De-Icing (EIDI) is about equal to the power for the landing lights for the same size airplane.

In addition to low power, advantages of the EIDI system are low maintenance (no moving parts), compact size, reliable de-icing and reasonable cost and weight. These benefits are realized only if the design is done properly. Careful matching of electrical pulse width with the electrical properties of the skin and with the structural dynamics of the iced struc-

ture is required; See Ref. 3 and 4. Low resistance, low inductance circuitry as well as good control of the coil-to-skin gap width, is necessary.

III. Model Design and Fabrication

Due to the desire to simulate as nearly as possible the full scale conditions of the AWT, it was decided to construct a short span, full scale chord model of the AWT turning vanes. The cross section was that of the "complex vane design" (Reference 5) that produces a nearly "flat" Mach number distribution over the initial length of the vane.

Front and rear spar locations and lengthwise rib locations were selected on the basis of past applications of EIDI. A fully cantilevered leading edge was selected because the clear span, uninterrupted by support members, would produce the best effectiveness of the EIDI as well as optimum placement of the de-icing coils. A bay width of 18 inches with three instrumented bays was selected (Figure 6). To provide flow continuity across the entire instrumented section, a non-instrumented bay of 15 inches span was placed at either end of the three instrumented sections giving a total length of 7 feet. Also shown in Figure 6 are the coil locations. The coils were mounted on the front spar in the case of the leading edge and to beams mounted between the ribs for the aft two bays of each section. In order to complete the flow simulation two exact duplicate vanes were constructed to be placed on either side of the one instrumented vane, thus providing a three-vane set of seven foot length. All internal structure was of aluminum. The instrumented vane was constructed of 0.062", 301 stainless steel for the pressure and suction surface skins and the leading edge was of 0.040", 301 stainless steel. All of the skins for the dummy vanes were 2024 aluminum.

The suction surface skin of the instrumented vane was attached with round head screws for easy removal. The pressure surface was attached with flush head countersunk rivets. At all skin fasteners in the instrumented bays, the internal bearing surface was reduced to promote a "rocking action" of the skin across the fasteners; thus improving the clearing action of the EIDI coils. The coils in the leading edge were of a race track design. All others were circular. All were wound from ribbon copper wire according to the specifications given in Figure 7. The coils ranged in size from 3-4 inches in diameter and had from 35-51 turns of wire. Each coil had its own supply wire to the power box so that any combination of coils could be fired simultaneously. The gap between the coil faces and the 0.062 inch copper doublers was 0.10 inch. The doublers were rectangular and approximately 50% larger in size than the diameter of the coils. These doublers were riveted at their corners as well as being bonded to the pressure and leading edge skins.

The material called out for the skins and leading edge was 304 stainless steel. Due to the difficulty in forming this material, 301 annealed stainless steel was substituted.

See Appendix C for detailed design drawings of the model.

IV LABORATORY TESTS

Prior to the tests in the Icing Research Tunnel, the vane was tested to measure skin and mounting movements when the coils were impulsed. The coils on the concave surface were series-connected as was done in the tunnel tests. The nose coils were not tested. To avoid local mass loading of the skin, 0.5 gram accelerometers were bonded to the skin. Since these small sensors have limited acceleration range, the impulse energies used were less than those used in actual de-icing. Typically, 600 microfarads and 400 volts were supplied to a pair of series-connected coils.

Accelerometers were bonded to the outside skin directly over the centers of coils 4, 10, 11, 14 and 16, and over the midpoint between coil pairs 1-6, 8-12, 14-18 and 15-19. (See Figure 6 for coil locations.) In addition, accelerometers were bonded to coil mounting beams midway between coil pairs 1-6 and 8-12; these were coils near the trailing edge with cramped space and smaller beams. As a result of these tests, the rear beams were re-worked for added stiffening.

The laboratory test results are shown in Figures 9a through 9g. The acceleration and displacement values can be expected to be proportional to the impulse energy. Thus, actual tunnel impulse conditions can be estimated from these data.

V. Icing Tunnel Tests

Model Installation

Due to the size of the model it was physically impossible to install it in the test section of the IRT. In addition, due to the large amount of air that would be deflected 90 degrees from the vane inlet direction, it was deemed not realistic to locate the model in the relatively confined size of the test section without the prospects of flow interference within the vanes. It was thus decided to install the model in the IRT diffuser as close to the first-corner turning vanes as possible. The model was located midway between the side walls on an elevated stand to place it in the center of the icing air stream. It was spaced approximately 1 1/2 chords ahead of the IRT turning vanes. Velocity distribution measurements showed that the model was located in a uniform flow stream and that the model location ahead of the IRT turning vanes was sufficient to preclude any interference with the model flow field.

Icing Tunnel Testing

In September 1985, the model was installed in the NASA Lewis Research Center Research Tunnel (IRT) and tests were run. Data gathered was in the form of remote television recording during icing and ice removal as well as hand held television, moving picture camera and still photographs during the ice removal process. Ice type and thickness were estimated prior to ice removal for each test. Observations were taken for test section air speeds from 100 to 200 miles per hour. This was equivalent to a maximum speed of about 92 miles per hour at the model. Air temperatures ranged from 15 to 27 degrees Farenheit (-9 to -3 degrees Celsuis). Liquid water content ranged

from 0.8 to 3.0 grams per cubic meter and water droplet size from 15 to 30 microns. Most tests were run with accumulation times of 15 minutes. However, a few were run for 30 minutes. The maximum icing time was for one hour for a very light icing condition. De-icing was accomplished by using 600 and 800 microfarad capacitance and voltages from 800 to 1400. Most of the coils were connected in pairs. However, some tests were run with singles and other combinations in an attempt to determine the optimum location and power required to optimally de-ice each of the two major bays as well as the leading edge section.

Good cleaning was demonstrated on all areas of the center vane with fairly low energy expenditures. Ice removal occasionally required 2 or 3 hits.

VI. Results and Conclusions

Results

The test data for the 20 runs are presented in Appendix B. For most of the tests points the vane leading edge accumulated 1/4-1 inch of ice for 15 minute runs and 1-2 inches for the longer (30 minute) runs (Figure 10). One run lasted 1 1/2 hours and the ice accumulation at the leading edge was 3.25-3.5 inches thick. The ice accumulation aft of the forward spar on the pressure surface ranged from a light frost to 5/8 inch thick (Figure 11). Most of these accumulations could be cleared with one or two hits from the coils. Occasionally three hits were required for clearing (Figure 12). Depending on the test airspeed and icing conditions (LWC, droplet size, temperature) the ice was grainy (popcorn ice), built up spikes from the surface or clear ice of nearly uniform thickness. Generally the leading edge accumulated the heaviest amount. Frequently very little accu-

mulated on the pressure surface. On some occasions there was a slight accumulation on the suction surface but only back to about the forward spar. Generally there was a light residue remaining scattered over the surfaces after the de-icing. This was not an amount to cause any problems and generally cleared off at the time of the next de-icing.

Post test examination of the model revealed no major structural damage. However, many of the doublers were debonded at their edges and were curling due to the electromagnetic forces. Some of the rivet heads for the doubler rivets had been deformed. There was evidence that the soft stainless steel that was used for the skins was being deformed at the coil location. The leading edge skin, at the forward spar, was deformed and the rivet's heads beginning to pull through the skin material. These types of problems were not unexpected. It is expected that if the skins had been constructed of 304 stainless steel, these problems would not have occurred.

Conclusions

Demonstration of the feasibility of applying EIDI to the de-icing of the turning vanes in the NASA Lewis Research Center's altitude wind tunnel was accomplished. This successful demonstration covered a wide range of icing conditions. The only apparent problems were some skin fatigue and debonding of the copper doublers. Specific design and fabrication suggestions can now be made on the basis of this study (See Section VII).

VII CONSTRUCTION RECOMMENDATIONS

Based on visual observations and post test inspections of the model, the following methods of construction are recommended:

1. The structural design used for the wind tunnel model should be considered for use in the actual construction. This uses two spars, ribs every 1.5 to 2.0 feet, with no rib extending into the leading edge section upstream from the front spar.
2. The front spar was placed far forward because the NASA ice accretion computations showed that a small region on the pressure side would collect almost no ice. However, in the tests, the ice-free region did not occur. It is recommended that both spars be moved rearward 3.0" inches. Then circular nose coils could be used instead of the race-track shaped coils used in these tests.
3. The skin material chosen for this test by NASA was stainless steel. Replacement by 0.062 inch thick alloy aluminum is suggested, preferably series 6061 or 7049. This material is cheaper, easier to form and is more readily heat treated. For this, doublers should not be needed.

4. Coil specifications for use with a power supply of 800 microfarads and 1400 volts are:

(a) For leading edge section, use circular coils made of 42 turns of .030" x .190" copper ribbon wire. Inside diameter = 0.25", outside diameter = 2.85". One coil per station with about 18 inches spanwise separation. Each coil is mounted on the forward spar and is centered over the pressure side of the leading edge.

(b) For the two concave sections, use 50 turns of .030" x .190" ribbon wire; ID = 0.25", OD = 3.5". These should be approximately centered in the bays formed by spars and ribs.

For all of these, two coils connected in series are to be impulsed twice before cycling to the next station. De-icing at six minute intervals should be very adequate for maintaining acceptable air flow.

5. This design will call for three coils for every 1.5 ft. of length. Since the coils are connected in pairs and pulsed twice, 3 pulses is required for each 1.5 foot of length. Thus, two pulses per foot of span constitutes one cleaning cycle. If capacitors recharge in 4.0 seconds, 7.5 feet of vane is cleaned each minute. For a 6 minute cycling time, a power box is needed for each 45 feet of vane length. If recharge time is shortened to 3.0 seconds, the length per power box is 60 feet.

VIII. REFERENCES

1. Gelder, T.F., et al, "Wind Tunnel Turning Vanes of Modern Design". AIAA 24th aerospace Sciences Meeting, Jan. 6-9, 1986, Reno, NV. AIAA Paper 86-0044.
2. Zumwalt, G.W. and A.A. Mueller, "Flight and Wind Tunnel Tests of an Electro-Impulse De-Icing System," AIAA/NASA General Aviation Technology Conference, Hampton, VA, July 10-12, 1984, AIAA Paper No. 84-2234.
3. Zumwalt, G.W. and R.A. Friedberg, "Designing an Electro-Impulse De-Icing System," AIAA 24th Aerospace Sciences Meeting, Reno, NV, January 6-9, 1986.
4. Lewis, G.J., "The Electrodynamic Operation of Electro-Impulse De-Icing Systems," AIAA 24th Aerospace Sciences Meeting, Reno, NV, January 6-9, 1986, AIAA Paper No. 86-0547.
5. Blaha, B.J. and Shaw, R.J., "The NASA Altitude Wind Tunnel: Its Role in Advanced Icing Research and Development," AIAA 23rd Aerospace Sciences Meeting, Reno, NV, January 14-17, 1985, AIAA Paper No. 85-0090.

Technical Papers Resulting from this Grant:

1. Ross, R., "Application of Electro-Impulse De-Icing to the NASA Lewis Altitude Wind Tunnel (AWT) Turning Vanes". AIAA 24th Aerospace Sciences Meeting, Reno, NV, Jan. 6-9, 1986. AIAA Paper No. 86-0548.
2. Ross, R. and Zumwalt, G.W., "Application of Electro-Impulse De-Icing (EIDI) to Ice-Covered Structures". Third International Workshop on the Atmospheric Icing of Structures, Vancouver, B.C., Canada, May 6-8, 1986.

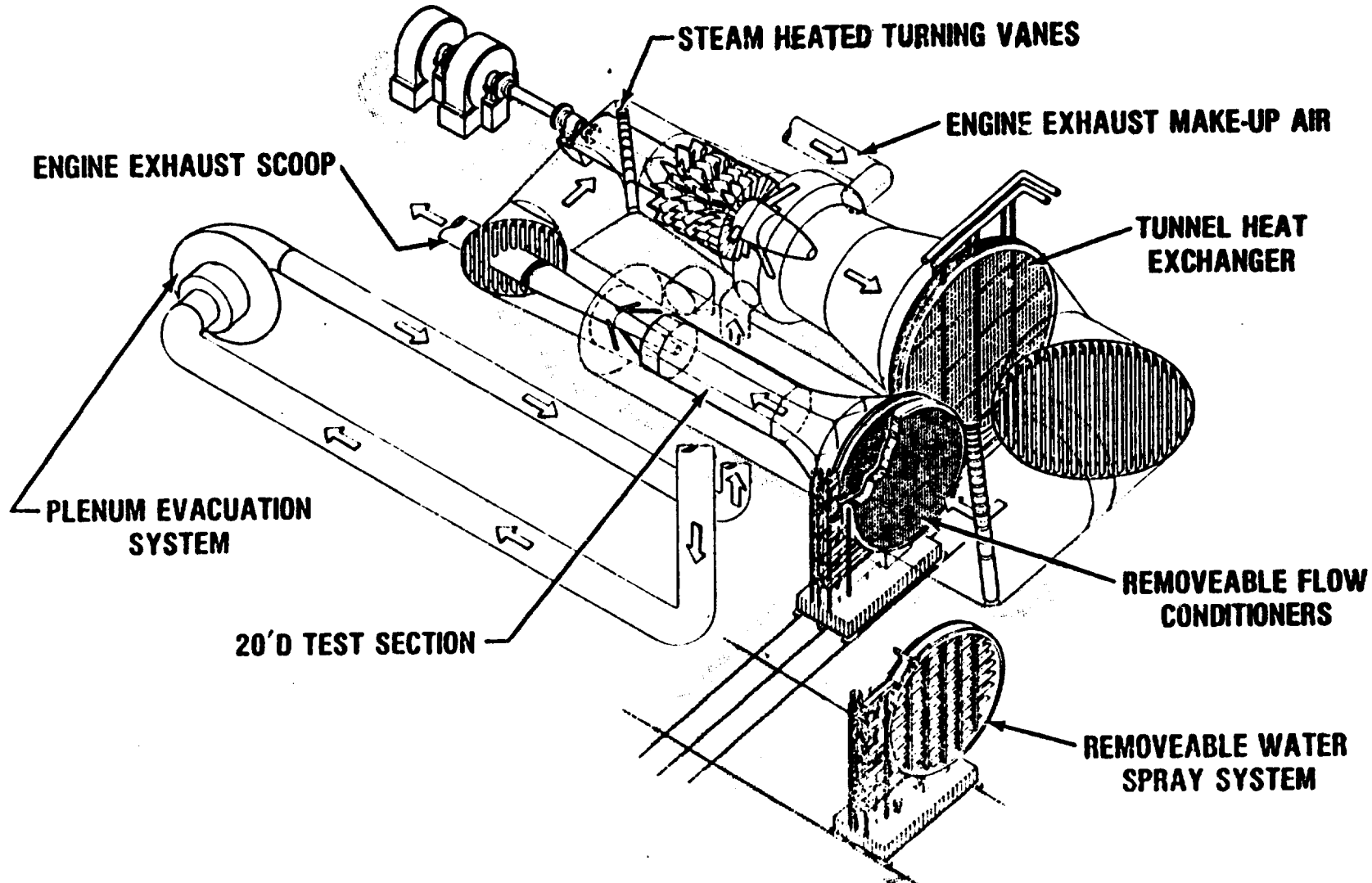

Figure 1 Altitude Wind Tunnel Refurbishment

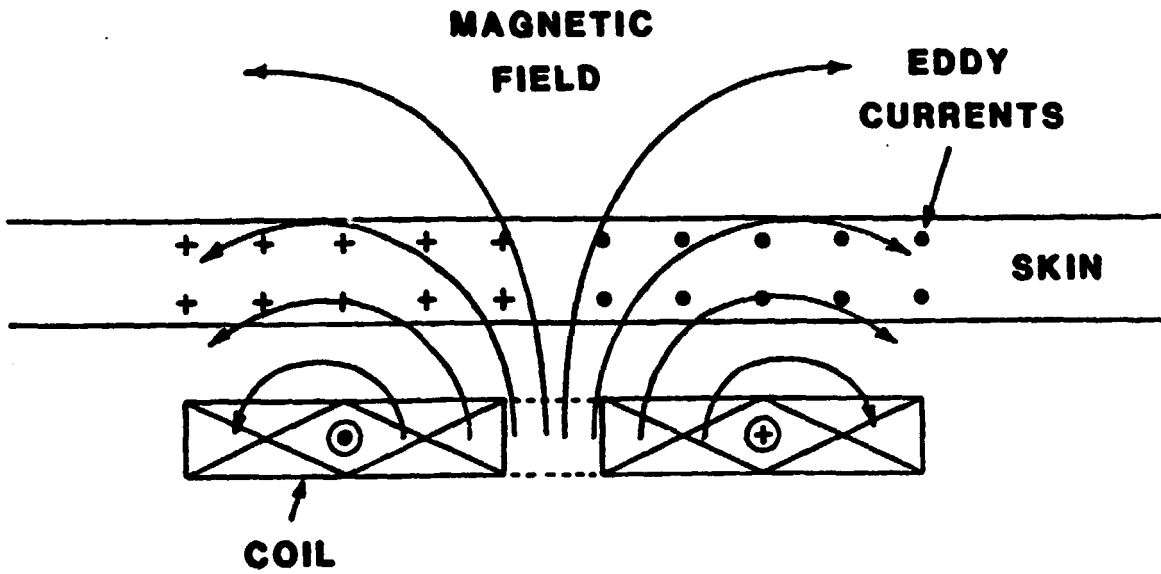

Figure 2 Coil's magnetic field and resulting eddy currents

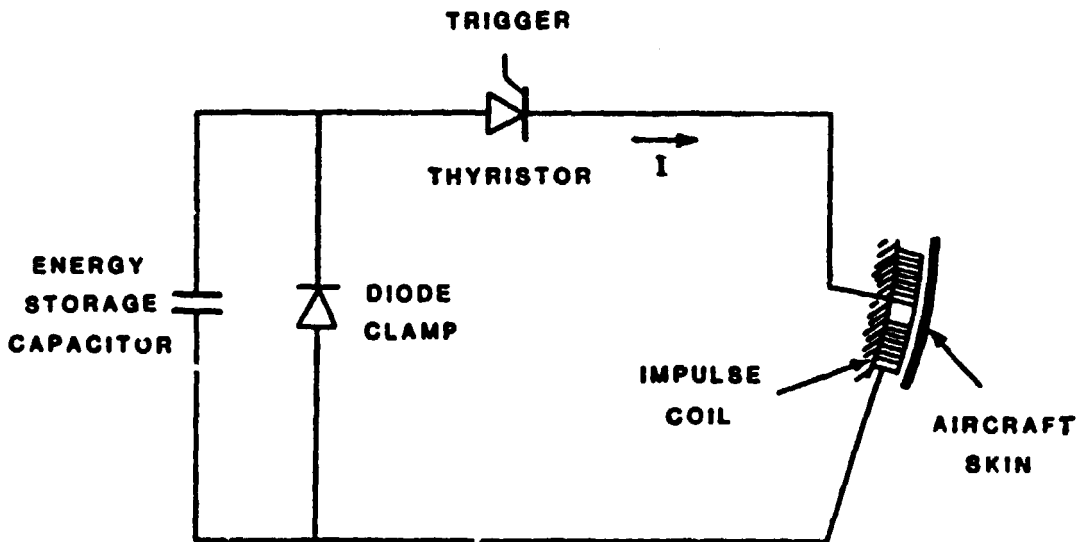

Figure 3 Basic EIDI circuit

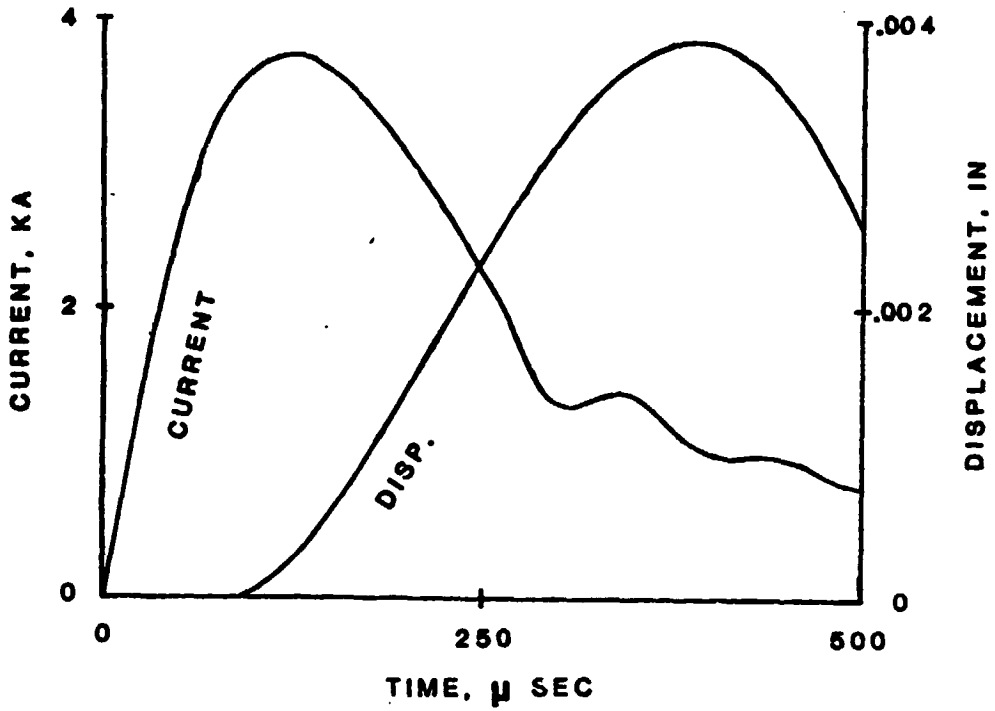

Figure 4 Typical coil current and skin displacement

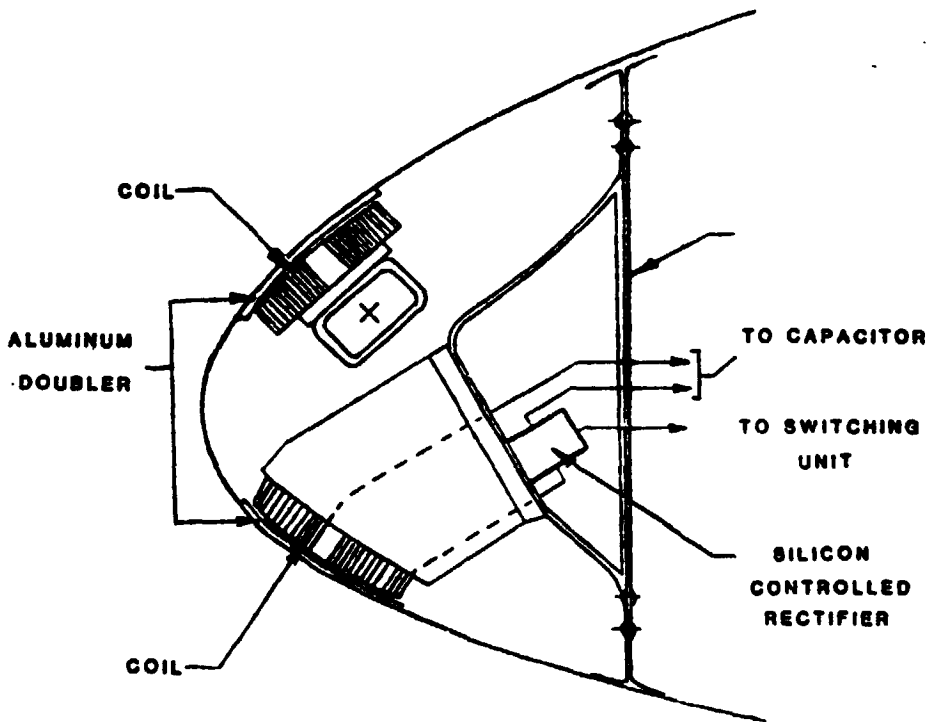

Figure 5 Impulse coils in a leading edge

A W T V A N E
 (VIEW ONTO CONCAVE SIDE)

ORIGINAL PAGE IS
 OF POOR QUALITY

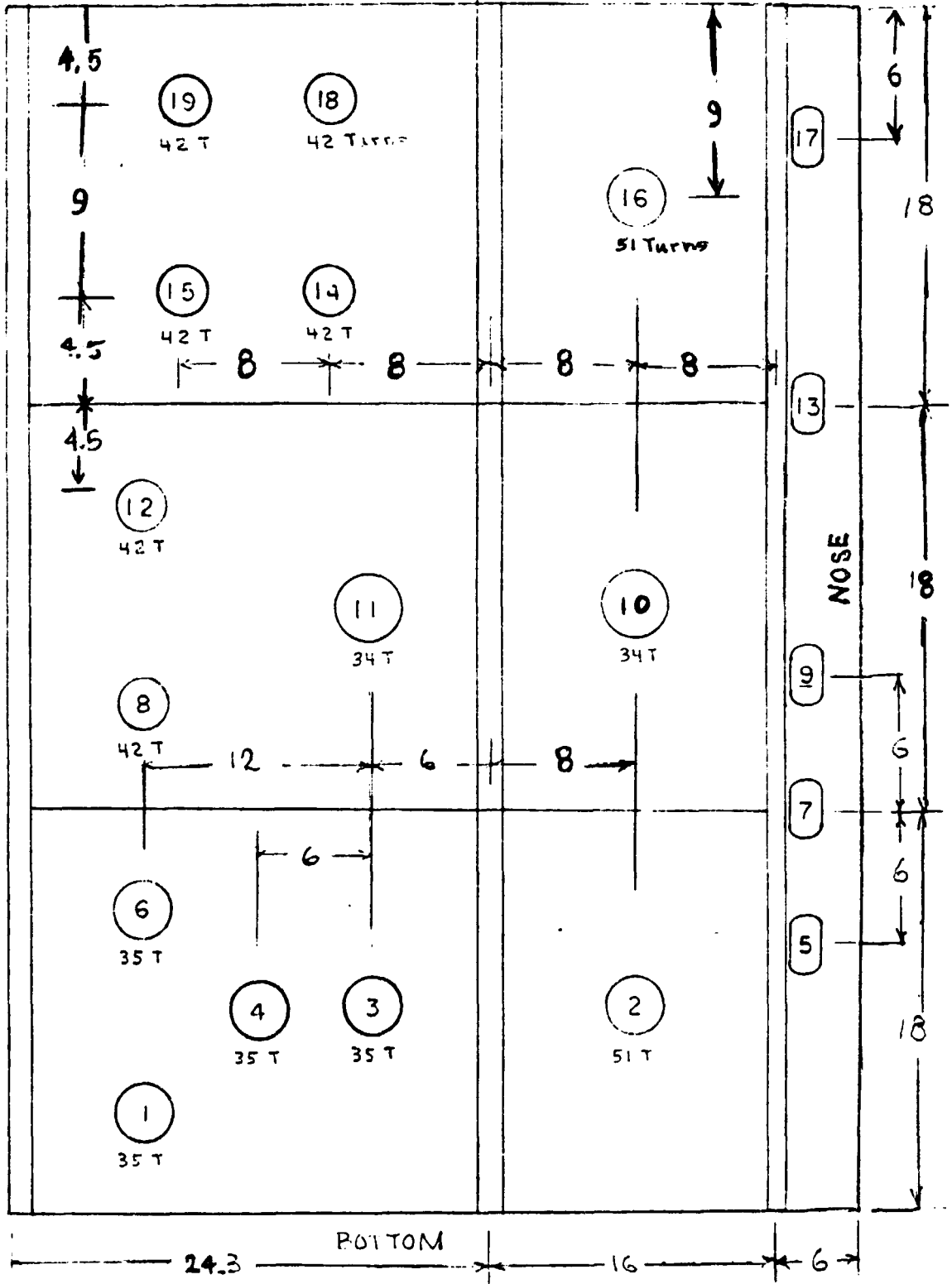

Figure 6, coil in placement in the AWT Vane Model
 (All dimensions are in inches)

Figure 7 COIL SPECIFICATIONS

No.	O.D.* (inches)	Wire Dimensions (inches)	Turns
1	3.5	.050 x .190	35
2	3.5	.032 x .190	51
3	3.5	.050 x .190	35
4	3.5	.050 x .190	35
5	racetrack**	.025 x .125	42
6	3.5	.050 x .190	35
7	racetrack**	.025 x .125	42
8	3.0	.032 x .190	42
9	racetrack**	.025 x .125	42
10	4.0	.050 x .190	34
11	4.0	.050 x .190	34
12	3.0	.032 x .190	42
13	racetrack**	.025 x .125	42
14	3.0	.032 x .190	42
15	3.0	.032 x .190	42
16	3.5	.032 x .190	51
17	racetrack**	.025 x .125	42
18	3.0	.032 x .190	42
19	3.0	.032 x .190	42

*All coils had inside diameters of 0.25 inches.

**Racetrack-shaped coils for the leading edge:
42 turns

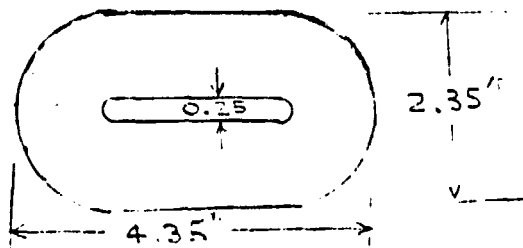

Figure 8 POWER BOX CHANNEL-TO-COIL CONNECTIONS

Coil Locations and Specifications are given in the two preceding pages.

<u>RUN NO.</u>	<u>CHANNEL</u>	<u>COILS IN SERIES</u>
1 - 9	1	9 & 17
	2	5 & 13
	3	2 & 16
	4	10 & 11
	5	15 & 18
	6	14 & 19
	7	8 & 12
	8	3 & 4
10 - 15	1 - 4	same as above
	5	3, 4, 14 & 18
	6	1, 6, 15 & 19
16 - 21	1	2 & 16
	2	14 & 15
	3	2 & 16
	4	10 & 11
	5	3 & 4
	7	9 & 17
	8	5 & 13

Channels 1 - 6 are the new power box.
 Channels 7 - 9 are the old power box.

STORED ENERGY EXPENDED

<u>C</u> <u>μFd</u>	<u>V</u> <u>Volts</u>	<u>J</u> <u>Joules</u>
600	1000	300
600	1200	432
600	1400	588

800	1000	400
800	1200	576
800	1400	784
800	1500	900

AWT VANE. COILS 2 & 16 IN SERIES

600 μ F

400 V

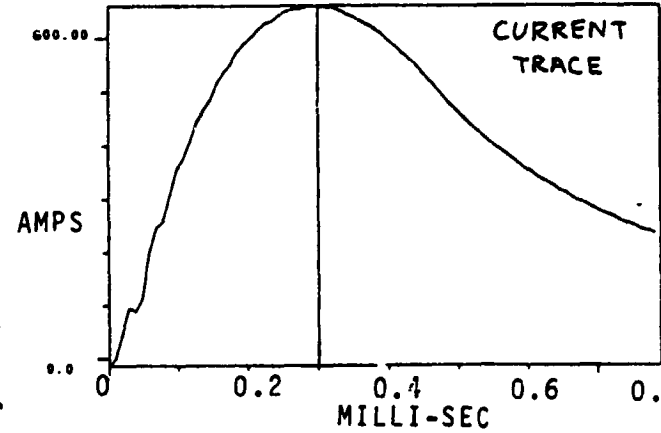
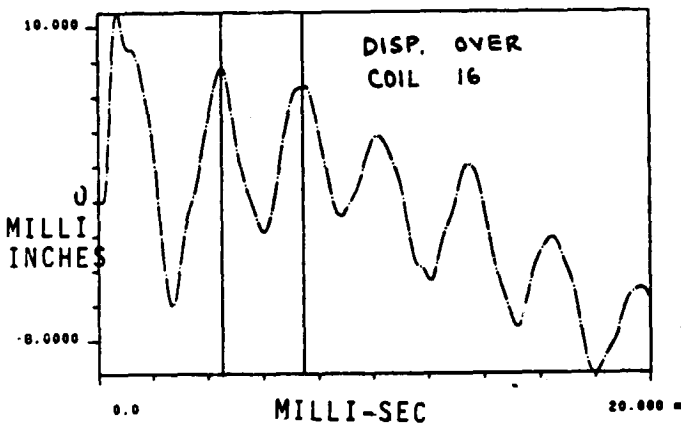
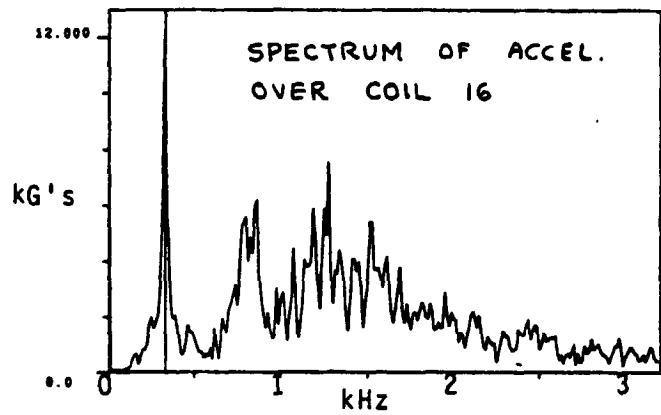
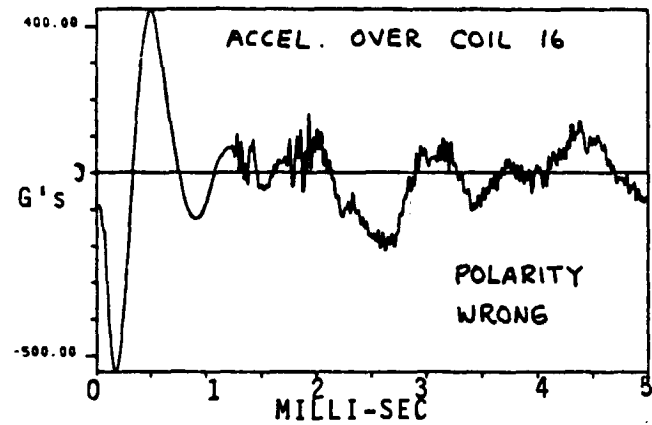

Figure 9a

Figure 9b

AWT VANE. COILS 10 & 11 IN SERIES

600 μ F

400 V

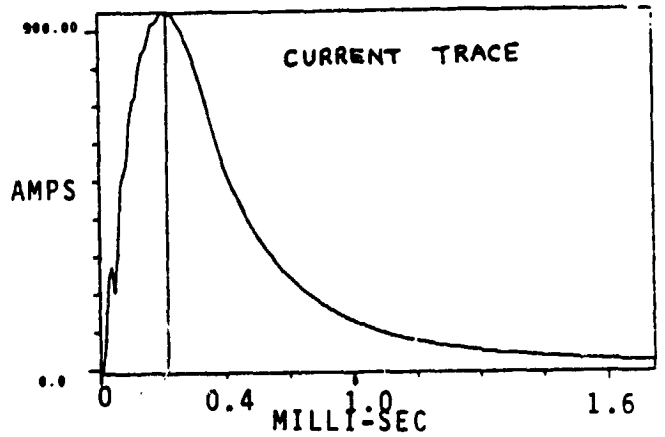
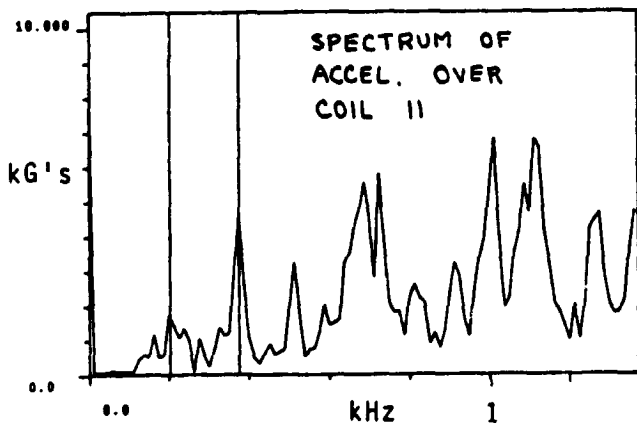
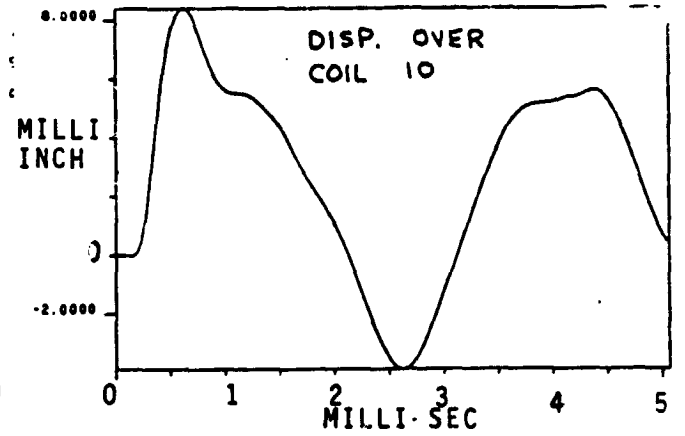
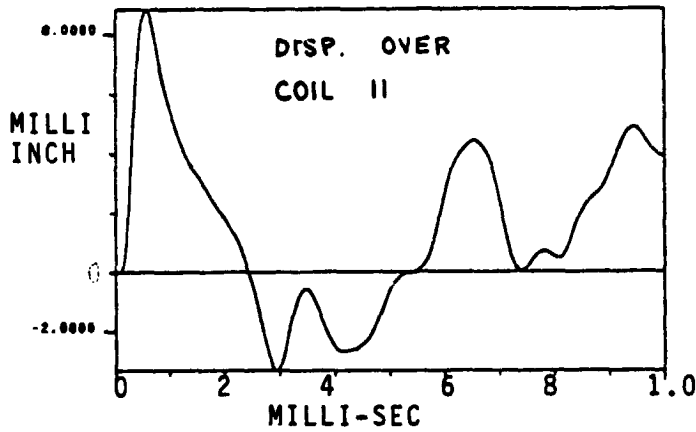
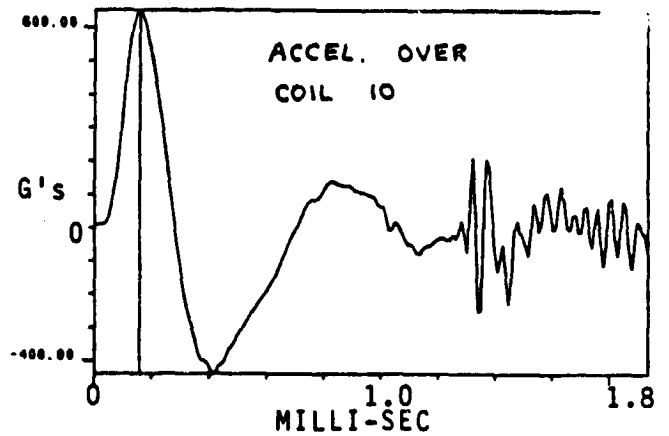
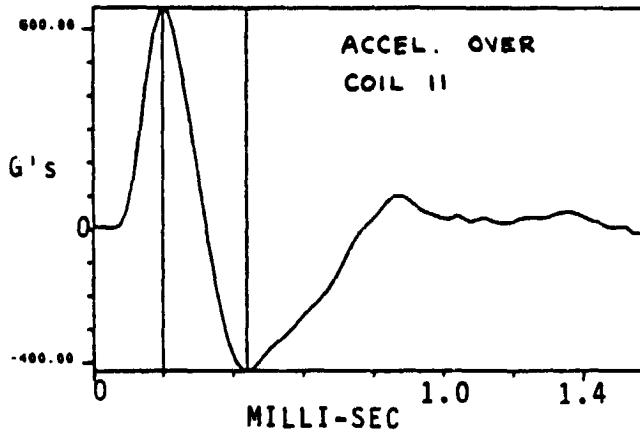

Figure 9c
 AWT VANE. COILS 14 & 18 IN SERIES
 600 μ F 400 V

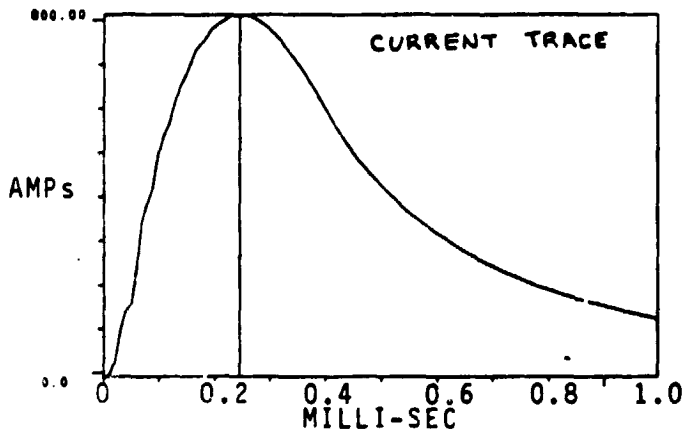
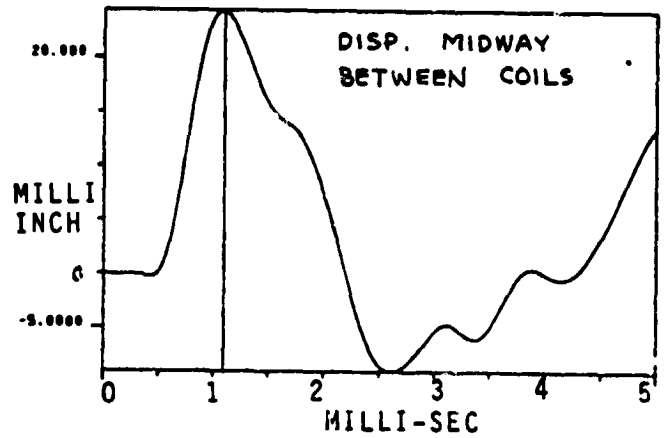
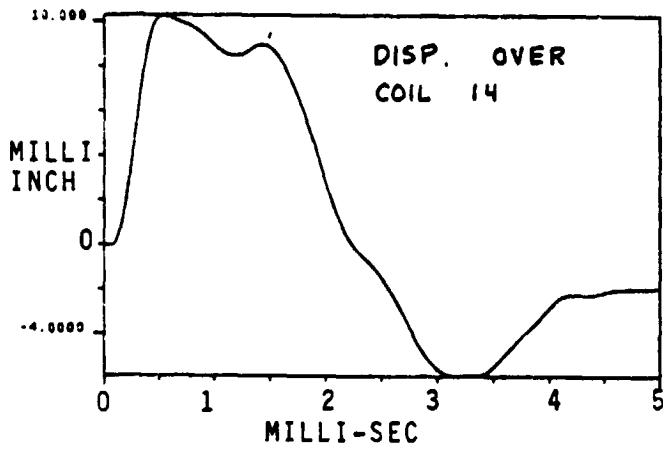
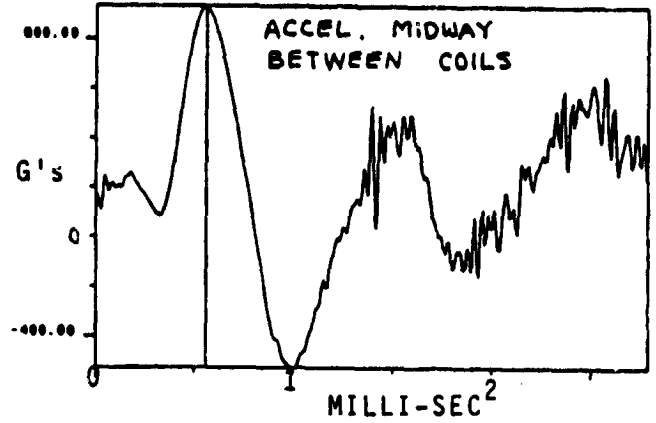
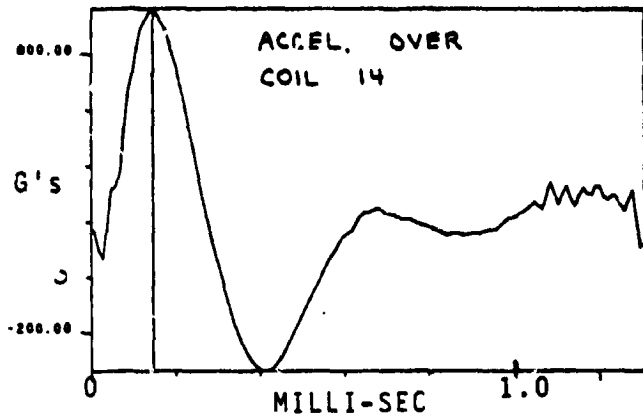

Figure 9d

AWT VANE. COILS 15 & 19 IN SERIES

600 μ F

400 V

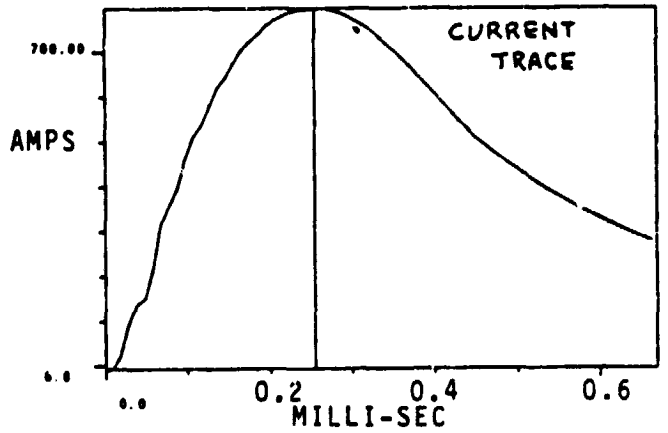
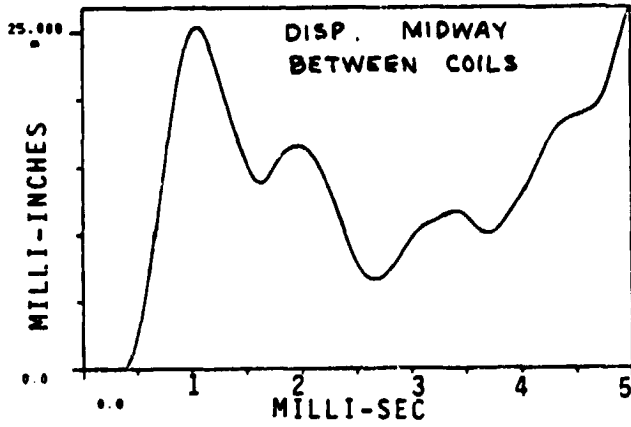
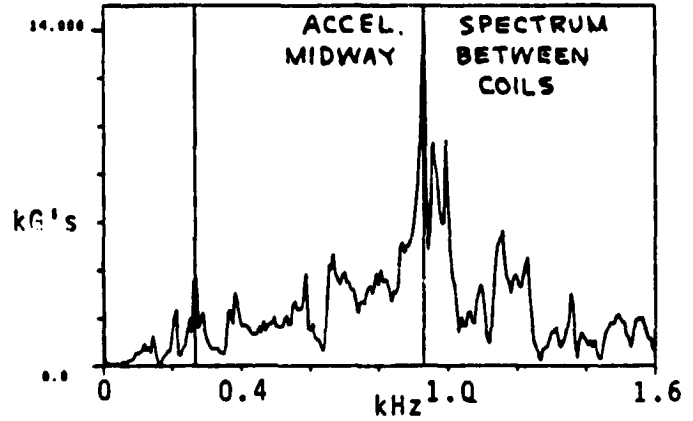
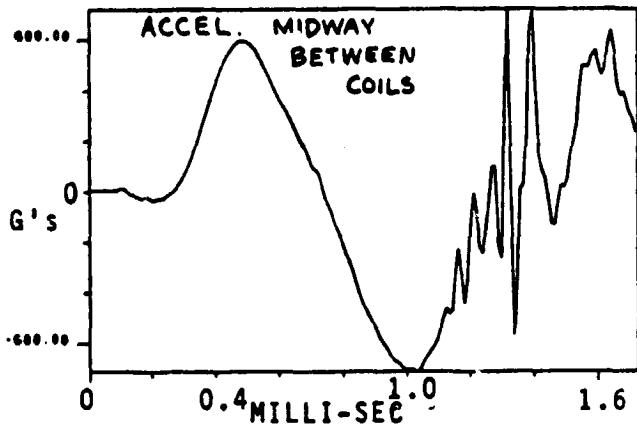

Figure 9e
AWT VANE. COILS 8 & 12 IN SERIES

600 F

400 V

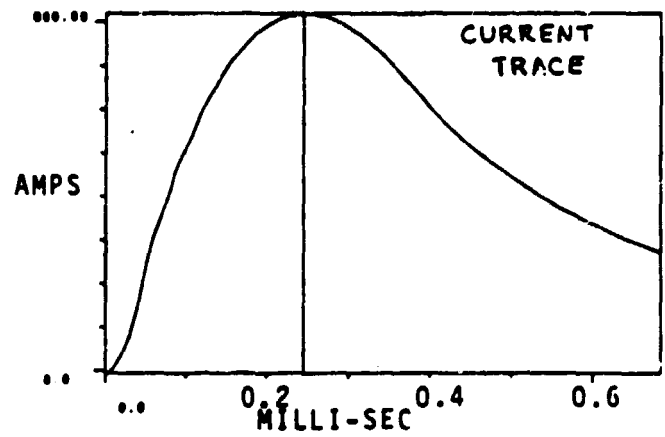
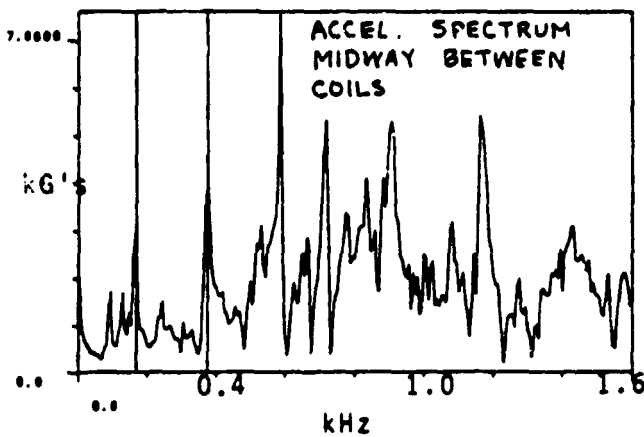
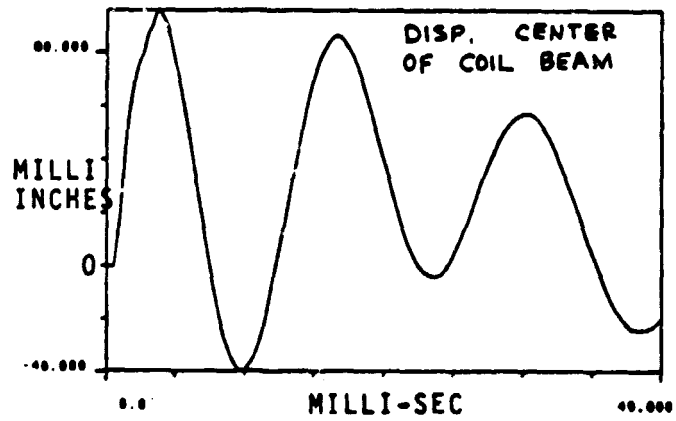
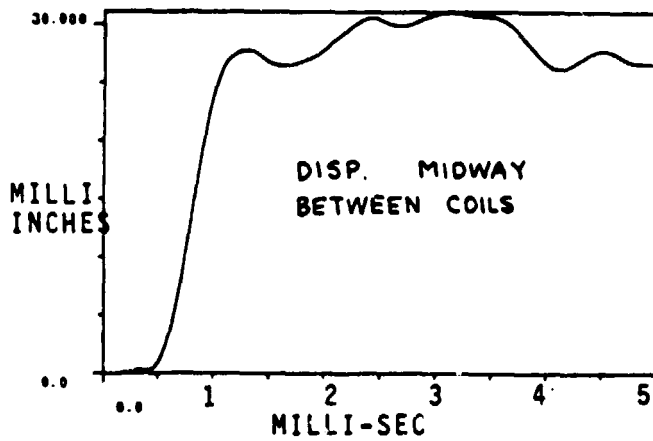
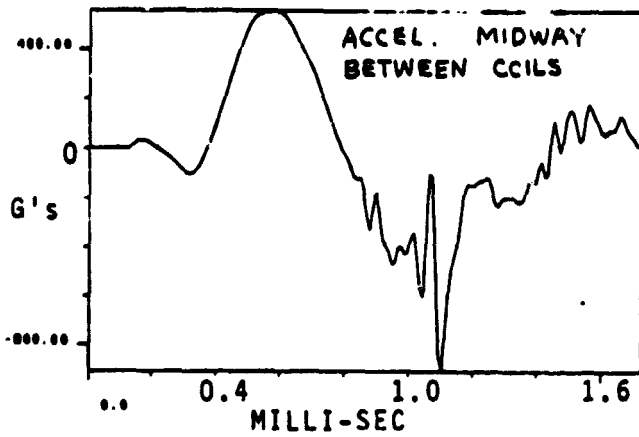
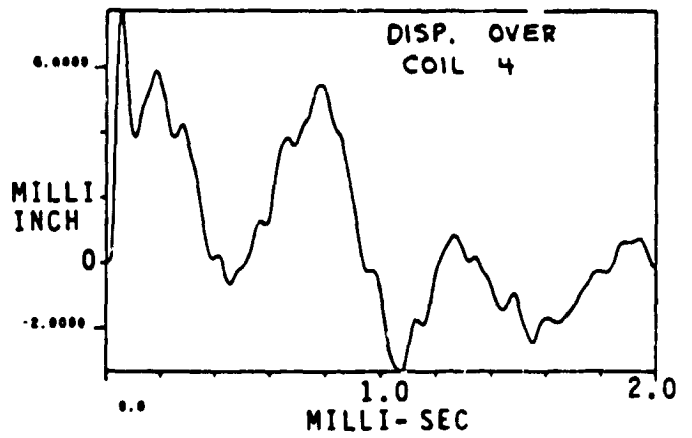
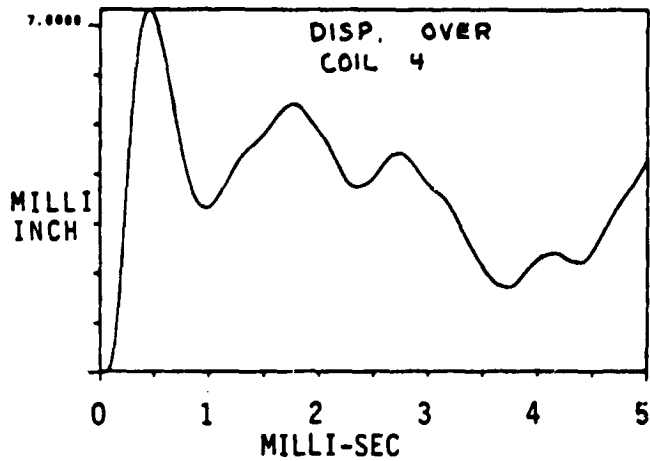
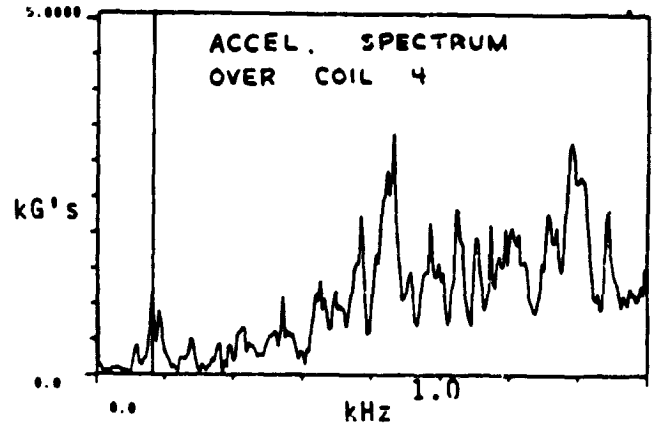
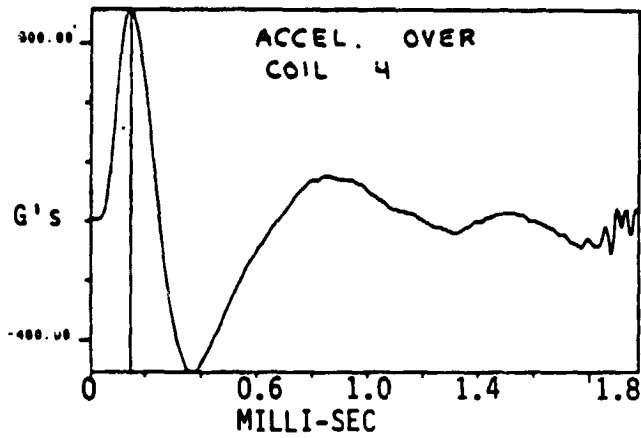

Figure 9f

AWT VANE. COILS 3 & 4 IN SERIES

600 μ F

400 V



$i_m = 1.03$ KA

$t_m = 192$ μ s

Figure 9g

AWT VANE. COIL 4 ALONE

600 μ F 400 V

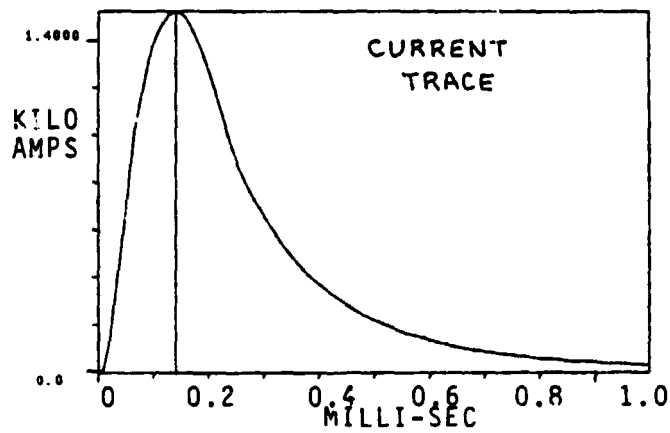
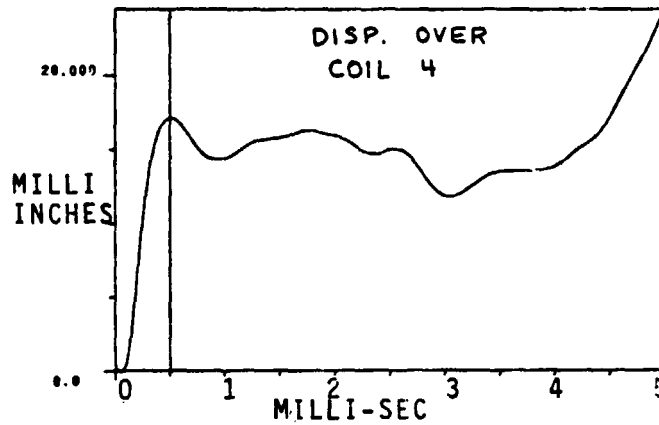
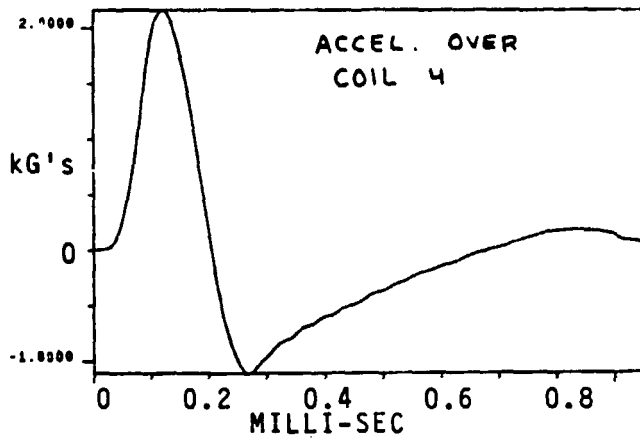
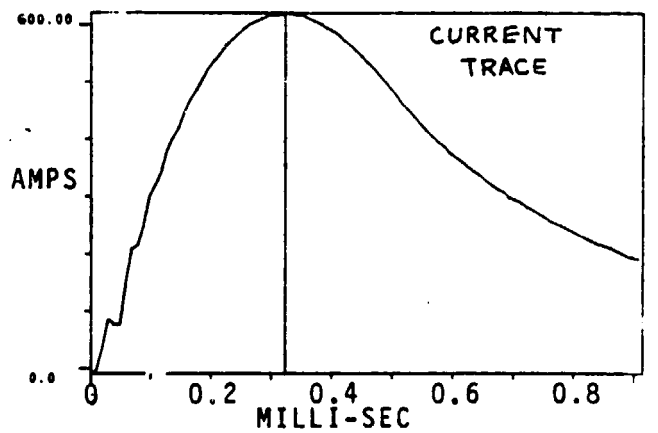
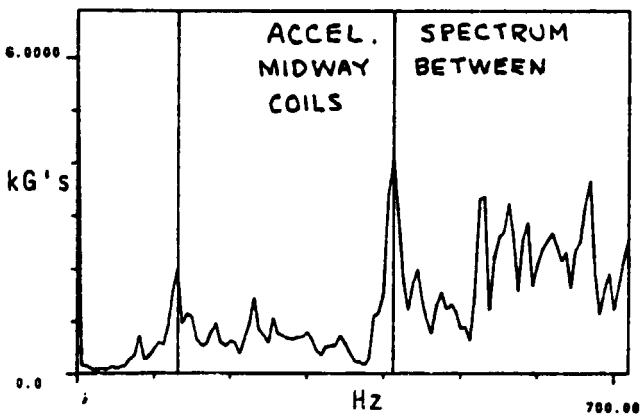
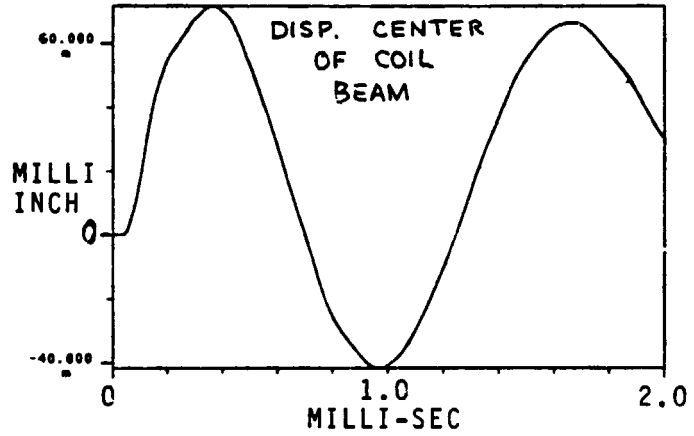
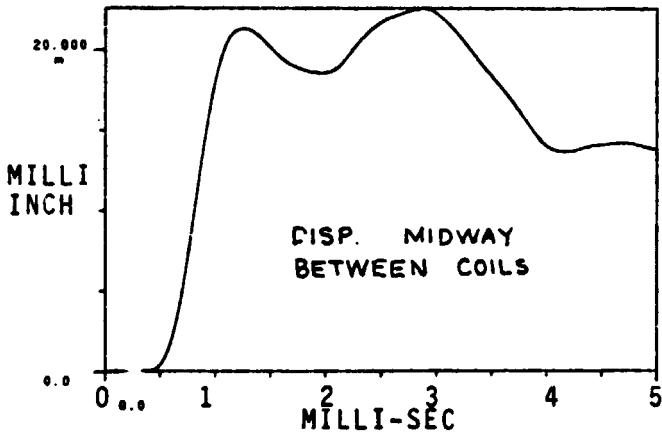
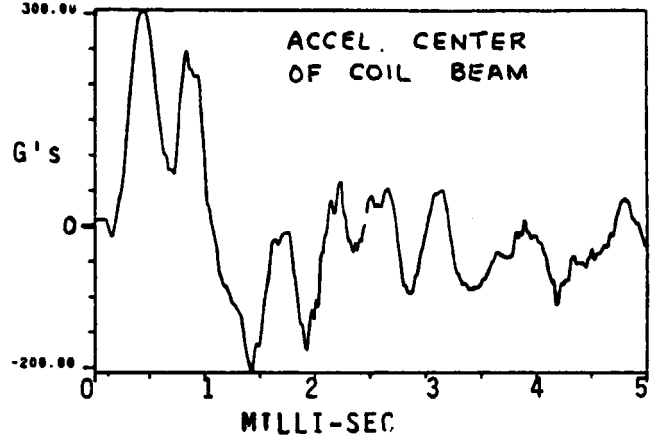
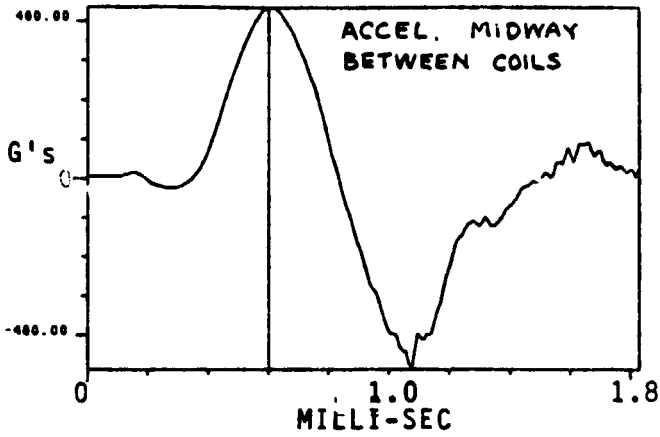

Figure 9h

AWT VANE. COILS 1 & 6 IN SERIES

600 μ F

400 V



ORIGINAL PAGE IS
OF POOR QUALITY



Figure 10
Ice accumulation on the leading edge.

ORIGINAL PAGE IS
OF POOR QUALITY

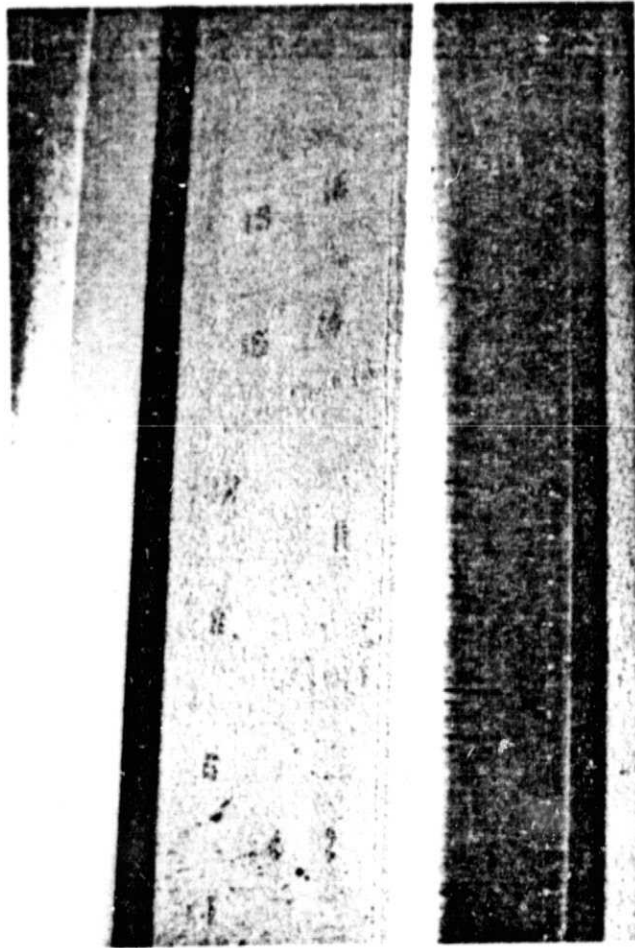

Figure 11
Ice accumulation on the pressure surface.

ORIGINAL PAGE IS
OF POOR QUALITY

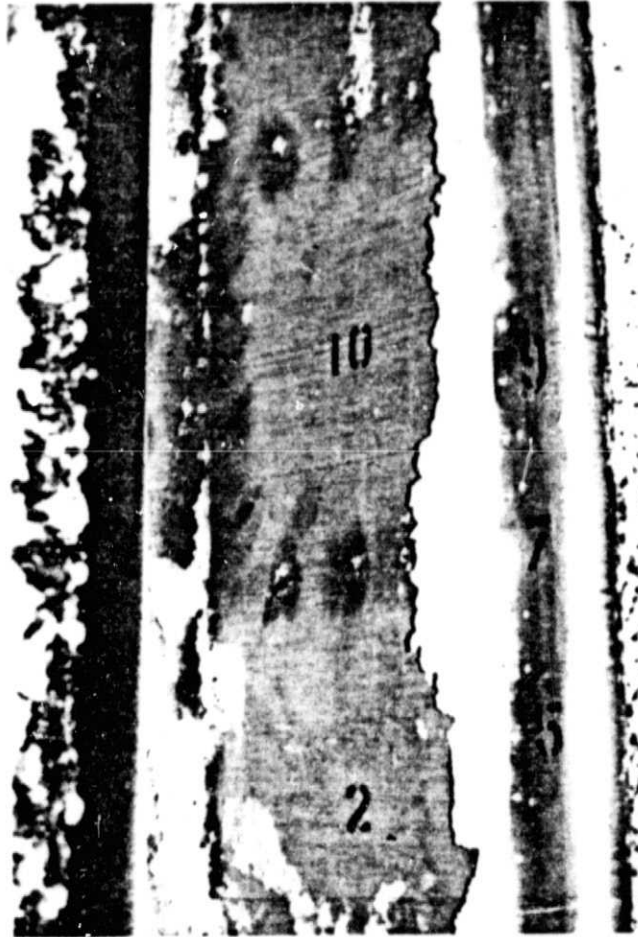

Figure 12
Surface clearing after EIDI action.

Appendix A
Project Personnel

Glen W. Zumwalt, Distinguished Professor of Aeronautical Engineering.
Project Director.

Richard Ross, Consultant and Lecturer in Aeronautical Engineering.
Project Administrator; Responsible for Overall Design.

Robert L. Schrag, Professor of Electrical Engineering. Responsible
for Electromagnetic Design and Testing.

Walter D. Bernhart, Professor of Aeronautical Engineering. Respon-
sible for Structural Dynamic Design and Testing.

Robert A. Friedberg, Research Associate. Responsible for Instrumenta-
tion, Procurement, Design Detail and Fabrication Coordination.

V. L. "Ben" Haghauer, Chief Technician. Constructed the Models, Coils,
Mounts, and Tunnel Installation Fixtures.

Appendix B

DATA FROM THE ICING WIND TUNNEL TESTS

ICING RESEARCH TUNNEL TESTS

AWT TURNING VANES

(See Figure 8 for coils connected to each channel)

RUN	TEST SECT. IAS mph	TEMP degF	LWC g/m3	MVD mic	ICE TIME min.	TUN'L PRESS psia	PULSE SEQ. CHAN. NO.	VOLTS	CAP uF	COMMENTS
Tuesday, September 10, 1985										
1	100	27	1.2	15	20	14.32	(No De-icing)			Visual Inspection for ice distribution. Very little ice build-up.
2	100	29	2.5	20	5more	14.32	1	800	800	Ice added to Run 1 ice.
			Total Icing =25 min.							
	100	29	2.5	20	25	14.32	1,1	1000	800	
	100	29	2.5	20	25	14.32	2,2,2	1400	800	Leading edge well de-iced.
	100	29	2.5	20	25	14.32	3	1000	800	Very thin ice on concave surfaces.
	100	29	2.5	20	25	14.32	3	1400	800	About 30% ice gone.
	100	29	2.5	20	25	14.32	4	1400	800	
	100	29	2.5	20	25	14.32	5	1000	800	
	100	29	2.5	20	25	14.32	5	1400	800	
	100	29	2.5	20	25	14.32	6	1400	800	Concave panels not de-iced well.
	100	29	2.5	20	25	14.32	7	1400	600	
3	100	27	2.5	20	15	14.32	(No De-icing)			Very light ice. Stopped to remove impingement grid from test section.
4	100	23	2.5	20	15	14.32	(No De-icing)			Some runback & freeze on convex side Ice .25" to .35" thick on l.e. Slightly less ice on concave side.
4a	100	23	2.5	20	15more	14.32				About 0.6" inch ice on l.e. (glaze)
			Total Icing =45 min.							
	100	23	2.5	20	30	14.32	1	1400	800	l.e. 90% clear
	100	23	2.5	20	30	14.32	2	1400	800	l.e. clean
	100	23	2.5	20	30	14.32	3,4,5,6	1400	800	Mostly clean. Some residue.

RUN	TEST SECT.	IAS mph	TEMP degF	LWC g/m3	MVD mic	ICE TIME min.	TUN'L PRESS psia	PULSE SEQ. CHAN. NO.	VOLTS	CAP uF	COMMENTS
4a		100	23	2.5	2	30	14.32	7,8	1400	600	Less clean than above.
		Model steam cleaned.									
5		100	15	1.6	25	30	14.30				l.e. ice 3.5" thick; thin "frost" on concave side (rime).
		100	15	1.6	25	30	14.30	1	1000	800	Little effect.
		100	15	1.6	25	30	14.30	1	1200	800	Still little shed.
		100	15	1.6	25	30	14.30	2	1400	800	l.e. mostly clean.
		100	15	1.6	25	30	14.30	1	1400	800	l.e. clean.
		100	15	1.6	25	30	14.30	3	1400	800	10" circle clean over coils.
		100	15	1.6	25	30	14.30	4	1400	800	Nearly clean on both bays.
		100	15	1.6	25	30	14.30	5	1400	800	Bay nearly clean.

End of day observations: Some slight over-coil deformations (stress exceeded yield strength.) This probably due to annealed stainless steel skin.

Wednesday, September 11, 1985

6		100	25	1.3	16	60	14.28				l.e. 3/4 in. thick; concave side 1/4". Ice-finger growth.
		100	25	1.3	16	60	14.28	4	1200	800	Almost all of this bay clean from l.e. to t.e. Next bay lower clean to rear spar.
		100	25	1.3	16	60	14.28	5	1200	800	Cleaned bay from rear spar to t.e.
		100	25	1.3	16	60	14.28	3	1200	800	All cleaned aft of front spar.
		100	25	1.3	16	60	14.28	1	1200	800	Most of ice between coils cleaned off.
		100	25	1.3	16	60	14.28	2	1200	800	l.e. clean except over coil 7.
		Model steam cleaned.									
7		175	24	1.8	25	15	13.88				About 0.7" on l.e. and 0.5" on concave. Some convex side runback freezing. Ice fingers aft of rear spar.

RUN	TEST SECT.		LWC g/m ³	MVD mic	ICE TIME min.	TUN'L PRESS psia	PULSE SEQ. CHAN. NO.	VOLTS	CAP uF	COMMENTS
	IAS mph	TEMP degF								
7	175	24	1.8	25	15	13.88	4	1200	800	Coil 11 cleaned most of bay; 10 cleared 10" circle. Coil 10 finished cleaning its bay. Most of bay clean. Good. Good cleaning. Some ice shed. Balance cleaned. Good cleaning. Cleaned most of the remaining l.e. 0.75" on l.e. Grainy surface. Mixed type ice.
	175	24	1.8	25	15	13.88	4	1200	800	
	175	24	1.8	25	15	13.88	6	1200	800	
	175	24	1.8	25	15	13.88	8	1200	800	
	175	24	1.8	25	15	13.88	3	1200	800	
	175	24	1.8	25	15	13.88	3	1200	800	
	175	24	1.8	25	15	13.88	1	1200	800	
	175	24	1.8	25	15	13.88	2	1200	800	
Model steam cleaned.										
8	175	24	1.8	20	15	13.88				Convex side has light frost. Concave side about 0.5" thick. Note: ice covering is continuous from l.e. to t.e.
	175	24	1.8	20	15	13.88	4	1000	800	Coil 11 cleaned well; Coil 10 only cracked ice.
	175	24	1.8	20	15	13.88	4	1000	800	30% of coil 10 bay clean.
	175	24	1.8	20	15	13.88	4	1000	800	40% of coil 10 bay clean.
	175	24	1.8	20	15	13.88	6	1000	800	Excellent cleaning.
	175	24	1.8	20	15	13.88	8	1000	800	Good cleaning.
	175	24	1.8	20	15	13.88	3	1000	800	Fair cleaning.
	175	24	1.8	20	15	13.88	3	1000	800	A bit more.
	175	24	1.8	20	15	13.88	3	1000	800	Ice remained aft of rear spar and small bit over coil 3.
	175	24	1.8	20	15	13.88	1	1000	800	Some shed near coil 17.
	175	24	1.8	20	15	13.88	1	1000	800	Cleaned well.
	175	24	1.8	20	15	13.88	2	1000	800	Most of ice gone.
	175	24	1.8	20	15	13.88	2	1000	800	All clean.

RUN	TEST SECT.		LWC g/m ³	MVD mic	ICE TIME min.	TUN'L PRESS psia	PULSE SEQ. CHAN. NO.	VOLTS	CAP uF	COMMENTS
	IAS mph	TEMP degF								
9	175	15	0.8	12	15	13.85				About 0.4 inches on l.e.; Concave side, frost, "popcorn" ice. .25" to .40" thick.
	175	15	0.8	12	15	13.85	4	1000	800	Some ice shed.
	175	15	0.8	12	15	13.85	4	1000	800	Some ice shed.
	175	15	0.8	12	15	13.85	4	1000	800	Clean over coil and between spars about 4 ft. span wise and 15 inches chord wise.
	175	15	0.8	12	15	13.85	3	1000	900	Very little shed.
	175	15	0.8	12	15	13.85	3	1000	800	Very little shed.
	175	15	0.8	12	15	13.85	3	1000	800	Still not clean.
	175	15	0.8	12	15	13.85	8	1000	800	Very little ice shed.
	175	15	0.8	12	15	13.85	8	1000	800	Very little ice shed.
	175	15	0.8	12	15	13.85	8	1000	800	Very little ice shed.
	175	15	0.8	12	15	13.85	6	1000	800	Only frost here.
	175	15	0.8	12	15	13.85	6	1000	800	Some shed.
	175	15	0.8	12	15	13.85	1	1000	800	Some ice shed.
	175	15	0.8	12	15	13.85	1	1000	800	
	175	15	0.8	12	15	13.85	1	1000	800	Still some ice on the surface.
	175	15	0.8	12	15	13.85	2	1000	800	?
	175	15	0.8	12	15	13.85	2	1000	800	?

Thursday, September 12, 1985

10	100	27	3.0	25	30	14.32				0.75" ice on l.e., .35" back to rear spar. Splotchy ice aft of rear spar.
	100	27	3.0	25	30	14.32	1	1000	800	50% clean.
	100	27	3.0	25	30	14.32	1	1000	800	95% clean.

RUN	TEST	TEMP	LWC	MVD	ICE	TUN'L	PULSE	VOLTS	CAP	COMMENTS
	SECT.									
	mph				min.	psia				
10	100	27	3.0	25	30	14.32	1	1000	800	Upper 3/4 of l.e. span is clean.
	100	27	3.0	25	30	14.32	2	1000	800	#13 already clean.
	100	27	3.0	25	30	14.32	2	1000	800	Most clean.
	100	27	3.0	25	30	14.32	2	1000	800	l.e. all clean; slight residue.
	100	27	3.0	25	30	14.32	3	1000	800	#16 cleared; #2 partial.
	100	27	3.0	25	30	14.32	3	1000	800	More shed.
	100	27	3.0	25	30	14.32	3	1000	800	100% clean.
	100	27	3.0	25	30	14.32	4	1000	800	Center bay clean; circle around #11.
	100	27	3.0	25	30	14.32	4	1000	800	Most of #11 bay clean.
	100	27	3.0	25	30	14.32	4	1000	800	95%.
	100	27	3.0	25	30	14.32	5	1500	800	Upper bay cleaner than lower.
	100	27	3.0	25	30	14.32	5	1500	800	Upper 95% clean.
	100	27	3.0	25	30	14.32	5	1500	800	Lower not completely clean.
	100	27	3.0	25	30	14.32	6	1500	800	All of vane is clean except for scattered residue.
11	140	27	2.5	30	15	14.11				l.e. ice thickness about 0.4". t.e. almost bare.
	140	27	2.5	30	15	14.11	1	1000	800	l.e. ice cracked.
	140	27	2.5	30	15	14.11	1	1000	800	Much shed.
	140	27	2.5	30	15	14.11	1	1000	800	l.e. mostly clean.
	140	27	2.5	30	15	14.11	2	1000	800	Some shed.
	140	27	2.5	30	15	14.11	2	1000	800	More.
	140	27	2.5	30	15	14.11	2	1000	800	All clean l.e.
	140	27	2.5	30	15	14.11	3	1000	800	Upper bay 80% clean.

RUN	TEST SECT.		LWC g/m3	MVD mic	ICE TIME min.	PULSE PRESS psia	SEQ. CHAN. NO.	VOLTS	CAP uF	COMMENTS
	IAS mph	TEMP degF								
11	140	27	2.5	30	15	14.11	3	1000	800	Upper clean.
	140	27	2.5	30	15	14.11	3	1000	800	Lower still not clean.
	140	27	2.5	30	15	14.11	4	1000	800	Cracked.
	140	27	2.5	30	15	14.11	4	1000	800	#10 is 70% clean; #11 some.
	140	27	2.5	30	15	14.11	4	1000	800	Both well cleaned.
	140	27	2.5	30	15	14.11	5	1500	800	Upper bay mostly clean; lower cracked.
	140	27	2.5	30	15	14.11	5	1500	800	Upper clean; lower 50% clean.
	140	27	2.5	30	15	14.11	5	1500	800	Lower has some ice remaining.
	140	27	2.5	30	15	14.11	6	1500	800	Upper clean; lower not.
	140	27	2.5	30	15	14.11	6	1500	800	All clean.
	140	27	2.5	30	15	14.11	3	1000	800	
	140	27	2.5	30	15	14.11	3	1000	800	All clean.
12	140	27	2.0	30	30	14.11				3/4 inch on l.e. Not much ice near l.e. 1/2 inch at front spar. Ice fingers at l.e.
	140	27	2.0	30	30	14.11	1	1000	800	Ice cracking only.
	140	27	2.0	30	30	14.11	1	1000	800	Some ice shed over coil 9.
	140	27	2.0	30	30	14.11	1	1000	800	Ice all loose, but not all shed.
	140	27	2.0	30	30	14.11	2	1200	800	Little removed.
	140	27	2.0	30	30	14.11	2	1200	800	Mostly cleaned.
	140	27	2.0	30	30	14.11	2	1200	800	Clean over #9 & #13; lower l.e. over #5 almost clean.
	140	27	2.0	30	30	14.11	3	1200	800	Some shed.
	140	27	2.0	30	30	14.11	3	1200	800	75% clean over #16 and #2.
	140	27	2.0	30	30	14.11	3	1200	800	All clean for bays of 2 and 6.

RUN	TEST SECT.		LWC g/m ³	MVD mic	ICE TIME min.	TUN'L PRESS psia	PULSE SEQ. CHAN. NO.	VOLTS	CAP uF	COMMENTS
	IAS mph	TEMP degF								
12	140	27	2.0	30	30	14.11	4	1200	800	Very little shed.
	140	27	2.0	30	30	14.11	4	1200	800	More.
	140	27	2.0	30	30	14.11	4	1200	800	70% clean for bays of #10 & #11.
	140	27	2.0	30	30	14.11	5	1500	800	Upper bay shed some.
	140	27	2.0	30	30	14.11	5	1500	800	Upper mostly clean.
	140	27	2.0	30	30	14.11	5	1500	800	Upper clean; lower has much ice over coils 3 & 4; much shed over 1, 6 & 8.
	140	27	2.0	30	30	14.11	6	1500	800	All clean.
	140	27	2.0	30	30	14.11	6	1500	800	Only lite, scattered pieces remain.
	140	27	2.0	30	30	14.11	4	1200	800	Removed much of residual ice.
										Notes: 3, 4 do not clean as well as 14, 18. 2 does not clean as well as 16. Coils with more turns are superior.
13	100	15	3.0	30	15	14.33				Scattered heavy accumulations. 0.5" ice fingers at t.e. Only frost from rear spar to t.e.
	100	15	3.0	30	15	14.33	1	1200	800	Upper 18 inch clean.
	100	15	3.0	30	15	14.33	1	1200	800	l.e. over 9 & 17 clean; some shed between 9 & 17.
	100	15	3.0	30	15	14.33	1	1200	800	All clean except at bottom 12 inches.
	100	15	3.0	30	15	14.33	2	1200	800	Cleaned most of l.e.
	100	15	3.0	30	15	14.33	2	1200	800	Some cleaned behind front spar.
	100	15	3.0	30	15	14.33	3	1200	800	Coils 2 and 16 cleaned most of their bays.
	100	15	3.0	30	15	14.33	3	1200	800	Some cleaned in adjacent bays.

RUN	TEST SECT.		LWC g/m3	MVD mic	ICE TIME min.	TUN'L PRESS psia	PULSE SEQ. CHAN. NO.	VOLTS	CAP uF	COMMENTS
	IAS mph	TEMP degF								
13	100	15	3.0	30	15	14.33	3	1200	800	More.
	100	15	3.0	30	15	14.33	4	1200	800	Cleaned most of residue.
	100	15	3.0	30	15	14.33	4	1200	800	Cleaned most of residue.
	100	15	3.0	30	15	14.33	5	1500	800	Removed remaining ice.
	100	15	3.0	30	15	14.33	5	1500	800	Removed remaining frost.
14	100	15	3.0	22	30	14.34				1.5 inch ice on l.e.; uneven ice on concave surface.
	100	15	3.0	22	30	14.34	1	1200	800	Half of l.e. is clean.
	100	15	3.0	22	30	14.34	1	1200	800	Only lower 2 ft. of l.e. has ice remaining.
	100	15	3.0	22	30	14.34	1	1200	800	Slight improvement.
	100	15	3.0	22	30	14.34	2	1200	800	Cleaned whole l.e. except for frosty residue.
	100	15	3.0	22	30	14.34	2	1200	800	Little change.
	100	15	3.0	22	30	14.34	3	1200	800	Most of vane is clean.
	100	15	3.0	22	30	14.34	3	1200	800	Some light residue shed.
	100	15	3.0	22	30	14.34	4	1200	800	0.10 inch frost still near coil 11.
	100	15	3.0	22	30	14.34	5	1500	800	Some very thin frost won't come off.

Monday, September 16, 1986

15	50	65	0	--	0		(No De-icing)			Velocity measured at model = 23 mph.
	75	65	0	--	0		(No De-icing)			Velocity measured at model = 34 mph.

RUN	TEST	TEMP	LWC	MVD	ICE	TUN·L	PULSE	VOLTS	CAP	COMMENTS	
	SECT										IAS
16		140	27	2.0	20	30	14.04			At 20 minutes, slowed to measure icing on the 1/8 inch reference collector. LWC probe was mounted on vane model. On l.e. 1.3" ice thickness. Only patches of ice aft of rear spar; very little ice at t.e.	
		140	27	2.0	20	30	14.04	7	1000	600	Cracking only.
		140	27	2.0	20	30	14.04	7	1000	600	80% clean.
		140	27	2.0	20	30	14.04	7	1000	600	l.e. clean except some over coil 7 and below.
		140	27	2.0	20	30	14.04	8	1000	600	l.e. over coil 5 cleaned.
		140	27	2.0	20	30	14.04	8	1000	600	l.e. clean over all 3 bays.
		140	27	2.0	20	30	14.04	3	1000	800	Most of vane is clean. Residue less than 0.25" thick.
		140	27	2.0	20	30	14.04	3	1000	800	Part of scattered residue shed.
		140	27	2.0	20	30	14.04	3	1000	800	More.
		140	27	2.0	20	30	14.04	4	1000	800	Most ice gone except over rear span.
		140	27	2.0	20	30	14.04	4	1000	800	Part of rear spar ice shed.
17		140	27	1.5	27	30	14.04			2" thick on l.e.; 0.75" over rear bays.	
		140	27	1.5	27	30	14.04	7	1000	600	Mostly cracking of ice.
		140	27	1.5	27	30	14.04	7	1000	600	More cracking.
		140	27	1.5	27	30	14.04	7	1000	600	Only partially clean; ice is debonded.
		140	27	1.5	27	30	14.04	8	1200	600	Much l.e. ice shed.
		140	27	1.5	27	30	14.04	8	1200	600	Most of l.e. between coils 5 & 17 clean.
		140	27	1.5	27	30	14.04	8	1200	600	All clean.

RUN	TEST SECT.		LWC g/m3	MVD mic	ICE TIME min.	TUN'L PRESS psia	PULSE SEQ. CHAN. NO.	VOLTS	CAP uF	COMMENTS
	IAS mph	TEMP degF								
17	140	27	1.5	27	30	14.04	4	1000	800	Much cleaning over 3, 4, 11, 14 & 15; Some off over 10.
	140	27	1.5	27	30	14.04	4	1000	800	All clean aft of rear spar.
	140	27	1.5	27	30	14.04	3	1000	800	Mostly clean between spars.
	140	27	1.5	27	30	14.04	3	1000	800	All clean between spars.
	140	27	1.5	27	30	14.04	3	1000	800	
	140	27	1.5	27	30	14.04	3	1000	800	Only small, scattered residue.
	140	27	1.5	27	30	14.04	5	1000	800	Some frost shed.
18	140	15	2.5	30	15	14.04	7	1200	600	Only ice cracking.
	140	15	2.5	30	15	14.04	7	1200	600	More cracking.
	140	15	2.5	30	15	14.04	7	1200	600	Small chips came off.
	140	15	2.5	30	15	14.04	8	1200	600	Much removed.
	140	15	2.5	30	15	14.04	8	1200	600	More.
	140	15	2.5	30	15	14.04	8	1200	600	All l.e. is clean.
	100	15	3.0	22	30	14.04	3	1000	800	A bit removed.
	100	15	3.0	22	30	14.04	3	1000	800	Bay of coil 16 fairly clean, but not coil 2.
	100	15	3.0	22	30	14.04	3	1000	800	Bay of coil 2 improved some.
	100	15	3.0	22	30	14.04	4	1000	800	A small bit removed; much loosened.
	100	15	3.0	22	30	14.04	4	1000	800	Almost clean.
	100	15	3.0	22	30	14.04	4	1000	800	Completely clean.
	100	15	3.0	22	30	14.04	5	1000	800	Most of ice is shed.
	100	15	3.0	22	30	14.04	2	800	800	Only light frost remains.
	100	15	3.0	22	30	14.04	2	800	800	Some of frost expelled.

RUN	TEST SECT.		LWC g/m ³	MVD mic	ICE TIME min.	TUN'L PRESS psia	PULSE SEQ. CHAN. NO.	VOLTS	CAP uF	COMMENTS
	IAS mph	TEMP degF								
18	100	15	3.0	22	30	14.04	1	800	800	More.
	100	15	3.0	22	30	14.04	1	800	800	Slightly more.
19	175	15	1.6	20	15	13.83				Light icing; tunnel speed kept up during de-icing.
	175	15	1.6	20	15	13.83	7	1000	600	Mostly clean near coils 9 & 17.
	175	15	1.6	20	15	13.83	7	1000	600	More of l.e. clean.
	175	15	1.6	20	15	13.83	7	1000	600	l.e. all clean except bottom 12 inches.
	175	15	1.6	20	15	13.83	8	1000	600	Ice near coil 5 expelled.
	175	15	1.6	20	15	13.83	8	1000	600	A little more.
	175	15	1.6	20	15	13.83	3	1000	800	Clear near coils 2 & 16.
	175	15	1.6	20	15	13.83	3	1000	800	Ice loosened, but not shed.
	175	15	1.6	20	15	13.83	3	1000	800	A small amount shed.
	175	15	1.6	20	15	13.83	4	1000	800	Some removed.
	175	15	1.6	20	15	13.83	4	1000	800	Small amount shed.
	175	15	1.6	20	15	13.83	4	1000	800	Small amount shed.
20	200	15	1.6	19	15	13.66				Ice on l.e. 1 inch thick. Jagged build-up on concave surface.
	200	15	1.6	19	15	13.66	7	1000	600	Good cleaning above coil 17; Some off at coil 9.
	200	15	1.6	19	15	13.66	7	1000	600	All de-iced from top to near coil 7.
	200	15	1.6	19	15	13.66	7	1000	600	Not much more.
	200	15	1.6	19	15	13.66	8	1000	600	No. 13 already clean. All the rest of l.e. clean except lower 6 inches.

RUN	TEST SECT.		LWC g/m3	MVD mic	ICE TIME min.	TUN'L PRESS psia	PULSE SEQ. CHAN. NO.	VOLTS	CAP uF	COMMENTS
	IAS mph	TEMP degF								
20	200	15	1.6	19	15	13.66	8	1000	600	A little more.
	200	15	1.6	19	15	13.66	3	1000	800	Cleaned most of ice for whole span between the spars.
	200	15	1.6	19	15	13.66	3	1000	800	Only light frost remains.
	200	15	1.6	19	15	13.66	4	1000	800	Not enough ice to remove.

Appendix C

Design Drawings

A large sheet is folded in the envelope at the back of this report. These are scale drawings of the vane model with dimensions and material specifications.