

ISCCP REDUCED RESOLUTION SATELLITE RADIANCE DATA

Dr. William Rossow
Goddard Institute for Space Studies
2880 Broadway
New York, New York 10025

The International Satellite Cloud Climatology Project (ISCCP) is the first active project of the World Climate Research Program. It is a multinational data collection project focused on collecting a data set that will improve the ability to predict and/or simulate the radiative effects of clouds on climate. For specified cloud parameters, the goals are to archive values for 3-hour periods over the whole globe for 5 years at 30 km resolution.

The task of collecting and processing radiance data from both geosynchronous and polar orbiting satellites began in July 1983. A diagram was shown illustrating the flow of data from the transmitting satellites to the various receiving institutions that handle it. The various stages of processing were then explained in detail, emphasizing Level B3-normalized, reformatted, reduced raw satellite data. The reduction of data by sampling is an essential step in the flow. By the time the ISCCP data reaches the Global Processing Center at GISS, the volume has been reduced by a factor of 1000.

The PCDS will provide access to the ISCCP data set. It should prove to be one of the "cleanest satellite data sets" because it will have been through three filters--that of the operational agency, the Global Processing Center, and the PCDS. The ISCCP data set also includes other correlative data sets delivered in compatible format. It also provides complete documentation for the archiver and important documentation of tape formats for the scientist or programmer.

The Level B3 ISCCP data are now standard products being produced and delivered to the official archive and to the PCDS. The algorithms involved in the analysis of the Level C cloud products continue to undergo scrutiny and improvement. The ISCCP data have many potential applications, such as their use in GCM validation studies, cloud algorithm improvements, and Earth and ocean applications during cloudless conditions.

Page Intentionally Left Blank

PCDS WORKSHOP 2

ISCCP REDUCED RESOLUTION SATELLITE RADIANCE DATA

William B. Rossow
NASA Goddard Space Flight Center
Institute for Space Studies

Page Intentionally Left Blank

Table 1

Data Specification for the International
Satellite Cloud Climatology

Parameters--Spatial and temporal averages and variances (or another statistical measure of the shape of the temporal distribution) are required for each of the following parameters.

<u>Amounts</u>	<u>Precision (30-day averages)</u>
Total cloud amount (fraction)*	±0.03
Cirrus cloud amount (fraction)*	±0.05
Middle cloud amount (fraction)	±0.05
Low cloud amount (fraction)*	±0.05
Deep convective cloud amount (fraction)	±0.05

Heights

Cirrus cloud-top height (km)*	±1.00
Middle level cloud-top height (km)	±1.00
Low-level cloud-top height (km)	±0.50
Deep convective cloud-top height (km)	±1.00

Cloud Top Temperature (°K) for each cloud category* ±1.00

Cloud Optical Depth

Cloud Size Distribution

Average Narrow Band Radiances (VIS and IR)*

Spatial Averaging--The information is to be averaged over approximately 250-km by 250-km boxes

Time Sampling--Every 3 hours, i.e., 8 times a day, centered around the synoptic observation times

Time Averaging--The global cloud climatology will consist of 30-day averages for each of the 8 observing times per day

Length of Time Series--5 years

* Highest priority

DATA PROCESSING SECTORS FOR THE INTERNATIONAL SATELLITE CLOUD CLIMATOLOGY PROJECT (ISCCP)

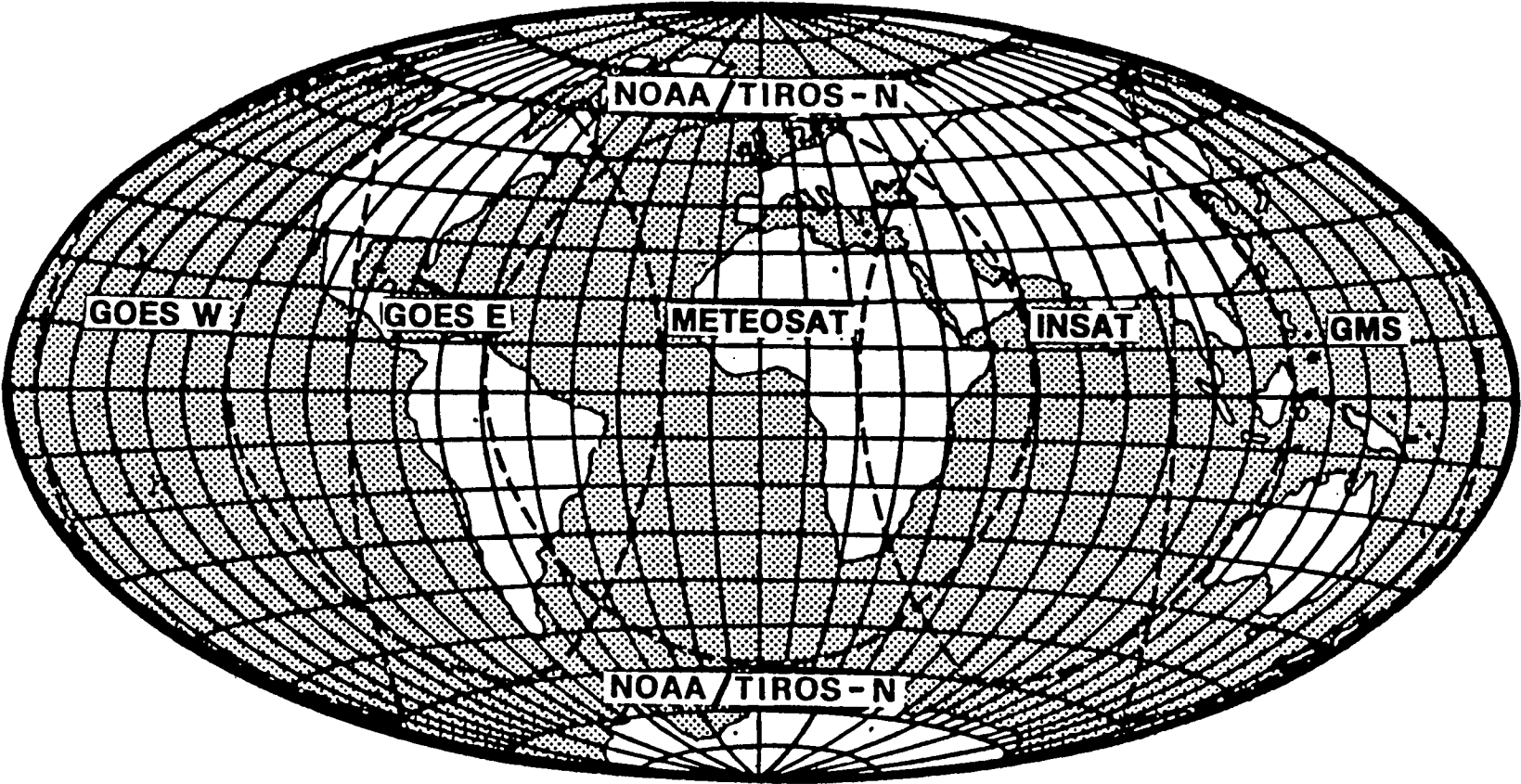

4-6

ISCCP DATA FLOW CONCEPT

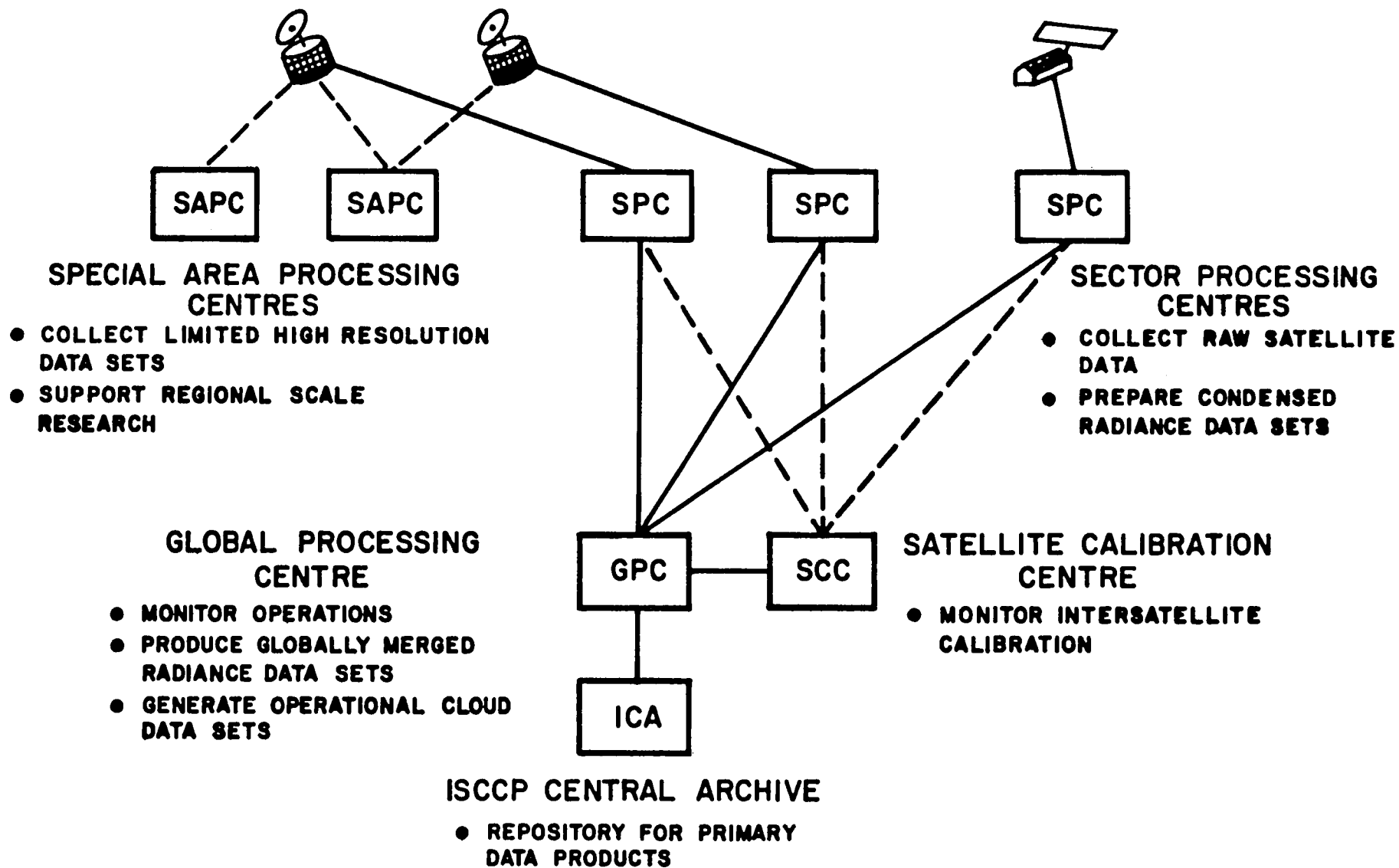

ISCCP DATA STAGES

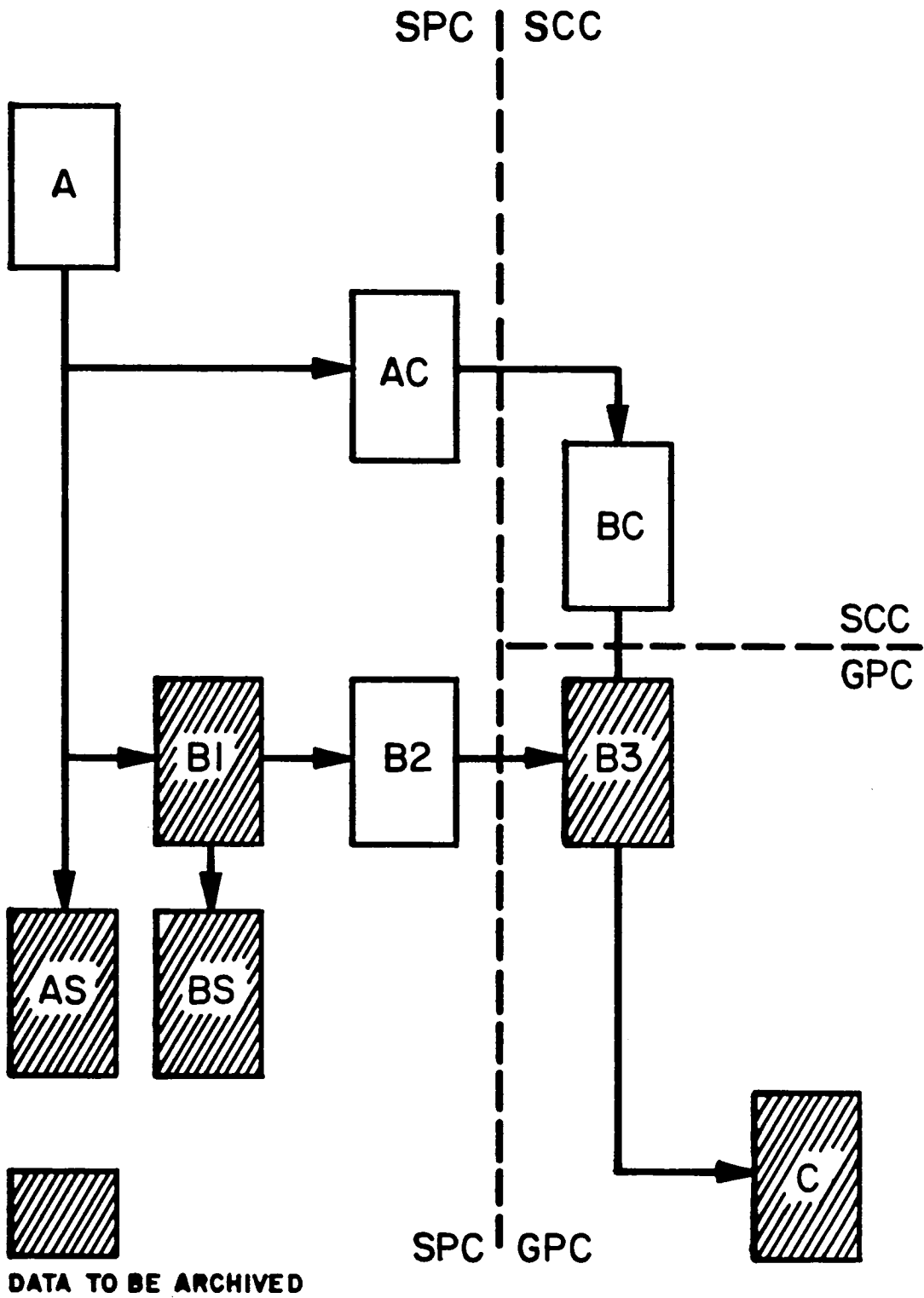

SPECIAL FEATURES OF ISCCP RADIANCE DATA

- PREDICTABLE ARRANGEMENT OF DATA BY SATELLITE AND TIME
- INDEX TO TAPE CONTENTS PROVIDED
- EACH IMAGE PIXEL HAS ALL SPECTRAL CHANNELS
- EACH IMAGE PIXEL HAS EARTH LOCATION AND VIEWING GEOMETRY
- ORIGINAL COUNT VALUES AND IMAGE FORM PRESERVED

SPECIAL FEATURES OF ISCCP RADIANCE DATA

- UNIFORM TAPE FORMAT FOR ALL SATELLITES
- ONE SOFTWARE TO READ ALL TAPES PROVIDED
- CALIBRATION TABLES FOR EACH CHANNEL CONVERTS COUNTS TO TWO QUANTITIES
- CALIBRATION TABLES FOR NOMINAL, NORMALIZED AND ABSOLUTE CALIBRATION

SPECIAL FEATURES OF ISCCP RADIANCE DATA

- DOCUMENTATION

EXPLAINS CALIBRATION PROCEDURES

PROVIDES RADIOMETER SPECIFICATIONS AND SPECTRAL RESPONSES

EXPLAINS NAVIGATIONAL PROCEDURES

EXPLAINS DATA TAPE FORMAT

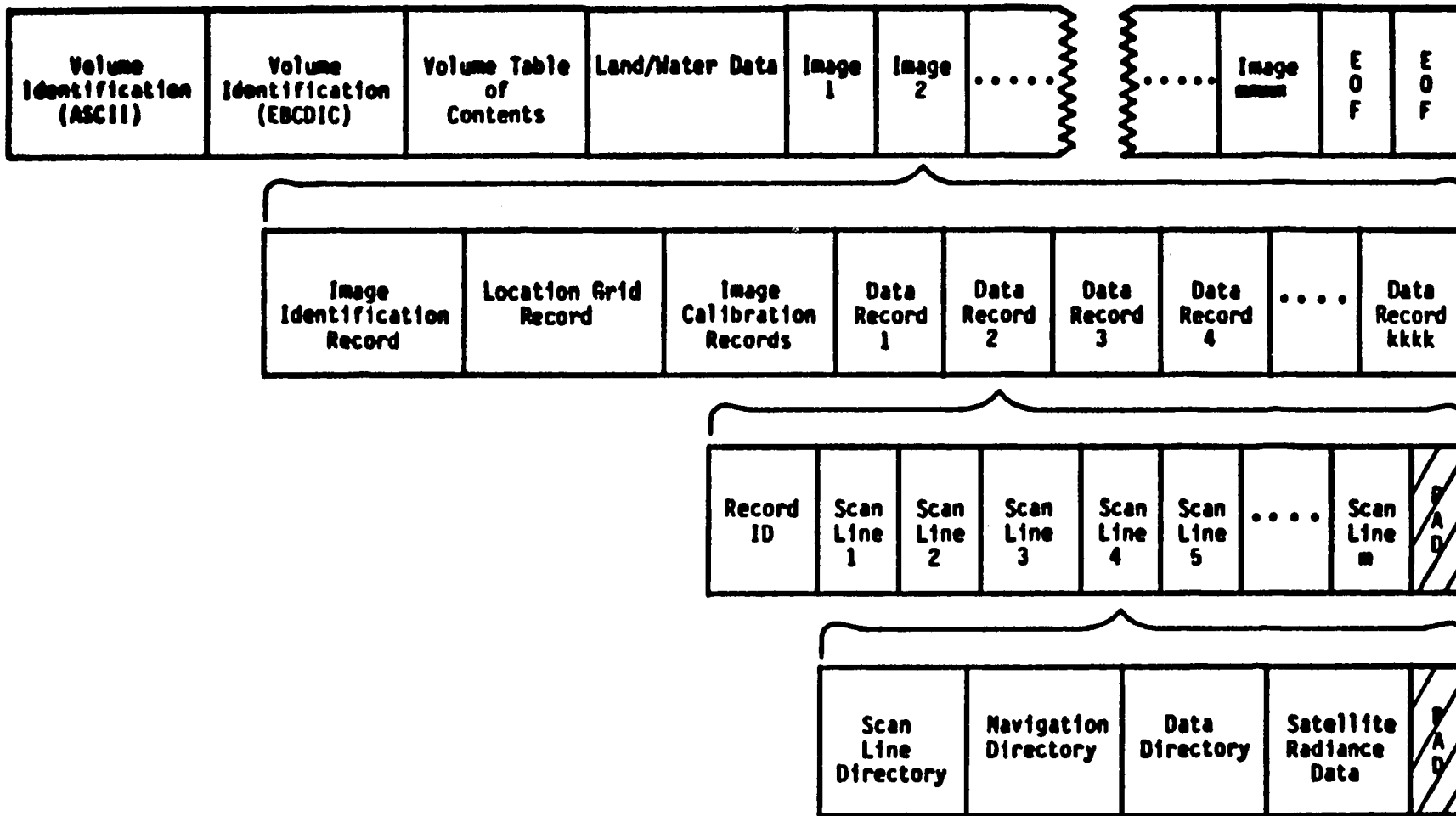

Fig. 5.1. B3 data tape format.

VOLUME TABLE OF CONTENTS

FILE NUMBER	IMAGE NUMBER	NOMINAL DATE	NOMINAL GMT	LOCATION 1 / 2	GMT 1	GMT 2	NUMBER RECORDS	NUMBER SCANS	PERCENT BAD	NUMBER PIXELS	DAY/NIGHT	CALIBRATION VIS	IR	CHANNEL VIS	IR	3	4	5	AVAILABILITY
5	1	83244	#	-148/ 44	18716	1614	134	1681	#	65	#	1	1	1	1	1	1	1	1
6	2	83244	#	-173/ 18	24915	15888	144	1789	#	65	#	1	1	1	1	1	1	1	1
7	3	83244	38888	168/ -6	43188	34886	142	1683	#	65	#	1	1	1	1	1	1	1	1
8	4	83244	38888	135/ -32	61382	52199	144	1783	#	65	#	1	1	1	1	1	1	1	1
9	5	83244	68888	189/ -57	75588	78397	134	1598	#	65	#	1	1	1	1	1	1	1	1
10	6	83244	98888	84/ -83	93698	84596	133	1587	#	65	#	1	1	1	1	1	1	1	1
11	7	83244	98888	58/-188	111897	182791	126	1514	#	65	#	1	1	1	1	1	1	1	1
12	8	83244	128888	33/-134	138896	128989	131	1568	#	65	#	1	1	1	1	1	1	1	1
13	9	83244	128888	-1/-159	-1	135187	68	733	#	65	#	1	1	1	1	1	1	1	1
14	10	83244	158888	-17/ 174	162488	153379	131	1558	#	65	#	1	1	1	1	1	1	1	1
15	11	83244	158888	-43/ 149	188681	171576	114	1362	#	65	#	1	1	1	1	1	1	1	1
16	12	83244	188888	-68/ 123	194876	185772	129	1543	#	65	#	1	1	1	1	1	1	1	1
17	13	83244	188888	-68/ 98	194878	283969	143	1788	#	65	#	1	1	1	1	1	1	1	1
18	14	83245	#	-145/ 47	5466	366	131	1565	#	65	#	1	1	1	1	1	1	1	1
19	15	83245	#	-178/ 21	23661	14557	135	1687	#	65	#	1	1	1	1	1	1	1	1
20	16	83245	38888	163/ -3	41857	32754	144	1787	#	65	#	1	1	1	1	1	1	1	1
21	17	83245	38888	138/ -29	68857	58952	142	1886	#	65	#	1	1	1	1	1	1	1	1
22	18	83245	68888	112/ -54	74251	65145	142	1683	#	65	#	1	1	1	1	1	1	1	1
23	19	83245	98888	87/ -88	92449	83343	134	1594	#	65	#	1	1	1	1	1	1	1	1
24	20	83245	98888	61/-185	118643	181541	125	1584	#	65	#	1	1	1	1	1	1	1	1
25	21	83245	128888	36/-131	124842	115741	134	1595	#	65	#	1	1	1	1	1	1	1	1
26	22	83245	128888	18/-156	143842	133948	133	1583	#	65	#	1	1	1	1	1	1	1	1
27	23	83245	158888	-14/ 177	161239	152137	133	1588	#	65	#	1	1	1	1	1	1	1	1
28	24	83245	158888	-48/ 152	175437	178335	132	1579	#	65	#	1	1	1	1	1	1	1	1
29	25	83245	188888	-65/ 126	193635	184535	112	1339	#	65	#	1	1	1	1	1	1	1	1
30	26	83245	188888	-65/ 181	193636	282732	143	1789	#	65	#	1	1	1	1	1	1	1	1
31	27	83245	218888	-116/ 75	238832	228938	135	1616	#	65	#	1	1	1	1	1	1	1	1
32	28	83246	#	-142/ 58	4232	235128	132	1574	#	65	#	1	1	1	1	1	1	1	1
33	29	83246	#	-142/ 58	4232	235128	132	1574	#	65	#	1	1	1	1	1	1	1	1
34	30	83246	#	-167/ 25	22438	13328	137	1635	#	65	#	1	1	1	1	1	1	1	1
35	31	83246	38888	166/ #	48627	31526	137	1629	#	65	#	1	1	1	1	1	1	1	1
36	32	83246	38888	141/ -25	54827	45725	144	1718	#	65	#	1	1	1	1	1	1	1	1
37	33	83246	68888	115/ -51	73825	63923	143	1698	#	65	#	1	1	1	1	1	1	1	1
38	34	83246	68888	98/ -76	91222	82128	134	1595	#	65	#	1	1	1	1	1	1	1	1
39	35	83246	98888	64/-182	185421	188319	127	1528	#	65	#	1	1	1	1	1	1	1	1
40	36	83246	128888	39/-127	123619	114517	132	1578	#	65	#	1	1	1	1	1	1	1	1
41	37	83246	128888	13/-153	141818	132716	134	1688	#	65	#	1	1	1	1	1	1	1	1
42	38	83246	158888	-11/-178	168817	158918	133	1576	#	65	#	1	1	1	1	1	1	1	1
43	39	83246	158888	-37/ 155	174216	165188	132	1575	#	65	#	1	1	1	1	1	1	1	1
44	40	83246	188888	-62/ 138	192489	183387	112	1337	#	65	#	1	1	1	1	1	1	1	1
45	41	83246	188888	-62/ 184	192414	281585	135	1619	#	65	#	1	1	1	1	1	1	1	1
46	42	83246	218888	-88/ 79	218686	215697	143	1718	#	65	#	1	1	1	1	1	1	1	1
47	43	83246	218888	-139/ 53	2999	233896	132	1576	#	65	#	1	1	1	1	1	1	1	1
48	44	83247	#	-164/ 28	21192	12889	133	1594	#	65	#	1	1	1	1	1	1	1	1
49	45	83247	38888	169/ 2	35398	38287	143	1691	#	65	#	1	1	1	1	1	1	1	1
50	46	83247	38888	144/ -22	53588	44483	145	1718	#	65	#	1	1	1	1	1	1	1	1
51	47	83247	68888	118/ -48	71783	62679	144	1782	#	65	#	1	1	1	1	1	1	1	1
52	48	83247	68888	93/ -73	88285	88874	132	1578	#	65	#	1	1	1	1	1	1	1	1
53	49	83247	98888	67/ -99	184176	95871	125	1587	#	65	#	1	1	1	1	1	1	1	1
54	50	83247	128888	42/-124	122375	113267	133	1581	#	65	#	1	1	1	1	1	1	1	1
55	51	83247	128888	16/-158	148578	131466	133	1581	#	65	#	1	1	1	1	1	1	1	1
56	52	83247	158888	-8/-175	154768	145659	133	1574	#	65	#	1	1	1	1	1	1	1	1
57	53	83247	158888	-33/ 158	172959	163854	132	1569	#	65	#	1	1	1	1	1	1	1	1
58	54	83247	188888	-59/ 133	191159	182854	111	1327	#	65	#	1	1	1	1	1	1	1	1
59	55	83247	188888	-59/ 187	191159	288251	134	1682	#	65	#	1	1	1	1	1	1	1	1
60	56	83247	218888	-84/ 82	285357	214449	142	1787	#	65	#	1	1	1	1	1	1	1	1
61	57	83247	218888	-135/ 56	1745	232643	134	1683	#	65	#	1	1	1	1	1	1	1	1

TEMPORAL COVERAGE

<u>GMT</u>	<u>DAY OF MONTH</u>																														
	1	2	3	4	5	6	7	8	9	10	11	12	13	14	15	16	17	18	19	20	21	22	23	24	25	26	27	28	29	30	31
#	2	2	3	1	1	2	2	2	#	#	#	#	#	#	#	#	#	#	#	#	#	#	#	#	#	#	#	#	#	#	#
3	2	2	2	2	2	1	1	1	#	#	#	#	#	#	#	#	#	#	#	#	#	#	#	#	#	#	#	#	#	#	
6	1	1	2	2	1	2	2	2	#	#	#	#	#	#	#	#	#	#	#	#	#	#	#	#	#	#	#	#	#	#	
9	2	2	1	1	1	2	2	2	#	#	#	#	#	#	#	#	#	#	#	#	#	#	#	#	#	#	#	#	#	#	
12	2	2	2	2	3	2	2	2	#	#	#	#	#	#	#	#	#	#	#	#	#	#	#	#	#	#	#	#	#	#	
15	2	2	2	2	2	1	1	2	#	#	#	#	#	#	#	#	#	#	#	#	#	#	#	#	#	#	#	#	#	#	
18	2	2	2	2	2	2	2	1	#	#	#	#	#	#	#	#	#	#	#	#	#	#	#	#	#	#	#	#	#	#	
21	#	1	2	2	2	2	2	2	#	#	#	#	#	#	#	#	#	#	#	#	#	#	#	#	#	#	#	#	#	#	

OUTPUT FROM SAMPLE PROGRAM USING B3READ SUBROUTINE TO ACCESS B3-FORMATTED DATA

READ AND DECODE IMAGE NUMBER : 5
FOR SCAN LINE 2## PRINT DATA VALUES AND ANGLE VALUES FOR ALL PIXELS

IMAGE DESCRIPTION

IMAGE SEQUENCE NUMBER : 5
SPC ID NOA CODE 1 SATELLITE ID NOAA-7 CODE 11
JULIAN DAY (DDD): 244 YEAR (YYYY): 1983 MONTH : 9 DAY : 1
NOMINAL GMT (HHMMSS) : 6### HOUR : 6 MINS : #
NUMBER OF DATA RECORDS : 134
NUMBER OF SCAN LINES : 1598
PERCENTAGE BAD SCAN LINES : #
GMT (HHMMSS) OF BEGINNING SCAN LINE : 63949 ENDING : 82617
DATE (YYDDD) OF BEGINNING SCAN LINE : 83244 ENDING : 83244
NUMBER OF PIXELS / SCAN LINE : 65
NUMBER OF ACTIVE CHANNELS : 5
CHANNEL 1 VIS (.58 - .68) MICRONS CODE : 1
CHANNEL 2 IR (10.5# - 11.3#) MICRONS CODE : 2
CHANNEL 3 .725 (.725 - 1.1#) MICRONS CODE : 3
CHANNEL 4 3.55 (3.55 - 3.93) MICRONS CODE : 4
CHANNEL 5 11.5 (11.5# - 12.5#) MICRONS CODE : 5
CALIBRATION FLAGS (VIS IR): 1 1
DAY OR NIGHT FLAG #
ASCENDING EQUATOR CROSSING LONGITUDE OR SUBSATELLITE POINT LONGITUDE 109 GMT 755##
DESCENDING EQUATOR CROSSING LONGITUDE OR SUBSATELLITE POINT LATITUDE -57 GMT 78397

LOCATION GRID

LATITUDE

LONG	-85	-75	-65	-55	-45	-35	-25	-15	-5	5	15	25	35	45	55	65	75	85	
5	2	#	#	#	#	#	#	#	#	#	#	#	#	#	#	#	#	#	
15	2	#	#	#	#	#	#	#	#	#	#	#	#	#	#	121	639	2211	
25	2	#	#	#	#	#	#	#	#	#	#	#	#	#	#	63	578	1591	
35	2	#	#	#	#	#	#	#	#	#	#	#	#	#	#	38	367	1481	
45	2	#	#	#	#	#	#	#	#	#	#	#	#	#	#	43	386	1391	
55	3	#	#	#	#	#	#	#	#	#	#	#	#	#	#	92	355	1341	
65	8	#	#	#	#	#	#	#	#	#	#	#	#	#	#	283	486	1271	
75	9	#	#	#	#	#	#	#	#	#	#	#	#	48	367	611	461	1181	
85	15	#	#	#	#	#	#	#	#	#	#	#	#	554	886	774	391	881	
95	43	1	#	#	#	#	#	#	71	219	466	811	1897	1286	1818	619	281	791	
105	44	113	117	158	219	352	555	861	1186	1467	1595	1518	1224	869	567	353	195	641	
115	66	194	356	688	936	1288	1529	1553	1366	1874	743	472	296	186	126	86	97	461	
125	88	292	639	1828	1168	1811	725	397	173	38	#	#	#	#	#	#	#	441	
135	98	398	766	761	515	185	18	#	#	#	#	#	#	#	#	#	#	141	
145	185	459	591	358	41	#	#	#	#	#	#	#	#	#	#	#	#	91	
155	119	453	371	68	#	#	#	#	#	#	#	#	#	#	#	#	#	81	
165	126	397	281	#	#	#	#	#	#	#	#	#	#	#	#	#	#	21	
175	135	347	97	#	#	#	#	#	#	#	#	#	#	#	#	#	#	31	
185	138	384	49	#	#	#	#	#	#	#	#	#	#	#	#	#	#	21	
195	144	278	28	#	#	#	#	#	#	#	#	#	#	#	#	#	#	21	
205	139	277	15	#	#	#	#	#	#	#	#	#	#	#	#	#	#	21	
215	139	279	23	#	#	#	#	#	#	#	#	#	#	#	#	#	#	21	
225	138	299	42	#	#	#	#	#	#	#	#	#	#	#	#	#	#	31	
235	136	335	85	#	#	#	#	#	#	#	#	#	#	#	#	#	#	181	
245	132	392	178	#	#	#	#	#	#	#	#	#	#	#	#	#	#	181	
255	117	441	336	38	#	#	#	#	#	#	#	#	#	#	#	#	#	241	
265	118	466	546	271	12	#	#	#	#	#	#	#	#	#	#	#	#	15	
275	92	417	749	674	383	79	#	#	#	#	#	#	#	#	#	#	#	154	
285	81	314	693	1837	1863	834	489	213	45	#	#	#	#	#	#	#	#	751	
295	66	214	412	785	1879	1398	1524	1482	1127	775	488	279	158	92	44	64	392	1241	
305	62	123	162	217	325	513	791	1126	1437	1637	1623	1481	1868	725	488	423	688	1411	
315	45	#	#	#	#	#	#	49	173	374	685	1848	1274	1258	965	798	729	1761	
325	18	#	#	#	#	#	#	#	#	#	#	#	74	332	686	895	1838	819	1911
335	18	#	#	#	#	#	#	#	#	#	#	#	#	92	441	883	842	2151	
345	8	#	#	#	#	#	#	#	#	#	#	#	#	#	92	495	888	2381	
355	3	#	#	#	#	#	#	#	#	#	#	#	#	#	#	262	786	2351	

VISIBLE CHANNEL NORMALIZATION
METEOSAT-2 (VIS 1 + VIS 2)/NOAA-7 CHANNEL 1

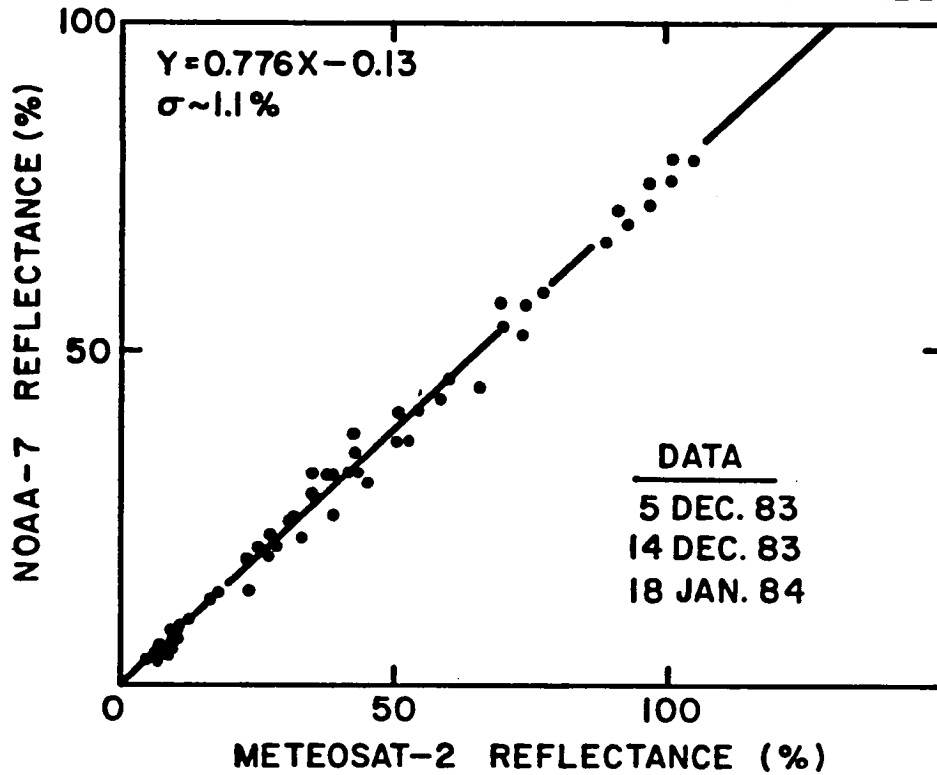

IR CHANNEL NORMALIZATION
METEOSAT-2 / NOAA-7 CHANNEL 4

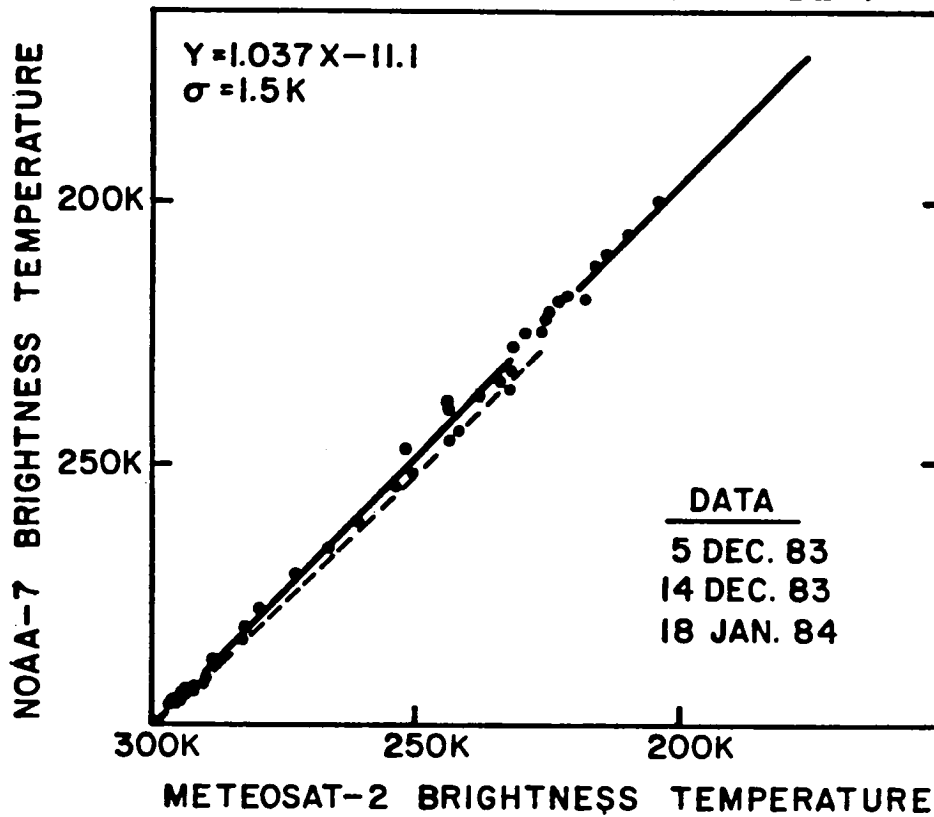

NOA8307 VS NOA8407

MEAN X:	8.7	R:	0.99
MEAN Y:	9.2	SLOPE:	1.00
DIFF (X-Y):	0.5	Y INT:	0.5
SDEV X:	9.4	RMSE:	1.6
SDEV Y:	9.5	TOT PIX:	182314

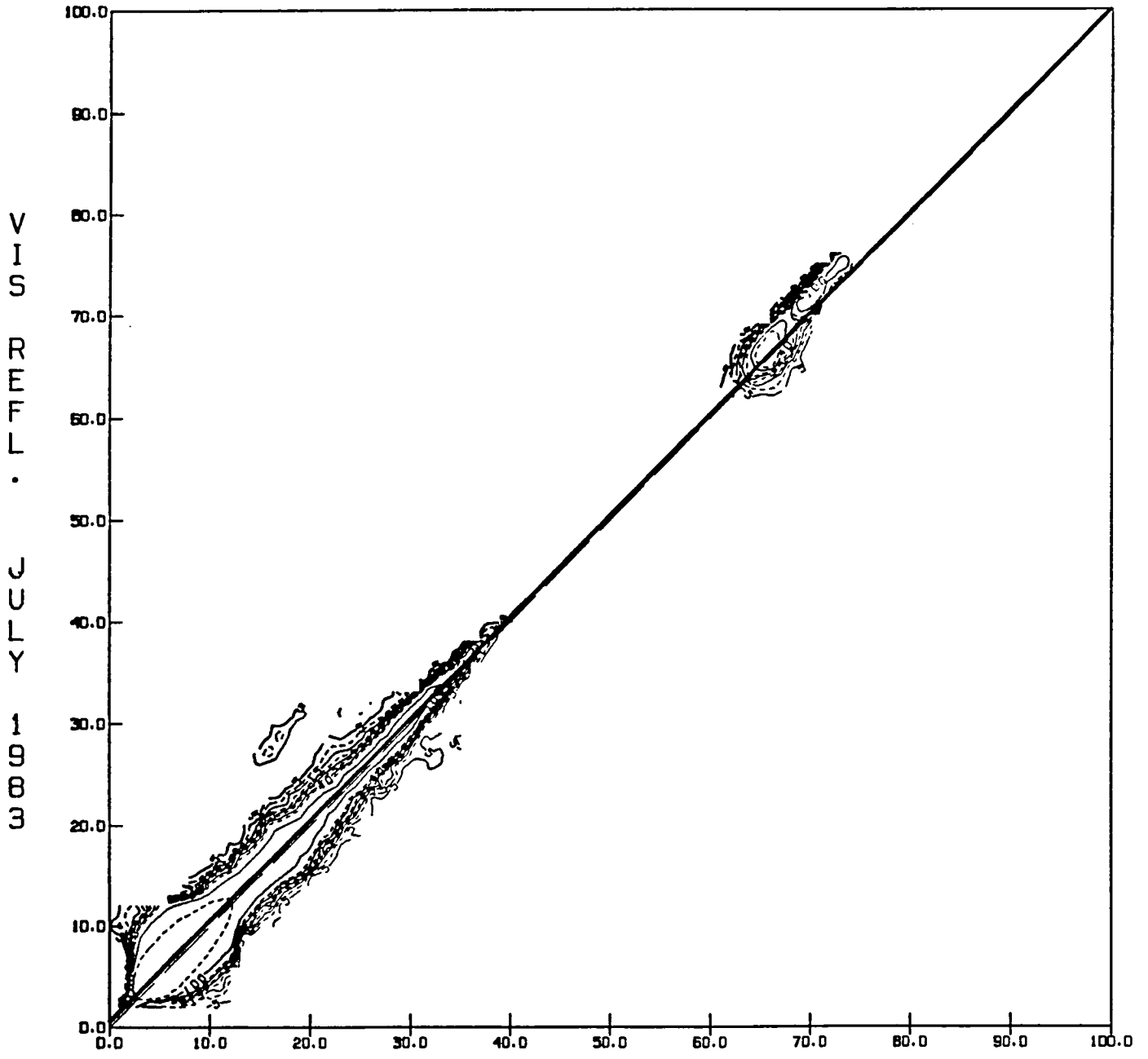

VIS REFL. JULY 1984

CORRELATIVE DATA
CONTENTS AND FORMAT

ATMOSPHERIC

DAILY OZONE COLUMN ABUNDANCE	(2.5°)	(TOVS)
6 HR HUMIDITY PROFILE	(2.5°)	(TOVS)
6 HR TEMPERATURE PROFILE	(2.5°)	(TOVS)

SURFACE

SST SHIP OBSERVATIONS	(2.5°)	(NMC)
3 HR SURFACE TEMPERATURE REPORTS	(1.25°)	(NMC)
3 HR SURFACE OBS (HUMIDITY, CLOUDS)	(1.25°)	(NMC)
WEEKLY SNOW COVER	(1.25°)	(NOAA)
WEEKLY SEA ICE COVER	(2.5°)	(NAVY)

FORMAT

MODEST EXTRAPOLATION BUT FLAGGED
COMPATABLE MAP GRIDS
SOFTWARE FOR REMAPPING
WEEKLY SINGLE VARIABLE FILES
ADDITIONAL GEOPHYSICAL MAPS (LAND/WATER, TOPOGRAPHY,
VEGETATION)

ISCCP CLOUD ALGORITHM

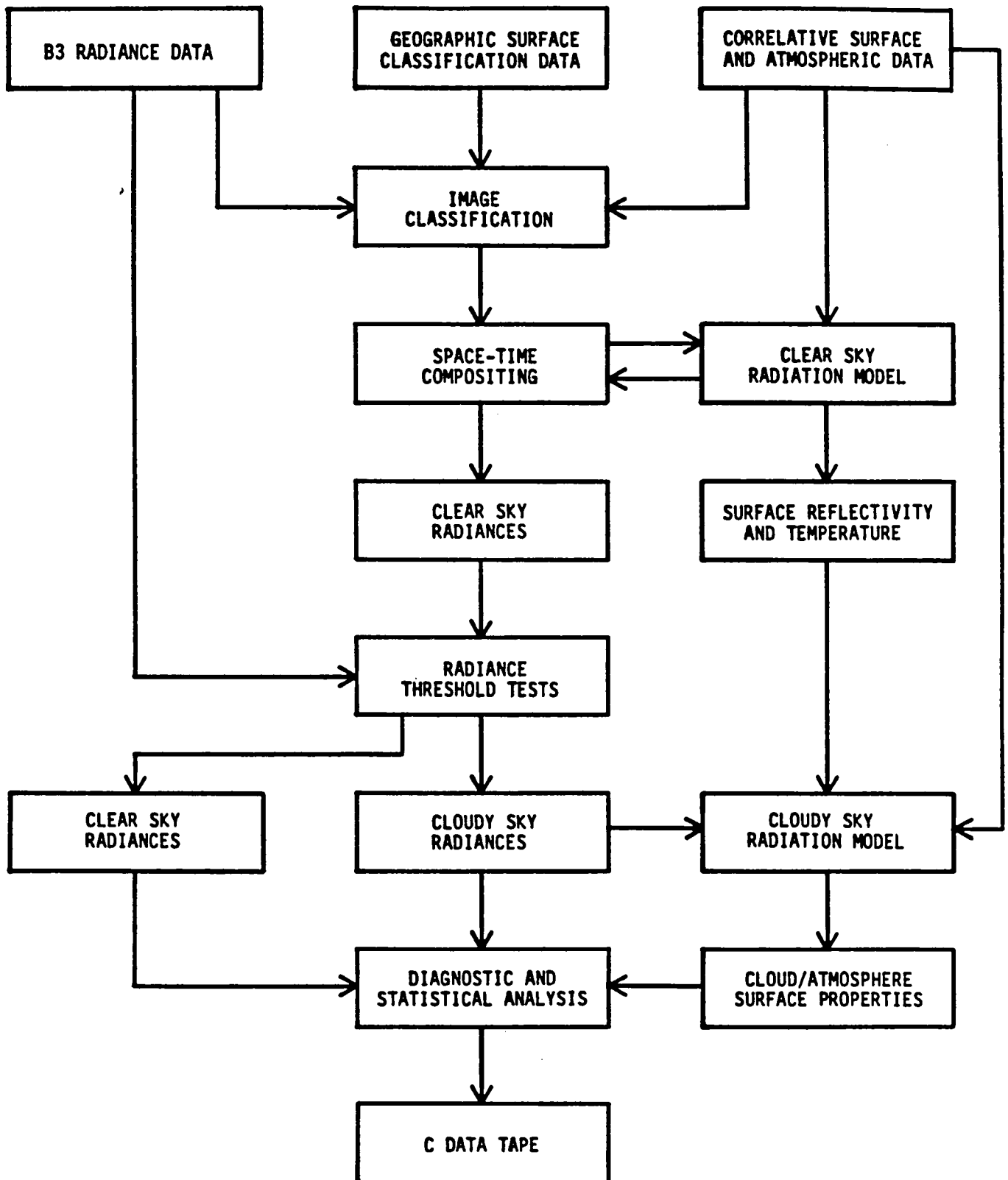

PROPOSED CLIMATOLOGY

TAPE CONTENTS

RESOLUTION : 3 HR, 250 KM ALSO MONTHLY, 250 KM

CLOUD TYPES : TOTAL, LOW, MIDDLE, HIGH, CIRRUS, DEEP CONVECTIVE

**CLOUD PROPERTIES : AMOUNT,
OPTICAL THICKNESS,
TOP TEMPERATURE AND PRESSURE
ANALYSIS FLAGS**

**RADIANCE PROPERTIES : TOTAL RADIANCES,
CLEAR SKY RADIANCES**

**ATMOSPHERIC PROPERTIES : TEMPERATURE AND HUMIDITY PROFILES
OZONE COLUMN ABUNDANCE**

**SURFACE PROPERTIES : TEMPERATURE
VISIBLE REFLECTANCE
SNOW/ICE**

**STATISTICS : MEAN (UNCORRELATED)
VARIANCE
CLUSTERS (CORRELATED)**

ISCCP PILOT STUDIES

- CLOUD ALGORITHM INTERCOMPARISON AND DATA COMPRESSION STUDY
- RADIANCE DATA FORMAT DESIGN TESTS
- ALGORITHM SENSITIVITY AND ERROR TESTS
- POLAR REGION CLOUD ALGORITHM STUDY
- CLOUD CLIMATOLOGY AND CLIMATE MODEL COMPARISON STUDY