

FLIGHT TEST OF A DISPLACEMENT SIDEARM CONTROLLER

Annual Conference on Manual Control 17 June 1985

Andrew L. Lippay, Ronald Kruk, Michael King
CAE Electronics Ltd, 8585 Cote de Liesse,
St Laurent, Quebec, Canada, H4L 4X4

and

Murray Morgan,
National Aeronautical Establishment,
Flight Research Laboratory,
Uplands Airport, Bldg U-61, Ottawa, Canada

ABSTRACT

A six-axis displacement-stick sidearm controller was developed to enable single-handed control of remote manipulator operations in space. Application of such a device to vehicular flight control has been a prime objective ever since CAE Electronics was involved in the TAGS program. With a working model available, piloted evaluation became possible in a fly-by-computer variable-stability research aircraft, originally a Bell 205 helicopter.

Following preliminary trials, the original mechanization was limited to three rotational axes and a linear one, analogous to the collective stick. A newly designed short stickgrip was mounted and the spring force pattern adjusted to suit the helicopter flight control environment.

A standard set of test maneuvers was flown by four experimental pilots with conventional helicopter flight controls and with sidearm controllers equipped with two different handgrips. Existing data from flight tests with an isometric-stick controller were added to complete the comparison. The displacement controller consistently achieved a rating of 3.0 to 3.5 on the Cooper-Harper scale, on par with the conventional controls. The learning period was generally short, with the controller becoming "transparent" to the pilot, giving the subjective impression of direct control of the helicopter lift vector.

The same basic controller design has been tested in spacecraft and remote manipulator simulations with very promising results. In each application operator/system integration was rapid and positive. The results demonstrate

feasibility and support the design philosophy of using deflection as well as force to generate proprioceptive feedback.

Preliminary evaluations in space systems simulations generally showed good operator/astronaut acceptance, reduced training/familiarization requirements and - in some cases - significant improvement in time-to-target control performance. A second-generation engineering effort is currently in progress to produce high-quality units for formal testing and eventual flight qualification.

1.0 INTRODUCTION

The appearance of on-board computers and advanced flight control systems has greatly increased the scope of aircraft performance and mission complexity that could be handled by human pilots and has caused radical changes in the nature of the piloting task. It has, therefore, become necessary to re-examine the physical interface which puts the pilot in direct contact with the flying task, namely the manual flight controls.

Conventional helicopter controls occupy all limbs of the pilot most of the time. This leaves no further capability for command tasks (e.g. forward speed control in future helicopters with auxiliary thrust). The controls occupy much prime cockpit space and are seldom operable by either hand to enable a wounded pilot to fly home. In precision maneuvers the collective-cyclic stick configuration may force the pilot into a "helicopter crouch" with resulting fatigue and spinal ailments due to the combination of poor posture and the high vibration environment. A multi-axis sidearm controller would leave one hand free and could relieve most of the other problems as well.

In some space applications currently under development there are scenarios where a vehicle and a dextrous manipulator may have to be operated concurrently. No one expects human operators to control 12 or more individual parameters simultaneously, continuously and accurately. However, a device whose dynamic characteristics and geometry correspond directly to the outer loop parameters may become "transparent" to the operator and promotes an intuitive mode of manual control. A pair of such transparent, function-oriented command devices may be manageable, with some sequential limitations, even in a proportional control system.

The principal difficulty in this proposition lies not in the derivation of electrical or mechanical command signals, nor in their processing, but rather in the packaging and cascading of the command axes in such a way that the controller movements remain compatible with the articulations of the human arm and hand, while matching the desired end results and system responses. Ideally, any related displays should also be harmonized with controller movements.

The objective of the present effort is to achieve a basic flightworthy controller design that satisfies the principal human-machine interface requirements and which could be optimized for a wide range of flight and remote manipulator applications with a minimum of modifications. The basic rationale for controller design, if correctly stated, should hold for a long time and for many control system variations.

This paper is intended as a progress report rather than as a comprehensive study of the state of the art. A brief summary of principal considerations and development drivers is offered by way of rationale.

2.0 SIX-DEGREE-OF-FREEDOM CONCEPT

2.1 Single Point Command Input

A single-point input device was envisaged, capable of commanding all vehicle responses, operable by either hand, in rate or position control modes. Leaving one hand free for such tasks as display management or communications selections was considered important. Auxiliary controls operable by the same hand were also to be accommodated.

2.2 Command Harmony

Spatial command harmony was considered essential, that is, the inputs (controller movements) would be followed by a vehicle or system response in the same sense and direction as the controller has moved, enabling the normative or inner model developed by the pilot to serve as a predictor in terms of the desired end results. Agreement between the predicted and actual responses largely determines the pilot's assessment of the task difficulty and the handling characteristics of the vehicle, and greatly influences overall success and performance.

2.3 Force Feedback

Manual controls also fulfill the role of a tactile display. The human hand can interpret loading forces appearing on the handgrip in terms of demands imposed on the system and its expectable response, enabling the pilot to develop a beneficial phase lead. This method of limiting accelerations or demand is preferable to that of derating vehicle responses in the control system; the latter may appear as sluggishness and invite poor pilot acceptance or even pilot-induced oscillations. (PIO)

Active force feedback raises a very severe packaging problem in integrated controllers, especially if redundancy is required. It appears, however, that passive forces generated within the controller and optimized for the command task may be adequate for most purposes.

2.4 Displacement vs Force Stick

On the basis of physiological characteristics and experimental results it may be said that the human operator is able to control motion or displacement with much greater ease and accuracy than he can control force. It was concluded that the intrinsic and near-instantaneous proprioceptive feedback on the command inputs developed by controller movements combined with a harmonious force pattern was essential. A deflection-stick concept was adopted despite the many obvious engineering advantages of the rigid stick.

2.5 Spring Return and Damping

Traditionally, spring return forces have been regarded as necessary to restore zero command or trim outputs for the hands-off condition. During informal simulation trials it was found that pilots could not differentiate between spring and damping forces in the short term, and that a heavily spring-loaded stick will cause drift with or against the force gradient because of accommodation to constant pressure which develops quite quickly. It is proposed that for many rate control applications, rate dependent damping and good null identification may be sufficient.

3.0 RELATED WORK

During 1968-72 a flight demonstration of the Tactical Aircraft Guidance System (TAGS) was conducted as a joint Canada-US Army project involving a CH-47 helicopter equipped with a digital triplex redundant fly-by-computer system. One principal objective was to increase flight safety and mission capability with the prospect of using marginally trained pilots in Viet Nam.

A Canadian contribution was a four-axis sidearm controller with linear fore-aft movement controlling forward speed, roll movement giving lateral speed at hover or flight path direction over 35 kts forward speed. A stick twist input controlled spot turn at hover or aircraft heading at speed. A pivoting armrest controlled vertical speed. This was later relocated to the conventional collective stick.

The mechanical design left much to be desired due to a highly constrained installation, which also prevented the armrest to be correctly adjusted to the individual pilot. Hence the failure of the vertical control in which the pilot lost contact with the arm support and hand reference. Nevertheless, 103 test flights were conducted successfully, including sling loads, precision and cross-country flights, and much valuable experience was gained.

In 1974-77 the Remote Manipulator System of the Space Shuttle required a command device. A six-axis controller was recommended but was later considered a high schedule risk and two three-axis controllers were used instead. One controls translations of the end effector, its near-linear movements are coordinated with the prime display means associated with the operation in a fly-to fashion. The rotational controller has three angular freedoms and controls the attitudes of the end effector.

In response to a NASA request, CAE Electronics performed a study to show the feasibility of a six-axis controller for spacecraft flight and remote manipulator systems. A state-of-the-art survey and literature search revealed many attempts but no mature designs with six degrees of freedom, and precious few with more than three. (1979) As a follow-on effort to this study, CAE developed controller models which were used in the Manipulator Development Facility of the NASA Johnson Space Center, in the Manned Maneuvering Unit (MMU) simulation at Martin-Marietta Denver. The original demonstrator model is currently installed at NASA-Marshall Space Center in a dextrous manipulator system being developed for spacecraft servicing.

In early 1984 CAE approached the National Aeronautical Establishment of the National Research Council of Canada to test the device as the primary flight controller of a highly maneuverable helicopter. A four-axis version was configured and preliminary flight tests were conducted. An improved engineering model was built and is undergoing flight testing. The results of flight testing this unit are presented later in this report.

4.0 DESCRIPTION

The basic controller design has three rotational and three linear motions. A universal ball-shaped handgrip contains the gimbal for two of the rotational axes (pitch and roll), the third is centered on the shaft supporting the ball. The three linear axes (X, Y, Z) are contained in the enclosure below the handgrip, together with the base-mounted electronics which pre-process the transducer outputs. Figure 1 shows the basic configuration.

This geometry allows all hand forces to pass through the same point, i.e. the center of the ball; the linear (translational) axes are constrained against torques developing due to their offset from this center. Thus any tendency to cross-coupling between axes is minimized and the ball is largely insensitive to hand position providing that the controller is located correctly with respect to the forearm and armrest.

The rotational displacements are approximately ± 15 degrees, the linear excursions $\pm 3/8$ inch. The total vertical movement as configured for the helicopter collective is approximately 1.1 inches.

Spring breakouts and gradients are adjustable by replacing the spring sets, and can be made non-symmetrical. The vertical axis has damping which is rate dependent and pilot-adjustable over a vernier scale of its total force range.

ORIGINAL PAGE IS
OF POOR QUALITY

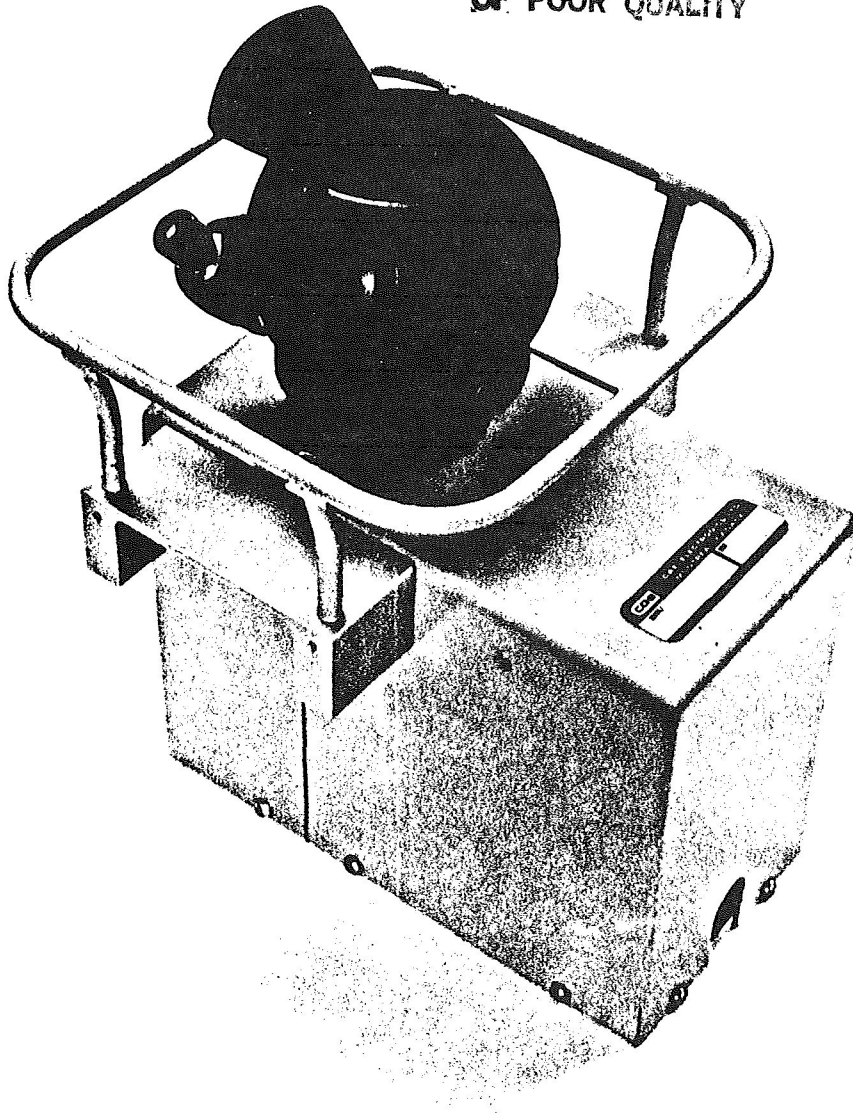

FIGURE 1 BASIC CONTROLLER CONFIGURATION

5.0 MANNED TESTING AND DEMONSTRATION

The following is based on flight tests conducted at the National Aeronautical Establishment (NAE) Ottawa, Canada. Additional information derived from NASA simulations and related tests is included as appropriate to the topics being discussed.

5.1 Initial Investigations

An early model was installed in the NASA-Johnson MDF (Manipulator Development Facility), in a position corresponding to the rotational controller of the CANADARM remote manipulator system, and the MDF arm was used for capturing and positioning moving targets. The Manned Mobility Unit (MMU) simulation at Martin-Marietta' Denver was temporarily equipped with the model, replacing two three-axis controllers. This unit is currently installed at the NASA-Marshall Space Center where it is used to operate a dextrous manipulator in a development project for satellite servicing and Orbital Maneuvering Vehicle (OMV) operations.

5.1.1 Helicopter configuration

Before conducting the first helicopter experiment, two informal flight development periods were held to adapt the controller characteristics to the helicopter flying task and investigate different handgrip shapes. Two of the generic model's translational axes were disabled (immobilized) and the third was modified as described below. The current version used for helicopter trials is an improved engineering model with helicopter-specific features.

5.1.2 Vertical Axis Modifications

The initial version had a center null position on the vertical axis with spring centering and breakout. For an open-loop collective drive in the helicopter the available range was objectionably short. The null was moved close to the bottom of this linear (vertical) stroke. The light friction levels in the axis resulted in a tendency to PIO. As a quick fix, friction damping was installed but this predictably produced lumpiness in the control due to its stick-slip properties. The final version had fluid damping and no spring return on the vertical motion.

For manipulator control and Manned Maneuvering Unit (MMU) flight the center-null vertical axis was found acceptable.

5.1.3 Ball Handgrip vs Stick Grip

The first models were equipped with a universal spherical handgrip of approx 3.5 inches in diameter. Helicopter pilots expressed a marked dislike of the ball handgrip, especially for large-amplitude maneuvers. For a quick trial, an existing handgrip developed for a semi-rigid stick configuration was installed with an adapter ring attached to the top part of the ball. Figure 2 shows this configuration. The resulting offset in the hand pressure point introduces some cross-coupling between the vertical and the pitch axes, but the pilots seem to accept this additional workload as long as they can have a stick grip. Figure 3 shows the current helicopter version with a combination ball-grip which minimizes the offset and combines the ball concept with special advantages of a vertical stick grip.

For space operations, the ball was found quite suitable even with an inflated spacesuit glove and was insensitive to hand positions with remote manipulators. A thin fin was later added for fore-aft hand reference, slipping between the index and middle finger. Pilots and astronauts alike recommended a smaller, baseball-sized grip. The diameter of the ball was eventually reduced to 2.9 inches.

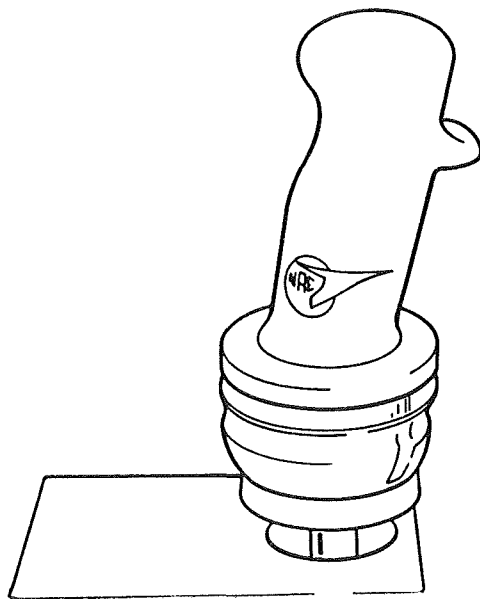

FIGURE 2 EXISTING STICK GRIP ADAPTATION

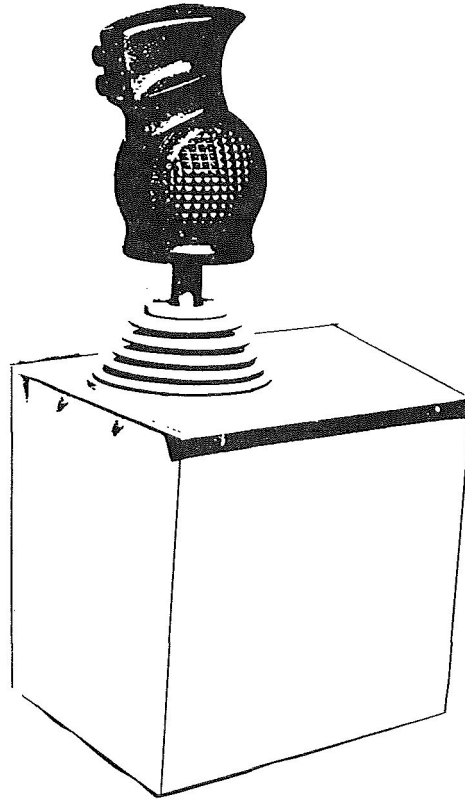

FIGURE 3 HELICOPTER STICK-GRIP CONFIGURATION

5.1.4 Installation Ergonomics

Due to schedule and manpower limitations, rigorous ergonomic investigations have not yet been carried out to optimize the hand pressure point with respect to the armrest (where there is one present) or to the relaxed or preferred hand position. In most cases, the controller was simply placed to have the ball center fall where previous devices had their hand pressure points or where a suited astronaut said he could see and reach the controller within the framework of existing vehicle or cockpit design.

In the helicopter cockpit the pilot's armrest acts as an essential reference surface but may also become an obstacle to wrist movement in dynamic maneuvers such as autorotation or quick stop. As a first step to resolve the ergonomic problem of arm support and wrist freedom, an adjustable armrest now replaces the standard unit on the helicopter

seat. Experience thus far indicates that orientation and positioning of the controller are critical factors in control performance and pilot acceptance. Therefore these issues will be addressed in greater detail as the development program continues.

5.1.5 Rotational Command Harmony

The order in which the rotational axes in the manipulator were cascaded resulted in the pitch and roll sensing axes rotating with a yaw input; this meant that there was no fixed relationship of pitch and roll inputs to airframe movements. Helicopter pilots had difficulty compensating for this effect. The problem was temporarily corrected by software transformation as a function of controller yaw angle. This aligned the command axes with the airframe but introduced variations in the effective spring rates in pitch and roll with respect to the transformed sensing axes. While this effect was noticeable under laboratory conditions, it was not reported by any of the evaluation pilots as a difficulty. Nevertheless, it might have had an influence on the overall handling qualities assigned.

The problem was removed by altering the cascading of axes in the next model such that the pitch and roll movements remained aligned to the aircraft pitch and roll axes.

No equivalent problem was reported by manipulator operators and MMU simulation pilots.

5.2 The NAE Airborne Simulator Facility

The Flight Research Laboratory (FRL) of the National Aeronautical Establishment of Canada (NAE) has been actively engaged in research into the use of integrated side-arm controllers in an airborne flight simulator for the last four years.

5.2.1 The Airborne Simulator

The FRL has extensively modified a Bell 205-A single-engine single main rotor helicopter to generate a variable-stability test bed with full-authority fly-by-computer command capability. An on-board digital system senses many environmental and aircraft state parameters, processes them in a variable-configuration flight control system and has a 64-channel digital recording capability. The facility is fully described in Reference (5).

5.2.2 Control Signal Conditioning

In addition to the sense axis transformation described above, inputs from the controller were subject to the following processing:

- o Normalising gain
- o Filtering (16 rad/sec first order low pass)
- o Deadband
- o Sensitivity setting gain

The two gains in series, while redundant, were useful because of ease of comparative documentation. A typical input conditioning chain is shown in Figure 4., the values used for the various conditioning parameters are given in Table 1.

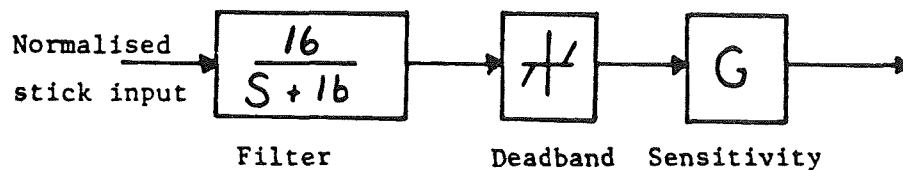

FIGURE 4 TYPICAL INPUT CONDITIONING

Axis	Filter B/point	Deadband	Sensitivity
Roll	16.0 r/sec	0.5%	0.5
Pitch	16.0	0.5%	0.5*
Yaw	4.0 r/sec	0.5%	1.0**
Collective	NIL	NIL	1.0
			0.8

* Grip configured
 ** Ball configured

TABLE 1 SIGNAL CONDITIONING PARAMETERS

5.3 Experiment Design

Seven representative tasks were flown over a course with position markings alid out on the ground. The tasks included off-level landings and takeoffs, lateral flight, rearward flight, quickstop, spot turn and spot turn with hesitations. The course itself and maneuver standards are described in Reference 3 and are routinely used by the FRL.

Instructions to pilots for the off-level landing and takeoff maneuver were as follows:

Establish a 10 foot hover, land within the marked box with a continuous downward motion of the aircraft, no hesitations and no vertical velocity reversals. Desired performance: complete task safely.

Raise the aircraft to a level attitude with the up hill skid in contact with the ground, hesitate for 5 seconds in that condition then make a clean transition to a 10 foot hover. Desired performance: Safe completion with no return to both skids and no premature lift-off from partial contact hover.

Each of the four FRL research pilots flew the full set of tasks using conventional centre mounted controllers, the CAE controller with ball grip, and the same device with the NAE grip. Cooper Harper ratings were requested for each task and verbal comments and written debriefs were taken also. Previous results on the same tasks flown with a force-stick sidearm controller were included in the comparative statistics, as recorded in Reference 3.

5.3.1 Control System Configuration

The aircraft control configuration for the primary experiment was a primitive system permitting comparison with conventional controls. This configuration had rate damping, augmentation in pitch, roll and yaw, a model of the 205 stabiliser bar, and collective inputs were de-coupled from the yaw axis. The rate damping augmentation was scheduled with airspeed to provide a vehicle with approximately -2 deg per second damping throughout the envelope in all three rotational axes. Collective control was simple direct drive. A slow follow-up trim system was installed which summed a low gain $[0.25]$ integral of the controller output with that output. A typical control system channel is shown in Figure 5, while the gains used are tabulated in Table 2.

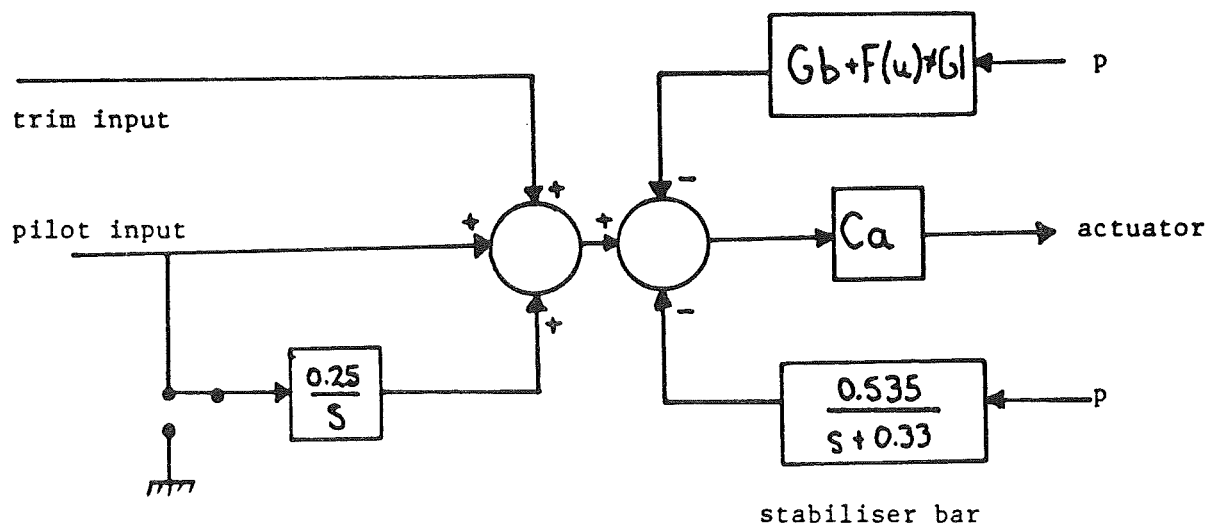

FIGURE 5 TYPICAL CONTROL CHANNEL (ROLL)

Axis	Delta Gain	Basic Gain	Actuator Coefficient
Roll	0.276	0.22	0.61
Pitch	0.39	0.61	0.66
Yaw	0.41	0.20	0.85
Collective	N/A	N/A	0.81

TABLE 2 CONTROL SYSTEM GAINS

5.4 Results and Discussion

5.4.1 Familiarization and Training Time

As a general characteristic, both versions of the controller required very little time to become familiar to pilots, astronauts and operators. This is attributed to the spatial command harmony achieved and the absence of mode switching and other activities which normally result in breaking of contact between the hand and the controller.

The NAE pilots had extensive helicopter experience, some including sidearm controllers. They all became sufficiently familiar with the controller during the first hour of flight to perform to the required standards. At least one other pilot with no previous sidearm experience was able to fly nap-of-the-earth after approximately 20 minutes; his comments during debriefing indicated that he was able to treat the controller as if it were transparent, and fly the aircraft intuitively.

The manipulator and spacecraft simulations showed that operators need only rudimentary instructions and a self-paced training period which is extremely short in comparison with other control mechanizations. The MDF arm was repeatedly operated with surprising proficiency by personnel of various backgrounds without the benefits of even a basic introduction. Preliminary trials with the dextrous manipulator at the Marshall Space Center showed a tendency of significantly reduced task times as well as training requirements even with novice operators.

5.4.2 Pilot Ratings

Figure 6 shows means of Cooper-Harper ratings and standard deviations for all maneuvers and test periods executed to date, for a global comparison between conventional controls, an isometric vertical grip, the CAE controller with the vertical grip and with the ball grip.

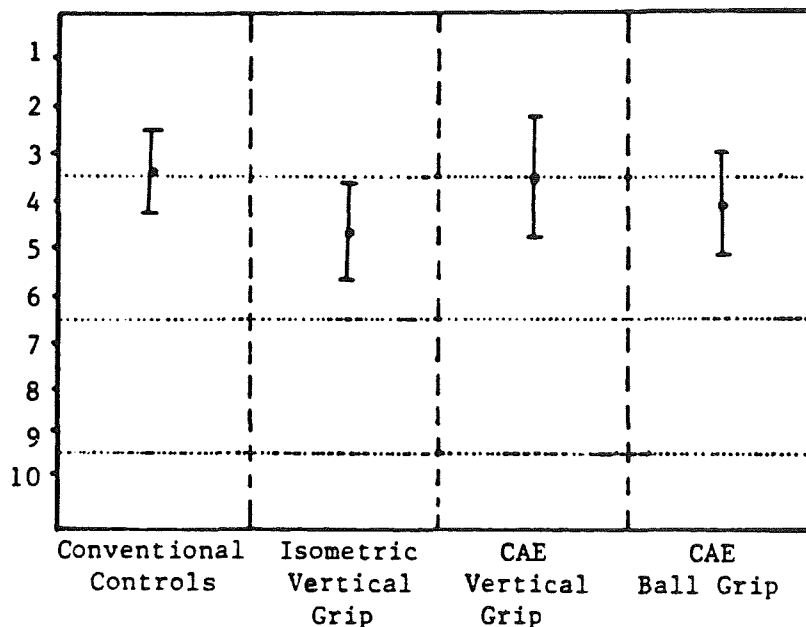

FIGURE 6 COOPER-HARPER RATINGS; COMPARATIVE SUMMARY

As the Bell 205-A with controls configured for the present study is a marginal Level One vehicle in handling qualities, there were few occasions when pilot compensation for handling deficiencies was not a factor. Within this overall constraint, however, there is a consistent hierarchy of handling quality ratings among the controller types evaluated.

Generally, the conventional controls are rated highest, with a mean of 3.3, satisfactory but with some mildly unpleasant characteristics. The CAE controller with the FRL stick grip is rated next, with a mean of 3.6, acceptable but with unpleasant characteristics. The CAE unit with the ball grip is rated 4.1, still acceptable but unpleasant. Last is the force stick at 4.7, tending towards unacceptable for normal operation.

The data from the individual tasks shows the same trend with one variation (See Figure 7a to 7g). The force stick provides unequivocal Level Two handling qualities for landing on flat surfaces. Off-level landings and takeoffs were not conducted systematically with this device. The performance of the CAE controller with the ball grip is rated much poorer than the conventional controls or the same unit with a vertical grip. In lateral and rearward flight the conventional controls are rated much better than any of the others and the force stick is again last. In the quick stop maneuver the conventional controls and the CAE controller with the FRL grip are similar, but the ball grip is worse than the force stick. In spot turns with and without hesitation the CAE controller is rated slightly ahead of the conventional controls but with a greater spread in ratings.

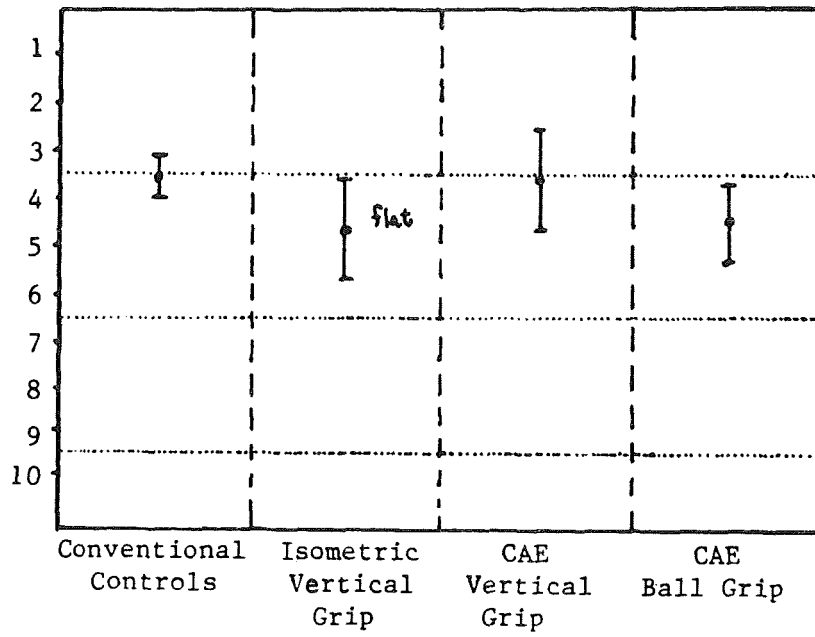

FIGURE 7a OFF-LEVEL LANDING MANEUVER RATINGS

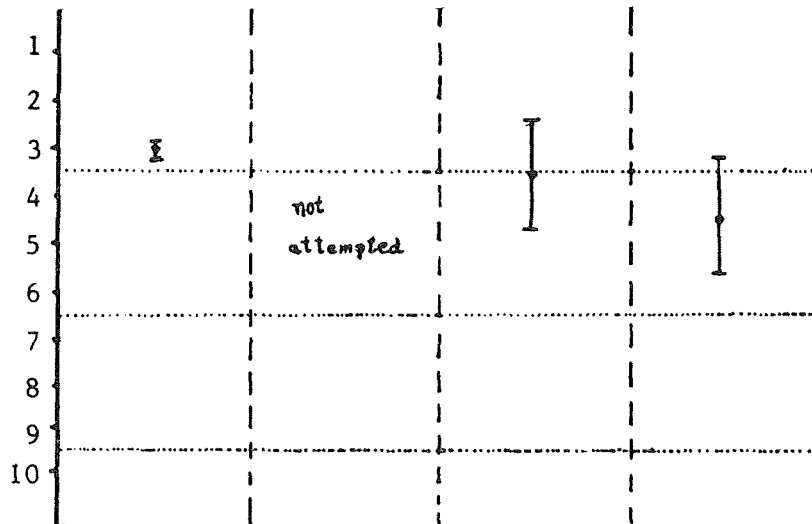

FIGURE 7b OFF-LEVEL TAKEOFF MANEUVER RATINGS

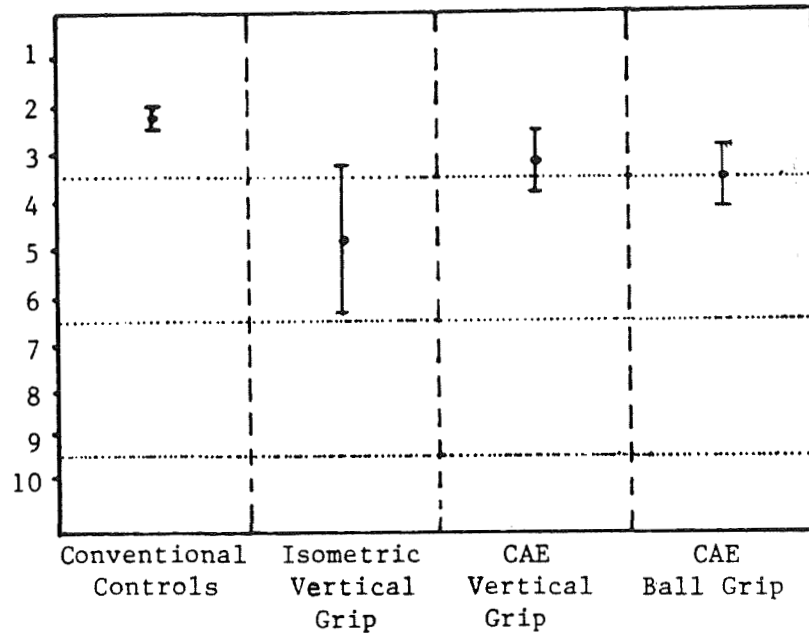

FIGURE 7c LATERAL FLIGHT MANEUVER RATINGS

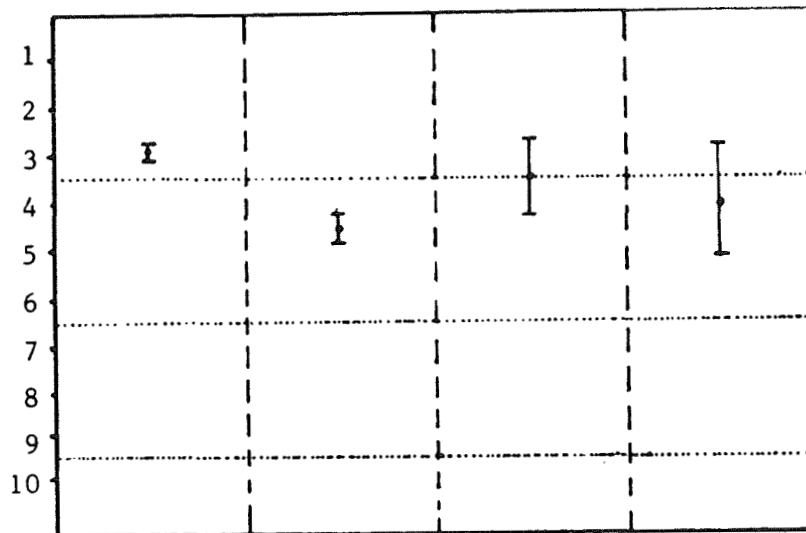

FIGURE 7d REARWARD FLIGHT MANEUVER RATINGS

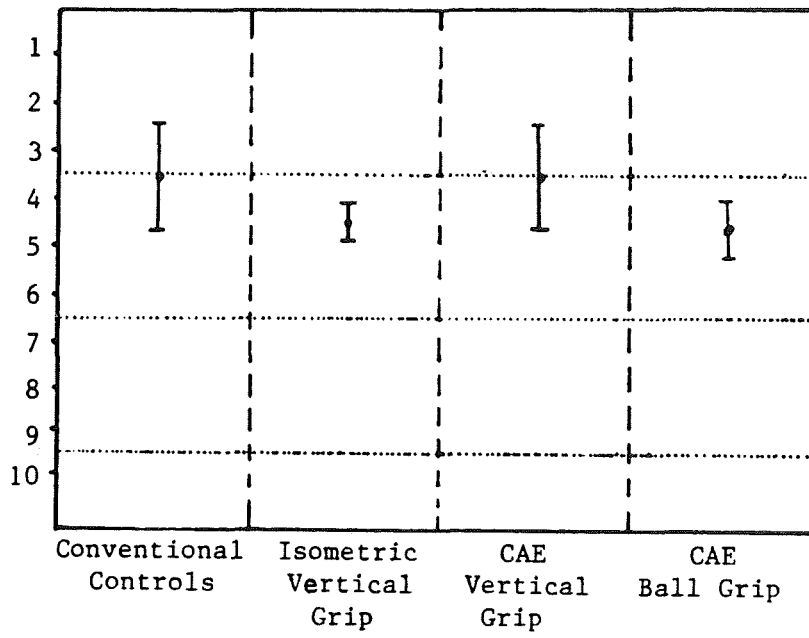

FIGURE 7e QUICK STOP MANEUVER RATINGS

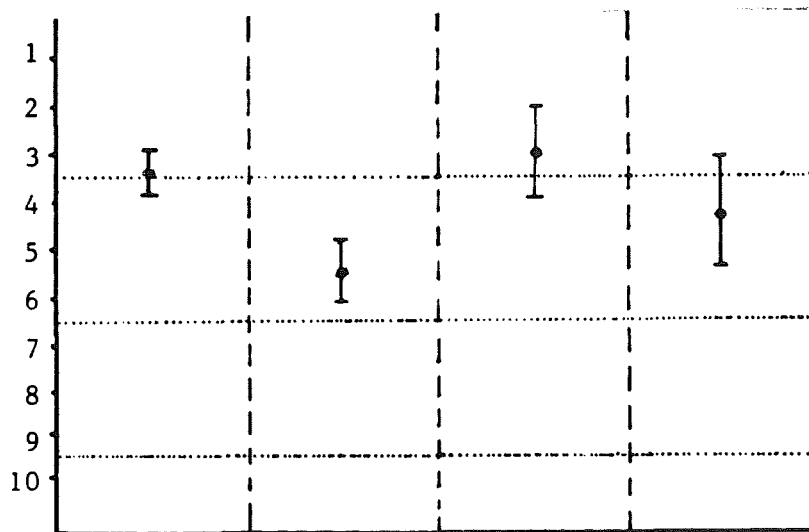

FIGURE 7f SPOT TURN MANEUVER RATINGS

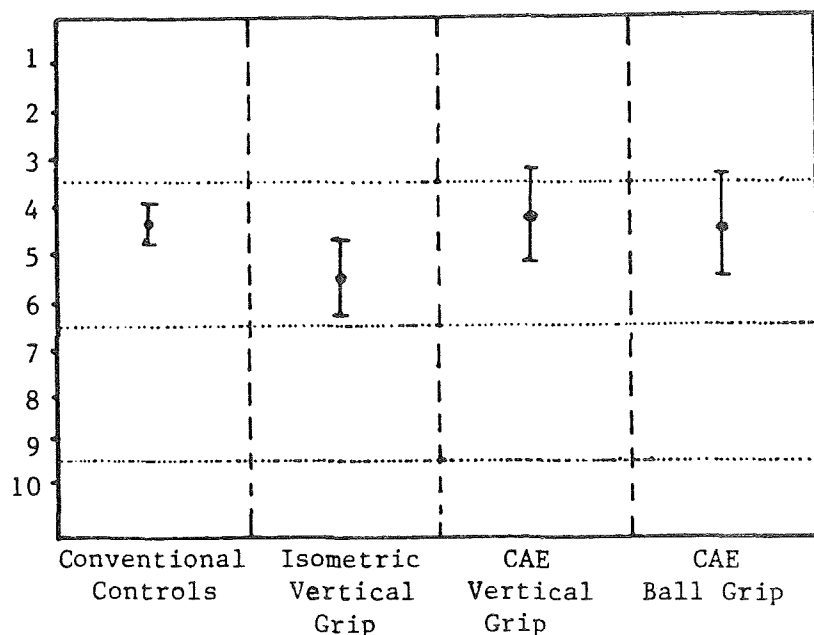

FIGURE 7g INTERRUPTED SPOT TURN RATINGS

6.0 DISCUSSION

In nearly all cases, performance with sidearm controllers is degraded as compared to conventional controls. This is most severe in cases where finely coordinated multi-axis inputs are required such as in off-level landing and takeoff. Degradation is least severe or is even reversed where vehicle characteristics are the limiting factor such as in spot turns; the aircraft demonstrates a powerful yaw/roll coupling when rapid yawing motions are abruptly terminated. This results in significant lateral instability and the vehicle is a definite Level Two machine in these conditions even with conventional controls.

Identifying the cause for poor performance with the force stick is relatively easy. Lack of immediate feedback from the controller itself on control inputs means that the pilot must wait until the vehicle responds to assess whether the input was appropriate. This introduces a lag which raises pilot workload substantially and even so, stability may be inadequate to permit off-level landings to be conducted as a routine maneuver.

With displacement controllers the case is somewhat more complex. Immediate feedback on control input is certainly available. However, ensuring that this feedback is appropriate in terms of rate and direction proves to be a distinctly non-trivial task. With the ball grip, the "natural" hand position seemed to rest the palm over the top. This did not generate inherent correlation between the sensed hand position and the lift vector. As well, in dynamic maneuvers involving the collective a tendency to cross couple needs to be actively neutralized. With upward collective inputs the ball does not provide a supporting grip surface, producing a subjective impression that the aircraft will fall out of the sky unless the ball is held in a death grip. This leads to white knuckles and fatigue, combined with excessive tension in the hand and forearm muscles which further reduces the precision of inputs and hence the ability to compensate for cross-coupling.

These problems are most noticeable when large-amplitude up-collective inputs must be combined with precision in other axes, such as in quickstop maneuvers and off-level takeoffs. Shifting the handgrip to the side of the ball reduces these problems somewhat, but the lack of adequate grip surface and tendency to cross couple remains. (The ball was left bare and smooth in order not to force a given hand position on the evaluation pilots.)

As the data shows, assessment of the controller with a vertical grip improved dramatically over the ball, coming close to conventional controls, and this by pilots with up to 2000 hours of conventional helicopter experience. That this performance could be achieved despite the fact that the damping characteristics and spring forces were still not optimal, the rotational inputs were off-axis and no systematic ergonomic work has been done to verify the installation, was a good indication that the concept of using displacement for control feedback in a sidearm controller is valid.

Interestingly, the ball grip was preferred by astronauts and operators in manipulator and MMU simulations. No significant cross-coupling problems were reported even with inflated space gloves. There may be several factors here, one being the strong familiarity of the vertical stick grip to helicopter pilots and its obvious analogy to the lift vector. Furthermore, the effects of command inputs in low-altitude precision hover and the resulting whole-body feedback cueing have a much greater effect than in a slow-moving manipulator where the operator is much more loosely coupled.

REFERENCES AND BIBLIOGRAPHY

[1] Sinclair, M. and Morgan, M. : AN INVESTIGATION OF MULTI-AXIS ISOMETRIC SIDE-ARM CONTROLLERS IN A VARIABLE-STABILITY HELICOPTER. NAE LR-606, NRC No. L9629, August 1981

[2] Morgan, M.: SOME PILOTING EXPERIENCES WITH MULTI-FUNCTION ISOMETRIC SIDE-ARM CONTROLLERS IN A HELICOPTER. Proc joint NASA/AHS Helicopter Handling Qualities Specialists Meeting, NASA CP 2219, April 1982

[3] Morgan, M.: A PILOT'S EXPERIMENT IN THE USE OF MULTI-FUNCTION SIDEARM CONTROLLERS IN A VARIABLE STABILITY HELICOPTER. Ninth European Rotorcraft Forum, Stresa, Italy, September 1983

[4] Heffley, R.K.A: COMPILATION AND ANALYSIS OF HELICOPTER HANDLING QUALITIES DATA. VOL 1, Data Compilation NASA CR-3144, August 1979

[5] Sattler, D: THE NATIONAL AERONAUTICAL ESTABLISHMENT AIRBORNE SIMULATION FACILITY. NAE Misc. 58, 31st Annual CASI General Meeting, Ottawa, Canada, May 1984

[6] Morgan, M: A COMPARATIVE STUDY OF AN ARTICULATED INTEGRATED SIDE-ARM CONTROLLER IN A VARIABLE STABILITY HELICOPTER Proc 41st Annual Forum of the American Helicopter Society, May 1985

[B] Sherbert, A.T: AN INVESTIGATION OF ADVANCED FLIGHT CONTROLLERS FOR AEROSPACE VEHICLES. The Boeing Company, Vertol Division D8-2424-1, July 1969 Proprietary Document.

[B] Pitrella, F.D: PROBLEMS AND METHODS IN EVALUATING FORCE STEERING AND OTHER FLIGHT CONTROL MODES. Forschungsinstitut fuer Anthropotechnik, Meckenheim, West Germany, Bericht Nr 20, A 3124, December 1974

[B] Lippay, A.L: MULTI-AXIS HAND CONTROLLER FOR THE SPACE SHUTTLE REMOTE MANIPULATOR. Proceedings, 13th Annual Conference on Manual Control, 1977

[B] CAE Technical Report SRMS-036, TRANSLATION HAND CONTROLLER EVALUATION AND DESIGN RECOMMENDATIONS.

[B] Lyman, Prof John, UCLA Los Angeles, Personal Communications on the NORMATIVE MODEL.

[b] Bejczy, A., Jet Propulsion Laboratory, Pasadena: Personal Communications on MULTI-AXIS CONTROLLER PROPERTIES AND RESEARCH.