

N87-16745 D3-39
20P.

1986

39619

NASA/ASEE SUMMER FACULTY FELLOWSHIP PROGRAM

MARSHALL SPACE FLIGHT CENTER
THE UNIVERSITY OF ALABAMA

LOW GRAVITY CONTAINERLESS PROCESSING
OF IMMISCIBLE GOLD RHODIUM ALLOYS

Prepared by:	J. Barry Andrews
Academic Rank:	Professor
University and Department:	University of Alabama at Birmingham Department of Materials Engineering
NASA/MSFC Laboratory:	Space Science
Division:	Low-Gravity Science
Branch:	Solidification Physics
MSFC Colleague:	Michael B. Robinson
Date:	September 6, 1986
Contract No.:	NGT 01-002-099 The University of Alabama

LOW GRAVITY CONTAINERLESS PROCESSING
OF IMMISCIBLE GOLD-RHODIUM ALLOYS

by

J. Barry Andrews
Professor of Materials Engineering
University of Alabama at Birmingham
Birmingham, Alabama

ABSTRACT

Under normal one-g conditions immiscible alloys segregate extensively during solidification due to sedimentation of the more dense of the immiscible liquid phases. However, under low-g conditions it should be possible to form a dispersion of the two immiscible liquids and maintain this dispersed structure during solidification. Several investigators have speculated that if these dispersed microstructures can be obtained in immiscible systems, extremely desirable material characteristics may result. Examples include superconductivity, fine particle permanent magnets, catalysis and high performance electrical contacts. In this project, immiscible (hypermonotectic) gold-rhodium alloys were processed in the Marshall Space Flight Center 105 meter drop tube in order to investigate the influence of low gravity, containerless solidification on their microstructure. Hypermonotectic alloys composed of 65 atomic % rhodium exhibited a tendency for the gold rich liquid to wet the outer surface of the containerless processed samples. This tendency led to extensive segregation in several cases. However, well dispersed microstructures consisting of 2 to 3 μ m diameter rhodium-rich spheres in a gold-rich matrix were produced in 23.4 atomic % rhodium alloys. This is one of the best dispersions obtained in research on immiscible alloy-systems to date.

ACKNOWLEDGEMENTS

I would like to acknowledge Mr. Mike Robinson, my NASA colleague in this project for his extensive participation and support during this research. Mike was always ready to lend a hand and was more than generous with his time, even though he already had an extremely busy schedule. Thanks also go to Ms. Nancy Turpen for her contribution to this project during sample preparation, drop tube processing and metallographic preparation of samples. Her participation in this research was invaluable.

I would also like to thank NASA and ASEE, in particular Ms. Ernestine Cothran, Dr. Fred Speer, and Dr. Mike Freeman, for providing me with the opportunity to participate in the Summer Faculty Program and for making it not only worthwhile professionally but also an enjoyable endeavor.

LIST OF FIGURES

Figure 1	Phase diagram for the gold-rhodium alloy system.	III-3
Figure 2	Schematic diagram of the Marshall Space Flight Center 105 meter drop tube. (Courtesy Mr. Mike Robinson).	III-4
Figure 3	A typical 65 atomic percent rhodium sample after alloying in the arc melter under one-g conditions. Magnification 10x.	III-6
Figure 4	A section through a typical 65 atomic percent sample processed in an arc melter under one-g conditions. Note sedimentation. Magnification 60x.	III-7
Figure 5	A 65 atomic percent rhodium sample as processed under low-g conditions in the 105 meter drop tube. Note presence of a gold rich layer at the outer surface. Magnification 34x.	III-8
Figure 6	A portion of the gold rich rim of the sample shown in Figure 5. Magnification 200x.	III-8
Figure 7	A drop tube processed, 65 atomic percent rhodium sample. Note similarity to the sample shown in Figure 5. Magnification 34x.	III-9
Figure 8	Cross-section of a typical 65 atomic percent rhodium sample processed under low-g containerless conditions in the MSFC 105 meter drop tube. Note absence of a gold-rich rim on this sample. Magnification 34x.	III-10
Figure 9	Higher magnification view of the edge of the 65 atomic percent rhodium sample shown in Figure 8. Magnification 200x.	III-10

- Figure 10 Cross-section of a 23.4 atomic percent rhodium, low-g processed sample showing a coarse dispersion of rhodium rich spheres in a gold rich matrix. Magnification 37x. III-11
- Figure 11 Higher magnification view of a cluster of rhodium rich spheres in the sample shown in Figure 10. Note lack of coalescence. Magnification 600x. III-12
- Figure 12 A fine, dispersed microstructure obtained in a 23.4 atomic percent rhodium sample processed under low-g containerless conditions. The diameter of the rhodium-rich particles is 2 to 3 micrometers. Magnifications 600x. III-13

OBJECTIVE

The objective of this study was to obtain a better understanding of segregation in containerlessly processed immiscible samples solidified under low gravity conditions. In particular, it was desirable to study segregation in immiscible systems caused by surface tension driven flows which occur due to wetting.

The goal of the project was the production of a finely divided dispersed microstructure through processing under low gravity conditions.

INTRODUCTION

There has been considerable interest in immiscible alloys over the past decade because of new capabilities for low gravity processing. In these alloys, drastic differences in structure are possible between low-g processed samples and samples processed under normal one-g conditions.

When solidified under one-g conditions, segregated structures are obtained in immiscible alloys due to sedimentation of the more dense of the two liquid phases. Since these highly segregated structures are of little use, there has not been a great deal of interest in most immiscible alloy systems. However, if these alloys are processed under low gravity conditions, the driving force for sedimentation is removed. Under these conditions it should be possible to form a dispersion of the two liquids during cooling and maintain this dispersed structure during solidification.

Several studies have indicated that very useful properties may be obtained in immiscible alloy systems if a fine dispersion of the phases can be maintained (1,2). There are possibilities of producing superconducting materials, fine particle magnetic materials, catalysis, and high performance electrical contact materials.

Work has been carried out by several other investigators on processing immiscible alloys under low gravity conditions in attempts to produce dispersed microstructures (3-5). However, most of these investigations resulted in segregated microstructures. This appeared to be primarily due to a surface tension induced flow that results when one of the liquid phases preferentially wets the walls of the container. It has been postulated that when the minority liquid phase wets the container wall, flow is induced that pulls additional minority liquid to the wall where it eventually forms a film. The result is a segregated sample composed of the minority liquid at the outer surface, surrounding the majority liquid in the central region.

It should be possible to avoid this difficulty if a crucible material is selected that is wet by the dominant phase as opposed to the minority liquid phase. This was actually demonstrated by Potard when he changed the crucible in his experiments from Al_2O_3 to SiC for tests done in orbit and obtained a fairly well dispersed microstructure (6).

In the experiments discussed in this report, crucible interactions were avoided since samples were processed in a drop tube using containerless conditions. However, there is still the possibility that one of the liquid phases may wet the outer surface of the sample. If this is the minority phase, segregation may still be the end result. If segregation occurs under these conditions it may be necessary to change the alloy composition such that the phase that wets the outer surface is the dominant phase.

EXPERIMENTAL PROCEDURE

In this work, two alloy compositions in the immiscible gold-rhodium alloy system were investigated. The phase diagram for the gold-rhodium system is shown in Figure 1 (7).

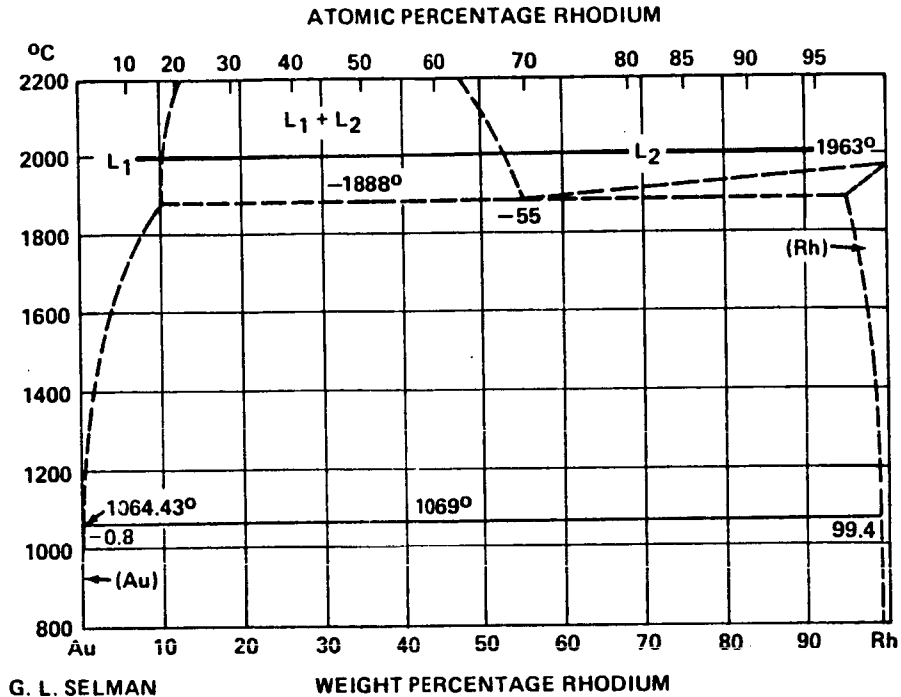

Figure 1. Phase diagram for the gold-rhodium alloy system. (from reference 7)

The gold-rhodium system was selected for this study for several reasons. First, the high monotectic temperature made it easy to track the droplets during free fall using silicon infrared detectors located in the drop tube. Second, the oxidation resistance of both components of this alloy helped ensure that the results obtained were not masked by the formation of surface oxides during processing. And third, the color difference between the two immiscible phases (one is gold colored, the other is silvery) made it easy to distinguish the phases when examining the microstructure. As an additional benefit, this alloy may have a practical application as a high performance electrical contact material (1).

As mentioned above, alloys of two compositions were investigated in this study. The first alloys were slightly hypermonotectic with the composition being selected to produce 10% by volume of the gold-rich immiscible liquid phase (with 90% by volume of the rhodium rich liquid) just above the monotectic temperature. This alloy contained 65 atomic percent rhodium. Since there was interest in studying segregation due to

wetting tendencies of the minority and majority liquids, another alloy was produced in which 90% by volume was composed of the gold-rich liquid phase (with 10% by volume of the rhodium rich liquid). This alloy contained 23.4 atomic percent rhodium.

The samples investigated were produced by melting and alloying the pure components in a small, copper hearth, arc furnace under an argon atmosphere. A tungsten electrode was used to melt the components. Sample masses were varied from approximately 150 to 300mg. The pure components were cleaned before melting by immersion in concentrated hydrofluoric acid for one minute, followed by rinsing in distilled water and storage in ethyl alcohol.

Once alloyed, samples were processed in the Marshall Space Flight Center 105 meter drop tube. The drop tube is a 10" diameter stainless steel tube, 105 meters in length that is held in a vertical orientation in the Dynamic Test Facility Building at the MSFC. Vacuum pumps are positioned along the tube permitting evacuation to the 10^{-6} Torr range. A schematic of the drop tube is shown in Figure 2.

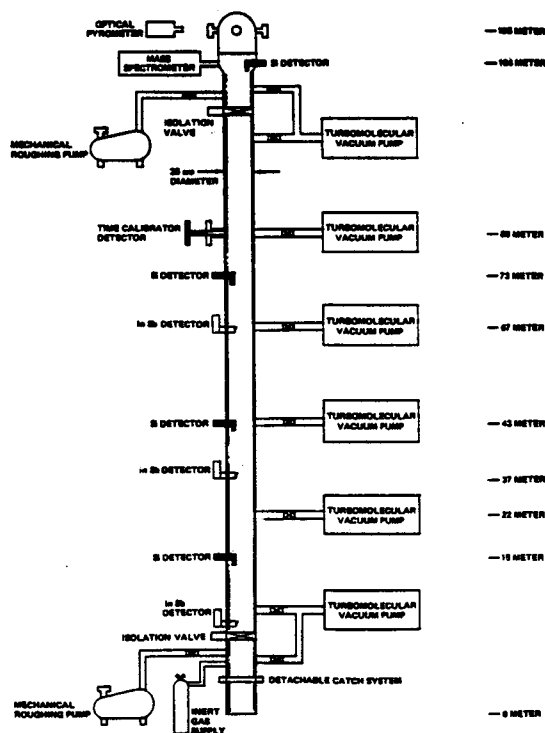

Figure 2. Schematic diagram of the Marshall Space Flight Center 105 meter drop tube. (Courtesy Mr. Mike Robinson).

A sample can be levitated and melted using an electromagnetic levitator furnace located at the top of the drop tube. Once the sample has reached the desired temperature, power to the levitator coil is removed and the sample is permitted to fall down the tube. Solidification takes place during free fall which provides low gravity containerless processing conditions.

There are several limitations to the use of a drop tube. One of the most severe is that free fall is limited to 4.6 seconds for a 105 meter tube. As a result, it is necessary to use small samples and to process alloys that possess fairly high melting points so that high rates of heat loss from radiative cooling are achieved. In the case of alloys with long freezing ranges, as in most immiscible alloys, the cooling rate in the tube can be increased by partially back filling with an inert gas in order to provide additional cooling due to convection. This does compromise the quality of the low gravity conditions somewhat. However, this approach was utilized in this study, apparently with no adverse effects.

In order to permit more rapid processing and to help stabilize the samples in the levitator coil, the samples were supported on 0.010 inch diameter tungsten wires that were attached to a carousel. This allowed several samples to be placed in the tube at one time. After processing one sample, the next would be brought into position through use of a mechanical feed-through into the chamber. The tungsten wires gave an added benefit as well. Gold-rhodium alloys have exhibited a tendency to fall from the levitator coil due to a lack of levitating force at elevated temperatures. When the sample is suspended from a wire, it experiences an additional force due to surface tension that helps hold the sample in the coil. This allows the samples to reach a higher temperature before falling and better insures a homogeneous sample when it drops.

RESULTS AND DISCUSSION

The 65 atomic percent rhodium sample shown in Figure 3 is typical of the samples after alloying in the arc melter. These samples solidified under one-g conditions and as a result experienced sedimentation of the more dense, gold-rich liquid. Figure 4 shows an arc melted and one-g solidified, 65 atomic percent rhodium sample after sectioning. Again, sedimentation of the gold-rich liquid is apparent. The rhodium rich region in the upper portion of this sample is of monotectic composition. The black areas are pores that apparently result from solidification shrinkage.

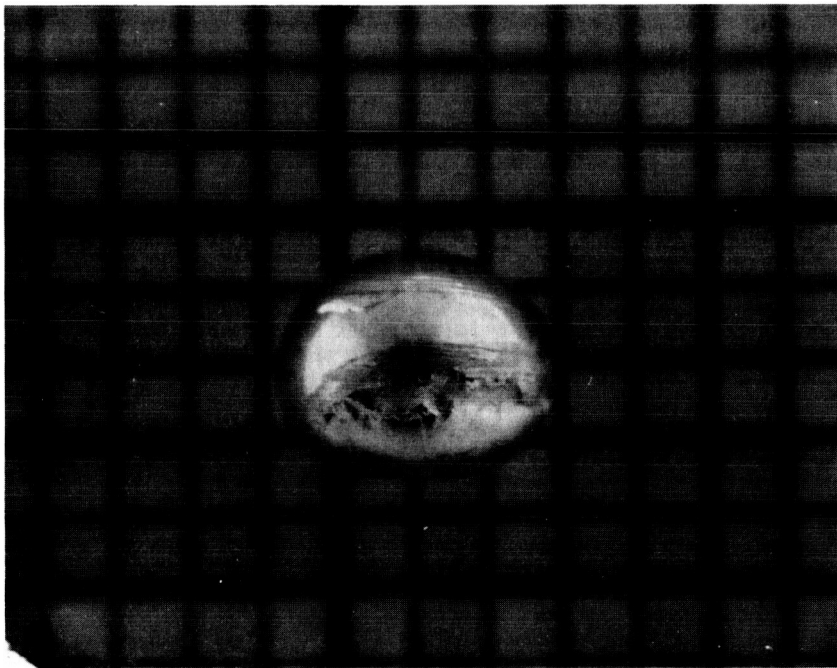

Figure 3. A typical 65 atomic percent rhodium sample after alloying in the arc melter under one-g conditions. Magnification 10x.

ORIGINAL PAGE IS
OF POOR QUALITY

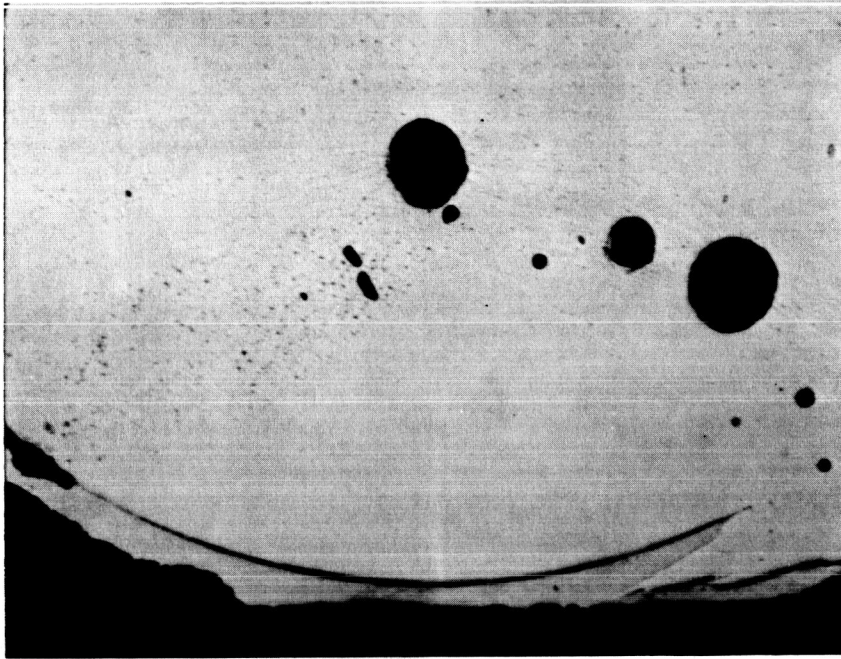

Figure 4. A section through a typical 65 atomic percent rhodium sample processed in an arc melter under one-g conditions. Note sedimentation. Magnification 60x.

When these samples are processed at the drop tube and solidified under low gravity conditions a different structure is obtained. The first noticeable difference is that the typical sample has a gold colored outer surface. Since the rhodium-rich monotectic liquid has a silver color, the gold color of the sample must be due to the presence of the hypermonotectic gold-rich liquid at the surface. A section through a typical 65 atomic percent rhodium sample, shown in Figure 5 reveals a gold rich layer completely surrounding the sample and two rather large gold-rich regions in the central area of the sample. These areas were apparently gold-rich hypermonotectic liquid that solidified during free fall. Figure 6 shows a higher magnification view of a portion of the gold-rich "rim". Notice that rhodium dendrites are present in this region. These dendrites were expected to form as the gold-rich liquid cools from the monotectic temperature. Some gold rich areas are also coarsely dispersed in the rhodium rich "matrix".

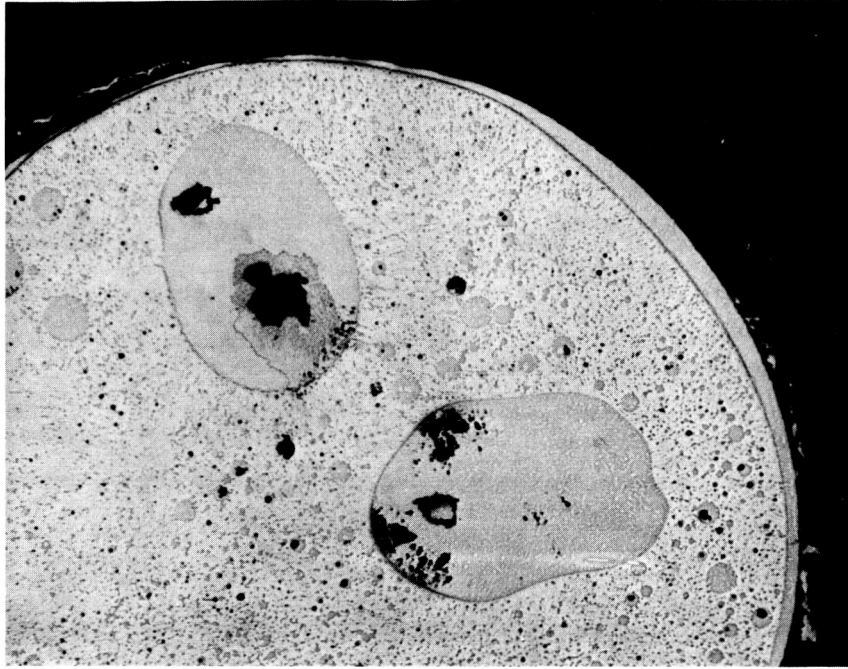

Figure 5. A 65 atomic percent rhodium sample as processed under low-g conditions in the 105 meter drop tube. Note presence of a gold rich layer at the outer surface. Magnification 34x.

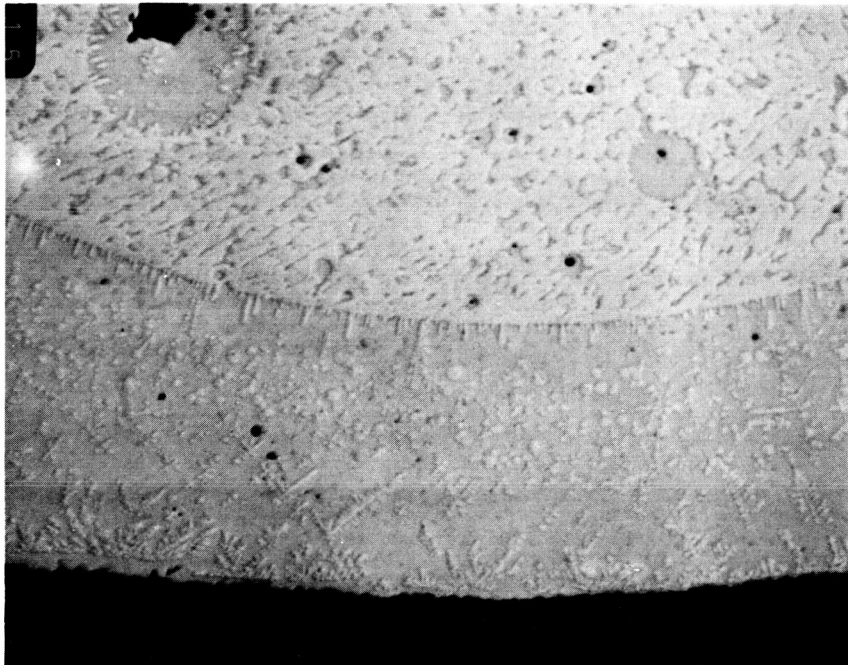

Figure 6. A portion of the gold rich rim of the sample shown in Figure 5. Magnification 200x.

**ORIGINAL PAGE IS
OF POOR QUALITY**

This type of segregation was typical of the structures obtained in the 65 atomic percent rhodium alloys. A section of another 65 atomic percent rhodium sample is shown in Figure 7. Apparently this segregation occurs as a result of the gold-rich immiscible liquid phase wetting the outer surface in most of the samples of this composition.

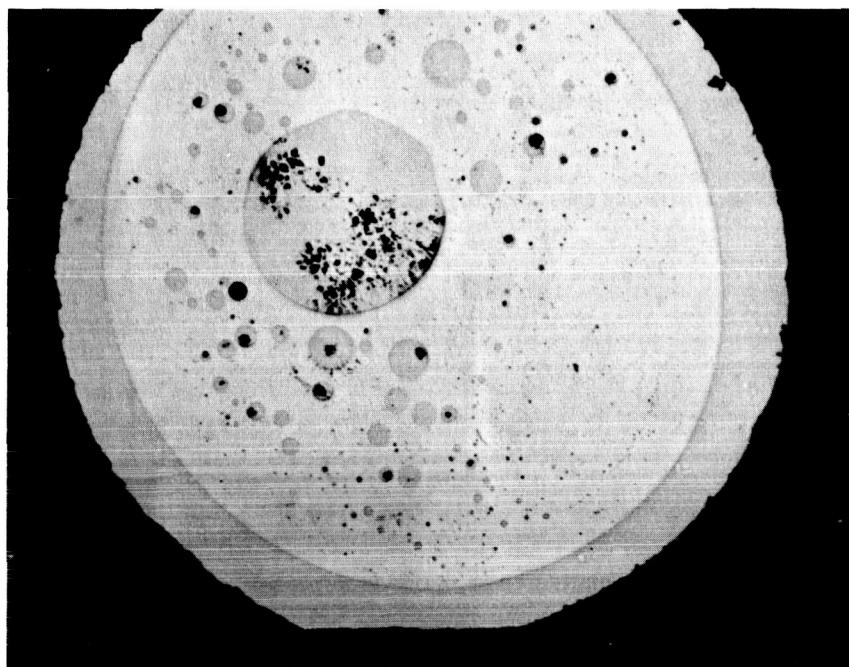

Figure 7. A drop tube processed, 65 atomic percent rhodium sample. Note similarity to the sample shown in Figure 5. Magnification 34x.

Although this segregated microstructure was typical of the 65 atomic percent rhodium samples, it did not occur in all cases. In particular, two samples of this composition did not exhibit a gold rich rim or any large gold rich regions in the central portions. A cross section of one of these samples is shown in Figure 8. Closer examination of the microstructure (Figure 9) shows that the gold-rich liquid is distributed throughout the sample. It appears as if the gold rich phase is interconnected. While not readily apparent in the photomicrographs, there was a noticeable variation in the volume fraction of the gold rich phase from a fairly low value near the center of the sample to a much higher value in the outer regions. The reasons for the lack of extensive segregation in these samples and the variation in the volume fraction of the gold rich phase is currently under investigation.

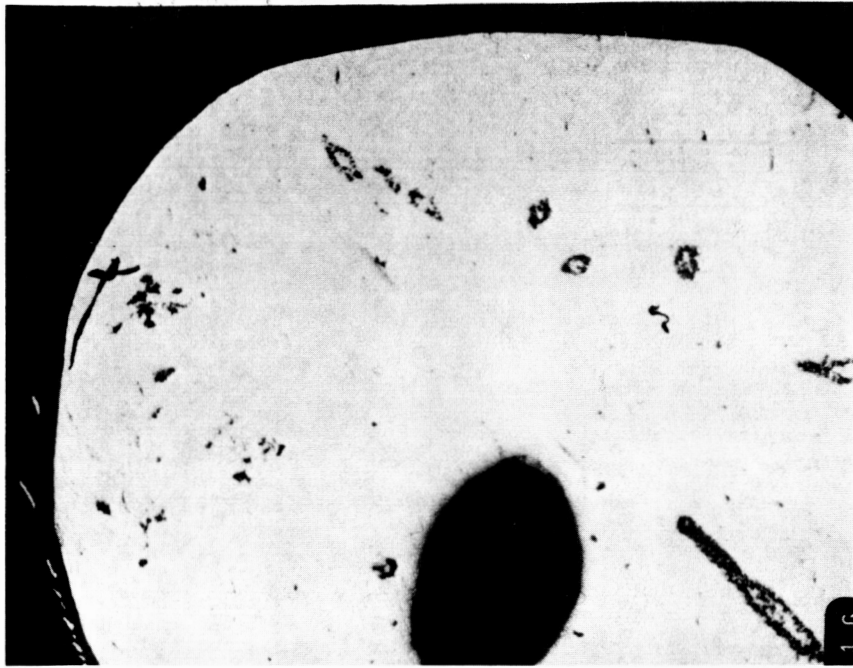
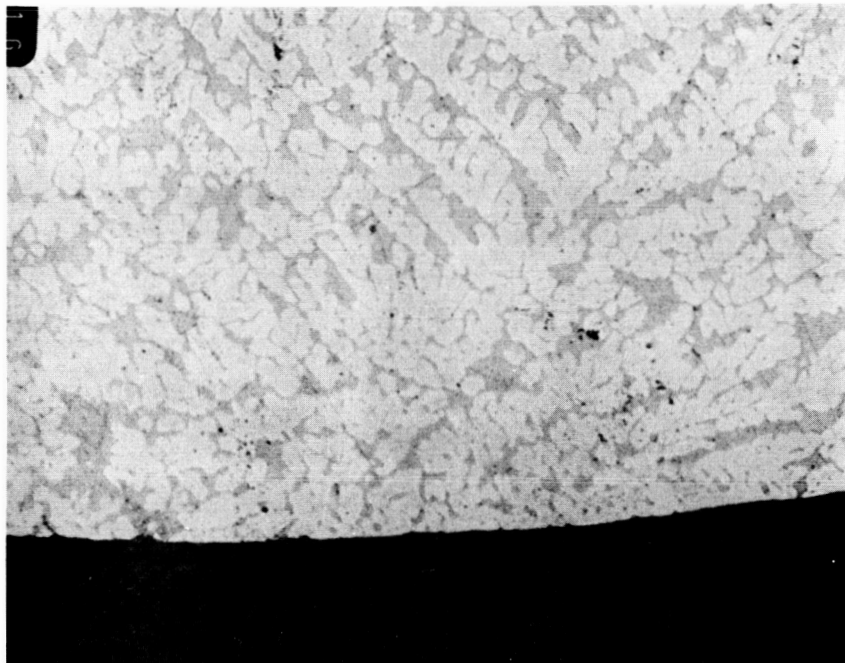

Figure 8. Cross-section of a typical 65 atomic percent rhodium sample processed under low-g containerless conditions in the MSFC 105 meter drop tube. Note absence of a gold-rich rim on this sample. Magnification 34x.



ORIGINAL PAGE IS
OF POOR QUALITY

Figure 9. Higher magnification view of the edge of the 65 atomic percent rhodium sample shown in Figure 8. Magnification 200x.

While several 65 atomic percent rhodium samples were obtained that did not exhibit extensive segregation, the more typical result was a badly segregated sample exhibiting a gold rich layer at the surface. This indicated a tendency for the gold rich liquid to wet the outer surface of the samples, a situation that would decrease the likelihood of forming a dispersion when the gold rich liquid is the minority phase. Because of this problem, alloys of a different composition were produced in which the gold-rich liquid would make up the majority constituent at the monotectic temperature and the rhodium rich liquid would be present at a volume fraction of 10 percent. This occurs for an alloy composition of 23.4 atomic percent rhodium.

Figure 10 shows a 23.4 atomic percent rhodium sample that was processed under low gravity conditions using the drop tube and then sectioned to reveal its structure. The cross section reveals rhodium rich spheres dispersed throughout a gold rich matrix. In this case, there appears to be a tendency for the rhodium rich spheres to cluster near the center of the sample. The dark areas near the center are pores.

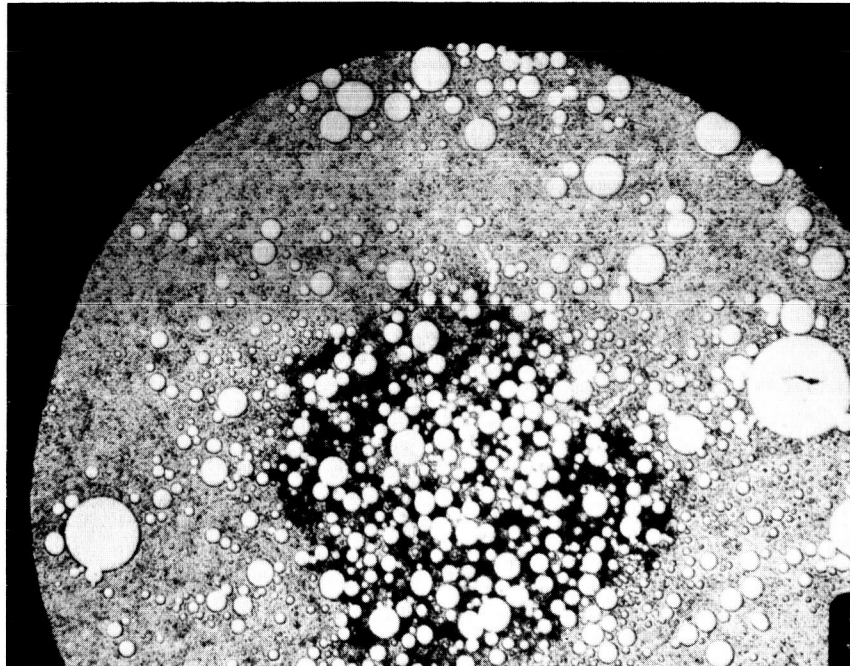

Figure 10. Cross-section of a 23.4 atomic percent rhodium, low-g processed sample showing a coarse dispersion of rhodium rich spheres in a gold rich matrix. Magnification 37x.

There were several areas in this sample that appeared to be rather devoid of the rhodium rich phase. However, examination at a higher magnification revealed that small rhodium dendrites were present in these regions as anticipated.

**ORIGINAL PAGE IS
OF POOR QUALITY**

In other areas it appeared as if the rhodium-rich spheres had come in contact but did not coalesce, an example is shown in Figure 11. These particles were most likely solid when they met. In this system there is a rather extensive temperature region over which the solid rhodium-rich particles would be present in the molten gold-rich liquid phase.

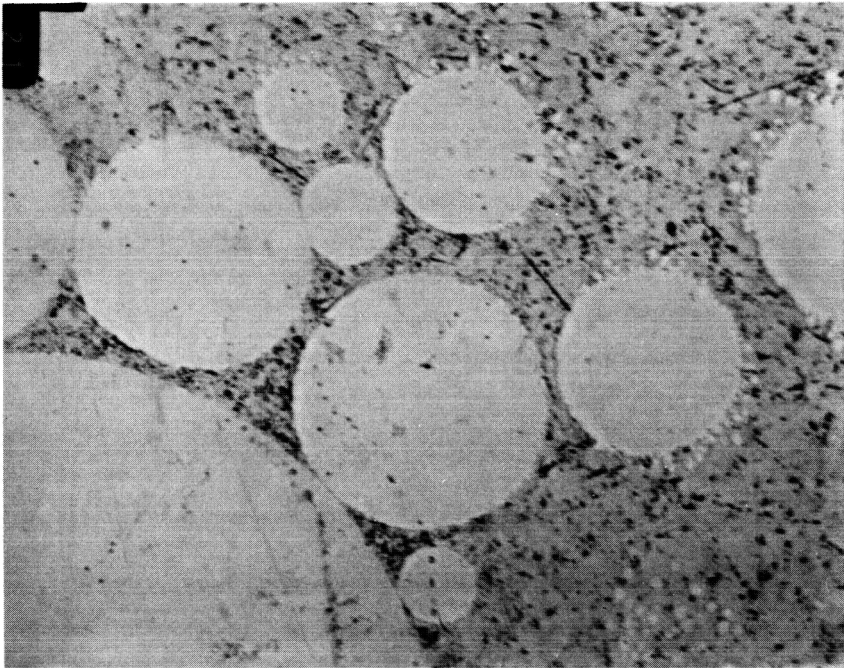

Figure 11. Higher magnification view of a cluster of rhodium rich spheres in the sample shown in Figure 10. Note lack of coalescence. Magnification 600x.

While the microstructure in this sample is rather coarse, the sample does definitely exhibit a dispersion of one of the immiscible phases in the other. This structure should be contrasted with the typical segregated structure normally obtained in the 65 atomic percent rhodium samples.

Several other 23.4 atomic percent rhodium samples were processed under low-gravity containerless conditions. The microstructures varied from the rather coarse microstructure that was shown in Figure 11 above, to a very desirable, finely dispersed microstructure. This dispersed microstructure is shown in Figure 12 which was taken at a magnification of 600X. (The same magnification as Figure 11.) This micrograph shows the finest dispersion obtained during this investigation. The roughly spherical rhodium-rich particles have a 2 to 3 micrometer diameter. This is one of the finest dispersions that has been obtained in immiscible alloy systems.

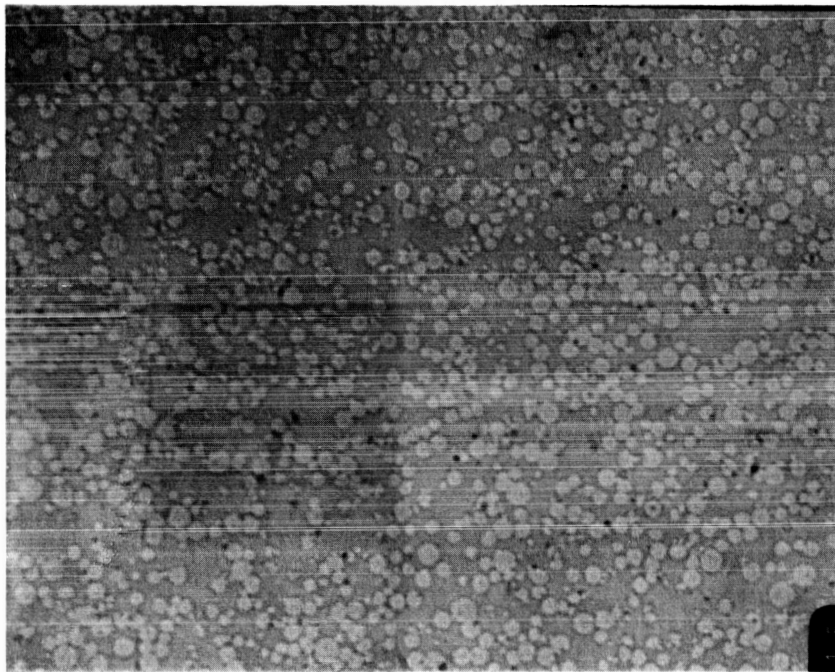

Figure 12. A fine, dispersed microstructure obtained in a 23.4 atomic percent rhodium sample processed under low-g containerless conditions. The diameter of the rhodium-rich particles is 2 to 3 micrometers. Magnification 600x.

The techniques that were used to produce the last two samples discussed; one with a coarse dispersion, one with a fine dispersion; were almost identical. The temperatures at which the samples were dropped different by only 2° Celcius. It is not known at this time why one sample produced a coarse microstructure while the other produced a very desirable finely dispersed microstructure.

CONCLUSIONS AND RECOMMENDATIONS

From the above investigation the following conclusions can be drawn.

1. There is a tendency for the gold-rich immiscible liquid phase to wet the outer surface of containerlessly processed immiscible gold-rhodium alloys.
2. Dispersed microstructures are more easily obtained when the gold-rich immiscible phase is the majority phase and serves as the matrix.
3. In alloys where the rhodium-rich immiscible liquid is the majority phase, the gold-rich liquid appears to be interconnected throughout the alloy.
4. Fine dispersions consisting of 2 to 3 micrometer diameter rhodium-rich spheres in a gold-rich matrix can be obtained through solidification of small samples under containerless low gravity conditions.

We plan to continue to investigate the microstructures obtained in low-gravity, containerless processed immiscible alloys. In particular the study of other gold-rhodium alloy compositions in the miscibility gap are being considered. Further testing is necessary to properly correlate the microstructures obtained in these alloys with processing variables such as drop temperature, and the time at temperature. To date, a statistically significant correlation has not been achieved. Quantitative microscopy measurements are also needed on these samples in order to determine the volume fractions of the phases present and their interfacial areas.

REFERENCES

1. J. L. Reger. "Study of Processing Immiscible Materials at Zero-G," Interim Report to NASA Marshall Space Flight Center, Contract NAS8-28267 (May, 1982).
2. R. A. Parr, M. H. Johnston, "Growth Parameters for Aligned Microstructures in Directionally Solidified Aluminum-Bismuth Monotectic," Metallurgical Transactions A, vol. 9A, pp 1825-1828 (1978).
3. S. H. Gelles, A. J. Markworth, "Microgravity Studies in the Liquid-Phase Immiscible System: Aluminum-Indium," AIAA Journal, vol. 16 pp. 431-438 (1978).
4. T. Carlberg, H. Fredriksson, "The Influence of Microgravity on the Solidification of Zn-Bi Immiscible Alloys," Metallurgical Transactions A, vol. 11A, pp. 1665-1676 (1980).
5. C. Potard, "Solidification of Hypermonotectic Al-In Alloys Under Microgravity Conditions," Materials Processing in the Reduced Gravity Environment of Space, G. E. Rindone, ed. Elsevier Science Publishing Company, Inc. pp. 543-551 (1982).
6. R. J. Naumann, "Microgravity Science and Applications Program Description Document, Marshall Space Flight Center, p. 7 (February, 1984).
7. American Society for Metals, Metals Handbook 8th Edition, Volume 8, "Metallography, Structures and Phase Diagrams," Metals Park, Ohio p. 268 (1973).