

Final  
Report

April 1986

# Tethered Orbital Refueling Study

NAS9-17059  
NAS9-17422

171954

**MARTIN MARIETTA**

MCR-86-587 and  
MCR-86-591

Final Report

April 1986

---

**TETHERED ORBITAL  
REFUELING STUDY**

Prepared for:

Lyndon B. Johnson Space Center

Prepared by:

Dale A. Fester  
L. Kevin Rudolph  
Erlinda R. Kiefel  
Peter W. Abbott  
Pat Grossrode

**MARTIN MARIETTA  
DENVER AEROSPACE**  
P. O. Box 179  
Denver, Colorado 80201

## ABSTRACT

---

One of the major applications of the space station will be to act as a refueling depot for cryogenic-fueled space-based orbital transfer vehicles (OTV), Earth-storable fueled orbit maneuvering vehicles, and refurbishable satellite spacecraft using hydrazine. One alternative for fuel storage at the space station is a tethered orbital refueling facility (TORF), separated from the space station by a sufficient distance to induce a gravity gradient force that settles the stored fuels. This eliminates the need for zero-gravity propellant management devices in the storage tanks. Furthermore, the settled liquid allows venting during fill, instead of relying on a no-vent fill.

This report is the final report for two programs focused on studying the feasibility of a TORF: the Tethered Orbital Refueling Study (NASA JSC Contract NAS9-17059) and the Tethered Propellant Resupply Depot Study (NASA JSC Contract NAS9-17422). The first study examined technical feasibility. Primary focus was placed on the refueling of  $LO_2/LH_2$  orbital transfer vehicles, because of the time at which this technology could be applied to the space station and the suitability of cryogenic propellants to settling with a tether. A tether length of 915 meters (3000 feet) was required to have settled propellant, which didn't uncover the outlet when disturbed. To minimize slosh energy accumulation, ring baffles with a 5% damping coefficient are required in the propellant tanks. Low-gravity fluid transfer should be demonstrated in orbit before being used on a refueling facility.

The second study examined the tethered facility on the space station and compared it to a zero-gravity facility. The best operating mode was found to be upward deployment of an intermittently deployed facility. A reaction control system was found to be required to limit libration while having an acceptable deployment time. The initial cost of the tethered facility was found to be substantially more than for a zero-gravity facility, but is negligible when looking at total life-cycle costs. The tethered facility has development risk for the tether system, while the zero-gravity facility has development risk for the fluid transfer system. The tethered facility can have substantially less contamination than a zero-gravity facility.

A tethered refueling facility should be considered as a viable alternative to a zero-gravity facility if the zero-gravity fluid transfer technology, such as the propellant management device and no vent fill, proves to be difficult to develop with the required performance.

CONTENTS

---

	<u>Page</u>
1.0 INTRODUCTION . . . . .	1-1
2.0 SYSTEM DESIGN . . . . .	2-1
2.1 Gravity Gradient . . . . .	2-1
2.2 Related Facilities . . . . .	2-5
2.2.1 Space Station Configuration . . . . .	2-5
2.2.2 OTV and OMV Design . . . . .	2-7
2.3 Facility Design Requirements . . . . .	2-11
2.4 LO <sub>2</sub> /LH <sub>2</sub> Fluid Subsystem . . . . .	2-16
2.4.1 Tank Arrangement . . . . .	2-16
2.4.2 Fluid Transfer Analysis . . . . .	2-19
2.4.3 Transfer Method Selection . . . . .	2-23
2.4.4 Fluid System Schematic . . . . .	2-24
2.5 Facility Design . . . . .	2-27
3.0 DYNAMICS ANALYSIS . . . . .	3-1
3.1 System Dynamic Modeling . . . . .	3-1
3.2 Disturbance Definition . . . . .	3-3
3.3 Mathematical Model . . . . .	3-4
3.3.1 Small Motion Planar Model . . . . .	3-4
3.3.2 General Model . . . . .	3-9
3.4 TORF/Fluid Behavior Analysis . . . . .	3-13
3.5 Facility/Tether Dynamics . . . . .	3-20
3.5.1 Permanently Deployed TORF . . . . .	3-20
3.5.2 Intermittently Deployed TORF . . . . .	3-24
3.5.3 Design Concept Evaluation . . . . .	3-30
3.5.4 Design Concerns . . . . .	3-34
3.5.5 Conclusion . . . . .	3-41
4.0 SYSTEM DESIGN EFFECTS . . . . .	4-1
4.1 Space Station Effects . . . . .	4-1
4.2 OTV Effects . . . . .	4-2
4.3 Propellant Contamination . . . . .	4-5
4.4 Hazards . . . . .	4-9
4.5 Summary . . . . .	4-10
5.0 MISSION OPERATIONS . . . . .	5-1
5.1 Upward versus Downward Deployment . . . . .	5-6
5.2 Permanent versus Intermittent Deployment . . . . .	5-8
5.3 Conclusions . . . . .	5-20
6.0 COST/BENEFITS ANALYSIS . . . . .	6-1
6.1 Cost Evaluation . . . . .	6-1
6.1.1 DDT&E and Fabrication Cost . . . . .	6-3
6.1.2 Launch Cost . . . . .	6-8
6.1.3 Assembly . . . . .	6-8
6.1.4 Operations . . . . .	6-8
6.1.5 Tanker and Propellant . . . . .	6-13
6.2 Benefits Comparison . . . . .	6-13
6.3 Conclusion. . . . .	6-19

	<u>Page</u>
7.0 CONCLUSIONS . . . . .	7-1
BIBLIOGRAPHY	B-1 thru B-7

Figure

---

2-1 TORF/Space Station Configuration . . . . .	2-1
2-2 Tether System Parameters . . . . .	2-4
2-3 Space Station Twin-Keel Configuration . . . . .	2-6
2-4 Reusable OTV with Aerobrake . . . . .	2-8
2-5 OTV Design with Aerobrake . . . . .	2-9
2-6 Orbital Maneuvering Vehicle (OMV) . . . . .	2-10
2-7 Space Station/TORF Configurations . . . . .	2-12
2-8 Facility Design Summary . . . . .	2-13
2-9 Tank Shape Alternatives . . . . .	2-17
2-10 MLI and Meteoroid Shield . . . . .	2-18
2-11 Gravity Transfer Analysis . . . . .	2-22
2-12 Facility Fluid Schematic . . . . .	2-26
2-13 Maximum Pressure Change without Venting Liquid . . . . .	2-27
2-14 Libration Angle Analyses Results . . . . .	2-28
2-15 Attached Zero-g Facility . . . . .	2-31
2-16 Propellant Management Device . . . . .	2-33
2-17 Tethered Refueling Configuration . . . . .	2-34
3-1 Motion Types . . . . .	3-2
3-2 Equivalent Slosh Model for a Spherical Tank . . . . .	3-5
3-3 Small Motion to Large Motion Comparison . . . . .	3-6
3-4 Basic Small Motion Model . . . . .	3-6
3-5 Static Equilibrium Position . . . . .	3-7
3-6 Mathematical Model Schematic . . . . .	3-9
3-7 10% Fill Level Center of Mass Motion versus Surface Tilt . . . . .	3-10
3-8 50% Fill Level Center of Mass Motion versus Surface Tilt . . . . .	3-11
3-9 Coordinate Systems . . . . .	3-12
3-10 Loss of Tether Tension as a Result of In-Plane Disturbances as a Function of Tether Length . . . . .	3-14
3-11 Swing Angle Response to In-Plane Disturbance as a Function of Tether Length . . . . .	3-15
3-12 Swing Angle Response to Out-of-Plane Disturbance as a Function of Tether Length . . . . .	3-16
3-13 Fixed-Ring Baffle Configurations . . . . .	3-18
3-14 External Damping Dynamics Model . . . . .	3-18
3-15 Comparison of Damped and Undamped Responses 305 m (1000 ft) Tether Length . . . . .	3-21
3-16 Facility/Tether Dynamics Study Flow . . . . .	3-22
3-17 Space Station/TORF/Crawler System . . . . .	3-23
3-18 Deployment Model Coordinate System . . . . .	3-25
3-19 $\rho$ , $\dot{\rho}$ and $\rho/\dot{\rho}$ Profiles . . . . .	3-28
3-20 Phase Plane Control . . . . .	3-29
3-21 Separation Length and Velocity for the Two-Hour Deployment Case . . . . .	3-31

	<u>Page</u>
3-22 In-Plane Libration Angle and Rate for the Two-Hour Deployment Case . . . . .	3-32
3-23 Tether Tension and Rate per Length Profile for the Two-Hour Deployment Case . . . . .	3-33
3-24 In-Plane Rotation of Space Station after Shuttle Docking (90% Fill) . . . . .	3-35
3-25 In-Plane Rotation of Space Station after Shuttle Docking (50% Fill) . . . . .	3-36
3-26 Space Station/TORF Libration as a Result of Shuttle Docking . . .	3-37
3-27 Facility Roll Model . . . . .	3-38
3-28 Roll Angle Time History for the 90% Fill Level . . . . .	3-39
3-29 TORF In-Plane Motion as a Result of TORF Roll Maneuver for the 10% Fill Level . . . . .	3-40
3-30 Roll Phase Plane for the 90% Fill Level . . . . .	3-41
4-1 Fluid Transfer Coupler . . . . .	4-4
4-2 Overpressurization Hazards . . . . .	4-6
5-1 Permanently Deployed Facility . . . . .	5-2
5-2 Intermittently Deployed Facility . . . . .	5-4
5-3 OTV Refurbishment Timeline . . . . .	5-5
5-4 Configuration at Tether Break . . . . .	5-7
5-5 Permanently Deployed TORF Operating Scenario . . . . .	5-10
5-6 Intermittently Deployed TORF Operating Scenario . . . . .	5-11
5-7 Nominal Operations for the Permanently Deployed TORF . . . . .	5-12
5-8 Relative Motion of OTV with TORF Near Rendezvous . . . . .	5-15
5-9 Separation Distance between OTV and TORF . . . . .	5-16
5-10 External Tether Crawler . . . . .	5-16
5-11 Internal Tether Crawler . . . . .	5-17
5-12 Nominal Operations for the Intermittently Deployed TORF . . . . .	5-19
6-1 Life-Cycle Costing Breakdown . . . . .	6-2
6-2 Tanker Fluid Transfer System Schematic . . . . .	6-14
6-3 Cost Difference Comparison . . . . .	6-20

Table

---

2-1 Minimum Gravity Gradient Acceleration . . . . .	2-3
2-2 OMV Component Masses . . . . .	2-10
2-3 LO <sub>2</sub> /LH <sub>2</sub> Facility Mass Estimates . . . . .	2-14
2-4 Storable Facility Mass Estimates . . . . .	2-15
2-5 Tank Shape Analysis Results . . . . .	2-19
3-1 Potential Motions of Facility Components . . . . .	3-1
3-2 Model Motions Types . . . . .	3-2
3-3 Model Characteristics . . . . .	3-3
3-4 Disturbance Sources . . . . .	3-3
3-5 Disturbance Magnitude and Types . . . . .	3-4
3-6 Modal Gains of the Planar Model . . . . .	3-8
3-7 Case Definitions . . . . .	3-13
3-8 Damping Coefficients . . . . .	3-17
3-9 Time to Deploy for Various $\theta$ Max Values (hrs) . . . . .	3-29
3-10 Maximum Tether Velocities (m/hr) . . . . .	3-29
3-11 Total Propellant Consumption . . . . .	3-34

	<u>Page</u>	
3-12	Space Station Maximum In-Plane Rotation . . . . .	3-37
3-13	Propellant Required for the 45° Maneuver . . . . .	3-40
5-1	Deployment Direction Concerns . . . . .	5-6
5-2	Intermittent Deployment Evaluation . . . . .	5-21
6-1	Zero-g System Hardware Cost . . . . .	6-5
6-2	Tethered System Hardware Cost . . . . .	6-6
6-3	Maintenance and Replacement Costs . . . . .	6-7
6-4	Zero-g Assembly Cost . . . . .	6-9
6-5	Tethered System Assembly Cost . . . . .	6-10
6-6	Zero-g System Operations Cost . . . . .	6-11
6-7	Tethered System Operations Cost . . . . .	6-12
6-8	Tanker Hardware Cost . . . . .	6-15
6-9	Benefits Comparison . . . . .	6-16
6-10	Cost Summary . . . . .	6-19

## ACRONYMS

---

ACS	- Attitude Control System
APS	- Auxiliary Propulsion System
ASE	- Airborne Support Equipment
CFMF	- Cryogenic Fluid Management Facility
CG	- Center of Gravity
DDT&E	- Design, Development, Test, and Engineering
DOD	- Depth of Discharge
EPS	- Electrical Power System
ET	- External Tank
EVA	- Extravehicular Activity
FOC	- Final Operational Capability
GEO	- Geosynchronous Earth Orbit
GH <sub>2</sub>	- Gaseous Hydrogen
GH <sub>2</sub>	- Gaseous Oxygen
IOC	- Initial Operational Capability
IR&D	- Independent Research and Development
IVA	- Intravehicular Activity
LEO	- Low Earth Orbit
LH <sub>2</sub>	- Liquid Hydrogen
LO <sub>2</sub>	- Liquid Oxygen
MLI	- Multilayer Insulation
MMH	- Monomethylhydrazine
NASA	- National Aeronautics and Space Administration
NPSH	- Net Pump Suction Head
N <sub>2</sub>	- Nitrogen
N <sub>2</sub> O <sub>4</sub>	- Nitrogen Tetroxide
OMV	- Orbit Maneuvering Vehicle
OTV	- Orbit Transfer Vehicle
PMD	- Propellant Management Device
RCS	- Reaction Control System
RMS	- Remote Manipulator System
SFMD	- Space Fluid Management Demonstration
SS	- Space Station
STAIS	- Selected Tether Applications in Space
STS	- Space Transportation System
TORF	- Tethered Orbital Refueling Facility
TPRDS	- Tethered Propellant Resupply Depot Study
TSS	- Tethered Satellite System
TVS	- Thermodynamic Vent System
VCS	- Vapor Cooled Shield



## 1.0 INTRODUCTION

---

One of the planned mission objectives of the space station is to act as a transfer station for payloads launched by the space shuttle and deployed to final orbit by either an orbital transfer vehicle (OTV) or an orbital maneuvering vehicle (OMV). The OTV will use cryogenic  $LO_2/LH_2$  propellants to transfer payloads to (and also return them from) higher Earth orbits and, in the longer-term, to the moon. The OMV will use Earth-storable  $N_2O_4/MMH$  away from the space station and cold-gas  $N_2$  close to the space station. It will transfer payloads from the station to various other low-Earth orbits (LEO) and will also serve to maneuver cargo from place to place in proximity with the space station itself. Both the OTV and OMV will be based at the space station and will require refueling between missions. Part of the function of the space station within its transfer station objective is to maintain a fuel storage facility to store propellants launched by the space shuttle for eventual use by either the OTV or OMV. In addition, for satellite refurbishment and reuse, it may be desirable to store small quantities of hydrazine to resupply the auxiliary propulsion systems on these refurbished spacecraft. Finally, the space station requires its own onboard propulsion system for stationkeeping and attitude control. Alternatives for this system include either a monopropellant hydrazine system or a bipropellant  $O_2/H_2$  system, which will also require propellant storage at the station.

Bulk storage and handling of propellant liquids onboard the space station involves considerable technical challenge because of the high vacuum, zero-gravity environment. Thermally conditioning these propellants to minimize boiloff will require sophisticated system designs. A zero-gravity storage facility will require a propellant management system for fluid transfer and to maintain a controlled interface between the fluid and the ullage vapor in the storage tanks. Ullage vapor venting is complicated by the need to prevent liquid from entering the vent system. Using no-vent fill processes to eliminate venting complications leads to concerns with tank fluid quantity gaging. Significant concerns exist with the potential for contamination of sensitive space station equipment as a result of venting or minor propellant spills during fluid transfer operations. Finally, the fluid motions in the tanks and storage facility operations may generate time-varying disturbance levels on the space station that could preclude certain sensitive operations, such as astronomical observations or low-g manufacturing.

An alternative to propellant storage on the space station (and its attendant design concerns) is to use a remote facility tied to the station with a long tether. Attaching the facility to the station in this way leads to an induced gravity gradient acceleration on the facility, which can settle and assist in the transfer of propellants. Such an acceleration can minimize the need for zero-gravity propellant management systems. In addition, remote placement of the storage facility can greatly reduce the contamination effects on the space station. Conversely, these advantages are counterbalanced by the increased complexity of the space station configuration implicit in having a tethered orbital refueling facility (TORF) attached to it.

Study and evaluation of the design implications and potential benefits of a TORF were carried out at Martin Marietta under NASA-JSC contracts NAS9-17059 and NAS9-17422 from late 1983 to 1986. This report summarizes the analyses and results completed under both of these contracts. The overall objective of the first contracted effort was to evaluate the technical feasibility of a TORF, specifically with regard to potential fluid management concerns, including slosh during fluid transfer operations. Based on the favorable results of the first study, the second contracted effort was carried out, with the overall objective of more specifically defining the incorporation of a TORF as a part of the space station system, and assessing the TORF costs and benefits relative to a zero-gravity fluid storage technology.

To meet the objective of the first study, it was divided into six major tasks. The first task (fluid transfer study) was a review and analysis of the alternative fluid transfer methods that may be used in a TORF. The second task (configuration definition) concentrated on identifying the basic TORF design characteristics (such as tether length) necessary to minimize and control fluid slosh motions in simple, bare storage tanks. The third task (augmented stability) repeated the Task 2 analyses for a facility with more complex tankage utilizing stability augmentation devices. The fourth task (hazard assessment) was a detailed review of the safety concerns arising from a tethered facility, to more clearly define the overall safety and contamination effects tradeoff between remote and onboard space station propellant storage. The fifth task (testing recommendations) reviewed the required technologies for the TORF and defined those areas where further testing was needed to more clearly develop a detailed TORF design. Finally, the sixth task (space system effects) was a review and analysis of the design operations and hardware effects that the TORF would have on the space station, OTV, and OMV.

During the course of these analyses, several areas requiring further study were identified. Of these, three of the most important were included in the second contracted effort. They are: (1) additional fluid-tether interaction dynamics analyses; (2) definition of the specific operations associated with build-up, deployment, and use of a TORF; and (3) analysis of the comparative costs and benefits between tethered and zero-g fluid storage.

When this study began, both cryogenic and Earth-storable propellants were included in the analysis and design efforts. After Task 1 of the first study was completed, it was refocused to emphasize cryogenic propellants, and to consider storable propellants only in a cursory sense. The refocusing was a result of the fact that large cryogenic tanks do not require as much acceleration to settle the fluids and because storable propellant refueling is likely to be in use before tethered facilities are available. As a result of this change, the configuration definition facility design results only include preliminary analyses of storable propellant design configurations. The more detailed TORF system definition results are confined to only cryogenic propellants. All of the fluid dynamics analyses were confined specifically to cryogenic propellants, although the general results are relevant to any fluid. The hazards assessment includes

considerations of both cryogenics and Earth-storables; while the testing recommendations and space system effects task results are relatively independent of fluid type.

These study efforts have been underway in parallel with a period of significant development of the space station. As such, the baseline space station design used to support these analyses was updated several times during the course of these studies. The space station baseline was changed from an integrated module cluster to the NASA Phase B power tower midway through the first contracted effort and then to the twin-keel configuration for the entire second contract. Changes in the space station configuration had little effect on the overall results of the study. The details of these space station designs are discussed in the following sections, where appropriate.

In addition to the above space station system configuration updates, for the second contracted effort the TORF design requirements were also modified. The first contracted effort had as a groundrule that the cryogenic LO<sub>2</sub>/LH<sub>2</sub> storage system have a total capacity of 45,400 kg (100,000 lbm). Further, only the fluid storage system and its necessary support subsystems were to be tethered. For the second effort, these groundrules were modified to be more in-line with current fluid storage system requirements. This resulted in the baseline capacity being increased to 90,800 kg (200,000 lbm) using two of the earlier fluid storage systems in parallel. Because the basic fluid storage tankage and lines were not changed, this added capacity had little effect on the overall study. Furthermore, to avoid logistics concerns associated with moving the OTV from its refurbishment hangar to the refueling facility, the OTV hangar was included as part of the overall tethered system and located with the fluid storage tanks.

This report is subdivided into sections that examine the basic subject areas analyzed during the two studies included herein. As such there is some overlap between the slightly different groundrules of these studies. To ensure that the reader is aware of the appropriate groundrules in a given discussion, they are explained wherever necessary. Section 2 of this report describes the space station, OTV, and OMV baselines used and then summarizes the fluid storage and associated subsystems designs for the TORF. With these designs in hand, Section 3 describes the detailed dynamics analyses of the overall fluid/TORF/space station system. Section 4 outlines the effects of a TORF on the designs of the space station, OTV, OMV, and other associated systems. Based on the TORF designs, dynamics, and system effects, Section 5 presents a detailed summary of the operations required throughout the TORF system life cycle. From these operations, the overall TORF life-cycle cost was evaluated and is presented in Section 6 along with an assessment of other comparison parameters. Finally, Section 7 presents the overall conclusions and recommendations of these two study programs. To keep this report from being too large, several of the analyses completed during these studies are only briefly summarized. For further details, the reader is referred to the bibliography at the end of this report.

## 2.0 SYSTEM DESIGN

---

A major goal of this study is to demonstrate the feasibility of a TORF, with particular emphasis on analyzing the fluid dynamic behavior in the low-g environment of a tethered system. To demonstrate this feasibility, the design concerns of this system must be identified and resolved. To do this, a facility design must be defined based on the overall system requirements and the interface requirements between the facilities and their associated systems, including the space station, space shuttle, OTV, and OMV.

A schematic of the TORF/Space Station system is shown in Figure 2-1. The overall facility designs must include several subsystems to support the fluid storage and transfer systems and to allow the necessary housekeeping functions to be autonomous. A TORF must generate its own power, maintain its own attitude, and drive the fluid transfer for its own refill as well as for spacecraft refill. The support subsystems must include electrical power, structure, avionics, communication, docking/berthing mechanism, meteoroid shielding, thermal control, and propulsion.

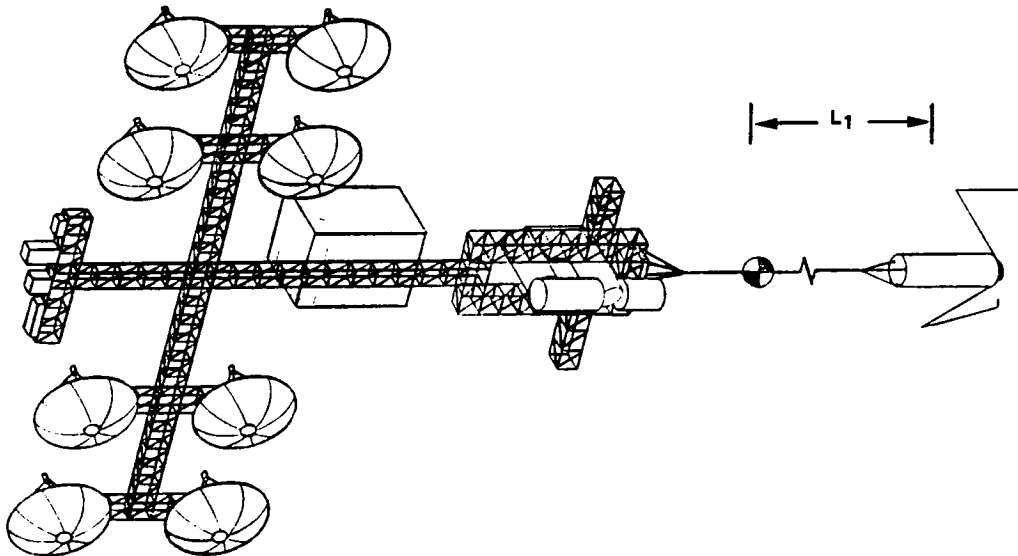

*Figure 2-1 TORF/Space Station Configuration*

### 2.1 GRAVITY GRADIENT

The apparent gravity gradient acceleration in a tethered system is a direct function of the distance from the system center of mass, which is determined by the end masses and the tether length. To make it easier to identify the relevant lengths and gravity gradient accelerations, an analysis was completed to define these quantities as functions of the overall tether length and spacecraft end masses. The gravity gradient can be described by:

$$[1] \quad \frac{g_{SS}}{L} = 3.1815 \times 10^{-7} (L_1/L),$$

where  $L_1$  is the distance between the center of mass of the space station and the center of mass of the overall system and  $L$  is the total length of the tether in meters. The lengths can be described by the equation:

$$[2] \quad \frac{L_1}{L_2} = \frac{M_{TORF}/M_{SS}}{1 + (M_{TORF}/M_{SS})},$$

where  $M$  represents the masses of the appropriate facilities. Figure 2-2 illustrates the results. The graph is nondimensionalized to facilitate the calculation of the induced gravity gradient and the center of mass for a mass or tether length change. Given the total tether length and the mass of the facilities, the two factors can be determined without performing tedious calculations.

For example, if the mass of the TORF is half the mass of the space station, the resulting gravitational force on the space station is  $1.3 \times 10^{-7} L$ . Given a 915-m (3000-ft) tether, this leads to an induced gravitational level of  $1.2 \times 10^{-4} g$ .

The gravity gradient acceleration induced in the TORF is used to orient the propellant in the supply tanks to ensure tank outlet coverage during propellant transfer. A minimum gravity gradient acceleration necessary to orient the liquid was determined from the acceleration needed to overcome capillary forces.

The relative magnitude of gravity and capillary forces is defined by the Bond number,  $B_0$ :

$$[3] \quad B_0 = \frac{\rho_{par} r^2}{\sigma}$$

The convention is to use the tank radius as the characteristic dimension in this application.

For Bond numbers less than one, capillary forces dominate the fluid dynamics. The influence of capillary forces on propellant motion and draining have disappeared by a Bond number of ten. To introduce some conservatism and design margin, a Bond number of 50 was selected to define the gravitational acceleration required to adequately dominate capillary forces.

Based on the definition of the Bond number and using Equation 1, the following expression for the tether length needed to overcome capillary forces is obtained:

$$[4] \quad L = \frac{50 \sigma}{3.80 \times 10^{-7} r^2 \rho},$$

where  $\sigma$  is the liquid surface tension (N/m),  $r$  is the tank radius (m), and  $\rho$  is the liquid density (kg/m<sup>3</sup>). Note that in this case,  $L$  is the distance from the fluid surface to the system center of mass.

Using Equation 4 with a facility tank inner diameter of 4.1 m (13.5 ft), the net acceleration and distance to the center of mass were calculated and are listed in Table 2-1. As is evident, the required tether length for LH<sub>2</sub> is longer than for LO<sub>2</sub>; hence the overall LO<sub>2</sub>/LH<sub>2</sub> facility tether length is determined by the LH<sub>2</sub> requirement. These required lengths represent the minimums necessary for gravity to dominate surface tension. In actual fact, the design tether lengths are considerably longer to allow for system disturbances such as shuttle docking forces.

*Table 2-1 Minimum Gravity Gradient Acceleration*

Propellant	Tank Radius, m	Gravity Gradient Acceleration, g	Distance to System Center of Mass, m
Oxygen	2.06	$1.4 \times 10^{-5}$	36.6
Hydrogen	2.06	$3.2 \times 10^{-5}$	85.3

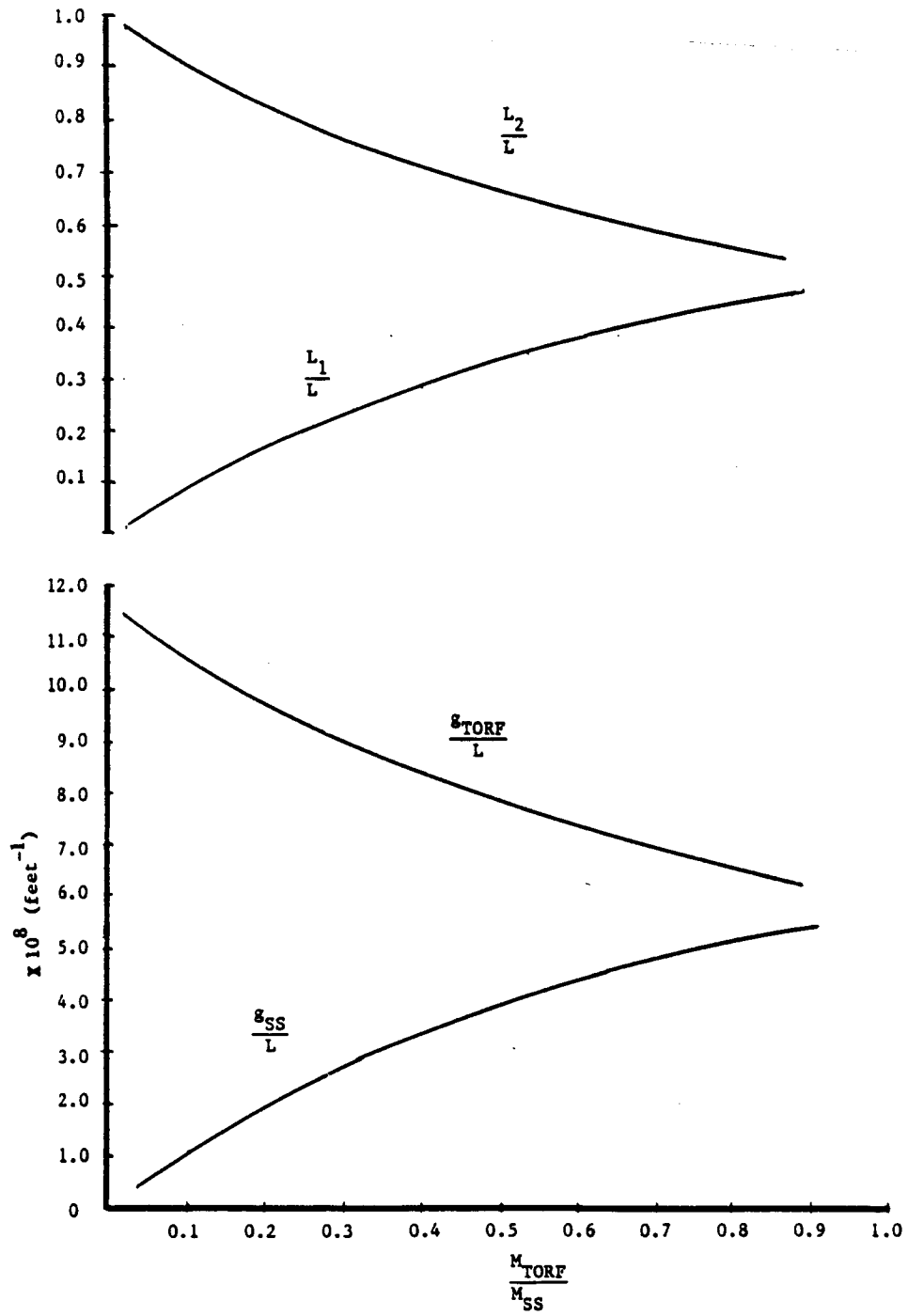

Figure 2-2 Tether System Parameters

## 2.2 RELATED FACILITIES

### 2.2.1 Space Station Configuration

Current concepts for the NASA space station start with an initial configuration composed of a few different modules to support habitation, power supply, elementary experiments, space observations, and necessary logistics. Two or three STS launches will be required to deliver the components to low-Earth orbit (LEO). From this basic configuration, the space station will increase in size to handle material processing, life science experiments, numerous observation activities, extensive experimentation, and satellite deployment and servicing. The final configuration will have the capability to service and refuel both the OTV and OMV. The baseline station orbit is at an altitude of 463 km (250 nmi) and an inclination of 28.5 degrees.

Only the mature space station was considered in this study. The initial space station core that was considered for the refueling facility was assumed to have a mass of 158,900 kg (350,000 lbm). This baseline has a strongback perpendicular to the orbit radius, which supports a variety of different modules attached in a three-dimensional arrangement. This compact design imposes relatively stringent limits on the location of the tether facility attach points. Furthermore, the horizontal orientation of this concept suggests the location of the shuttle when berthed to the station can be relatively far from the station center of mass. As will be seen, these characteristics tend to be disadvantageous relative to the use of a TORF.

Following the NASA Phase B start, the baseline space station design was changed to the "power tower" configuration. This configuration has a single strongback that is gravity-gradient stabilized in the vertical direction. The ends of this beam are relatively open such that a tethered system can be attached relatively easily. This space station concept was used as the study baseline for only the latter half of the first contract effort and had minimal effect on the overall study results.

The present NASA space station reference design is the so-called "twin keel." This concept has two beams that are gravity-gradient stabilized in the vertical direction and is shown in Figure 2-3. A variety of modules are placed along this structure, however, the ends (where the tether facility would attach) are relatively open. Furthermore, the shuttle berthing location is relatively close to the station center of mass, which eases station/TORF attitude control. This twin keel concept is relatively less affected by the use of a tethered facility because of its characteristics. This design was used as the study baseline for the mission operations and cost/benefits analysis.

A number of adjustments would need to be made to the space station to allow deployment and/or tethering of the TORF. Rearrangement of the space station modules may be required, rails to guide deployment of the TORF added, strengthening in some areas of the space station may be required, and positioning of some payloads may be affected.



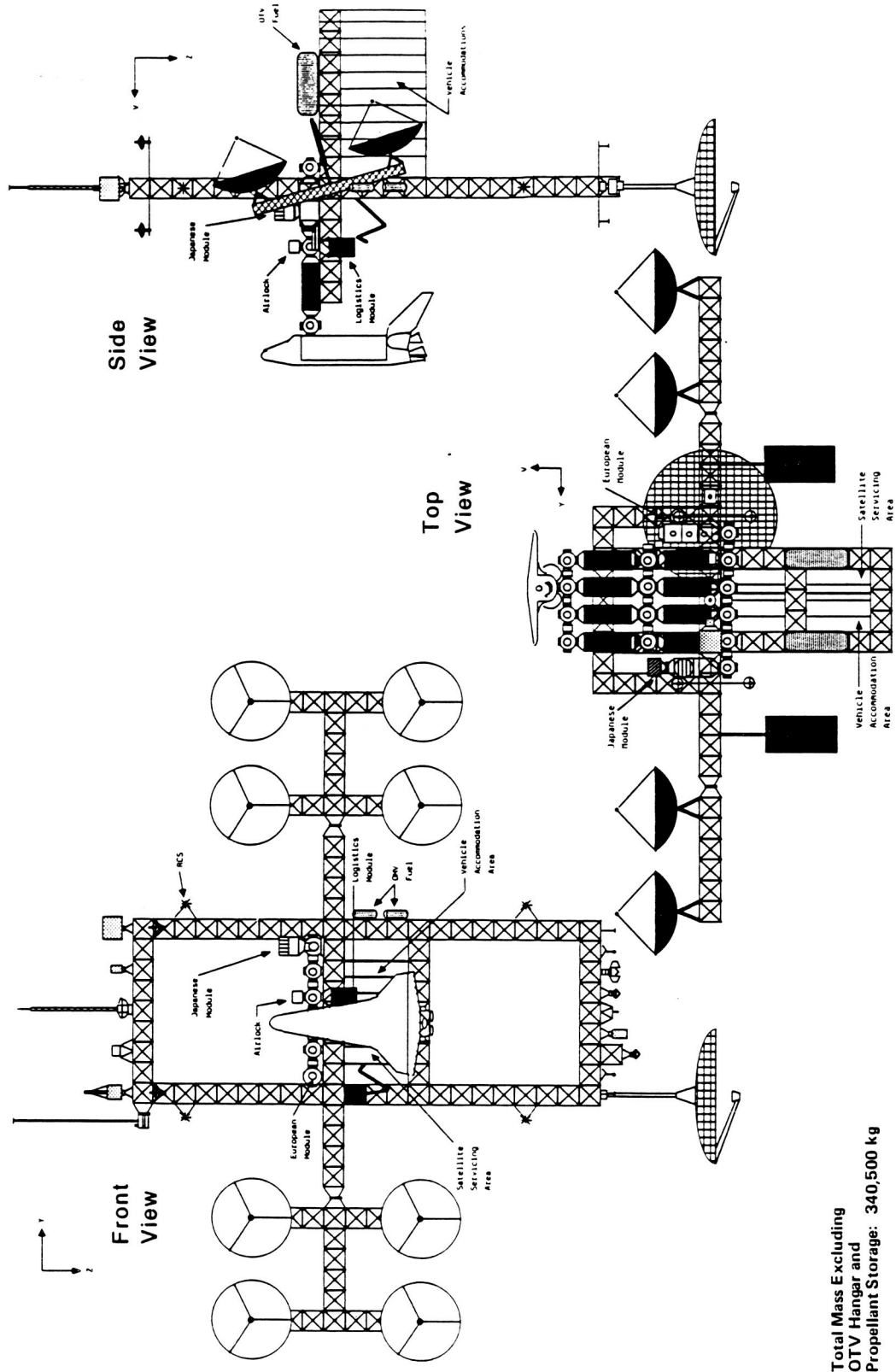

Total Mass E excluding  
OTV Hangar and  
Propellant Storage: 340,500 kg

Note:

Truss Bays Are 5.0 Meters between Strut Centerlines

Figure 2-3 Space Station Twin-Keel Configuration

### 2.2.2 OTV and OMV Designs

Orbit Transfer Vehicle--The space-based OTV projected for use with the space station is a reusable concept with aerobrake. Total propellant for the vehicle will be 20,400 kg (45,000 lbm), which includes usable (main impulse) propellant, performance reserve, engine start/shutdown losses, boiloff, and residuals. The OTV will be designed for repair and refurbishment at the space station. Important OTV characteristics for this study are the mass distribution for the dynamic response analyses and the refill characteristics for propellant transfer.

Several studies have been completed on the reusable aerobraked OTV concept and our design contains characteristics from some of these studies. The basic design and mass statement of the vehicle used in the initial phase of this study is shown in Figure 2-4 and the updated design is shown in Figure 2-5.

Orbital Maneuvering Vehicle--The OMV will eventually be equipped to deploy, rendezvous and dock, service, and return payloads. The concept envisioned for space station basing will be an Earth-storable propellants ( $N_2O_4/MMH$ ) vehicle that can operate remotely from the station. Designs are currently being reviewed by NASA for deployment of the OMV in the late 1980s for placement and retrieval of payloads from the shuttle. By the early 1990s the OMV is expected to be performing servicing duties for those spacecraft designed for this capability. As the space station evolves, the OMV is expected to perform similar duties as well as other nearby and remote operations that would otherwise require astronaut extravehicular activity (EVA).

The basic OMV is shown in Figure 2-6 and is sized for 2497 kg (5500 lbm) of propellant. Total vehicle mass, when fully loaded, will be about 4086 kg (9000 lbm) for the current concept. Table 2-2 is a list of the mass distribution used as baseline.

Mass Statement			
Component	Mass, kg	Propellant	Mass, kg
Power	227	Usable	19,545
P/L Adapter	91	(Isp = 482, MR = 6)	
Avionics	318	Performance Reserve	390
Structure	409	(2% of Usable)	
Auxiliary Propulsion	227	Start Losses	66
Aerobrake	318	(5 Burns)	
Thermal Control	204	Boiloff (12 hour Checkout,	23
Pressurization	191	40 hour Trip Time)	
Tanks (10% Ullage)	563	Residuals	406
Engine	218	(2% of Total)	
Plumbing & Instrumentation	272		
<b>Total</b>	<b>3038</b>	<b>Total</b>	<b>20,430</b>
<b>Total Loaded Vehicle Mass: 23,468 kg</b>			

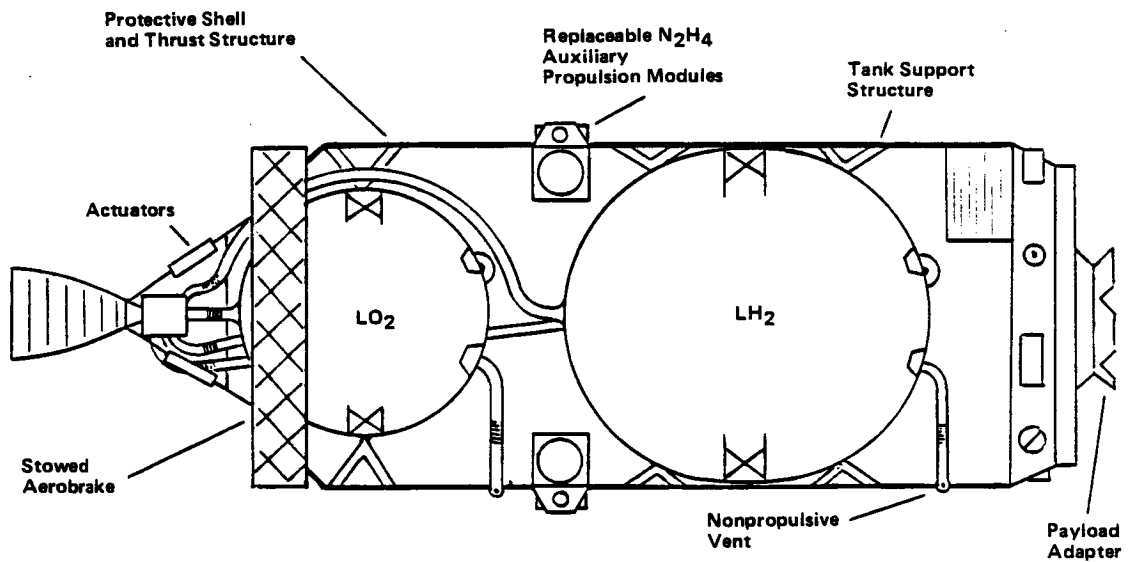

Figure 2-4 Reusable OTV with Aerobrake



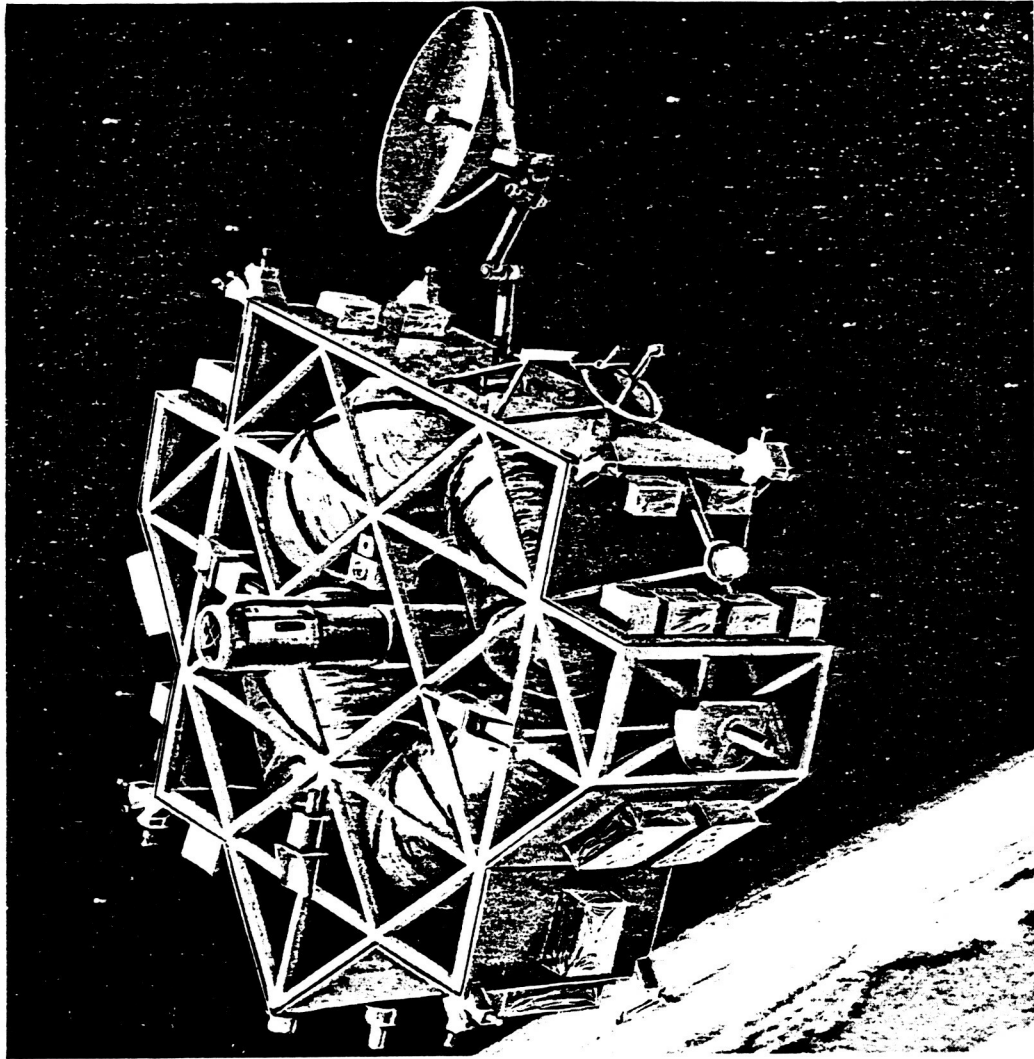

Figure 2-6 Orbital Maneuvering Vehicle (OMV)

Table 2-2 OMV Component Masses

Component	Mass, kg
Structure/mechanism	445
Thermal	45
ACS	27
Electrical	372
Propulsion	572
RF and data system	100
Pressurant	27
Propellant	2497
	<u>4085</u>

ORIGINAL PAGE IS  
OF POOR QUALITY

### 2.3 FACILITY DESIGN REQUIREMENTS

Initial analyses in this study considered the use of a TORF to store both Earth-storable and cryogenic propellants. The quantities to be stored were specified as study groundrules and are as follows:  $N_2H_4$  - 5,450 kg (12,000 lbm); MMH - 2,060 kg (4,530 lbm);  $N_2O_4$  - 3,390 kg (7,470 lbm);  $LO_2$  - 36,770 kg (81,000 lbm), and  $LH_2$  - 8,630 kg (19,000 lbm). Following the initial facility design analyses and fluid transfer analysis, the study refocused on just cryogenic propellants, while storable propellants were dropped from further consideration. The following discussions reflect this shift in approach.

Potential configurations for the space station/TORF are shown in Figure 2-7. The first configuration uses a combined facility that contains both the cryogenic and Earth-storable propellants. The second configuration has separate facilities for each of the two classes of propellants. Separation of the cryogenic and Earth-storable propellants is considered appropriate, because thermal considerations and acceleration levels (governed by tether lengths) required to settle the liquids are significantly different for cryogenics and Earth storables. Each configuration shown in Figure 2-7 could remain deployed or can be deployed only for propellant transfer. In addition, the second configuration would allow deployment of either facility singularly or both facilities simultaneously.

A sustained acceleration field within the space station is currently considered detrimental, because many of the processes being developed on the space station require zero-g conditions. Any configuration that displaces the space station from the system center of mass will create this unwanted situation. Deploying the TORF only during propellant transfer will reduce the percentage of time that g-field is present.

The propellant quantity to be stored in a single tethered cryogenic fluid storage system was baselined at 45,400 kg (100,000 lbm) of cryogenic  $LO_2$  and  $LH_2$ . This represents roughly two 20,400 kg (45,000 lbm) OTV refuelings plus a 10% margin for contingencies including boiloff. The storage mixture ratio of the propellants depends on the required delivery ratio to the OTV (6:1) and the effective boiloffs of the cryogenics during long-term storage. Because the hydrogen will boil off at a faster rate than the oxygen, a ratio of oxygen to hydrogen of 4.3 to 1 is used, giving 8,630 kg (19,000 lbm)  $LH_2$  and 36,770 kg (81,000 lbm)  $LO_2$ . The tank volumes are  $36.4 \text{ m}^3$  ( $1285 \text{ ft}^3$ ) for  $LO_2$  and  $138.8 \text{ m}^3$  ( $4900 \text{ ft}^3$ ) for  $LH_2$ . The baseline concept of the facility is shown in Figure 2-8. For the initial studies, a single system, as shown, was evaluated, while for the follow-on effort, two systems, attached in parallel and colocated with the OTV refurbishment hangar were evaluated.

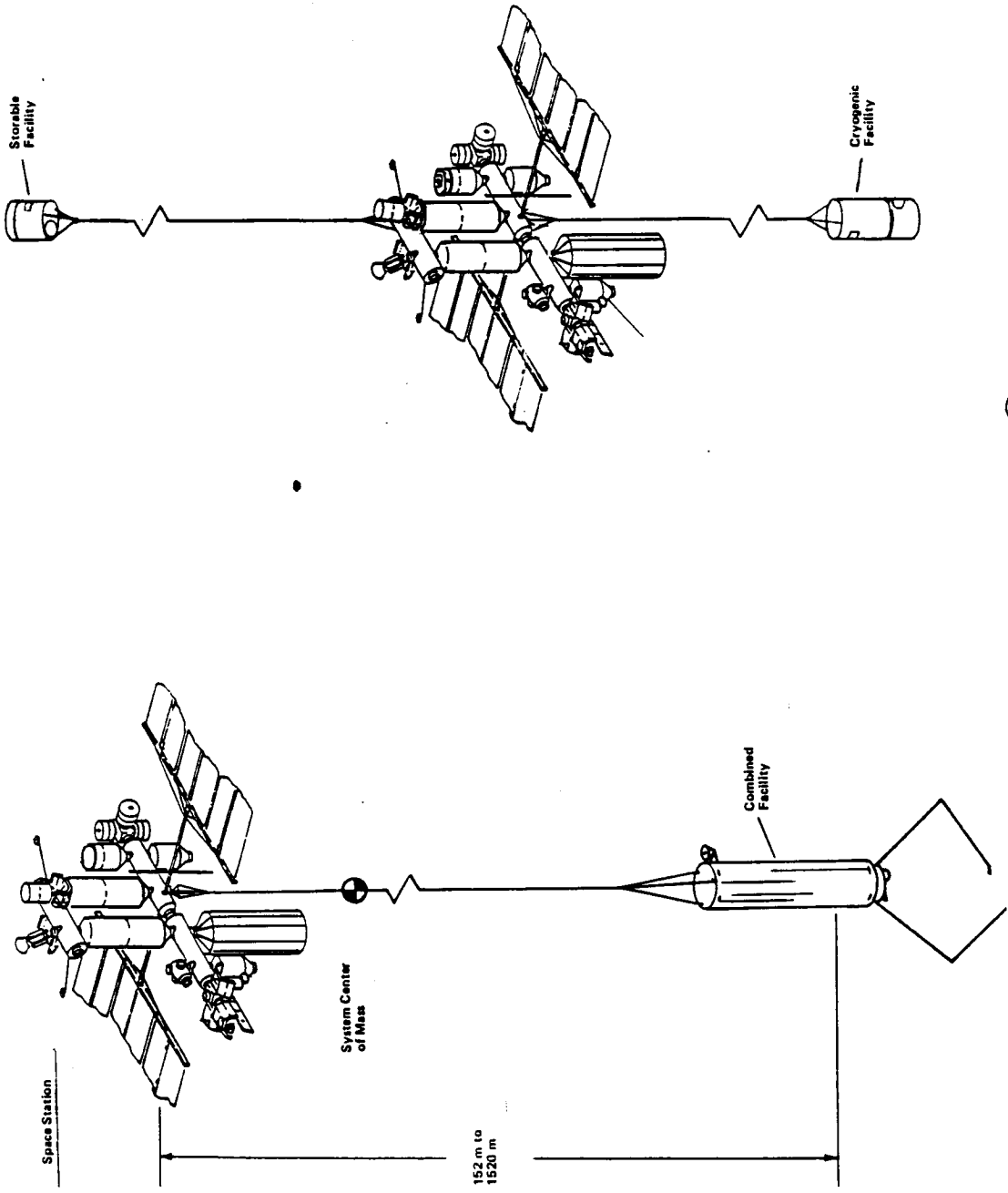

(B) SPLIT, BALANCED FACILITIES

(A) COMBINED FACILITY

Figure 2-7 Space Station/TORF Configurations

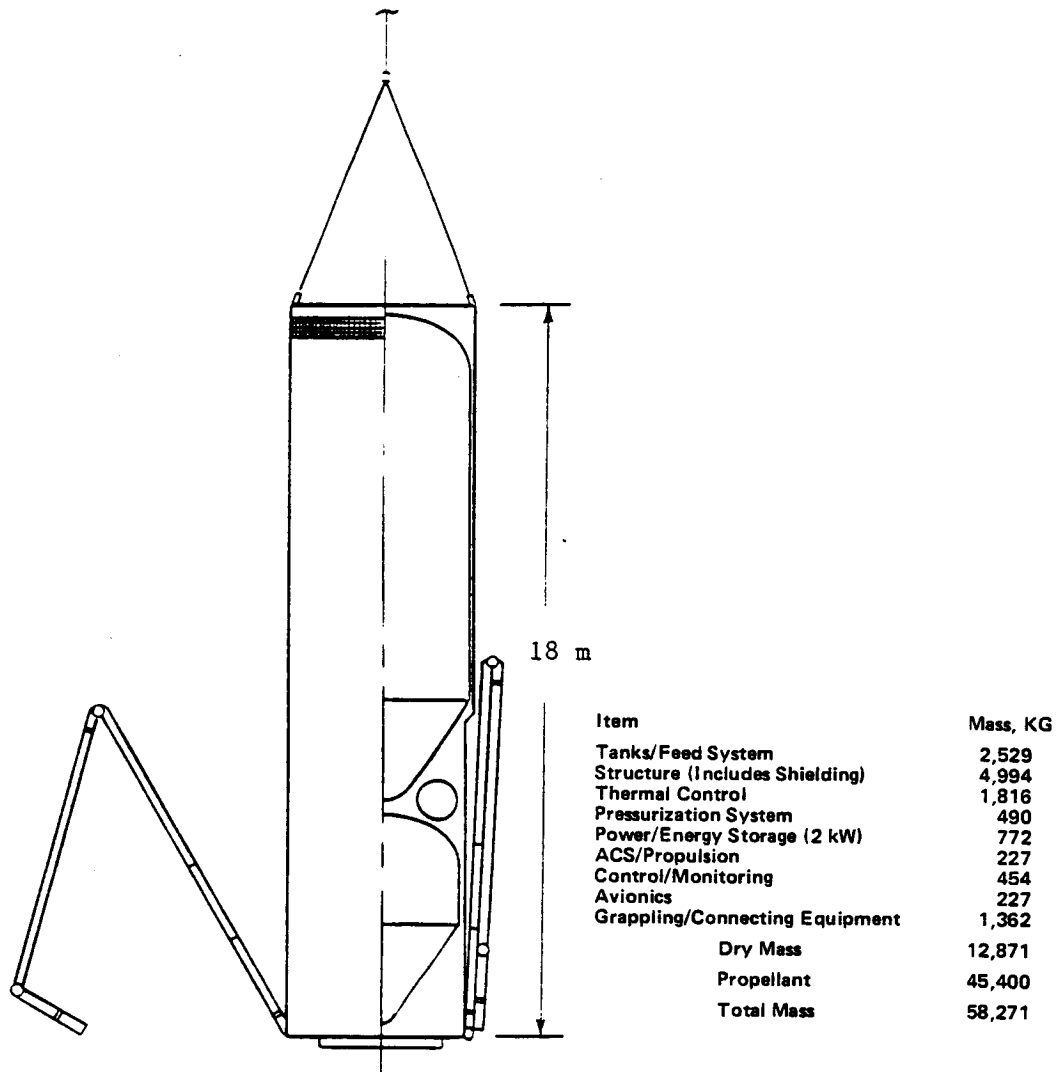

Figure 2-8 Facility Design Summary

An estimate of the dry mass of the tethered facility was developed by determining the components required for the facility and estimating the mass of each item. Tables 2-3 and 2-4 list the preliminary estimates for separate LO<sub>2</sub>/LH<sub>2</sub> and storable propellant facilities, respectively. Additional masses involved with the cryogenic facility are 45,400 kg (100,000 lbm) of propellants, and an OTV dry mass of 3040 kg (6690 lbm) with a payload of up to 6360 kg (14,000 lbm). A total of 10,900 kg (24,000 lbm) of propellants, and an OMV dry mass of 1590 kg (3500 lbm) with a payload of up to 11,350 kg (25,000 lbm) could be added to the dry mass of the storable facility. The space shuttle payload capability to the 463 km (250 nmi) altitude space station orbit is approximately 16,340 kg (36,000 lbm), thus the LO<sub>2</sub>/LH<sub>2</sub> facility could be lifted (dry) by one shuttle launch with up to 3,630 kg (8,000 lbm) of margin. The LO<sub>2</sub>/LH<sub>2</sub> facility volume is just equal to that of the shuttle payload bay (4.6 m x 18.3 m).



Table 2-3 LO<sub>2</sub>/LH<sub>2</sub> Facility Mass Estimate

Item	Mass, kg	Remarks
<u>Tanks/Feed System</u>		
- LH <sub>2</sub> Tanks	1212	3 Spherical Tanks, Al, 345 kPa (50 psia)
- LO <sub>2</sub> Tanks	340	2 Spherical Tanks, Al, 345 kPa (50 psia)
- Feed/Refill Lines	69	Composite Lines, Foam Insulation
- Valves	454	50 at 9.1 kg (20 lbm)/Valve
<u>Structure</u>		
- External Shell	2270	2.5-cm (1-in.) Thick Honeycombed Composite Arrangement
- Aluminum Backwall	2270	0.25-cm (0.1-in.) Thick Sheet for Protection
- Support Structure	454	Required for Tanks and Other Components
<u>Thermal Control</u>		
- Insulation	1590	8 cm (3 in.) of MLI Covering Outside of Shell
- Other Components	227	TVS, Radiators, Controls
<u>Pressurization</u>		
- System	454	Tanks, Helium, Controls
- Lines	36	Composite Lines, Foam Insulation if Required
Compressor/Liquifier	454	
Power/Energy Storage	772	2 kWe, Advanced Array with Regenerative Fuel Cells
ACS	227	GO <sub>2</sub> /GH <sub>2</sub>
Control/Monitoring	454	Electronics and Mechanisms Required
Avionics	227	Orbital Sensing and Command Interpretation
Grappling/Connecting Equipment	1360	RMS-Type System, Quick Disconnects and Robotics Equipment
<b>Total</b>	<b>12,870</b>	

Table 2-4 Storable Facility Mass Estimates

Item	Mass, kg	Remarks
<u>Tanks/Feed System</u>		
- Tanks	280	2 Each for All 3 Propellants, Titanium, 1,034 kPa (150 psia)
- Feed/Refill Lines	18	Composite Lines
- Valves	454	50 at 9.1 kg (20 lbm) Each
<u>Structure</u>		
- External Shell	617	2.5-cm (1-in.) Thick Honeycombed Composite Arrangement
- Aluminum Backwall	1500	0.5-cm (0.2-in.) Thick Sheet for Protection
- Support Structure	227	Required for Tanks and Other Components
<u>Thermal Control</u>		
- Insulation	90	2.5 cm (1 in.) of SOFI on Inside Wall of Shell
- Heaters	90	To Prevent Freezing
- Other Components	90	Radiators, Controls, Shields
<u>Pressurization</u>		
- System	23	Tanks, Helium, Controls
- Lines	18	Composite Lines
Pumps	45	
Power/Energy Storage	772	2 kWe, Advanced Array with Regenerative Fuel Cells
Control/Monitoring	454	Electronics and Mechanisms Required
Avionics	227	Orbital Sensing and Command Interpretation
Grappling/Connecting	1362	RMS-Type System, Quick Disconnects and Robotics Equipment
<u>Equipment</u>		
Total	6267	

## 2.4 LO<sub>2</sub>/LH<sub>2</sub> FLUID SUBSYSTEM

### 2.4.1 Tank Arrangement

Single and multiple tank arrangements were included in the initial design concepts. Single tanks have several advantages over multiple tanks, including greater thermal efficiency because of lower surface-area-to-volume ratio, larger Bond numbers, and greater design simplicity. Therefore, single tank systems have received the major attention. To manufacture the tanks on Earth for launch in the shuttle payload bay, the tank diameter, including the external structure cannot exceed 4.6 m (15 ft). Therefore, the tank diameter was restricted to less than 4.3 m (14 ft) to allow for insulation and external structure.

The tank shapes considered are shown in Figure 2-9. Several ordinary cylindrical tanks with hemispherical ends were considered, each with a different length-to-diameter (L/D) ratio. An L/D ratio of one represents a spherical tank, while larger L/D ratios indicate longer, narrower tanks. Multiple tanks are required for the lower L/D shapes as a result of the 4.3 m (14 ft) diameter restriction. Conical-based tanks were also considered. All of the tank shapes were sized for the required propellant volumes. Using the same volume for different shaped tanks, it is possible to evaluate the effectiveness of the tank shape in minimizing the propellant slosh and to identify which tank provides the greatest thermal efficiency for the least mass.

The tank thermal characteristics are based on the amount of heat entering the tanks for a given amount of multilayer insulation (MLI). Each tank was evaluated to determine the tank mass, the MLI mass and thickness, the coupled thermodynamic vent system (TVS)/vapor-cooled shield (VCS) system mass, and the mass of the H<sub>2</sub> boiloff during a 10-year mission. A coupled TVS/VCS system was employed in the design to allow for a vent-free LO<sub>2</sub> tank. Basically, the TVS withdraws LH<sub>2</sub> and vaporizes it to a lower temperature and pressure. The vapor is routed through a heat exchanger mounted on the tank, where it absorbs heat entering from the outside environment and, as a result, also controls pressure within the tank. The vapor is then routed around the LO<sub>2</sub> tank to absorb additional heat. Each VCS is constructed of minimum thickness aluminum and intercepts most of the major heat leaks.

To determine the required MLI thickness, several properties of the tank system were determined, including the heat entering the tanks, the hydrogen flowrate through the VCS (which is the hydrogen boiloff rate), and the H<sub>2</sub> temperature exiting off the VCS. The final bounding condition is to keep the LO<sub>2</sub> tank vent-free. Theoretically, the LH<sub>2</sub> tanks require extremely thick MLI because of thermal leaks during the 10-year mission life. The maximum manufacturing limit for MLI is 7.6 cm (3 in.), thus 7.6 cm was used between the tank and the VCS, and 7.6 cm was used between the VCS and the outer wall (see Figure 2-10).

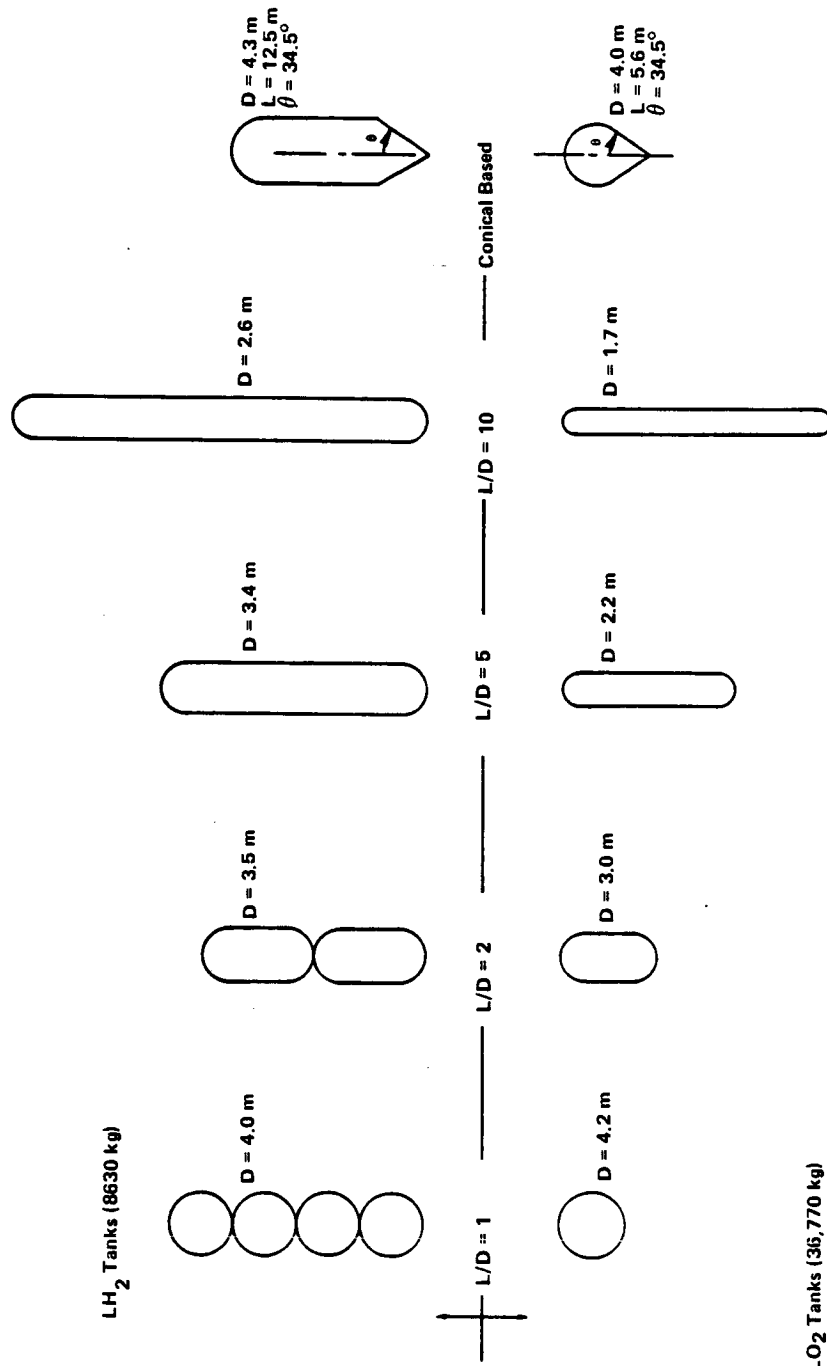

Figure 2-9 Tank Shape Alternatives

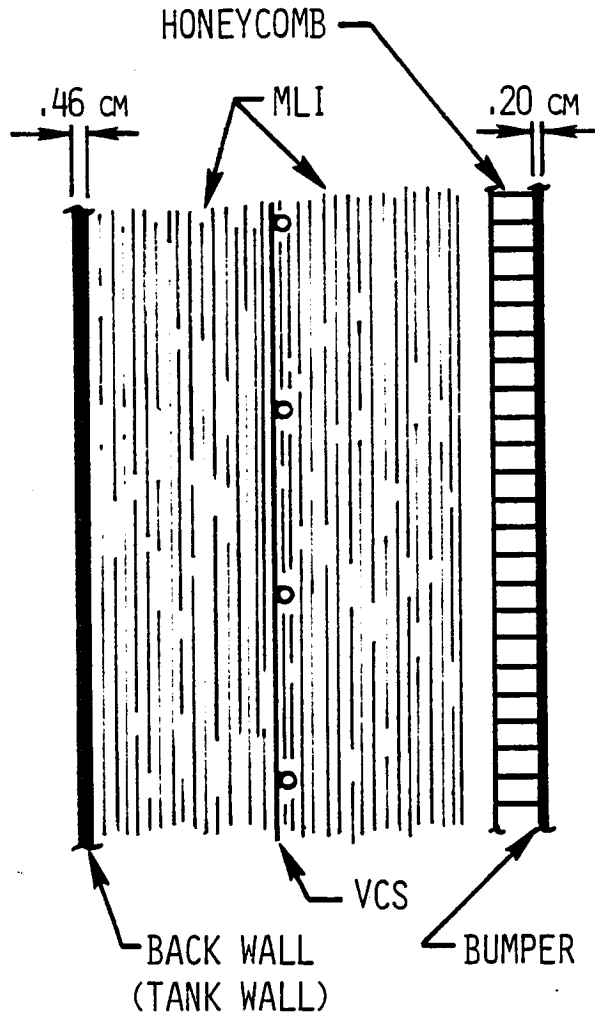

Figure 2-10 MLI and Meteoroid Shield

The LO<sub>2</sub> tanks require between 8.9 and 15.2 cm (3.5 and 6 inches) of MLI. Table 2-5 shows the required MLI thickness and mass for each tank configuration. The mass value includes the tank mass, the VCS mass, and the H<sub>2</sub> boiloff for the 10-year mission. The results show the LH<sub>2</sub> conical-based tank and the spherical LO<sub>2</sub> tank are the least massive. The mass difference between the spherical and conical-based LO<sub>2</sub> tank is relatively small.

The other weighting factor in the tank trade is how effective the tank shape is in reducing fluid slosh. The propellant slosh induced in a TORF storage tank will be of primary concern during fluid transfer if this slosh is severe enough to uncover the tank outlet. The energy required to induce a slosh magnitude sufficient to uncover the outlet of some given tank is strongly dependent on the tank shape. To develop a better understanding of this dependence, an analysis was carried out to evaluate this energy requirement for various tank shapes and fill levels. Each of the six tank shapes were analyzed for three fill levels: 10%, 50%, and 90% by volume.

Table 2-5 Tank Shape Analysis Results

Tank Shape	L/D = 1	L/D = 2	L/D = 5	L/D = 10	Conical Based
<b>LH2 Tanks</b>					
Tank and MLI					
Mass, kg	2,595	1,980	2,274	2,798	1,866
Boiloff, kg	13,061	9,943	11,454	14,078	9,386
Total Mass, kg	15,656	11,923	13,728	16,876	11,252
Allowable Slosh Energy, Joules (10% fill, 915 m tether)	2.7	4.1	5.4	8.1	8.1
<b>LO2 Tanks</b>					
Total Mass, kg	546	590	831	1,146	573
Allowable Slosh Energy Joules (10% fill, 915 m tether)	8.1	9.5	14.9	21.7	19.0

The energy required to raise the fluid from its settled position to the level where the outlet is exposed can be written as:

$$[5] \quad \Delta E = m \Delta g \Delta h,$$

where  $m$  is the fluid mass,  $\Delta g$  is the TORF gravity gradient, and  $\Delta h$  is the vertical height that the fluid center of mass must raise to expose the outlet. A large value for the energy indicates a system that is more stable and less sensitive to disturbances than a system with a low value of slosh energy. The most sensitive slosh occurs for fill levels of 10%. Table 2-5 shows the energy required to expose the tank outlet at a 10% tank fill level.

The spherical tank ( $L/D = 1$ ) is the least desirable shape for slosh control. The long tank ( $L/D = 10$ ) and the conical base tank are the most stable shapes for slosh control. The shuttle payload bay length constrains the tank length and drives the design away from the long tank. Therefore, the conical-based LH<sub>2</sub> and LO<sub>2</sub> tanks are the most desirable tank shapes for maximizing the slosh energy.

The overall results of the slosh energy and tank mass analyses show the LH<sub>2</sub> and LO<sub>2</sub> conical-based tanks are the most desirable. The sum of the different analyses and trades show that the optimum tank set that gives a minimum mass and slosh is a combination of the two conical-based tanks as shown in Figure 2-9.

#### 2.4.2 Fluid Transfer Analysis

Parameters pertinent to the transfer of propellants from a tethered propellant resupply facility include the magnitude of the gravity gradient acceleration necessary to orient the propellant, the tank volumes, and the propellant flow rates. The method used to fill the receiver tank on the vehicle being serviced also imposes requirements on the transfer method.

## Tank Fill Methods

Based on the current development of propellant resupply systems, there are three tank fill methods that are expected to be used: venting while filling, evacuated fill, and ullage recompression. No one method is expected to fulfill all resupply requirements.

Venting While Filling--This fill method is possible because the gravity gradient acceleration orients the gas and liquid within the receiver tank. The question arises as to what to do with the vent gas. One approach is to dump it into space, but this is undesirable from a contamination viewpoint. Other options are to return the vented gas to the supply tank or compress the gas and store it for future use, as a pressurant, a propellant, or for return to Earth.

This fill method requires that the propellant be supplied at a pressure sufficient to overcome the losses in the transfer line and the back-pressure produced with the specific vent configuration. A low supply pressure [about 34.5 kPa (5 psi) above the saturation or ambient tank pressure] would be adequate, although higher pressures may be desired if transfer times less than 8 hours are necessary.

Evacuated Fill--This involves evacuating the receiver tank, closing the vent, and then filling with propellant. Concerns about disposing of the vented gas are similar to those discussed above. When the tank is pressurized to its operating pressure, any entrapped gas will condense, permitting desired filling of the tank. This fill method is used routinely on Earth to ensure proper filling of tanks having positive expulsion devices and some tanks with surface tension devices. It would function equally well in space.

The propellant must be supplied at a pressure greater than the saturation pressure of the propellant in the receiver tank. When filling with cryogenics, the size of the tank, heat input, and initial tank wall temperature affect the fill, but it is most sensitive to the entering liquid temperature and the amount of mixing in the receiver tank during fill. Some rise in the tank pressure is expected during the final filling of the tank as a result of stratification and compression of the ullage.

Ullage Recompression--The tank is filled by inflowing propellant at sufficient pressure to compress the ullage. In the case of a tank with a blowdown pressurization system, the propellant that was expelled during the mission would be replaced during refill and the compression of the ullage would return it to its original pressure. A hybrid method incorporating a mix of venting and recompression involves a tank with regulated pressurization. It could be vented to a sufficiently low pressure, and then be filled, compressing the ullage to the operating pressure when full. For either of these fill methods, the propellant must be supplied to the receiver tank at a pressure no less than the final ullage-recompression pressure.

These refill methods are best suited for the refill of small hydrazine tanks and are not expected to find as much use as the other tank fill methods.

## Propellant Transfer Methods

Three methods of transferring propellants from the TORF tanks to the spacecraft receiver tanks were considered. These were gravity, pressurized, and pumped transfer. Both autogenous and helium pressurant were considered for pressurized transfer.

Gravity Transfer--With the tether-induced acceleration acting on the TORF, the most logical approach would be to use gravity-assisted transfer with the hydrostatic head provided by locating the supply tank "above" the receiver tank. An analysis of gravity transfer was performed to determine if propellant resupply could be accomplished in a reasonable time period with typical transfer line diameters and tether lengths.

The gravitational hydrostatic pressure driving the flow is typically on the order of 6.9 kPa ( $10^{-3}$ psi), so the pressure losses in the transfer line are critical to the feasibility of this transfer method. It was assumed that ball-type valves could be used that would not add to the pressure drop. Very large flow area filters (on the order of  $16,390 \text{ cm}^3$ ) are also required to minimize the pressure drop.

Using the Fanning equation, where:

$$[6] \quad \Delta P = \frac{2fl}{D} \frac{\rho v^2}{g_c} ,$$

and setting the pressure drop equal to  $\rho ah$ , the following expression for the tether length needed to achieve a given transfer flowrate is obtained:

$$[7] \quad L = \frac{2(K + fl/d)(\dot{Q}^2/A^2)}{1.23 \times 10^{-5} h} .$$

K is the flow resistance of the TORF tank outlet, receiver tank inlet, and four large radius elbows, f is the Fanning friction factor, l is the transfer line length, d is the line diameter,  $\dot{Q}$  is the volumetric flow rate, A is the transfer line area, and h is the hydrostatic head. Note that this tether length is the distance from the facility to the center of mass.

The transfer line length and hydrostatic head were set equal. A typical value of 9.1 m (30 feet) was selected for both. For a 6:1 mixture ratio and 20,430 kg (45,000 lbm) of propellant transferred (one OTV load), the volumetric flow rate can be directly related to the desired transfer time. The necessary tether length is shown for both LO<sub>2</sub> and LH<sub>2</sub> as a function of transfer time for various line diameters in Figure 2-11. For comparison, the minimum tether length needed for gravity to dominate capillary forces is also shown.



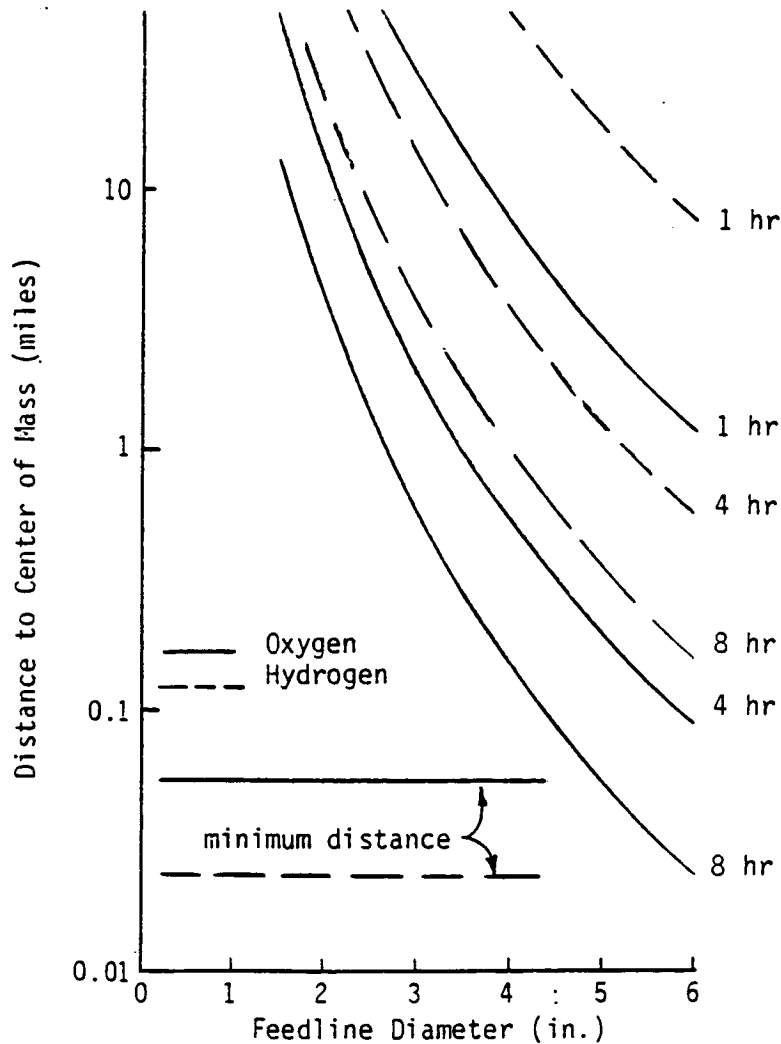

Figure 2-11 Gravity Transfer Analysis

Gravity transfer of hydrogen is slow, because of its low density. Oxygen is somewhat faster, but the tether length must be much longer than the minimum requirement to obtain reasonable transfer times. Using a 7.6-cm (3-in.) diameter transfer line, which is the maximum size envisioned for an OTV, and allowing 4 hours for transfer, a 24.1-km (15-mile) tether is required for hydrogen and a 3.2-km (2-mile) tether is required for oxygen. To achieve a one-hour transfer time, feasible with pressurization or pumps, the tether length would grow beyond 160 km (100 miles). From this, it appears that transfer using "vent while filling" (interconnected ullages) would need to be augmented using pressurization or pumps to maintain reasonably short transfer times and tether lengths, however, gravity transfer could serve as a backup. Because some back-pressure is expected for the "evacuated fill" method and significant back-pressure would occur with the "ullage recompression" method, gravity transfer would not be possible.

Pressurized Transfer with Autogenous Pressurant--Autogenous pressurant is propellant vapor that is either generated because of boiloff or is specifically created by heating the propellants. The use of combustion gases from a gas generator was not considered because the combustion products would contaminate a propulsion system that must be reused.

For the "vent while filling" method, a simple approach is to route the gas vented from the receiver tank through a compressor to the supply tank. The compressor need only provide enough output pressure to overcome the flow losses. Any liquid that unintentionally gets into the tank vent line could reduce the efficiency, but, providing a heater is in the line prior to the pump, will not cause a system failure.

Autogenous pressurization solves two problems--it accomplishes the transfer of propellants and also provides a means of using excess vapor produced by the cryogenics during chilldown and boiloff. Vapor would have to be generated and pressurized to higher levels for the other fill methods.

Pressurized Transfer with Helium--A helium pressurization system connected to the supply tank prevents any gas vented from the receiver tank from being returned to the supply tank. Therefore, any gas vented from the receiver must be disposed of in some way.

For the "vent while filling" tank fill method, the pressure differential needed for flow could be provided by venting the receiver tank to a pressure less than the supply tank. The pressurization system only needs to maintain a low blanket pressure in the supply tank. The requirements for "evacuated fill" are similar, unless the pressure rises in the receiver tank as it becomes full. For this case, a higher supply tank pressure would be needed. For "ullage recompression", pressurant would have to be supplied at the pressure to be achieved at the end of fill.

Pumped Transfer--Cryogenic centrifugal pumps are being developed that will meet the resupply facility requirements and could be expected to operate for extended periods in space with no maintenance. These pumps would have a magnetically coupled rotor to avoid dynamic seals and eliminate the need for a helium purge that would limit pump life.

For the "vent while filling" method, the gases vented from the receiver tank would be routed back to the supply tank to maintain the pump net pump suction head (NPSH). For the "evacuated fill" and "ullage recompression" fill methods, a pump with a higher output pressure would be needed to obtain the required receiver tank pressure. These methods would also require a pressurization system to maintain the pump NPSH as the supply tank was emptied.

#### 2.4.3 Transfer Method Selection

With helium pressurization, no gas can be returned to the supply tank so all the gas vented from the receiver must be disposed in some way. With certain tank fill methods, return of vented vapor to the supply tank is possible with autogenous pressurization. Likewise, for pumped transfer there are more ways to return gas to the supply tank.

Pumped transfer, which can require a pressurization system in addition to the pump, has the highest mass penalty and is relatively low in reliability because it has the most active components (pump and pressurization controls). It is the preferred method for storables, however, because of venting of inerts and autogenous pressurization's present problems. Further, it is the most practical method for ullage recompression. Gravity transfer is the most reliable, because it does not add any components to the basic transfer system.

The simple gravity transfer method, however, requires (1) long transfer times using realistic line sizes, and (2) longer tether lengths than are desired for this application and the associated operations.

For cryogenic propellants, the above considerations suggest that the most desirable transfer method would be pressurized transfer using autogenous pressurization. This method allows the transfer to take place in a reasonable time, has relatively few active components, and a minimal mass penalty. None of the transfer methods impose any safety hazards that would be considered abnormal for a space station.

#### 2.4.4 Fluid System Schematic

A schematic of the facility fluid storage and handling system is shown in Figure 2-12. This schematic has been simplified by removing the component redundancies required for single fault tolerant design to clarify the overall system layout. Single-fault tolerant design requires redundancy for every component. Every control valve requires a total of three latching valves; two in parallel and one in series. The primary flow control is with one of the parallel valves, while the other parallel valve is normally closed. Should the primary valve fail closed, the other parallel valve will be operated. If the primary valve fails open, the series valve is used. In addition to the valve redundancy, the pumps must have a parallel backup unit.

The schematic shows both the LO<sub>2</sub> and LH<sub>2</sub> systems. The overall system is designed to transfer liquid out to an OTV and also to transfer liquid in from a shuttle tanker, through fluid couplers shown at the bottom right of this schematic. Pressurization is driven by low-pressure, single-stage turbine pumps that are plumbed to accept input vapor from either the receiver tank ullages, the system TVS/liquid subcoolers, and/or liquid vaporizers using either solar or electric heat. Once through the pumps, the pressurant gases can be delivered to either the TORF tanks, to an OTV, or to the resupply tanker for liquid transfer. The TVS/liquid subcoolers are included to allow the delivered liquid to be subcooled to minimize receiver tank chilldown and boiloff vaporization during the fill process.

As shown in Figure 2-12, the LO<sub>2</sub> tank is maintained at its liquid/vapor saturation temperature with the support of a VCS cooled by gaseous H<sub>2</sub> supplied from the LH<sub>2</sub> tank TVS/VCS system. This thermal control assures that the LO<sub>2</sub> tank will be vent-free under nominal conditions. Hydrogen vapor boiloff generated during the TVS/VCS operation is stored in a high-pressure tank using a positive displacement multistage compressor. This vapor is ultimately used to partially support the autogenous pressurization of the LH<sub>2</sub> tank during fluid transfer, and to provide propellant for the TORF attitude

control and stationkeeping system. Any excess boiloff not needed for these functions is vented overboard in a nonpropulsive vent.

During quiescent periods, the TVS/VCS system operates to maintain the tank's temperature and pressure. The TVS/VCS system will not be in use during the fluid transfer operation. The fluid transfer will be initiated by increasing the pressure in the storage tank by vapor injection or by TVS/VCS shutdown. The subcoolers will then be started by withdrawing a small amount of liquid, vaporizing it and running through the cooler. The fluid lines are chilled by running subcooled liquid through the lines. The receiver tank is also chilled by flashing liquid in the tank and withdrawing the vapor. Once the entire system is chilled, the fluid transfer can begin. Approximately four hours later, the transfer is completed and the liquid lines are shut down. The lines will need to be drained before disconnect to eliminate pressure buildup in the lines and to reduce spillage/contamination.

The design for the fluid transfer system is baselined for a vented fill of the OTV receiver tanks, however, concerns exist with a vented fill in low-g. This is true even when starting with settled liquid having a clearly defined liquid/vapor interface. Even under settling accelerations of  $10^{-4}g$  to  $10^{-5}g$ , rapid depressurization of a cryogenic S-IVB tank containing saturated hydrogen on the AS-203 flight caused a severe disturbance of the liquid surface, creating conditions that could result in loss of control of the liquid position in the tank. Larkin and Bowman examined the venting of saturated liquids in a drop tower and found that the vapor that formed from boiling below the liquid surface, pushed the liquid surface toward the vent because of the lack of buoyancy. Their correlation is shown in Figure 2-13 as the maximum pressure drop that can be incurred without venting liquid as a function of initial ullage volume fraction and initial tank pressure. For this reason, the present system design includes maintaining the receiver tank pressure well above saturation during fluid transfer, to minimize or eliminate liquid boiling.

The  $\text{GH}_2$  storage tank sizing is dependent on several dynamic factors in the system including the TVS, the Auxiliary Propulsion System (APS) and the fluid transfer period. A balance must be achieved between  $\text{GH}_2$  generation and usage. The actual tank volume is dependent on the storage temperature and pressure. The vapor generation rate from the  $\text{LH}_2$  storage tank can be adjusted by using the TVS system. The APS timeline defines the  $\text{GH}_2$  usage for attitude control, vehicle docking, and drag make-up. The actual  $\text{GH}_2$  usage can be adjusted by changing the specific impulse of the thruster. Tank chilldown will generate vapor but the actual fluid transfer will require vapor in the  $\text{LH}_2$  storage tank to drive the transfer. The  $\text{GH}_2$  storage tank size will depend on a balance between these factors.

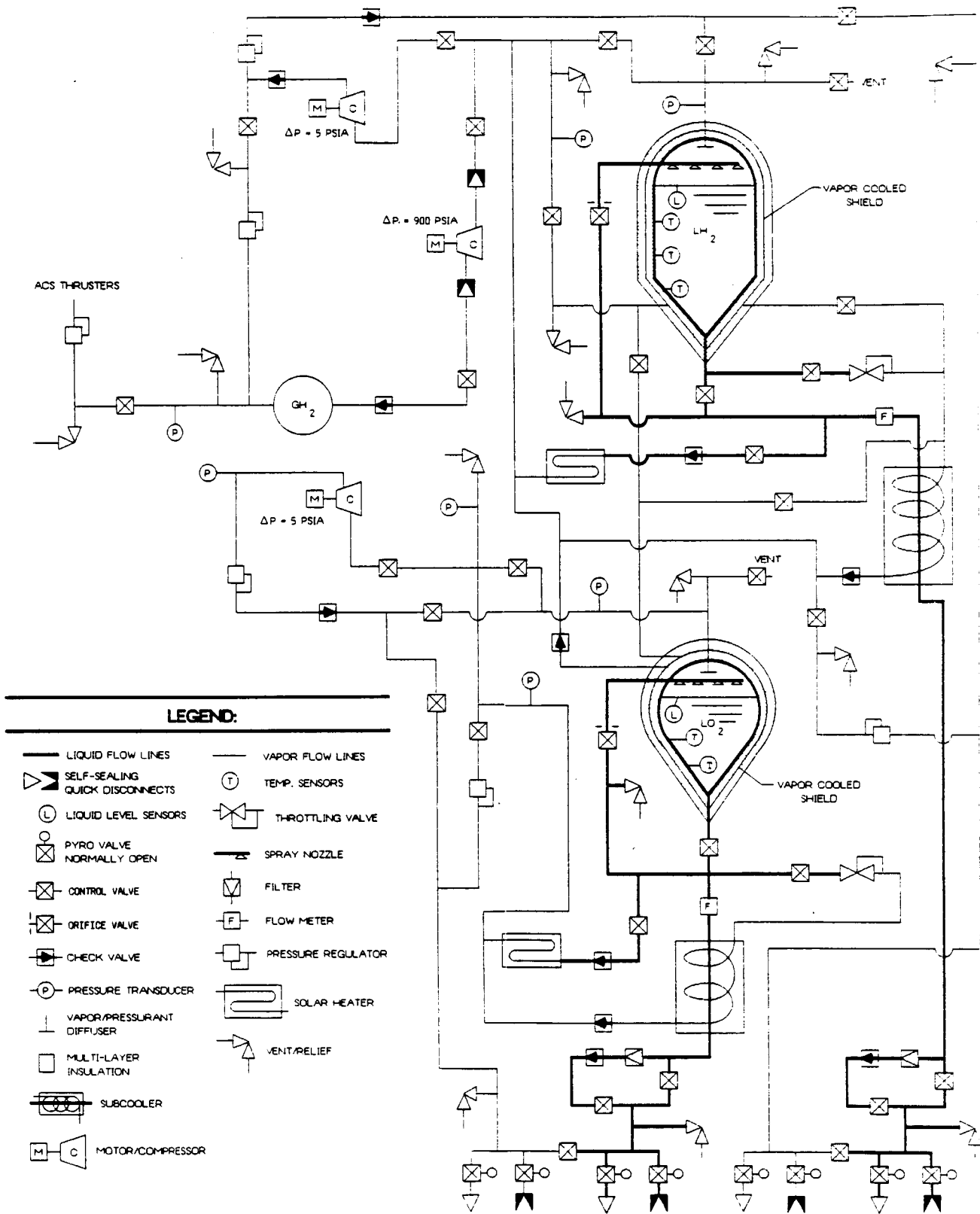

**LEGEND:**

- |                                |                    |
|--------------------------------|--------------------|
| LIQUID FLOW LINES              | VAPOR FLOW LINES   |
| SELF-SEALING QUICK DISCONNECTS | TEMP. SENSORS      |
| LIQUID LEVEL SENSORS           | THROTTLING VALVE   |
| PYRO VALVE NORMALLY OPEN       | SPRAY NOZZLE       |
| CONTROL VALVE                  | FILTER             |
| ORIFICE VALVE                  | FLOW METER         |
| CHECK VALVE                    | PRESSURE REGULATOR |
| PRESSURE TRANSDUCER            | SOLAR HEATER       |
| VAPOR/PRESSURANT DIFFUSER      | VENT/RELIEF        |
| MULTI-LAYER INSULATION         |                    |
| SUBCOOLER                      |                    |
| MOTOR/COMPRESSOR               |                    |

Figure 2-12 Facility Fluid Schematic

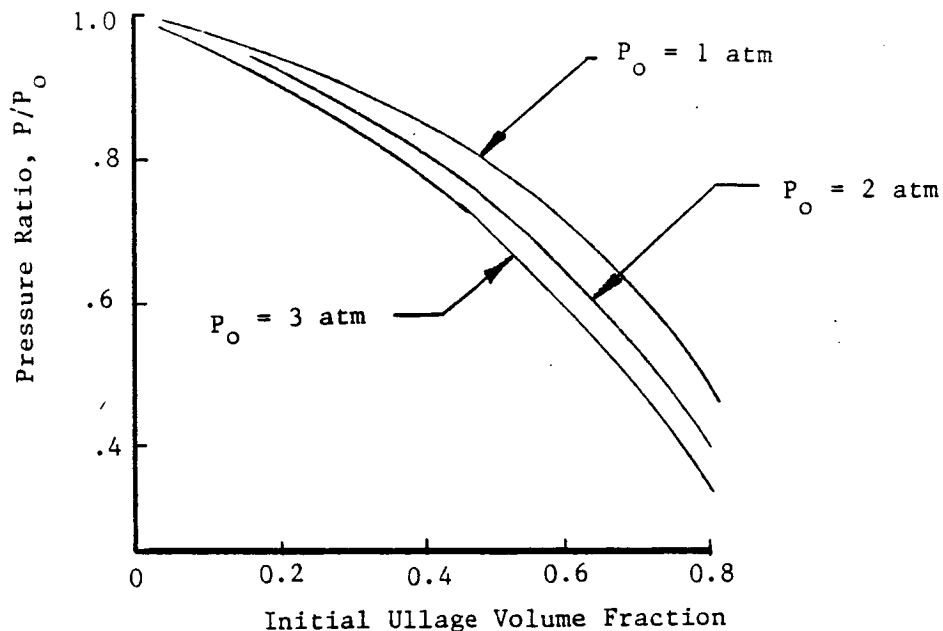

Figure 2-13 Maximum Pressure Change without Venting Liquid

## 2.5 FACILITY DESIGN

The TORF includes a number of subsystems necessary for it to carry out its functions and to maintain itself in orbit. These include the avionics (command, telemetry, and communication), support structure, power subsystem, auxiliary propulsion, thermal control, and docking/berthing subsystem. Several of these subsystems have an important effect on the TORF design and thus have been analyzed in more detail than the others. The following paragraphs summarize these analyses for a LO<sub>2</sub>/LH<sub>2</sub> TORF.

### Auxiliary Propulsion

The TORF APS must provide propulsion to make up the losses as a result of atmospheric drag, control the TORF attitude (particularly roll about the tether axis), and control the TORF tether libration arising from external disturbances. The atmospheric drag depends on the nominal altitude and spacecraft frontal area. For a typical space station area (2045 m<sup>2</sup>) the drag is roughly 0.09 N (0.02 lbf), while the 84-m<sup>2</sup> (900-ft<sup>2</sup>) TORF drag is only  $4 \times 10^{-3}$  N ( $8 \times 10^{-4}$  lbf). With normal TORF operations, there would be no net perturbing torques about the tether axis. Thus, any roll control requirements that do arise are expected to be much smaller than the other APS requirements. Because the atmospheric drag make-up requirement dominates the APS design, the following analyses were performed to more carefully define the APS operation.

For a permanently deployed facility, drag make-up can be performed either on the space station, on the TORF, or on both simultaneously. Performing drag make-up on both simultaneously requires that the individual thruster burns be coordinated to maintain the tether tension and to keep the facility relative position fixed. Any imbalance in the

thruster burns can cause system libration and possible fluid slosh in the tanks. Performing drag make-up on the space station requires that relatively large amounts of propellant be stored at the station and delivered from the Earth or from the TORF. Performing drag make-up on the TORF appears to be the best option because propellant is readily available from the storage system boiloff. Drag make-up at the TORF would also reduce any possible propellant plume contamination of sensitive space station instrumentation.

Drag make-up can be done continuously using small thrusters that instantaneously cancel the drag forces or intermittently by reboosting the system to its nominal orbit after a "drift period" of approximately 30 days. The effects of a 30-day reboost on the system were analyzed to identify the resulting libration angles as a result of a high-thrust burn on either the space station or the TORF. Thrust levels of 111, 222, and 445 N (25, 50, and 100 lbf) were considered. The thruster burn times were adjusted such that the total delivered impulse for these three thrust levels was fixed at that necessary to reboost the system after 30 days of orbit decay. The results, as shown in Figure 2-14, indicate that even for the lowest thrust case, the resulting system libration angles are well in excess of 30° with the largest being over 90° such that the system actually flips over. The maximum allowable libration angle is limited to less than 30°, to keep the resulting torques on the space station to a minimum. Accordingly, it appears that periodic reboost cannot be used for this type of tethered system. A similar libration angle analysis was completed for the continuous drag make-up option and resulted in angles of less than 0.1°, which is essentially negligible. Thus, continuous stationkeeping represents the preferred drag make-up alternative for a permanently deployed TORF/space station system.

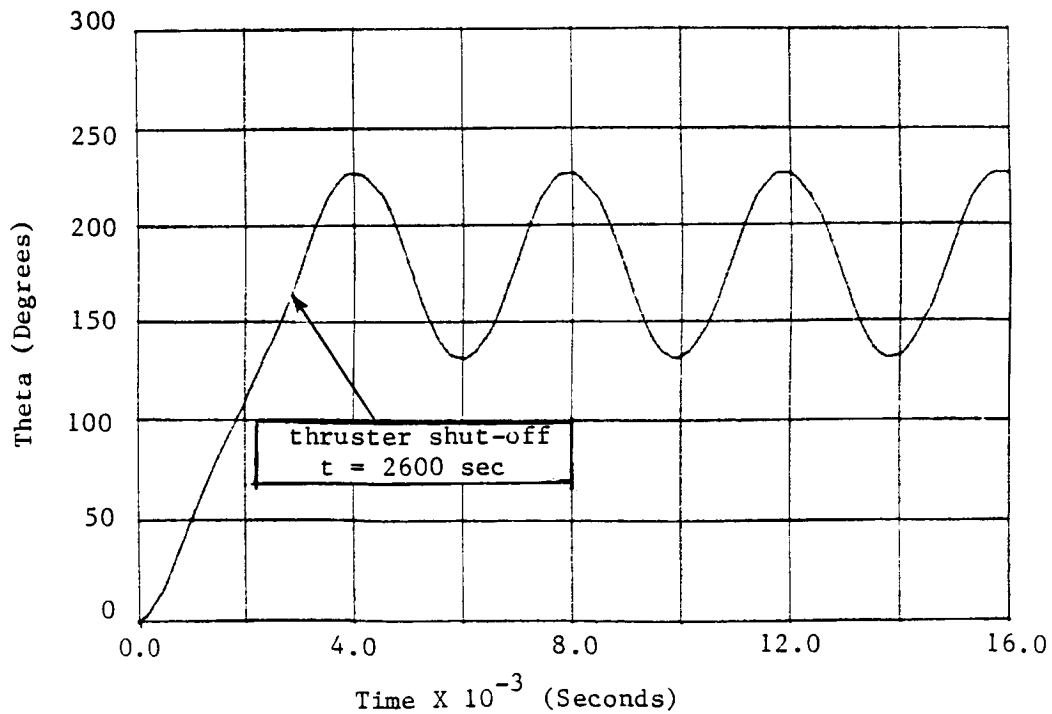

Figure 2-14 Libration Angle Analyses Results

The total propellant mass required for the TORF APS can be estimated from the total impulse arising from drag make-up and the available specific impulse of the design thruster concept. Conversely, if the available propellant mass is known (say from the net system H<sub>2</sub> boiloff), the required thruster specific impulse can be calculated. For a total impulse requirement that includes space station drag make-up, and using the estimated total H<sub>2</sub> boiloff rate as the available propellant mass, the necessary specific impulse is 570 s. If the design thrusters provide a specific impulse less than this value, extra propellant will be required over the available boiloff. If higher specific impulses are available, less propellant is required and some of the boiloff will have to be dumped overboard nonpropulsively. Typical hydrogen resistojets can generate specific impulses of over 800 s with hydrogen propellant at the thrust levels of interest using less than 1 kWe of power. Thus, it appears that the TORF APS will require no additional propellant over that already available from the storage system boiloff.

### Space Debris Shielding

The meteoroid debris shield encases the entire facility to protect all of the TORF subsystems (tanks, avionics). The shield is designed to prevent the penetration of a 1-cm diameter or smaller aluminum particle moving at 9 km/sec. This capability fulfills the NASA space station requirement of a 95% probability of no penetration in a 10-year period. The TORF shield, which is of the bumper-backwall type, is illustrated previously in Figure 2-10.

The thicknesses of the shield components were determined based on experimental correlations that support the NASA requirement. When a debris particle impacts the bumper, much of its kinetic energy is converted into thermal energy, vaporizing both the particle and a small section of the bumper. For vaporization to be complete, the bumper thickness must be 20% of the particle diameter. Therefore, the shield bumper thickness must be 0.2 cm (0.8 in.).

The vaporized particle/bumper material exits the bumper in a cone-shaped expanding plume whose energy is absorbed by the backwall. The required thickness for the backwall is 0.32 cm (0.13 in.), assuming a 15.2-cm spacing between the bumper and backwall. However, in the TORF design, the propellant tank wall is utilized as the backwall shield. To simplify the manufacturing of both the LO<sub>2</sub> and LH<sub>2</sub> tanks, the tank wall thickness was chosen to be equal to the minimum weld land thickness (0.05 cm) to eliminate the need for chemical milling. This exceeds the minimum needed for the shield and thus provides safety margin in the design. The additional subsystems (avionics, plumbing) are protected by a separate backwall that is supported off the honeycomb support structure.

### Refrigerators

Refrigerators were examined as an alternative to GH<sub>2</sub> storage. The trade was based on the mass of each system and the usage capability for each alternative. To evaluate the mass of a refrigerator system, the power requirement was determined based on the H<sub>2</sub> boiloff rate. The



average H<sub>2</sub> boiloff rate used in the calculations is 0.11 kg/hr (0.24 lbm/hr), and represents the minimum rate determined by the tankage MLI design for a 100,000-lbm facility as discussed earlier.

Several refrigerator systems were investigated including the Stirling cycle, the Vuilleumier system, the Solvay refrigerator, the Brayton refrigerator, and the Joule-Thomson system. The reversed Brayton turbo-refrigerator was chosen as a baseline considering its projected long life, high-cooling capacity, and growth potential. The projected five-to-ten year technology of refrigeration systems predicts a potential five-to-seven year service life. Therefore, the facility will require, at minimum, two refrigeration systems during the 10-year mission life.

The refrigeration capacity was determined from:

$$[8] \quad Q = H (W_c/Q) V,$$

where H is the heat removed (W-hr/l), W<sub>c</sub>/Q is the actual efficiency based on the Carnot efficiency (W/W) and V is the volumetric flowrate (l/hr). The refrigerator was assumed to be 10% efficient based on predicted cryogenic refrigerator efficiencies. The baseline tank system requires 9300 W of actual refrigerator power. A relationship has been developed for the refrigerator power and system mass for the reversed Brayton turbo-refrigerator. A system that can produce 9300 W of cooling power has an estimated mass of 835 kg (1840 lbm), which includes an 88 kg/kWe power supply. Currently, the refrigerator system reliability is relatively low and more frequent replacements may be necessary.

The boiloff mass during the 10-year mission life is 9530 kg (21,000 lbm). Using a refrigerator, this boiloff can be reliquified and recovered. Another option, however, would be to use this boiloff as propellant in the required APS. The mass of the GH<sub>2</sub> storage tank system will probably be the same order of magnitude as the refrigeration system. It eliminates introducing more subsystems into the facility and eliminates system replacements. Therefore, the current facility design includes a GH<sub>2</sub> storage tank and no refrigerator or reliquification system.

#### Depot and OTV Hanger

Based on the analyses carried out in the initial study the overall TORF design configuration was expanded for comparison with a zero-g facility on the space station. The considered attached zero-g facility is shown in Figure 2-15. The hangar is located near the center of the space station to minimize the center of gravity shift. The hangar is 30 m x 30 m x 40 m (98 ft x 98 ft x 131 ft) and is covered with a blanket of multilayer insulation (MLI). The tanks are located in the hangar to insulate them and to provide additional meteoroid protection.

ORIGINAL PAGE IS  
OF POOR QUALITY

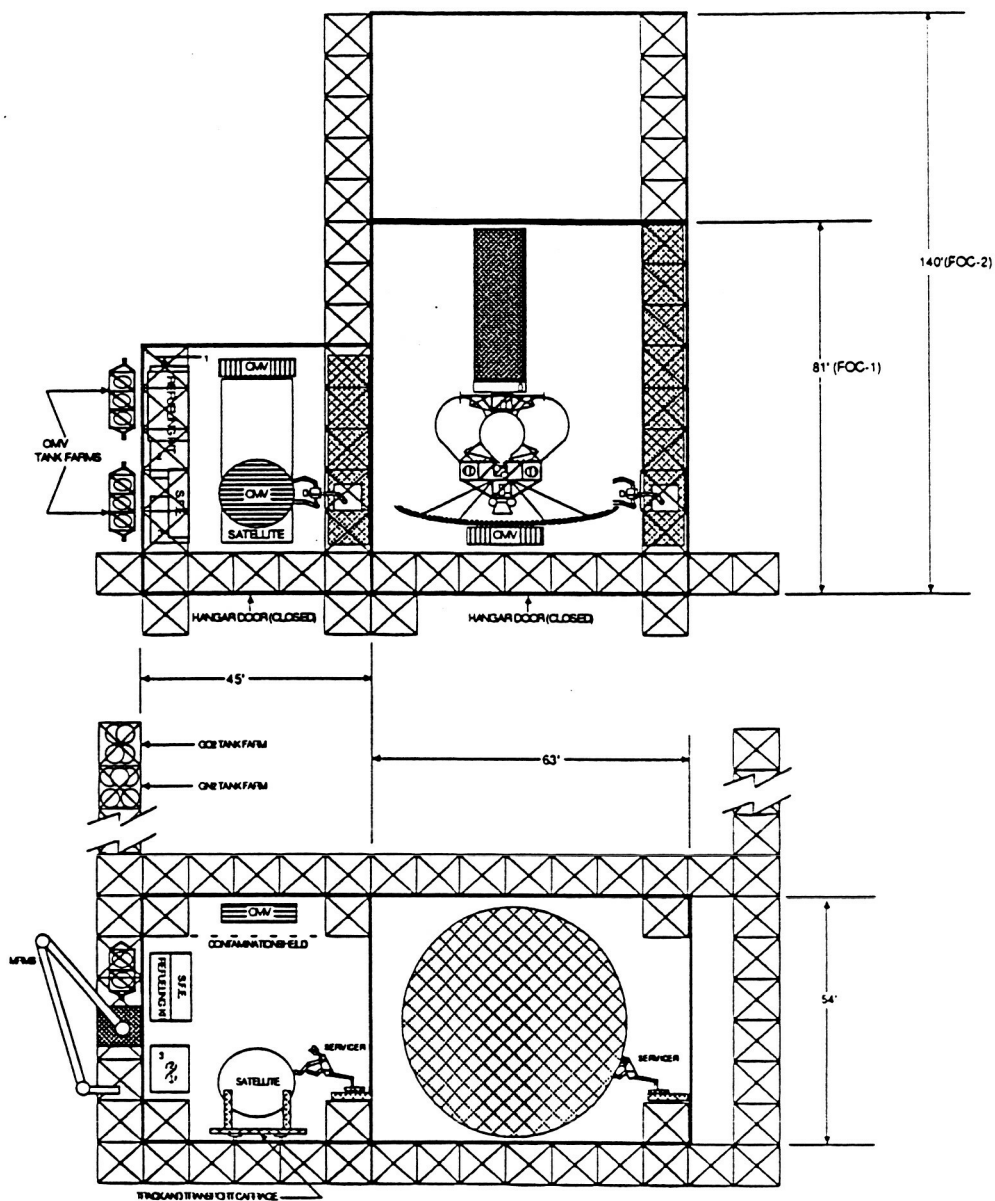

Figure 2-15 Attached Zero-g Facility

The zero-g facility requires a propellant management device (PMD). The PMD is responsible for facilitating the flow of liquid out of the storage tanks in a low-g environment. Figure 2-16 illustrates the conceptual design of the PMD for the attached facility. The device consists of four channels longitudinally attached to the inside of the tank. The channels are actually mounted on the slosh baffles and not directly on the tank wall. This allows for a more efficient flow through the channel. The channel, shown on the insert, consists of two screens mounted on a aluminum track. The screen is double Dutch twill, which has the highest surface area to allow for greatest working action. The channels are 15 cm x 2.5 cm (6 in. x 1 in.), which is large enough to support the required flowrate to fill to OTV in four

hours. The PMD design is based on designs completed in the Martin Marietta Large Cryogenic Storage Supply System study and the Cryogenic Fluid Management Facility (CFMF) Study.

The tethered facility is shown in Figure 2-17. The hangar is an integral structure by itself and is attached to the station via a tether. The hangar requires more truss structure than the zero-g facility to maintain the hangar as an individual structure. The tether platform with the tether and tether reel is mounted on space station truss structure and attached to the hangar in the center of the bottom panel. Berthing rails are shown on the side of the space station twin keels to guide the hangar during reel-in and reel-out. The hangar is reeled out only for fluid transfer operations. All other operations, like vehicle refurbishment, vehicle servicing, hangar refurbishment, and payload attachment are completed with the hangar reeled in and secured to the station. The internal hangar configuration is identical to the zero-g facility.

The main difference between the fluid handling systems is the conical-based tanks in the tethered facility and additional quick-disconnects. The fluid transfer system is shown in Figure 2-12. The fluid system supports transfer into and out of the tanks. The majority of gas accumulators will be stored on the station and the tethered facility will be disconnected from the accumulators during the reel-out period. Some of the gas accumulators will be in the hangar to supply gaseous H<sub>2</sub> during the fluid transfer.

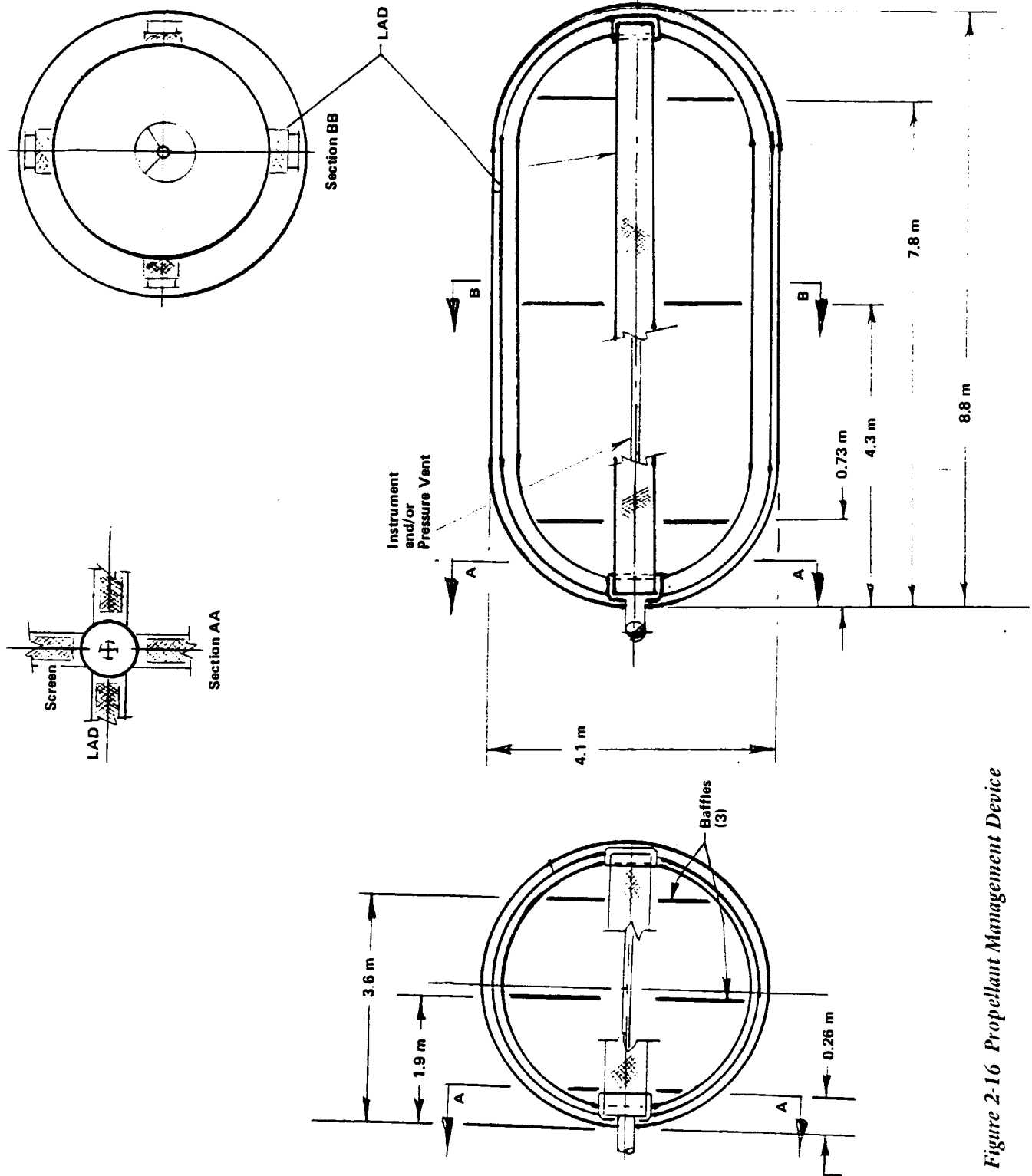
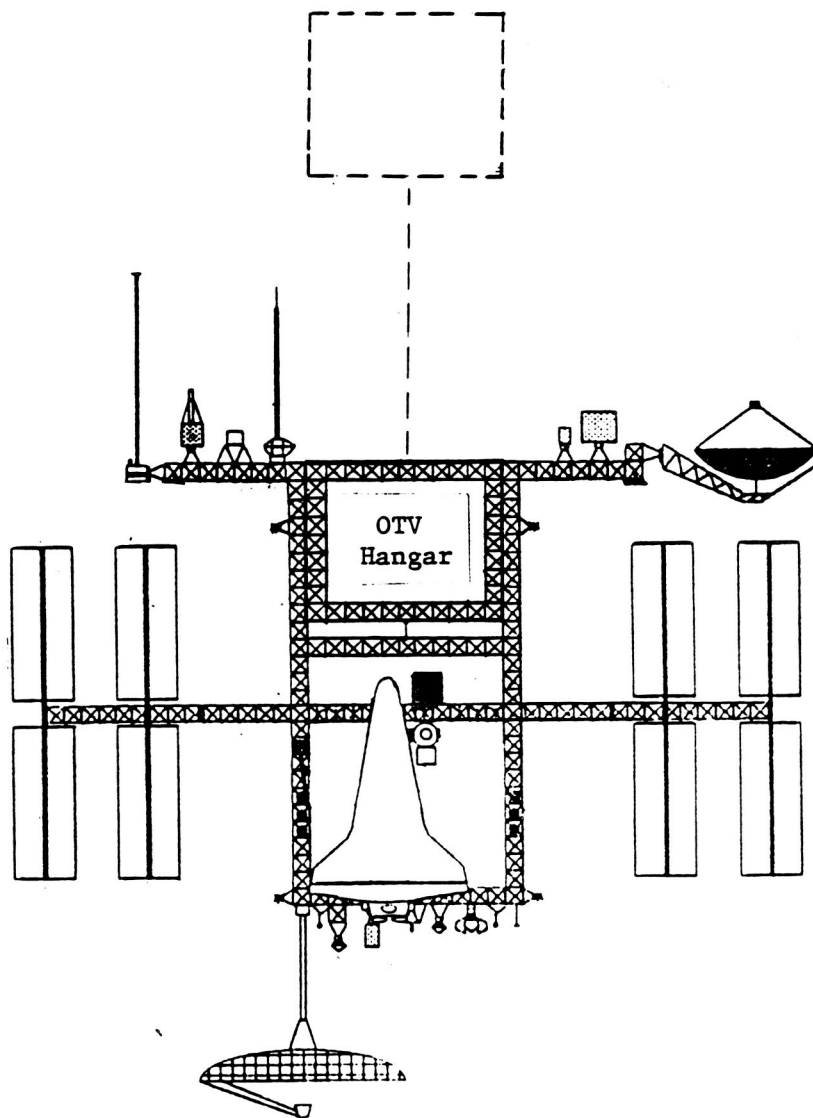

Figure 2-16 Propellant Management Device



*Figure 2-17 Tethered Refueling Configuration*

3.0 DYNAMICS ANALYSIS

---

The facility dynamics study is aimed at identifying the dynamic characteristics of the fluid/tether vehicle system represented by a TORF with an emphasis on the fluid behavior in the tethered storage tanks.

3.1 SYSTEM DYNAMIC MODELING

In the case of the tethered facility there are many obvious motions that may occur between the fluid, its storage tanks, the tether, and the space station. These motions are listed in Table 3-1.

Table 3-1 Potential Motions of Facility Components

Structure Motions	Fluid Motions
Rigid Pendulum	Lateral Slosh
Lateral String	Vertical Slosh
Facility Pendulum	Rotational Slosh
Facility Roll	Vortex Motion
Tether Stretch	Surface Spray
Facility Bending	Bubble Formation

In the system dynamic model, certain motion types are important in the alteration of the system energy as a result of the disturbances. These motion types are those that have significant linear or angular momentum and are believed to be first-order effects for the particular problem to be solved. The problem in general is a very low-frequency dynamics problem and therefore elastic effects can be ignored, including the stretching of the tether. For the short tether lengths required by the facility, the tether stretching modes are of a relatively high frequency. The motion types included in the model are defined in Table 3-2.

These motion types are illustrated in Figure 3-1. Other motion types such as tether stretch, string-type tether motion, and fluid vortex motion were considered, but not thought to be of primary importance in the context of the problem. Table 3-3 summarizes the approximate frequency characteristics of the phenomena included in the model. The tether stretch mode is estimated to have a period of 50 seconds, which is well separated from the lower slosh modes. The tether string modes are not significant as a result of the very low mass involved in this type of motion. Fluid vortex motion is related to fluid viscosity and as such is a second-order effect during short periods of time.

*Table 3-2 Model Motion Types*

System Libration -	Angular motion of the tether axis. This motion has a period of approximately 3000 seconds and is independent of tether length. The inplane period of libration is related to the orbital period by $T_1 = T_0/3$ .
Facility Pendulum -	Angular motion of the facility axis relative to the tether axis. The period of this motion is on the order of 200 seconds for a 300-m (1000-ft) tether and is inversely proportional to the square root of tether length.
Fluid Slosh -	A pendulum analogy for the lateral motion of the fluid center of mass. The period of this motion is on the order of 100 seconds for a 300-m (1000-ft) tether length and is inversely proportional to the tether length.

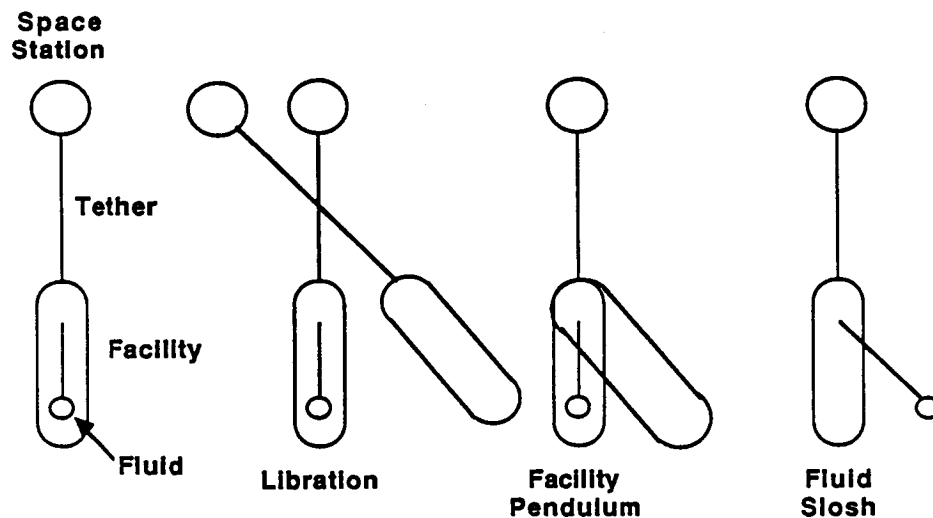

*Figure 3-1 Motion Types*

*Table 3-3 Model Characteristics*

<u>Type</u>	<u>Period</u>
Tether Pendulum	50 Minutes
Tether String	10 Seconds
Facility Pendulum	200 Seconds
Fluid Lateral Slosh	100 Seconds
Tether Stretch	50 Seconds
Space Station Pendulum	400 Seconds

3.2 DISTURBANCE DEFINITION

Disturbances that may act on the system have been identified and categorized by source, type, and order of magnitude. Out of this list, those disturbances that would most likely uncover the fluid outlet have been defined and those that could be avoided by a suspension of operations identified. Table 3-4 gives the identification of disturbances by source. Table 3-5 gives estimates of the order of magnitude of these disturbances and their type.

*Table 3-4 Disturbance Sources*

<u>Fluid Transfer Operation</u>	<u>Berthed Vehicle Operation</u>
Dump Torques	Stage Tank Venting
Valve Operation	Sloshing in Stage Tank
Fluid CG Shift	Crew Movement (STS, OTV)
Suction Induced Fluid Motion	
Geysering	<u>Space Station Operation</u>
<u>Tether Operation</u>	STS, OTV, OMV Berthing
Deployment of Facility *	Orbital Maintenance
Tether Instabilities	Attitude Control
Total System CG Shift *	Solar Panel Movement
	Crew Movement
	RMS Movement
<u>Facility Operation</u>	<u>Gravity/Atmospheric</u>
STS, OTV, OMV Berthing	Drag
Orbital Maintenance	Electromagnetic Interaction
Attitude Control	Gravity Variations
RMS Movement *	
* Will Not Occur During Fluid Transfer	



Table 3-5 Disturbance Magnitude and Types

<u>Type</u>	<u>Magnitude</u>	<u>Description</u>
Impulsive	71200 N-sec 14 N-m-sec	Berthing Attitude Control
Random	45 N	Crew Movement
Sinusoidal (90 min period)	$9 \times 10^{-2}$ N $10^{-6}$ g	Solar Arrays Drag Lunar Gravity
Steady State	$13 \times 10^{-3}$ N	Atmospheric Drag
Step	0.12 N 450 N for 10 min Every 30 Days	Stationkeeping Reboost
Transients	$4 \times 10^{-3}$ N $4 \times 10^{-2}$ N	Fluid Transfer Start Steady Flow

Disturbances acting on the facility along the length of the tether will be directly coupled to the facility. The effect of this type of disturbance will depend on the angular orientation of the facility at the time of the disturbance. For instance, if the facility axis is lined up with the tether, then the disturbance effect will be minimal.

The tether effectively isolates the facility from disturbances acting on the space station. Disturbances that act directly on the facility will have the largest effect in creating fluid motions.

### 3.3 MATHEMATICAL MODEL

#### 3.3.1 Small Motion Planar Model

The description of the dynamic behavior of the system is very difficult except in the simplest of terms. The effect, for instance, of having motion out of the orbit plane results in complicated terms in the equations as a result simply of conservation of angular momentum. The other consideration in the development of a model is that for the fluid portion there is a more significant difference in behavior for small motions than for large motions. NASA SP-106 defines equivalent pendula for small-amplitude fluid slosh as illustrated in Figure 3-2.

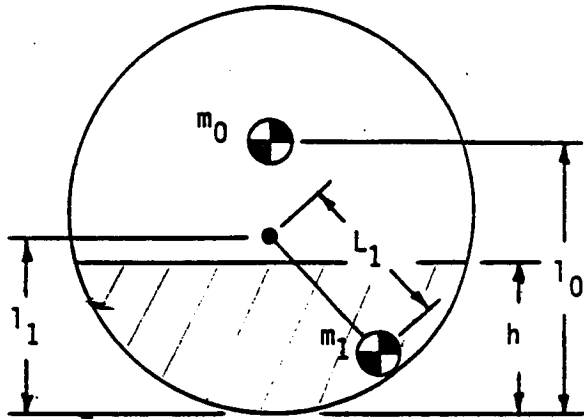

Figure 3-2 Equivalent Slob Model for a Spherical Tank

For larger amplitude motions, a model that would allow the fluid to take on an entirely different geometry is required. For a spherical tank, this type of model is not a large departure from the small motion model. For a cylindrical tank, however, a significantly different model results. Figure 3-3 illustrates this behavior.

A simple small motion planar model initially was developed to be able to understand the basic fluid response characteristics. The model is depicted in Figure 3-4. In this model, we assume the gravitational field is constant, the facility/OTV constitutes a rigid body, and the tether is rigid and massless. For this analysis, the basic 45,400-kg (100,000-lbm) capacity TORF as described in the previous section was considered.

The resulting model is described by a set of linear second-order differential equations of the form:

$$[1] \quad M\ddot{q} + Kq = F.$$

The characteristics (eigenvalues and eigenvectors) of this system are the natural figures and mode shapes. These characteristics can be used to understand how the system responds to disturbances acting on the facility.

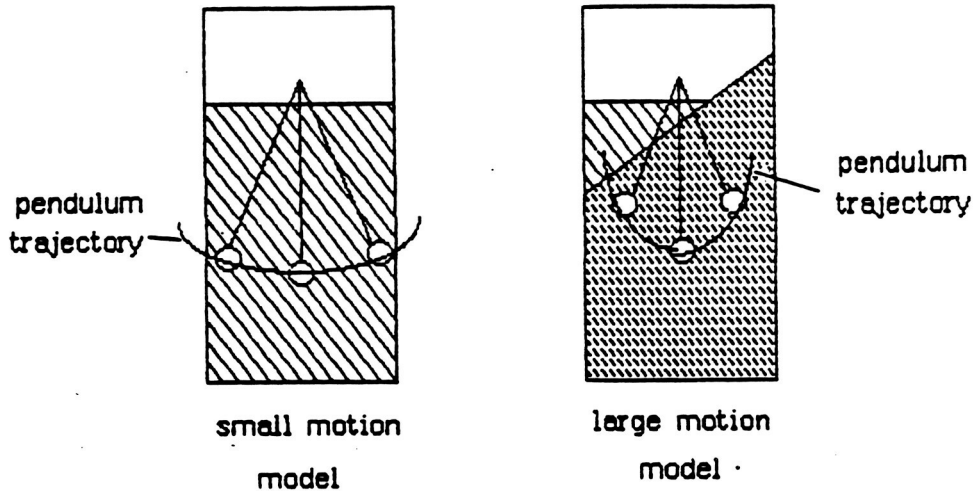

Figure 3-3 Small Motion to Large Motion Model Comparison

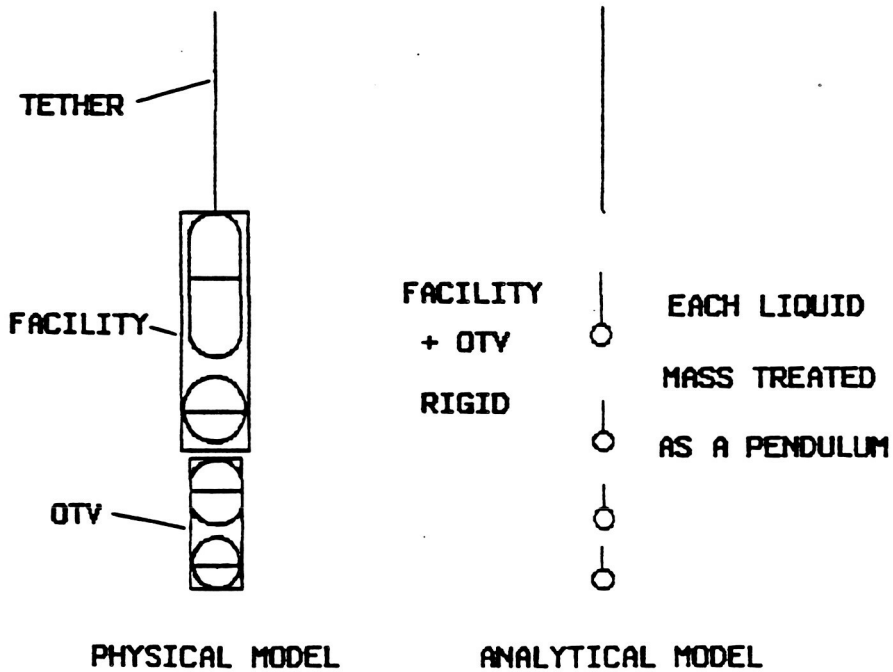

Figure 3-4 Basic Small Motion Model

The discrete response to a given disturbance is a linear combination of modal responses. For a single force (or moment) input and a single response point, the response may be written:

$$[2] \quad \frac{q_i}{F_k} = \frac{\sum \phi_{ki} \phi_{ki} \omega_i^2}{(1 - \lambda_i^2) + jL\zeta_i \lambda_i},$$

where  $\zeta$  is the modal damping,  $\omega$  equals  $2\pi f$ ,  $f$  is the natural frequency, and  $F$  is the external force.

The term  $\phi_{ki} \phi_{ki} \omega_i^2$  is called the static modal gain and describes the fluid motion magnitude per unit disturbing force. Table 3-6 gives the static modal gain for a typical system for all of the degrees of freedom in the model. The motion of the slosh degrees of freedom may be thought of as the tipping of the fluid surface. A brief study of these numbers shows that it will take static forces on the order of 45 kg (100 lbs) to move the fluid to a point where it would uncover the outlet.

Notice, also, that the addition of the modal gains for all slosh degrees of freedom results in the same angle as would be expected from the static equilibrium. Figure 3-5 illustrates this equilibrium position.

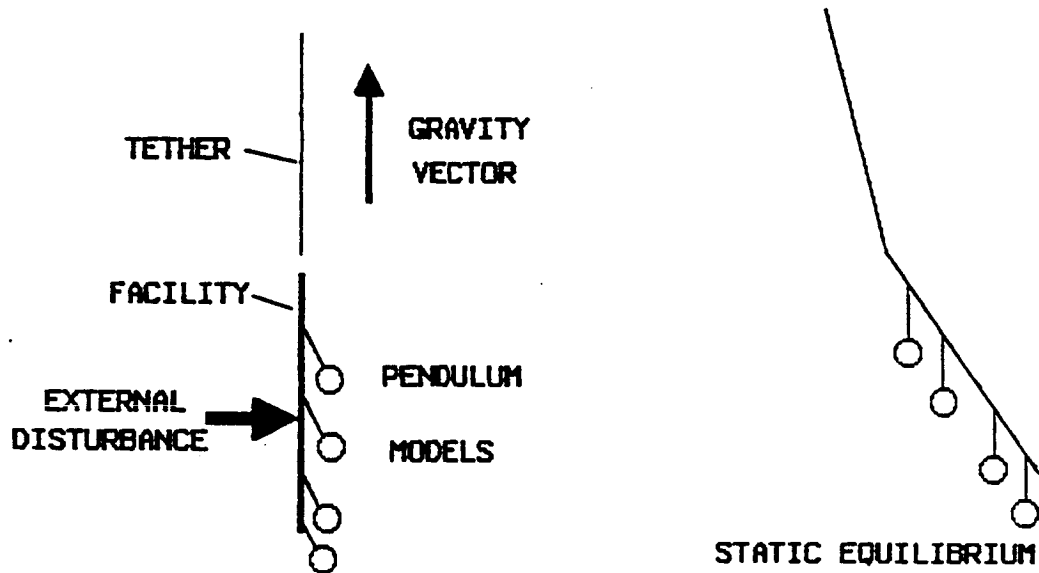

Figure 3-5 Static Equilibrium Position

Table 3-6 Modal Gains of the Planar Model

	Propellant	Mode Number ( $10^{-5}$ Degrees/N)					
		1	2	3	4	5	6
Facility Full OTV Empty	LH2	- .369	- 190	- 245	- 76.7		
	LO2	5.60	- 12.3	14.4	- 522		
Facility 50% OTV Full	LH2	- 3.37	- 118	497	- 886	- 10.8	5.46
	LO2	1.34	- 35.7	- 301	- 157	- 6.86	- 16.4
Facility 50% OTV 10%	LH2	- 13.9	34.6	- 4.16	15.5	654	- 1410
	LO2	- 7.10	.976	.764	- 6.97	- 459	- 25.8
Facility 10% OTV Full	LH2	- 19.2	- 21.8	- 636	- 76.0	- 3.60	- 7.67
	LO2	- 14.3	- 5.96	67.0	- 787	- 4.27	- 19.3
Facility Full OTV 10%	LH2	- .874	- 117	- 23.8	- 77.3	- 196	- 73.5
	LO2	4.86	- 12.3	- 1.37	2.99	12.3	- 501

### 3.3.2 General Model

Figure 3-6 illustrates the idealization of the TORF/OTV configuration modeled in this analysis. This model is simply a collection of point masses that are connected by rigid links. This is a Large Amplitude Slosh (LAMPS) type of model that assumes the fluid may be represented by a point mass moving on a constraint surface. The constraint surface for this model is a sphere, although the basic technique used to define the constraint is not limited to a spherical surface. The radius of the sphere in each case is a function of tank shape and fill level and is determined by using the geometric modeling program, GEOMOD. The space station is treated as a point mass. The facility is represented as 2 point masses, which give the total mass, center of mass, and pitch and yaw moments of inertia equal to those of the 45,400-kg (100,000-lbm) capacity TORF described earlier.

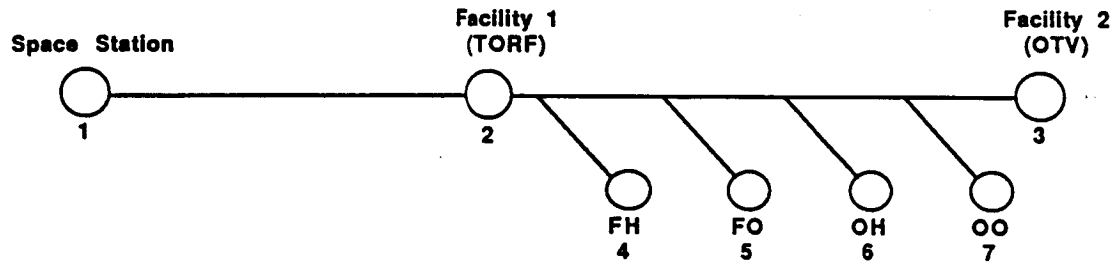

*Figure 3-6 Mathematical Model Schematic*

One implication of this model is that the fluid surface remains flat even though it tilts with respect to the TORF axis. Figures 3-7 and 3-8 illustrate how the motion of the pendulum arm, which represents the fluid, relates to the surface tilt for the 10% and 50% fill cases for the LH<sub>2</sub> tank. The data for these figures was determined using the geometric modeling program, GEOMOD. Based on these figures, the angle implied by the model motion is very nearly equal to the tilt of the surface (for small amplitudes) and hence is a good indicator for determining if the outlet becomes uncovered.

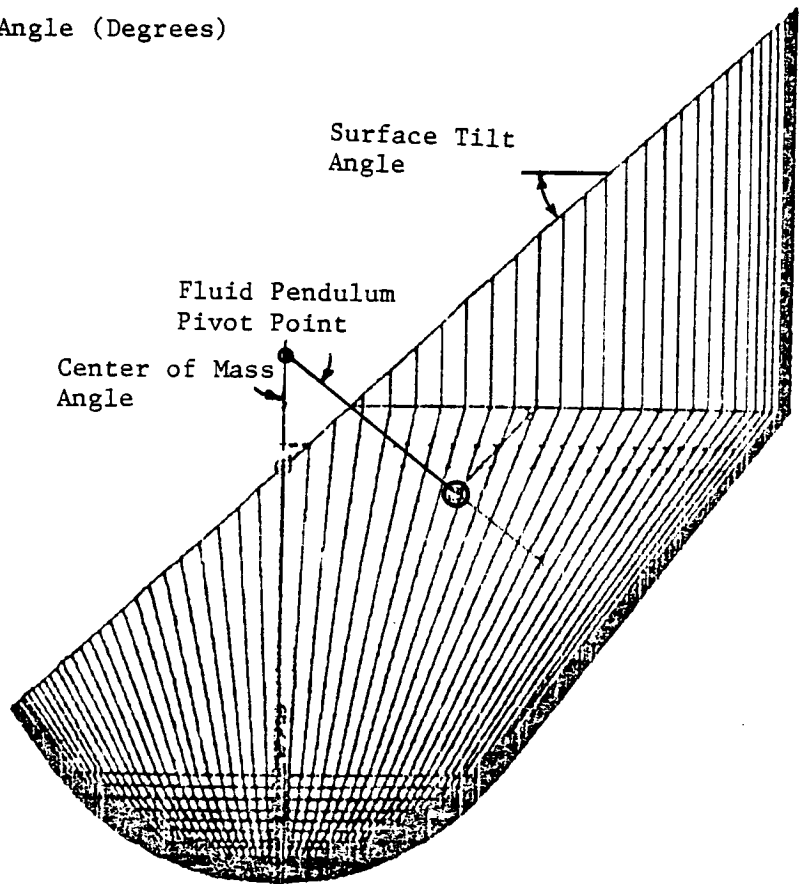
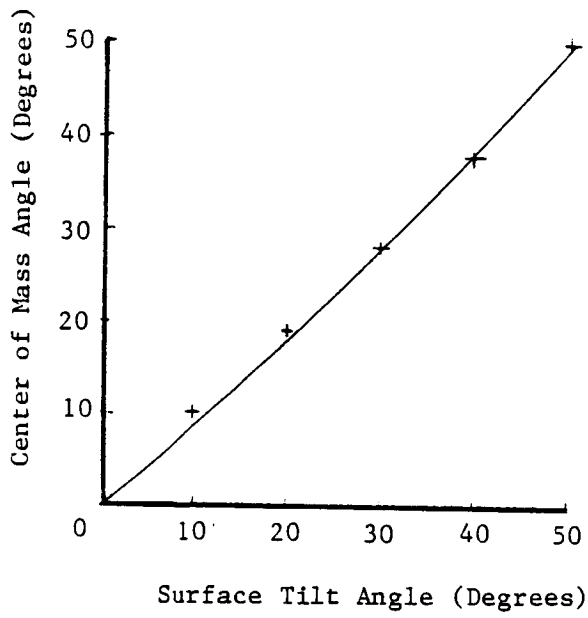

Figure 3-7 10% Fill Level Center of Mass Motion versus Surface Tilt

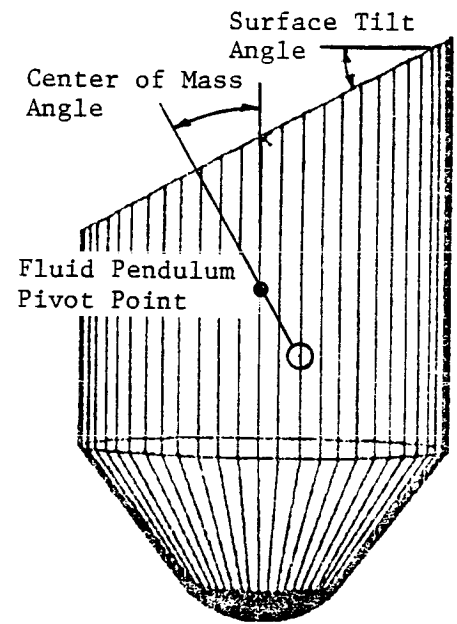
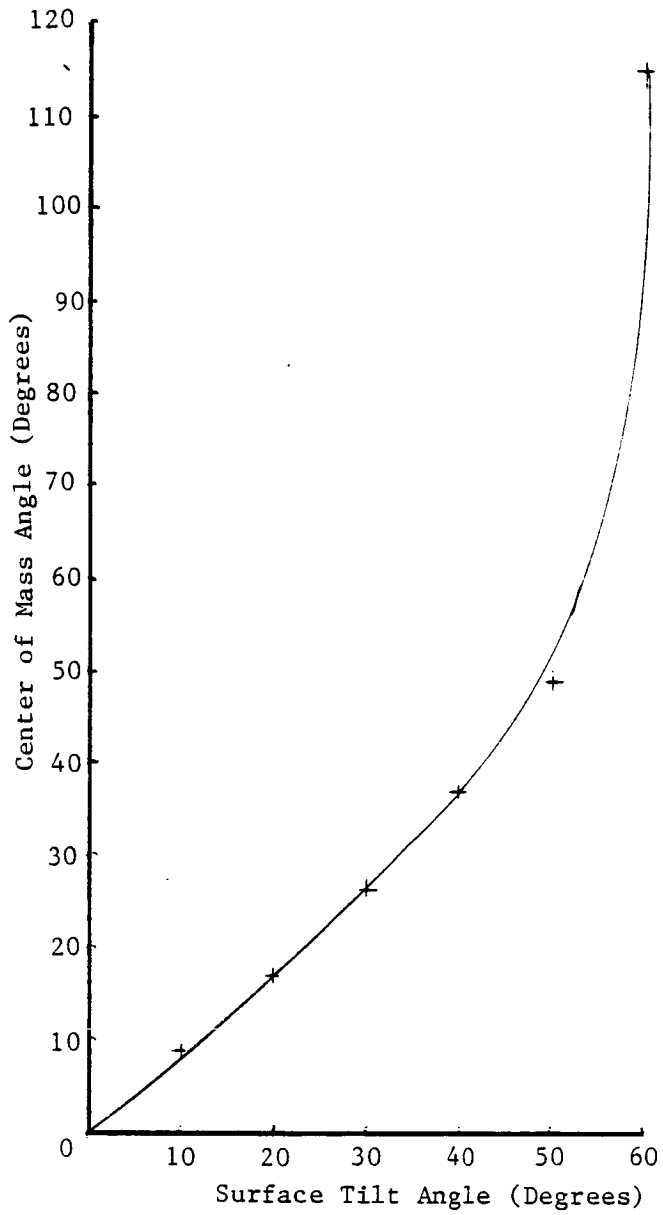
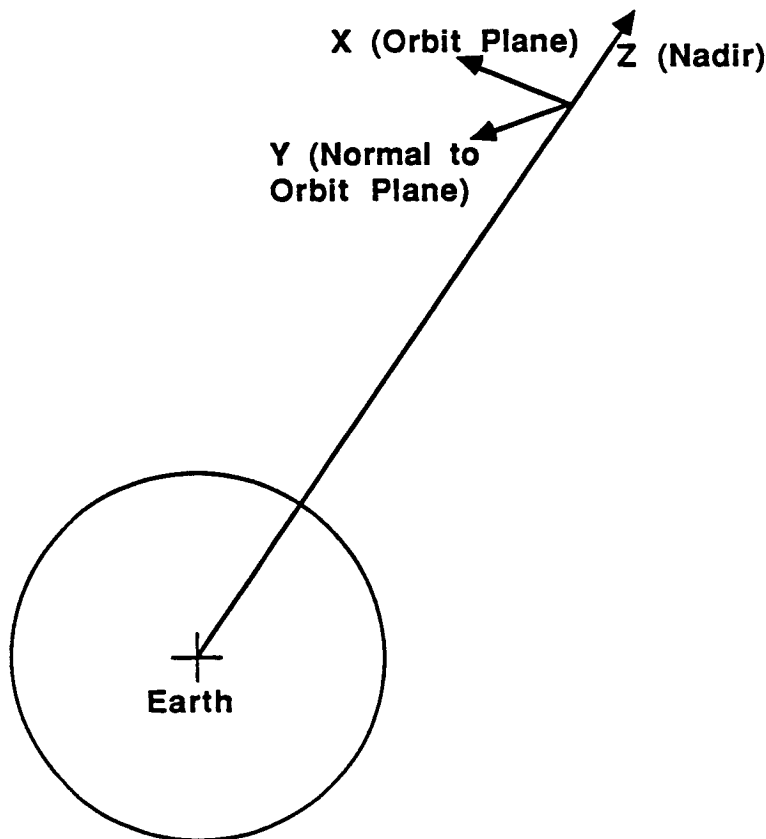

Figure 3-8 50% Fill Level Center of Mass Motion versus Surface Tilt



The seven-node model indicated in Figure 3-6 is used to describe the motion of the system. The generalized coordinates are simply the cartesian translations of each node. These are measured with respect to a reference frame that rotates at the orbital rate. We assume that the system is in a circular orbit for simplicity. Figure 3-9 illustrates the coordinate systems used for writing the equations of equilibrium of the system. Seven nodes times three degrees of freedom for each node results in a 21 degree-of-freedom model. These degrees of freedom are not independent because of the constraint that rigid links are used to connect certain nodes to certain nodes. These constraints merely say that the distance between the two nodes is constant. Mathematically we use the constraints in the form that the relative accelerations of the two points along the line of action of the constraint is zero. This is a necessary, but not sufficient condition to guarantee the satisfaction of the constraint. In the solution procedure we guarantee that initially the constraint is satisfied and that the first and second derivatives of the constraint are zero for all time, therefore the constraint is satisfied for all time except for numerical errors.



*Figure 3-9 Coordinate Systems*

A digital computer program was written in FORTRAN IV to solve the equations of equilibrium of the system. The numerical solution technique is the Runge-Kutta integration scheme. Inputs to the program include orbital parameters, mass properties, geometry, and initial conditions. The main outputs from the program are time histories of the relative angles between the fluid slosh masses and the facility. These are provided in the form of graphics.

### 3.4 TORF/FLUID BEHAVIOR ANALYSIS

Using the generalized model, the dynamics of the TORF/fluid system were evaluated. There are three important considerations for this study: (1) tether tension, (2) swing angle, and (3) fluid slosh angle. It is desired that the tether never go slack as this would have a completely undesirable effect on the system behavior. Secondly, the swing angle should never exceed 30 degrees as this would violate the operational constraints of the tether control mechanism on the space station. Finally the fluid outlet should never become uncovered, i.e./, fluid slosh angles should remain small.

The initial positions assumed for this study were the system tilted either in or out of the orbit plane by as much as 30 degrees. The initial velocity given to the space station of 0.3 m/s (1 ft/s) corresponds roughly to the maximum impulse given to the space station as a result of the Orbiter berthing at 0.6 m/s (2 ft/s). This is conservative because a very low mass space station was assumed (136,200 kg for the IOC versus 454,000 kg for the FOC). The conservatism in this calculation is simply the mass ratio, i.e., a factor of 3. Hence for a given tether length the smaller mass space station results in 3 times the system motion. This also translates to the use of shorter tethers for the more massive space station. Table 3-7 gives a summary of the important cases considered in these analyses.

*Table 3-7 Case Definitions*

Case	Description	Purpose
1	Berthing Along Tether Axis	Check Tether Tension
2	Berthing in Plane of Orbit	Check Swing and Slosh
3	Berthing Normal to Plane of Orbit	Check Swing and Slosh

Note: For Each Case Several Different Tether Lengths and Initial Swing Angles Were Considered

Case 1

Figure 3-10 illustrates the tether tension loss as a function of tether length for the case of berthing along the tether axis. This does not appear to be a serious problem even for this very energetic event.

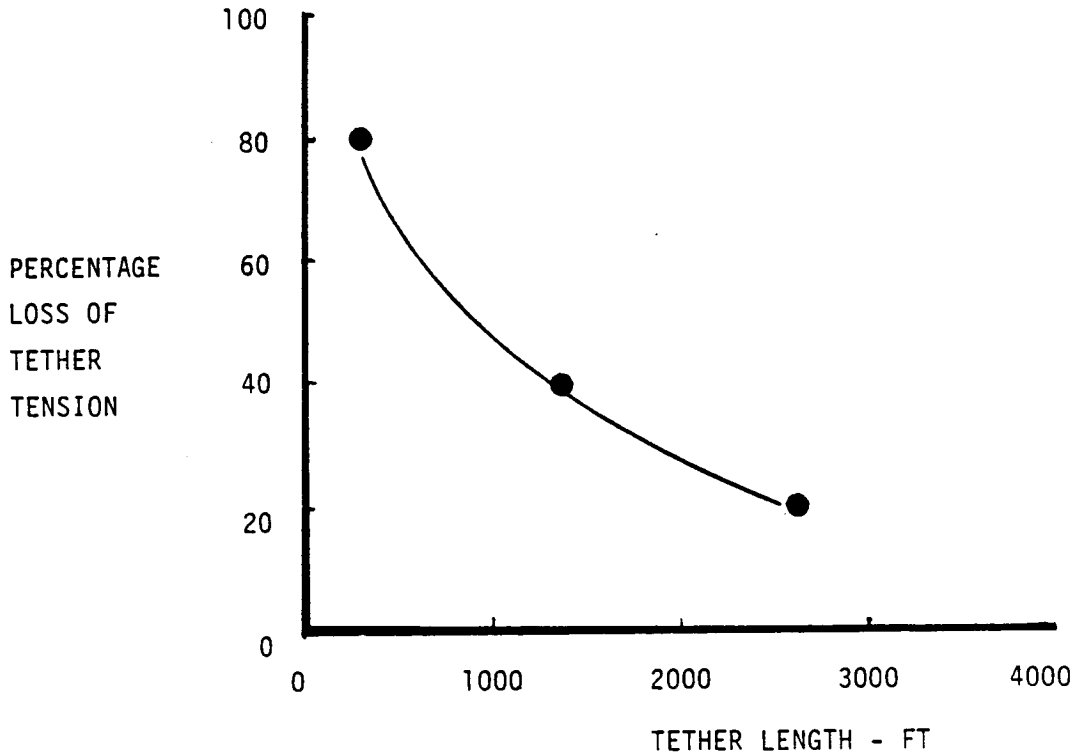

*Figure 3-10  
Loss of Tether Tension as a Result of In-Plane Disturbances  
as a Function of Tether Length*

Case 2

Figure 3-11 illustrates system swing angle and facility sloss angles as a function of tether length. The significant thing to note here is that there is an important lower limit for tether length to prevent excessive motions of the system and fluids.

Case 3

Figure 3-12 illustrates facility sloss angles for the out-of-plane berthing case. A comparison of this figure to Figure 3-11 shows that the inplane berthing of the shuttle to the space station is more severe than the out-of-plane berthing. This is because of the difference in the equilibrium equations for the xz versus the yz planes of motion.

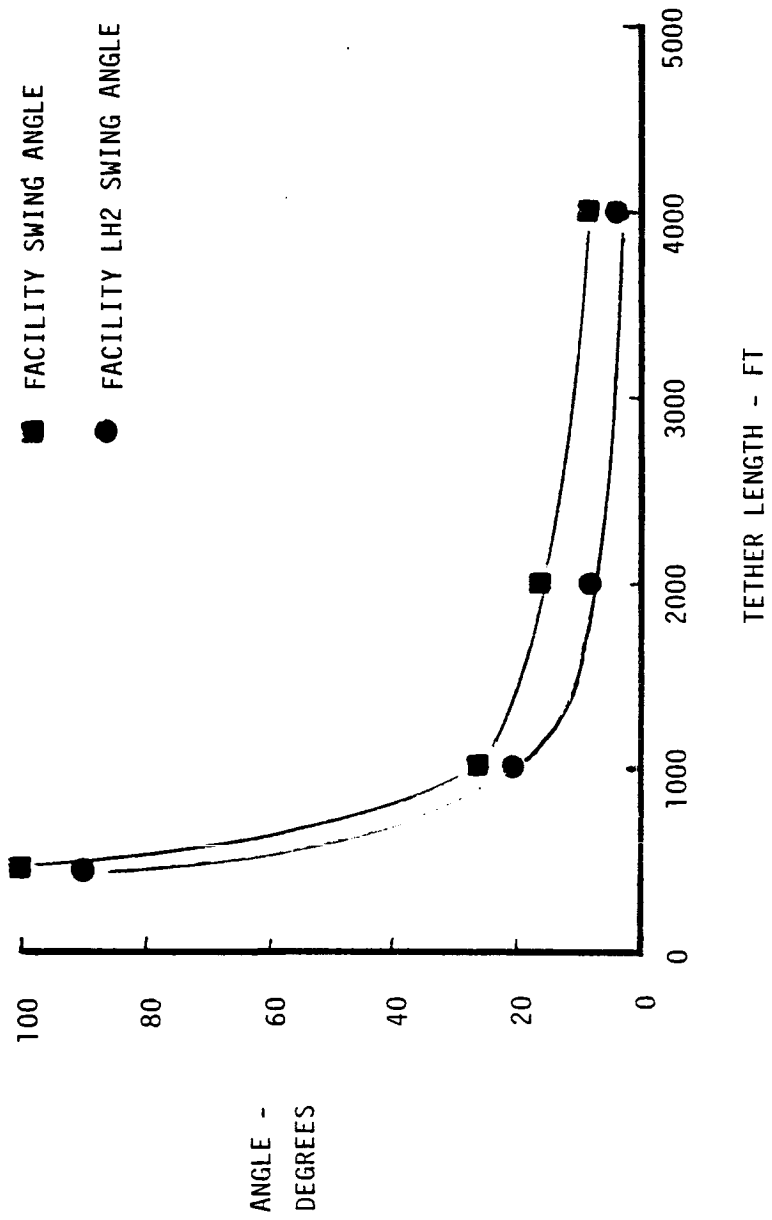

Figure 3-11  
Swing Angle Response to In-Plane Disturbance as a Function of Tether Length

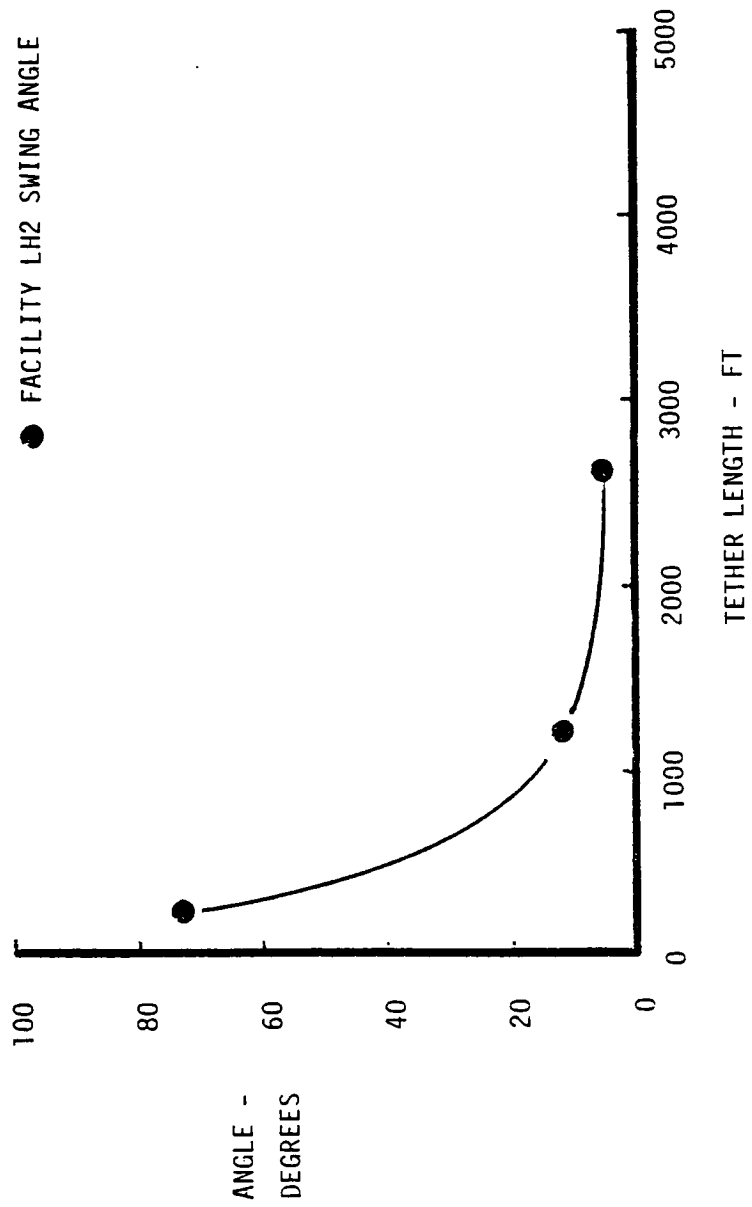

Figure 3-12  
Swing Angle Response to Out-of-Plane Disturbance as a Function of Tether Length

Fluid Slosh Damping

Propellant slosh is of concern during the fluid transfer if the slosh is large enough to uncover the tank outlet. The inherent viscous damping of the fluid will provide a small amount of damping, but slosh baffles will need to be included in the design to provide enough damping. Several correlations exist for viscous damping both under nominal gravity and zero-gravity conditions. No correlations exist for low-g conditions, so the damping coefficient has been extrapolated from the existing correlations. Damping coefficients describe how quickly the slosh energy in a fluid is dissipated. A high coefficient indicates a system that dissipates the energy quickly. Damping coefficients for bare tanks were calculated for several tank shapes, fill levels, and gravitational conditions, as shown in Table 3-8. The trend shows that the slosh dissipates quicker under low-g conditions and generally for emptier tanks. The correlations show that the damping coefficient increases for lower gravity because surface tension forces begin to dominate. Therefore, the viscous damping will become more predominant as the gravity gradient decreases.

*Table 3-8 Damping Coefficients*

	Tank Shapes				
	Sphere	Cylinder L/D = 2*	Cylinder L/D = 5	Cylinder L/D = 10	Conical- Based
<u>Hydrogen</u>					
1 g Acceleration					
90% Fill	.0026	.00077	.00079	.00096	.00067
50% Fill	.0042	.00078	.00079	.00097	.00068
10% Fill	.0035	.0012	.00088	.0097	.0013
10 <sup>-4</sup> g Acceleration					
- - -	.107	.112	.113	.120	.106
<u>Oxygen</u>					
1 g Acceleration					
90% Fill	.0025	.00083	.00108	.00129	.00247
50% Fill	.0041	.00085	.00108	.00129	.0041
10% Fill	.0033	.00132	.0017	.00143	.00125
10 <sup>-4</sup> g Acceleration					
- - -	.128	.139	.151	.160	.129

\*L/D = Length-to-Diameter Ratio

Augmented damping may be required because of the high disturbance periods such as docking. Several damping devices were investigated for use in the tanks. Both fixed-ring and flexible baffles are potential candidates (see Fig. 3-13). They both provide damping in the required range for a small weight penalty.

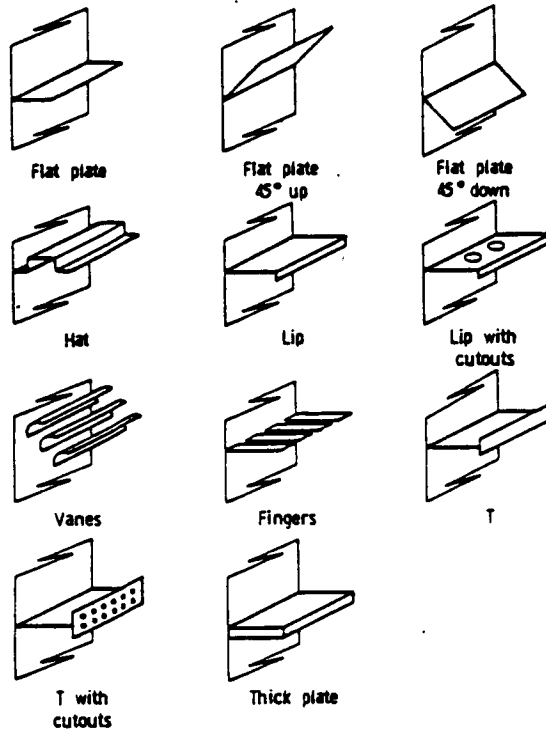

Figure 3-13 Fixed-Ring Baffle Configurations

Another concept that was examined for damping the fluid motion is to have the actual fluid holding tanks connected to an outer tank through a soft structure and damping device. This concept will provide some damping if enough relative motion is available between the holding tanks and the outer tank. This would be equivalent to the simple system shown in Figure 3-14, where  $K_1$  represents the slosh stiffness (gravitational),  $K_2$  represents the structural stiffness between fluid holding tank and the outer structure, and  $C$  is the damping coefficient for the external damping device.

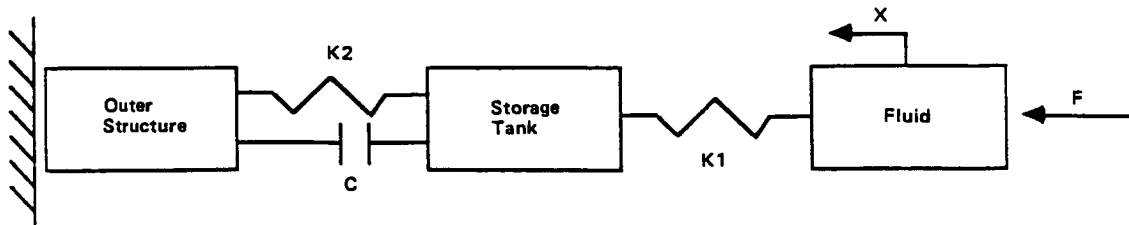

Figure 3-14 External Damping Dynamics Model

The transfer function for this model is given by the following equation;

$$[3] \quad F = K_1 \frac{(K_2 + Cs)}{(K_1 + K_2 + Cs)} .$$

This equation illustrates the sensitivity of the transfer function to the relative stiffnesses of structure and fluid. If the structure is much stiffer than the fluid slosh stiffness, then the transfer function approaches that for an undamped spring. Because the slosh stiffness is proportional to the local gravitational field and hence is very small, the structural stiffness must be almost zero and the geometry must be such that a very large stroke is allowed. Because of Shuttle volume constraints, it is unlikely that enough stroke could be allowed so that effective damping could be achieved.

For the baseline cases, zero damping was assumed for the fluid. For the augmented cases, 5% of critical damping was assumed. This is an achievable value of damping by using simple ring-type baffles in the tanks.

Damping has very little effect on the peak response (relative motion) of the fluid in the facility tanks. However, if there is no damping, then the relative motion will persist. If the time lines for space station operations allow closely spaced events that are significant in terms of system response, then the initial energy stored will result in possibly greater response than if the event occurred with no initial energy. Figure 3-15 illustrates a comparison of time responses for the undamped and damped case. Approximately 5% of critical damping was used for this case. Note that damping only applies to the relative fluid motion and hence will not damp the overall libration of the system. Some external devices must be used to damp the libration.

### Conclusions

The most significant outcome of this analysis is the simple fact that there is a definite tether length above which the system performance will not be compromised, even as a result of a very energetic shuttle berthing event that has been conservatively applied. This tether length is on the order of 305 m (1000 feet). There is a very simple physical reason for this effect. The fluid in the facility basically responds to lateral motions of the facility. The velocity change of the space station because of the impact with the shuttle alters the direction of the tether with respect to the facility and hence develops a lateral component of force from the tether tension. This results in a lateral and angular acceleration of the facility and some fluid motion. The longer the tether, the less severe the angle between tether and facility becomes (for a given velocity change of the space station) and hence, the less the fluid motion. In effect, the long



tether acts like an isolator and decouples facility motions from space station disturbances. Another way to achieve this isolation or frequency separation would be by controlling the individual tank sizes. Smaller tanks will result in lower slosh periods and hence provide effects similar to increasing the tether length. For a given tether length the slosh period varies as the square root of tank size.

For the types of disturbances considered in this study, damping of the fluid motion is not all that important. In general, it will be a good idea for the tanks to contain slosh baffles so that the fluid energy will be somewhat controlled and dissipated over time.

In addition to fluid damping, some form of attitude damping of the system for dissipation of the libration motion will be necessary and must be coordinated with space station requirements. Also, it will be necessary to provide roll control as the general sloshing motion of the fluids in the facility will undoubtedly couple with facility roll through viscous forces. It will be necessary to have the roll orientation of the facility either known or controlled so that any libration control will be effective. This will probably be most effectively done through the use of small thrusters.

### 3.5 FACILITY/TETHER DYNAMICS

In addition to an evaluation of the fluid behavior in a TORF, several analyses were completed to evaluate the basic dynamics of various TORF/space station activities to identify preferred TORF design and operational concepts. Specific tasks included evaluation of tether deployment and retrieval dynamics, tether crawler dynamics, and fluid/tether interactions. Two TORF design concepts were given consideration. The first is a permanently deployed TORF that would require a tether crawler. The second is an intermittently deployed TORF. Results were used to weigh the two concepts in terms of effect on the dynamics of the TORF. Once a selection was made, the dynamics study focused on specific design concerns. Figure 3-16 illustrates the logic flow for this portion of the dynamics study. The baseline TORF design used in these remaining dynamics analyses consists of the 90,800-kg (200,000-lbm) capacity system with the OTV hangar, as described in Section 2.5.

#### 3.5.1 Permanently Deployed TORF

A permanently deployed TORF has the same inherent complexities as any of the tether systems that have been considered. In addition, a transport vehicle is required for transporting materials and astronauts between the space station and the tethered facility. Two options have been considered. The first is a free-flying vehicle such as an OMV. The second is a tether-traversing vehicle such as a crawler. The free-flying vehicle would have no more of an effect on the tether system dynamics than a shuttle docking at the space station. A tether crawler presents a unique effect on the tether system dynamics, therefore, a crawler analysis was the focus of the permanently deployed TORF analysis.

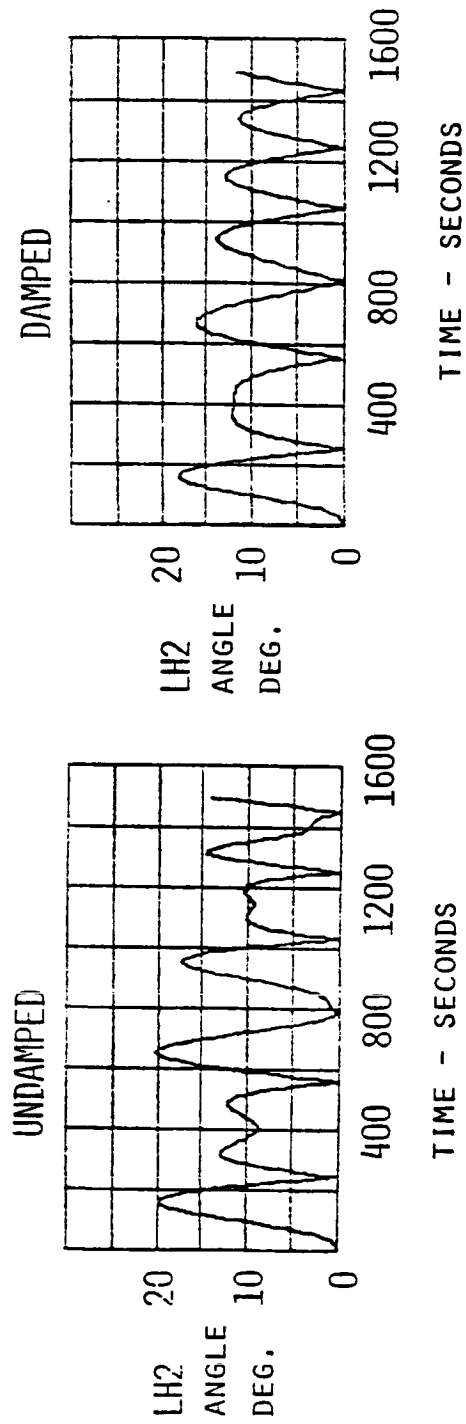

Figure 3-15 Comparison of Damped and Undamped Responses 305 m (1000 ft) Tether Length

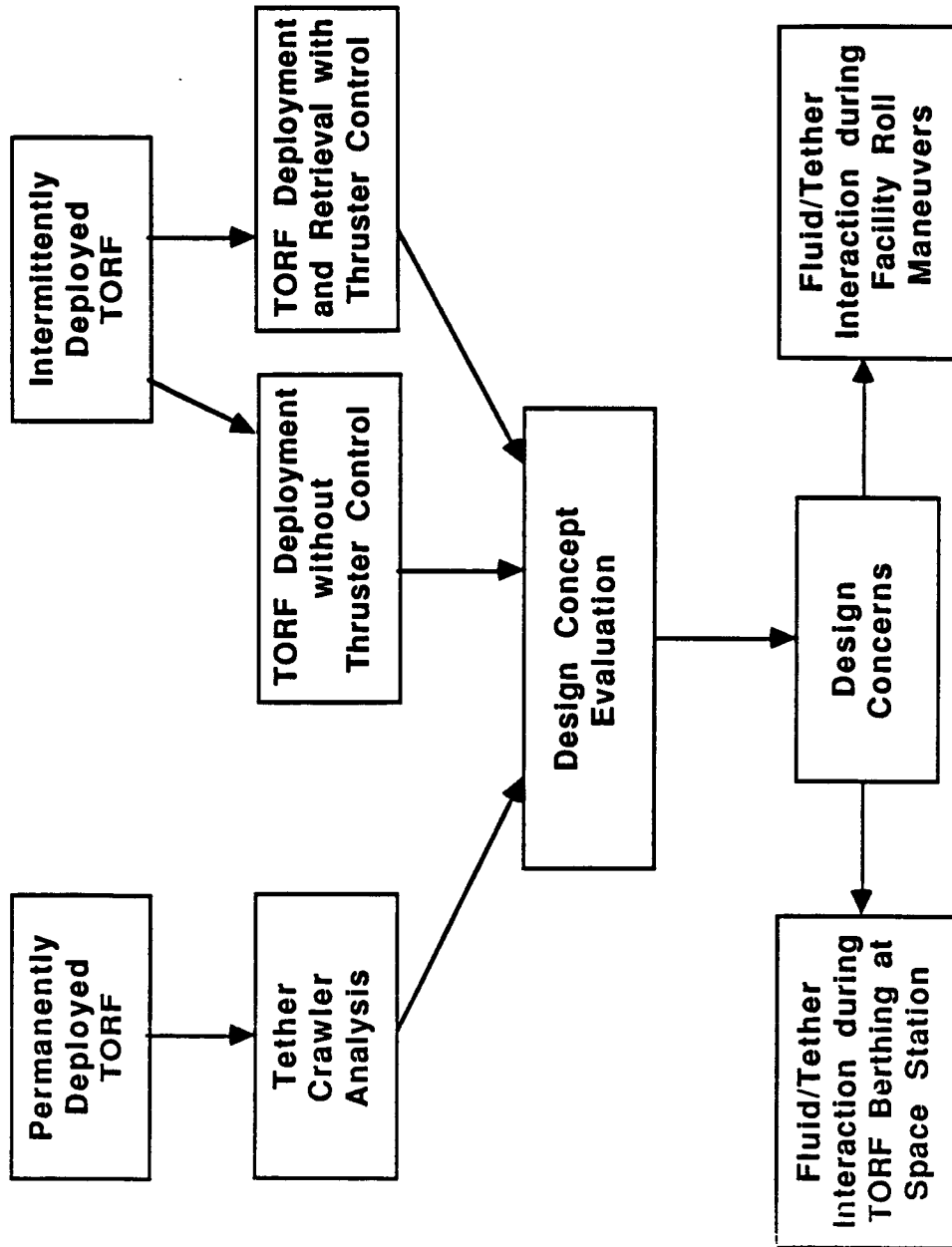
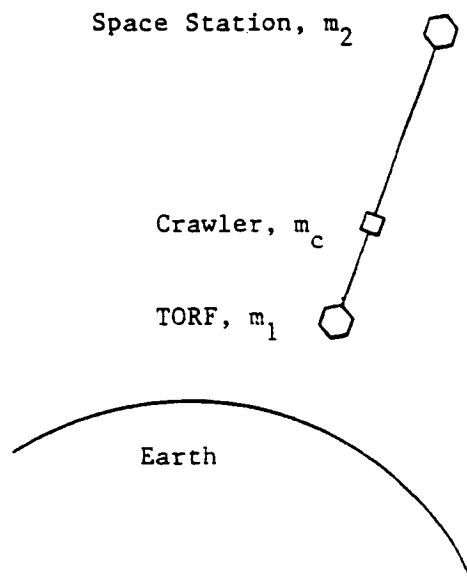

Figure 3-16 Facility/Tether Dynamics Study Flow

To assess the effect of tether crawler motions on the overall system dynamics and to determine what specific motions require more detailed analysis, a preliminary assessment of the crawler dynamics was performed. The dynamic motions of a tether system as a result of the action of a crawler are possibly complex. For a preliminary study of this situation, a relatively simple system of two masses connected by a rigid tether was considered. This system only exhibits very long period (approximately 3000 seconds) libration characteristics. Figure 3-17 illustrates this system with the crawler.



*Figure 3-17*  
*Space Station/TORF/Crawler System*

One of the immediate effects of the crawler is to cause the tether to deflect laterally. For this preliminary study, only the case of a straight tether was considered. The indicated forces were estimated, assuming that the crawler mass is small relative to the end masses. The fact that the center of mass of the system will shift because of the motion of the crawler can be ignored under this assumption. Any out-of-plane motion of the tether system was also ignored. This analysis was only to get a estimate of the allowable range of crawler speeds.

The equations of equilibrium are derived using Lagrange's equation and result in the following form:

$$[4] \quad I \ddot{\phi} = F_t + F_c,$$

where  $\phi$  is the libration angle,  $F_g$  is the gravitational force, and  $F_c$  represents the coriolis and centrifugal terms. It is useful to linearize this equation for small motions, because small motions are the concerns. The result is:

$$[5] \quad I \ddot{\phi} + 3 \Omega^2 I \phi = -2 \dot{\ell} \ell m_c \Omega.$$

This is a simple linear second order differential equation. The right hand side of the equation is a slowly varying force. Consider the "static" solution, i.e.,  $\dot{\phi} = 0$ . Hence,

$$[6] \quad \phi = \frac{-2 \dot{\ell} \ell m_c}{3 \Omega I}.$$

If we allow  $\theta$  to reach 2 degrees, the allowable  $\dot{\ell}$  can be determined. Assuming the following parameters for the system,  $M_1 = 10,000$  slugs,  $M_2 = 20,000$  slugs,  $\ell = 3000$  ft.,  $M_c = 2,000$  slugs, and  $\Omega = .001$  rad/sec (a typical value for low-Earth orbit), then

$$[7] \quad I = m_1 \left( \frac{2\ell}{3} \right)^2 + m_2 \left( \frac{\ell}{3} \right)^2 = 6 \times 10^{10} \text{ slug-ft}^2.$$

This yields an allowable  $\dot{\ell}$  of approximately 0.2 m/sec (0.5 ft/sec). This value implies a transit time well within an acceptable range in terms of the time lines of facility operations.

The magnitude of the force that would load the tether laterally because of a 0.2-m/s (0.5-ft/s) crawler is simply  $2 \dot{\ell} m_c \Omega$ . For the parameters chosen, this force is 9 N (2 lbs). The tether tension for these parameters is approximately 270 N (60 lbs). The tether would have to deflect approximately 2 degrees. A more detailed model confirmed the above results. This model considered motion in the orbital plane only, but motion was not restricted to a straight line tether.

### 3.5.2 Intermittently Deployed TORF

An intermittently deployed TORF would require a control system capable of deploying and retrieving the TORF at periodic intervals. Libration of the tethered system would be limited to 2 degrees during deployment and retrieval operations. Two control systems were considered. The first is a passive control system where thrusters are not used. The second is an active control system where TORF side thrusters are used for libration control. TORF deployment can be achieved using a passive control system. TORF retrieval would require thrusters, because of the unstable nature of retrieving a tethered object.

3.5.2.1 TORF Deployment Without Thruster Control--Tethered system libration can be passively controlled during deployment by specifying the tether length and velocity. The tethered satellite program has developed deployment equations that specify tether length and velocity based on a model consisting of two point masses connected by a rigid tether. Figure 3-18 shows the model coordinate system. These equations were used to calculate the time required to deploy the TORF, maximum tether velocity, and the amount of libration. The following is a summary of this analysis.

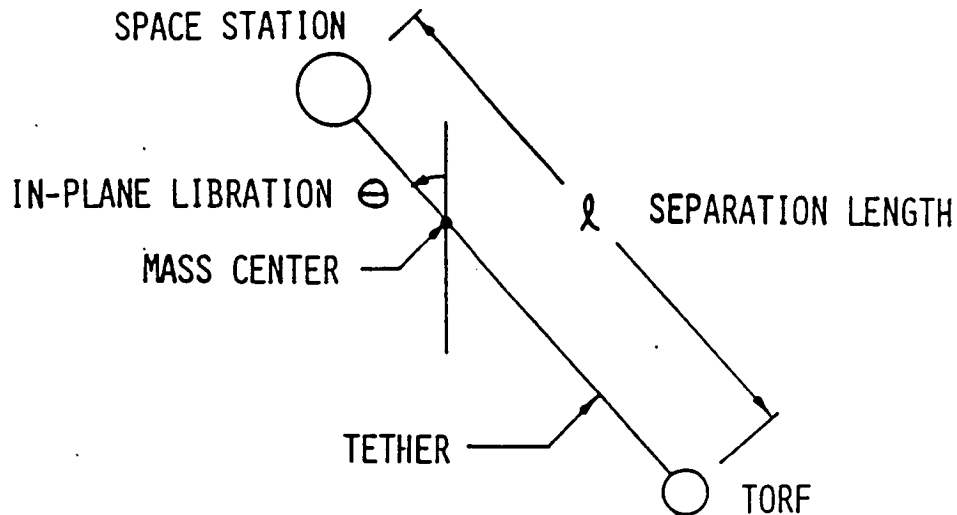

Figure 3-18 Deployment Model Coordinate System

Consider the in-plane libration differential equation.

$$[8] \quad \ddot{\theta} = -\frac{3}{2} \Omega^2 \sin(2\theta) - \frac{2\dot{\ell}}{\ell} (\dot{\theta} - \Omega) - r_r,$$

where

$\theta$  - in-plane libration,

$\ell$  - separation length between space station and TORF mass centers,

$\Omega$  - orbital rate,

$r_r$  - small nonlinear residue. Note, equation [8] becomes unstable for small values of  $\ddot{\theta}$ ,  $\dot{\theta}$  and  $r_r$ . The dominant term of the libration equation is

$$[9] \quad \frac{\dot{\ell}}{\ell} = \frac{3}{4} \Omega \sin(2\theta).$$

At initiation of deployment when  $\ell$  is a minimum, we want to maximize  $\dot{\ell}$  (in equation [9],  $\theta = \theta_{\max}$ ).

$$[10] \quad \frac{\dot{\ell}}{\ell} = \frac{3}{4} \Omega \sin(2\theta_{\max}).$$

At the end of deployment when  $\ell$  is maximum, we want to minimize  $\dot{\ell}$  (in equation [9],  $\theta = 0$ )

$$[11] \quad \frac{\dot{\ell}}{\ell} = 0.$$

We seek a function for  $\ell$  and  $\dot{\ell}$  having characteristics described above. For deployment a function for  $\ell$  has been adopted that has the desired  $\dot{\ell}/\ell$  characteristics.

$$[12] \quad \ell = \ell_0 e^{\left\{ \ln\left(\frac{\ell}{\ell_0}\right) \left[ \tau + \frac{1}{\pi} \sin(\pi \tau) \right] \right\}},$$

where

$\ell_0$  - initial separation,

$\ell$  - deployed length,

$\tau$  - normalized time,  $t/T_D$

$T_D$  - time required to deploy TORF.

Taking the first derivative with respect to time yields,

$$[13] \quad \dot{\ell} = \frac{\ell_0}{T_D} \ln\left(\frac{\ell}{\ell_0}\right) [1 + \cos(\pi \tau)] e^{\left\{ \ln\left(\frac{\ell}{\ell_0}\right) \left[ \tau + \frac{1}{\pi} \sin(\pi \tau) \right] \right\}}.$$

Taking the ratio of equations [12] and [13] gives

$$[14] \quad \frac{\dot{\ell}}{\ell} = \frac{1}{T_D} \ln\left(\frac{\ell}{\ell_0}\right) [1 - \cos(\pi \tau)].$$

Equation [14] has the characteristics of the desired  $\dot{\ell}/\ell$ . A maximum at initiation of deployment ( $\tau = 0$ );

$$[15] \quad \frac{\dot{\ell}_{max}}{\ell} = \frac{2}{T_D} \ell n \left( \frac{\ell}{\ell_0} \right),$$

a minimum at the end of deployment (  $\tau=1$  );

$$[16] \quad \frac{\dot{\ell}}{\ell} = 0.$$

Combining equations [15] and [10] and solving for  $T_D$  yields

$$[17] \quad T_D = \frac{8}{3\Omega \sin(2\theta_{max})} \ell n \left( \frac{\ell}{\ell_0} \right).$$

Figure 3-19 shows the  $\ell$ ,  $\dot{\ell}$  and  $\dot{\ell}/\ell$  profiles. Times required for deployment and maximum tether velocities were calculated for several libration angles and tether lengths. Tables 3-9 and 3-10 summarize the results.

To control libration to within a  $2^\circ$  bound, a deployment time of 37 hours, for a 915-m (3000-ft) tether is needed. This time requirement is excessive. A thruster control system would probably be required.

3.5.2.2 TORF Deployment and Retrieval Using Thruster Control--A computer simulation for analyses of combined orbital, librational, and control dynamics has been developed by the tethered satellite system (TSS) program (model 1B). The simulation uses a point mass and rigid tether representation of the tethered system. An active control system is used to control in-plane and out-of-plane libration. Forces induced by aerodynamic drag are included. Libration angles and rates are kept within prescribed limits by using a phase plane control scheme. Libration angle and rate are monitored. If the combination of these parameters lie outside the limits, thrusters are fired to correct the angle and rate. An illustration of the phase plane is shown in Figure 3-20.



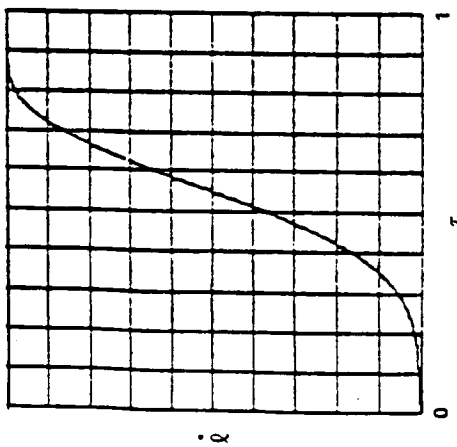
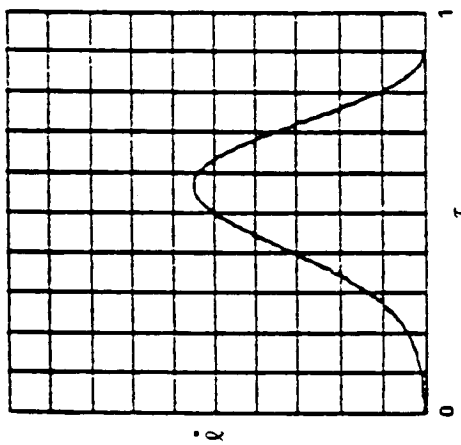
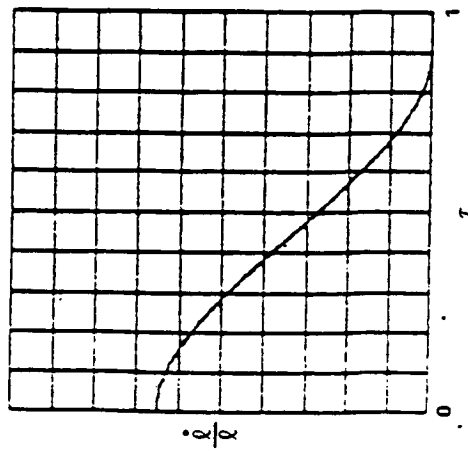

Figure 3-19  $q$ ,  $\dot{q}$  and  $\dot{q}/q$  Profiles

Table 3-9 Time to Deploy for Various  $\theta$  Max Values (hrs)

Deployed Length (m)	Maximum Libration Angle			
	2°	5°	10°	15°
305 (1000 ft)	27	11	6	4
915 (3000 ft)	37	15	8	5

Table 3-10 Maximum Tether Velocities (m/br)

Deployed Length (m)	Maximum Libration Angle			
	2°	5°	10°	15°
305 (1000 ft)	20	88	49	131
915 (3000 ft)	49	229	122	366

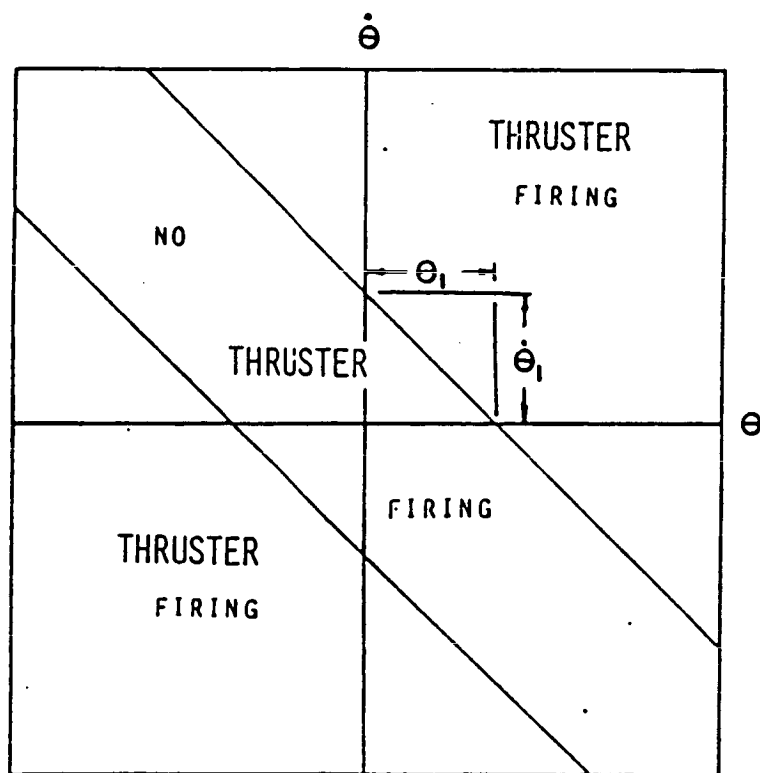

Figure 3-20 Phase Plane Control

The limits  $\theta_1$  and  $\dot{\theta}_1$  are chosen such that  $\theta$  max is limited to  $\pm 2^\circ$ .

Results were obtained for 2-, 4-, and 6-hour deployment and retrieval times. For all cases, in-plane and out-of-plane libration was controlled within  $\pm 2^\circ$ . A tether length of 915 m (3000 ft) and an orbit of 463 km (250 nmi) were assumed. Results from the 2-hr deployment and retrieval case are shown in the following figures. Figure 3-21 shows the separation length and velocity. The TORF was deployed to 915 m (3000 ft), held for 1 hour, and retrieved as shown in the length profile. The maximum tether velocity is less than 1 km/hr (0.9 f/s). Figure 3-22 shows the in-plane libration angle and rate. Note the angle is initially at  $180^\circ$  indicating that the TORF is deployed away from the Earth. Libration is controlled within the  $2^\circ$  limit. The results of the thruster firing is reflected in the libration rate. Figure 3-23 shows tether tension and the  $\dot{\theta}$  profiles. A maximum tension value of 400 N (91 lbs) occurs when the TORF is fully deployed.

To assess the amount of thruster propellant required to control libration, the total impulse was calculated, based on a 112-N (25-lb) thruster, with a minimum impulse of 5 lb-s/pulse and a specific impulse of 220 s. Table 3-11 summarizes the total propellant consumption for the three cases.

The results indicate that libration control using thrusters could be accomplished with a relatively small amount of propellant.

### 3.5.3 Design Concept Evaluation

The permanently deployed TORF design requirement for a tether crawler adds an extra degree of complexity to the TORF design. Although the TORF would remain deployed, a mechanism for initial deployment and periodic retrieval would be required. A simple crawler analysis has shown that a crawler speed of 0.2 m/sec (0.5 ft/s) is allowable. This speed would enable the crawler to traverse the tether in an acceptable amount of time.

TORF deployment without thrusters would not be feasible because of the long period of time required to control libration to  $\pm 2^\circ$ . Deployment and retrieval could be accomplished in a short period of time with thruster control without an excessive amount of thruster propellant.

The results from the above analyses as well as facility operational considerations indicate that an intermittently deployed TORF is probably a more favorable design. Therefore, the remainder of the dynamics study focused on the design concerns associated with this concept.

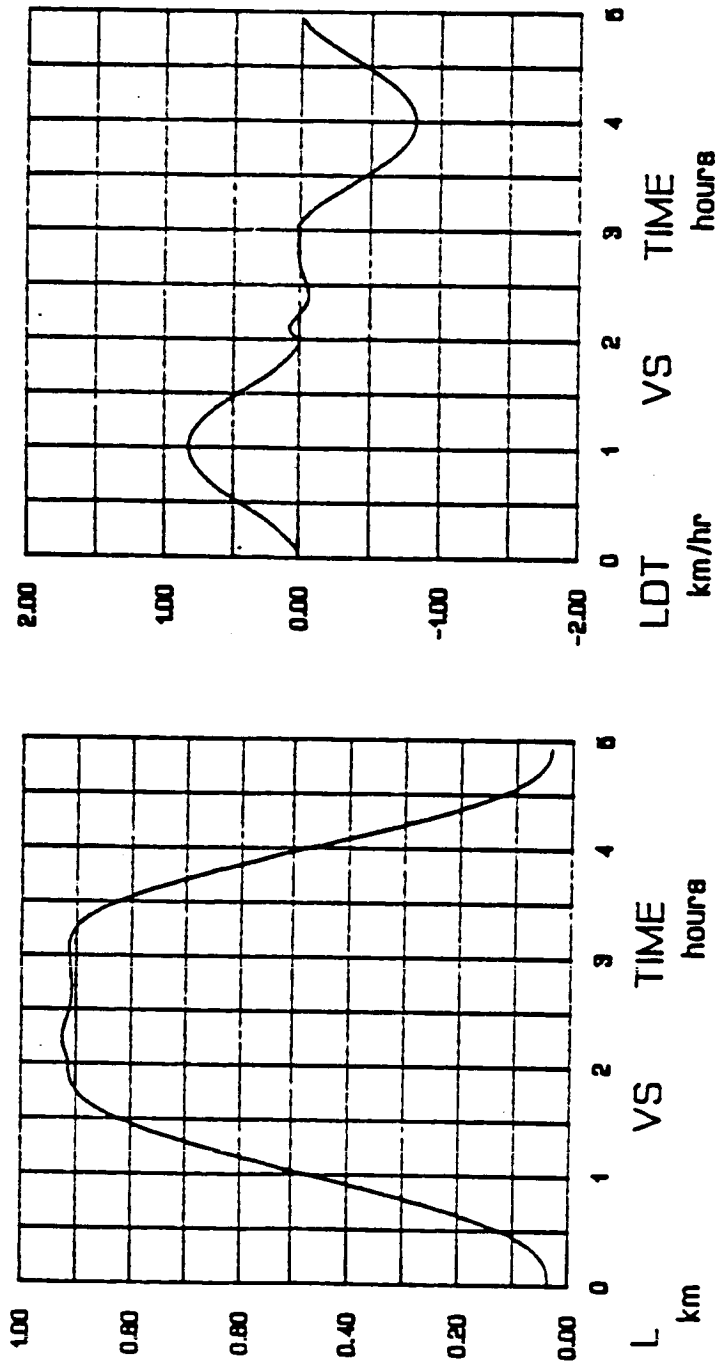

Figure 3-21 Separation Length and Velocity for the Two-Hour Deployment Case

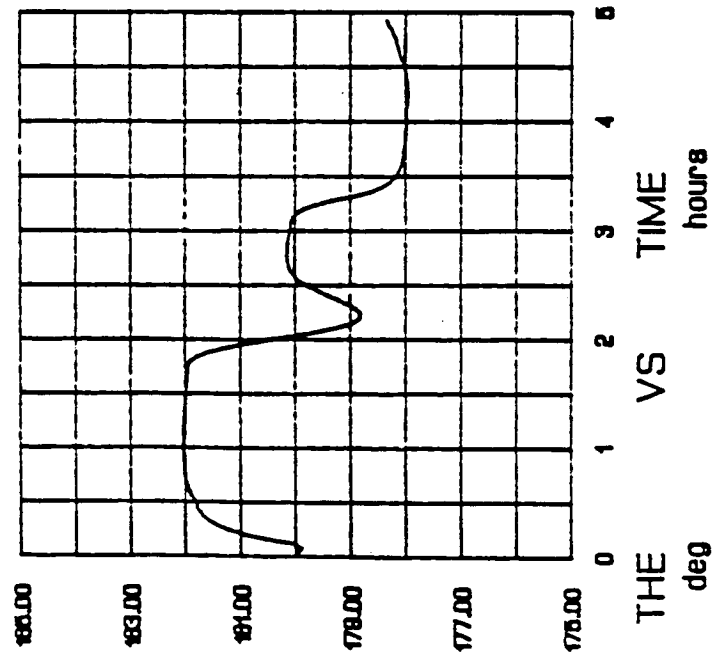
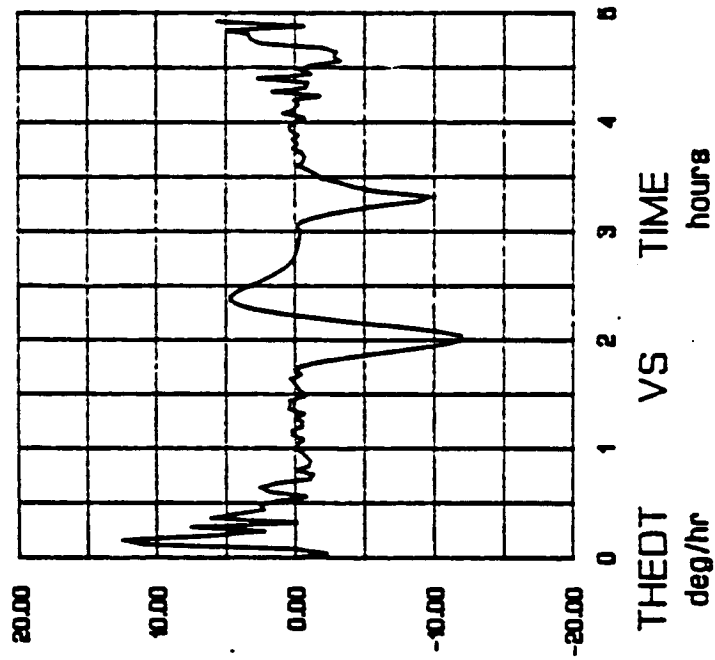

Figure 3-22 In-Plane Libration Angle and Rate for the Two-Hour Deployment Case

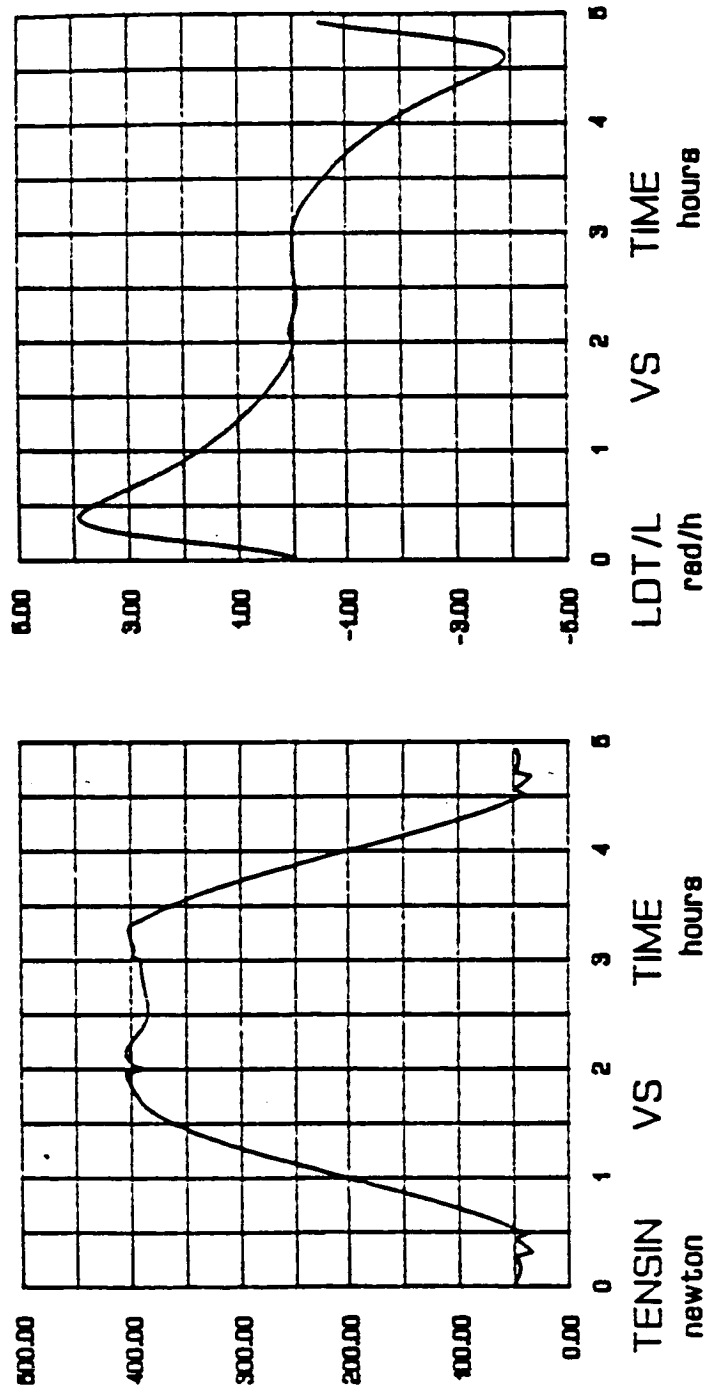

Figure 3-23 Tether Tension and Rate per Length Profile for the Two-Hour Deployment Case

Table 3-11 Total Propellant Consumption

Case	Deployment Time, hrs	Retrieval Time, hrs	Consumption, kg*
1	2	2	245 (540 lbm)
2	4	4	200 (440 lbm)
3	6	6	165 (360 lbm)

\* Assuming a specific impulse of 220 s

#### 3.5.4 Design Concerns

Several design concerns associated with the intermittently deployed TORF have been identified. The TORF would be docked at the space station when not in operation. Fluid/tether interaction during this time period is a concern. Fluid/tether interaction during the final phase of retrieval could also be a potential problem.

The TORF would be attached to the space station by a single tether when deployed. This configuration would allow the facility to roll about the tether axis virtually unrestrained. A need arises for a control system to prevent facility roll about the tether axis, or "yaw" relative to the orbital coordinates. Fluid/tether interaction during this yaw maneuver must also be assessed.

To assess these concerns, an analysis of fluid/tether interaction during TORF berthing and of fluid/tether interaction during facility roll maneuvers were performed. A discussion of these are presented in the next section.

##### 3.5.4.1 Fluid/Tether Interaction During STS Berthing at Space Station--

To assess the effect of propellant slosh on the tethered system dynamics during STS berthing, the generalized model described in Section 3.3.2 was used.

Several cases for various facility fill levels were considered. A shuttle docking at the space station/TORF mass center with facility tanks full (90%) was used as a baseline case. Additional cases included shuttle docking with facility 50% and 10% full. For these cases, the mass center moved as a function of fluid fill level while the docking point remained fixed. Docking velocities of 0.3 m/s (1 ft/s) and 0.6 m/s (2 ft/s) were used in the analysis. A 5% critical damping value was assumed for propellant damping.

The results indicate that propellant slosh in the facility tanks does not appreciably effect the stability of the space station/TORF during shuttle docking. Figure 3-24 shows the in-plane libration of the space station/TORF for a 0.3 m/s (1 ft/s) docking velocity and a 90% fill level presuming the docking point is at the system center of mass. A maximum of less than 1° rotation occurs after docking.

The space station motion is damped proportionally to the fluid motion. The motion is completely damped out after 1 hour.

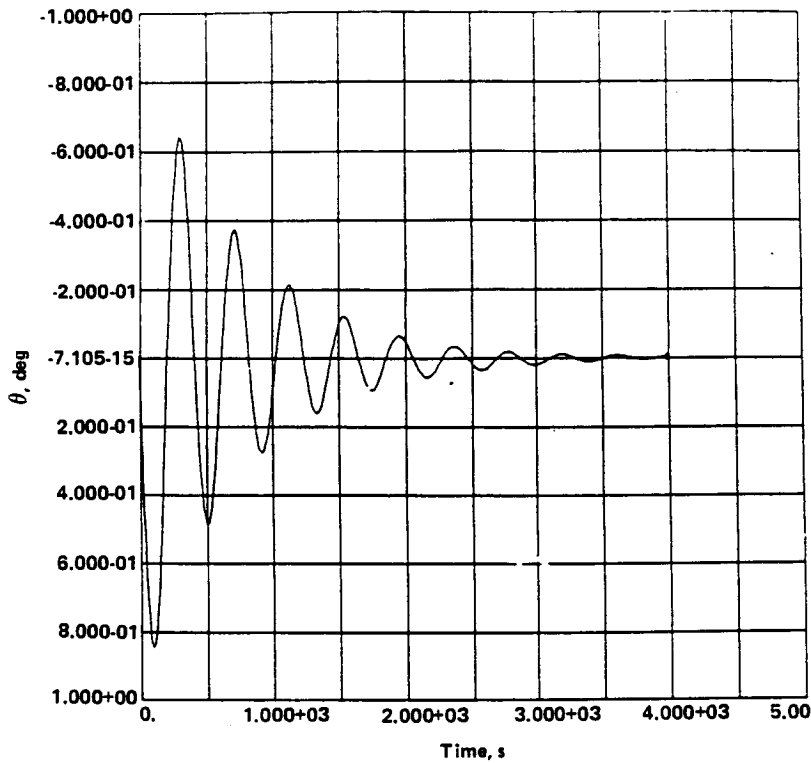
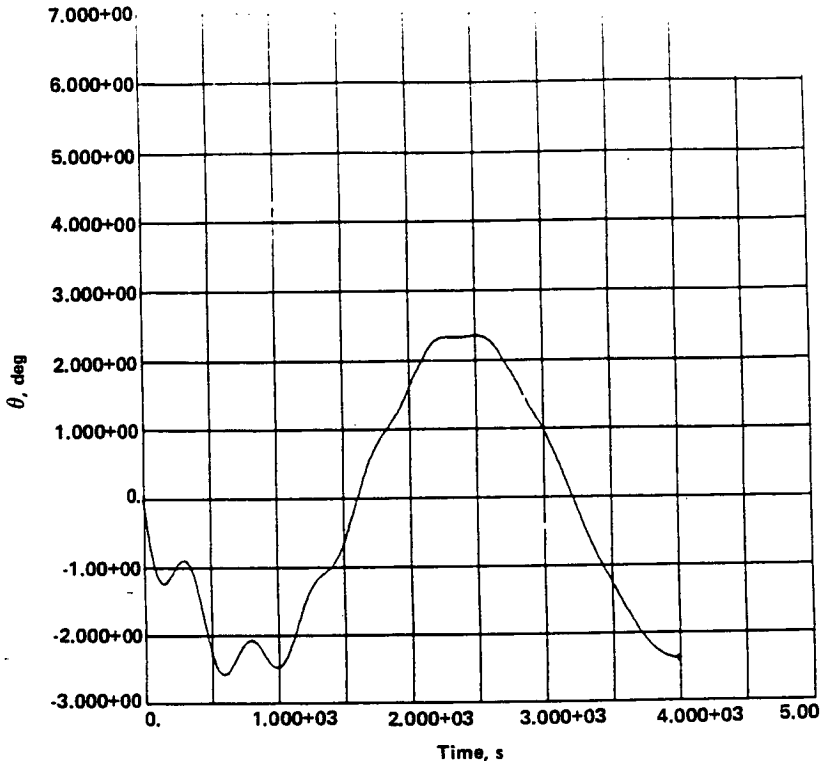

*Figure 3-24  
In-Plane Rotation of Space Station after Shuttle Docking  
(90% Fill)*

If the shuttle docks away from the center of mass, a torque is produced about the mass center, exciting the space station libration frequency.

The mass center moves 0.3 m (1 ft) away from the docking point for the 50% fill level. This case is illustrated in Figure 3-25.





**Figure 3-25**  
*In-Plane Rotation of Space Station after Shuttle Docking*  
*(50% Fill)*

The motion as a result of libration dominates. Propellant slosh interaction occurs during the first portion of the transient and is quickly damped out leaving libration motion, which has no damping mechanism. Table 3-12 summarizes the maximum in-plane rotation for the various cases. The distance from the docking point to the composite mass center is included in the table.

The linear model was also used to evaluate the fluid/tether interaction during the final phase of retrieval, (i.e., TORF/space station docking). The retrieval control law would allow the tethered system to librate up to 2°. Thrusters are fired to maintain this bound. During the final phase of retrieval, the tethered system has a docking velocity of 0.02 m/s (0.05 ft/s) and a libration rate of 10°/hr. This velocity and rate were used as initial conditions to the berthing simulation. The space station/TORF motion was evaluated for several tank fill levels. Figure 3-26 shows a TORF docking case for a 50% fill level. The libration motion dominates with very little fluid interaction.

Table 3-12 Space Station Maximum In-Plane Rotation

Tank Fill, %	Distance From CM (Dock Pt), (m)	Impact Velocity, m/s	Max Deg
Docking Point at System CM for 90% Fill			
90	0.0	0.31	0.9
90	0.0	0.62	1.7
50	0.31	0.31	2.5
50	0.31	0.62	5.2
10	0.58	0.31	6.2
10	0.58	0.62	12.4
Docking Point at System CM for 50% Fill			
50	0.0	0.31	0.6
50	0.0	0.62	1.1
Docking Point at System CM for 10% Fill			
10	0.0	0.31	0.2
10	0.0	0.62	0.4

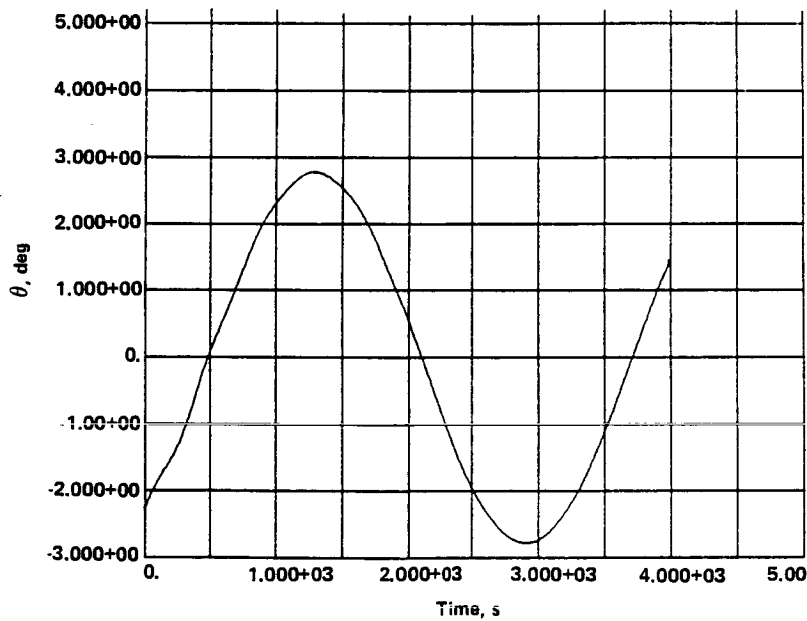
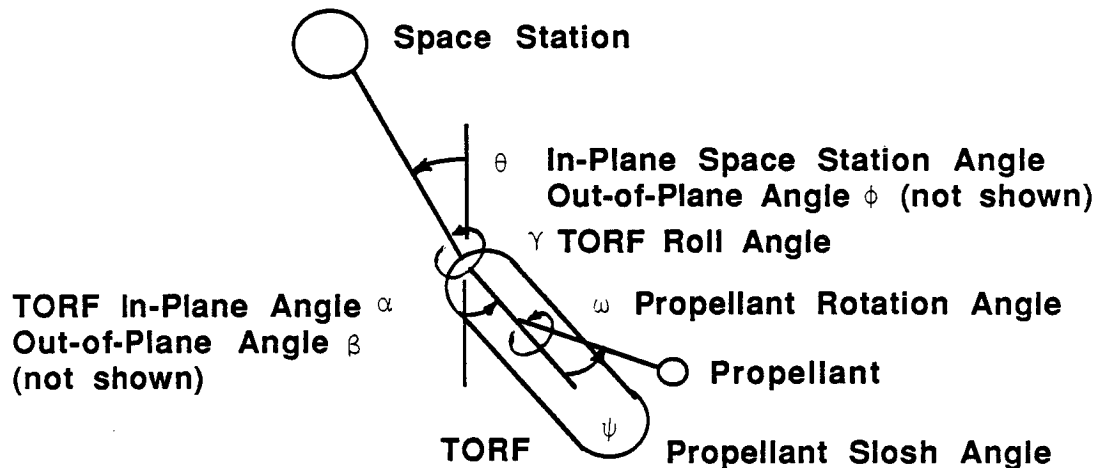

Figure 3-26  
Space Station/TORF Libration as a Result of Shuttle Docking

3.5.4.2 Fluid/Tether Interaction During Facility Roll Maneuvers--The TORF is attached to the space station by a single tether. This configuration would allow free rotation about the TORF tether or yaw axis. To maintain TORF attitude, a roll control system would be required capable of maneuvering the TORF about the tether axis.

Figure 3-27 illustrates the model used to represent this system. This model contains a rotational degree of freedom representing TORF roll. A pendulum model characterizes both propellant rotary and lateral slosh motion. Tank baffles are assumed to provide 5% damping.



*Figure 3-27 Facility Roll Model*

Facility thrusters would provide the necessary torque to maneuver the TORF about the tether axis. To simulate this system, a simple phase plane control system similar to the libration control system discussed previously was implemented in the computer simulation. In the simulation, roll angle and rate are monitored and kept within a specified bound by applying a torque impulse to the TORF model. This torque is assumed to be provided by two 112-N (25-lb) thrusters spaced at 15.2 m (50 ft) with an impulse of 22.4 N-s (5 lb-s). Ten percent of this impulse was applied to the TORF model in-plane and out-of-plane axes to account for thruster misalignment. Coupling between facility roll and fluid rotation was modeled as a viscous drag force.

In the case that was considered, the TORF model is given an initial roll angle and rate of  $45^\circ$  and  $0.3^\circ/\text{s}$  respectively. The control system bounds are  $\pm 5^\circ$  and  $\pm 0.1^\circ/\text{s}$ . A torque impulse is applied to the model until the roll angle is within the specified boundary. Fill levels of 10%, 50%, and 90% were considered.

The results were used to assess the fluid/tether interaction with TORF motion, introduced by the control system. The performance of the control system was of lesser interest. Indeed the control system parameters selected are probably not optimal, but the intent here is not to assess the control aspects but to understand fluid interaction.

Figure 3-28 shows the roll angle as a function of time for the 90% fill level. The roll angle begins at the initial 45° value and eventually comes to rest within the control bounds.

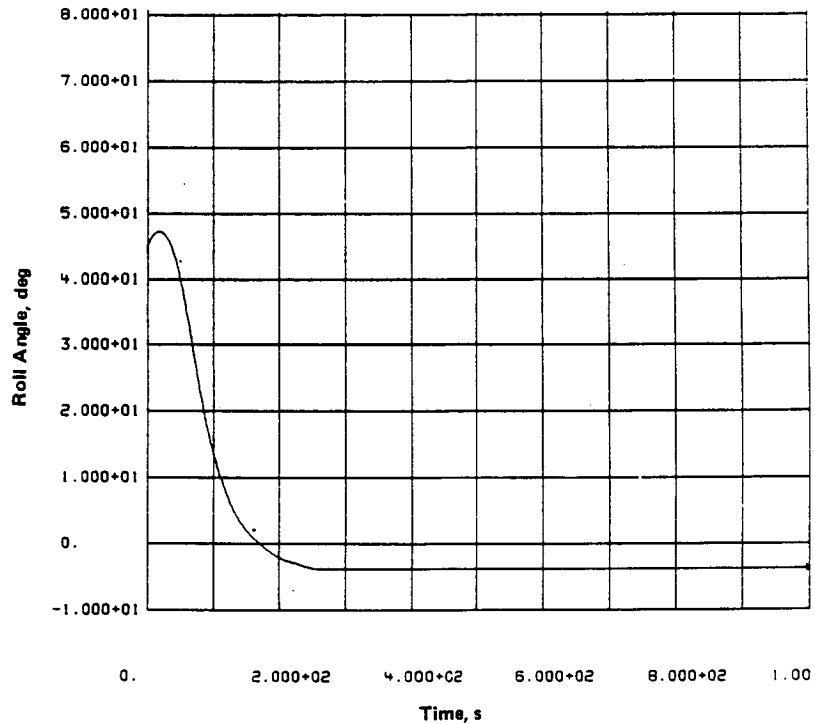

*Figure 3-28 Roll Angle Time History for the 90% Fill Level*

Table 3-13 summarizes the propellant consumption required to perform this roll maneuver. Again, the actual control system would be an optimal design and therefore the propellant consumption values are only approximate numbers.

Table 3-13 Propellant Required for the 45° Maneuver

Fill Level	Consumption*
90%	1.1 kg (2.4 lbm)
50%	1.0 kg (2.2 lbm)
10%	0.9 kg (2.0 lbm)

\* Assuming a specific impulse of 220 s

A plot of the in-plane angle of the facility for the 10% fill level is shown in Figure 3-29. The in-plane angle reaches a maximum of less than 1° during the roll maneuver. This motion is primarily a result of the thruster misalignment. Coupling between propellant slosh and the TORF in-plane motion is minimal.

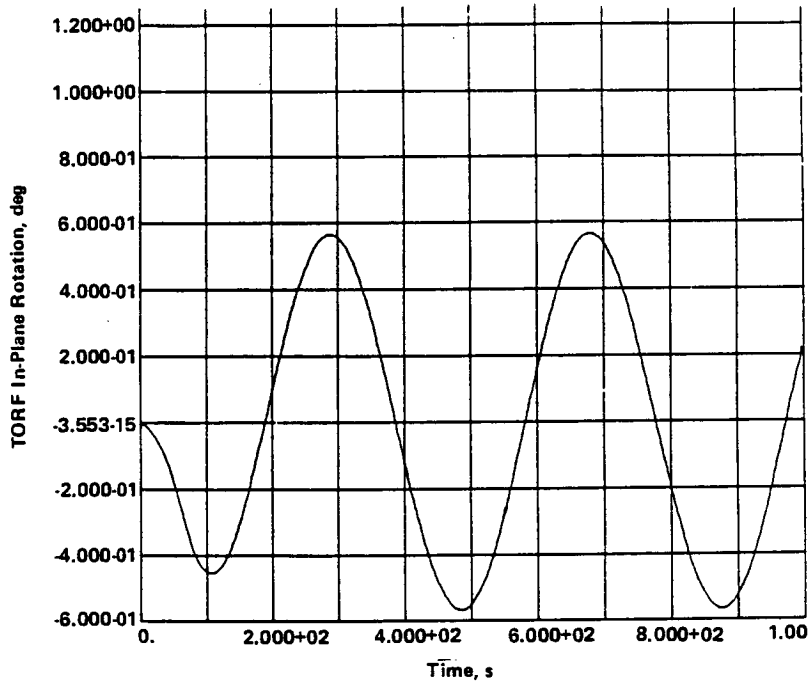

Figure 3-29  
TORF In-Plane Motion as a Result of TORF Roll  
Maneuver for the 10% Fill Level

The roll angle and rate phase plane is shown in Figure 3-30 for the 90% fill level. The roll thrusters fire until the TORF comes to rest within the  $\pm 5^\circ$  bound.

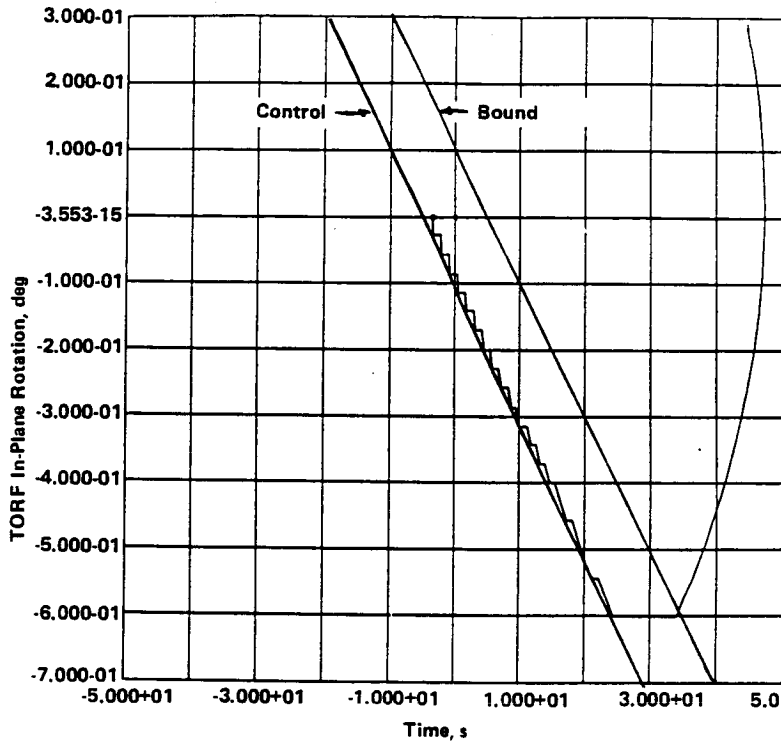

Figure 3-30 Roll Phase Plane for the 90% Fill Level

The analyses indicate that fluid/tether interaction during a facility yaw maneuver would be small and therefore probably not of great concern. Two 112 N (25 lb) thrusters would provide enough torque to maintain TORF attitude about the tether axis. A relatively small amount of propellant would be required to perform this maneuver.

### 3.5.5 Conclusion

A major outcome of this study is that both the intermittently and permanently deployed TORF designs are feasible, as far as meeting design requirements of  $2^\circ$  libration control. Tether deployment and retrieval would require thruster control to minimize operational time periods. Thruster fuel consumption during deployment and retrieval would not be excessive.

A tether crawler that would be required for a permanently deployed facility could traverse the tether at a maximum velocity of 0.2 m/s (0.5 ft/s). The tether crawler does introduce a greater degree of complexity to the TORF design from both an operations and dynamic analysis point of view. Therefore, the intermittently deployed TORF is probably a more feasible design.

Several concerns are associated with the concept of an intermittently deployed TORF. The first is fluid/tether interaction during shuttle berthing at the space station. A second concern is fluid interaction during TORF roll maneuvers.

A linear model was used to analyze fluid interaction during shuttle berthing at the space station while the facility is berthed at the station. Results from the analysis indicate that the coupling between space station and propellant slosh as a result of a shuttle docking at the space station would be small. In addition, fluid interaction during the final stages of TORF retrieval would probably be negligible.

An analysis of fluid/tether interaction during facility roll maneuvers was performed using a model that contained rotational degrees of freedom representing facility roll motion and fluid rotary slosh. A simple phase-plane control system was used to control rotation of the facility about the tether axis. Results show that fluid slosh during a roll maneuver would be small and therefore not have a substantial effect on the TORF roll control system.

The models used in this study are simple in nature, but believed to represent the primary characteristics of the fluid/tethered system. The analysis provided an understanding of the basic dynamics for both design options that were considered.

#### 4.0 SYSTEM DESIGN EFFECTS

---

For the TORF to carry out its design functions, it must interface with the space station, OTV, and OMV. This interfacing imposes requirements on the facility design and also on the designs of these other systems. To meet these requirements, these related systems may require modifications that can affect their overall cost and hence the relative comparison between a TORF and a zero-g refueling facility on the space station. Accordingly, these interface requirements have been reviewed and used to define the major design effects on the OTV, OMV, and space station systems.

#### 4.1 SPACE STATION EFFECTS

TORF effects on space station design can be split into two broad areas dealing with hardware modifications and operations modifications, respectively. In general, the identified hardware modifications are no more complex than those required by any other type of space station module (such as a zero-g propellant storage facility), except for the need to ensure that the entire station can withstand time-varying gravity gradient accelerations of up to  $10^{-4}$  g. Specialized hardware is required that can be included in the TORF design and need only interface with space station hardware in a way consistent with the station standard interfacing requirements. This interfacing includes structural, power, thermal, and electronic ties to the appropriate station subsystems. The gravity gradient-induced acceleration on the space station structure may have a negligible effect if the structural design is driven by docking loads, or other forces that are large compared to the TORF tether tension (tens of Newtons). Further analysis is required to fully define the total effect the TORF would have on the station structure.

The major TORF effects on the space station arise in the area of operations. In particular, all those operations that are acceleration sensitive, including various testing and most importantly, station rendezvous and docking with the space shuttle, are affected. A variety of manufacturing technology studies and processes to be carried out at the space station require low-g. The current space station design specification includes the requirement for an acceleration level of less than  $10^{-5}$  g because of the need to support these manufacturing and research activities. With a TORF, either these activities must be modified or eliminated, or the TORF must be retrievable to the station to allow the gravity gradient acceleration to drop below the design specification. One of the major reasons for baselining an intermittently-deployed facility is to minimize the time during which the space station acceleration exceeds  $10^{-5}$ g.



Rendezvous and docking with either the space station or the TORF by a free-flying spacecraft is much more complex when the TORF is deployed. This complexity arises from the displacement of the target from its nominal orbit and the resulting need to fly a complex rendezvous trajectory. Furthermore, during the necessarily short duration docking maneuver, the individual spacecraft centers of mass must be carefully controlled to keep the induced torques around the tether axis to a minimum. The entire rendezvous/docking process requires real-time computer control and relatively sophisticated hardware. This is another reason for baselining an intermittantly-deployed facility.

Aside from the above mentioned concerns, the effects on space station design and operation with a TORF appear to be straightforward. No single technical concern is insurmountable; however, in sum, the requirements pose a substantial challenge to today's state-of-the-art technology.

#### 4.2 OTV EFFECTS

The changes in OTV hardware needed to support a TORF are relatively small. Most of the necessary hardware is already included in the vehicle designs to support other operations. In general, these changes are no more complex than those needed for any other vehicle interface.

##### Dedicated OTV Hardware

The three main interface points on the OTV are the grapple pins, the docking point, and the fluid transfer system.

The OTV will need to have two grapple pins located on opposite sides of the vehicle. Two pins are necessary to stabilize the vehicle and payload. Current designs of the vehicle include only one grapple pin located near the aerobrake. Another pin could be mounted on the opposite side of the OTV at a structural hard point identical to that used for the existing pin.

The docking points on the OTV for the TORF can be the same points used by the OMV. The current design for the OMV payload berthing uses three latch jaws mounted on a berthing ring. The latches attach to the aerobrake support structure at a dedicated location. The OTV can detach from the OMV and reattach to the TORF OTV hangar with a minimum of additional maneuvering.

The final interface is the fluid transfer system. Several designs exist for a fluid transfer coupler, one of which is shown in Figure 4-1. The connector would be mounted on a self-damping spring to absorb some of the hook-up forces. The automatic umbilical actuator mounted on the TORF moves on a track to make contact with the OTV connector. One possible design would incorporate all the transfer lines in one unit and reduce the need for redundant hardware. The required line diameter (roughly 5 cm) for the cryogenic fluids may necessitate several units. The lines necessary for a successful fluid transfer include two fluid lines ( $LO_2$  and  $LH_2$ ), two vapor lines ( $GO_2$  and  $GH_2$ ), as well as electrical and command control lines. The fluid transfer connector should be mounted near a structure member to reduce the load. The connector will move in place once the OTV and payload have been stabilized on the payload ring and will need to be well insulated to accommodate the cryogenic fluids.

The lines leading between the connector and the fuel tanks will also need to be well insulated and constructed out of material that handles cryogenic fluids.

To vent the OTV while filling, the incoming liquid must not be allowed to slosh to the vent port. To prevent this, a baffle diffuser to dampen fluid velocities from the fill line must be added to the OTV tanks. Also, two additional lines between the OTV tanks and the TORF (one for each cryogen) are necessary to permit venting while filling.

An analysis was conducted to determine the chilldown process for warm, evacuated OTV fuel and oxidizer tanks. Traditionally, chilldown is cyclical and begins with the injection of a slug of cryogenic liquid into the warm, evacuated tank. The mass of the slug is calculated such that the slug may completely vaporize and reach thermal equilibrium with the tank without exceeding a specified pressure. After the slug has vaporized, the tank walls continue to heat the vapor and thermal equilibrium is approached. When the rate of tank wall cooling becomes sufficiently low, the vapor is removed, and the cycle is repeated until the tank reaches an acceptably low temperature.

The chilldown of the OTV tanks is not a significant problem because of their low mass-to-volume ratios:  $0.0047 \text{ g/cm}^3$  ( $0.29 \text{ lbm/ft}^3$ ) for the  $H_2$  tanks and  $0.0064 \text{ g/cm}^3$  ( $0.40 \text{ lbm/ft}^3$ ) for the  $O_2$  tanks. Relatively large slugs of liquid may be introduced as a result of the large tank volume, permitting chilldown in one or two cycles.

However, because the OTV tank masses are small and a gravitational field exists, it may be possible to effect OTV chilldown using simply a slow fill process. As filling begins, boiling will possibly occur at or near the bottom of the tank. If the fill rate is slow enough, the foam created by the boiling may be held down before reaching the tank vent port.

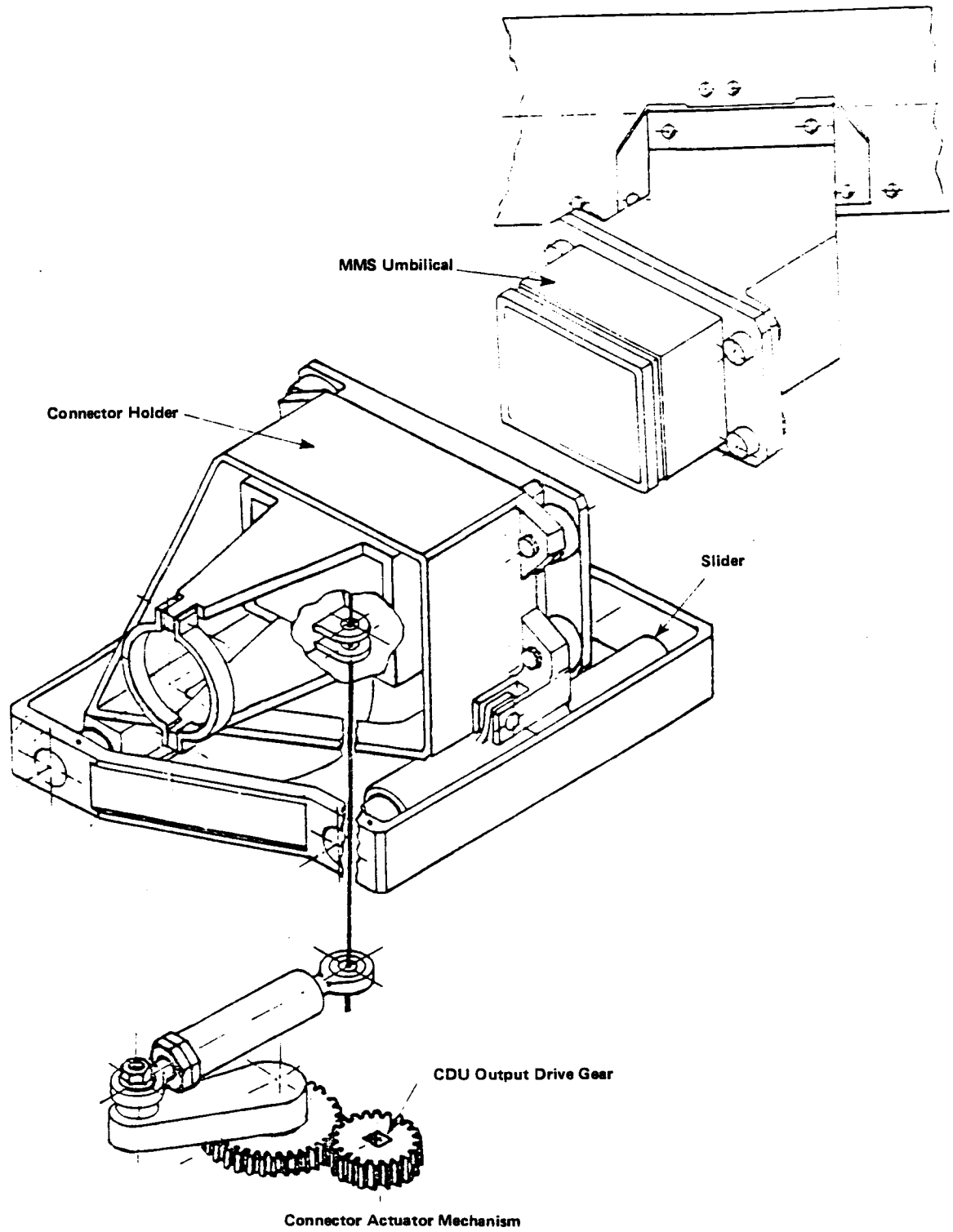

Figure 4-1 Fluid Transfer Coupler

The ullage may then be removed to maintain the desired tank pressure. Then, once a layer of liquid has covered the tank bottom, the fill rate may be increased because only local boiling along the liquid/ullage/tank interface will occur. A maximum generated vapor mass of 68 kg (150 lbm) of hydrogen and 68 kg (150 lbm) of oxygen was estimated for the OTV tank chilldown. In addition, 17 kg (37 lbm) of hydrogen and 30 kg (65 lbm) of oxygen are required to chill down to facility transfer lines, valves, and filters.

The decision to use a cyclical or slow fill chilldown process must be based on further analysis. The complexity of each technique (the ability to inject a measured mass of liquid, or the ability to control flow rate), the time required, and perhaps most importantly the mass of vaporized cryogen created must be considered. These considerations, when combined with TORF operating procedures and constraints, will determine which chilldown method is selected.

#### 4.3 PROPELLANT CONTAMINATION

Contamination associated with the propellant storage and handling system arises from propellant leakage. This leakage typically occurs because of tank overpressurization and can be deliberate as in the case of relief valve venting, or unintentional as in the case of a tank or valve failure. Leakage can also occur at nominal system pressure as a result of valve sealing failures or tank rupture by external processes (for example, meteoroids). Figure 4-2 illustrates the various stages of pressure-driven propellant leakage starting with nominal pressure leakage and ending with catastrophic tank rupture at very high pressure. Generally, as the propellant warms and the system pressure increases, a pressure relief valve would release. The vented fluids can lead to surface contamination as shown in Figure 4-2. If the pressure is allowed to continue to rise (i.e., a line restriction that does not allow pressure relief through the venting of propellant vapor), pin-hole leaks may occur through welds or around fittings. The amount of fluid released under these conditions will not only lead to surface contamination, but can also support chemical and thermal processes that can further degrade exposed system components. Continued pressure increase may cause the rupture of the tank along a seam or crack and may, in fact, lead to sufficient fluid leakage to cause measurable forces on the facility. Under very rare conditions, the tank may explode causing fragmentation of the tank and the concurrent hazard associated with fragments propelled at high velocities.

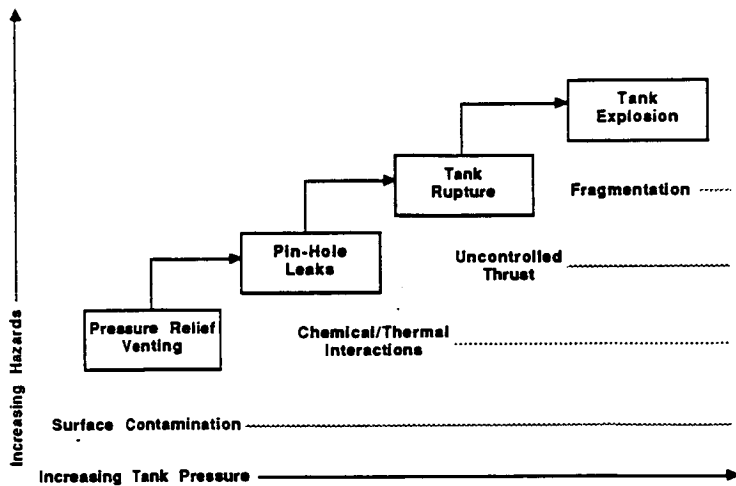

Figure 4-2 Overpressurization Hazards

#### Contamination

This section includes an assessment of the buildup of surface contamination on the space station and TORF by contaminants emanating from the TORF. Because gases leaking from the TORF will essentially distribute themselves uniformly as they leave the TORF, the concentration of contaminants at the space station will be an inverse function of the distance between the two facilities (i.e., the length of the tether) squared.

As a liquid is forced from a pressurized tank through a ruptured wall or some other opening, it will vaporize as a result of the pressure differential between the tank pressure and the pressure in space. In a particular droplet, the outermost surface will vaporize and cool the remainder of the droplet until either the entire droplet has vaporized or the remaining core has solidified.

As fluid moves through a vent opening from the tank to open space, it will accelerate to a velocity given approximately by Bernoulli's equation. For liquid oxygen stored at 138 kPa (20 psi), the velocity becomes roughly 15 m/s (50 ft/s). At this velocity, a solid particle will travel 915 m (3000 ft) (the nominal space station/TORF separation distance) in one minute. If it is assumed that solids are formed and that solar flux will be absorbed by 50% of the surface area of each solid particle, the maximum sized particle that will vaporize during the flight from the TORF to the space station is about 1 mm. Every larger particle could impact the space station, but will be smaller in size than when it left the TORF. It is not expected that any of these larger particles will form in the spray, but some solids of the 1-cm size may form around the leaking hole and break away.

The allowable levels of space station contamination are listed in the space station Phase B Reference Design. During quiescent operations, the allowable molecular deposition levels are 40 A/year on a 4 K surface and 100 A/year on a 298 K surface at sensitive instrumentation locations. It was assumed that 4 K infrared sensors are located in the Earth observation position and at the upper end for astronomical observations. As a worst-case scenario, it was assumed that each of these 4 K sensors has a direct line of sight to the TORF. Sunshades and off-axis orientations decrease the deposition rate and therefore are less critical. No analysis was done on deposition other than line of sight.

Cryogenic Propellants--The first case considered in this analysis assumes a constant leak rate and a spherical distribution of gaseous contaminants emanating from the TORF. This source of leakage was assumed to be three oxygen line or three hydrogen line pressure relief valves, each leaking gas at 1000 cm<sup>3</sup>/hr. The leakage could also be from pin-hole leaks resulting from holes in the welds, etc. The leakage rates are  $2.39 \times 10^{-3}$  g/sec and  $1.51 \times 10^{-4}$  g/sec for oxygen and hydrogen, respectively.

Other assumptions related to this analysis are that (1) water permanently adheres to a 4 K surface but will not deposit on a 298 K surface; (2) oxygen and hydrogen initially condense on a 4 K surface, but reevaporate as a function of their vapor pressure; (3) neither oxygen nor hydrogen will deposit on a 298 K surface; and (4) oxygen and hydrogen contain 75 ppm and 1 ppm of condensable contaminants, respectively.

The mass flux at a distance of 915 m (3000 ft) between the TORF and the space station is  $2.28 \times 10^{-4}$  g/cm<sup>2</sup>-s and  $1.45 \times 10^{-15}$  g/cm<sup>2</sup>-s for oxygen and hydrogen, respectively.

To consider reevaporation, the Langmuir-Knudson relationship can be used to convert vapor pressure to evaporation rate. Given existing uncertainties, the evaporation rates for solid oxygen and solid hydrogen are calculated at the vapor pressure of the solid.

The calculated oxygen and hydrogen vapor pressures at 4 K are zero and approximately  $2.4 \times 10^{-7}$  torr, respectively. The hydrogen evaporation rate is calculated using the Langmuir-Knudson equation and is  $1.0 \times 10^{-8}$  g/cm<sup>2</sup>-s. Because the vapor pressure of oxygen is very low, it is assumed that there is no evaporation of solid oxygen from a 4 K surface. Therefore, a constant 3000 cm<sup>3</sup>/hour leak at 915 m (3000 feet) to a 4 K sensor will deposit 55 A/year. Increasing the tether length to 950 m (3500 ft) will reduce this deposition to the allowable level of 40 A/year. The hydrogen evaporation rate ( $1.0 \times 10^{-8}$  g/cm<sup>2</sup>-s) is several orders of magnitude greater than the deposition rate ( $1.45 \times 10^{-15}$  g/cm<sup>2</sup>-s) so no hydrogen will accumulate on 4 K surfaces.

At 298 K, the temperature is well above the critical points of both hydrogen and oxygen so no liquids will condense. If it is assumed that 75 ppm of impurities are available and condensable, the deposition rate is 0.0026 A/year at 915-m (3000-ft) separation.

The second case considered includes pressure relief valves that leak only during 18 fill or drain events each year (6 scavenging, 6 shuttle resupply, and 6 OTV propellant transfers). It is assumed that each event takes 6 hours so the time of the leak is 6 hours. Under these conditions, the total time that the valves leak is 108 hours. Because these are less stringent conditions than the first case and hydrogen did not deposit during Case 1, it will not deposit under these conditions. Oxygen will deposit on a 4 K surface at the rate of 0.68 A/year at 915-m (3000-ft) separation. Shorter tether lengths will lead to greater deposition rates, and the allowable rate of 40 A/year will be reached with a 119-m (391-ft) tether, that is significantly shorter than that required for fluid dynamic reasons.

In summary, the expected operational condition of Case 2 results in contamination within acceptable limits for tether lengths as short as 119 m (391 ft). Even Case 1, that represents a worst-case operating condition, is acceptable for a tether length of 950 m (3500 ft). Operation of a zero-g fluid storage facility on the space station will require shutdown and protection of sensitive instrumentation with a cover during fluid transfer operations to ensure contamination remains within acceptable limits. For the expected operational condition on the TORF (Case 2), this instrumentation can be operated continuously with no concern for what is occurring at the refueling facility. This represents a significant simplification of station operations and benefit to the scientific payload users on the station.

Earth-Storable Propellants--Two separate configurations for storable propellants are considered. The first configuration is a monopropellant hydrazine storage depot with 5450 kg (12,000 lbm) in a single tank. The second configuration is a bipropellant  $N_2O_4$ /MMH storage depot with 3390 kg (7472 lbm) of MMH and 2056 kg (4528 lbm) of  $N_2O_4$ . Hydrazine, MMH, and  $N_2O_4$  are all gases at low pressure at 298 K, thus none of these will deposit on sensitive surfaces at this temperature; however, significant deposition can occur on 4 K surfaces. Furthermore, these propellants do contain condensable impurities that can deposit on both 4 K and 298 K surfaces.

For the monopropellant hydrazine configuration, consider a situation where three valves each leak gas at  $1000 \text{ cm}^3/\text{hour}$  during 18 6-hour propellant transfers each year. Using the space station contamination criteria described above and a tether length of 915 m (3000 ft), three valves cause a 1.6 A/year deposition on a 4 K surface. This is about 4% of the allowable, annual thickness. A spherical distribution of the propellant vapor results in 0.75 A/year or about 2% of the annual deposition thickness on a 4 K surface. The deposition of hydrazine nonvolatile residues and carbonaceous materials, assumed to be the only condensables on a 298 K surface, is insignificant ( $3 \times 10^{-4}$  A/year).

For the bipropellant system configuration using monomethylhydrazine (MMH) and dinitrogen tetroxide ( $N_2O_4$ ) assume that three valves in the MMH system leak and three valves in the  $N_2O_4$  system leak, all at the rate of  $1000 \text{ cm}^3$  of gas per hour during 18 propellant transfer operations. The results are that 3.6 A of MMH (liquid) and 3.7 A of  $N_2O_4$  (liquid) will condense on a 4 K surface in one year. The results are expressed in terms of liquid film thickness only because the densities of these solids were not available. The total liquid film thickness is 7.3 A or 18% of the allowable limit. The solids are expected to be more dense and, as a result, the film thickness will be smaller than the liquid film thickness.

For deposition on a 298 K surface, the condensible concentrations in each propellant must be known. MIL-P-27404B does not specifically define 0.2% of the MMH composition, so it was assumed that this 0.2% is composed of condensible contaminants. Similarly, the undefined composition added to the chloride concentration in the  $N_2O_4$  specification is 0.33%. These condensables deposit 9 A/year or 9% of the allowable thickness.

#### 4.4 HAZARDS

A tethered orbital refueling facility is subject to all the potential hazards associated with a zero-g facility on the space station, except their effect is greatly reduced by the TORF remote location. Propellant spillage as a result of leaking valves, tank punctures, fluid coupler disconnects, or tank venting has a much smaller effect on space station operations because the resulting vapors disperse over a much larger volume before affecting sensitive instrumentation. Catastrophic failures resulting in free-flying debris also have a smaller effect for the same reason. In fact, for tether lengths of over roughly 152 m (500 ft), space station operations can be carried fully independently of TORF operations, resulting in considerable simplification of the station operations planning, unlike the requirements imposed by a zero-g fluid storage facility.

The TORF also has some potential hazards not found with a zero-g facility including uncontrolled libration and tether breaking. These hazards are extremely remote by design and can be minimized by using a combination of TORF and space station propulsion. Furthermore, a guillotine system on the space station can sever the tether, if necessary to minimize the effects on space station.

The tether tension for the nominal design point of 915 m (3000 ft) is approximately 112 N (25 lbf). Should the tether break, the reaction would cause the TORF and the space station to enter diverging elliptical orbits. These orbits were evaluated earlier in this study and the results are discussed in the first interim report. A concern with tether breaking is the potential deorbit into the Earth's atmosphere of the lower spacecraft as it moves into an elliptical orbit



from the nominal circular orbit before the break. The earlier analysis evaluated this possibility assuming an elliptic orbit with a perigee altitude of 185 km (100 nmi) representing a deorbit condition. For a nominal tethered system orbit of 463 km (250 nmi) altitude, a tether length from system center of mass to the lower vehicle (either the space station or the TORF) of over 23 km (14 mi) is necessary to cause a deorbit, even under worst-case libration. Because the tether lengths required for slosh control on the TORF are less than a mile in total, there is no danger of deorbit should the tether break.

There are potential hazards associated with the tether backlash in the event of a break. The major hazard involves tangling of the broken tether with the space station configuration, especially the large solar arrays. To prevent this occurrence, the tether system must incorporate a guillotine that can cut the tether at the station immediately following a break. This guillotine can also be used to intentionally sever the tether, if it becomes necessary because of uncontrollable TORF libration, etc.

In general, the reduction in fluid storage and handling system hazards as a result of the remote location of the TORF appear to outweigh the addition of those specific hazards associated with a tethered system. This reduction in overall hazard relative to a zero-g onboard system represents a major advantage of the TORF concept.

#### 4.5 SUMMARY

The TORF hardware interfaces with the space station include the tether reel mounting and facility berthing equipment. The interfaces are no more complex than many other systems associated with the space station.

The major TORF hardware interfaces with its associated OTV are the berthing points, the fluid transfer connector, and the grappling device. The OMV program has defined a berthing port design and a fluid transfer coupler. Similar berthing points and couplers are being included in the current TORF design. The OTV handover from the OMV to the facility can be simplified by using the same interfaces.

To allow an OTV tank vented fill, the OTV tank inlets must incorporate a velocity diffuser to ensure that the incoming propellant settles to the tank base without sloshing to the required vent port. This requirement could be alleviated if a no-vent fill process is used.

An important area of concern with any propellant storage facility are the potential hazards (including contamination) to the space station because of facility operations. Based on the analyses completed during these studies, it appears that the potential contamination for a TORF is less than what would be expected from an attached facility. Furthermore, other potential hazards of a TORF appear to be no more of a concern than those of an attached facility, provided good design practice is followed.

Aside from the above mentioned concerns, the effects on the space vehicle operations and hardware with a TORF appear to be straightforward. No single task seems insurmountable, but all the concerns taken together pose a challenge to today's state-of-the-art technology.

## 5.0 MISSION OPERATIONS

---

It appears, from previous analyses, that the most significant difference between a TORF and a zero-g system on the space station is the mission operations. Furthermore, the differences between a permanently-deployed fluid storage facility and an intermittently-deployed facility need to be defined. The objective of the task was to define techniques for conducting operations on a tethered propellant resupply depot. All phases of the TORF operational life, including assembly, deployment, day-to-day use, and refurbishment were examined with the objective being to minimize the operational complexity and maximize the advantage of the tether system. Ultimately, the chosen tethered facility was compared to a zero-g facility to determine which facility is more beneficial to fluid transfer.

The operations are quite varied and many different possibilities exist. To clarify and simplify the analysis, several groundrules were set. The groundrule assumptions include: the system is a single tether with the tether length nominally 305-915 m (1000-3000 ft), all shuttle dockings occur at the space station, and all OTV servicing (except emergency) occurs at the facility. Previously defined operations from the Martin Marietta OTV program and space station program were used in the analysis, with tether-specific operations added.

Early analysis identified several operations as being important for differentiating between a tethered facility and a zero-g facility. Two major trade studies were identified: upward or downward deployment and permanent or intermittent deployment. The facility is considered upwardly deployed when the facility is in a higher orbit than the space station. The decision of upward or downward deployment was based on space station effects and facility effects. This trade study had to be resolved before the permanent or intermittent trade study could be completed. A concern associated with the permanent facility is the method of transporting materials between the space station and TORF. Two choices were identified that consist of a free-flyer vehicle or a tether traversing mechanism. The investigated operations include: OTV refuel and refurbishment; facility resupply; transport of materials, vehicles, payloads and astronauts; and OTV launch.

The space station configuration used in the operations study was the Martin Marietta twin-keel configuration. This is an update of the power tower configuration. Two configurations for a tethered facility were considered in the trade studies. Figure 5-1 illustrates the permanently-deployed hangar configuration. The hangar is deployed 915 m (3000 ft) away from station and attached to the station via a tether. The tether platform is mounted on the station top boom among the experiments. The hangar contains all the OTV servicing and maintenance equipment, the hangar maintenance equipment, and the fluid storage and transfer system. The facility is self-contained and requires minimum maintenance. The vehicle payload and supplies are delivered to the hangar with a free-flyer vehicle (OMV) or using a tether traversing vehicle (crawler). The hangar and fluid storage tanks have a combined mass of 136,000 kg (300,000 lbm) and the space station mass is approximately 350,500 kg (700,000 lbm).

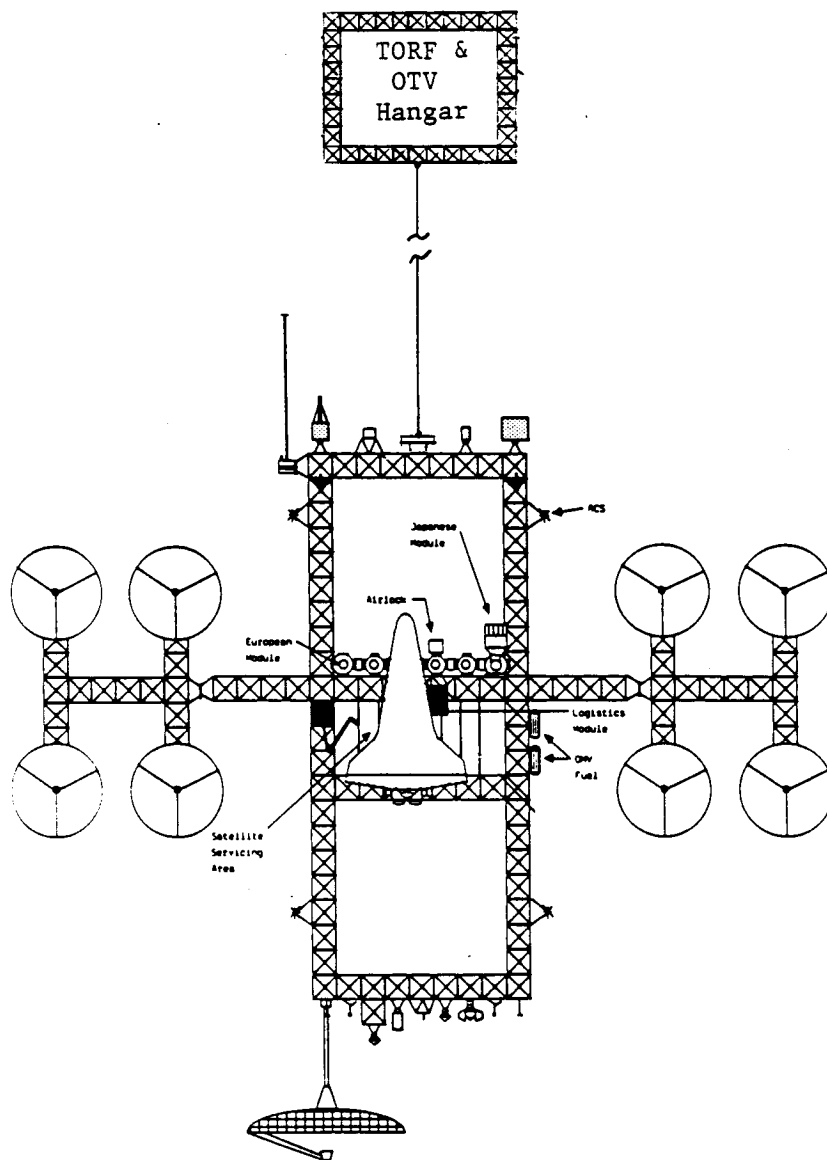

Figure 5-1 Permanently Deployed Facility

The other tethered configuration is an intermittently-deployed hangar as shown in Figure 5-2. The hangar is deployed only for fluid transfer into the OTV or into the facility. The hangar is nested inside the twin keels of the space station. The upper boom on the station must be extended over the sides of the station to move the space viewing experiments away from the hangar path. An alternate location for the experiments is on the hangar. The concern with this alternative is that the experiments are reeled away from the station for every fluid transfer and the hangar is not stable. Space viewing instruments would be jostled during every fluid transfer. The internal hangar configuration is identical to the permanently-deployed facility. The hangar is a standalone structure that contains all the OTV servicing, hangar maintenance equipment, and the fluid handling system.

All OTV operations are performed in the hangar regardless of facility configuration. The OTV design used in the study is shown in the facility design section, Figure 2-5. The design shown is the space-based, OTV with aerobrake that requires 20,400 kg (45,000 lbm) of propellant, can deliver a 7300-kg (16,000-lbm) payload, and has a dry mass of 3200 kg (7000 lbm). The OTV and payload are stored in the hangar between missions and all servicing is done in the hangar. A groundrule of this study is six OTV missions per year. A space station requirement dictates that the OTV cannot operate its engines within one kilometer of the station. Therefore, the OTV must either be transported away from the station by the OMV or the OTV's orbit changed by releasing it from the tethered facility, using the velocity difference between the tethered facility and the space station.

The OTV refurbishment requirements are dictated by the mission frequency. Component maintenance and replacement is required on a periodic basis. The Martin Marietta OTV program has defined refurbishment needs for the vehicle and refurbishment operations as being limited to modular replacement because no repair is to be performed on station. All operations are performed using robotics and intravehicular activity (IVA). No extravehicular activity (EVA) work will be done except in emergency and contingent situations. The maintenance includes vehicle inspection, leak checks, and component testing. The replacement operations will consist of removal and storage of old units, installation of new units, and checkout of new units. The OTV study has advised that the fluid transfer system be located in the hangar to ensure the time between OTV release and main engine ignition is less than eight hours.

Every mission will require some time for checkout and refurbishment. Figure 5-3 illustrates the refurbishment time per mission but only reflects 1/2 of the total 10-year lifetime of the facility. The requirements for the second half of the lifetime are very similar to the initial five years. The graphs show periodic replacements of components. The refurbishment frequency is dependant on the component. The nominal replacement schedule accounts for an engine replacement every 10 missions, an aerobrake replacement every 5 missions, propellant tanks replacement every 30 missions, and RCS tanks replacement every 5 missions. The total OTV refurbishment, refuel and launch operation requires approximately 50 hours every 60 days. Hangar refurbishment occurs approximately every three years.

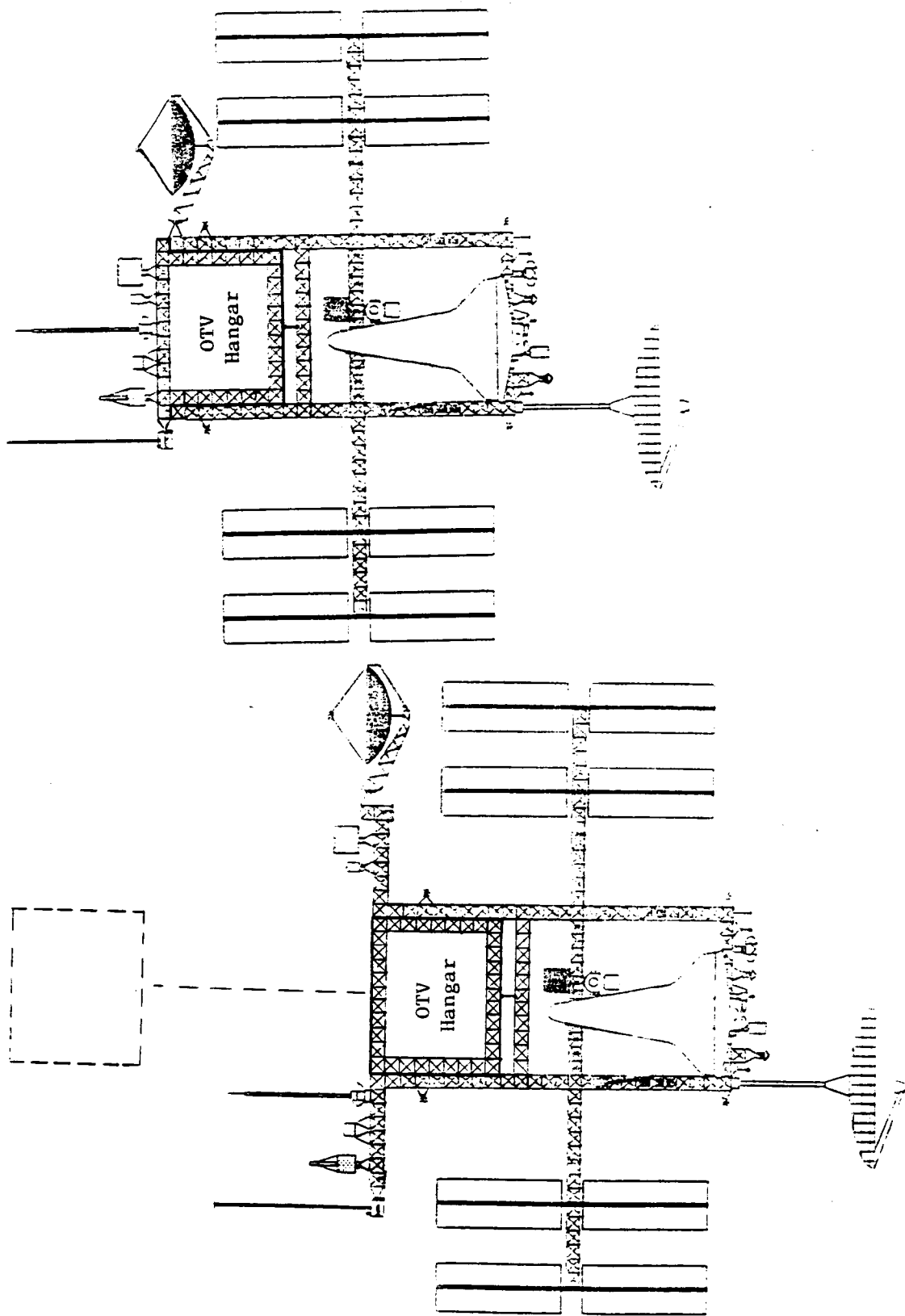
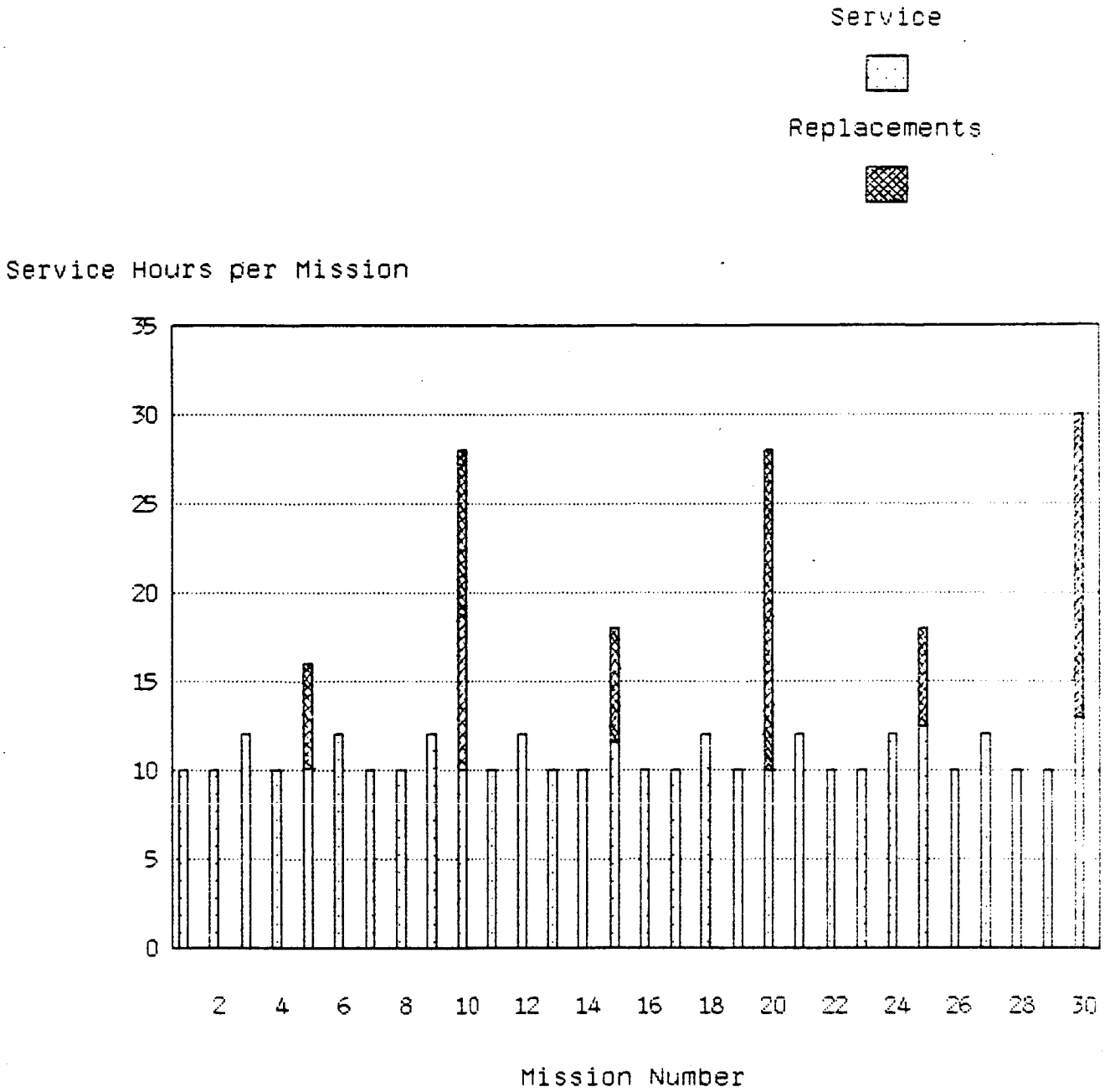

Figure 5-2 Intermittently Deployed Facility



*Figure 5-3 OTV Refurbishment Timeline*

The facility resupply is an operation of importance to the trade studies. Two options exist for resupply. The fluid system can have a dedicated tanker that delivers propellant on the shuttle and requires one and a half shuttle flight every OTV mission (approximately every month and a half). The other option is to use a scavenging unit to remove residuals from the external tank (ET). The scenario requires a scavenging mission approximately every two weeks and dramatically increases the frequency of fluid transfer. This affects the tethered facilities by increasing the frequency of facility reel-out or tether traversing.

5.1 UPWARD VERSUS DOWNWARD DEPLOYMENT

The decision of upward or downward deployment is dependant upon several factors. These factors include space station operations, OTV launch, communication, and vehicle rendezvous. The deployment direction concerns are shown in Table 5-1. The table shows an assessment of an upwardly deployed facility.

Table 5-1 Deployment Direction Concerns

Upward Deployment	Advantages	Disadvantages
Earth Viewing	No Obstruction	-
Space Viewing		- Minor Obstruction
Facility Viewing	Easier To See Facility From Space Station	-
Communication	No Interference with Direct Earth Communication	Could Interfere With Satellite Contact
OTV Launch	Tethered Launch Can Be Coupled With Tethered Shuttle Deboost; No OMV Usage	-
Vehicle Rendezvous with Space Station	Reduces Interference with Shuttle Rendezvous Maneuvers	
Tether Attach Point	Does Not Interfere with Instruments on Lower Keel	Interferes with Instruments on Upper Keel
Tether Breaking		Lowers Space Station Altitude



A concern exists with viewing of the Earth, space, and the facility. The upward facility does not interfere with Earth viewing whereas the downward deployment interferes with most Earth viewing. A space-oriented facility does not interfere with Earth communication, but could interfere with satellite contact. Space station operations are not as affected by upward deployment. The shuttle rendezvous maneuvers are less constrained because the tether is not on the lower end of the station. The OTV launch is enhanced by releasing directly from the space-oriented hangar. This eliminated the need for an OMV to move the OTV/payload away from the space station. The OTV launch can be further enhanced by reeling the OTV out from the deployed hangar on another tether system. The OTV launch can be coupled with a shuttle deboost to transfer momentum and reduce the overall effect of the launches on the space station.

An effect of the upwardly-deployed facility is on the experiments and instruments on the upper keel. The tether must not come in contact with the instruments and the facility must not block the view of the instruments for any extended length of time. Another concern is the effect of a tether severing. An upwardly deployed facility will cause the space station altitude to drop. Comparison of the advantages and disadvantages of upward deployment leads to the conclusion that the upward deployment is more advantageous. Overall, upward deployment appears more feasible and is recommended for the tethered facility.

The possibility of the tether breaking during orbital operations is a valid concern with the tethered facility. The space station orbit could decay to an unacceptably low altitude where aerodynamic drag would cause a total deorbit. The space station is in danger of deorbit at an altitude of 185 km (100 nmi). The conditions (tether length and libration motions) that would cause the space station to have an elliptical orbit with a perigee of 185 km (100 nmi) have been examined. Assuming an initial nominal system orbit of 463 km (250 nmi), a space station mass of 340,000 kg (750,000 lbm), and facility mass of 136,000 kg (300,000 lbm), the configuration illustrated in Figure 5-4 shows that the space station is at its apogee at the instant the tether is cut.

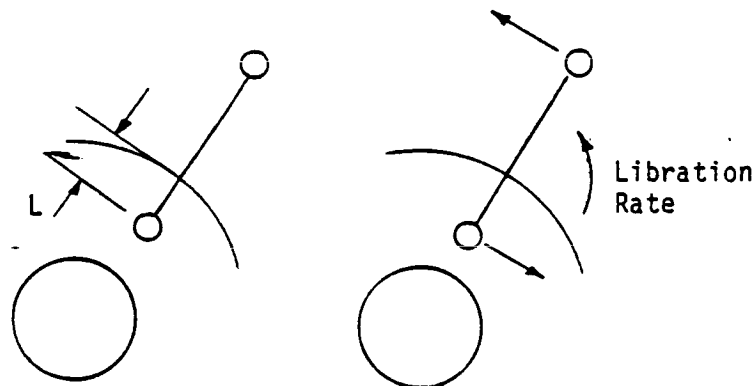

No Initial Libration With Initial Libration

Figure 5-4 Configuration at Tether Break

Orbital equilibrium can be described by:

$$[1] \quad \frac{1}{R} = \frac{GM_e m^2}{P_a^2} (1 - \epsilon \cos \phi)$$

where R is the instantaneous radius, G is the universal gravitational constant,  $\phi$  is the angle relative to perigee,  $P_a$  is the angular momentum equal to  $mR^2\dot{\theta}$ .  $M_e$  is the Earth mass, m is the body mass, and  $\epsilon$  is the orbit eccentricity.

For the nominal orbit where  $\dot{\phi}$  is the angular rate,

$$[2] \quad \dot{\phi} = \frac{GM_e}{R_o^3}$$

The initial condition for the space station in an elliptical orbit the instant the tether breaks is;

$$[3] \quad P_a = mR_a^2\dot{\theta}$$

For  $R_p$  equal to 6540 km (4065 mi) and  $R_o$  equal to 6818 km (4237.5 mi), the equation can be solved for  $\epsilon$ , which results in a value of 0.01763 for  $\epsilon$  and  $R_a$  equals 6774 km (4210 mi).

The equations 5-1, 5-2 and 5-3 can be combined to obtain:

$$[4] \quad R_a^3 = R_o^3 (1 - \epsilon)$$

Perigee and apogee are related by:

$$[5] \quad R_a = \frac{1 + \epsilon}{1 - \epsilon} R_p$$

For small  $\epsilon$ , the equations [4] and [5] may be combined and written as

$$[6] \quad R_p^3 = R_o^3 \frac{1 - 4\epsilon}{1 + 3\epsilon}$$

This leads to a tether length of 44 km (27.5 mi), which is the distance from mass center to space station. The tether length is related to L by the equation:

$$\text{Tether length} = L \left( 1 + \frac{m_{\text{TORF}}}{m_{\text{SS}}} \right)$$

which is 62 km (38.5 mi). The baseline tether length of 915 m (3000 ft) is much shorter than the 62 km tether necessary to deorbit the space station. Therefore, there is no concern of a deorbit associated with a tether break.

## 5.2 PERMANENT VERSUS INTERMITTENT DEPLOYMENT

Once the decision of upward deployment was made, the evaluation of the other major trade study could be completed. The objective of the study was to determine whether the facility should be intermittently or permanently deployed. A series of steps were followed to evaluate the facility deployment. Initially, operating scenarios were defined for both the permanent and intermittent facility. The scenarios included design and fabrication of hardware, launch, assembly, deployment, and day-to-day activities. These scenarios were used to identify the major

drivers of each deployment option. The major drivers and concerns were then investigated to determine their effect on the overall design. The effects were assessed to identify the recommended deployment option.

The operating scenarios for the permanently and intermittently deployed facility cover the entire lifetime of the facilities. Figure 5-5 illustrates the sequence of operations for the permanent facility. Differences can be seen between the permanent scenario and the intermittent scenario shown in Figure 5-6. The major differences involve the fluid transfer operations.

The initial steps of both scenarios involve facility design, construction, launch, installation, and check-out. The hardware included in these steps are propellant tanks and plumbing, hangar materials, tools, tether, tether attach point controller, tether platform, reel mechanism, and the onboard propulsion system. Differences exist in the hardware of both facilities. The permanent facility will require a tether traversing mechanism (crawler), which involves a significant amount of design and development.

Once the hardware is installed and checked out, propellant must be delivered to the facility. In the scenarios, the propellant is delivered using a tanker. Several flights are needed to initially fill the facility to capacity. When the facility is fully operational, the nominal operations for the permanent facility, shown in Figure 5-7, will be implemented. The operations cover everything from OTV mission preparation to refurbishment. The scenario shows several dark outlined boxes to represent optional operation. The current OTV mission model does not include astronaut support for payload integration or OTV refurbishment. In the event of astronaut EVA, the scenario reflects the transportation of astronauts between the space station and the facility. This concern is eliminated with the intermittent facility because all servicing is performed with the facility at the station.

Some concerns became apparent from the scenarios. One concern with the permanent facility is maintaining a gravity level of less than  $10^{-5}g$  on the space station. This requirement can be met by installing a counterbalance on the opposite side of the station. An adjustable, tethered counterbalance can either be another tethered facility or a dedicated mass. A permanently-deployed counterbalance allows for a typical vehicle docking at the station, but considerably increases the overall mass. The counterbalance is needed for the permanent facility to maintain the  $10^{-5}g$  level, yet even with this structure, the g-level can be exceeded during OTV launch and tether length adjustment periods. The problem is aggravated by the fact that the center of mass would be constantly shifting as propellant is on- and off-loaded and as OMVs, OTVs, and shuttles are docked and undocked at various locations on the space station and TORF.

To better define the magnitude of the center-of-mass fluctuations, the center-of-mass location was analyzed for a wide variety of scenarios, including full and partially full TORF/space station combinations, with and without the space shuttle and/or OTV docked to the TORF. The results indicate that, even within a given design concept, the center of mass can fluctuate over locations spanning 50% of the tether length as various fill and docking operations are carried out.





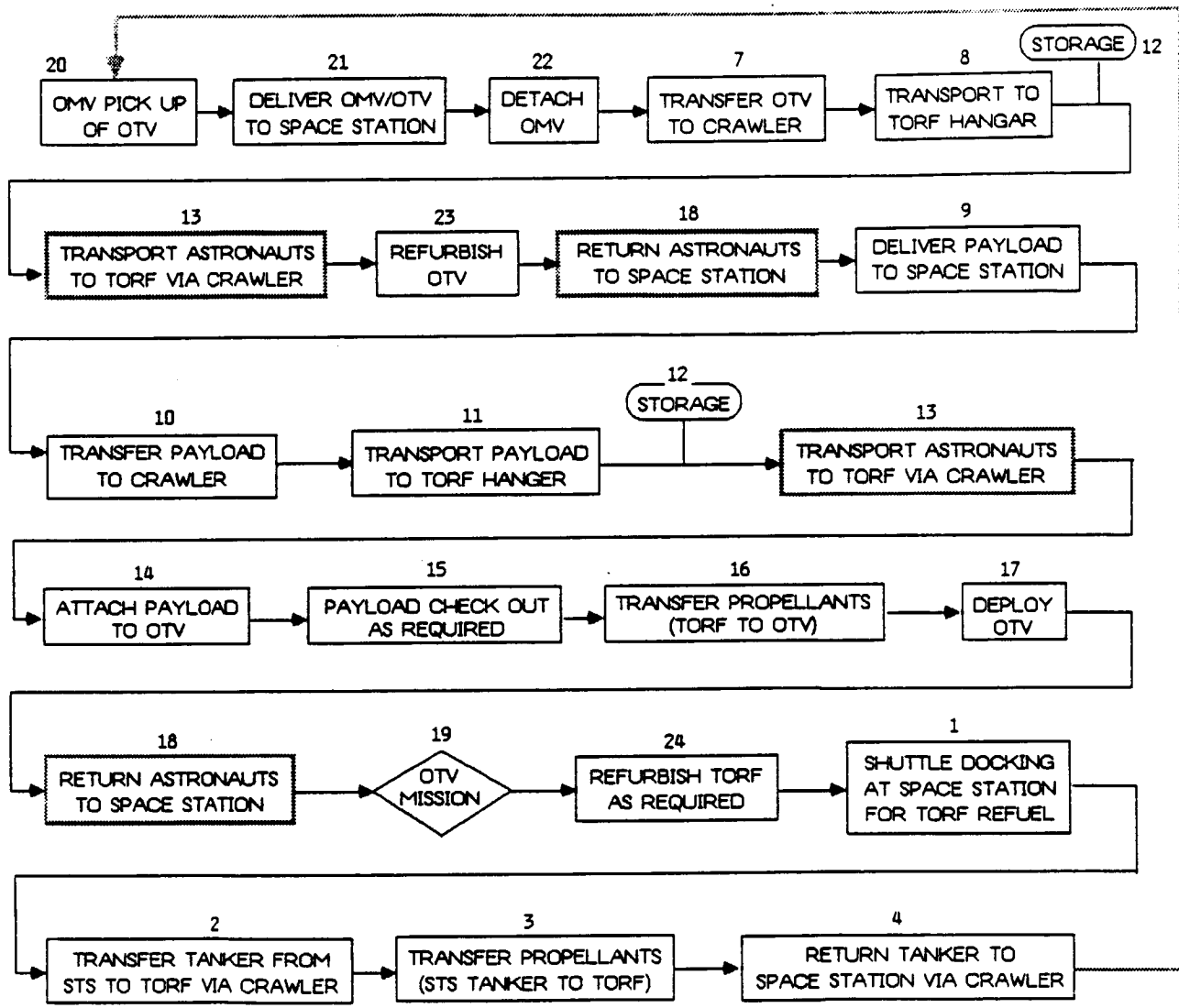

Figure 5-7 Nominal Operations for the Permanently Deployed TORF

Another concern with the permanent facility is the transportation system between the facility and the space station. Various payloads must be transported to the hangar on a periodic basis. The transportation system is responsible for transporting the OTV, astronauts, payloads, servicing parts, and fuel between the space station and the facility. Several requirements are imposed on the system. It must transport materials in a reasonable amount of time, secure and protect the transporting articles, and transport payloads of variable size and mass. Two systems were considered for this application, a free-flyer vehicle like the OMV and a tether traversing vehicle known as a crawler.

A free-flyer vehicle design is already being developed and many analyses have been done. The OMV baseline design is capable of moving relatively massive payloads, but its range and speed decreases with the mass of the payload. The transport time between the station and the facility is dependant on the orbital path. If the vehicle follows Hohmann transfer paths, the transfer time is on the order of hours. A direct R-bar approach results in a shorter transport time (on the order of an hour) but it increases the propellant usage. Either approach leads to a difficult rendezvous because the facility is in a non-Keplerian orbit. The rendezvous requires a fly-by maneuver and must be completed in less than one minute unless active OMV control is used. The rendezvous difficulties arise from the tethered configuration.

The TORF is displaced from the overall system center of mass by a distance that may be up to one or two miles. Accordingly, the orbital velocity of the TORF will not correspond to that given by an ordinary Keplerian orbit at the actual TORF altitude. For a vehicle to rendezvous and berth with the TORF, it must be in an orbit with the appropriate altitude and must also match the TORF velocity. The most straightforward approach to accomplish this is to be in an elliptical orbit with an apogee or perigee altitude and velocity equal to that of the TORF. If the TORF is deployed above the space station, the elliptical orbit should have a perigee with the required characteristics, so that relative to the TORF, the vehicle drops down to it. If the TORF is deployed below the space station, the elliptical orbit should have an apogee with the required characteristics, so that relative to the TORF, the vehicle climbs up to it.

In the Selected Tether Applications in Space (STAIS) study, a rendezvous between an OTV in a 370 km (200 nmi) by 487 km (263 nmi) orbit and a tethered spacecraft deployed from a space station in a 500 km (270 nmi) circular orbit was analyzed. The tether length was chosen to be 13 km (7 nmi) so that its altitude would match the apogee altitude of the OTV orbit. If the exact conditions are met, the relative velocity between the OTV and the tethered spacecraft will be zero at intercept. Figure 5-8 is taken from the final report of STAIS, and shows the relative motion of the OTV with respect to the tethered spacecraft near rendezvous. The figure shows how rapidly the relative position and velocity changes from one minute before intercept to one minute after intercept. This type of operation is much more time constrained than typical rendezvous maneuvers carried out by two free-flying spacecraft. To complete such a rendezvous will required sophisticated control techniques and hardware not yet available.

Certainly during the final phases of the rendezvous, computer control will be required because of the speed of the process. In addition, some sort of remote manipulator arm will be needed to grab hold of the OTV at the intercept.

The intercept of an OTV with a TORF at the end of a 1 km (0.5 nmi) tether will be somewhat less difficult than the previous example (13 km tether), because the relative velocities will be smaller. An analysis was completed that examined the rendezvous maneuver for a space station/TORF system under the assumption of no active vehicle control. The analysis evaluated the time available for a vehicle rendezvous based on the separation distance between it and the facility. Figure 5-9 illustrates the separation distance between the vehicle and facility as a function of time for various tether lengths. The graph actually shows a reverse rendezvous maneuver with the facility and vehicle initially attached at time zero and drifting apart as time progresses. The actual rendezvous maneuver can be accomplished when the separation distance is less than 15 m (50 ft). Therefore, for a 915 m (3000 ft) tether, the rendezvous must be completed in less than 30 seconds. Historically, this type of rendezvous has not been completed in that short of a time. This tends to move the decision away from a free-flyer vehicle transport of materials.

An alternate means of transporting payloads is to use a tether traversing vehicle such as a crawler. The crawler has the same constraints as the free-flyer, and in addition, must account for center-of-gravity offsets caused by unevenly distributed masses, minimally abrade the tether, and not cause excessive librations in the system. The crawler will require more complex tether equipment, but it eliminates rendezvous concerns and requires no fuel mass (just power). A dynamics analysis shows a traverse time of approximately two hours.

Two concepts were developed for a crawler. One design consists of a docking mechanism mounted externally on a truss platform. The other concept is a minihangar with the docking mechanism enclosed in a complete structure. They both can carry the various payloads for transport. Figure 5-10 illustrates the external carrier crawler. The payload or vehicle is attached to the crawler on the docking mechanism and is suspended away from the truss structure. The torque produced by the offset mass is compensated by the tether tension torque produced by a tipping crawler. The crawler tip angle increases with the payload mass and with increased distance from the center of mass of the space station/TORF system. The drawback of this concept is that the center of gravity (CG) control is complex and can be difficult to maintain.

The alternate concept for the crawler is the internal carrier as shown in Figure 5-11. The crawler is essentially a large box that can hold the vehicle and/or payload. The crawler traverses the tether by using a series of pulleys and completely encloses the vehicle to protect against debris and contamination. This concept eliminates the CG control concern of the external carrier but it makes the payload handover difficult. The primary advantage of the internal crawler is it has a fixed attitude for any payload mass. The internal carrier concept appears to be more promising than the external carrier, but no final decision has been made.



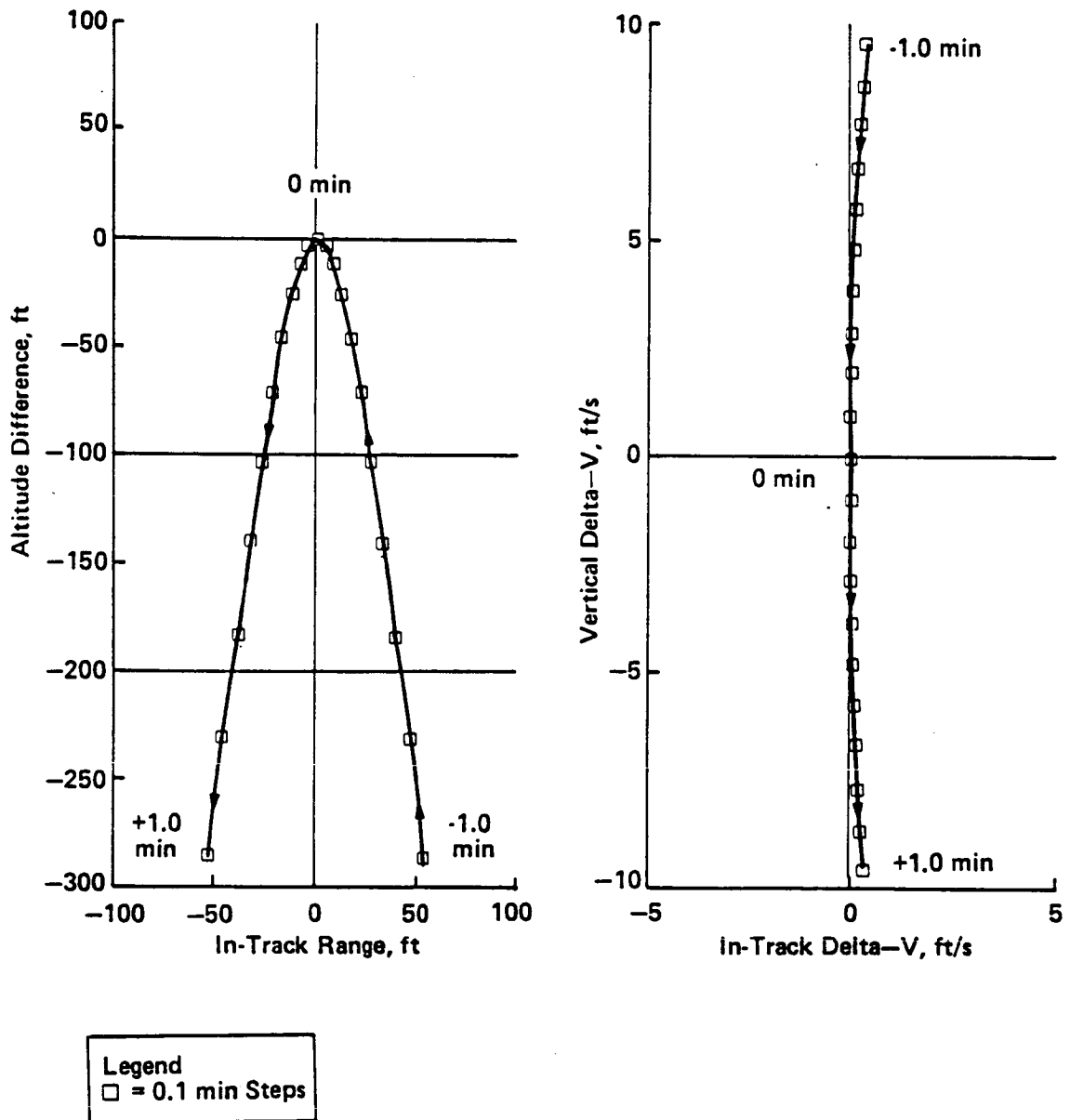

Figure 5-8 Relative Motion of OTV with TORF Near Rendezvous

OTV/TORF RENDZVOUS  
FROM 0 TO 300 SEC

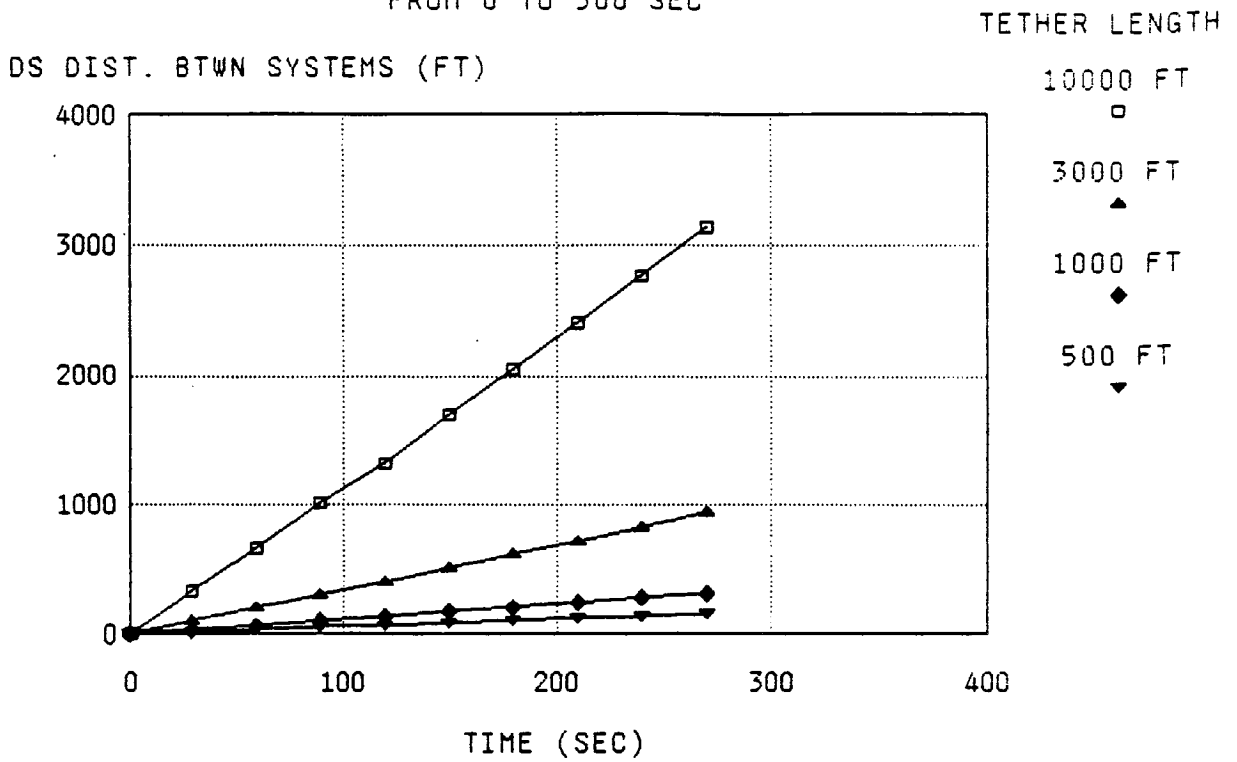

Figure 5-9 Separation Distance between OTV and TORF

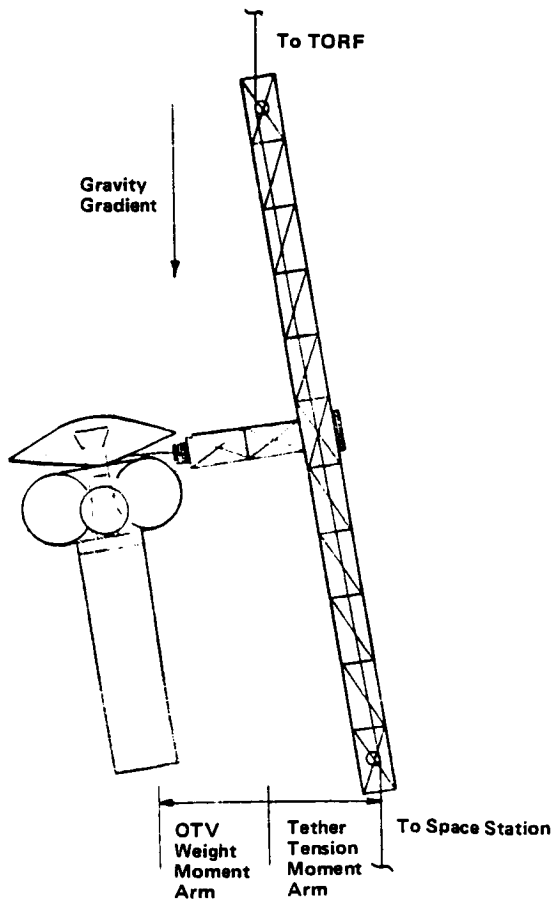
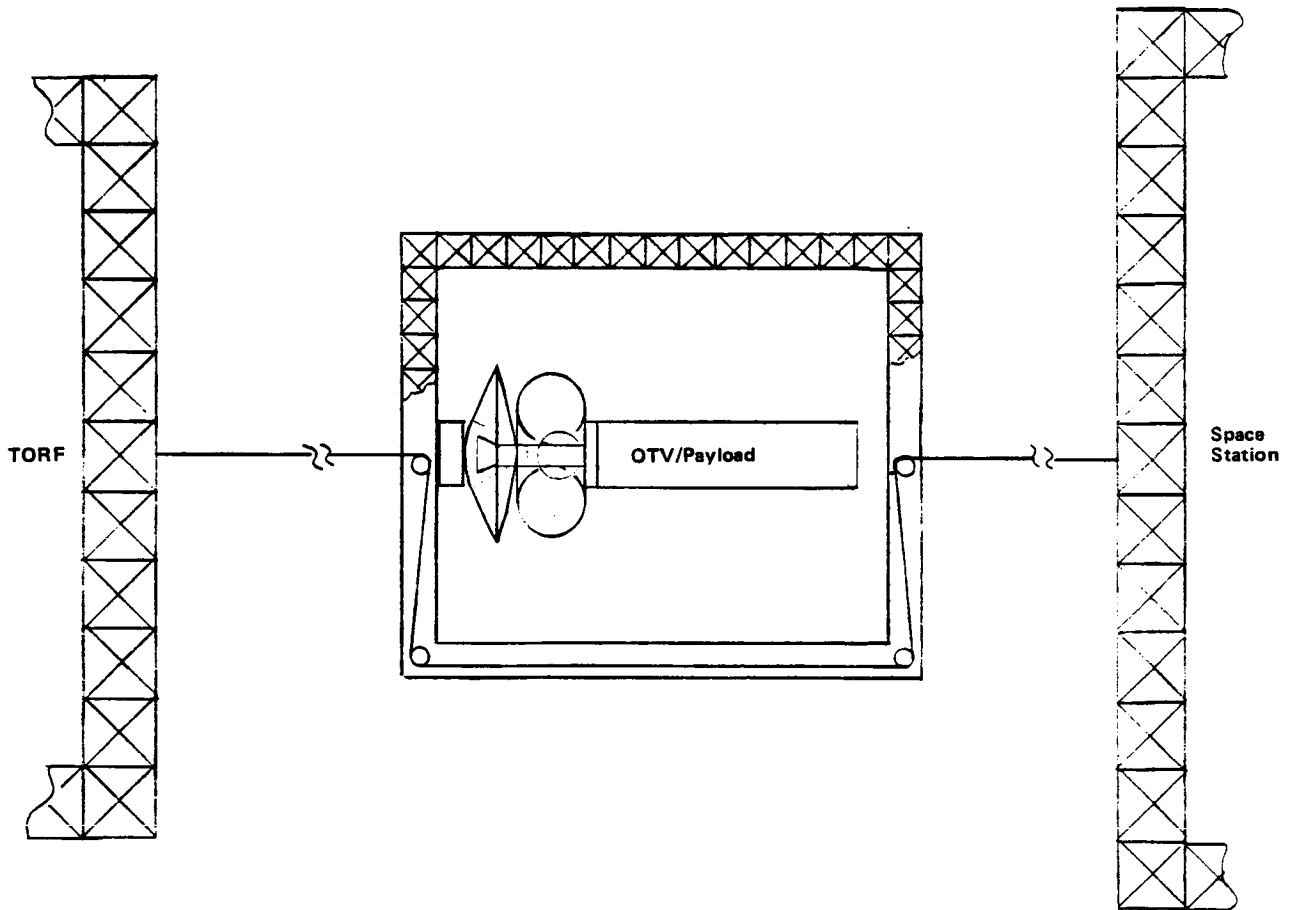

Figure 5-10 External Tether Crawler



*Figure 5-11 Internal Tether Crawler*

Either transportation system choice imposes severe operational and hardware design constraints that significantly reduce the benefits of permanent deployment. The crawler appears more feasible than the free-flyer because of the elimination of rendezvous maneuvers. The decision of which system to use is a second-order decision based on the results of the permanent versus intermittent deployment.

A final concern with the permanent facility is astronaut safety. In the event of emergency servicing, astronauts must be transported to the remote facility. If the astronauts are required to stay at this remote location for any length of time, a safe haven is needed at the hangar. The safe haven is a pressurized module that can support human life for a period of time. The safe haven will introduce additional hardware and complexity to the system.

The intermittently-deployed facility requires many of the same operational steps as the permanent facility. The initial facility design and construction includes many of the same components. These consist of the propellant tanks and plumbing, hangar material, tools, robotics, tether, tether attach point controller, tether platform, reel mechanism, and an onboard propulsion system. The reel mechanism, fluid storage system, and propulsion system are different than on the permanent facilities because of slightly different requirements. The TVS system must be modified for the intermittent facility to operate efficiently when reeled into the station and in the low-g environment. The reel mechanism will be used more frequently and therefore, will require high reliability. The propulsion system will require a higher degree of accuracy to guide the facility towards the station. These modifications are not a major factor in the deployment decision because they can all be included in the initial hardware development design.

The assembly of the facility will require EVA and that will be discussed in the cost/benefit analysis. The nominal operations of the intermittently-deployed are shown in Figure 5-12. The major difference between the intermittent and the permanent is the fluid transfer operations. The intermittent facility will be reeled out for all fluid transfers, which includes OTV refuel and facility resupply. The scenario does not include any astronaut transport because the hangar is reeled-in to the station for OTV servicing and payload attach. The possibility of remote EVA is practically negligible.

An intermittently-deployed facility has several advantages over a permanently-deployed facility. The hardware requirements are reduced because a crawler is not required. All the design and development associated with the crawler will not be needed. The intermittent facility does not require a counterbalance unless it is deployed more often than once approximately every 30 days. Because the facility is attached to the station the majority of the time, vehicle rendezvous is simplified and all the OTV refurbishment is done in close proximity to the station. The facility servicing can also be completed when reeled-in to the station.

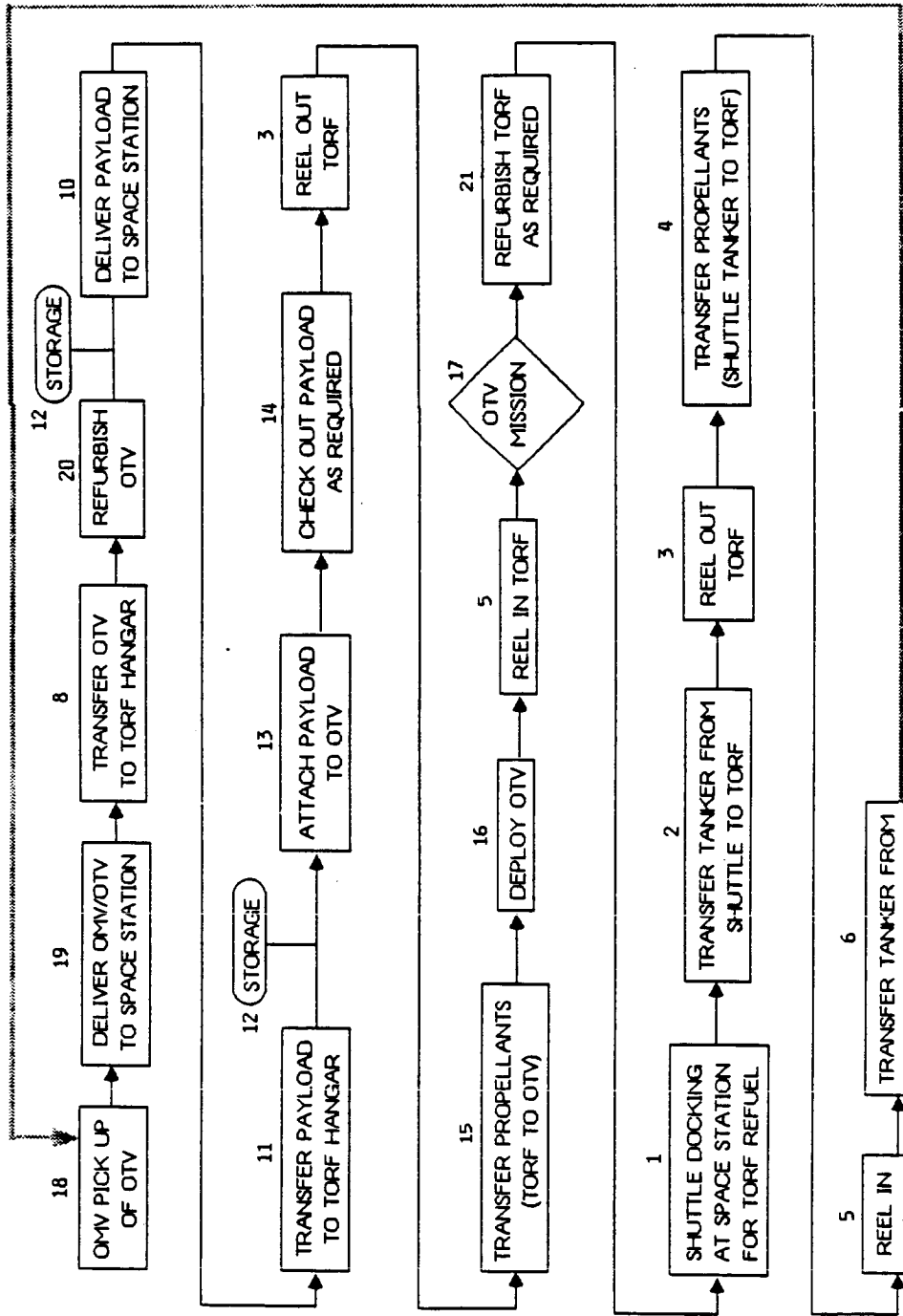

Figure 5-12 Nominal Operations for the Intermittently Deployed TORF

### 5.3 CONCLUSIONS

The advantages and disadvantages of the intermittent facility as compared to the permanent facility can be summarized. Table 5-2 shows an assessment of intermittent deployment relative to permanent deployment. The table summarizes all the concerns discussed previously.

Transportation of materials to the hangar does not require a crawler or a free flyer. This is a major advantage because no hardware development of a transportation system is required. All the servicing of the OTV and the facility can be performed on the station, which eliminates remote service. The possibility of remote EVA work is extremely reduced for the intermittent facility.

To refuel the OTV, the intermittent facility will need to be reeled out before fluid transfer can occur. The deployment rate for the intermittent facility is on the same order as a crawler traverse. The reeling process requires approximately two hours. The permanent facility needs a crawler to transport the tanker whereas for the intermittent facility requires a reel-out to refuel the facility. A concern exists with the reeling process. Reeling of a large facility is high risk and requires extensive control. The intermittent facility has the advantage of easier tether replacement because the facility is attached to the station for the majority of the time. The intermittently deployed tether is less exposed to breakage as a result of debris impact than the permanently deployed tether.

Another major advantage concerns vehicle rendezvous. The intermittent facility is attached to the station during shuttle and OMV docking. Therefore, currently employed vehicle rendezvous scenarios are feasible and normal operations are employed for docking with the space station.

A concern with the intermittent facility is contamination and violation of the  $10^{-5}$ g requirement. When the facility is attached to the station, venting could lead to contamination of sensitive instruments or the shut-down of sensitive instruments and operations. This same concern exists for a hangar attached to the space station permanently. The reeling process can cause contamination from thruster impingement. When the facility is reeled out for a fluid transfer, the station experiences greater than a  $10^{-5}$  g-level. Maintaining a constant  $10^{-5}$ g level is not considered possible on the station and the intermittent facility can probably violate the low-g requirement if the facility is reeled out no more than approximately once every 30 days. The permanent facility requires a counterbalance to meet this requirement.

From an overall evaluation of the operations, the intermittently-deployed facility appears less complex. No crawler development is required, a counterbalance is probably not required and the OTV refurbishment operations are simplified. Therefore, the baseline used for the cost/benefit analysis is an upward intermittently-deployed facility.

*Table 5-2 Intermittent Deployment Evaluation*

Evaluation Concern	Advantages	Disadvantages
Material Transport to Hangar	No Crawler or Free-Flyer	-
OTV Servicing	No Remote Servicing	
OTV Refuel	No Crawler Transport	Reeling is High Risk
Transport Rate	Reeling Process Requires Same Time as Crawler	
Propellant Resupply	No Crawler Transport of Tanker	Reeling is High Risk
Tether Abrasion	No Crawler Motion to Abrade Tether; Tether Replacement Easier; Less Exposed to Debris Impact	Reeling Process Abrades Tether
Low-g Requirement	No Counterbalance Required	Violated When Facility Reeled Out
Vehicle Rendezvous	Normal Operation	
Safety	No Remote EVA	Reeling is High Risk
Contamination		Thruster Impingement During Reeling and Venting at Station Can Cause Problems

## 6.0 COST/BENEFIT ANALYSIS

---

The cost/benefit analysis compares the intermittently-deployed tethered facility to an attached zero-gravity facility. Both a cost analysis and a benefits comparison were completed to assist in identifying the more desirable facility configuration. The purpose of the cost analysis is to determine the cost magnitude of both an attached fluid transfer facility and a tethered facility to evaluate the cost differential between the two. The cost assessment was a top-level evaluation of hardware, launch, assembly, and operation costs to determine magnitude and was not a detailed cost breakdown of every task.

A benefits comparison was performed to better understand the concerns associated with facility configuration. The purpose of the benefits comparison is to evaluate the intangible factors of the facilities that cannot be included in the cost analysis. These factors include development risk, safety, contamination, vehicle effects, and space station effects. The comparison results affect the decision of which facility configuration is more desirable for fluid handling.

### 6.1 COST EVALUATION

Previous analyses have shown that the tethered facility requires more hardware and support equipment than a zero-g facility, but the TORF does not require a propellant management device (PMD). The costs included in the analysis are design, development, test, and engineering of hardware (DDT&E), fabrication, launch, assembly, operations, replacements, and maintenance. Figure 6-1 illustrates the breakdown of the different costs. The cost analysis is based on 1985 dollars. The percent difference in cost between the tethered facility and the zero-g facility uses the zero-g facility as the base.

The DDT&E and fabrication costs include all the fluid-handling associated hardware. The hardware for the zero-g facility consists of the tanks, fluid transfer system, PMDs, and a tanker for facility resupply. The tethered facility includes the same hardware (except the PMD) and, in addition, a tether platform and additional hangar structure. The launch cost is based on the mass of the hardware plus associated STS orbiter airborne support equipment (ASE) mass. The cost does not account for volume-constrained launches of the large propellant storage tanks, which would tend to increase the launch costs. But the same increases would occur in the tethered and the zero-g facility, so no major difference is expected in costing by mass only. The tanker launch cost and propellant launch cost are the total 10-year lifetime costs that require multiple launches.

The assembly costs are based on hangar structure construction, tank installation, fluid transfer system installation, and tether platform installation for the tethered facility. The onorbit assembly will require some EVA work by the astronauts. The only costs included for hangar assembly are the fluid-handling associated costs, which are assumed to be 15% of the total cost.



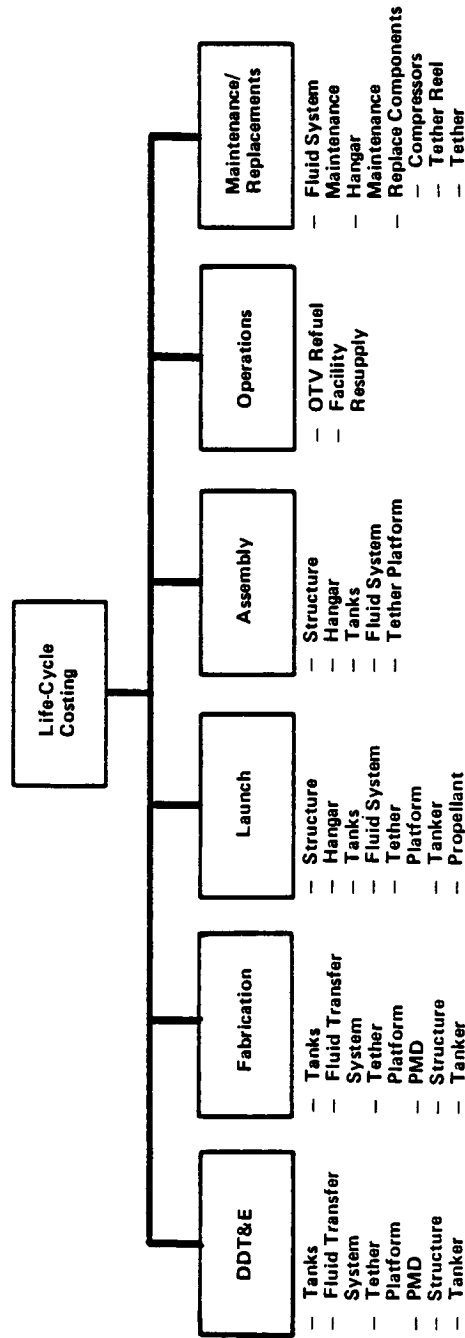

Figure 6-1 Life-Cycle Costing Breakdown

The operational costs are based on the fluid-handling associated operations. Many operations were defined in a previous chapter, but not all were included in the cost analysis. The operations costs include only those related to facility resupply and the OTV refuel. General timelines of the fluid-related operations were constructed to determine the manhours required to complete each task. The cost per task was based on the manhours and the associated IVA or EVA cost. All operations except onorbit assembly are assumed to require IVA manhours and no EVA manhours. All EVA work requires three astronauts, two astronauts onsite and one astronaut in a module viewing the other two. The operation manhours estimates are based on an analysis performed by the Martin Marietta OTV program.

The maintenance and replacement costs are estimated based upon a combination of all the previously mentioned costs. The only hardware requiring replacement are the compressors, tether reel, and tether. The DDT&E costs are negligible and the fabrication costs are slightly reduced from the first-unit costs. The launch and installation costs are based on the same factors as the original hardware. The hangar maintenance cost associated with the fluid-handling system is assumed to be 10% of the total hangar maintenance cost. The fluid system maintenance is minimal throughout, but does allow for small contingency repairs.

The total life-cycle cost is based on all the factors mentioned. Two comparisons will be made with the life-cycle costs. The cost of the zero-g facility will be compared to the tethered facility without including the tanker and propellant costs while the other comparison will include these costs. The difference in cost between the two comparisons is significant and an important factor in the decision of which facility is more desirable.

Additional costs associated with fluid storage at the space station include space station modification or scarring and OTV design modifications. Space station scars include a design development that is compatible with the eventual installation of a fluid storage facility, and the inclusion of hardware attach points, and extra station control system capacity. Presuming such considerations are included early in the space station design phase, it was assumed that the difference in costs between the scar of a zero-g facility and that of a tethered facility is negligible. The OTV design includes the requirement that it be able to offload propellant to the storage facility in the event of a mission abort. As such, it must include zero-g propellant management devices in each of its tanks if a zero-g storage facility is used. For a TORF, the OTV requires extra vent lines and fluid and inlet baffling to assure acceptable vented fill performance. These differences are not included in the cost analyses because of a lack of detailed cost effect data.

#### 6.1.1 DDT&E and Fabrication Cost

The associated costs for DDT&E and fabrication include all the fluid handling components and are broken down for each facility. Each individual fluid-handling component was evaluated and assigned a cost factor. Tables 6-1 and 6-2 show the cost breakdown of components for

the zero-g facility and the tethered facility, respectively. The tables show all the hardware costs associated with the fluid-handling system and any facility-specific components that are unique to either configuration.

The fluid system components associated with both facilities are similar and the similarities are reflected in the component breakdown. The major difference with the zero-g facility is the PMD. The PMD cost estimate was based on the PMDs used in the reaction control system (RCS) tanks on the shuttle. The cost associated with the RCS PMDs was obtained from Martin Marietta RCS tank program. The shuttle PMDs are more complex than the PMD required in the zero-g facility. Therefore, a reduced complexity factor was included in the cost comparison to reflect the decreased complexity. The TORF system tanks are about 10% heavier than the zero-g facility because of conical-based tanks. The conical-based tanks also increase the complexity factor on the DDT&E and production costs for the tanks, VCS, and MLI.

The additional structure listed on the TORF system accounts for all the hangar and berthing structure needed. The tethered hangar requires a truss structure to make the hangar an individual facility separate from the space station. The tethered hangar requires 30 additional truss bays to complete the entire structure, while 10 truss bays are needed for the tether platform and berthing rails.

The tether system costs were extracted from estimates compiled in the Tethered Satellite System (TSS) program cost analysis. The tether platform has been defined in detail by the TSS project. Many of the components needed on the TORF tether platform are similar to the TSS and can be used directly for estimates. The TSS system is larger than what is required on the TORF both in tether length and power requirements. The TSS tether platform uses a 20-km tether, whereas the TORF only requires 915 m (3000 ft) of tether, but the TORF system is moving a much larger, bulkier facility in and out of a confined area. This motion is so slow, however, that the required reel power for the TORF is less than 100 W, as compared to over 1000 W for TSS. To account for the difference between the two systems, one-third of the applicable TSS system costs were used to obtain a cost estimate for the TORF tether system. The cost of the tether was based on cost per foot estimates obtained from the TSS cost analysis.

The DDT&E and fabrication costs reflect the first-unit costs for the fluid handling system and any specific components for each facility. The tethered facility appears to be 45% more expensive to design and fabricate than the attached facility.

In addition to the first-unit cost of components, maintenance and replacements must be included. The majority of the components will not require replacements throughout the 10-year lifetime. The few replacement components for both the tethered and the attached facility are shown in Table 6-3. The cryogenic compressors will last approximately two to three years and will require five replacements.

Table 6-1 Zero-g System Hardware Cost

Item	Cost in Thousands of 1985\$		
	No. Req'd	Mass/Item ( kg )	Prod. Cost
Tank,LH2	2	1878	\$6,859
Tank,LO2	2	762	\$4,787
VCS,LH2 Tank	2	364	\$930
VCS,LO2 Tank	2	148	\$489
Gas Accumulators	8	101	\$500
Latch Valves	58	1	N/A
Check Valves	22	1	N/A
Subcooler Assembly	8	23	\$500
Quick Disconnects	8	9	\$300
Regulators	12	7	\$200
Avionics	2	464	\$33,329
MLI for LH2 Tank	2	964	\$23,551
MLI for LO2 Tank	2	240	\$5,522
Compressors	6	91	\$24,000
Baffles & Diffusers,LH2	2	124	\$454
Baffles & Diffusers,LO2	2	100	\$367
PMD,LH2 Tank	2	38	\$1,600
PMD,LO2 Tank	2	43	\$1,500
<b>Total Mass</b>	<b>12,080</b>	<b>kg</b>	
<b>ASE</b>	<b>1,210</b>	<b>kg</b>	
<b>Launch Mass</b>	<b>13,288</b>	<b>kg</b>	
<b>Launch Cost</b>	<b>\$78,148</b>		
		<b>Total DDT&amp;E</b>	<b>\$104,887</b>
		<b>Total Prod</b>	<b>\$103,044</b>
		<b>Total Hardware Cost</b>	<b>\$207,931</b>

Table 6-2 Tethered System Hardware Cost

Item	No. Req'd	Mass/Item ( kg )	Cost in Thousands of 1985\$	
			DDT&E	Prod. Cost
Tank,LH2	2	2066	\$8,231	\$17,873
Tank,LO2	2	838	\$5,744	\$6,041
VCS,LH2 Tank	2	400	\$1,116	\$2,288
VCS,LO2 Tank	2	162	\$587	\$1,203
Gas Accumulators	8	101	\$500	\$1,040
Latch Valves	58	1	N/A	\$1,450
Check Valves	26	1	N/A	\$195
Subcooler Assembly	8	23	\$500	\$120
Quick Disconnects	9	9	\$300	\$135
Regulators	12	7	\$200	\$1,200
Avionics	2	464	\$33,329	\$33,680
Pyro Valves	22	1	N/A	\$506
MLI for LH2 Tank	2	1083	\$28,500	\$33,106
MLI for LO2 Tank	2	263	\$6,672	\$7,750
Compressors	6	91	\$24,000	\$4,800
Baffles & Diffusers,LH2	2	146	\$532	\$963
Baffles & Diffusers,LO2	2	103	\$375	\$678
Additional Structure	40	91	\$2,000	\$22,800
Berthing Hardware	2	681	\$5,000	\$6,500
Tether System	1	570	\$11,690	\$1,783
RCS System	1	26	\$3,000	\$3,125
Total Mass	18,331 kg		Total DDT&E	\$132,276
ASE	1,835 kg		Total Prod	\$147,236
Launch Mass	20,166 kg		Total Hardware Cost	\$279,512
Launch Cost	\$118,600			

The tether reel and tether will last from three to five years and will require two replacements. The total replacement cost reflects the hardware procurement, launch, and installation.

The maintenance cost reflects the manpower required to maintain and inspect the components and hardware in the facilities. The entire system will be inspected periodically for leaks, wear, and inconsistencies. Any anomalies will be corrected at this time. The maintenance and replacement costs are a small percentage of the overall cost.

*Table 6-3 Maintenance and Replacement Costs*

<b>Cost in Thousands of 1985 \$</b>			
<b>Zero-g Facility Item</b>	<b>No. Req'd</b>	<b>Mass/Item ( kg )</b>	<b>Prod. Cost</b>
<b>Compressors</b>	<b>5</b>	<b>91</b>	<b>\$4000</b>
<b>Component Mass:</b>	<b>454 kg</b>		
<b>ASE:</b>	<b>454 kg</b>		
<b>Launch Mass:</b>	<b>908 kg</b>		
<b>Launch Cost:</b>	<b>\$5,340</b>		
<b>Installation Cost:</b>	<b>\$427</b>		
<b>Total Cost (Hardware,Launch,Installation):</b>			<b>\$9,767</b>
<b>Maintenance (10-year Lifetime):</b>			<b>\$5,490</b>
<b>Tethered Facility Item</b>	<b>No. Req'd</b>	<b>Mass/Item ( kg )</b>	<b>Prod. Cost</b>
<b>Compressors</b>	<b>5</b>	<b>91</b>	<b>\$4,000</b>
<b>Tether Reel and Tether</b>	<b>2</b>	<b>125</b>	<b>\$352</b>
<b>Component Mass:</b>	<b>705 kg</b>		
<b>ASE:</b>	<b>454 kg</b>		
<b>Launch Mass:</b>	<b>1159 kg</b>		
<b>Launch Cost :</b>	<b>\$6,816</b>		
<b>Installation Cost:</b>	<b>\$598</b>		
<b>Total Cost (Hardware,Launch,Installation):</b>			<b>\$11,766</b>
<b>Maintenance (10-year Lifetime) :</b>			<b>\$5,490</b>

### 6.1.2 Launch Cost

The reported launch costs are based on the mass of the hardware and the ASE. No consideration has been included for volume-constraints which would tend to increase the launch costs. A base rate of \$5880/kg was used for all launch cost estimates. The mass of the ASE was estimated at 10% of the original hardware mass. This estimate works for relatively heavy systems but for less massive systems (45,400 kg), the ASE mass was estimated at 454 kg (1000 lbm). The tethered facility appears to be 20% more expensive to launch.

### 6.1.3 Assembly

The assembly costs are based on manhour estimates of installation of all the components and systems needed for the fluid transfer system. Assembly costs are summarized in Tables 6-4 and 6-5. The support systems installation costs reflect only a small percentage of the total cost for installation of that system. The percentage accounts only for the fluid handling associated costs. For example, the installation cost of the power and signal umbilicals represents only 15% of the total cost for installation. The facility assembly requires astronaut EVA to install certain systems. The assembly cost reflects the higher rate for EVA. Any EVA time requires one hour pre-EVA and one-hour post-EVA for every six hours of worktime. Therefore, the total EVA hours is higher than the actual worktime.

The tethered facility has higher costs associated with the assembly because of the installation of the additional structure and the tether platform. Overall, the tethered facility is approximately 35% more expensive for assembly than the zero-g facility.

### 6.1.4 Operations

The operation analysis includes only fluid-transfer associated costs. These operations consist of the facility resupply and OTV refueling. Tables 6-6 and 6-7 show the manhour and cost estimates for the zero-g facility and the tethered facility. The major cost difference between the two facilities is a result of the tethered facility reeling process. Virtually all other operations are identical in cost and manhours. A slight difference exists in the vehicle transport from the shuttle to the hangar. This difference is because of the slightly longer distance from the shuttle docking port to the tethered hangar. The tethered facility is approximately 38% more expensive for fluid-transfer operations than the attached facility.

Table 6-4 Zero-g Assembly Cost

Task	Costs in Thousands of 1985 \$					
	EVA Hours	IVA Hours	EVA Cost	IVA Cost	Total Cost	
Attach Trusses	29.33	19.00	\$7,341	\$406	\$7,747	
Install Tanks	24.00	13.17	\$6,330	\$281	\$6,611	
Install Power, Lighting, Signal, and CCTV Cables	4.65	2.68	\$1,238	\$57	\$1,295	
Install Power and Signal Umbilicals	1.53	0.94	\$647	\$20	\$667	
Install Propellant Transfer System	9.33	8.83	\$2,486	\$189	\$2,675	
Install Propellant Umbilicals	4.83	3.00	\$1,218	\$64	\$1,282	
Install Propellant Control Console	0.00	7.83	\$00	\$167	\$167	
Install Berthing and Mating Cradles	10.83	6.58	\$2,770	\$141	\$2,911	
Install Hangar Control Console	0.00	3.00	\$00	\$64	\$64	
Conduct Hangar Checkout	0.00	0.45	\$00	\$10	\$10	
<b>Total Facility Assembly</b>	<b>84.51</b>	<b>65.48</b>	<b>\$22,030</b>	<b>\$1,399</b>	<b>\$23,428</b>	



Table 6-5 Tethered System Assembly Cost

Task	Costs in Thousands of 1985 \$					
	EVA Hours	IVA Hours	EVA Cost	IVA Cost	Total Cost	Total Cost
Attach Trusses and Berthing Rail Assembly	50.33	33.00	\$12,746	\$705	\$13,451	\$13,451
Install Tether Platform	24.25	6.25	\$6,376	\$134	\$6,509	\$6,509
Install Tanks	24.00	13.17	\$6,330	\$281	\$6,611	\$6,611
Install Power, Lighting, Signal, and CCTV Cables	4.65	2.68	\$1,238	\$57	\$1,295	\$1,295
Install Power and Signal Umbilicals	1.53	0.94	\$647	\$20	\$667	\$667
Install Propellant Transfer System	9.33	8.83	\$2,486	\$189	\$2,675	\$2,675
Install Propellant Umbilicals	4.83	3.00	\$1,218	\$64	\$1,282	\$1,282
Install Propellant Control Console	0.00	7.83	\$00	\$167	\$167	\$167
Install Berthing and Mating Cradles	10.83	6.58	\$2,770	\$141	\$2,911	\$2,911
Install Hangar Control Console	0.00	3.00	\$00	\$64	\$64	\$64
Conduct Hangar Checkout	0.00	0.45	\$00	\$10	\$10	\$10
<b>Total Facility Assembly</b>	<b>129.76</b>	<b>85.73</b>	<b>\$33,811</b>	<b>\$1,831</b>	<b>\$35,642</b>	<b>\$35,642</b>

Table 6-6 Zero-g System Operations Cost

Action	Costs are in Thousands of 1985 \$	
	Man-Hours	Total Cost
Tanker Off-Load	7.67	\$163.8
Tanker Transfer to Hangar/Berthing		
Facility Resupply	3.16	\$ 67.6
Connect and Chilldown Lines	4.67	\$ 99.7
Propellant Transfer	1.67	\$ 35.6
Completion and Shutdown	7.33	\$156.6
Tanker Return to STS		
<b>Tanker Total</b>	<b>24.50</b>	<b>\$523.3</b>
OTV Off-Load	7.67	\$163.8
OTV Transfer to Hangar and Berthing		
Payload Off-Load	7.67	\$163.8
Payload Transfer and Berthing		
OTV Fuel Transfer	2.42	\$ 51.6
Connect and Chilldown Lines	4.25	\$ 90.8
Propellant Transfer	1.42	\$ 30.2
Completion and Shutdown		
<b>OTV Total</b>	<b>23.43</b>	<b>\$500.2</b>
Tanker Operational Lifetime Cost = $523.3 \times 90 = \$47,097$ OTV Operational Lifetime Cost = $500.2 \times 60 = \$30,012$		
<b>Total Operational Cost = \$77,109</b>		

Table 6-7 Tethered System Operations Cost

Action	Costs are in Thousands of 1985 \$	
	Man-Hours	Total Cost
<b>Tanker Off-Load</b>		
Tanker Transfer to Hangar/Berthing	8.17	\$ 174.5
Facility Resupply		
Facility Reel-Out	9.00	\$ 192.2
Connect and Chilldown Lines	3.16	\$ 67.6
Propellant Transfer	4.67	\$ 99.7
Completion and Shutdown	1.67	\$ 35.6
Facility Reel-In	7.00	\$ 149.5
Tanker Return to STS	7.83	\$ 167.2
<b>Tanker Total</b>	<b>41.00</b>	<b>\$ 886.4</b>
<b>OTV Off-Load</b>		
OTV Transfer to Hangar and Berthing	8.17	\$ 174.5
Payload Off-Load		
Payload Transfer and Berthing	8.17	\$ 174.5
OTV Fuel Transfer		
Facility Reel-Out	9.00	\$ 192.2
Connect and Chilldown Lines	2.42	\$ 51.6
Propellant Transfer	4.25	\$ 90.8
Completion and Shutdown	1.42	\$ 30.2
Facility Reel-In	7.00	\$ 149.5
<b>OTV Total</b>	<b>40.42</b>	<b>\$ 863.3</b>
<p>Tanker Operational Lifetime Cost = \$886.4 x 90 = \$79,776</p> <p>OTV Operational Lifetime Cost = \$863.3 x 60 = \$51,798</p> <p>Total Operational Cost = \$131,574</p>		

### 6.1.5 Tanker and Propellant

The tanker is used to transport cryogenic propellant from the Earth to the space-based fluid storage facility. The tanker is an insulated tank that consists of virtually the same components as in the hangar fluid transfer system. A preliminary schematic for the tanker has been developed and is shown in Figure 6-2. The tanker holds 13,710 kg (30,200 lbm) of propellant and is delivered to the space station via the shuttle. The launch mass of the tanker propellant and ASE is 15,530 kg (34,200 lbm). Throughout the 10-year lifetime of the facility, the tanker will require 90 flights to deliver sufficient propellant to fuel 60 OTV missions. Fewer tanker flights can be flown if propellant scavenging is used. For the cost/benefit analysis, the assumption was made that all 90 flights must be flown to resupply the facility. The cost estimate of the tanker is shown in Table 6-8. The costs have been derived from the same factors and values as the facility cost estimate. The table also reflects the amount of propellant that is deliverable in the tanker.

The tanker cannot deliver a full-OTV mission of propellant (20,430 kg), therefore, the number of tanker launches (90) exceeds the number of OTV missions (60). The tanker must also replace the propellant boiloff caused by long-term storage of cryogenics. Over the entire 10-year lifetime, approximately two tanker loads are dedicated to boiloff. The launch cost of the propellant includes the mission propellant and the boiloff replacement propellant.

### 6.2 BENEFITS COMPARISON

The cost/benefit analysis cannot be completed without a benefits comparison. Several important parameters are intangible and cannot be included in the cost analysis. These parameters are of importance to the overall operations of the facility and influence the selection process. Several factors have been identified in previous analyses completed in this study. These factors have been combined and identified as either an advantage or disadvantage to each facility. A concise summary of the factors is included in this comparison.

The parameters encompass all areas that influence the facilities. The parameters include development risk, safety, facility repair, contamination, space station design effects, and vehicle rendezvous. Table 6-9 shows the parameters and some of the pros and cons for each facility configuration.

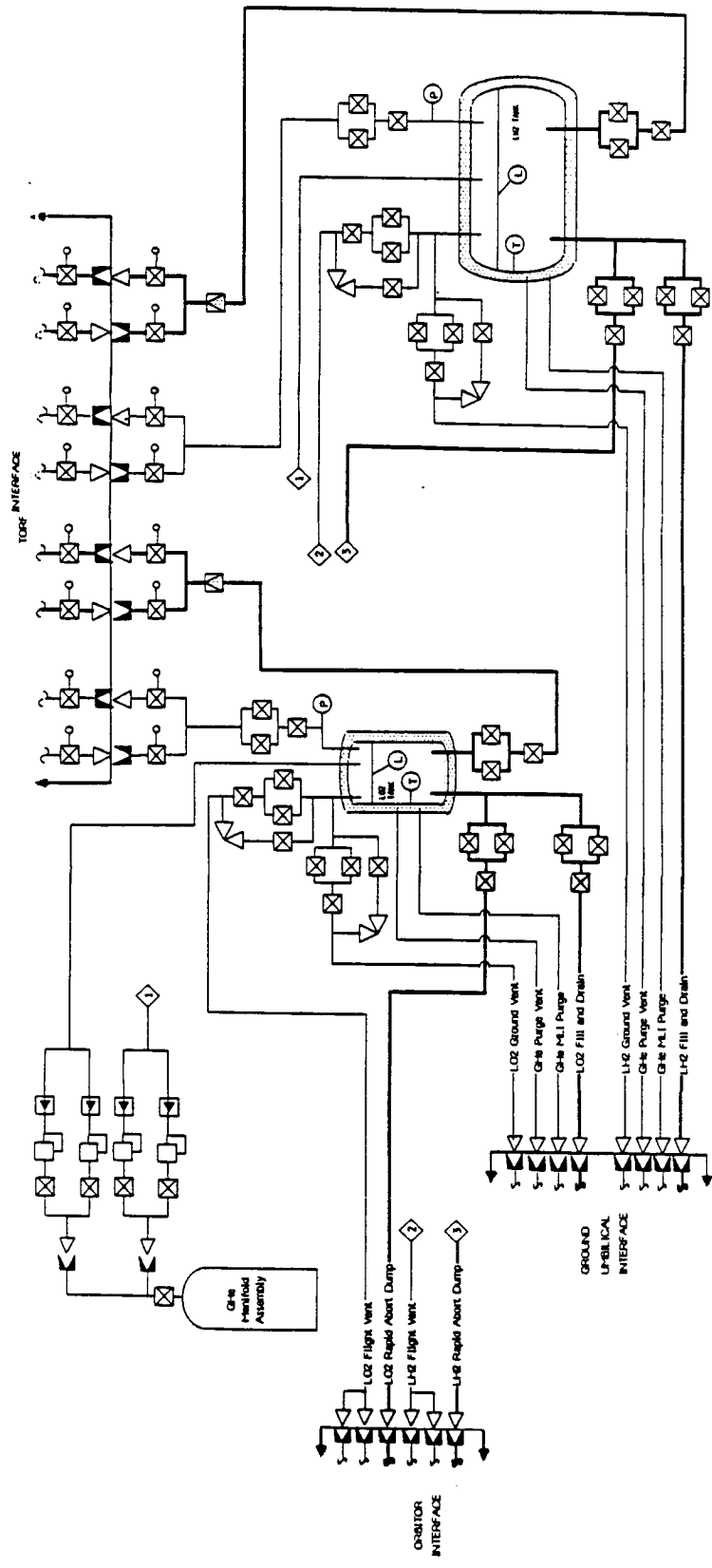

Figure 6-2 Tanker Fluid Transfer System Schematic

Table 6-8 Tanker Hardware Cost

Item	Mass/Item			Cost in Thousands of 1985\$	
	No. Req'd	( kg )	DDT&E	Prod. Cost	
Tank,LH2	1	940	\$3,432	\$3,105	
Tank,LO2	1	407	\$2,556	\$1,344	
Latch Valves	34	1	N/A	\$850	
Check Valves	6	1	N/A	\$45	
Quick Disconnects	24	9	\$300	\$360	
Regulators	8	7	\$200	\$800	
MLI for LH2 Tank	1	95	\$2,282	\$1,325	
MLI for LO2 Tank	1	35	\$851	\$494	
<b>Total Mass</b>	<b>1,800 kg</b>	<b>Total DDT&amp;E</b>	<b>\$9,621</b>		
<b>Propellant Mass</b>	<b>13,727 kg</b>	<b>Total Prod</b>	<b>\$8,324</b>		
<b>Tanker &amp; Prop.</b>	<b>15,527 kg</b>	<b>Total Hardware Cost</b>	<b>\$17,945</b>		
<b>ASE</b>	<b>1,553 kg</b>				
<b>Launch Mass</b>	<b>17,080 kg</b>				

Table 6-9 Benefits Comparison

Item	Advantages	Disadvantages
<u>Development Risk</u>		
TETHERED	Does not require a PMD or a no-vent-fill	Tether system is complex
ATTACHED	Simpler System	PMD needs development
<u>Safety</u>		
TETHERED	Cryogen transfer at remote location	Facility reeling process is risky
ATTACHED		Cryogen transfer performed on space station
<u>Facility/Vehicle Repair</u>		
TETHERED	Nominal repairs performed on station	Contingency repair could require remote EVA
ATTACHED	Nominal and contingency repairs performed on station	
<u>Contamination</u>		
TETHERED	Lower contamination contamination potential	
ATTACHED		Higher contamination potential
<u>SS Design Effects</u>		
TETHERED	Hangar is self-contained	Reel-out violates $10^{-5}g$ Interferes with experiments during reeling
ATTACHED	Maintains $10^{-5}g$ level in manned modules	Requires a counter-balance
<u>Vehicle Release</u>		
TETHERED	OMV not required for OTV release	
ATTACHED		OMV required for OTV release

Development risk is not inherent to one facility concept. Each facility has some development risk associated with it; the tethered facility has the tether system and the attached facility has the no-vent-fill and the PMD. The tether platform must be able to reel-in and reel-out a 136,000 kg (300,000 lbm) facility with a very small margin for error. This is a complex concept and must be proven before a tether platform can be installed on the space station. A similar tether system is projected to be demonstrated on the TSS flight in 1988. The major concern for the attached facility is the effectiveness of the PMD and the no-vent-fill. The PMDs must be proven effective for cryogenics in large-diameter tanks. Currently, studies and tests are being performed in scaled-down tanks to evaluate the PMDs. The no-vent-fill must keep the fill level high in the OTV or the size of the OTV and the refueling facility will be greatly affected, directly affecting operating cost.

Safety of astronauts and materials is a major concern of the space station. The safety concern associated with the facilities is cryogenic propellant transfer. Cryogenic propellant transfer can be a hazardous situation if leakage occurs or venting is required. The risk is reduced for the tethered facility because the fluid transfer occurs at a remote location. The attached facility is a higher risk because the cryogenic fluid transfer occurs near the manned habitation modules. A leak would have a significant effect on the station operations. Another safety concern exists with the tethered facility. For the intermittent facility, the reeling process is inherently unstable especially when the hangar is close to the station because of the reduced tether tension. The hangar requires a lot of control during the reeling process. Reeling the facility adds risk to the station and the astronauts. Therefore, there are safety concerns with both facilities.

The facility and vehicle repair is another parameter influenced by facility configuration. In the nominal operations of both configurations, all facility and vehicle repair is done on the station. Concerns exist with the tethered facility in the case of contingency repair. If the tether system should fail with the facility reeled-out, repair work may require remote EVA, which is expensive and risky. Yet, in the event of a risky or dangerous OTV or hangar repair, the tethered facility could be reeled out from the station.

The issue of contamination is also included in the comparison. The problems and concerns associated with contamination are discussed in the hazard section. The major concern is during propellant transfer. In the event of propellant leakage, sensitive instruments must be covered or protected. The life support systems are also sensitive to propellant contamination. The tethered facility eases the concern of contamination in the event of leakage because of the 915-m (3000-ft) separation distance. The possibility of contamination is much lower



than for the attached facility. The major hazard of contamination occurs during fluid transfer, but concern also exists during quiescent periods. The hazard of contamination during quiescent periods is the same for either facility.

The space station design is affected differently by the two facilities. The tethered facility is a self-contained structure that requires more truss structure than the attached. Concerns exist with the space station requirement of maintaining a  $10^{-5}$  g-level on the station. The tethered facility violates this requirement during the reel-out period. Yet, even when attached to the station, movement within the hangar could produce greater than a  $10^{-5}$  g-level. Therefore, either facility can violate the requirement. Another concern with the reel-out of the tethered facility is the interference with space-pointing experiments. The hangar interferes for just a short time and may not affect the viewing considerably. The attached facility does not interfere with the experiments, but is slightly more restricted in its installation area. The modules are in closer proximity to the hangar and have a greater influence on the placement of the hangar.

An advantage of the tethered facility is its ability to perform atmospheric drag make-up burns. When at the reeled-out position, the facility can use its onboard propulsion system to reboost the space station/TORF system. This removes the contaminants from the station as well as relieving the space station propulsion requirements. The early space station is planned to have a hydrazine propulsion system. This system can stay intact with minor revisions and the tethered cryogenic system could be installed as an additional system.

The final area of concern is the vehicle release and rendezvous. The tethered facility can directly release the OTV/payload and avoid using the OMV for transport away from the station. In addition, the OTV can be reeled further out from the hangar on a tether to increase the propellant savings by using a higher orbit release. The OTV release can be coupled with an STS deboost to utilize the momentum transfer and reduce the effect on the space station. The attached facility will require OMV movement to transport the OTV/payload away from the space station and into a safe firing zone.

6.3 CONCLUSION

Overall, the cost analysis shows the tethered facility is more expensive than the zero-g facility for initial hardware. Table 6-10 shows the cost summary of both facilities and the difference in cost between the two. Two comparisons can be completed with the values. A comparison that includes only the hardware, launch, assembly, and operations leads to an overall difference of approximately 40%. Figure 6-3 illustrates the cost difference between the two facilities. The tethered facility costs about \$260 million dollars more than the attached facility. Yet, when the propellant launch cost and tanker launch cost are included in the total, the percent difference drops to 3%.

Table 6-10 Cost Summary

10-year Lifetime Item	Cost in Thousands of 1985 \$		
	Zero-G	Tethered	Difference
Hardware	\$207,931	\$279,512	\$71,581
Launch of Hardware	\$78,148	\$118,600	\$40,452
Assembly	\$23,428	\$35,642	\$12,214
Operations	\$ 77,109	\$131,574	\$54,465
Maintenance/ Replacements	\$15,257	\$17,256	\$ 1,999
Subtotal	\$401,873	\$582,584	\$180,711
Tanker	\$17,945	\$17,945	—
Tanker Launch	\$1,775,577	\$1,775,577	—
Propellant Launch	\$7,324,023	\$7,324,023	—
Total	\$9,519,418	\$9,700,129	\$180,711

The results of the cost analysis show that for hardware and operations the tethered facility is more expensive than the zero-g facility, yet, when the propellant costs are included in the comparison, the difference becomes insignificant. The cost analysis does not conclusively determine a choice. Therefore, the benefit comparison is needed to augment the final decision. There are numerous concerns with each facility. The tethered facility increases the versatility of the hangar. Concerns exist with space station effect because the tethered facility imposes changes in operations of other users of the station. Some of these changes could be incorporated into the initial design of the station to minimize their overall effect of cost.

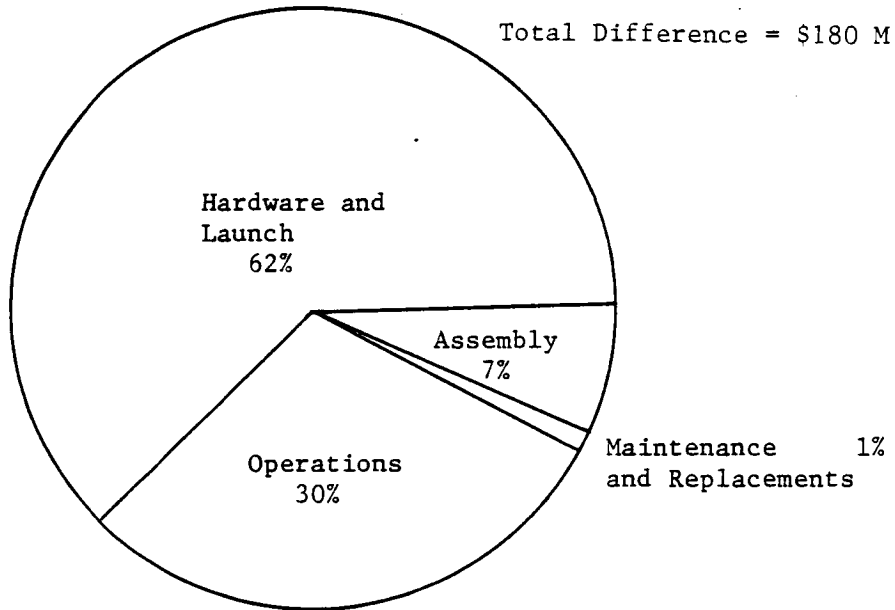

Figure 6-3 Cost Difference Comparison

## 7.0 CONCLUSIONS

---

Tethered orbital refueling is a viable alternative to zero gravity fluid transfer. Because zero gravity fluid transfer of cryogenics is an untried technology, concern exists with relying solely upon this technology for refueling the Orbital Transfer Vehicle. A tether can produce a low gravity for performing fluid transfer as it is performed on the Earth. Tethered orbital refueling should be re-examined at the time the Space Station configuration is being finalized to incorporate servicing Orbital Transfer Vehicles.

Initially, two TORF concepts were considered: one for Earth-storable propellants and one for cryogenics. The design concepts developed for these storage facilities were defined to the extent necessary to support the identification of the preferred fluid transfer method and the fluid slosh characteristics. Estimates of the facility dry masses were developed from system level considerations of the overall facility requirements, including avionics, structure, power, ACS, etc. These estimates indicate that a cryogenic TORF able to store 45,500 kg (100,000 lbm) of propellants will have a dry mass of roughly 13,200 kg (29,000 lbm), while an Earth-storable TORF able to store 10,900 kg (24,000 lbm) of propellants will have a dry mass of roughly 6,400 kg (14,000 lbm). The largest single item in these facilities is the meteor/space debris shielding estimated to be 4,500 kg (10,000 lbm) for the cryogenic TORF and 2,100 kg (4,700 lbm) for the Earth-storable TORF. This shield mass may be reduced by using thicker walled storage tanks or accepting a higher probability of tank rupture. The cryogenic TORF volume is roughly equal to the space shuttle payload bay, hence the launch cost of the empty facility is determined by volume, not mass, and the facility could be heavily overbuilt with little effect on cost.

A second important design feature is that the hydrogen tank boiloff can be used to cool the LH<sub>2</sub> and LO<sub>2</sub> tanks and then be used as propellant for the TORF and space station drag make-up needs. This eliminates the requirement for extra stationkeeping propellant, and allows stationkeeping propulsion to be done remotely from the space station, thereby reducing potential contamination concerns.

Transfer of propellants from the TORF to the user vehicle (OTV or OMV) can be done in any of several ways, including pressurized, pumped, or gravity transfer. The choice of method depends strongly on the way the receiver tank is filled. Three basic fill methods were considered, including vent while filling, evacuated fill, and ullage recompression. Initially, it might be expected the gravity transfer would be the preferred transfer method because the facility is purportedly taking advantage of the gravity gradient, however, several reasons preclude this choice. The total head pressure generated by the TORF gravity gradient is very small, thus the flow rates generated in this way are also small. To complete a fluid transfer in a reasonable time (less than 8 hours), the required transfer line diameters are prohibitively large. Use of flow restricting components such as filters would be virtually precluded. For receiver tank fill with

ullage recompression (used primarily for storable propellants), gravity transfer is impossible. For storable propellants, the recommended transfer method is a pumped transfer. For cryogenics, the recommended transfer method is a pressurized transfer using autogenous pressurant.

Following the completion of the fluid transfer study, the overall program approach shifted from equal considerations of Earth-storable and cryogenic propellants to a concentration on just cryogenic propellants. Furthermore, the studies described in this report focus on consideration of single, large-diameter tanks for fluid storage, rather than on smaller, multiple tanks. Single tanks are simpler and cheaper to manufacture and are thermodynamically more efficient for cryogenics because of their larger volume-to-surface area ratios. In addition, the larger diameters of single tanks allow the gravity gradient forces induced on the TORF to dominate surface tension forces at reasonably short tether lengths. This dominance is necessary to ensure that the propellant will adequately settle in the tank. For LH<sub>2</sub>, using a 14-ft diameter tank and a Bond number of fifty (indicating gravity dominance), the tether length is 85 m (280 ft). For LO<sub>2</sub>, the required tether length is 36 m (120 ft). Accordingly, for a cryogen propellant TORF, the minimum required tether length is 85 m (280 ft).

The major emphasis of this study has been to evaluate and identify the TORF design constraints imposed by fluid dynamics in the TORF storage tanks. A wide variety of situations have been examined and three basic parameter limitations have been identified. The three basic parameters are tether length, facility libration angle (swing angle), and fluid surface slosh angle. The facility libration angle is limited by the ability of the tether reel system to keep the tether axis in line with the space station center of mass. Otherwise, unacceptable torques on the station will arise. The maximum libration angle is determined by the reel system design and the distance between the tether attach point and the space station center of mass, with typical designs allowing no more than 30°. This limitation imposes a constraint on the tether length, given a maximum disturbance arising from a shuttle docking. The tether length is also constrained by the requirement that the maximum fluid slosh angle never be greater than that which would lead to uncovering the tank outlet. For a 10% tank fill level, this slosh angle can be as little as 20 degrees. Given the libration angle and slosh angle requirements, the tether length for an LH<sub>2</sub> storage tank is the worst case and must be longer than 305 m (1000 ft). The recommended length is 915 m (3000 ft) considering engineering margin and analytical error in the dynamics model. The level of fluid damping has little effect on the maximum fluid motion, however, it strongly affects the duration of this motion. Considering the frequencies of disturbances and the need for minimal fluid motion while transferring to an OTV, damping coefficients of over 5% are recommended.

One of the major benefits of the TORF concept is in the reduction of contamination by using a sufficient tether length (which is less than that required by dynamics concerns and is therefore not a design determinate). By using the TORF hydrogen boiloff for space station drag make-up, the net contamination at the space station as a result of onboard propulsion and fluid storage can be reduced to negligible

levels. Hazards associated with the tethered system partially offset these advantages, but can be reduced significantly by careful design.

Based on a preliminary assessment of TORF design requirements, it became apparent the TORF mission operations could be much more complex than more typical spacecraft systems. This prompted a more detailed evaluation of the necessary operations for a large TORF system with an incorporated OTV hangar. Using a level of automation consistent with present space station planning, the necessary operations can be largely automated, with virtually no EVA for day-to-day requirements and with only minimal IVA. Based on these studies, TORF operations now appear to be not much more complex than those of an attached depot. Using the results of all of the previous analyses, an overall cost/benefits comparison between a TORF and an attached facility was completed. The results are subject to interpretation, as are all analyses of this type, but the analyses of the configuration developed in this study suggest that overall cost of a space-based OTV refueling system is not greatly affected by the choice of storage facility type. Taking a narrow focus on just facility costs, however, the TORF configuration in this study appears significantly more expensive. Other comparisons besides cost include safety, contamination, versatility, and other operational requirements. NASA Johnson Space Center is planning to examine the relative costs of incorporating the OTV hanger on the Space Station versus installing it on the TORF platform.

Based on the overall study results, several areas requiring further study and test have been identified. A number of assumptions have been made regarding the behavior of propellant fluids in low-g (not zero-g) conditions. Very little data exists for this situation, and thus significant questions remain to be answered before developing a complete understanding of the TORF feasibility. These questions center around three basic areas: (1) slosh damping, (2) tank inflow/outflow behavior, and (3) tank venting. Although some information can be developed through low-g drop tower and KC-135 flight tests, the limited durations of these tests severely constrains the breadth of the resulting data.

Space flight tests are necessary using a tethered system similar to the TSS currently under development. Indeed, the TSS could be modified to carry out the necessary tests and, if properly scheduled, could provide invaluable experience in tethered system behavior to support the much more challenging primary TSS flight satellite mission.

Overall, the results of this study indicate that several potential advantages exist for a TORF as compared to a zero-g propellant storage facility at the space station. These include improved space station stability, easier facility fluid management, improved space station safety, and reduced space station contamination. These advantages are countered by a higher facility cost, and a minimal change in overall OTV refueling system life-cycle cost.

The final choice of tethered versus attached facility will probably be determined by the developmental progress of zero-g fluid handling systems, including screen management devices, no-vent fill systems, thermal control systems, and quantity gaging. Should progress in any

of these areas cease because of technical challenges beyond existing capabilities, then a tethered refueling depot will represent a viable alternative.

## BIBLIOGRAPHY

Abramson, H. Norman, ed: "The Dynamic Behavior of Liquids in Moving Containers with Applications to Space Vehicle Technology." NASA SP-106, Washington, D.C., 1966.

Anderson, D. C., Olsen, T. M., and Owings, W. D.: Fragment Environments for Postulated Accidents of the STS and Postulated Accidents of the Orbiting Vehicle, Teledyne Energy Systems, Timonium, MD 21093, TES-16018-04, NASA Contract NAS9-16018, October 1980.

Baker, W. E., Kulesz, J. J., Ricker, R. E., Bessey, R. L., Westine, P. S., Parr, V. B., and Oldham, G. A.: Workbook for Predicting Pressure Wave and Fragment Effects of Exploding Propellant Tanks and Gas Storage Vessels, Southwest Research Institute, San Antonio, TX 78284, NASA CR-134906, September 1977, p 191 ff.

Bareiss, L. E.: Calculated from Martin Marietta Contamination Effects Data Base, Martin Marietta Aerospace, Denver, Co. 80201.

Bekey, I.: "Advanced Tether Applications Briefing to the Administrator." August 10, 1984.

Bekey, Ivan: "Application of Space Tethers." IAF-84-436. Presented at the 35th Congress of the International Astronautical Federation, Lausanne, Switzerland, October 8-13, 1984.

Berenyi, S. G. and Abdalla, K. L.: "Vapor Ingestion Phenomena in Hemispherically Bottomed Tanks in Normal Gravity and in Weightlessness." NASA TND-5704, NASA Lewis Research Center, Cleveland, Ohio, April 1970.

Bevilacqua, F., Merlina, P., Anselmi, A.: "The Science and Applications Tethered Platform (SATP) Project." Aeritalia Space Systems Group, Presented at the 2nd Workshop on Tether Applications in Space, Venice, Italy, October 15-17, 1985.

Boeing Aerospace Company: Space Station Needs, Attributes, and Architecture Options. Seattle, Washington.

Boeing Aerospace Company: Future Orbital Transfer Vehicle Technology Study. NASA CR 3536, May 1982, Contract NAS1-16088.

Buongiorno, Carlo, Vallerani, Ernesto: "The Tether Satellite System: A New Tool for Aerodynamic Investigation." IAF-84-441. Presented at the 35th Congress of the International Astronautical Federation, Lausanne, Switzerland, October 8-13, 1984.

Carroll, Joseph A.: "A Scenario for Evolution of Tether Uses on a Space Station." AIAA-84-1110. Presented at the AIAA/NASA Space Systems Technology Conference, Costa Mesa, California, June 5, 1984.

Carroll, Joseph A.: "Some Tether-Related Research Topics." Tether Applications Task Force, November, 1984.



Carroll, Joseph A.: "Tether Applications in Space Transportation." IAF-84-438. Presented at the 35th Congress of the International Astronautical Federation, Lausanne, Switzerland, October 8-13, 1984.

Crouch, D. S., Vignoli, M. M.: "Shuttle Tethered Satellite System Development Program." AIAA-84-1106. Presented at the AIAA/NASA Space System Technology Conference, Costa Mesa, California, June 5-7, 1984.

Daney, David E.: "Tether SOC Tanks." National Bureau of Standards.

Davis, Eldon E.: Future Orbital Transfer Vehicle Technology Study. NAS1-16088, Vol.II, 1982.

Dodge, F. T. and Garza, L. R.: "Simulated Low-Gravity Sloshing in Spherical Tanks and Cylindrical Tanks with Inverted Ellipsoidal Bottoms", Tech. Report No. 6, Southwest Research Institute, San Antonio, TX, February 1986 (Contract NAS 8-20290).

Eberhardt, R. N., G. R. Cunnington, and W. A. Jones: "Conceptual Design and Analysis of Orbital Cryogenic Liquid Storage and Supply Systems". Final Report, NASA CR-165321. May 1981 (Contract NAS3-22264)

Eberhardt, R., Bailey, W. J., and Symons, E. D.: "Cryogenic Fluid Management Facility." AIAA Paper No. 84-1340, Presented at 20th Joint Propulsion Conference, Cincinnati, Ohio, June 11-13, 1984.

"Evaluation of AS-203 Low Gravity Orbital Experiment," Technical Report HSM-R421-67, Chrysler Corporation Space Division, 13 January 1967.

Fester, Dale A., Rudolph, L. Kevin, Tegart, James R., and Abbott, Pete W.: "Tethered Orbital Refueling Study - Interim Report." Martin Marietta Aerospace Report No. MCR-85-512, for NASA-JSC Contract No. NAS9-17059, Denver, Colorado, January 1985.

Fester, Dale A., Rudolph, L. Kevin: "Tethered Orbital Refueling Study - Space Station Impact Report." Martin Marietta Aerospace Report No. MCR-83-633, for NASA-JSC Contract No. NAS9-17059, Denver, Colorado, November 1984.

Friedlander, A. L., et. al.: "Performance Requirements Analysis for Payload Delivery from a Space Station." NASA Reference Publication 1110, July, 1983.

Garrison, P. W. and Klemetson: "Space Station Propulsion System Trade Study." Paper AIAA-83-1220, Presented at 19th Joint Propulsion Conference, Seattle, Washington, June 27-29, 1983.

General Dynamics Convair Division: Space Station Needs, Attributes and Architecture Options. San Diego, California.

General Dynamics Convair Division: Orbit Transfer Vehicle (OTV) Concept Definition Study. Report GDC-ASP-80-012, February 1981, Contract NAS8-33533.

General Dynamics Convair Division: Centaur F(G') Technical Description: A High-Performance Upper Stage for the NASA Space Transportation System. Report CDTD-3, August 1982.

General Dynamics Convair Division: Centaur G Technical Description: A High-Performance Upper Stage for the NASA Space Transportation System. Report CGTD-1, January 1982.

Giellis, R. T., Eberhardt, R. N., et. al.: Long-Term Cryogenic Storage Study, Interim Report. MCR-82-588. Martin Marietta Corporation, Denver, Colorado, December 1982.

Grumman Aerospace Corporation: Space Station Needs, Attributes, and Architecture Options. Bethpage, N.Y.

Grumman Aerospace Corporation: System Technology Analysis of Aeroassisted Orbit Transfer Vehicle, Mid-Range Lift/Drag. Second Quarter Review, Marshall Space Flight Center, April 1983.

JANNAF Handbook, Rocket Exhaust Plume Technology, Chapter 6, Spacecraft Plume Contamination, CPIA Publication 263, The Johns Hopkins University, Applied Physics Laboratory, Laurel, MD, June 1983, p 6.3-18.

JANNAF Handbook, Rocket Exhaust Plume Technology, Chapter 6, Spacecraft Plume Contamination, CPIA Publication 263, June 1983.

Jensen, H. L., Nast, T. C., et. al.: Handbook of External Refrigeration Systems for Long-Term Cryogenic Storage. LMSC-A984158. Lockheed Missiles and Space Company, February 1971.

Johnson Space Center: "Orbital Refueling System." JSC-18921, Houston, Texas, 1984.

Kirkland, Z. D. and Tegart, J. R.: "On-Orbit Propellant Resupply Demonstration Preliminary Flights Results," 22nd Space Congress Proceeding, Canaveral Council of Technical Societies, April 23-26, 1985, pp 4-15 to 4-24.

Kirkland, Z. and Tegart, J.: "On-Orbit Propellant Resupply Demonstration." AIAA Paper No. 84-1342, Presented at 20th Joint Propulsion Conference, Cincinnati, Ohio, June 11-13, 1984.

Kroll, K. R.: "Tethered Propellant Resupply Technique for Space Station." IAF-84-442. Presented at the 35th Congress of the International Astronautical Federation, Lausanne Switzerland, October 8-13, 1984.

Kroll, Ken R.: "Tethered Propellant Resupply Technique for Space Stations." NASA-S-84-05268.

Larkin, B. K. and Bowman, T. E.: "The Venting of Saturated Liquids in Zero Gravity," Institute of Environmental Sciences Proceedings, Volume II, April 1967, pp 591-598.

Lebreton, J. P., Bonifazi, C. et. al.: "Laboratory Simulation of the Electrodynamic Interaction of the Tethered Satellite with the Ionosphere." Presented at the 7th ESA Symposium on European Rocket and Balloon Programmes and Related Research, Loen, Norway, May 5-11, 1985.

Lomax, R., McCarthy, K., Banning, D., Kirk, E., Smith, L., and Erdahl, D.: Space Propulsion Hazards Analysis Manual, Program Review Data Package (Interim), Martin Marietta Aerospace, Denver, CO 80201, 22 March 1985, pp 5-10 thru 5-12.

Lorenzini, Enrico: "Study of Orbiting Constellations (TESCONS) in Space, Phase II, Studies of Selected Tether Applications in Space." Contract RH4-394019, Martin Marietta Denver Aerospace, December 1984.

Lunquist, Charles A.: "Artificial or Variable Gravity Attained by Tether Systems." Presented at the Applications of Tethers in Space Workshop, Venice, Italy, October, 15-17, 1985.

Martin Marietta Denver Aerospace: "Orbital Transfer Vehicle Concept Definition and System Analysis Study". Appendix A to Volume IV, Space Station Accommodations Final Study Report, NAS8-36108. 20 August 1985.

Martin Marietta Denver Aerospace: "Orbital Transfer Vehicle Concept Definition and System Analysis Study". Volume IV Programmatic & Program Trade Studies Final Review, NAS8-36108. 22 August 1985.

Martin Marietta Denver Aerospace: "Space Station Definition and Preliminary Design, WP-01". Operations Planning, NAS8-36525. 18 December 1985.

Martin Marietta Denver Aerospace: "Detailed Design of the Cryogenic Fluid Management Facility". Preliminary Fluid and Thermal Analysis, NAS3-23355. January 1985.

Martin Marietta Denver Aerospace: Space Station Requirements for Tether Applications - Final Report. Contract NA58-35499. Marshall Space Flight Center, Alabama, July 26, 1984.

Martin Marietta Denver Aerospace: Advanced OTV Propulsion System Study. Denver, Colorado. November, 1984.

Martin Marietta Denver Aerospace: Orbital Maneuvering Vehicle Program Overview. Denver, Colorado. January 17, 1985.

Martin Marietta Denver Aerospace: Orbital Maneuvering Vehicle Program - Midterm Review. Marshall Space Flight Center, Alabama. March 22, 1985.

Martin Marietta Denver Aerospace: Advanced Orbit Transfer Vehicle Propulsion System Study - Final Report. Contract NAS3-23858. NASA Lewis Research Center, Ohio. February 1985.

Martin Marietta Denver Aerospace: Space Station Needs, Attributes, and Architecture Options. Denver, Colorado.

Martin Marietta Denver Aerospace: Space Station Requirements for Tether Applications - Final Report. Contract NAS8-35499. Marshall Space Flight Center, Alabama. July 26, 1984.

Martin Marietta Denver Aerospace: Selected Tether Applications in Space - Final Report. Contract NAS8-35499. Marshall Space Flight Center, Alabama, February 1985.

Martin Marietta Denver Aerospace: Selected Tether Applications in Space - An Analysis of Five Selected Concepts - Final Report/Presentation. Contract NAS8-35499. Marshall Space Flight Center, Alabama, July 31, 1984.

Martin Marietta Denver Aerospace: Selected Tether Applications in Space - Phase II Study Interim Review. Contract NAS8-35499. Marshall Space Flight Center, Alabama, November 1984.

Martin Marietta Denver Aerospace: Selected Tether Applications in Space - Phase II Final Briefing. Contract NAS8-35499. Marshall Space Flight Center, Alabama, February 1985.

Martin Marietta Denver Aerospace: Tethered Satellite System, System and Subsystem Analysis, Orbital Dynamics Model 1B. TSS-M1B-01. Contract NAS8-36000, Marshall Space Flight Center, June, 1984.

Martin Marietta Denver Aerospace: Tethered Satellite System, System and Subsystem Analysis, Orbital Dynamics Model 1B. TSS-M1B-02. Contract NAS8-36000, Marshall Space Flight Center, February, 1985.

McCarthy, K.: Space Propulsion Hazards Analysis Manual, Annotated Bibliography, Martin Marietta Aerospace, Denver, CO 80201, MCR-84-612, prepared for AFRPL, Edwards AFB, CA 93523, 10 December 1984.

McDonnell Douglas Astronautics Company: Space Station Needs, Attributes, and Architecture Options. Huntington Beach, California.

Military Specification, Propellant, Hydrazine, MIL-P-26536C, Amendment 2, 1 February 1982.

Military Specification, Propellant, Monomethylhydrazine, MIL-P-27404B, 22 May 1979.

Military Specification, Propellant, Nitrogen Tetroxide, MIL-P-26539C, 30 March 1970.

Monitor, Dean S.: "A Low-Cost External Tank Orbital Transfer System." Interoffice Memo, Martin Marietta Denver Aerospace, November 22, 1982.

Monti, R.: "Tethered Elevator: A Unique Opportunity for Space Processing." Presented at the Applications of Tethers in Space Workshop, Venice, Italy, October, 15-17, 1985.

Napolitano, Luigi G., Bevilacqua, Franco: "Tethered Constellation, Their Utilization as Microgravity Platforms and Relevant Features." IAF-84-439, Presented at the 35th Congress of the International Astronautical Federation, Lausanne, Switzerland, October 8-13, 1984.

Orbit Transfer Systems with Emphasis on Shuttle Applications - 1986-1991. NASA TMX-73394, Marshall Space Flight Center, April 1977.

Pittman, J. F.: Blast and Fragment Hazards From Bursting High Pressure Tanks, Naval Ordnance Laboratory, White Oak, Silver Spring, MD, NOLTR 72-102, 17 May 1972.

Private Communication: Dick Carpenter, Crane Company, Chempump Division, Warrington, Pennsylvania, 1984.

Private Communication: Paul Wren, Sundstrand Aviation Mechanical, Rockford, Illinois, 1984.

Proceedings of the Applications of Tethers in Space Workshop. Williamsburg, Virginia, June 15-17, 1983. NASA Office of Space Flight, Washington, D.C.

Proceedings of the Tether Applications in Space Program Review. NASA Office of Space Flight, Washington D.C., McLean, Virginia, July 17-18, 1985.

Rockwell International Corporation: Space Station Needs, Attributes, and Architecture Options. Downey, California.

Roder, H. M.: The Thermodynamic Properties of Slush Hydrogen and Oxygen, prepared for NASA-Johnson Space Center, Houston, TX 77058 by Cryogenics Division, National Bureau of Standards, Boulder, CO 80302, Final Report, NBSIR 77-859, November 1977.

Ryan, Gregory G.: "Tether Applications for the Inertial Upper Stage." Boeing Aerospace Company.

Salzman J. A., Labus T. L., and Masica, W. J.: "An Experimental Investigation of the Frequency and Viscous Damping of Liquid During Weightlessness," NASA TN D-4132, NASA Lewis Research Center, Cleveland, Ohio, August 1967.

Space Shuttle Program Specification, Space Shuttle Fluid Procurement and Use Control, NASA-Johnson Space Center, Houston, TX, SE-S-0073, Rev. B, 9 February 1975, p 24.

Space Station Definition and Preliminary Design, Request for Proposal, 15 September 1984, Section C Statement of Work, Attachment C-4 Space Station System Requirements, p C-4-15.

Steinbrown, O., et. al.: "Operations/Serviceing of a Space-Based OTV on a Space Station." Paper IAF-83-39, Presented at the 34th Congress of the International Astronautical Federation, Budapest, Hungary, October 10-15, 1983.

Strobridge, T. R.: "Refrigeration for Superconducting and Cryogenic Systems." National Bureau of Standards, Institute for Basic Standards, Cryogenic Division. Boulder, Colorado.

Sutton and Ross: Rocket Propulsion Elements, Wiley Interscience Publication, 1976, 4th ed.

TRW Space and Technology Group: Space Station Needs, Attributes, and Architecture Options. Redondo Beach, California.

Taylor, J. R.: Handbook of Piece Part Failure Rates (Long Life Space Vehicle Investigations), Report No. T-70-48891-007, Martin Marietta Aerospace, 22 June 1970.

Tegart, J. R. and Kirkland, Z. D.: "On-Orbit Propellant Resupply Demonstration - Flight Results," AIAA Paper 85-1233, AIAA/SAE/ASME/ASEE 21st Joint Propulsion Conference, Monterey, California, July 8-10, 1985.

The Boeing Company: Orbit Transfer Vehicle Concept Definition Study. Final Report D180-26090, 1980, Contract NAS8-33532.

Universities Space Research Association: Final Report Ad Hoc Orbiter Charging Committee for the TSS-1 Mission. November 8, 1985.

Von Tiesenhausen, Georg, ed.: The Roles of Tethers on Space Station. NASA TM-86519. George C. Marshall Space Flight Center, October, 1985.

Wapato, P. G. and Norman, R. H.: Long-Duration Cryogenic Cooling with the Reversed Brayton Turbo-Refrigerator SPIE Vol. 245, 1980.

Willcockson, Bill: "OTV Flight Operations Aeropass Guidance." November 5, 1985.