

MISSION & SPACE VEHICLE SIZING DATA
FOR A CHEMICAL PROPULSION/AEROBRAKING OPTION

John Butler
Bobby Brothers
Marshall Space Flight Center
Marshall Space Flight Center, AL

ABSTRACT

This paper presents sizing data for various combinations of Mars missions and chemical-propulsion/aerobraking vehicles. Data is compared for vehicles utilizing opposition (2-year mission) and conjunction (3-year mission) trajectories for 1999 and 2001 opportunities, for various sizes of vehicles. Payload capabilities for manned and unmanned missions vehicles and for propulsive-braking and aerobraking cases are shown. The effect of scaling up a reference vehicle is compared to the case of utilizing two identical vehicles, for growth in payload capability. The rate of cumulative build up of weight on the surface of Mars is examined for various mission/vehicle combinations, and is compared to the landed-weight requirements for sortie missions, moving-base missions, and fixed-base missions. Also, the required buildup of weight in low Earth orbit (LEO) for various mission/vehicle combinations is presented and discussed.

REFERENCE VEHICLE

A typical chemical propulsion/aerobraking Space Vehicle (SV) for a manned Mars landing mission is shown in Figure 1, along with the key assumptions and parameters associated with the mission. The vehicle utilizes cryogenic propellants in its propulsive stages, aerocapture at Mars and Earth, and aerobraking plus propulsive burns during the descent to the Martian surface. The mission for which this vehicle is sized is an opposition mission which arrives at Mars in 2001. The total mission time is 780 days, including a stopover time of 60 days at Mars. In this mission, three of the crew members remain in Mars orbit, and the other three descend to the surface. This mission and vehicle are described more fully in references 3, 4, and 5.

* C-4

FIGURE 1. TYPICAL CHEMICAL (CRYO) PROPULSION/AEROBRAKING SPACE VEHICLE CONCEPT FOR MANNED MARS MISSION

4569-85

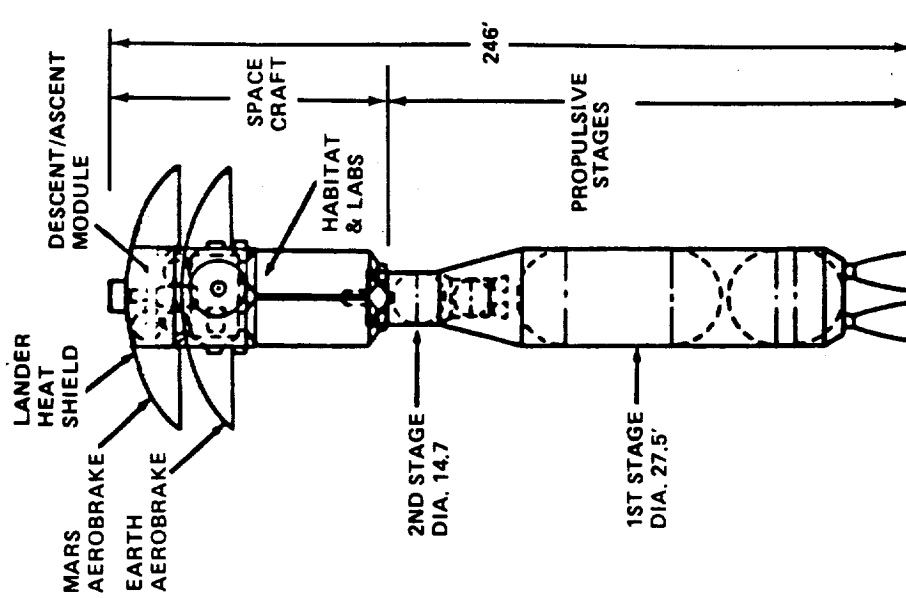

KEY MISSION & VEHICLE PARAMETERS

- OPPOSITION CLASS MISSION
MARS ARRIVAL IN 2001
- TOTAL MISSION DURATION 780 DAYS
- MARS STOPOVER TIME: 60 DAYS
- AEROBRAKING & PROPULSIVE DESCENT AT MARS
- TOTAL VEHICLE WET WEIGHT: 1.57M LB.
- 1ST & 2ND STAGE CRYO PROPELLANT WEIGHT: 1.14 M I.B.
- AEROCAPTURE AT MARS
- AEROCAPTURE AT EARTH
- CREW SIZE: 6 (3 TO SURFACE)
- USES SS HAB, LAB, & LOG MODULES
- 1ST STAGE IS ET DERIVATIVE, W/2 EACH STME CRYO ENGINES
- 2ND STAGE IS OTV, W/2 EACH RL 100 CRYO ENGINES
- LANDER HAS 3 EACH NEW ENGINES (LOX/MMH)

SPACE VEHICLES SIZING SENSITIVITIES

Using this mission and vehicle as a reference, parametric data have been developed for various other missions and vehicles. The left side of Figure 2 shows how the SV low Earth orbit (LEO) weight would change as this mission and vehicle are scaled from a 2-year to a 3-year mission. The data shown for the crew consumables, science equipment, and spacecraft subsystems is shown as a linear function of time, and is independent of the mission date. The additional science equipment would have to be provided in order to make better use of the additional time at Mars, and a rough estimate of weight for this equipment has been made here. Spacecraft subsystems weight would increase as shown to accommodate the increased volume of consumables and experiments and to provide additional systems lifetime. The total SV weight is dominated by the weight of the propulsive stages, so the increase in spacecraft weight is more than offset by the decrease in propulsion weight for the 3-year mission, compared to the 2-year mission.

In actuality, there is no continuum in mission possibilities between the 2-year and the 3-year data points. The 2-year data point corresponds to an opposition-type mission arriving at Mars in 2001, which has about a 60-day stopover time; the 3-year data point corresponds to a conjunction-type mission arriving at Mars in 1999, which has a stopover time of about 1 year. There are no realistic choices of missions in the region between these data points. The propulsive vehicle weights vary considerably from opportunity to opportunity, as discussed in reference 1, with the opposition-class missions varying much more than the conjunction-class missions. The conjunction missions require less propellant than the opposition missions. More discussion on these is provided in references 3 and 5.

The right-hand side of Figure 2 gives an idea of the sizing sensitivity associated with scale-up of the reference vehicle to a vehicle with greater payload capability. In this case, the term "residual payload" implies the payload delivered to the surface of Mars and left there (excludes the ascent stage on manned landing missions). There is a pound-for-pound increase in the SV LEO weight for each payload pound added to the SV. In addition, the weight of the propulsive stages must increase as shown to deliver the additional payload weight. Increasing

FIGURE 2. SPACE VEHICLE SIZING SENSITIVITIES

- CRYO PROPULSION
- AEROBRAKING FOR MARS CAPTURE/DESCENT & EARTH CAPTURE ("ALL - AEROBRAKING")
- 6-MAN CREW

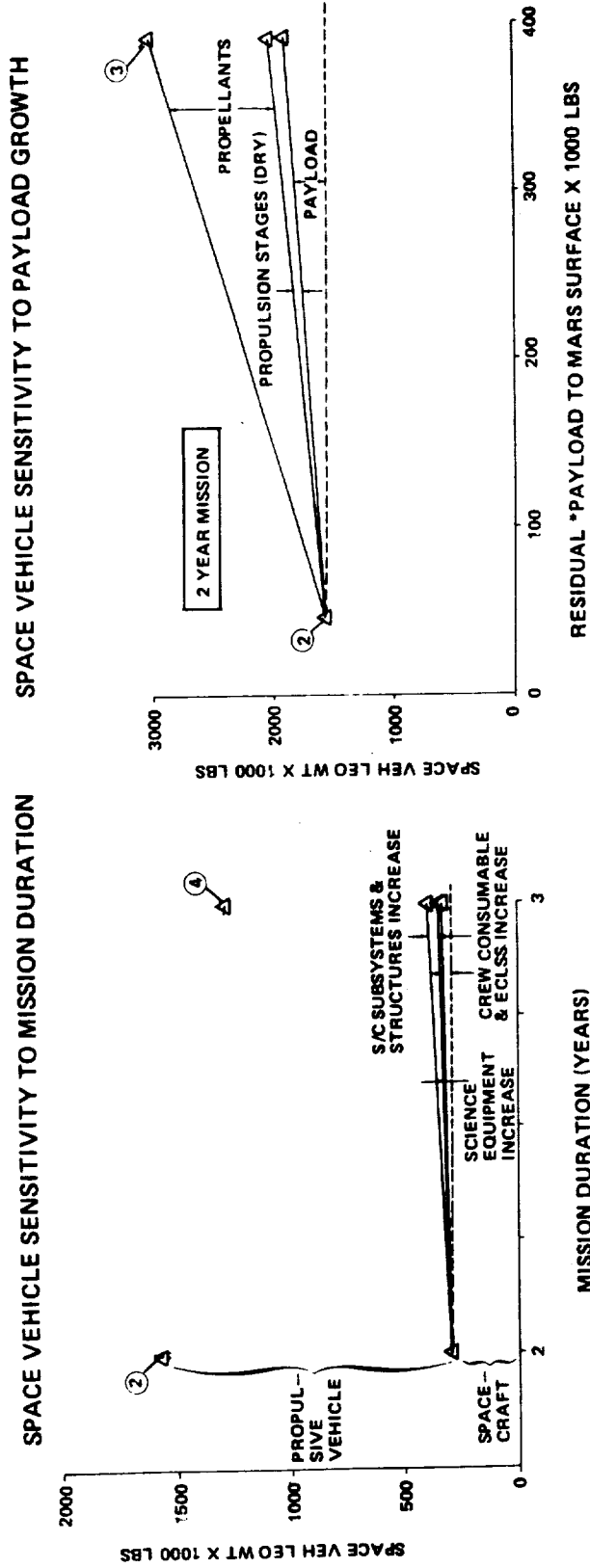

*PAYLOAD DELIVERED TO MARS SURFACE AND LEFT THERE

○ DATA POINTS FOR BARS ON SUBSEQUENT BAR CHART

the residual payload to the surface of Mars by a factor of 8 only costs an increase in SV LEO weight of about a factor of 2, providing a net 4-to-1 benefit-to-cost ratio. Flying 2 of the initial SV's would result in only a 1 to 1 ratio; hence, a growth version of the SV's appears to be much more efficient than 2 SV's for transporting payload to Mars. The circled numbers denote data points corresponding to bars on Figure 3.

MISSION/VEHICLE COMPARISONS

Figure 3 is a bar graph showing the total SV LEO weight for several types of SV's across a large portion of the spectrum of possibilities for cryo propulsion systems.

Bars #1-3 are for 2-year missions and #4 is for a 3-year mission. Bar #1 is for an "all propulsive" SV (although aerobraking is used here during part of the Mars descent), and bars #2-4 are for "all-aerobraking" SV's (although retro propulsion is used here during the final descent to Mars). Bars #1 and #2 show the savings on propulsion system weight which is possible with an aerobraking vehicle compared to an all-propulsive vehicle, for the same size payload.

Bar #2 is for the reference SV mentioned previously (Figure 1). This bar corresponds to the 2-year data point in Figure 2 (left-hand side of both graphs), and bar #4 is for the 3-year data point (right-hand side of the left graph) on Figure 2. Bar #3 is for the growth version of the 2-year SV shown in the right-hand graph of Figure 2.

Each bar is divided into subelements to show which portion of the total weight represents the SV propulsion stages' dry weight, propellant weight, and payload (spacecraft or other) weight. Two cases are shown for the residual payload weight for each bar (residual payload weight here means weight delivered to and left on the Martian surface). One case ("A") is representative of payload for a manned mission, wherein additional elements and propellants must be provided to return the crew to Earth. The other case ("B") is a preliminary estimate of payload for an unmanned one-way delivery mission, which allows greater payload weight to be delivered and left on the surface, since no crew or equipment have to be returned to Earth. The unmanned payload numbers represent merely a estimate (essentially the total spacecraft weight from the manned landing cases), but these numbers are believed to be fairly accurate. There are intermediate cases, not shown, of missions having the spent propulsive

**FIGURE 3. SPACE VEHICLE WEIGHT BREAKDOWN
(CRYO PROPULSION)**

3183-85

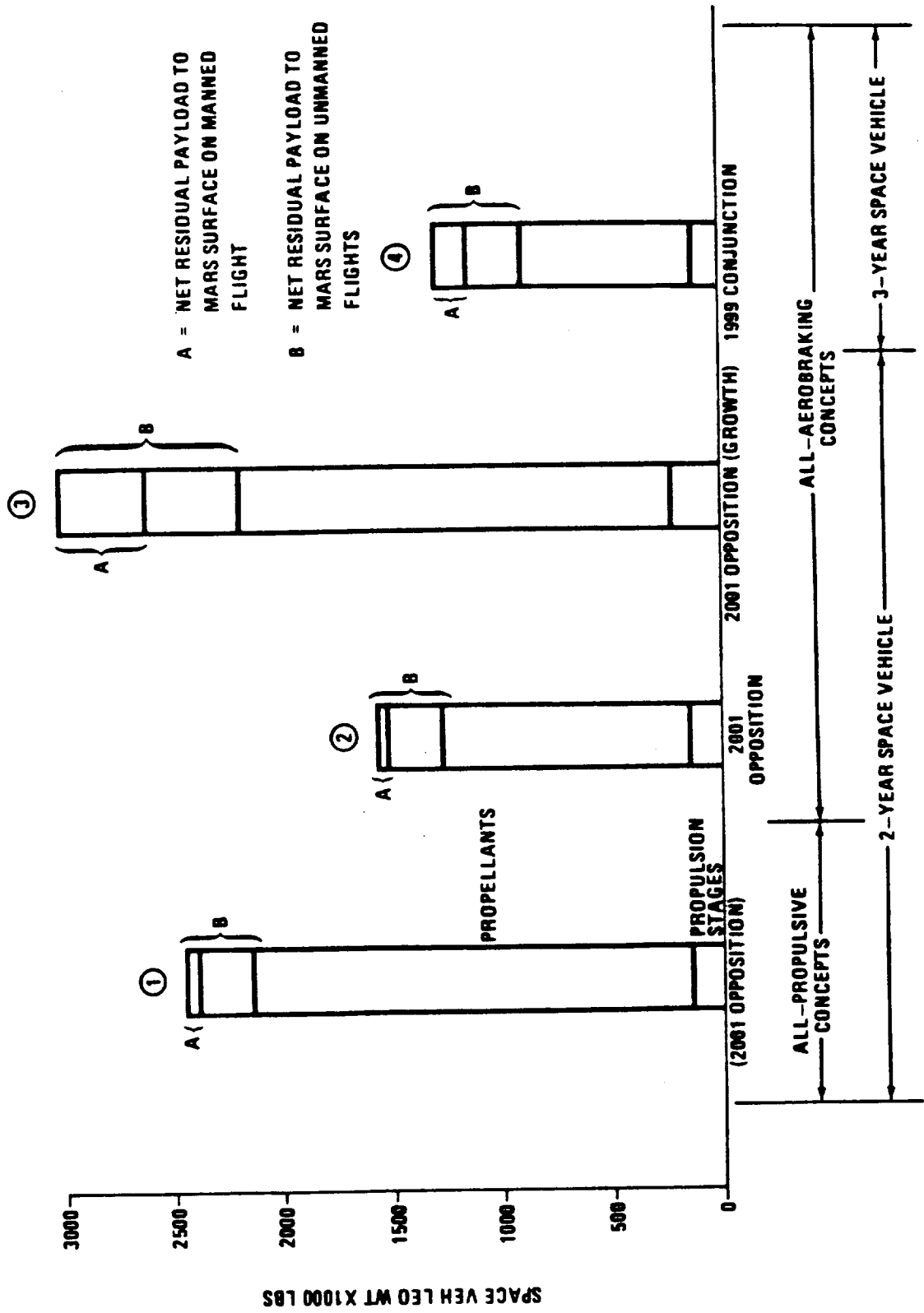

stages returned to Earth for reuse. This is an issue of considerable interest to NASA, and further study must be done to determine its cost-effectiveness.

CUMULATIVE BUILDUP AT MARS

Figure 4 shows the potential cumulative buildup of weight of equipment left on the surface of Mars for manned and unmanned missions, using different propulsive vehicles of the types shown on previous charts. The circled numbers refer to the bars on Figure 3, and indicate which type of vehicle and mission was used for each line of Figure 4. The degree of improvement in buildup rate can be seen for cases using growth versions of the propulsive vehicle compared to cases using two vehicles, and compared to cases using just the basic propulsive vehicle. Assumptions were made here that launches occur at every opportunity and that propulsion requirements for every opportunity are the same. As previously mentioned, the latter assumption is not the true situation, and considerable differences may exist between opportunities. Hence, the launch vehicle sizes and/or payload capabilities would vary from one opportunity to another, and the curves would not be as smooth as shown. Trends, however, should be roughly the same. The horizontal lines shown on Figure 4 represent amounts of weight necessary to be delivered to Mars and left there to achieve weight buildups equivalent to those required for 5 different types of bases, as identified in reference 6. As can be seen, the manned landing case which uses the basic propulsive vehicle and the case which uses 2 vehicles both require a significant number of missions before meeting the required levels of buildup for bases. The growth SV and/or combinations of manned and unmanned launches allow implementation of the bases in much more reasonable time spans.

An example of the variation in overall SV LEO mass from one opportunity to another (over different years than those discussed thus far) can be seen in Figure 5, which plots all-propulsive vehicle data from reference 1. The corresponding variation in mission time for those years is shown in Figure 6.

CUMULATIVE BUILDUP IN LEO

Figure 7 is similar to Figure 4, except that it shows the cumulative weight buildup required in LEO to accomplish the launches to Mars for the mission and vehicle options previously mentioned. Here, the

FIGURE 4. CUMULATIVE BUILDUP OF PAYLOAD WEIGHT ON MARS SURFACE

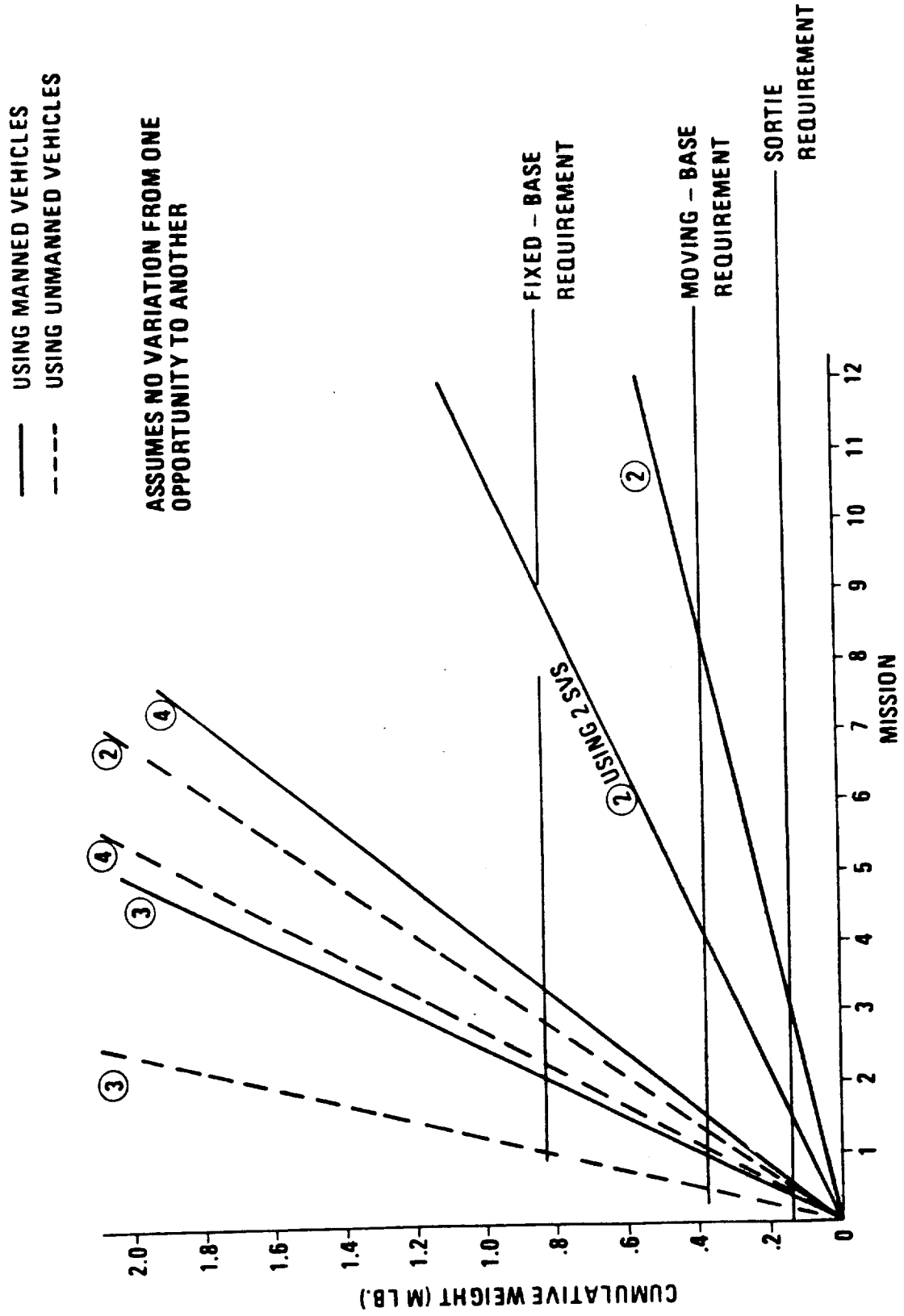

FIGURE 5. TYPICAL LEO MASS REQUIREMENTS FOR MARS MISSIONS

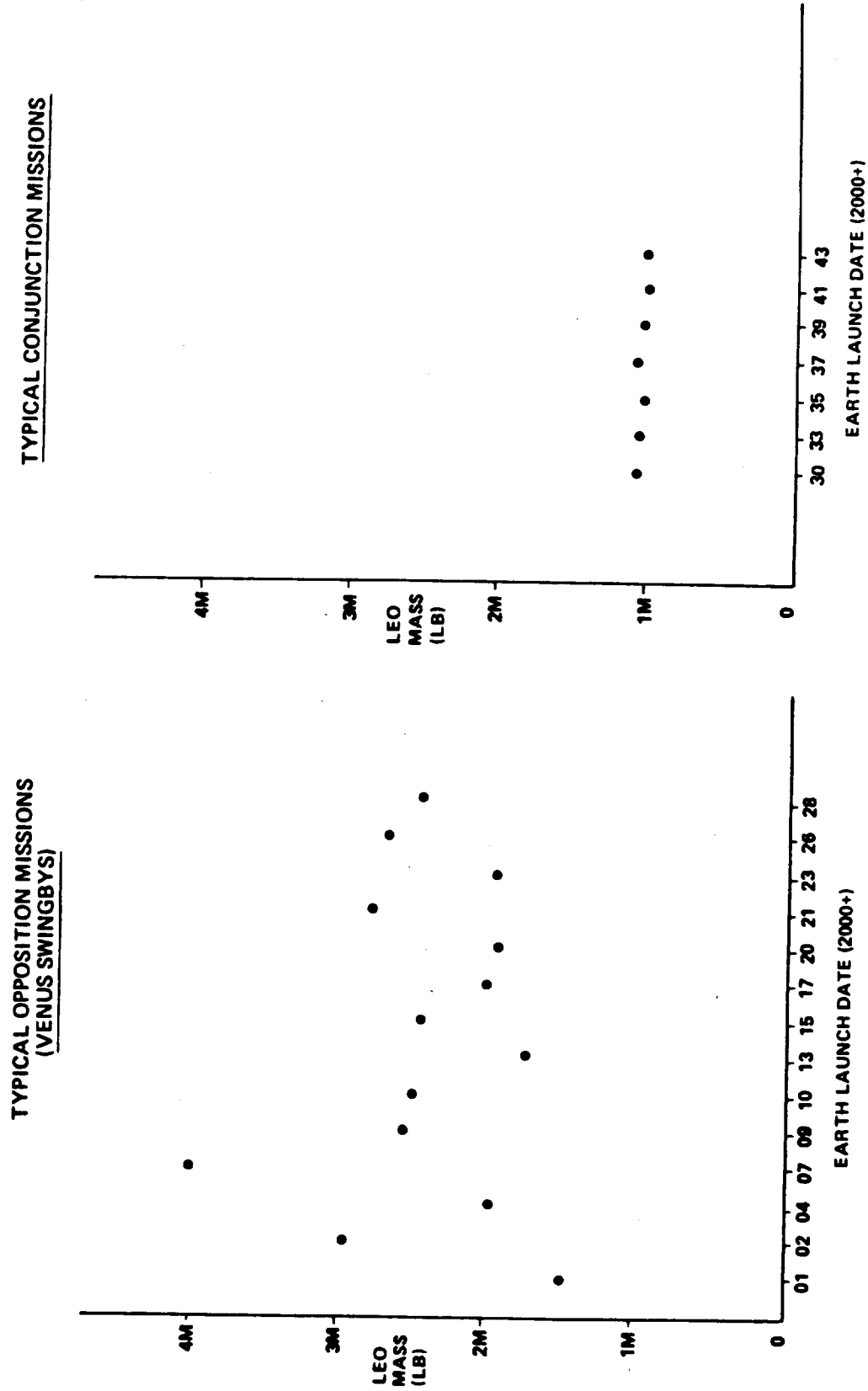

FIGURE 6. TYPICAL MARS MISSION DURATIONS

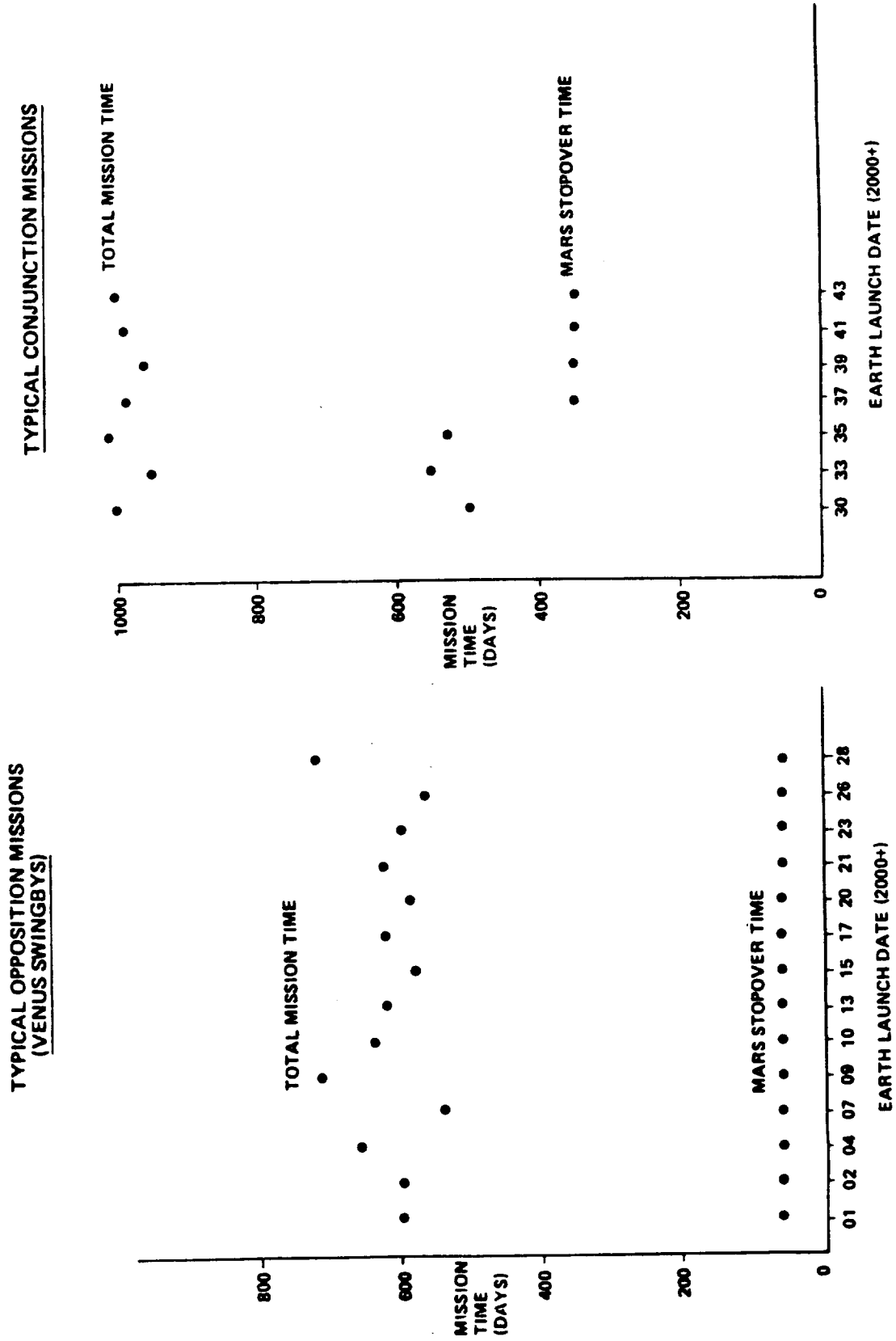
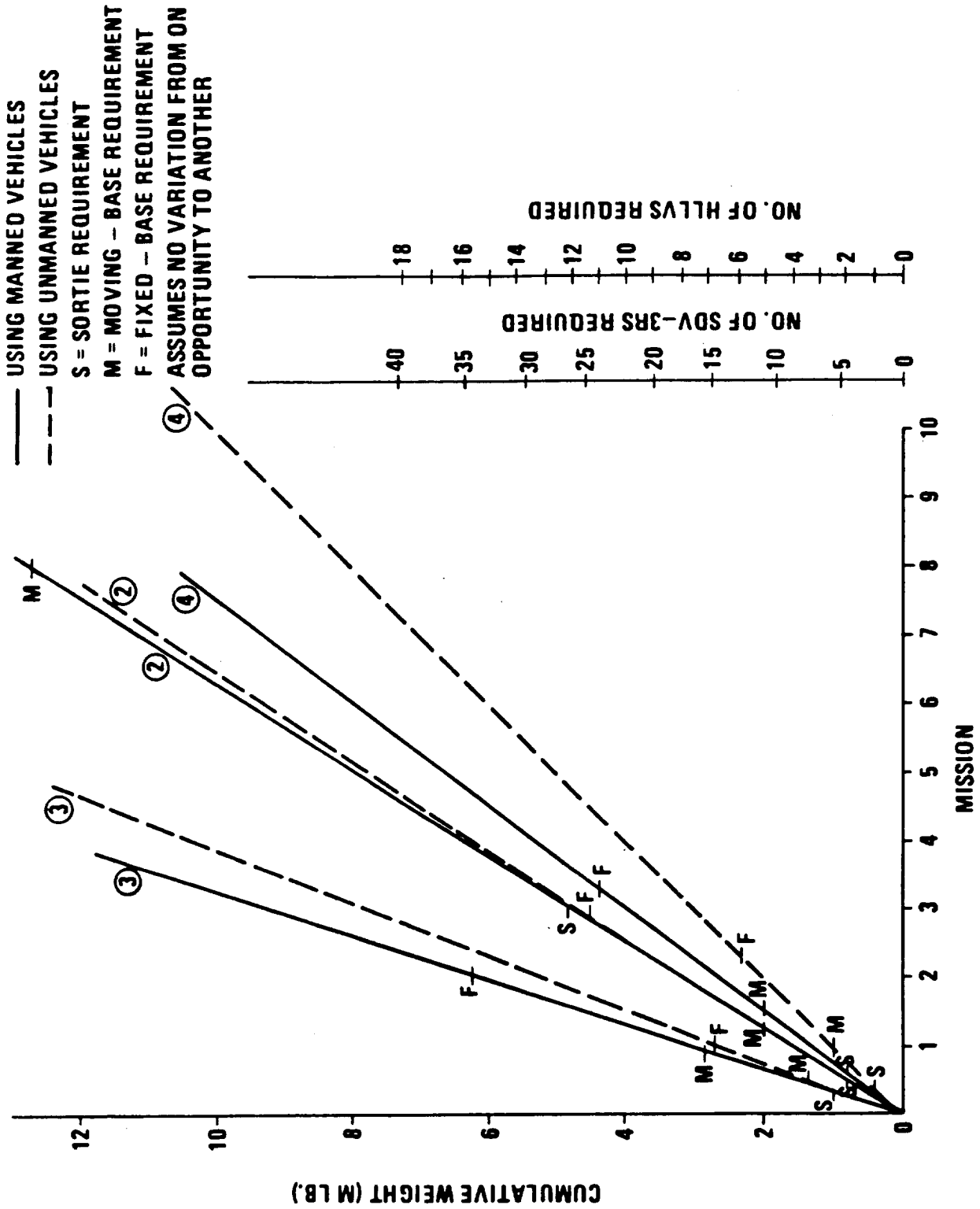

FIGURE 7. CUMULATIVE BUILDUP OF LEO WEIGHT



3184-86

effect can be seen of the more efficient trajectory of the 3-year conjunction mission (curve #4) compared to the 2-year opposition mission (curves #2 and 3). As discussed in references 4 and 7, both types of missions will probably be desired as part of a Mars program. The ordinate axes on the right-hand side of this chart show the quantity of Shuttle-Derived Vehicles (SDV's) or Heavy-Lift Launch Vehicles (HLLV's) required, depending on which of these concepts is used. Here, the SDV-3R and the HLLV of the type defined in reference 2 were assumed. These vehicles would have launch capabilities of about 182K pounds and about 400K pounds, respectively, to the Space Station (SS) orbit (assumed to be 270 nautical miles altitude and 28.5 degrees inclination). No detailed "capture" analysis was done here, so the data shown on these axes may be overly optimistic in terms of estimates of packaging efficiency in the SDV-3R and HLLV.

REFERENCES

1. Young, Archie C., Mulqueen, John A., and Skinner, James E.; "Mars Exploration - Venus Swingby and Conjunction Class Mission Modes, Time Period 2000 to 2045", NASA TM-86477; National Aeronautics and Space Administration, 1982; p. 296.
2. Page, Milt; "Earth-to-Orbit Vehicles", Manned Missions and Configuration Concepts; MSFC paper in Section III.
3. Young, Archie C. ; "Mission and Vehicle Sizing Sensitivities"; MSFC paper in Section II.
4. Tucker, M., Meredith, O. and Brothers, B.; "Space Vehicle Concepts"; MSFC paper in Section III.
5. Young, Archie C.; "Mars Mission Concepts and Opportunities"; MSFC paper in Section II.
6. Butler, J., and McDaniel, S.; "Mission and Surface Infrastructure Concepts"; MSFC paper in Section IV.
7. Butler, J.; "Mission and Space Vehicle Concepts"; MSFC paper in Section III.