

NASA Technical Memorandum 88966

Tribological Properties of Polymer Films and Solid Bodies in a Vacuum Environment

(NASA-TM-88966) TRIBOLOGICAL PROPERTIES OF
POLYMER FILMS AND SOLID BODIES IN A VACUUM
ENVIRONMENT (NASA) 34 p CSCL 11B

N87-1790b

Unclas

G3/27 43528

Robert L. Fusaro
Lewis Research Center
Cleveland, Ohio

Prepared for the
1987 Annual Meeting of the American Society of Lubrication Engineers
Anaheim, California, May 11-14, 1987

NASA

TRIBOLOGICAL PROPERTIES OF POLYMER FILMS AND SOLID BODIES
IN A VACUUM ENVIRONMENT.

Robert L. Fusaro
National Aeronautics and Space Administration
Lewis Research Center
Cleveland, Ohio 44135

Abstract

The tribological properties of ten different polymer based materials were evaluated in a vacuum environment to determine their suitability for possible lubrication applications in a space environment, such as might be encountered on the proposed space station. A pin-on-disk tribometer was used and the polymer materials were evaluated either as solid body disks or as films applied to 440C HT stainless steel disks. A 440C HT stainless steel hemispherically tipped pin was slid against the polymer materials. For comparison, similar tests were conducted in a controlled air atmosphere of 50 percent relative humidity air. In most instances, the polymer materials lubricated much better under vacuum conditions than in air. Thus, several of the materials show promise as lubricants for vacuum applications. Friction coefficients of 0.05 or less and polymer material wear rates of up to 2 orders of magnitude less than found in air were obtained. One material showed considerable promise as a traction drive material. Relatively high friction coefficients (0.36 to 0.52) and reasonably low wear rates were obtained in vacuum.

INTRODUCTION

The construction and use by the United States of a space station in the 1990's could mean that the tribological problems encountered in the past on space vehicles will become even more complex and difficult. Most lubricating situations to date on space vehicles have been solved either by using low vapor pressure oils and greases or by using solid lubricants. Oils and

greases have their drawbacks because even low vapor pressure oils can evaporate and contaminate nearby sensitive surfaces such as optical devices. Solid lubricants have their limitations because they have generally higher friction coefficients than oils and because of finite endurance lives. Also some solid lubricants, which are used in terrestrial applications, do not function well in a vacuum, e.g., graphite.

The challenge will be to find new solid lubricant materials which will be able to operate for long sliding durations in the vacuum of space and under the changing temperature conditions of day and night. Three principal classes of solid lubricant materials have been used to date: polymers, such as PTFE; dichalcogenides, such as molybdenum disulfide (MoS_2); and soft metals, such as lead (1).

It is the author's belief that polymer and polymer composite materials, especially the class of polymers called polyimides are the best prospects to meet the new lubrication challenges. In previous studies (2-4), it was observed that the friction and wear of some polyimide films dropped dramatically as the temperature was raised above a certain level in an air atmosphere. It was postulated that this might be due to the desorption of absorbed water vapor, since polyimides have a free hydrogen bond which tends to bond water vapor. Getting rid of the water could give the polyimide molecules the necessary freedom to flow as a thin films on the polymer surface. Thus, one of the objectives of this study was to determine if the friction and wear of polyimide materials would drop in the absence of air and water vapor. However, the main objective of the study was to tribologically evaluate in a vacuum environment several commercially available polymeric materials (either in the form of a solid body or a film applied to a metal) in order to determine if any of these materials might have potential for future space station applications. A pin-on-disk apparatus was used and vacuums of

either 0.13 Pa (10^{-3} torr) or 0.00013 Pa (10^{-6} torr) were employed. For comparison, similar experiments were also conducted in a controlled 50 percent RH air atmosphere.

MATERIALS

Ten different types of polymer materials were evaluated. Seven as solid body disks and three as films applied to AISI 440C HT (high temperature) stainless steel disks with a Rockwell hardness of C-58. Most of the materials are commercially available and can be purchased from a vendor. The solid body materials were: a polyphenylene sulfide (PPS) disk reinforced with 40 percent graphite fibers, a Poly (amide-imide) disk with PTFE and graphite powder additives, a commercially available polyimide with no additives, a PMR-15 polyimide (5) with a 70 percent PTFE powder additive, a polyimide made from the diamine 2,2-bis (4-(aminophenoxy)phenyl) - hexafluoropropane (4-BDAF) and the dianhydride pyromellitic acid (PMDA) (6,7) (for short this polyimide will be referred to as 100 PMDA), a co-polyimide made from the diamine 4-BDAF and 80 mol % of the dianhydride PMDA and 20 mol % of the dianhydride benzophenonetetra-carboxylic acid (BTDA) (6,7) (for short this polyimide will be referred to as 80 PMDA/20 BTDA), and an 80 PMDA/20 BTDA polyimide reinforced with 50 percent high modulus graphite fibers (8). The films evaluated were a 100 PMDA polyimide film, a PI-4701 polyimide film (2,3), and a PI-4701 polyimide film with 50 wt % of the solid lubricant graphite fluoride (9).

APPARATUS

A pin-on-disk tribometer was used to evaluate the polymer materials. The apparatus used for the air tests is described in detail in Ref. 10. A schematic of the test specimens is shown in Fig. 1. The vacuum tribometer was essentially the same as the air tribometer except that the friction specimens were enclosed in a stainless steel vacuum chamber and a magnetic drive

coupling was used to rotate the disk. The fulcrum of the lever arm used to apply the load to the pin could be translated in the direction of the lever's length, so that the diameter of the circumference of the wear track on the disk could be changed without removing the specimens from the vacuum. A sorption pump was used to achieve a pressure of 0.13 Pa (10^{-3} torr) and an ionization pump was used to achieve a pressure of 0.00013 Pa (10^{-6} torr).

PROCEDURE

Specimen Cleaning

The AISI 440C HT stainless steel pins and disks were cleaned by washing with ethyl alcohol and then by scrubbing with a water paste of levigated alumina. They were then scrubbed with a brush under running tap water to remove the levigated alumina, rinsed with distilled water, and dried with clean compressed air.

The polymer solid bodies were scrubbed with a nonabrasive detergent, rinsed with distilled water, and then dried with clean compressed air. The films were not cleaned since they were put in a desiccator immediately after coating and were not touched by human hands.

Experimental Testing

The specimens were inserted into the tribometer and the chamber sealed. For the air tests, a controlled 50 percent relative humidity air was purged through the chamber for 15 min before commencing the tests and continuously throughout the tests. For the vacuum tests, the chamber was held at the desired vacuum pressure for 15 min before commencing the tests. The disk was then set into motion at 100 rpm and a 9.8 N load was gradually applied to the disk through the pin. The pin slid against the disk at a constant diameter which could be varied from 1.5 to 6.0 cm.

After various intervals of sliding, the tests were stopped and the specimens removed from the tribometer. The pin and disk rubbing surfaces were

then studied by optical microscopy and surface profiles of the disk wear track were taken. From these profiles, polymer wear track cross-sectional area was measured and wear rate calculated. The specimens were reinserted into the tribometer and the above procedure repeated. The tests were terminated after constant wear rates were ascertained or failure occurred (films worn through to the metal substrate and high friction obtained).

RESULTS AND DISCUSSION

Friction Coefficient

Previous Work - In previous studies (2-4), it was observed that for some polyimide materials, the friction coefficient tended to decrease as a function of increasing temperature. It was postulated that the reason for this was that water vapor hydrogen bonded to the polyimide chains at lower temperatures and constrained the chains freedom "to unfold" into an extended molecular chain type of structure (2); and thus brittle fracture and higher friction occurred under these sliding conditions. By increasing the temperature to a higher level, the H₂O molecules either debonded or their influence became negligible, and friction and wear dropped up to an order of magnitude. When this happened very thin plastically flowing surface layers were observed on the film wear tracks and on the pin sliding surfaces.

Experiments in dry argon (20 ppm, H₂O), dry air (100 ppm, H₂O), and moist air (10 000 ppm H₂O) (3) indicated that this transition from high friction-high wear to low friction-low wear occurred at a lower temperature as the amount of water vapor in the air decreased, and indicating that even a very small amount of water vapor could affect the friction and wear of polyimides. Thus, in addition to evaluating several polymer materials for possible space usage, an objective of this study was to determine if low friction and low wear could be obtained at ambient temperature in the complete

absence of water vapor. The following is a discussion of the frictional characteristics of the polymer materials evaluated in air and in vacuum.

Polyphenylene Sulfide Disk Reinforced with Graphite Fibers - Figure 2 plots friction coefficient as a function of sliding duration for the polyphenylene sulfide solid disk which was reinforced with 50 percent graphite fibers and evaluated in air and in a 0.13 Pa vacuum. For both environments, the friction coefficient started out at 0.30 and then rose with sliding duration to a value of about 0.44. In vacuum, after about 40 kc of sliding, there was a sharp drop in friction, and the value eventually leveled off and remained stable at about 0.03. There was also a drop in air after about 200 kc of sliding, but the value dropped off only to 0.30. Only the first 400 kc of sliding are shown in the figure but the air test was for 1300 kc and the vacuum test for 925 kc and in both instances the friction remained stable.

Poly(amide-imide) with PTFE and Graphite Disk - Figure 3 compares the friction properties of a Poly(amide-imide) solid polymer disk with PTFE and graphite additives. The friction coefficient for this composite started out at about 0.18 in air and in vacuum and rose to an average value of about 0.42. In air the friction remained relatively constant at this value for 1560 kc of sliding. In vacuum, the friction started to gradually drop after about 40 kc of sliding and eventually reached a steady-state value of 0.07 after about 83 kc. The friction remained constant at this value until the test was terminated at 380 kc of sliding.

After the vacuum test on this composite was terminated, instead of removing the specimens from the tribometer, the pin was repositioned to slide on a new track on the disk. The friction coefficient for this test again initially started out at a value of 0.18, but only rose to a value of 0.29 in about 18 kc of sliding, then it dropped to a value of about 0.07 after 20 kc

of sliding. This indicates that a long exposure to the vacuum helped desorb the water vapor from the polymer and shortened the run-in period.

Commercially Available Polyimide Solid Disk - Figure 4 plots friction coefficient as a function of sliding distance in air and in vacuum for a commercially available polyimide solid body. As with the previous two polymer materials, the friction coefficient for the tests in air and in vacuum started out at the same value, in this case 0.18. In air, the friction rose to a steady-state value of 0.45 in about 45 kc of sliding and stayed constant for the duration of the test 860 kc. In vacuum, the friction coefficient tended to oscillate between 0.33 and 0.18 until it finally reached a steady-state value of 0.03 after 40 kc of sliding. It remained constant at this value until the test was terminated at 1450 kc of sliding.

Again, instead of removing the specimens from the vacuum tribometer, the pin was repositioned to slide on a new wear track on the disk. Figure 4 shows that the friction coefficient dropped after approximately 7 kc of sliding to a friction coefficient value of 0.03. As with the previous test, this indicates that long exposures to vacuum can help desorb water vapor from the polyimide and shorten the run-in period.

PMR-15 Polyimide Disk with PTFE Additive - Figure 5 plots friction coefficient as a function of sliding duration for the PMR-15 polyimide solid disk with a 70 wt % PTFE additive. The friction coefficient in air and vacuum did not start at the same value for this composite. The friction in air tended to increase gradually from 0.12 as a function of sliding distance until it reached a steady-state value of 0.22 after approximately 650 kc of sliding. After which it remained constant for the duration of the test, 1690 kc. In vacuum, the friction coefficient started out at 0.08 but then rose to a steady-state value of 0.12 after about 280 kc of sliding. It remained constant at this value for the duration of the test, 1292 kc.

This composite material did not produce a low friction coefficient in vacuum like the previous three materials. It is believed that this might be due to the large amount of PTFE in the composite. Desorbing the water may have had a lesser effect due to the fact that the PTFE may have dominated the friction process.

80 PMDA/20BTDA Polyimide Disk - Figure 6 plots friction coefficient as a function of sliding distance for the 80 PMDA/20 BTDA polyimide. For the 80 PMDA/20 BTDA polyimide in air, the friction coefficient started out at 0.18 and then rose constantly for 15 kc of sliding until it reached a constant value of 0.58 (steady-state). In the vacuum, the friction coefficient also first rose with sliding distance but then after 8 kc of sliding it started to decrease and eventually after about 60 kc of sliding reached a steady-state value of 0.04. The tests were slid for 540 kc in air and for 1690 kc in a vacuum of 0.13 Pa.

One additional test was performed on the 80 PMDA/20 BTDA polyimide only. In that test the film was evaluated under a better vacuum of 0.00013 Pa. Under the better vacuum, the friction coefficient started out at the same value as in the 0.13 Pa vacuum, but instead of increasing with sliding distance it dropped very quickly (after about 0.4 kc of sliding) to a steady-state value of 0.02. The friction coefficient remained constant at this value for 1920 kc of sliding.

The results thus substantiate the initial postulation that hydrogen bonded water vapor is responsible for the high friction obtained with the polyimide type materials. The water appears to be removed under the action of sliding in a vacuum and the higher the vacuum, the faster the removal.

80 PMDA/20 BTDA Polyimide Disk Reinforced with Graphite Fibers - Figure 7 shows friction coefficient as a function of sliding distance for an 80 PMDA/20 BTDA polyimide reinforced with 50 wt % of high modulus chopped graphite

fibers. For the first 225 kc of sliding, the friction coefficient in air and in vacuum was nearly the same (a value of about 0.26), then the friction in vacuum rose slightly to 0.30. The vacuum test was terminated after 300 kc of sliding due to wear considerations (cracking and spallation of the graphite fibers) but the air test was continued on to 5400 kc and the wear surfaces were still in great shape.

100 PMDA Polyimide Solid Disk - Figure 8 gives friction coefficient as a function of sliding duration for a polyimide which did not show a low steady-state friction coefficient in vacuum, the 100 PMDA polyimide solid body. The friction coefficient started out between 0.18 to 0.20 in vacuum and air and rose very quickly to a steady-state friction coefficient that was greater than 0.40. As the figure shows there was a considerable amount of slip-stick type of friction which produced a wide variation of friction as the pin transversed the disk. These two tests were evaluated for 160 kc of sliding.

100 PMDA Polyimide Film - Figure 9 plots friction coefficient as a function of sliding duration for the 100 PMDA polyimide that was applied as a film to a 440C HT stainless steel disk. Similar friction characteristics were obtained for the film as for the solid body. That is, there was no dramatic drop in friction (as was found for some of the other polymers in vacuum) and that the values of steady-state friction obtained in air and vacuum were nearly the same (about 0.40). Though the steady-state friction coefficient was slightly lower for the film than for the solid body.

PI-4701 Polyimide Film - The friction coefficient of the PI-4701 film applied to the 440C HT stainless steel disk started out at about 0.28 in air and in vacuum and then dropped rapidly (Fig. 10). In air the steady-state value was 0.15 and in vacuum it was 0.04. In air, the film wore through to

the substrate in about 30 kc of sliding, but in vacuum it was still functioning perfectly after 3020 kc of sliding when the test was terminated.

PI-4701 Film with a Graphite Fluoride Additive - In air, it was found that a 50 percent weight addition of graphite fluoride powder could dramatically increase the endurance life and sometimes decrease the friction coefficient when compared to PI-4701 films alone (9). In vacuum, neither improved friction coefficients or endurance lives were obtained by adding graphite fluoride powder to PI-4701 films. Figure 11 plots friction coefficient as a function of sliding distance for the PI-4701/graphite fluoride film. The average friction coefficient in vacuum was 0.07 and the endurance life was 150 kc. The average friction coefficient in air was 0.16 and the endurance life was 500 kc.

Comparison of Friction Coefficients - Figure 12 compares the maximum, minimum, and average steady-state friction coefficients obtained for the 10 polymer materials evaluated. For the vacuum tests, when the friction characteristics of the neat polyimides are compared to the same polyimide with solid lubricant additives (graphite fibers or CF_x), it is found that the steady-state friction coefficients are greater for the polyimides with the solid lubricants additives than without. Thus it is seen that the friction coefficient of at least some polyimides in vacuum is so low that they do not need solid lubricant additives and that the addition of solid lubricant additives can be detrimental.

WEAR

In all instances, the wear to the metallic pins was too low to measure. Only polished surfaces and transferred polymer material was observed on the pins. Wear to the polymer disks was measurable, however. Figure 13 plots disk wear track cross-sectional area as a function of sliding duration in kilocycles for the 80 PMDA/20 BTDA polyimide disk. Since the wear track

circumference and the sliding distance per cycle are the same, the slope of the straight line in this figure represents wear volume per unit sliding distance.

As found for friction coefficient, most of the low friction producing polymers produced a run-in wear interval before steady-state wear took place. Comparing Fig. 6 with Fig. 13 for the 80 PMDA/20 BTDA polyimide, it took about the same period of time for steady-state friction and steady-state wear to occur in air and in the 0.13 Pa vacuum. There essentially was no run-in wear found for the test run in the 0.00013 Pa vacuum, although this might be disputable since only two wear points were determined.

Figure 14 plots disk wear track cross-sectional area as a function of sliding duration for the 100 PMDA polyimide disk. The figure indicates that the wear increases at a constant rate as a function of sliding distance and that little or no run-in wear took place for this polyimide in either air or in vacuum, since the lines pass through zero. No run-in wear corresponds to the short run-in friction that took place with this polyimide (Fig. 8).

Figure 15 plots cross-sectional area as a function of sliding distance for the commercially available polyimide solid disk. In vacuum, this polyimide had a very long run-in wear period. It took about 440 kc of sliding before steady-state wear occurred. It appears that this is related to the time in vacuum; since when the pin was moved to a new track without removing it from vacuum after 1450 kc of sliding, the wear rate obtained was identical to the steady-state value. Comparing Fig. 15 to Fig. 4, the run-in periods for friction and wear in a vacuum do not correlate. Low friction was obtained after 40 kc of sliding but it took over 400 kc for the lowest wear rate to occur.

The following polymer materials showed no or very little run-in wear in vacuum: the PI-4701 film, the PI-4701 film with CF_x additive, the

80 PMDA/20 BTDA polyimide with graphite fiber additives, and the 100 PMDA polyimide film. In vacuum, the polyphenylene sulfide disk with graphite fibers had a run-in period of about 70 kc, the Poly(amide-imide) disk with PTFE and graphite additive had a run-in period of about 80 kc, and the PMR-15 polyimide disk with 75 percent PTFE had a run in period of about 25 kc.

Figure 16 compares the steady-state wear rate values that were determined for all the polymer materials in air and in vacuum. For the majority of the polymers, the wear rate in vacuum was wither equivalent or less than that obtained in air. The two exceptions were the GFRPI composite and the PI-4701 film with the fluorinated graphite (CF_x) additive. Reasons for this will be discussed in a following section.

Figure 17 plots friction coefficient as a function of steady-state wear rate for all the polymer materials evaluated in vacuum and for 440C HT stainless steel evaluated unlubricated in air. The wear rates of all the polymer materials evaluated can be considered excellent when compared to unlubricated 440C HT stainless steel, whose wear rate is in the order of $10^{-8} M^3/M$ of sliding. It might be mentioned that the 440C HT unlubricated stainless steel was not evaluated in vacuum but that the friction and wear should be even worse in a vacuum since protective oxide films would not be formed.

The best low wear/low friction material in a vacuum environment was found to be the 80 PMDA/20 BTDA solid polyimide disk. The steady-state wear rate of this polyimide was about one-fifth that of the PI-4701 film and about one-tenth that of the PMR-15 film with the PTFE additive. The 80 PMDA/20 BTDA polyimide which was evaluated in the higher vacuum (0.00013 Pa) gave even less wear than the low vacuum (0.13 Pa) test which indicates that the polymers which work well in a low vacuum will work even better in a high vacuum.

The 100 PMDA polyimide film and solid body gave high friction but reasonably good wear protection. A polymer with these characteristics might be useful for coatings or as solid body rollers for space station traction drives which would be used to position solar arrays, telescopes, etc.

Wear Surface Analysis

Except for the two polymer solid disks which contained graphite fibers, the polymer materials did not wear the sliding 440C HT stainless steel pin counterfaces. Very thin, flowing transfer films were produced on the pins. The wear that was produced by the graphite fiber reinforced disks was not great and hardly discernible. It was more like fine polishing and the wear conformed to the radius of the pin hemisphere.

In vacuum, very smooth wear tracks were observed on the polyimides without any solid lubricant additives. Figure 18(a) shows a photomicrograph of the 80 PMDA/20 BTDA disk wear track. Similar surfaces to this were obtained on the PI-4701 and the commercially available polyimides. These surfaces were much smoother than those obtained in air on the same polyimides and it is believed this is due to polyimide's ability to plastically deform as a thin film in the absence of water vapor. Figure 18(b) shows a photomicrograph of the wear surface of the 100 PMDA polyimide film. A similar wear surface was also found on the 100 PMDA polyimide solid disk. In general, the wear surface was smooth but there are many large pits on the wear track. These may have been caused by the high friction between the sliding surfaces.

The powdered solid lubricants which were added to the polymers, tended to produce wear track surfaces that were not as smooth as the neat polymers. Figure 19(a) shows a photomicrograph of the PMR-15 polyimide with the PTFE additive. The surface looks smooth but the surface profile of it shows many voids. The smooth looking nature is due to the transparency of the 70 percent PTFE additive in the polyimide.

Figure 19(b) shows a photomicrograph of the poly(amide-imide) polymer with the PTFE and graphite additives. Fine cracks perpendicular to the sliding direction and many small pits can be seen. The PI-4701 polyimide with CF_x additive produced a similar surface with many small pits. Thus, powdered solid lubricant additives tended to produce weak points in the polymers where cracks could initiate and spalls be produced.

It is generally well known that graphite fibers tend to dust in a vacuum environment. Dusting was not observed in this study, but the graphite fibers on the wear track surfaces were observed to crack and debond from the surfaces. Figure 20(a) gives a photomicrograph of the wear surface of the polyphenylene sulfide polymer with 40 percent graphite fibers and Fig. 20(b) gives a similar photomicrograph for the 80 PMDA/20 BTDA polyimide with 50 percent graphite fibers. The polyphenylene sulfide with graphite fibers shows considerable crumbling and pitting on the wear track; while the polyimide with graphite fibers shows less crumbling, but some cracking within the fibers and some shallow surface pitting did occur. In either case, graphite fibers did not produce good sliding wear surfaces.

SUMMARY OF RESULTS

Friction, wear, and surface morphological studies of 10 different polymer based materials evaluated in a vacuum environment indicated that:

1. Polymer materials, in general, have a great potential for use as long term lubricants for applications which occur under vacuum conditions. Very low wear rates and friction coefficients as low as 0.02 were obtained in a vacuum environment.

2. Of the ten polymer materials evaluated, the 80 PMDA/20 BTDA solid body polyimide and the PI-4701 polyimide film showed the best potential for use as a space environment lubricant.

3. The 100 PMDA polyimide solid or film produced high friction and relatively low wear in vacuum. Thus, this polymer may have potential for such applications as space station traction drives.

4. The friction and wear properties of most of the polyimides in vacuum were so good that other solid lubricant additives are not necessary.

5. In vacuum, powdered solid lubricant additives to the polymers tended to produce weak points in the composites where cracks could be initiated and spallation could occur under sliding conditions.

6. In vacuum, polymers which contained graphite fibers did not produce good sliding wear surfaces. The fibers on the surfaces tended to crack and debond on long sliding durations.

7. All the polymer materials, except the 80 PMDA/20 BTDA polyimide with 50 percent graphite fibers and the 100 PMDA solid and film, produced lower friction coefficients in vacuum than in air.

8. Only the polyimides without solid lubricant additives produced substantially lower steady-state wear rates in vacuum than in air.

REFERENCES

1. Todd, M.J., "Solid Lubrication of Ball Bearings for Spacecraft Mechanism," Tribol. Int., 15, 331-337 (1982).
2. Fusaro, R.L., "Molecular Relaxations, Molecular Orientation, and the Friction Characteristics of Polyimide Films," ASLE Trans., 20, 7-14 (1977).
3. Fusaro, R.L., "Effect of Atmosphere and Temperature on Wear, Friction, and Transfer of Polyimide Films," ASLE Trans., 21, 125-133 (1978).
4. Fusaro, R.L., "Low-Wear Partially Fluorinated Polyimides," ASLE Trans., 28, 542-552 (1985).
5. Serafini, T.T., Delvigs, P., and Lightsey, G.R., "Thermally Stable Polyimides from Solutions of Monomeric Rectants," J. Appl. Polym. Sci., 16, 905-916 (1972).

6. Vaughan, R.W., Jones, R.J., O'Rell, M.K., and Zakrzewski, G.A.,
"Development of Autoclave Moldable Addition-Type Polyimides,"
TRW-26446-6015-RU-00, NASA CR-134900 (1976).
7. Jones, R.J., O'Rell, M.K., and Hom, J.M., "Polyimides Prepared from
Perfluoroisopropylidene Diamine," U.S. Patent 4,111,906 (Sept. 5, 1978).
8. Fusaro, R.L. and Hady, W.F., "Tribological Properties of
Graphite-Fiber-Reinforced, Partially Fluorinated Polyimide Composites,"
ASLE Trans., 29, 214-222 (1986).
9. Fusaro, R.L., "Mechanisms of Lubrication and Wear of a Bonded
Solid-Lubricant Film," ASLE Trans., 24, 191-204 (1981).
10. Fusaro, R.L., "How to Evaluate Solid Lubricant Films Using a Pin-on-Disk
Tribometer," NASA TM-87236 (1986).

ORIGINAL PAGE IS
OF POOR QUALITY

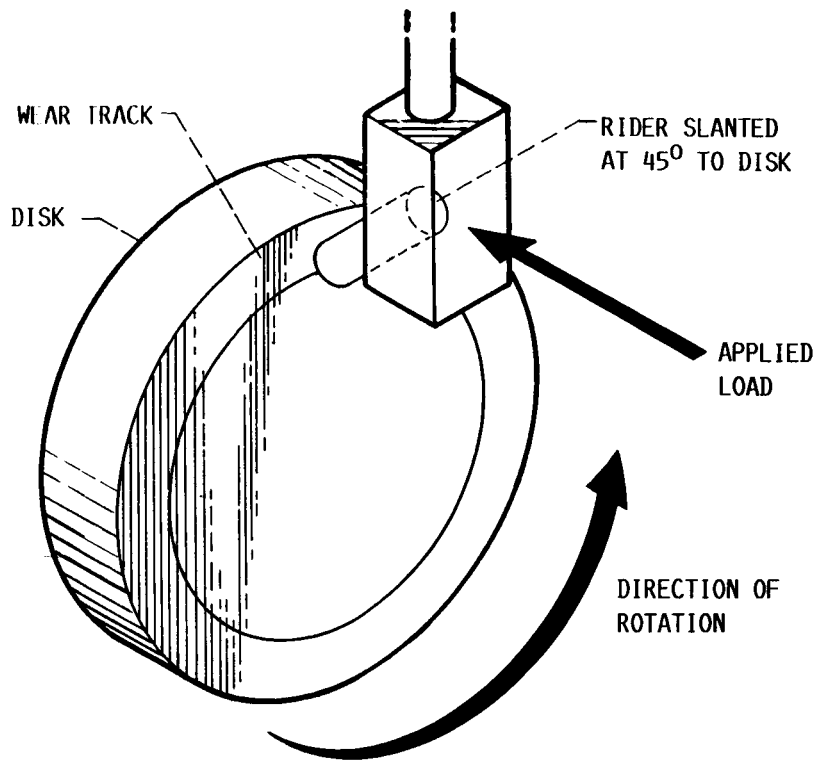

FIGURE 1. - SCHEMATIC ARRANGEMENT OF FRICTION SPECIMENS.

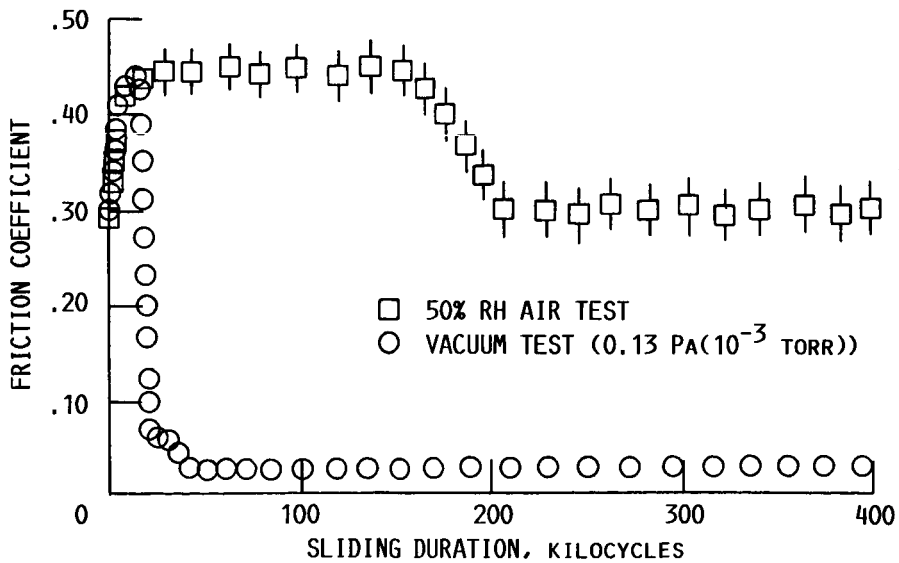

FIGURE 2. - COMPARISON OF THE FRICTION PROPERTIES OF A POLYPHENYLENE SULFIDE SOLID DISK WITH 50 PERCENT ADDED GRAPHITE FIBERS SLIDING IN 50 PERCENT RH AIR AND IN VACUUM.

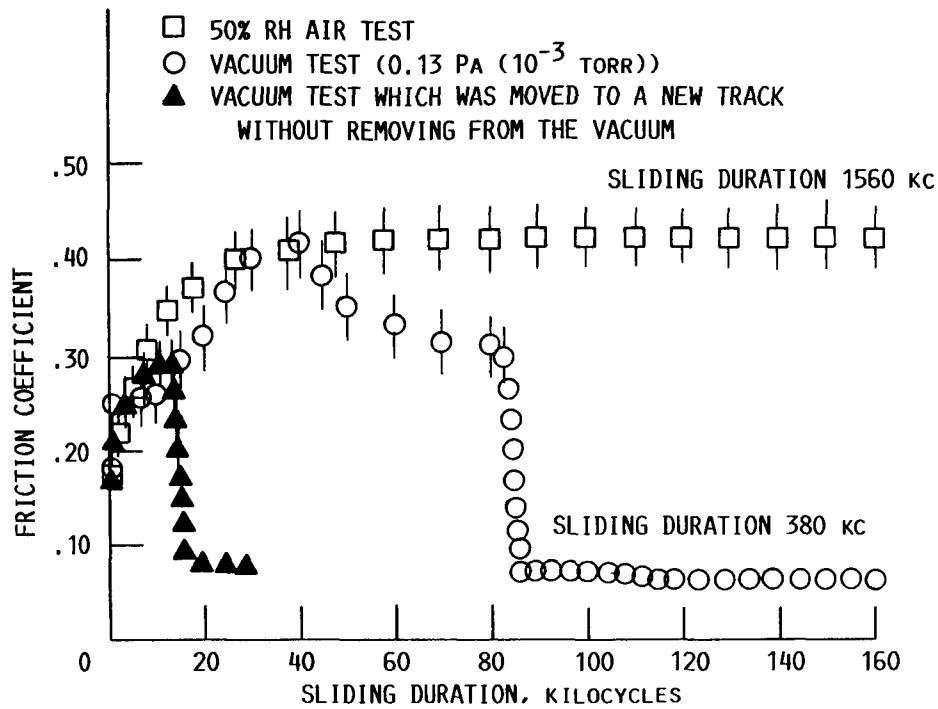

FIGURE 3. - COMPARISON OF THE FRICTION PROPERTIES OF A POLY (AMIDE-IMIDE), PTFE AND GRAPHITE COMPOSITE SOLID BODY SLIDING IN AIR (50 PERCENT RELATIVE HUMIDITY) AND IN VACUUM.

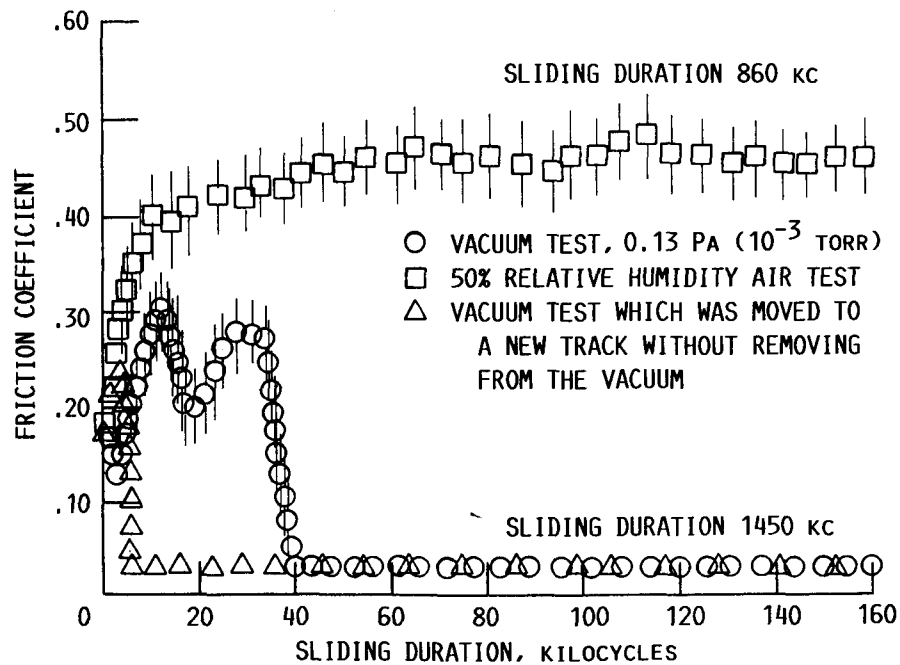

FIGURE 4. - COMPARISON OF THE FRICTION PROPERTIES OF A COMMERCIALLY AVAILABLE POLYIMIDE SOLID BODY IN VACUUM AND IN 50 PERCENT RELATIVE HUMIDITY AIR.

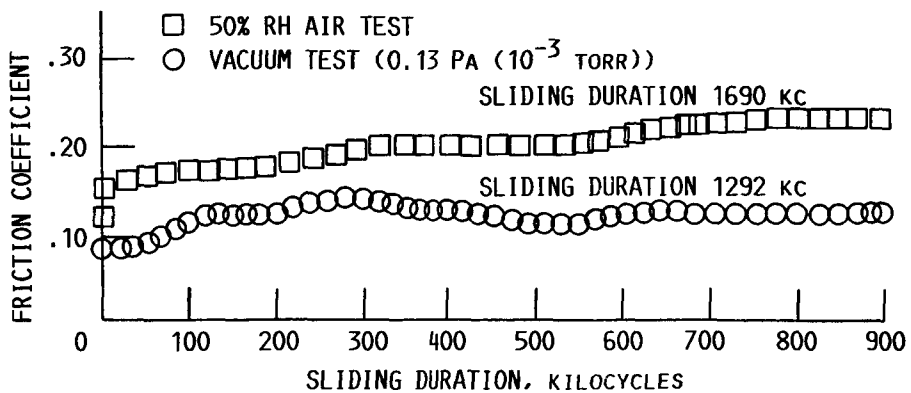

FIGURE 5. - COMPARISON OF THE FRICTION PROPERTIES OF A PMR-15 POLYIMIDE SOLID BODY WITH 70 WEIGHT PERCENT ADDITIVE OF PTFE IN AIR AND IN VACUUM.

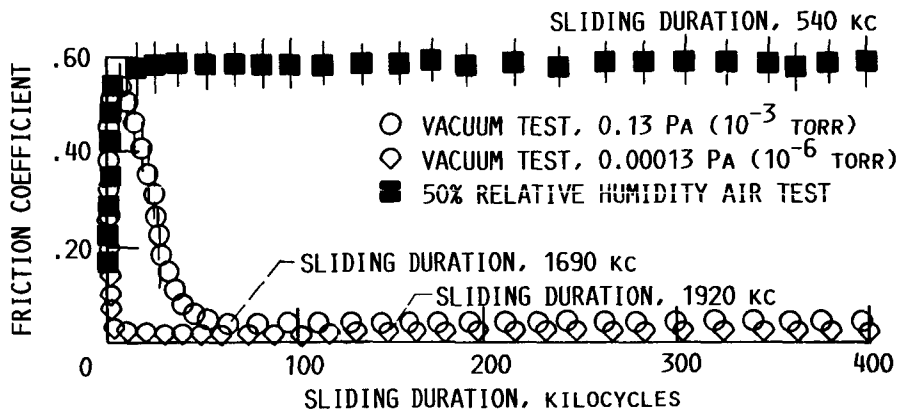

FIGURE 6. - COMPARISON OF THE FRICTION PROPERTIES OF A COPOLYIMIDE MADE FROM A 4-BDAF DIAMINE AND 80 PERCENT PMDA AND 20 PERCENT BTDA DIANHYDRIDES IN AIR AND IN TWO DIFFERENT VACUUM ENVIRONMENTS.

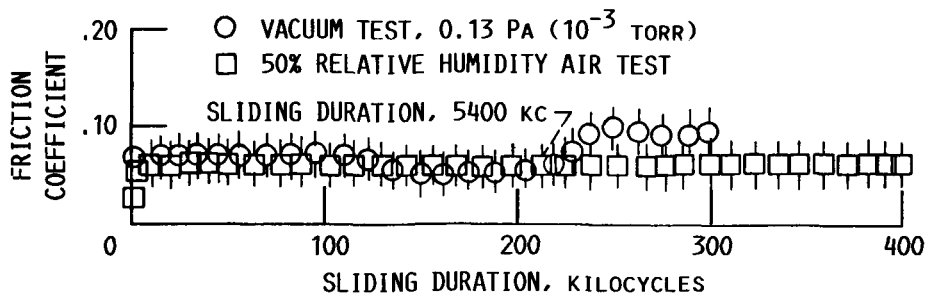

FIGURE 7. - COMPARISON OF THE FRICTION PROPERTIES OF AN 80 PERCENT 4-BDAF/PMDA AND 20 PERCENT 4-BDAF/BDTA COPOLYIMIDE REINFORCED WITH 50 PERCENT BY WEIGHT OF HIGH MODULUS GRAPHITE FIBERS IN VACUUM AND IN AIR.

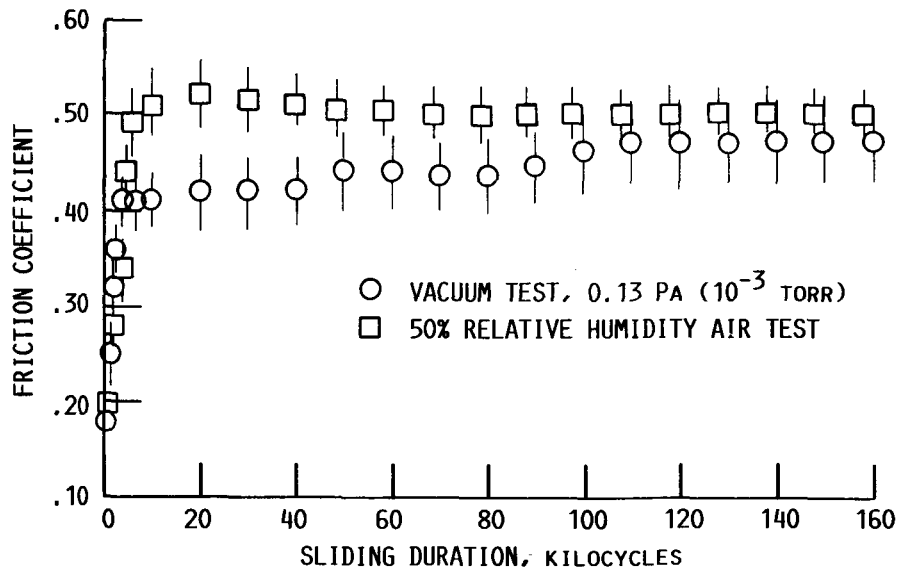

FIGURE 8. - COMPARISON OF THE FRICTION PROPERTIES OF A 4-BDAF/PMDA POLYIMIDE SOLID BODY IN VACUUM AND IN 50 PERCENT RH AIR.

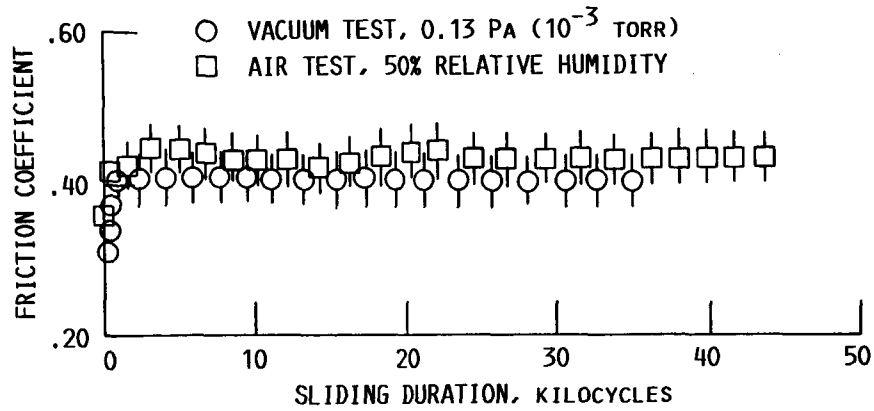

FIGURE 9. - COMPARISON OF THE FRICTION PROPERTIES OF A 100 PERCENT PMDA POLYIMIDE FILM IN AIR AND IN VACUUM.

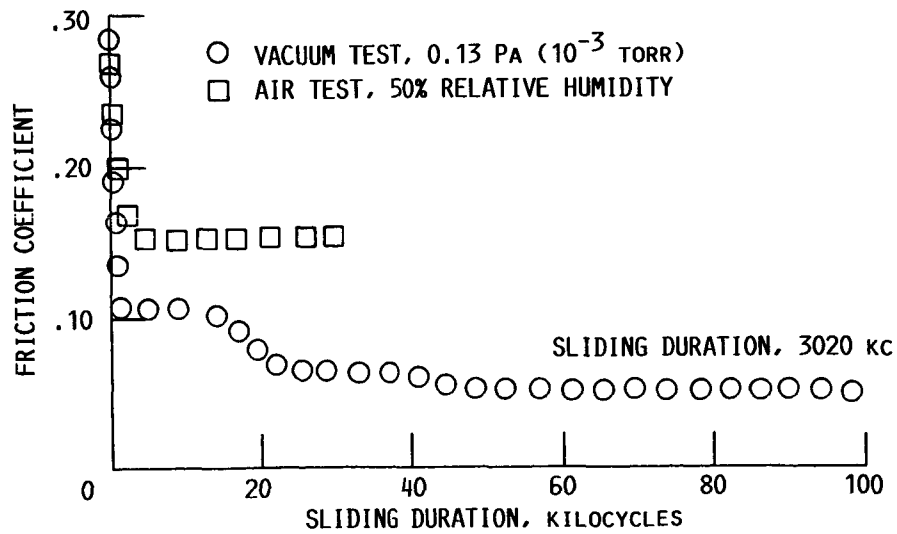

FIGURE 10. - COMPARISON OF THE FRICTION PROPERTIES OF A PI-4701 POLYIMIDE FILM IN AIR AND IN VACUUM.

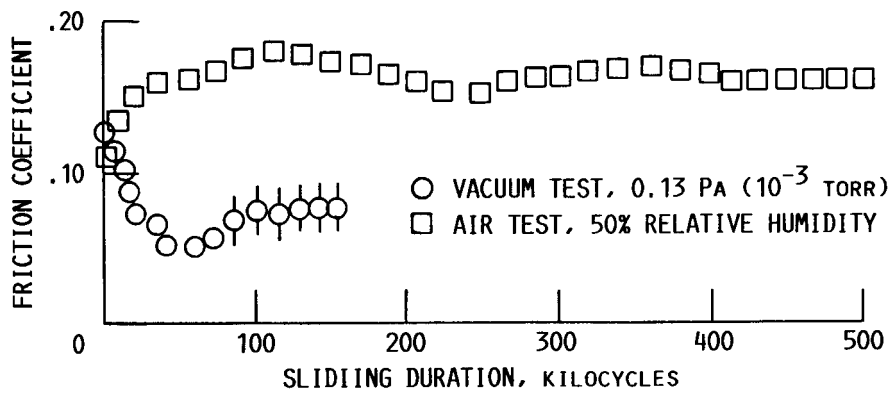

FIGURE 11. - COMPARISON OF THE FRICTION PROPERTIES OF A PI-4701 POLYIMIDE FILM WITH 50 WEIGHT PERCENT ADDITIVE OF GRAPHITE FLUORIDE IN AIR AND IN VACUUM.

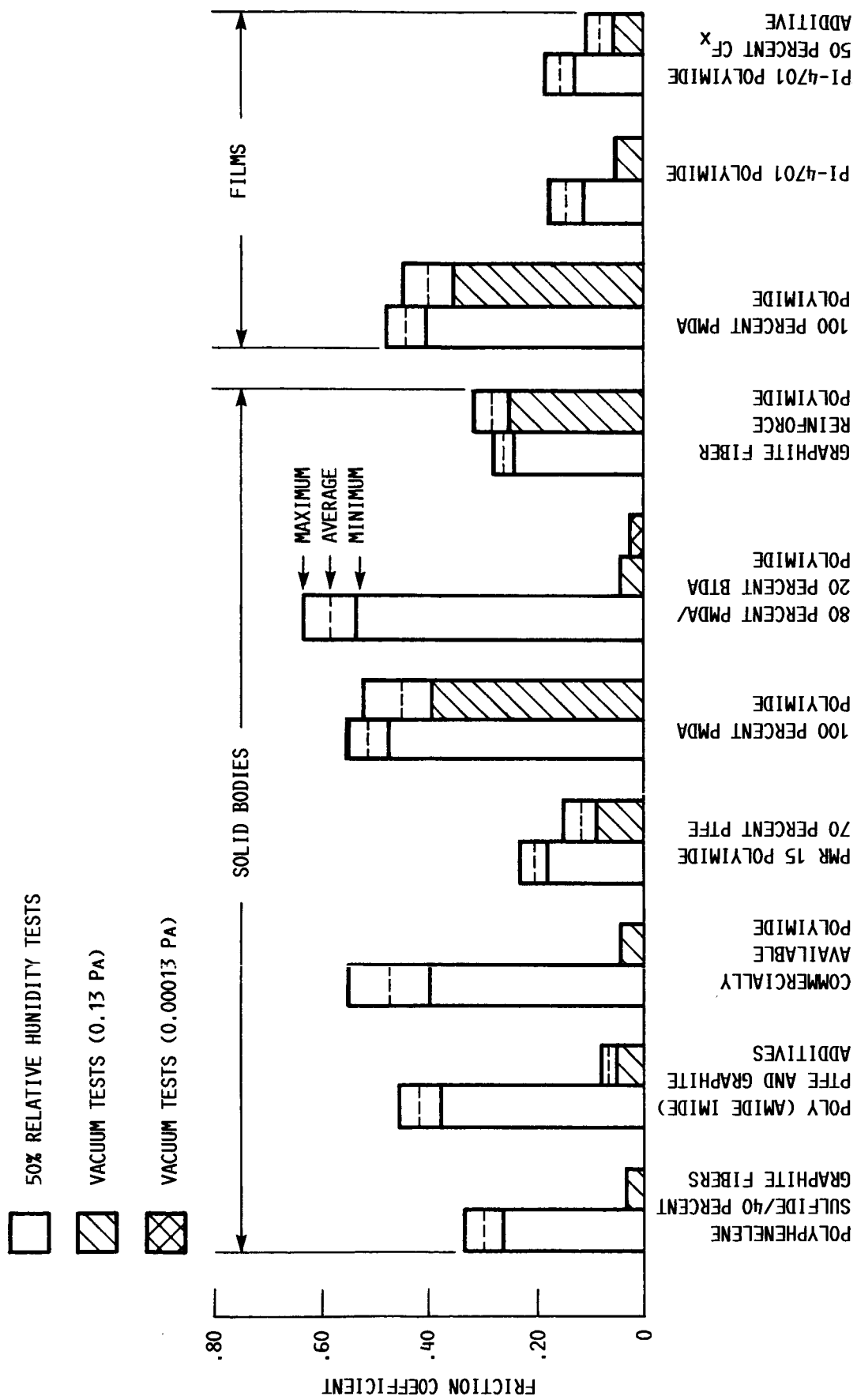

FIGURE 12. - COMPARISON OF THE STEADY-STATE FRICTION COEFFICIENTS OBTAINED AFTER RUN-IN IN AIR AND IN VACUUM FOR DIFFERENT POLYMER MATERIALS.

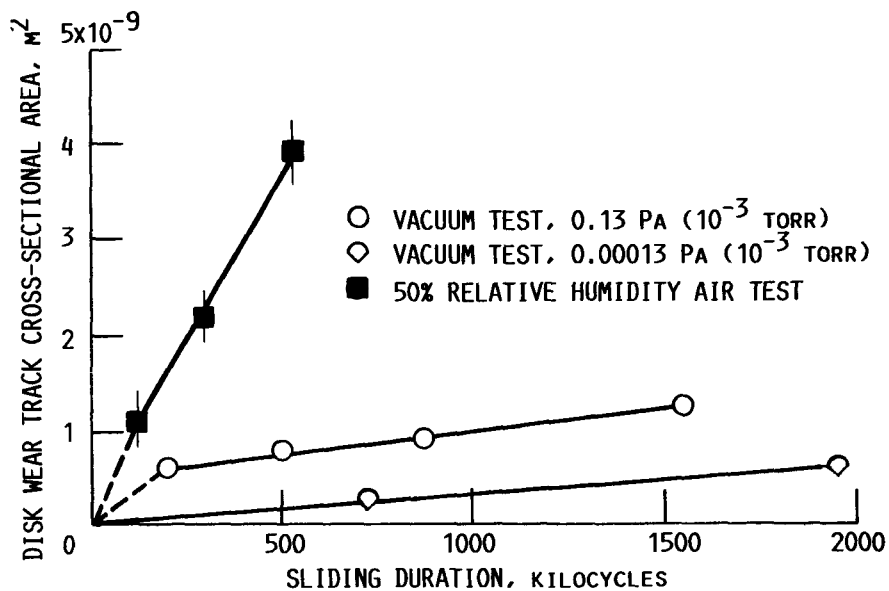

FIGURE 13. - DISK WEAR TRACK CROSS SECTIONAL AREA AS A FUNCTION OF SLIDING DISTANCE FOR A 440 C HT STAINLESS STEEL PIN SLIDING AGAINST A COPOLYIMIDE MADE FROM A 4-BDAF DIAMINE AND 80 PERCENT PMDA AND 20 PERCENT BTDA DIANHYDRIDES.

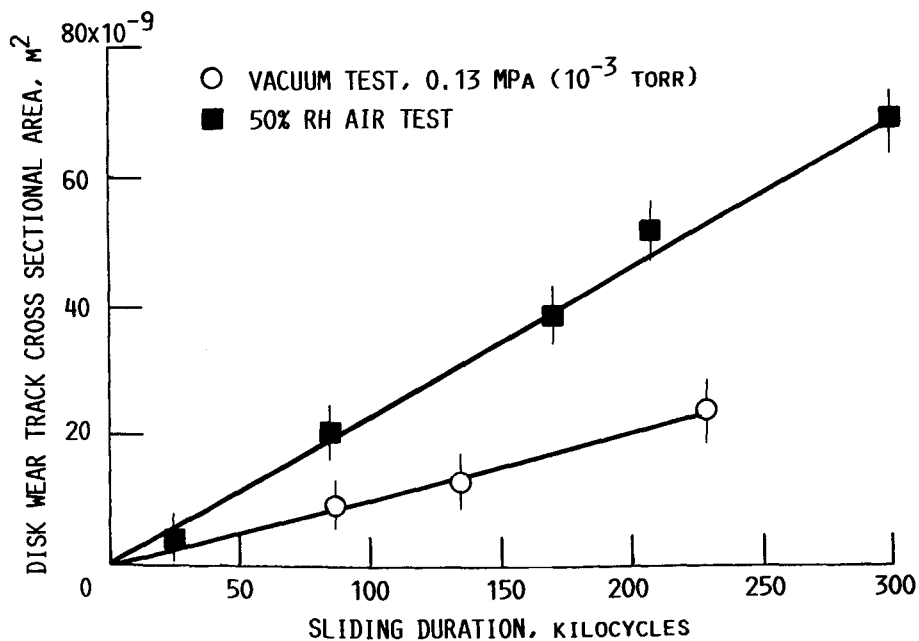

FIGURE 14. - DISK WEAR TRACK CROSS SECTIONAL AREA AS A FUNCTION OF SLIDING DURATION FOR A 440 C HT STAINLESS STEEL PIN SLIDING ON A 100 PERCENT 4-BDAF/PMDA SOLID DISK.

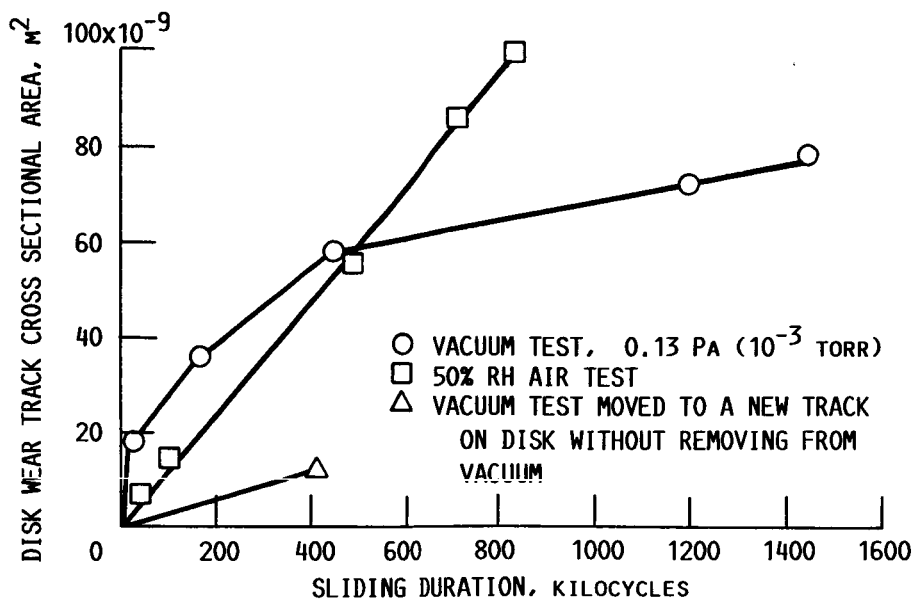

FIGURE 15. - DISK WEAR TRACK CROSS SECTIONAL AREA AS A FUNCTION OF SLIDING DURATION FOR A 440 C HT PIN SLIDING ON A COMMERCIALY AVAILABLE POLYIMIDE SOLID DISK.

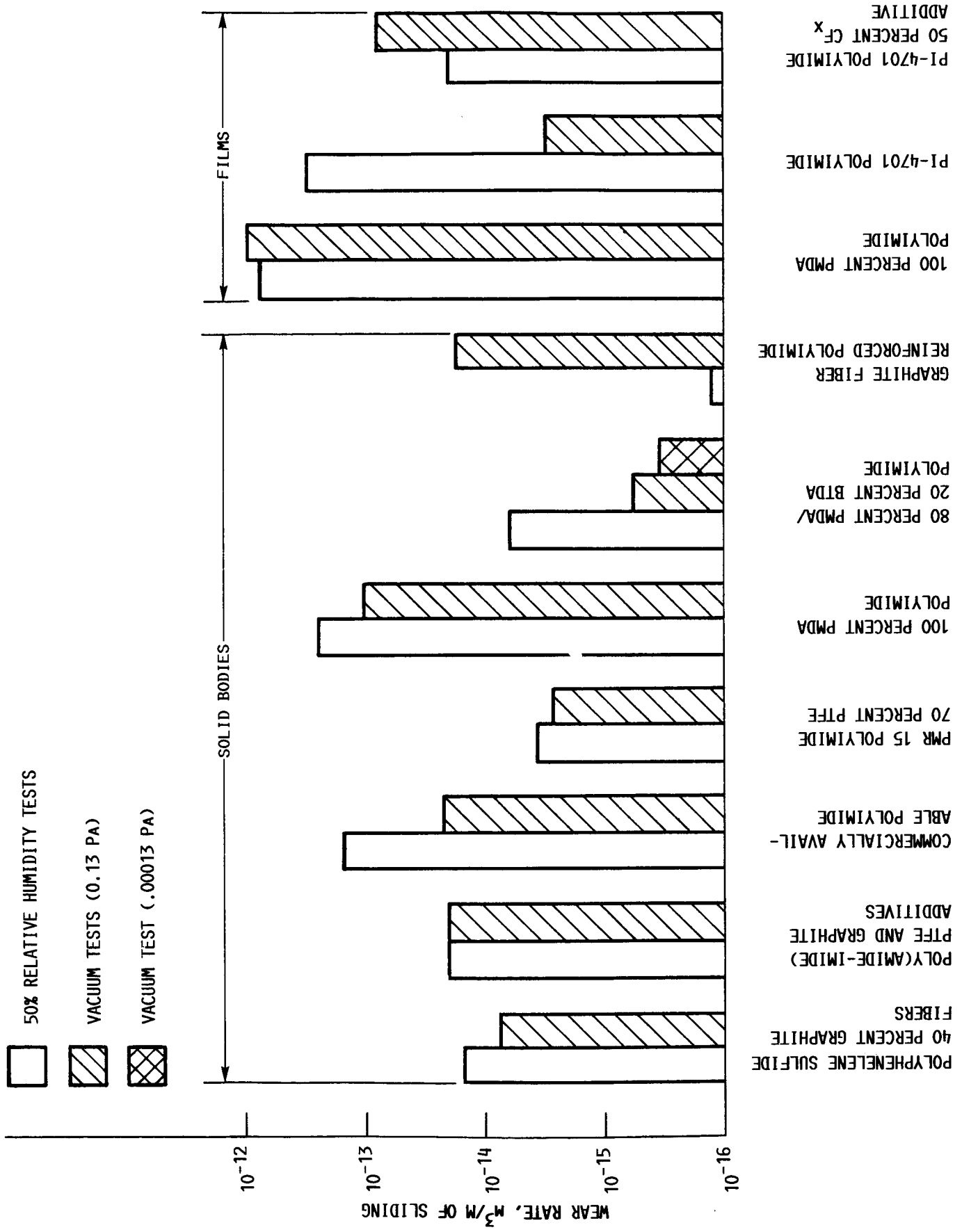

FIGURE 16. - COMPARISON OF STEADY-STATE WEAR RATES IN AIR AND IN VACUUM FOR DIFFERENT POLYMER MATERIALS.

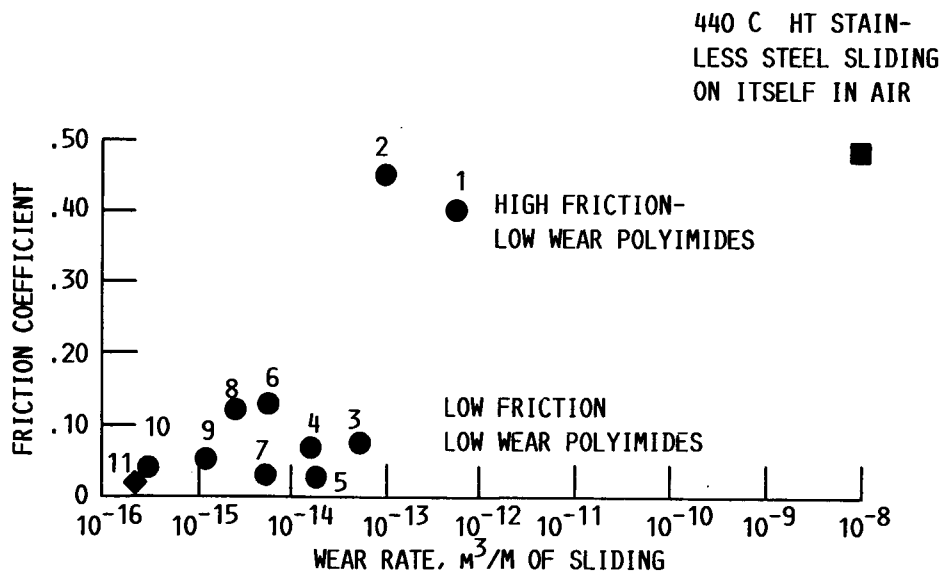
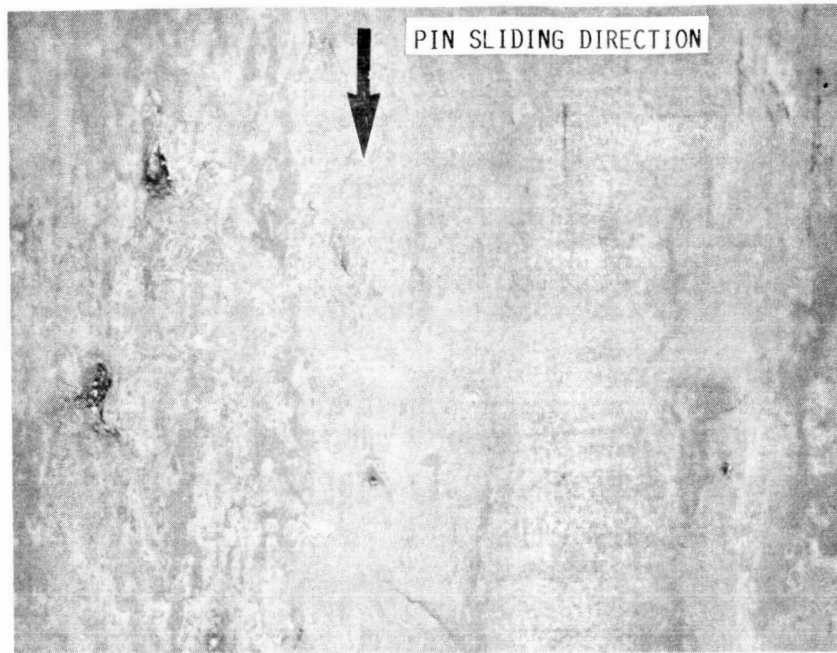
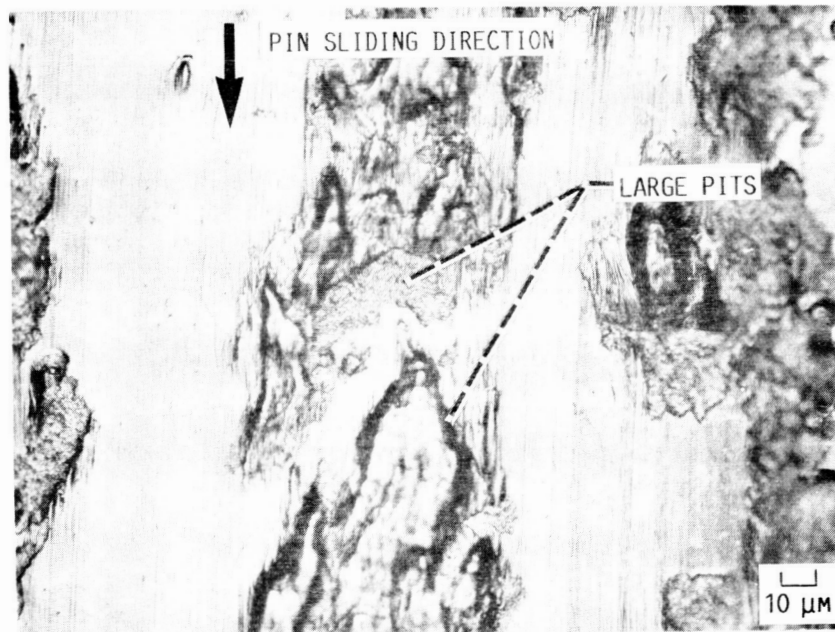

FIGURE 17. - FRICTION COEFFICIENT AS A FUNCTION OF POLYMER WEAR RATE FOR VARIOUS POLYMER MATERIALS SLIDING IN A VACUUM OF 0.13 PA. (1) 100 PERCENT PMDA POLYIMIDE FILM, (2) 100 PERCENT PMDA POLYIMIDE SOLID, (3) PI-4701 POLYIMIDE/50 PERCENT CF_x FILM, (4) POLY (AMIDE-IMIDE)/PTFE AND GRAPHITE SOLID, (5) COMMERCIALY AVAILABLE POLYIMIDE SOLID, (6) GRAPHITE FIBER REINFORCED POLYIMIDE SOLID, (7) POLYPHENELENE SULFIDE/50 PERCENT GRAPHITE FIBER SOLID, (8) PMR-15 POLYIMIDE/70 PERCENT PTFE SOLID, (9) PI-4701 POLYIMIDE FILM, (10) 80 PERCENT PMDA/20 PERCENT POLYIMIDE SOLID, (11) 80 PERCENT PMDA/20 PERCENT BTDA POLYIMIDE SOLID IN A 0.00013 PA VACUUM.

ORIGINAL PAGE IS
OF POOR QUALITY



(A) POLYIMIDE (80% PMDA/20% BTDA).



(B) POLYIMIDE (100% PMDA).

FIGURE 18. - HIGH MAGNIFICATION PHOTOMICROGRAPHS OF THE WEAR
TRACKS OBTAINED IN VACUUM ON TWO DIFFERENT POLYIMIDE FILMS.

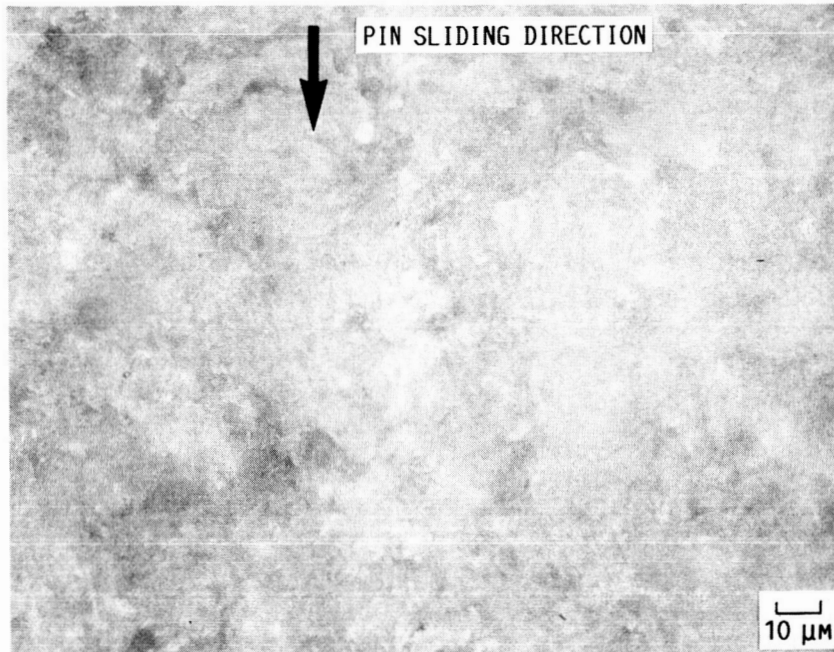

(A) PMR-15 POLYIMIDE POLYMER WITH PTFE ADDITIVE.

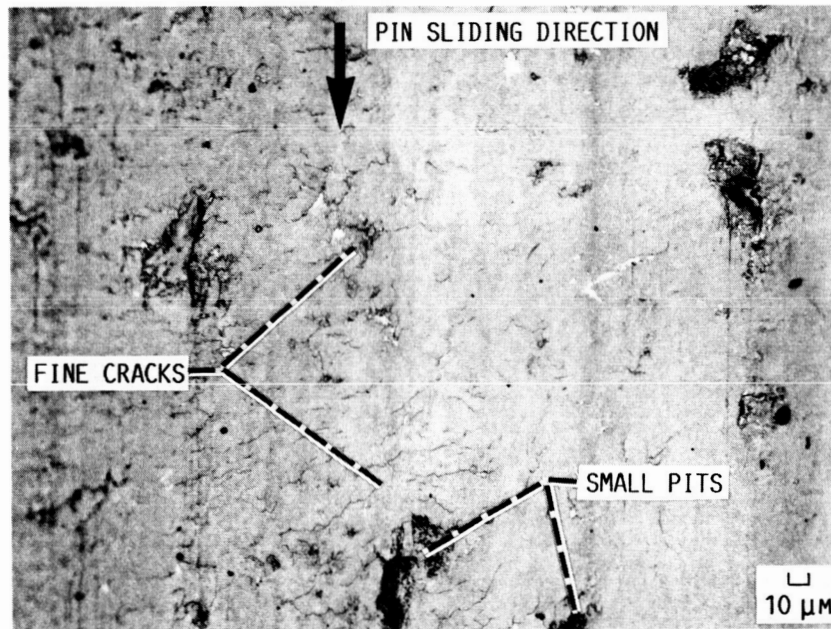

(B) POLY (AMIDE-IMIDE) POLYMER WITH PTFE AND GRAPHITE
ADDITIVES.

FIGURE 19. - HIGH MAGNIFICATION PHOTOMICROGRAPHS OF THE WEAR
TRACKS OBTAINED IN VACUUM ON POLYMER DISKS WITH POWDERED
SOLID LUBRICANT ADDITIVES.

ORIGINAL PAGE IS
OF POOR QUALITY

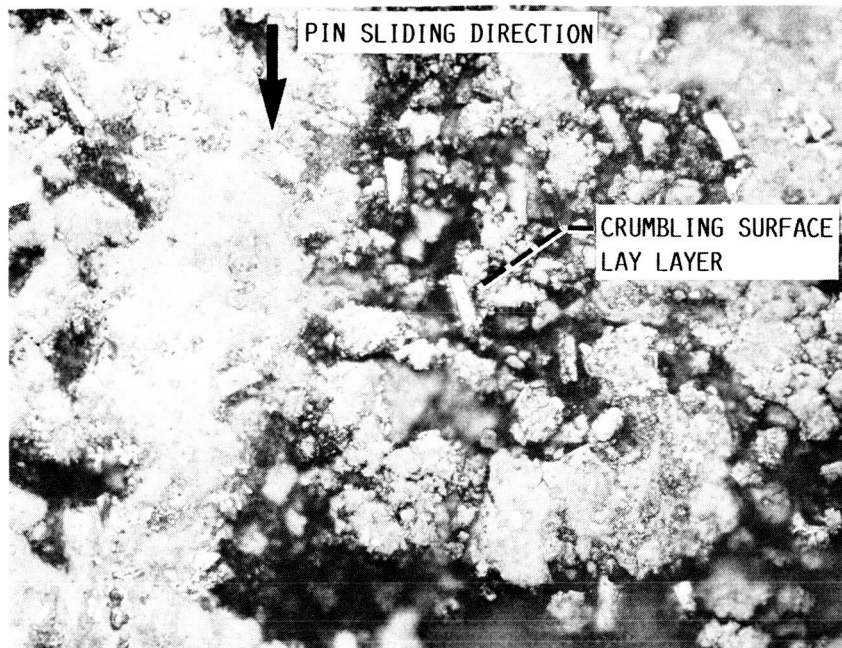

(A) POLYPHENELENE SULFIDE.

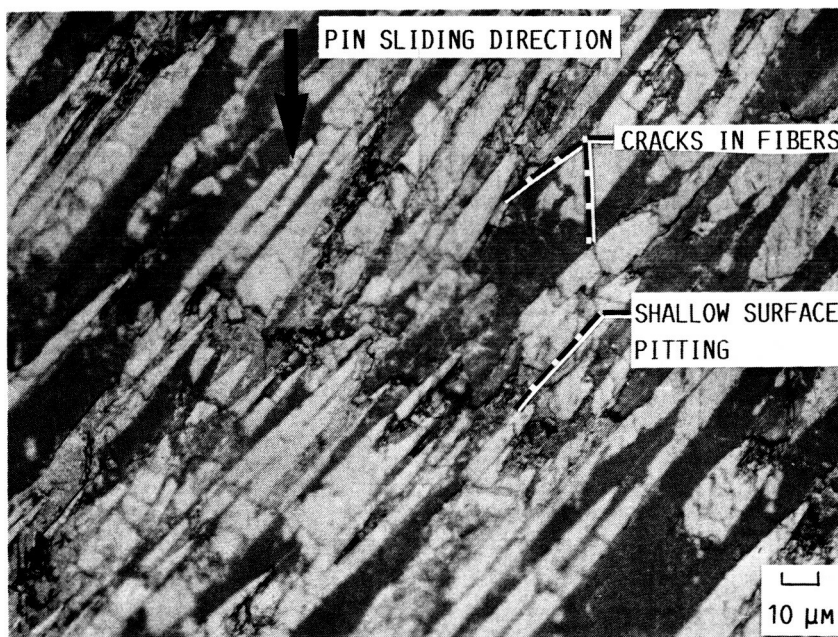

(B) POLYIMIDE (80% PMDA/20% BTDA).

FIGURE 20. - HIGH MAGNIFICATION PHOTOMICROGRAPHS OF THE WEAR TRACKS OBTAINED IN VACUUM ON GRAPHITE FIBER REINFORCED POLYMER DISKS.

1. Report No. NASA TM-88966	2. Government Accession No.	3. Recipient's Catalog No.	
4. Title and Subtitle Tribological Properties of Polymer Films and Solid Bodies in a Vacuum Environment		5. Report Date	
		6. Performing Organization Code 505-63-01	
7. Author(s) Robert L. Fusaro		8. Performing Organization Report No. E-3429	
		10. Work Unit No.	
9. Performing Organization Name and Address National Aeronautics and Space Administration Lewis Research Center Cleveland, Ohio 44135		11. Contract or Grant No.	
		13. Type of Report and Period Covered Technical Memorandum	
12. Sponsoring Agency Name and Address National Aeronautics and Space Administration Washington, D.C. 20546		14. Sponsoring Agency Code	
15. Supplementary Notes Prepared for the 1987 Annual Meeting of the American Society of Lubrication Engineers, Anaheim, California, May 11-14, 1987.			
16. Abstract <p>The tribological properties of ten different polymer based materials were evaluated in a vacuum environment to determine their suitability for possible lubrication applications in a space environment, such as might be encountered on the proposed space station. A pin-on-disk tribometer was used and the polymer materials were evaluated either as solid body disks or as films applied to 440C HT stainless steel disks. A 440C HT stainless steel hemispherically tipped pin was slid against the polymer materials. For comparison, similar tests were conducted in a controlled air atmosphere of 50 percent relative humidity air. In most instances, the polymer materials lubricated much better under vacuum conditions than in air. Thus, several of the materials show promise as lubricants for vacuum applications. Friction coefficients of 0.05 or less and polymer material wear rates of up to 2 orders of magnitude less than found in air were obtained. One material showed considerable promise as a traction drive material. Relatively high friction coefficients (0.36 to 0.52) and reasonably low wear rates were obtained in vacuum.</p>			
17. Key Words (Suggested by Author(s)) Solid lubricant; Polymers; Friction; Wear, Vacuum, Space lubrication; Composites		18. Distribution Statement Unclassified - unlimited STAR Category 27	
19. Security Classif. (of this report) Unclassified	20. Security Classif. (of this page) Unclassified	21. No. of pages 31	22. Price* A03