

NASA Technical Memorandum 89064

**Integration of Altitude and
Airspeed Information Into a
Primary Flight Display Via
Moving-Tape Formats**

Terence S. Abbott and George G. Steinmetz

APRIL 1987

NASA

NASA Technical Memorandum 89064

•

Integration of Altitude and Airspeed Information Into a Primary Flight Display Via Moving-Tape Formats

Terence S. Abbott and George G. Steinmetz
Langley Research Center
Hampton, Virginia

NASA

National Aeronautics
and Space Administration

Scientific and Technical
Information Branch

1987

Summary

A ground-based aircraft simulation study was conducted to determine the effects on pilot preference and performance of replacing the electromechanical altimeter and airspeed indicators with electronically generated representations which were integrated into an advanced flight display via moving-tape (linear moving scale) formats. Several key factors related to the representation of information on moving-tape formats were examined during this study: tape centering, trend information, and tape orientation. The factor of centering refers to whether the tape was centered about the actual airspeed or altitude or about some defined reference value. Tape orientation refers to whether the represented values are arranged in descending or ascending order. Six pilots participated in this study, with each pilot performing 18 runs along a single, well-learned flight profile. The results of this study are as follows. In general, the pilots preferred the presentation of the information with the moving-tape formats to that of the conventional instruments. However, a higher work load was noted with the moving-tape formats, possibly due to a greater precision of the displayed information (generally legible to 1 knot and 10 ft), therefore causing increased work load as pilots attempted to correct for insignificantly small errors. Subjective results indicated that an actual-centered fixed pointer was preferred to a reference-centered pointer. While no differences were noted in airspeed tracking or altitude tracking performance, the performance data for a visual secondary task showed that formats not containing trend information produced better performance, but subject opinion did not reflect this result. Regarding tape orientation, subjective comments indicated that there was lower work load and better performance when the airspeed tape had the high numbers at the top as opposed to the low numbers at the top.

Introduction

Electronically generated primary flight displays have shown great potential in reducing the pilot's visual work load, and their ever-increasing use in the aircraft environment is obvious with the introduction of the Boeing 757-767 and the Airbus 310-320 families. Because of this increasing use of electronically generated display formats, particularly formats generated with cathode-ray-tube (CRT) technology, a simulator study was undertaken to determine the effects on pilot preference and performance of replacing the electromechanical altimeter and airspeed indicators with electronically generated representations providing the same information; these repre-

sentations would be integrated into the format of an advanced flight display. The current trend for the presentation of this type of information is toward either digital or moving-tape formats. While digital displays have been shown to be viable in presenting exact and somewhat static information, for example, oil pressure and temperature, they appear to be somewhat lacking in presenting more dynamic information in that trend information is difficult to obtain. Thus the focus of this study was on moving-tape formats for the representation of airspeed and altitude information.

Several key questions related to the representation of information in a moving-tape format were examined during this study: (1) tape centering, (2) trend information, and (3) tape orientation. The reasons for these choices were as follows. The first question relates to the criticality of what is considered the center of the tape. That is, does there exist a significant difference in interpretability if, for example, a pilot-selected, or reference, altitude is used as the centering index of the altitude tape instead of the actual altitude as the center? The second question is, how beneficial would trend information, such as acceleration on an airspeed tape, be to the pilot? The possibility exists for reducing the pilot's mental work load by providing trend information that the pilot would otherwise have to derive from the original information. Conversely, the possibility exists for increasing work load by providing superfluous information or information that is overly compelling relative to its importance. Third, is the orientation or the direction that the tape moves critical? Conventional design criteria require that the larger numbers be at the top of the tape, that is, higher airspeed and altitude. Using this convention and placing these tapes in their normal T locations could pose a serious problem by producing a perceived roll effect during some flight maneuvers. This study was conducted in order to provide some insight into the design implementation issues of these representations.

Description of Equipment

Simulation Facility

This study employed a fixed-base simulator configured as the aft research cockpit of the NASA Transport Systems Research Vehicle (TSRV) airplane. This simulation included a six-degree-of-freedom set of nonlinear equations of motion as well as functionally representing the aspects of the advanced flight control configuration of the airplane with nonlinear models of the servo-actuators. The processing of the equations was performed in a Control Data Corporation (CDC) CYBER 175

digital computer at a 32 hertz iteration rate. A calm air model was used.

Electronic displays were provided in the form of an over-and-under arrangement of primary and navigation displays. The formats for these displays were generated on an Adage AGT 340 graphics computer. The graphics computer was linked via a digital buffer to the CDC CYBER 175 computer. This hardware produced stroke drawings and contains no raster features. For this study, the primary display was presented on a cathode ray tube (CRT) of approximately 21-centimeter diagonal. Seven colors could be presented: red, green, yellow, amber, blue, cyan, and orange. The navigation display was presented on a CRT of approximately 23-centimeter diagonal. The cockpit arrangement of these displays can be seen in figure 1. Mode and feature control panels for the displays are located on the center aisle panel along with the throttles. An advanced guidance and control system (AGCS) mode control is provided to allow management of the flight control systems. Through this panel the flight functions of navigation, guidance, and levels of automation are achieved.

Airplane Control Modes

For this study, the semiautomatic control mode of velocity-vector control-wheel steering of the TSRV simulator was used. The pilot interface to the control system was provided through a two-axis sidestick (fig. 2) rather than the panel-mounted controllers generally associated with this simulator. In addition, no automatic throttle features were used (manual throttles only). Descriptions of the systems operations can be found in references 1 and 2.

Basic Display Format

The advanced electronic flight displays in this simulator are custom tailored to the flight control system being employed. The velocity-vector control-wheel steering (CWS) mode couples to a display format which centers the displayed information about the velocity vector (refs. 2 and 3). An attitude-centered format is used with attitude control-wheel steering modes. In this study, velocity-vector CWS was used; hence the basic display format was velocity-vector centered. As can be seen in figure 3, the major information elements are the velocity vector, attitude, horizon, roll scales, pitch scales, and path-deviation indicators.

Horizontal path navigation information was provided by the horizontal situation display (HSD), which was the lower of the over-and-under displays. A description of the navigation format can be found in reference 1.

A display configuration was formed which was composed of conventional round-dial electromechanical instruments providing altitude, airspeed, and vertical speed information along with the advanced electronic flight display (described above). For the purpose of this paper, this arrangement is defined as configuration 9, the basic display configuration.

Alternate Display Formats

Eight alternate primary flight display (PFD) formats, which included airspeed and altitude information, were used in this study. The variations in the

Table I. Experiment Design for Airspeed and Altitude Presentation

| Configuration | Fixed-pointer value (centering) | Orientation of airspeed tape (direction) | Trend information |
|---------------------|---------------------------------|--|-------------------|
| Alternate displays: | | | |
| 1 | Actual | High-to-low | Yes |
| 2 | Actual | Low-to-high | Yes |
| 3 | Actual | High-to-low | No |
| 4 | Actual | Low-to-high | No |
| 5 | Reference | High-to-low | Yes |
| 6 | Reference | Low-to-high | Yes |
| 7 | Reference | High-to-low | No |
| 8 | Reference | Low-to-high | No |
| Basic display: | | | |
| 9 | | | |

eight formats were obtained from the $2 \times 2 \times 2$ display factors under investigation (see table I). Airspeed information was presented by a moving-tape, fixed pointer (moving linear scale) format positioned on the left side of the display screen. The center of this tape, defined by either the actual or the reference airspeed pointer, depending on the display configuration, was always aligned with the velocity vector symbol (figs. 4 and 5). The scales and associated values (240, 220, 200, 160, 140, and 120 for the airspeed tape of figs. 4 and 5) moved as a unit. The total length of the tape, from top to bottom, was equivalent to 132 knots. Two pointers were provided on this tape, one indicating the actual (current) airspeed and the other indicating a reference airspeed (179 and 169, respectively, for the airspeed tape of figs. 4 and 5). The actual airspeed pointer always had priority over the reference pointer in that the reference pointer could be physically masked by the actual airspeed pointer. The value of the reference pointer was the speed profile for the predefined (RNAV-type), desired path. As part of the experimental design, the fixed (or tape-centering) pointer could be either the actual or the reference airspeed. Four of the eight alternate PFD formats utilized actual airspeed as the fixed pointer and the other four alternate display formats used reference airspeed as the fixed pointer. As a second factor in the experimental design, airspeed trend information (acceleration) was added to the airspeed tape. This information was displayed as an arrow with the base of the arrow at the actual airspeed position and a length proportional to the magnitude of the acceleration. The length of the arrow indicated the instantaneous 20-sec prediction of the airspeed (predicting 170 for the airspeed tape of figs. 4 and 5). Four of the eight alternate PFD formats included acceleration information. The third factor in the experimental design involved tape orientation. This factor was based on the following potential problem discussed in reference 4. "For example, increasing pitch attitude has the instantaneous effect of causing altitude to start increasing and speed to start decreasing; lowering the nose has the opposite effect. If the altitude and speed scales were similarly oriented with larger numbers toward the top, the scale motion would be in opposite direction in each of these conditions. There is some concern that this opposing motion occurring on opposite sides of the attitude indicator might give the pilot the illusion that a rolling motion has been initiated." While this issue was not addressed in this study, tape orientation was included as a display factor. Four of the eight alternate PFD formats had airspeed tapes with the higher values at the top of the tape (high-to-low), as shown in figures 4 and 5, and

the other four configurations had lower airspeed values at the top of the tape (low-to-high). It should be noted that in the high-to-low actual-value-centered configuration, the length of the acceleration arrow referenced to the pitch grid indicates the flight-path angle change required to maintain the current actual airspeed.

Similar to the airspeed information, altitude information was also presented by a moving-tape, fixed-pointer implementation (fig. 4). This tape was positioned on the right side of the display screen. The total length of the tape, from top to bottom, was equivalent to 1200 ft. Unlike the airspeed tape, where the center of the tape was always aligned with the velocity-vector symbol, the entire altitude tape was allowed to "float" as a function of the desired vertical flight-path angle. For example, if the desired flight-path angle was $+2^\circ$ for a climb condition, the center of the altitude tape would be positioned 2° above the center of the horizon line. For any condition where the airplane was paralleling the desired flight path, the center of the altitude tape would be aligned with the velocity-vector symbol. Two pointers were provided on this tape, one indicating the actual altitude and the other indicating a reference altitude. The value of the reference pointer was either the altitude profile for the predefined path or instrument landing system (ILS) vertical path information. The reference altitude was that of the predefined path unless the airplane was within the final approach fix for an ILS approach and the ILS data were valid, at which time the ILS path was used. Again, as part of the experimental design, the fixed (or tape-centering) pointer could be either the actual or the reference altitude. Four of the eight alternate PFD formats utilized actual altitude as the fixed pointer and the other four alternate display formats used reference altitude as the fixed pointer. In addition, path-deviation trend information could be added to the altitude tape. This information was displayed as an arrow with the base of the arrow at the actual altitude position and a length proportional to the difference between the actual and the desired flight-path angle. The length of the arrow was proportional (3:10) to the pitch angle scale such that a 3° path-deviation angle was equivalent to 10° of pitch attitude. Figure 4 shows a path deviation of approximately 0.8° which produced a trend arrow equivalent to approximately 2.7° . Four of the eight alternate PFD formats included path-deviation trend information. The altitude tape was always presented in a high-to-low configuration.

It should be noted that the tape-centering conditions were always paired in that the reference-centered tapes were always used together and

similarly the actual-centered tapes were used together. The same pairing scheme was used for the trend information: either both tapes had trend information or neither tape had trend information. The electromechanical altitude, airspeed, and vertical speed instruments were covered for all alternate display conditions.

Preliminary Engineering Evaluation

The final versions of the alternate display formats examined in this study were evolved and refined through an engineering evaluation. Scale ranges, hence resolution, were chosen after examining several sizes. The smaller ranges of airspeed mapped onto the scale yielded increased resolution but seemed to impose higher than nominal control activity. An engineering judgment was made to increase the airspeed range so that the resolution of the airspeed was approximately the same between the electromechanical and electronic representations. Discrimination between actual and reference airspeeds was also examined during this evaluation. Design guidelines of redundant coding (shape, size, and color) for identification were employed, but it was found that the reference airspeed was more easily recognized when it was "boxed in." The actual airspeed was represented by a caret and larger, unboxed numerals.

The altitude scale was chosen after examining several ranges. Design guidelines, similar to the airspeed representation of actual and reference, were employed on the altitude scale. A major change in the original design occurred on the representation of rate information accompanying the altitude scale. At first, vertical speed was used as the rate cue. This cue was presented as an arrow with a length proportional to the magnitude of the current vertical speed and centered about the actual altitude caret. Subjective engineering evaluation found this presentation and information to be of relatively little value. Part of the problem was that the inertial flight-path angle, which encompasses vertical speed, was already being displayed and used for vehicle control. It was then determined that a more useful type of rate information for managing altitude would be the desired flight-path angle. Thus the length of the arrow was driven proportional to the difference between actual and desired flight-path angles. Full-scale deflection was set at $\pm 3^\circ$.

Task Description and Conditions

Primary Task

Simulation runs were conducted along a single, horizontally straight path which included a climb, a

descent, an acceleration, and a deceleration (fig. 6). In addition, the latter portion of the path changed into an ILS approach to landing and included the landing touchdown. The airplane was initialized at an airspeed of 150 knots, with flaps at 15° , in level flight, and on the path. The nominal landing conditions were 125 knots and flaps at either 30° or 40° . A single run took approximately 7 minutes from start to touchdown. The pilot's primary task was to fly the airplane along this well-learned, preprogrammed path (the desired path) with a minimum of deviation in altitude and airspeed. A test engineer acted as the copilot in regard to lowering the flaps and other such tasks as directed by the evaluation pilot. The test engineer did not offer comments on the simulated situation during the sessions.

Secondary Task

A secondary task was employed in this study in order to determine the amount of residual capacity the pilot had above that of performing the primary flight task. This task used a CRT which could display either an upward pointing arrow (fig. 7(a)), a downward pointing arrow, or no arrow (fig. 7(b)). This CRT was one that is normally used as the primary display for the copilot and is located on the right side of the instrument panel, level with the pilot's primary display, and outside the pilot's normal peripheral view. The arrows appeared at random intervals between 2 and 4 seconds and remained on for 1 second. The pilot was told to turn the arrows off by using a three-position rocker switch, spring loaded to the center position, located on the top of the sidestick controller. Pushing the switch forward would be the correct response to an upward pointing arrow and pulling the switch rearward would be the correct response to a downward pointing arrow. Either switch movement would immediately turn off the arrow. In addition to the 1-second interval that the arrow was displayed, the pilot had 1 additional second after the arrow disappeared to make a correct input. The pilot was instructed to perform this task only when time was left from performing the flight task. The percentage of correct responses on this task was used as a measurement of the residual capacity of the pilot.

Data

Sampled data were gathered throughout the run and included path performance parameters, pilot-control inputs, and secondary task parameters. Through the use of questionnaires, subjective pilot opinion was gathered after each simulation run (appendix A) and after each nine-run simulation session (appendix B).

Conditions

Six evaluation pilots were used in this study. All the pilots were qualified in multi-engine jet airplanes. The pilots were briefed prior to the simulation tests with respect to the display configurations, the control system, the experiment flight profile, the secondary work load task, and the recorded performance measurements. In addition, each pilot was provided with approximately 2 hours of familiarization and practice in the simulator prior to the actual test runs.

Each simulator session consisted of nine runs, one run for each of the display configurations. Each pilot flew two sessions for a total of 18 runs per pilot. All runs were flown in velocity-vector control-wheel steering mode, utilizing a sidestick controller, with manual throttles. The test sequence is given in table II.

Simulation Results and Discussion

These results and discussions are divided into two parts, objective and subjective. The objective findings are presented first and are divided into tracking performance and secondary work load results. Objective results were deemed statistically significant only if they were valid at the 98-percent confidence level.

Path Tracking Performance

Speed performance. The mean of the root-mean-square (rms) speed errors for each display configuration is given in figure 8. No significant tracking difference was noted between the basic display (configuration 9) and the other display configurations. No significant differences in speed tracking performance were noted among the alternate display formats with respect to tape centering, trend information, or tape orientation.

Altitude performance. The mean of the rms altitude errors for each configuration is given in figure 9. A significant tracking difference was noted between the basic display configuration and the other display configurations, with the basic display configuration yielding better results. One possible factor that may account for this difference is the resolution (full-scale deflection) of the vertical deviation symbology (shown electronically on the CRT). With the basic display configuration the scale range was ± 200 ft while the scale range used with alternate displays was ± 600 ft (a 3:1 difference in resolution of the displayed information). Note that because of the nature of the task, actual altitude information was not strictly required for the pilot to perform the flight task. No significant differences in altitude tracking

performance were noted among the alternate display formats with respect to tape centering, trend information, or tape orientation.

Secondary Task Performance

The mean of the percentage of correct secondary task responses for each of the display configurations is given in figure 10. No significant performance difference was noted between the basic display configuration and the other display configurations. No significant differences were noted in the secondary task performance among the alternate display formats with respect to tape centering or tape orientation. Among the alternate display formats, a significant difference was noted between formats containing trend information (configurations 1, 2, 5, and 6) and those without, with the formats containing trend information producing poorer secondary task scores; thus higher pilot work load is indicated for formats that included trend information. This poorer secondary task performance may possibly be due to the higher sensitivity of the trend information to path tracking error, thereby increasing the pilots' work loads as they adjusted for insignificantly small errors.

Subjective Results and Comments

The subjective results were obtained primarily from the responses to the questionnaire of appendix A. For each question of the questionnaire, the responses were divided into five groups (e.g., *easy* through *difficult* on question 1). These data were split into the major factors of the experimental design (tape centering, trend information, and tape orientation), summed across other factors, and normalized. For example, to determine the effects of tape centering, all runs involving actual-centered displays, regardless of the availability of trend information or the orientation to the speed scale, were summed, normalized, and compared with the results of a similar procedure performed for the runs involving reference-centered displays. The major factors considered were actual or reference tape centering, high-to-low or low-to-high airspeed tape orientation, trend information available or not, and basic or alternate display configurations. The normalized data were then paired by groups and graphed, (e.g., data from formats with trend information were paired with data from formats without trend information). An example of these graphed data is shown in figure 11. Differences in the data were considered significant only if the trends between two consecutive paired groups were consistent and the sum of the differences was greater than approximately 15 percent. Applying this criterion, the following results were obtained.

Table II. Test Sequence

| Run | Configuration | Pilot | Run | Configuration | Pilot |
|-----|---------------|-------|-----|---------------|-------|
| 1 | 1 | 1 | 55 | 9 | 4 |
| 2 | 2 | 1 | 56 | 1 | 4 |
| 3 | 3 | 1 | 57 | 2 | 4 |
| 4 | 4 | 1 | 58 | 3 | 4 |
| 5 | 9 | 1 | 59 | 4 | 4 |
| 6 | 8 | 2 | 60 | 5 | 4 |
| 7 | 7 | 2 | 61 | 6 | 4 |
| 8 | 6 | 2 | 62 | 7 | 4 |
| 9 | 5 | 2 | 63 | 8 | 4 |
| 10 | 9 | 2 | 64 | 8 | 3 |
| 11 | 5 | 1 | 65 | 7 | 3 |
| 12 | 6 | 1 | 66 | 6 | 3 |
| 13 | 7 | 1 | 67 | 5 | 3 |
| 14 | 8 | 1 | 68 | 4 | 3 |
| 15 | 4 | 2 | 69 | 3 | 3 |
| 16 | 3 | 2 | 70 | 2 | 3 |
| 17 | 2 | 2 | 71 | 1 | 3 |
| 18 | 1 | 2 | 72 | 9 | 3 |
| 19 | 8 | 1 | 73 | 1 | 5 |
| 20 | 7 | 1 | 74 | 2 | 5 |
| 21 | 6 | 1 | 75 | 3 | 5 |
| 22 | 5 | 1 | 76 | 4 | 5 |
| 23 | 4 | 1 | 77 | 9 | 5 |
| 24 | 3 | 1 | 78 | 5 | 5 |
| 25 | 2 | 1 | 79 | 6 | 5 |
| 26 | 1 | 1 | 80 | 7 | 5 |
| 27 | 9 | 1 | 81 | 8 | 5 |
| 28 | 9 | 2 | 82 | 8 | 6 |
| 29 | 1 | 2 | 83 | 7 | 6 |
| 30 | 2 | 2 | 84 | 6 | 6 |
| 31 | 3 | 2 | 85 | 5 | 6 |
| 32 | 4 | 2 | 86 | 9 | 6 |
| 33 | 5 | 2 | 87 | 4 | 6 |
| 34 | 6 | 2 | 88 | 3 | 6 |
| 35 | 7 | 2 | 89 | 2 | 6 |
| 36 | 8 | 2 | 90 | 1 | 6 |
| 37 | 1 | 3 | 91 | 8 | 5 |
| 38 | 2 | 3 | 92 | 7 | 5 |
| 39 | 3 | 3 | 93 | 6 | 5 |
| 40 | 4 | 3 | 94 | 5 | 5 |
| 41 | 9 | 3 | 95 | 3 | 5 |
| 42 | 5 | 3 | 96 | 2 | 5 |
| 43 | 6 | 3 | 97 | 4 | 5 |
| 44 | 7 | 3 | 98 | 1 | 5 |
| 45 | 8 | 3 | 99 | 9 | 5 |
| 46 | 8 | 4 | 100 | 9 | 6 |
| 47 | 7 | 4 | 101 | 1 | 6 |
| 48 | 6 | 4 | 102 | 2 | 6 |
| 49 | 5 | 4 | 103 | 3 | 6 |
| 50 | 9 | 4 | 104 | 4 | 6 |
| 51 | 4 | 4 | 105 | 5 | 6 |
| 52 | 3 | 4 | 106 | 6 | 6 |
| 53 | 2 | 4 | 107 | 7 | 6 |
| 54 | 1 | 4 | 108 | 8 | 6 |

Work load. Slightly lower work load was perceived when the basic display configuration was used (fig. 12). This result may be attributed to the fact that the alternate display formats provided exact airspeed and altitude information to the pilots (generally legible to 1 knot and 10 ft). This high quality of information (high precision) may have caused the pilots to adjust for insignificantly small errors, thereby increasing their work load. Among the alternate display formats, it was perceived that there was lower work load when the airspeed tape had a high-to-low orientation than when it had a low-to-high orientation (fig. 13). The work load perceived with trend information presented did not differ greatly from that perceived with no trend information presented (fig. 14). However, the pilots felt that the trend information was beneficial (fig. 15).

Vertical path performance. Slightly better performance was perceived when the conventional airspeed and altimeter instruments of the basic display configuration were used (fig. 16).

Speed performance. Among the alternate display formats, it was perceived that there was better performance when the airspeed tape had a high-to-low orientation than when it had a low-to-high orientation (fig. 17).

Speed presentation. Among the alternate display formats, it was perceived that the presentation of the speed information was better when the airspeed tape had a high-to-low orientation than when it had a low-to-high orientation (fig. 18).

General comments. The following results were obtained from the responses to the general questionnaire of appendix B. For each question of the questionnaire, the responses were again divided into five groups and normalized. Differences in the graphed data were considered significant only if the trends between all the groups were consistent. Only the significant, display-related data are presented. First, it was noted that only a slight-to-moderate effort was required in adapting to the alternate display formats (fig. 19). Second, it was felt that the presentation of the information with the alternate display formats was generally better than that with the basic display configuration (fig. 20). Third, it was felt that the scale range of the alternate display formats was too large for both vertical information (fig. 21) and speed information (fig. 22). Fourth, the high-to-low presentation of airspeed information was the preferred (fig. 23). Next, the actual-centered fixed pointer was

preferred to the reference-centered pointer (fig. 24). Finally, it was felt that the shifting, or "floating," of the altitude tape as a function of the desired vertical flight-path angle was beneficial (fig. 25).

Conclusions

A ground-based aircraft simulation study was conducted to determine the effects on pilot preference and performance of replacing the electromechanical altimeter and airspeed indicators (basic display format) with electronically generated representations integrated into an advanced flight display via moving-tape formats (alternate display formats). Several key factors related to the representation of information on moving-tape formats were also examined during this study: tape centering, trend information, and tape orientation. Six evaluation pilots participated in this study, with each pilot performing 18 runs along a single, well-learned flight profile. Based on the results of this study, the following conclusions are drawn.

1. Subjective results indicated that the scale range of the alternate display formats were too large for both vertical information and speed information. Additionally, while the perceived work load was higher and performance was lower with the alternate display formats than with the basic display configuration, the presentation of the information with the alternate display formats was rated generally better than that of the basic display configuration. In addition, it was noted that only a slight-to-moderate effort was required in adapting to the alternate display formats.

2. A statistically significant difference in altitude tracking performance was noted, with the basic display configuration yielding better results. This result may be partially attributed to the difference in the resolution in the presentation of altitude error. Additionally, subjective results showed that a slightly lower work load was perceived when the conventional airspeed and altimeter instruments of the basic display configuration were used. This result may be attributed to the alternate display formats providing exact airspeed and altitude information to the pilots (generally legible to 1 knot and 10 ft) and therefore causing the pilots to adjust for insignificantly small errors, thereby increasing their work load.

3. Based on subjective results, the actual-centered fixed pointer was preferred to the reference-centered pointer.

4. A significant difference was noted in the secondary task performance with respect to trend information, with the formats not containing trend information producing better performance on the secondary task. This result was possibly due to the

higher sensitivity of the trend information to path tracking error, thereby increasing the pilots' work loads as they again adjusted for insignificantly small errors. However, the perceived work load, obtained from the responses to the questionnaire, did not show this difference and other responses to the questionnaire showed that the pilots felt that trend information was beneficial.

5. Subjective comments indicated that there was lower work load and better performance when the airspeed tape had the high numbers at the top instead of the low numbers at the top.

NASA Langley Research Center
Hampton, VA 23665-5225
February 26, 1987

Appendix A Post-Run Questionnaire

1. Rate the overall work load of the task.

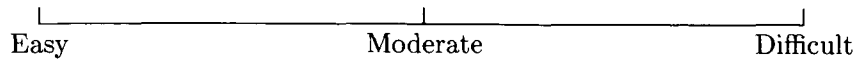

2. Rate your performance on the quantitative task.

Vertical

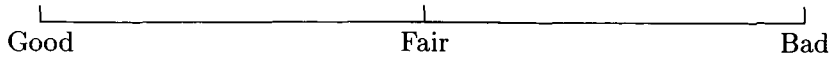

Horizontal

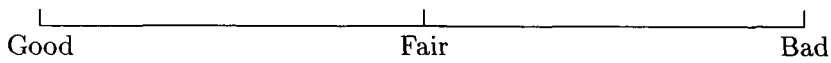

Speed

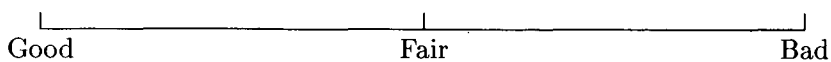

3. Rate your performance on the secondary task.

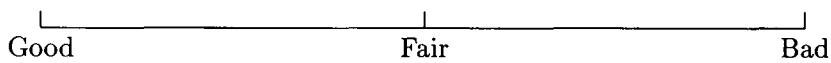

4. How would you rate the presentation of the situational information?

Vertical

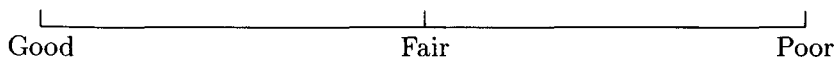

Horizontal

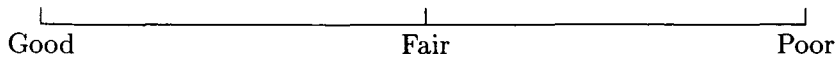

Speed

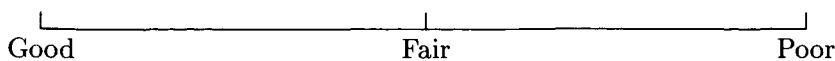

5. Was there any information presented you felt you did not need?

6. How beneficial was the trend information (when presented)?

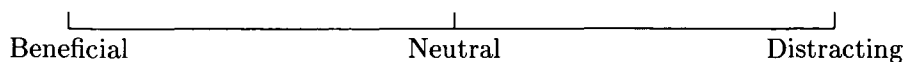

7. Did you feel that the centering (actual or reference) of airspeed and altitude affected your performance?

Greatly Undecided Not at all

8. Did the orientation of the airspeed scale affect your performance?

Greatly Undecided Not at all

Appendix B
General Questionnaire

1. Rate the flight task.

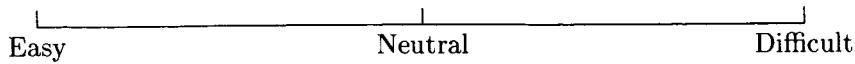

2. If you had to perform the same flight task in a conventional cockpit, how would you rate the flight task?

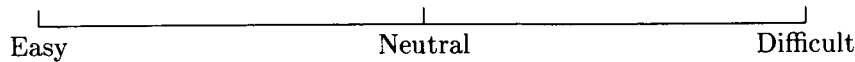

3. How would you rate your adaptability to the following:

Display

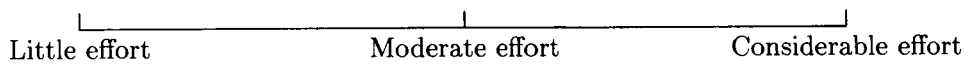

Control System

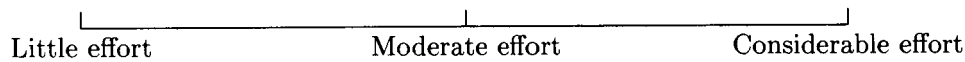

Sidestick

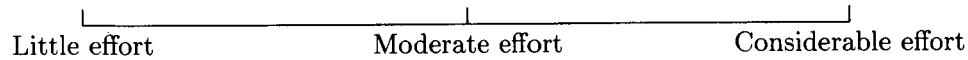

4. Rate the sidestick relative to a conventional wheel-and-yoke.

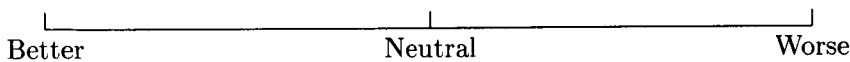

5. Rate the tape presentation relative to conventional instruments.

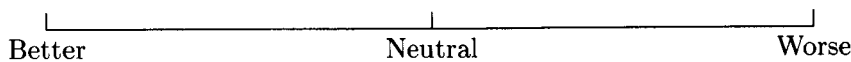

6. What are the best three features of the display?

7. What are the worst three features of the display?

8. Rate the resolution of the following items:

Pitch/flight-path angle

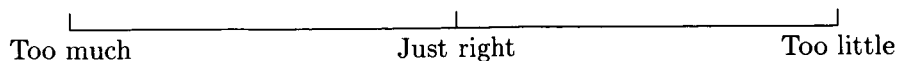

Vertical/altitude

┌──────────────────────────┐
Too much Just right Too little

Speed

┌──────────────────────────┐
Too much Just right Too little

9. Which airspeed orientation did you find the easier to use?

┌──────────────────────────┐
High-to-low Equal Low-to-high

10. Which centering did you find the easier to interpret?

┌──────────────────────────┐
Reference Equal Actual

11. Rate the shifting of the vertical/altitude tape center with respect to the reference flight-path angle.

┌──────────────────────────┐
Beneficial Neutral Confusing

General comments (if desired):

References

1. Gandelman, Jules; and Holden, Robert: *A Pilot Training Manual for the Terminal Configured Vehicle Electronic Attitude Director Indicator*. NASA CR-159195, 1980.
2. Steinmetz, George G.: *Simulation Development and Evaluation of an Improved Longitudinal Velocity-Vector Control-Wheel Steering Mode and Electronic Display Format*. NASA TP-1664, 1980.
3. Steinmetz, George G.: *Development and Evaluation of an Airplane Electronic Display Format Aligned With the Inertial Velocity Vector*. NASA TP-2648, 1986.
4. Miles, W. L.; Miller, J. I.; and Variakojis, V.: *Advanced Commercial Cockpit Concepts. Behavioral Objectives in Aviation Automated Systems Symposium—Proceedings*, P-114, Soc. of Automotive Engineers, Inc., c.1982, pp. 103-123. (Available as SAE Paper 821387.)

CRITICAL POINTS
OF POOR QUALITY

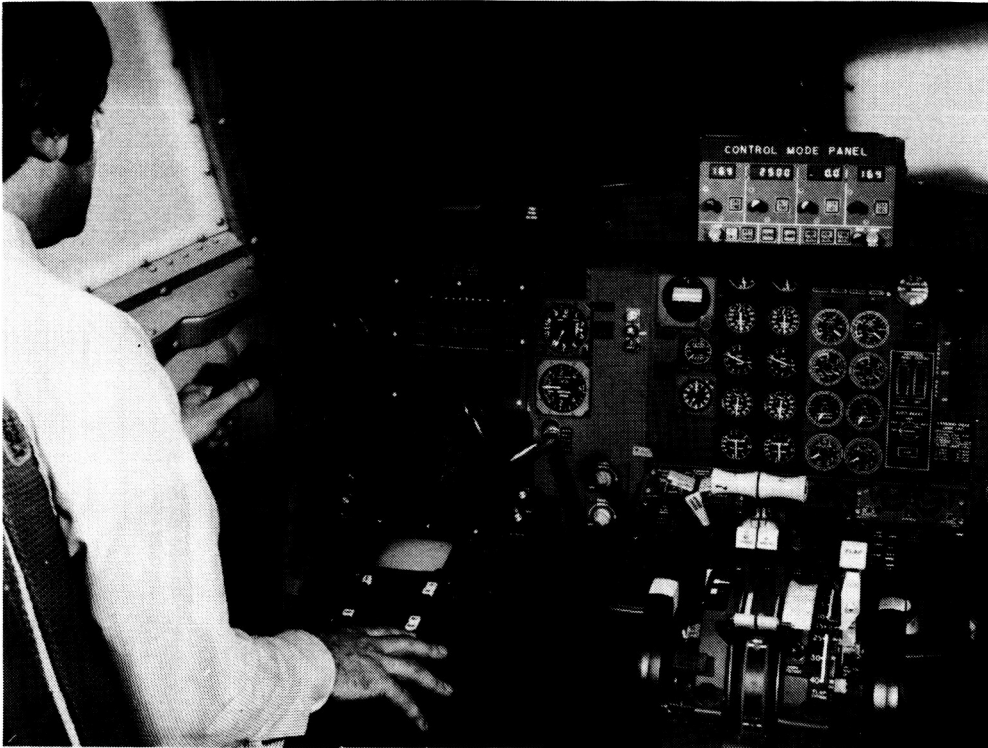

L-80-2111

Figure 1. Simulator cockpit.

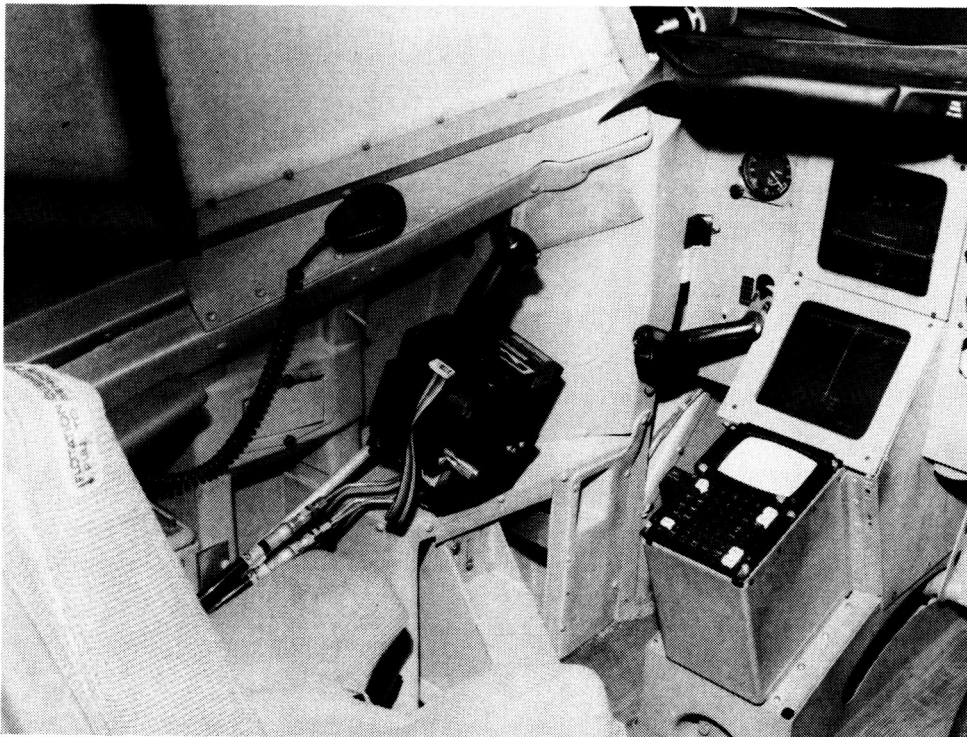

L-86-3592

Figure 2. Two-axis sidestick controller.

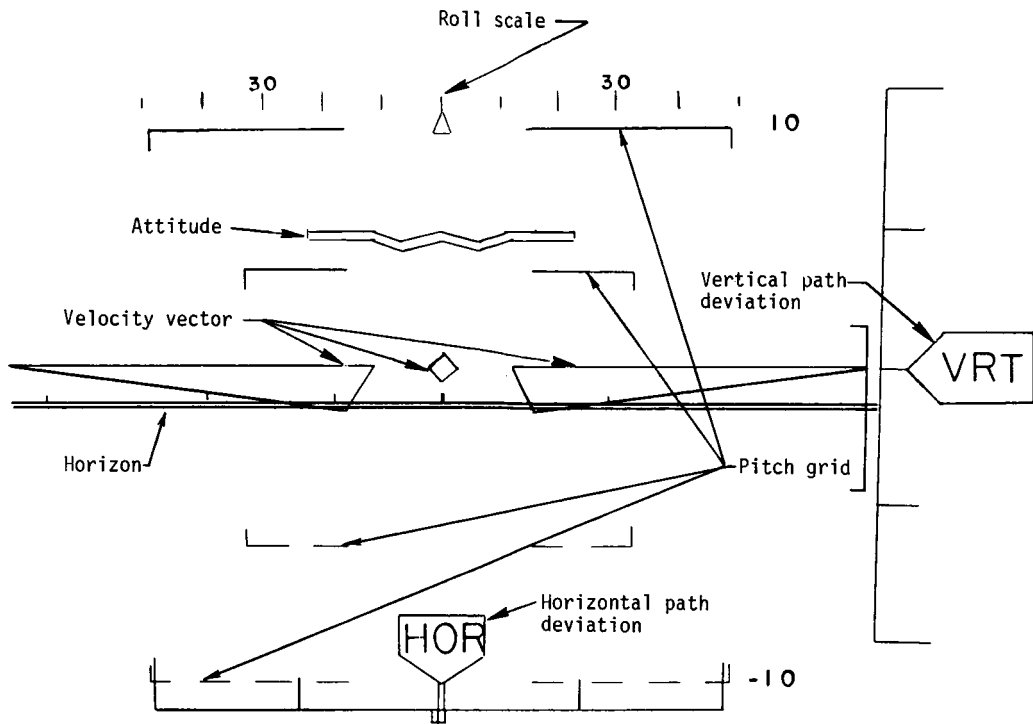

Figure 3. Basic display format.

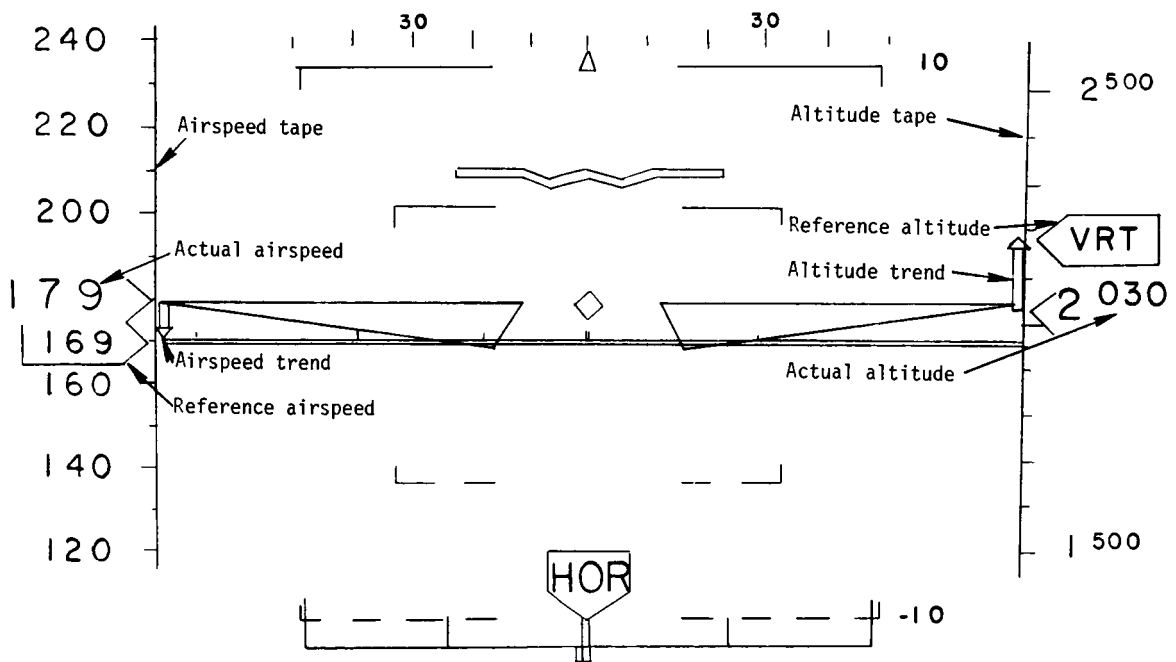

Figure 4. Alternate display format.

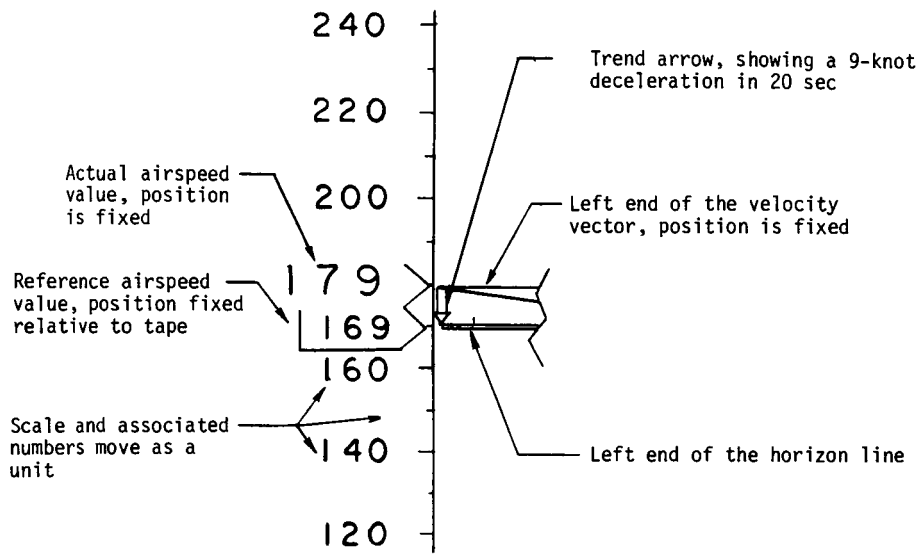

Figure 5. Airspeed tape in an actual-centered, high-to-low format with trend orientation.

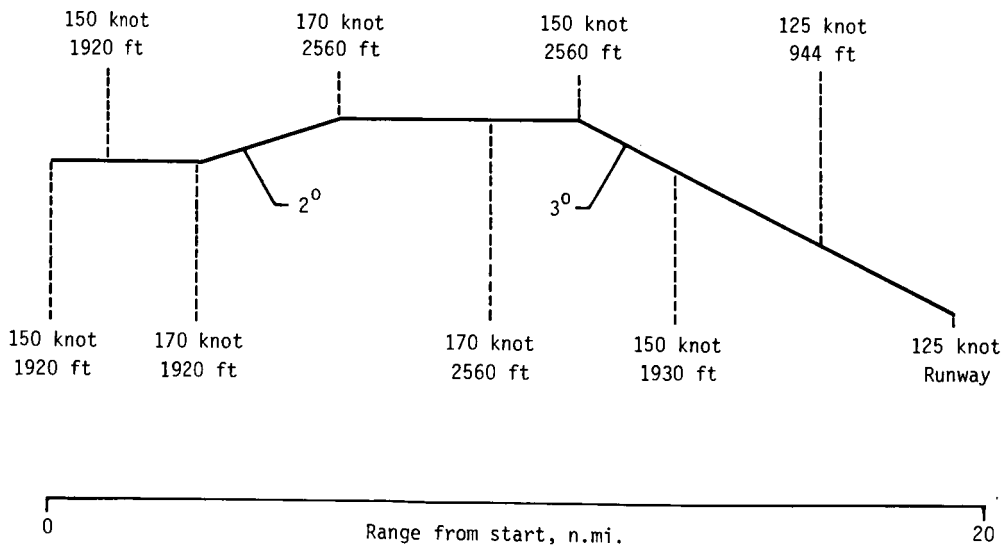

Figure 6. Prescribed path.

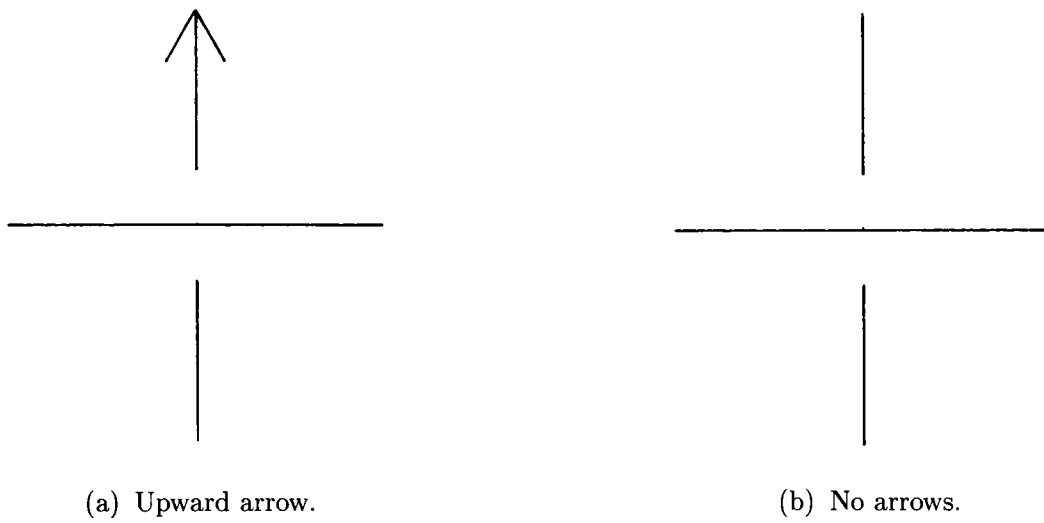

Figure 7. Secondary task display format.

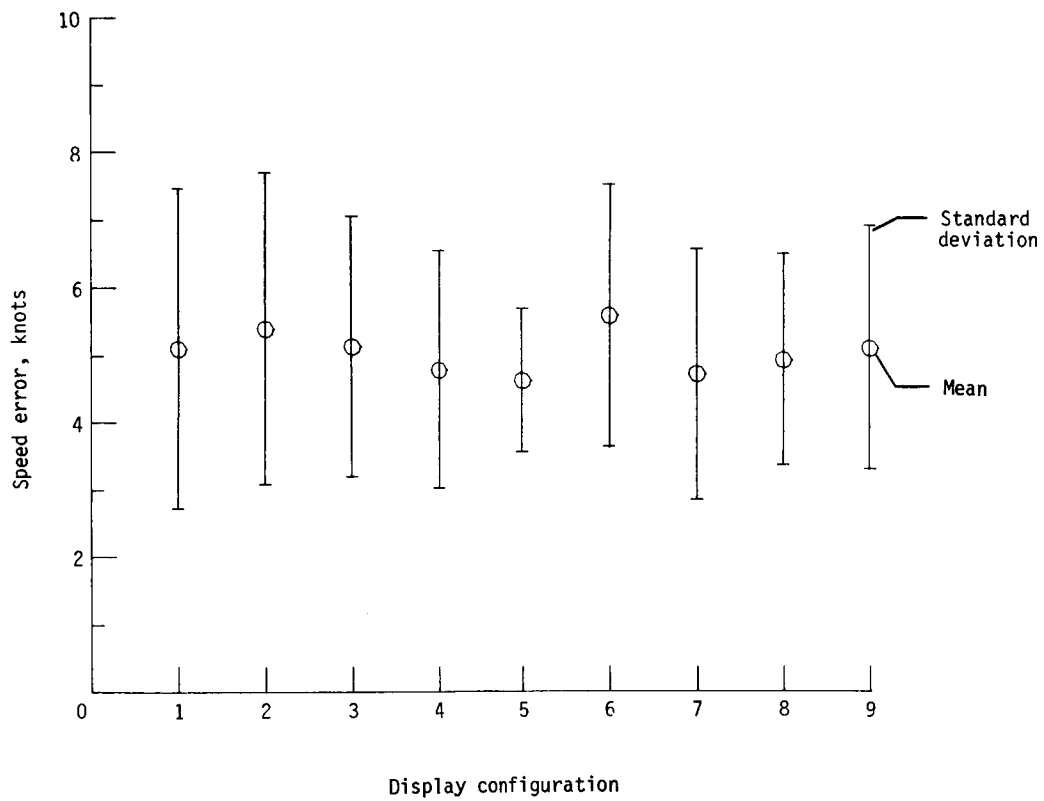

Figure 8. Effect of display configuration on rms speed error.

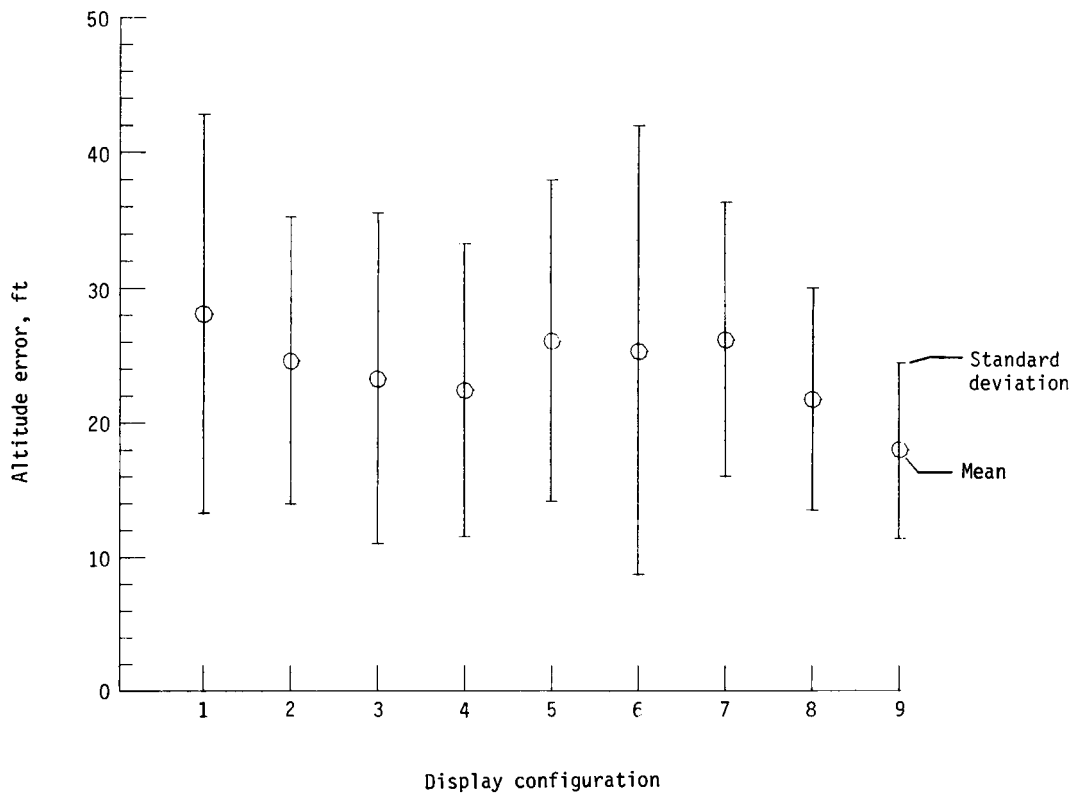

Figure 9. Effect of display configuration on rms altitude error.

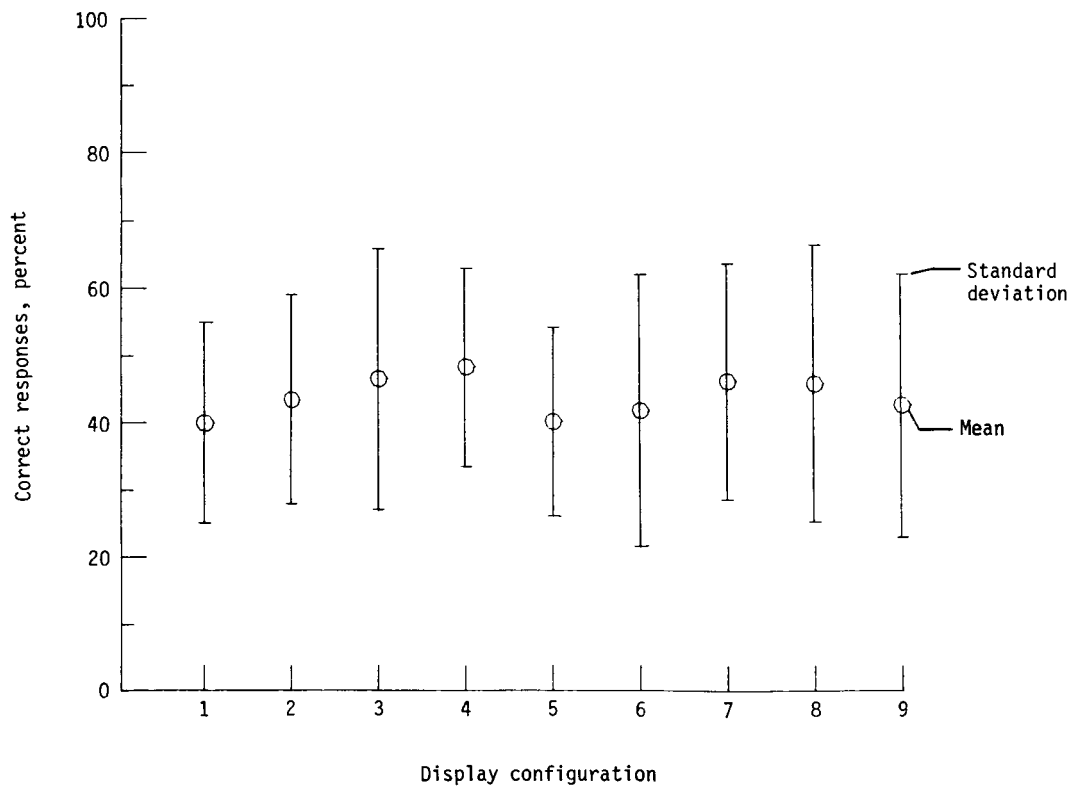

Figure 10. Effect of display configuration on secondary task performance.

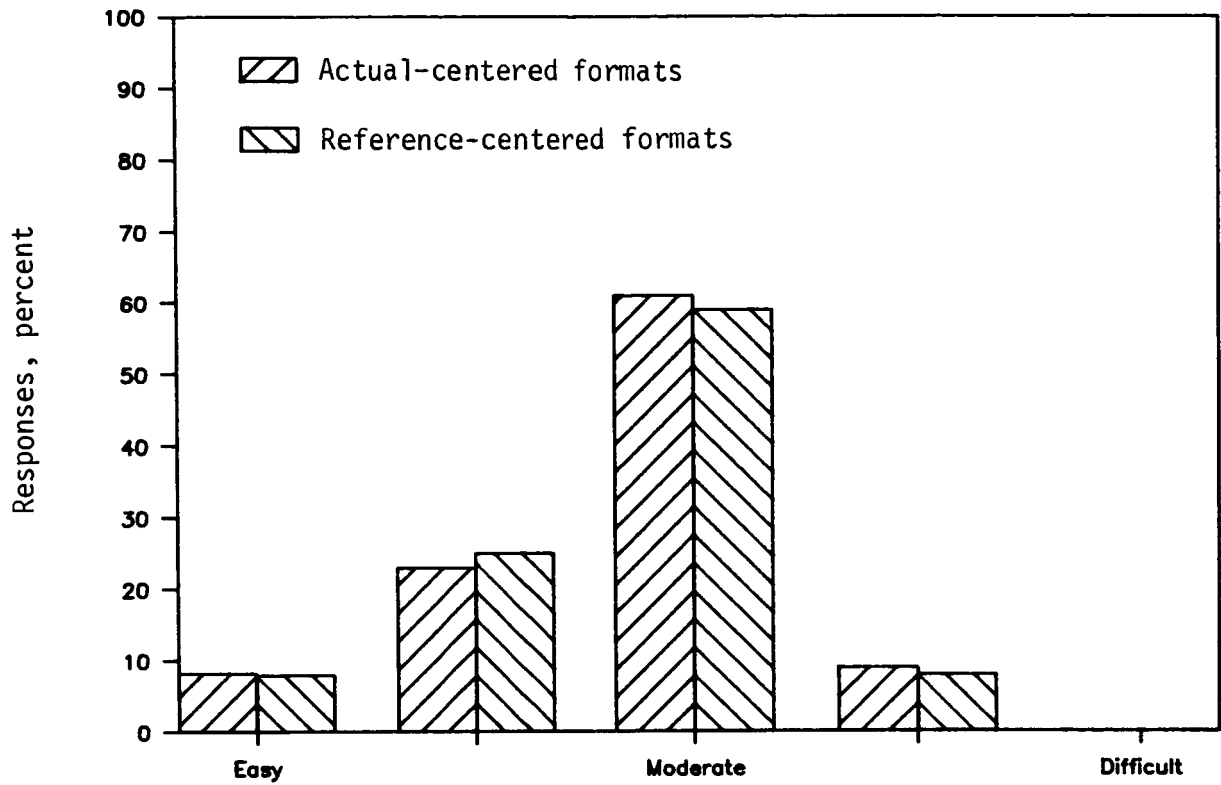

Figure 11. Example of the subjective results.

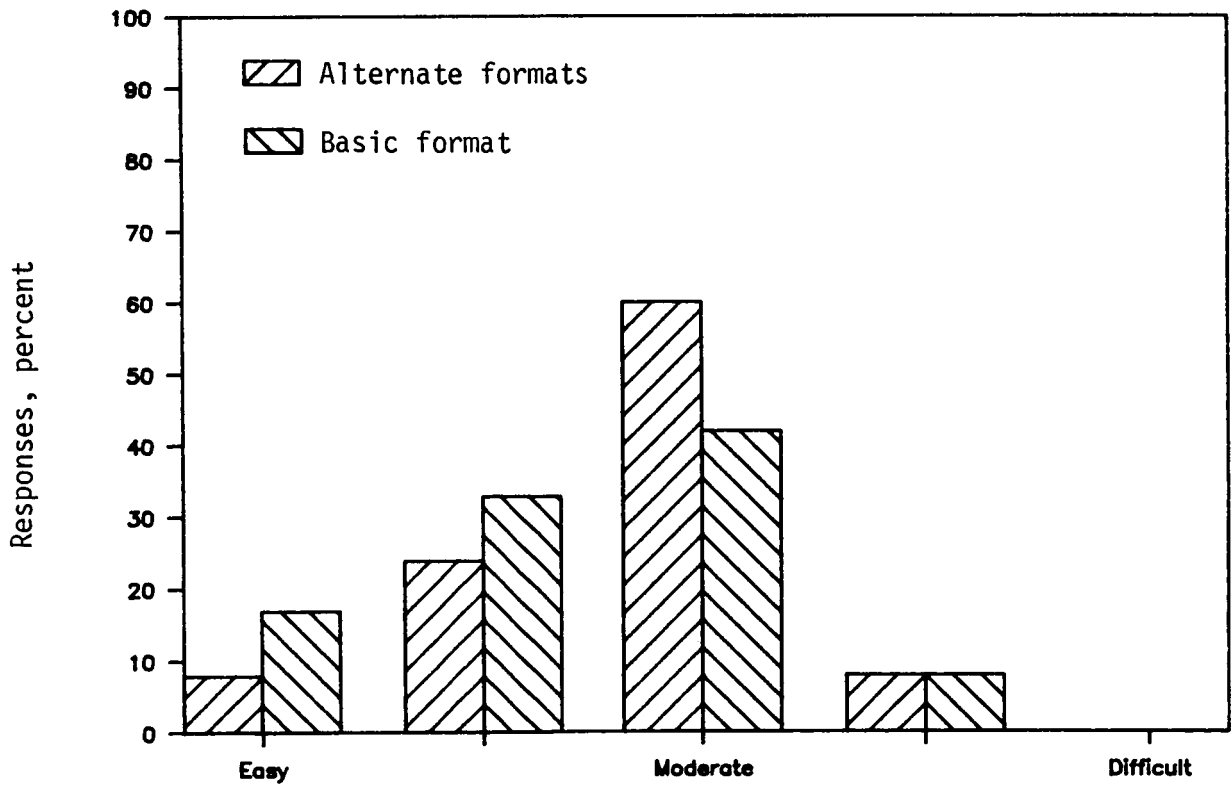

Figure 12. Perceived work load with basic and alternate formats.

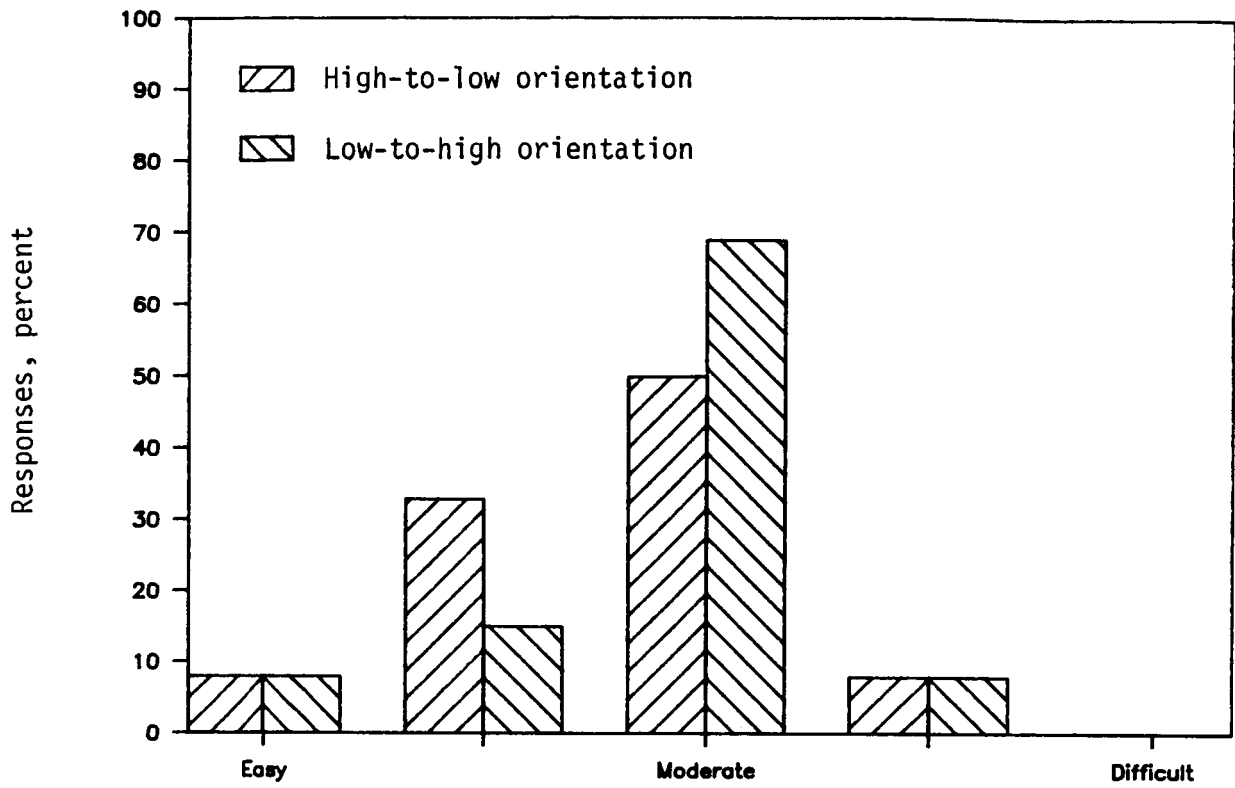

Figure 13. Perceived work load with respect to airspeed tape orientation.

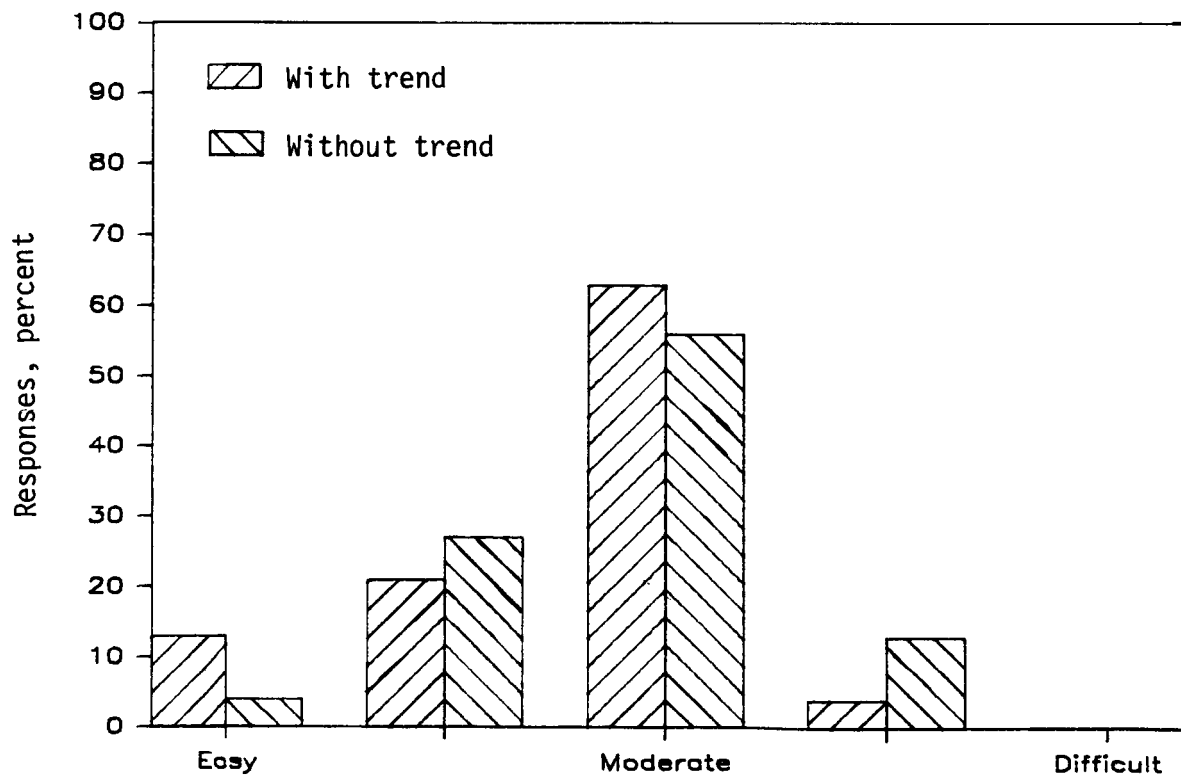

Figure 14. Perceived work load with respect to trend information.

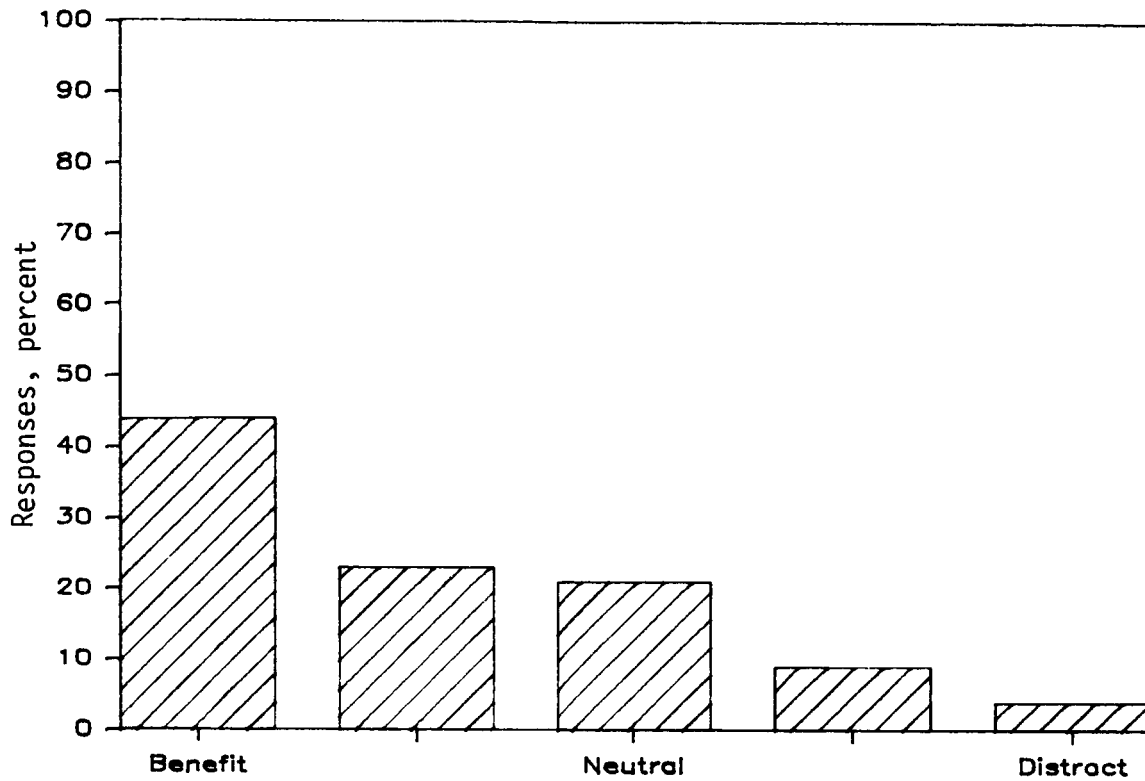

Figure 15. Perceived effect of trend information.

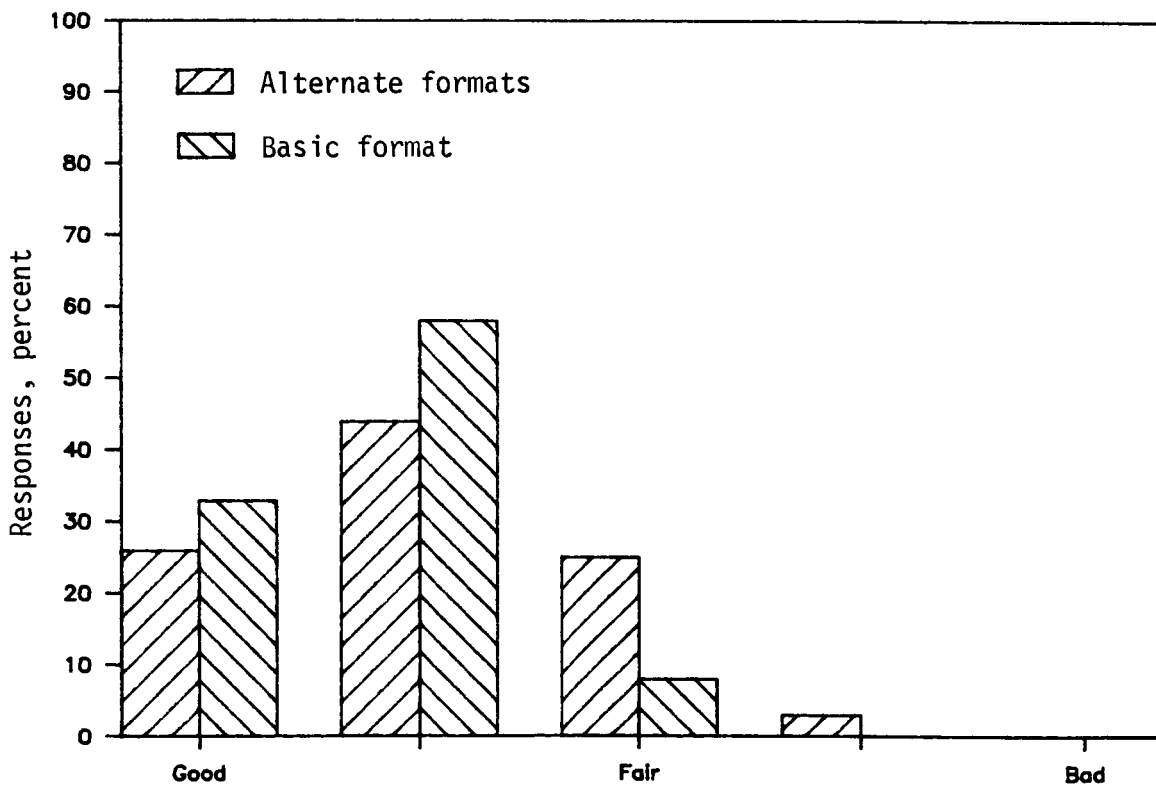

Figure 16. Perceived vertical path performance with basic and alternate formats.

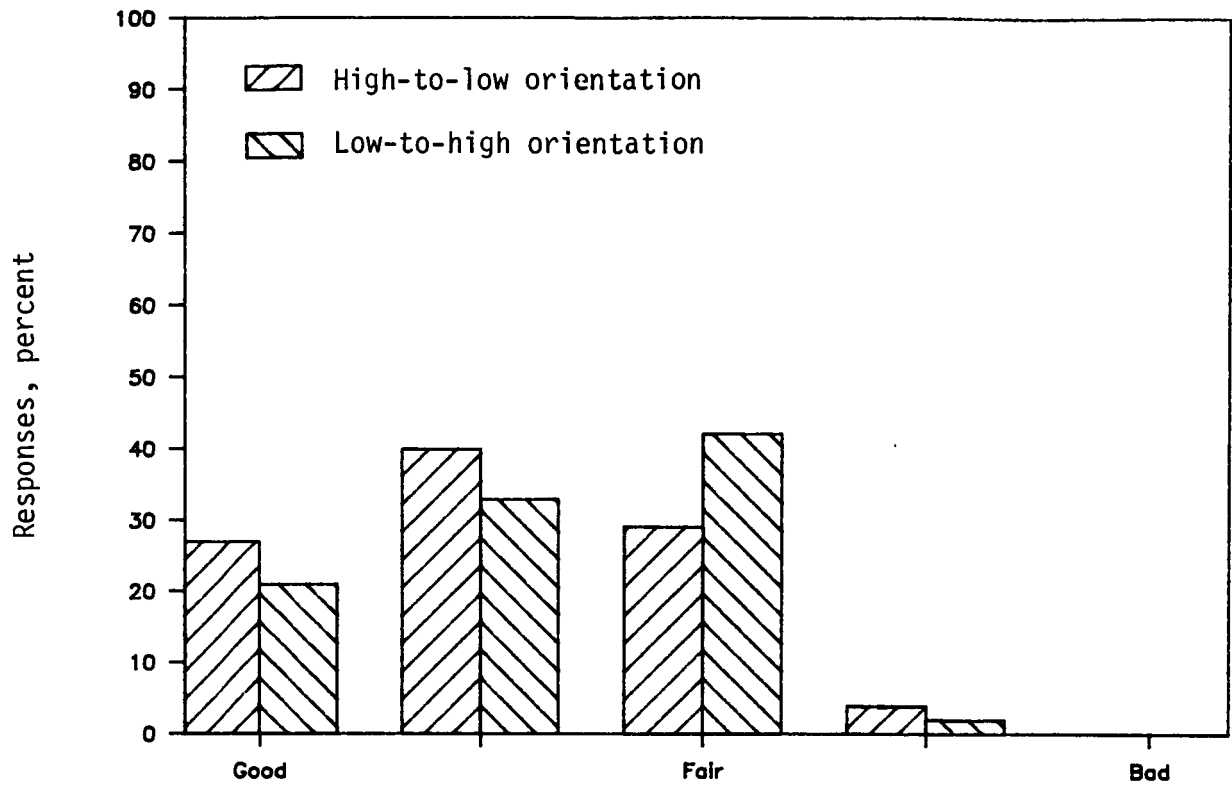

Figure 17. Perceived speed performance with respect to airspeed tape orientation.

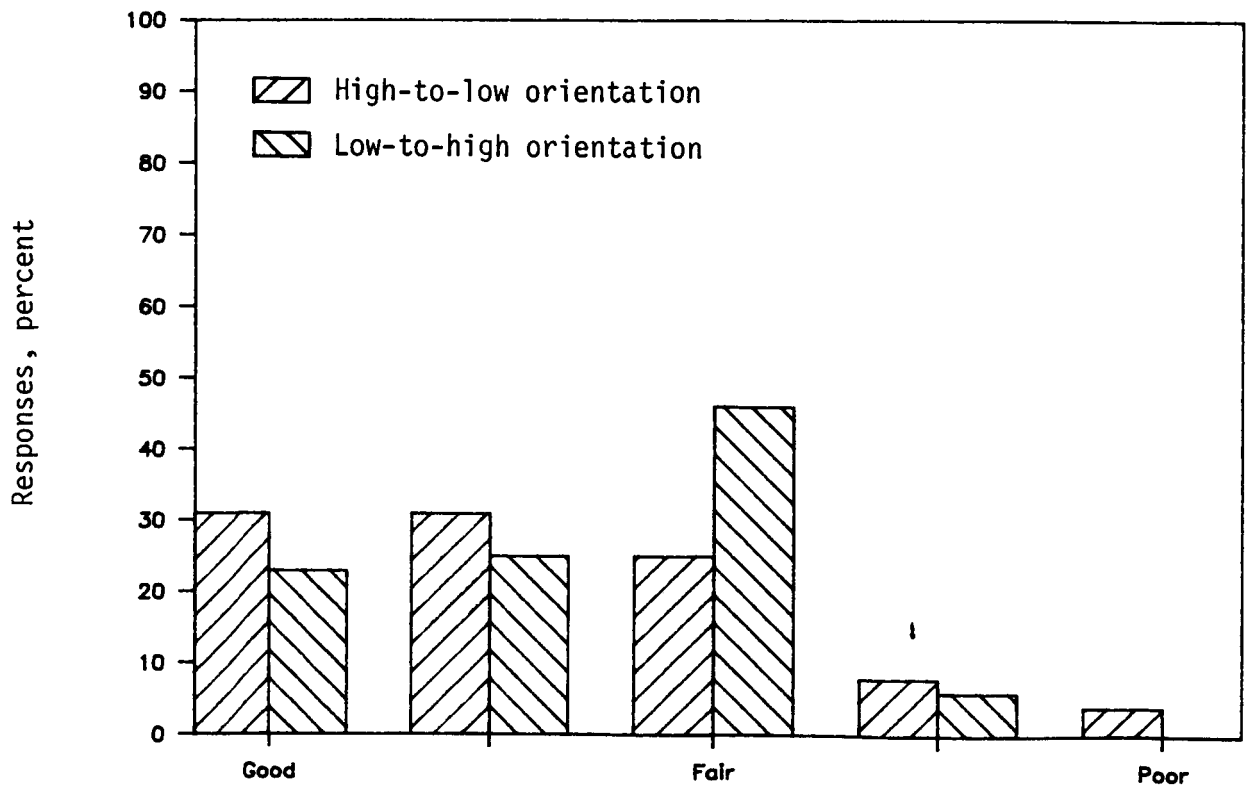

Figure 18. Airspeed presentation with respect to tape orientation.

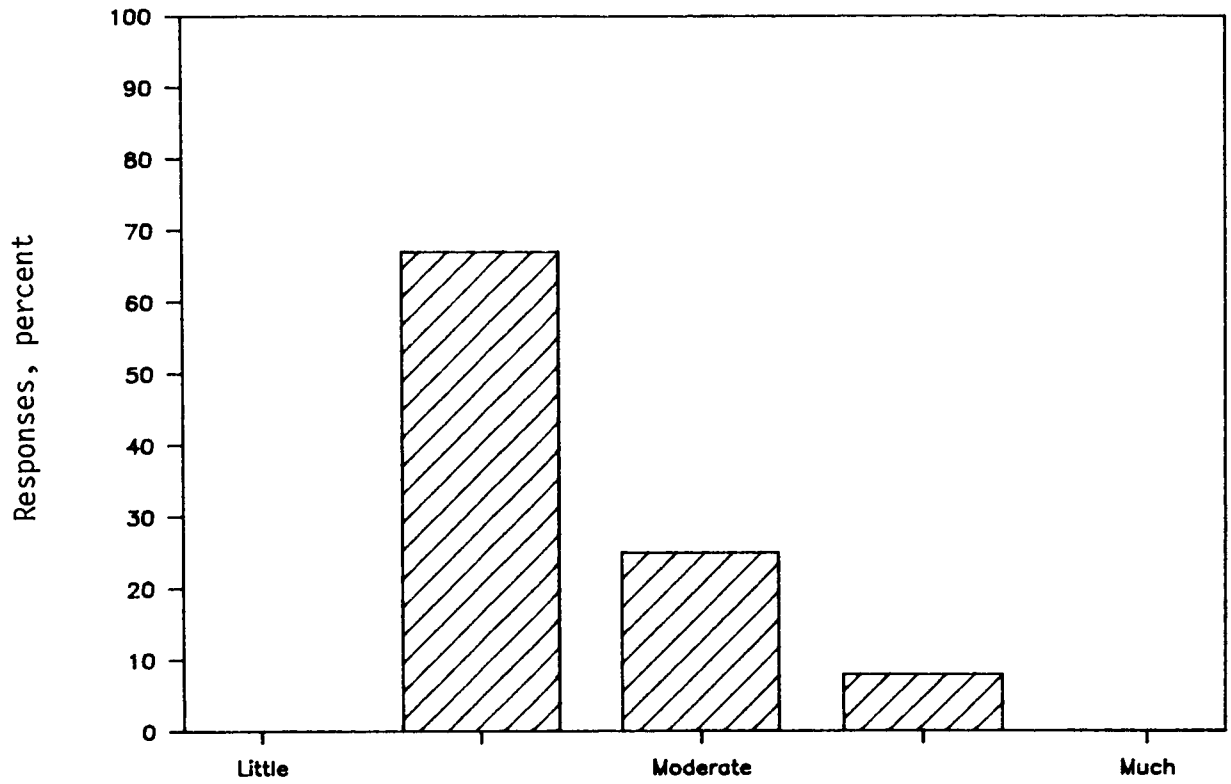

Figure 19. Effort required for adaptation to the alternate formats.

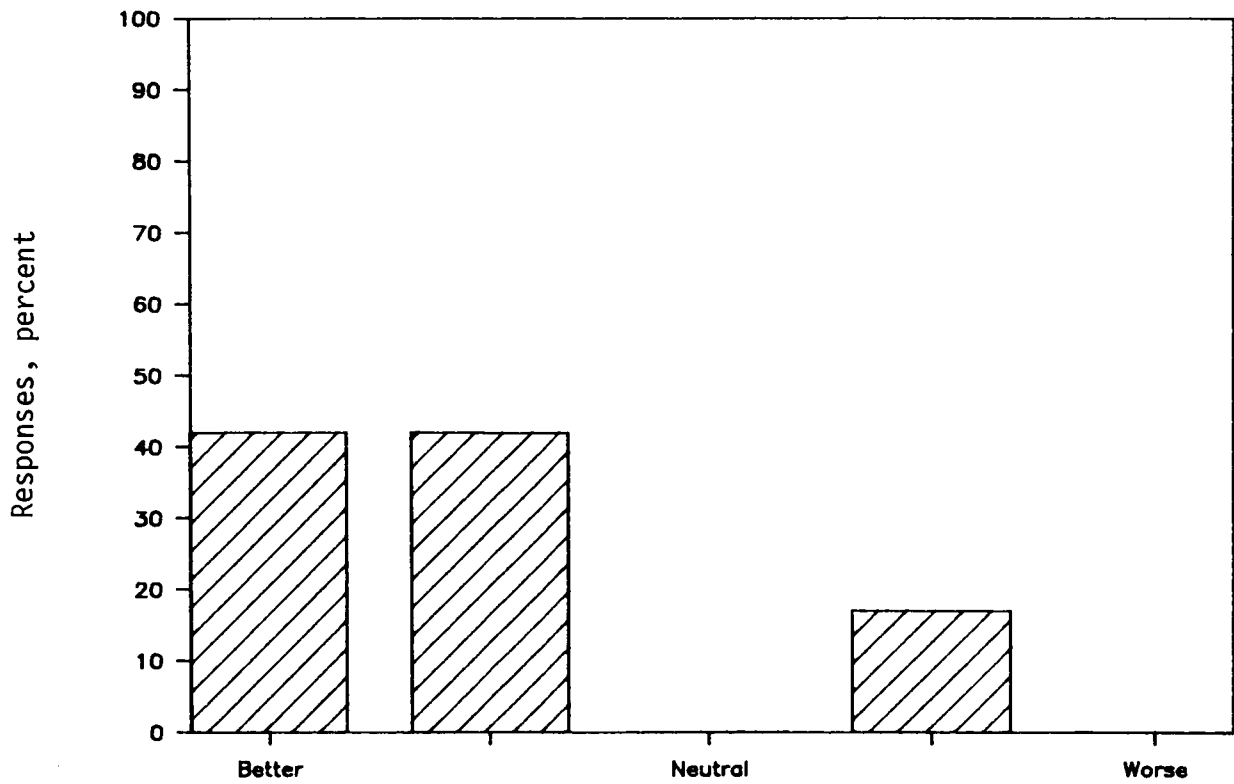

Figure 20. Ranking of alternate formats with respect to basic format.

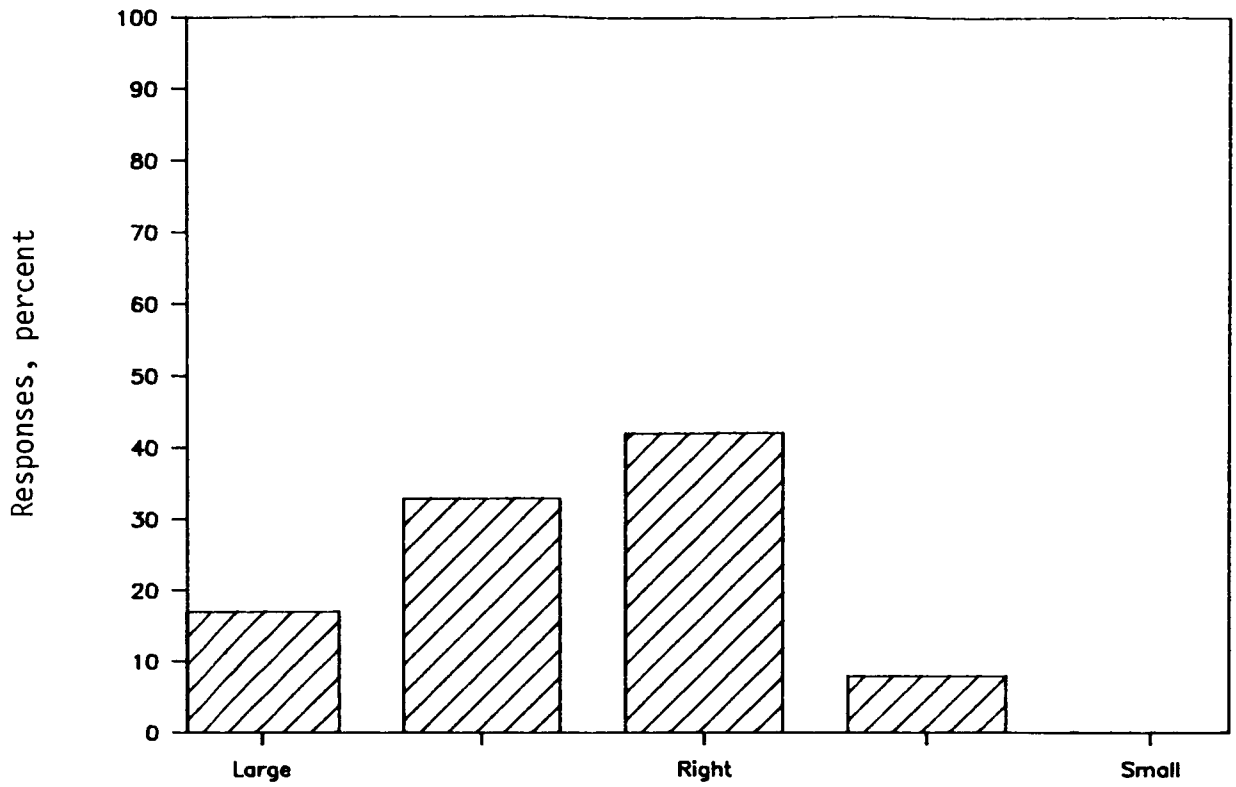

Figure 21. Scale range of vertical information on the alternate formats.

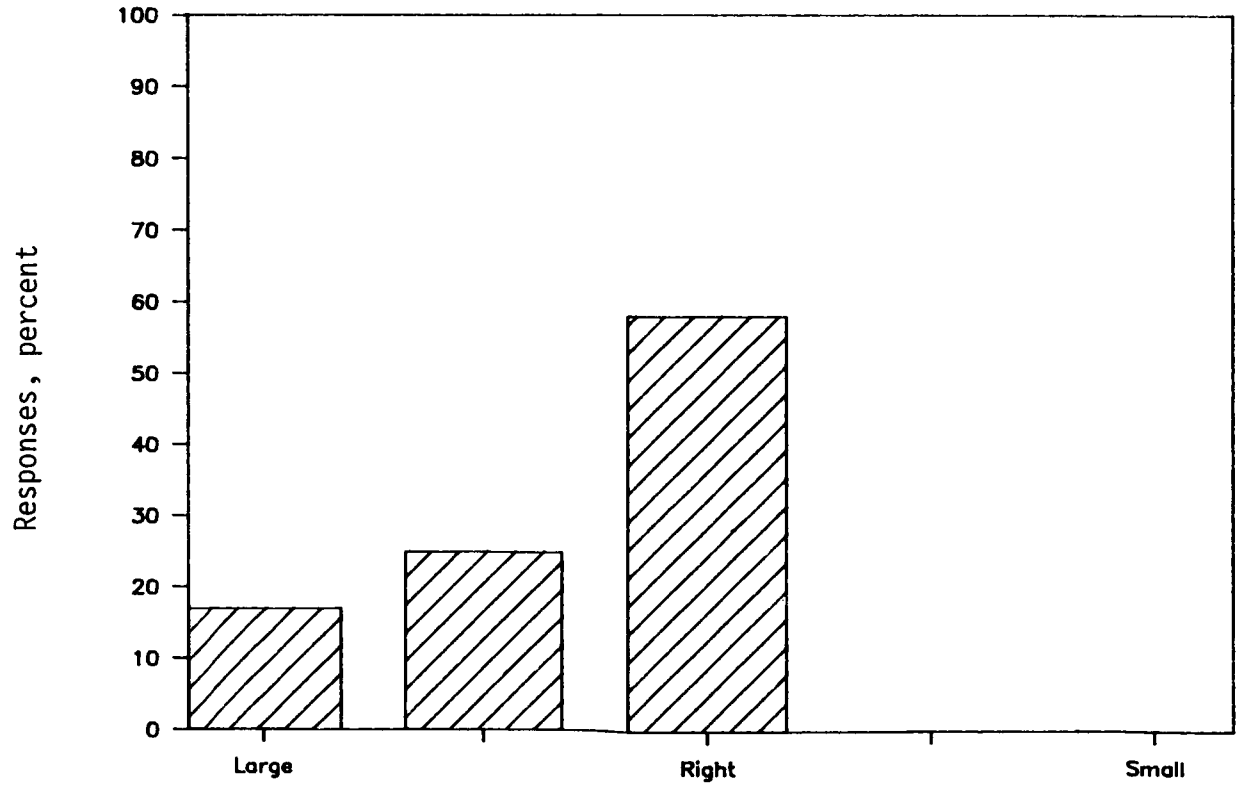

Figure 22. Scale range of speed information on the alternate formats.

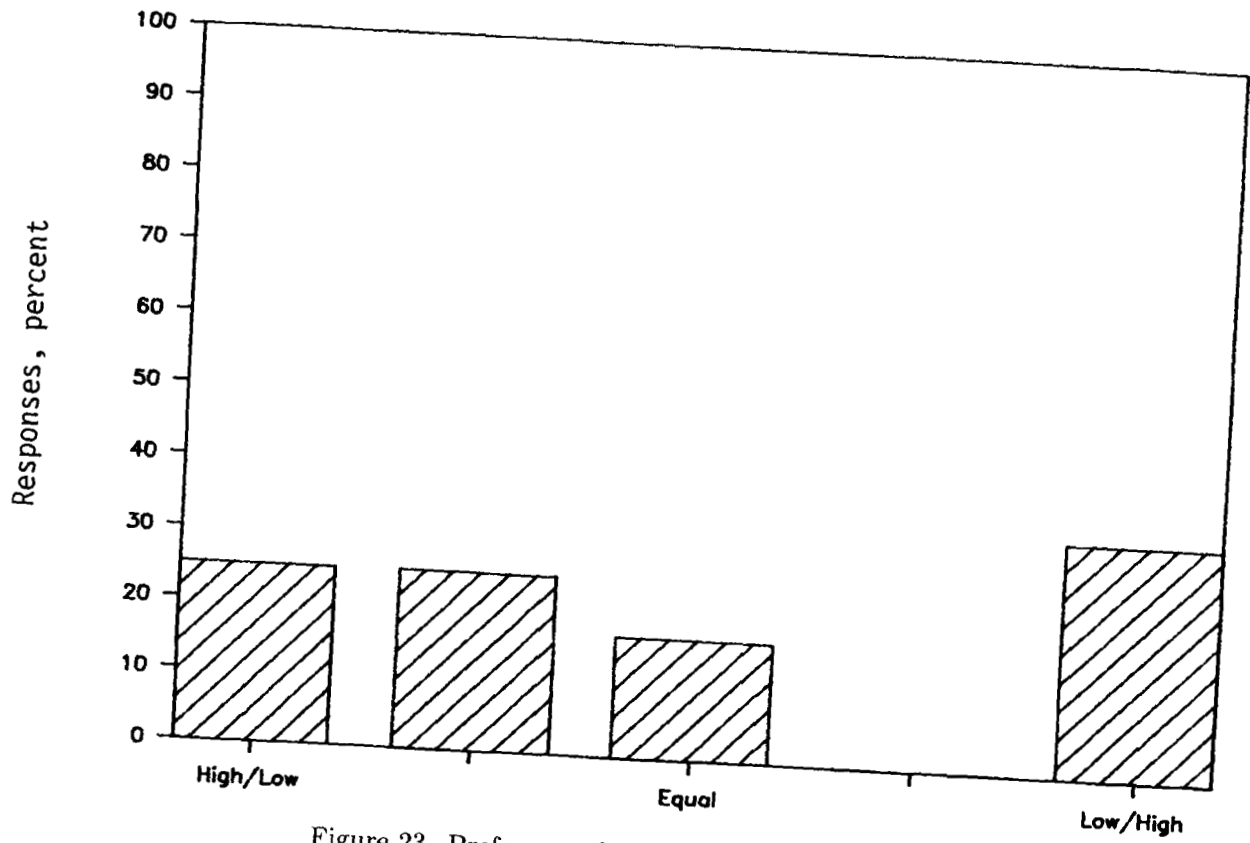

Figure 23. Preference of speed tape orientation.

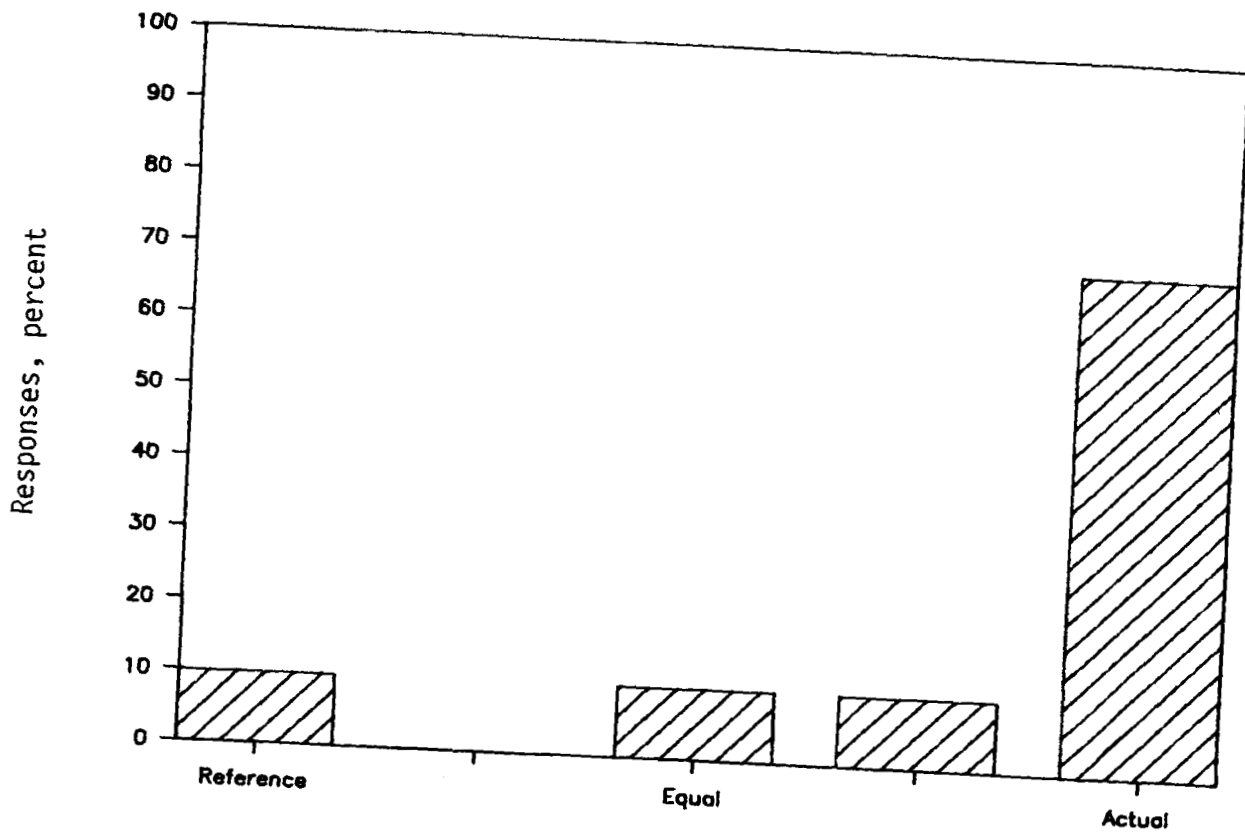

Figure 24. Preference of tape centering.

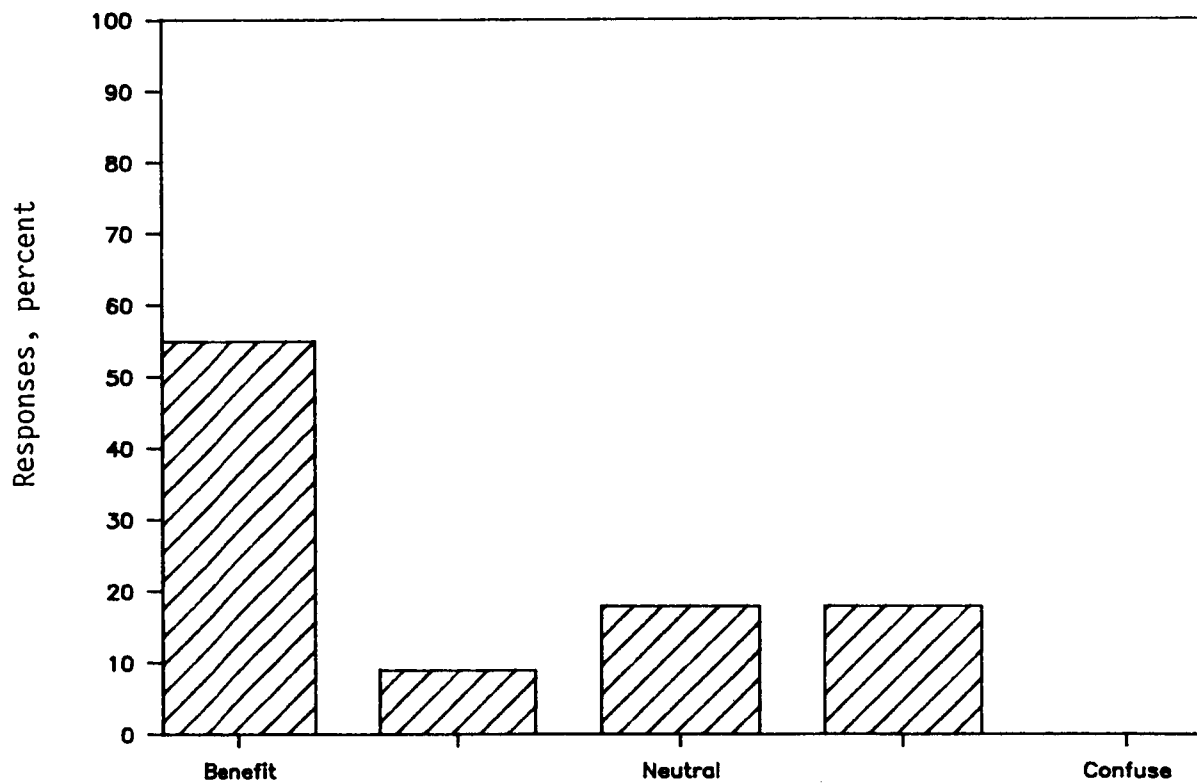

Figure 25. Effect of shifting the altitude tape.



Report Documentation Page

| | | | |
|---|---|---|---------------------------------|
| 1. Report No. NASA TM-89064 | 2. Government Accession No. | 3. Recipient's Catalog No. | |
| 4. Title and Subtitle Integration of Altitude and Airspeed Information Into a Primary Flight Display Via Moving-Tape Formats | | 5. Report Date April 1987 | 6. Performing Organization Code |
| | | 8. Performing Organization Report No. L-16221 | |
| 7. Author(s) Terence S. Abbott and George G. Steinmetz | | 10. Work Unit No. 505-67-01-02 | 11. Contract or Grant No. |
| 9. Performing Organization Name and Address NASA Langley Research Center Hampton, VA 23665-5225 | | 13. Type of Report and Period Covered Technical Memorandum | |
| | | 14. Sponsoring Agency Code | |
| 15. Supplementary Notes | | | |
| 16. Abstract A ground-based aircraft simulation study was conducted to determine the effect on pilot performance of replacing the electromechanical altimeter and airspeed indicators with electronically generated representations which were integrated into the primary flight display via moving-tape (linear moving scale) formats. Several key factors relating to moving-tape formats were examined during this study: tape centering, secondary (trend) information, and tape orientation. The factor of centering refers to whether the tape was centered about the actual airspeed or altitude or about some defined reference value. Tape orientation refers to whether the represented values are arranged in either descending or ascending order. Six pilots participated in this study, with each subject performing 18 runs along a single, known flight profile. Subjective results indicated that the moving-tape formats were generally better than that of the conventional instruments. They also indicated that an actual-centered fixed pointer was preferred to a reference-centered pointer. Performance data for a visual secondary task showed that formats not containing trend information produced better performance; however, no difference was noted in airspeed tracking or altitude tracking performance. Regarding tape orientation, subjective comments indicated that there was lower work load and better performance when the airspeed tape had the high numbers at the top. | | | |
| 17. Key Words (Suggested by Authors(s)) Cockpit display Aircraft guidance | | 18. Distribution Statement Unclassified—Unlimited Subject Category 06 | |
| 19. Security Classif.(of this report) Unclassified | 20. Security Classif.(of this page) Unclassified | 21. No. of Pages 27 | 22. Price A03 |