

NASA Technical Memorandum 100187
IAF-87-491

Monolithic Microwave Integrated Circuit (MMIC) Technology for Space Communications Applications

Denis J. Connolly, Kul B. Bhasin,
and Robert R. Romanofsky
*Lewis Research Center
Cleveland, Ohio*

Prepared for the
38th International Astronautical Federation Congress
Brighton, United Kingdom, October 9-17, 1987



(NASA-TM-100187) MONOLITHIC MICROWAVE
INTEGRATED CIRCUIT (MMIC) TECHNOLOGY FOR
SPACE COMMUNICATIONS APPLICATIONS (NASA)
18 p Avail: NTIS HC A02/EF A01 CSCL 09C

N87-27883

Unclas
G3/32 0094532

MONOLITHIC MICROWAVE INTEGRATED CIRCUIT (MMIC) TECHNOLOGY
FOR SPACE COMMUNICATIONS APPLICATIONS

Denis J. Connolly, Kul B. Bhasin, and Robert R. Romanofsky
National Aeronautics and Space Administration
Lewis Research Center
Cleveland, Ohio 44135

SUMMARY

Future communications satellites are likely to use gallium arsenide (GaAs) monolithic microwave integrated-circuit (MMIC) technology in most, if not all, communications payload subsystems. Multiple-scanning-beam antenna systems are expected to use GaAs MMIC's to increase functional capability, to reduce volume, weight, and cost, and to greatly improve system reliability. RF and IF matrix switch technology based on GaAs MMIC's is also being developed for these reasons. MMIC technology, including gigabit-rate GaAs digital integrated circuits, offers substantial advantages in power consumption and weight over silicon technologies for high-throughput, on-board baseband processor systems. For the more distant future pseudomorphic indium gallium arsenide (InGaAs) and other advanced III-V materials offer the possibility of MMIC subsystems well up into the millimeter wavelength region. All of these technology elements are in NASA's MMIC program. Their status will be reviewed in this paper.

I. INTRODUCTION

Studies conducted by NASA in the late 1970's showed that the demand for orbital locations and frequency allocations for fixed satellite service will exceed the orbit and spectrum capacity (at the C and K_U bands) by the early 1990's (refs. 1 and 2). NASA's approach to addressing these problems was to develop new technologies

- (1) To open the K_a band
- (2) To use multiple-beam antennas to obtain the benefits of many-fold frequency reuse
- (3) To use onboard processing and multiple scanning beams to address "customer premises" traffic so that large, complex K_a-band satellites would be economically viable in the 1990's, notwithstanding advances in optical-fiber-based competing systems for trunking traffic

The experimental Advanced Communications Technology Satellite (ACTS) is expected to complete the planned development.

Second-generation operational satellites that apply the concepts proven by ACTS can exhibit greatly improved performance and economics by capitalizing on the longer range monolithic microwave integrated circuit (MMIC) technology developments recently initiated (ref. 3). These include

- (1) 20-GHz transmitter modules and 30-GHz receiver modules with digitally addressed amplitude and phase control
- (2) Matrix switches at both 20 GHz and intermediate frequencies
- (3) GaAs digital integrated-circuit (IC) modules for high-speed, low-power baseband processor components
- (4) Optical fiber/MMIC monolithic interfaces

E-3763

All of these technology elements are in NASA's MMIC program. They will be addressed respectively in sections II to VI, followed by concluding remarks on their status and potential. For the more distant future InGaAs and other advanced III-V materials offer the possibility of MMIC subsystems well up into the millimeter wavelength region. Pseudomorphic InGaAs grown in GaAs substrates could be implemented on existing GaAs MMIC lines with only the change of two or three process steps. General ideas concerning the impact of MMIC's are also discussed.

II. GaAs MMIC TECHNOLOGY --STATUS

GaAs MMIC's are increasingly becoming a practical reality.^{4,5} Their use is being extended to millimeter-wave frequencies (ref. 6). The driving factor behind the development of this technology has been batch processing, leading to low cost, high performance, small size, and reproducibility similar to that for silicon integrated circuits. The excellent microwave properties of semi-insulating GaAs substrates, GaAs crystal and epitaxial film growth techniques, the development of the GaAs metal-semiconductor field-effect transistor (MESFET), and MESFET computer-aided circuit design have provided additional impetus for this rapid growth in the last several years.

A GaAs MMIC consists of several active and passive components. The active components are GaAs MESFET's and Schottky barrier diodes. The major passive components are thin-film resistors, metal-insulator-metal overlay capacitors, interdigitated capacitors, and spiral inductors. Lumped- or distributed-element circuitry is used. Plated air bridges are used for circuit element connections, and through-substrate holes are used for ground interconnections.

The active layers in GaAs MESFET's for MMIC's are commonly formed by ion implantation and chemical vapor deposition (CVD). Molecular beam epitaxy, organo-metallic chemical vapor deposition, and vapor-phase epitaxy are examples of CVD techniques. These techniques are also providing new microwave device structures based on the properties of heterojunctions. High-electron-mobility transistors are emerging as a promising structure and will soon find their way into high-performance MMIC's (refs 7 and 8).

The level of microwave devices and passive component integration has been steadily increasing in the last few years, as shown in figure 1 for MMIC's developed in the 20/30-GHz band. However, several aspects of the technology still need to mature to produce low-cost, reliable MMIC's for system applications. Improvements in material quality, accuracy in circuit modeling, faster and easier techniques for circuit characterization, and advances in circuit packaging are required. To a large extent these improvements will be brought about by efforts funded under the DoD MIMIC program. A significant task for NASA will be to see that the results of this program are applied to the components discussed below, thus speeding their insertion into space communications systems.

III. GaAs MMIC TECHNOLOGY FOR SCANNING-BEAM, PHASED-ARRAY ANTENNAS

A block diagram of communications payload for future 20/30-GHz advanced communications satellites is shown in figure 2. This payload contains phased-array antennas and baseband processing and switching. MMIC technology is under development in each of these areas. Several types of MMIC modules for use in scanning-beam, phased-array antennas are discussed here.

A. 20-GHz MMIC Transmitter Module

Rockwell International, under NASA contract, has developed a fully monolithic 20-GHz transmitter module on a GaAs substrate. The technology goals for these devices are given in Table I, and the module is shown in figure 3.

The module consists of five cascaded, single-bit, switched-line phase shifters, employing field-effect transistor (FET) devices for switches. The phase shifters, with phase bits of 11.25°, 22.5°, 45°, 90°, and 180°, can be easily identified in figure 3. FET's in series-shunt configurations are employed to effect a single-pole, double-throw switch (SPDT). The series and shunt FET gate widths are 290 and 190 μm , respectively. Two of each of these FET's are employed in each SPDT switch. All FET gates are 1 mm long. A two-stage buffer amplifier follows the phase shifters to compensate for their insertion loss, and a final three-stage power amplifier provides the required output power. The module represents the highest level of component and function integration for circuits operating near 20 GHz. The total active device count is 73 (FET's and diodes); the passive devices number approximately 75.

Figure 3 shows the digital-to-analog (D/A) converter employed as the interface between the transistor-transistor logic input signals and the switch control for the 20-GHz phase shifter. Experimental data for five phase shifter states are presented in figure 4. The circuit represents the first monolithic integration of digital functions with microwave circuit functions above the X band (ref. 9).

B. 20-GHz Variable-Power Amplifier

Texas Instruments is developing, on NASA contract, a 20-GHz variable-power amplifier (VPA) for power level control in a phased-array antenna feed (ref. 10). The technology goals for the VPA are given in table I, and the amplifier is shown in figure 5.

The objective of the VPA development is to provide an amplifier that is electronically switchable to any one of five output power levels: 500, 125, 50, 12.5, and 0 mW. The efficiency varies from 15 percent at 500 mW to 6 percent at 12.5 mW. The VPA consists of a four-stage, dual-gate FET amplifier and a D/A converter on a 3.05- by 6.45-mm GaAs chip. The D/A converter controls the output power level by providing the required bias voltage to the second gate of the dual-gate FET in each stage. Power control with a dual-gate FET has several advantages. The FET gain can be changed over a large dynamic range (20 to 40 dB). Over most of this range the transmission phase shift is less than 5 percent and the FET input/output impedances are essentially constant, providing a gain-versus-frequency-response curve with a nearly constant shape (fig. 6).

The VPA module employs four stages of amplification. The initial single-gate amplifier module has achieved an output power of 630 mW with 25-dB gain and 21 percent power-added efficiency. The four-stage, dual-gate amplifier (in fig. 5) has demonstrated an output power of 250 mW with 15-dB gain. The chip size is 6.45 by 3.05 mm. The four stages of amplification employ a total gate periphery of 2.7 mm. The final-stage power combines the output of 11 FET's (0.5-mm gates) with 1.5 mm of gate periphery.

Both the single- and dual-gate amplifier versions were the first reported 20-GHz amplifiers to monolithically integrate large-periphery power FET's. Total gate peripheries of 2.7 mm of 0.5-mm-gate FET's were used.

Texas Instruments has now delivered 173 20 GHz variable power amplifiers. Fifty have been rigorously tested. Gain approaching 20 dB, with a dynamic range in excess of 20 dB, has been achieved over a 1 GHz bandwidth. Performance at the upper end of the 17.7 to 20.0 GHz band is somewhat degraded. Gain control was achieved primarily by varying bias on the first gates of the four stage amplifier in lieu of the second gate TTL control which provided only marginal dynamic control. The characterization has indicated good chip to chip repeatability but appreciable wafer to wafer variations. All tests were performed using a waveguide probe test fixture developed by GE (fig. 7) and an HP-8510 automatic network analyzer. Future tests will include de-embedding procedures utilizing a ridge guide test fixture and chip level calibration standards. Current measured results include fixture effects which account for nearly 3 dB of insertion loss.

In a related effort a high-power, high-efficiency monolithic power amplifier for the 19- to 21-GHz band is being developed by Texas Instruments for other advanced communications applications. The objectives are 20-percent efficiency and 15-dB gain with a power output of 2.5 W at saturation.

Two approaches are being considered to meet these objectives, a three-stage amplifier and a power-combined distributed amplifier. The three-stage amplifier (fig. 8) has achieved 2.5-W output power with 18-dB gain and 16-percent efficiency at 18 GHz. The amplifier's total gate periphery of 9.6 mm of 0.5-mm-gate FET's produced the highest reported output power from a single chip (2 W). The amplifier gain was 12 dB with a 20-percent power-added efficiency.

C. 30-GHz Monolithic Receiver Module

Several groups have fabricated and tested GaAs monolithic receivers in the X band (ref. 11) and the K band (ref. 12). However, fully monolithic receivers with variable phase shifting and gain functions for application in phased-array satellite receivers have not been demonstrated. To achieve this objective, an effort has been undertaken to integrate a low-noise amplifier, a variable phase shifter, a mixer, and an intermediate-frequency (IF) amplifier on a single GaAs MMIC chip for operation in the 27.5- to 30-GHz band. The technology goals for this 30-GHz MMIC receiver module are shown in table II.

Two approaches have been taken to achieve the desired performance. The first approach has a phase shifter and a variable-gain control at the receiver frequency. The receiver module under this approach (fig. 9(a)) is being developed at Honeywell Physical Sciences Center under NASA contract. The second approach uses a Lange coupler and a pair of GaAs Schottky diodes to form an analog phase shifter that operates at the local oscillation frequency (23.5 to 26 GHz). The variable-gain control is achieved at the intermediate-frequency stage. This approach (fig. 9(b)) has been taken by Hughes Torrance Research Center under NASA contract. With the first approach Honeywell has completed all four sub-modules. A 30-GHz variable-phase-shift MMIC submodule is reported in reference 13 and a variable-gain-control amplifier module in reference 14. Honeywell has delivered three receivers, each comprised of a complete set of interconnected submodules. An interconnected receive module, delivered by Honeywell, is shown in figure 10. Gain control data and phase control data

are shown in figures 11 and 12 respectively. A maximum RF to IF gain of 12 dB has been achieved with a dynamic range of 13 dB. A phase envelope of $+10^\circ$ at band center, was obtained over the five gain settings.

A two-stage low-noise amplifier (LNA) with 14-dB gain and 7-dB noise figure has been demonstrated under the second approach by Hughes (ref. 15). The low-noise amplifier is shown in figure 13. An IF amplifier (fig. 14), a mixer (fig. 15), and a phase shifter module (Fig. 16) have also been fabricated. The IF amplifier has 13-dB gain with 30-dB control range. The mixer and phase shifter have conversion loss and insertion loss of 10.5 and 11.6 dB respectively (ref. 16).

IV. MONOLITHIC OPTICAL INTEGRATED CONTROL CIRCUITRY FOR GaAs MMIC's

It is becoming apparent that using conventional microwave transmission line components for signal distribution in a phased array results in a complex signal distribution system. Furthermore using a waveguide for millimeter-wave frequencies adds weight and bulk.

Fiber optic technology may provide an answer to the MMIC phased-array signal distribution problem (ref. 17). Optical fiber can be used to transmit both analog and digital signals. It has other advantages - small size, light weight, flexibility, and large bandwidth. Optical wavelength division multiplexing, which allows distribution of diverse signals simultaneously on a single fiber, will further reduce signal distribution complexity. Since short links are involved in the phased-array signal distribution network, the shorter 850- to 900-nm wavelength will suffice. Also, GaAs-based optoelectronic devices, required to provide the interface between the optical fiber and the GaAs MMIC's, operate in this region. The optical electronic integrated circuits (OEIC) required to interface with GaAs MMIC's have not yet been integrated on a single chip. Their feasibility depends on the development of compatible fabrication techniques.

In an active, solid-state phased array based on a fiber optic network an optical fiber from the central processing unit will be connected to the MMIC module for the phase and gain control functions. The RF input or IF output to the MMIC's will be connected to the baseband processor by an optical fiber if feasible. It may be possible to combine the two links on a single fiber. Implementing these optical fiber links for an MMIC phased-array signal distribution network will require integrated optical transmitters and receivers on GaAs substrates. As an example an MMIC transmitter module with optical integrated feed circuitry is shown in conceptual diagram (fig. 17). Interfaces for phase and amplitude control of a transmitter module require transmission of the digital signal by optical fiber. The input signal to the transmitter module will require RF optical links. Design and component considerations for these connections are described here.

Optical intensity modulation techniques, either direct or indirect depending on the frequency limitation of the various optical components, can be used for distributing the RF signal to the MMIC. The major considerations in using optical fiber for distributing the RF signal are insertion loss, stability, dynamic range, and signal-to-noise ratio. The major advantage is that a single fiber can carry multiple signals.

Direct laser modulation to 30 GHz (using a GaAs/AlGaAs semiconductor laser) has been demonstrated (ref. 18).

A traveling wave-modulator with bandwidth in excess of 20 GHz on a GaAs substrate operating at 1.3 microns wavelength has been demonstrated by Wang et al. (ref. 19).

Phase and amplitude control of GaAs MMIC's can be achieved via a single fiber from the array processor rather than the several electrical connections needed currently. The control signals can be brought to the MMIC chip in series and by utilizing a photoreceiver and demultiplexer changed to the desired parallel signals. The NASA Lewis Research Center has taken the initiative in developing an integrated photoreceiver on a GaAs substrate that will demonstrate the control of the phase and gain functions of a MMIC. A GaAs photoreceiver circuit operating up to 2 Gbits/sec and also employing a 1:16 demultiplex chip on a GaAs substrate tested with a clock speed up to 2.7 GHz has been demonstrated. Full monolithic integration has been initiated. When the basic optical devices and circuits technology required to control GaAs MMICs up to 20 GHz becomes available, an optically controlled GaAs MMIC phased array antenna will be evaluated.

V. MONOLITHIC GaAs IF SWITCH MATRIX

An IF switch matrix for onboard satellite signal processing is being designed, fabricated on a single GaAs chip, and evaluated by Microwave Monolithics, Inc., for NASA. FET switches are used for signal steering. FET buffer amplifiers provide an overall insertion loss of zero dB, allowing two-dimensional cascading to form very large arrays (up to 100 by 100), also with 0-dB insertion loss. Switching is obtained by a proprietary crosspoint element design technique.

A monolithic GaAs IF switch array (100 by 100) will weigh only 17 lb in 200 in.³. For comparison, a hybrid crosspoint switch matrix will weigh 500 lb in approximately 12 000 in.³ of volume. Additional benefits of 60-dB isolation between input and output lenses and higher reliability are also anticipated.

VI. GaAs SERIAL-PARALLEL INTERFACE MODULE

Because of an anticipated growth in the volume of communications, onboard data processing is a key area of development for advanced communications systems. High-speed, low-power, parallel-to-serial (P/S) and serial-to-parallel (S/P) converters are being developed on a GaAs substrate in order to interface onboard high-speed processors to large volumes of onboard solid-state memory. Gallium arsenide converters - 1-16, 1-32, and 1-64 S/P and 16-1, 32-1, and 64-1 P/S - are under development. To date, 16:1 multiplexers and 1:16 demultiplexers with enhancement/depletion-mode, direct-coupled MESFET logic have been fabricated by Honeywell's Physical Science Center. Two versions of the 16:1 and 1:16 were designed, each with TTL-compatible input and output ports. One design of the 16:1 and 1:16 operated at 200 MHz with 25 to 30 mW per chip. A faster design operated at 450 MHz with 50 mW per chip.

In these modules low power was obtained by multiplexing or demultiplexing in two separate stages. For the 16:1 multiplexer the outputs of four low-speed 4:1 multiplexers are fed into a single high-speed 4:1 multiplexer. Simply, the 1:16 is implemented as a high-speed 1:4 demultiplex operation and four low-speed 1:4 demultiplex operations. Thus only four registers are

required to clock at the maximum data rate. These S/P and P/S interface module characteristics will greatly reduce the power required for this function from that required with currently available electronic couple logic technology.

VII. CONCLUDING REMARKS

Developments in gallium arsenide (GaAs) monolithic microwave integrated circuit (MMIC) technology presented in this paper have shown that high levels of device and component integration are feasible up to 30 GHz. These developments have also demonstrated integration of substantial power capability and integration of digital and microwave functions.

It is not overly optimistic to extrapolate the ultimate capabilities of this technology to higher frequencies, perhaps to 100 GHz. Passive components tend to become smaller with increasing frequency. At 30 GHz they are not even close to the limits of available microfabrication techniques. Active components presently limit the frequency range of MMIC's, but GaAs field-effect transistor (FET) operation has already been demonstrated at 70 GHz. Recently, for 0.25 μm InGaAs pseudomorphic HEMT, power efficiency of 28 percent and gain of 5.7 at 60 GHz has been achieved (ref. 20). MMIC-compatible active device technologies like high-electron-mobility transistors promise to substantially extend the frequency range available with MMIC's. NASA Lewis Research Center is taking an initiative to develop 30 to 70 GHz MMIC transmitter technology using InGaAs pseudomorphic HEMT. It is clear that MMIC technology will eventually enable the manufacture of very low-cost millimeter-wavelength components. Potential applications in consumer, industrial, and military products could constitute an enormous market for these components.

An important concept to focus longer term technology developments in satellite communications is global interconnectivity through hierarchical switching satellite networks (ref. 20). Key system technologies will include multi-beam antennas, switching and processing, low-cost user terminals, and laser intersatellite links. All of these technologies except laser intersatellite links may be substantially affected by incorporation of MMIC components. Current developments in the NASA MMIC program are in the feasibility demonstration stage, where the circuit yield is expected to be small and unpredictable and where there are substantial chip-to-chip variations in the device performance parameters. Emphasis will shift to maturing these devices to the point where the technology could support proof-of-concept system or subsystem developments (ref. 21). It is hoped that the MMIC program funded by the Department of Defense will stimulate development of MMIC fabrication capability in the United States and greatly reduce the NASA investment necessary to develop MMIC-based satellite communications components.

REFERENCES

1. J.N. Sivo, "Advanced Communications Satellite Systems," IEEE J. Selected Areas in Communication, Vol. SAC-1, pp. 580-588, 1983.
2. W.A. Poley, J.F. Lekan, J.A. Salzman, and S.M. Stevenson, "A Comparison of Domestic Satellite Communications Forecast to the Year 2000," NASA TM-83516, 1983.
3. G. Anzic, T.J. Kascak, A.N. Downey, D.C. Liu, and D.J. Connolly, "Microwave Monolithic Integrated Circuit Development for Future Spaceborne Phased Array Antennas," in 10th AIAA Communications Satellite Systems Conference, New York: AIAA, 1984, pp. 43-53.
4. R.A. Pucel, ed., Monolithic Microwave Integrated Circuits, New York: IEEE Press, 1985.
5. J. Frey and K.B. Bhasin, eds., Microwave Integrated Circuits, 2nd ed. Dedham, MA: Artech House, 1985.
6. A. Chu, W.E. Courtney, and L.J. Mahoney, "Monolithic Circuits for Millimetre-Wave Systems," Microwave J., Vol. 26, pp. 28-48, 1983.
7. U.K. Mishra, S.C. Palmateer, P.C. Chao, P.M. Smith, and J.C.M. Hwang, "Microwave Performance of 0.25- μ m Gate Length High Electron Mobility Transistors," IEEE Electron Device Lett., Vol. EDL-6, pp. 142-145, 1985.
8. M. Scholley, J. Berenz, A. Nichols, K. Nakano, R. Sawires, and J. Abell, "36.0-40.0 GHz HEMT Low-Noise Amplifier," in 1985 IEEE MTT-S International Microwave Symposium Digest, New York: IEEE, 1985, pp. 555-558.
9. A. Gupta, G. Kaelin, R. Stine, S. Huston, K. Ip, W. Peterson, M. Mikasa, and I. Petroff, "A 20 GHz 5-Bit Phase Shift Transmit Module with 16 dB Gain," in 1984 IEEE GaAs IC Symposium Technical Digest, New York: IEEE, 1984, pp. 197-200.
10. P. Saunier, H.Q. Tserng, B. Kim, and G.H. Westphal, "Monolithic GaAs Dual-Gate FET Variable Power Amplifier Module," in IEEE 1985 Microwave and Millimeter-Wave Monolithic Circuit Symposium Digest, New York: IEEE, 1985, pp. 1-3.
11. S. Mori, K. Kamei, K. Shibata, M. Tatematsu, K. Mishima, and S. Okano, "GaAs Monolithic MIC's for Direct Broadcast Statellite Receivers," IEEE Trans. Microwave Theory Tech., vol. MTT-31, pp. 1089-1095 (1983).
12. A. Chu, W.E. Courtney, and R.W. Sudbury, "A 31-GHz Monolithic GaAs Mixer/Preamplifier circuit for Receiver Applications," IEEE Trans. Electron Devices, vol. ED-28, pp. 149-154 (1981).
13. V. Sokolov, J.J. Geddes, A. Contolatis, P.E. Bauhahn, and C. Chao, "A Ka-Band GaAs Monolithic Phase Shifter," IEEE Trans. Microwave Theory Tech., Vol. MTT-31, pp. 1077-1083, 1983.
14. J. Geddes, V. Sokolov, and T. Contolatis, "Ka-Band Monolithic Gain Control Amplifier," Electron. Lett., Vol. 22, pp. 503-504, 1986.

15. L.C.T. Liu, P. Riemenschneider, S.K. Wang, and H. Kanber, "A 30 GHz Monolithic Two-Stage Low Noise Amplifier," in 1985 IEEE GaAs IC Symposium Technical Digest, New York: IEEE, 1985, pp. 7-10.
16. L.C.T. Liu, C.S. Lin, J.R. Kessler, and S.K. Wang, "A 30 GHz Monolithic Receiver," IEEE 1986 Microwave- and Millimeter-Wave Monolithic Circuit Symposium Digest, New York: IEEE, 1986, pp. 41-44.
17. K. B. Bhasin, G. Anzic, R. R. Kunath, and D. J. Connolly, "Optical Techniques to Feed and Control GaAs MMIC Modules for Phased Array Antenna Applications," Proc. AIAA, 11th Annual Communications Satellite Systems Conference, pp. 506-514, San Diego, CA, 1986. Also in NASA TM-87218.
18. K. Uomi, T. Mishima, and N. Chinone, "Ultrahigh Relaxation Oscillation Frequency (up to 30 GHz) of highly p-doped GaAs/GaAlAs Multiple Quantum Well Lasers, Appl. Phys. Lett. 51, pp. 78-80 (1987).
19. S. Y. Wang, S. M. Lin, and Y. M. Houg, "GaAs Traveling-Wave Polarization Electro-optic Waveguide Modulator with bandwidth in excess of 20 GHz at 1.3 μ m," Appl. Phys. Lett. 51, pp. 83-85 (1987).
20. R. Lovell and C.L. Cucia, "Global Interconnectivity in the Next Two Decades - A Scenario," AIAA 11th Annual Communications Satellite Systems Conference, New York: AIAA, 1986, pp. 39-49.
21. E. Maynard, "DOD Microwave and Millimeter-Wave Monolithic Integrated Circuits (MIMIC) Program," IEEE 1986 Microwave- and Millimeter-Wave Monolithic Circuit Symposium Digest, New York: IEEE, 1986, pp. 1-4.

TABLE I. - TECHNOLOGY GOALS FOR MMIC COMPONENTS

	Variable phase shifter	Constant-gain amplifier	Variable-power amplifier
RF band, GHz	17.7 to 20.2	17.7 to 20.2	17.7 to 20.2
RF power output, W	-----	200 by 10^{-3}	0 to 0.5 (variable)
Gain, dB	0	16	20 max. (variable)
Phase bits, deg	11.25, 22.5, 45, 90, 180	-----	-----
Phase control	Five-bit digital input	-----	-----
Amplitude control	-----	-----	Four-bit digital input
Efficiency, percent	-----	15	15/6*
Mechanical, design	Monolithic	Monolithic	Monolithic
Chip size, mm	4.7 by 4.7	3.1 by 1.5	3.05 by 6.45

*15 percent at maximum gain. The amplifier was designed to provide minimal efficiency degradation at lower gain levels.

TABLE II. - TECHNOLOGY GOALS FOR 30-GHz RECEIVER

RF band, GHz	27.5 to 30
IF center frequency, GHz	4 to 8
Noise figure at room temperature, dB	5 (7 for LNA)
RF/IF gain, dB	30 at highest level of gain control
Gain control, dB	At least six levels (30, 27, 24, 20, 17, and off)
Module power consumption, mW	
In all states except off	250
In off state	25
Phase and gain control	Five- and four-bit digital input
Mechanical design	Monolithic
Chip size, mm	12 by 7

TABLE III. - TECHNOLOGY GOALS FOR GaAs OPTICAL INTEGRATED CIRCUIT

Optical input	1-Gbps optical signal on multimode fiber (50- μ m core diameter)
Electrical input	
For optical receiver	+5 V dc
For voltage interface circuits	+5 V dc
Timing input	1-V minimum pulse amplitude at 100-MHz repetition rate
Receiver performance	Sensitivity higher than -30 dB with bit error rate less than 10^{-9}
Power consumption	
For receiver and control logic	<50 mW
For output drivers to interface TTL	30 mW/bit
logic levels for MMIC modules	
Output to control MMIC phase shifter	16-bit parallel data stream
and MMIC gain TTL compatible and for circuits clocked at 50 MHz	

ORIGINAL PAGE IS
OF POOR QUALITY

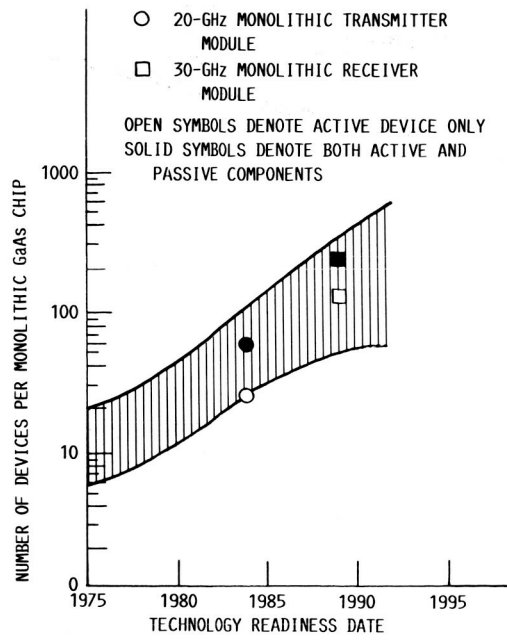

FIGURE 1. - LEVEL OF MONOLITHIC INTEGRATION OF MICROWAVE DEVICES AND PASSIVE COMPONENTS ON GaAs SUBSTRATE.

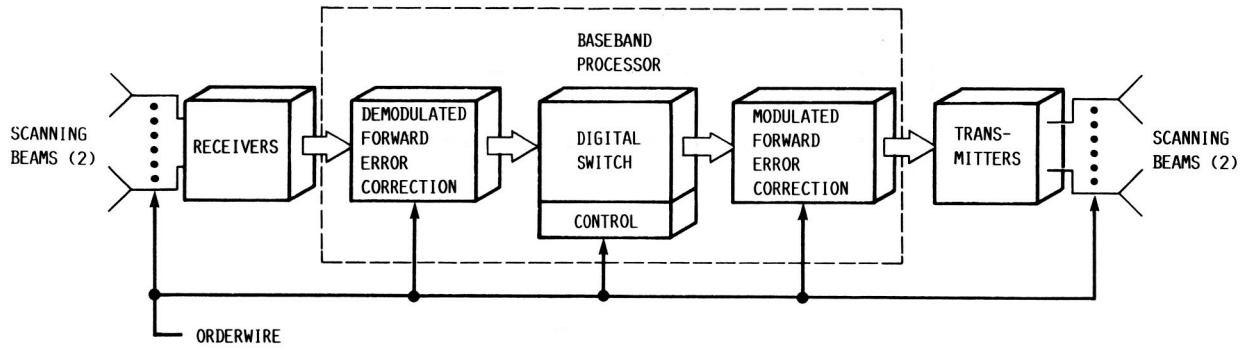

FIGURE 2. - COMMUNICATIONS PAYLOAD FOR EXPERIMENTAL FLIGHT SYSTEM BASED ON PHASED-ARRAY ANTENNA AND BASEBAND PROCESSING TECHNOLOGY.

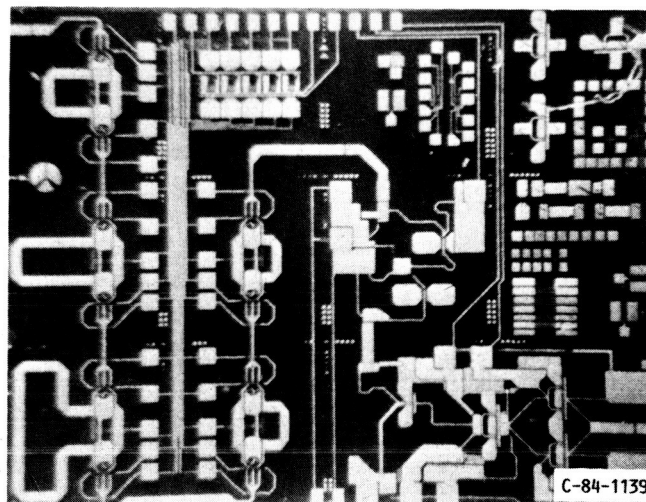

FIGURE 3. - 20-GHz MONOLITHIC PHASE SHIFTER MODULE (4.8x6.4x0.127 MM).

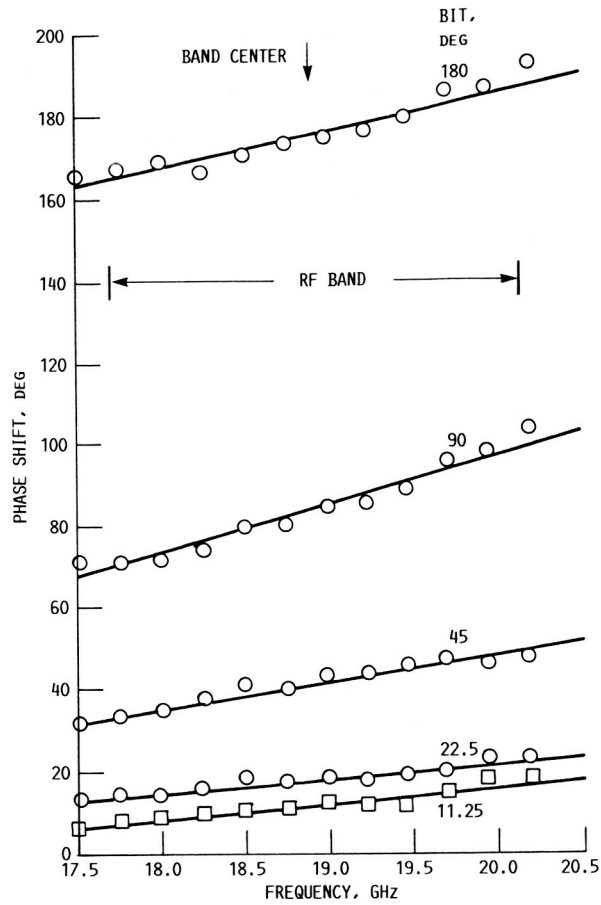

FIGURE 4. - PHASE SHIFT VERSUS FREQUENCY FOR FIVE PHASE SHIFTER STATES FOR 20-GHz VARIABLE-PHASE-SHIFTER MODULE.

ORIGINAL PAGE IS
OF POOR QUALITY

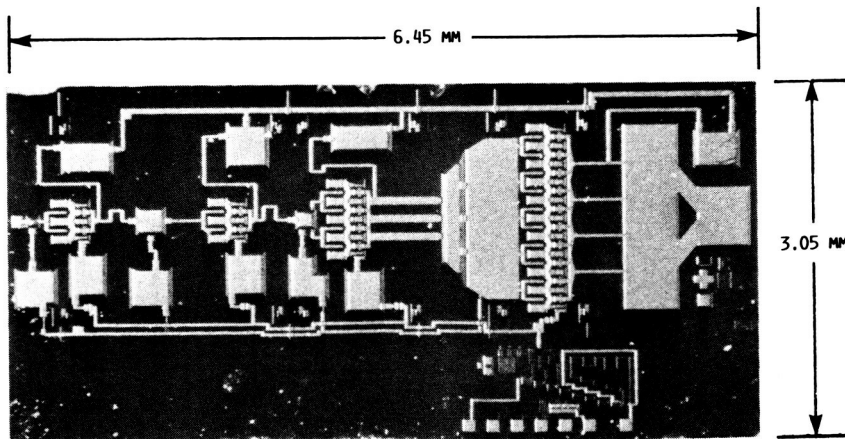

FIGURE 5. - MMIC CHIP FOR 20-GHz VARIABLE-POWER AMPLIFIER.

ORIGINAL PAGE IS
OF POOR QUALITY

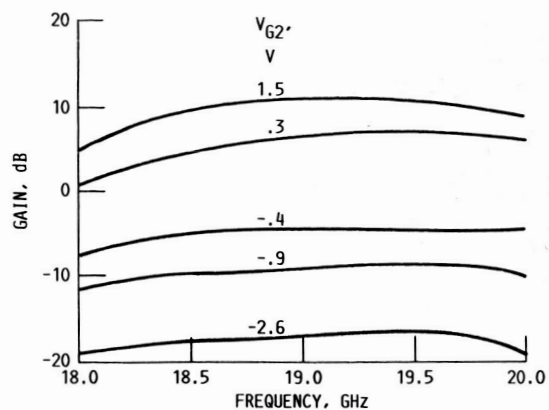

FIGURE 6. - MEASURED GAIN VERSUS FREQUENCY RESPONSE OF VARIABLE-POWER AMPLIFIER. RF INPUT: 0 dBm. DRAIN VOLTAGE: 5.5 V. DRAIN CURRENT: 300 mA. FIRST GATE VOLTAGE: 0.73 V. SECOND GATE VOLTAGE (V_{G2}) IS VARIED AS SHOWN.

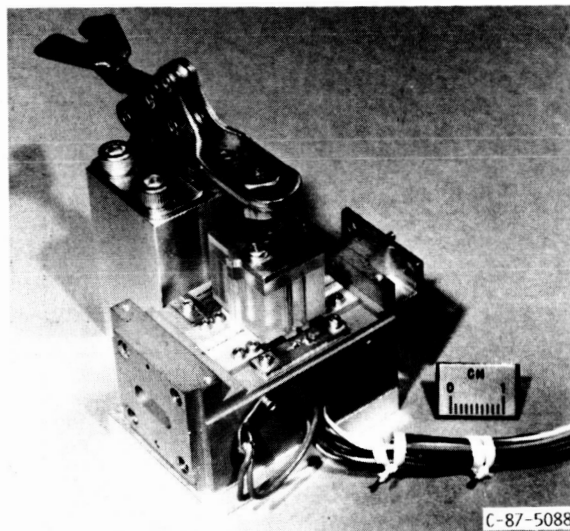

FIGURE 7. - 20-GHz TEST FIXTURE FOR CHARACTERIZING PACKAGED MMICs. THE TRANSITION TO MICROSTRIP IS ACCOMPLISHED USING E-PLANE WAVEGUID PROBES.

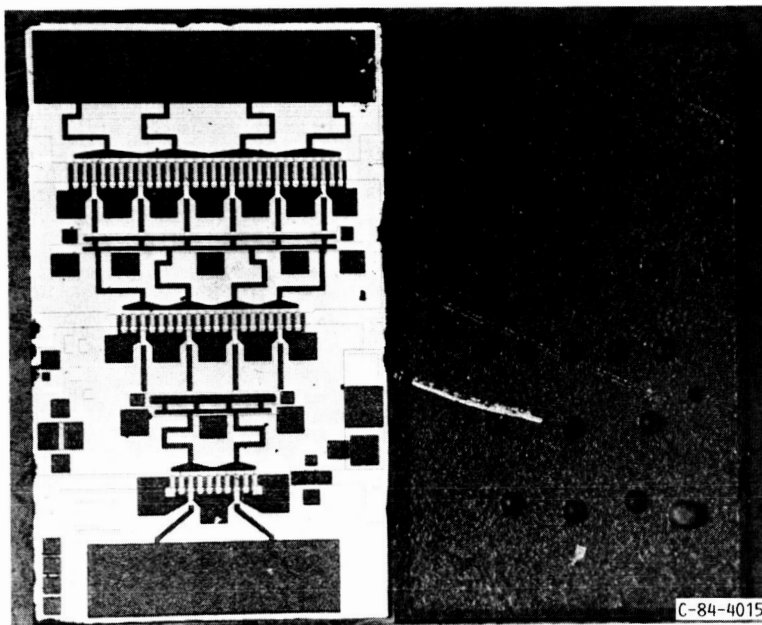
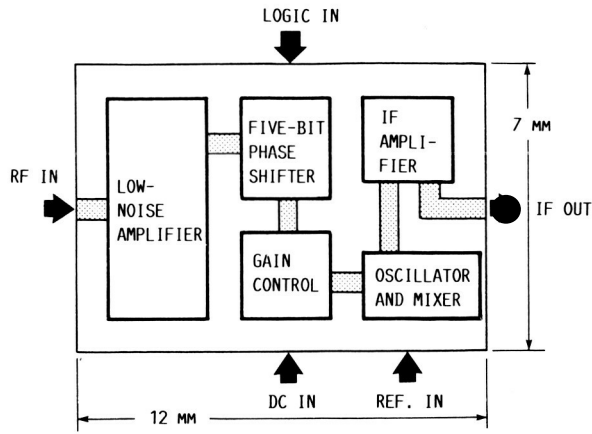
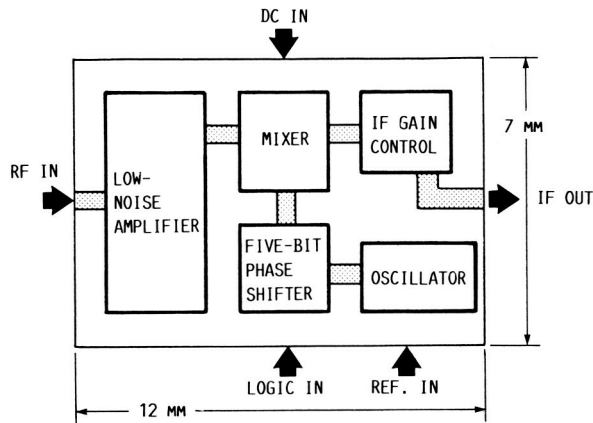

FIGURE 8. - DUAL-STAGE AMPLIFIER.



(A) HONEYWELL APPROACH.



(B) HUGHES APPROACH.

FIGURE 9. - BLOCK DIAGRAMS OF FULLY INTEGRATED 30-GHZ RECEIVER MMIC CONCEPTS.

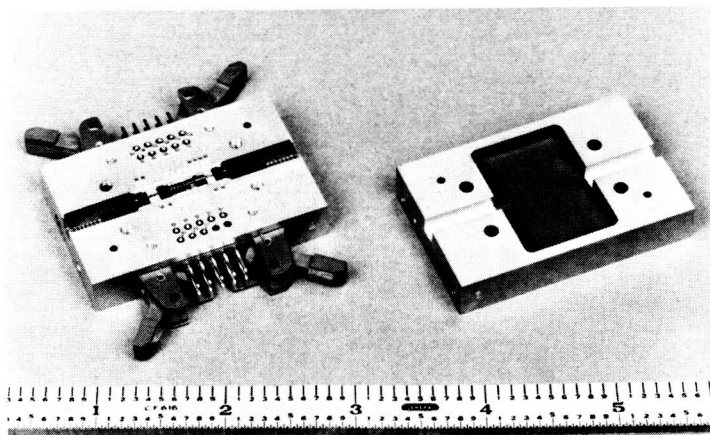

C-87-5086

FIGURE 10. - 30-GHZ INTERCONNECTED RECEIVE MODULE CONSISTING OF THE LOW-NOISE AMPLIFIER, GAIN CONTROL AMPLIFIER, AND PHASE SHIFTER SUBMODULE. SHOWN ARE THE THREE CHIPS, FINLINE TRANSITIONS, OFF CHIP BIAS FILTERS, AND WR-Z8 WAVEGUIDE HOUSING.

ORIGINAL PAGE IS
OF POOR QUALITY

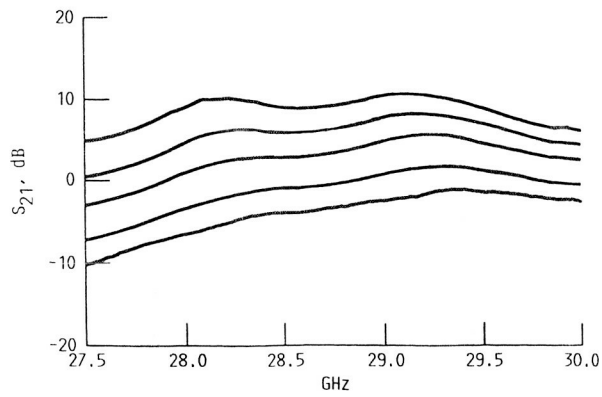

FIGURE 11. - FIVE GAIN STATES OF THE INTERCONNECTED RECEIVE MODULE AT ZERO PHASE SHIFT. BIAS ON THE SECOND GATE OF EACH STAGE WAS VARIED DISCREETLY FROM 0 TO -0.75 V.

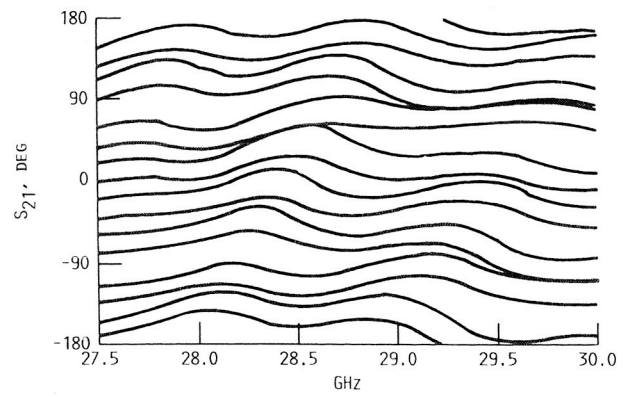

FIGURE 12. - DIFFERENTIAL INSERTION PHASE FOR 16 PHASE STATES OF THE INTERCONNECTED RECEIVE MODULE AT MAXIMUM GAIN.

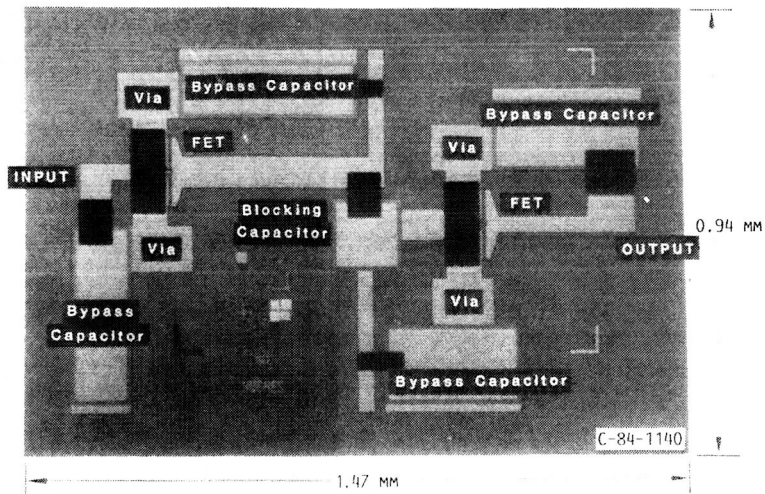

FIGURE 13. - 27.5- TO 30-GHz MONOLITHIC LOW-NOISE AMPLIFIER.

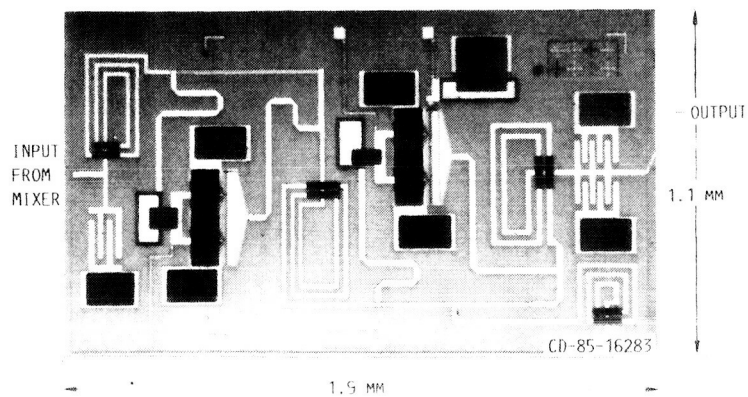

FIGURE 14. - 2- TO 6-GHz INTERMEDIATE-FREQUENCY AMPLIFIER.

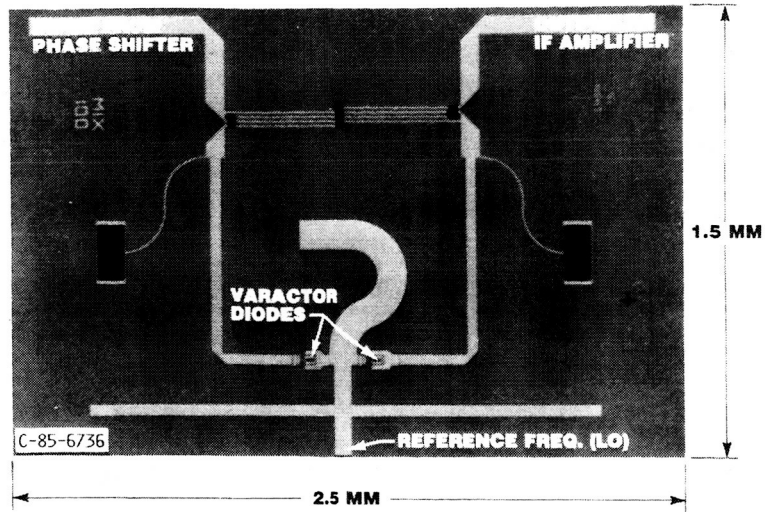

FIGURE 15. - K_a BAND MIXER.

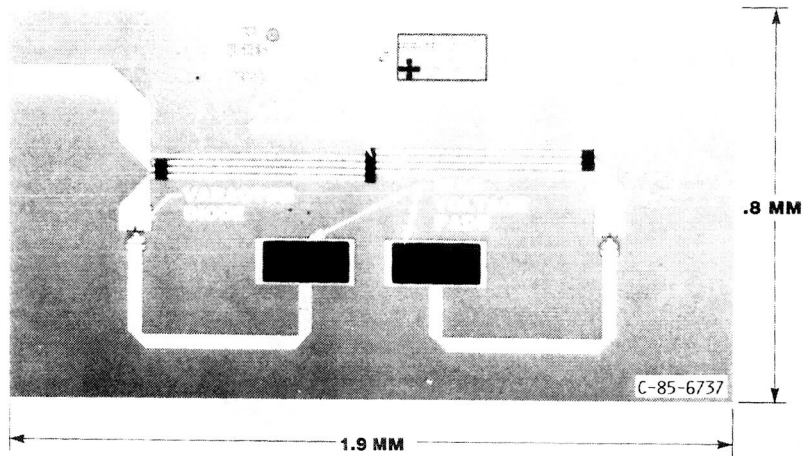

FIGURE 16. - 23.5-GHZ PHASE SHIFTER.

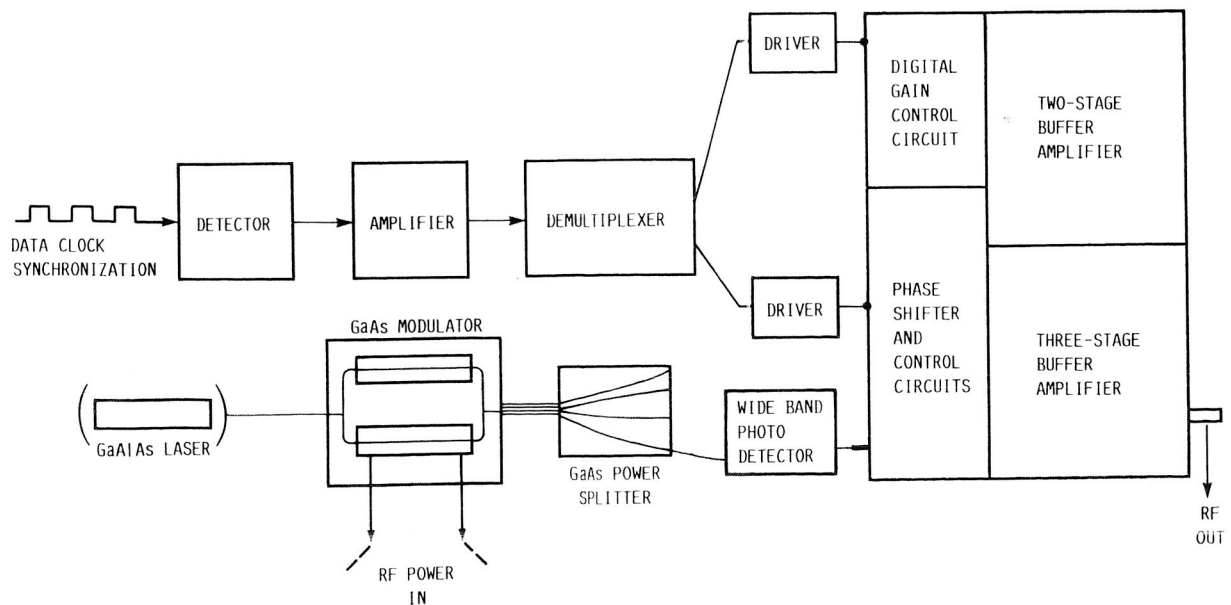

FIGURE 17. - BLOCK CIRCUIT DIAGRAM OF OPTICAL/MMIC INTERFACE.

1. Report No. NASA TM-100187 IAF-87-491		2. Government Accession No.		3. Recipient's Catalog No.	
4. Title and Subtitle Monolithic Microwave Integrated Circuit (MMIC) Technology for Space Communications Applications				5. Report Date	
				6. Performing Organization Code	
7. Author(s) Denis J. Connolly, Kul B. Bhasin, and Robert R. Romanofsky				8. Performing Organization Report No. E-3763	
				10. Work Unit No. 506-44-21	
9. Performing Organization Name and Address National Aeronautics and Space Administration Lewis Research Center Cleveland, Ohio 44135-3191				11. Contract or Grant No.	
				13. Type of Report and Period Covered Technical Memorandum	
12. Sponsoring Agency Name and Address National Aeronautics and Space Administration Washington, D.C. 20546-0001				14. Sponsoring Agency Code	
15. Supplementary Notes Prepared for the 38th International Astronautical Federation Congress, Brighton, United Kingdom, October 9-17, 1987.					
16. Abstract Future communications satellites are likely to use gallium arsenide (GaAs) monolithic microwave integrated-circuit (MMIC) technology in most, if not all, communications payload subsystems. Multiple-scanning-beam antenna systems are expected to use GaAs MMIC's to increase functional capability, to reduce volume, weight, and cost, and to greatly improve system reliability. RF and IF matrix switch technology based on GaAs MMIC's is also being developed for these reasons. MMIC technology, including gigabit-rate GaAs digital integrated circuits, offers substantial advantages in power consumption and weight over silicon technologies for high-throughput, on-board baseband processor systems. For the more distant future pseudomorphic indium gallium arsenide (InGaAs) and other advanced III-V materials offer the possibility of MMIC subsystems well up into the millimeter wavelength region. All of these technology elements are in NASA's MMIC program. Their status will be reviewed in this paper.					
17. Key Words (Suggested by Author(s)) Monolithic Microwave Integrated Circuit Satellite Communications Phased arrays			18. Distribution Statement Unclassified - Unlimited Subject Category 32		
19. Security Classif. (of this report) Unclassified		20. Security Classif. (of this page) Unclassified		21. No of pages 17	22. Price* A02