

A CAD/CAE ANALYSIS OF PHOTOGRAPHIC AND ENGINEERING DATA

S. Michael Goza* and Wayne L. Peterson*

ABSTRACT

In the investigation of the STS 51-L accident, engineers within the Advanced Programs Office (APO) of the NASA Johnson Space Center were given the task of visual analysis of photographic data extracted from the tracking cameras located at the launch pad. An analysis of the rotations associated with the right Solid Rocket Booster (SRB) was also performed as part of the study. The visual analysis involved pinpointing coordinates of specific areas on the photographs. The objective of the analysis on the right SRB was to duplicate the rotations provided by the SRB rate gyros and to determine the effects of the rotations on the launch configuration. To accomplish the objectives of the investigation, Computer Aided Design and Engineering (CAD/CAE) was employed. The solid modeler, GEOMOD, inside the Structural Dynamics Research Corporation (SDRC) I-DEAS package, proved invaluable to the study. This paper will discuss the problem areas that were encountered in the course of the study and the corresponding solutions that were obtained.

The first problem addressed was the need for an accurate model of the STS launch configuration. A brief description detailing the construction of the computer generated solid model of the STS launch configuration is given. Positioning of the model in coordinate space was also a concern. A discussion of the coordinate systems used in the analysis is provided for this purpose. One coordinate system was used in the assembly of the solid model and for the rotations on the right SRB while another coordinate system was used in duplicating photographic orientations. Secondly, the mathematics involved in determining the eye position for correct photographic matching as well as the area of perspective viewing with respect to telephoto lenses are also presented. The final section of the paper describes the techniques and theory used in the model analysis. The use of GEOMOD abilities to extract coordinates and to place markers on the solid model to match photographic areas of interest is presented along with the discussion on the interaction between the right SRB and the rest of the launch vehicle due to the rotations applied to it. A description of the process employed in rotating the SRB on the solid model is given along with the assumptions used in the analysis.

*Advanced Programs Office, NASA Johnson Space Center, Houston, TX

INTRODUCTION

The NASA Johnson Space Center Advanced Programs Office (APO) is in a unique situation. The APO is concerned with the design of future concepts. That is to say, the APO is responsible for the conceptual design of next generation space transportation systems, heavy lift launch vehicles, space platforms, lunar bases, Mars bases, and the vehicles to get personnel and materials to these places. The work is varied, complex, and extremely visual. Two years ago, the Structural Dynamics Research Corporation (SDRC) I-DEAS software package was chosen to perform the math modeling and to provide the visual capabilities. The precise surface definition provided by solid modeling as well as the excellent color shading and display options are invaluable to our work.

Recently, with Space Transportation System (STS) 51-L accident, the APO was required to use I-DEAS in a new way. The APO was required to match solid models of the STS launch configuration to photographic data acquired from various cameras located around the launch pad and the Florida coast. This paper will discuss the problems involved with matching solid models created with I-DEAS GEOMOD to photographs. Some of the problem areas were orientation matching, perspective, and scaling. This paper will also briefly discuss how the computer model was used in the engineering analysis.

MODEL DESCRIPTION

The first task to be addressed in the STS 51-L accident investigation was the need for an accurate computer solid model of the STS launch configuration. A GEOMOD model of the Orbiter was created by SDRC previously for a demonstration tape and the remaining components were created to complete the launch configuration. These components included both SRB's, the External Tank (ET), and all of the attachment hardware. Enough detail was modeled into the SRB's and ET to assist in coordinate extraction from the screen point picking function.

Several coordinate systems were used in setting up the model for analysis. The launch configuration was modeled using the shuttle launch configuration coordinate system. This is a right handed cartesian coordinate system. The tip of the ET is located at X=8.31 meters (327.22 in.), Y=0 meters, and Z=10.16 meters (400 in.). The X-axis is the longitudinal axis where the positive direction is toward the aft end of the configuration. The lateral axis is the Y-axis where the positive direction is out the right wing of the Orbiter if looking from the tail. The Z-axis is the vertical axis where all elevations are positive. Figure 1 depicts the shuttle launch configuration coordinate system. For the orientation matching part of the analysis, two coordinate systems

were used; the aries-mean of 1950 (M50) and the navigation body system. The M50 coordinate system is an inertial coordinate system. It is fixed in space and time. See figure 2 for description. The navigation body (NB) coordinate system is the standard coordinate system used for aircraft by navigation, guidance, and control analysts. The NB coordinate system is shown in figure 3.

ORIENTATION MATCHING

The first problem encountered after creation of the model was to match the orientation of the GEOMOD model of the STS launch configuration to that of the photograph. To compound the problem further, there were thousands of photographs, all at different times and from different cameras. Also, speed in generation was of the essence. The investigation was on a strict time line and could not afford to wait days for output. Therefore, an algorithm for computing the view orientation had to be developed. Guessing or eyeballing the view was tried, but it was too crude and slow a method for analysis. Rotation angle errors, as much as ten degrees could be induced with no visibly detectable change. This was due to the poor photography on some pictures. Therefore, orientation and position data of the stack and cameras versus time had to be acquired. The Best Estimated Trajectory (BET) data was used for the stack. This data is extrapolated from measurements made by the inertial measurement unit (IMU) on board the Orbiter. It contains orientation matrices, euler angles, and position of the stack in various coordinate systems. The camera positions were at known fixed latitudes and longitudes.

Since the algorithm would be used by other computer systems, a generic method had to be derived. Rotating the model itself was discarded because GEOMOD would not do euler angles simply nor would it allow input of direction cosine matrices. Also, different computer systems handle rotations differently. It was decided that the position of the eye vector would be the only method used to obtain the correct view. With this criteria in hand, the following algorithm was devised.

For a specified time and camera, the position in M50 coordinates of the camera and the origin of the NB coordinate system can be extracted from data generated for us by TRW, Inc., and the BET, respectively. By subtracting the stack position from the camera position, the resultant vector is the eye position in M50 coordinates. Multiplying by the orientation direction cosine matrix going from M50 to NB coordinates, which is also extracted from the BET, gives the new eye position in NB coordinates. If the GEOMOD stack model and the NB coordinate system are coincident, then inputting this new eye position will reveal a view with the correct orientation for the specified photograph. The equation is shown in figure 4. An example of the output product is shown

in figure 5. This method was automated through the use of FORTRAN programs and I-DEAS program files. With this, views of photography could be generated in minutes which aided tremendously in speeding up the analysis process.

VIEWING PARAMETERS

After the orientation problem was eliminated, scaling and perspective became a problem. Scaling the computer image to the photograph was and continues to be a problem. There seems to be no way mathematically to match the two. The guessing method gets close and the use of optical means yields better results. It was eventually decided to disregard scaling, not by choice, but due to the complexity and the lack of speed.

Perspective also posed an interesting problem. The cameras used were automatic focus, zoom, speed, and F stop. The depth of field function in GEOMOD attempts to handle some of the operations, but the value changes when you zoom in on the image. It would have been advantageous if GEOMOD was capable of imitating telephoto lense attributes. For our purposes, though, the distances involved were so immense that the effects of perspective were negligible. Therefore, perspective was turned off in GEOMOD for all images.

ANALYSIS

The analysis of the images proved very fruitful. The GEOMOD software was flexible enough that its features could be exploited to expedite the analysis. The analysis consisted of pinpointing the exact coordinates of specified areas of interest which are visible on the photography. The analysis proceeded in the following manner. A flash of light or puff of smoke would be detected on a photograph. The computer model would be oriented to that photographic view. The GEOMOD software was then utilized with the crosshair screen point picking function to extract the coordinate off the model. These coordinates were then checked against the known positions of access ports, structural joints, etc. If a known opening was nearby, the point was moved to that location, and an arrow marker would be positioned appropriately to highlight the area. The image would then be rechecked against the photograph as well as other views from different cameras. An iterative process would continue until a probable opening was found. An example of the marking method is shown in figure 6. The arrow is pointing out the surface of the solid rocket booster at the propellant segment joint.

An analysis was performed on the right SRB in order to duplicate the rotations provided by the SRB rate gyros. During the analysis an assumption was made that one of the three lower attachment struts between the right SRB and the ET failed. The theory in

this assumption was that the flame plume emerging from the SRB casing burned through the strut or that the forces generated by the thrust of the plume caused the strut to fail. Under this condition the SRB is free to pivot about the remaining two struts and the forward SRB attachment fitting. Thus, the right SRB on the solid model was rotated about an axis passing through the forward attachment fitting and a point bisecting the remaining lower two struts. Rotation angles of 5, 10, and 32 degrees were applied to the booster and interference between the booster and the ET was checked. Since the SRB was being rotated towards the Orbiter, an interference check between the SRB and the Orbiter wing was also investigated.

The results of the rotations established that the right SRB interfered with the ET right above the forward SRB fitting in the intertank area of the ET. The actual angle of rotation for initial contact was not verified, but it was shown that a small interference volume existed when the SRB was rotated through a 32 degree angle. Interference did not occur for the 5 degree rotation, but it was felt that the severe binding that occurs in the forward attachment fitting during the 10 degree rotation would cause the thrust ball fitting to fail. Figure 7 depicts a top view and a side view of the launch configuration after a SRB rotation of 32 degrees. The location of the interference volume between the SRB and the ET is highlighted by an arrow. The figure also shows that the SRB does not come into contact with the Orbiter.

CONCLUSION

In conclusion, the SDRC GEOMOD software proved invaluable to the performance of the analysis. The computer images enhanced the photography and provided insight into what the photography was actually depicting. These images helped focus the analysis effort to specific areas thereby reducing the engineering work load and they aided tremendously in presentations. The computer images were examined on two occasions by the Rogers Commission for the STS 51-L investigation, and documented in the NASA/JSC Visual Analysis Sub Team (VAST) Final Report. A discussion of the study and the results were also published in Aviation Week and Space Technology, as well as Design Graphics World. The computer image results could have been improved if GEOMOD was able to model the effects of regular and telephoto camera lenses as well as the scaling. Otherwise, the software performed flawlessly.

The algorithm was also a success. It was adopted as the official method for reproducing photographic views on the computer systems involved at the Johnson Space Center. The algorithm was also published in the VAST Final Report.

The analysis of the SRB rotations helped to explain the appearance of dense vapor clouds in the ET intertank region in photographs taken by the tracking cameras. A bright flash near the SRB forward attachment is visible in the photographic data which is the region of impact predicted by the rotational analysis. Thus, the CAE analysis helped to visually understand the mechanics of the accident.

BIBLIOGRAPHY

1. Computer Graphics Depict Events Leading to Explosion. Aviation Week and Space Technology, March 24, 1986, pp. 74-75.
2. Oft Ascent/Descent Ancillary Data Requirements Document. Mission Planning and Analysis Division. JSC-14370, 78-FM-40, Rev. 1, February, 1980.
3. STS 51-L JSC Visual Data Analysis Sub-Team Report. JSC-22175, Final, June 1986. Figure 1 - Aries-mean-of-1950 coordinate system.
4. Aerodynamic Design Data Book, Volume 2, Launch Vehicle. IVBC-3, August, 1983.
5. NASA and CAD: The Way Back to Space. Design Graphics World, December, 1986, pp. 14-19.

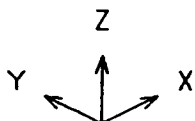
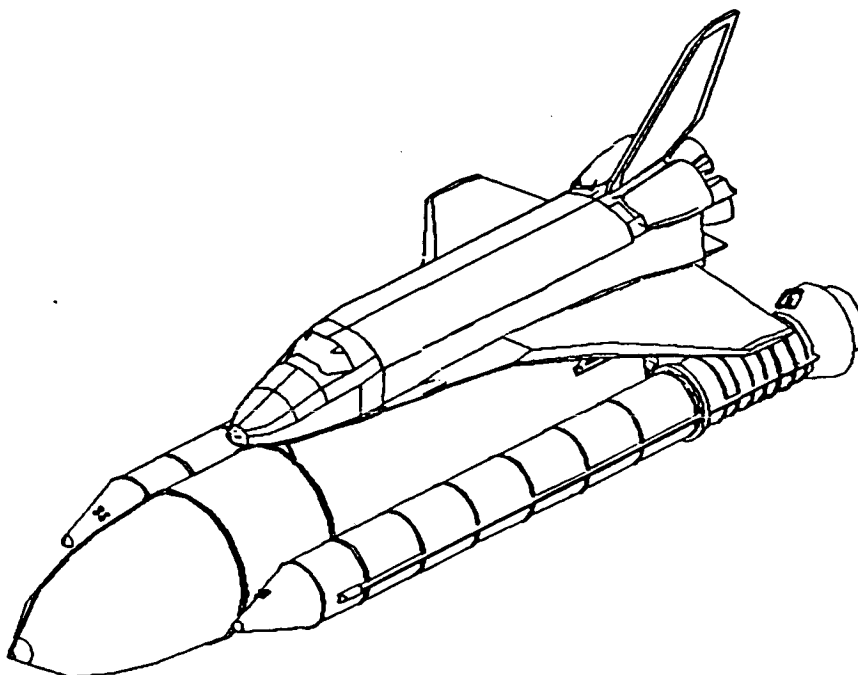

NAME: Shuttle Launch Configuration coordinate system.

ORIGIN: -8.31 meters (-327.22 in.) in X, 0.0 meters in Y, -10.16 meters (-400 in.) in Z from the tip of the External Tank.

ORIENTATION: The X axis (longitudinal axis) is positive towards the aft end of the configuration.

The Y axis is positive out the right wing of the Orbiter.

The Z axis is the vertical axis where all elevations are positive.

CHARACTERISTICS: Right-handed, Cartesian system.

Figure 1 - Shuttle Launch Configuration coordinate system.

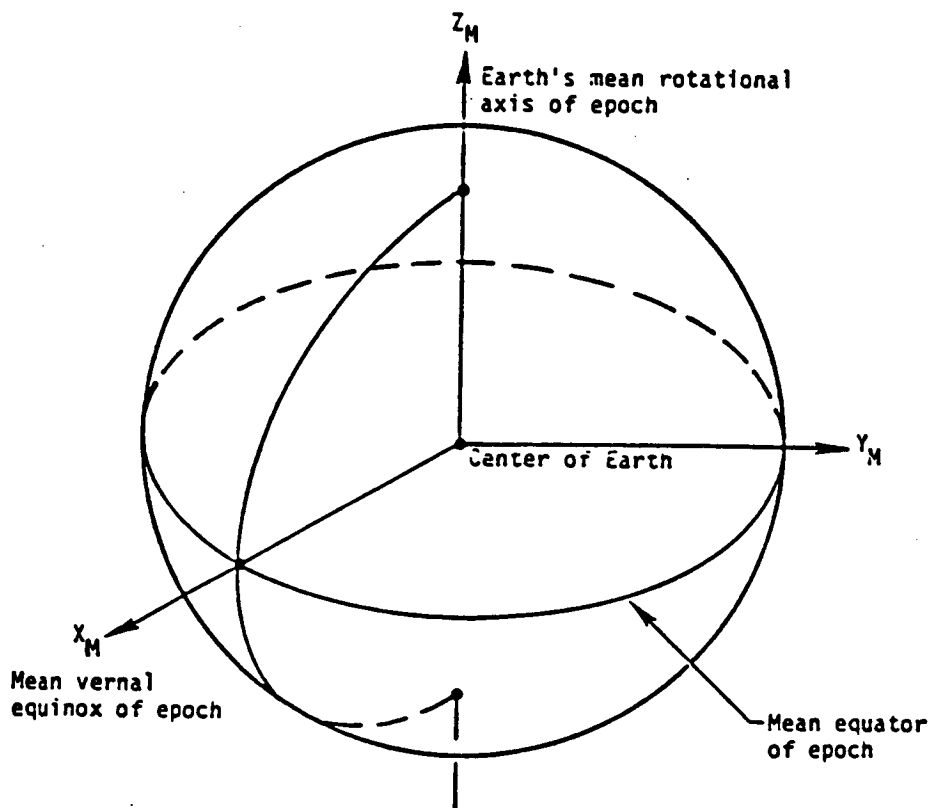

NAME: Aries-mean-of 1950, Cartesian, coordinate system.

ORIGIN: The center of the Earth.

ORIENTATION: The epoch is the beginning of Besselian year 1950 or Julian ephemeris date 2433282.423357.

The X -Y plane is the mean Earth's equator of epoch.

The X axis is directed towards the mean vernal equinox of epoch.

The Z axis is directed along the Earth's mean rotational axis of epoch and is positive north.

The Y axis completes a right-handed system.

CHARACTERISTICS: Inertial, right-handed, Cartesian system.

Figure 2 - Aries-mean-of-1950 coordinate system

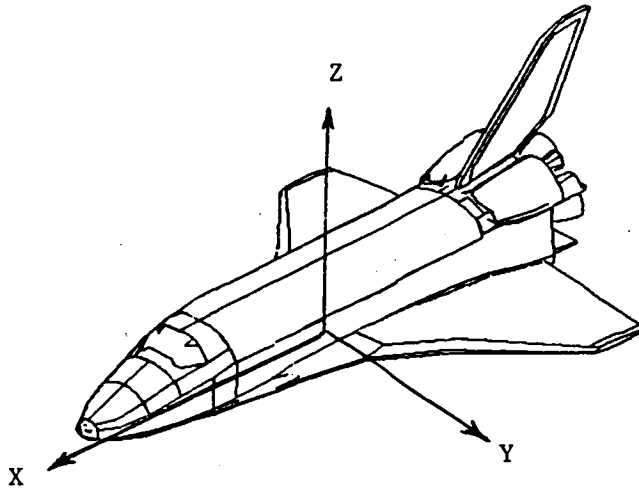

NAME: Navigation Base coordinate system.

ORIGIN: The center of the inertial measurement unit.

ORIENTATION: The X axis is positive out the nose of Orbiter.

The Y axis is positive out the left wing of the Orbiter.

The Z axis is positive going up through plane of the vertical tail.

CHARACTERISTICS: Right handed cartesian coordinate system.

Figure 3 - Navigation Base coordinate system.

$$\begin{bmatrix} X_{ENB} \\ Y_{ENB} \\ Z_{ENB} \end{bmatrix}_{3 \times 1} = \begin{bmatrix} DC \end{bmatrix}_{3 \times 3} \begin{bmatrix} X_c - X_s \\ Y_c - Y_s \\ Z_c - Z_s \end{bmatrix}_{3 \times 1}$$

WHERE

DC = ORIENTATION DIRECTION COSINE TRANSFORMATION MATRIX FROM BET

s = STACK POSITION IN M50 COORDINATES

c = CAMERA POSITION IN M50 COORDINATES

ENB = EYE POSITION IN NAVIGATION BASE COORDINATES

Figure 4 - Eye position algorithm.

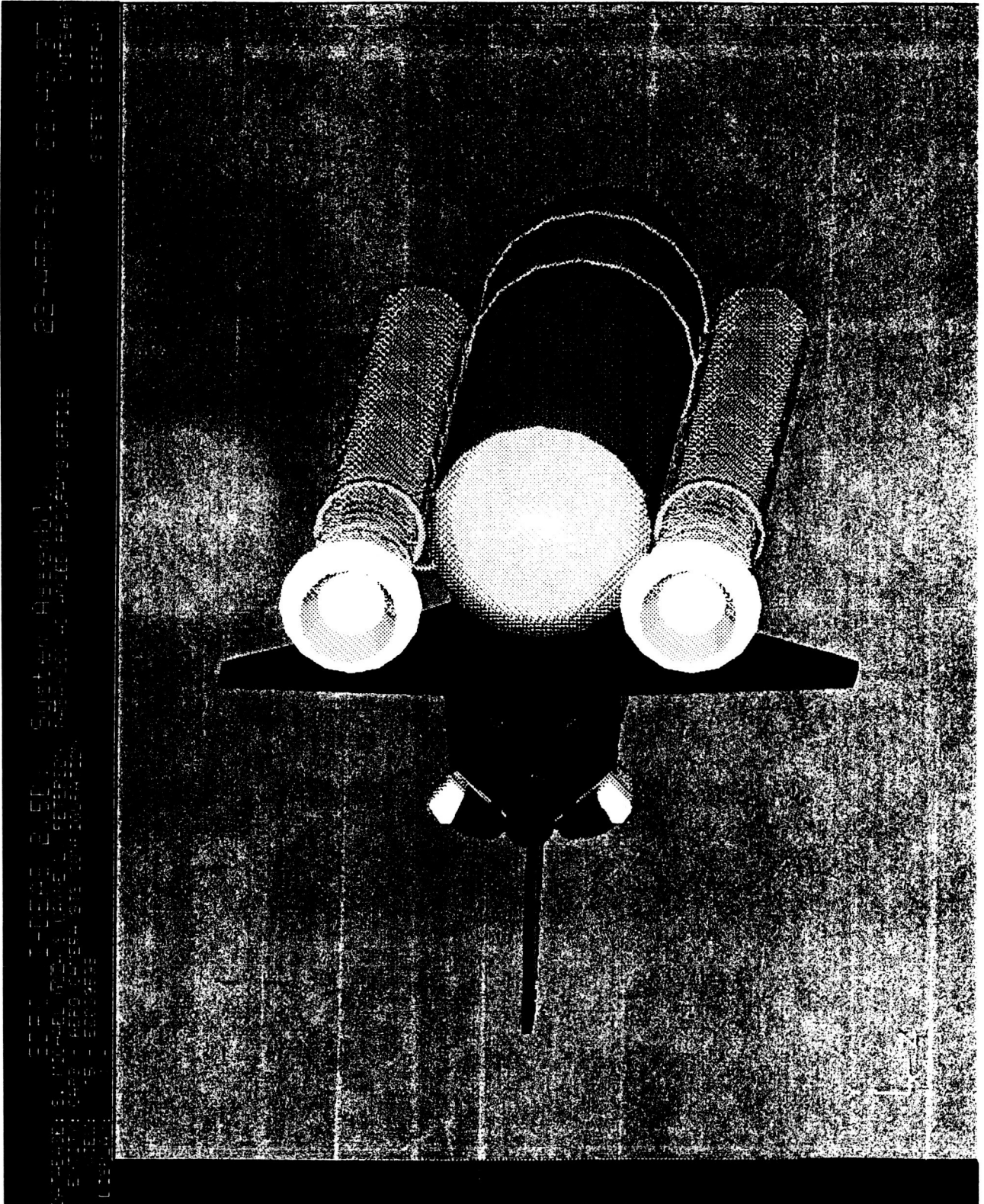

Figure 5 - Computer generated image

ORIGINAL PAGE IS
OF POOR QUALITY

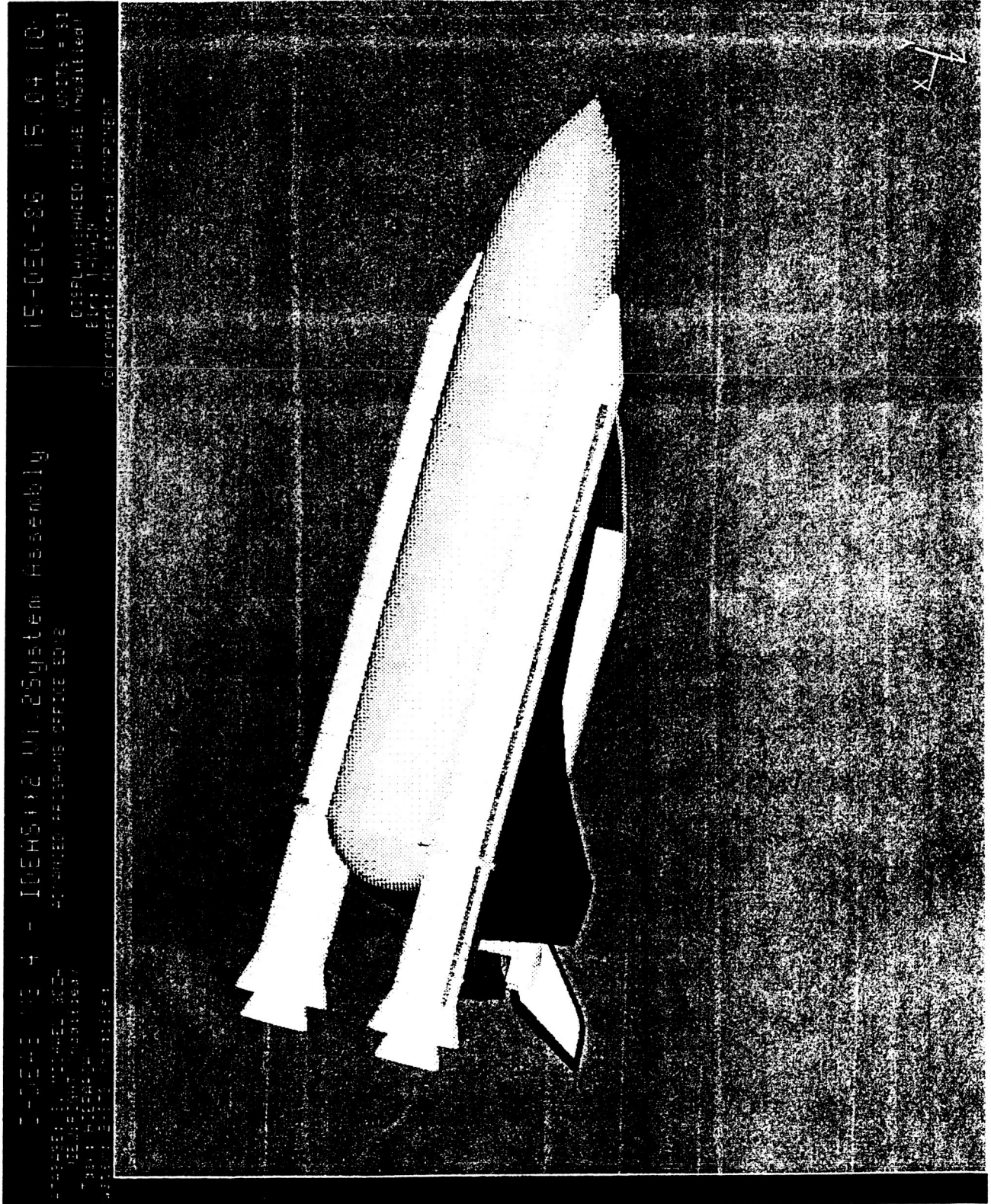

Figure 6 - Computer generated image with highlighting

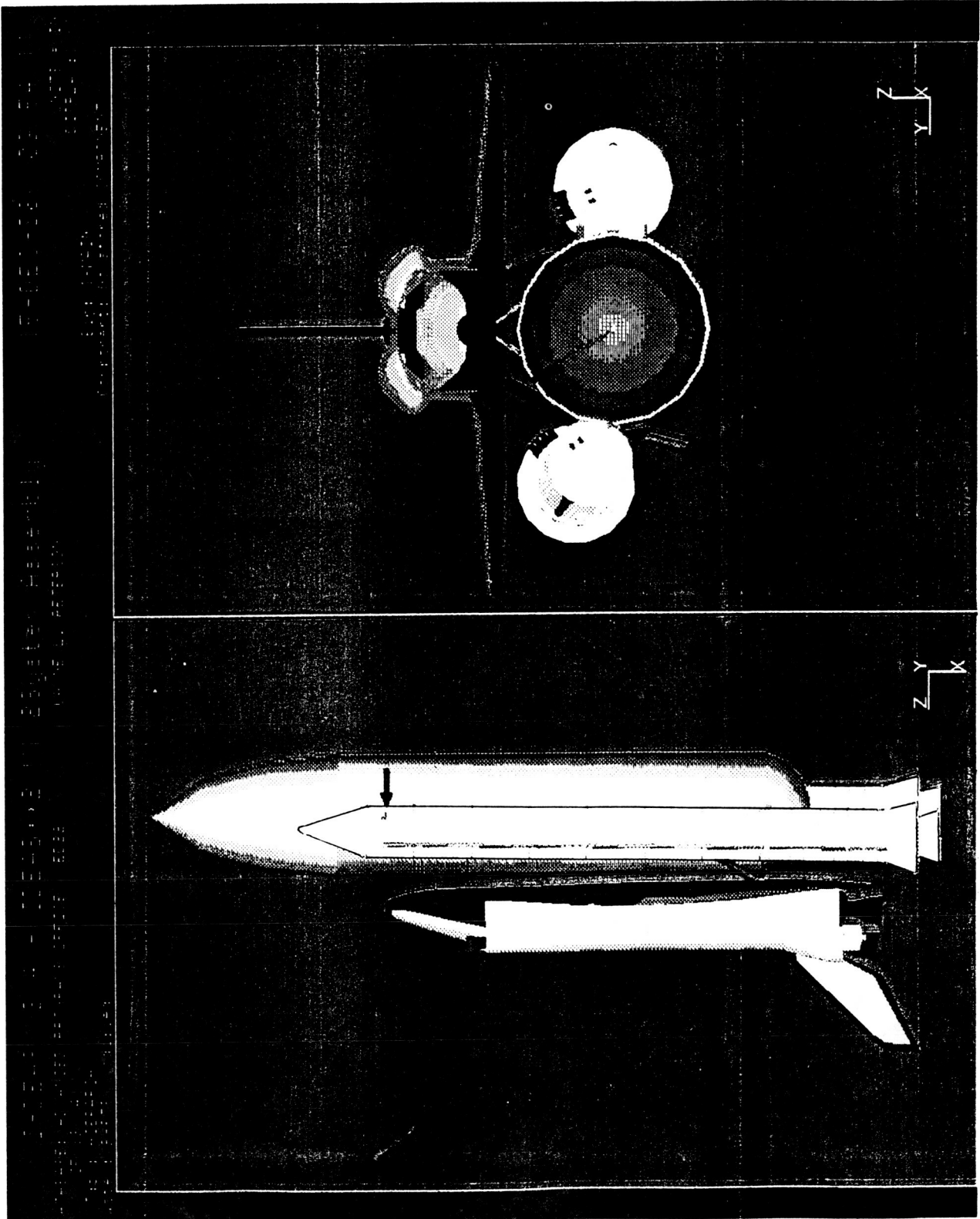

Figure 7 - Computer generated image with SRB rotation