

**NASA
Technical
Paper
2778**

1987

Continuous Flow Electrophoresis
System Experiments on Shuttle
Flights STS-6 and STS-7

Robert S. Snyder,
Percy H. Rhodes,
and Teresa Y. Miller

*George C. Marshall Space Flight Center
Marshall Space Flight Center, Alabama*



National Aeronautics
and Space Administration

Scientific and Technical
Information Division

TABLE OF CONTENTS

| | Page |
|--|------|
| INTRODUCTION | 1 |
| MATERIALS AND METHODS | 2 |
| Electrophoresis Instruments | 2 |
| Samples and Buffer for STS-6 | 2 |
| Samples and Buffer for STS-7 | 4 |
| SPACE ELECTROPHORESIS EXPERIMENTS..... | 4 |
| DISCUSSION AND CONCLUSION..... | 10 |
| REFERENCES..... | 12 |

PRECEDING PAGE BLANK NOT FILMED

LIST OF ILLUSTRATIONS

| Figure | Title | Page |
|--------|--|------|
| 1. | Continuous flow electrophoresis system (CFES) | 3 |
| 2. | Photographs of the collection of high concentration sample of hemoglobin | 6 |
| 3. | Band spread of high concentration hemoglobin sample | 7 |
| 4. | Band spread of low concentration hemoglobin and polysaccharide sample | 7 |
| 5. | Photographs of polystyrene latex samples with unmatched conductivity (A and C) and matched conductivity (B and D) | 8 |
| 6. | Band spread of polystyrene latex samples | 9 |

TECHNICAL PAPER

CONTINUOUS FLOW ELECTROPHORESIS SYSTEM EXPERIMENTS ON SHUTTLE FLIGHTS STS-6 AND STS-7

INTRODUCTION

A series of electrophoresis experiments on Apollo [1], Apollo Soyuz Test Project (ASTP) [2], and Space Shuttle [3] have been carried out in space to show that disturbances due to buoyancy-induced thermal convection and sample sedimentation during the separation process are negligible in reduced gravity. The experiments to date have been small-scale demonstrations of specific principles that have increased our knowledge of electrokinetic and fluid dynamic phenomena and have supported our long range electrophoresis goals [4]. Simultaneously, the limitations of ground-based electrophoretic separators have been documented [5], and new concepts have been proposed for future experiments [6].

Several laboratory instruments have been constructed utilizing past developments in the design and operation of continuous flow electrophoretic separators by Strickler [7] and Hannig [8] combined with innovative developments in the field of fluid analysis by Saville [9] and Ostrach [10]. Building on these developments, the McDonnell Douglas Astronautics Company (MDAC) designed a continuous flow electrophoresis system that evolved from a detailed survey of the requirements for fractionation of biological materials.

In 1978, MDAC began discussions with NASA on the opportunities to develop a space continuous flow electrophoresis system (CFES) that would incorporate specific modifications to their laboratory instruments to take advantage of weightlessness. The first MDAC flight experiments with the CFES on STS-4 in June 1982 fractionated a proprietary tissue culture medium and evaluated the effect of sample concentration using mixtures of rat and egg albumin. MDAC concluded that there was no loss of resolution at the higher concentrations processed in space. In addition, MDAC reported that the quantity of albumin that could be fractionated in the CFES in space was significantly higher (over 400 times) than the quantity that could be processed in their ground laboratory instrument during the same time interval. They proposed that these improvements originated from both instrument modifications and increased sample concentrations permitted by weightlessness.

Under the terms of a Joint Endeavor Agreement (JEA), NASA was provided an opportunity to process two samples on STS-6 in April 1982 [11]. All experiment objectives and operational parameters, such as applied field, sample residence time in the field, and buffer composition had to accommodate the MDAC capabilities and NASA flight constraints. The NASA objectives were formulated so as to include validation of the sample concentration effects reported by MDAC on STS-4. The specific objectives were (1) to use a model sample material at a high concentration to evaluate the continuous flow electrophoresis process in the MDAC CFES instrument and compare its separation and sample throughput resolution with related devices on Earth and (2) to expand our basic knowledge of the limitations imposed by fluid flows and particle concentration effects on the electrophoresis process by careful design and evaluation of the space experiment. Hemoglobin and a polysaccharide were selected as primary samples for STS-6 by the Marshall Space Flight Center (MSFC).

The NASA experiments on STS-7 in June 1983 were intended to build upon the results obtained on STS-6 [12]. Because MDAC changed the curtain buffer on STS-7 from a barbital buffer (pH 8.3) to a propionate buffer (pH 5.2), it was not possible to perform a follow-up experiment using hemoglobin and polysaccharide as processed on STS-6. The change in pH would have resulted in both the hemoglobin and polysaccharide becoming positively charged and migrating toward the cathode. Polystyrene latex particles (PSL) were, therefore, chosen for separation on STS-7 since they are known to be negatively charged at pH 5.2 and are produced in a range of sizes with different surface charge groups and surface charge densities.

MATERIALS AND METHODS

Electrophoresis Instruments

The internal dimensions of the space CFES (Fig. 1) plexiglass separation (flow) chamber is 16 cm wide, 120 cm long, and 0.3 cm thick. A cooling jacket covers each broad chamber face with one electrode in each cooling chamber positioned diagonally across from each other to provide the electric field across the length of the chamber. The platinum electrodes are in contact with the separation chamber via slots cut into the chamber plates and are covered with a proprietary, porous membrane. The circulation of cooled electrolyte, from the bottom (flow entrance) of the chamber to the top through a serpentine passageway, establishes a uniform lateral temperature gradient and removes the bubbles formed at each electrode. Rectangular struts used to form the coolant passage also provide some support to the thin separation chamber plates. The sample enters the chamber through a thin-wall glass tube (0.1 cm inside diameter) located 11 cm from the curtain buffer entrance of the chamber. The buffer and separated sample fractions exit at the top of the chamber through a collection array of 197 Tygon tubes (0.068 cm inside diameter, 0.078 cm outside diameter) which span the width of the chamber.

Samples and Buffer for STS-6

Hemoglobin was selected as the primary sample candidate based upon its availability in large quantities as a single, molecular species; its visibility for easy analysis; its utility as an electrophoresis standard in laboratories; its availability as variants with different electrophoretic mobilities, and its stability in the cyanmethemoglobin form. Hemoglobin A (HbA) provided for ground and space use was prepared at the Centers for Disease Control (CDC). Selected from a single donor, the HbA was purified on an ion exchange column, converted to cyanmethemoglobin and concentrated to nearly 11 percent. The hemoglobin was sent to MSFC where it was then dialyzed against the flight buffer and stored for use in the planned experiments.

The second sample was one type of pneumococcal capsular polysaccharide (PCP) obtained from Lederle Laboratories, Pearl River, New York. PCP type 6 had a distinctly higher mobility than HbA with minimal variation and, although not colored, could be detected in low concentrations immunologically. The purity of the PCP was determined by specific antibody tests. Since it is known that the PCPs have multiple repeating units of the basic saccharide chain, an attempt was made to obtain PCP with constant molecular weight using chromatography and laboratory continuous flow electrophoresis.

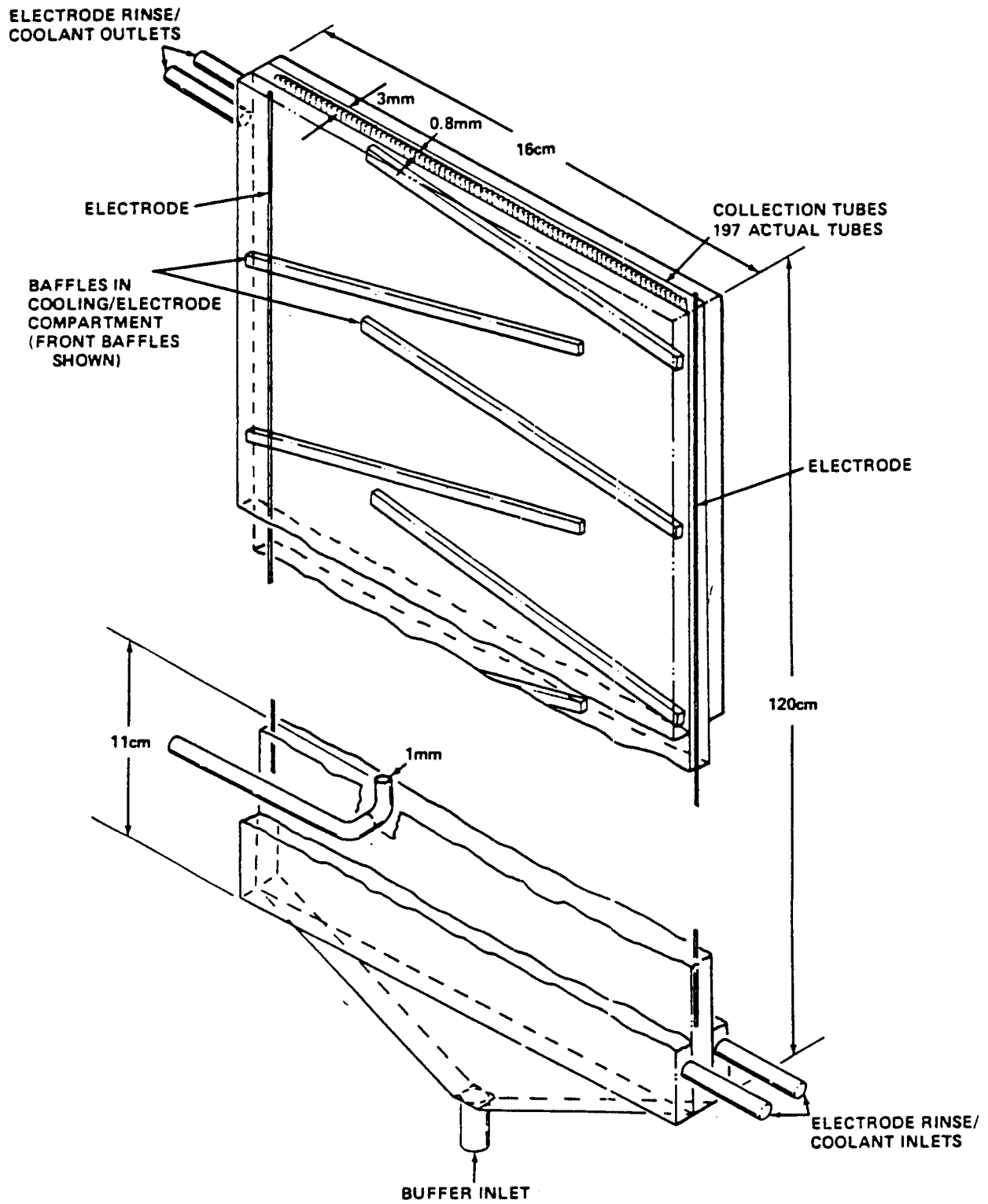

Figure 1. Continuous flow electrophoresis system (CFES).

The buffer selected by MDAC for laboratory and flight experiments was 2 mM barbital consisting of 0.386 mg/ml sodium barbiturate, 0.070 mg/ml barbituric acid, and 50 µg/ml gentamycin sulfate, pH 8.3 and electrical conductivity 160 µmho/cm at 25°C.

Samples and Buffer for STS-7

Monodisperse polystyrene latex (PSL) particles less than 1.0 µm in diameter were chosen to minimize sedimentation and eliminate any requirement for resuspending the sample during flight. Three particle sizes were selected, and two of the particle populations were dyed to enhance photographic detail and aid in experimental analysis.

The latex particles with the highest mobility (nominal diameter of 0.56 µm) were dyed red; the particles with the lowest mobility (nominal diameter 0.80 µm) were dyed blue. The particles with intermediate mobility (nominal diameter 0.30 µm) were not dyed. The latexes were then suspended in the curtain buffer containing Brij using a procedure of buffer exchange with filtration. Appropriate volumes of each latex were combined to yield equal concentrations for the final flight sample with the following properties: total latex concentration, 5.0 percent; pH, 5.6 percent; and conductivity, 155 ± 5 µmhos/cm. The conductivity of a second sample of PSL was increased approximately three times that of the initial sample to 455 ± 5 µmhos/cm using 0.10 M NaCl, while maintaining a total latex concentration of 5.0 percent by weight.

The curtain buffer was prepared from a 100X stock solution of 225 mM sodium propionate, pH 5.2 by 100X dilution with distilled water to give a 225 mM solution of pH 5.0 and conductivity of 140 ± 5 µmhos. Laboratory tests were initially performed with a nonionic surfactant, 0.05 percent w/v Brij 35 (polyoxyethylene lauryl ether 35) added to the sample and curtain buffer. Shortly before flight, however, it became necessary for MDAC to remove the Brij from the curtain buffer. Since the sample latex had been selected according to their separation in buffer with Brij, the flight samples included Brij in the suspension medium although Brij was excluded from the curtain buffer.

SPACE ELECTROPHORESIS EXPERIMENTS

The two samples processed in the first NASA space experiment on CFES were (1) a high concentration of hemoglobin alone and (2) a mixture of polysaccharide and hemoglobin at a lower concentration. The band behavior obtained from processing the single species was used to define the performance of the space instrument. The low concentration mixture, 1.9 percent Hb and 0.5 percent PCP-6, although still higher than can be processed at high resolution on Earth, would permit a comparison of the separations achieved before flight in the various laboratory units.

In orbit, the NASA hemoglobin sample of 8.7 percent concentration was processed first to establish the initial CFES performance. The hemoglobin experiments each started with an initial zero voltage segment. The sample band spread only slightly during its 8-minute passage through the chamber which can be attributed to diffusion. After the zero run, an electric field of 25 V cm^{-1} was applied for an interval of about 32 minutes in order to establish steady state conditions. Photographs of the electrophoresis runs were taken at sample insertion, midway up the chamber and at the collection end. A portion of the separated samples was also collected for later analysis.

Photographs of the high concentration HbA, taken at the same chamber region are shown in Figure 2 with the time in hours and minutes shown in the lower right hand corner of each picture. Figure 2a shows the zero voltage position of the sample stream. With the cathode on the left, the sample should proceed only toward the right to the anode when the electric field is applied. However, Figures 2b through 2d were taken over a period of 10 min and show that the band spreading is so extensive that some of the sample is in a retrograde migration. This condition could only exist if the sample spread in the chamber thickness past the electroosmotic stationary layer. Based on comparison of the photographs, there also appears to be a build up of sample near the walls as the more intense color of the later photograph seems to suggest.

After completing half the MDAC proprietary samples, the second NASA preparation, the HbA and PCP mixture, was processed. Although faint, the stream was more compact with little indication of spreading. The migration of the leading edge of the sample was roughly the same as in the previous experiment. However, there does not appear to be the large retrograde migration observed in the high concentration experiment.

In addition to the photographs just described, the sample was collected for the two experiments. The entire fluid output of the space chamber was collected, as noted previously, during the middle of each separation run in 197 small (1.5 ml) polypropylene pockets arranged in a steel tray. The trays containing the NASA samples were analyzed for hemoglobin and polysaccharide with the results shown in Figures 3 and 4.

Figure 3 shows a very broad single peak with some sample deflected toward the cathode side of the zero field location. However, this does not show the total amount of retrograde sample migration, since some of the sample near the walls clearly remained in the chamber. This is apparent by observing the color extending to the left (cathode) wall in Figure 2d.

Figure 4 shows a separation of the low concentration hemoglobin and polysaccharide. The separation, however, was not as distinct as obtained in the laboratory CFES or in the Desaga FF48 [11]. Also, none of the Earth-based laboratory experiments had samples appear on the cathode side of the zero field location. It is interesting to note that Figure 4 shows about the same amount of retarded and retrograde sample between tubes No. 28 and No. 55, as observed for the high concentration experiment in Figure 3.

The same procedures were followed with the polystyrene latex samples on the next flight, STS-7. The results of the earlier flight demonstrated considerable band broadening when the sample conductivity was approximately three times that of the curtain buffer. These results, as well as prior ground-based data, provided the justification for the design of the STS-7 experiment which evaluated the relationships between the sample and curtain buffer properties and the fractionation resolution.

Figure 5 shows a series of photographs of the unmatched sample conductivity (left side) and matched sample conductivity (right side). These photographs are of the separated latexes just before entering the collection tray at the top of the CFES. The band distortion and spreading of the PSL samples when the conductivities of the samples and curtain were not matched is evident from the photographs and was confirmed by analysis of the collected fractions (Fig. 6).

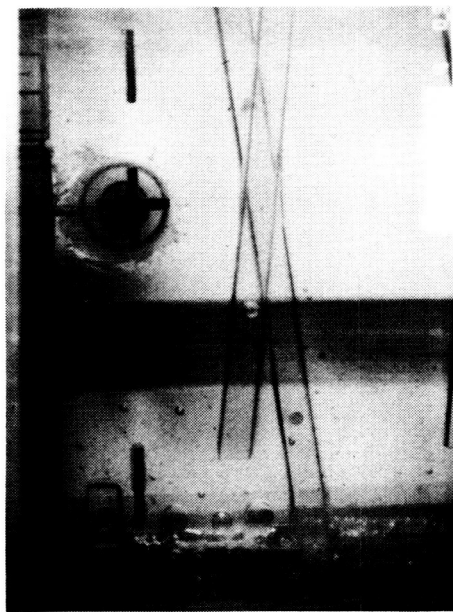

A. Zero Voltage

B. Deflection at 4 hr 3 min.

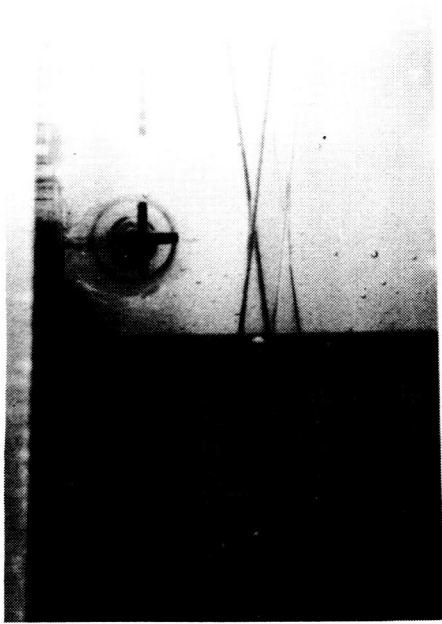

D. Deflection at 4 hr 13 min.

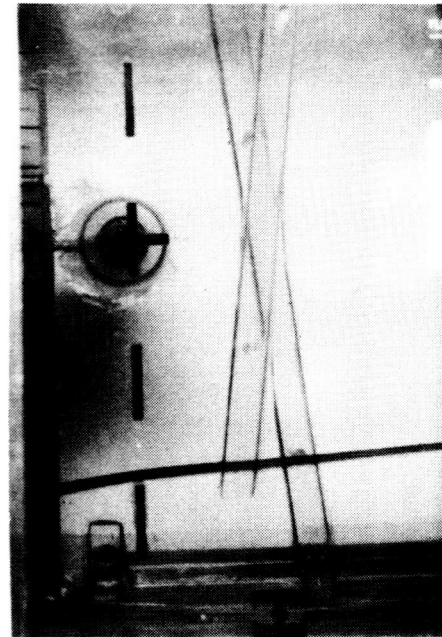

C. Deflection at 4 hr 10 min.

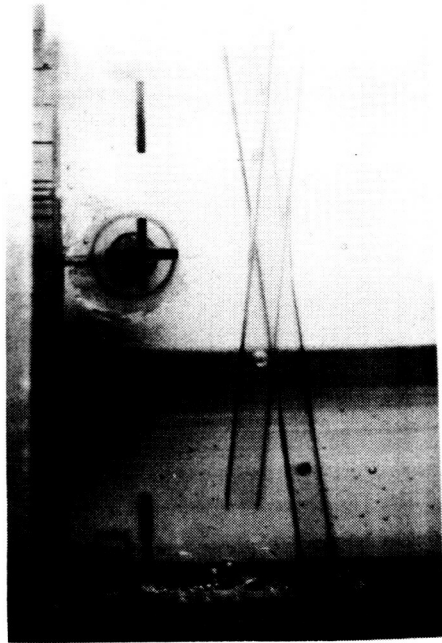

Figure 2. Photographs of the collection of high concentration sample of hemoglobin.

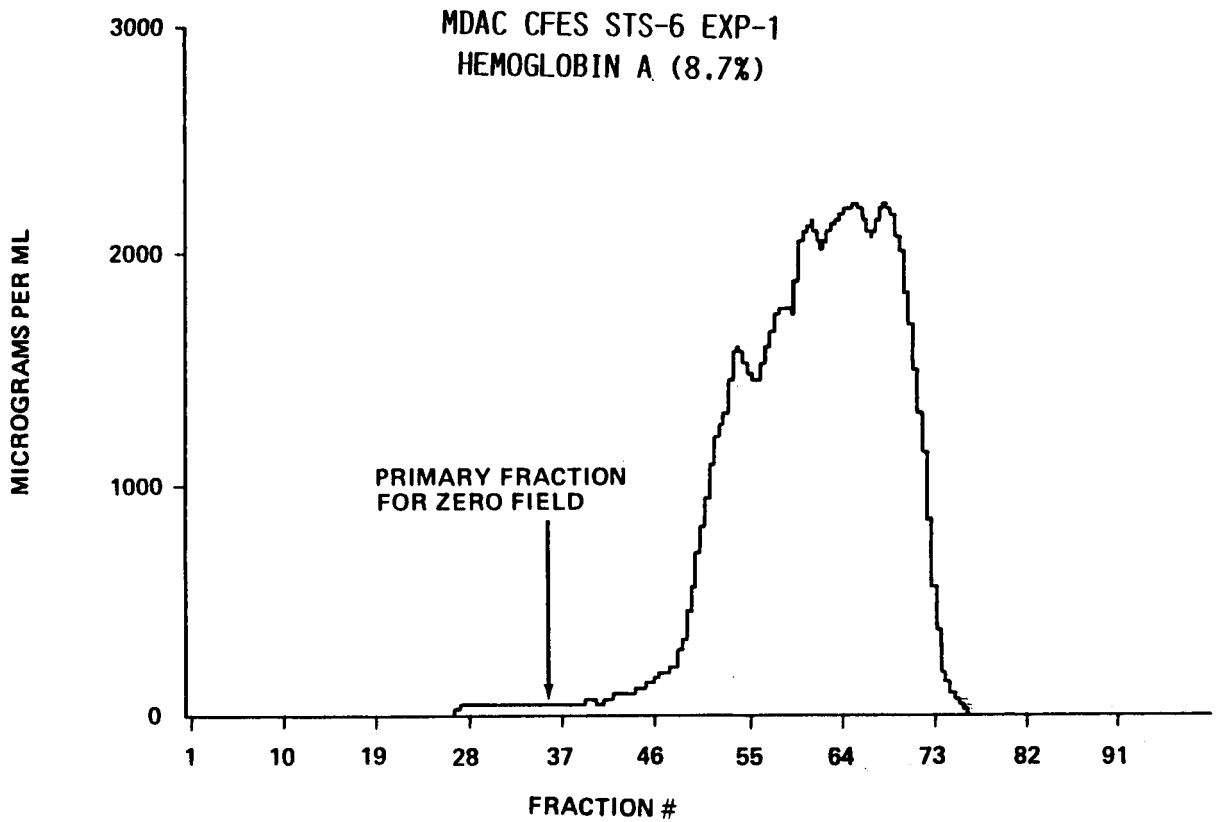

Figure 3. Band spread of high concentration hemoglobin sample.

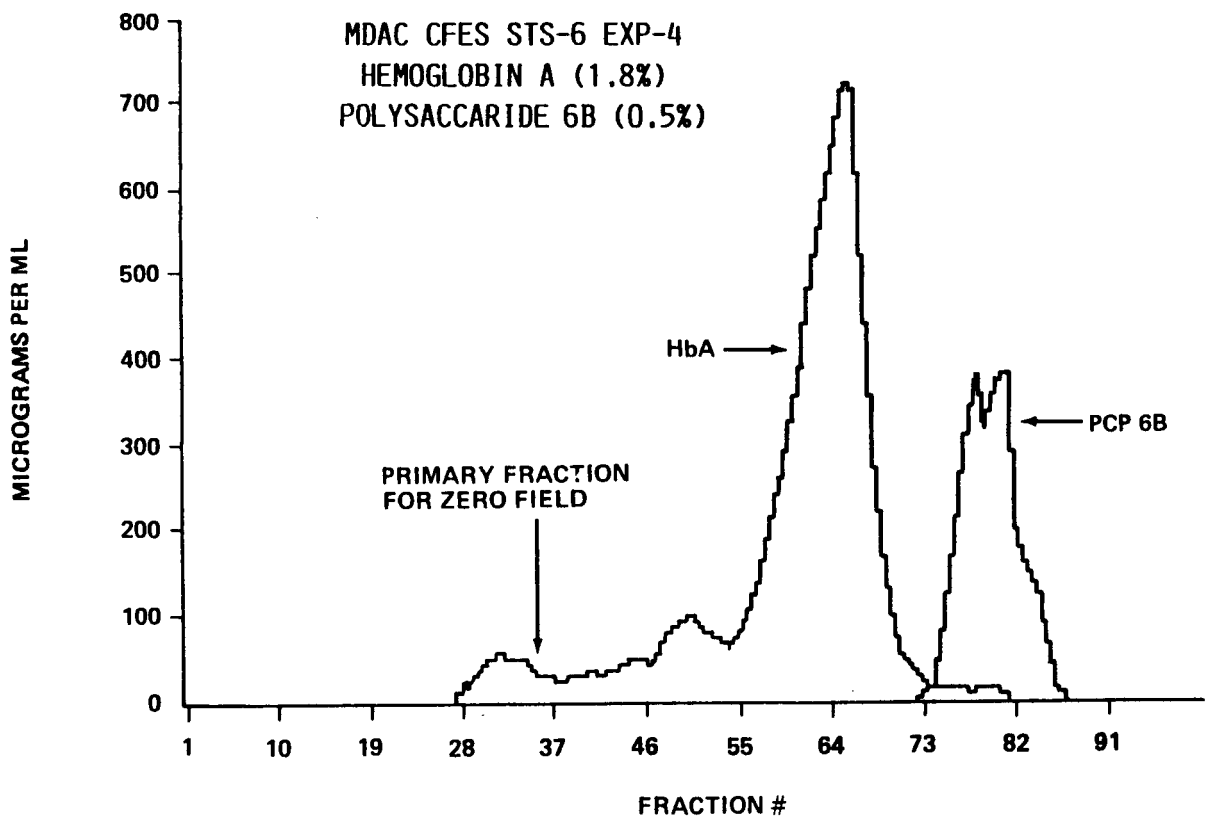

Figure 4. Band spread of low concentration hemoglobin and polysaccharide sample.

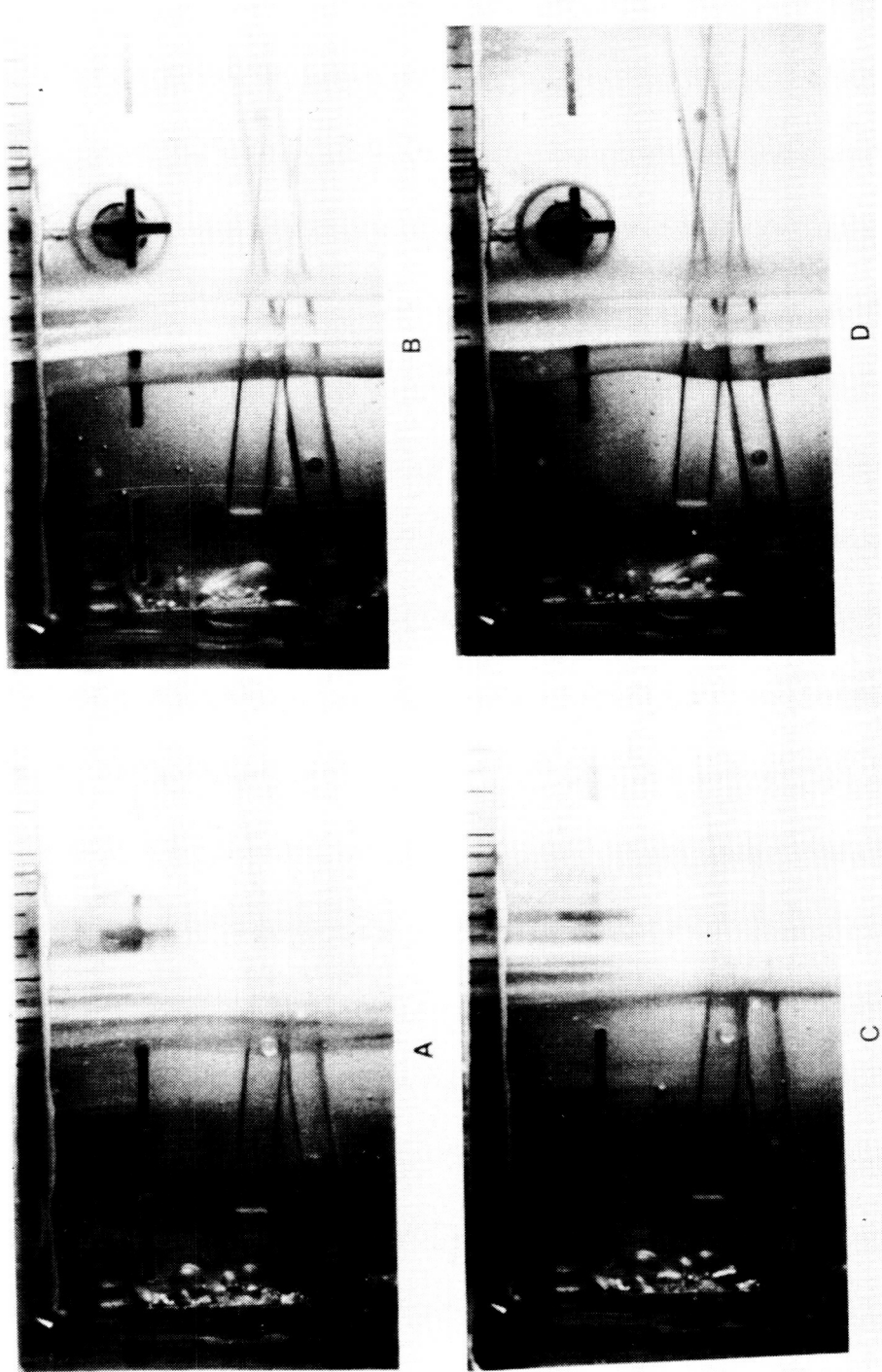

Figure 5. Photographs of polystyrene latex samples with unmatched conductivity (A and C) and matched conductivity (B and D).

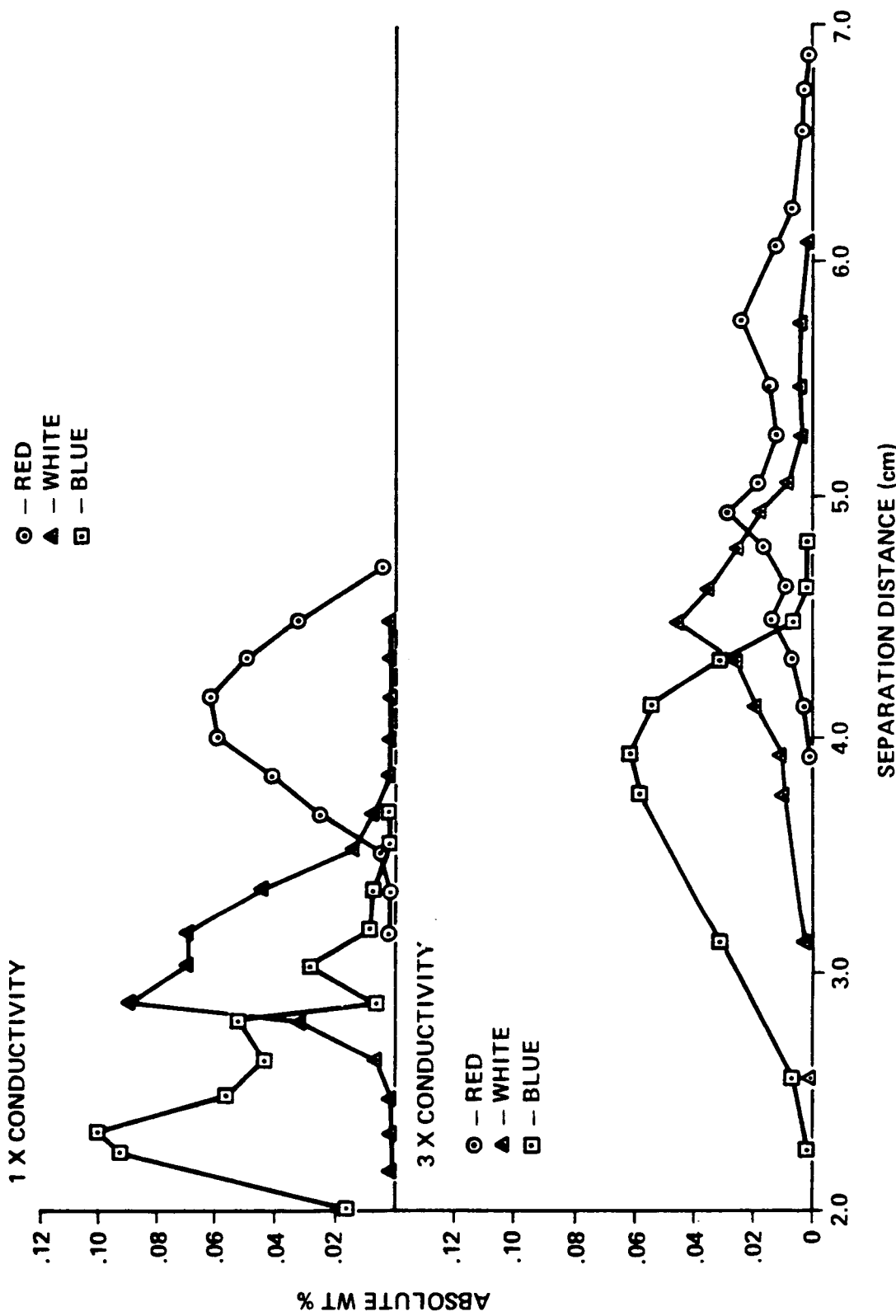

Figure 6. Band spread of polystyrene latex samples.

DISCUSSION AND CONCLUSION

These two experiments in the MDAC CFES were intended to confirm two previous space observations: only electrophoresis and electroosmosis determined particle migration in an electric field during zone electrophoresis on Apollo 16 and electrophoresis was independent of sample concentration with albumin up to 20 percent on STS-4. Instead, these experiments showed that the previous conclusions were too simplistic.

First, the sample insertion disk used for the Apollo zone electrophoresis experiments is not a valid model for the sample filament configuration of continuous flow electrophoresis. Second, increasing the quantity of protein or latex particles added to the electrophoresis buffer to constitute the sample also proportionally changes the electrical properties of the sample and this has a significant impact on the subsequent electrophoresis of that sample by continuous flow electrophoresis.

The predisposition of the analysis made the interpretation of the two separate but complementary microgravity experiments more difficult. The hemoglobin samples were done first in space, but the pattern of the collected sample did not fit our model. Although the hemoglobin had a single electrophoretic mobility, this mobility could not be measured with precision in the barbital buffer. This made any estimate of electroosmosis subject to error and thus the band structure of the high concentration of hemoglobin was not understood.

During the past year, a more detailed analysis of the hemoglobin experiment has led to the following probable sequence of events. The 9 percent hemoglobin sample added to the 2 mM barbital buffer (pH 8.2) reduced the overall sample pH to 7.5. Since the pK of the barbituric ion is 7.8, less than half of those ions in the sample were ionized. As soon as the sample entered the chamber and the region of the electric field, the positive sodium ions had to carry most of the current so Na^+ rapidly built up at the rear of the sample. This led to a hemoglobin sample with reduced conductivity in the front of the band and higher conductivity in the rear. The significance of this conductivity distribution in causing the dispersion of the hemoglobin in space was not determined until after the polystyrene latex distributions in space were analyzed.

Electrophoretic mobilities of the polystyrene latex were measured in a microscope electrophoresis instrument for the next flight experiment but the sample bands still did not fit the anticipated distribution. The sample with higher conductivity showed the expected broader spread but an attempt to fit the shape of the sample distribution into the nested crescents formed by electroosmosis was only partially successful.

The resulting sample geometry may be the product of a phenomena first reported by Sir Geoffrey Taylor [13] describing the distortion which occurs when an electric field is applied to a conducting drop suspended in a liquid of lower conductivity. The elongation of the drop parallel to the field is analogous to the spread of the high conductivity polystyrene latex sample in the center-plane of the chamber when the electric field was applied. Ground-based experiments and a theoretical analysis of continuous flow electrophoresis based upon Taylor's framework now appears to confirm this analogy. The polystyrene latex apparently did not reach the vicinity of the chamber walls where electroosmosis would dominate. Instead, the sample was smeared by the conductivity mismatch with the surrounding electrophoresis buffer.

A plausible model of the hemoglobin sample can also be obtained from Taylor's drop analysis. Since a low conductivity drop in a higher conductivity liquid elongates perpendicular to an applied electric field, the low conductivity front of the hemoglobin sample spread perpendicular to the field and approached the chamber walls where electroosmosis carried the hemoglobin toward the cathode. At the rear of the hemoglobin sample, the higher conductivity caused a sample spread in the chamber center-plane similar to the polystyrene latex. Thus, the collected hemoglobin distribution shows some sample spread by electroosmosis and a broad but uniform concentration of hemoglobin near the front of the electrophoresis pattern.

This qualitative model of the space experiments is an attempt to explain the observed results of past experiments. When CFES is operated again on the Shuttle, it will be important to conduct additional experiments to test the sample distortion predicted by Taylor.

REFERENCES

1. Snyder, R. S.; Griffin, R. N.; Johnson, A. J.; Leidheiser, H, Jr.; Micale, F. J.; Ross, S.; van Oss, C. J.; and Bier, M.: Free Fluid Electrophoresis on Apollo 16. *Sep. and Purif. Meth.*, vol. 2 (2), 1973, pp. 259-282.
2. Allen, R. E.; Rhodes, P. H.; Snyder, R. S.; Barlow, G. H.; Bier, M.; Bigazzi, P. E.; van Oss, C. J.; Knox, R. J.; Seaman, G. V. F.; Micale, F. J.; and Vanderhoff, J. W.: Column Electrophoresis on the Apollo-Soyuz Test Project. *Sep. and Purif. Meth.*, vol. 6 (1), 1977, pp. 1-59.
3. Snyder, R. S.; Rhodes, P. H.; Herren, B. J.; Miller, T. Y.; Seaman, G. V. F.; Todd, P.; Kunze, M. E.; and Sarnoff, B. E.: Analysis of Free Zone Electrophoresis of Fixed Erythrocytes Performed in Microgravity. *Electrophoresis*, vol. 6, 1985, pp. 3-9.
4. Snyder, R. S.: Separation Techniques. In *Materials Sciences in Space – A Contribution to the Scientific Basis of Space Processing*, eds. B. Feuerbacher, H. Hamacher, and R. J. Naumann (Springer-Verlag: Berlin), 1986, pp. 465-481.
5. Miller, T. Y.; Williams, G. O.; and Snyder, R. S.: Effect of Conductivity and Concentration on the Sample Stream in the Transverse Axis of a Continuous Flow Electrophoresis Chamber. *Electrophoresis*, vol. 6, 1985, pp. 377-381.
6. Rhodes, P. H.; and Snyder, R. S.: Sample Band Spreading Phenomena in Ground and Space-Based Electrophoretic Separators. *Electrophoresis*, vol. 7, 1986, pp. 113-120.
7. Stricker, A.: Continuous Particle Electrophoresis: A New Analytical and Preparative Capability. *Sep. Sci.*, vol. 2 (3), 1967, pp. 335-355.
8. Hannig, K.: Separation of Cells and Particles by Continuous Free Flow Electrophoresis. *Tech. Biochem. Biophys. Morphology*, vol. 1, 1972, pp. 191-232.
9. Saville, D. A.: The Fluid Mechanics of Continuous Flow Electrophoresis. *Physicochemical Hydrodynamics*, vol. 2, 1978, pp. 832-912.
10. Ostrach, S.: Convection in Continuous Flow Electrophoresis. *J. Chrom.*, vol. 140, 1977, pp. 187-197.
11. Snyder, R. S., et al.: Unexpected Electrophoretic Behavior of Macromolecular Sample on Space Shuttle Flight STS-6. In preparation, 1987.
12. Snyder, R. S.; Rhodes, P. H.; Miller, T. Y.; Micale, F. J.; Mann, R. V.; and Seaman, G. V. F.: Polystyrene Latex Separations by Continuous Flow Electrophoresis on the Space Shuttle. *Separation Sci. and Tech.*, vol. 22 (1), 1986, pp. 157-185.
13. Taylor, G. I.: Studies in Electrohydrodynamics in the Circulation Produced in a Drop by an Electric Field. *Proc. Roy. Soc., Sec. A*, vol. 291, 1966, p. 159.

| | | | | | |
|---|--|--|--|--|------------------|
| 1. REPORT NO. NASA TP -2778 | | 2. GOVERNMENT ACCESSION NO. | | 3. RECIPIENT'S CATALOG NO. | |
| 4. TITLE AND SUBTITLE Continuous Flow Electrophoresis System Experiments on Shuttle Flights STS-6 and STS-7 | | | | 5. REPORT DATE October 1987 | |
| | | | | 6. PERFORMING ORGANIZATION CODE | |
| 7. AUTHOR(S) Robert S. Snyder, Percy H. Rhodes, and Teresa Y. Miller | | | | 8. PERFORMING ORGANIZATION REPORT # | |
| 9. PERFORMING ORGANIZATION NAME AND ADDRESS George C. Marshall Space Flight Center Marshall Space Flight Center, Alabama 35812 | | | | 10. WORK UNIT NO. M-574 | |
| | | | | 11. CONTRACT OR GRANT NO. | |
| 12. SPONSORING AGENCY NAME AND ADDRESS National Aeronautics and Space Administration Washington, D.C. 20546 | | | | 13. TYPE OF REPORT & PERIOD COVERED Technical Paper | |
| | | | | 14. SPONSORING AGENCY CODE | |
| 15. SUPPLEMENTARY NOTES Prepared by Space Science Laboratory, Science and Engineering Directorate. | | | | | |
| 16. ABSTRACT <p>In 1978, McDonnell Douglas Astronautics Company (MDAC) began discussions with NASA on the opportunities to develop a space continuous flow electrophoresis system (CFES) that would incorporate specific modifications to their laboratory instruments to take advantage of weightlessness. A Joint Endeavor Agreement (JEA) that allocated certain flights on the Space Shuttle to MDAC in return for opportunities for NASA and interested scientists to do research in the MDAC laboratory and on their space instruments was made.</p> <p>Under terms of the JEA, NASA was provided an opportunity to process two samples on STS-6. All experiment objectives and operational parameters, such as applied field, sample residence time in the field, and buffer composition had to accommodate the MDAC capabilities and NASA flight constraints. The NASA objectives were formulated so as to include investigation of the sample concentration effects reported by MDAC on STS-4. The specific objectives were (1) to use a model sample material at a high concentration to evaluate the continuous flow electrophoresis process in the MDAC CFES instrument and compare its separation resolution and sample throughput with related devices on Earth and (2) to expand our basic knowledge of the limitations imposed by fluid flows and particle concentration effects on the electrophoresis process by careful design and evaluation of the space experiment. Because the MDAC instrumentation did not include sample mixing facilities, cell separation procedures were precluded and after a variety of soluble materials were considered, hemoglobin and polysaccharide were selected as primary samples. The results from space show a large band spread of the high concentration of the single species of hemoglobin that was principally due to the mismatch of electrical conductivity between the sample and buffer.</p> <p>The seventh mission of the Space Shuttle carried two additional NASA experiments in the CFES instrument. The major objective was to evaluate the influence of the electrical properties of the sample constituents on the resolution of the continuous flow electrophoresis device. As expected, the polystyrene latex microspheres dispersed in a solution with three times the electrical conductivity of the curtain buffer separated with a significantly larger band spread than in to the second experiment under matched conductivity conditions. The structure of the bands is also different between the samples and laboratory experiments have been conducted to further evaluate the phenomena affecting the electrophoresis. The analysis of both flight results is nearing completion and a qualitative explanation based upon the non-gravity dependent electrical conductivity mismatch is being developed.</p> | | | | | |
| 17. KEY WORDS Electrophoresis Space Shuttle Electrohydrodynamics | | | 18. DISTRIBUTION STATEMENT Unclassified - Unlimited Subject Category: 29 | | |
| 19. SECURITY CLASSIF. (of this report) Unclassified | | 20. SECURITY CLASSIF. (of this page) Unclassified | | 21. NO. OF PAGES 15 | 22. PRICE A02 |