

Electricity from Photovoltaic Solar Cells

Flat-Plate Solar Array Project

10 Years of Progress

October 1985



United States
Department of Energy

JPL
Jet Propulsion Laboratory
California Institute of Technology

NASA
National Aeronautics and
Space Administration

(NASA-TM-89653) ELECTRICITY FROM
PHOTOVOLTAIC SOLAR CELLS. FLAT-PLATE SOLAR
ARRAY PROJECT OF THE US DEPARTMENT OF
ENERGY'S NATIONAL PHOTOVOLTAICS PROGRAM: 10
YEARS OF PROGRESS (NASA) 105 p Avail:

N88-12188

Unclas
G3/44 0106689



Electricity from Photovoltaic Solar Cells

Flat-Plate Solar Array Project

of the
**U.S. Department of Energy's
National Photovoltaics Program**

10 Years of Progress

October 1985

Elmer Christensen



United States
Department of Energy

JPL
Jet Propulsion Laboratory
California Institute of Technology

NASA
National Aeronautics and
Space Administration

The Role of Photovoltaics: An Historical Perspective

The world's demand for more energy continues, and will continue in the foreseeable future. The economic growth of developing nations depends upon increasing energy supplies. In technically advanced countries, long-range economic growth depends on the availability of inexpensive energy. Historically, in the United States, the main source of energy has changed from wood to coal to petroleum, and it is inevitable that change will continue as fossil fuels are depleted. Within a lifetime, it is expected that most U.S. energy will come from diverse sources, including renewables, instead of from a single type of fuel. There are many indications that the percentage of the total consumed energy supplied by electrical power will continue to increase.

The use of photovoltaics (PV) is a promising way to generate electricity that could provide significant amounts of power in the years to come. It is a form of solar energy that uses solar cells to generate electricity cleanly and reliably, directly from sunlight without moving parts. PV power systems are simple, flexible, modular, and adaptable to many different applications in an almost infinite number of sizes and in many environments. Although photovoltaics is a proven technology that is cost-effective for hundreds of small applications, it is not yet cost-effective for large-scale utility use in the United States. For economical widespread use, the cost of generating PV power must continue to be decreased by reducing the initial system cost, by reducing land or area requirements, and by increasing the operational lifetime of its systems.

Early needs of the space program for electrical power were satisfied by crystalline silicon solar cells. During the 1960s and 1970s, it was demonstrated that PV was a dependable electrical power source for spacecraft. In this time interval, solar-cell quality and performance improved and the costs decreased. However, the costs were still much too high for widespread use on Earth. There was a need to drastically lower the manufacturing costs of solar cells if they were to be a practical, widely used terrestrial power source.

In 1975, the U.S. Government initiated a terrestrial PV research and development (R&D) project with the

objective of reducing the cost of manufacturing solar cells and modules. This effort, which was assigned to the Jet Propulsion Laboratory (JPL) in Pasadena, California, evolved from more than a decade and a half of spacecraft PV power-system experience at JPL and from recommendations of a conference held in 1973 at Cherry Hill, New Jersey, on Solar Photovoltaic Energy.

After about 2 years of technical progress and economic analyses by the Flat-Plate Solar Array (FSA) Project, a growing community of people became convinced that the Project's goals were realistic and that PV power systems had the potential of being competitive with those based on fossil fuels. Additional federally supported efforts, sponsored by the U.S. Department of Energy (DOE), covering all aspects of PV power-system R&D, were initiated at the Solar Energy Research Institute (SERI), Sandia National Laboratories, and other organizations. These broadened efforts included concentrator modules, PV systems studies, application demonstrations, and research on cell materials other than silicon and devices such as thin-film cells. Most of the DOE funds have sponsored R&D in private organizations and universities. The result has been an effective Government-university-industry team that has cooperated to advance PV technology rapidly.

In parallel, a small but fast-growing terrestrial PV industry evolved, with products that were economically competitive for small stand-alone PV power systems. A few megawatt-size utility-connected PV installations, made possible by Government sponsorship and tax incentives, have demonstrated the technical feasibility and excellent reliability of large multi-megawatt PV power-generation plants.

Although fuel prices have leveled off, worldwide interest in photovoltaics continues, especially in countries where electricity is more expensive than in the United States. It is anticipated that the field of photovoltaics, with its tremendous potential, will regain its place in the sun as fossil fuel energy sources deplete and new energy technologies continue to evolve.

Flat-Plate Solar Array Project Summary

The Flat-Plate Solar Array (FSA) Project, a Government-sponsored photovoltaics project, was initiated in January 1975 (previously named the Low-Cost Silicon Solar Array Project) to stimulate the development of PV systems for widespread use. Its goal then was to develop PV modules with 10% efficiency, a 20-year lifetime, and a selling price of \$0.50 per peak watt of generating capacity (1975 dollars). It was recognized that cost reduction of PV solar-cell and module manufacturing was the key achievement needed if PV power systems were to be economically competitive for large-scale terrestrial use.

The project was initiated at JPL to meet these goals through R&D of all phases of flat-plate module technology, from solar-cell silicon material refinement through verification of module reliability and performance. The Project sponsored parallel technology efforts with periodic progress reviews and continuing sponsorship of only the most promising options. A module manufacturing cost-analysis capability was developed that permitted cost goal allocations to be made for each module technology, based upon potential for achievement. Economic analyses, done as technical progress was achieved, permitted assessments to be made of each technical option's potential for meeting the goal and of the Project's overall progress toward the national goal.

Excellent technical progress across the entire project was accomplished over the years, with growing interest and participation by the private sector. More recently, effective energy conservation practices, a leveling of energy prices, a perception that energy prices are not increasing endlessly, and a change in Government emphasis has altered the picture for photovoltaics. DOE's National Photovoltaics Program was redirected to longer-range efforts that the private sector avoids because of higher risk and longer payoff time. Consistent with these new directions, FSA has been concentrating its efforts on overcoming specific critical technological barriers that inhibit large-scale PV use. These activities require an in-depth, long-range, integrated effort that industry cannot reasonably be expected to undertake alone. This work is being performed by a team that includes universities, industry (which shares the cost), and Government laboratories. This team has worked together successfully for 10 years.

An estimate that PV-generated power should cost about \$0.15/kWh in the 1990s to be competitive in utility central-station generation plants is the basis for a DOE Five-Year Research Plan. The high cost of PV generating equipment, especially modules, remains

the major limitation. Continuing solar-cell and module cost reductions are still the key activities. However, it is now known that, for a utility plant, area-related costs are significant enough that flat-plate module efficiencies must be raised to between 13 and 17% (more energy generated per fixed-area dollar), and module life should be extended to 30 years. It is believed by FSA researchers that both of these requirements and the corresponding cost reductions are possible, but are achievable only with a dedicated effort. Present FSA activities emphasize high efficiency, long life, reliability, and low cost for solar cells, modules, and arrays.

Major Project Accomplishments

- Established the basic technologies for all aspects of manufacturing and evaluated non-concentrating crystalline silicon PV modules and arrays for terrestrial use.
- Established a new low-cost, high-purity silicon-feedstock-material refinement process.
- Made significant advances in quality and cost reduction of:
 - Silicon sheet for solar cells.
 - Higher efficiency solar cells.
 - Manufacturing processes.
- Established PV module/array engineering/design and evaluation knowledge and capabilities.
- Established PV module encapsulation systems.
- Devised manufacturing and life-cycle cost economic analysis capabilities.
- Transferred the above technologies to the private sector by dynamic interactive activities including hundreds of contracts, comprehensive module development and evaluation efforts, 25 Project integration meetings, research forums, presentations at hundreds of technical meetings, and advisory efforts to industry on specific technical problems.
- Stimulated the establishment of a commercial PV industry in the United States.

Photovoltaics Community Interactions

Following the OPEC oil embargo of 1973, a conference of photovoltaics experts was held at Cherry Hill, New Jersey, to assess the viability of photovoltaics as a terrestrial electrical energy source. In response to a 1974 request from the National Science Foundation, JPL proposed a PV module R&D effort based upon the Cherry Hill conference recommendations. This was accepted in January 1975 and a Project, now called Flat-Plate Solar Array, was initiated.

The JPL Project quickly established relationships with university research teams, non-profit organizations, and commercial firms interested in the development of low-cost photovoltaics. The fundamental strategy adopted by JPL was to involve industry and university teams in a highly interactive effort along parallel paths of technology development, and to select the best options. The effort has been highly goal oriented using a scheme of cost allocations to guide the progress of the activities.

By 1978, the MIT-Lincoln Lab; MIT-Energy Lab; Brookhaven National Lab, the NASA-Lewis Research Center; Sandia National Lab; a newly formed SERI; the U.S. Army MERADCOM; and others had become members of the Federal program under the newly established U.S. Department of Energy (DOE), which replaced the Energy Research and Development Administration (ERDA). The JPL/FSA became very much involved through many technical interfaces with all of the DOE Laboratories in order to carry out the national mandate.

Perhaps the most important strategy in ensuring technology transfer has been to directly involve the recipient photovoltaics community. The single, most prominent effort in the technology transfer strategy

has been the conduct of 25 Project Integration Meetings (PIMs) over the 10-year life of the Project. The PIMs have been conducted to enable the rapid exchange of data between all FSA participants, assess recent progress, gain perspective on trends and new developments, and to guide the FSA Project's planning and priority adjustment. The communication has been open between the Federal program and the PV community at all levels of detail regarding problem-solving and choice-making. At each PIM, contractors presented their achievements and problems encountered since the previous PIM. These presentations to their peers and the ensuing discussions stimulated extensive technical exchanges and progress. DOE management participated in every PIM, lending the guidance needed for credible technology transfer.

Changes in the overall political environment resulted in the FSA reducing its scope of activities starting in 1981. The DOE thrust became less oriented toward the direct development of the U.S. photovoltaics industry infrastructure and more toward the research into long-term, high-risk, high-payoff technical options that industry would not likely undertake themselves.

Continuing under the new charter, FSA developed the idea of Research Forums on specific technical problems of special difficulty wherein a working group of experts both within and outside the PV community would convene. Of the many such forums held to date, every one has resulted in new ideas and contractual relationships to help solve the problem.

The legacy of the FSA Project consists of significant measurable technical and economic achievements. An equally enduring part of the legacy may well turn out to be the way in which the Project was able to work both effectively and efficiently with the PV community to achieve the progress to date.

The FSA organization has been changed throughout the years to meet the programmatic needs and has evolved to its present form as shown below in the Project Organization Chart.

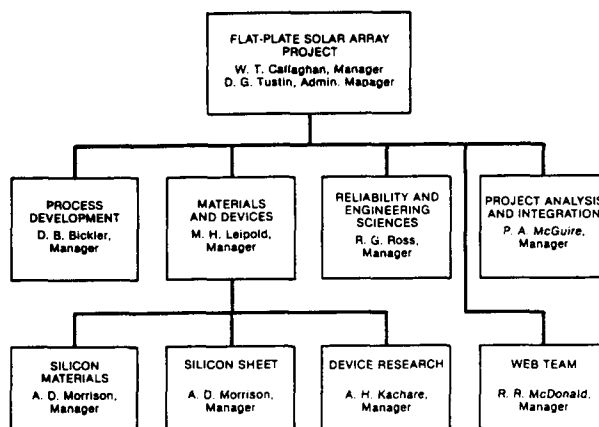

Contents

Project Overview	1
Project Technical Thrusts	2
FSA Project Technologies	5
Project Analyses and Integration	7
Silicon Material	12
Silicon Sheet	23
High-Efficiency Solar Cells	38
Process Research and Development	42
Modules and Arrays	53
Module and Array Evolution	58
Engineering Sciences and Design	66
Encapsulation	70
Reliability Physics	77
Module Performance and Failure Analysis	82
Appendix A: Glossary	88
Appendix B: FSA Project Contractors	91

Acknowledgment

The progress of the past 10 years in crystalline silicon PV technology (non-concentrating) has been accomplished only because there has been a strong motivation to work on a very challenging and worthwhile activity in which many people believe. Without the sustaining support of the Federal Government and cost sharing by private industry, the excellent achievements across the complete broad scope of activities would not have progressed so rapidly. The thousands of people in many diverse large and small organizations deserve credit for the excellent work performed individually and as a team. This report, which summarizes 10 years of FSA activities, was possible only with the help of many other members of the FSA Project.

Prepared by the Jet Propulsion Laboratory, California Institute of Technology, for the U.S. Department of Energy through an agreement with the National Aeronautics and Space Administration.

The JPL Flat-Plate Solar Array Project is sponsored by the U.S. Department of Energy and is part of the Photovoltaic Energy Systems Program to initiate a major effort toward the development of cost-competitive solar arrays.

This report was prepared as an account of work sponsored by an agency of the United States Government. Neither the United States Government nor any agency thereof, nor any of their employees, makes any warranty, express or implied, or assumes any legal liability or responsibility for the accuracy, completeness, or usefulness of any information, apparatus, product, or process disclosed, or represents that its use would not infringe privately owned rights.

Reference herein to any specific commercial product, process, or service by trade name, trademark, manufacturer, or otherwise, does not necessarily constitute or imply its endorsement, recommendation, or favoring by the United States Government or any agency thereof. The views and opinions of authors expressed herein do not necessarily state or reflect those of the United States Government or any agency thereof.

This publication reports on work done under NASA Task RE-152, Amendment 66, DOE / NASA IAA No. DE-AI01-76ET20356.

Project Overview

Objectives

- To develop the flat-plate PV array technologies required for large-scale terrestrial use late in the 1980s and in the 1990s:
 - To advance crystalline silicon PV technologies.
 - To develop the technologies required to convert thin-film PV research results into viable module and array technology.
- To stimulate transfer of knowledge of advanced PV materials, solar cells, modules, and arrays to the PV community.
- Develop module and array specifications, develop performance and lifetime criteria, and assess contemporary module and array technologies.
- Continue to fund and cost-share efforts with industry, universities, and other institutions.
- Continue economic analyses to evaluate technical options and overall progress.

The definition of a solar cell, module and array is shown in Figure 1.

Plans

- To sponsor or cost-share efforts that industry reasonably would not fund because of high risks and/or long-time requirements:
 - Perform advanced solar cell, module, and array technology R&D that the private sector can use to establish economical central station and rooftop applications, competitive with large-system power-generation costs of \$0.15/kWh in the 1990s.
 - Emphasize efforts to reduce technical barriers to the development of high-performance, economical, and long-life solar cells, modules, and arrays.
 - Establish the technologies for a low-cost, 15% efficient, 30-year-life, crystalline-silicon flat-plate module.
 - In cooperation with SERI, establish the technology for a low-cost, 12% efficient, long-life, thin-film module.

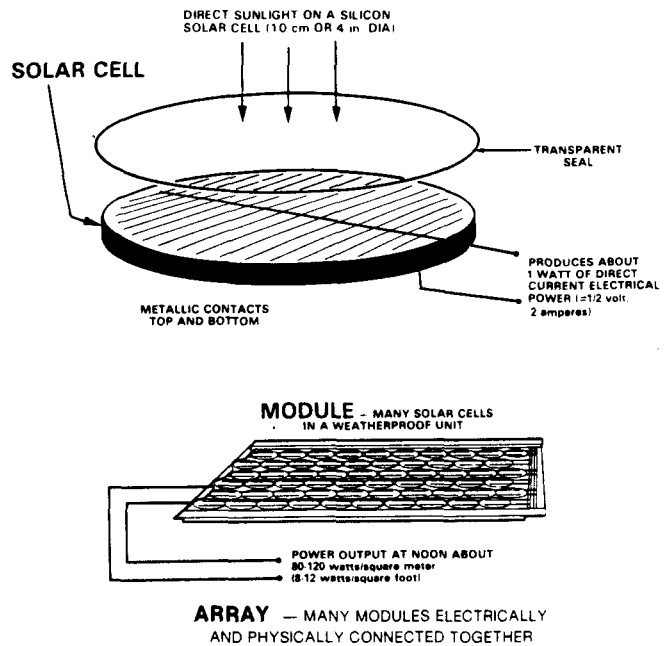

Figure 1. Definitions

Project Technical Thrusts

The three flat-plate-array technical thrusts now required to meet the DOE Program goal of PV power system generations costs of \$0.15/kWh are:

- High efficiency.
- Low cost.
- Reliability.

To achieve the overall goal, individual goals have

been set for each thrust and for specific contributing efforts; the contribution and potential contribution of individual efforts are periodically assessed, as is the combined contribution toward each thrust. The Project as a whole contributes to each thrust; the synergistic, integrated value of that contribution is important, and is likewise assessed. The goals of each thrust are the result of years of integrated assessments of user needs to meet competition and the potential of each technology to meet the requirements. These efforts are all interrelated.

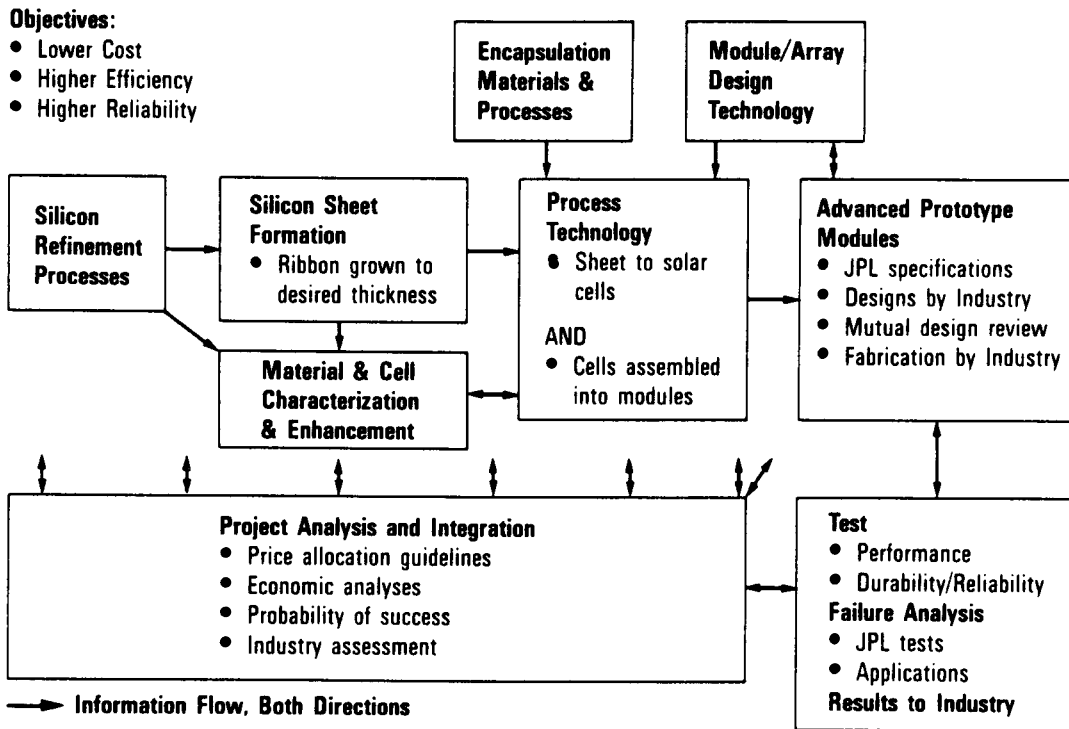

High Efficiency: Crystalline Silicon

- Factors contributing to more efficient solar cells, modules, and arrays:
 - High-purity silicon material.
 - High-quality silicon sheet as grown or deposited.
 - Advanced solar cell designs.
 - Advanced module and array designs.
 - Advanced cell processes.
 - Advanced module processes.
- R&D is required to:
 - Understand the influence on efficiency of:
 - Silicon growth-related defects including:
 - Impurities.
 - Structural defects.
 - Advanced solar cell designs.
 - Advanced cell processing.
 - Develop advanced silicon sheet growth capabilities for high quality sheet that is also inexpensive.
 - Develop advanced material and solar cell property measuring techniques and equipment.
 - Develop advanced solar cell designs and fabrication processes.
 - Develop advanced module and array designs.

High Efficiency: Thin-Film Solar Cells

- Thin-film solar cells consist of thin layers of semiconductor materials deposited on a substrate so that the cell can absorb and convert usable light to electricity in a small thickness. The potential for depositing cells and cell interconnections in a continuous production line holds promise for low-cost thin-film modules that require small amounts of semiconductor materials.
- Achievement of higher-efficiency cells and modules is the key to widespread use of thin-film technology for PV power generation.
- Basic research on materials and devices leading to higher performance is being sponsored and/or performed by SERI for DOE, and by the private sector.

- Translation of thin-film research and the blending of crystalline silicon PV experience into commercial manufacturing technologies for thin-film PV power units is now being accelerated by industry and by FSA in support of SERI. FSA is involved in:
 - Developing thin-film cell and module process appropriate for large-area modules.
 - Developing and verifying module and array technologies for reliable units.

Low Cost: Crystalline Silicon

- Factors contributing to low-cost solar cells, modules, and arrays are:
 - Low-cost, high-purity silicon semiconductor material.
 - Rapid growth or deposition of silicon in sheet form of a quality consistent with cost-efficient solar cells.
 - Efficient solar-cell designs that are inexpensive to fabricate.
 - High-volume cell processes using inexpensive materials that have high yields of cost-effective solar cells.
 - Efficient module designs using inexpensive materials that are easily mass-produced with high yields of long-life, reliable modules.
- R&D is required to achieve:
 - Completion of silicon refinement research.
 - Cost-effective silicon sheet formation resulting in high-quality, inexpensive sheet.
 - High-efficiency solar cell designs for cost-effective processing and performance.
 - Mass-production processes with high yields of high-efficiency, inexpensive solar cells and modules.
 - Verification of long-life effectiveness of module and encapsulation materials.

Low Cost: Thin-Film Solar Cells

- Comprehensive manufacturing technology efforts have not been accomplished as yet because material, device, and basic cell and module designs are still evolving.
- A thorough assessment and subsequent efforts are required when the research results are definitive.

Reliability: Crystalline Silicon

Module and array reliability means consistent high performance for 30 years.

- Factors contributing to high reliability are:
 - Stable, long-life materials.
 - Compatible solar cell and module materials.
 - Appropriate cell and module designs.
 - Suitable cell and module processes.
 - High quality of manufacturing workmanship.
 - Capability of integration into PV power systems and installation.
- Types of reliability or performance degradation are:
 - Infant mortality.
 - Wear-out or aging.
 - Random failures.
 - Environment-induced soiling (weather-variable).
- Causes of degradation are:
 - Cell cracking.
 - Corrosion.
 - Cell-interconnect fatigue.
 - Module material aging.
 - Module material fatigue.
 - Insulation failure.
- Soiling or dirt accumulation on face of module.
- Structural failure.
- Design and fabrication flaws.
- Methods of reliability verification are:
 - Development of precise performance-measurement capabilities.
 - Accelerated testing of materials and modules.
 - Module qualification testing.
 - Field testing of modules and arrays.
- R&D is required for:
 - Advanced module and array specification definitions.
 - Material aging and stability research.
 - Advanced module and array design technology research.
 - Solar-cell, module, array, and PV system compatibilities.
 - Advanced module design verification.
 - Correlation of accelerated testing with field testing and with operational results.

Reliability: Thin-Film Solar Cells

- Unknown, evaluation just beginning.
- Most of the crystalline-silicon technology, noted above, will apply to thin-film hardware, but probably with unique variations.

FSA Project Technologies

SILICON MATERIAL

- QUARTZ (SiO_2) IS REFINED BY REMOVING O_2 AND IMPURITIES
- THE PRODUCT IS VERY HIGH PURITY SILICON



NEW SILICON REFINEMENT PROCESSES ACCOMPLISHMENTS

- LARGE-SCALE SILANE PRODUCTION PLANT BY UCC IN OPERATION
- PRACTICAL CONVERSION OF SILANE TO SILICON IN FBR DEMONSTRATED
- OTHER PROCESS AND PROCESS IMPROVEMENTS ADOPTED BY INDUSTRY

RESEARCH REQUIRED

- ESTABLISH PURITY OF SILICON FROM UCC PROCESS
- VERIFY ECONOMICS OF PROCESS

SILICON SHEET

- SILICON IS GROWN WITH SPECIFIC ELECTRICAL AND CRYSTALLOGRAPHIC CHARACTERISTICS
- INGOTS ARE SLICED INTO WAFERS
- RIBBONS ARE GROWN TO DESIRED THICKNESS



INGOT

WAFER



ACCOMPLISHMENTS

- NEW SEMICONTINUOUS, LARGER CZ INGOTS GROWN
- NEW SHAPED-INGOT TECHNOLOGIES EVOLVED
- FASTER, MORE EFFICIENT SAWING DEVELOPED
- GROWTH OF WIDE, FLAT-RIBBON ACHIEVED

RESEARCH REQUIRED

- INVESTIGATE CRYSTALLIZATION RATE LIMITATIONS AND INFLUENCE OF PRIMARY GROWTH PARAMETERS
- CONTINUE CHARACTERIZATION OF SILICON SHEET MATERIAL VERSUS GROWTH RATES
- CONTINUE BASIC INVESTIGATION OF HIGH-QUALITY, RAPID CRYSTAL GROWTH; ESPECIALLY RIBBON GROWTH

HIGH-EFFICIENCY SOLAR CELLS

SOLAR CELL EFFICIENCY IS A FUNCTION OF:

- SILICON SHEET QUALITY
- CELL DESIGN
- CELL FABRICATION PROCESSES
- UNIFORMITY AND REPEATABILITY OF ABOVE

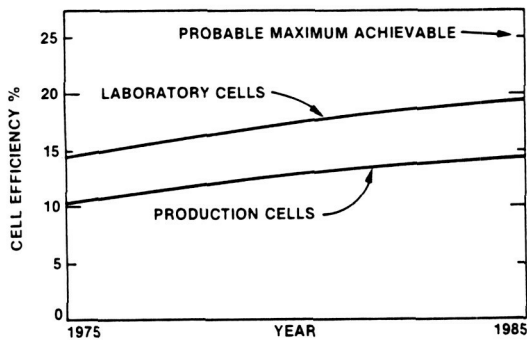

ACCOMPLISHMENTS

- KEY BARRIERS TO HIGHER-EFFICIENCY SOLAR CELLS IDENTIFIED
- HIGH-EFFICIENCY SOLAR CELLS MODELED AND ANALYZED
- NEW SOLAR CELL CHARACTERIZATION TECHNIQUES DEVELOPED

RESEARCH REQUIRED

- CONTINUE INVESTIGATION OF LOSS MECHANISMS WITHIN SOLAR CELLS
- CONTINUE DEVELOPMENT OF SOLAR CELL CHARACTERIZATION ANALYSIS AND MEASUREMENT TECHNIQUES
- CONTINUE RESEARCH CELL DEVELOPMENT AND TESTING

CELL AND MODULE PROCESS RESEARCH AND DEVELOPMENT

- SOLAR CELLS ARE FABRICATED FROM SILICON SHEET
- CELLS ARE ELECTRICALLY INTERCONNECTED AND ENCAPSULATED IN A SUPPORTING STRUCTURE

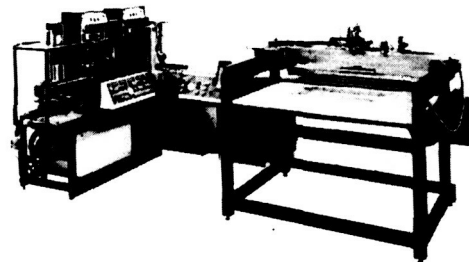

ACCOMPLISHMENTS

- IMPROVED CELL SURFACE TREATMENTS, JUNCTION FORMATION, AND METALLIZATION HAVE RESULTED IN LESS EXPENSIVE YET MORE EFFICIENT SOLAR CELLS
- SIMPLIFIED FABRICATION SEQUENCES SUITABLE FOR AUTOMATION DEVELOPED
- PROTOTYPE MASS-PRODUCTION EQUIPMENT DEVELOPED

RESEARCH REQUIRED

- INVESTIGATE HIGH-EFFICIENCY SOLAR CELL PROCESSING
- INVESTIGATE ELECTRICALLY CONDUCTIVE SILICIDES, CORROSIVE EFFECTS ON METALLIZATION, AND THE EFFECTS ON JUNCTION FORMATION
- CONTINUE INVESTIGATING CRITICAL PROBLEMS OF ION IMPLANTATION, METALLIZATION, INTERCONNECTIONS, AND MODULE ASSEMBLY

MODULE/ARRAY ENGINEERING SCIENCES AND DESIGN

DESIGN AND TEST METHODS HAVE BEEN DEVELOPED AND USED TO IMPROVE THE PERFORMANCE, ENVIRONMENTAL DURABILITY, AND SAFETY OF PHOTOVOLTAIC MODULES AND ARRAYS

FIRE TEST OF MODULES



ARRAY STRUCTURE TEST

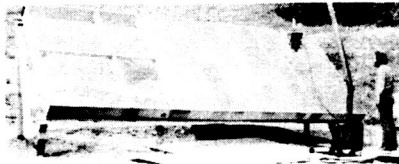

ACCOMPLISHMENTS AND ONGOING ACTIVITIES

- MODULE AND ARRAY DESIGN REQUIREMENTS GENERATED FOR FUTURE LARGE-SCALE APPLICATIONS
- IMPROVED DESIGN CONCEPTS, ANALYSIS, AND TEST METHODS AVAILABLE AND UNDER DEVELOPMENT (CIRCUIT DESIGN, SAFETY, STRUCTURES, RELIABILITY, ETC.)
- PERFORMANCE EVALUATION METHODS AND DESIGN AND TEST SPECIFICATIONS DEVELOPED THROUGH INTERACTION WITH INDUSTRY

RESEARCH REQUIRED

- PERFORM ABOVE FUNCTIONS FOR MODULES MADE FROM THIN-FILM SOLAR CELLS

ENCAPSULATION

SOLAR CELLS AND INTERCONNECTS ARE PROTECTED FROM THE ENVIRONMENTS

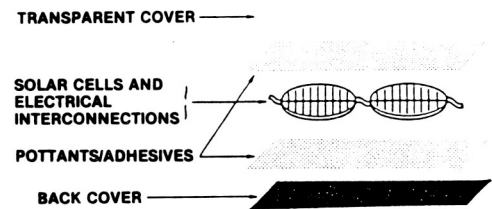

ACCOMPLISHMENTS

- EXPERIENCE INDICATES 30-YEAR MODULE LIFE IS ACHIEVABLE
 - SELECTED MATERIALS AND PROCESSES EXPECTED TO MEET GOALS AND AUTOMATED PROCESSING NEEDS
 - MATERIALS INDUSTRY RESPONDING TO NEEDS AS DEFINED BY FSA
- RESEARCH REQUIRED
- CONTINUE INVESTIGATION OF ENCAPSULATION MATERIALS TO ACHIEVE LONG-TERM PHOTOTHERMAL STABILITY
 - CONTINUE DEVELOPMENT AND USE OF ACCELERATED AND LONG-LIFE, DURABILITY-TESTING TECHNIQUES
 - CONTINUE INVESTIGATION OF ENCAPSULANT, METALLIZATION, AND OTHER INTERFACIAL BONDING STABILITY AND CORROSION CRITERIA AND MECHANISMS

RELIABILITY PHYSICS

POWER GENERATION WITHOUT DEGRADATION REQUIRES:

- STABLE, LONG-LIFE MATERIALS
- GOOD, COMPATIBLE CELL, MODULE, ARRAY AND PV SYSTEM MATERIALS AND DESIGN
- GOOD FABRICATION AND INSTALLATION WORKMANSHIP

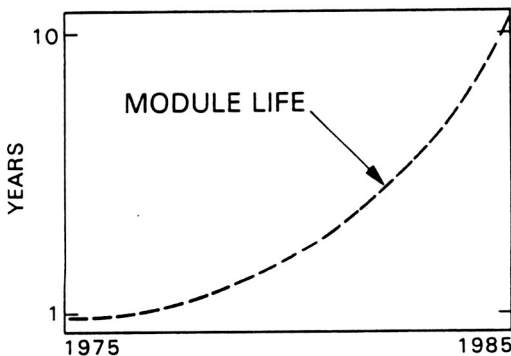

ACCOMPLISHMENTS

- DEVELOPED ANALYSIS TECHNIQUES FOR EVALUATING PARAMETRIC INFLUENCES ON RELIABILITY
- DEVELOPED MANY TEST TECHNIQUES AND EQUIPMENT FOR EVALUATING MODULE RELIABILITY
- MODULE LIFE-TIMES HAVE INCREASED DRAMATICALLY

RESEARCH REQUIRED

- CORRELATE FUTURE FIELD OPERATIONAL RESULTS WITH EXISTING DATA
- EVALUATE AND IMPROVE THIN-FILM MODULE RELIABILITY

MODULE PERFORMANCE AND FAILURE ANALYSES

- PHOTOTYPE ADVANCED MODULES HAVE BEEN DESIGNED AND MANUFACTURED BY INDUSTRY TO JPL SPECIFICATIONS
- MODULE ELECTRICAL PERFORMANCE AND ENVIRONMENTAL DURABILITY ASSESSMENT BY JPL

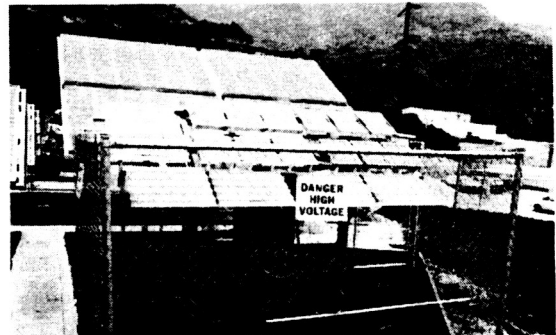

PROGRESS IN MODULE PERFORMANCE

- MODULE PERFORMANCE AND DURABILITY IMPROVEMENT WITH EACH NEW PROCUREMENT
- LATEST MODULES (5th PROCUREMENT) INCORPORATE INNOVATIVE DESIGN FEATURES
- CONTINUING CHARACTERIZATION AND DIAGNOSTIC ANALYSES OF MODULE DEFICIENCIES/FAILURES ARE TRANSFERRED TO INDUSTRY

PROJECT ANALYSIS AND INTEGRATION

- DEVELOPED PV ANALYSIS METHODS, ESPECIALLY FOR MANUFACTURING COSTS
- ESTABLISHED GOALS INTERNAL TO FSA AND MEASURED TECHNICAL PROGRESS BY USE OF ANALYSIS TECHNIQUES

ORIGINAL PAGE IS OF POOR QUALITY

Project Analysis and Integration

Those responsible for initiating and organizing the FSA Project recognized the need for coordination within the Project and with private industry to achieve the objectives established for the Project. To that end, the Project Analysis and Integration (PA&I) effort has served as a channel of communication for Project activities, private industry, and the U.S. Department of Energy.

PA&I performs planning and integration activities to coordinate the various R&D tasks. Goals are established for Project R&D activities that reflect the objectives of the National Program. Analytical support is given to the Project Office, providing a channel for the integration of individual task work into the overall Project. Integration activities have also supported the coordination of research activities between the Project and other research laboratories.

PA&I performs analytical studies to measure the progress toward accomplishing Project goals and to determine which R&D tasks are the most likely to result in significant performance and cost improvements. Guidelines for module production costs are established by PA&I which are consistent with the National Program goals. Performance and cost criteria are set for separate module elements, creating objectives for the individual R&D tasks. Sensitivity studies are performed to see how technical advances in the Project and changes in the economic environment affect Project objectives.

Background

FSA research and development has encompassed all phases of flat-plate module technology, from the basic feedstock materials for the photovoltaic manufacturing processes, through verification of module reliability and performance in the field. When the Project was organized in 1975, it was recognized that this broad spectrum of activities would require the Project to be somewhat unique at JPL because of the number of industrial organizations, Government laboratories, academic institutions, and other entities, such as utilities, with which JPL would have to interact. It was apparent at the outset that communication between JPL and the other participating organizations would be an important factor in the success of the effort. In addition, the Project was one of the first, and certainly the largest at JPL, for which technical performance was not the ultimate goal but only a contributing factor to the principal measure of success, economic performance. Thus, it was also apparent that analytical methods would be needed to translate technical performance into future economic performance. The PA&I Task was formed as part of

the original Project structure to address the problem of communication and to help guide the Project technical developments toward the National PV Program's economic goals.

Project Activities

In 1975, analytical capabilities were needed to evaluate competing technologies and establish realistic guidelines for their development. Initially, cost goals were allocated to silicon material, silicon sheet, encapsulation materials, cell fabrication processes, and module assembly. As economic analysis capabilities were developed, thereby allowing Project-wide technology assessments to be made, these goal allocations were revised. The technical objectives that were established were used to determine the division of resources throughout the Project. As time passed, the completeness and sophistication of the analysis capabilities matured.

The assessing of technology status and the tracking of progress has been one of the principal PA&I activities throughout the duration of the FSA Project. It has established a set of standards by which progress can be measured. The standards are part of an overall methodology developed by PA&I so that research findings could be reported in a common format. The methodologies are being used to track and assess progress within the Project so as to derive the maximum technical and economic benefits from research and development work. Technical reports and research activity assessments are an integral part of the overall Project effort.

The FSA Project participation in the early efforts of DOE to establish a National PV Program Plan was coordinated and implemented by PA&I. It authored several major sections of the first DOE Program Plan. The planning and organization of the Photovoltaic Technology Development and Applications Lead Center at JPL in 1978 was a major PA&I activity at that time.

Today's Status

PA&I provides ongoing support to the Project in the form of up-to-date technology assessments. Manufacturing technology descriptions are revised to reflect new technical developments, and new manufacturing cost estimates are made using the SAMICS (Solar Array Manufacturing Industry Costing Standards) methodology. Examples of this analysis capability are the 1985 production cost estimate updates for Czochralski (Cz) and dendritic web silicon solar cell modules.

Module cost estimates were made for state-of-the-art Cz silicon solar cell technology, assuming the construction of a 25-MW-per-year production facility and current material costs. Assuming 3 shifts per day, full-time operation and module efficiencies of 13.5%, production prices were estimated at \$1.47 per

peak watt (1985) dollars. This represents significant progress over early assessments for this technology.

Module cost estimates were made for state-of-the-art, dendritic web silicon solar cell technology, assuming three shifts per day, full-time operation at a 25-MW-per-year production rate and current material costs. Assuming module efficiencies of 13.7%, production prices were estimated at \$1.48/W_p or more. This is based upon a web growth rate of 10 cm²/min or less (today's best growth rate).

The dendritic web solar cell technology, while still under active development, promises to be a most attractive photovoltaic option. The principal impediment to economic feasibility of dendritic web has been the low crystal growth rates. If the technology development presently in progress is successful in increasing the dendritic web growth rates to 30 cm²/min, then the production price can be reduced to \$0.86/W_p (1985 dollars). If modules at this price are placed in a PV electrical generation plant, electricity could be produced at \$0.17/kWh, very close to the DOE Program goal of \$0.15/kWh.

Accomplishments

PA&I supports a systems analysis capability for evaluating developments within the Project and assessing progress. The present status of this capability and its accomplishments are best summarized in terms of the methodologies or analytical tools maintained for Project analysis and integration efforts. These analytical tools have provided a consistent and reliable framework for measuring developments throughout the Project.

SAMICS

One of the most important analytical tools developed and supported through PA&I is the Solar Array Manufacturing Industry Costing Standards (SAMICS). SAMICS has proven itself as a credible costing methodology for an emerging technology. The SAMICS methodology provides a standardized way for comparing cost estimates of many competing technical options.

SAMICS has been used repeatedly to assess the cost of photovoltaic module production at output levels representative of commercial ventures using state-of-the-art technology. SAMICS has also been used for projections of what might reasonably be expected at some future date for the technology given successful completion of research activities. These snapshots of technology development in progress have provided FSA valuable insights into the likelihood of achieving desired reductions in the cost of photovoltaic module production.

The SAMICS methodology is a complete procedure for evaluating the cost of manufacturing PV solar arrays. The SAMICS methodology includes:

- Computer programs designed for user implementation on personal computers (SAMIS PC, SAMPEG, IPEG-4).
- Formats for the preparation of complete manufacturing process descriptions.
- A detailed cost account catalog which can easily be modified to meet user requirements.
- A standard set of financial assumptions making direct technology comparisons possible.
- A report format that provides detailed value added estimates for all process steps.
- The option to vary any of the technical, financial, or overhead parameters.

A series of competitive procurements, designated Block I through Block V, was initiated by FSA to encourage the adoption of new technology and stimulate reduction in the cost of photovoltaic module production. SAMICS has made it possible to assess the technical progress made. Detailed process descriptions reflecting the latest technology developments were converted into manufacturing cost estimates under commercial production conditions. These were then compared with previous block purchases and the cost goals of the National Program.

SIMRAND

Analytical tools have been developed which were designed specifically for support of program management activities. The FSA Project must continually make decisions regarding support levels for various projects. These decisions are necessarily based on information that is quite uncertain in nature. The SIMRAND (Simulation of Research and Development Projects) model was developed as a tool that allows this uncertainty to be directly incorporated into the information used by decision-makers.

The SIMRAND model assesses the probability that a combination of R&D activities will meet a given set of price goals. The descriptions developed by SIMRAND for each technology reflect the uncertain nature of the database used. Technologies can then be compared to see which has the highest probability of reaching Project goals. The decision process is modeled by means of alternative networks that represent the feasible technologies being considered. SIMRAND performs repeated simulations to

ECONOMIC ANALYSES

SAMICS — THE SOLAR ARRAY MANUFACTURING INDUSTRY COSTING STANDARDS

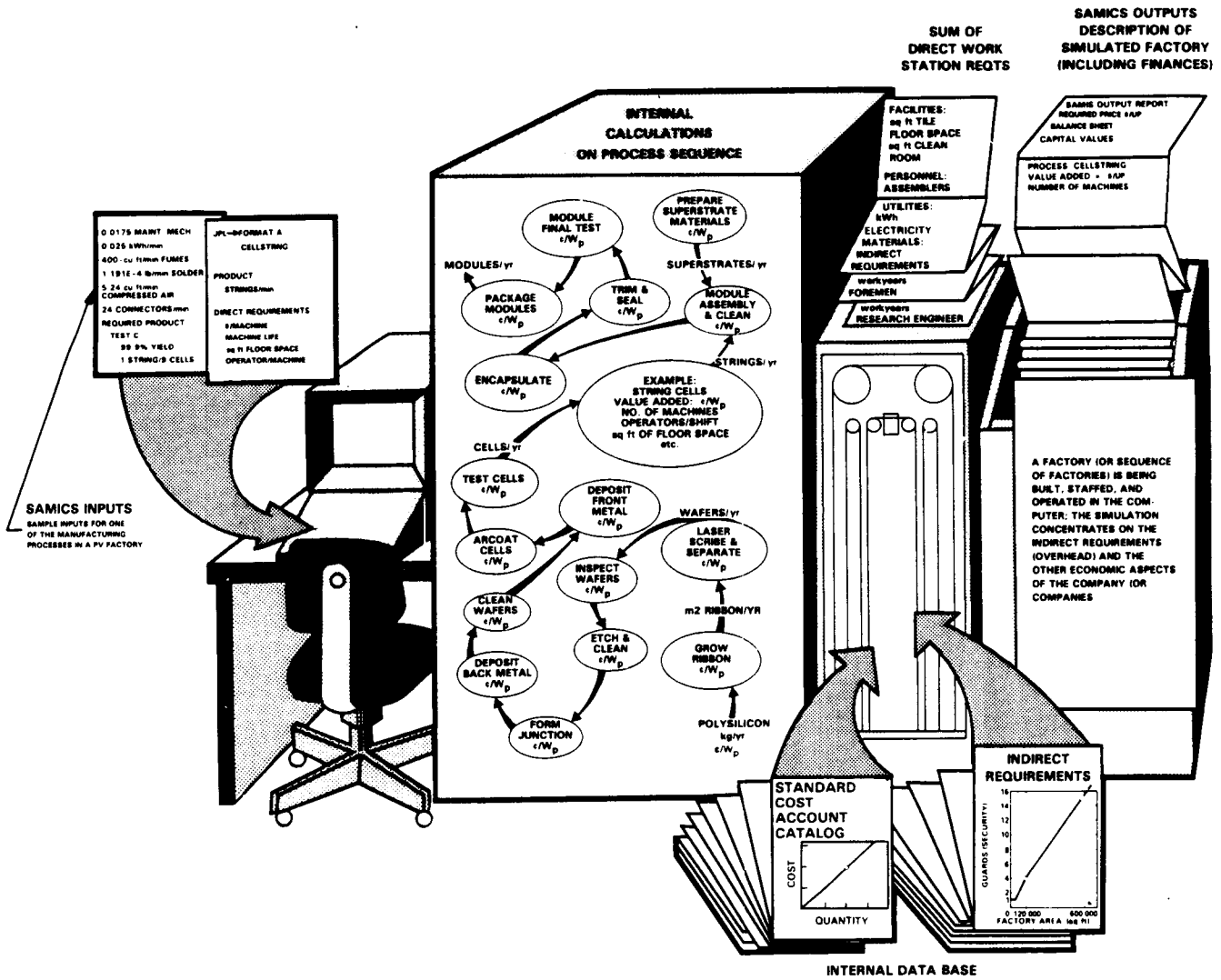

determine the likely distribution of outcomes for each technology. The network reflecting the various technology options is continually reevaluated during the simulation to find the optimum subset of research tasks.

SIMRAND is a management decision methodology that incorporates information uncertainty. The SIMRAND model (Figure 2) includes:

- The capability of evaluating relatively complex networks of technical options representing the feasible choices.
- The ability to replace process parameters with probability distributions reflecting information uncertainty.
- The option to include decision-maker's preferences regarding risk into the decision process.
- Computer program available for implementation on a personal computer.

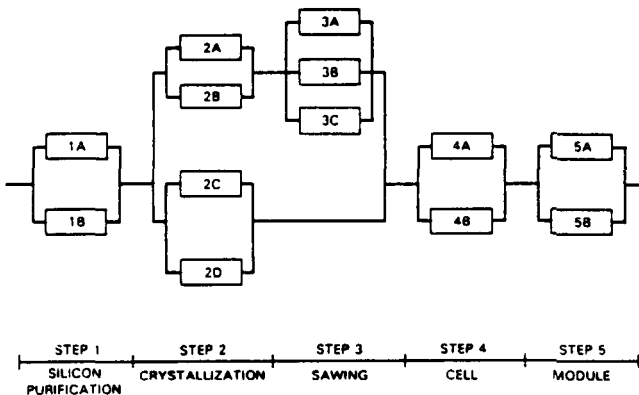

Figure 2. Module Production Network

A joint JPL/SERI silicon sheet material study successfully used SIMRAND to incorporate uncertainty about potential technical progress and material costs into the outlook for each silicon sheet technology. The product was a set of distributions indicating the possible range of outcomes for each research activity. The study results were instrumental in redirecting the technology mix pursued by the National PV Program.

The SAMICS and SIMRAND models and the Allocation Guidelines have been applied individually to specific technical problems and as an integrated set when longer range management decisions have been required. Technical options have been evaluated by applying the manufacturing cost simulations to processing sequences and comparing the results with the cost-goal allocations. Manufacturing cost point estimates generated by SAMICS have been combined by using SIMRAND with the uncertainties associated with those estimates to form probability distributions of technical performance and/or cost. The inclusion of uncertainty has allowed Project management insight into the risks associated with the technical options being considered.

LCP

Assessment of a PV systems capability to compete with conventional energy resources requires simulation of its performance over its lifetime and recognition of regional variations in solar energy resources. The Lifetime Cost and Performance (LCP) model was developed and is now used to simulate the energy output of a PV power plant over its useful life. LCP relates the effect of hourly weather conditions, system design and component efficiencies, electrical design, long run effects of exposure, and alternative operation and maintenance strategies to system cost, performance, and value (Figure 3). Fixed array, one-axis tracking and two-axis tracking systems can be evaluated at different locations throughout the country.

LCP simulates the performance of PV systems using actual solar resource measurements as recorded in weather data tapes. The LCP model includes:

- The ability to use insolation data, temperature measurements, and precipitation and dirt accumulation measurements to model location specific performance.
- The ability to evaluate the effects of balance of system component failures and electrical mismatches within modules.
- A computer model that can be implemented on a personal computer.

LCP, which was used to assist Acurex Corp. in making economic assessments of alternative designs

for the first phase of the Sacramento Municipal Utility Districts proposed 100-MW PV installation. The performance of each design alternative was simulated over its lifetime using weather data characteristic of the location and the parameters of the PV array system.

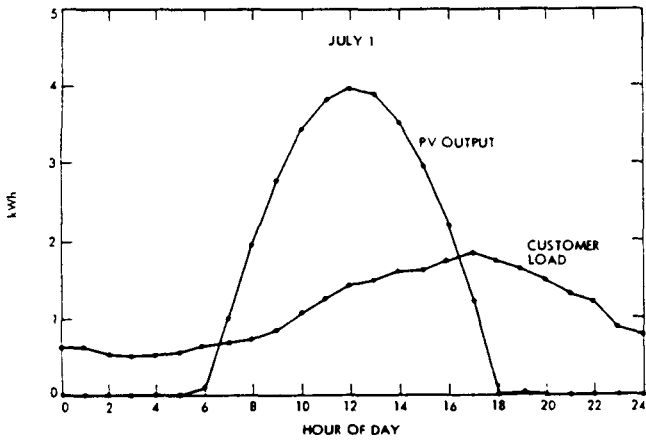

Figure 3. Time-of-Day Output and Customer Load Profile

PVARRAY

The PVARRAY model simulates array performance over time. Using PVARRAY, the power profiles of modules representing various state-of-the-art and advanced designs have been obtained and the effects of the current-voltage (I-V) changes resulting

from a variety of causes have been assessed. PVARRAY can model the effect of specific solar cell failure mechanisms on system performance and correct for various failed module replacement strategies.

PVARRAY simulates the power output of a PV array over its lifetime. The PVARRAY model includes:

- The ability to compare performance of different module designs.
- The capacity to consider alternative series parallel wiring schemes.
- The ability to evaluate alternative replacement strategies for different cell failure rates and diode placements.
- Computer program that can be implemented on a personal computer.

The combination of PVARRAY, SAMICS, and LCP has been used at JPL to estimate the net present value of energy from a photovoltaic system over its useful lifetime. Manufacturing costs for the module production sequence have been estimated using SAMICS, and the life-cycle cost and performance have been simulated using the LCP and PVARRAY models. The three programs have allowed PA&I to calculate the cost of different module designs and determine the time-dependent economic impact of design changes by simulating array performance and life-cycle cost (Figure 4).

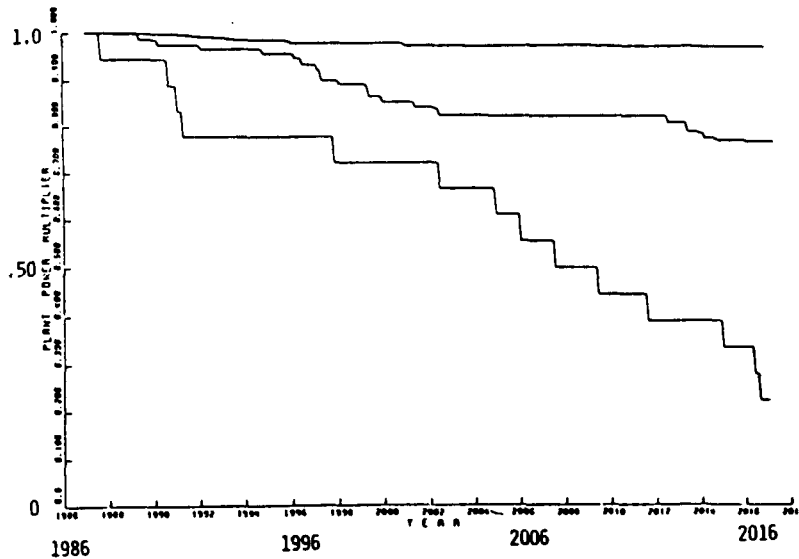

Figure 4. Cell Degradation and Lifetime Performance for Three Different Module Designs

Silicon Material

Semiconductor-grade silicon is the material used to fabricate crystalline-silicon solar cells, most solid-state devices, and most integrated circuits. It is very highly purified, with tight specifications limiting the concentrations of specific impurities. The manufacturing yields during the production of solid-state devices and the performance of the devices are directly related to the quality of the silicon. Semiconductor-grade silicon, as produced in the Siemens reactor for the semiconductor industry, has been and continues to be used by the PV industry for the production of the great majority of the solar cells. The cost of the silicon is a minor part of the cost of producing semiconductor devices, but it has been and still is a significant fraction of the cost of manufacturing solar cells. Integrated circuits are very small and many can be fabricated on one silicon wafer, but only one solar cell is fabricated from a wafer. The small market provided by solar-cell users has not justified industry's development of an inexpensive high-volume silicon production technique that would result in low-cost silicon material. Considerable FSA funding has been devoted toward advancing silicon purification technology and processes.

The *objective* of the silicon refinement effort is to overcome the technical barriers to low-cost silicon purification in order to achieve a process capable of producing high-quality, low-cost silicon (appropriate for photovoltaic use), at a price consistent with FSA objectives.

The *goals* are to establish silicon material processes appropriate to:

- Purity adequate for efficient crystalline-silicon solar cells that meet the requirements of the FSA Project.
- Market price of \$19/kg (1985 dollars).
- High-volume production plants (<1000 MT/year).

Background

Silicon, the second most abundant element in the Earth's crust, occurs naturally primarily as silicon dioxide and as silicates: sand, quartz, etc. Large quantities of quartzite, a crystalline form of silicon dioxide, are reduced in arc furnaces to metallurgical-grade silicon (mg-Si) for use by many industries. It sells for \$1 to \$2/kg and is about 98 to 99% silicon. A much purer silicon is required to fabricate semiconductor devices and solar cells. A small portion (a few thousand metric tons) of mg-Si is used annually in processes to produce semiconductor-grade silicon.

Most solar cells have been and still are fabricated from silicon with a total impurity concentration less

than one part per million, which possesses semiconductor properties. In 1975, the available material of this quality was produced by the Siemens process and was referred to as semiconductor-grade silicon. The price then was greater than \$50/kg and was very sensitive to the supply-and-demand fluctuations. It was known that solar cells could be made from a less-pure silicon. How much less pure, with which impurities, and how much of each impurity could be tolerated, was unknown, nor was such a material commercially available.

Project Activities: 1975 TO 1981

The status of the Siemens process for the production of semiconductor grade silicon was:

Advantages

High purity (more than adequate at that time)

Acceptable form

Proven process

Potential for improvements:

Decreased energy use

Increased production rate

Disadvantages

High-energy consumption process

Low conversion rate and yield

Large amount of waste by-product

High labor costs

High product cost

A plan was formulated within FSA to develop a silicon refinement process to meet PV sheet and solar cell requirements. The plan was to develop low-cost semiconductor-grade silicon processes; to develop a solar-grade silicon refinement process (a less-pure, but unspecified material that should be even less expensive); and to determine the effects of various impurities and their concentrations on silicon refinement processes and on solar cell performance. The plan consisted of three process development phases for both the semiconductor-grade and the solar-grade process (Table 1). The intent was to establish the practicality of the processes by production, energy consumption, and economic criteria. To classify candidate processes and define the process specifications, information was required about the effects of specific impurities on silicon and on solar cell

Table 1. Planned Process Research Phases

Phase	Purpose
Laboratory-Scale Experiments	<p>Demonstrate process feasibility</p> <p>Determine reaction kinetics and yields</p> <p>Identify reactor-material problems</p> <p>Obtain silicon deposition rates of 0.01 to 1 kg/h</p> <p>Obtain product purity information</p>
Process Development Units (PDUs)	<p>Demonstrate practicality of reactors and critical process steps</p> <p>Obtain reactor scale-up information</p> <p>Characterize critical process components</p> <p>Establish suitability of reactor materials</p> <p>Determine process capability by chemical engineering analyses using acquired data and extended process design</p> <p>Perform preliminary economic analyses</p>
Experimental Process System Development Units (EPSDUs)	<p>Establish technical readiness of integrated processes</p> <p>Design and build pilot plant EPSDUs with silicon deposition rates of up to 100 MT/year</p> <p>Obtain operating data to characterize complete process including steady-state operation</p> <p>Obtain data for optimization of design and operation of a full-scale production plant</p> <p>Confirm product purity at steady-state conditions</p> <p>Confirm economic analyses</p>

performance. These purity requirements directly affected the process designs and, thus, the economics of the candidate processes. The impurity studies consisted of two phases: the measurements of the effects on the final product of impurities that are found in mg-Si or that might be introduced during a process step, and the determination of the interrelationships of impurities and the processing steps and their combined effects on solar cell performance.

The feasibility of 11 potentially low-cost processes were investigated. Their technical feasibilities were assessed by initially studying basic chemical reactions and general chemical engineering designs, which led to an analysis of the chemistry and chemical engineering

parameters based upon data from laboratory-scale experiments. After an investigation lasting 1 to 3 years, each of the promising specific processes was then evaluated for its practicality.

Scaled-up reactors were used for chemical engineering studies to derive data for mass and energy balances, process flows, kinetics, mass transfer, temperature and pressure effects, and operating controls. This information was used in analyses and extrapolations that resulted in improved process concepts and designs. The processes being examined in June 1977 and a number of supporting studies are shown in Table 2. By this time some process developments had progressed rapidly.

Table 2. Silicon Material Refinement Contractors in 1977

Contractor	Technology
Semiconductor-Grade Production Processes	
AeroChem Research Laboratories, Princeton, New Jersey	Silicon halide-alkali metal flames
Battelle Memorial Institute, Columbus, Ohio	SiCl ₄ reduction by Zn using FBR technology
Union Carbide, Sistersville, West Virginia	Pyrolysis of SiH ₄ derived from redistribution of SiHCl ₃ (with a feed of metallurgical grade silicon)
Motorola, Phoenix, Arizona	Chemical vapor transport and pyrolysis of SiF ₂ generated from SiF ₄ reaction with metallurgical grade silicon
Solar-Cell-Grade Specifications	
Northrop Research, Hawthorne, California	Lifetime and diffusion length measurements
C. T. Sah Associates, Urbana, Illinois	Model and studies of effects of impurities on solar cell properties
Spectrolab, Inc., Sylmar, California	Solar cell fabrication and analysis
Westinghouse Electric, Pittsburgh, Pennsylvania	Investigation of effects of impurities on solar cell performance
Monsanto Research Corp., St. Louis, Missouri	Investigation of effects of impurities on solar cell performance
Solar-Cell-Grade Production Processes	
AeroChem Research Laboratories, Princeton, New Jersey	Use of a nonequilibrium plasma jet
Dow Corning, Hemlock, Michigan	Arc furnace process using purer source materials
Stanford Research Institute, Menlo Park, California	Na reduction of SiF ₄
Schumacher, Oceanside, California	Reduction of SiHBr ₃ in an FBR
Texas Instruments, Dallas, Texas	Carbothermic reduction of SiO ₂ in a plasma
Westinghouse Electric, Pittsburgh, Pennsylvania	Plasma-arc-heater reduction of SiCl ₄ with Na
Commercial Potential of Processes	
Lamar University, Beaumont, Texas	Evaluations of relative commercial potentials of silicon-production processes developed under the Silicon Material Task

After analytical and experimental studies indicated that a process was feasible and potentially economical, and the practicality of its reactors and critical steps were demonstrated, a comprehensive economic analysis was made. Professor Carl Yaws, of Lamar University, and JPL personnel made these economic analyses which not only calculated the costs to produce silicon, but also made comparative assessments of the progress of each process. The most technically and economically promising processes were then carefully reviewed before they were deemed ready for design and development of a pilot plant. The verification of a process in a pilot plant was necessary to validate silicon refinement economics and product purity, because of limited capabilities in scaling-up chemical processes by analytical means alone.

Purification processes involving deposition of the silicon from silane and dichlorosilane were emphasized. Because these two substances can be purified relatively easily and, because of their high reactivity, they can be more easily and completely decomposed or reduced to form silicon than can trichlorosilane, which is used in the conventional Siemens process. Research on other processes that offered promise for making a less-pure solar-cell-grade silicon by refinement of metallurgical-grade silicon were continued because of the potential for even lower-cost silicon.

A comprehensive study of the effects of impurities and their concentrations on semiconductor-grade silicon and crystalline-solar-cell performance was carried out by a number of organizations, with the major focus of this effort at Westinghouse Electric Corp. A functional empirical model was formulated based upon the relationship that impurity atoms primarily decrease minority carrier recombination lifetime, reduce the short-circuit current of a cell, and essentially act independently. Experimental data confirmed this and provided quantitative relationships of the effects of specific elements on cell efficiency.

Project Activities: 1981 to Present

In 1981, the funds available were reduced considerably, which resulted in many activities being dropped and support being given only to the most promising, advanced efforts. At about the same time, the then newest PV system cost assessments indicated that higher-efficiency solar cells and modules were necessary to offset the area costs of an array. Analysis indicated that the power generation cost reductions possible by the use of higher-efficiency solar cells were greater than cost reductions possible by use of solar-cell-grade silicon. Cell efficiency is directly related to silicon purity. Therefore, solar-cell-grade silicon seemed to be impractical economically and efforts were reduced. The Union Carbide Corporation silane process and the Hemlock Semiconductor Corp. dichlorosilane process developments were continued.

In support of these efforts, a basic investigation of the technology of a high-performance silane fluidized-bed reactor (FBR) has been continued at JPL; research to characterize the aerosol phenomena involved in the growth of particles formed by the thermal decomposition of silane is being performed at the California Institute of Technology, and an engineering development of the silane-to-silicon FBR is being performed by Union Carbide Corporation. Continuing studies within FSA of the influence of impurities in silicon on solar cell performance are described here under the heading, "High Efficiency Solar Cells."

Today's Status

- A silane process has been developed by the Union Carbide Corp. that seems to be capable of meeting FSA goals, including price.
- A pilot plant (100-MT/year capacity) has demonstrated the following (see Figure 5):
 - The silane portion of the Union Carbide Corp. silane process has met FSA goals.
 - The silane produced in the first section of the Union Carbide Corp. process is very high purity and will be a low-cost material suitable for amorphous-silicon solar cells and/or other products when and if they become large-quantity products.
 - The R&D results of the silane-to-silicon deposition FBRs of the process are good. Research at JPL, which established the fundamental technology for FBR silane-to-silicon pyrolysis, will end in 1985. The FBR development at Union Carbide Corp., which has been sponsored by DOE, will continue with Union Carbide Corp. funds.
- Silane process production plants (completely funded by Union Carbide Corp.) include:
 - A 1200-MT/year plant which started operation early in 1985 converting mg-Si to silane, based upon DOE-sponsored technology. Komatsu chemical-vapor-deposition (CVD) reactors convert silane into high purity silicon at a price that is expected to be less than that of Siemens-produced silicon. It is almost at full capacity now (see Figure 6).
 - A second 1200-MT/year plant is under construction with completion scheduled for 1987.
 - A third plant of 3000-MT/year capacity is in design, with completion scheduled late in 1988. Use of a FBR is under investigation.
- The plants listed above will significantly increase world production of silicon. World capacity to produce semiconductor-grade silicon was about 6000 MT/year at the end of 1984.



Figure 5. A 100-MT Silane Process Pilot Plant, Washougal, Washington

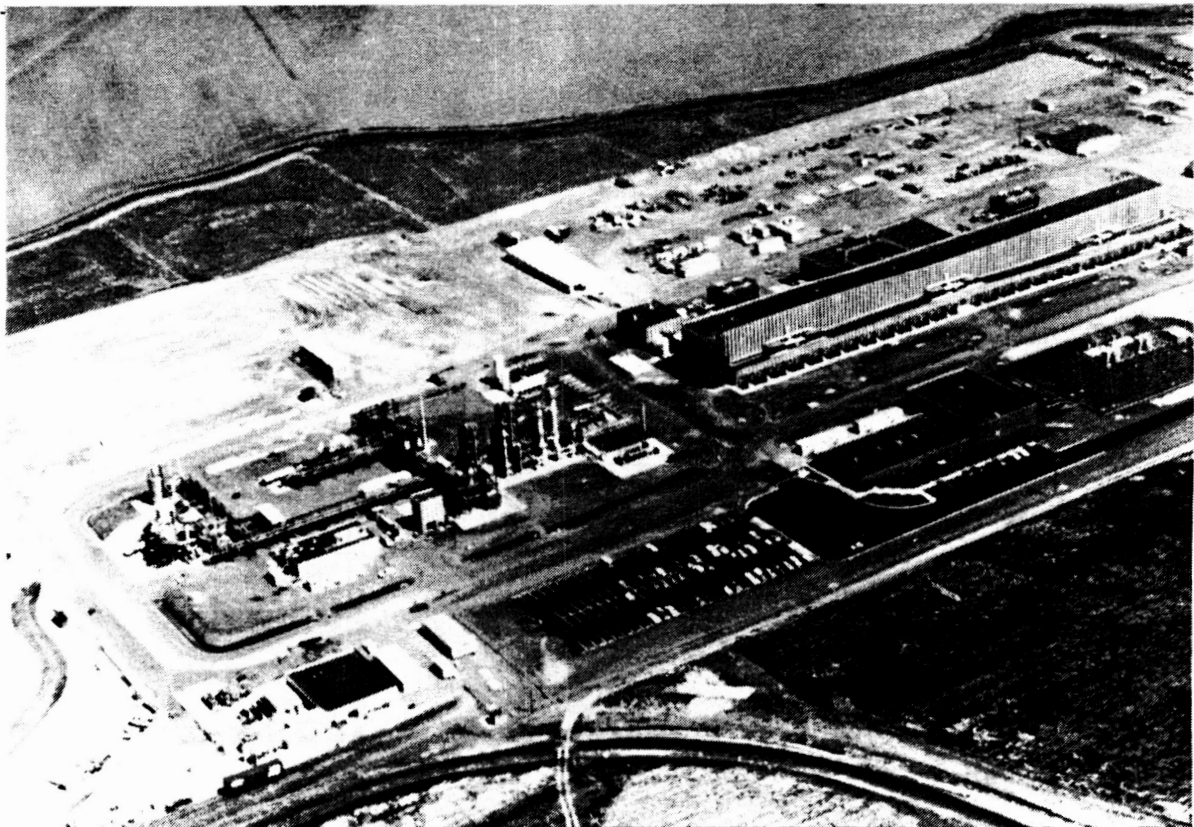

Figure 6. A 1200-MT Silane Process Production Plant, Moses Lake, Washington

Significant Accomplishments

The silane process developed at Union Carbide Corp. under an FSA contract seems to have the capability to meet the FSA goal of semiconductor-grade silicon at \$19/kg (1985 dollars). This process comprises two parts: the preparation of pure silane (SiH_4) from metallurgical-grade silicon, and the deposition of high-purity silicon from the silane using a FBR. Operation of a 100-MT/year pilot plant has verified the technical and economical practicality of the silane portion of the process. The rate of production and the purity of the silane from the Union Carbide Corp. pilot plant are consistently high. A silane sample tested by Brookhaven National Laboratory was the purest silane it had ever tested. Good research and development results for low-cost pyrolysis of silane to silicon are coming from the collaborative fluidized-bed-reactor efforts at Union Carbide Corp. and JPL. The Union Carbide Corp. effort is determining the steady-state operational conditions for the design of a production prototype reactor for silane feed concentrations of 20 to 25%. For more cost-effective pyrolysis, JPL research is being performed at silane concentrations up to 100% with emphasis on 40 to 60% concentrations. The problems of reactor clogging, bed slugging, and excessive production of silicon dust have been solved along with raising the silane feed limits from 2 to 100% concentration. The Union Carbide Corp. FBR has successfully run for 66 h at 20% silane. Unresolved problems are suitable silicon seed particle material, prevention of contamination, product purity confirmation, and verification of production economics.

The progress of 10 years of effort has resulted in Union Carbide Corp. building a 1200-MT/year silicon production plant (now in production) in which the silane is deposited as silicon in Komatsu chemical vapor deposition reactors. (These reactors were also operated in conjunction with the pilot plant.) The silicon produced is of very high purity. It is expected that the cost will be less than Siemens-process-produced silicon, but not as much less as with a FBR.

The dichlorosilane chemical vapor deposition

process of Hemlock Semiconductor Corp. was successfully carried through the demonstration of the practicality of the reactor and the critical process steps. A PDU was designed, constructed, and tested. This PDU was used to investigate the making of dichlorosilane from trichlorosilane. A pilot plant was not sponsored by DOE/JPL because process economics indicated a product price less than for the conventional Siemens process, but greater than that of the silane process. This technology is available for use in a production plant and Hemlock may have assimilated it into their ongoing production of silicon, although Hemlock has never divulged its commercialization plans to JPL.

Numerous FSA studies also contributed to advancements in trichlorosilane and modified Siemens-reactor technologies. A thorough examination of the many silicon processes has resulted in significant improvement in the understanding of many other silicon refinement technologies. The solar-cell-grade silicon efforts were stopped because of (1) large budget reductions, (2) the advanced state of the Union Carbide Corp. silane process, (3) improved understanding of the need for higher-purity silicon to obtain high cell efficiency, and (4) the economic value of higher-efficiency solar cells.

A good fundamental understanding of the effects of impurities in silicon upon the properties of silicon material and upon the performance of solar cells has been determined by extensive studies, principally by the Westinghouse R&D Center, and supported by others.

Silane Process (Union Carbide Corporation)

Preparation of Silane from Metallurgical-Grade Silicon and Conversion of Silane into Semiconductor-Grade Silicon

The process flow diagram is shown in Figure 7.

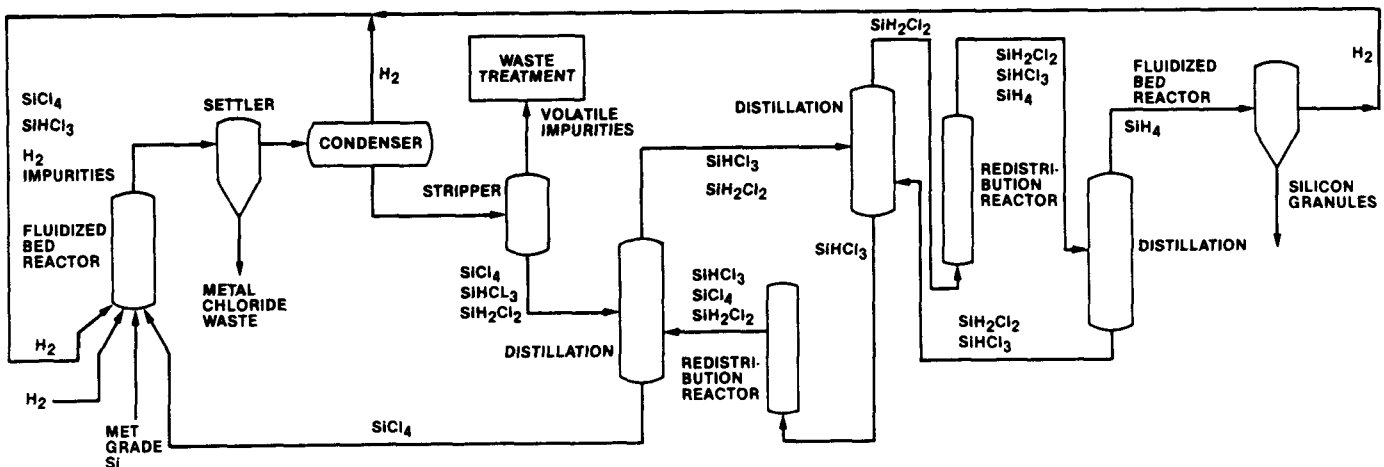

Figure 7. Silane Process Flow Diagram

Past Accomplishments

- Process feasibility demonstrated in laboratory-scale experiments for silane production and for silane conversion to silicon by thermal decomposition in free-space reactors and FBRs.
- Practicality of reactors and process steps for continuous, steady-state silane production demonstrated in scaled-up process development units.
- Thermodynamic values and reaction kinetics measured in hydrochlorination and redistribution reactors.
- Vapor-liquid equilibria calculated for chlorosilanes.
- Detailed process design for 100-MT/year EPSDU completed (silane portion).
- Engineering design and economic analysis for 1000-MT/year plant completed (silane portion).
- Hydrochlorination reaction characterized in extended studies (Solarelectronics, Inc.) consists of:
 - Equilibrium constants and reaction kinetics measured over wide temperature and pressure ranges.
 - Reaction rate equation and reaction model formulated.
 - Suitable materials of construction for reactor determined.
- Conventional free-space reactor for conversion of silane to silicon discarded because of unsuitable fine powder product.
- FBR R&D plan formulated.

More Recent Accomplishments

- Low-cost silane process technical readiness demonstrated by operation of pilot plant (EPSDU) at Washougal, Washington:
 - High-purity silane produced under optimized-continuous steady-state conditions.
 - High-purity silicon produced using Komatsu chemical-vapor-deposition reactors.
- Operating data obtained for design and operation of production plant.

- Engineering model FBR successfully operated at Washougal, Washington:
 - Process operating parameters assessed with a 6-in.-diameter FBR.
 - Long-duration runs with modified reactor extended range to continuous operation for 66 h using 20% silane.
 - Conditions for continuous, steady operation and for producing high-purity silicon remain to be defined.
- FBR research at JPL:
 - Characterization for high-silane-concentration operation extended to 100% silane using 6-in.-diameter reactor and cooled distributor plate (see Figure 8).
 - Operation at various high silane concentrations demonstrated, e.g., 80% silane for 3 h at deposition rate of 3.5 kg/h.

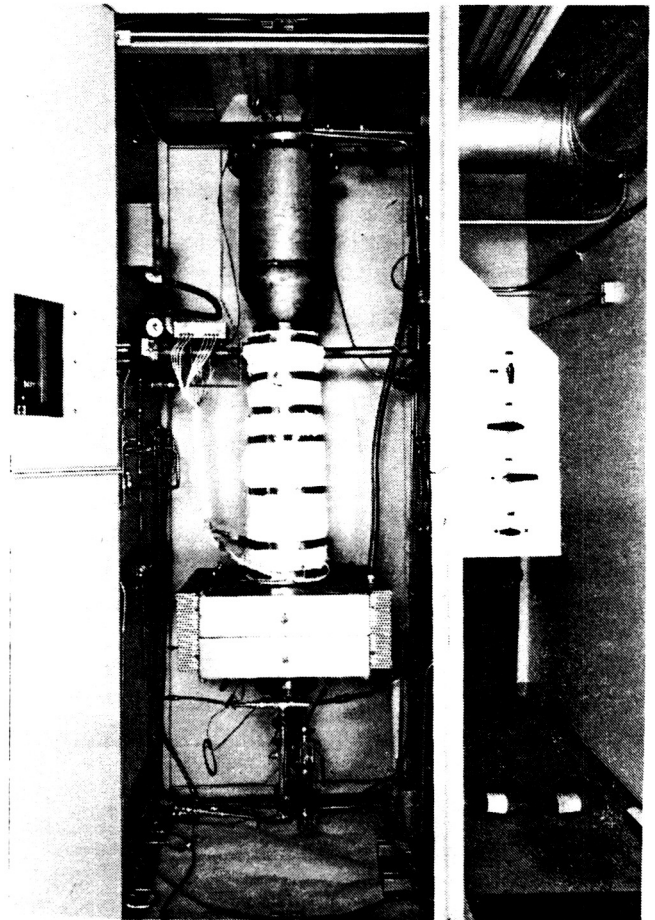

Figure 8. JPL Research Fluidized Bed Reactor

- Feasibility of periodic removal of product demonstrated.
- Scavenging mechanism describing high bed deposition and very low fines formation demonstrated.
- Fine particle growth in silane free-space reactor at California Institute of Technology:
 - Aerosol theory modified to describe formation and growth of fine particles in silane pyrolysis system.
 - Reactor developed and experimental conditions investigated with the objective of growing silicon particles to size suitable for seed in an FBR.
- Purity of product from both facilities:
 - Cleansing procedures established to ensure purity of initial seed particles.
 - Quartz liners installed in FBR to prevent contamination from reactor wall.
 - Final purity needs to be determined.
- Practicality of redistribution and deposition reactors as well as integrated unit demonstrated in scale-up process development unit (see Figure 10).
- Redistribution reactor with Dowex catalyst characterized for kinetics and conversion yield.
- Dichlorosilane characteristics determined to assess hazard:
 - Autoignition, explosion severity, hydrolysis, and explosive output measured; dichlorosilane found to be considerably more hazardous than hydrogen or trichlorosilane.
 - Process redesigned, including elimination of dichlorosilane storage, to minimize problems.
- Intermediate and advanced design deposition reactors studied:
 - Objectives developed from economic goal. A $2 \text{ gh}^{-1} \text{ cm}^{-1}$ deposition rate, 40 mol % conversion yield, and 60 kWh/kg energy use.
 - Results from intermediate reactor studies indicated reactor modifications required:
 - Deposition rate, conversion yield, and energy usage objectives achieved separately.
 - HCl etching step introduced to remove silicon wall deposits.
 - Results from advanced reactor with cooled wall showed all objectives achievable by optimizing conditions.
 - Semiconductor-grade purity demonstrated for product silicon:

Dichlorosilane CVD Process (Hemlock Semiconductor Corporation)

Preparation of Dichlorosilane from Metallurgical-Grade Silicon and Deposition of Semiconductor-Grade Silicon from Dichlorosilane

The process flow diagram is shown in Figure 9.

- Process feasibility for conversion of metallurgical-grade silicon to dichlorosilane and for chemical-vapor deposition of dichlorosilane demonstrated.

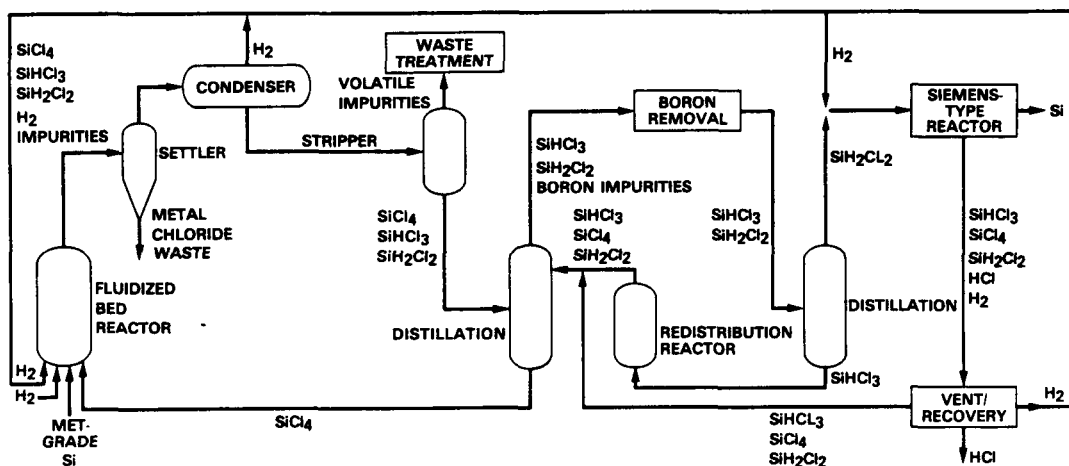
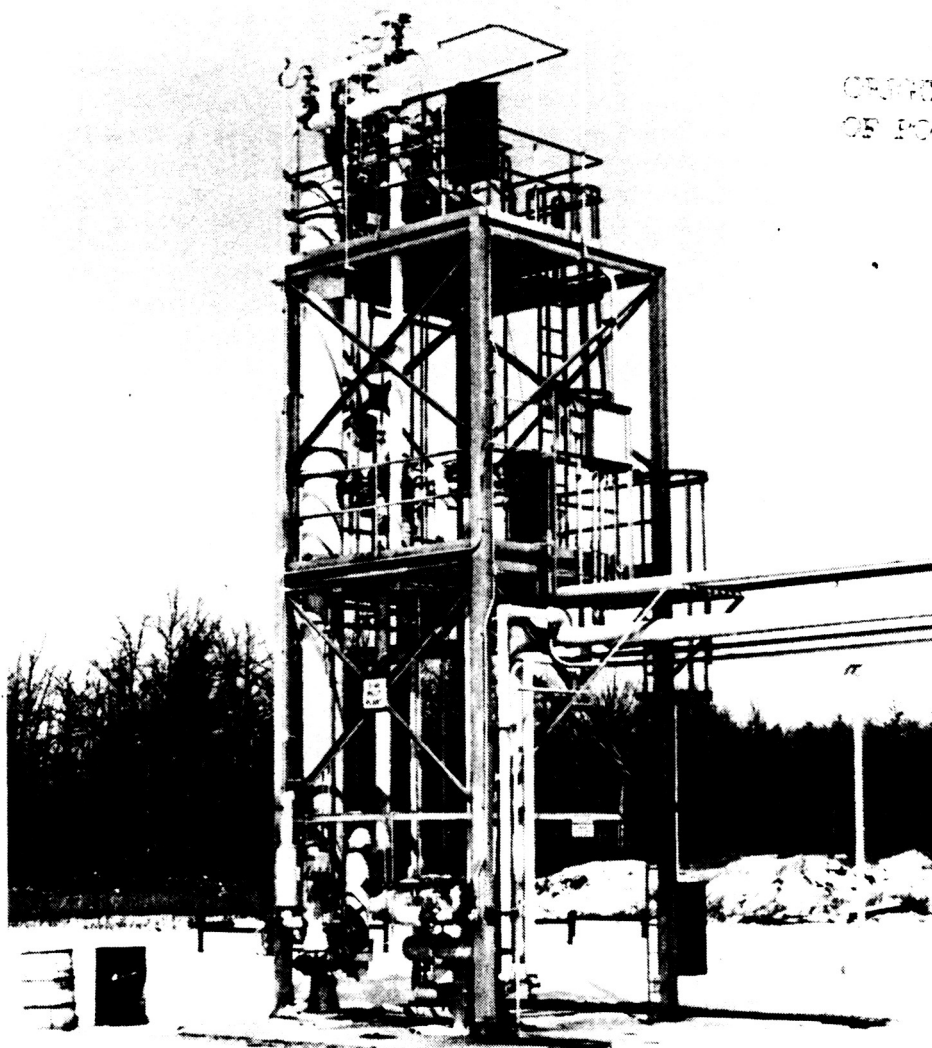

Figure 9. Dichlorosilane CVD Process Flow Diagram



ORIGINAL PAGE IS
OF POOR QUALITY

Figure 10. Process Development Unit

- Boron, phosphorus, carbon, and metal concentrations commensurate with, or less than, those of commercial semiconductor-grade silicon.
- Energy conversion efficiency of photovoltaic cells made from this material shown to be equivalent to that of baseline cells fabricated from commercial semiconductor-grade silicon.
- EPSDU sized to 100-MT/year outlined.
- Economic analysis for a 1000-MT/year plant indicated \$34.80/kg (1985 dollars) for product cost (without profit).

Effects of Impurities in Silicon

The objective was to relate silicon purity to the economics of silicon refinement processes by the

determination of impurity effects on material and solar-cell properties. The approach was to characterize materials and solar cells prepared from deliberately doped ingots.

The studies included the following parameters:

- Deep-level impurity concentrations in singly and multiply doped ingots.
- Methods and growth rates for single crystals.
- Melt-replenishment methods.
- Base dopant type and concentration (resistivity).
- Anisotropic distributions of deep-level impurities.
- Grain boundary structure (impurity interactions in polycrystalline cells).
- Thermal and gettering treatments during cell processing.

- High-temperature aging of cells.
- Effects on high-efficiency PV solar cells (minor activity).

Tolerable concentrations of impurities were found to be determined by the effects of: (1) specific metallic impurities on the performance of cells, (2) boron and phosphorus on resistivity and single-crystal yield in ingot growth, and (3) total impurity concentration in the silicon on single-crystal growth yield. The effects of impurities on cell efficiency were related empirically through the base diffusion length and were shown to be species-dependent. For example, the concentrations causing a 10% decrease in efficiency ranged from 0.1 ppba for tantalum to 10 ppma for copper (see Figure 11). The tolerable concentrations in the polycrystalline silicon are dependent on the methods used for crystal growth. Crystalline structure breakdown occurs when the total impurity concentration exceeds a critical value for a particular set of conditions of ingot or sheet growth. For example, the critical concentration is in the range of 200 to 500 ppma when a 10-cm-diameter Cz crystal is pulled at a rate of about 8 cm/h. (The available database for these trade-off studies has

been incorporated into a slide rule.) The impurity limits can be relaxed considerably for a near-equilibrium, uni-directional solidification in which liquid-solid impurity segregation is the concentration controlling factor. Unfortunately, these studies have not been carried experimentally into various forms of silicon ribbon and solar cells made from silicon ribbons.

In a fundamental approach to the impurity effects problem, a transmission-line-equivalent circuit model was developed by C.T. Sah to compute the exact steady-state characteristics of one-dimensional silicon solar cells. The model was used for calculations of limiting concentrations of specific impurities for defined cell structures and efficiency. A model was also developed to study the effects of defects across the back-surface-field junction on the performance of high-efficiency cells. A new theory to distinguish an acceptor-like deep level from a donor-like deep level was developed using measured values of the thermal emission and capture cross sections. This theory also provides information concerning the lattice distortion around an impurity atom before and after the capture or emission of an electron or hole at the impurity center.

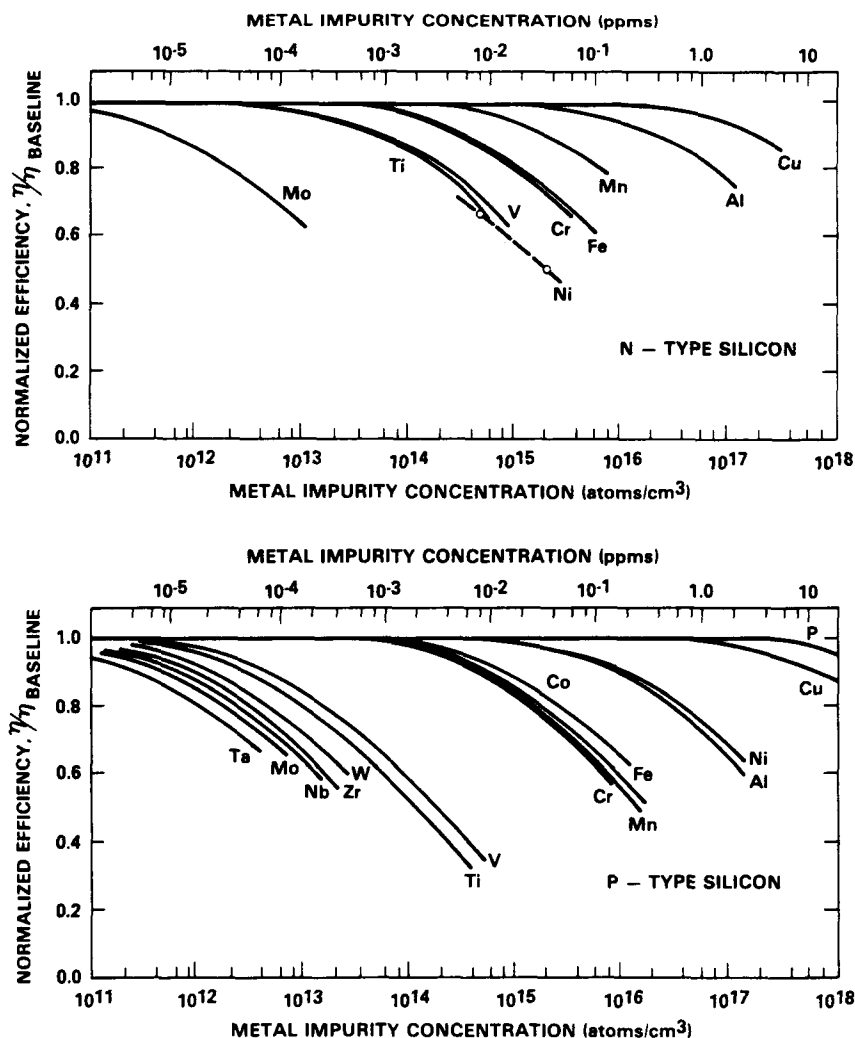

Figure 11. Impurity Concentration Effects on Solar Cell Efficiencies, n-Type and p-Type Silicon

Conclusions

- Decrease of cell conversion efficiency is uniquely dependent on specific impurities and their concentrations.
- General empirical model correlates measured impurity effects on cell performance.
- Significantly less performance reduction caused by most deleterious elements in n-base cells.
- Reduction of electrical activity of impurities by precipitation in vicinity of grain boundaries in polycrystalline material is dependent on impurity diffusion coefficients.
- Removal of impurity elements by thermal and gettering procedures is dependent on diffusion.
- Composition of acceptable polysilicon feedstock depends on factors of single-crystal growth technique, melt-replenishment strategy, and cell-processing sequence.
- Long-term, ambient-temperature cell performance is not significantly changed further by presence of deep-level impurities.

- Only about 10% variation in cell performance is attributable to nonuniform impurity concentration.
- Model and data indicate that higher-efficiency cells are increasingly sensitive to impurities.

Research and Development Needs

- Complete understanding of silicon particle growth mechanisms and particle size control in a fluidized bed reactor.
- Establish product purity and other characteristics of FBR-produced silicon.
- Complete characterization of JPL FBR for operation using high silane concentrations and producing semiconductor-grade silicon.
- Establish engineering design and operation of FBR for long-duration steady-state production of semiconductor-grade silicon.
- Verify low-cost production of polysilicon in Union Carbide Corp. silane/FBR EPSSU.
- Define effects of silicon produced by the silane/FBR process on solar-cell efficiency.

Silicon Sheet

In 1975, all of the silicon sheet used for manufacturing semiconductor devices, including solar cells, consisted of wafers sliced from Czochralski (Cz) crystals by diamond-embedded inside-diameter (ID) saws. This semiconductor-industries technology had evolved to a level of sophistication that was adequate for solar cells for use on spacecraft. However, the cost of producing these wafers was prohibitive for large-scale terrestrial PV uses. The cost of the silicon material and the processes required to produce the thin-sheet constituted the majority of the manufacturing costs of the early terrestrial PV modules. It was known that solar cells could be made from silicon less perfect than single-crystal Cz wafers, but the effects on solar cell performance were not understood. Potentially less expensive silicon sheet had been experimentally grown in a laboratory; however, the quality of solar cells that might be made from these new forms of silicon was unknown. Therefore, an extensive investigation of silicon materials, its processing into thin sheets, and its characteristics for PV use was initiated by the FSA Project.

The *objective* of the silicon sheet activity is to develop a sheet growth technology that will meet the cost and quality requirements for large-scale PV applications. Initially, the objective had been to define, develop, and demonstrate process technologies capable of producing large-area silicon sheet material for production of low-cost solar arrays at a price of \$0.50 per peak watt (1975 dollars) by 1986.

The *goals were* to:

- Develop silicon sheet growth technologies to meet specific cost and quality criteria (including ribbon growth, ingot growth, and ingot slicing).
- Develop growth and slicing equipment to meet these criteria.
- Verify equipment performance.

The *goals now* are to establish crystalline silicon growth technology appropriate for:

- Silicon sheet of quality suitable for fabrication into solar cells with efficiencies up to 20%.
- Sheet at a cost compatible with FSA goals.

The *key technical issues* are to understand the technologies so that sheet growth can be controlled to meet:

- High-area throughput rates that meet quality and economic needs.

- A sheet quality with acceptable crystallographic and impurity characteristics, i.e., type, quantity, and uniformity of distribution.
- Material stability with little stress/strain.

Background

Based upon the silicon sheet R&D performed during the early 1960s, considerable potential existed in 1975 for lower-cost silicon sheet that was surmised to be of adequate quality for terrestrial solar cells, i.e., growth of ribbons, casting of silicon, and advanced (less expensive) Cz and float-zone (FZ) crystal-growth techniques. Three new ribbon growth techniques, by which silicon is grown directly to the thickness of a solar cell, had been conceived and their feasibility had been demonstrated experimentally: the dendritic-web, Stepanov, and edge-defined film-fed growth (EFG) methods.

Direct growth of silicon ribbons that did not require cutting to obtain the appropriate thickness for solar cells obviously was a way to eliminate costly wafering and silicon-material waste. The growing or casting of silicon ingots in rectangular shapes so that they could be cut into square or rectangular wafers, for more efficient solar cell packing into PV modules, also seemed to be economically plausible. However, if cast-ingot technology was to be cost-effective, the slicing of the large ingots into wafers had to be accomplished more economically than with contemporary single-blade ID saws. A common characteristic of these new silicon sheet forms was that they were not ideal, with imperfections and impurities of greater densities and more uneven distributions than those of Cz crystals. The electronic properties of these less-than-perfect forms of sheet were not well known in the 1970s, so many questions had to be answered. What would be the effect on solar cell performance? How would performance be affected by the material purity, the size and characteristics of the grains, and the quality of the crystallographic structure? What quality of silicon sheet could be obtained consistently from the various sheet-growth techniques? How would the cost to produce sheet using each specific technique vary with sheet quality? To answer these questions, considerable research was needed and manufacturing cost-analysis capabilities had to be developed that could be used to periodically assess the progress of the competing technologies.

Project Activities: 1975 to 1981

In 1975, under the stimulus created by the need for large-area low-cost silicon sheet and the availability of Government funds, several more growth techniques than mentioned above were devised. The emphasis was on ribbon technologies because they seemed to offer the greatest potential for inexpensive PV power. However, ingot

technologies were also funded because there was greater assurance that these efforts could succeed. An initial plan was devised that included a four-phase effort: research and development on sheet-growth methods (1975-1977); advanced development of selected growth methods (1977-1980); prototype production development (1981-1982); development, fabrication, and operation of growth production plants (1983-1986).

Concurrently, with the early phases, a cost-to-manufacture economic analysis capability was developed and refined to maturity. Periodic assessments of the economic value of each sheet technology were performed, based upon the latest progress of sheet and other PV technologies. The sheet technologies showing the greatest promise for economic viability were selected for advanced development, and the less promising were dropped. The silicon sheet technologies funded by FSA during the late 1970s are shown in Tables 3 and 4. The lists of active contracts in June 1977 and September 1978 show that in this period, the less promising ribbon techniques were dropped, and that new advanced Cz growth efforts (and die and container material studies) were initiated. Early in 1981, a major review of the remaining sheet techniques was performed. The dendritic web, EFG, and silicon-on-ceramic (SOC) efforts continued to be supported. Also, the advanced Cz (by Kayex Corp.), heat-exchange method (HEM), a Semix, Inc., casting process, and multiwire ingot slicing received continued support.

The Cz growth technique is shown in Figure 12. Semiconductor silicon chunks, the "charge," are melted in a quartz crucible within a sealed grower furnace filled with argon. A silicon "seed" of the appropriate crystallographic orientation is lowered until it is in contact with the molten silicon surface, and is then withdrawn slowly. The single-crystal silicon that grows on the seed has the same crystallographic structure as the seed, as long as the furnace conditions and seed withdrawal are properly controlled. The dimensions of the Cz crystal or ingot are determined by the quantity of the silicon charge and the rate of seed withdrawal. The dopant and impurity levels in the crystal are determined by the trace elements in the charge, except that additional oxygen and carbon are introduced during the growth process from the quartz (SiO_2) crucible and the graphite furnace components. Control of impurities, structural defects, and their uniformities have been improved considerably by careful analysis, experimentation, and improved grower design and operational control. Goals and status are shown in Table 5.

Cast-silicon ingots (Figures 13 and 14) have the advantage of being cast in such a form that square or rectangular wafers can be sliced directly from the ingot. Some cast ingots are large enough that they can be slabbed into four or nine square ingots before being sliced into wafers. Cast ingots are less expensive than Cz ingots because their solidification

rates are faster. However, they are polycrystalline. The quality, size, and uniformity of grains in the ingot, plus the non-uniform distribution of impurities, are parameters that influence the electronic quality of specific cast ingots. The efficiencies of solar cells made from these materials are generally less than those of Cz cells, and are highly dependent upon the ingot quality. Goals and status are shown in Tables 6 and 7.

Three ingot slicing techniques on which FSA has sponsored R&D are ID, multiblade, and multiwire (shown in Figures 15, 16 and 17). The ID and multiwire saws have cutting materials embedded in a softer matrix and are subject to wearout as the cutting particles are dulled or eroded away. The multiblade saw and a multiwire saw (also funded by DOE) use a slurry containing abrasive particles. In all cases, cooling of the cutting area with a fluid is required. The sawing occurs by the tearing away of silicon, causing surface damage to the sawed wafer. The surface damage is different for each sawing technique; in each case it must be removed, usually by etching the wafer in acid. Goals and status are shown in Table 8.

The most advanced and still the most promising ribbon technologies are the EFG methods and the dendritic web methods (shown in Figures 18 and 19).

In the EFG method, the molten silicon moves upward between parallel walls of a graphite die by capillary action. A silicon seed is lowered to make contact with the molten silicon in the top of the die, and is then pulled upward. The shape of the resulting ribbon grown on the seed is defined by the shape of the top of the die. Relatively large quantities of ribbon can be grown quickly, especially by pulling several ribbons simultaneously from the same melt. Mobile Solar Energy Corp. devised, with its own funds, and is producing nine ribbons from one melt by its "nonagon" concept (a tubular shape with nine flat sides). The quality of the EFG ribbon is its major limitation: it produces solar cells with lower efficiencies than are possible with Cz or FZ wafers. The molten silicon reacts with the graphite dies and, as the silicon cools, silicon carbide precipitates are incorporated into the ribbon. The result is a ribbon that has a disrupted crystalline structure with uneven impurity distributions. Goals and status are shown in Table 9.

Ribbon grown by the dendritic-web method is of higher quality than EFG ribbon and other ribbons. Its electronic quality can be almost as good as that of Cz wafers, except that it has a "twinning plane" in the plane of the ribbon throughout the ribbon length. By precise control of temperatures and temperature gradients, during and after seeding and growth initiation, parallel silicon filaments, called "dendrites," can be grown in the silicon melt. Under carefully controlled withdrawal, the dendrites continue to grow and a film of molten silicon forms and solidifies between them. The only solid material that the molten silicon contacts is the quartz crucible which minimizes contamination and results in a

Table 3. Silicon Sheet Contractors: June 1977

Contractor	Technology Area
Ribbon Growth Processes	
Mobil-Tyco Solar Energy Waltham, Massachusetts (JPL Contract 954335)	Edge-defined, film-fed growth
IBM Hopewell Junction, New York (JPL Contract 954144)	Capillary action shaping technique
RCA Princeton, New Jersey (JPL Contract 954465)	Inverted Stepanov growth
Univ. of So. Carolina, Columbia, South Carolina (JPL Contract 954344)	Web-dendritic growth
Motorola Phoenix, Arizona (JPL Contract 954376)	Laser zone ribbon growth
Westinghouse Research Pittsburgh, Pennsylvania (JPL Contract 954654)	Dendritic web process
Sheet Growth Processes	
Honeywell Bloomington, Minnesota (JPL Contract 954356)	Dip coating of low-cost substrates
Rockwell Anaheim, California (JPL Contract 954372)	Chemical vapor deposition on low-cost substrates
General Electric Schenectady, New York (JPL Contract 954350)	Chemical vapor deposition on floating silicon substrate
Univ. of Pennsylvania, Philadelphia, Pennsylvania (JPL Contract 954506)	Hot-forming of silicon sheet
Ingot Growth Process	
Crystal Systems Salem, Massachusetts (JPL Contract 954373)	Heat-exchanger ingot casting ^a
Ingot Cutting	
Crystal Systems Salem, Massachusetts (JPL Contract 954373)	Multiple wire sawing ^a
Varian Lexington, Massachusetts (JPL Contract 954374)	Breadknife sawing
^a Single contract provides for both ingot casting and multiple wire sawing.	

Table 4. Silicon Sheet Contractors: September 1978

Contractor	Technology Area
Shaped Ribbon Technology	
Mobil-Tyco Solar Energy Waltham, Massachusetts (JPL Contract 954355)	Edge-defined film-fed growth
Motorola, Inc. Phoenix, Arizona (JPL Contract 954376)	Ribbon growth, laser zone regrowth
Westinghouse Research Pittsburgh, Pennsylvania (JPL Contract 954654)	Dendritic web process
Supported Film Technology	
Honeywell Corp. Bloomington, Minnesota (JPL Contract 954356)	Silicon on ceramic substrates
RCA Labs Princeton, New Jersey (JPL Contract 954817)	Epitaxial film growth on low-cost silicon substrates
Ingot Technology	
Crystal Systems, Inc. Salem, Massachusetts (JPL Contract 954373)	Heat exchanger method (HEM), cast ingot, and multiwire fixed abrasive slicing
Kayex Corp. Rochester, New York (JPL Contract 954888)	Advanced Cz growth
Siltec Corp. Menlo Park, California (JPL Contract 954886)	Advanced Cz growth
Texas Instruments Dallas, Texas (JPL Contract 954887)	Advanced Cz growth
Varian Vacuum Division Lexington, Massachusetts (JPL Contract 954374)	Multiblade slurry sawing
Varian Vacuum Division Lexington, Massachusetts (JPL Contract 954884)	Advanced Cz growth
Die and Container Materials Studies	
Battelle Labs Columbus, Ohio (JPL Contract 954876)	Silicon nitride for dies
Coors Porcelain Golden, Colorado (JPL Contract 954878)	Mullite for container and substrates
Eagle Picher Miami, Oklahoma (JPL Contract 954877)	CVD silicon nitride and carbide
RCA Labs Princeton, New Jersey (JPL Contract 954901)	CVD silicon nitride
Tylan Torrance, California (JPL Contract 954896)	Vitreous carbon

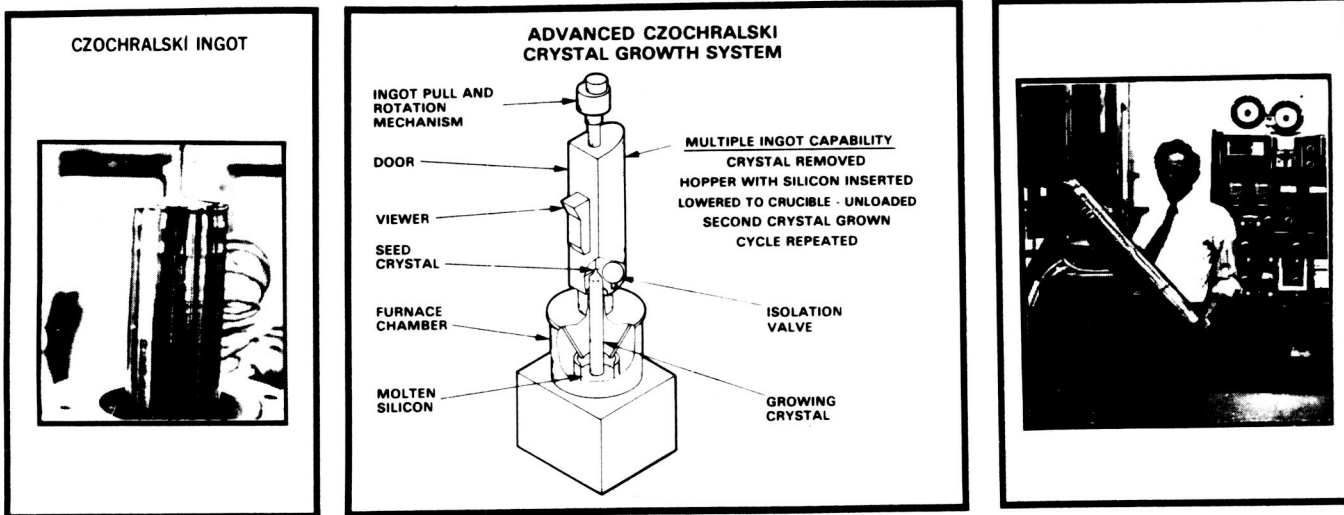

Figure 12. Advanced Czochralski Crystal Growth by Hamco Division (Kayex Corp.)

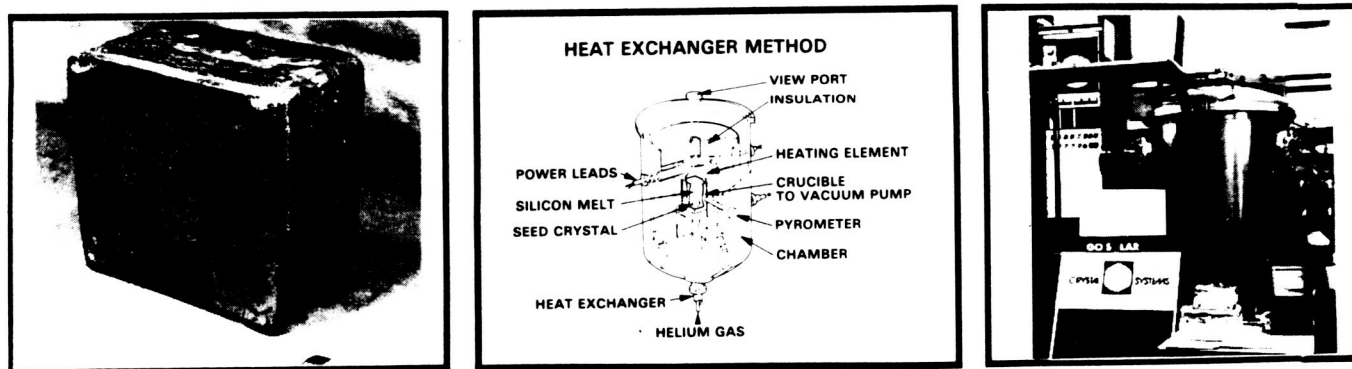

Figure 13. Ingot Casting by Heat Exchanger Method by Crystal Systems, Inc.

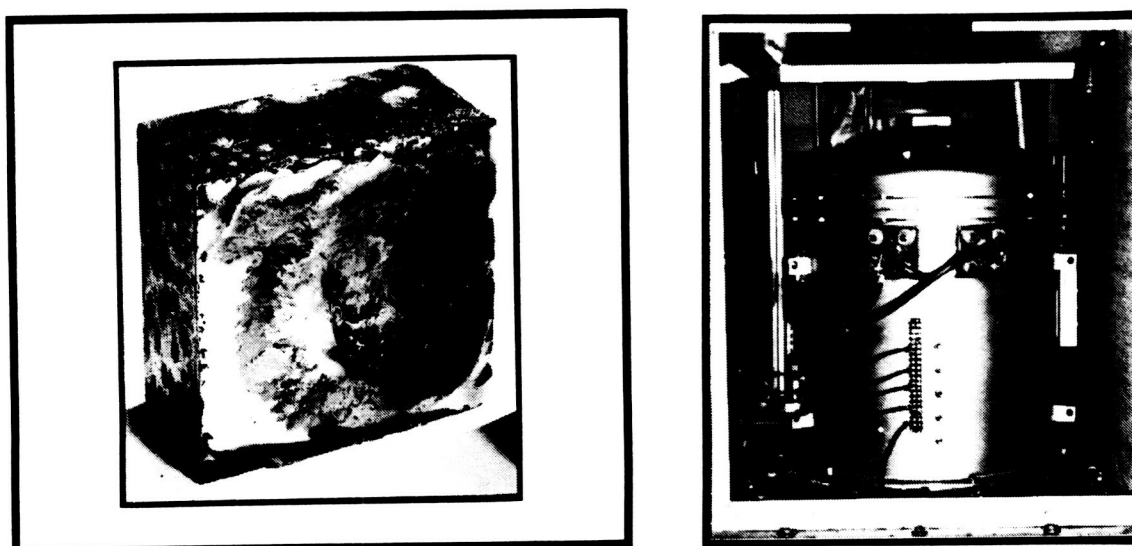

Figure 14. Ingot Casting by Semicrystalline Casting Process by Semix, Inc.

Table 5. Advanced Czochralski Crystal Growth by Hamco

GOALS:	STATUS	R&D NEEDS
<ul style="list-style-type: none"> • 150 kg OF INGOTS/ CRUCIBLE • 15-cm-DIA INGOT • 2.5 kg/hr THROUGHPUT • AUTOMATION • 15% ENCAPSULATED SOLAR CELL EFFICIENCY • 90% YIELD 	<ul style="list-style-type: none"> • 150 kg OF INGOTS/ CRUCIBLE • 15-cm-DIA INGOT • 2.2 kg/hr THROUGHPUT • UNDER DEVELOPMENT AT END OF CONTRACT (LATER ACHIEVED BY HAMCO) • 15% SOLAR CELL EFFICIENCY** • 86% YIELD 	<ul style="list-style-type: none"> • INGOT QUALITY: STRUCTURAL PERFECTION • GROWTH PARAMETER OPTIMIZATION <hr/> <p>1986 INGOT ADD-ON PRICE* (1980 \$/W_p)</p> <hr/> <ul style="list-style-type: none"> • FSA PRICE ALLOCATION 0.112 • SAMICS PROJECTION 0.162

* ASSUMES 0.73 m² OF WAFERS/kg OF INGOT
 ** ENCAPSULATED CELL EFFICIENCY N.A.

Table 6. Ingot Casting by Heat Exchanger Method by Crystal Systems, Inc.

GOALS:	STATUS:	R&D NEEDS
<ul style="list-style-type: none"> • 30 cm x 30 cm x 15 cm SHAPED INGOT (35 kg) • > 90% SINGLE CRYSTAL • 2.0 kg/hr GROWTH RATE • 15% ENC. SOLAR CELL EFFICIENCY • > 95% YIELD 	<ul style="list-style-type: none"> • 34 cm x 34 cm x 17 cm SHAPED INGOT (35 kg) • > 95% SINGLE CRYSTAL • 1.9 kg/hr GROWTH RATE • 15% SOLAR CELL EFFICIENCY • > 95% YIELD 	<ul style="list-style-type: none"> • IMPROVED INGOT QUALITY • INCREASED INGOT YIELD <hr/> <p>1986 INGOT ADD-ON PRICE* (1980 \$/W_p)</p> <hr/> <ul style="list-style-type: none"> • FSA PRICE ALLOCATION 0.194 • SAMICS PROJECTION 0.17

• ASSUMES 1 m² OF WAFERS/kg OF INGOT

Table 7. Semicrystalline Casting Process by Semix

GOALS:	STATUS:	R&D NEEDS
<ul style="list-style-type: none"> • 30 cm x 30 cm x 19 cm SHAPED INGOT (40 kg) • SEMICRYSTALLINE • 15% SOLAR CELL EFFICIENCY • 98% INGOT YIELD • 2.3 kg PER HOUR CRYSTALLIZATION RATES 	<ul style="list-style-type: none"> • 20 x 20 x 15 (14 kg) • SEMICRYSTALLINE • 15% SOLAR CELL EFFICIENCY • 83% INGOT YIELD • 2.3 kg PER HOUR 	<ul style="list-style-type: none"> • LARGE QUANTITY OF LARGE AREA CELLS AT 15% • DEMONSTRATION OF HIGH THROUGHPUT PROCESSING <hr/> <p>1986 ADD-ON PRICE* (1980\$/W_p)</p> <hr/> <ul style="list-style-type: none"> • FSA PRICE ALLOCATIONS 0.256 • SEMIX PROJECTION 0.115

* USING 0.81 m² OF WAFERS/kg OF INGOTS

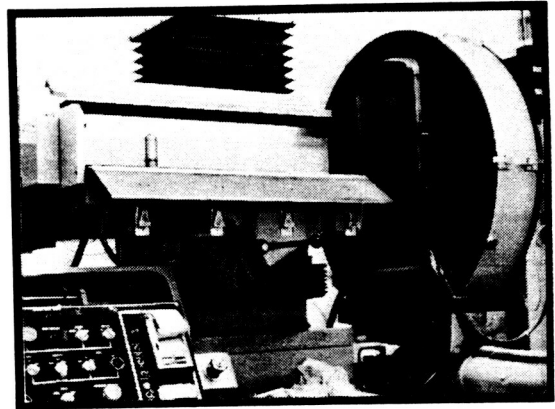
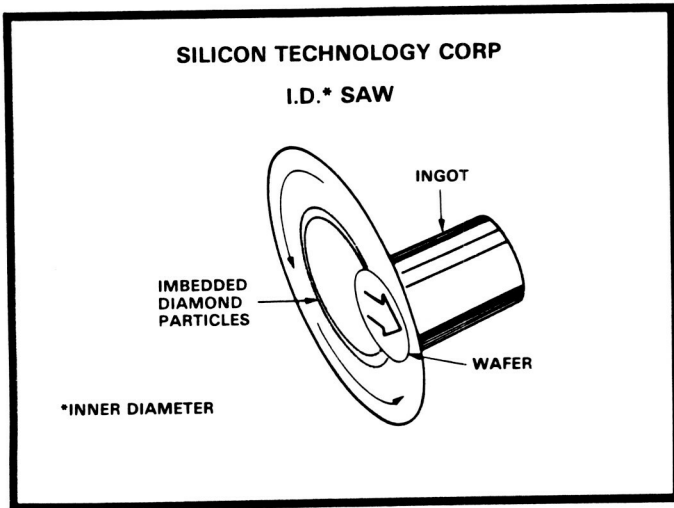

Figure 15. Inside Diameter Ingot Saw by Silicon Technology Corp.

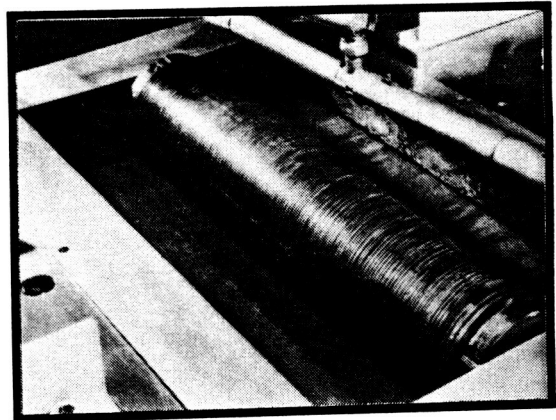
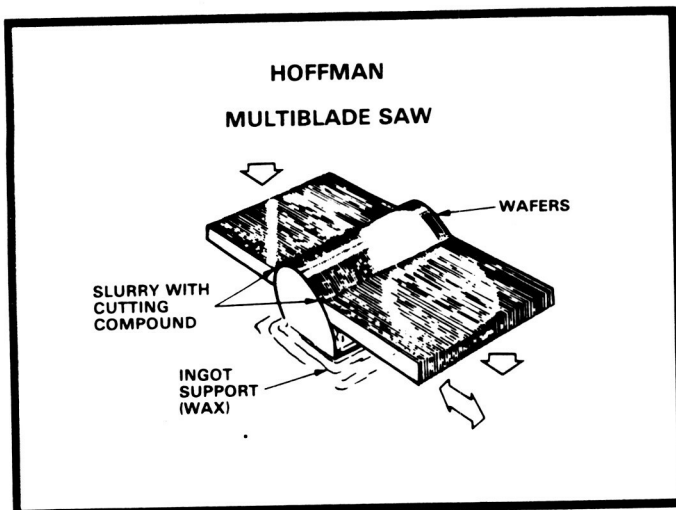
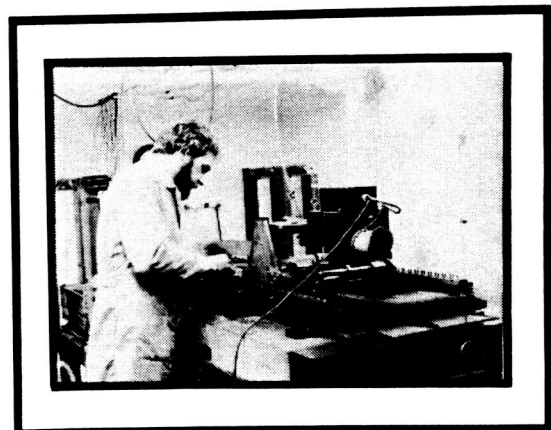
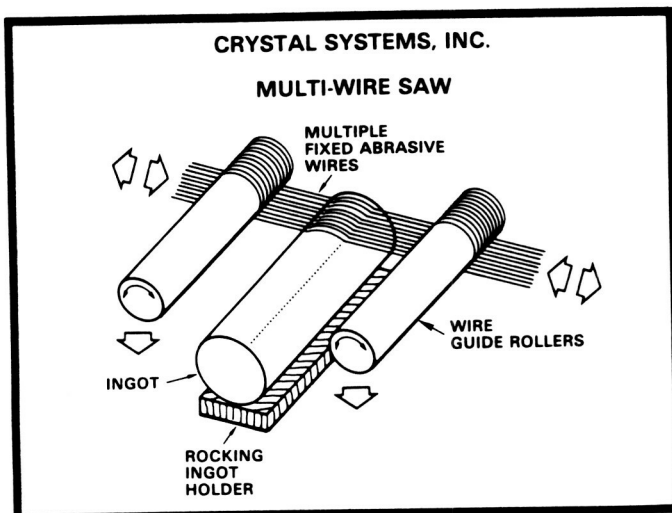

Figure 16. Multiblade Saw by P.R. Hoffman Co.

ORIGINAL FACTORY
OF BOOR QUALITY



* Figure 17. Multiwire Saw by Crystal Systems, Inc.

Table 8. Advanced Wafering Technologies by Crystal Systems Inc., P.R. Hoffman, and Silicon Technology Corp.

GOALS		STATUS (BEST SINGLE DEMONSTRATION)		ADDITIONAL R&D REQUIRED
<u>15 cm DIA</u> 20 WAFERS/cm OF INGOT	<u>10 x 10 cm square</u> 25 WAFERS/cm OF INGOT	<u>15 cm DIA</u> 17 WAFERS/cm	<u>10 x 10 cm</u> 25 WAFERS/cm	<ul style="list-style-type: none"> • DEVELOP FUNDAMENTAL UNDERSTANDING OF WAFERING PROCESS, FOR INCREASING THROUGHPUT • INCREASED WAFER THROUGHPUT • REDUCED EXPENDABLE COSTS • SENSITIVITY TO EXTENDED OPERATION <hr/> 1986 WAFER ADD-ON PRICE (1980 \$/W _p) <hr/> <ul style="list-style-type: none"> • FSA PRICE ALLOCATION 0.081 (15 cm DIA) • SAMICS 0.110 (15 cm DIA)
0.5 WAFER/min	1 WAFER/min	0.42 WAFER/min	1.25 WAFER/min	
0.82 m ² /kg*	1.0 m ² /kg*	0.69 m ² /kg**	1.0 m ² /kg	
95% YIELD	95% YIELD	95%	95%	

*NO LONGER UNDER DEVELOPMENT

**SQUARE METER OF WAFERS/KILOGRAM OF INGOT

clean, smooth ribbon. The dendrites are easily removed after the ribbon has cooled. The major disadvantage of this method is the low production rate of quality ribbon. Significant difficulties have been encountered as faster growth rates and sustained operation for many hours have been attempted. The problems of growing low-stress ribbons at economical growth rates continue to plague the web efforts. Goals and status are shown in Table 10.

The silicon-on-ceramic (SOC) technique was the third promising non-ingot growth method. It was unique in that it had high growth rates; but the efficiency of solar cells made from it was low. Consequently, when the need for higher efficiency became widely accepted and the Project funds were cut, SOC efforts were dropped (see Figure 20 and Table 11).

In 1981, the direction of the National Photovoltaics Program was altered to emphasize long-term, high-risk research efforts, and funding was significantly reduced. Concurrently, there was a growing awareness that PV module efficiencies had to be raised considerably if PV was to be cost effective for large utility applications. Higher-efficiency modules and solar cells require higher-quality silicon sheet. Consequently, the production-development-oriented third and fourth phases were discontinued, and ingot growth, ingot slicing, and ribbon technologies other than dendritic web and EFG were no longer funded.

The status of the sheet technologies that were dropped because of programmatic changes are shown in Table 12, as they were at time of contract completion. An exception, low-angle silicon sheet (LASS) growth method, was funded for about 2 years.

Project Activities: 1981 to Present

With a change in Project directions, R&D on specific growth technologies was then replaced by generic growth R&D. More recently, a concerted effort to increase the area growth rates of high-quality dendritic web are now supported by a consortium of utilities, DOE and Westinghouse. The status of web and EFG in 1985 is shown in Table 13.

As time passed, ribbon-buckling problems and reduced ribbon quality that were encountered when higher ribbon growth rates were attempted led to the conclusion that a more fundamental understanding of the impediments to high-speed silicon ribbon growth and quality was required. This resulted in the establishment of an interactive university-industry-Government effort that continues to actively pursue theoretical and experimental ways to achieve high-speed, high-quality silicon crystal growth. Computer models have been developed and are being used to study the stress/strain relationship in the silicon solidification zone and the nearby areas in the ribbon. The analytical results are then experimentally evaluated on ribbon-growth equipment at Westinghouse and Mobil Solar. In support, high-temperature silicon material properties are being determined and sophisticated instrumentation and measurement techniques continue to be developed. Progress and problems of the various efforts are discussed at frequent meetings and the results iterated into the appropriate activities. A low-angle (horizontal) silicon sheet growth effort was also initiated to explore the potential value of this very high-speed-ribbon-growth technique (Figure 21 and Table 14). This technique has the potential to evolve into a practical growth technology, but is not now funded by DOE because of a shortage of funds. It was funded in an attempt to gain generic information about high-speed silicon growth.

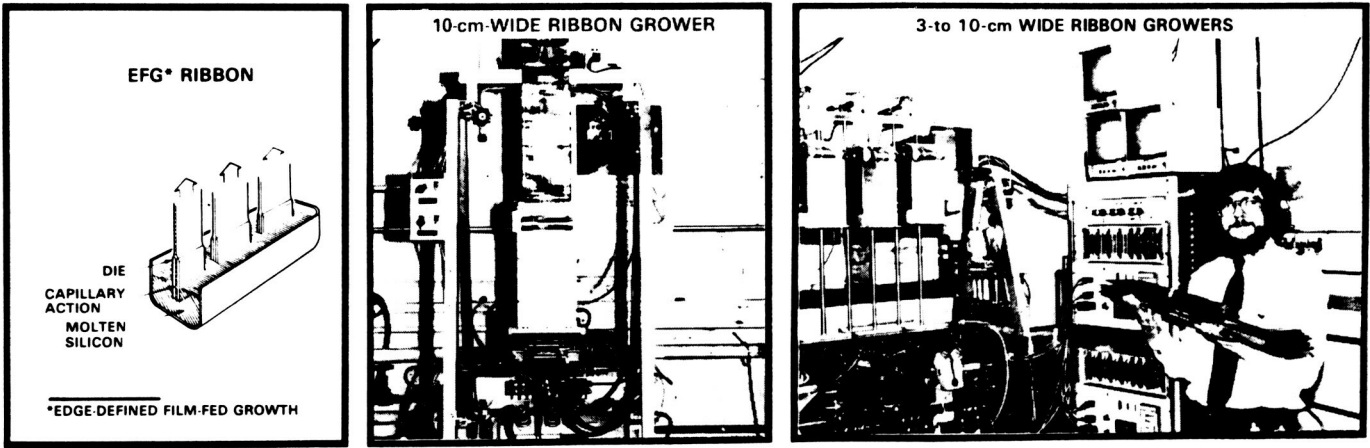

Figure 18. Edge-Defined Film-Fed Ribbon Growth by Mobil Solar Energy Corp.

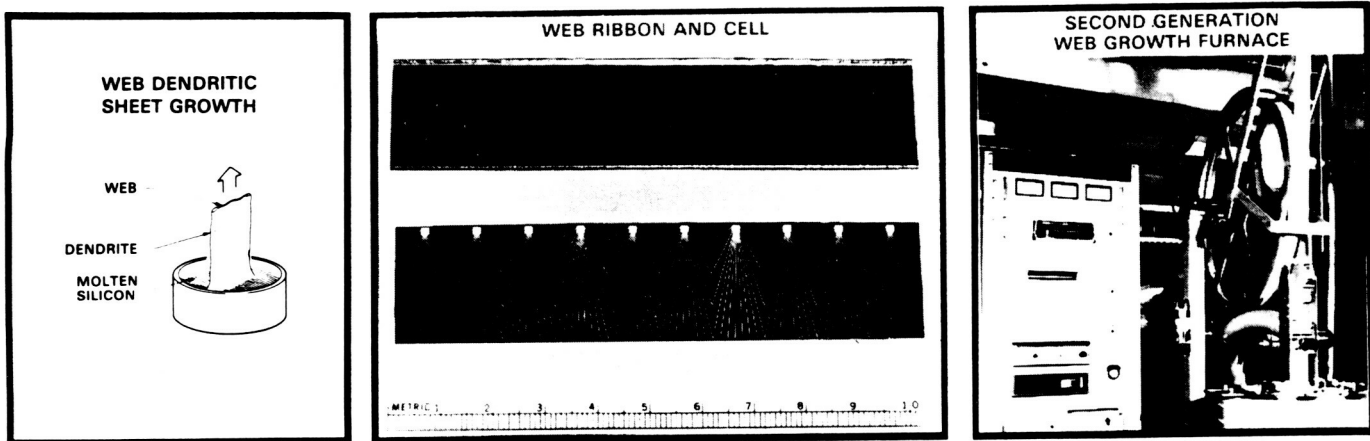

Figure 19. Dendritic-Web Ribbon Growth by Westinghouse

ORIGINAL PAGE IS
OF POOR QUALITY



Figure 20. Silicon-on-Ceramic by Honeywell

Table 9. Edge-Defined Film-Fed Ribbon Growth by Mobil Solar Energy Corp.

<u>GOALS:</u>	<u>STATUS:</u>	<u>R&D NEEDS:</u>
<ul style="list-style-type: none"> • SIMULTANEOUS GROWTH OF* 4 RIBBONS, 10 cm WIDE EACH, AT 4 cm/min FOR 8 hr WITH AUTOMATIC CONTROLS • MULTIPLE RIBBON GROWTH* STATION • 0.20 mm RIBBON THICKNESS • 12% ENCAPSULATED SOLAR CELL EFFICIENCY • 80% YIELD 	<ul style="list-style-type: none"> • 40 cm²/min (10 cm WIDE* x 4.0 cm/min) (4 hr DEMO OF ONE RIBBON) • DEMONSTRATED* (5 RIBBONS AT 5 cm WIDE) (3 RIBBONS AT 10 cm WIDE) • 0.15-mm RIBBON THICKNESS • >12% SOLAR CELL** EFFICIENCY 	<ul style="list-style-type: none"> • IMPROVED SHEET QUALITY • INCREASED THROUGHPUT GROWTH SPEED <hr/> 1986 SHEET ADD-ON PRICE (1980 \$/W _p) <hr/> <ul style="list-style-type: none"> • FSA PRICE ALLOCATION 0.205 • SAMICS* PROJECTION 0.194

*MOBIL DEVELOPING COMPETITIVE NONAGON EFG TECHNOLOGY

**ENCAPSULATED CELL EFFICIENCY N.A.

Table 10. Dendritic-Web Ribbon Growth by Westinghouse

<u>GOALS (LATE 1986):</u>	<u>STATUS:</u>	<u>R&D NEEDS:</u>
<ul style="list-style-type: none"> • 30-cm²/min AREA GROWTH RATE FOR 50 METER-LONG CRYSTAL AND CONSTANT MELT LEVEL • 17.5% SOLAR CELL EFFICIENCY • PROCESS AUTOMATION 	<ul style="list-style-type: none"> • 13-cm²/min AREA GROWTH RATE FOR SHORT RIBBON LENGTHS AND GROWTH RATE • 16.9% CELL EFFICIENCY • AUTOMATION BEING INCORPORATED • 8-hr DEMONSTRATION RIBBON GROWTH FOR 8-3/4 hr AT CONSTANT MELT LEVEL 	<ul style="list-style-type: none"> • INCREASED THROUGHPUT • GROWTH AND STABILITY <hr/> 1986 SHEET ADD-ON PRICE (1980 \$/W _p) <hr/> <ul style="list-style-type: none"> • FSA PRICE ALLOCATION 0.292 • SAMICS PROJECTION 0.160

Table 11. Silicon-on-Ceramic by Honeywell

<u>GOALS:</u>	<u>STATUS:</u>	<u>ADDITIONAL R&D REQUIRED:</u>
<ul style="list-style-type: none"> • <\$6/m² SUBSTRATE COST • 350-cm²/min AREA GROWTH RATE (2 SHEETS) • 0.10-mm FILM THICKNESS • 11% ENCAPSULATED SOLAR CELL EFFICIENCY • 95% YIELD 	<ul style="list-style-type: none"> • MULLITE SUBSTRATE IDENTIFIED <\$6/m² PROJECTED • 60-cm²/min AREA GROWTH RATE (1 SHEET) • <0.10-mm FILM THICKNESS • 10.5% SOLAR CELL** EFFICIENCY ON DIP-COATED SOC 	<ul style="list-style-type: none"> • IMPROVED SHEET QUALITY • INCREASED THROUGHPUT • OPTIMIZED CELL DESIGN <hr/> 1986 SHEET ADD-ON PRICE (1980 \$/W _p) <hr/> <ul style="list-style-type: none"> • FSA PRICE ALLOCATION 0.190 • SAMICS PROJECTION N.A.

*NO LONGER UNDER DEVELOPMENT

**ENCAPSULATED CELL EFFICIENCY N.A.

Table 12. Technology Status at Completion of Contract

SHEET TECHNOLOGY	DIMENSIONS (cm)		THROUGHPUT (kg/hr)† or (m ² /hr)		MATERIAL UTILIZATION m ² /kg		SOLAR CELL EFFICIENCY %AM1		ADD-ON PRICE \$/W _p (1980\$)
							ENCAPSULATED	BARE CELL	
	TR GOAL	STATUS	TR GOAL	STATUS	TR GOAL	STATUS	TR GOAL	ESTIMATED* STATUS	TR ALLOCATION
INGOT	TR GOAL	STATUS	TR GOAL	STATUS	TR GOAL	STATUS	TR GOAL	ESTIMATED* STATUS	TR ALLOCATION
Adv. CZ	15 DIA	15 DIA	2.5†	2.2†	n.a.	n.a.	15	13.5	0.112
HEM	30x30x15	34x34x17	1.0†	1.0†	n.a.	n.a.	15	11.5	0.194
Semix Casting Process	30x30x19	20x20x15	2.3****	2.3****	n.a.	n.a.	15	11.0	0.245****
Adv. Wafering**	15 DIA & 10x10 SQ	15 DIA & 10x10 SQ	0.53 0.60	0.42 0.75	0.73 1	0.65 1	n.a. n.a.	n.a. n.a.	0.081 0.062
SHAPED SHEET									
LASS	1 @ 15			3.6		3.6	12		
SOC	2 @ 12.5 x 0.010	1 @ 10 x 0.010	2.1	0.3	4.3	4.3	11	9.5	0.190

*HIGHER EFFICIENCY INDIVIDUAL CELLS HAVE BEEN FABRICATED
 **DATA GIVEN FOR ID WAFERING. OTHER WAFERING APPROACHES WILL ALTER THE FIGURES
 ***ADDED VALUE FOR CASTING AND WAFERING
 ****CRYSTALLIZATION RATE kg/hr

Table 13. Technology Status of Active Contracts

SHEET TECHNOLOGY	DIMENSIONS (cm)		THROUGHPUT (m ² /hr)		MATERIAL UTILIZATION m ² /kg		SOLAR CELL EFFICIENCY %AM1		ADD-ON PRICE \$/W _p (1980\$)
							ENCAPSULATED	BARE CELL	
	TR GOAL	CURRENT STATUS	TR GOAL	CURRENT STATUS	TR GOAL	CURRENT STATUS	TR GOAL	ESTIMATED* STATUS	TR ALLOCATION
SHAPED SHEET									
EFG**	4 @ 10 WIDE x 0.020 THICK	3 @ 10 WIDE x 0.020 THICK	0.96	0.60	2.15	2.15	12	14	0.205
WEB	—	—	0.18	0.05	≤3.2	≤3.2	15	16.9	0.292

*HIGHER EFFICIENCY INDIVIDUAL CELLS HAVE BEEN FABRICATED
 **NONAGON RIBBON CONFIGURATION FUNDED BY MOBIL SOLAR HAS HIGHER VALUES.

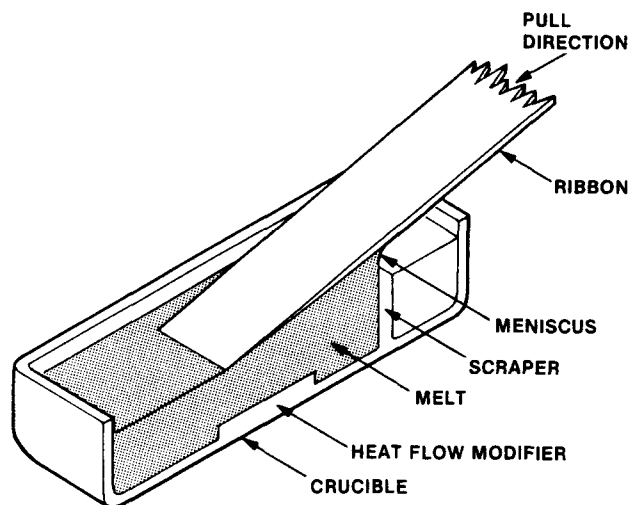

Figure 21. Low-Angle Silicon Sheet Ribbon Growth by Energy Materials Corp.

Of all of the sheet technologies, dendritic web is viewed today as having the greatest potential for high-quality sheet with the best economical value. However, close temperature control of the silicon liquid-solid interface regions in the grower are required. By 1981, a number of web-growth requirements to meet Project goals had been

Table 14. Low-Angle Silicon Sheet Growth by Energy Materials Corp.

STATUS (BEST INDIVIDUAL ACHIEVEMENT)	
RIBBON WIDTH:	15 cm
RIBBON THICKNESS:	25 mils
PULL SPEED:	1 RIBBON AT 85 cm/min
THROUGHPUT:	450 cm ² /min
EFFICIENCY:	12.9%

demonstrated individually. But until a few months ago, progress had been very slow in the efforts to achieve all growth requirements simultaneously and to grow web continuously for hours while meeting the requirements. To obtain a fresh look at this growth technique, a special JPL Web Team was formed and has recently made interesting advancements (Table 15). During the last few months, Westinghouse has also made good progress (Table 16). The major question still remains: How economically can high-quality web be grown under production conditions?

Table 15. JPL Web Team

Objective
The objective of the JPL Web Team is to conduct an independent R&D activity that will increase the likelihood that dendritic web technology will achieve the DOE goals.
Approach
Team effort consists of a combination of analytical and experimental work.
Operate a modified Westinghouse web growth system.
Measure high temperature physical properties of silicon.
Use improved stress web model to determine a web temperature profile resulting in higher area growth rates of web with satisfactory quality.
Use thermal model of web to determine a growth system thermal configuration that will yield the desired web temperature profile.
Use thermal analysis of web-growth interface and the susceptor-crucible melt to determine a growth system thermal configuration that will improve stability of growth process.
Design, fabricate, and test the new thermal configurations and feed results back into the models.
Accomplishments
High temperature properties of silicon have been measured.
A stress model of growing web has been developed and used.
A thermal model of growth system configuration to control web temperature has been developed.
A thermal model of susceptor, crucible, and melt has been developed.
Westinghouse growth system has been installed with an improved data acquisition system.
Numerous web ribbons have been grown.

Table 16. Dendritic-Web Growth Progress by Westinghouse (Westinghouse data)

Development	1977	1978	1979	1980	1981	1982	1983	1984	Mid 1985
Area Growth Rate, cm ² /min 1) Transient (Lengths Of Several Centimeters) 2) Quasi-Steady-State (Lengths Of 30 To 100 cm) 3) Steady-State (Meters Of Length, Hours Of Growth)	2.3	8	23	27	7 4	13 8	42		
Maximum Undeformed Width, Centimeters	2.4	3.5	4.0	4.4		5.5	5.8		6.7
W ₁₅₀ -Undeformed Width At 150 μm Thickness (An Inverse Measure Of Buckling Stress)		2.0	2.7	3.2		4.9			
Maximum Area Throughput For Single Furnace in 5-Day Week (cm ² /week)								9,000	27,000
Maximum Demonstrated Solar Cell Efficiency, AM1	13	14	15	15.5			15.9	16.2	16.9

All three ingot technologies (shown in Figures 12, 13, and 14) are in commercial use today for terrestrial solar cells. The majority of the wafers for terrestrial solar cells are still sliced from Cz single-crystal ingots. In 1975, the solar cells fabricated specifically for terrestrial use were made from the circular wafers sliced from Cz cylindrical crystals. Today, Cz crystals generally are slabbed lengthwise, converting cylinders into polygons that are then sliced into polygon wafers, thereby enabling the solar cells to be more efficiently "packed" into modules. Now, much larger Cz crystals are grown and multiple crystals can be grown from the same crucible by using melt-replenishment. Formerly, a new crucible was required for each crystal grown.

Today, ID sawing remains the predominant commercial, and most economical, slicing technology. More economical sawing remains the major impediment to continued long-term use of ingot technologies for PV. Studies of the basic mechanisms involved in the removal of silicon, including the influence on cutting rates and surface damage of various fluids, are promising. These results, as yet, have not been applied in an attempt to develop a new saw or to improve existing saws.

The best-quality silicon sheet today is obtained by FZ crystal growth; the next best is by Cz crystal growth. Very high-efficiency solar cells have been made in the laboratory from FZ wafers. However, FZ technology is not used commercially for PV because of its high cost. FZ technology development has never been part of the FSA Project. Excellent progress in reducing the cost of growing Cz crystals was made during the late 1970s, primarily by FSA-sponsored efforts. During the early 1980s, continuing progress in improved Cz crystal quality has been made for and by the integrated-circuit industry to meet its needs for more compact and sophisticated devices. The achievement of even higher-quality Cz crystals by MCz (Cz crystals grown in a magnetic field), improved understanding of growth phenomena, and better equipment is continuing for more stringent future integrated-circuit industry needs. These activities fit in well with the PV need for higher-efficiency cells. However, the major obstacle to future use of Cz or FZ wafers for PV is the cost of wafering. The added cost of the wafering step is incidental to the cost of manufacturing integrated-circuit devices, but it looms as the single most costly item if Cz or FZ technology is to be used for future solar cells (one cell/wafer) and modules. A very low key, but promising effort on understanding the basic mechanism of silicon fracturing during sawing has been continuing. With the uncertainties in the economical value of ribbon growth, it would be prudent to increase efforts leading to more economical slicing and an evaluation of the technical and economical potential of advanced Cz and advanced FZ crystal growth for higher-efficiency, low-cost PV cells and modules.

Progress Since 1975

Ingot Technology

- Cz Ingots
 - Ingot diameters increased from 3 to 6 in.
 - Throughput rates were increased threefold.
 - Ingot quality was improved.
 - Sheet costs were decreased to one-seventh.
- Cast Ingots
 - Two concepts have proven feasible: HEM and Semix (semicrystalline).
 - The same two techniques have advanced to commercial products.
- Wafering
 - Developed and demonstrated increased ingot slicing capabilities.
 - Reduced production costs.

Ribbon Technology

- Thirteen ribbon and non-ingot technologies were investigated.
- Two ribbon technologies continue to be supported:
 - Dendritic web, by Westinghouse Electric Corp.
 - EFG, by Mobil Solar Corp. (now funded only as generic ribbon growth).
- One ribbon technology (EFG) is now commercially available. One ribbon technology (web) is scheduled to be demonstrated by late 1986.
- Significant improvements in understanding high-speed crystalline silicon growth phenomena are being obtained.
- Low-angle silicon sheet, by Energy Materials Corp. (contract ended June 1985).

Recent Achievements

- Thin, flat, essentially stress-free dendritic-web ribbon width has been increased to 6.7 cm (Westinghouse).

- Using a new grower with dynamic controls, dendritic-web linear growth rates have been increased to 3.0 cm/min for 150- μ m-thick ribbons under transient growth conditions (Westinghouse).
- Dendritic-web transient area growth rate for short ribbon lengths was increased from 27 to 42 cm²/min (Westinghouse: see web growth progress, Table 16).
- Continuous web ribbon growth with melt replenishment was increased to 7-m length at 7 cm²/min using technology developed for FSA (Westinghouse).
- Integration of the theoretical studies of heat flow and interface stability by Massachusetts Institute of Technology (MIT), and plastic flow near the interface region by Harvard University, were integrated with residual stress data by Mobil Solar.
- Microhardness tests of silicon in various fluid environments has revealed that the surface hardness of silicon varies apparently as a function of the fluid's dielectric constant. Tests were conducted with toluene, acetone, ethanol, methanol, glycerol, and deionized water (University of Illinois at Chicago).
- A research forum and other meetings on high-speed growth and characterization of crystals for solar cells have resulted in a definition of the areas requiring research.
- A comprehensive plan for increasing ribbon quality and growth capability has been devised and is being partially implemented.
- Stress/strain effects on ribbon and bulk silicon during growth.
- Effects of impurities on stress/strain in silicon growth.
- Fracture mechanics and surface chemistry effects on:
 - Device efficiency.
 - Cell and module performance lifetime.
 - Fabrication and processing rates and yields.

Ribbon Technology

- A general thermal stress model of ribbon growth integrating creep behavior, growth speed, and ribbon width should be completed and applied to all ribbon growth processes.
- Correlation of observed buckling phenomena and stress model.
- Data on basic silicon material properties (i.e., creep behavior and stress moduli) at temperature range of interest (800 to 1400 °C).
- Correlation of structure (i.e., dislocations and grain boundaries) effects with generated stress.
- Impurity effects on stress generation.
- Verification of stress model with experimental growth systems in industry.
- Construction of or modification of a growth system that integrates all information generated to produce optimum silicon ribbons at high speed.

Research and Development Needs

Silicon sheet material R&D is needed for ribbon or ingot in the cost-to-produce range of \$90/m², suitable for production-type processing into high-performance 17 to 20% efficiency solar cells.

- Requirements
 - Diffusion length equal to or greater than 300 μ m.
 - A 60- to 100-cm/s bulk recombination velocity.
- Research Areas

Basics of physics and chemistry of silicon materials at room temperature and near the melting point:

Ingot Technology

- Improved understanding of the effects of impurities on the growth of uniformly high-quality single crystal ingots.
- Improved understanding of defect formation during single-crystal ingot growth.
- Verification of the feasibility of growth techniques that improve quality of ingots.
- Improved understanding of slicing phenomena that will lead to higher quality, more economical wafers.

Current Research and Plans

- *Stress and strain relationships in wide, thin ribbons grown at high speeds:*
 - Develop methods of measuring thermal fields in growing ribbons.
 - Develop methods of measuring residual stress in ribbons.
 - Develop methods of observing ribbon deformation in real time.
 - Measure the high-temperature mechanical properties of silicon.
 - Develop models for plastic deformation and elastic buckling in growing ribbons.
 - Verify models by relating the observed thermal fields to observed ribbon stress and strain.
 - Use verified models to define ribbon thermal fields and growth dynamics that will yield low-stress growth environments.
- Modify present ribbon growth processes to use the data obtained on the above.
- Design, fabricate, and test low-stress ribbon growth systems.
- *Impurity effects and interface stability during ribbon growth:*
 - Model heat flow and interface stability criteria for ribbon growth.
 - Test and verify model.
- *Sheet quality effects on solar cell performance:*
 - Characterize ribbon material grown under various conditions.
 - Fabricate baseline cells on ribbons grown under various growth-process conditions.
 - Relate cell performance to ribbon growth process variables and specific defects.
 - Optimize growth processes that compensate for specific ribbon defects.

High-Efficiency Solar Cells

During the past 10 years, as FSA efforts continued, it has been perceived that the original Project goal of 10% module efficiency (from 6% in 1975) would be met as a result of the planned FSA efforts. It was anticipated that this would occur as solar cell efficiencies improved and as module packing factors increased, i.e., more active solar cell area per unit of module area. Logic indicated that cell efficiency should increase as low-cost cell design and fabrication technology matured, and as mass production and quality assurance were introduced. Module packing factors of 0.90 were thought to be achievable from the then 0.54 value. (1.0 equals total coverage.) These presumptions have proven to be accurate because, today, production modules fabricated using single-crystalline silicon cells have efficiencies as high as about 11%.

Economic analyses now indicate that module efficiency must be about 15% for photovoltaics to be economically competitive for central-station applications, which is now expected to be the first widespread use of photovoltaics in the United States. The achievement of 15% efficiency modules requires the repeatable fabrication of large-area laboratory solar cells with 20% or greater efficiency, demonstrating that high-efficiency solar cell principles are understood. This knowledge then must be converted into low-cost production cell technology that will yield uniform quality production cells of 17 to 18% efficiency and, subsequently, module efficiencies of 15%.

The *objective* is to perform research that identifies and resolves key generic limitations to increased efficiency of crystalline silicon solar cells as required for large power generation applications.

The *goal* is to establish device technology required for repeatable fabrication of large-area laboratory crystalline silicon solar cells of greater than 20% efficiency.

Background

Years ago, the need for high-power output from spacecraft solar cells motivated a sustained research for higher-efficiency cells. With the realization that photovoltaics had the potential to become a practical terrestrial power source, the research broadened. Consequently, the performance of silicon solar cells has been gradually increasing as a result of these systematic efforts to gain an understanding of how solar cells function, how to reduce cell losses by better cell designs, and by improved processing. A large number of relatively small advances, over many years, have added to our knowledge of solar cell technology and to increased cell efficiency. Early

progress in cell designs and process techniques were largely empirical, which has been strengthened by better understanding of the underlying principles of operation. These activities have led to a general agreement regarding the factors that limit cell performance and to those that can be changed to further increase the performance of crystalline silicon solar cells.

These efforts by many researchers and technologists over many years have gradually increased efficiencies from about 6% when silicon solar cells were devised in 1954 to the following efficiencies at present:

- Production cells made from Cz ingots for terrestrial use have efficiencies up to 14%.
- Research cells made from Cz ingots have reached 17 to 18%.
- Research cells made from float-zone silicon have reached 19% efficiency.
- Theoretical limit of crystalline silicon cells is about 30%.
- Probably maximum achievable limit is about 25%.

Project Activities: 1982 to Present

The general approach being used to increase solar cell efficiency to greater than 20% has been established. The required changes in certain cell parameters to achieve this high efficiency are believed to have been identified. However, the exact cell parametric changes and the cell design modifications required so that large-area 20% laboratory cells can consistently be fabricated have not been devised. To assist in better understanding how a cell functions and how various parts of a cell influence its performance, the following figures and description are included.

The main features of a crystalline silicon solar cell are shown in Figure 22. The cell is made from a semiconductor material doped (minute amounts of a specific element have been introduced under carefully controlled conditions) in a manner so as to make the semiconductor sheet photosensitive. The typical silicon cell made from p-type silicon (doped with boron) sheet material is modified by the diffusion or implantation of a phosphorus dopant to an extremely thin layer (now n type) on the surface that will become the top of the cell (emitter). The semiconductors must be doped correctly, so that the n-type material has large electron densities and the p-type material has large hole densities. (A hole is a vacancy in a silicon atom's outer electron ring after an electron has been freed.) After the n/p junction is formed, a basic requirement for PV energy conversion has been met by the creation of an

electrical field, which separates electrons and holes within the cell. Near the junction, most of the photogenerated holes from the n side transfer to the p side; similarly, most of the photogenerated electrons transfer to the n side. The n/p junction is permanent and the electrical field is stable. When light shines on a cell, the light that is not reflected is absorbed by the semiconductors. When a photon enters the cell and is of sufficient energy (appropriate wavelength) and strikes one of the four outer (valence) electrons of a silicon atom, that electron is dislodged. This leaves a silicon bond missing an electron, called a hole, and frees an electron to move about in the cell. Electrical current flow in a solar cell, when it does occur, is due to both the motion of electrons and to effective motion of the holes. When sunlight is absorbed in the cell and frees electrons and holes from their bonds, the electrical field separates the charges and establishes an electrical potential, or voltage. If the cell top and bottom contacts are connected to an external circuit, an electrical current (amperage) will flow as long as light continues to be absorbed by the cell.

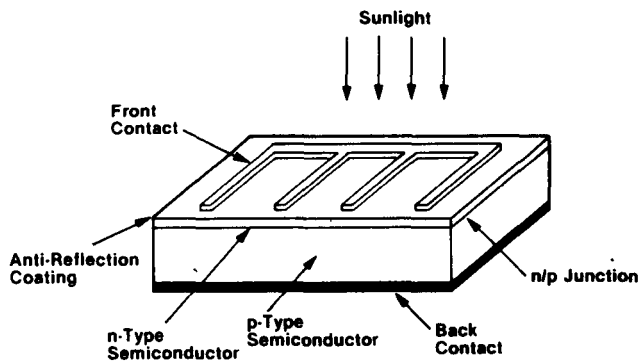

Figure 22. Crystalline Silicon Solar Cell

For over a decade, there have been significant improvements in crystalline silicon solar cell performance, mainly as a result of increased cell short-circuit current output. (Figure 23 is an I-V curve showing the current and voltage of a typical high-efficiency solar cell fabricated at JPL.) The improvements have resulted by use of shallow junctions, back surface fields, back surface reflectors, textured surfaces, and multilayer antireflection coatings. Shallow junctions help to reduce the effects of cell front surface losses. Back-surface fields reduce the effects of back-surface losses. Back-surface reflectors increase photon absorption. Textured surfaces and multilayer antireflection coatings reduce light reflection losses at the front surface. Figure 24 shows a solar cell with key factors that influence cell efficiency. The potential for further improvements in a cell's short-circuit current are limited. However, single-junction crystalline silicon cell performance can be increased by increasing the cell open circuit voltage. This is the area of endeavor now being emphasized by FSA high-efficiency silicon solar cell research.

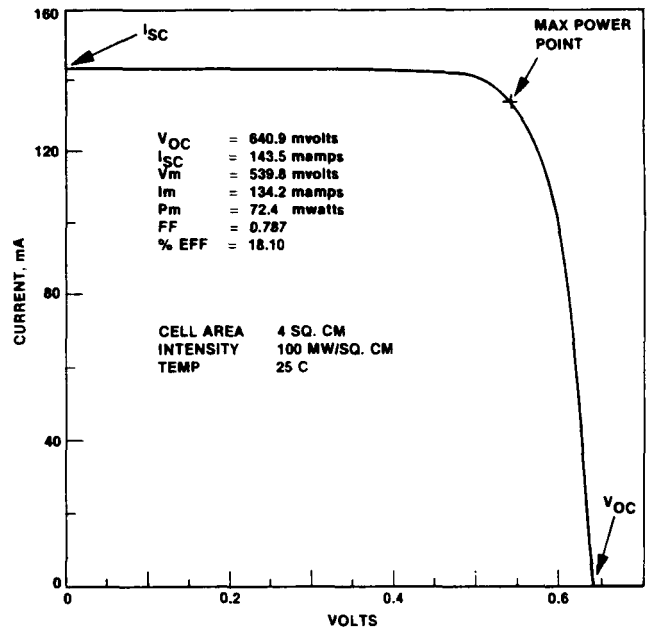

Figure 23. Current-Voltage Curve of a High-Efficiency Solar Cell

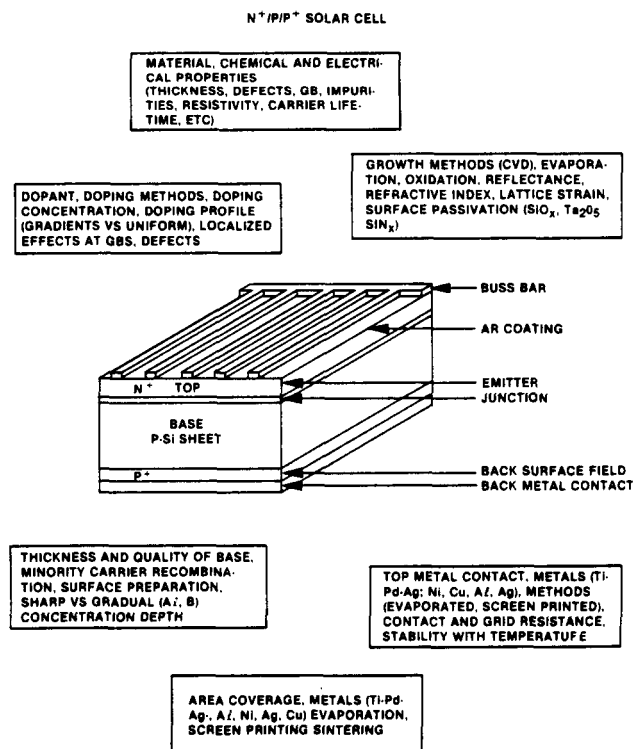

Figure 24. Key Factors that Influence Cell Efficiency

The primary thrust of the FSA high-efficiency efforts has been and continues to be directed toward reducing solar cell bulk and surface losses, with specific focus on reducing the minority carrier recombination rates throughout the cell. Three methods being used are: increased minority carrier lifetime, reduced volume of silicon for bulk recombination, and reduced surface recombination. By obtaining silicon sheet with properties so that the

recombination rates in the bulk material do not dominate cell performance, the emphasis can then be on reducing recombination in the thin emitter region and at the cell surface. Future cells will be multilayer structures with each layer thickness designed according to the electrical properties of that layer and the other layers.

Within FSA, the efforts being implemented are directed toward gaining a better understanding of the physics of carrier losses and their influence on cell design by the use of comprehensive modeling, by the development and use of new and improved measurement techniques, and by new and improved cell fabrication techniques. The surface recombination velocity of a solar cell (a measure of surface losses) is generally greater than 10^5 cm/s. An effort is under way to reduce the surface recombination velocity, to less than 10^3 cm/s by addressing critical problems of controlling recombination losses at surfaces and interfaces (for example, the investigation of transparent conducting materials). To better understand and control surface-interface phenomena, surface passivants (such as SiN_x , polycrystalline silicon, and ultra-thin oxide layers) are under development. Also, reliable measurement techniques to characterize passivants, surfaces, and interfaces are evolving. As part of surface loss investigations, work on transparent conducting materials is emphasizing study of the interaction of a polymer with a silicon surface and the effects on optical and electrical characteristics. Studies to understand and control bulk loss mechanisms by improvements in silicon sheet structural, electrical, and chemical properties are leading to improved minority carrier diffusion lengths. The complicated and varied nature of sheet is a function of its growth conditions and its processing, including solar cell fabrication.

Characterization of bulk material and device performance evaluation are using or will use a variety of measurement techniques for chemical, structural, and electrical characterization. These include optical electron and ion beam analyses, X-ray characterization, light and dark current-voltage relationships, spreading resistance, diffusion lengths by surface photovoltage, scanning electron microscopy, deep-level transient spectroscopy, secondary ion microprobe spectroscopy, and Zeeman spectroscopy.

Measurement techniques are being developed that are critical to gaining a basic understanding of loss mechanisms, to correlating model parameters with measured ones, and to optimizing cell performance. For example, the short-circuit current-decay (SCCD) method (Figure 25) has been developed at the University of Florida. It simultaneously measures the carrier lifetime in the bulk of the cell and the recombination velocity at the back surface interface. With this method, a forward bias is applied to the solar cell to set up a steady-state condition. Then, by rapidly applying a zero bias across an extremely small

resistance, a short circuit is obtained. This causes the p/n junction region and the base and emitter regions to discharge. If the discharge times related to the junction and emitter regions are much smaller than the time related to the base region, the lifetime and recombination velocity can be determined.

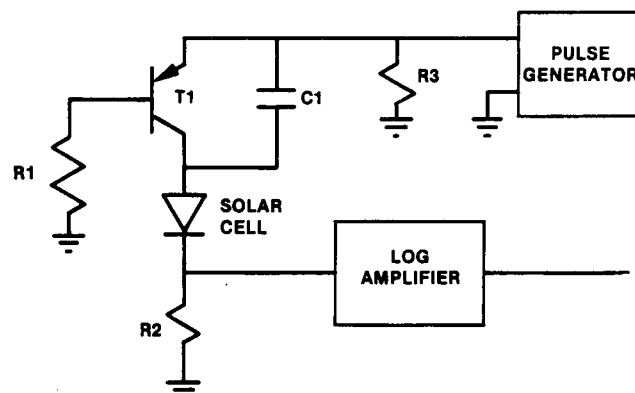

Figure 25. SCCD Cell Loss Mechanism Measurement Method

One of the main advantages of this technique is that the discharge time of the p/n junction (on the order of 10^{-11} s) is much less than the discharge times associated with either the emitter or the base. This makes it very easy to interpret the observed transient current. The SCCD method is simple, fast, and less expensive than methods used to measure other key solar cell parameters. It can be routinely used during cell fabrication steps. It is being evaluated as a possible method for determining carrier lifetimes and recombination velocities in the thin emitter region.

A highly sensitive microwave reflectance measuring system with computer data acquisition has been designed and built at JPL. The experimental results illustrate that the microwave technique can probe accurately the decay of photogenerated minority carriers in silicon sheet materials that depend on the minority carrier lifetime and surface recombination velocity. Under controlled surface conditions, one can measure bulk minority carrier lifetimes in silicon sheets, such as silicon wafers grown by Czochralski and floating-zone techniques and dendritic web ribbons. With known lifetime in the bulk material, the technique has been demonstrated to be an effective tool for monitoring the surface recombination velocity. Preliminary results reveal that the silicon surface polished by Syton has a small surface recombination velocity when it is freshly etched in a diluted hydrofluoric solution, but the recombination velocity increases drastically when the surface is exposed to the air. The effect becomes saturated after several hours. Currently, JPL scientists are working on an adequate analysis method to extract quantitative results from experimental data. The microwave technique is reliable, nondestructive, effective, and easy to use. It

can be used on as-grown and processed samples without any contact.

Electron beam-induced current technique to measure minority carrier lifetime in n^+ and surface recombination velocity at n^+ front surface is being investigated.

More complete analytical solar cell modeling and analysis capabilities development has led to the establishment of a program [Solar-Cell Efficiency Estimation Methodology and Analysis (SEEMA)] that uses computer models to evaluate and design advanced silicon cells. After an extensive search, FSA located two models to use in SEEMA. One of these, Solar-Cell Analysis Program in One Dimension (SCAP1D), was designed by Purdue University. It is a general purpose program used to analyze and design silicon solar cells. The other SUPREM-II, was designed by Stanford University. It is used to calculate information about the emitter doping profile which is then used as input to the SCAP1D model.

Researchers in FSA validated the utility of SCAP1D by evaluating the metal-insulator-n/p junction (MINP) structure of the high-efficiency silicon cell reported by Martin Green of Australia. Using experimental data provided in the literature as input, SCAP1D's evaluation closely agreed with Green's experimental results. Researchers also used SCAP1D to perform a sensitivity analysis on the structure by changing various design parameters one at a time, while holding the other parameters constant. Their analyses indicated that a cell with the MINP structure could obtain 20% efficiency by increasing the bulk minority carrier lifetime from its present 20 μm to 250 μm . This would make the diffusion length much greater than the cell thickness of 280 μm (Figure 26). Under these conditions, using a back surface field would further improve the cell's efficiency.

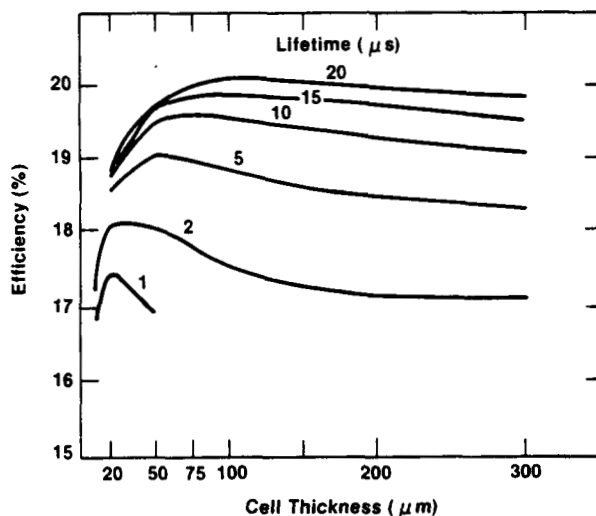

Figure 26. Sensitivity of Efficiency to Solar Cell Thickness for Various Minority-Carrier Lifetime Values

For future use, JPL is establishing improved versions of the two models. Purdue's upgraded model, SCAP2D, performs two-dimensional analysis. This will enable researchers to analyze complicated structural designs that are difficult to reduce to one-dimensional equivalents. Stanford's new SUPREM-III also has additional features for calculating electrical properties after each process step.

Recent Accomplishments

- New techniques to simultaneously measure bulk minority carrier lifetime and back surface recombination velocity developed, including SCCD and microwave techniques.
- Key barriers to obtain high-efficiency cells identified by use of comprehensive numerical analysis techniques.
- Use of new passivants for front and back cell surfaces showing promising results.
- High-efficiency solar cells modeled.
- Theoretical analysis of a new cell design, called "Floating Emitter Solar Cell Transistor," indicates that the cell has the potential to achieve greater than 20% efficiency.

Research Needed

- Establish relationships between residue defects and recombination mechanisms in highest quality available silicon sheet.
- Investigate recombination mechanisms in low-cost silicon sheet in bulk, in all layers, and at all surfaces.
- Develop technique for measurement of front surface recombination velocity.
- Establish correlations between material defects, device fabrication steps, and device performance.
- Improve modeling capabilities.
- Develop new higher-efficiency device concepts.
- Continue characterization of silicon sheets and devices as their quality improves.
- Continue device modeling and experimental verification of high-efficiency device structures.
- Investigate cell efficiency improvements for new advanced cell processes.

Process Research and Development

In 1975, the processes for fabrication of solar cells, for use on Earth, were either those used for making space solar-cells or their derivatives. These techniques, borrowed from diode production technology, were very labor intensive and material intensive with respect to the total product price. Acid etching and cleaning steps were extensively used along with photolithographic grid-line definition.

The performance of individual solar cells was not consistent. Fabricated in batches, even the performances of those cells for use in space varied significantly. The best of these small rectangular "space cells" were assembled on panels, as closely packed as possible, to produce the maximum power per unit area. The lower performance cells were not used in spacecraft power systems because of high-performance requirements. Instead, these reject space cells were used for terrestrial applications. By that time, solar cells made specifically for terrestrial use had become competitive with reject space cells. These circular cells were made from one complete Cz wafer. The cell processing was similar, but simpler and less expensive. For example, semiconductor industry-reject wafers were used. The result was that terrestrial solar-cell performance was less than space-cell performance. The challenge in 1975 was to reduce the cost of terrestrial solar cells, but still retain good quality and performance.

The *objectives* are to develop cell fabrication and module assembly process technologies required to meet cost and performance requirements for terrestrial PV power production.

The *goals* were to:

- Identify and develop low-cost cell and module production processes.
- Design facilities and equipment to perform the processes.
- Demonstrate fabrication of low-cost PV cells and modules in a pilot line environment.
- Implement the transfer of mass production technology to industry.

The *goals now* are to develop processes to:

- Fabricate high-efficiency cells from available silicon sheet substrates.
- Assemble cells into higher-efficiency longer-life modules.

The *key technical issues* are to develop processes so that:

- Silicon sheet substrate quality is not degraded.
- A variety of high-efficiency cell designs can be fabricated.

Background

Crystalline silicon solar cells were invented at Bell Laboratories in the mid-1950s. These solar cells or solar batteries, as they were called, are still the most commonly used solar cells. A solar cell is fabricated by a series of processes, from a silicon sheet doped with either an n or p type impurity. The other type of impurity (p or n) is then added to an extremely thin (about 0.3 μm) layer on the surface that will be the top of the cell. This creates the n/p junction (or p/n) where the photovoltaic effect can occur in the solar cell. The addition of metallic electric current collectors, on the top and on the bottom of the wafer, permits electricity that is generated within the cell to flow from the cell. The top current collector consists of uniformly spaced fine lines that minimize the amount of sunlight that is blocked from entering and from being absorbed by the solar cell. Cell fabrication, although it seems simple, is sophisticated with improvements in process and equipment continuing even after 30 years of progress. Completed solar cells are electrically interconnected and then encased to form a module that supports and protects the cells.

Project Activities: 1975 to 1981

Within FSA, the research and development required for solar cell fabrication and module assembly were conducted by a group familiar with the processes and equipment used to produce solar cells and semiconductor devices. A plan consisting of five phases, which was compatible with the other FSA activities, was devised and implemented. The plan consisted of:

- I. Technology Assessment: Determine availability and applicability of cell and module processes.
- II. Process Development: Develop applicable old and required new processes.
- III. Facility and Equipment Design: Develop automated equipment and facility designs.
- IV. Experimental Plant Construction: Incorporate previous efforts into a pilot line to define yields and remaining key cost factors.
- V. Conversion to Mass Production: Transfer technology to industry.

The Technology Assessment contracts awarded to Motorola, RCA and Texas Instruments in early 1976 assessed the state of the art of PV process technologies in terms of cost, large volume production potential, ability to be automated, reliability, and process synergistics. Identification of those processes with the most potential for cost-effective implementation and recommendations for further study of those processes were also performed. More than 50 processes covering all areas of cell fabrication and module assembly were studied. Processes evolved that clearly distinguished terrestrial cells from space cells. As an example, copper metallization was identified as being more cost effective for top and bottom electrical conductors than either solder or silver. Metallization methods were expanded from space-oriented vacuum evaporation to include electroless plating, electrolytic plating, thick film metal (printing), and reflow solder. Wafer surface treatments were expanded to include brushing, plasma etching, texture etching, and new cleaning solutions. Junction formation, in addition to the standard space cell process (gaseous diffusion), was expanded to include spin-on and spray-on of liquid dopants, solid dopant diffusion, doped oxides, ion implantation, and advanced ion implantation. Other good candidate cell processes that were added included silicon nitride (CVD), oxide growths, mechanical edge grinding, and laser scribing. Assembly methods included the use of: glass substrates, glass superstrates, and conductive adhesives; new encapsulation materials such as silicones, PVB, EVA; and new cell interconnection methods. Selected processes were studied regarding their "sensitivity to variables" such as purity or condition of input materials and supplies and processing parameters, primarily time and temperature. Efforts at JPL were concentrated on process verification and synergisms along with cell metallization analysis programs.

The problem facing the Project rather early in its inception was how to compare the potential production costs of competing processes and process sequences being investigated by a number of different researchers. This was clearly brought out during the Technology Assessment phase in which cost comparisons between the different contractors on the same processes were significantly different. This pinpointed a need for a standard methodology that allowed relative comparisons of the potential production costs attributable to competing processes, and an estimate of the actual cost to mass produce using a specific process.

Three key costing analyses methods developed by FSA PA&I personnel are:

- Interim Price Estimation Guidelines (IPEG), a costing system simple enough to be run on a hand calculator. This method uses standard coefficients for costing inputs such as equipment, direct labor, material, floor space, and utilities.

- Solar Array Manufacturing Industry Simulation (SAMIS), a factory simulation which runs on a main frame computer. This document requires the filling out of detailed costing sheets called Format As which are then fed into a computer for accurate and consistent process costs.
- Solar Array Manufacturing Industry Cost Standards (SAMICS), a catalog of material costs, labor costs, and other input costs which assisted the contractors in inputting standard costs.

These three techniques were verified and upgraded continually throughout the life of the Project and used extensively.

At the conclusion of the assessment effort, it was determined that cost effective processes should:

- Consume a minimum of material and supplies.
- Use low-cost, recyclable supplies.
- Have high production yields.
- Result in high-efficiency modules.

Before the assessment effort, automation and capital equipment were thought to be major cost factors. It was shown that when labor is a significant cost factor in a process, the process should be automated. Most semiconductor processes were, to a significant extent, already automated and, generally, capital costs for equipment could be distributed over large production runs resulting in low costs per unit.

Requests for Process Development proposals were distributed to the entire PV industry and were broadly scoped to include new and novel processes and those processes identified in the Technology Assessment Phase as requiring further development. Also, unsolicited proposals from PV contractors were encouraged, reviewed, and acted upon. Twenty PV industry contractors and two universities participated in these studies, which reflected the thinking of the PV industry at that time. A partial review of some of the contractors and their diversified activities during this phase are:

- Applied Solar Energy Corp.: Low-cost copper-plated contacts; ion-planted cell evaluation.
- Lockheed Missiles and Space Division: Sprayed-on fluorocarbon encapsulation.
- Mobil Solar Energy: Module assembly.
- Motorola: Antireflective (AR) coatings; palladium/nickel/soldermetallization.
- Sensor Technology (later called Photowatt International): Nickel/copper metallization.

- RCA: Epitaxial cell processing.
- Solarex: Wafer thickness studies; solar breeder studies; high efficiency module; nickel/solder metallization.
- Sollos, Inc.: Nickel metallization.
- Spectrolab: Thick-film metallization.
- Spire Corp.: Ion implantation; pulsed electron beam annealing.
- University of Pennsylvania: Process analysis and evaluation.
- Westinghouse: Cell processing using dendritic web.

All contracts during this phase required process cost evaluations to be made using the costing methodology and the writing of process specifications. The costing documentation included all of the direct inputs for equipment cost and performance; required labor, floor space, utilities, maintenance, supplies and input materials for each process. The process specifications included detailed descriptions of equipment, chemicals and materials used, and process parameters including time, temperature, pressure, etc.

Selection of an individual process depended upon what other processes were used before and after that process. Accordingly, an additional effort, the development of process sequences, was initiated. Discrete process steps were combined to form process sequences that were synergistically sound and cost effective, such as shown in Figure 27. Contracts were awarded to develop and demonstrate viable, cost-effective sequences. It became clear that there was no one single process sequence that was most cost effective, but rather a number of process sequences could be demonstrated to be viable and cost effective. Photowatt (then called Sensor Technology) demonstrated a process sequence with

spray-on dopant junction formation and printed metal mask followed by plating; Spectrolab demonstrated a spin-on dopant junction formation and a thick-film metallization system; Motorola demonstrated ion implantation junction forming, a CVD silicon nitride AR coating and plasma etching; Solarex demonstrated cost-effective processing of polycrystalline material; Westinghouse indicated that conventional semiconductor processes such as gaseous diffusion and vacuum metallization could be made cost effective with large volume production equipment.

Collectively, the process sequences showed the results of the cross-fertilization of technology that FSA emphasized. Copper metallization was used in two of the sequences. RCA cleaning technology was used extensively, as was laser scribing and thick film systems. The sequences illustrated the large number of possible low-cost process combinations that could be used to make a cell. The process sequences demonstrated that there was a new breed of solar cells, terrestrial solar cells, fabricated distinctly different than the space cell from which it evolved.

Most of the process R&D efforts have been conducted by private industry and universities through subcontracts with FSA which, to date, have included over 60 contracts. A parallel effort was the creation of a Process Research Laboratory at JPL in which the contractor process work could be verified and, in many cases, directly supported. Independent research has also been conducted in the laboratory by JPL personnel.

A major tool used to transfer the evolving process technology to the entire PV industry and to obtain cross fertilization has been the distribution of process specifications for verification. Near the end of the Process Development Phase, more than 140 process specifications covering cell and module fabrication had been documented and distributed to interested PV industry members. A feedback request resulted in industry verification of more than 40 of these processes. The results of these efforts are shown in

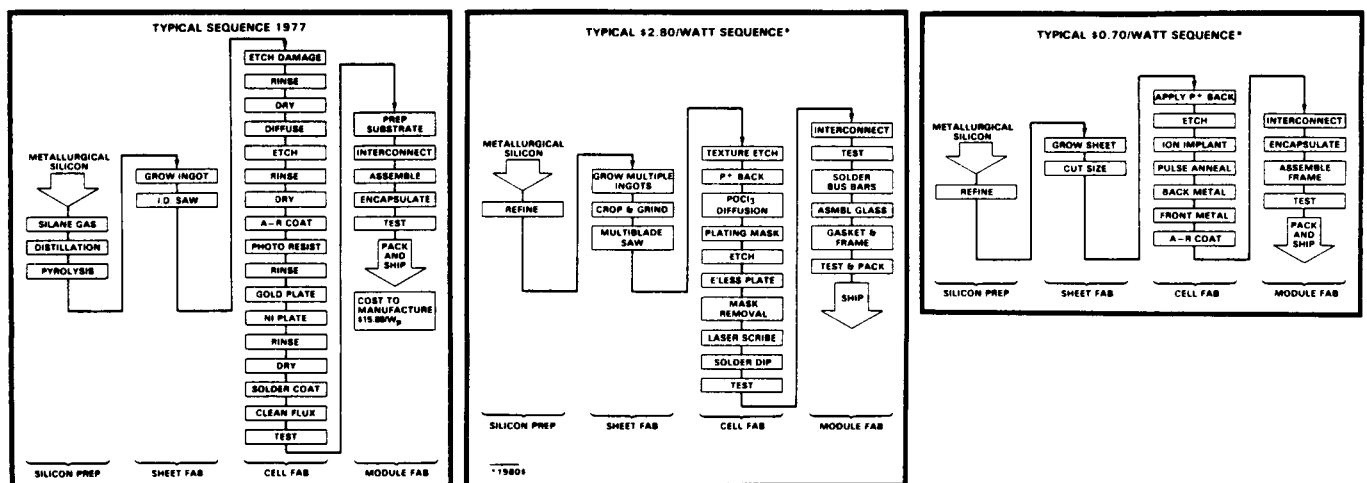
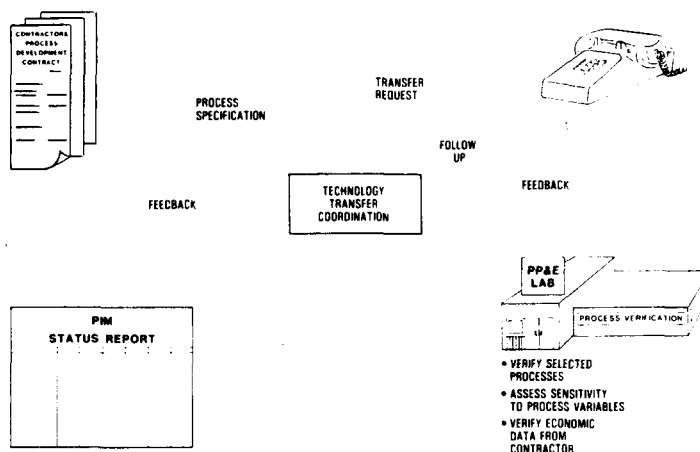

Figure 27. Module Process Sequences

Figure 28. The JPL Process Research Laboratory was also very much involved in the process verification

effort by providing a place for supplementary experimentation and verification.

An important function of FSA is to promote the advancement of the photovoltaics industry by the transfer of technology



Former Technology Transfer Procedures circa 1981

Processing Technology Transfer Status 1981

	Available	Under Evaluation	Confirmed
Surface Preparation	19	7	5
Junction Formation	18	4	5
Metallization	13	6	3
Module Assembly	16	5	0
Totals	66	22	13

Technology transfer continues but in a less formal manner

RECENT TYPICAL TECHNOLOGY TRANSFER

- MELT REPLENISHMENT EQUIPMENT**
 Westinghouse Electric Corp. is using equipment developed by Kayex Corp. and modified at Westinghouse to replenish silicon in a dendritic-web growth process.
- CuInSe₂ MODULE LAMINATION**
 Boeing Eng'g & Construction used the JPL Process Research Task laboratory's equipment and processes to laminate CuInSe₂ cells.
- THERMALLY INSULATED TOOLING FOR LAMINATORS**
 Sunelco Corp., Tideland Signal Corp., Solarex Inc. and Boeing Eng'g & Construction have shown great interest in thermal insulation techniques used in the JPL Process Research Task's laminator (capable of producing 4 x 4-ft modules) and are adopting them.
- TERRESTRIAL MODULE PRODUCTION LINE**
 Tideland has set up a production operation in Australia based on processes transferred from Spectrolab, Inc., developed under contract with JPL.
- UNSUPPORTED ("CREDIT-CARD") MODULE LAMINATION**
 The first unsupported (no superstrate or substrate) module was fabricated by Spectrolab using the JPL Process Research Task's 4 x 4-ft laminator.
- CELICAL PROGRAM AVAILABLE FROM COSMIC**
 An engineer-interactive computer program for solar-cell metallization design has been transferred to and is available from Computer Software Management and Information Center (COSMIC).
- AUTOMATED ROLLING-SPOT BONDER CELL STRINGING**
 Kulicke and Soffa, Inc., has built an automated machine for Westinghouse based on a concept developed under contract with JPL.
- THICK-FILM INK AVAILABILITY**
 Silver and aluminum thick-film inks are available from Electrinx, Inc., based on formulations developed under JPL contracts.

Figure 28. Technology Transfer to Industry

In late 1979, a bill sponsored by Senator Tsongas of Massachusetts provided additional funds for near-term reduction of solar energy production costs by soliciting ideas from industry. The following contracts were implemented:

Organization	Activities
ARCO Solar	Automated cell interconnection
Kulicke & Soffa	Automated cell interconnection
Motorola	Wax patterning. Thin cell processing
Photowatt	Polysilicon cell processing; surface texturizing
Sollos	Thick-film metallization
RCA	Megasonic cleaning

The important assembly equipment that evolved from the near-term effort were the automated cell

interconnect machines by ARCO Solar and Kulicke & Soffa and a vacuum laminating system by ARCO Solar. First-generation machines are shown in Figure 29.

The Facilities and Equipment Design Phase was never heavily stressed because most of this technology was already being developed for non-PV semiconductor devices. In addition to the special near-term funding, the development of other process equipment was funded. Important process equipment developments were ion implantation equipment for large area junction formation and a pulsed electron beam wafer annealing unit by Spire Corp., and a robotic cell interconnection and module assembly system by Tracor MB Associates. The robotic equipment was especially meaningful because it demonstrated that cells could be handled robotically in large-volume quantities without breakage. These machines demonstrated the potential for high-volume production.

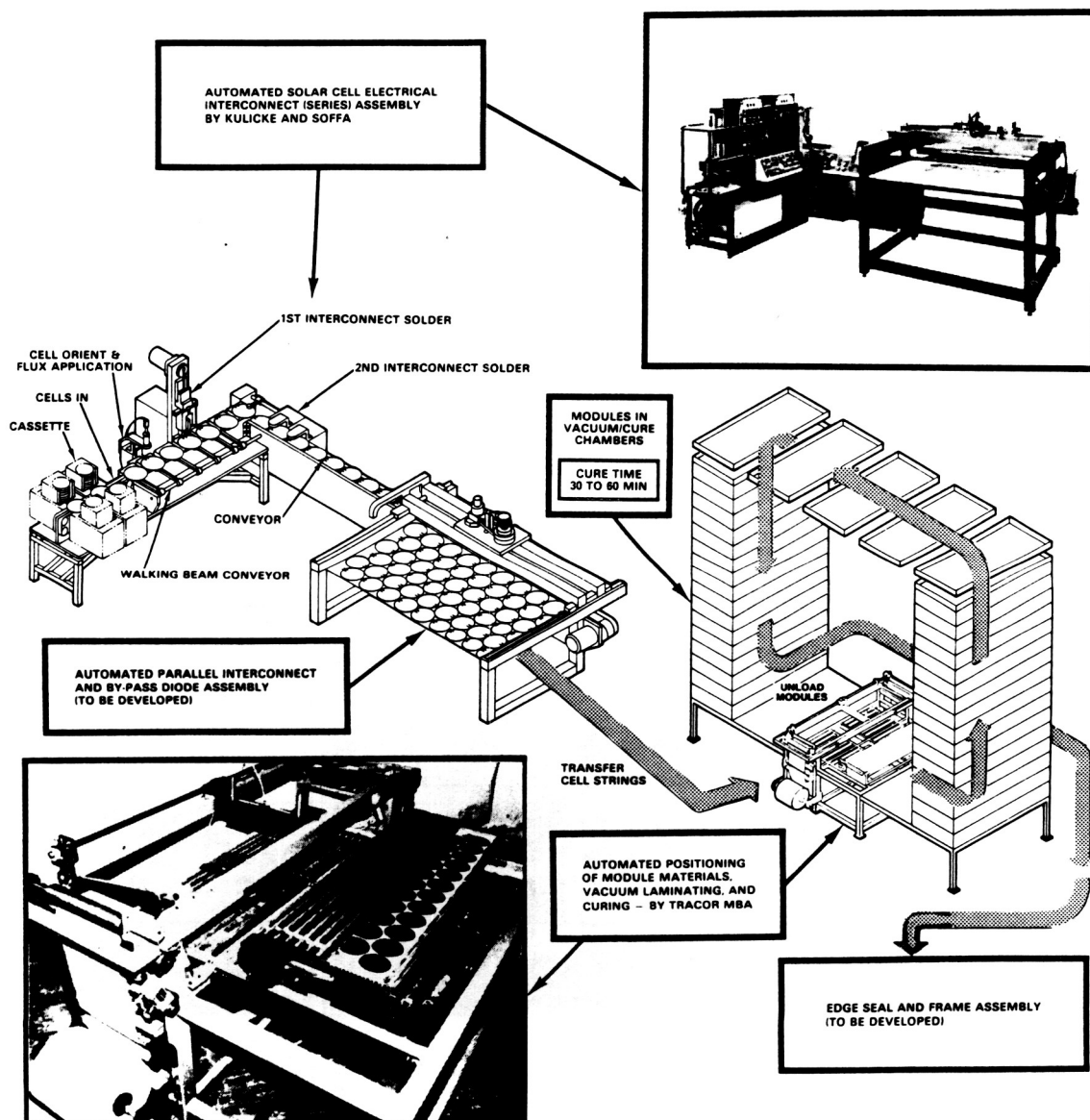

Figure 29. First-Generation Module Assembly

In late 1980, two Module Experimental Process System Development Unit (MEPSDU) contracts were awarded to provide the first controlled pilot-line data on cell and module processing. They were to reflect the culmination of the technology gained from the earlier phases. Prior to this time, the contractors produced cells and modules in a laboratory environment and then extrapolated the data for input into the SAMIS factory simulation program. In the MEPSDU contracts, each of the two contractors was required to construct and operate a pilot line. The contractors were required to record the production rate, yield, and process parameters. Three technical demonstration runs were required, two of which allowed no major adjustments, modifications, or repairs during and between runs. Solarex, Inc. and Westinghouse were competitively selected for the MEPSDU contracts. The two contractors chose diametrically opposite approaches as shown in Figure 30. The Solarex process sequence would produce lower efficiency cells using low-cost processes and polycrystalline silicon substrates. The Westinghouse process sequence would result in higher-efficiency cells using more expensive processes. The Solarex process sequence used semicrystalline silicon wafers, whereas the Westinghouse process sequence used dendritic web silicon. Ultrasonic bonding of cell interconnections to the solar cells was to be used by Westinghouse and soldered connections by Solarex. Vacuum lamination was the

proposed module assembly technique for both processes.

However, within 6 months the MEPSDU contracts were reduced in scope because of Project budget reductions. Within a year and a half, the MEPSDU efforts were cancelled entirely and the contractors were redirected toward research-oriented efforts in accordance with new Project guidelines.

Project Activities: 1981 to Present

The first three phases were completed, or almost completed, as planned with significant reductions in cell and module fabrication costs. Project redirection starting in 1981 resulted in cancellation of the MEPSDU and Mass Production Phases.

Good progress had been made toward meeting the individual parts of the original Project goals. However, an end-to-end integrated sequence was never accomplished. Efforts were then directed toward basic process research and, later, toward higher-efficiency cell process research. With new emphasis on higher efficiency and longer life, development of more advanced and sophisticated technology was initiated. Also, an examination of the needs of the PV industry, at that time, and the results of the earlier efforts led to the conclusion that metallization and overall process yields were two key items in which efforts should be continued.

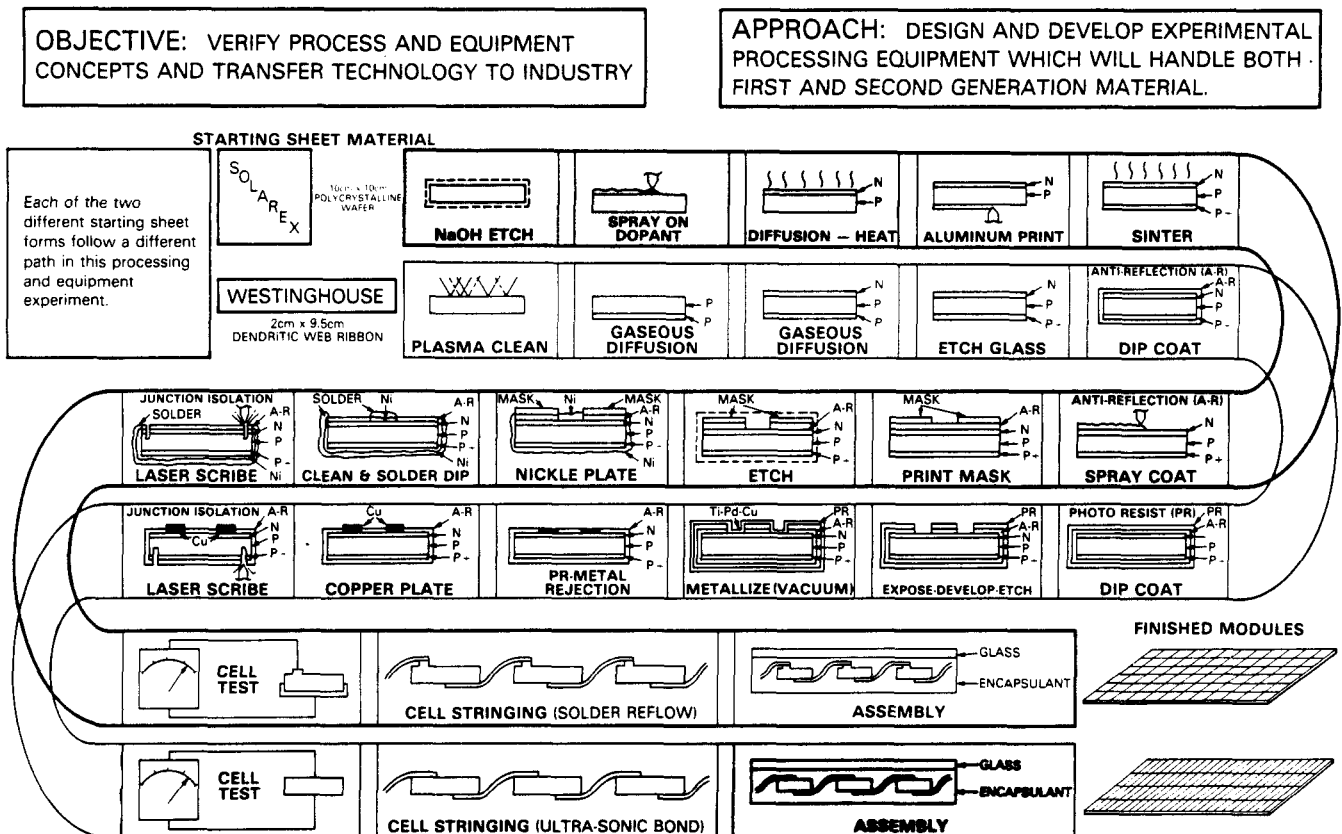

Figure 30. Module Experimental Process System Development Unit

The Westinghouse MEPSDU effort was redirected to investigate liquid-dopant processing for junction formation, which ultimately replaced the gaseous diffusion process on the Westinghouse pilot line. The Solarex MEPSDU effort was redirected toward investigating process mechanisms affecting lifetime and performance of cells made from polycrystalline material. A second generation of automated cell interconnection equipment evolved from the Westinghouse MEPSDU effort. The initial effort was cost-shared with JPL and, after MEPSDU cancellation, was continued to completion by Westinghouse. Kulicke and Soffa, under contract, developed, designed, and fabricated the ultrasonic bonding machine, which is capable of interconnecting one cell every 3.5 seconds or a 180 cell module every 10.5 minutes. The machine is shown in Figures 31 and 32. Figure 33 shows interconnected dendritic web cells.

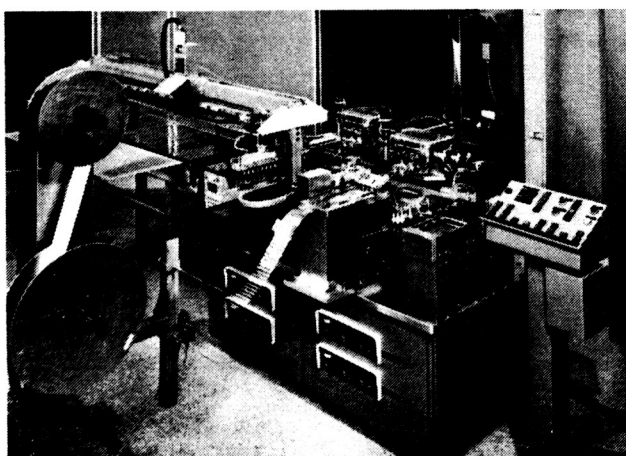

Figure 31. Second-Generation Cell Stringing Machine

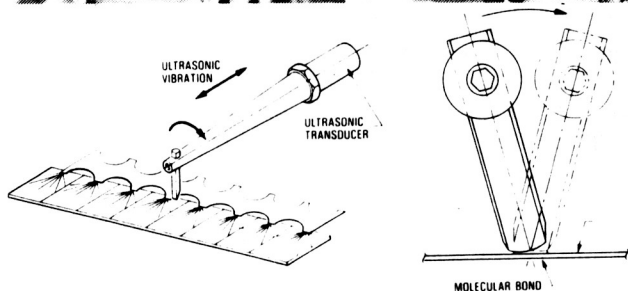
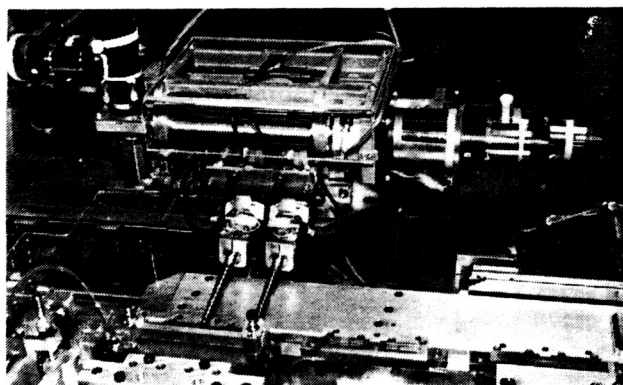

Figure 32. Rolling Spot Ultrasonic Bonding

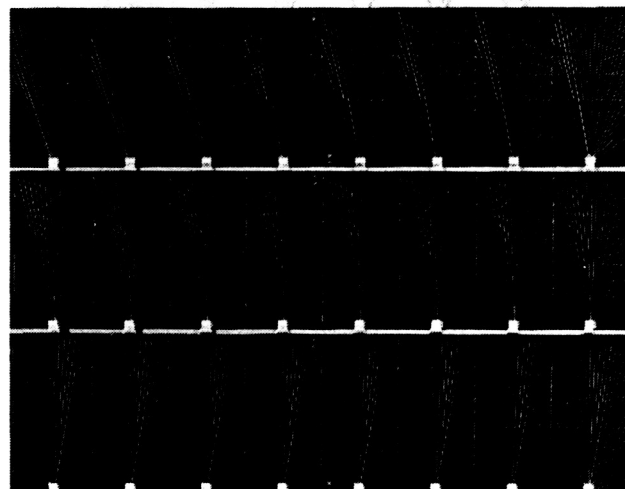

Figure 33. Ultrasonic Interconnect Bonding of Dendritic Web Solar Cells

Metallization was determined to be the major remaining higher-cost factor for cell processing. Figure 34 shows the results of cost analysis efforts on metallization systems. A number of innovative metallization ideas were generated as a result of the Cell Metallization Research Forum held in 1983. The objectives of the Forum were to clarify and define the state of the art of current solar cell metallization systems to: report on performance experience with these systems, including advancements made and problems encountered; describe advanced processing techniques under development; and to discuss expectations for future improvements.

Process control became a major area of concern as industry yields were not as high nor as predictable as had been expected. Industry proprietary concerns and lack of large-scale engineering pilot lines limited the availability of data. To overcome the lack of information and to explore processing for higher-efficiency cells, process and device modeling capabilities were investigated. For example, SUPREM (developed for the semiconductor industry by Stanford University) provides a comprehensive computer process simulation program that allows the prediction of device structures from any fabrication technology sequence. An example of a device model is SPCOLAY, by the University of Pennsylvania, a one-dimensional PV cell model which has been particularly useful in defining the interactions between cell substrate material parameters and preferred cell processes. The soft boundary shown in Figure 35 defines the "Domain of Practical Significance" for those characteristics which are prevalent in present state-of-the-art materials.

Candidate Processes/Systems

PROCESS/SYSTEM	COST/m ²	DATA SOURCE
Evaporation (EV)		
• SOA (Ti/Pd/Ag)	\$90	ASEC
• Advanced (Ti/Ni + Cu plating*)	\$14	Westinghouse
Screen print (PRINT)		
• SOA (Ag paste)	\$8 to \$35	2.80/W, Block IV**
• 1990 (Ag paste*)	\$7 to \$34	JPL BPU**
• SOA (Al paste)	\$2.4	2.80/W, Block IV
• 1990 (Al paste*)	\$1.4	JPL BPU
• 1990 (Mo/Sn*)	\$2.0	JPL BPU, Sol/Les
Electroless plating		
• SOA (Print resist, Ni-plate, Sinter, Wave solder)	\$8	Solarex, Motorola
• Advanced (PR, Ni plate, Sinter, Cu plating*)	\$9.4	Motorola
Midfilm* (Ag) (MID)	\$5 to \$16	Spectrolab**
Midfilm* (Mo/Sn)	\$2	Spectrolab, Sol/Les
Ion plating* (Ti/Ni/Cu) (ION)	\$6	Illinois Tool Works

*Advancement of Photovoltaic state-of-the-art
 **Ag price from \$10 to \$50/oz

Current Results

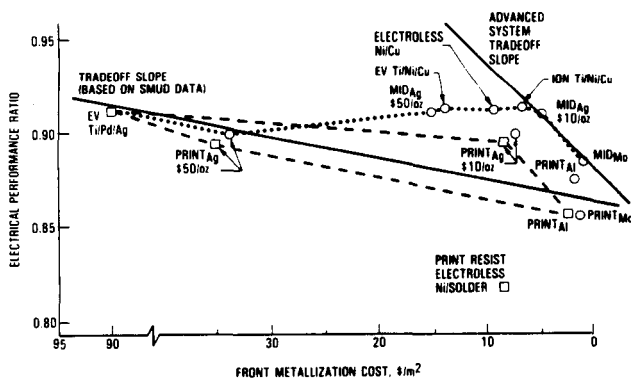

PURPOSE OF THIS ANALYSIS:

- Compare costs and effectiveness of state-of-the-art (SOA) metallization and projected metallization approaches
- Estimate the potential impact of R&D in this area

APPROACH:

- Use data from FSA contractors as the major source for calculating cell metallization costs with IPEG2
- Use JPL's grid optimization model to establish electrical performance ratios based on geometrical and electrical data (ratio to a cell without resistive or shadow losses)
- Develop metallization cost vs performance trade-off slopes for several PV systems; the cell metallization system farthest above a trade-off slope has the greatest value
- Study as yet has not included process compatibility, reliability, or unconventional metallization systems

Figure 34. Metallization Cost Comparison

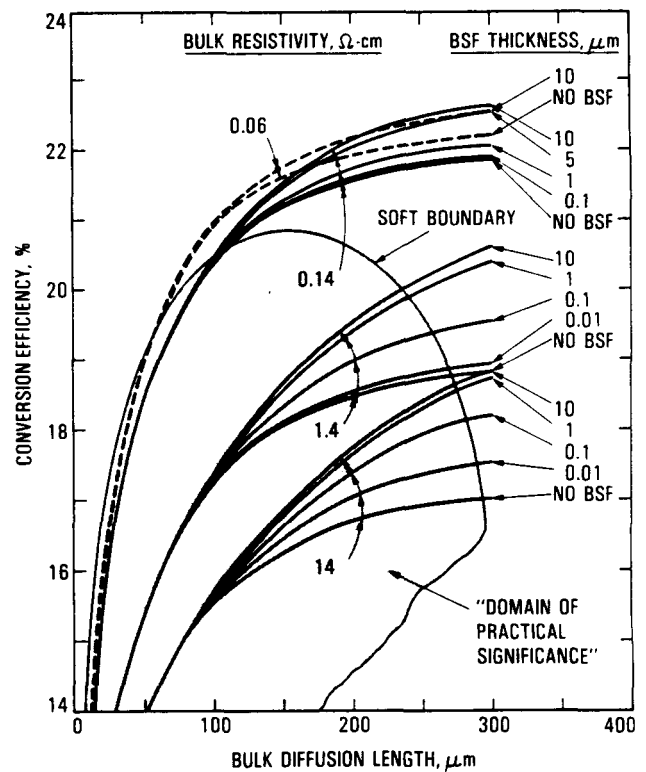
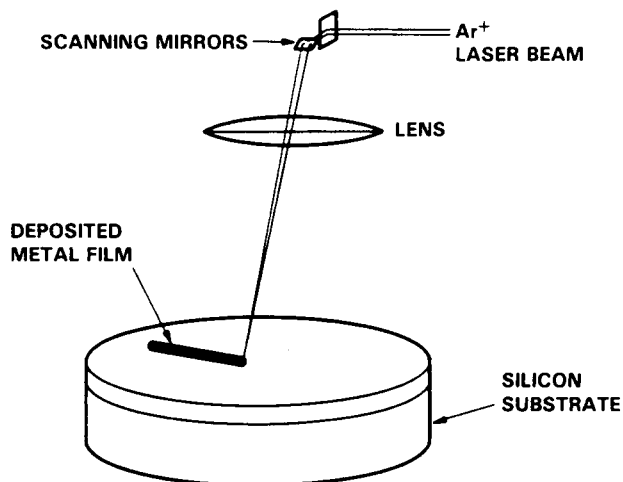

Figure 35. Low- and High-Bulk Resistivity Cell Behavior; Effects of Bulk Resistivity, Diffusion Length, and Back Surface Field

The term "directed energy research" was coined to describe the increased emphasis on high-efficiency processes, which covers the use of microwave, laser, and thermal pulse energy sources. All of these new energy sources are of technical interest because they allow many cell processes to be performed without heating the bulk of the substrate. PV cell fabrication by "cold" processing is used to avoid degradation of bulk substrate properties, particularly minority carrier lifetime.

Results from directed energy research have been very gratifying. Westinghouse demonstrated that thermal pulse (heat lamps) can be used to simultaneously form n and p⁺ junctions using liquid dopants. Previous processing required more handling, cleaning, and the use of expensive oxide masks. Excimer lasers can be scaled up and have been used by ARCO Solar and Spire for annealing ion-implanted junctions. Superwave Technology developed a microwave-powered plasma system used for thin-filmed silicon nitride deposition as well as a passivating silicon dioxide layer. Argon lasers were used by Westinghouse in a successful new metallization method in which lasers scan wafers covered with metal, bonding the metal to the solar cell where the "laser writing" has occurred, eliminating the costly photolithography process (Figure 36).



SAMPLE BASE TEMPERATURE 75°C
 FOCUSED LASER SPOT DECOMPOSES SPUN-ON FILM
 METALLIZATION PATTERNS ARE FORMED BY DIRECT WRITING

Figure 36. Laser Pyrolysis of Spun-On Metallo-Organic Film

One of the new metallization research efforts funded was the development of metallo-organic decomposition (MOD) films by Purdue University. The MOD process uses liquid compounds containing metal atoms bonded to organic compounds such as neodecanoic acid. Figures 37 and 38 illustrate the wide variety of possible compounds that can be synthesized for research or for use in production. Decomposition of these compounds by the application of heat between 250°C-300°C results in the formation of fugitive gases such as carbon dioxide and deposition of a thin layer of metal. Many different metals have been successfully tried such as titanium, chromium, silver, bismuth, and palladium. Combinations of metals have also been successful with especially good results obtained from a bismuth-silver formulation. Choice of organic acid and various viscosity adjusters allows application of MOD inks by spinning, dipping, spraying, screen printing, and ink jet printing. Multiple layers have also been successfully deposited, and lines as narrow as 3 μm have been achieved.

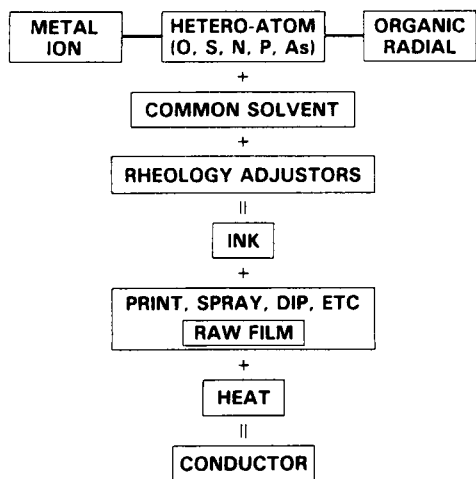
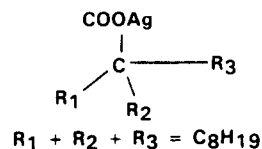

Figure 37. Metallo-Organic Deposition Processing



SUBSTITUENTS	% ABUNDANCE
R ₁ = CH ₃ R ₂ = CH ₃ R ₃ = C ₆ H ₁₃	31
R ₁ = CH ₃ R ₂ > CH ₃ R ₃ < C ₆ H ₁₃	67
R ₁ > CH ₃ R ₂ > CH ₃ R ₃ < C ₅ H ₁₁	2

Figure 38. Alternative Formations of Metallo-Organic Deposition Precursor Chemicals

Today's Status

Low-cost processes have been developed for cell and module fabrication steps such as:

- Surface Preparation
 - Hot alkaline damage etch.
 - Spray, dip, roller, spin, and meniscus coating of antireflective films.
- Junction Formation
 - Gaseous diffusion of 6-in.-diameter cells.
 - Liquid-dopant junctions.
 - Liquid-dopant back surface fields.
 - Aluminum-paste back surface fields.
- Metallization
 - Silver thick-film ink systems.
 - Copper cell metallization systems.
 - Pioneering of molybdenum-tin inks.
- Module Assembly
 - Ultrasonic cell interconnection.
 - Automated cell stringing.
 - EVA encapsulation processes.
 - Double-chamber vacuum lamination.

The above processes seem to have the potential to meet the original Project goals.

A complete processing sequence using all the steps, the individual yields, and the process parametric sensitivities was not completed.

The need for higher-efficiency and longer-life modules, but manufactured at essentially the same costs has imposed the need for new, more advanced technology and processes.

Accomplishments

The following is a list of accomplishments with the associated contractor(s) credited.

Processes

- Surface Preparation
 - A cost-effective etching processing for saw damage removal prior to junction formation (Sensor Technology, Lockheed).
 - Anisotropic etching process to produce large area textured surfaces for enhanced photon collection (Motorola, Sensor Technology, Solar Technology).
 - Developed a number of antireflection coatings with concurrent processes, including multi-layer evaporation, spraying, dipping and spinning, and the required material development (RCA, Westinghouse).
 - Polycrystalline silicon processing (Solarex).
 - Microwave enhanced CVD (Superwave).
 - Surface passivation of front emitter areas using silicon dioxide, silicon nitride, and silicon oxynitride (Motorola, Westinghouse, Spire).
 - Megasonic cleaning (RCA).
 - Plasma pattern etching (Motorola).
- Junction Formation
 - Large area, large volume, gaseous diffusion processing using POCl_3 , and PH_3 and BCl_3 (Sensor Technology, Westinghouse).
 - Simultaneous front and back junction formation using liquid dopants and infrared (IR) rapid heating pulse techniques (Westinghouse).
 - Ion implantation of both front and back junction at a rate of 1200 wafers/hour (Spire).
 - Non-mass analyzed ion implantation of both back and front junctions (Motorola, Spire).
- Laser annealing, electron pulse beam annealing, and rapid thermal pulse annealing of ion implanted junctions as well as conventional thermal annealing to maintain lifetime of the initial silicon material (Spire, ARCO Solar, Lockheed).
- Spin-on, spray-on, and meniscus coating of liquid dopants (Spectrolab, Sensor Technology, Westinghouse).
- Laser scribe (Sensor Technology).
- Metallization
 - Thick film screenable cost-effective metallization processes using Ag, Al, AgAl, Cu, and MOD AgBi (Spectrolab, Bernd Ross Assoc., RCA, Purdue, Electrink, Sollos, Solec).
 - Metallo-Organic decomposition films (MOD films) using low-temperature processes ($< 300^\circ\text{C}$) (Purdue, Electrink, Westinghouse).
 - Reliable plating systems using Pd and Ni followed by solder build-up by immersion (Motorola, Solarex).
 - Pyrolytic decomposition of MOD films using a laser as the thermal source (Westinghouse).
 - Development of a generic fabrication process for producing MOD film (Purdue, Electrink).
 - Diffusion barriers (Caltech).
- Module Assembly
 - Ultrasonic bonding of interconnects (Westinghouse, Kulicke & Soffa).
 - Automated soldering of interconnects (ARCO, Kulicke & Soffa, Foothill Engineering).
 - Laminated encapsulation in a partial vacuum.
 - PVB and attendant processes for 4 x 4 ft module (ARCO Solar, RCA).
 - EVA and attendant processes (RCA).
 - PV shingle assembly (General Electric).
 - Silane primers, antioxidants, and UV screening agents (Springborn Laboratories)
 - Electrostatic/ultrasonic edge sealing (Spire) (see Figure 39).

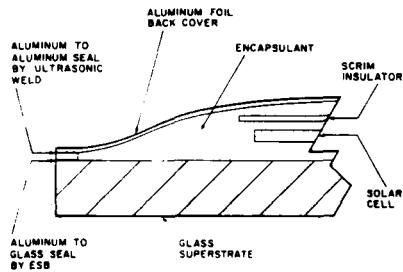

ANTICIPATED BENEFITS

- REDUCED H₂O VAPOR TRANSMISSION
- REDUCED O₂ TRANSMISSION
- REDUCED AIRBORNE POLLUTANT TRANSMISSION
- UV AND TEMPERATURE STABLE SEAL

APPLICATIONS

- MODULES IN SEVERE ENVIRONMENTS
 - COASTAL AND MARINE SITES
 - HOT AND HUMID REGIONS
- REMOTE LOCATIONS
 - REDUCED MAINTENANCE AND REPLACEMENT COSTS
- MODULES WITH SENSITIVE COMPONENTS
- EXTENDED LIFETIME FOR STANDARD MODULES

Figure 39. Hermetic Edge Sealing

Equipment

- Surface Preparation
 - Megasonic cleaning equipment (RCA).
 - Microwave enhanced CVD System (Superwave).
- Junction Formation
 - Ion implanter with 4-mA capability for phosphorous and throughput of 400 wafers/h (Spire).
 - Non-mass analyzed ion implant equipment (JPL, Motorola, Spire).
 - Pulsed electron beam annealing system (Spire).
 - Laser annealing system (Spire, ARCO Solar, Lockheed).
 - Meniscus coating machine for dopant additions to dendritic web material (Westinghouse).
- Metallization
 - Ink jet printer-computer controlled (Purdue).
 - Argon ion laser decomposition system (Westinghouse).
 - Dry film/mid film (Spectrolab, Applied Solar Energy Corp.).
- Module Assembly
 - Anti-reflectance treatment of glass (Motorola).

- Automated cell stringing machine (ARCO Solar, Kulicke & Soffa).
- Ultrasonic automated cell stringing for dendritic web (Westinghouse, Kulicke & Soffa).
- A laminator capable of producing large area modules (JPL, ARCO Solar, Spire, ASEC).
- Robotic module assembly (Tracor MB Associates).

Analyses

- SPCOLAY (University of Pennsylvania). PV cell modelling program for investigation of process variable sensitivities.
- Zero depth concentrator effect (JPL, Science Applications, J. Mark, General Electric). Mathematical model of the effect of light trapping by non-specular reflection in thick films.
- Grid line optimization (JPL, Texas Instruments, Motorola, RCA, Spectrolab). Mathematical models and computer optimization programs to allow design of minimum power loss collector grids.
- \$2.00/watt (JPL). "Strawman" process analyses for low cost cell and module fabrication.
- \$0.50/watt (JPL). "Strawman" process analyses using projected, automated processes.
- Diffusion barriers (Caltech). Development of the scientific basis for formation of diffusion barriers, especially those of amorphous films.
- Solar breeder (Solarex). An analysis of a photovoltaics production facility powered by photovoltaics.
- Wafer thickness (Motorola, Solarex). An analysis of wafer thickness cost tradeoffs.
- Polycrystalline cell processing (Solarex, Sensor Technology). Development of techniques for processing polycrystalline silicon material.
- Solar Area Production System Handbook (Theodore Barry Associates). A compilation of costing variables related to large volume production of solar cells.
- Tandem Junction cell (Texas Instruments). An analysis of a novel photovoltaic device structure to produce electrical power.

Modules and Arrays

In 1975, crystalline-silicon solar cells for use on spacecraft had already been manufactured for about 15 years. There was significant progress made during these years in understanding how solar cells functioned and how to improve their performance. However, there was little information about how to design, fabricate, and use PV modules and arrays for terrestrial applications. There was an immediate need for module and array knowledge and experience. A complete technology had to be established including environmental and design specifications, engineering concepts and design knowledge, encapsulation materials and processing, module assembly techniques, quality assurance techniques, module performance and durability evaluation techniques and facilities, and failure analysis techniques and capabilities. An intensive effort to meet this need was initiated with the start of the FSA Project in 1975.

The *objectives* of the module and array activities for both crystalline silicon and thin-film technologies are to:

- Develop design requirements and specifications compatible with various operational and safety environments for a variety of applications.
- Develop the engineering sciences technology required to integrate low-cost, efficient cell technologies into cost effective and safe modules and arrays that meet the operational requirements of future large-scale applications.
- Develop the technologies required to achieve and to verify reliable 30-year life flat-plate PV modules.

- Verify adaptability of technology to meet required operational conditions.
- Transfer the above technology to industry.

The *goals*, as established in 1983, are to develop flat-plate (non-concentrating) module and array technology as follows:

- Modules with crystalline silicon solar cells.
 - High efficiency, 15%.
 - Low cost, \$90/m² (1982 dollars).
 - Thirty-year reliable operation.
- Modules with thin-film solar cells.
 - Efficiency, 12%.
 - Low cost, \$70/m² (1982 dollars).
 - Thirty-year reliable operation.

In 1975, the *goals* established were to develop flat-plate module and array technology that industry could use as early as 1986 to achieve:

- Module prices less than \$0.50 per peak watt FOB (1975 dollars), marketing and distribution costs not included.
- Production rates sufficient to attain economies of scale.
- Operating lifetimes in excess of 20 years.
- Module efficiency greater than 10%.

Background

Early in the 1970s, small modules were made using reject space cells sealed into heavy cast-glass modules that were durable, but expensive (Figure 40). However, typical mid-1970s terrestrial modules, designed for more economical manufacturing, had a lifetime ranging from 6 months to 2 or 3 years (Figure 41). The solar cells for these modules were made using circular wafers directly sliced from a Cz ingot and processed by essentially space-cell technology. The electrically interconnected cells were usually placed on a layer of silicone rubber covering a fiber-glass panel, covered with a second layer of poured silicone rubber and cured. The entire process was very labor intensive and subject to product variations. The module designs and processing were often by trial

and error. The products had high failure rates, caused by both immature designs and poor processing.

During the past 10 years, the FSA-industry partnership has significantly advanced the basic technology for terrestrial module and array design and fabrication, using crystalline-silicon solar cells. This was accomplished by concurrent experimental and analytical research efforts supported by iterative fabrication and testing of developmental and commercial modules, as described in Module and Array Evolution, Engineering Sciences and Design, Encapsulation, Reliability Physics, and Module Performance and Failure Analysis. The evaluation of modules using thin-film solar cells is just beginning, as is the adoption of existing knowledge and the development of unique new techniques for thin-film modules.



Figure 40. Durable Modules Made from Space Solar Cells in Early 1970s.

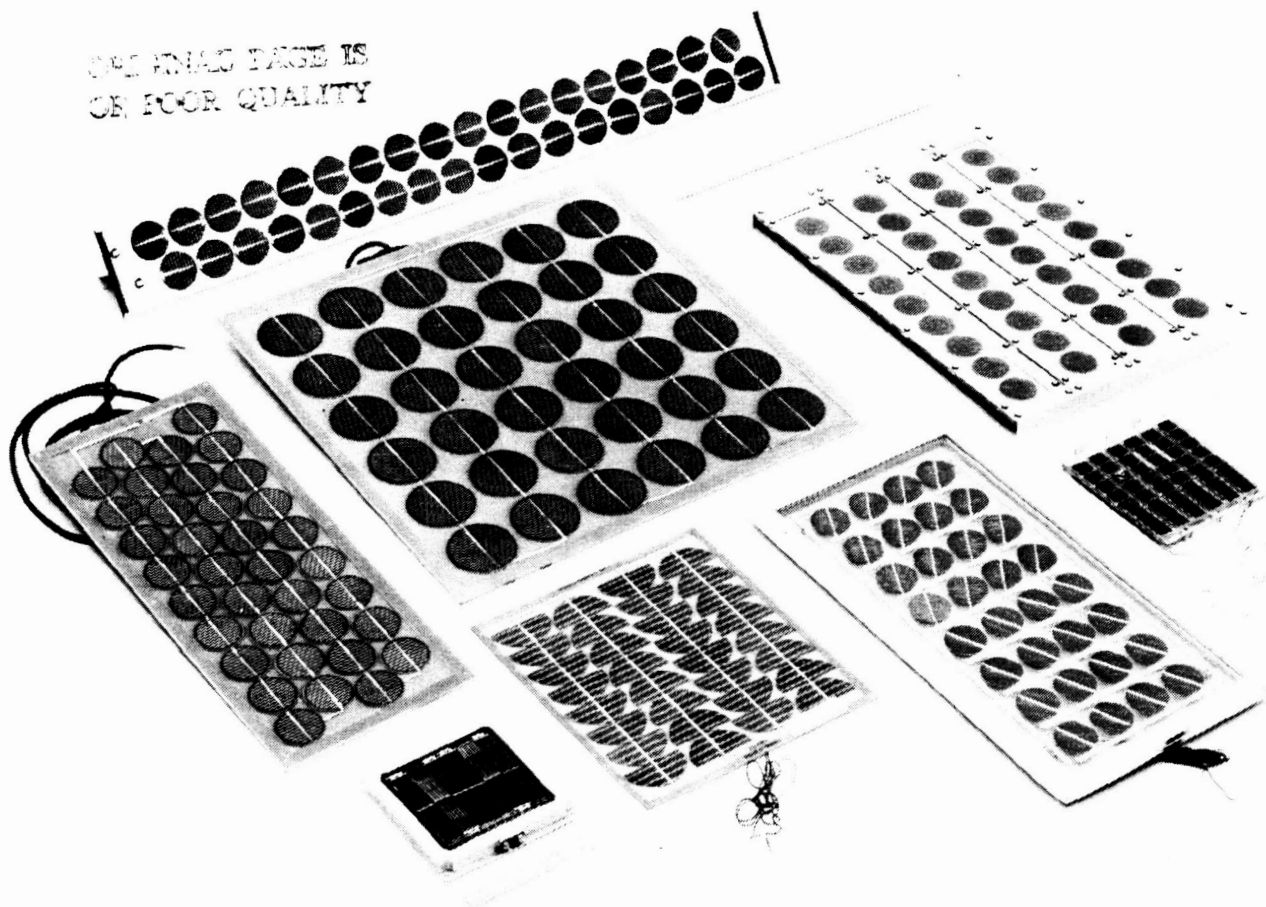

Figure 41. Mid-1970s Terrestrial Photovoltaic Modules

Project Activities: 1975 to 1981

Initially, in 1975, contemporary modules were purchased and evaluated; concurrently, developmental work was initiated on module specifications, designs, materials, and processing. These studies evaluated both the technical and economical feasibilities of various technical concepts. During the next few years, simultaneous assessment of the needs, capabilities, deficiencies, and potential solutions across the entire spectrum of module technologies was accomplished by an excellent cooperative effort by industry, universities,

and Government. This effort resulted in a continuing iterative evolution of new knowledge and capabilities. Practical, realistic environmental protection requirements and approaches were developed along with techniques for evaluating module capabilities for meeting these specifications. Practical module design knowledge grew as encapsulation materials and processing methods were developed and evaluated, and the compatibility of the modules with PV power systems was established. As the technology evolved, it was incorporated by industry into durable hardware. This was accomplished by the Project sponsoring cell and module technology

developments, the purchase of advanced modules, the evaluation of these modules, and the analysis of module problems and failures (Figure 42). A flow of information from operational PV systems, as shown in Figure 43, helps the technology development activities shown in Figure 42. Five sequential purchases ("block buys" of modules designed and fabricated by industry to JPL specifications) have resulted in an effective cooperative effort by the FSA Project and industry. The large quantities of modules purchased

(large at the time) for the first three block buys were intended to increase industry production capacity as well as provide modules for evaluation and field testing. Block IV and V modules were purchased in limited quantities in the 1980s, for test and evaluation only. These Project efforts were instrumental in developing practical flat-plate module design and manufacturing technology and in stimulating industry to incorporate much of it into its commercial products.

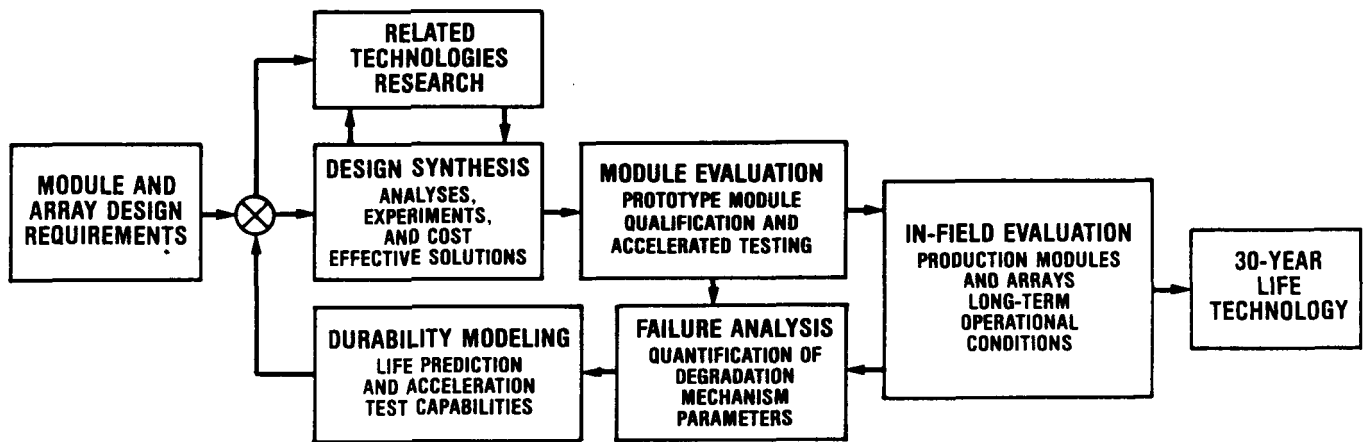

The design requirements were periodically updated based upon new knowledge of application needs, environmental conditions, realism of evaluation and testing techniques and hardware performance.

Figure 42. Module/Array Technology Development

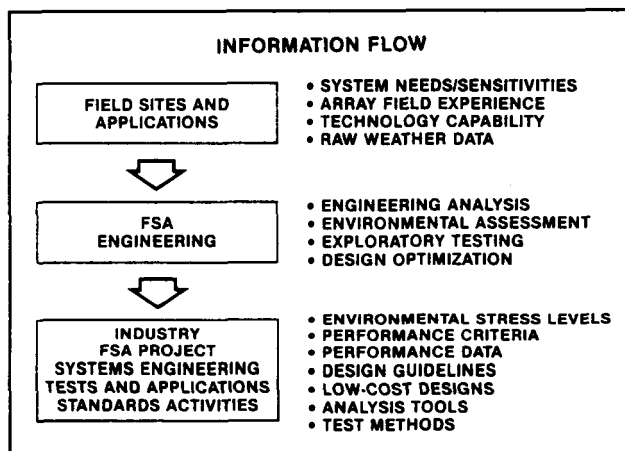

Figure 43. Information and Flow

Project Activities: 1981 to Present

Since 1981, the evolution of module technology and the adoption by industry has continued with emphasis now on high-efficiency, cost-effective modules that meet safety and reliability requirements of future large-scale applications such as for utilities. Efforts on rooftop and residential applications are fewer now that it is anticipated that utility applications will be the first large-scale use of photovoltaics in the United States.

A second parallel effort, just starting, is establishing the practicality of modules made using thin-film solar cells. This requires going through many of the above sequences using as much of the existing knowledge and capabilities as possible; however, many unique new techniques and new knowledge will have to be developed and evaluated. As an example, new accurate, repeatable electrical performance measurement techniques for thin-film cells and modules are being developed and verified so that degradation can be accurately quantified and performance measurements standardized. With the expanding availability of first-generation thin-film modules, performance evaluation and assessment of reliability characteristics are under way.

Today's Status

Crystalline Silicon Modules

- Estimated life of contemporary production modules is more than 10 years.
- Module efficiency is as high as +11% in standard production modules.
- Encapsulation materials have been life-tested to 20 years.
- Comprehensive terrestrial module design technology and knowledge exist, which have been gained from 10 years of analytical, design, fabrication, and test activities in active cooperation with industry.

- Modules of 0.9 MW sold for just under \$5 per peak watt (1983 SMUD purchase).
- Estimated module price would be about \$1.47 per peak watt if a multi-tens of megawatts production plant were built with the latest existing technology (see PA&I section of report).

Thin-Film Modules

Prototype modules (other than consumer products) are only beginning to become available for evaluation:

- Reliability is unknown.
- Efficiency is about 3 to 5%.
- Prices are about the same as for crystalline-silicon modules.

Thin-film module differences requiring new or expanded research:

- New cell environmental durability (temperature/humidity/ultraviolet) failure modes.
- Altered hot-spot heating failure mechanisms.
- Short-circuit cell failure modes and effect on size and series/parallel redundancy.
- New cell electrical-interconnect failure modes.
- Altered glass breaking strength.
- Flexible substrate technology demands.
- High-cell stresses caused by glass bending.
- Non-linear electrical response and effect on measurement.
- Cell-to-cell electrical variability and effect of electrical mismatch on circuit design.

Module and Array Evolution

The PV terrestrial modules have evolved during the past 10 years so that they are now practical, reliable, and cost effective for many applications. There have been major improvements in design, fabrication, performance, and reliability. These improvements have resulted in large reductions in module prices and life-cycle PV power generation costs. An important factor contributing to this evolution has been the series of five module procurements known as "block buys." The module design and development were performed by industry to FSA specifications; the module performance

evaluations were performed by FSA. These activities served three functions: (1) they encouraged industry to incorporate the latest technology developed in the PV program, (2) the various modules were evaluated by uniform repeatable tests that enabled identification of design and/or fabrication deficiencies, and (3) they enabled a cooperative manufacturer/evaluator quick response to module problems that occurred.

A module from each of the five block buys is shown in Figure 44. Table 17 lists the representative characteristics of each block of modules. The photograph, the list of characteristics, and the five trend charts (Figures 45 through 49) portray the progress of flat-plate PV modules with crystalline silicon solar cells during the past 10 years.

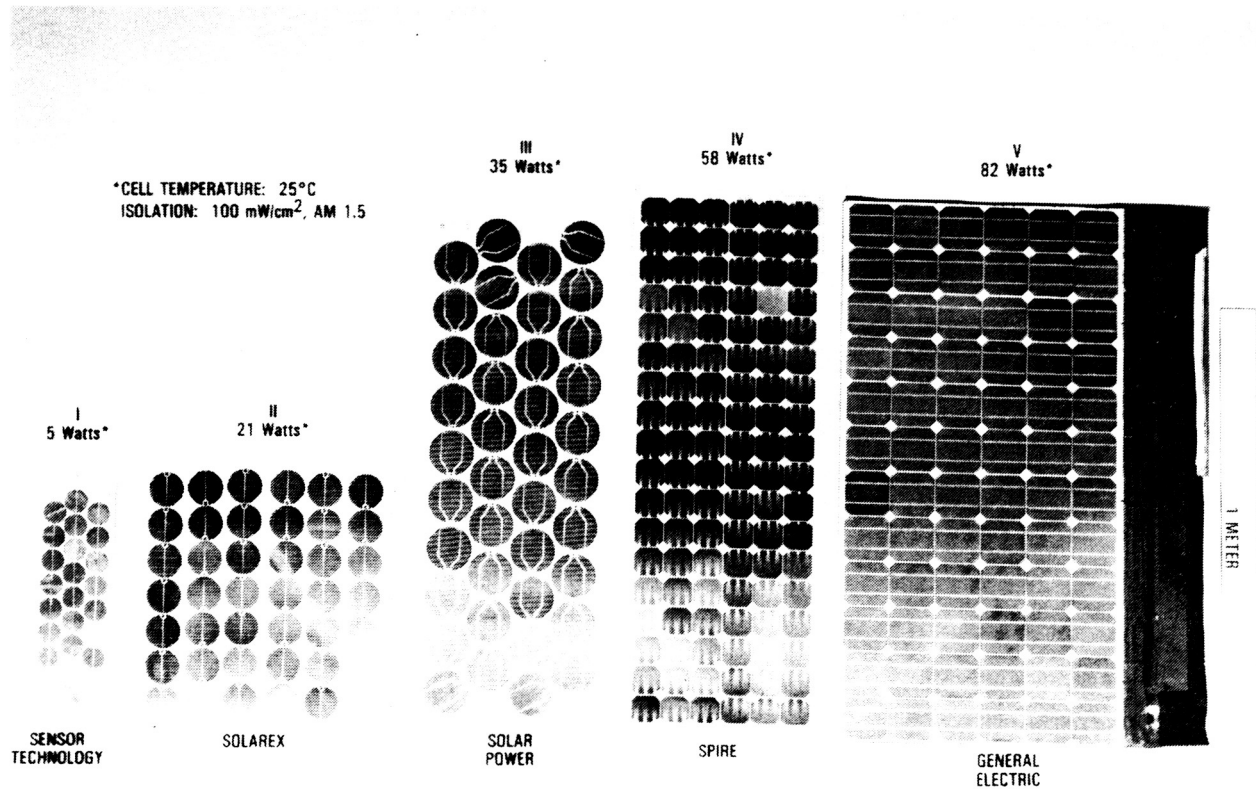

Figure 44. Examples of Block I Through V Modules

Table 17. Representative Characteristics of Block Modules

	I	II	III	IV	V
AREA (m ²)	0.1	0.4	0.3	0.6	1.1
WEIGHT (kg)	2	5	5	9	17
SUPERSTRATE OR TOP COVER	SILICONE RUBBER	SILICONE RUBBER	SILICONE RUBBER	GLASS	GLASS
SUBSTRATE OR BOTTOM COVER	RIGID PAN	RIGID PAN	RIGID PAN	FLEXIBLE SHEET	FLEXIBLE LAMINATE
FRAME	NO	YES	YES	YES	NO
CONNECTIONS	TERMINALS	J-BOX	TERMINALS	PIGTAILS	PLUG-IN
ENCAPSULATION SYSTEM	CAST	CAST	CAST	LAMINATED	LAMINATED
ENCAPSULATION MATERIAL	SILICONE RUBBER	SILICONE RUBBER	SILICONE RUBBER	PVB	EVA
CELLS					
QUANTITY	21	42	43	75	117
SIZE (mm)	DIA: 76	DIA: 76	DIA: 76	95 x 95	100 x 100
CONFIGURATION	ROUND	ROUND	ROUND	SHAPED	SHAPED
MATERIAL	CZ	CZ	CZ	CZ	CZ
JUNCTION	N/P	N/P	N/P	N/P P ⁺	N/P
FAULT TOLERANCE					
PARALLEL CELL STRINGS	NONE	NONE	NONE	3	6
INTERCONNECT REDUNDANCY	NONE	MINOR	MINOR	MUCH	MUCH
BY-PASS DIODES	NO	NO	NO	YES	YES
PACKING FACTOR	0.54	0.60	0.65	0.78	0.89
NOCT ^a	43	44	48	48	48
PERFORMANCE AT 28°C CELL TEMP. ^b					
POWER, MAX. (W)	8	24	28	54	112
MODULE EFFICIENCY (%)	5.8	6.7	7.4	9.1	10.6
ENCAPSULATED CELL EFFICIENCY (%)	10.6	11.2	11.5	11.8	12.3

^a NOMINAL OPERATING CELL TEMPERATURE: CELL TEMPERATURE IN OPEN-CIRCUITED MODULE EXPOSED TO 80 mW/cm² INSOLATION IN AMBIENT OF 20°C, 1 m/s WIND VELOCITY.

^b AT 100 mW/cm², AM 1.5 INSOLATION.

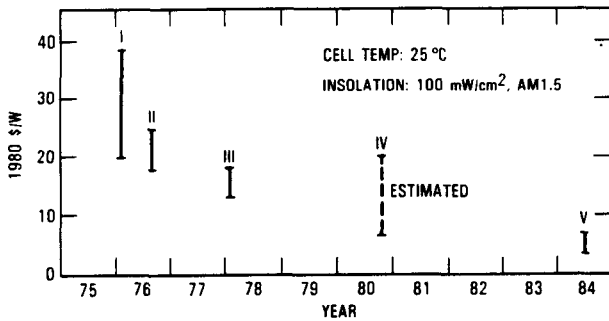

Figure 45. Module Cost Trend

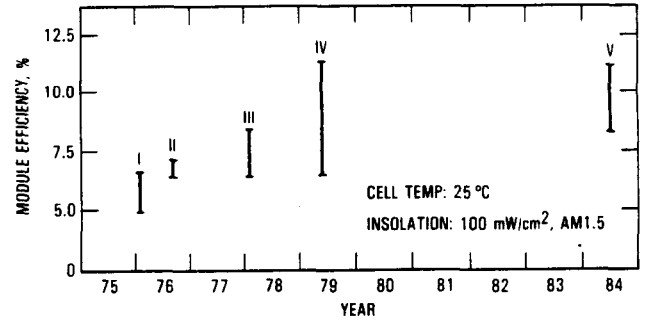

Figure 46. Module Efficiency Trend

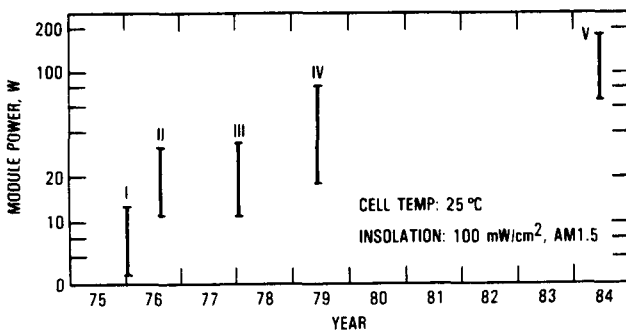

Figure 47. Module Power Trend

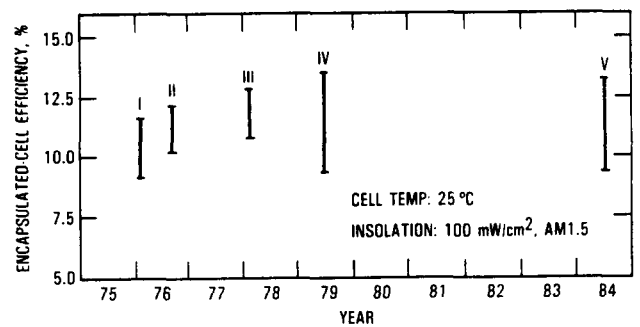

Figure 48. Cell Efficiency Trend

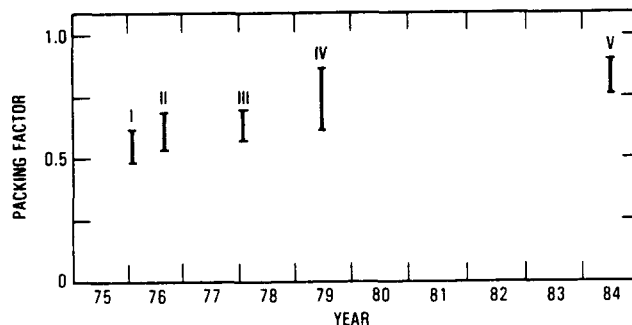

Figure 49. Packing Factor Trend

The following sequence of events typifies the activities of a recent block buy:

- FSA prepares design and test specification based upon prior experience.
- FSA conducts competitive procurement culminating in award of parallel contracts for alternate design concepts.
- Contractor performs module design.
- FSA conducts design review.
- Contractor fabricates 10 prototype modules.
- FSA performs module qualification tests (and failure analysis, as applicable).
- Contractor modifies design and/or processing procedures to correct problems revealed by qualification tests.
- FSA conducts design review.
- Contractor fabricates 10 modules.
- FSA performs module qualification test (and failure analysis, as applicable).
- Contractor modifies design and/or processing as necessary and supplies modules for retest.
- FSA completes final testing.
- FSA prepares and issues User Handbook describing construction details and performance of successful module design by each contractor.

This series of module procurements has produced the following results in PV module technology:

- A systematic upgrading of module quality and performance by the incorporation of new technology into improved designs that are more amenable to mass production.
- Establishment and continuing upgrading of design and performance specifications based upon the

needs of the users and the desires of the manufacturers.

- Development and continuing improvement in module evaluation capabilities and equipment including electrical performance, physical qualification tests, and correlation of both with field experience.
- Systematic development of module failure analysis techniques, equipment and supplementary analysis, and experimentation leading to the solution of module problems.
- Adoption by the international PV community of the FSA-developed specifications and design features of the Block V module.
- Variations of three of the Block V modules being purchased for the second phase of the 1-MW PV central station power plant being

The success of these activities can be attributed, at least in part, to the following:

- The competitive nature of the module procurements which included updated design and test specifications and a work statement indicating design parameters requiring improvement.
- Extensive advances in cell, module, and processing technology performed primarily by DOE/JPL-sponsored R&D.
- Participation by FSA personnel having access to the entire spectrum of PV technology and PV field operational results including items such as quality assurance.
- The excellent cooperation established and continued at the working level by the PV industry and FSA personnel throughout all these technical activities.

Figures 50 through 54 show the five block buys and Tables 18 through 20 show their characteristics.

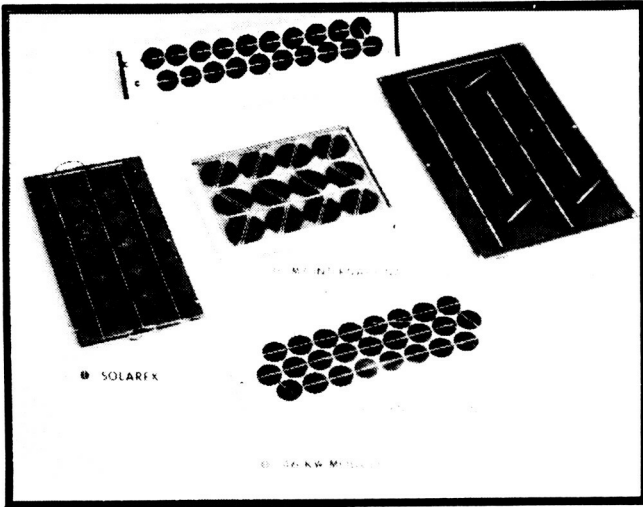

- ENVIRONMENTAL TESTS LIMITED TO:
TEMPERATURE CYCLE
HUMIDITY SOAK
- MANY DESIGN IMPROVEMENTS
DURING PRODUCTION
- ELECTRICAL PERFORMANCE PER
MANUFACTURERS RATINGS

Figure 50. Block I: 1975-1976, Off-the-Shelf Design, 54 kW

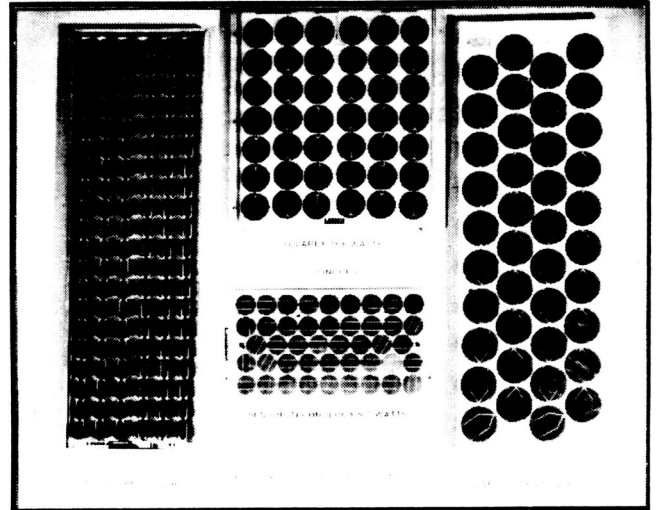

- FIRST LAMINATED MODULE
- CELL INTERCONNECT AND TERMINAL REDUNDANCY
- QA SPECIFICATION INTRODUCED
- ELECTRICAL PERFORMANCE CRITERIA
(15.8 VOLTS — 60°C CELL TEMPERATURE)
- STANDARD ARRAY SIZE AND MOUNTING
- INTRODUCTION OF GROUNDING SAFETY PROVISIONS
- EXPANDED ENVIRONMENTAL QUALIFICATION TESTING
 - THERMAL CYCLE
 - HUMIDITY CYCLE
 - STRUCTURAL LOADING

Figure 51. Block II: 1976-1977, Designed to FSA Specification, 127 kW

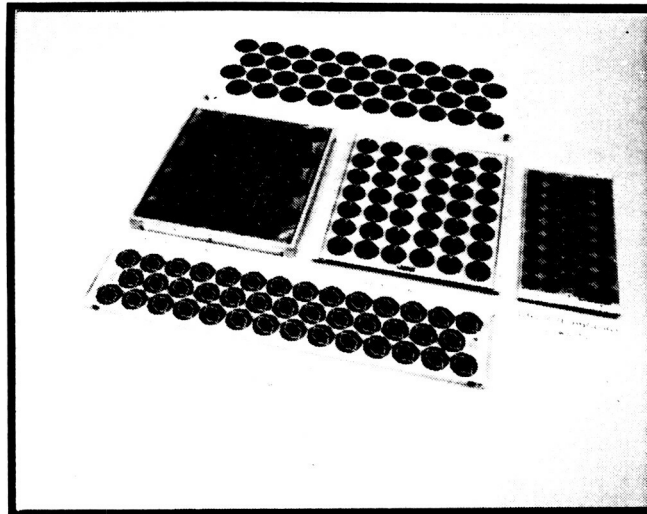

- DESIGN AND TEST SPECIFICATIONS ESSENTIALLY SAME AS BLOCK II
- IMPROVEMENTS IN DESIGN AND PRODUCTION PROCESSES RESULTING
FROM BLOCK II EXPERIENCE
- MORE UNIFORM QA STANDARDS

Figure 52. Block III: 1978-1979, Similar Specifications, 259 kW

ORIGINAL PAGE IS
OF POOR QUALITY

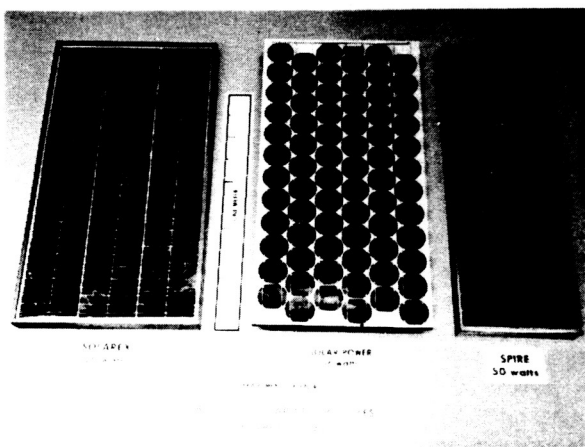
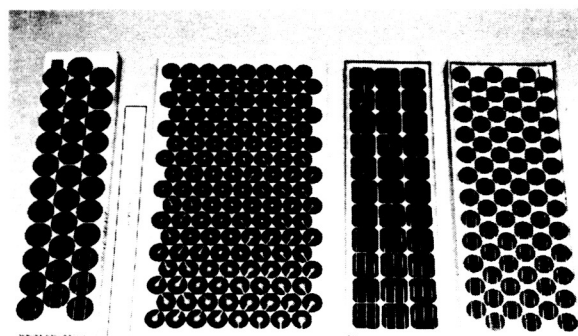
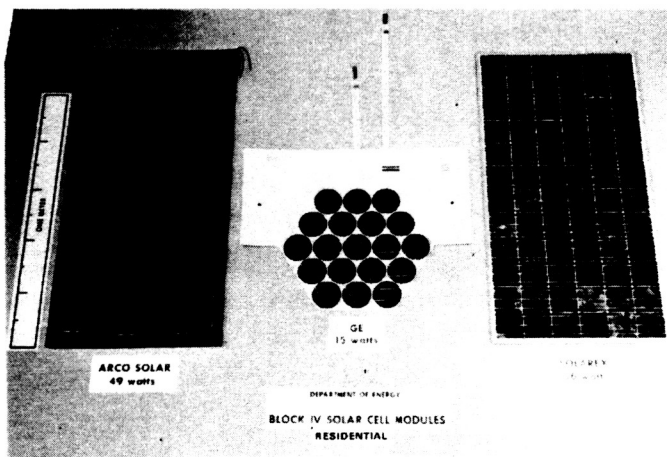

- **TYPICAL DESIGN FEATURES**
 - LAMINATED MODULE CONSTRUCTION
 - FAULT TOLERANT CELL AND CIRCUIT DESIGNS
 - LARGER POWER OUTPUT
 - CELLS WITH BACK SURFACE FIELDS
 - GLASS FRONT FACE
- **INNOVATIVE DESIGN FEATURES**
 - SHAPED CELLS
 - ION IMPLANTED CELLS
 - SEMICRYSTALLINE CELLS
 - ETHYLENE VINYL ACETATE ENCAPSULANT
 - BATTEN — SEAM ROOFING SUBSTRATE
 - FRAMELESS MODULE
 - INTEGRAL BYPASS DIODES

Figure 53. Block IV: 1980-1981: Industry Designs Reviewed by FSA, 26 kW of Prototype Modules

ORIGINAL PAGE IS
OF POOR QUALITY

CRITICAL FACTORS
OF GOOD QUALITY

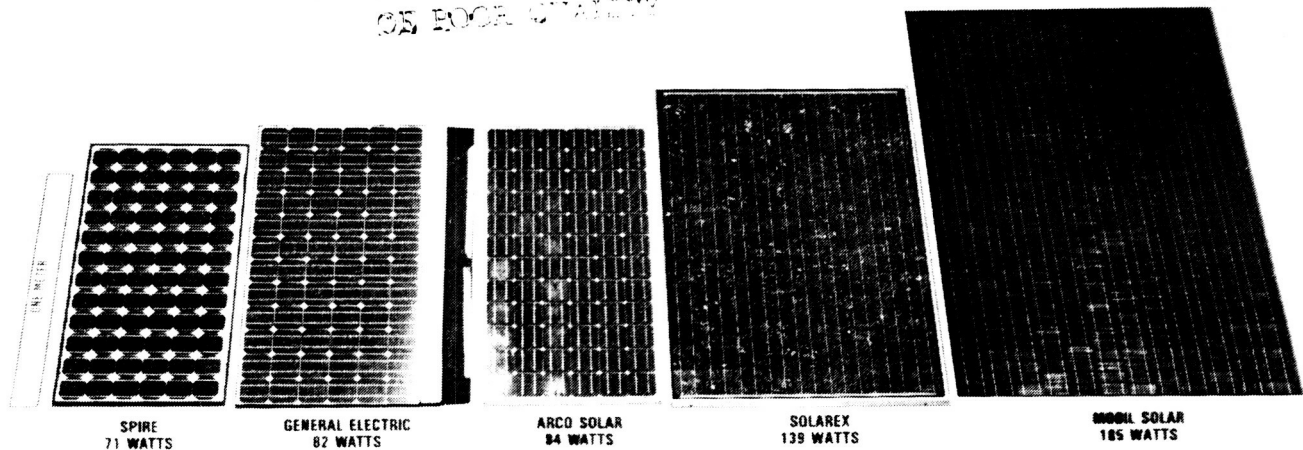

• TYPICAL DESIGN FEATURES

- LARGER POWER OUTPUT
- MODULE EFFICIENCY > 10% (EXCEPT RIBBON CELL MODULE)
- GLASS TOP COVER
- ETHYLENE VINYL ACETATE ENCAPSULANT
- LAMINATED COMPOSITE FILM BACK COVER
- LAMINATED MODULE CONSTRUCTION
- FRAMELESS MODULE
- SHAPED CELLS (HIGHER PACKING FACTOR)
- PARALLEL CELL STRINGS
- FAULT TOLERANT CELL AND CIRCUIT DESIGNS
- BYPASS DIODES

• INNOVATIVE DESIGN FEATURES

- MAJOR INCREASE IN AREA AND POWER OUTPUT
- MET MORE STRINGENT QUALIFICATION TESTS
- VIRTUAL ELIMINATION OF THE FOLLOWING CATASTROPHIC FAILURE MODES
 - UNACCEPTABLE CELL CRACKS
 - INTERCONNECT FAILURES
 - HOT-SPOT FAILURES
 - HAIL DAMAGE
- MODULE WITH CELLS MADE FROM SILICON RIBBON (EFG) GROWN TO THE CORRECT THICKNESS

Figure 54. Block V: 1981-1985: Industry Designs Reviewed by FSA, Small Module Quantities for Evaluation Only

Table 18. Module Cell and Circuit Characteristics

	MANUFACTURER	MODEL NO.	CELL					CIRCUIT			
			QNTY	SIZE (mm)	SHAPE	BASE MATL	JUNCTION	SERIES CELLS	PARALLEL CELLS	CROSS TIES	BY-PASS DIODES
I	SENSOR TECH.	V-13-AT	25	50 DIA	ROUND	CZ	N/P	25	-	-	-
	SOLAREX	785	18	76 DIA				18	-	-	-
	SOLAR POWER	E-10-229-1.5	22	87 DIA				22	-	-	-
	SPECTROLAB	060513-B	20	50 DIA				20	-	-	-
II	SENSOR TECH.	20-10-1452-J	44	56 DIA	↓	↓	↓	44	-	-	-
	SOLAREX	A-0221-D	42	76 DIA				42	-	-	-
	SOLAR POWER	E-10008-C	40	102 DIA				40	-	-	-
	SPECTROLAB	022962-G	120	50 DIA				40	3	-	-
III	ARCO SOLAR	10699-C	41	76 DIA	↓	↓	↓	41	-	-	-
	MOTOROLA	P-0170-770-J	48	76 DIA				12	4	11	-
	SENSOR TECH.	20-10-1646	44	56 DIA				44	-	-	-
	SOLAREX	A-0221-G	42	76 DIA				42	-	-	-
	SOLAR POWER	E-10008-F	40	102 DIA				40	-	-	-
IV	ARCO SOLAR	012110-E	35	103 DIA	ROUND W/2 FLATS	↓	↓	35	-	-	1
	ASEC	60-3062-F	138	76 DIA	ROUND			34	4	5	1
	G.E. ^a	47J254977G1-C	19	100 DIA	ROUND W/1 FLAT			19	-	-	-
	MOTOROLA	MSP43D40-G	33	100 x 100	QUASI-SQUARE			33	-	-	-
	PHOTOWATT	ML-1961-D	72	76 DIA	ROUND			12	6	-	-
	SOLAREX	580-BT-L-C	72	95 x 95	SQUARE			36	2	35	36
	SOLAREX ^a	580-BT-R-C	72	95 x 95	SQUARE			12	8	11	12
	SPIRE	058-0007-A	108	64 x 64	QUASI-SQUARE			36	3	11	2
V	ARCO SOLAR	004-014168-2	72	97 x 97	QUASI-SQUARE	↓	↓	12	8	3	1
	G.E. ^a	47E258449G2-A	72	100 x 100	QUASI-SQUARE			36	2	34	3
	MSEC ^a	Ra-180-12-D	432	95 x 48	RECTANGULAR			36	12	2	1
	SOLAREX	C-120-10A	117	101 x 101	RECTANGULAR			13	9	-	1
	SPIRE ^a	058-0008-B	72	91 x 91	QUASI-SQUARE			36	2	2	3

NOTE: ^aRESIDENTIAL MODULE

Table 19. Module Performance Characteristics

		SAMPLE PERFORMANCE														NOCT ^b (°C)			
		AT 100 mW/cm ² , AM 1.5, 28°C CELL TEMP.							AT 100 mW/cm ² , AM 1.5, NOCT ^b										
MANUFACTURER	MODEL NO.	P _{max} (W)	V _{pmax} (V)	I _{pmax} (A)	V _{oc} (V)	I _{sc} (A)	FILL FACTOR (%)	MODULE EFF. (%)	CELL EFF. ^c (%)	P _{max} (W)	V _{pmax} (V)	I _{pmax} (A)	V _{oc} (V)	I _{sc} (A)	FILL FACTOR (%)		MODULE EFF. (%)	CELL EFF. ^c (%)	
I	SENSOR TECH.	V-13-AT	4.7	9.8	0.48	DATA NOT AVAILABLE	4.8	9.4	39	DATA NOT AVAILABLE									
	SOLAREX	785	8.7	7.0	1.24					48									
	SOLAR POWER	E-10-229-1.5	13.2	9.6	1.38					49									
	SPECTROLAB	060513-B	4.7	9.4	0.50					35									
II	SENSOR TECH.	20-10-1452-J	11.4	20.7	0.55	24.8	0.60	0.77	8.8	10.6	10.4	18.7	0.56	23.4	0.59	0.75	6.3	9.6	43
	SOLAREX	A-0221-D	20.5	18.0	1.14	24.3	1.43	0.59	6.0	10.7	18.7	16.3	1.15	22.4	1.44	0.58	5.5	9.8	47
	SOLAR POWER	E-10008-C	33.8	18.0	1.88	23.5	1.98	0.73	7.4	10.7	31.3	16.6	1.89	22.0	1.98	0.72	6.9	9.7	46
	SPECTROLAB	022962-G	30.0	18.2	1.65	23.0	1.86	0.70	6.6	12.7	28.5	17.3	1.65	21.9	1.88	0.69	6.3	11.7	41
III	ARCO SOLAR	10699-C	22.8	18.2	1.25	23.3	1.38	0.71	8.4	12.2	20.6	16.5	1.25	22.0	1.40	0.67	7.6	11.0	50
	MOTOROLA	P-0170-770-J	26.2	5.9	4.45	7.1	4.82	0.76	7.7	11.8	23.6	5.3	4.45	6.6	4.88	0.73	7.0	10.8	53
	SENSOR TECH.	20-10-1646	11.3	20.2	0.56	24.6	0.62	0.74	8.8	10.5	10.2	18.6	0.55	23.0	0.62	0.72	6.1	9.4	43
	SOLAREX	A-0221-G	21.7	17.8	1.22	23.7	1.40	0.65	6.5	11.6	19.7	16.4	1.20	22.1	1.41	0.63	5.8	10.4	46
	SOLAR POWER	E-10008-F	34.8	18.3	1.90	23.6	1.97	0.75	7.7	11.2	32.2	17.2	1.87	22.0	1.98	0.74	7.1	10.3	46
IV	ARCO SOLAR	012110-E	35.7	18.6	2.15	21.0	2.42	0.70	9.6	12.8	32.4	15.0	2.16	19.6	2.42	0.68	8.7	11.4	46
	ASEC	60-3062-F	84.6	18.5	5.11	20.2	5.40	0.78	10.1	13.6	77.4	15.0	5.16	19.2	5.45	0.74	9.3	12.6	47
	G.E. ^a	47J254977G1-C	18.8	8.5	2.21	11.0	2.53	0.68	9.6	12.6	15.3	7.1	2.16	9.6	2.53	0.63	7.8	10.3	58
	MOTOROLA	MSP43D40-G	37.3	16.2	2.30	19.5	2.50	0.76	8.8	11.6	34.3	15.1	2.27	18.4	2.52	0.74	8.1	10.6	49
	PHOTOWATT	ML-1961-D	38.6	5.88	6.79	6.98	7.58	0.73	7.2	11.6	34.9	5.10	6.84	6.5	7.62	0.70	6.6	10.6	47
	SOLAREX	580-BT-L-C	62.6	16.1	3.90	19.6	4.50	0.71	8.2	9.6	57.3	14.4	3.98	18.1	4.58	0.69	7.5	8.8	49
	SOLAREX ^a	580-BT-R-C	80.8	5.31	11.4	6.60	13.2	0.69	8.1	9.3	54.5	4.70	11.6	6.2	13.3	0.66	7.3	8.4	56
SPIRE	058-0007-A	57.0	16.2	3.52	20.3	3.64	0.77	11.4	13.6	50.8	14.2	3.58	18.6	3.67	0.74	10.1	11.9	49	
V	ARCO SOLAR	004-014168-2	84.1	5.82	14.5	7.16	15.9	0.74	11.3	12.6	75.0	5.20	14.4	6.58	16.1	0.71	10.1	11.2	49
	G.E. ^a	47E258449G2-A	81.7	17.0	4.81	20.9	5.65	0.69	10.5	11.7	85.4	13.3	4.82	17.7	5.89	0.65	8.4	9.3	85
	MSEC ^a	Ra-180-12-D	185.	15.3	12.1	18.9	13.3	0.74	8.4	9.4	165.	13.2	12.5	17.9	13.7	0.87	7.5	8.4	48
	SOLAREX	C-120-10A	139.	5.84	23.8	7.47	26.7	0.70	10.3	11.7	123.	5.18	23.7	6.79	27.2	0.87	9.1	10.3	48
	SPIRE ^a	058-0008-B	70.7	16.1	4.39	20.7	4.79	0.71	10.1	13.3	62.7	14.5	4.32	18.9	4.84	0.69	9.0	11.8	47 ^d

NOTES: ^aRESIDENTIAL MODULE

^bNOMINAL OPERATING CELL TEMPERATURE: CELL TEMPERATURE IN OPEN-CIRCUITED MODULE EXPOSED TO 80 mW/cm² INSOLATION IN AMBIENT OF 20°C, 1 m/s WIND VELOCITY

^cENCAPSULATED CELL

^dRACK-MOUNTED

Table 20. Module Mechanical Characteristics

MANUFACTURER	MODEL NO.	AREA ^b (m ²)	LENGTH (m) ^c	WIDTH (m) ^c	MASS (kg)	SUPERSTRATE OR TOP COVER	SUBSTRATE OR BOTTOM COVER	ENCAPSULANT	ENCAPSULANT METHOD	FRAME	ELECTRICAL CONNECTIONS	PACKING FACTOR	
i	SENSOR TECH. SOLAREX	V-13-AT 785	0.097 0.133	0.57 0.51	0.17 0.26	1.3 1.1	RTV-615 SYLGARD 184	ALUMINUM NEMA-610 BOARD	RTV-615 SYLGARD 184	CASTING	NONE	TERMINALS	0.51 0.61
	SOLAR POWER SPECTROLAB	E-10-229-1.5 060513-B	0.229 0.080	0.61 0.66	0.37 0.12	2.6 1.6	D.C. R4-3117 GLASS	NEMA-610 BOARD ALUMINUM	SYLGARD 184 RTV-615	↓	↓	J-BOX/CABLE TERMINALS	0.57 0.49
	SENSOR TECH. SOLAREX	20-10-1452-J A-0221-D	0.168 0.335	0.582 0.578	0.289 0.579	1.5 4.1	RTV-E15 SYLGARD 184	ALUMINUM NEMA-610 BOARD	RTV-615 SYLGARD 184	↓	ALUM.	TERMINALS	0.64 0.56
	SOLAR POWER SPECTROLAB	E-10008-C 022962-G	0.454 0.453	1.168 1.168	0.399 0.388	7.6 6.1	D.C. XL-2577 GLASS	GFR POLYESTER BOARD MYLAR	SYLGARD 184 PVB	LAMINATION	NONE ALUM.	J-BOX PLUG-IN	0.69 0.52
ii	ARCO SOLAR MOTOROLA	10699-C P-0170-770-J	0.270 0.340	1.168 0.583	0.231 0.583	3.7 6.6	↓	TEDLAR STAINLESS STEEL	PVB D.C. Q3-6527A	LAMINATION CASTING	ALUM. ST. STEEL	TERMINALS	0.69 0.65
	SENSOR TECH. SOLAREX	20-10-1646 A-0221-G	0.166 0.335	0.582 0.579	0.286 0.579	3.7 4.4	RTV-615 SYLGARD 184	ALUMINUM NEMA-610 BOARD	RTV-615 SYLGARD 184	↓	NONE ALUM.	↓	0.65 0.56
	SOLAR POWER SPECTROLAB	E-10008-F 012110-E	0.454 0.372	1.168 1.219	0.389 0.305	7.4 5.2	D.C. R4-3117 GLASS	GFR POLYESTER BOARD TED/ST/ITD	SYLGARD 184 PVB	LAMINATION	NONE	J-BOX	0.69 0.76
	ARCO SOLAR ASEC G.E. ^a	012110-E 60-3082-F 47J254977G-C	0.372 0.834 0.198	1.219 1.198 0.818	0.305 0.896 0.689	5.2 13.5 4.0	GLASS	TED/ST/ITD TEDLAR MEAD PAN-L-BOARD	PVB PVB G.E. SCS2402	LAMINATION	ALUM. ALUM. NONE	↓	0.76 0.74 0.76
iv	MOTOROLA PHOTOWATT	MSP43D40-G ML-1981-D	0.426 0.532	1.198 1.199	0.356 0.444	5.8 7.4	↓	TED/AL/ITD TED/AL/ITD	PVB PVB	↓	ST. STEEL ALUM.	J-BOX PLUG-IN	0.76 0.62
	SOLAREX SOLAREX ^a	580-BT-L-C 580-BT-R-C	0.782 0.749	1.200 1.193	0.835 0.628	13.9 11.2	↓	TEDLAR TEDLAR	EVA	↓	ALUM. NONE	PIGTAILS PIGTAILS	0.85 0.87
	SPIRE ^a	058-0007-A 004-014168-2	0.504 0.745	1.200 1.221	0.417 0.610	7.8 12.0	↓	MYLAR-AL-COAT TED/PET/ITD ^b	↓	↓	ST. STEEL ALUM.	PLUG-IN J-BOX	0.85 0.80
	ARCO SOLAR G.E. ^a MSEC ^a	058-0008-B 47E258449G2-A R ₀ -180-12-D	0.875 0.778 2.154	1.134 1.228 1.791	0.595 0.833 1.203	7.3 13.6 29.5	↓	TEDLAR TED/PET/AL/ITD ^{d,a} PET/AL/ITD ^b	↓	↓	NONE	↓	0.76 0.90 0.89
v	SOLAREX SPIRE ^a	C-120-10A 058-0008-B	1.331 0.875	1.391 1.134	0.957 0.595	23.6 7.3	↓	PET/MYLAR/ITD ^b TEDLAR	↓	↓	ALUM.	J-BOX PLUG-IN	0.88 0.76

^aRESIDENTIAL MODULE

^bEXPOSED AREA

^cOVERALL DIMENSION

^dPLUS SHINGLE MATERIAL

^ePET-POLYESTER FILM, POLYETHYLENE TEREPHTHALATE

Engineering Sciences and Design

At the start of the FSA Project, there was a need to establish a complete new PV module and array technology for terrestrial applications. The use of solar cells in space was a very different application than any found on Earth. Thus, there was a need to define potential terrestrial applications, and to develop the operational and environmental requirements and technology needed for the manufacture and use of PV products in these applications.

The *objective* is to develop reliable, low-cost module and array engineering and design technologies for integrating cells and modules into cost-effective and safe arrays for large-scale applications.

- Identify and develop functional requirements and specifications to ensure module compatibility with the various operational and safety environments of future PV applications.
- Develop engineering design methods and data and advanced safe, reliable design concepts focused at the needs of future large-scale PV applications.
- Verify the adaptability of the technology to meet required operational conditions.

Background

The use of crystalline silicon solar cells in space had demonstrated that PV power systems were a practical and reliable method of generating electrical power. The solar cells and the "solar panels," as designed, were light-weight, resistant to radiation, capable of withstanding rapid heating and cooling, and were cost effective as used in space. The idea of using photovoltaics as a major power source in the terrestrial environment meant that the new functional requirements of these applications had to be identified and the necessary technologies developed. Not only were the environmental requirements significantly different with the addition of wind and moisture-related weathering, but the institutional requirements were vastly changed with added considerations of building and safety codes, user interaction, product liability concerns, and interaction with the community of installation trades and operation and maintenance personnel.

Project Activities: 1975 to 1981

Deficiencies and failures were prevalent in the first (pre-1975) terrestrial modules. In addition to the early reliability problems, the modules were found to be ill suited for use in the first kilowatt-scale, high-voltage

systems. Their size was too small, the mechanical interfaces (bolt patterns) varied from module to module (even within the same manufacturers model, they were unsafe electrically for use at high voltages), and they lacked means of electrically interconnecting them cost effectively. To define the needed changes, the FSA Project worked closely with the systems and applications researchers at NASA Lewis Research Center and Sandia National Laboratory to understand the problems being uncovered and the future applications being identified. Next, FSA researchers contracted with leading industrial teams, knowledgeable of the detailed technical characteristics of future applications, to identify and develop concepts and requirements for flat-plate PV modules specifically suited to these uses. Large architect and engineering (A&E) firms with extensive experience building large central utility power plants defined optimum modules and arrays for utility-scale applications; simultaneously, residential and commercial architectural firms developed the detailed requirements and concepts appropriate for these sectors, including consideration of applicable building and safety codes and labor practices.

As the early deficiencies were gradually resolved, the above activities coalesced into a coherent array subsystem design effort (Figure 55) addressed to optimizing the overall module and array designs for the intended applications so as to reduce costs and increase efficiency and lifetime. The environmental conditions that PV modules and arrays are subjected to during field operation were assessed, measured, and defined. This covered mean operating conditions in addition to extremes for conditions such as UV/ solar weathering, temperature, temperature cycling, hail impact, and combinations of the above (Figure 56). Means of quantifying and reducing the operating temperatures of modules were developed; detailed wind tunnel analyses were conducted to define expected wind loading levels, the effectiveness of wind barriers, and dynamic flutter magnitudes. Based on the structural loading studies, new module structural designs were developed. These designs included frameless modules and low-cost ground-mounted array structures (Figure 57). A new methodology for determining the breaking strength of glass was also developed.

To improve the reliability of the arrays, complex circuit analyses were used to define optimum series-parallel electrical circuit redundancy approaches at the array and module level, and optimum maintenance and replacement trade-offs (Figure 58); other design studies explored low-cost electrical inter-connection techniques.

One of the key institutional barriers uncovered in the electrical circuit studies was the unique electrical safety attributes of PV which are inconsistent with many standard safety practices. Unlike conventional electrical sources, PV modules cannot be turned off and they cannot generate the overcurrent needed to

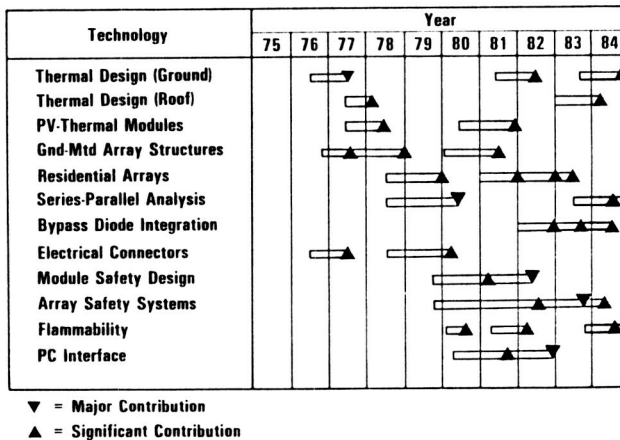

Figure 55. Engineering Sciences Developments

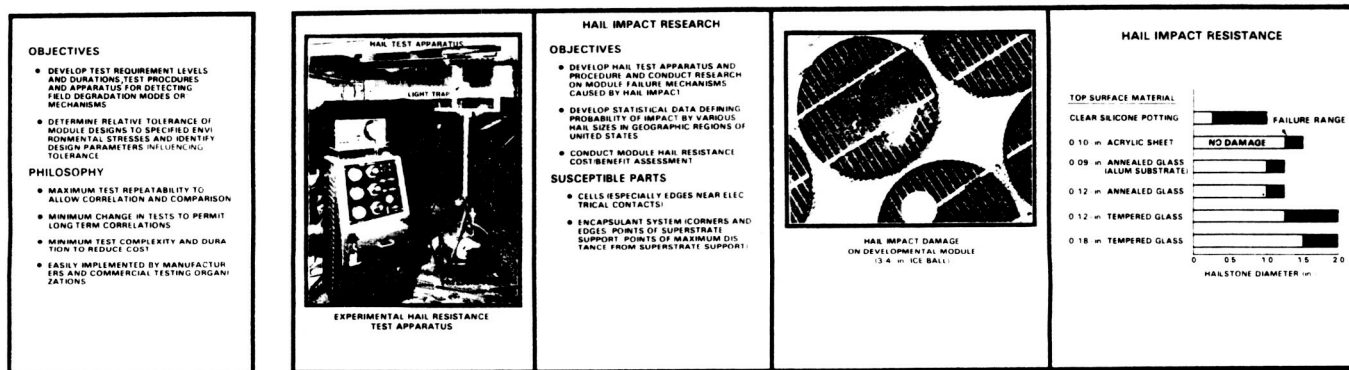

Figure 56. Environmental Requirements Example

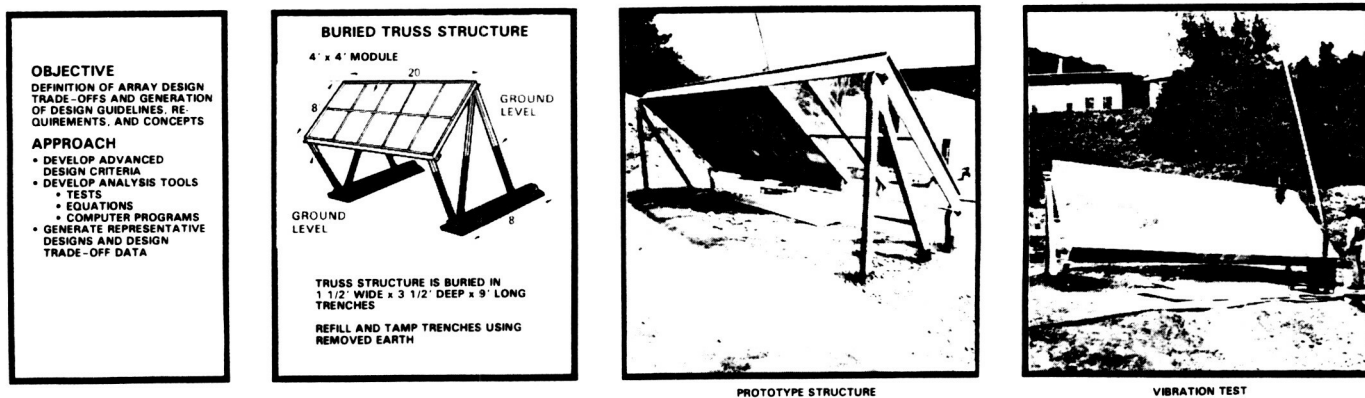

Figure 57. Advanced Array Structures

blow fuses or circuit breakers in the event of a short circuit or short to ground. To develop the needed safety technology, JPL contracted with Underwriters Laboratories who developed detailed module safety requirements and conceptual approaches to the entire electrical safety system for a complete PV

power system (Figure 59). On the basis of this work, requirements for UL listing of modules have been developed, and a new Article 690, covering required electrical safety features in high-voltage PV power systems, has been included in the 1984 revision of the National Electrical Code.

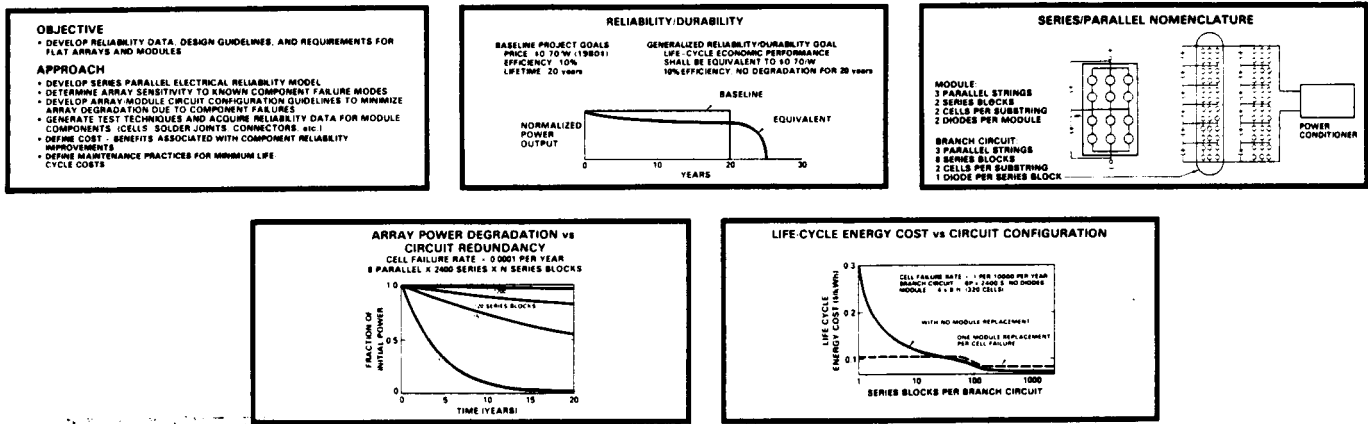

Figure 58. Electrical Circuit Reliability

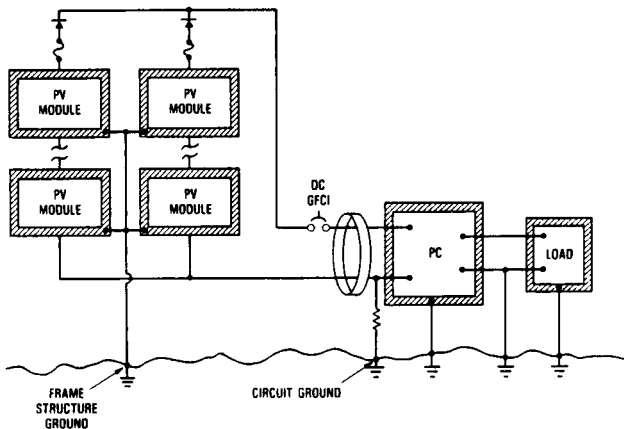

Figure 59. Isolation/Grounding Safety Concepts

The most important technique for getting module-manufacturing industry participation in the module/array design process and for transferring new knowledge into practice, was to make periodic procurements of modules. These purchases of advanced-design modules to successively more definitive and more appropriate requirements, and the subsection of these modules to qualification life tests and field tests, resulted in a very dynamic and fruitful cooperative industry/Government effort.

There were a number of design specifications that evolved over the years, each building on the previous one together with the technology developments and the application and testing experience. The latest Block V Module Design and Test Specification was issued in two versions in 1981; one specification is for Residential Applications, and the second is for Intermediate Load Applications, i.e., general purpose uses.

Project Activities: 1981 to Present

Since 1981, the evolution of module and array requirements and technology has continued with emphasis on completing the technology base for residential applications and supporting the design and fielding of the first megawatt-scale utility

applications. Detailed studies were conducted characterizing the operating temperatures of roof-mounted modules and defining residential array design guidelines including array wiring practices and bypass-diode packaging concepts. Testing of the new environmentally durable encapsulants indicated substantial progress in the area of reliability, but a step backward relative to flammability and suitability for module applications with a high fire risk. Research was initiated to characterize the flame resistance of new module designs and to develop flame-resistant design approaches and encapsulant materials (Figure 60).

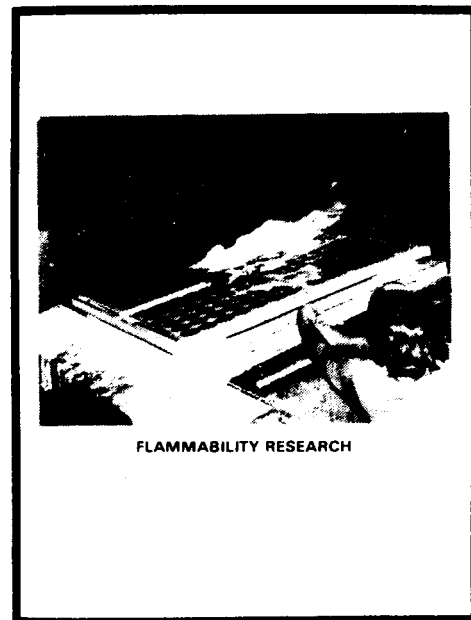

Figure 60. Flammability Research on Rooftop Module

The need for improved integration between the array and the power conditioner led to extensive modeling of array output versus time for various sites in the United States. Characterizations included

statistical data on maximum array voltage, current and power levels and the performance efficiency of various maximum-power tracking algorithms.

With the gradual completion of the engineering technologies for crystalline-silicon modules, Engineering Sciences research has gradually phased down in recent years and turned to the needs of the emerging new thin-film modules. These needs seem to be well served by the technology base resulting from the 10 years of research on crystalline-silicon modules and arrays.

Significant Accomplishments

Specific design data and recommendations that have evolved include:

- Module design specifications including environmental endurance test requirements
- Module electrical safety design requirements and practices (UL 1703)
- Safety system design concepts and recommendations (National Electrical Code Article 690)
- Detailed assessments of residential and commercial building codes and the implications on the use of photovoltaics
- Module product-liability guidelines
- Array wire selection and safety design guidelines
- Array series/parallel electrical circuit design guidelines including grounding and bypass diode design guidelines
- Module electrical circuit design guidelines including interconnect redundancy and cell contacting techniques
- Module electrical terminal needs and designs
- Module electrical insulation system design guidelines and testing techniques
- Module and array thermal design guidelines for cooler operation, resulting in increased power output and longer life
- Standardized module thermal testing methods
- Fire resistant module designs and encapsulant materials
- Residential array design approaches
- Low-cost ground-mounted array design approaches including frameless modules
- Guidelines for optimum maintenance/replacement of failed modules in the field
- Data on array cleaning costs and automated washing techniques
- Wind pressure loads on flat modules and arrays
- Structural capabilities of glass as used in modules, and glass sizing algorithms
- Design guidelines for optimally interfacing arrays with power conditioners

Encapsulation

In 1975, the encapsulation requirements of PV cells for terrestrial use had not been comprehensively assessed, needs had not been defined, nor potential low-cost encapsulation materials investigated. Therefore, the FSA Project set out to assess the needs in order to identify, and/or develop new materials and new material technologies that were inexpensive and could protect solar cells for years. The assessment led to the establishment of encapsulation needs, goals, and detail requirements and a plan on how to meet the goals.

The *objectives* of the encapsulation activities were to define, develop, demonstrate, and qualify encapsulation systems, and materials and processes that meet the FSA Project module life, cost, and performance goals; and to develop and validate encapsulation system life prediction methodology based on modeling life-limiting failure modes and on conducting and analyzing aging tests.

The *goals* are to develop encapsulation system technology adequate for:

- Module life of 30 years (increased from 20 years).
- Encapsulation materials, including substrate and/or superstrate, costs not exceeding \$14/m² (1980 dollars).
- Initial optical transmission of 90% and a loss of less than 5% after 20 years of use.
- Capability to withstand an electrical breakdown voltage of 3000 V dc.
- Structural integrity and durability to withstand handling and weather.
- Cost-effective processing in an automated factory with high yields.

Background

Typical terrestrial PV module fabrication prior to 1975 was by hand assembly. The solar cells were interconnected by hand soldering. The strings of cells were encased by hand-poured silicone rubber, which usually resulted in non-uniform products. The durability of a module was unpredictable, often with delamination and/or cracking of the encapsulant. The module materials were expensive and the encapsulation concepts, designs, and processes were not amenable to mass production. Consistent module quality was a problem because of a lack of good processing knowledge, capabilities, and quality

assurance, for example, requirements for and control of encapsulant curing. The product quantities were so small that manufacturers could not afford to do a thorough job of studying materials and processes. A comprehensive long-range encapsulation technology plan was needed and was formulated by the FSA Project.

Project Activities: 1975 to 1981

In the implementation of the plan to meet the objectives and goals, five activities were followed: (1) the generation of specifications and functional requirements for encapsulation materials; (2) the identification or development of low-cost materials satisfying the specifications and functional requirements; (3) engineering material usage; (4) recognition of life and/or weathering deficiencies in the low-cost materials; (5) generation of necessary design approaches or material modifications to enhance life or weathering stability; and (6) life-prediction methodologies for encapsulation systems.

Two basic encapsulation systems for terrestrial modules evolved: substrate and superstrate (Figure 61). This nomenclature refers to the method of structurally supporting the encapsulated cells and their electrical interconnections, i.e., sub or bottom side and super or top sunnyside. Today, the superstrate design is universally used because tempered glass is a practical top cover for use with crystalline silicon solar cells. Thin-film cells have the potential for use in flexible modules; however, a practical flexible top cover is unavailable. Consequently, the preponderance of the effort, to date, has centered on the technology for laminating the active components in a PV module and their function are shown in Figure 62.

The key component is the *pottant*, which is a transparent, elastomeric material that encases the cells and their electrical circuitry. In the fabricated module, the pottant provides:

- Maximum optical transmission in the silicon solar cell operating wavelength range of 0.4 to 1.1 μm .
- Retention of a required level of electrical insulation to protect against electrical breakdown, arcing, etc., with the associated dangers and hazards of electrical fires, and human safety.
- The mechanical properties to maintain spatial containment of the solar cells and interconnects, and to resist mechanical creep. The level of mechanical properties also must not exceed values that would impose undue mechanical stresses on the solar cells.

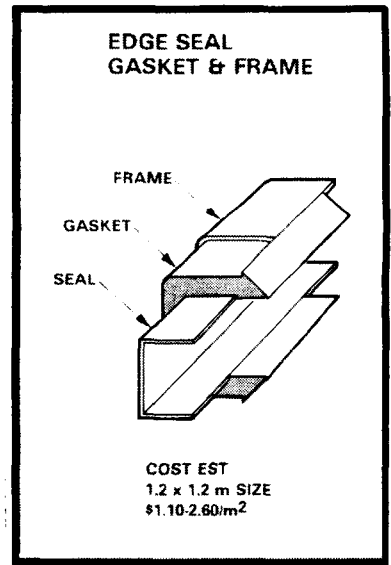
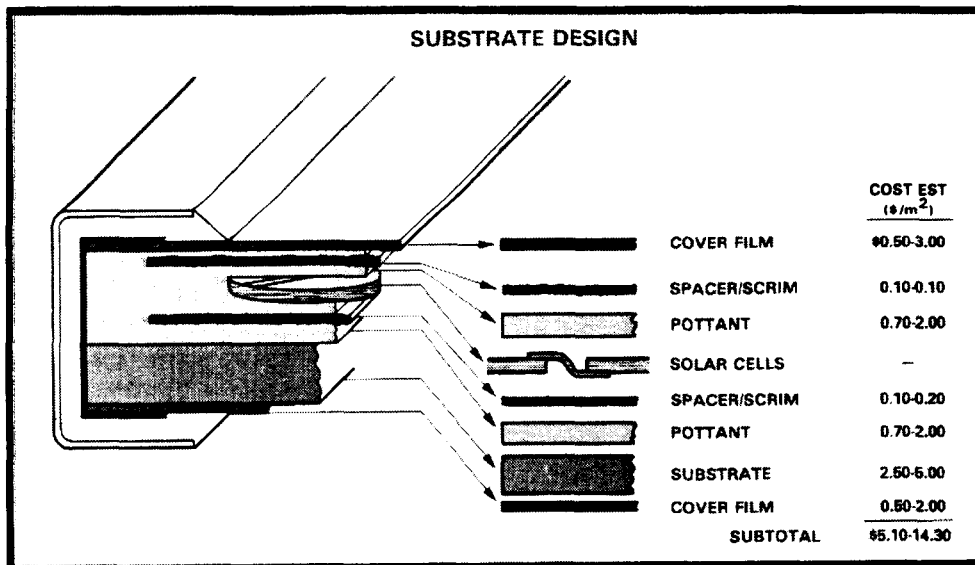
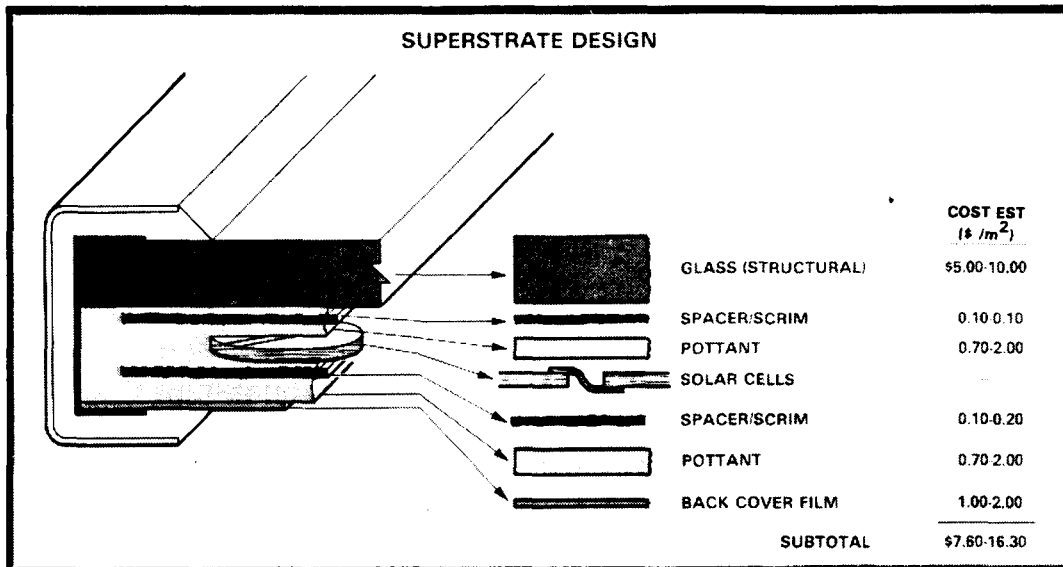

Figure 61. Encapsulation System Designs

Also, the pottant must be commercially available and be readily processible for automated fabrication. Because there is a significant difference between the thermal-expansion coefficients of polymeric materials and the silicon cells and metallic interconnects, stresses developed from the thousands of daily thermal cycles can result in fractured cells, broken interconnects, or cracks and separations in the pottant material. To avoid these problems, the pottant material must not overstress the cell and interconnects, and must itself be resistant to fracture. From the results of a theoretical analysis, experimental efforts, and studies of available materials, the pottant must be a low-modulus elastomeric material.

The top cover is in direct contact with all of the weathering elements: ultraviolet, humidity, water, oxygen, sunlight, etc., and must protect underlying materials from degrading effects. The outer surface

must also be resistant to atmospheric soiling, and be abrasion resistant, anti-reflective, and easily cleanable.

The back cover protects the cells, interconnects, pottant, and the substrate, if there is one, from weather and from electrical shorting. The cover should be weatherable, hard, mechanically durable and tough, and have a white, high-emissivity surface for cool module operation.

The edge of the laminate needs to be protected so that delamination does not begin and destroy the module. A gasket is used if the module is to have a frame or it may be used for the installation of frameless modules.

During module fabrication, primers are required to obtain good adhesion of the polymeric pottant to glass, solar cells, and polymeric films that are used for back covers.

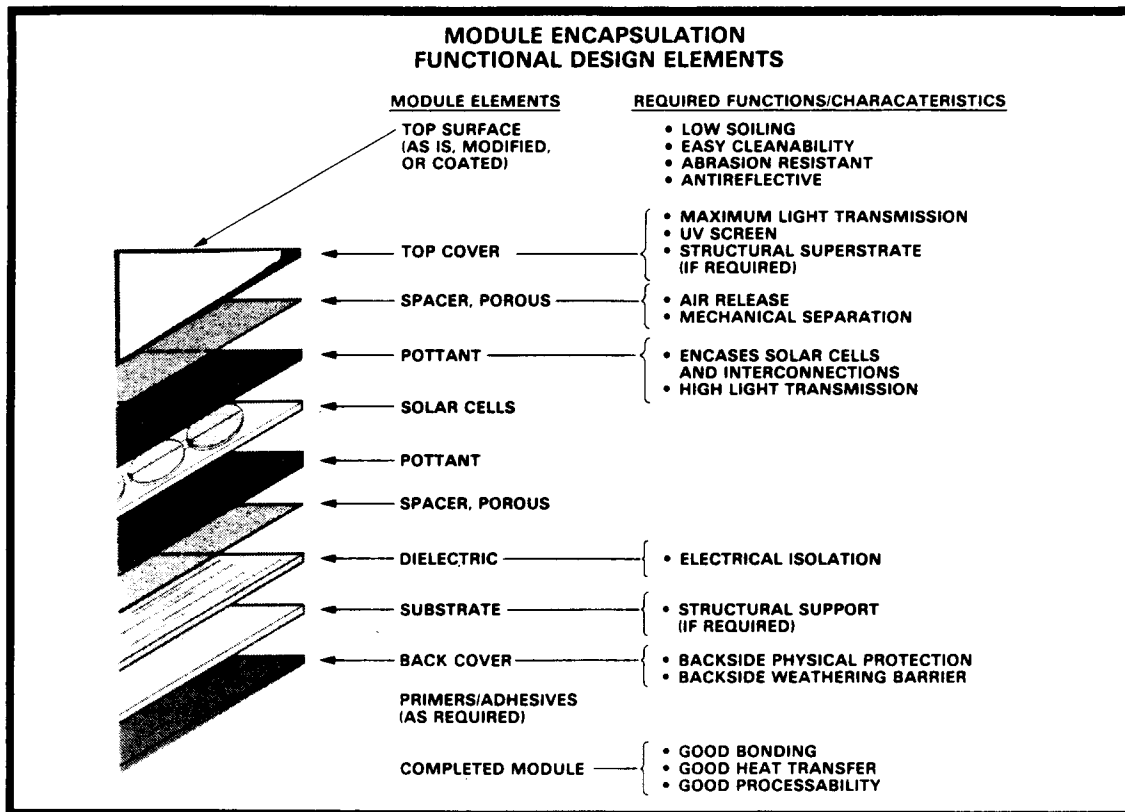

Figure 62. Module Encapsulation Functional Design Elements

Many of the low-cost polymeric materials that satisfy module engineering and encapsulation processing requirements are not intrinsically weather stable. Therefore, emphasis has been applied to specific efforts to overcome life and/or weathering deficiencies, to enhance weather stability, and to develop accelerated aging techniques. Specific items include the development of chemically attachable stabilization additives (ultraviolet screening agents, anti-oxidants, etc.), computer-assisted kinetic modeling of outdoor weathering reactions, and the use of new and novel outdoor-heating racks and controlled-environment reactors as accelerated aging techniques.

Transparent polymeric pottants are subject to three weathering actions: ultraviolet reactions, thermal oxidation, and hydrolysis. During the assessment of various pottants, each polymer was studied for its ability to withstand the above weathering actions and the cost of the product. It was determined that all the lowest cost polymers were subject to all three weathering actions, a number of expensive polymers were subject to no weathering actions, and a few intermediate cost polymers were resistant to weathering (at

temperatures up to 80 °C), except for ultraviolet weathering. Of the four intermediate cost polymers, two were casting liquids and two were dry films that could be used for fabricating laminated modules. The dry films are practical for PV module uses because of the ease and simplicity of handling and processing. Initially, ethylene vinyl acetate (EVA) was the only low-cost dry film available; therefore, emphasis was placed upon efforts to adopt it for PV use. The search for a second dry film polymer continued in case EVA did not fulfill the encapsulation requirements. Ethylene methyl acrylate (EMA) was discovered 2 or 3 years later, but by then it seemed that EVA would satisfy the needs. A lack of sufficient funds inhibited a thorough investigation of EMA although, to date, there are no known EMA deficiencies for use as a PV module pottant. The approach used was to develop an EVA that could be thoroughly evaluated while work progressed on an advanced EVA.

Other encapsulation topics addressed related to life and durability included: (1) soiling, (2) electrical insulation, (3) primers and adhesives, (4) encapsulant system design analysis, and (5) material characterization (see Figures 63 and 64).

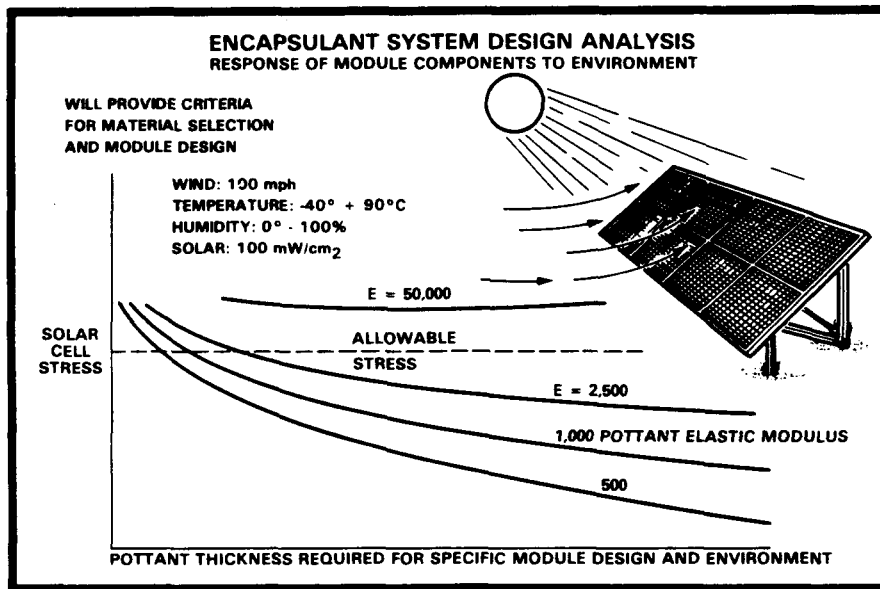

Figure 63. Encapsulant System Design Analysis

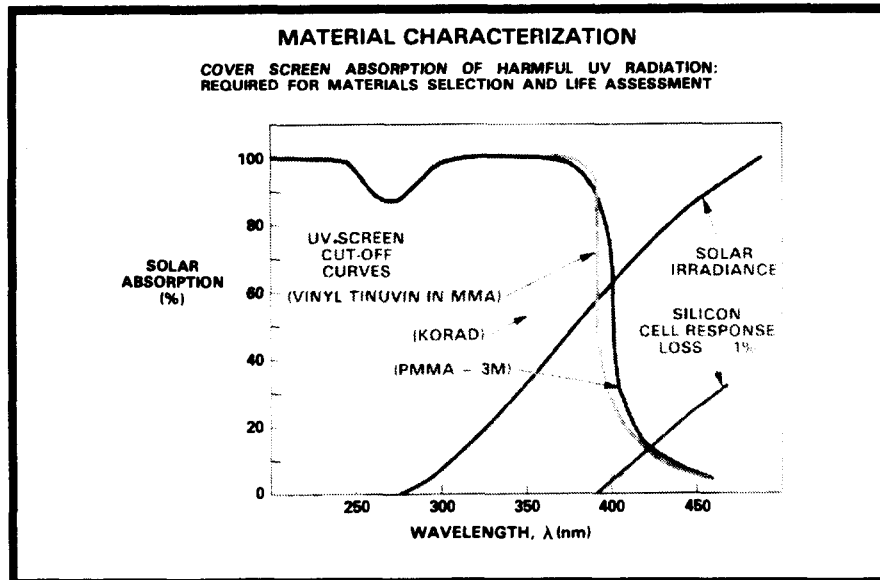

Figure 64. Material Characterization

Project Activities: 1981 to Present

The PV industry has been using a first-generation EVA in commercial modules for more than 5 years. This material has proven to be a surprisingly stable polymer when correct module design and processing have been used. The life-limiting characteristics of this EVA have been found from experiments, qualification testing, field operation, and accelerated testing. With this knowledge, an advanced EVA that corrects minor deficiencies of the earlier EVA has been devised. On the basis of the results of 1 year of evaluating the advanced EVA, it seems to have corrected the previous materials deficiencies. At this time, there are no known reasons why this new EVA should not satisfy the requirements for a 30-year module life. However, testing needs to be done to

verify the life of the pottant and of a complete encapsulation system using this pottant.

In experimental studies of EVA aging, it seems that EVA does not undergo thermal oxidation at temperatures up to 50°C. However, it does undergo photo-oxidation. EVA, which yellows and degrades within 1000 h when subjected to normal weather conditions at 50°C, did not yellow or degrade in 20,000 h when protected by an ultraviolet screening film. Therefore, the life of an EVA pottant in outdoor service at 50°C (or less) is directly related to the permanence of the module's protection from ultraviolet.

The advanced EVA material (formulated by Springborn Laboratories) uses a curing agent (TBEC)

ADVANCED ADDITIVES DEVELOPMENT

MATERIALS IMPROVEMENT USING ADDITIVES

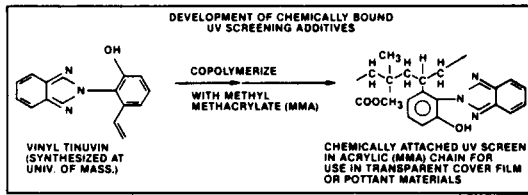

CONCEPT DEVELOPMENTS IN ADVANCED STABILIZATION ADDITIVES PROVIDED DIRECTIONS FOR A MORE WEATHER STABLE, EASIER TO PROCESS, EVA FORMULATION



IMPROVED ADVANCED EVA FORMULATION

COMPONENT	FUNCTION
• EVA — DUPONT ELVAX 150	• BASIC RESIN
• LUPERSOL TBEC (PENN WALT)	• PEROXIDE CURING AGENT REPLACING LUPERSOL 101 <ul style="list-style-type: none"> • FASTER CURE AT LOWER TEMPERATURES • IMPROVED LONG-TERM STORAGE STABILITY
• UV-2098 (AM. CYANAMID)	• UV SCREENING — CHEMICALLY ATTACHABLE FOR BETTER WEATHERING PERMANENCE
• UV-3346 (AM. CYANAMID)	• UV ANTI-OXIDANT, A HINDERED AMINE LIGHT STABILIZER (HALS) — HIGH MOLECULAR WEIGHT ADDITIVE FOR WEATHERING PERMANENCE

Figure 65. Advanced Encapsulation Materials Research

which cures faster at a lower temperature in addition to having a longer storage or shelf life; it also has a chemically attachable, nondepleting ultraviolet screen component and has a nondepleting polymeric weather stabilizer (see Figure 65). The test results to date have been excellent.

The components of an encapsulation system need to be bonded to each other permanently. Significant advances have been made in this chemical bonding technology during the past 10 years and especially during the last 2 years when the number of adhesives recommended for use in the PV industry has been reduced from 23 to 3 and the adhesives themselves are of improved quality (see Figure 66).

A definition of the intrinsic dielectric strength of insulating materials which can be considered as a fundamental material property has been proposed. This is being used to quantify the aging characteristics of potants in regard to their electrical insulation properties.

Predictive aging models that connect change of encapsulation material properties and rates of changes to module performance and life have been developed. A correlation of accelerated outdoor aging to normal outdoor aging by elevating the temperature of encapsulants has been determined (see Figure 67). Equipment for accelerated testing has also been developed.

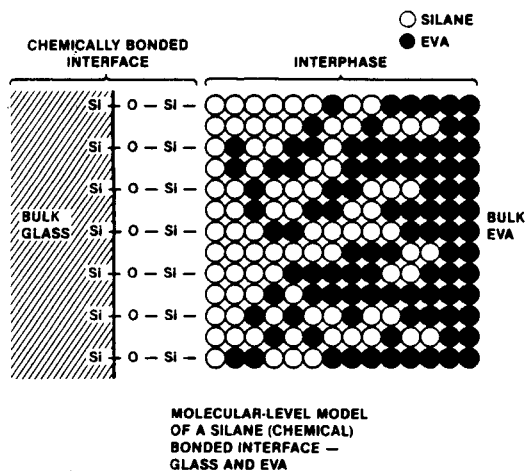
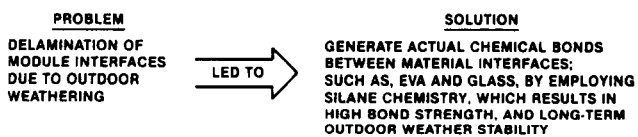
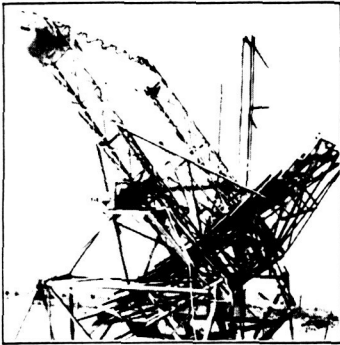

Figure 66. Chemical Bonding Research

Power loss of modules caused by 3 years of outdoor soiling has been reduced significantly by the use of fluorocarbon coatings on the module top surface. On glass surfaces, this amounted to a time-averaged loss reduction of from 2.65 to 1.55%.

The use of flexible top cover materials is receiving increased interest by thin-film module manufacturers. However, there is no proven top layer material other than glass. It is the judgment of Project personnel that neither Tedlar nor Acrylar materials, as envisioned, will become an acceptable top material. Present ultraviolet additives to Tedlar are depleted too quickly and the mechanical properties of Acrylar are deficient for handling, processing, and in-field operation. Years ago, the study of substrate encapsulation systems was downgraded so that, with the available funds, superstrate encapsulation could be emphasized. If flexible module designs are to become a reality, a new film material must be developed for use as a top layer, combining properties such as long-term life, low-cost, weatherability, ultraviolet permanence, good transparency in the visible spectrum, and good characteristics during film processing, handling, and encapsulation processing.

INCREASING THE SUNS INTENSITY (8 SUNS), AT DSET—ARIZONA



THIS INITIAL FSA LEARNING EXPERIENCE EVOLVED TO A 2ND GENERATION OUTDOOR AGING CONCEPT



INCREASING TEST TEMPERATURE AT 1 SUN, STRINGBORN LABS, ENFIELD, CONNECTICUT

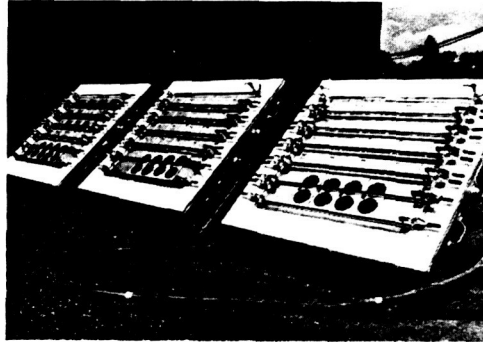

- UNITS ARE CALLED OUTDOOR PHOTOTHERMAL AGING REACTORS (OPTAR)
- UNITS OPERATE AT 70, 90, AND 105°C
- IN A TRIAL RUN, UNITS SUCCESSFULLY YIELDED ACCELERATING AGING RATES OF POLYPROPYLENE AT 70, 90, AND 105°C, WHICH EXTRAPOLATED TO THE ACTUAL AGING TIME OF POLYPROPYLENE AT ROOM TEMPERATURES

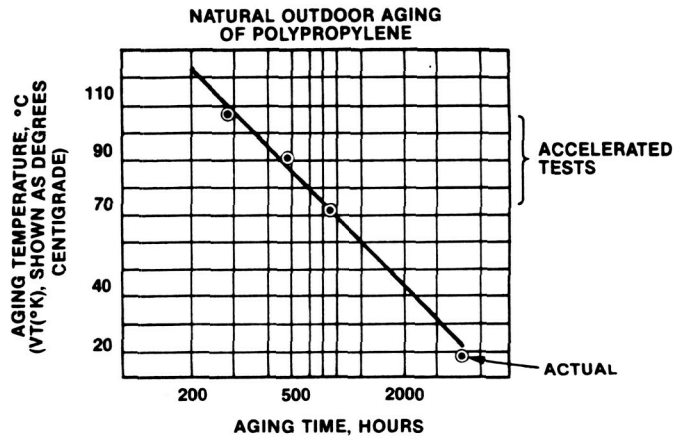

Figure 67. Outdoor Accelerated Aging Testing of Module Designs and Low-Cost Encapsulation Materials

Table 21. Encapsulation Materials—1985

MODULE ELEMENT	MATERIAL	STATUS	NOTES	PROJECTED COST IN PRODUCTION QUANTITIES	
				\$/m ² (1980 DOLLARS)	THICKNESS (mm)*
SUPERSTRATE (STRUCTURAL)	GLASS — LOW-IRON TEMPERED (SUNADEX) — LOW-IRON ANNEALED	*	STRONGEST, BUT DEFECT SENSITIVE THICKNESS DETERMINED BY HAIL OR WIND	5.50 - 8.50	3.0 - 5.0
				5.00 - 6.00	3.0 - 5.0
PLASTIC FILMS (UV SCREEN)	FLUOROCARBON — (TEDLAR)	**	DuPONT UV SCREENING FILM	1.00 - 3.00	0.025 - 0.10
	ACRYLIC — (ACRYLAR)	**	3M UV SCREENING FILM	0.50 - 0.70	0.05 - 0.08
PLASTIC FILMS (NON-UV SCREEN)	FEP	**	EXCELLENT WEATHER RESISTANCE	109	1
	FLUOREX	***	EXPERIMENTAL FLUOROCARBON FILM	.170	1
PRIMERS	A 11861	**	FOR BONDING EVA TO GLASS	—	—
SURFACE TREATMENTS	ANTI-REFLECTION TREATMENT FOR GLASS ANTI-SOILING TREATMENTS	***	BEING DEVELOPED	—	—
		**	①	—	—
POTTANT	SILICONE RUBBER (RTV 615, SYLGARD)	*	HIGH COST CASTING LIQUID	30.00 - 60.00	1.5 - 3.0
	POLYVINYL BUTERAL (PVB SAFLEX)	*	THERMOPLASTIC IN SAFETY GLASS LAMINATION	3.60	0.7
	ETHYLENE VINYL ACETATE (EVA)	*	MELTS AND CURES DURING LAMINATION	1.00 - 2.00	0.5 - 1.0
	ETHYLENE METHYL ACRYLATE (EMA)	*	SOFTENS AND CURES DURING LAMINATION	1.00 - 2.00	0.5 - 1.0
	ALIPHATIC POLYETHER URETHANE	*	②	1.50 - 3.00	0.5 - 1.0
SPACER	NON-WOVEN GLASS MAT (CRANEGLAS)	*	FOR AIR RELEASE AND ELECTRICAL ISOLATION SPACING	0.075/m ²	0.125
SUBSTRATE (STRUCTURAL)	GLASS, TEMPERED OR ANNEALED	*	DIELECTRIC AND THERMAL MATCH	5.50 - 8.50	3.0 - 5.0
	STEEL ALUMINUM (SHEET AND EXTRUSIONS)	*	HIGH STRENGTH COST AND THERMAL EXPANSION DISADVANTAGES	5.40 10.00	0.91 1.5
BACK COVER	POLYESTER FILM — (MYLAR)	*	DIELECTRIC FILM	1.00/m ²	0.13
	FLUOROCARBON, PIGMENTED (TEDLAR)	*	DIELECTRIC FILM	1.00	0.05
	ALUMINUM FOIL/POLYMER LAMINATES	**	PROVIDES HERMETICITY AND DIELECTRIC	1.00 - 2.00	0.05 - 0.13
	STEEL FOIL/POLYMER LAMINATES	**	BETTER THERMAL EXPANSION MATCH THAN AT	1.00 - 2.00	0.05 - 0.13
	FIBER GLASS COMPOSITE	**	FLAME RESISTANT BACK COVER	—	—

* USED IN CURRENT PV MODULES
 ** COMMERCIAL MATERIAL BEING EVALUATED FOR PV MODULES
 *** MATERIAL UNDER DEVELOPMENT AND EVALUATION FOR PV

• 0.001 in. = 0.025 mm, 0.040 in. = 1.0 mm

Today's Status

- Superstrate encapsulation designs, materials, and material processing are compatible with mass production requirements for modules using crystalline silicon solar cells and should meet cost allocations.
- Encapsulation materials have been life-tested to 20 years.
- Advanced encapsulation materials are expected to have a 30-year life expectancy.
- More testing and field operational results are needed to determine actual module life capabilities.
- Superstrate and substrate module design concepts devised and verified by passing module qualification tests.
- Devised photodegradation resistant additives for pottants and devised and carried out degradation tests that verified their value.
- Devised life prediction modeling and tests, and performed studies of module encapsulation lifetimes.
- Encapsulation materials life-tested to 20 years.
- Materials industry responded very well to JPL-defined material development needs and have established commercial products.

Significant Accomplishments

- Assessed module encapsulation requirements and potential materials for use under terrestrial operating conditions.
- Developed a polymeric pottant material (EVA) and processing techniques suitable for mass production of PV modules.
- Developed back-cover concepts and materials.
- Developed primers and adhesives for glass superstrate modules using the above materials.

Encapsulation System R&D Needs

- Thin-film module encapsulation systems.
- Flexible top cover films.
- Durable bonding technology for thin-film modules.
- Life verification of above and superstrate module encapsulation systems for crystalline silicon solar cell modules.

Reliability Physics

Reliability has always been an inherent part of FSA activities. In fact, efforts in all parts of the Project have been directed toward a low-cost, long-life product. As terrestrial PV technology evolved, the more easy-to-solve failure mechanisms were addressed first; in parallel, excellent progress was made on long-term studies of encapsulation materials and designs for long-life modules. As each aspect of module technology evolved, as an entity, the need to understand all the degrading mechanisms and their interactions within a module became apparent. These efforts have been consolidated and are called Reliability Physics.

The *objective* is to develop the reliability and durability knowledge required to produce long-life PV modules and arrays:

- Develop an understanding of module long-term degradation and failure mechanisms and techniques for reducing degradation.
- Develop a reliability prediction capability.
- Develop accelerated test capabilities.
- Verify material, device, and module reliabilities.

Background

In the early 1980s, when the DOE PV Program emphasis was shifted to electric utility applications, module and array lifetime goals were increased to 30 years from 20 years. This was considered to be a practical goal based upon technology advancements, typical utility planning for 30-year operational times, and the economic advantages of longer operation of power systems.

The longer-life requirement necessitated that a more basic understanding be determined of all the phenomena involved in module/array degradation. A long-range integrated approach of analyses and experiments covering all important parameters that can shorten the life and/or reduce the power generating capabilities of PV arrays was established. Within FSA, these efforts are now grouped under Reliability Physics and include the durability of cells, cell metallization, cell interconnects (within a module), encapsulation materials and their use, effects on module life of fabrication processing; and the influence of operational and environmental conditions.

Project Activities

During the course of the project, a steady stream of module failure mechanisms (Figure 68) was observed and identified through module testing, application experiments, and failure analyses. To resolve the

reliability problems a systematic research effort was undertaken with parallel efforts focused on the most troublesome failure mechanisms. Initial emphasis, placed on the development of test methods useful for quantifying the reliability weaknesses during the module design phase, led to the continuing evolution and development of module qualification tests. These tests and their severity were selected to fail older module designs with known deficiencies and to pass modules with good in-the-field performance. As module designs and fabrication techniques improved, emphasis was gradually shifted toward achieving a physical understanding of the longer-term, less-well-understood failure mechanisms and devising qualification tests and design solutions for them. Research activities were initiated studying interconnect fatigue (Figure 69), sheet glass strength (Figure 70), module soiling (Figure 71), hot-spot heating (Figure 72), breakdown of electrical insulation materials (Figure 73) and various others. All of these activities have led to comprehensive amounts of directly usable data and knowledge as shown in Figure 74. This information has been quickly transferred to industry and continues to be incorporated into production module designs and fabrication techniques.

Over the years, the reliability/durability research in FSA has evolved into a general methodology with six major elements:

- Identification of key degradation mechanisms.
- Establishment of mechanism-specific reliability goals.
- Quantification of mechanism parameter dependencies.
- Development of degradation prediction methods.
- Identification of cost-effective solutions.
- Testing and failure analysis of trial solutions.

Although a substantial degree of synergism exists among these elements, it is useful to address each separately.

Identification of the failure mechanism is a critical step. During the early years of the Project, module qualification testing was effective in detecting module failure. With the better quality of contemporary modules, the best evidence of a generic problem is well documented field failures. This requires careful monitoring of field applications with statistically significant numbers of modules, an active problem-failure reporting system, and a comprehensive failure analysis capability. The voltages and currents in an operating system also play an important role in hot-spot heating failures, shorts to ground and in-circuit arcs. Failures that show up only after prolonged field exposure must be identified by a variety of accelerated tests, unless waiting for years is acceptable.

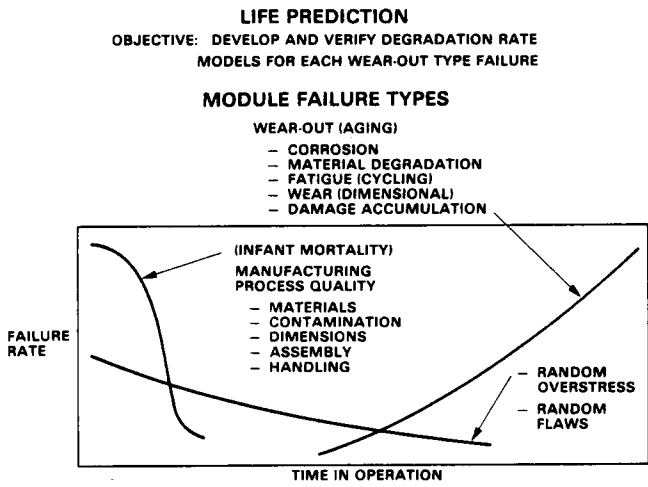

Figure 68. Module Failure-Rate Classification

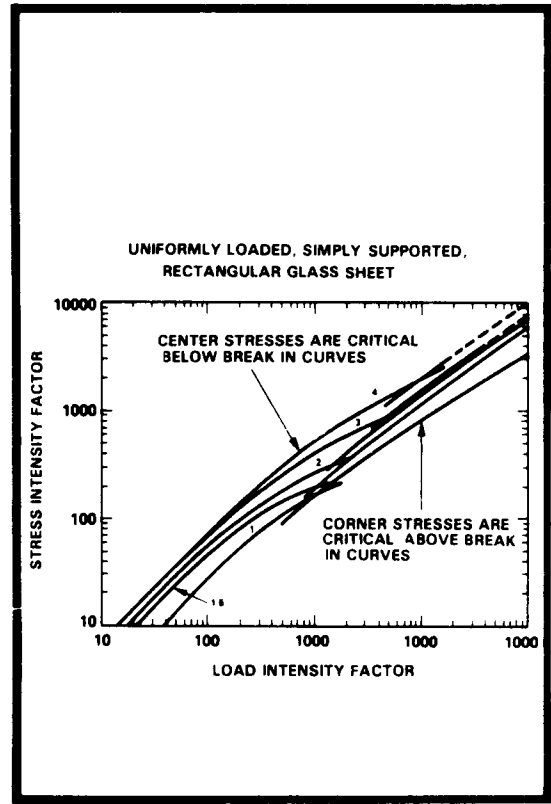

Figure 70. Glass Breakage and Sizing Research

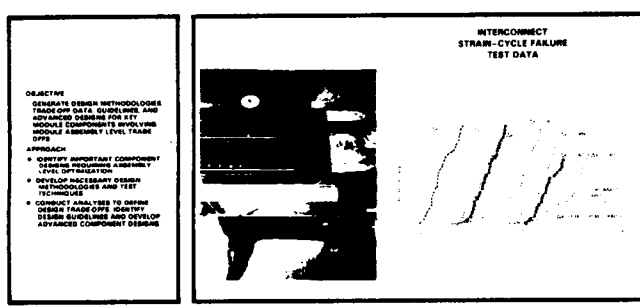

Figure 69. Electrical Interconnect Fatigue Research

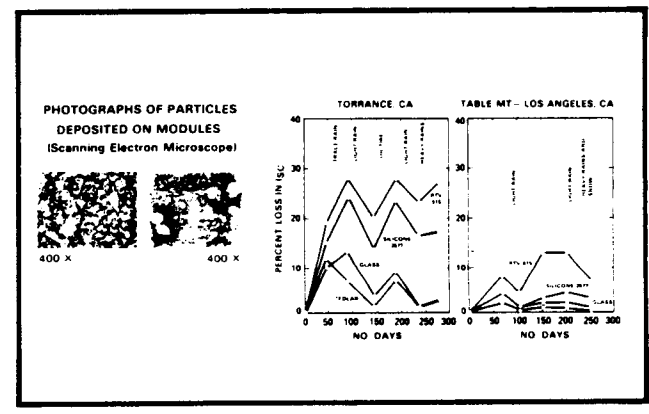

Figure 71. Module Soiling Research

ORIGINAL PAGE IS OF POOR QUALITY

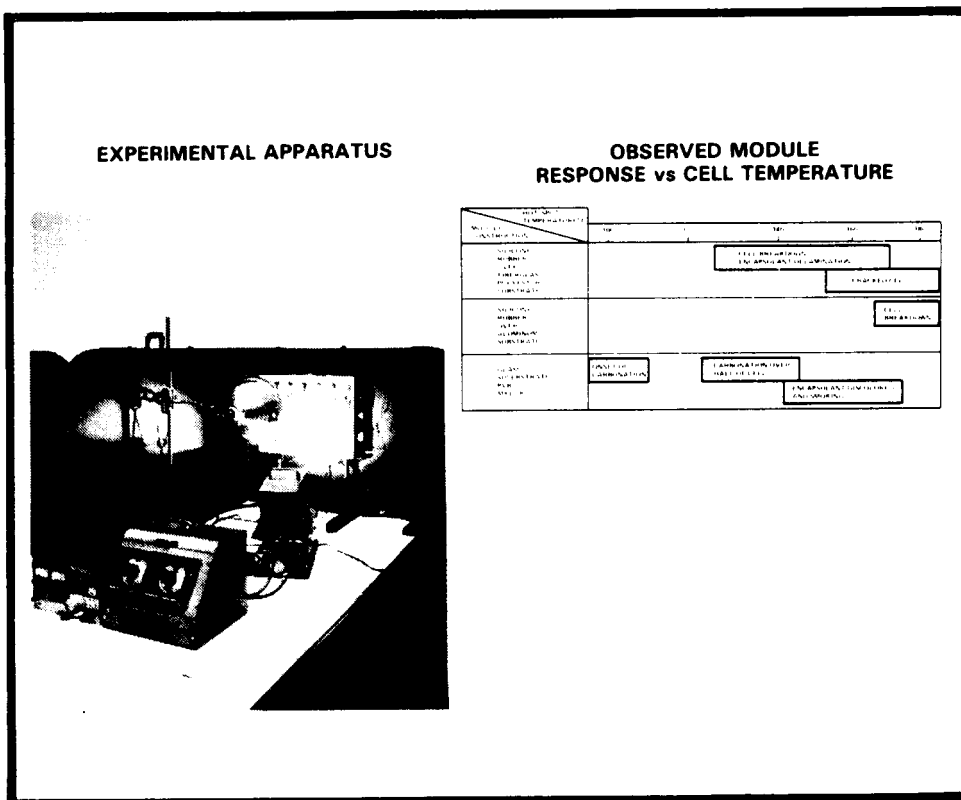

Figure 72. Hot-Spot Endurance Test Development

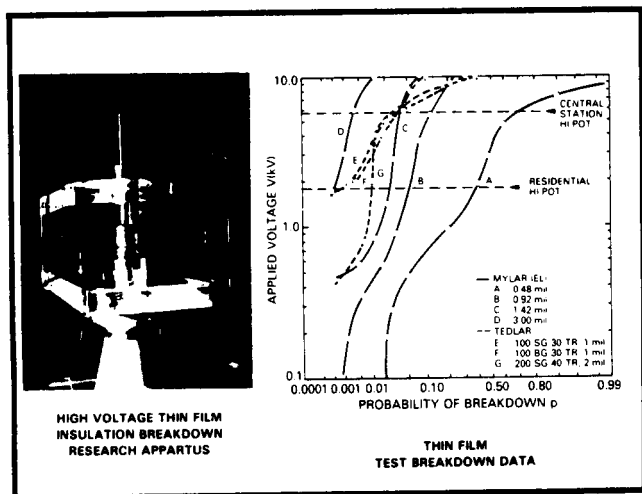

Figure 73. Insulation Breakdown Research

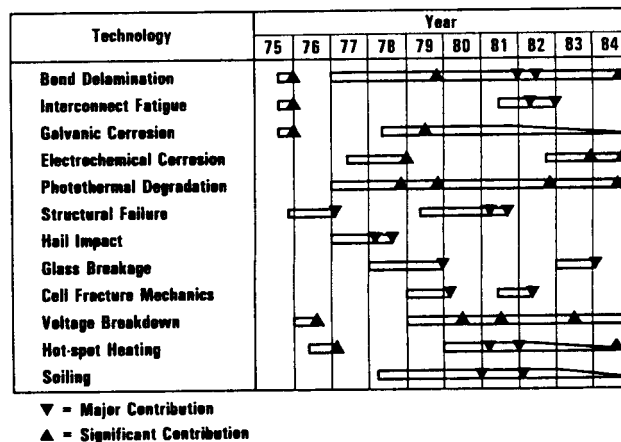

Figure 74. Reliability and Durability Developments, 1975 to 1984

ORIGINAL PAGE IS OF POOR QUALITY

Thirteen principal failure mechanisms of flat crystalline-silicon modules, grouped into four types of degradation are shown in Table 22. The key failure mechanisms identified to date, and target degradation levels for each that are consistent with a 30-year lifetime, are shown together with their economic significances and target allocation levels. The units of degradation in the third column provide a convenient means of quantifying failure levels of individual mechanisms according to their approximate time dependence. Columns 4 and 5 indicate the level of degradation for each mechanism that will result in a 10% increase in the cost of delivered energy from a large PV system. Because the mechanisms will generally occur concurrently, the total cost impact is the sum of the 13 cost contributions. Column 6 of the table carries the analysis a step further and suggests a strawman allocation of allowable degradation among the 13 mechanisms to achieve a total reliability performance consistent with expectations of a 30-year lifetime. The total effect of the allowable levels is a 20% increase in the cost of energy over that from a perfect, failure-free system. The distribution among the mechanisms reflects the judgment of FSA personnel at this time. It is important to update these allocations as field operation experience becomes available in the next few years.

A specific degradation or failure mechanism is dependent upon a large number of field-stress parameters, system operating parameters, component-design parameters, and manufacturing-processing parameters. In order to understand the test data, a quantitative understanding of the importance of each principal parameter is required. This is best derived from understanding the chemical and physical processes in the degradation, plus a qualitative insight into the mechanism physics as can best be determined by specific tests and analyses.

A specific degradation prediction can be made by determining the time history of an applied stress of the appropriate parameter. A variety of these environmental stress characterizations have been developed at JPL including hail impact probability, wind loading pressures, and array voltage and current durations. Solar radiation surface meteorological observations (SOLMET) weather data have been used to model ultraviolet, temperature, and humidity levels to which modules are exposed. These models have been combined with other parametric variables in making module useful-life predictions.

Cost effectiveness of modules and arrays requires trade-offs of degradation rates, failure rates, and lifetimes against initial-manufacturing costs, field maintenance costs, and lost energy revenues. Life-cycle costing analysis integrates these variables and permits trade-offs to be made. In the identification of cost-effective solutions, it is important to minimize sensitivities to processing variations and design and material uncertainties. These analyses permit rational judgments and cost-effective levels of reliability to be selected.

The first and last step in a reliability program is extensive testing of the complete product. Such testing cuts across the entire reliability development effort from beginning to end. It plays a key role in the identification of failure mechanisms, in the illumination of parameter dependencies, in the selection of cost-effective solutions, and in the verification of final designs. By the end of the reliability effort, tests with quantitative correlation to field applications should be available, based on the parameter dependencies determined and the prediction algorithms developed. A key element of complete-product testing is inclusion of the synergistic reactions between all of the components, including likely interfacing components on

Table 22. Life-Cycle Cost Impacts and Allowable Degradation Levels

Type of Degradation	Failure Mechanism	Units of Degrad.	Level for 10% Energy Cost Increase*		Allocation for 30-Year-Life Module	Economic Penalty
			k = 0	k = 10		
Component failures	Open-circuit cracked cells	%/yr	0.08	0.13	0.005	Energy
	Short-circuit cells	%/yr	0.24	0.40	0.050	Energy
	Interconnect open circuits	%/yr ²	0.05	0.25	0.001	Energy
Power degradation	Cell gradual power loss	%/yr	0.67	1.15	0.20	Energy
	Module optical degradation	%/yr	0.67	1.15	0.20	Energy
	Front surface soiling	%	10	10	3	Energy
Module failures	Module glass breakage	%/yr	0.33	1.18	0.1	O&M
	Module open circuits	%/yr	0.33	1.18	0.1	O&M
	Module hot-spot failures	%/yr	0.33	1.18	0.1	O&M
	Bypass diode failures	%/yr	0.70	2.40	0.05	O&M
	Module shorts to ground	%/yr ²	0.022	0.122	0.01	O&M
	Module delamination	%/yr ²	0.022	0.122	0.01	O&M
Life-limiting wearout	Encapsulant failure due to loss of stabilizers	Years of life	27	20	35	End of life

*k = Discount rate

the user's side of the interface. This latter consideration is one of the reasons field-application data are more convincing than laboratory test data because they include interaction with the user.

Significant Accomplishments

- Developed long-term soiling data for various module surface materials and synthesis of antisoiling surface treatments.
- Developed analysis tools, test methods, and design data for the control of solar-cell hot-spot heating.
- Developed data on probability of impact of various-sized hailstones, and means of surviving hail impact.
- Developed analysis tools and design data for predicting the breaking load of glass sheets.
- Developed design data and test methods on the photothermal stability of module encapsulants.
- Developed test methods and performance data on the reliability of solar-cell metallization systems.
- Characterized the electrical breakdown strength of polymeric dielectric films.
- Characterized the parameters involved in electrochemical corrosion of modules.
- Developed analysis tools and design data for predicting interconnect fatigue and designing long-life, reliable cell interconnections.
- Developed design data and qualification testing technique to ensure the reliability of bypass diodes.
- Developed design data and testing techniques on the fracture strength of crystalline-silicon wafers and cells.
- Developed a comprehensive set of module qualification tests, testing facilities, and failure analysis facilities.

Module Performance and Failure Analysis

In 1975, at the start of the FSA Project, little or no quantitative data were available on the electrical efficiency of the early PV modules or on the exact cause of the reliability problems common to modules in use at that time. Building on JPL's history of making precise measurements and performing failure analyses as part of its space photovoltaic activities, the Project initiated the measurements, testing, and failure analysis of terrestrial modules in 1975. This was an important part of the Block I module procurement activities and it has continued throughout the duration of the Project.

The objectives of the module performance measurement and failure analysis activity are to support the module development effort:

- By providing accurate electrical measurements of state-of-the-art and advanced development modules, including developing and providing international recognized electrical performance measurements and facilities.
- By conducting various characterization and environmental qualification tests including the development of unique testing methods and facilities.
- By establishing a problem-failure reporting procedure, conducting detailed analysis of module failures, and developing advanced failure analysis techniques and facilities.

Background

At the start of the JPL Project, it was recognized that to succeed with the development of advanced module technologies there must be accurate measurements data to continually determine the status of the technology, and to guarantee accurate communication among the large number of researchers involved. The need to accurately define costs and cost standards was the responsibility of the Project Analysis and Integration portion of the Project; the need to accurately measure efficiency and reliability became this activity's responsibility. This evaluation function served to determine whether design and fabrication innovations were successful in their objectives, and to identify deficiencies that should be the object of design and fabrication modifications or the subject of further research.

Project Activities

Electrical Performance Measurement

The electrical performance of a new module design is the necessary criterion for determining

whether module innovations have resulted in increased efficiency. Therefore, progress would have been impossible to assess without the development of precise and accurate methods of performing this measurement. Because the measurement of modules under natural sunlight is prohibitively time-consuming, use is made of solar simulators. Early in the Project, a standard irradiance (magnitude and spectral distribution) was defined and various solar simulators were put into commercial use by the many companies and laboratories involved in the program. Because none of the simulators could duplicate the standard spectrum, methods were developed for correcting the simulator measurement to the value of power output that would have been obtained if the module had been exposed to a standard irradiance.

In 1975, electrical performance measurement of solar cells and arrays had already undergone considerable development in connection with the use of these devices on spacecraft over the prior 15 years. Measurement for that application was simpler than measurement for the terrestrial application because the solar irradiance spectrum above the Earth's atmosphere is more stable and more easily measured and described. It was also feasible to devote extensive resources to the measurement of a single spacecraft module (or array) because of its high cost and need as part of space mission success.

In the terrestrial application, the irradiance spectrum is far more difficult to measure and define because it is subject to spectral absorption and scattering in the atmosphere and because it consists of both a direct and diffuse component. Because the commercial cost of an individual module must be low, the resources allotted to its measurement must also be low.

The first method consisted of performing a primary (natural sunlight) calibration of a solar cell that was a sample of the cells used in the modules; it could be presumed to have the same spectral response. Using this cell as a reference cell for adjusting the magnitude of irradiance from any simulator, the resultant measurement was then independent of the simulator spectrum. Subsequently, a new method known as mismatch factor correction was developed. With this method, which required knowledge of the simulator spectrum and of the spectral response of both the reference cell and the module, it was possible to perform a computer correction of the measured power value even though the reference cell spectral response did not match that of the module.

The disadvantage of the above two methods is that either they assume that the spectral response of the module is the same as that of the cell, or they require the difficult or impossible operation of measuring the spectral response of the module. A solution to these problems consisted of designing a simulator/filter combination that produced the

standard spectrum. Such a system has now been implemented for both of the current irradiances defined in the U.S. standards documents. These are the airmass 1.5 direct normal irradiance (ASTM E 891-82) and the airmass 1.5 global spectrum (combining direct and diffuse components, ASTM E 892-82). With this system, the reference cell need only be of the same generic material as the module's cells, and very large modules can be measured because their spectral response need not be known.

The simulator used in this system is known as the Large Area Pulsed Solar Simulator; it produces the spectrum shown in Figure 75 when it is not filtered. The filtered spectra for the direct normal case and the global case are shown in Figures 76 and 77, respectively, along with the desired standard spectra. These spectral matches are close enough in both cases so that the error due to the mismatch is not greater than 1%.

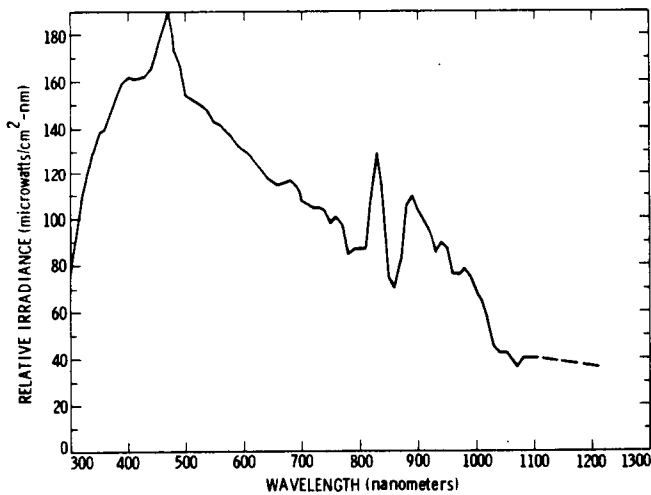

Figure 75. Spectral Irradiance (JPL Unfiltered LAPSS)

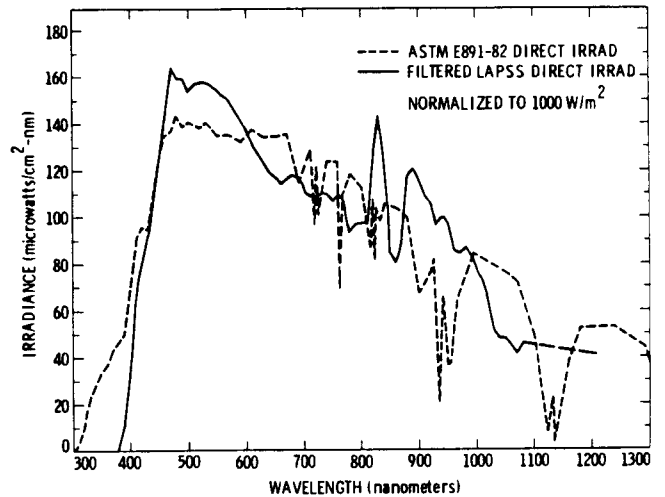

Figure 76. Spectral Irradiance (AM 1.5 Direct LAPSS Versus ASTM AM 1.5 Direct)

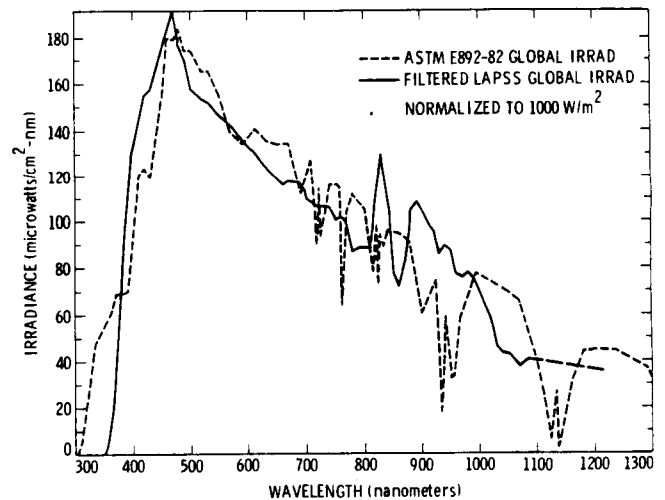

Figure 77. Spectral Irradiance (AM 1.5 Global LAPSS Versus ASTM AM 1.5 Global)

Qualification Testing

In addition to determining whether a new module design provides a desired increase in efficiency, the electrical performance measurement of a module also serves as the principal criterion for determining the success of a new module in terms of its ability to withstand the environmental and electrical stresses expected in the field. An accelerated program of these stresses has been applied to all new modules developed under the FSA Project as well as to other commercial modules available from U.S. and foreign sources. The test program consists of a set of formally defined qualification tests whose description and sequence are illustrated and described in detail in

Figure 78. As the figure also shows (under the heading "Qualification Test Specifications"), the specifications evolved during a series of module development programs over a 10-year period. The evolution has resulted from the information provided by the tests themselves, from module field test experience, and from module research.

Qualification tests have been performed on modules of about 150 different designs. With few exceptions, the tests have revealed defects necessitating module design or manufacturing process changes. This is proof of the critical role of this type of testing in identifying module modifications needed, and in identifying required research in materials, processes, and/or design.

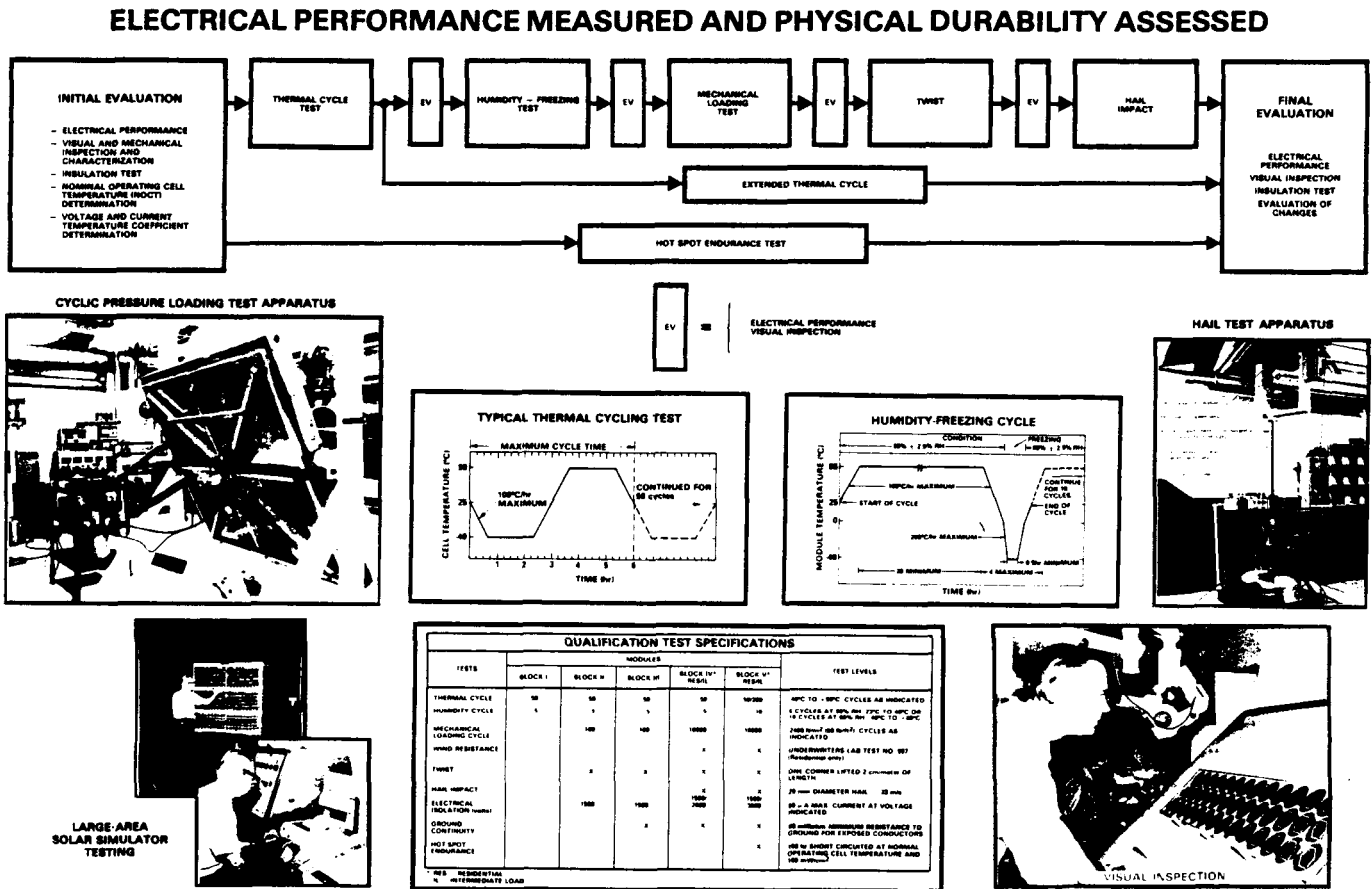

Figure 78. Module Qualification

Qualification tests are performed on a small sample of modules of any given design. The proof of satisfactory performance, including reliability, requires field testing the modules in the various environments in which PV power stations would be installed. Such a program was instituted early during the Project history using the sites listed in Figure 79. The performance observed in the tests at these sites, and at other array installations that were part of the DOE program, resulted in important modifications to the earlier qualification test specifications. These provided for better accelerated testing to reveal the potentiality of failures because of such phenomena as hail impact, thermal stress, and cell back-biasing. The early history of failure statistics is shown in Figure 80. Because of reductions in support of field testing, statistics are not available for the Block IV or Block V modules.

Failure Analysis

When problems occur during qualification tests, or field tests, or at array installations, it is necessary to

perform an in-depth failure analysis to find the exact cause of the problem. A Problem Failure Reporting system was established by the FSA Project in 1975 to provide formal reporting of all failures, regardless of the site of occurrence. The reports and the failed modules were delivered to failure analysis personnel who then applied a variety of sophisticated techniques (some derived from the NASA space exploration program and some developed explicitly for the terrestrial PV program) to isolate the specific cause of the failure (Figure 81). A highly detailed report was prepared describing each such analysis and presenting the results, with recommendations for correcting the module deficiencies. These Performance and Failure Analysis Reports were supplied to the manufacturer of the module and to JPL personnel responsible for module development research. During the various module development programs, such analyses were instrumental in correcting design and processing problems to the extent that new modules incorporating the recommended changes were then successful in passing the qualification tests.

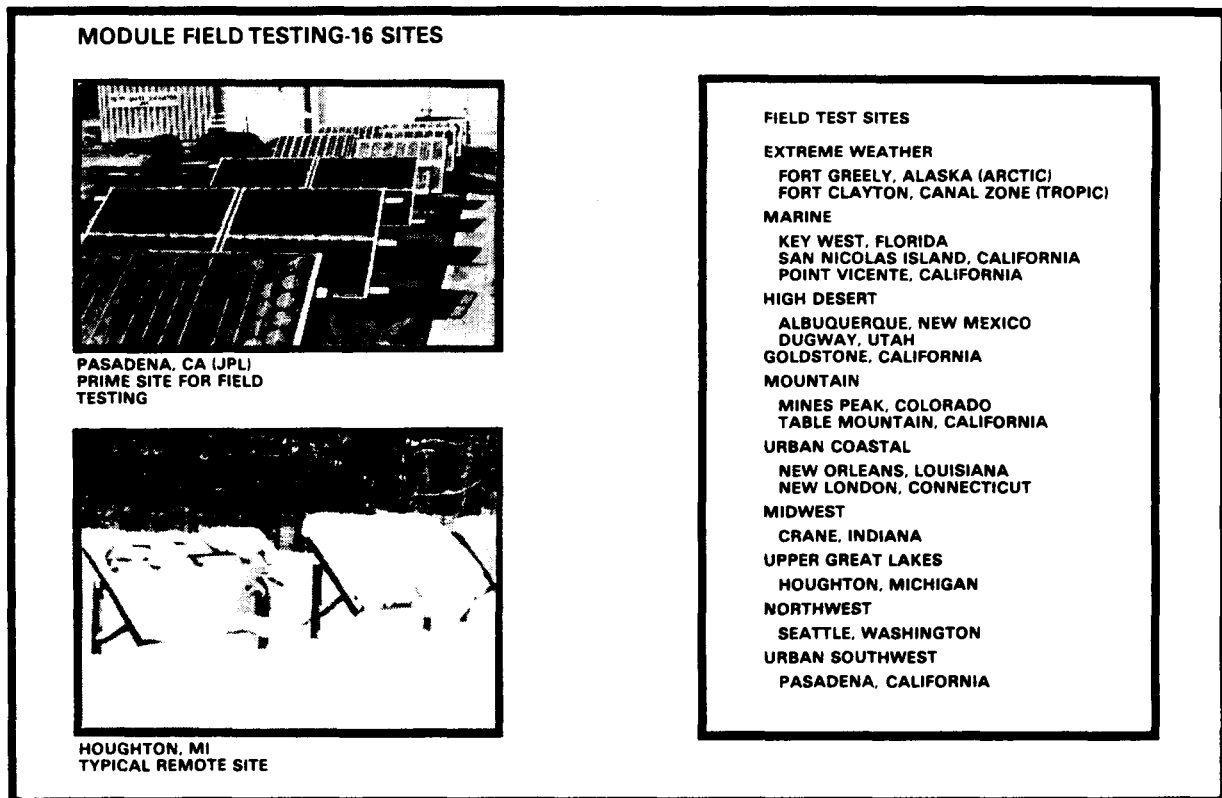

Figure 79. Module Field Testing (16 Sites)

NEEDS FOR LONG-LIFE, DURABLE MODULES/ARRAYS

• MODULE AND ARRAY FIELD TESTING

- REQUIRED BECAUSE MODULE QUALIFICATION TESTING HAS NOT BEEN ENTIRELY SUCCESSFUL IN PREDICTING AND/OR DUPLICATING MODULE FIELD FAILURES
- KNOWLEDGE OF MODULE WEAR-OUT MECHANISMS WHICH, OTHER THAN CELL INTERCONNECT FAILURES, HAVE NOT BEEN DETECTED AS YET; POTENTIAL LONG-TERM OPERATION DEFICIENCIES/FAILURES ARE EVIDENT (CRACKED CELLS AND COVER GLASS)
- REDUCTION OF SINGLE MODULE ENDURANCE FIELD TESTING IN FAVOR OF MODULE TESTING IN ARRAYS

• FIELD TESTING IN REAL-USE POWER SYSTEM CONFIGURATIONS

- DETECTION OF DEFICIENCIES/FAILURES WHICH OFTEN HAVE BEEN A SURPRISE
- PERFORMANCE VERIFICATION, UNDER OPERATIONAL CONDITIONS, OF NEW ADVANCED MODULES, WITH INNOVATIVE DESIGN FEATURES
- KNOWLEDGE OF MODULE/ARRAY PERFORMANCE AND SAFETY PROBLEMS WITH THE REMAINDER OF THE POWER SYSTEM AND WITH UTILITY INTERACTIONS
- CENTRAL STATION: ESTABLISHMENT OF CREDIBILITY OF MODULE/ARRAYS AS POWER GENERATORS FOR CENTRAL STATION USE; i.e., COST EFFECTIVE WITH LONG LIFE OPERATION

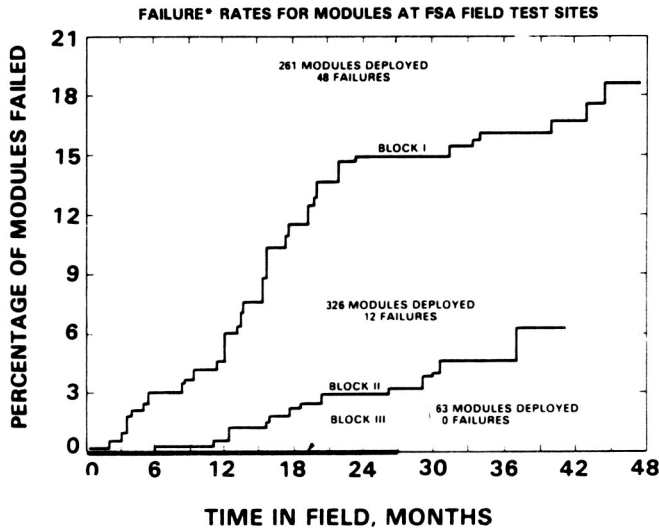

*FAILURE - OUTPOWER DECREASE GREATER THAN 25%

Figure 80. Needs for Long-Life, Durable Modules/Arrays

MODULE PROBLEM/FAILURE ANALYSIS

X-RAY OF OVERHEATED CELLS SHOWING MELTED SOLDER

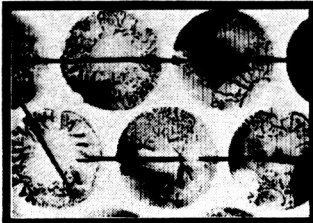

LASER SCAN OF MODULE OUTPUT SHOWING CRACKED CELL

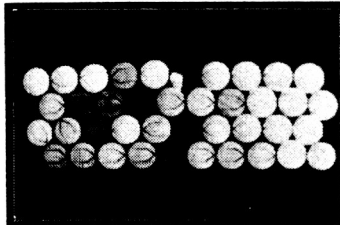

PHOTOMICROGRAPH OF HAIL DAMAGE

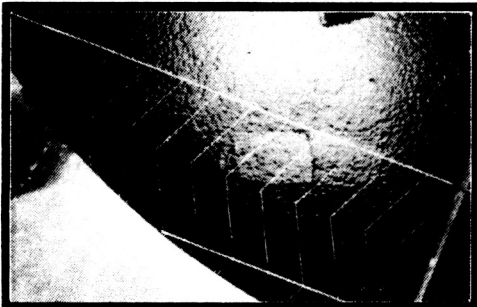

HIGH VOLTAGE BREAKDOWN OF INSULATOR

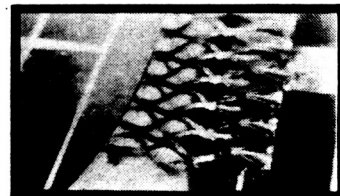

CELL INTERCONNECT FAILURE

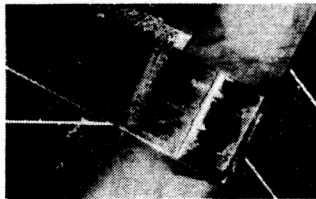

- PROBLEMS/FAILURES AT TEST/APPLICATION SITES REPORTED
- JPL AND MANUFACTURER EVALUATE P/F AND DETERMINE CORRECTIVE ACTIONS
- MANUFACTURER CHANGES MODULE DESIGN OR WORKMANSHIP AS NEEDED

Figure 81. Module Problem/Failure Analysis

Significant Accomplishments

- Environmentally tested more than 150 different module designs to date over the 10-year period.
- Processed 1200 reports of failures, involving 460 major failure analyses.
- Developed unique environmental testing facilities including hail guns, mechanical cyclic-loading apparatus, hot-spot test equipment, and nominal operating cell temperature (NOCT) test racks and instrumentation.
- Established outdoor field test-rack facilities throughout the United States in various geographical climates.
- Developed module inspection techniques and guidelines.
- Developed a unique Large Area Pulsed Solar Simulator with closely matched airmass 1.5 direct and airmass 1.5 global spectra.
- Calibrated numerous reference cells that have served as the primary industry standards over the past 10 years.
- Developed a simple, accurate method of secondary calibration of reference cells; have calibrated cells for many U.S. and foreign PV manufacturers.
- Developed a unique laser scanner instrument for the failure analysis of large-area modules.

Appendix A: Glossary

A	Ampere(s); Angstrom(s)
A&E	Architects and engineering
AM	Air mass (e.g., AM1 = unit air mass)
AR	Antireflective
a-Si	Amorphous silicon
ASME	American Society of Mechanical Engineers
ASTM	American Society for Testing and Materials
BSF	Back-surface field
BSR	Back-surface reflection
C	Celsius (temperature scale)
CAST	Capillary Action Shaping Technique
COSMIC	Computer Software Management Information Center
CVD	Chemical vapor deposition
CVT	Chemical vapor transport
Cz	Czochralski (classical silicon crystal growth method)
DCS	Dichlorosilane
DOE	U.S. Department of Energy
EFG	Edge-defined film-fed growth (silicon-ribbon growth method)
EMA	Ethylene methyl acrylate
EPSDU	Experimental process system development unit
ERDA	Energy Research and Development Administration
EVA	Ethylene vinyl acetate
FAST	Fixed Abrasive Slicing Technique
FBR	Fluidized-bed reactor
FSA	Flat-Plate Solar Array Project
FZ	Float-zone (silicon crystal growth method)
h	Heat transfer coefficient; hour(s)
HEM	Heat-exchange method (silicon-crystal ingot-growth method)
I_{sc}	Short-circuit current
I-V	Current-voltage
ID	Inside diameter

IPEG	Improved Price Estimation Guidelines
IR	Infrared
J_{sc}	Short-circuit current density
JPL	Jet Propulsion Laboratory
Kg	Kilogram
LAPSS	Large-area pulsed solar simulator
LASS	Low-angle silicon sheet growth method
MEPSDU	Module experimental process system development unit
mg-Si	Metallurgical-grade silicon
MINP	Metal insulator, n-p
MOD	Metallo-Organic deposition
MSEC	Mobil Solar Energy Corp.
MT	Metric ton(s)
NASA	National Aeronautics and Space Administration
NEC	National Electrical Code
NOCT	Nominal operating cell temperature
O&M	Operation and maintenance
P_{max}	Maximum power
PA&I	Project Analysis and Integration Area (of FSA)
PDU	Process development unit
PIM	Project Integration Meeting
ppba	Parts per billion, atomic
ppm	Parts per million
PU	Polyurethane
PV	Photovoltaic(s)
PVB	Polyvinyl butyral
R&D	Research and development
RH	Relative humidity
s	Second(s)
SAMICS	Solar Array Manufacturing Industry Costing Standards
SAMIS	Standard Assembly-Line Manufacturing Industry Simulation
SCAP1D	Solar-Cell Analysis Program in One Dimension

SCCD	Short-circuit current-decay
SEEMA	Solar-Cell Efficiency Estimation Methodology and Analysis
SERI	Solar Energy Research Institute
Si	Silicon
SIMRAND	SIMulation of Research And Development Projects
SMUD	Sacramento (California) Municipal Utility District
SOA	State of the art
SOC	Silicon-on-ceramic
SOLMET	Solar radiation surface meteorological observations
STC	Silicon tetrachloride
T	Temperature
TCM	Transparent conducting material
TCS	Trichlorosilane
UL	Underwriters Laboratories, Inc.
V_{oc}	Open-circuit voltage
W_p	Peak watt(s)

Appendix B: FSA Project Contractors

COMPANY	CONTRACT TITLE	AREA
Aerochen Research Laboratories, Inc.	Si Halide-Alkali Metal Flanes as a Source of Solar Grade Si	SIMAT
Aerochen Research Laboratories, Inc.	Development Processes for the Production of Solar Grade Si from Si Halides & Alkali Metals	SIMAT
Aerochen Research Laboratories, Inc.	Synthesis of Model and Computer Code for Si Reactions	SIMAT
Aerochen Research Laboratories, Inc.	Synthesis of Silane and Si in a Non-Equilibrium Plasma Jet	RES
AIA Research Corp.	Integrated Residential PV Array Development	DR
Applied Solar Energy Corp.	Development of High-Efficiency Solar Cells	PD
Applied Solar Energy Corp.	Evaluation of Non-Implanted Solar Cells	PD
Applied Solar Energy Corp.	Development of High-Efficiency (14%) Solar Cell Array Modules	PD
Applied Solar Energy Corp.	Assessment of Present State-of-the-Art Sawing Tech. of Large Diameter Ingots for Solar Sheet Material	PD
Applied Solar Energy Corp.	High-Efficiency, Long-Life Terrestrial Solar Panel	PD
Applied Solar Energy Corp.	Design, Fabrication, Test and Price Analysis of Third Generation Design Solar Cell Module	MPFA
Applied Solar Energy Corp.	Development of low-Cost Contacts to Si Solar Cells	PD
Applied Solar Energy Corp.	Laboratory Services	DR
Applied Solar Energy Corp.	Microcrystalline Si Growth for Heterojunction for Solar Cells	RES
Applied Solar Energy Corp.	Intermediate Load Modules for Test and Evaluation	PD
Applied Solar Energy Corp.	Solar Cell Process Development	PD
ARC0 Solar, Inc.	Solar Cell Panel Development Effort	SIMAT
ARC0 Solar, Inc.	Vacuum Die Cast of Si Sheet for PV Applications	MPFA
ARC0 Solar, Inc.	Design, Fabrication, Test, Qualification and Price Analysis of Third Generation Design Solar Cell Modules	PD
ARC0 Solar, Inc.	Automated Solar Panel Assembly Line	MPFA
ARC0 Solar, Inc.	Design of Block V Solar Cell Modules - 1981	RES
ARC0 Solar, Inc.	Block V Documentation and Solar Cell Modules	PD
Arizona State University	Adapt Pulsed Excimer Laser Processing Techniques to Fabricate Cost-Effective Solar Cells	-
Astrosystems, Inc.	Conduct an Evaluation and Calibration of a Czochralski (Cz) Crystal Growth System	-
Battelle Memorial Institute	Si Film Solar Cell Process	-
Battelle Memorial Institute	Part 1 - Evaluation of Si Production Suitable for Solar Cells	-
Battelle Memorial Institute	Module Encapsulation Task of Low-Cost Si Solar Array Project	-
Battelle Memorial Institute	Study Program to Develop & Evaluate Die and Container Materials	-
Battelle Memorial Institute	Study Program to Develop & Evaluate Die and Container Materials	-
Bechtel National, Inc.	Terrestrial Central Power Utility Array Life-Cycle Analysis	-
Bechtel National, Inc.	Development of Requirements for Terrestrial Solar Arrays	-
Bechtel National, Inc.	Development of an All Metal Thick Film Cost Effective Metallization System for Solar Cells	-
Bechtel National, Inc.	Economic Improved Thick Film Solar Cell Contact	-
Bechtel National, Inc.	Operation and Maintenance Cost Data for Residential Photovoltaic Modules/Panels	-
Bechtel National, Inc.	Commercial/Industrial PV Modules Requirements Study	-
Bechtel National, Inc.	Residential PV Modules Requirements Study	-
Bechtel National, Inc.	A Study of Effect of Impurities in Si Material	-
Bechtel National, Inc.	A Study of Relationships of Material Properties and Hi-Eff Solar Cell Performance on Material Composition	-
Bechtel National, Inc.	Investigation of Free Space Reactor Si Production	-
Bechtel National, Inc.	Diffusion Barrier Studies	-
Bechtel National, Inc.	Exploratory Study of Product Safety and Product Liability Considerations for Photovoltaic Module/Array Devices	-
Bechtel National, Inc.	Encapsulation System Studies for Low Cost Si Solar Array	-
Bechtel National, Inc.	Amorphous Si Module Research	-
Bechtel National, Inc.	Investigation of Reliability Attributes and Accelerated Stress Factors on Terrestrial Solar Cells	-
Bechtel National, Inc.	Study Program to Develop and Evaluate Substrate and Container Materials	-
Bechtel National, Inc.	Investigation of Physical Structure and the Chemical Nature of Defects in Si Sheet Material	-
Bechtel National, Inc.	Characterization of Structural, Electrical & Chemical Properties of Si Sheet Material	-
Bechtel National, Inc.	Multi-Wire Wireforming Technology Development by a Fixed Abrasive Slicing Technique (FAST)	-

C-2

COMPANY	CONTRACT TITLE	OPEN	AREA
Crystal Systems, Inc. Dow Corning Corp. Dow Corning Corp. Eagle-Picher Ind., Inc. Electrlink, Inc. Endurex Corp. Energy Materials Corp. Energy Materials Corp. Energy Materials Corp. Energy Materials Corp. General Electric Co. General Electric Co. General Electric Co. General Electric Co. General Electric Co. General Electric Co. General Electric Co. General Electric Co. Hemlock Semiconductor Corp. Honeywell, Inc. IBM Corp. ITT Research Institute Illinois Tool Works, Inc. J.C. Schumacher Co. Kayex Corp. Kayex Corp. Kayex Corp. Kinetic Coatings, Inc. Kulicke & Soffa Industries Lamar University Lockheed Missiles & Space Co. Lockheed Missiles & Space Co. Lockheed Missiles & Space Co. Lockheed Missiles & Space Co. M7 International, Inc. M7 International, Inc. Massachusetts Institute of Technology Massachusetts Institute of Technology Materials Research, Inc. Materials Research, Inc. Materials Research, Inc. Mitre Corp. Mobil Solar Energy Corp. Mobil Solar Energy Corp. Mobil Solar Energy Corp. Mobil Solar Energy Corp. Mobil Solar Energy Corp. Monsanto Research Corp. Motorola, Inc.	Heat-Exchanger-Ingot Casting/Slicing Process, Si Sheet Growth Task I - Si Material Part 3 Develop Si Encapsulation Systems for Terrestrial Silicon Solar Arrays Study Program to Develop and Evaluate Die and Container Materials Laboratory Services for the Devel. & Charac. of Screenable Mats. Utilized in the Fabrication of Solar Cells Solar Cell Module Ion-Plating Process and Testing Electrochemical Production of Si Low-Angle Si Sheet Growth Gaseous Melt Replenishment System Technology Development for Low-Angle Si Sheet (LASS) Growth Technique for PV Applications Development & Testing of Single-Type Solar Cell Modules Integrated Residential Photovoltaic Array Development Design, Fabrication, Test, Qualification and Price Analysis of Third Generation Design Solar Cell Modules Design of Block V Solar Cell Module - 1981 Floating Substrate Sheet Growth Process LASS Task for LSSA Project Bypass Diode Encapsulation Study Industrialization Study Development of a Polysilicon Process Based on Chemical Vapor Deposition Dip Coating Process, Si Sheet Growth Development for the Large Area Silicon Sheet Task Si Ribbon Growth Using a Capillary Shaping Technique Technical Support in Reliability Engineering of Photovoltaic Modules Demonstration of Capability to Metallize Solar Cells by Ion-Plating High Velocity Continuous-Flow Reactor for Production of Solar Grade Si Low-Cost Czochralski Crystal Growing Technology Development of Advanced Methods for Continuous Czochralski Growth Advanced Cz Growth Process to Produce Low-Cost 150 Kg Si Ingots from a Single Crucible for Technology Readiness Phase 2 of the Array Automated Assembly Task Automated Solar Module Assembly Line Process Feasibility Study in Support of Si Material Spraylon Fluorocarbon Encapsulation for Si Solar Cell Arrays Transparent Solar Cell Module Development Effort Phase 2 of the Array Automated Assembly Task Evaluation of Laser Annealing of Solar Cells Five (5) Kilowatt Solar Cell Modules Three (3) Kilowatts of Solar Cell Modules Hi Speed Growth of Si Sheets in Inclined Meniscus Configurations Investigation of the Hydrogenation of SiC14 Analysis of Defect Structure in Si Quantitative Analysis of Defects in Si Analysis of Defect Structure in Si Mitre Solar Energy Test System Evaluation Solar Modules Design of Block V Solar Cell Modules - 1981 Edge-Defined Film Fed Growth for Si Growth Development Crystal Growth by Edge-Defined Film-Fed Growth Technique (EFG) Block V Documentation and Solar Cell Modules Si Material Task - Part 2 PV Module Electrical Termination Design Requirements Study	* * * *	SHEET SINAT PD SHEET PD PD SINAT SHEET SINAT SHEET PD RES MPFA MPFA SHEET RES RES PD SINAT SINAT SINAT SINAT PD PD SINAT RES PD PD PD MPFA MPFS SHEET SINAT SINAT SINAT DR PD PD MPFA SHEET SHEET RES SINAT RES

COMPANY	CONTRACT TITLE	AREA
Motorola, Inc.	Design, Fabricate, Test, Qualification & Price Analysis of 3rd Generation Design Solar Cell Modules	MPFA
Motorola, Inc.	Si Material Task, Part 1	SINAT
Motorola, Inc.	Processing Experiments on the non-Cz Si Sheet	PD
Motorola, Inc.	Establishment of a Production-Ready Mfg. Process Utilizing Thin-Si Substrates for Solar Cells	PD
Motorola, Inc.	Phase 2 of the Array Automated Assembly Task	PD
Motorola, Inc.	Metalization of Large Si Wafers	PD
Motorola, Inc.	Solar Cell Modules with Parallel-Oriented Interconnections	PD
Motorola, Inc.	Studies and Testing of Anti-Reflective Coatings for Soda-Line Glass	PD
Motorola, Inc.	Development of a Method of Producing Etch Resistant Wax Patterns on Solar Cells	SHEET
Motorola, Inc.	Laser-Zone Growth in a Ribbon-to-Ribbon Process (RR), Si Sheet Growth Development	SHEET
Motorola, Inc.	Anti-Reflective Coatings on Large Area Glass Sheets	DR
Motorola, Inc.	Anti-Reflective Coatings Applied by Acid-Leaching Process	DR
Motorola, Inc.	Phase 1 of the Automated Array Assembly Task	MPFA
Motorola, Inc.	Evaluation of LSA Test and Performance Methods	RES
Motorola, Inc.	Study of Effects of Row-to-Row Shading on PV Arrays	DR
Motorola, Inc.	Rapid Thermal Processing of Ion Implanted Si	SINAT
Motorola, Inc.	Lifetime Measurement Analysis	SHEET
Motorola, Inc.	Development of Fluidized-Bed Si Technology	SHEET
Motorola, Inc.	Slicing of Single Crystal & Polycrystalline Si Ingots using Multi-Blade Saws	SHEET
Motorola, Inc.	Multiple-Blade Sawing (MBS) of Si Ingots	DR
Motorola, Inc.	Use of Low Energy Hydrogen Ion Implants in Hi-Efficiency Crystalline Si Solar Cells	PD
Motorola, Inc.	Phase 2 of the Array Automated Assembly Task	PD
Motorola, Inc.	Development of Technique for AR Coatings & Nickel & Copper Metallization of Solar Cells	RES
Motorola, Inc.	Intermediate Load Module for Test & Evaluation	PD
Motorola, Inc.	In-Depth Study of Si Wafer Surface Texturing	PD
Motorola, Inc.	Development of Low-Cost Polysilicon Solar Cells	RES
Motorola, Inc.	40 Kilowatts Solar Cell Modules	PD
Motorola, Inc.	Eight Kilowatts of Solar Cell Modules	MPFA
Motorola, Inc.	Development of Low-Cost, Hi-Energy/Unit-Area Solar Cell Modules	RES
Motorola, Inc.	Design, Fabricate, Test, Qualification & Price Analysis of 3rd Generation Design Solar Cell Modules	PD
Motorola, Inc.	Development & Demonstration of Synthetic Procedures for Polymeric UV Stabilizers & Absorbers	PD
Motorola, Inc.	Ink Jet Printing of Silver Metallization for PV	PD
Motorola, Inc.	MO Silver Metallization for PV	SHEET
Motorola, Inc.	Epitaxial Si Growth for Solar Cells	PD
Motorola, Inc.	Phase 1 of the Automated Array Assembly Task	PD
Motorola, Inc.	Phase 2 of the Array Automated Assembly Task	SHEET
Motorola, Inc.	Inverted Stepanov Tech (IST) for Si Sheet Growth Development	PD
Motorola, Inc.	Development of Megasonic Cleaning for Si Wafers	PD
Motorola, Inc.	Evaluation & Verification of Epitaxial Process Sequence for Si Solar Cell Production	PD
Motorola, Inc.	Design of Block V Solar Cell Modules - 1981	MPFA
Motorola, Inc.	Develop. & Evaluation Die Mats. for Producing Si Ribbons by the Inverted Ribbon Growth Process	SINAT
Motorola, Inc.	Comprehensive Si Solar Cell Computer Modeling	DR
Motorola, Inc.	Develop & Demonstrate Methods for Accelerated & Abbreviated Testing of Encapsulated Materials	PD
Motorola, Inc.	Chemical Vapor Deposition Growth Si Sheet Growth Development	SHEET
Motorola, Inc.	Study Program for Encapsulation Materials Interface for Low-Cost Si Solar Array	PD
Motorola, Inc.	Material Analysis of PV Cells and Module Test Samples	RES
Motorola, Inc.	Analysis of Cost-Effective PV Panel Design Concepts Using Light Trapping	PD
Motorola, Inc.	Advanced ID Wafering Technology	SHEET
Net'l Research for Geosciences Labs, Inc.		
North Carolina A&T Foundation, Inc.		
North Carolina State University		
Northrop Corp		
Oregon State University		
P. R. Hoffman (Moxlin Indus.)		
P. R. Hoffman (Moxlin Indus.)		
Pennsylvania State University		
Photowatt Intl, Inc.		
Photowatt Intl, Inc.		
Photowatt Intl, Inc.		
Photowatt Intl, Inc.		
Photowatt Intl, Inc.		
Photowatt Intl, Inc.		
Photowatt Intl, Inc.		
Photowatt Intl, Inc.		
Polytechnic Institute of New York - Albany		
Purdue Research Foundation		
Purdue Research Foundation		
RCA Corp.		
RCA Corp.		
RCA Corp.		
RCA Corp.		
RCA Corp.		
RCA Corp.		
RCA Corp.		
RCA Corp.		
RCA Corp.		
Research Triangle Institute		
Rockwell International Corp.		
Rockwell International Corp.		
Rockwell International Corp.		
Rockwell International Corp.		
Scanning Electron Analysis Laboratory		
Science Applications, Inc.		
Silicon Technology Corp.		

COMPANY	CONTRACT TITLE	AREA
Silicon Technology Corp.	Development of Methods of Producing LASS by the Slicing of Silicon Ingots Using ID Saws	SHEET
Siltec Corp.	Development of Advanced Methods for Continuous Cz Growth	SHEET
Siltec Corp.	Enhanced ID Slicing Technology for Silicon Ingots	SHEET
Solar Energy Research Institute	Purification of Metallurgical Grade Si by Chemical Vapor Transport	SHEET
Solar Energy Research Institute	Solid/Melt Interface Studies of High-Speed Si Sheet Growth	SHEET
Solar Energy Research Institute	Optimization of Si Crystals for High-Efficiency Si Solar Cells	SHEET
Solar Power Corp.	Design, Fabricate, Test, Qualification & Price Analysis of 3rd Generation Design Solar Cell Modules	MPFA
Solar Technology International	Solar Cell Panel Development Effort	PD
Solarelectronics, Inc.	Hydrochlorination of SiCl4 & Metallurgical Grade Si	SHEET
Solarex Corp.	Process Research of Polycrystalline Si Material	PD
Solarex Corp.	Block V Documentation and Solar Cell Modules	RES
Solarex Corp.	Design of Block V Solar Cell Modules - 1981	MPFA
Solarex Corp.	Process Research of Polycrystalline Si Material	PD
Solarex Corp.	Phase 2 of the Array Automated Assembly Task	PD
Solarex Corp.	Analysis of the Effects of Impurities on Si	SHEET
Solarex Corp.	Si Solar Cell Modules with a Total Power Capability of 30 Kilowatts	RES
Solarex Corp.	Technical Feasibility & Effective Cost of Various Wafer Thicknesses for Manufacturing	PD
Solarex Corp.	High-Efficiency, High-Density Terrestrial Solar Panels	PD
Solarex Corp.	Solar Breeder Feasibility Investigation	PD
Solarex Corp.	Design, Fabricate, Test, Qualification & Price Analysis of 3rd Generation Design Solar Cell Modules	MPFA
Solarex Corp.	Mitre Solar Energy Test System Evaluation	MPFA
Solarex Corp.	Intermediate Load Modules for Test and Evaluation	RES
Solavolt International	Antireflective Coatings to Single Crystal or Polycrystalline Solar Cells by Use of Roller Coating Method	RES
Solec International, Inc.	Intermediate Load Modules for Test and Evaluation	RES
Solenergy Corp.	Intermediate Load Modules for Test and Evaluation	RES
Sollos, Inc.	A New Method of Metallization for Si Solar Cells	PD
Sollos, Inc.	Investigation of Nickel Silicon Metallization Process	PD
Spectrolab, Inc.	High Resolution, Low Cost Solar Cell Contact Development	PD
Spectrolab, Inc.	Phase 2 of the Array Automated Assembly Task	PD
Spectrolab, Inc.	Design, Development & Prototype Production of Si Solar Cell Modules	MPFA
Spectrolab, Inc.	High Resolution, Low-Cost Solar Cell Contact Development	PD
Spectrolab, Inc.	Analysis of Effects of Impurities Intentionally Incorporated into Si	PD
Spectrolab, Inc.	Si Solar Cell Process Development, Fabrication and Analysis	MPFA
Spectrolab, Inc.	Development of Metallization Process	SHEET
Spectrolab, Inc.	Design, Analysis, & Test Verification of Advanced Encapsulation Systems	SHEET
Spire Corp.	Development & Fabrication of a Solar Cell Junction Process System	RES
Spire Corp.	Hermetic Edge Sealing of PV Modules	PD
Spire Corp.	Ion Implantation of Non-Cz Si	PD
Spire Corp.	Verification & Implementation of Electrostatic Bonding Technologies	RES
Spire Corp.	Design of Block V Solar Cell Modules - 1981	MPFA
Spire Corp.	Block V Documentation and Solar Cell Modules	RES
Spire Corp.	Adapt Pulse Excimer Laser Processing Technology to Fabricate Cost-Effective Solar Cells	PD
Spire Corp.	High-Efficiency Solar Cell Modules	RES
Spire Corp.	Development of Pulsed Processes for the Manufacture of Solar Cells	PD
Spire Corp.	Design, fabricate, Test, Qualification & Price Analysis of 3rd Generation Design Solar Cell Modules	MPFA
Spire Corp.	Develop and Test Encapsulation Materials	PD
Spire Corp.	Solar Cell Panel Development	PD
Spire Corp.	Assess Government Owned JPL Advanced CZO Crystal Growth System Model	SHEET
Spire Corp. (Simulated Physics, Inc.)	Hi-Rate Low-Energy Expenditure Fabrication of Solar Cells	PD

COMPANY	CONTRACT TITLE	AREA
Springborn Labs, Inc.	Module Encapsulation Task	RES
Springborn Labs, Inc.	Fabrication of Solar Cell Modules	RES
SRI International	Novel Duplex Vapor-Electrochemical Method for Si Solar Cells	SINAT
Stanford University	Study of Parameters of Heavily Doped Si	DR
Stanford University	Interfacial Barriers in Hi-Efficiency Crystalline Si Solar Cells	SHEET
State University of New York-Albany	Oxygen & Carbon-Related Defects on Hi-Efficiency Si Solar Cells	SHEET
Superwave Technology, Inc.	Microwave Heating in a Non-Reactive FBR	SINAT
Superwave Technology, Inc.	Depositing Semiconductor Layers Using Microwave Techniques	PD
Texas Instruments, Inc.	Si Material Task I, Part 3	SINAT
Texas Instruments, Inc.	Closed Cycle Process for Low-Cost Solar Si Using a Pottery Chamber Reactor	SINAT
Texas Instruments, Inc.	Si Crystal Growth & Wafering Process Improvements	SHEET
Texas Instruments, Inc.	Phase 2 of the Array Automated Assembly Task	SHEET
Texas Instruments, Inc.	Advanced Methods for Continuous Cz Growth, Si Sheet Growth Development	SHEET
Texas Instruments, Inc.	Phase I of the Automated Array Assembly Task	PD
Texas Research & Engineering Institute	Si Production Process Evaluation	SINAT
The Aerospace Corp.	Composition Measurements by Analytical Catalysis	SINAT
The Boeing Co.	Feasibility Study of Solar Dome Encapsulation of PV Arrays	ESRP
The Boeing Co.	Mitre Solar Energy Test System Evaluation	PD
The Mitre Corp.	Support of the Lifetime Cost Performance (LCP) Modeling Effort	P&I
Theodore Barry & Associates	Study to Support Development of Solar Array Manufacturing Industry Costing Standards	P&I
Theodore Barry & Associates	Solar Array Production System (SAPS) Production Program Handbook & Mathematics Model	PD
Tracor PB Associates	Phase 2 of the Array Automated Assembly Task	PD
Tracor PB Associates	Automation Equipment Development and Modification	PD
Tracor PB Associates	Phase 2 of the Array Automated Assembly Task	PD
Tylen Corp.	Use of Glass Reinforced Concrete (GRC) as a Substrate for PV Modules	PD
Underwriters Labs, Inc.	Vitrograph Coatings on Multiite	SHEET
Underwriters Labs, Inc.	PV Module and Array Materials	RES
Union Carbide Corp.	Solar Array/Module Safety Requirements	RES
Union Carbide Corp.	Solar Cells on Multicrystalline Substrates of Si Refined by DS/RMS Process	SINAT
University of California at Los Angeles	Silane to Si Process	SINAT
University of California at Los Angeles	Optimization Methods & Si Solar Cell Numerical Models	DR
University of California at Los Angeles	Si Solar Cell Fabrication Technology	SHEET
University of California at Los Angeles	Delayed Fracture of Si	SHEET
University of California at Los Angeles	Development of Methods of Characterizing Si Sheet Material	SHEET
University of California at Los Angeles	Si Sheet with Molecular Beam Epitaxy for Hi-Efficiency Solar Cells	SHEET
University of California at Los Angeles	Visible-Irradiance Optical Properties of Conducting Polymers	SHEET
University of California at Santa Barbara	Time Resolved Spectroscopic Measurements	DR
University of California at Santa Cruz	Surface and Allied Studies in Si Solar Cells	DR
University of Florida	Study of the Abrasive Wear Rate of Silicon	RES
University of Illinois	Stress-Strain Analysis of Si Ribbon	DR
University of Kentucky	Synthetic Procedures for Polymeric UV Stabilizers and Absorbers	SHEET
University of Massachusetts	Determine Effects of Pressure of Reactant Gases Where Si is in Contact with Die & Container & Container Metals	SHEET
University of Missouri	Analysis & Evaluation of Processes and Equipment	SHEET
University of Pennsylvania	Hot Forming of Si, Si Sheet Growth Development	SHEET
University of Pennsylvania	Analysis & Evaluation of Module Experimental Process System Development Unit Processes	SHEET
University of Pennsylvania	Chairman of Advisory Committee on Low Cost Solar Cells	SHEET
University of Pennsylvania	Si Solar Cells of Near 20% Efficiency	SHEET
University of South Carolina	Web-Dendritic Ribbon Growth	DR

COMPANY	CONTRACT TITLE	OPEN	AREA
University of Southern California	Measurement of the Absorption Coefficients of Si	•	SHEET
University of Southern California	Accelerated Aging and Analysis of Polymers	•	PD
University of Southern California	Study of Deep Level Impurities and Defects in Si	•	DR
University of Toronto	Photodegradation in Solar Cell Modules of Substrate & Superstrate Design	•	RES
University of Washington	Si Inversion Layer Solar Cells & Carrier Lifetime Measurements	•	DR
Varian Associates	Development of Advanced Methods for CZ Growth	•	SHEET
Varian Associates	Slicing of Si into Sheet Material	•	SHEET
Washington University at St. Louis	Cz Crystal Modeling Study	•	SHEET
Washington University at St. Louis	Fluidized Bed Reactors for Production of Si from Silane	•	SHEET
Westinghouse Electric Corp.	Dendritic Web-Type Solar Cell Mini-Modules	•	SHEET
Westinghouse Electric Corp.	Development of Si Sheet by Dendritic Web Ribbon Process	•	SHEET
Westinghouse Electric Corp.	Methods of Production of Large Areas of Si Sheet by the Web Dendrite Process	•	SHEET
Westinghouse Electric Corp.	Si Dendritic Web Material Process Development	•	SHEET
Westinghouse Electric Corp.	Phase 2 of the Array Automated Assembly Task	•	SHEET
Westinghouse Electric Corp.	Process for High Capacity Arc Heater Prod of Si for Solar Arrays	•	SHEET
Westinghouse Electric Corp.	Part 2-Develop & Define Requirements of Purity for Solar Cell Grade Si	•	SHEET
Westinghouse Electric Corp.	Process Research of non-Cz Si Material	•	SHEET
Westinghouse Electric Corp.	Single Crystal Si Dendritic Web Ribbon & Hi-Efficiency Solar Cells	•	SHEET
Westinghouse Electric Corp.	Dendritic Web Process Development	•	SHEET
Westinghouse Electric Corp.	Laser Assisted Solar Cell Metallization Processing	•	SHEET
Westinghouse Electric Corp.	High-Efficiency Solar Cells on Si Web	•	SHEET
Westinghouse Electric Corp.	Process Research of Non-Cz Si Material	•	SHEET
Westinghouse Electric Corp.	Electrochemical Research on Solar Cells and PV Materials	•	SHEET
Westinghouse Electric Corp.	Durability/Reliability Performance Criteria & Test Methods for Array Subsystem Elements	•	SHEET
Westinghouse Electric Corp.	Center Punched Solar Cell Module Development Effort	•	SHEET
Wiley College			
Wyle Laboratories			
Xerox Corp.			
LEGEND:			
Cz	- Czochralski		
DR	- Device Research		
MPFA	- Module Performance & Failure Analysis		
OPEN	- Open or Continuing Contracts		
PAGEI	- Project Analysis & Integration		
PD	- Process Development		
PV	- Photovoltaic(s)		
RES	- Reliability & Engineering Science		
SHEET	- Advanced Silicon Sheet		
SI	- Silicon		
SIMAT	- Silicon Materials		