

DEVELOPMENT OF AEROELASTIC ANALYSIS METHODS FOR TURBOROTORS AND
PROPFANS - INCLUDING MISTUNING

Krishna Rao V. Kaza
Structural Dynamics Branch
NASA Lewis Research Center

INTRODUCTION

The NASA Lewis aeroelastic research program is focused on unstalled and stalled flutter, forced response, and whirl flutter of turborotors and propfans. The basic research effort was started 6 years ago as a continuation of the ATE (Aeroelasticity of Turbine Engines) Program. The objectives of the effort are to understand the physical phenomena of cascade flutter and response including blade mistuning (also called detuning or mode localization). By starting with simple aeroelastic models and then progressively improving the models, aeroelastic prediction capability has been significantly improved and the role of mistuning has become well understood.

While this basic research effort was in progress, a propfan wind tunnel model (the SR-5, with 10 titanium blades) fluttered unexpectedly during a performance test. The basic aeroelastic research program was then redirected and focused on propfans in an effort to understand the physics of the instability phenomenon and to develop required analysis methods. The redirected program has been supplemented by a balanced experimental effort. The experiments have been specifically designed to clarify the physics of flutter, to guide the development of analytical models, and to provide quality data for validating the analysis methods. The unique features of propfan blades, such as their significant blade sweep and twist and their thinness and low aspect ratio, put additional demands on basic technology disciplines, such as two-dimensional and three-dimensional steady and unsteady aerodynamics in subsonic, transonic, and supersonic flow regimes; structural dynamics modeling of composite blades; geometric nonlinear theory of elasticity; linear and nonlinear Coriolis effects; and passive and active control of flutter and response. Furthermore the aeroelastic models with their refined aerodynamic and structural models have imposed additional demands on computer power (speed and memory). New analytical models in unsteady aerodynamics, structural dynamics, and aeroelasticity have been conceived that exploit the capabilities of the Cray-XMP supercomputer. Some of these models have been completed and some are in progress. These new models have been incorporated in a general-purpose computer program, ASTROP (Aeroelastic STability and Response Of Propulsion Systems). A part of the ASTROP program has been validated by comparing theoretical and experimental results for single-rotation (SR) propfans. More recently the ASTROP code has been extended to calculate the forced response of propfan blades in yawed flow, including blade mistuning.

This presentation briefly reviews the aeroelastic models employed in the basic research effort, describes the focused propfan aeroelastic program, and presents an overview of the ASTROP code. It also outlines the flutter and forced-response models employed in ASTROP, presents predicted results from these models, and validates the models by comparing predicted and measured data.

Future research in aeroelasticity will include more emphasis on computational aeroelasticity with two- and three-dimensional full velocity potential models and Euler and Navier-Stokes aerodynamic models to clarify transonic flow effects, on dynamic stall, and on the reverse thrust effects of both single-rotation and counterrotation propfans and turborotors. This effort will be supplemented with balanced wind tunnel tests to validate the new methods.

TYPICAL SECTION FLUTTER AND RESPONSE MODEL (MISER2)

A research program was begun about 6 years ago to improve the basic understanding of blade mistuning effects on aeroelastic stability and response and to explore the possibility of using mistuning as a passive response control. This program was started with simplified aeroelastic models, and the models were progressively improved. The first aeroelastic model (Kaza and Kielb, 1982; Kielb and Kaza, 1983; and Busby et al., 1985) was based on a two-degrees-of-freedom structural dynamic model with plunging and pitching motion of each blade and arbitrary frequency mistuning and on four two-dimensional cascade aerodynamic models. The results from this aeroelastic model showed that the bending and torsion coupling has a significant effect on cascade flutter and that frequency mistuning has a beneficial effect on flutter in all the flow regimes addressed and has either a beneficial or adverse effect on forced response. Furthermore these simple models were used as benchmarks for checking more complicated subsequent models.

- **STRUCTURAL DYNAMICS MODEL**
 - PLUNGING AND PITCHING MOTION OF EACH BLADE
 - ARBITRARY FREQUENCY MISTUNING

- **TWO-DIMENSIONAL UNSTEADY CASCADE AERODYNAMIC MODELS**
 - INCOMPRESSIBLE FLOW (WHITEHEAD, 1960)
 - SUBSONIC FLOW (SMITH, 1973; RAO AND JONES, 1975)
 - SUPERSONIC FLOW (ADAMCZYK AND GOLDSTEIN, 1978)
 - SUPERSONIC FLOW WITH SHOCKS (GOLDSTEIN, BRAUN, ADAMCZYK, 1977)

- **SOLUTION METHOD—FREQUENCY DOMAIN METHOD**

BLADED-DISK FLUTTER MODEL

This model is designed to account for the effects of structural coupling between the blades and the elastic, inertial, and aerodynamic coupling between the bending and torsional motions of each individual blade on the vibration and flutter characteristics of mistuned bladed-disk assemblies. These objectives are accomplished in two phases (Kaza and Kielb, 1984 and 1985). Each blade is represented by an Euler-Bernoulli beam with normal modes of a nonrotating beam. The disk is represented by a circular plate. The structural dynamic model is obtained by a component-mode synthesis approach. The generalized aerodynamic loads are obtained from two-dimensional theory in a stripwise fashion. The parametric results showed that the beneficial effect of frequency mistuning on flutter is unaffected by either the structural coupling between the blades or the additional bending and torsion coupling of each individual blade. Also, it was identified that the pretwist introduces strong coupling between the disk bending and blade chordwise motions.

- **STRUCTURAL DYNAMIC MODEL**
 - BEAM NONROTATING MODES FOR EACH BLADE
 - PLATE MODES FOR DISK
 - COMPONENT MODE SYNTHESIS
 - FREQUENCY MISTUNING

- **AERODYNAMIC MODEL**
 - STRIPWISE APPROACH
 - TWO-DIMENSIONAL SUBSONIC AND SUPERSONIC CASCADE THEORY

- **SOLUTION METHOD—FREQUENCY DOMAIN SOLUTION**

WHY FOCUSED PROPFAN AEROELASTIC RESEARCH?

Flutter occurred unexpectedly during a performance test on the SR-5 wind tunnel model, a single-rotation model with 10 titanium blades. This flutter was not predicted before the test by the existing helicopter blade flutter analysis code. Because of the unique features of the propfans listed below, it was decided that the existing aeroelastic technology for conventional propellers, turbofans, or helicopters was not adequate. It was also recognized that developing new aeroelastic methods requires new models in basic disciplines such as two-dimensional and three-dimensional, steady and unsteady (stalled and unstalled) aerodynamics in subsonic, transonic, and supersonic flow regimes and modeling of composite blades and tailored experiments to guide the analytical model development and to validate the theory.

- **THIN BLADES (FLEXIBLE), CENTRIFUGAL LOADS (LARGE DEFLECTIONS)—GEOMETRIC NONLINEAR THEORY OF ELASTICITY AND CORIOLIS FORCES**
- **SUBSONIC, TRANSONIC, AND POSSIBLY SUPERSONIC MACH NUMBERS; LOW ASPECT RATIO; AND LARGE SWEEP—THREE-DIMENSIONAL STEADY AND UNSTEADY AERODYNAMIC THEORY**
- **HIGH SWEEP AND TWIST—COUPLED BLADE VIBRATORY BENDING AND TORSION MODES AND STRUCTURAL COUPLING BETWEEN BLADES**
- **8 TO 10 BLADES—AERODYNAMIC COUPLING BETWEEN BLADES (CASCADE EFFECTS)**
- **COUPLING BETWEEN AFT AND REAR ROTORS**
 - **THREE-DIMENSIONAL STEADY AND UNSTEADY AERODYNAMIC THEORY**
 - **TIME DOMAIN AEROELASTIC MODEL**

CD-88-31790

IDEALIZED SWEEP-BEAM AEROELASTIC MODEL FOR PROPFANS

The main purpose of the beam model was to predict the flutter speed of the SR-5 wind tunnel model and to clarify the mechanism of the flutter phenomenon. For expeditious results the beam model (Kaza and Kielb, 1984) was modified to account for blade sweep in an approximate manner as shown in the left-hand graph below. Since the unsteady aerodynamic models for swept blades were not available at that time, the two-dimensional cascade aerodynamic theory was modified to account for blade sweep by using similarity laws. The disk is assumed to be rigid. The predicted flutter boundary is compared with the measured one in the right-hand graph. The measured and calculated flutter boundary trends and flutter frequencies are in agreement (Mehmed et al., 1982). Although not shown in the figure, the observed flutter mode and the measured interblade phase angle agree well with the theory. But the analytical results depend on the users' judgment in selecting effective blade sweep and blade elastic axis position. However, this model was very useful in conducting parametric studies to clarify the flutter mechanism.

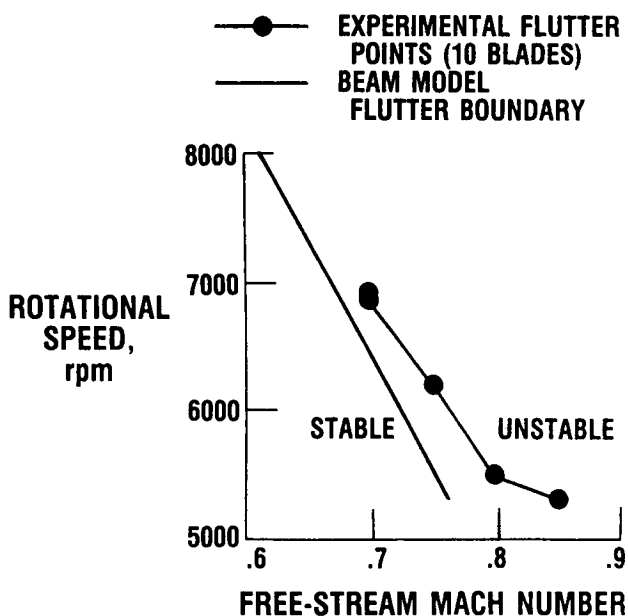
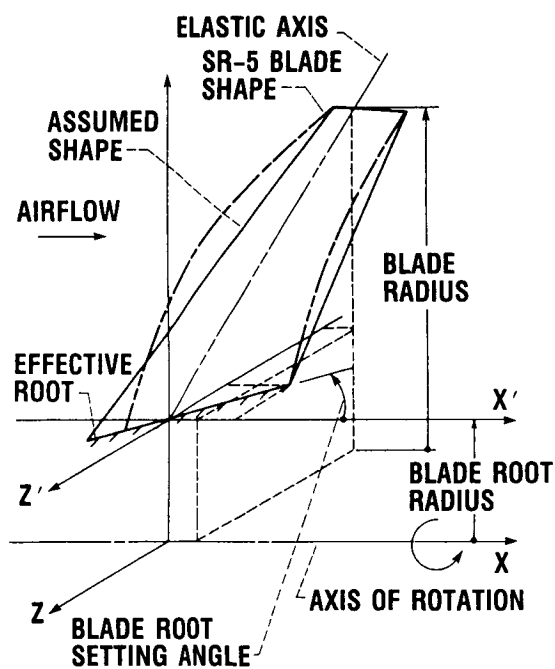

CD-88-31791

AEROELASTIC STABILITY AND RESPONSE OF PROPULSION SYSTEMS (ASTROP)

The preliminary investigation (both experimental and theoretical) of the SR-5 flutter clearly demonstrated that more refined aeroelastic prediction methods are needed so that propfans can be designed for maximum efficiency and safety. At the same time these methods should have the flexibility to incorporate new and future models in basic disciplines and have the capability to analyze new propfan concepts. With this in mind we have begun the development of a comprehensive aeroelastic program, ASTROP, as shown below. The current status of the various modules in the program is also shown. In all the ASTROP structural dynamic models the Coriolis forces are neglected because these forces were shown by Subrahmanyam et al. (1986) to have negligible effect on vibration for thin blades. The first module, ASTROP2, and the subsonic flutter (with and without mistuning) portion of second module, ASTROP3, have been completed and validated (Kaza et al., 1987a and 1987b). Extensive parametric results, which are believed to be useful for propfan designers, are also presented in these references.

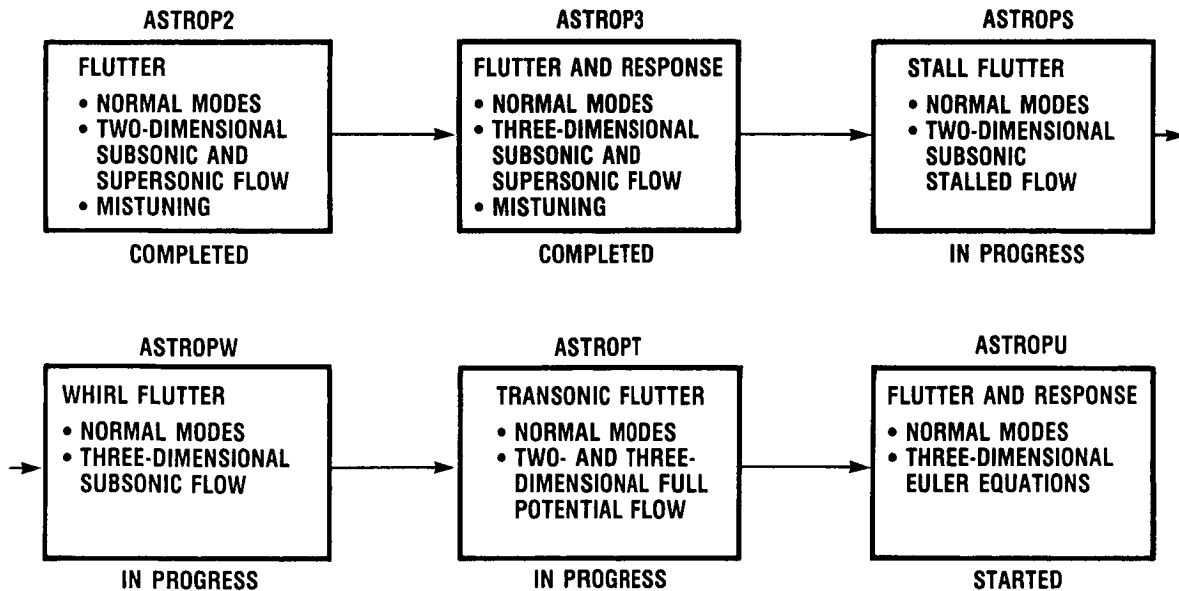

CD-88-31792

APPLICATION OF ASTROP3 CODE FOR INVESTIGATING FLUTTER
OF A COMPOSITE SR PROPFAN MODEL

The ASTROP3 code uses three-dimensional subsonic steady and unsteady cascade aerodynamics (Williams and Hwang, 1986) and a NASTRAN finite element model to represent the blade structure. The equivalent anisotropic material properties for each finite element are generated by using a preprocessor code, COBSTRAN, developed by Chamis (1981). The effect of centrifugal loads and steady-state airloads on the steady-state geometry of a composite wind tunnel model (SR3C-X2) blade is shown in the left-hand graph. The aerodynamic cascade effects (or the effect of blade number) on the eigenvalues are shown in the right-hand graph. Both centrifugal loads and aerodynamic loads untwist the blades, and this untwist increases with rotational speed. It is evident that the cascade effect is very significant on the real part of the eigenvalue and hence on stability.

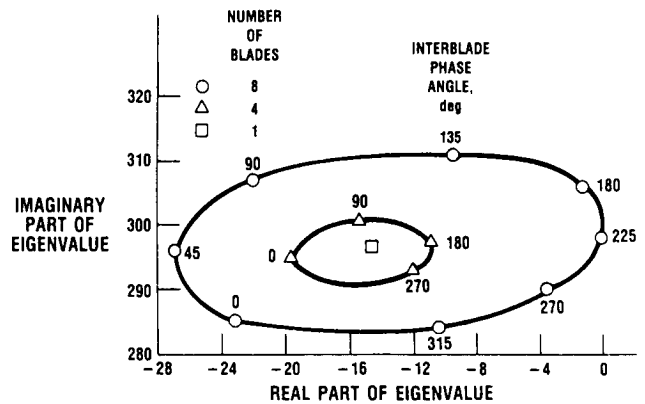
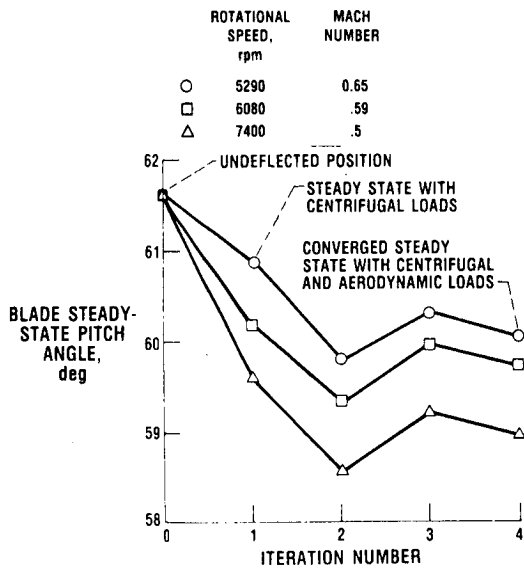

CD-88-31793

COMPARISON OF MEASURED AND CALCULATED FLUTTER
BOUNDARIES FOR SR3C-X2 PROPFAN MODEL

Theoretical flutter results obtained from the ASTROP3 code have been correlated in the graph below with flutter data on a wind tunnel propfan model, SR3C-X2, with composite blades (Mehmed and Kaza, 1986). Theoretical results include the effects of centrifugal loads and steady-state airloads. The theory does reasonably well in predicting flutter speeds and boundary slopes. However, the difference between the calculated and measured flutter Mach numbers is greater for the four-blade case than for the eight-blade case. This implies that the theory may be overcorrecting for aerodynamic cascade effects with four blades. Calculated interblade phase angles at flutter (not shown) also compared well with measured values. However, calculated flutter frequencies were about 8 percent higher than measured.

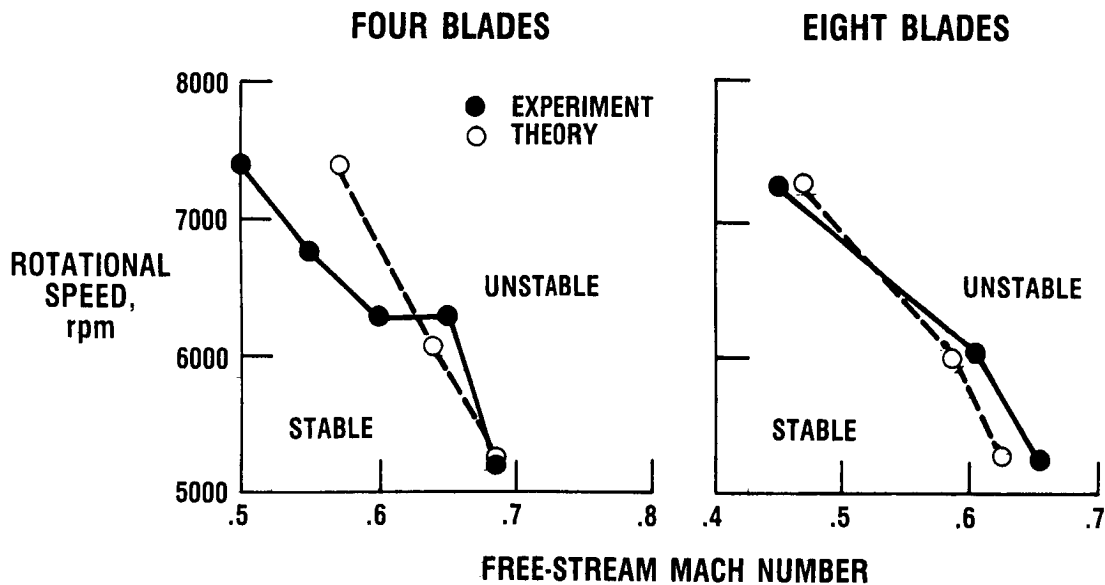

CD-88-31794

EVALUATION OF TWO-DIMENSIONAL UNSTEADY AERODYNAMIC THEORY
FOR PROPFAN FLUTTER PREDICTION

So that the validity of two-dimensional aerodynamic theory and the associated sweep correction could be assessed, the real part of the eigenvalue of the critical mode was calculated by using both ASTROP2 and ASTROP3. The results are compared in the graph below, which also shows the measured flutter Mach number. The two-dimensional theory is shown to be less accurate than the three-dimensional theory in predicting flutter Mach number for this case. Correlative studies (not shown) of measured and calculated flutter boundaries were also conducted by varying Mach number, blade sweep, rotational speed, and blade setting angle. The correlation varied from poor to good. The expected conservative nature of the two-dimensional theory sometimes did not prevail, possibly because of the arbitrary nature of the reference line employed in the strip method and the associated sweep correction.

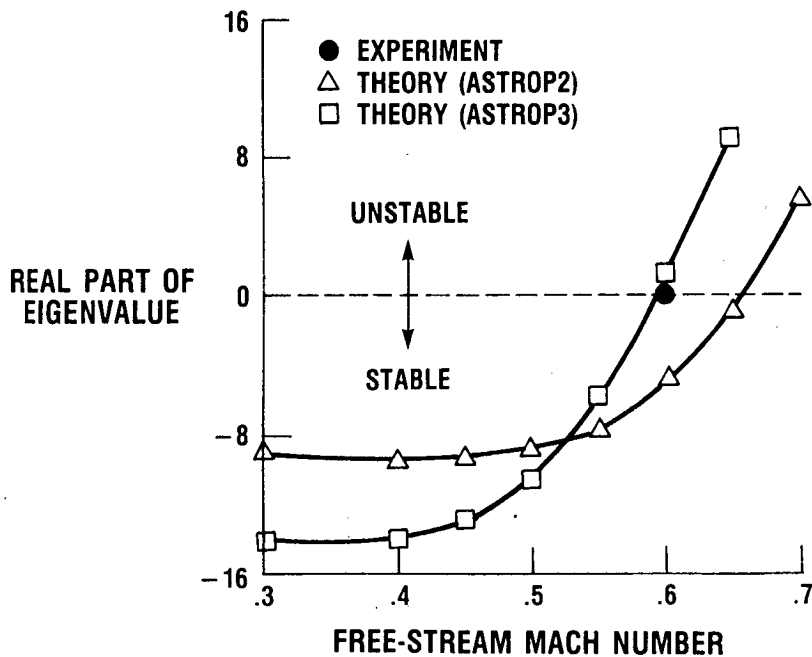

CD-88-31795

PROPFAN BLADE MISTUNING MODELS

Blade mistuning affects vibration, flutter, and forced response of turbomachinery rotors and so is a current research topic. Its effects on propfan flutter were investigated analytically and experimentally. Schematics of an eight-blade mistuned rotor used in formulating the analytical model and blade ply directions used in constructing the wind tunnel model are shown below. The analytical model, which is more general than the wind tunnel model, is based on the normal modes of a rotating composite blade and on subsonic unsteady lifting-surface aerodynamic theory. The natural frequencies and mode shapes of the SR3C-X2 and X3 model blades differed because of the ply angle variations between the blades. The first-mode frequencies of both blades were very close and insensitive to ply angles. However, the average second-mode frequency of the SR3C-3 blade was about 12 percent higher than that of the -X2 blade. More details can be found in Kaza et al. (1987b).

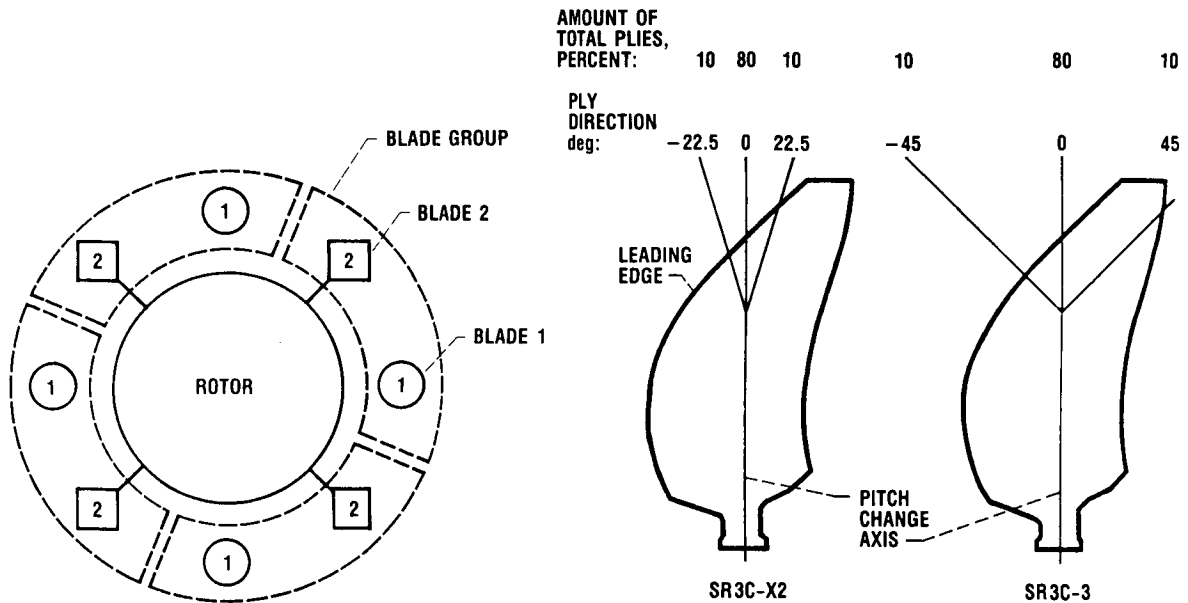

CD-88-31796

COMPARISON OF MEASURED AND CALCULATED FLUTTER BOUNDARIES
FOR TUNED AND MISTUNED PROPFAN MODELS

Measured and calculated results for the tuned rotor SR3C-X2 and the mistuned rotor SR3C-X2/SR3C-3 are compared in the figure. The calculations for each rotor were made with the calculated modes and frequencies, except that the measured second-mode frequency was substituted for the calculated one. The calculated flutter Mach numbers for the SR3C-X2 were lower than the measured ones for all rotational speeds. The agreement would be better if the effects of steady airloads and structural damping were included in the calculations. The agreement of the mixed rotor is better but would become unconservative if steady airloads and structural damping were included in the theory. However, the overall agreement between theory and experiment is more than satisfactory. Finally the comparison of flutter boundaries for the SR3C-X2 and SR3C-3 propfans shows that a laminated composite propfan can be tailored to optimize its flutter speed by selecting the proper ply angles.

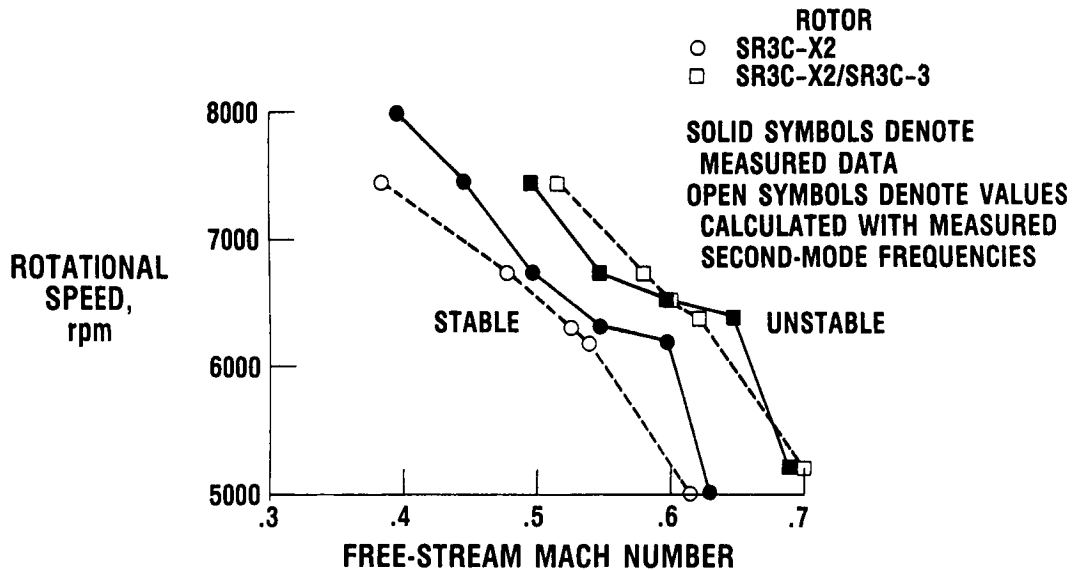

CD-88-31797

COMPARISON OF MEASURED AND CALCULATED VIBRATORY
STRESS AMPLITUDES OF A PROPFAN MODEL

A new feature of the ASTROP3 code that has just been completed (Kaza et al., 1988) is the capability to perform a modal forced-response vibration analysis that includes structural and aerodynamic mistuning of aerodynamically excited propfans. The figure depicts a single-rotation, advanced propfan wind tunnel model (the SR-5 with 10 metallic blades) operating in a generally uniform, steady inflow field and inclined at a small angle with respect to the axis of rotation. Although the absolute inflow field is constant, rotating the propfan results in velocities with oscillatory components relative to the blades. Under such conditions ASTROP3 is able to determine the oscillatory loading distributions over the propfan blades at various excitation frequencies and to calculate the vibratory displacements and stresses of the propfan. The figure shows measured and calculated one-per-revolution vibratory stress amplitudes for the SR-5 blade. The correlation between theory and experiment is very good.

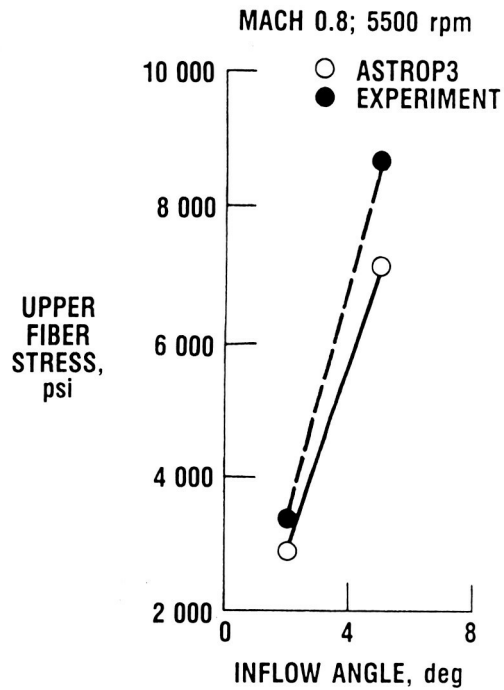
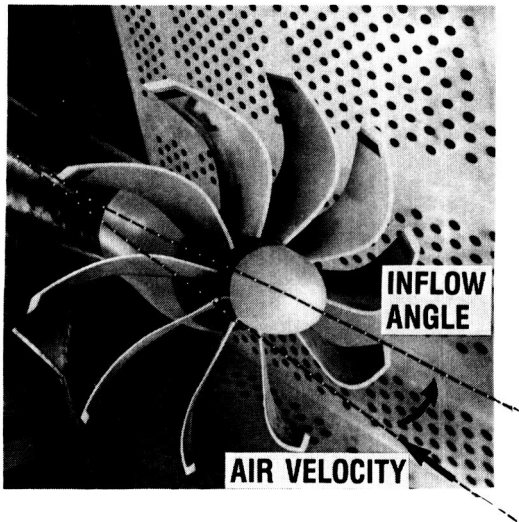

CD-88-31798

COMPARISON OF MEASURED AND CALCULATED FLUTTER BOUNDARIES
OF SR-5 WIND TUNNEL MODEL

Another new feature of the ASTROP3 code that is in development is the capability to calculate flutter when the helical Mach number of the flow is supersonic. The aerodynamic code was developed by M.H. Williams of Purdue University (personal communication). This new feature of ASTROP3 is being evaluated by applying it to the SR-5 wind tunnel model since the helical flutter Mach number at the tip is near unity, or above, for most of the data. Measured and calculated flutter Mach numbers are shown for three rotational speeds at a blade setting angle of 69.3° at the three-quarter radius. The calculated mean angle of attack of the blade is also shown. The experimental flutter Mach number range was 0.86 to 0.96, with the mean angle varying from 3.07° to 11.57° . The difference between the calculated and measured flutter Mach numbers increased with increasing mean angle of attack. The maximum difference between theory and experiment was 16.7 percent at 6800 rpm. This is not surprising because a blade with substantial sweep and mean angle of attack is operating in transonic flow. Even though the blade is thin, this kind of a disagreement is expected because of the "transonic dip" (drop in flutter Mach number) phenomenon associated with substantial blade sweep. To shed further light on the transonic dip phenomenon for thin airfoils, a further investigation has been conducted (Srivastava, et al., 1988).

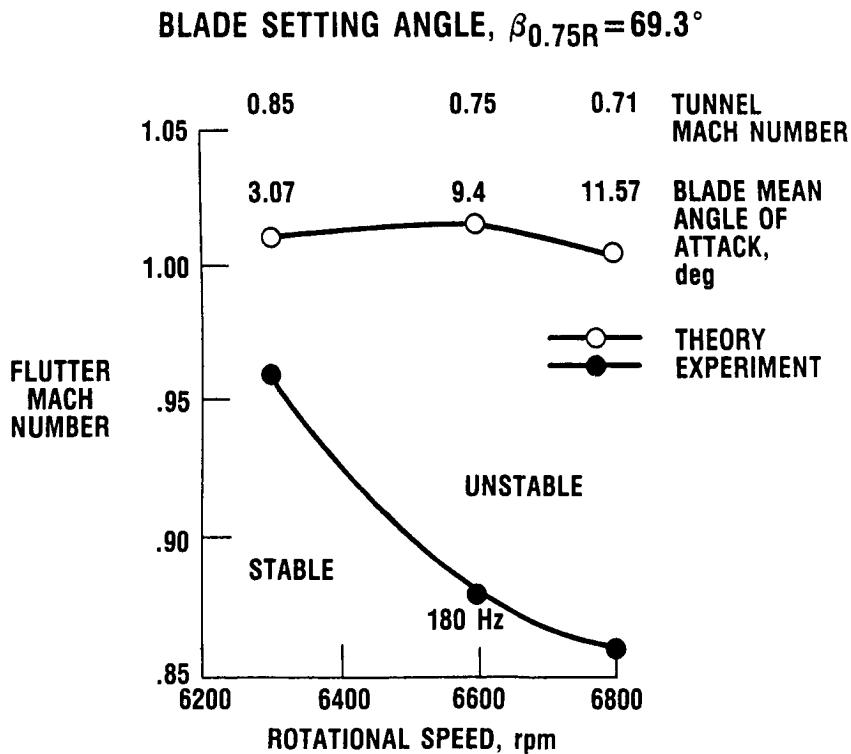

REFERENCES

- Adamczyk, J.J., and Goldstein, M.E., 1978, "Unsteady Flow in Supersonic Cascade With Subsonic Leading-Edge Locus," AIAA Journal, Vol. 16, No. 12, Dec. 1978, pp. 1248-1254.
- Busby, B.C., Kaza, K.R.V., and Kieth, T., 1985, "The Effects of Strong Shock Loading on Coupled Bending-Torsion Flutter of Tuned and Mistuned Cascades," Presented at the Tenth Biennial ASME Design Engineering Conference and Exhibit on Mechanical Vibration and Noise, Cincinnati, OH, Sept. 10-13, ASME Fluid-Structure Interaction and Aerodynamic Damping, E.H. Dowell and M.K. Au-Yang, eds., pp. 93-108.
- Chamis, C.C., 1981, "Integrated Analysis of Engine Structures," NASA TM-82713.
- Goldstein, M.E., Braun, W., and Adamczyk, J.J., 1977, "Unsteady Flow in a Supersonic Cascade With Strong In-Passage Shocks," Journal of Fluid Mechanics, Vol. 83, Part 3, pp. 569-604.
- Kaza, K.R.V., and Kielb, R.E., 1982, "Flutter and Response of a Mistuned Cascade in Incompressible Flow," AIAA Journal, Vol. 20, No. 8, Aug., pp. 1120-1127.
- Kaza, K.R.V., and Kielb, R.E., 1984, "Flutter and Response of Turbofan Rotors With Mistuned Blades," AIAA Journal, Vol. 22, No. 11, Nov., pp. 1618-1625.
- Kaza, K.R.V., and Kielb, R.E., 1985: "Vibration and Flutter of Mistuned Bladed-Disk Assemblies," Journal of Propulsion and Power, AIAA, Vol. 1, No. 5, Sept.-Oct., pp. 336-344.
- Kaza, K.R.V., et al., 1987a, "Analytical Flutter Investigation of a Composite Propfan Model," AIAA Paper No. 87-0738 (NASA TM-88944).
- Kaza, K.R.V., et al., 1987b, "Analytical and Experimental Flutter Investigation of Mistuning in Propfan Flutter," AIAA Paper No. 87-0739 (NASA TM-88959).
- Kaza, K.R.V., Williams, M.H., Mehmed, O., and Narayanan, G.V., 1988, "Forced Response of Metallic and Composite Propfan Models in Yawed-Flow," AIAA/ASME/ASEE/SAE 24th Joint Propulsion Conference and Exhibit, Boston, MA, July 11-14.
- Kielb, R.E., and Kaza, K.R.V., 1983, "Aeroelastic Characteristics of Cascade of Mistuned Blades in Subsonic and Supersonic Flows," Journal of Vibration, Stress and Reliability in Design, Vol. 105, pp. 1120-1127.
- Mehmed, O., et al., 1982, "Bending-Torsion Flutter of a Highly Swept Advanced Turboprop," NASA TM-82975.
- Mehmed, O., and Kaza, K.R.V., 1986, "Experimental Classical Flutter Results of a Composite Advanced Turboprop Model," NASA TM-88972.

Rao, B.M., and Jones, W.P., 1975, "Unsteady Airloads for a Cascade of Staggered Blades in Subsonic Flow," 46th Propulsion Energetic Review Meeting, Monterey, California.

Smith, S.N., 1973, "Discrete Frequency Sound Generation in Axial Flow Turbomachines," R&M No. 3709, British Aeronautical Research Council.

Srivastava, R., Reddy, T.S.R., and Kaza, K.R.V., 1988, "The Effects of Thickness and Shape, Viscosity and Rotation on Transonic Flutter Dip Phenomena," AIAA 29th Structures, Structural Dynamics and Materials Conference, April 18-20, Williamsburg, VA.

Subrahmanyam, K.B., et al., 1986, "Nonlinear Bending-Torsional Vibration and Stability of Rotating, Pretwisted, Preconed Blades Including Coriolis Effects," NASA TM-87207.

Whitehead, D.S., 1960, "Force and Moment Coefficients for Vibrating Airfoils in Cascades," R&M 3254, British Aeronautical Research Council.

Williams, M.H., and Hwang, C., 1986, "Three-Dimensional Unsteady Aerodynamics and Aeroelastic Response of Advanced Turboprops," AIAA 27th Structures, Structural Dynamics and Materials Conference, Part 2, NY, pp. 116-124.