

NGT-24002-080
NET-80001

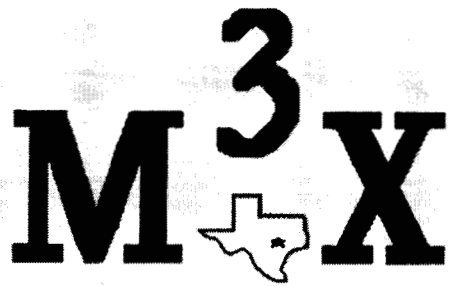

**THE MARS COMPANY PRESENTS
A FINAL REPORT ON
A FAST CREW TRANSFER VEHICLE TO MARS**



MANNED MISSION TO MARS: EXPRESS

THE UNIVERSITY OF TEXAS AT AUSTIN

MAY 6, 1988

(NASA-CR-124713) DESIGN OF A FAST CREW
TRANSFER VEHICLE TO MARS Final Report
(Texas Cr/10) 127 p. (SOL) 228

M39-15986

Uncles

03/10 0189629

**FINAL REPORT ON THE DESIGN OF
A FAST CREW TRANSFER VEHICLE
TO MARS**

**WRITTEN IN RESPONSE TO
RFP #ASE274L**

**SUBMITTED TO:
DR. WALLACE FOWLER
THE UNIVERSITY OF TEXAS AT AUSTIN
DEPARTMENT OF AEROSPACE ENGINEERING
AND ENGINEERING MECHANICS
AUSTIN, TEXAS 78712**

**PRESENTED BY:
THE MARS COMPANY
THE UNIVERSITY OF TEXAS AT AUSTIN
AUSTIN, TEXAS 78712**

May 6, 1988

"Although the nation is firmly dedicated to achieving a manned lunar landing in this decade, landing on the moon is not the ultimate goal. Man will travel beyond the moon to explore the solar system. When, I do not know. But it will take all the disciplines of technology and management to push the frontiers of space into the backyards of the planets."

--Wernher von Braun, 1964

(Stoker, p. 30)

Executive Overview

This document outlines a final report on the trajectory and vehicle requirements for a fast crew transfer vehicle to Mars which will complete an Earth to Mars (and Mars to Earth) transfer in 150 days and will have a stay time at Mars of 40 days. This vehicle will maximize the crew's effectiveness on Mars by minimizing detrimental physiological effects such as bone demineralization and loss of muscle tone caused by long period exposure to zero gravity and radiation from cosmic rays and solar flares.

The crew transfer vehicle discussed in this report will complete the second half of a "Split Mission" to Mars, as proposed by the University of Texas at Austin Spacecraft Design Group in the Spring of 1985. In the Split Mission, a slow, unmanned cargo vehicle, nicknamed the "Barge", is sent to Mars ahead of the crew vehicle. Once the Barge is in orbit around Mars, the fast crew vehicle will be launched to rendezvous with the Barge in Mars orbit.

The vehicle presented is designed to carry six astronauts for a mission duration of one year. The vehicle uses a chemical propulsion system and a nuclear power system. Four crew modules, similar to the proposed Space Station Common Modules, are used to house the crew and support equipment during the mission. The final design also includes a command module that is shielded to protect the crew during major radiation events.

MARCO's engineering section was divided into two major branches: Vehicle Design and Trajectory Design. The results of the Trajectory Group were used by the Vehicle Group for vehicle system selection and sizing.

This report presents the design results and a discussion of the management considerations for the project.

Table of Contents

	<u>Page</u>		
		Executive Overview	i
		List of Figures	iv
		List of Tables	iv
		List of Acronyms	v
1.0		General Summary	1
1.1		Project Background	1
1.2		Design Overview	1
1.3		Design Groundrules and Assumptions	2
2.0		Trajectory Considerations and Results	4
2.1		Trajectory Scenarios Considered	4
2.1.1		Multiple Vehicles - Constant Thrust	4
2.1.2		Single Vehicle - Impulsive Thrust	5
2.1.3		Multiple Vehicles - Impulsive Thrust	5
2.2		Trajectory Decision Tables	5
2.2.1		Constant Thrusting	6
2.2.2		Impulsive Thrusting	6
2.3		Final Mission Design: Single Vehicle - Impulsive Thrust	9
2.3.1		Nominal Mission	9
2.3.1.1		Earth Departure	9
2.3.1.2		Heliocentric Transfer	10
2.3.1.3		Mars Capture	10
2.3.1.4		On Orbit	10
2.3.1.5		Mars Departure	11
2.3.1.6		Heliocentric Transfer	11
2.3.1.7		Earth Capture	11
2.3.2		Mission Windows	12
2.3.2.1		Earth Departure	12
2.3.2.2		Mars Departure	12
2.3.3		Abort Contingencies	13
3.0		Vehicle Systems	22
3.1		Propulsion systems	22
3.2		Power Systems	26
3.3		Aerocapture	33
3.4		Human Factors	36
3.4.1		Crew Complement	36
3.4.2		Environmental Control/ Life Support System	37

3.4.3	Module Design	38
3.4.4	EVA	39
3.4.5	Health	39
3.4.6	Activities	40
3.4.7	Psychology	41
3.5	Artificial Gravity	48
3.6	Shielding	51
3.7	Guidance, Navigation, and Control	58
3.8	Ship Design and Summary	59
4.0	Management	63
4.1	Design Branches	63
4.2	Task Scheduling	63
4.3	Organization Review	64
5.0	Cost Status	70
5.1	Personnel Costs	70
5.2	Computer/Materials Costs	71
5.3	Final Cost Status	72
6.0	Bibliography	73
7.0	Appendix	79

List of Figures

<u>Figure</u>	<u>Page</u>
2.1 a) Earth Operations	14
b) Mars Operations	15
c) Mission Overview	16
2.2 ΔV s vs Stay Time	17
2.3 Mission Overview (0 Stay Time Abort Trajectory)	18
3.1 SP-100 Mass and Power	30
3.2 Power System Decision Table	31
3.3 Boom Mounted RBMR	32
3.4 Partially Closed Life Support Systems Loop	41
3.5 Open Loop Requirements for a Crew Size of 8	42
3.6 Open Versus Closed Life Support	42
3.7 Closed Versus Open Loop ECLSS	42
3.8 Regenerable CO ₂ Removal Benefit	43
3.9 Water Recycling Benefit	43
3.10 Oxygen Regeneration Benefit	43
3.11 Life Support Systems Scaling Equations	44
3.12 Boeing's Current Concept of the SSCMs	45
3.13 Connecting Nodes	46
3.14 Common Module Shielding Weight vs. Proton Energy	55
3.15 Common Module Shielding Weight vs. Material Density	55
3.16 MARCO's Conceptual Design	61
4.1 MARCO Organizational Chart	65
4.2 Vehicle and Trajectory Decision Task Schedule	66
4.3 Critical Design Path	67

List of Tables

<u>Table</u>	<u>Page</u>
2.1 Low Thrust Decision Table	7
2.2 Impulsive Thrust Decision Table	8
2.3 Dates and ΔV 's for Departure Opportunities	19
2.4 Heliocentric Transfer Parameters	20
3.1 Weight Distribution of Propulsion System	24
3.2 Propulsion Systems Performance	25
3.3 Hardware Dedicated to the Exercises Countermeasures Facility	47
3.4 Radiation Exposure Limits	56
3.5 Summary Definition of Maximum Meteoroid Environment	57
3.6 Mass of Ship Components	62
4.1 MARCO Design Team	69
4.2 Personnel Time Summary	69
5.1 Final Cost Status	72

List Of Acronyms

AMTEC	Alkali Metal Thermo-Electric Converter
BASE	Beta-Alumina Solid Electrolyte
CTV	Crew Transfer Vehicle
ΔV	Delta-V
ECLSS	Environmental Control/Life Support Systems
EVA	Extra-Vehicular Activities
g	Gravity of Earth
GNC	Guidance, Navigation and Control
HEP	High Energy Protons
HLLV	Heavy Lift Launch Vehicle
HMF	Health Maintenance Facility
HMO	High Mars Orbit
ISF	Industrial Space Facility
I_{sp}	Specific Impulse
JPL	Jet Propulsion Laboratory
LEO	Low Earth Orbit
LMO	Low Mars Orbit
MARCO	The Mars Company
MMU	Manned Maneuvering Unit
MT	Metric Ton (1000 kg)
NASA	National Aeronautics and Space Administration
NEP	Nuclear Electric Propulsion
NERVA	Nuclear Electric Rocket Vehicle Acceleration
NSO	Nuclear Safe Orbit
OTV	Orbital Transfer Vehicle
RBMR	Rotating Bubble Membrane Radiator
RFP	Request for Proposal
RTG	Radio-isotope Thermoelectric Generator
SAIC	Space Applications International Corporation
SEP	Solar Electric Power
SRB	Solid Rocket Booster
SSCM	Space Station Common Module
SSME	Space Shuttle Main Engine
TOF	Time of Flight

1.0 General Summary

1.1 Project Background

As stated in the report of the National Commission on Space, the establishment of permanent manned bases on the Moon and Mars are long term goals for the U.S. space program (National Commission on Space, p. 5-18). Only through extensive manned exploration can the U.S. fully determine the applicability of available resources of the Moon and the outer planets. The Mars Company, MARCO, concentrated its efforts on specifying the requirements for a fast Crew Transfer Vehicle (CTV) for a manned Mars mission. This vehicle will make a heliocentric transfer to Mars in 150 days, stay at Mars for 40 days, and return to Earth in another 150 days.

MARCO's work is a continuation of the work begun by the University of Texas at Austin Spacecraft Design Group in the Spring of 1985 and further developed in 1986 and 1987. This proposed mission design developed a scenario using two vehicles and was nicknamed the "split mission." A slow, unmanned Barge containing scientific experiments, fuel, and extra supplies would first be sent to Mars. Once the Barge was in orbit around Mars, a fast CTV would leave Earth and dock with the Barge in Mars orbit. The fast CTV, built only for the crew transportation and not for the transport of extra supplies, has the advantage of requiring less fuel during its flight.

MARCO focused on the fast CTV, determining requirements for its systems, subsystems, and trajectories.

1.2 Design Overview

MARCO determined requirements for a fast CTV for a manned mission to Mars with the goal of delivering the crew in a healthy state to Mars. Major emphases of this design were on minimizing time of flight and detrimental health effects on the crew. To accomplish this, the Trajectory Design Branch investigated high thrust/ free fall trajectories, low thrust trajectories and a combination of both. After determining times of flight, ΔV 's, and rocket engine

performance requirements, the trajectory group gave this information to the vehicle design group. The vehicle design group then used this data to size and establish requirements for vehicle systems in several areas including shielding; power; propulsion; guidance, navigation and control; artificial gravity; human factors, including life support and health maintenance; and aerobraking for the non-nuclear scenarios.

The final product is an integrated vehicle/trajectory package with system and subsystem requirements. Final trajectory designs are also be presented.

1.3 Design Groundrules and Assumptions

Based on the RFP requirements and basic initial simplifications of the problem, MARCO defined the following groundrules and assumptions:

Basic Groundrules

- Minimum crew of six
- Minimal crew exposure to zero gravity and solar/cosmic radiation effects
- Safe haven for crew in case of major radiation events
- Abort scenarios - minimal energy
- Departure from Low Earth Orbit (LEO)
- Reserve fuel available during flight for low energy aborts
- Refueling at Mars for high energy return

Assumptions

• A Space Station in LEO will be functional and will be able to support the constructions of the CTV. The station will also be capable of supporting a rescue mission of the CTV while it remains in Earth's sphere of influence. Assembly will be in LEO for easy access to the space station.

• Energiya class Heavy Lift Launch Vehicle (HLLV) will be available to lift a minimum of 100 metric tons to the space station in LEO. It will be assumed that a minimum of 5 launches will be required.

- Coplanar Orbits of Earth and Mars will be used for trajectory analysis.

An additional 10% of the required propellants will be added to the final mass of the CTV to compensate for plane changes.

- Two-body Problem in geo-, helio-, and areocentric phases will be considered for each respective portion of the trajectory.

- Perturbations due to any outside influence will not be considered for the design of the trajectories.

- A technology baseline of 1995 will be used in studying systems needed for the mission.

- Mission duration of 1 year maximum, transfer time of 100 to 150 days, and a stay time of 30-60 days will be the baseline.

- The Barge will already be in orbit around Mars and in nominal working order.

2.0 Trajectory Considerations and Results

2.1 Trajectory Scenarios Considered

To solve the fast crew transfer to Mars problem three conceptual mission designs were developed. These included a Multiple Vehicles - Constant Thrust scenario, a Single Vehicle - Impulsive Thrust scenario, and a Multiple Vehicles - Impulsive Thrust scenario. The three scenarios are discussed in greater detail in the Proposal in Appendix B.

2.1.1 Multiple Vehicles - Constant Thrust

The Multiple Vehicles - Constant Thrust mission concept uses two vehicles to solve the fast crew transfer to Mars problem. The first vehicle is a large nuclear powered spacecraft propelled at a constant thrust level provided by its nuclear propulsion system. It is used mainly to complete the heliocentric transfer phases of the mission.

The second vehicle is a smaller spacecraft used to transport the crew from Low Earth Orbit (LEO) to the constant thrust vehicle just prior to the latter vehicle's escape from Earth. Because it will take several months for the low thrust vehicle to escape from Earth, it was decided not to place the crew on board the larger vehicle until Earth escape was imminent. The smaller vehicle will then remain docked with the larger vehicle until the final stages of the mission.

After the heliocentric transfer to Mars, the small vehicle/ large vehicle combination will rendezvous with the Barge in Low Mars Orbit (LMO) where on-orbit phases of the mission will be performed and Martian landing begun. The small vehicle/ large vehicle combination will then depart Mars.

After the heliocentric transfer back to Earth, the smaller vehicle will transport the crew back to LEO while the constant thrust vehicle executes a long return back to LEO.

2.1.2 Single Vehicle - Impulsive Thrust

The Single Vehicle - Impulsive Thrust mission concept uses one vehicle to perform the fast crew transfer to Mars. The vehicle is chemically propelled but uses a small nuclear reactor for power.

The single vehicle will make a high thrust impulsive burn in LEO to place it on a heliocentric transfer to Mars. At Mars an impulsive braking burn will be made so the vehicle can enter LMO and rendezvous with the Barge for the on-orbit and transport to surface phases of the mission. Mars escape will then be performed by a third high thrust burn.

After heliocentric transfer back to Earth the single vehicle will again make an impulsive braking burn to return the crew back to LEO.

2.1.3 Multiple Vehicles - Impulsive Thrust

The Multiple Vehicles - Impulsive Thrust mission concept is essentially the same as the Single Vehicle - Impulsive Thrust Concept except that the near Mars mission phases requires two vehicles instead of one.

In this concept a large and small impulsive vehicle make a braking burn into High Mars Orbit (HMO). The smaller vehicle is then used to transport the crew from the larger vehicle to the Barge and back. Both vehicles then make a high thrust impulsive burn to escape Mars and return to Earth where a final burn is made to return both the vehicle and the crew to LEO.

2.2 Trajectory Decision Tables

Tables 2.1 and 2.2 summarize the decision strategies used to determine which trajectory scenario is best based on its propulsion type (i.e., constant thrust or impulsive thrust) for the fast transfer to Mars. The ratings for each criteria range from 5-good to 1-poor. An entry of 0 (zero) means that either no solution for that criteria was found or that the solution violated the groundrules and assumptions of this analysis. An entry of zero thus disqualifies the particular scenario from consideration.

2.2.1 Constant Thrusting

As one can see in Table 2.1 the criteria "Stayover Time Allowed" has only "zero" entries, thus every constant thrust scenario was disqualified. The reason behind this disqualification was that the constant thrust trajectory scenarios that presented adequate times of flight (TOF) and adequate mass fractions for each phase of the mission required stayover times greater than the allowable limit. Because the required phase angle for departure from Mars would not reoccur until almost the full synodic period of Earth and Mars (2.13 years) had elapsed, stayover times of more than 600 days were needed before the constant thrust vehicle could return to Earth. Although other constant thrust return trajectories have been proposed, such as University of Michigan's Project Kepler, those trajectories violated the maximum heliocentric transfer time limit and required a close proximity to the Sun to gain sufficient speed to "catch up with the Earth." Thus, those alternate mission scenarios were also eliminated.

2.2.2 Impulsive Thrusting

Table 2.2 shows the decision structure used to determine the best mission scenario for the Single Vehicle - Impulsive Thrusting concept based on comparisons of Mars stayover times. Prior to completing this decision table an analysis based on comparisons of different transfer times showed that as the transfer time to Mars approached the Hohmann transfer time the total mission ΔV decreased. Thus, the maximum allowable transfer time of 150 days was chosen for the mission scenario. Determining the relative ratings of Minimum ΔV Found, Stayover Time and Number of Departure Opportunities lead to the conclusion that a mission scenario of 150 days transfer time to Mars/ 40 days stayover time/ 150 days return transfer time to Earth was the optimum for the the fast crew transfer mission.

The third mission concept of Multiple Vehicles - Impulsive Thrusting was dropped from consideration because of its unnecessary complexity and

because it would cost less ΔV to arrive in an elliptical orbit with a periapse of approximately 270 N.MI. at Mars and dock with the Barge for refueling.

Thus it was determined that a Single Vehicle - Impulsive Thrust Scenario was the best concept to fulfill the requirements of the fast crew transfer to Mars problem.

Table 2.1 Low Thrust Decision Table.

CRITERIA	Wt. Factor	INITIAL VEHICLE ACCELERATION (g's)			
		0.5E-4	0.75E-4	1.0E-4	>>1.0E-4
MASS FRACTION AT EARTH ESC.	3x	4	4	5	5
MASS FRACTION AT MARS	6x	5	4	2	1
MASS FRACTION AT EARTH RETURN	5x	5	1	1	0
TOF EARTH ESC.	1x	3	4	5	5
TOF TO MARS	5x	4	4	5	5
TOF RETURN TO EARTH	4x	5	5	5	0
STAY OVER TIME	4x	0	0	0	0
TOTALS	 	110	85	77	46

RATINGS: GOOD — POOR NO SOLUTION
 5 4 3 2 1 0

TABLE 2.2: IMPULSIVE THRUST DECISION TABLE

	STAY OVER TIME (DAYS)						
	0	10	20	30	40	50	60
MINIMUM DELTA V FOUND 3x	5	5	4	4	4	3	3
STAY OVER TIME 2x	1	1	2	3	4	5	5
NUMBER OF DEPARTURE OPPORTUNITIES (DELTA V WITHIN 5% OF MINIMUM)	3	5	5	5	4	4	3
TOTALS	20	22	21	23	24	23	22

• TRANSFER TIME = 150 DAYS

RATINGS: GOOD — POOR NO SOLUTION
 5 4 3 2 1 0

2.3 Final Mission Design: Single Vehicle - Impulsive Thrust

The following sections detail the final Single Vehicle - Impulsive Thrust mission design chosen by MARCO as the best scenario to solve the fast crew transfer to Mars problem.

2.3.1 Nominal Mission

The nominal mission for the fast crew transfer to Mars is divided up into several segments. They are:

- Earth Departure
- Heliocentric Transfer to Mars
- Mars Capture
- On-Orbit
- Mars Departure
- Heliocentric Transfer to Earth
- Earth Capture

As explained in section 2.0, the crew of the single, impulsive thrusting vehicle will be placed on board the vehicle before Earth departure and will remain on the vehicle during the return to Low Earth Orbit (LEO). Figure 2.1 is a mission overview for this scenario - Figure 2.1 (a) shows the orbital maneuvers in LEO, Figure 2.1 (b) shows the orbital maneuvers in the Mars orbit, and Figure 2.1 (c) shows the heliocentric transfer between Earth and Mars.

A complete listing of required ΔV 's for each applicable segment of the mission (listed by departure dates within the mission windows) is given in Table 2.3. Table 2.4 lists the parameters for the heliocentric transfer orbits.

2.3.1.1 Earth Departure

The first segment of the mission is departure from a LEO altitude of 200 nautical miles. The Crew Transfer Vehicle (CTV) makes Impulsive Burn 1 or the Trans-Mars Injection, placing it on the heliocentric transfer orbit to

Mars. Table 2.3 shows that the magnitude of this burn is approximately 6.1 kilometers per second (km/s).

2.3.1.2 Heliocentric Transfer to Mars

The heliocentric transfer to Mars segment of the mission will require a 150 day time of flight (TOF). During this segment the crew will settle into a routine of exercise, scientific observation and experimentation, training, and recreation. These routines are explained in more detail in section 3.4 Human Factors. The heliocentric trajectory to Mars is shown in Figure 2.1(c).

2.3.1.3 Mars Capture

After heliocentric transfer to Mars, Impulsive Burn 2 or the Mars Orbit Insertion burn is made, placing the vehicle into an elliptical orbit with a 270 nautical mile periapse altitude above Mars. The required burn to accomplish Mars Capture has an average magnitude of 7.7 (km/s) and is the most "expensive" for the mission. The capture maneuver will also be made so the single, crew transfer vehicle may rendezvous with the Barge.

2.3.1.4 On-Orbit

Once rendezvous with the Barge has been completed the on-orbit segment of the mission will begin. This will again include a routine of exercise, scientific observation and experimentation and health maintenance. Also included in this segment will be the descent to the Martian surface and performance of surface tasks.

A total of forty (40) days is allowed for the on-orbit and surface segment of the mission within which the surface-mission members of the crew must perform surface tasks and return to the CTV to prepare for the return to Earth. Final preparation for return to Earth includes refueling the CTV from the Barge and stowing all surface-mission materials such as collected soil samples.

2.3.1.5 Mars Departure

Impulsive Burn 3, the Trans-Earth Injection burn, will be made to place the CTV on its heliocentric transfer trajectory back to Earth. The magnitude of this burn averages 7.4 (km/s). The Barge will remain at Mars to be used in the future as a possible building block for a permanent Mars Station.

2.3.1.6 Heliocentric Transfer to Earth

The heliocentric transfer to Earth will require a TOF of 150 days. This segment will have much the same routine as the heliocentric transfer to Mars except for additional logging of on-orbit and surface events and preliminary analysis of collected surface materials.

2.3.1.7 Earth Capture

The final phase of the mission is Earth Capture. This will be accomplished by Impulsive Burn 4, the Earth Orbit Injection burn, which will return the CTV to a LEO altitude of 200 nautical miles. The magnitude of this burn averages 5.5 (km/s) and is the least "expensive" for the mission.

2.3.2 Mission Windows

In order to run trajectory analyses for this impulsive scenario, two computer programs were written. One program, TRNSFR3, calculates the velocities, ΔV 's, patched conic parameters, and transfer ellipse parameters for the impulsive scenario recommended. A second program, PLOT1, uses a numerical integration package to plot the resulting two-body heliocentric transfer. Complete listings of the source code of both TRNSFR3 and PLOT1 can be found in the MARCO Project Book. All of the trajectory analysis programs written for this project make use of the Mission Planning Subroutine Library developed at the University of Texas at Austin. The departure opportunities were divided into two areas: departure from Earth and departure from Mars. The required ΔV 's and departure dates are discussed in the next two sections.

2.3.2.1 Earth Departure

After determining the the total mission ΔV 's and the ΔV 's at each burn based on departure dates from Earth ranging from from January 1, 2000 to December 31, 2009, Table 2.3 was made. This table lists the departure dates from Earth, the total mission ΔV 's, and the ΔV 's at each burn. It is evident from the table that the lowest total ΔV is around 26.6 km/sec, and the highest total ΔV that was considered for the mission is around 27.0 km/sec. To qualify as a valid mission window the total ΔV for the first segment of the mission (i.e., the sum of ΔV_1 and ΔV_2) could not be greater than 14.0 (km/s). The same criteria applied to the second segment of the mission. Thus only seven departure opportunities were found in the 10 year period from 2000 - 2010. They are from February 27, 2003 to March 5, 2003.

2.3.2.2 Mars Departure

Departure dates from Mars are determined simply by adding the transfer time from Earth to Mars and the stay time at Mars (190 days) to the

departure date from Earth. Figure 2.2 shows the relationship between the total mission ΔV and the stay time at Mars. From this figure it is evident that no extra ΔV penalty will be incurred if the stayover time at Mars is made shorter than 40 days. Table 2.4 shows the velocities, transfer ellipse parameters, and ΔV 's for a representative mission departing the Earth March 2, 2003. These parameters are shown for Earth to Mars and Mars to Earth trajectories.

2.3.3 Abort Contingencies

For the single vehicle impulsive scenario which was chosen, there are five main abort situations which must be considered. These are:

- the initial burn fails to eject the CTV from LEO into the heliocentric transfer orbit
- the propulsion system fails after escape from Earth
- complete docking with the barge is not possible
- the propulsion system fails to eject the CTV from Mars orbit into a heliocentric transfer orbit back to Earth
- the final burn fails to initiate Earth capture of the CTV

For the first case, failure to escape from Earth, a rescue of the astronauts will be performed from the Space Station. For the second case, failure of the propulsion system after escape from Earth, the abort contingency was determined to be too complex for definition in this report. It is therefore recommended that further study on this situation be performed. In the third case where complete docking with the Barge is not possible the CTV will refuel and will depart for Earth, essentially just reducing the normal mission scenario to one of zero stay time but the same transfer time in each direction. The trajectory for this contingency is shown in Figure 2.3. For the fourth case, failure to escape from Mars, backup fuel will be available on the Barge in order to perform another burn. In the fifth and final abort scenario, failure to capture at Earth, a rescue of the astronauts will be performed from the Space Station.

Near Earth Operations

CTV: Crew transfer vehicle

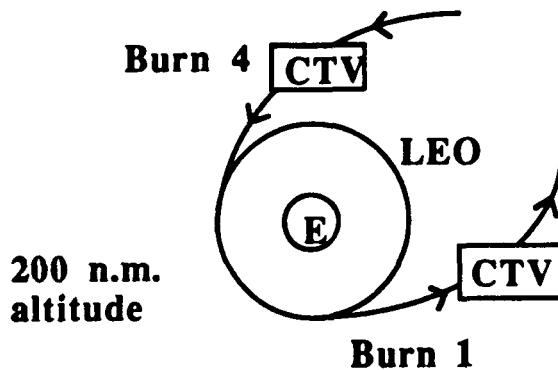

MISSION SEQUENCE

Burn 1: Departure from LEO to heliocentric transfer orbit using Impulsive maneuver (Trans-Mars Injection)

Burn 4: Capture from heliocentric transfer to LEO using Impulsive braking (Earth Orbit Insertion)

Figure 2.1(a) Earth Operations

Near Mars Operations

CTV: Crew transfer vehicle

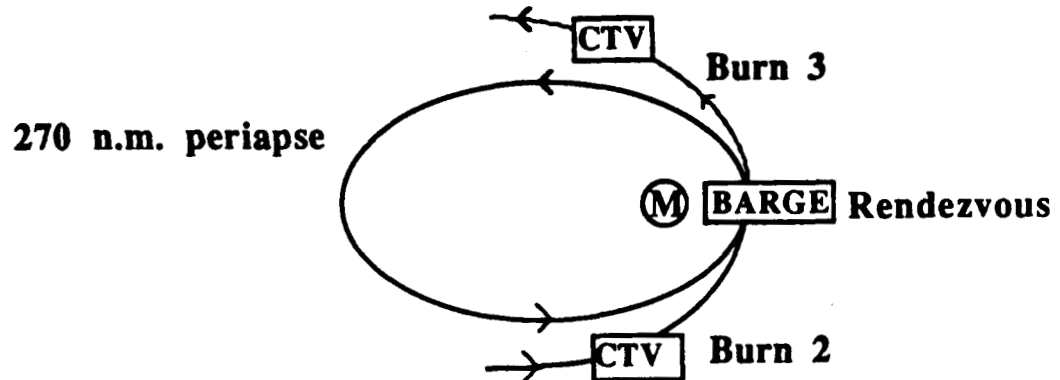

MISSION SEQUENCE

Burn 2: Capture from heliocentric transfer orbit using Impulsive braking (Mars Orbit Insertion)

Rendezvous with Barge in Mars Orbit

Burn 3: Departure from Mars Orbit to transfer orbit using Impulsive maneuver (Trans-Earth Injection)

Figure 2.1(b) Mars Operations

Figure 2.2 Total Mission ΔV vs Stay time at Mars for 150 Day Heliocentric Transfers

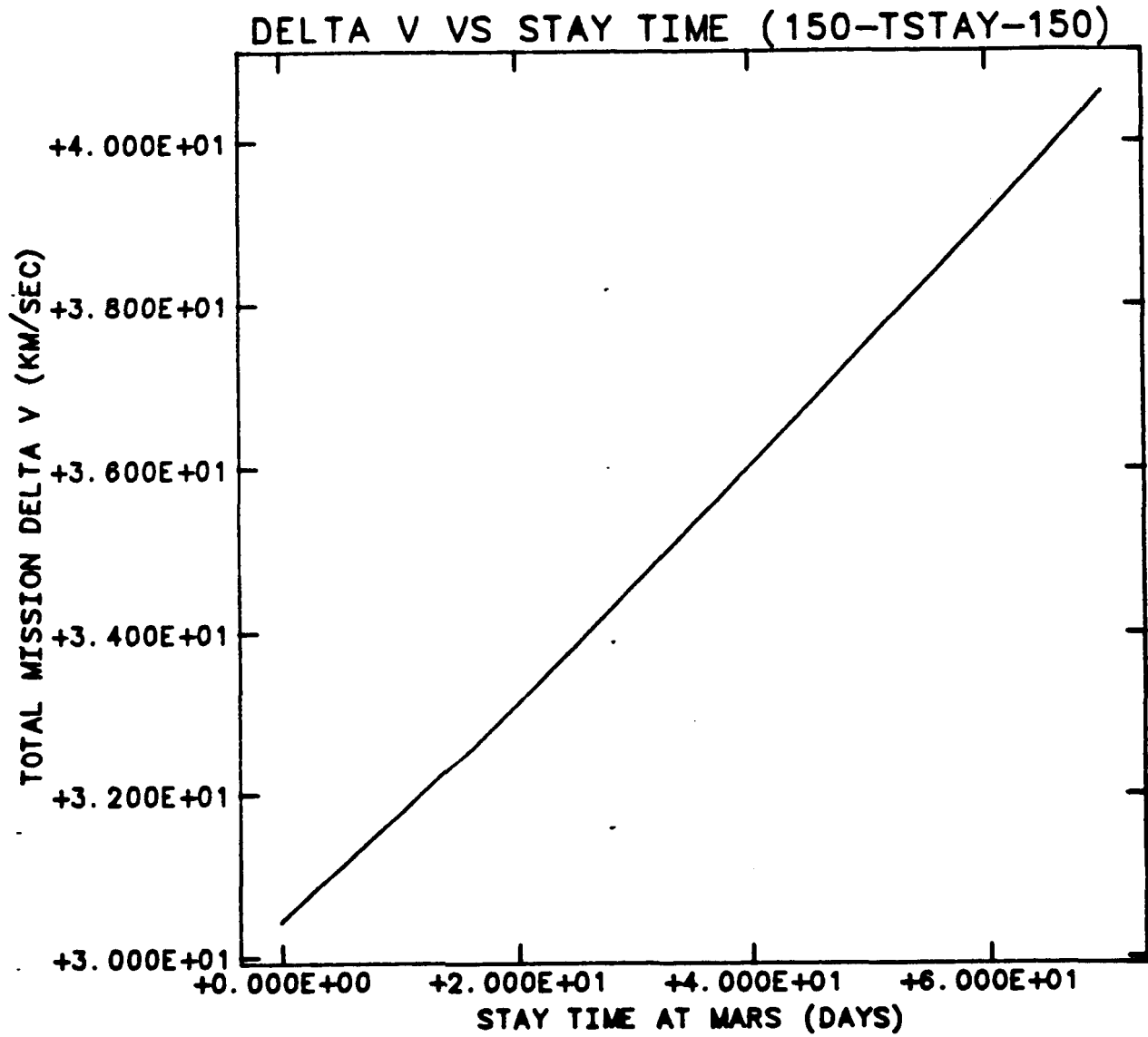

Figure 2.3 Mission Overview (Zero Stay Time Abort Trajectory)

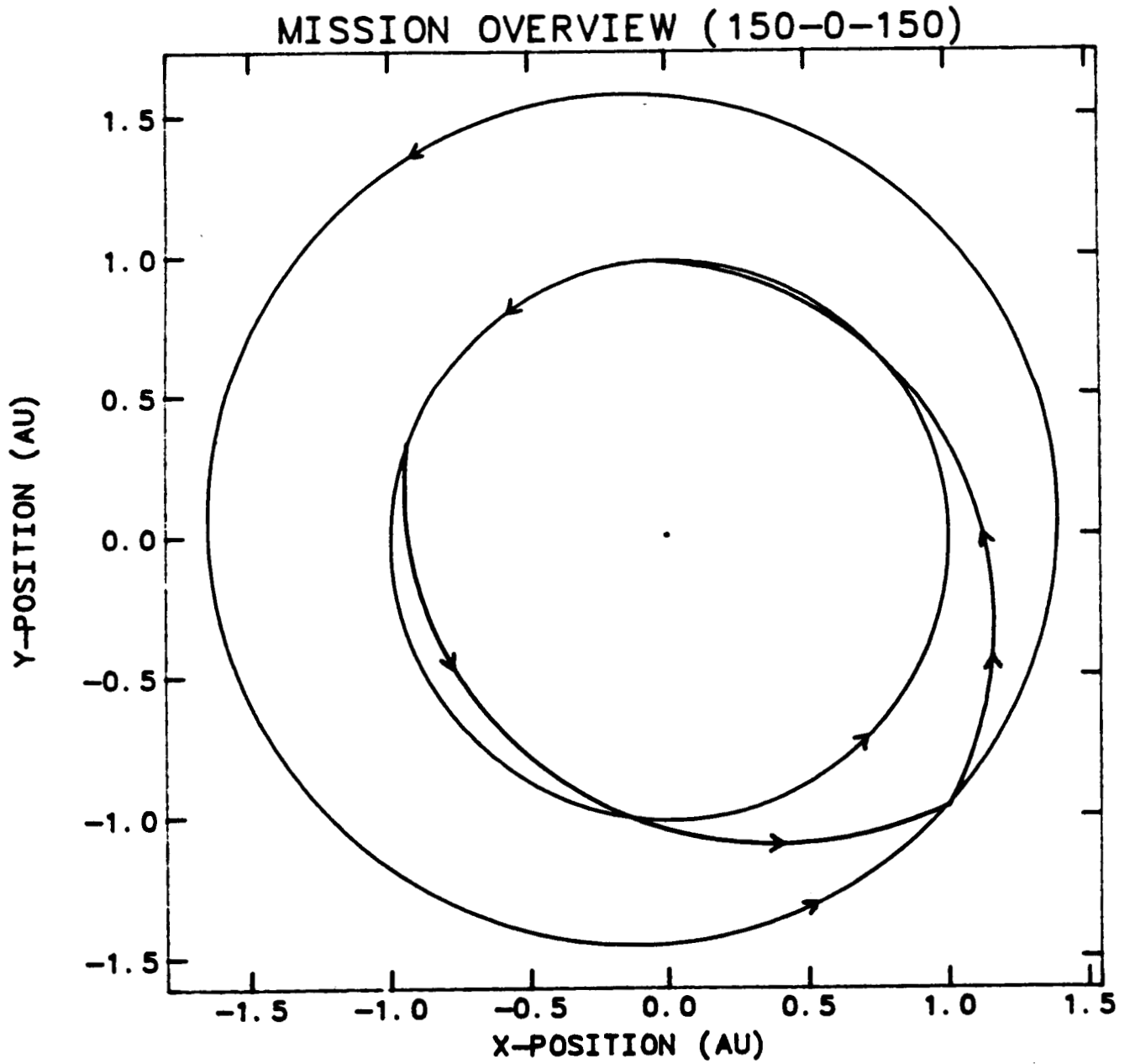

Table 2.3 Dates and ΔV 's for Departure Opportunities

<u>Date</u>	<u>Total ΔV(km/s)</u>	<u>$\Delta V1$</u>	<u>$\Delta V2$</u>	<u>$\Delta V3$</u>	<u>$\Delta V4$</u>
2/27/2003	26.6	6.2	7.8	7.2	5.4
2/28/2003	26.8	6.2	7.8	7.3	5.5
3/ 1/2003	26.9	6.2	7.7	7.4	5.6
3/ 2/2003	26.8	6.1	7.7	7.4	5.6
3/ 3/2003	26.9	6.1	7.6	7.5	5.7
3/ 4/2003	26.9	6.0	7.6	7.6	5.8
3/ 5/2003	27.0	6.0	7.5	7.6	5.8

Table 2.4 Heliocentric Transfer Parameters and Velocities for a 150 day - 40 day -150 day transfer

DEPARTURE FROM EARTH: 3/2/2003
 ARRIVAL AT MARS: 7/30/2003
 TRANSFER TIME= 150.0 DAYS

	EARTH POSITION KM	EARTH VELOCITY KM/S	MARS POSITION KM	MARS VELOCITY KM/S
X - COMPONENT:	-.14026E+09	-.10328E+02	.14975E+09	.17755E+02
Y - COMPONENT:	.49100E+08	-.28224E+02	-.14446E+09	.19529E+02
Z - COMPONENT:	.00000E+00	.00000E+00	.00000E+00	.00000E+00
MAGNITUDE:	.14861E+09	.30054E+02	.20807E+09	.26379E+02

SEMI-MAJOR AXIS OF TRANSFER ORBIT= .21480E+09 KM
 ECCENTRICITY OF TRANSFER ORBIT= .37042E+00
 SEMI-LATUS RECTUM OF TRANSFER ORBIT= .18533E+09 KM

	V_{∞} AT EARTH KM/S	V_{∞} AT MARS KM/S
X - COMPONENT:	-.40557E+01	.23365E+02
Y - COMPONENT:	-.33938E+02	.10579E+02
Z - COMPONENT:	.00000E+00	.00000E+00
MAGNITUDE:	.34180E+02	.25648E+02

	ΔV AT EARTH KM/S	ΔV AT MARS KM/S
MAGNITUDE:	.61147E+01	.76597E+01

Table 2.4 continued

DEPARTURE FROM MARS: 9/ 8/2003
 ARRIVAL AT EARTH: 2/ 5/2004
 TRANSFER TIME= 150.0 DAYS

	EARTH POSITION KM	EARTH VELOCITY KM/S	MARS POSITION KM	MARS VELOCITY KM/S
X - COMPONENT:	.19627E+09	.86797E+01	-.10494E+09	-.21468E+02
Y - COMPONENT:	-.66165E+08	.25027E+02	.10413E+09	-.21254E+02
Z - COMPONENT:	.00000E+00	.00000E+00	.00000E+00	.00000E+00
MAGNITUDE:	.20712E+09	.26489E+02	.14784E+09	.30209E+02

SEMI-MAJOR AXIS OF TRANSFER ORBIT= .21114E+09 KM
 ECCENTRICITY OF TRANSFER ORBIT= .35569E+00
 SEMI-LATUS RECTUM OF TRANSFER ORBIT= .18443E+09 KM

	V_{∞} AT EARTH KM/S	V_{∞} AT MARS KM/S
X - COMPONENT:	-.97152E+00	-.28435E+02
Y - COMPONENT:	.25534E+02	-.18928E+02
Z - COMPONENT:	.00000E+00	.00000E+00
MAGNITUDE:	.25553E+02	.34159E+02

	ΔV AT EARTH KM/S	ΔV AT MARS KM/S
MAGNITUDE:	.74216E+01	.56310E+01

3.0 Vehicle Systems

3.1 Propulsion Systems

Propulsion systems studied for the sprint mission included solar, nuclear electric, nuclear thermal, and chemical. The requirement for the propulsion system were to provide the required Δv needed to meet the mission time constraints. The mass of the payload (300 metric tons) used for the analysis included all systems other than the propulsion system. The time of flight set Δv constraints to a worst case senario of 27.6 km/s.

The solar powered propulsion system studied used a parabolic solar reflector to heat the propellant in a gas chamber prior to expulsion. Despite its high specific impulse, the system would require a complex support structure which would complicate the design of the mission. In additon, this type of system has not been tested on large manned spacecraft. For these reasons, solar power was disregarded as a possible propulsion system.

Ion propulsion systems using mercury, argon, and xenon were considered under nuclear electric propulsion. With specific impulses of 3000 to 5000 seconds trip times could be reduced to under 60 days. However, the high mass and experimental nature of ion propulsion systems were considered impractical for this mission.

Of the nuclear thermal propulsion systems studied, the most practical and promising system was the solid core reactor system. This system offered a high specific impulse and moderate thrust to weight ratio. However, since this system has not been fully tested to ensure its safety and reliability in space, it was decided that this system would not be used on this mission.

The propulsion system chosen for the mission was a liquid oxygen/liquid hydrogen propulsion system using 5 modified Space Shuttle Main Engines (SSMEs). This decision was based on information from the Science Application International Corporation (SAIC) report on hybrid propulsion systems and the Texas A&M University final report on a manned Mars mission (Friedlander and Texas A&M University). In these reports, dry mass to propellant ratios of around 1:4 were achieved. However, studies by MARCO using similar specific impulses for a one way trip with one burn at each planet yielded mass ratios on the order of

1:36. Due to the disparity in the SAIC and MARCO calculations, it is with reservation that this type of chemical propulsion system is recommended for the mission. All of the propellant mass calculation results presented in this report (Tables 3.1 and 3.6) were based on the SAIC information and are therefore subject to question. The mass calculations did take into account propellant boiloff, for which a 6% mass loss was accounted for. If the actual mass ratio can be lowered to 1:6 or better using propellants with higher specific impulses, then this type of chemical propulsion system may be considered practical. It is recommended that these calculations be rechecked before being used in future reports. Finally, MARCO recommends that the other propulsion systems briefly mentioned in this report, in particular the nuclear thermal system, be studied further for possible use on a sprint mission to Mars.

Table 3.1 shows Weight Distribution of the Propulsion System based on the SAIC data. This table was made on the assumption that the spacecraft will expend nearly all of its fuel on the trip to Mars and will refuel from the Mars orbiting cargo vehicle. Table 3.2 shows a comparison of Propulsion Systems Performance.

Table 3.1 Weight Distribution of the Propulsion System

Mass of Propellant	760,800.0 kg
Auxiliary Propellant	39,500.0 kg
Propellant Storage Tanks	75,500.0 kg
Main Engines	34,600.0 kg
Total	910,400.0 kg

System	Thrust F(lbf)	Specific Impulse Isp (sec)	Thrust/Weight Ratio, F/W	Typical Propellants	Mass of System	
Chemical	Liquid Solid	2 x 10 ⁶ 5 x 10 ⁶	400 - 480 260	100.0 200.0	Products of C, H, O, N, F, and Br.	890Mt N/A
Nuclear products	Heat Transfer	10 ⁶	1200	30.0	H ₂	570Mt
	Gas Cavity 500Mt	10 ⁶	3000	10.0	U, fission	
Electric	Thermo- 700Mt nuclear	10 ⁶	3000	0.1	Li	
	Thermal Ion	10 .1 - 10	2500 3000 - 5000	0.01 0.01	He, Li, H ₂ , and NH ₃ Ar, Xe, Hg	1000Mt 1000Mt
Solar	Heater	1	800	0.01	H ₂	900Mt

Table 3.2 Propulsion Systems Performance

3.2 Power Systems

The purpose of an onboard power system is to supply electrical power to the life support, communication, and computer systems on the spacecraft. The three types of power systems studied for use on a manned mission to Mars were solar, chemical, and nuclear. The predicted power requirement for the crew transfer vehicle without nuclear propulsion is around 200 kW. This value is based on estimates of the space station power requirements for a crew of 6 to 8 astronauts (Colston, p. 762). The results of the preliminary analysis of power generation systems will be presented in this section along with a discussion of a heat to electricity conversion system and a heat rejection system.

The two types of solar power systems studied were the photovoltaic and solar dynamic systems. Photovoltaic power systems convert solar energy directly into a voltage. The primary problems with photovoltaic systems are the size and mass of the solar panels required to provide enough power for a large manned spacecraft. The ratio of solar power received at Earth to that received at Mars is approximately 2.25 (University of Michigan, p. 98). Therefore, in order to produce 200 kW of power at Mars, the solar panels must produce 450 kW of power at Earth. Since the Skylab space station required 2400 square feet of solar cells to generate 7.5 kW of electrical power and since the power is directly dependent on the area, it can be seen that approximately 144000 square feet of solar cells would be required for this manned Mars mission. In addition to the large mass of a solar power system of this size, the solar panels used would be very flexible. Also, the chance of the solar panels being hit by micrometeorites, etc., increases as the size increases. These facts indicate that a solar photovoltaic system would not be suitable for the first manned Mars mission.

The second solar power system studied was the solar dynamic system. This system uses parabolic mirrors, called collectors, to concentrate solar energy to heat a fluid from which energy can be extracted using a heat to energy

converter operating on a thermodynamic cycle such as the Rankine or Brayton cycle. This system is more efficient than the photovoltaic system, however, solar dynamic systems are limited to 40 kW maximum power per collector (University of Michigan, p. 99). Therefore, at least 12 bulky collectors would be required to provide power for the mission. Another problem that affects solar dynamic as well as photovoltaic systems is the need to orient the spacecraft so the solar power collectors or cells face the Sun. Also, both solar photovoltaic and dynamic systems require some sort of backup power system to take over whenever the CTV is in shadow in its orbit about Mars. These problems affecting solar power systems indicate that they are impractical for use on this mission to Mars.

The two primary chemical systems studied were fuel cells and batteries. Fuel cells use hydrogen and oxygen as fuels to produce heat which is then converted to electrical energy. In addition to electrical energy, fuel cells produce water as a by-product of the reaction between the hydrogen and oxygen. This water can then be broken down into hydrogen and oxygen using a process known as electrolysis, which requires electricity to break the water down into hydrogen and oxygen. The main problems with fuel cells are their limited power output and lifetime. The fuel cells used on the Space Shuttle are limited to 12 kW maximum power per cell. On the Shuttle, three fuel cells are required to produce a continuous power output of 21 kW. These Shuttle fuel cells also require 1134 kg of hydrogen and oxygen to provide power for a seven day mission (Rockwell, pp. 263-270). Due to the amount of fuel required to run fuel cells for the one year long Mars mission, fuel cells were also deemed impractical for the mission.

The most promising battery type studied was the sodium-sulfur (Na-S) battery being developed primarily by the Air Force for use on military satellites. These batteries have an energy density that is 2 to 3 times higher than nickel-hydrogen (Ni-H) batteries. The new Na-S batteries have operating efficiencies between 85 and 90 percent compared to a 75 percent efficiency for

Ni-H and nickel-cadmium (Ni-Cad) batteries. The operating temperature of Na-S batteries, 620°K, is also lower than the operating temperature of most nuclear reactors which is around 1000°K (Dueber, pp. 21-23). The problems with these batteries are their limited power output (≈ 20 kW maximum), their high mass due to metal electrodes, and their limited lifetime (approximately 6 months) due to chemical breakdown of the electrolytes used in the batteries. Thus, the role of chemical power systems on a Mars mission will be limited to providing emergency power for minimal life support systems if the primary power source breaks down.

The main nuclear power system studied was the SP-100 nuclear reactor. This reactor is currently being developed for use on Strategic Defense Initiative (SDI) projects requiring high power output and relatively low mass. Figure 3.1 shows the predicted mass of the SP-100 reactor versus the output power. From the figure, it can be seen that a reactor capable of producing 200 kW of power will have a mass of about 6000 kg without shielding for the crew. The reactor with shielding for the crew has a mass of approximately 20000 kg (Carlson). Since these reactors will operate for 5 to 10 years, they can be used on several successive missions, thus increasing their effectiveness and reducing their net cost. The operating temperature of the SP-100 is around 1200°K and it will generate approximately 2 MW of thermal energy that will need to be radiated (Mondt). Due to its long lifetime and high output power, the SP-100 is recommended as the primary power source for the mission. Figure 3.2 shows the decision table used to evaluate the power systems. The most important difference between the systems was the specific power, which was given a weight factor of 5 since it was the most important criteria and since it also determines the final system weight and cost.

The SP-100 power system discussed requires a heat to electricity converter and a heat rejection system. One of the most efficient conversion systems studied for use primarily with nuclear power systems is the Alkali Metal Thermoelectric Converter (AMTEC). This converter is capable of producing

between 1 kW and 1 MW of electrical power with an operating efficiency of 20 to 40 percent. The AMTEC system accepts heat at 900 K to 1300 K and rejects heat at 400 K to 800 K. This system uses the conducting properties of the sodium ion of a beta-alumina solid electrolyte (BASE). The Jet Propulsion Laboratory (JPL) is currently working on the development of this conversion system due to its potentially light weight, reliability, simplicity, and modularity (Bankston, pp. 715-719).

The most promising heat rejection system studied was the Rotating Bubble Membrane Radiator (RBMR) shown in Figure 3.3. The radiating surface, or thin film membrane, can be made of epoxy-carbon, zirconium and titanium alloys, or niobium-tungsten composites, depending on the chosen operating temperature of the radiator system. This heat rejector is able to radiate approximately 1 MW of heat using a sphere radius of about 7 feet. The total mass of the RBMR system, including support boom, is around 1100 kg (Webb, pp. 826-828).

Thus, the final power system decided upon is the SP-100 nuclear reactor, AMTEC heat to electricity conversion system, and two rotating bubble membrane radiators for heat rejection.

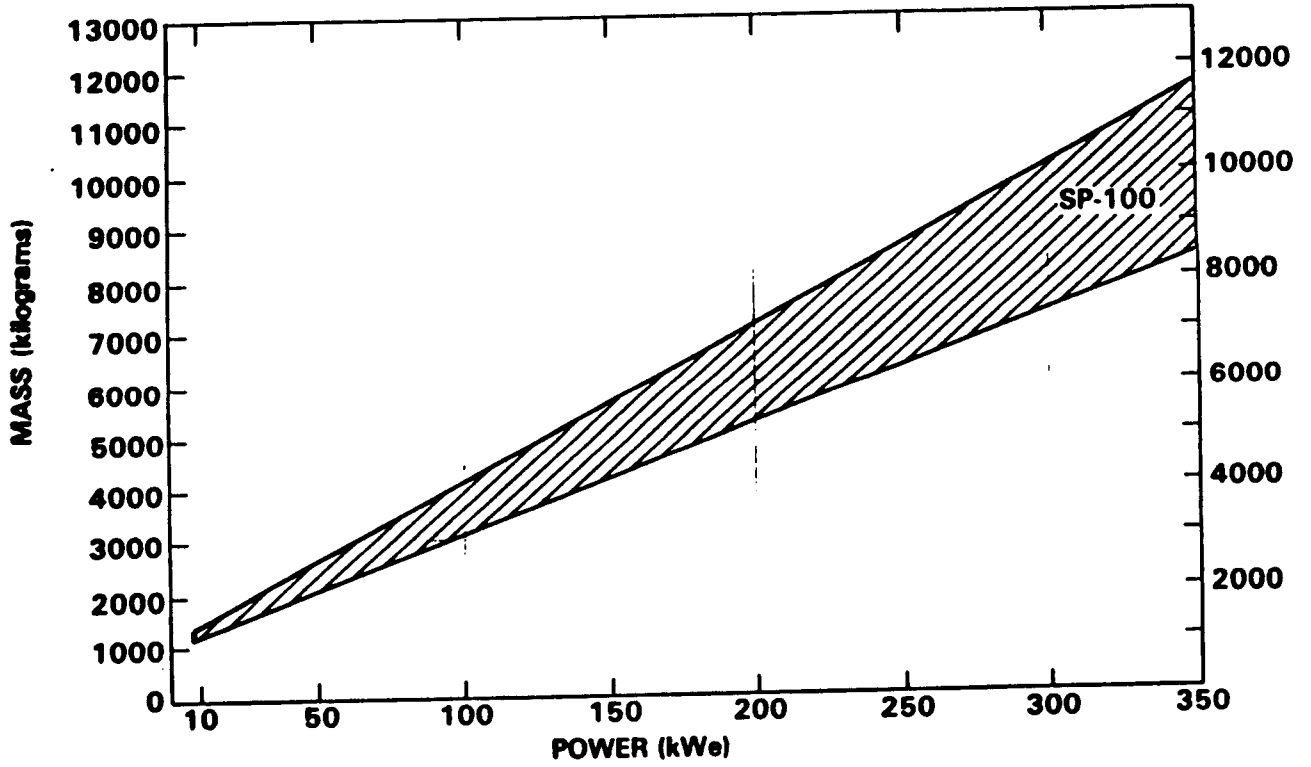

Figure 3.1 SP-100 mass and power (Mondt)

POWER SYSTEM DECISION TABLE

CRITERIA	Solar		Chemical		Nuclear
	Photovoltaic	Solar Dynamic	RFC	Batteries	SP-100
Specific Power (power out/ mass) [x5]	3 (x5)	4 (x5)	2 (x5)	1 (x5)	5 (x5)
Efficiency	1	2	3	2	5
Safety	5	4	3	3	2
Operating Temperature	5	3	2	2	1
Technology Availability	5	5	5	5	5
Operating Lifetime	3	3	1	1	5
TOTALS	34	37	24	18	43

NOTE: All systems are rated on a scale from 5 (best) to 1 (worst).

Thus, highest total indicates the best system.

RFC = Regenerative Fuel Cell

Figure 3.2 Power system decision table.

Figure 3.3 Boom mounted rotating bubble membrane radiator (Webb, p.825)

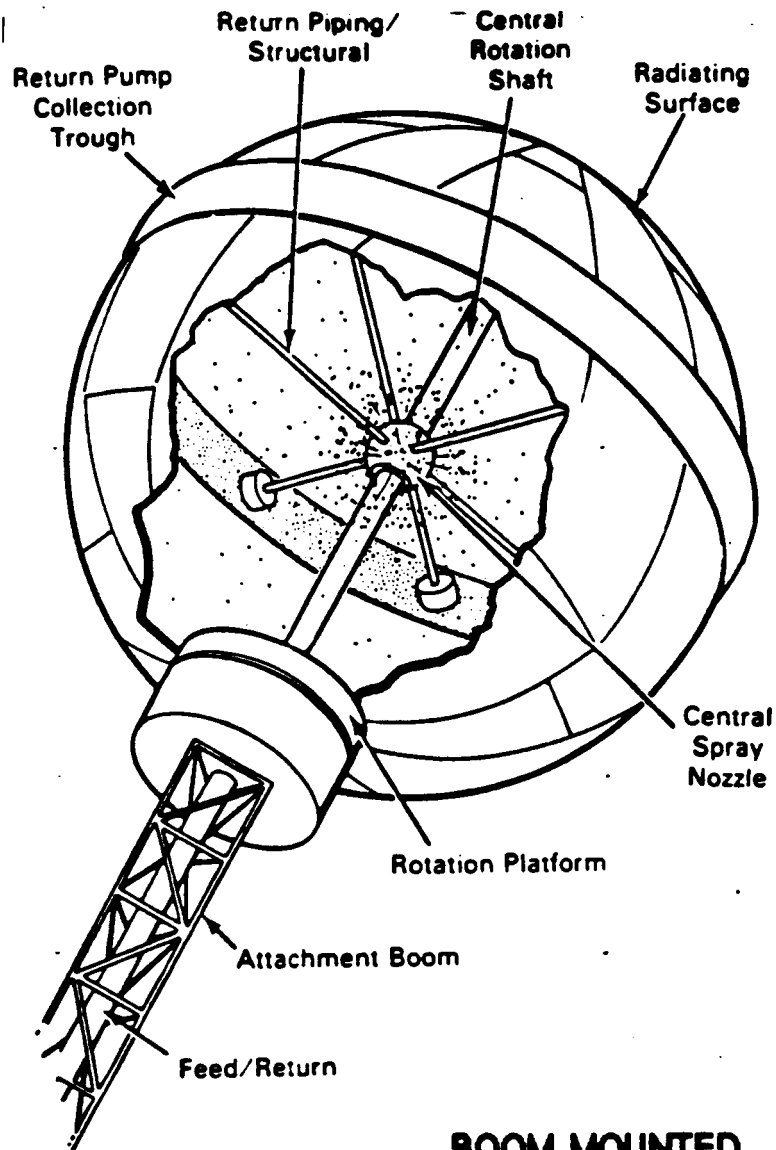

**BOOM MOUNTED
ROTATING BUBBLE MEMBRANE RADIATOR**

TYPICAL CHARACTERISTICS:

THERMAL POWER TO RADIATE = 1.01 MW_t
RADIUS OF RADIATOR = 7 feet
MASS OF RADIATOR = 90 - 140 kg

3.3 Aerocapture

Aerocapture involves decelerating a space vehicle through the use of atmospheric braking to capture a spacecraft at a planet with a suitable atmosphere. The most important possible benefit of aerocapture is a reduction in the propellant mass required to complete the mission. This would occur if the mass of the aeroshield required for aerobraking is less than the mass of fuel required to produce the same velocity change. Although this appears to be an important advantage, it is offset by the numerous problems posed by aerobraking.

One of the problems associated with aerobraking is the size of the shield required to protect the ship during the aerobraking maneuver. The size of the aeroshield required depends on the size of the vehicle and the heating rate encountered during atmospheric entry. A Martin Marietta study concluded that a typical ship with a mass of about 200 MT would require an aeroshield with a diameter of approximately 43 m and a mass of about 9 MT (Martin Marietta, p.55).

Another problem that must be solved in order to make aerocapture effective is the management of heat produced when the shield passes through the planet's atmosphere at very high speeds. Predicted heating rates vary from 230 kilowatts per square meter to 5.11 megawatts per square meter (Comer, pp. 756-758). These high heating rates will require the use of ablative materials that are generally very heavy. This fact, coupled with the size problem, may make the aeroshield too heavy to be practical for a manned Mars mission designed with a technology baseline of 1995.

A few of the other problems with aerocapture include the disastrous consequences of the breakup of a nuclear propelled/powered vehicle over the surface of Mars and the need to fly low through the thin Martian atmosphere to produce enough of a velocity change to put the craft in orbit around Mars. In addition, the vehicle will require a very complex guidance and reaction control system to maintain the proper yaw, pitch, and roll during atmospheric entry.

Finally, the most important problem with aerocapture is whether the crew can withstand the high g-loads placed on the ship during aerobraking maneuvers. A crew in perfect shape (i.e., not experiencing health problems caused by zero-g) would be able to tolerate 2.5 to 5 g's for about 1 minute, depending on the orientation of their bodies relative to the direction of deceleration (Hanrahan, p.77). However, since there will not be a gravity field on the spacecraft, the crew's tolerance of g-loads will be much lower. One way to overcome this problem is to use propulsive braking to slow the craft down before aerocapture is attempted. However, this option still requires the use of an aeroshield which must be carried to and from Mars if aerocapture at Earth is to be attempted.

The second method of overcoming the crew's inability to tolerate high g-loads during aerobraking is to submerge the crew in a fluid, with a specific gravity equal to that of the human body, while they wear scuba gear. While submerged, any acceleration forces applied to the crew are offset by equal but opposite buoyant forces, thus leaving the crew in a weightless state. This technique was studied by the U.S. Navy during the 1950's. Using this method of countering high g-forces, humans were able to withstand 12 to 13 g's for periods of 4 minutes before beginning to feel serious discomfort. The discomfort was caused by pressure exerted on organs with densities different than the surrounding organs. The lungs and air passages were the primary organs affected by this problem. One problem with the submersion of the crew during aerocapture is the weight of the fluid required to submerge the six man crew. In addition, proper air mixtures for the scuba equipment must be determined to prevent the onset of caisson disease (also known as the "bends" to divers) during aerocapture (Hanrahan, pp. 95-105). The onset of caisson disease is caused by the extreme hydraulic pressure of the fluid during deceleration of the vehicle. Due to this high pressure, a special module would have to be constructed to contain the fluid and astronauts during aerocapture.

At this time, the problems imposed by aerobraking outweigh its possible

advantage. Therefore, the use of aerocapture on this first manned Mars mission is not recommended. However, it is recommended that further studies be carried out on the subjects of new lightweight ablative materials and the use of crew submersion to overcome the effects of high decelerations during aerocapture maneuvers. Future developments in these areas could make the use of aerocapture viable for later manned Mars missions.

3.4 Human Factors

Human factors has been described as "Those facts of mission planning which affect the physiological and psychological condition of the...crew members" (French, p. 342). In this report, the term "human factors" covers a wide range of systems and considerations for the crew, including, but not limited to, environmental control/ life support systems (ECLSS) and consumables, thermal protection and control, module design, extra-vehicular activity (EVA), health maintenance, crew activities, and psychology of an extended mission.

All of these considerations will apply to any of the three conceptual designs; however, the amount and mass of the consumables is dependant on the time of flight necessary for the entire trip.

3.4.1 Crew Complement

Several sources have suggested sending an odd number of crew members on this voyage. "Experience has shown that even numbers of people under stress tend more often to split into two equal and opposing camps, unable to reach a democratic solution to urgent mission decisions;" seven is a number that has been most often mentioned (Oberg, p. 79; Stoker, p. 36). The command structure must be rigid yet flexible, with one person in ultimate charge aboard the craft. However, questions arise as to whether decisions should be made by ground controllers (centralized) or on board (decentralized). "One common proposal is that mission-related decisions should be made autocratically whereas decisions regarding communal life should be made democratically" (Harrison , p. 649). It should be noted that this is a critical but unsolved problem area.

This report will not discuss the gender makeup of the crew, with the exception that if there is to be a mixed crew, there should not be only one female crewmember aboard.

Crewmembers should be chosen based on areas of skills and specialization.

Among the necessary skills will be doctor, mechanic, geologist, pilot, psychologist, scientist, and systems specialist. Cross-training of the crew will be mandatory in the event one crew member becomes incapacitated.

3.4.2 Environmental Control/ Life Support Systems (ECLSS)

The life support systems generally provide food, potable water, a habitable atmosphere, waste management, and hygiene for the crew. A "partially closed" life support system will be implemented on the final ship design. This means that the air and water will be recycled, but not the solid food. Current technology can support a virtually complete recycling of the air and water aboard the ship, but it is infeasible to either grow the food needed or recycle human and ship wastes enough to support a complete recycling of food. Figure 3.4 shows a partially closed life support system loop.

"In general, the mass of stored food increases as a linear function of crew size and mission length" (Rambaut, p. 113). The point at which it becomes more economical to produce some food on board rather than carry all of it depends on the mass and efficiency of the on-board food production system. The growing time for some edible plants is about equal to the time spent on the entire mission, about one year, although certain vegetables have shorter growing times. However, both the volume of growing area and the amount that needs to be grown to feed a crew of at least six would be prohibitive, making the closed-loop food system not workable. therefore all food needed for the trip will be carried frozen, to be heated in a microwave oven; rehydratable, needing only water; or stored dry in boxes or cans. Human wastes may be processed and stored for possible use as fertilizer on a base on the surface of Mars. Figures 3.5-3.10 show open versus closed loop performance parameters.

ECLSS functions such as air revitalization, CO₂ reduction, O₂ generation, N₂ generation, trace contaminant control, water reclamation, and solid waste management will be provided with current or soon-to-be-developed technology

for the Space Shuttle or the Space Station. Atmospheric pressure should be kept between 12.0 and 14.7 psia, near Earth normal. Gas content would be simplified to consist of 20% oxygen and 80% nitrogen, and humidity kept to about 20% so as not to interfere with mechanical systems.

Figure 3.11 shows the life support systems scaling equations.

3.4.3 Module Design

Thermal control is concerned with maintaining an adequate temperature range for the personnel and equipment on board and will be achieved by means of circulating a working fluid through the area to be controlled. In the habitation areas this fluid will be air. For equipment that generates large amounts of excess heat, such as power generators and computers, the working fluid will be a liquid.

Boeing's current (Spring 1988) version of the Space Station Common Modules (SSCM) are being used as a baseline for designing the Laboratory and Habitation Modules, known as the Lab and Hab modules. Full-size mockups are on display at the Johnson Space Center in Houston, Texas. These modules, or the final design which is actually implemented on the Space Station, will have the advantage of being essentially "off-the-shelf" technology by the time a Mars mission is considered. Most spacecraft subsystems will be assumed to be of the Space Station type for sizing and costing purposes.

Figure 3.12 shows an artist's conception of the modules and the connecting nodes. Each module has a length of 47 feet and diameter of 14 feet. The Hab module has four sleeping compartments, one bathroom/shower facility, storage areas, a kitchen and galley, and experiment sections. Since there will be at least six astronauts, two Hab modules will be needed; duplicated systems can be either kept as redundant backups or converted to another use. The interconnecting nodes are cylindrical, 17.66 feet long and 14.5 feet in diameter, as shown in Figure 3.13. As originally designed for the Space Station, these nodes will have six airlock adaptations, and any not in use for

joining nodes or modules may have airlock attachments. Two cupolas will be on these nodes for observation of extra-vehicular activities.

The Lab modules contain most of the scientific experiments and hardware, including the ECLSS subsystems. Furthermore, one Lab module may be partially or wholly converted to either a mockup of the Mars Lander controls or other systems for training on the way to Mars, or as a recreation area. Two Lab and two Hab modules are expected to be used, with four nodes to connect them and the command module which houses the computers and logistics as well as the safe haven. At least two separately pressurizable habitation modules will be in use as a safety consideration, in the event one module were to become uninhabitable during the mission.

3.4.4 Extra-Vehicular Activity

EVA will be carried out in spacesuits based on those currently in use by NASA. Each crew member should have access to one spacesuit, with one or two spares for the entire crew. Manned Maneuvering Units, or MMUs, will be provided in storage for use in EVA. Airlocks will be on board the ship for use in docking and/or exit to the outside environment. If the current SSCM systems are used, there may be at least one airlock per interconnecting node, up to a total of four airlocks, although the final design presented here only provides two. Radiation suits will also be available for journey into the ship during a solar radiation event or to work on the nuclear reactor.

3.4.5 Health

Since the mission will last up to a year, the crew will only be in audio/video contact with Mission Control for that period, and so the ship will need to carry more than just a year's worth of medicine. A Health Maintenance Facility (HMF) such as those designed for the Space Station will be used. The HMF will store drugs and instrumentation for diagnosing and treating all medical problems commonly encountered on Earth and meet

unusual emergencies as well that would normally require transport back to Earth, such as surgery. Space sickness, or Space Adaptation Syndrome, is not a concern, since all astronauts who do experience this illness recover within the first week of flight. At least two physician must be included in the crew.

Some studies have shown that it is the longitudinal force on the bones that keeps them strong, and certain exercise facilities may be able to provide this, such as a trampoline or treadmill with bungee cords such as used on Skylab and the Space Shuttle. The correct combination of exercise, diet, and drugs may be able to offset bone demineralization, and a reduced workload during the first week or so on the surface of Mars could ease the sudden transition from microgravity to 0.38-g. It should be stressed, however, that the effect of a gravity field of less than 1-g is a largely undocumented process. Table 3.2 shows a list of the exercise facilities, as well as their masses and volumes, that are currently planned for the Space Station astronauts. These devices can be stored inside locker storage areas.

A great deal more man-hours in space will be needed aboard the Space Station to obtain more knowledge of long-duration operations in microgravity.

3.4.6 Activities

Mission simulations and planning will take up a large block of the astronauts' time, but the crew will find itself with free time between duties and sleeping. With about a 150 day one-way trip, this time would be useful and invaluable for astronomical observations of all sorts, including X-ray, gamma ray, infrared, visual, etc. Other blocks of time may be used on scientific endeavors, such as long-duration exposure experiments and medical studies. Free time must be provided for, such as designing a familiar five day work week with two weekend days.

Some repetitious tasks may be able to be automated, but with a technology baseline of mid-1990's, it seems improbable that many tasks could be undertaken by robots.

3.4.7 Psychology

The crew must not be allowed to be too overworked or stressed, as the mission depends on the mental and physical well-being of the astronauts. Special considerations must be made for the privacy and crowding of the crew. Areas should be designated for solitary and communal use, possibly with movable panels or furniture for a change in environment. Maximum visual access to the outside must be provided through the use of windows to reduce the possibility of claustrophobia or "cabin fever." The most-often cited activities for astronauts in space are viewing through windows, physical exercise, listening to tapes, and reading books, so design and crew planning should take into account these types of routines (Petrov, p. 181).

However, much still needs to be studied in the area of long-term isolation and group dynamics in order to complete a successful manned Mars mission.

Figure 3.4 Partially closed life support system loop (Modell, p. 136).

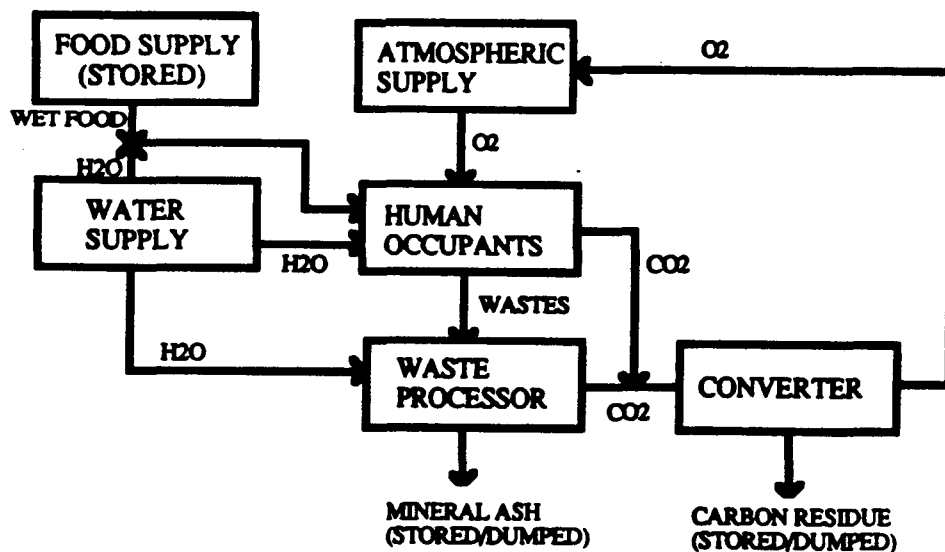

	EXPENDABLES lb/d	TANKAGE/PACKAGING lb/d
O ₂ (b)	17.3	17.3
N ₂	9.8	9.8
LiOH/CO ₂ REMOVAL)	23.8	11.9
WATER	83.3 - 170	18.6 - 38.1
FOOD	10.9	5.6
SUBTOTAL	145.1 - 231.8	62.1 - 82.6
		TOTAL 208.2 - 314.4 lb/d

(b) CREW SIZE = EIGHT
(b) INCLUDES LEAKAGE

Figure 3.5 Open loop requirements for a crew size of eight (Carlisle, p. 267)

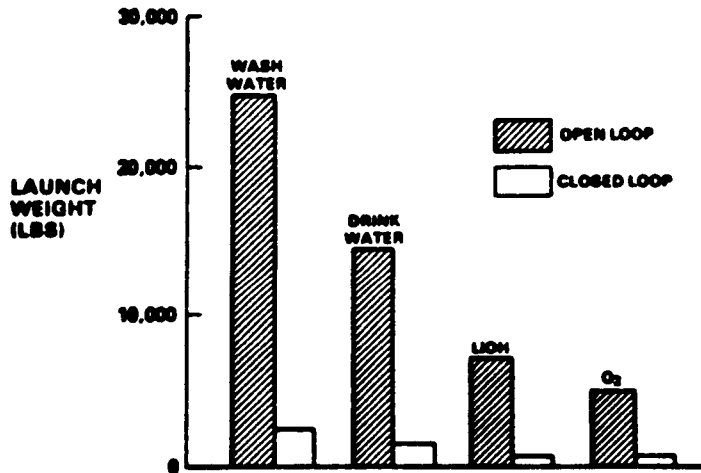

Figure 3.7 Closed versus open loop ECLSS (Carlisle, p. 267)

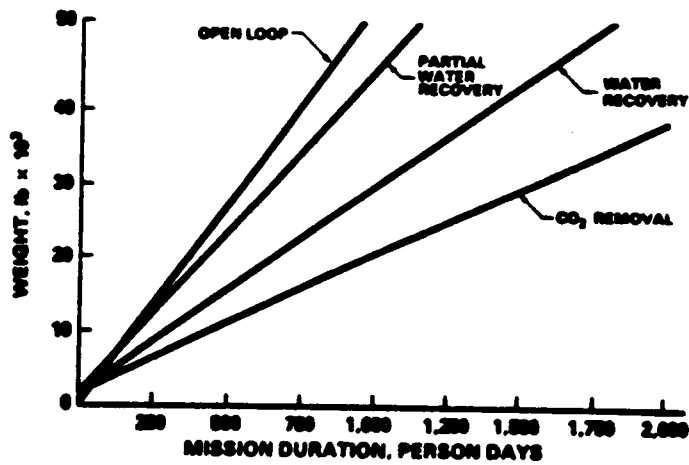

Figure 3.6 Open versus closed life support (Carlisle, p. 267)

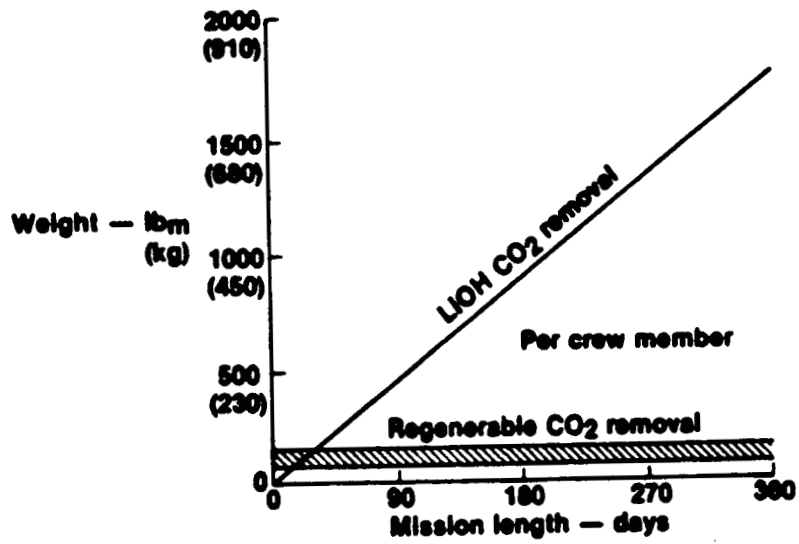

Figure 3.8 Regenerable CO2 removal benefit (Brose, p. 288)

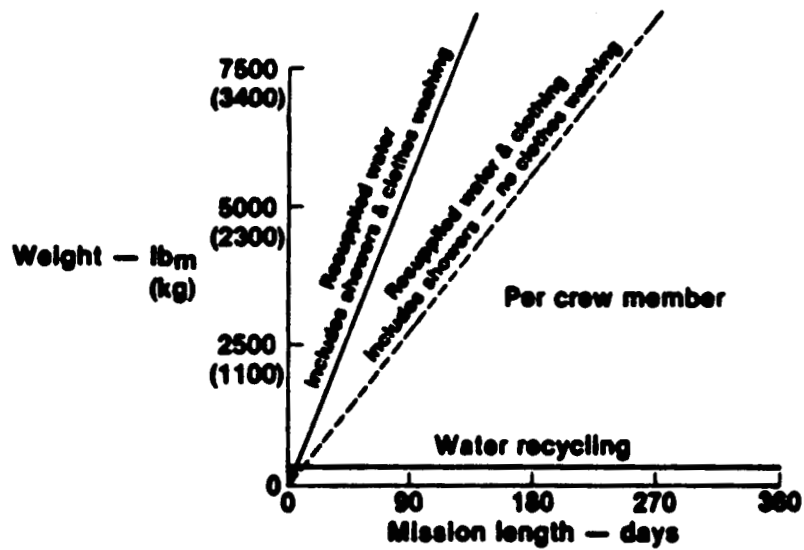

Figure 3.9 Water recycling benefit (Brose, p. 288)

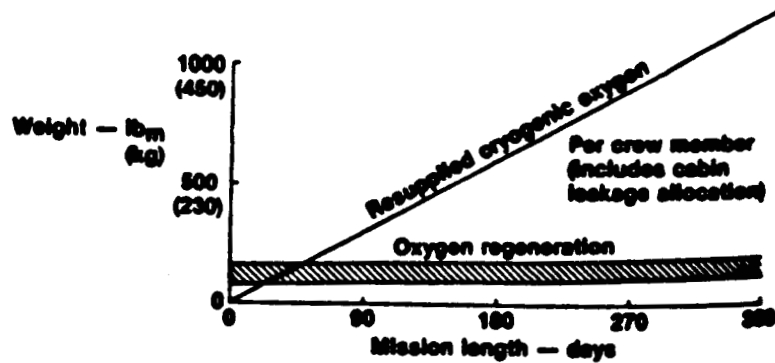

Figure 3.10 Oxygen regeneration benefit (Brose, p. 288)

	Weight (lb)	Volume (ft ³)	Power (watts)
Food Management, e.g., Preparation Colinary supplies Storage	50 +25/M +.05/D +1.64/M-D	52 +.5/M +.2/M-D	200 +10/M
Water recovery 2-stage recovery	80 +80/M	2 +1.5/M	50 +100/M
Waste Management, e.g., Toilet room Feces and Urine Collection Wash waste Personal hygiene	72 +13.5/M +.15/D +.10/M-D	56 +1/M +.015/D +.01/M-D	85
Temp./humidity control Heat exchanger Heating coils Fans Ducting Condensed water handling	225 +54.5/M	20 +2.5/M	25 +40/M
Atmosphere purification and supply CO ₂ collection Catalytic burner Bosch CO ₂ reduct.	100 +110/M +.15/M-D	4 +.5/M +.01/D	300 +250/M
Instruments/ Controls	150	4	200
Leakage/Pressurization	4/D		
TOTALS	677 +283/M +4.20/D +1.89/M-D	138 +6/M +0.025/D +0.21/M-D	860 +400/M

note: M=Man, D=Day
M-D=Man-Day

(Repic, p. 4-33)

Figure 3.11 Life Support System scaling equations.

ORIGINAL PAGE IS
OF POOR QUALITY

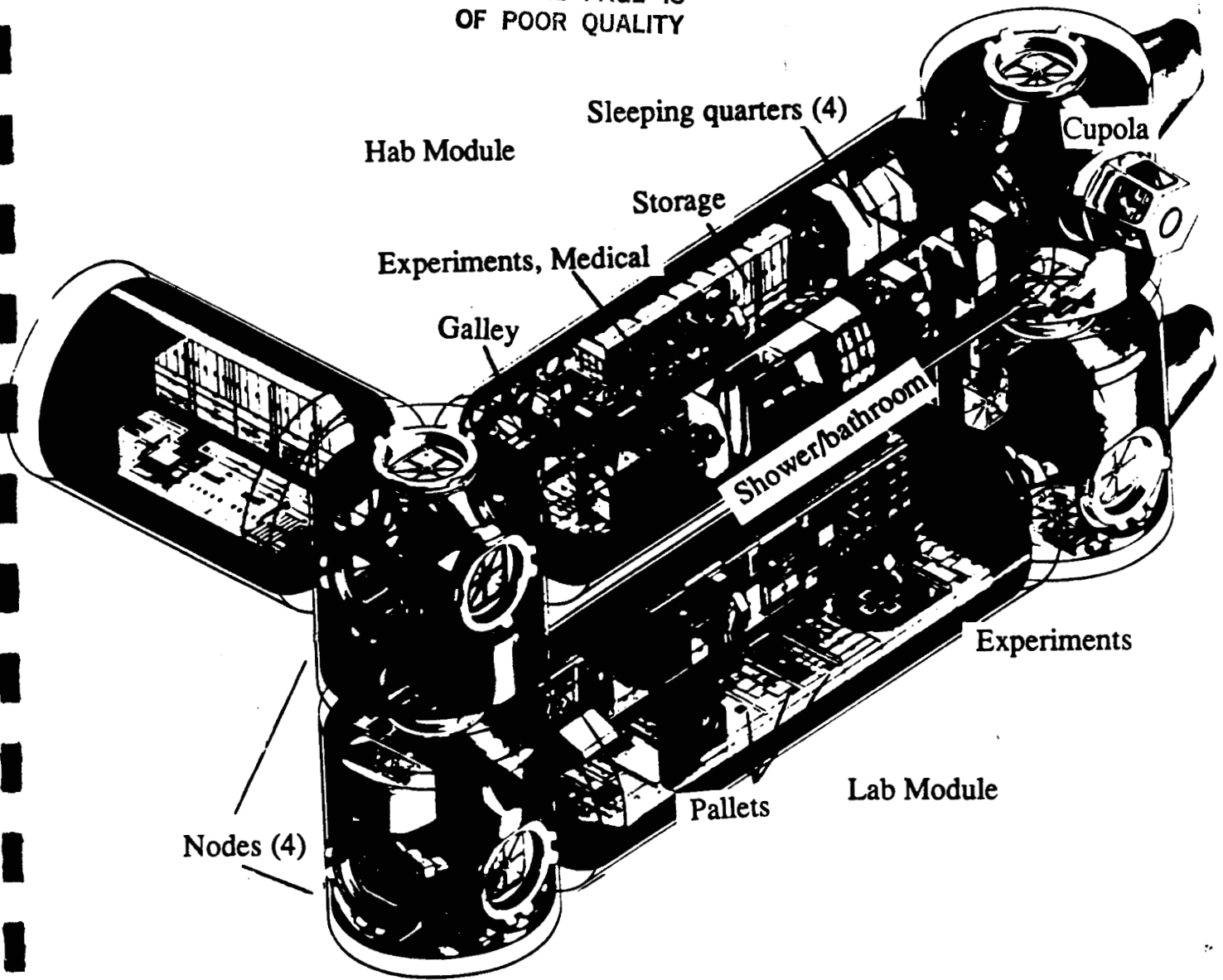

Figure 3.12 Boeing's current concept of the space station's common modules
(Grey, p. 24)

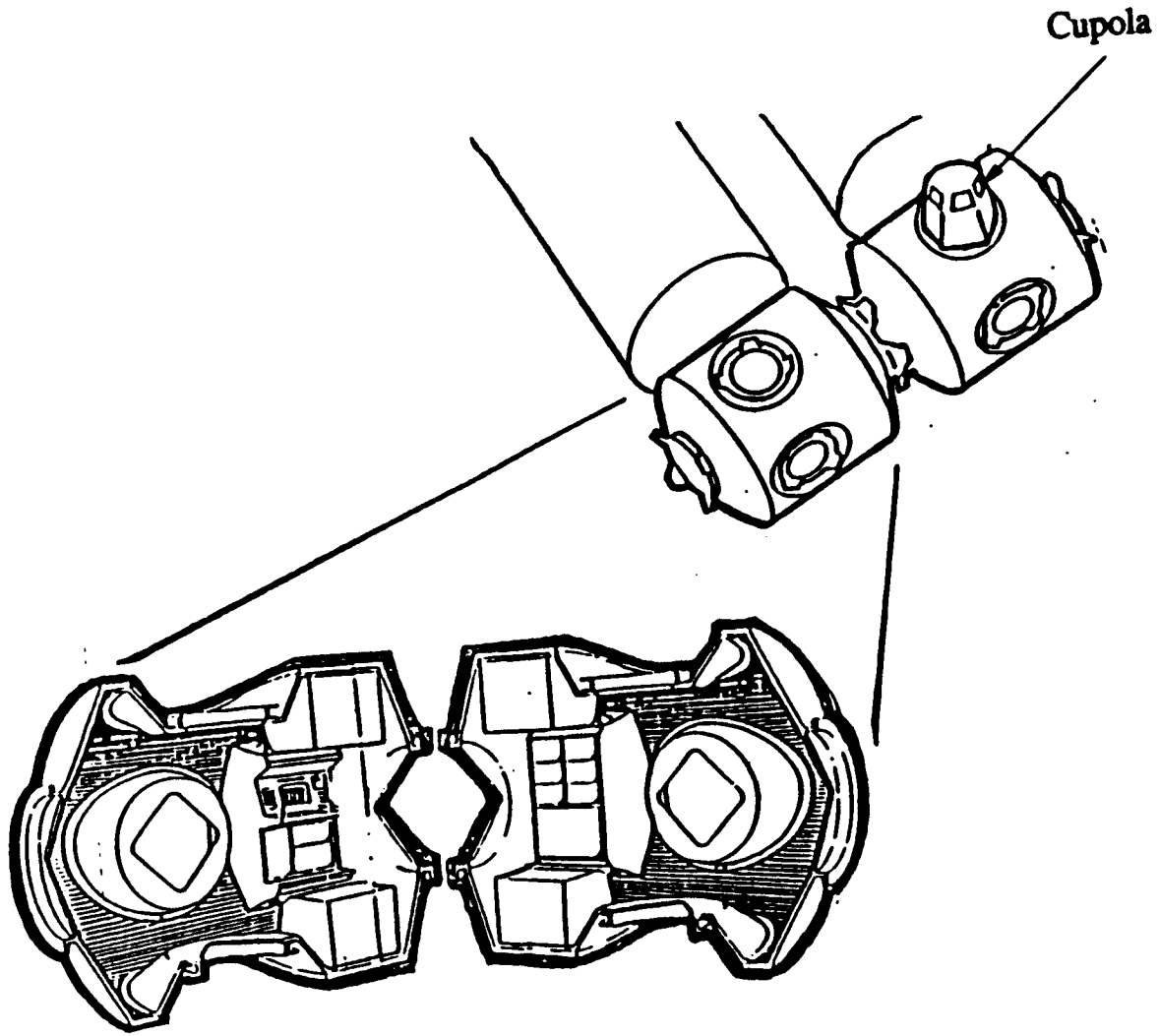

Figure 3.13 Connecting nodes.

(CETF, p. 46)

Table 3.3. Hardware dedicated to the exercise countermeasures facility

<u>#</u>	<u>device</u>	<u>volume (cu. ft.)</u>	<u>weight (lbs.)</u>
1	Treadmill	20	150
2	Bike/Rower	24	75
3	Resistive Exercise	6	60
4	ECG Monitor	3	20
5	Blood Pressure	2	20
6	Metabolic Gas	3	25
7	Mass Measurement	46	80
8	Bioimpedance Analyzer	2	5
9	Graphics Display	3	20
		-----	-----
	TOTAL	109	455

(Hayes, 1988)

3.5 Artificial Gravity

This project will be considering a total trip duration time for the crew of approximately one year as a baseline. This includes a trip time of 150 days each way, and a stay time of 40 days on and around the surface of Mars.

The Soviets currently have a rudimentary space station, Mir, which is comparable to the proposed Industrial Space Facility (ISF) in size and function: Mir is essentially a man-tended ISF. The Soviet station is much smaller than the proposed American Space Station of the late 1990's.

Eight Soviet cosmonauts have endured microgravity for a period of longer than 180 days, one for almost a full year, as compared with the American record of three astronauts spending only 84 days on Skylab. However, the Soviets either have not recorded significant data or have been reluctant to share what they have. The information that has been exchanged has contained some, but not much, meaningful physiological data (Charles, 1988). Experiments on the crew of Salyut-7, in orbit from Feb. 8 to Oct. 2, 1984, showed that although erratic changes in body mass occurred to the cosmonauts in the first 100 days, the measurements did seem to level off at about 95% of original body mass until the end of the mission after 237 days. Preventative measures included wearing a weighted suit, daily exercises, forced circulatory system work with "vacuum trousers," and increased consumption of water (Feoktistov, p.97).

The physiological data recorded aboard Skylab, while for shorter periods than that of the Soviets, is nevertheless more extensive and complete. After the 59-day Skylab 3 mission, for example, it was found that the astronauts' physical reactions stabilized by day 39 of the mission, and readaptation time was much faster than that of the 28-day Skylab 2 astronauts. Doctors attributed this to daily rigorous exercise (NASA Mission Report, p.5).

Present studies suggest that bone demineralization and body systems losses reach a plateau of finite but minimal degradation, and that there is not much difference between a mission of 90 days and one of 180 days (Charles, 1988). Therefore data from Skylab has been utilized in this section. However, it

should be stressed that the analysis of long-term exposure to microgravity on humans is far from complete. Many more man-hours in space are needed to more fully understand these effects; the Space Station will provide this facility.

Additionally, the effects of exposure to a gravity field between zero-g and 1-g are almost totally unknown. Only the astronauts who walked on the moon have had actual experience, although it may be possible to simulate a partial-g environment in a buoyancy tank.

Although there are many advantages and disadvantages to providing artificial gravity (from about 1/6 to 1-g), it was felt that the negative aspects of providing the gravity outweighed the positive ones.

Artificial gravity will be necessary for periods of prolonged weightlessness, chiefly to retard bone demineralization and to decrease time required for exercise. Pseudo-gravity would also facilitate adaptation to Martian gravity (0.38-g) or allow for a gradual change from Earth to Mars gravity. Other factors in favor of providing gravity include conventionality in hygiene and health maintenance, and ease of some mechanical systems.

Primary among the disadvantages are human and mechanical systems considerations. Coriolis forces caused by the rotating structure will produce disorientation and unknown effects due to gravity gradients across the human body. Physiological constraints limit the rotation rate of a spinning structure to a maximum of 4 RPM; thus the spinning boom with the spacecraft modules on the end must have a radius of rotation of about 200 feet in order to provide 1-g acceleration. This is considered too cumbersome. Life support in the tunnels connecting the modules and a hub will be difficult due to the gravity gradients in the tubes. Safety hazards of employing a spinning mechanism, such as nutation, wobbling, and metal fatigue due to the rotating force, must also be considered. Mass penalties will be incurred in providing spinup/spindown mechanisms, transportation elevators between modules, telescoping equipment for retractable booms, and locking and structural restraints. A spinning structure is difficult to adequately shield from solar and cosmic radiation, and

any benefits of micro-g are negated except at the hub. Additionally, a communications module must be despun from the spinning portion to point successfully and continually towards Earth (Martin Marietta, p. 60-61).

Counter-rotating parts might be an answer, but will probably add too much complexity to the ship and to the mission.

It was felt that, with the Space Station assumed to be in orbit by the time a Mars mission is undertaken, astronauts will have had experience in prolonged weightlessness. Since the Soviets have already had cosmonauts in orbit for periods longer than MARCO's proposed one-way transfer time, they have shown that the human body is indeed capable of sustaining mission times of many months.

At least two of the crew members may remain in Mars orbit aboard the ship and/or the Barge while others descend to the surface. This means that any who do remain will be spending the entire mission in zero-g. A reduced workload upon the surface of Mars for the first several weeks is also recommended to allow a gradual adaptation to 0.38-g work levels from zero-g.

3.6 Shielding

This report studies both radiation and particle shielding for the fast crew transfer vehicle to Mars.

There are two different types of limits to the amount of ionizing radiation the human body can withstand, total dosage and dosage rate. It can be seen from the limits shown in Table 3.4 that for various organs, the absolute limits for mission design are governed by those of the bone marrow (Hall, p. 686). The radiation that a crew is exposed to on an interplanetary mission comes from three sources: the Van Allen belts, cosmic radiation, and solar flares. Each of these sources have their own characteristics and will impact the design of the CTV in different ways.

The Van Allen belts are two overlapping belts of trapped atomic particles, the inner belt composed of protons and the outer one of electrons. The Apollo missions passed directly through these belts, incurring an average mean dosage of less than 1.14 rads. It is assumed that shielding adequate for protection against solar flares will also be adequate for shielding through the belts.

Cosmic radiation is made up chiefly of high energy (10^3 to 10^7 MeV) protons (85%) along with some heavier nuclei like helium and iron (15%). It is impractical to shield against this radiation as shown graphically in Figure 3.14. It would require 1300 metric tons of the lowest density shielding material to protect the occupants of a common module against the lowest energy (10^3 MeV) particles. However, since the dose rate is 0.165 to 0.265 rems/day, borderline for the bone marrow dose limit, and the yearly dose is approximately 56 to 90 rems (Hall, p. 696), it was felt that no shielding against cosmic radiation should be provided unless some sort of active radiation shield becomes available.

Solar flares produce extremely high discharges of high energy protons (HEP) over a period of a few hours, and the same region may produce many subsequent flares. During the maximum solar activity in what is known as Cycle 19, more than half the predicted 2781 rems in a two-year period occurred during a single week (Hall, p. 686). Since stations on the Earth may

not be able to observe the solar longitudes of these events, equipment is necessary for the accurate prediction of a solar event by the crew of the CTV. An x-ray imaging telescope, a hydrogen-alpha chromospheric scanner and a solar magnetograph have been recommended for inclusion in the baseline configuration for event predictions (Heckman, p. 674). With this equipment, a 95% accurate forecast 23-30 minutes before an event can be achieved. With a 1-10 day forecast period, an event cannot be as accurately predicted, but a higher alert condition can be decided upon. Because of the relatively short duration of these flares compared to the length of the mission, they will be treated as special events so that the impact on mission design will be reduced.

The meteor environment of interplanetary space is described by a model created by the Space Division Flight Science Department of North American Rockwell Corporation and is presented in Table 3.4. The meteoroid particles can be divided into two classes, cometary and asteroidal.

Cometary particles tend to be omnidirectional and of low density (0.5 g/cm^3) as compared to asteroidal particles. Asteroidal particles have direct, circular orbits with average inclinations of 9° and are more plentiful and denser (3.5 g/cm^3) than cometary particles. The overall shielding of the ship need account only for the cometary particles in general. Heavier shielding along the line of flight should be sufficient to take care of the larger asteroidal strikes. Analytic methods developed in the Rockwell report were used to determine the thickness required for the shielding.

The crew habitation, laboratory, command, and other modules used by the crew will be designed after those proposed for the Space Station to reduce developmental costs and increase modularity of design. Costs due to shielding against radiation can also be reduced by considering the additional shielding mass supplied by internal structures and equipment. Fuel tanks and reactor shields for nuclear propulsion should also be considered in reducing shielding mass in certain areas.

The required thickness of material for shielding is based on not only

desired stopping energy and material qualities, but also on shield shape. Aluminum is not optimal as a shielding material; for the enclosure of a large area compared to the volume of the shield, materials of lower density are more effective at stopping high energy particles than those with a higher density. Carbon chain materials that have a similar density to water are preferred over the often-used aluminum as is shown in Figure 3.15 for the shielding required for a common module. This may lead to the use of a composite material that could provide protection against meteoroid impact (Wilson, p. 770- 773).

HEP bombardments due to solar flares are predictable and shielding can be provided in a number of ways. Although probabilistic predictions can be made on when solar flares will occur, the mission will be planned on the basis of one large event occurring. This will insure the usefulness of the fast crew transport beyond the first mission as far as radiation protection is concerned. HEP protection required to reduce this deadly amount of radiation to acceptable levels may be provided for by three methods: the use of a radiation-hardened area or "Storm Shelter;" turning the forward shield, already hardened against asteroid penetration, toward the flux path; or by shielding the entire habitable area of the ship against HEP.

The storm shelter would be an area of the ship set aside for bombardments of HEP that would exceed the capabilities of the normal shields. The storm shelter would have an omnidirectional shielding capability and would provide additional protection of critical systems. However, the confinement the crew would have to endure if the event is sustained over several days would have to be taken into account when designing the shelter, as well as the inability the crew may have to react to an emergency in another part of the ship, such as an electrical fire or meteoroid puncture.

The forward shield of the CTV could be designed to provide the primary protection against HEP bombardment from solar flares. The benefits of such a system are full accessibility to all areas of the ship and increased protection of subsystems not housed in a storm shelter. Drawbacks include the cost in fuel to

turn the entire ship about and maintain precise pointing, and increased shielding required to reduce the possibility of penetration by asteroidal particles. There would also be a serious drawback in the unlikely event that a flare occurred around the time a critical burn needed to take place. The final option of shielding the entire inhabited area of the ship against HEP bombardments was chosen to add robustness to the system. All areas are accessible and vulnerability to asteroidal puncture is reduced to the forward facing area of the ship. A beneficial side effect is that the chances of penetration of the forward facing Command Module are reduced by the radiation shielding alone to 0.8% per year. Unfortunately, this benefit does not extend to the common modules and connecting nodes. There is a 67% chance per year that one of these units will be punctured by a cometary particle. A more detailed study of structural strategies to prevent penetration by meteors needs to be made before a weight figure can be given.

A ready-made shelter is already in place on the Martian moon of Phobos for protection in Mars orbit. A single large crater, Stickney Crater, always faces Mars, and so the ship might be placed within the crater by matching orbits with the moon to provide for shielding in orbit. In their Second Preliminary Design Review, the University of Texas design team IGS proposed the use of this crater to shield the ship and mining expedition on Phobos from solar and cosmic radiation (IGS, pp. 40-44). The benefits of a system are reduction of both radiation and meteor particles, but the disadvantages include the fuel cost to match orbits with Phobos and additional structural weight used for anchoring and contact points with the moon. Because of the complexities of the problem, this option was not considered.

Total shield weight for the 28' x 28' x 15' Command Module will be 46.6 MT, that for the 7' radius by 47' long common modules will be 15.2 MT, and that for the 7' radius by 17' long nodes to connect the modules will be 6.8 MT. Additional weight for the common modules may be needed to protect against cometary particles.

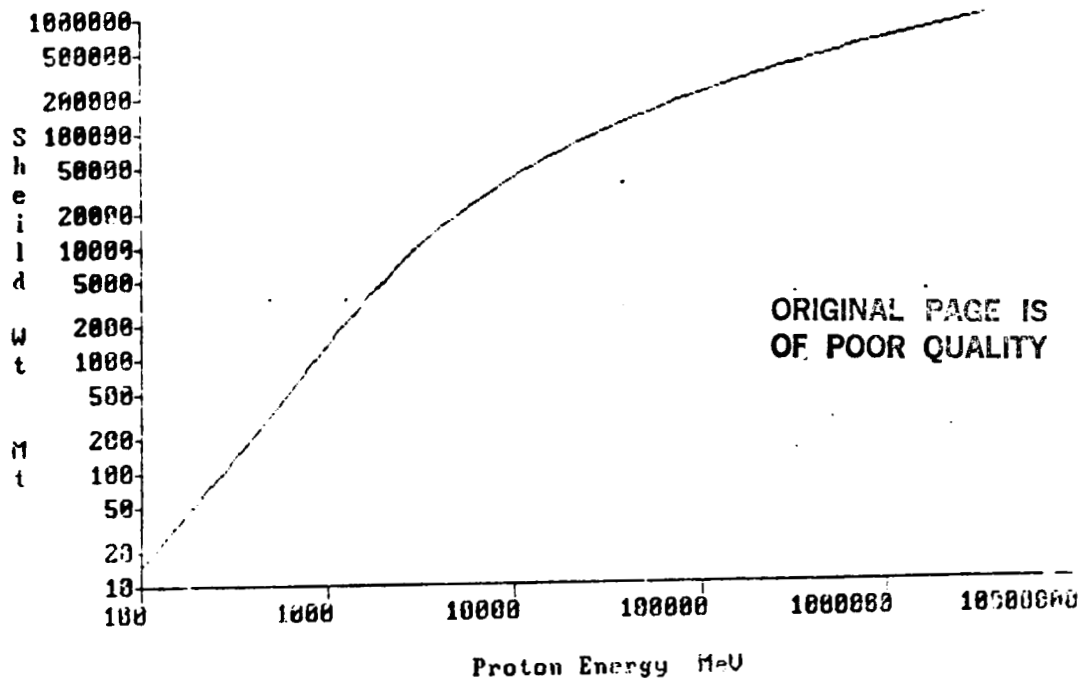

Figure 3.14 Common Module Shield Weight vs. Proton Energy.

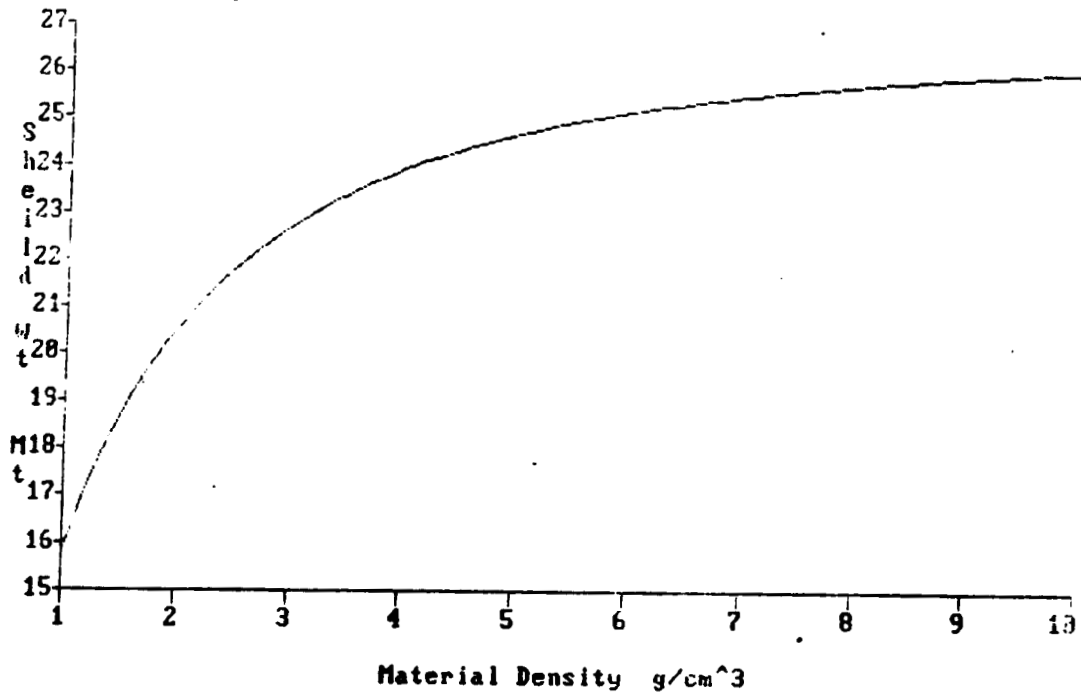

Figure 3.15 Common Module Shield Weight vs. Material Density.

Table 3.4 Radiation exposure limits recommended for spaceflight crewmembers.

<u>Constraint</u>	<u>Bone Marrow (Rem at 5 cm)</u>	<u>Skin (Rem at 0.1 mm)</u>	<u>Ocular Lens (Rem at 3 mm)</u>
1-year average daily dose	0.2	0.6	0.3
30-day maximum	25.0	75.0	37.0
Quarterly maximum	34.0	105.0	52.0
Yearly maximum	75.0	225.0	112.0
Career limit	400.0	1200.0	600.0

(Hall, p. 686)

Table 3.5 Summary Definition of Maximum Meteoroid Environment

<u>Item</u>	<u>Cometary</u>	<u>Asteroidal</u>
K ₁	-12.448	-19.28
K ₂	0.65	-
K ₃	1.0	1.0
K ₆	-	1.33
K ₇	-	6.67
Particle density (g/cm ³)	0.5	3.5
Particle orbit	Direct/retro	Direct
Max. orbit inclination (deg)	90.0	40.0
Avg. orbit inclination (deg)	45.0	9.0
Orbit	Circular to parabolic	Circular

Meteor flux is given by the following formula:

$$N = 10^{\frac{K_1}{f(R)} + \frac{K_3}{m}}$$

$$f(R) = R^{K_2} \quad (\text{cometary})$$

$$f(R) = 10^{(K_7 R + K_6 R^2)} \quad (\text{asteroidal})$$

For both fluxes, heliocentric particle velocity is $V_m = 30/\sqrt{R}$

V_m = meteoroid velocity (km/sec)

N = meteoroid flux (number of mass m or larger/ M^2 -sec)

M = meteoroid mass (grams)

R = radial distance from sun (A.U.)

(Repic, p. 3-128)

3.7 Guidance, Navigation, and Control

In order to meet the requirements of the orbital, planetary departure, heliocentric transfer, and planetary approach phases of the mission, the space navigation and guidance system will consist of several sun and planet optical sensors, an atomic reference clock, a gyroscopically stabilized platform with accelerometers, a computer, and the display and control equipment needed to support the system.

Mission objectives and flight-path constraints on the spacecraft form the basis for the formulation and application of navigation corrections. From these objectives and constraints, an envelope of possible trajectories near the target planet is defined as the "correction-success zone." One needs the orbit injection sequence and any other needed corrections to place the spacecraft in this zone. A typical number of corrections required to reach Mars and enter this zone would be at least two interplanetary, an orbit-insertion, and up to twelve orbit-trim navigation corrections. The prelaunch analysis would require sophisticated simulation programs to handle this many corrections.

Attitude control for the Mars mission vehicle will be achieved by a system that incorporates position and rate feedback and reaction jets for control torque sources. Present attitude control system components and angular rate and position sensors can maintain attitude to within at least five degrees during coast, and at least one fourth of a degree during thrusting periods.

Once a necessary trajectory correction is established by the guidance and navigation system, the flight controller uses the spacecraft's attitude control system to point the thrust-vector in the desired direction. It will be held there until the velocity of the spacecraft changes and the required course alteration is complete. The hardware for these controls will be a three-axis-stabilized spacecraft with a powered flight trajectory. This spacecraft uses impulsive thrust throughout the mission. The small out-of-plane changes can be made by biasing the celestial sensors; this would rotate the entire spacecraft.

3.8 Ship Design and Summary

Figure 3.16 shows MARCO's final conceptual design for a fast crew transfer vehicle to Mars. This ship will have a mass of about 350 metric tons (MT), excluding the mass of the propulsion systems; including the fuel, thrusters, and storage tanks, the total mass will be approximately 1250 MT. Assuming a HLLV lift capacity of 100 MT, lifting the entire ship in components to LEO would call for approximately 14 launches. However, some components are small enough to fit inside the Space Shuttle's cargo bay, such as the Space Station common modules (SSCMs), which may reduce the number of HLLV flights needed.

The ship will carry about 800 MT of fuel for use in a chemical propulsion system, characterized by 5 modified SSME's using liquid oxygen/liquid hydrogen.

The CTV will use an SP-100 nuclear power source, which can generate 300 kW of power with a lifetime of 5-10 years. The heat-to-electricity converter will be an alkali metal thermoelectric converter (AMTEC), which has an operating efficiency of 20-40%. Excess heat will be radiated through two boom-mounted rotating bubble membrane radiators (RBMR).

There will be four cylindrical SSCMs: two Habitation (Hab) Modules and two Laboratory (Lab) Modules. Each Hab module sleeps four, and has a bathroom/ shower facility, storage areas, kitchen and galley. The Lab modules contain most of the scientific equipment and the ECLSS subsystems. Since there will be duplication of functions, one Lab module could be partially converted into a Mars Lander mockup for in-flight simulations. Four nodes connect the four modules to the command module and four nodes connect the modules with the rest of the ship. Each module is 47 feet long by 14 feet in diameter and each node is 17.66 feet long with a diameter of 14.5 feet.

A Command Module will be located at the front of the ship. The Command Module will carry enough shielding to protect it from solar flares as well as from asteroidal and cometary particles, and will thus act as a "safe haven" for the crew. The Command Module will be accessible from each of the four life

support modules and was designed to be large enough to act as a shield along the line of flight. It will be a two-deck structure, one deck serving as the location for the ship's computers and logistics instrumentation, and the other capable of housing the crew for up to a week as a safe haven in case of a long duration solar event. This module is 28 feet by 28 feet across and 15 feet long.

It was decided that there would be no aerobraking at Mars or Earth. Additionally, it was felt that for a mission of less than a year, artificial gravity would not be needed. Further study in the area of space physiology may prove this assumption wrong.

Table 3.6 lists the mass of the components of the ship and the total mass of the ship.

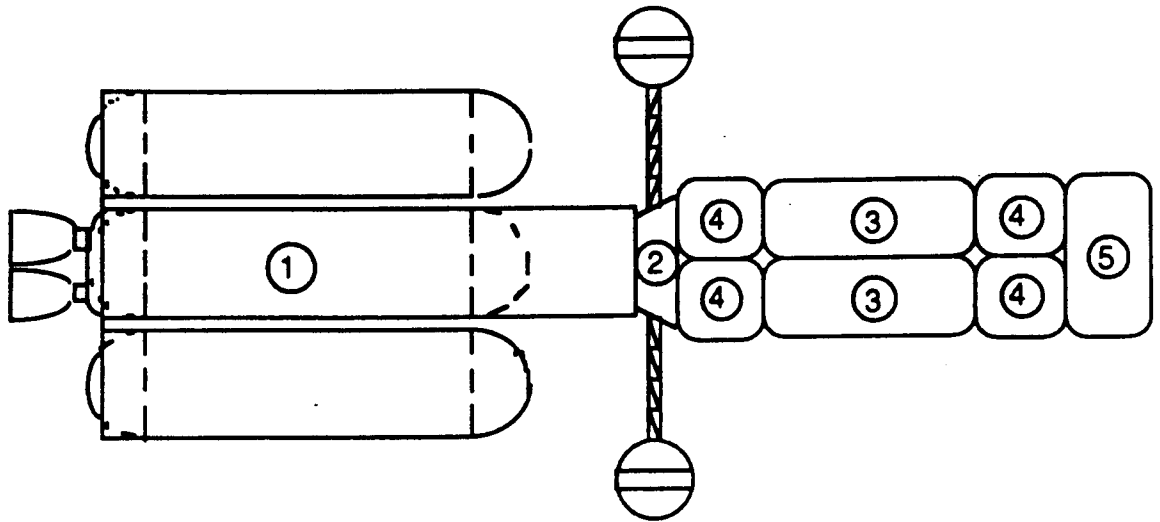

- ① FUEL TANKS/PROPULSION SYSTEM (5 SSME's)
- ② POWER SYSTEM: SP-100 NUCLEAR REACTOR AND 2 BOOM MOUNTED ROTATING BUBBLE MEMBRANE RADIATORS
- ③ CREW AND LAB MODULES (TWO EACH)-14' DIAMETER BY 47' LONG
- ④ NODES FOR CONNECTING MODULES (8)-14' DIAMETER BY 18' LONG
- ⑤ LOGISTICS AND COMMAND MODULE- 28' HIGH BY 28' WIDE BY 15' LONG

Figure 3.16 MARCO's Final Conceptual Design.

Table 3.6 Mass of Ship Components

component	number	mass per component (MT)	mass (MT)
Power plant & shielding for SP-100	1	20.50	20.50
RBMR	2	1.10	2.20
Life Support: air, food, water, thermal, waste management, etc.	1	16.96	16.96
Lab modules	2	31.46	62.92
Hab modules	2	19.95	39.90
Module shielding	4	15.15	60.60
Nodes	8	4.07	32.56
Node shielding	8	6.79	54.32
Cupola	4	0.73	2.92
Command module	1	23.52	23.52
Command module shielding	1	20.70	20.70
Airlocks	2	3.20	6.40
Crew	1	0.40	0.40
Exercise facilities	1	0.46	0.46
TOTAL PAYLOAD MASS			344.36

Fuel	1	800.30	800.30
Fuel storage	1	75.50	75.50
Propulsion system/ thrusters	1	34.60	34.60
TOTAL PROPULSION MASS			910.40

TOTAL MASS OF SHIP			1254.76
---------------------------	--	--	----------------

HLLV needed for payload only	4
HLLV needed for propulsion only	10
Total HLLV needed	14

4.0 Management

The Mars Company design staff was led by a Project Manager, a Trajectory Design Technical Director, and two Vehicle Design Technical Directors. Figure 4.1 shows the organizational structure of the company. The Project Manager's job was to control all administrative and planning functions, including maintaining contact with the Contract Monitor and keeping the project on schedule. The Technical Directors had to make sure that all tasks in their analysis branches were being accomplished. In addition, they had to resolve and report all problems encountered by the engineers involved in the project. Table 4.1 lists the employees of MARCO, their titles, and their project assignments. Table 4.2 shows the personnel time summary. Appendix A is a brief biographical sketch of each member of the MARCO team.

4.1 Design Branches

The company was split into a Vehicle Design Branch and a Trajectory Design Branch. The Vehicle Design Branch was responsible for studying vehicle systems and for deciding which system options would be most practical for a manned mission to Mars. This branch studied the propulsion, power, life support, and other systems that would be used on the spacecraft. The Trajectory Design Branch was responsible for studying the possible trajectories for a fast (i.e., 100 to 150 day flight time going one way) trip to and from Mars. This branch worked on software to determine the departure dates, ΔV s, times of flight, and other trajectory parameters for the mission.

4.2 Task Scheduling

Figure 4.2 shows the task schedule for the Vehicle and Trajectory Design Branches. Figure 4.3 shows the critical design path followed by the design teams.

4.3 Organization Review

The company organization and task assignment presented in section 4.0 worked fairly well at the beginning of the semester when enthusiasm was high and time was available. By splitting the company into two branches, the design goals were clarified and distributed more easily. Communication between the branches was maintained by holding group meetings several times each week. This organization structure enabled the company to meet all of its design deadlines. However, there were some problems with the task assignment.

The main problem with the task assignment was the different work requirements. While it was possible to complete some sections early and with minimal effort, other sections required many man-hours to complete. Since most of the sections were complex, once the research and design was started by one or more engineers, it was difficult to add a new worker to this design section halfway through the design period. To prevent this problem in the future, it is recommended that everyone work on at least two design tasks so that when work in one section is completed, effort can be redirected to the second design task.

In addition to this problem, the company experienced the usual lack of effort which occurred when assignments outside of the company were being undertaken. Also, procrastination lead to periods of frenzied activity before each major deadline, leading to time and scheduling conflicts with other companies concerning the use of computer facilities.

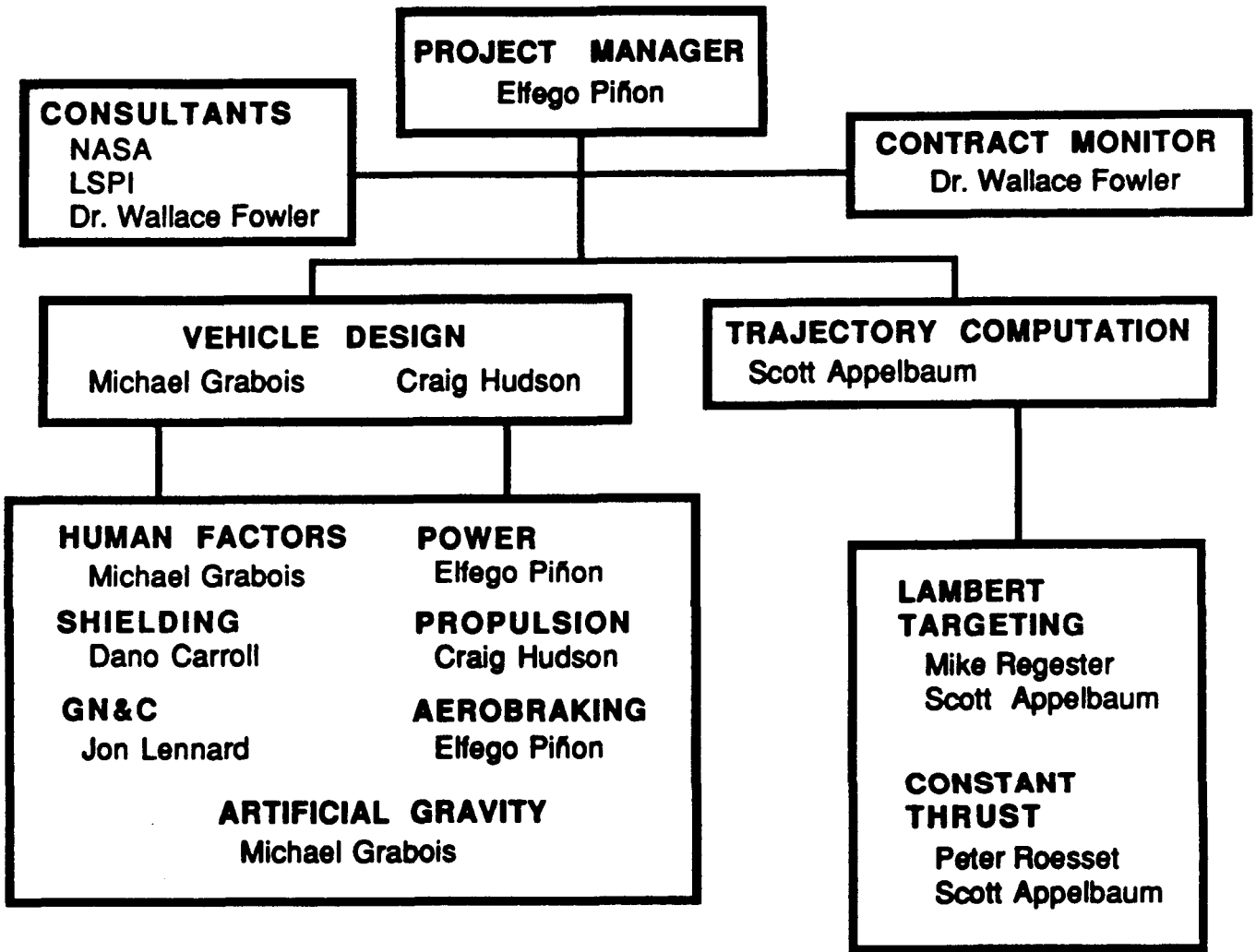

Figure 4.1 MARCO organizational chart.

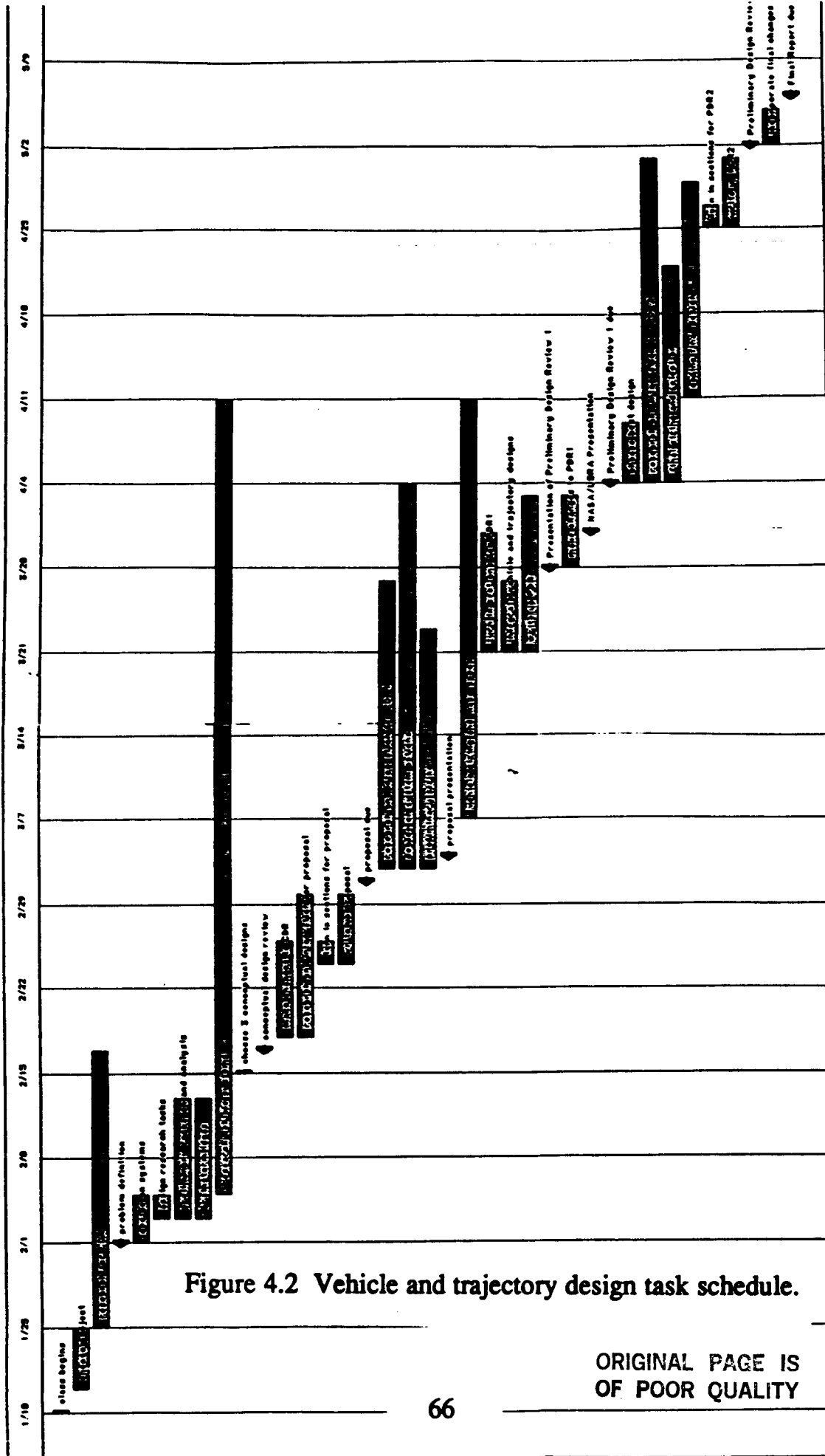
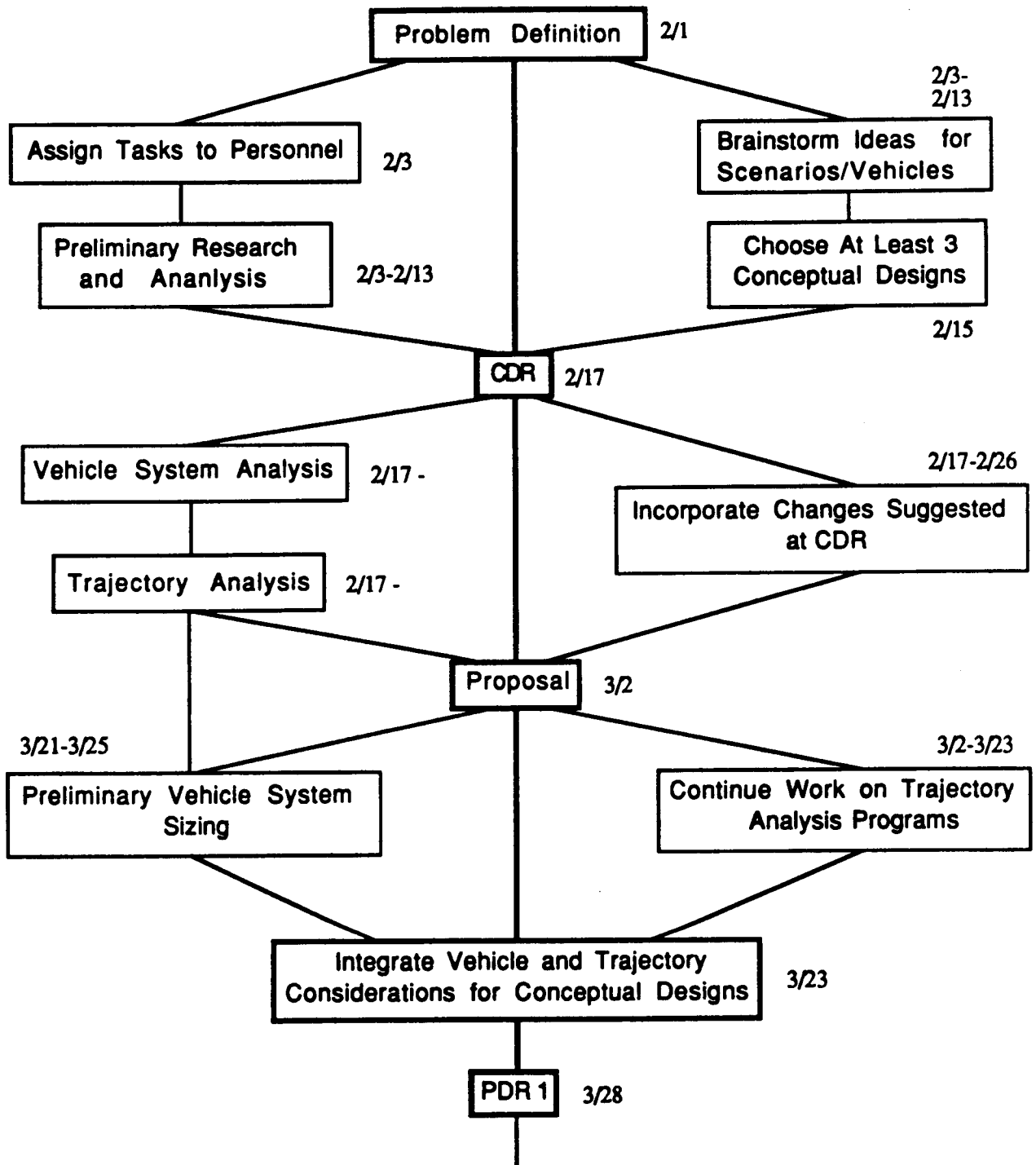

Figure 4.2 Vehicle and trajectory design task schedule.

ORIGINAL PAGE IS
OF POOR QUALITY



(Continued On Next Page)

Figure 4.3 Critical design path.

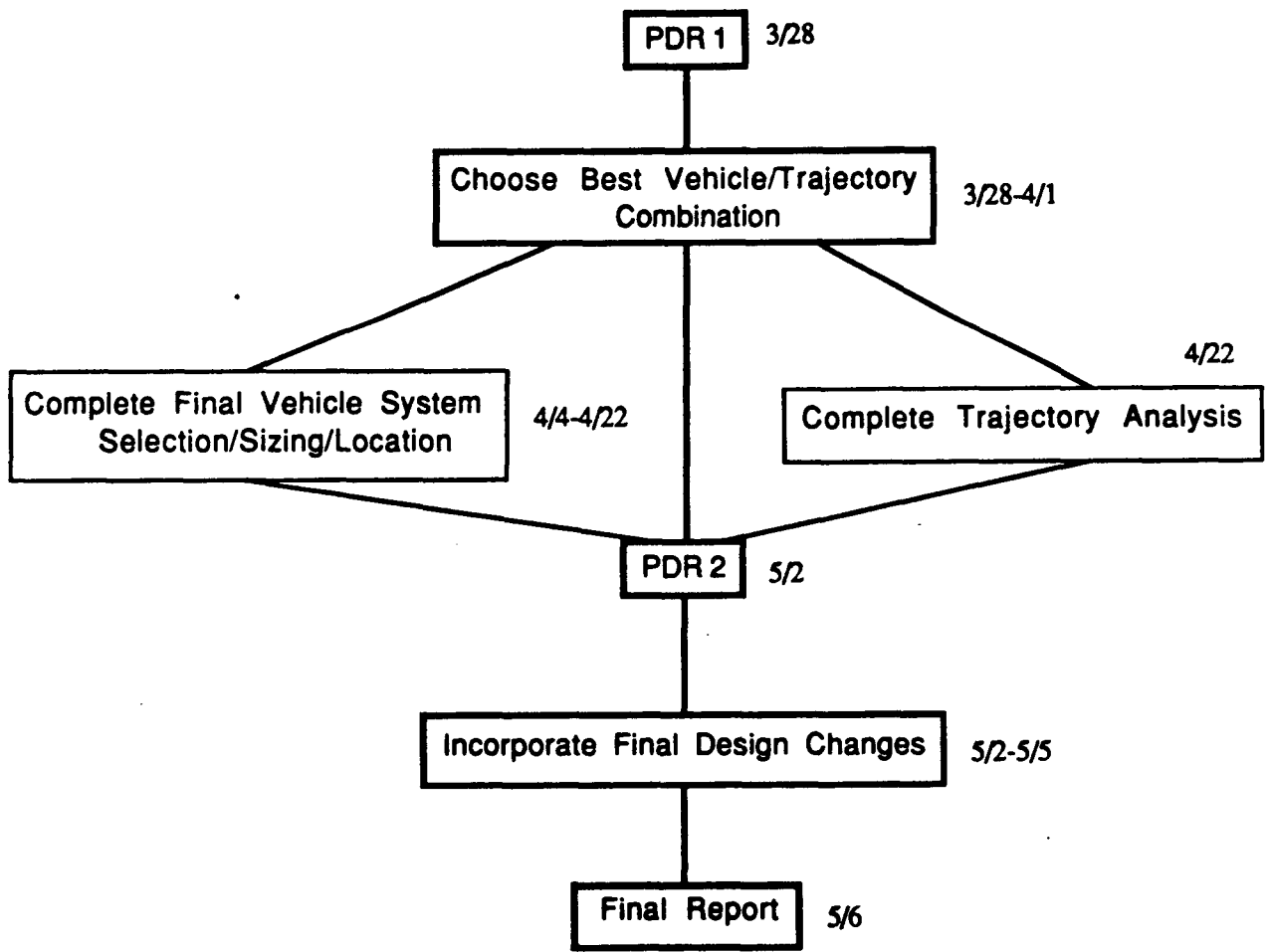

Figure 4.3 (continued)

Table 4.1 MARCO Design Team

<u>Employee Name</u>	<u>Title</u>	<u>Assignment</u>
Scott Appelbaum	Trajectory Branch Technical Director	Trajectory Computation
Dano Carroll	Engineer	Spacecraft Shielding
Michael Grabois	Vehicle Branch Technical Director	Human Factors/Artificial Gravity
Craig Hudson	Vehicle Branch Technical Director	Propulsion
Jon Lennard	Engineer	Guidance, Navigation, and Control
Elfego Piñon	Project Manager	Power/Aerobraking
Michael Register	Engineer	Lambert Targeting
Peter Roesset	Engineer	Trajectory Computation

Table 4.2 Personnel Time Summary

Semester Summary

Name	Group	Research	Admin.	Writeup	Weekly Totals		
	Meetings	/Engr.	Funct.	Duties	Graphics	Other	per Person
Piñon	57.0	68.0	23.0	82.0	37.0	8.0	275.0
Grabois	39.5	52.5	17.0	63.0	31.0	14.0	217.0
Hudson	34.0	76.0	0.0	47.0	17.0	8.0	182.0
Appelbaum	51.0	112.0	10.0	47.5	27.0	12.5	280.0
Carroll	45.5	31.0	0.0	27.0	12.0	0.0	115.5
Lennard	33.0	30.5	0.0	8.0	0.0	0.0	71.5
Register	47.0	100.0	0.0	37.5	17.0	15.0	216.5
Roesset	48.5	34.5	0.0	19.5	12.0	0.0	114.5
Totals	355.5	504.5	50.0	331.5	153.0	57.5	1452.0

5.0 Cost Status

The estimated personnel costs for the design project are outlined in section 5.1. The estimated hardware and software costs are tabulated in section 5.2. The total estimated cost of the design project is also given in section 5.2. The personnel cost status is discussed in section 5.3.

5.1 Personnel Cost Estimates

The salary figures used in the personnel cost estimates were taken from the RFP package. They are as follows:

Project Manager	\$ 25.00 /hr
Technical Director	\$ 22.00 /hr
Engineer	\$ 17.00 /hr
Technical Consultant	\$ 75.00 /hr

The estimated weekly costs are based on past design groups' estimates. They are as follows:

1 Project Manager	\$	25.00/hr x 16hrs/wk	=	\$ 400.00 /wk
3 Technical Directors: 3 x	\$	22.00/hr x 16hrs/wk	=	\$ 1056.00 /wk
4 Engineers: 4 x	\$	15.00/hr x 12hrs/wk	=	<u>\$ 720.00 /wk</u>
Total Weekly Cost Estimate				\$ 2176.00/wk

The total estimated personnel costs for the project are based on 14 weeks of actual work. The final figures are:

14 weeks of work	@	\$ 2176.00/wk	=	\$ 30464.00
20 hours of consulting	@	\$ 75.00/hr	=	\$ 1500.00
Total				\$ 31964.00
10% cost error estimate				<u>\$ 3196.40</u>
Total Personnel Cost Estimate				\$ 35160.40
FINAL PERSONNEL COST ESTIMATE:				\$35160.40

5.2 Computer/Materials Cost

Hardware and software cost estimates were also based on past design groups estimates.

Computer related costs:

Apple Macintosh Rental	\$ 1200.00
IBM PC-AT Rental	\$ 600.00
Software	\$ 50.00
Cyber System Time	\$ 500.00
Cyber System Supplies	<u>\$ 40.00</u>
Total Computer Cost Estimate	\$ 2390.00

Presentation/Miscellaneous Supplies:

Photocopies (@ 5¢ each)	\$ 250.00
Transparencies (@ 50¢ each)	<u>\$ 90.00</u>
Total Materials Cost Estimate	\$ 340.00

Total Computer/Materials Cost Estimate:	\$ 2730.00
10% Error Estimate:	\$ 273.00

Final Computer/Materials Cost Estimate:	\$ 3003.00
Final Personnel Cost Estimate	\$ 35160.40

TOTAL ESTIMATED PROJECT COST: \$38,163.40

5.3 Final Cost Status

MARCO completed its project coming in \$681.12 under budget. For a complete breakdown of costs, see Table 5.1.

Table 5.1 Final Cost Status

Expense	Predicted cost	Actual cost	Savings
Project Manager	5600.00	6875.00	-1275.00
Technical Directors	14784.00	14498.00	286.00
Project Engineers	10080.00	7770.00	2310.00
Consulting	1500.00	1500.00	0.00
Personnel cost error 10%	3196.40	3064.30	132.10
Computer rental/software	1850.00	1800.00	50.00
Mainframe time	500.00	1389.12	-889.12
Mainframe supplies	40.00	92.68	-52.68
Photocopies	250.00	100.00	150.00
Transparencies	90.00	50.00	40.00
Material cost error 10%	273.00	343.18	-70.18
TOTAL COST	38163.40	37482.28	681.12

6.0 Bibliography

Trajectory Design Section

Bate, Roger R., et al. Fundamentals of Astrodynamics. Dover Publications: New York, 1971.

Breakwell, J.V., et al. "Researches in Interplanetary Transfer," ARS Journal, vol. 3, no. 2, Feb 1961, p. 201-207.

Clarke, Victor C. Jr. Constants and Related Data for Use in Trajectory Calculations as Developed by the Ad Hoc NASA Standard Constants Committee (Technical Report 32-604). Jet Propulsion Laboratory, California Institute of Technology: Pasadena, CA, March 6, 1964.

Fowler, Wallace T. ASE 166M Course Notes, Packets 1 and 2. Kinko's Copies: Austin, TX, Fall 1987.

----- "First Order Control for Low-Thrust Interplanetary Vehicles." Doctoral Dissertation, University of Texas at Austin, May 1965.

Galecki, Diane and Micheal J. Patterson. Nuclear Powered Mars Cargo Transport Mission Utilizing Advanced Ion Propulsions. Lewis Research Center: Cleveland, OH, 1987.

Jordan, James F. "Application of Lambert's Theorem to the Solution for Interplanetary Transfer Problems," Jet Propulsion Laboratory report TR-32-521. JPL: Pasadena, CA, 1964.

Planetary Flight Handbook, vol. III, parts 1, 2, and 3 (NASA SP-35). NASA Scientific and Technical Information Branch: Washington, D.C., 1963.

Ruffa, Gregory J. and Bruce M. Cordell. Performance of Electric / Chemical Combination for Manned Mars Missions. General Dynamics Space Systems Division : San Diego, CA, 1987.

Vehicle Design Section

Bankston, C.P., and M. Shirbacheh. "AMTEC: High Efficiency Static Conversion for Space Power." Paper in Manned Mars Missions, Working Group Papers, Vol. 2 (NASA M002), pp. 715-732. NASA: Los Alamos, NM,

June 1986.

Beichel, R. "Propulsion Systems for Single-Stage Shuttles," Astronautics and Aeronautics, November 1974, pp. 32-39.

Bilby, Curt. "Extraterrestrial Infrastructure Design Projects." American Astronautical Society publication AAS-86-309, preprint of "33rd Annual Meeting of Aerospace: Century XXI," AAS Publications Office: San Diego, CA, Oct. 1987.

Brose, H. F. "Space Station Environmental Thermal Control and Life Support (ETCLS): 'Meeting the Evolutionary Growth Challenge'," Journal of Engineering for Industry, vol. 106, no. 11, Nov. 1984, pp. 287-291.

Buden, David. "Nuclear reactors for space power," Aerospace America, vol. 23, no. 2, Feb. 1985, pp. 66-69.

Bussard, R.W., and DeLauer, R.D., Fundamentals of Nuclear Flight, McGraw-Hill Book Company, New York, 1965

Carlisle, R. F. and J. M. Romero. "Space Station Technology Readiness," Journal of Engineering for Industry, vol. 106, no. 11, Nov. 1984, pp. 260-275.

Carlson, Donald E. Size and Mass Characteristics of Several-Megawatt Space Nuclear Power Systems: NASA program review, Integrated Mars/Moon Base Exploration and Development Plan, NASA: Los Alamos, NM, May 30 1986.

Charles, John B. Cardiovascular Physiologist with NASA. Personal conversation, Houston, TX: March 15, 1988.

Cheston, T. Stephen and David L. Winter, eds. Human Factors of Outer Space Production (AAAS Selected Symposium 50). Westview Press, Inc.: Boulder, CO, 1980.

Colston, B.W. "Nuclear Power Supplies: Their Potential and the Practical Problems to Their Achievement for Space Missions." Paper in Manned Mars Missions, Working Group Papers, Vol. 2 (NASA M002), pp. 761- 768. NASA: Los Alamos, NM, June 1986.

Comer, G. "Mass Vehicle TCS and Aerobrake TPS." Paper in Manned

Mars Missions, Working Group Papers, Vol. 2 (NASA M002), pp.755-760.
NASA: Los Alamos, NM, June 1986.

Critical Evaluation Task Force. Findings of the Critical Evaluation Task Force (CETF). NASA JSC: Houston, TX, Sept. 1986.

Dankhoff, W., Herr, P., and McIlwain, M., "Space Shuttle Main Engine - The Maturing Process," Aeronautics and Aeronautics, January 1983, pp. 26-33.

Disher, J. H. "Skylab." Paper in "Space Station and Space Platforms-- Concepts, Design, Infrastructure, and Uses in Progress" in Aeronautics and Astronautics, Vol. 99, ed. by Ivan Bekey. AIAA: New York, NY, 1984.

Dueber, Ross E. "Sodium-Sulfur Batteries for Spacecraft Energy Storage." Paper in The 1985 Goddard Space Flight Center Battery Workshop (NASA Conference Publication 2434). NASA Scientific and Technical Information Branch: Washington, D.C., 1986.

Duke, Michael B. and Paul W. Keaton, eds. Manned Mars Missions: A Working Group Report. NASA/Marshall Space Flight Center: Huntsville, AL, June 1985.

Feoktistov, Konstantin. "Two Hundred Thirty Seven Days in Salyut-7," Aerospace America, vol. 23, no. 5, May 1985, pp. 96-98.

French, J. R. "The 'Case for Mars' Concept." Paper in Manned Mars Missions, Working Group Papers, Vol. 1 (NASA M002), pp.342-360. NASA: Los Alamos, NM, June 1986.

Friedlander, A. "Hybrid Propulsion and Other Topics," a Presentation to the Advanced Space Propulsion Workshop (LeRC), April 13, 1988.

Grey, Jerry. "Space station careens past all obstacles," Aerospace America, vol. 25, no. 9, Sept. 1987, pp. 24-28.

Gooder, E.M., Principles of Spaceflight Propulsion, Pergamon Press, New York, 1970

Hall, Stephen B., and Michael E. McCann. "Radiation Environment and Shielding for Early Manned Mars Missions." Paper in Manned Mars Missions, Working Group Papers, Vol. 2 (NASA M002), pp.686-705. NASA: Los

Alamos, NM, June 1986.

Hanrahan, James S. and David Bushnell. Space Biology: the Human Factors in Space Flight. Basic Books: New York, 1960.

Harrison, Albert A. and Mary M. Connors. "Psychological and Interpersonal Adaptation to Mars Missions (#AAS 84-186)." Paper in The Case for Mars II, pp. 643-654. Christopher McKay, ed. American Astronautical Society Publication no. 57 in the Science and Technology Series, Univelt Inc.: San Diego, CA, 1984.

Hayes, Judy C. Exercise physiologist with NASA. Personal conversation, Houston, TX: March 15, 1988.

Heckman, Gary. "Solar Particle Event Predictions for Manned Mars Missions." Paper in Manned Mars Missions, Working Group Papers, Vol. 2 (NASA M002), pp. 674-683. NASA: Los Alamos, NM, June 1986.

IGS. A Phobos Industrial Production and Supply Base (Preliminary Design Review #2) IGS: Austin, Texas, Dec. 1986.

Martin Marietta Astronautics Space Systems. Manned Mars Systems Study (NAS8-37126): Second Quarterly Report. Viewgraphs of "Manned Mars/Lunar Studies Mid-Term Reviews." Marshall Space Flight Center: Huntsville, AL, Dec. 1987.

Massachusetts Institute of Technology 1986 Space Systems Engineering Class. Mars: A Program for its Exploration and Development, vol. II. MIT: Boston, MA, 1986.

McKay, Christopher P., ed. The Case for Mars II, vol 62: Science and Technology Series. AAS: San Diego, CA, 1985.

Modell, Michael and Jack M. Spurlock. "Rationale for Evaluating a Closed Food Chain for Space Habitats." Paper in Human Factors of Outer Space Production (AAS Selected Symposium #50), ed. by Cheston and Winter, pp. 133-145. Westview Press, Inc.: Boulder, CO, 1980.

Mondt, Jack F. An Overview of the SP-100 Space Reactor Power System for NASA--OAST S TAC, viewgraphs. Jet Propulsion Laboratory: Pasadena,

CA, March 1987.

NASA. "Mission Report MR-14: The Second Skylab Mission." U.S. Government Printing Office: Washington, D.C., 1979.

NASA LeRC. "Advanced Space Propulsion Workshop." Advanced Space Analysis Office: Cleveland, Ohio, April 12-13, 1988.

National Commission on Space. Pioneering the Space Frontier: The Report of the National Commission on Space. Bantam Books: New York, May 1986.

Nicogossian, Arnauld E. and James F. Parker. Space Physiology and Medicine (NASA SP-447). NASA Scientific and Technical Information Branch: Washington, D.C., 1982.

Oberg, James E. Mission to Mars. New American Library: New York City, 1982.

Palaszewski, B. "Advanced Propulsion for Manned Lunar and Mars Missions," a Presentation to the Planetary Mission Analysis Meeting (LeRC), April 12-13, 1988.

Petrov, Yuri A. "Habitability of Spacecraft." Paper in Foundations of Space Biology and Medicine vol. III: Space Medicine and Biotechnology by NASA and the Academy of Sciences of the USSR. NASA: Washington, D.C., 1975.

"Planetary Navigation: The New Challenges," Astronautics and Aeronautics, vol. 8, no. 5, May 1970, pp. 50-65.

Rambaut, Paul C. "Nutritional Criteria for Closed-Loop Space Food Systems." Paper in Human Factors of Outer Space Production (AAS Selected Symposium #50), ed. by Cheston and Winter, pp. 113-131. Westview Press, Inc.: Boulder, CO, 1980.

Repic, E. M. Final Report: Study of Technology Requirements for Atmospheric Braking to Orbit About Mars and Venus; Volume II: Technical Analyses (Contract # NAS2-4135, document # SD67-994-2). North American Rockwell Corporation: Downey, CA, Jan. 1968.

Rockwell International, Press Information: Space Shuttle Transportation

System. Rockwell International: Houston, TX, March 1982.

Salkel, R. "Mixed-Mode Propulsion for the Space Shuttle", Aeronautics and Aeronautics, August 1971, pp. 52-58.

-----, and R. Beichel. "Reusable One-Stage-to-Orbit Shuttles: Brightening Prospects," Aeronautics and Astronautics, August 1971, pp. 45-58.

Science Applications International Corp. Piloted Sprint Missions to Mars (Report no. SAIC-87/1908, study no. 1-120-449-M26). SAIC: Schaumburg, IL, Nov. 1987.

Stoker, Carol, and Christopher P. McKay. "Mission to Mars: The Case for a Settlement," Technology Review, vol. 86, Nov. 1983, pp. 26-32.

Texas A & M University. Final Report on Manned Mars Mission Project. TAMU: College Station, TX, Fall Semester 1985.

University of Michigan Department of Aerospace Engineering Aerospace System Design Team. Project Kepler: A Manned Mission to Mars. University of Michigan: Ann Arbor, MI, Winter 1986.

Webb, Brent J. "Rotating Bubble Membrane Radiator for Space Applications." Paper in Manned Mars Missions, Working Group Papers, Vol. 2 (NASA M002), pp. 823-832. NASA: Los Alamos, NM, June 1986.

Williams, O. S. "Liquid Rockets and Perspective Developments in the 1980's," Astronautics and Aeronautics, March 1976, pp. 47-57.

-----, "Liquid Rockets in Perspective: Propulsion for the 1970's and the 1980's", Astronautics and Aeronautics, April 1976, pp. 42-49.

Wilson, John W. "Weight Optimization Methods in Space Radiation Shield Design," AIAA Journal of Spacecraft and Rocketry V. 12, Dec. 1975.

Woodard, Daniel and Alcestis R. Oberg. "The Medical Aspects of a Flight to Mars (#AAS 81-239)." Paper in The Case for Mars, pp. 173-180. Penelope J. Boston, ed. American Astronautical Society Publication no. 62 in the Science and Technology Series, Univelt Inc.: San Diego, CA, 1981.

7.0 Appendix

(A) Biographies of MARCO employees

(B) Proposal

APPENDIX A. MARCO BIOGRAPHIES

Scott Appelbaum was born February 18, 1965 in Baltimore, Maryland. After attending The University of Maryland Baltimore County from September 1983 to December 1985 where he majored in Mechanical Engineering, he moved to Austin, Texas in January 1986 and enrolled in the Aerospace Engineering Department of The University of Texas. At the University he was elected a member of Tau Beta Pi and Sigma Gamma Tau as well as being designated a College Scholar in 1987 and 1988. He also joined the University of Texas Students for the Exploration and Development of Space (UTSEDS) and the American Institute of Aeronautics and Astronautics (AIAA). His interests are in spending time with his wife and daughter, space history and orbital mechanics. He will begin working in the Orbit Design section of the Rockwell Shuttle Operations Company in Houston, Texas after receiving his Bachelor of Science Degree in Aerospace Engineering from The University of Texas in May, 1988, and hopes to become an astronaut. He served as the Trajectory Computation manager for MARCO and investigated constant thrust trajectories, patched conics, mission windows and helped coordinate the trajectory/ vehicle integration phase of the project.

Dano Carroll has worked since early 1987 at The University of Texas Center for Space Research, managing a database of GPS ranging data. He has been an undergraduate since 1978 with majors in Radio, Television and Film; Computer Science; and Aerospace Engineering, for which he finally received his degree in May, 1988. His interests include celestial mechanics and computer programming. He has lived in Austin since 1967 after moving there from Lexington, Kentucky, where he was born on April 15, 1960. His contributions to this project have been in the areas of Radiation and Asteroidal Shielding and working out several design scenarios.

Michael R. Grabois was born on August 13, 1966 in Akron, Ohio. After living in several states, he moved to Houston, Texas in the summer of 1981. He has attended The University of Texas since his freshman year in the fall of 1984. Enrolling in the Department of Aerospace Engineering and Engineering Mechanics at UT, he graduated with a Bachelor of Science Degree in Aerospace Engineering in May 1988. At the University, he was involved with AIAA and UTSEDS, worked on the staff of the campus yearbook, and participated in Intramural Sports. His interests include reading science fiction and fantasy books, comic books, photography, and the space program. He will begin employment in the Ascent Department at Rockwell Shuttle Operations Company in Houston in June 1988, and plans on eventually becoming an astronaut. He served as a co-manager of the Vehicle Design Branch of MARCO, and provided the Human Factors and Artificial Gravity sections as well as general editing and designing the company logo and many graphics.

Craig R. Hudson was born on June 27, 1966 at West Point (USMA), New York. The son of a career Army officer, he has travelled throughout the United States and most of Continental Europe. He has attended The University of Texas from August, 1984 to December, 1988, attaining a commission in the United States Army as a Second Lieutenant in the Ordnance Corps through ROTC and earning a Bachelor of Science Degree in Aerospace Engineering. At The University, he was a member of AIAA and actively involved in ROTC. His main interests include American/European History 1750 -1850, Soviet-U.S. relations, Military History, photography, camping, and space flight. He served as co-manager of the Vehicle Design Branch of MARCO where he provided the Propulsion systems information and worked on several design scenarios.

Jon Lennard was born on December 24, 1965 in Fort Worth, Texas. He has lived in Houston since the age of three. He enrolled in The University of Texas in September of 1984 and graduated in May of 1988 with a Bachelor of Science degree in Aerospace Engineering. While enrolled at the University, he became a member of Sigma Gamma Tau and AIAA. His interests include swimming, martial arts, guitar, basketball, and reading. At the present time he is planning to work for a NASA contractor in Houston. He hopes to become active in the space program. He served in the Vehicle Design Branch of MARCO as the Guidance, Navigation and Control resident expert.

Elfego Piñon III was born in Alamogordo, New Mexico, on December 26, 1965. After attending schools in Texas, California, and Alabama, he enrolled at The University of Texas at Austin in the Aerospace Engineering Department. At The University, he was an active member of the AIAA, a charter member of the University's American Helicopter Society, and has played intramural sports for four years. He also became a member of Sigma Gamma Tau and Tau Beta Pi. His interests include photography, radio-controlled helicopters, photography, astronomy, and computer simulations. He has received a fellowship and plans to attend graduate school at The University of Texas at Austin where he will continue to study mission planning and orbital mechanics. As project manager of MARCO, his duties included coordinating the work being done by the Trajectory and Vehicle Design Branches. In addition, he studied the application of aerocapture and the power systems to be used on the vehicle.

Michael Regester was born in San Antonio, Texas on July 6, 1966, and lived there until entering college. He enrolled in The University of Texas at Austin in the Fall of 1984. He majored in Aerospace Engineering and graduated in May of 1988 with an overall GPA of 3.76 and a GPA of 3.9 in his major. Mike's activities at UT were intramural basketball and football, and he also participated in the Longhorn Basketball Band in the Fall of 1985. He was also a member of Tau Beta Pi and Sigma Gamma Tau, both Engineering Honor Societies. His other interests include computers, sports, model building, and music. Mike served as an Engineer in the Trajectory Analysis branch of MARCO, where he concentrated on the study of Lambert targeted trajectories between Earth and Mars. Mike will begin work as an Associate Engineer at Radian Corporation in Austin, Texas in the area of Vehicle Flight Analysis.

Peter Roesset was born on October 20, 1966 in Santiago, Chile. After living in a number of places, he moved to Austin, Texas where he has lived since 1978. He has attended The University of Texas at Austin since his freshman year in the fall of 1984. He graduated with a Bachelor of Science Degree from the Department of Aerospace Engineering and Engineering Mechanics in May 1988. While at the University he has been a member of AIAA and participated in intramural sports. His interests include space and the space program, science fiction/fantasy, skiing, and assorted other sports. He will either work in the Descent Department at Rockwell Shuttle Operations Company in Houston or pursue a graduate degree at The University of Texas. At MARCO, he worked as an engineer in the Trajectory Design Branch, investigating the constant thrust scenario, and produced the final conceptual design of the ship.

**A PROPOSAL FOR THE DESIGN
OF A FAST CREW TRANSFER VEHICLE
TO MARS**

**WRITTEN IN RESPONSE TO
RFP #ASE274L**

**SUBMITTED TO:
DR. WALLACE FOWLER
THE UNIVERSITY OF TEXAS AT AUSTIN
DEPARTMENT OF AEROSPACE ENGINEERING
AND ENGINEERING MECHANICS
AUSTIN, TX 78712**

**PRESENTED BY:
THE MARS COMPANY
THE UNIVERSITY OF TEXAS AT AUSTIN
AUSTIN, TX 78712**

MARCH 2, 1988

Executive Overview

This document outlines a proposal by The Mars Company, MARCO, for a fast (i.e. 100 to 150 transfer time) crew transfer vehicle to Mars. This vehicle will maximize mission effectiveness by minimizing detrimental environmental effects, such as muscle atrophy caused by lack of gravity, on the crew. It will also serve as the in-transit habitat for the crew and as a possible building block of a transportation node in Low Mars Orbit.

This report presents three conceptual designs proposed for the crew transfer vehicle. The first design is a multiple vehicle-constant thrust design. The second conceptual design is a single vehicle-impulsive thrust design with the possibility of aerobraking at Mars or Earth. The final design presented is a multiple vehicle-impulsive thrust scenario which combines attributes of the first two conceptual designs.

In the attempt to solve the technical problems of this project, MARCO's engineering section has been divided into two major branches: Vehicle Design and Trajectory Design. The Vehicle Design Group will analyze mission parameters that directly influence vehicle configuration and will develop vehicle system and subsystem requirements to maximize effectiveness of the mission. The Trajectory Design Group will be primarily concerned with minimizing time of flight. The results of the trajectory group will be used by the vehicle group during vehicle system selection and sizing

MARCO is headed by a Project Manager while the individual branches are headed by Technical Directors. The Project Manager controls the management structure, accounting and documentation. The Technical Directors control task assignment and analyses.

TABLE OF CONTENTS

	Executive Overview	i
	Table of Contents	ii
	List of Figures	iv
1.0	General Summary	1
1.1	Project Background	1
1.2	Design Overview	1
1.3	Design Groundrules and Assumptions	2
2.0	Technical Proposal	3
2.1	Overview	3
2.2	Conceptual Designs	4
2.2.1	Conceptual Design #1	4
2.2.2	Conceptual Design #2	6
2.2.3	Conceptual Design #3	7
2.3	Vehicle Design	9
2.3.1	Goals of Vehicle Design Group	9
2.3.2	Human Factors	11
2.3.3	Power and Propulsion Systems	12
2.3.3.1	Propulsion	12
2.3.3.2	Power Systems	13
2.3.4	Aerocapture	14
2.3.5	Shielding	15
2.3.6	Artificial Gravity	16
2.3.7	Guidance, Navigation & Control	17
2.3.8	Integration with Trajectory	17
2.4	Trajectory Analysis	18
2.4.1	Goals of Trajectory Analysis	18

2.4.2	Lambert Targeting Analysis	19
2.4.3	Constant Thrust Analysis	20
2.4.4	Patched Conic Analysis	20
3.0	Management Proposal	21
3.1	Design Branches	21
3.2	Task Scheduling	21
4.0	Cost Proposal	28
4.1	Personnel Cost Estimates	28
4.2	Computer/Materials Cost Estimates	29
5.0	Bibliography	30
6.0	List of Acronyms	32

LIST OF FIGURES**FIGURE
PAGE**

2.1 Trajectories for Conceptual Design #1	5
2.2 Trajectories for Conceptual Design #2	8
2.3 Trajectories for Conceptual Design #3	10
3.1 Organizational Chart	22
3.2 Vehicle Design Task Schedule	24
3.3 Trajectory Design Task Schedule	25
3.4a Critical Design Path	26
3.4b Critical Design Path	27

1.0 General Summary

1.1 Project Background

As stated in the report of the National Commission on Space, the establishment of permanent manned bases on the Moon and Mars are long term goals for the U.S. space program. Only through extensive manned exploration can the U.S. fully determine availability of resources of the Moon and the outer planets. The Mars Company, MARCO, is concentrating its efforts on a previously proposed manned Mars mission, which could become a reality by the year 2000.

MARCO's work is a partial continuation of the work done by the University of Texas at Austin Spacecraft Design Group in the Spring of 1985. Developed a senario using two vehicles subsequently termed a split mission. A slow, unmanned barge containing scientific experiments, fuel, and extra supplies would be sent to Mars first. Later, a fast crew transfer vehicle would leave Earth and dock with the barge in Mars orbit. The fast crew transfer vehicle, built only for the crew and not for extra supplies, has the advantage of requiring less fuel usage during its shorter flight time.

MARCO will focus on the design of the fast crew transfer vehicle, determining requirements for its systems, subsystems, and trajectories.

1.2 Design Overview

MARCO will design a fast crew transfer vehicle for a manned mission to Mars that optimizes crew effectiveness. Major emphases of this design will be on minimizing time of flight and detrimental health effects on the crew. To accomplish this, the Trajectory Design Branch will investigate high thrust/ free fall trajectories, low thrust trajectories and a combination of both. After determining times of flight, ΔV 's and rocket engine performance requirements, the trajectory group will give this information to the vehicle design group.

The vehicle design group will then use this data to size and establish requirements for vehicle systems in several areas including shielding; power and propulsion; guidance, navigation and control; artificial gravity; human factors; and aerobraking.

The final product will be an integrated vehicle/trajectory package with system and subsystem requirements. A final trajectory design will also be presented. The final vehicle design will include system requirements for the mission and mass of each system.

1.3 Design Groundrules and Assumptions

Based on the RFP requirements and some basic initial simplifications of the problem, MARCO has defined the following groundrules and assumptions:

Basic Groundrules

- Minimum crew of six
- Minimal crew exposure to zero gravity and solar/cosmic radiation effects
- Safe haven for crew in case of major radiation events
- Abort scenarios - free return, low energy
- Departure from Low Earth Orbit (LEO) or Nuclear Safe Orbit (NSO)
- Reserve fuel available during flight for low energy aborts
- Refueling at Mars for high energy burn

Assumptions

- Space Station in LEO
- Energia class Heavy Lift Launch Vehicle (HLLV)
- Assembly in LEO
- Nuclear/Ion Propulsion Technology available
- Coplanar and Circular Orbits for preliminary analyses
- Two-body problem in geo, helio, and ariancentric phases respectively
- No perturbations
- Technology baseline of 1990.

2.0 Technical Proposal

2.1 Overview

MARCO will focus on developing requirements for systems and subsystems of a fast crew transfer vehicle that will optimize the mission time and effectiveness. The primary goal is to minimize the time of flight to Mars so as to deliver a crew capable of completing an extensive preliminary mission in the Mars system (i.e. Mars, Phobos, Deimos).

The concerns of this study will include:

- | | |
|--|---|
| <ul style="list-style-type: none"> -Trajectory Determination <ul style="list-style-type: none"> • Lambert Targeting • Patched Conic Analysis • Constant Thrust • Δv Requirements • Limitations of Trajectories • Minimize Time of Flight • Provide Mission Abort Scenarios • Maximize Payload | <ul style="list-style-type: none"> - Vehicle Systems Analysis <ul style="list-style-type: none"> • Maximize Payloads • Propulsion Trade Studies • Shielding Requirements • Power Systems Trade Studies • Artificial Gravity Options • Aerobraking • Human Factors • Guidance, Navigation, Control |
|--|---|

The "Barge" referred to in this report is a slow vehicle that has already transported a Mars lander and other supplies into low Mars orbit. The vehicles in the conceptual designs will dock with the Barge in some manner. The Barge may or may not be independently powered and supplied for life support. The "Bus" is the large interplanetary transfer vehicle, and the "Taxi" is the small intership transfer vehicle.

A "free return abort" is a trajectory that will bring a vehicle back to Earth upon failure of the propulsion system, similar to the lunar free abort designed for the Apollo missions. If this is not possible a minimal energy retrun will be studied.

C-2

2.2 Design Scenarios

2.2.1 Multiple Vehicle - Constant Thrust

In conceptual design #1, the fast transfer abilities of a high thrust orbital transfer vehicle (OTV) and low thrust spacecraft have been combined. Two vehicles, one abort assist device and one Barge make up this concept.

Figure 2.1 shows the orbital trajectories of design 1. Beginning in low Earth orbit (LEO), a constant thrust nuclear powered "Bus" will use a spiralling trajectory to gain enough energy to escape Earth's sphere of influence. Just prior to Earth escape, a high thrust OTV "Taxi" carrying the crew will rendezvous with the Bus for the Heliocentric transfer. In this phase the utility of the Bus becomes apparent by seeing that a low thrust spacecraft can make the Heliocentric transfer to Mars faster than a free fall vehicle. After the Heliocentric transfer there are two possible mission scenarios while at Mars.

Option I:

- Bus is captured into low Mars orbit (LMO) by impulsive braking
- Crew takes Taxi from Bus to Barge, already in LMO
- LMO and surface missions are performed
- Crew returns on Taxi to Bus which is about to escape Mars either through impulse or spiralling trajectory

Option II:

- Bus-Taxi is captured into LMO and docked with Barge so Bus may be used as primary power system
- LMO and surface missions are performed
- Bus escapes Mars through high impulse burn

After escape from Mars the scenarios are the same. The Bus is placed on a low thrust Heliocentric trajectory back to Earth. When in the vicinity of Earth the crew will take the Taxi back to LEO while the Bus executes a spiralling trajectory back to LEO.

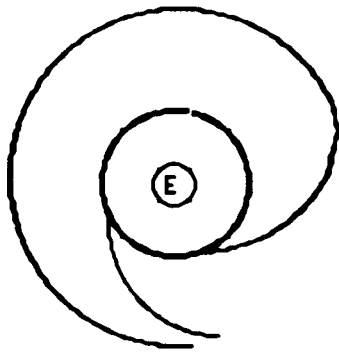

EARTH SPIRAL & RENDEZVOUS

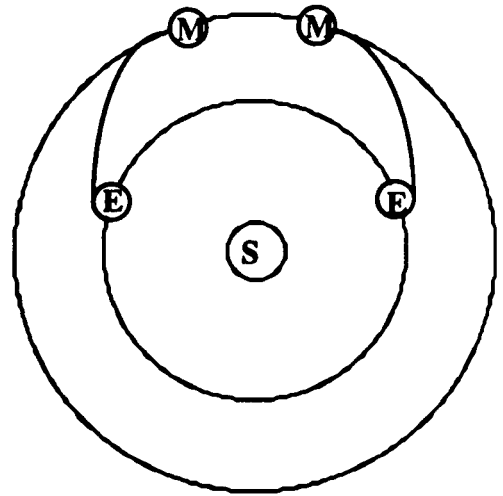

HELIOCENTRIC TRANSFERS

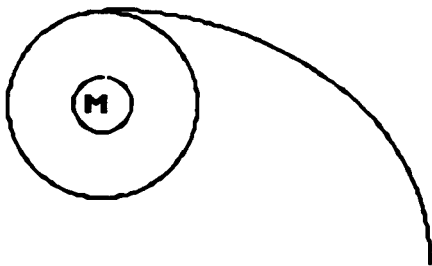

MARS CAPTURE

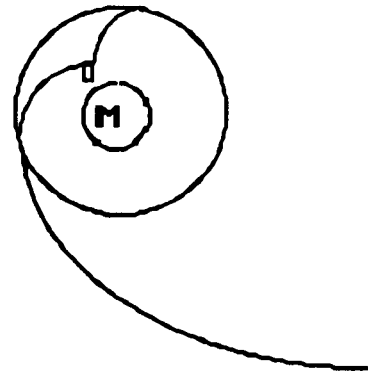

MARS SHUTTLING AND DEPARTURE

FIGURE 2.1 TRAJECTORIES FOR CONCEPTUAL DESIGN #1

Abort Contingencies:

1. Bus fails in spiral before Taxi departs from LEO
 - a) bring Bus back with remote control, or
 - b) transport repair crew with Taxi or OTV
2. Taxi cannot dock with Bus in vicinity of Earth
 - a) return Taxi to LEO and return Bus for fixing if possible
3. Bus fails irreparably in transit
 - a) abort assist device, "Trailer," is connected to Taxi for return to LEO and place Bus on minimal energy return trajectory
4. Bus fails past point of no return for Taxi-Trailer combination
 - a) Propulsion failure: free return abort
 - b) Total Bus failure/Emergency: go to Barge with Taxi-Trailer and wait for rescue or resupply
5. Taxi cannot dock with Barge in LMO
 - a) return to Bus for eventual return to Earth
6. Bus cannot dock with Barge
 - a) return to Earth
7. Taxi cannot dock with Bus in vicinity of Mars
 - a) return to Barge and wait for rescue or resupply
8. Bus fails on return to Earth
 - a) Propulsion failure: free return abort and take Taxi back to LEO
 - b) Total Bus failure/Emergency: Take Taxi-Trailer back to LEO
9. Catastrophic failure- ????????????????

2.2.2 Multiple Vehicle - Impulsive Thrust

The second design scenario consists of a high thrust option used to transport the crew to Mars and dock with the Barge. The crew transfer vehicle (CTV) will be designed as one operating system with sectional modules. Four burns will be required during the mission; one from geocentric space to heliocentric space,

one to establish a Mars orbit, another to leave Mars orbit, and the last to reenter Earth's orbit; and course corrections. Two propulsion systems will be considered, chemical and nuclear, with the possibility of an aerobrake assist at Mars. Other systems under consideration with this design are solar, nuclear, and battery assisted power sources. Figure 2.2 shows the orbital trajectories of design 2.

Abort Contingencies:

1. Initial burn to eject CTV from LEO to heliocentric space fails
 - a) Rescue from Space Station.
2. Propulsion system failure after escape from geocentric space
 - a) Free return abort
3. Docking not possible with Barge
 - a) Abort mission, eventual return to Earth
4. Propulsion failure to escape from Mars gravity well
 - a) Backup SRB's on Barge
5. Propulsion system failure after departing Mars.
 - a) Free return abort
6. Independent System Failure
 - a) Backup systems
7. Catastrophic failure - ??????????

2.2.3 Single Vehicle - Constant Thrust

This design incorporates the double vehicle setup of design 1 and the chemical propulsion system of design 2. Three vehicles are required, an orbital transfer Taxi, an interplanetary Bus and the Barge. The Bus and Taxi as a unit will boost away from LEO after the first impulsive burn, with no spiral out. Upon reaching Mars, the second burn will insert the Taxi-Bus into an elliptical orbit. The Taxi will then take the landing crew down to the lower orbit of the

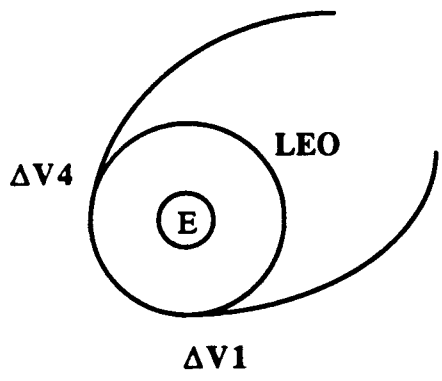

DEPARTURE/CAPTURE (LEO)

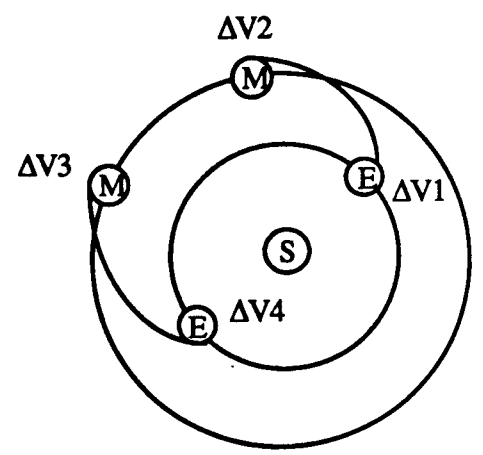

HELIOCENTRIC TRANSFERS

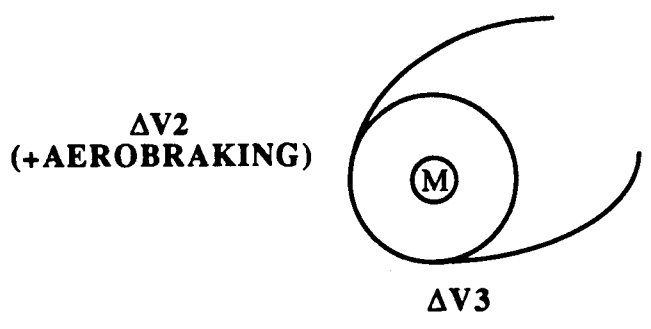

MARS CAPTURE/DEPARTURE (LMO)

FIGURE 2.2: TRAJECTORIES FOR CONCEPTUAL DESIGN #2

Barge. Solid rocket boosters or liquid fuel will be transferred to the Bus using the Taxi. The Taxi will bring up the remainder of the crew and the Taxi-Bus will boost out of Mars orbit. The final impulsive burn will place the Taxi-Bus into Earth orbit and the Taxi will transfer the crew to the Space Station. Figure 2.3 shows the orbital trajectories of design 3.

Abort Contingencies:

In general, the Taxi is to be used as a lifeboat in case a catastrophic failure renders the Bus completely uninhabitable. This would be an extreme circumstance since there would be limited space for consumables.

1. Booster does not fire or fires incompletely in leaving Earth orbit
 - a) Taxi is used to transfer crew back to Space Station.
2. Bus becomes uninhabitable in transit to or from Mars
 - a) Taxi is used for return to Earth
3. Rockets do not fire to brake into Mars orbit
 - a) Free return abort to Earth
4. Bus cannot be slowed down enough for Earth capture
 - a) Taxi is used to return to Earth at closest approach

2.3 Vehicle Design

2.3.1 Goals of Vehicle Design Group

The goals of this project are to design a combination of possible vehicle configurations for three mission concepts. The major considerations of the group are human factors, propulsion systems, power systems, shielding, guidance, navigation, and control systems, and mass requirements. Possible options in these scenarios under consideration are aerobraking and artificial gravity. Software will be written to complete the analysis of the possible vehicle configurations.

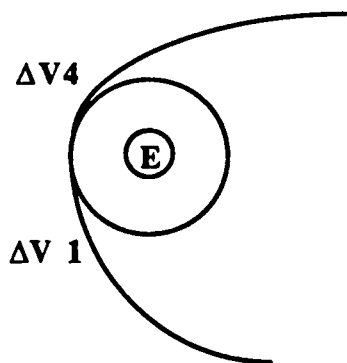

EARTH DEPARTURE AND CAPTURE

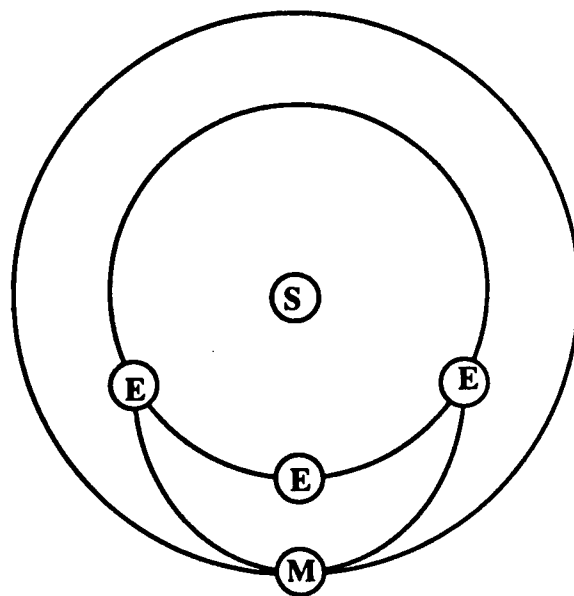

HELIOCENTRIC TRANSFERS

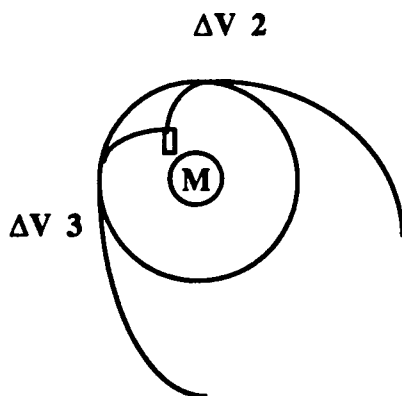

MARS CAPTURE/DEPARTURE & SHUTTLING

FIGURE 2.3: TRAJECTORIES FOR CONCEPTUAL DESIGN #3

2.3.2 Human Factors

In this report, the term "human factors" covers a wide range of systems and considerations for the crew, including but not limited to environmental control/life support systems (ECLSS) and consumables, thermal protection and control, extra-vehicular activity (EVA), health maintenance, crew activities, and psychology of an extended mission.

With the exception of the amount and mass of the consumables, these considerations will apply to any of the three conceptual designs. Mass and amount of consumables will vary with the time of flight necessary for the entire trip.

A "partially closed" life support system will be implemented on the final ship design. This means that the air and water will be recycled, but not the solid food. All food needed for the trip will be carried frozen, dehydrated, or stored dry.

Thermal control is concerned with maintaining an adequate temperature range for the personnel and equipment on board and will be achieved by means of circulating a working fluid through the area to be controlled. In the habitation areas this fluid will be air. For equipment that generates large amounts of excess heat, such as power generators and computers, the working fluid will be a liquid. The use of aerobraking will be considered as a transient event in determining the proper type of thermal control.

EVA will be carried out in spacesuits based on those currently in use by NASA. Each crew member should have access to one spacesuit, with one or two spares. There will be at least one airlock on board the ship for use in docking and/or exit to the outside environment.

Since the crew will only be in audio/video contact with Mission Control for a period of up to a year, the ship will need to carry more than just a year's worth of medicine. A Health Maintenance Facility (HMF) such as those designed for the Space Station will be used. The HMF will store drugs for caring for all types

of typical human maladies, as well as many kinds of conditions that would normally require transport back to Earth, such as any type of surgery. The correct combination of exercise, diet, and drugs may be able to offset bone demineralization, and a reduced workload during the first few days on the surface of Mars could ease the sudden transition from microgravity to 0.38 g.

The crew may find itself with some free time between duties and sleeping. With about a 150 day one-way trip, this time would be useful and invaluable for astronomical observations of all sorts, including X-ray, gamma ray, infrared, visual, etc. Other blocks of time may be used in mission simulations and planning.

The crew must not be allowed to be too overworked or stressed, as the mission depends on the mental and physical well-being of the astronauts. Special considerations must be made for the privacy and crowding of the crew. Areas should be designated for solitary and communal use, possibly with movable panels or furniture for a change in environment. Maximum visual access to the outside must be provided through the use of windows to reduce the possibility of claustrophobia or "cabin fever."

2.3.3 Power and Propulsion systems

2.3.3.1 Propulsion

For the constant thrust Nuclear Electric Rocket Vehicle Acceleration (NERVA) propulsion system, an accurate estimate of the power plant mass is influenced by the exhaust velocity required for the vehicle's engines. The optimum exhaust velocity must be determined so that the power plant mass will be as low as possible. This optimum velocity depends on "loss" velocity of the propellant, the characteristic velocity for the mission, and the mission Δv 's. The sizing process will allow an integration of the vehicle and trajectory design efforts.

A second propulsion system being considered is chemical. The technology

for this system has the advantage of being current and practical. The studies to optimize the system are mass-to-thrust ratios, total mass required for the system, and specific impulse of the propellant. Concerns with the chemical system are boiloff of liquid hydrogen, corrosive and toxic effects of other propellants, and the cost of lifting the large mass out of the Earth's gravity well.

Electrical propulsion is also under consideration using either the sun or a nuclear reactor as the source of the power. Again, mass, specific impulse, and total thrust will be considered. In addition, concerns with nuclear reactor electric propulsion (NEP) are additional mass for shielding, removability and serviceability of the core, and the feasibility of the multimegawatt reactor. Solar electric propulsion (SEP) studies will include solar power area arrays required for the various portions of the mission high specific impulses. Concerns with both systems being integrated with the mission are advancement of technology in this field to improve thruster efficiencies and larger mass flow rates to supply the larger thrust required for this mission.

2.3.3.2 Power Systems

The purpose of an onboard power system is to supply electrical power to the life support, navigation, communication, and computer systems on the space vehicle. There are essentially three types of power systems that can be used on space vehicles: nuclear, chemical, and solar. Each of these systems, including its benefits and drawbacks, is being studied to determine its applicability on a manned Mars mission.

Although nuclear power plants have high efficiencies and high power outputs, they have several major drawbacks that must be studied. Main drawbacks include the high mass of a nuclear reactor power plant and the need for extra radiation shielding between the reactor and the crew. Despite these drawbacks, radioisotope thermoelectric generators, have been used successfully on unmanned space missions and may prove to be useful on manned missions.

The chemical power systems being studied include fuel cells and batteries. Hydrogen-oxygen fuel cells, such as those used on the Space Shuttle, can produce water in addition to electrical power. The main disadvantage of these fuel cells is that they require hydrogen and oxygen fuel to operate, thus making them impractical for constant use on long duration missions. The batteries being studied include the relatively new sodium-sulfur and nickel-hydrogen batteries. The primary drawbacks with batteries are their high mass and limited power output. Currently, chemical power systems are being studied as backup systems for either nuclear or solar main power systems.

The two types of solar power systems being studied are photovoltaic cell and solar dynamic systems. Photovoltaic systems produce electricity by converting solar energy directly into a voltage but require large panels of photovoltaic cells to capture solar energy. Problem with photovoltaic systems include its inefficiency and the size and mass of the solar panels required to power a large spacecraft. Solar dynamic systems use solar energy to heat a fluid from which energy can then be extracted using a heat engine that operates on either a Rankine or Brayton thermodynamic cycle. Solar dynamic systems are more efficient than photovoltaic systems, but whether these systems are efficient enough for use on a Mars mission remains to be seen. Solar power systems may prove to be impractical due to the decrease in solar energy flux at Mars as compared to Earth.

There are many problems that must be studied before a power system can be chosen for a manned Mars mission, including the amount of waste heat generated by the different power systems and the mass of the various power systems. Finally, the power requirements of the vehicle must be determined before the proper power system can be chosen and sized for the vehicle.

2.3.4 Aerocapture

Aerobraking is the deceleration of a space vehicle through the use of

atmospheric braking. Although a mission involving aerocapture has never been flown, the concept has been proven theoretically possible. The only hardware that will be needed to perform aerocapturing is a heat shield to protect the ship.

The primary benefit of aerocapture is a reduction in the propellant mass required to complete a mission. Currently, the use of an aerobrake is being studied for use only in Conceptual Design 2.

After an extended period in microgravity, the crew may not be able to withstand the 2.4 to 5 g's experienced during aerocapture maneuvers, and so the use of aerobraking in conjunction with propulsive braking is being studied for capture into Mars orbit.

A possible drawback to the combined aero/ propulsive braking maneuver is that the mass of an aerobrake may be higher than the mass of the fuel required to perform a purely propulsive braking maneuver. Trade studies will determine which system is optimal. Another disadvantage is the size of the shield required to protect the entire ship as it enters the planet's atmosphere. Current thermal protection materials may be impractical, necessitating the creation of new materials before aerobraking can be used effectively. Additionally, a mission involving aerocapture would require a new guidance and control system capable of accounting for changes in predicted atmospheric conditions and capable of keeping the vehicle in a narrow atmospheric entry corridor.

All of these problems must be studied more extensively before a final decision on the use of aerocapture during a manned Mars mission can be made.

2.3.5 Shielding

Shielding protects the crew and ship from excessive doses of radiation and collisions with micrometeors. Excessive dosage is defined as being beyond the maximum lifetime dosage, and radiation levels will be assumed to be NASA-defined levels for the purposes of determining the amount of shielding necessary. Another consideration will be for the case of a solar flare or other

event that raises the radiation levels significantly above the norm. An area of the ship will be set aside as a "safe haven" shelter, where the shielding will be much greater. In addition to natural radiation, the radiation caused by such things as NERVA propulsion or a nuclear power supply will be considered.

Micrometeorite protection will be provided for by a shield mounted at the bow of the ship that will either deflect or stop the micrometeorite. One possibility is to mount a thick armor plate designed to stop the particles. Another scheme is a shield designed like a lance-head that would deflect the particles. Mass considerations will determine which design is best.

2.3.6 Artificial Gravity

This project will be considering a total trip duration time for the crew of approximately one year as a baseline. This includes a one-way trip time of about 150 days, and a stay time of about two months on and around the surface of Mars. Although there are many advantages and disadvantages to using artificial gravity, it was felt that the negative aspects of providing the gravity outweighed the positive ones.

Artificial gravity will be necessary for periods of prolonged weightlessness, chiefly to retard bone demineralization and decrease time required for exercise. Pseudo-gravity would also facilitate adaptation to Martian gravity [0.38 g] or allow for a gradual change from Earth to Mars gravity. Other factors in favor of providing gravity include conventionality in hygiene and health maintenance and ease of some mechanical systems.

Primary among the disadvantages are human and mechanical systems considerations. Coriolis forces caused by the rotating structure will produce disorientation and unknown effects due to gravity gradients across the human body. To offset these forces, the boom must be prohibitively long. Safety hazards of employing a spinning mechanism, such as nutation, wobbling, and material fatigue due to the rotating force, must also be considered. Mass

penalties will be incurred in providing spinup/ spindown propulsion, transportation elevators between modules, telescoping equipment for retractable booms, and locking and structural restraints. A spinning structure is difficult to adequately shield from solar and cosmic radiation, and any benefits of micro-g are negated. Additionally, a communications module must be despun from the spinning portion to point successfully and continually towards Earth.

This project recommends the use of gravity in the form of rotating, retractable booms only for those personnel on the "Barge," or slow cargo vehicle, who will remain in Mars orbit.

2.3.7 Guidance, Navigation, and Control

A navigational platform will be used for the guidance, navigation, and control aspects of the mission. This platform will include four star seekers and four planet seekers to provide for adequate redundancy. It will also have a precision timer and three accelerometers. The platform will use reaction torque gyros to seek the planets and will incorporate an ephemeris to aid in position determination. While on the interplanetary leg, this platform will line up with the ecliptic plane, and the spacecraft's orientation will be relative to this plane. Velocity will be found by the integration of the accelerometers' output and will be updated regularly using position sensors. The output from this platform will be used to make course corrections. During the planetary spirals, the platform will need to be parallel to the horizontal plane, or surface, of the planet. This requires four horizon scanners and one star tracker to maintain the required reference frame. This is necessary in order to determine the exact distance from the planet's surface.

2.3.8 Vehicle and Trajectory Integration

The engineers on this project are separated into two sections, vehicle design

and trajectory development. These groups work together, exchanging information about certain parameters relevant to both. These parameters are in the areas of propulsion, mass, and time of flight.

Trajectory designers will receive data concerning initial mass, fuel mass flow rate and engine performance (e.g., I_{sp}) from the vehicle engineers and in turn will calculate time of flight. The total mission time will affect shielding requirements, total fuel mass, total consumables mass (food, water, air), and crew health considerations (osteoporosis, immune system suppression, psychological impact, radiation exposure) for the vehicle design group.

The groups will repeat this iterative process until a design has been created that satisfies both vehicle and trajectory requirements.

2.4 Trajectory Analysis

2.4.1 Goals of Trajectory Analysis

The goals of the trajectory group are to develop three software packages in the areas of Lambert Targeting, Constant Thrust, and Patched Conics. These packages will then be used as tools for the trajectory analysis .

The analysis itself will study launch opportunities between 2000 and 2010 for flights to Mars (opposition class) while:

- Minimizing Time of Flight
- Maximizing Payload
- Providing for Free Return and Propulsion Assisted Abort Scenarios and Flyby Return Aborts

The software will also help provide information on trajectory limitations, Δv limits, and rocket engine/fuel requirements.

This software will be based on the assumptions that the orbits of Earth and Mars are circular and coplanar.

2.4.2 Lambert Targeting Analysis

Lambert Targeting Analysis will be used in calculating trajectories for vehicles using impulsive thrusting. Impulsive thrusting can be used in the flight between Earth and Mars as well as maneuvering between orbits around Earth or Mars. Given the initial position, final position, and transfer time, the Lambert software will yield a trajectory between the two points and the velocities in the transfer orbit at these points. Knowing the initial and final velocities, it is possible to determine Δv 's and thus the amount of fuel that a vehicle will require for such maneuvers. For this reason Δv 's will be restricted to the lowest values possible. Other constraints, however, may change fuel requirements so the lowest values may not be the best. Abort trajectories using impulsive thrusting will also be determined using Lambert targeting so that reserve fuel requirements can be determined for necessary Δv 's.

Elliptical transfers will be sought within Lambert's four possibilities with the central gravitational body (the Earth, Sun or Mars) at one focus. Choosing among the four possibilities involves picking the shortest route around the ellipse (less than 180° as opposed to greater than 180°). The assumptions made for the analyses are as follows:

1. Orbits are coplanar
2. The Sun is the primary gravitational body when targeting between Earth and Mars
3. Each planet is the primary gravitational body when targeting between orbits around the planet
4. Δv 's are applied instantaneously

By varying the departure date from Earth and transfer time, many sets of Δv values will be determined for the interplanetary trajectory. Data will be formatted either in tabular form or in the form of velocity contours, and these forms can be easily used to find the best Δv 's for any combination of the input parameters.

2.4.3 Constant Thrust

In Conceptual Design 1, the "Bus" vehicle will use a constant, low thrust propulsion system. The use of this system implies a spiralling trajectory leaving and returning to Earth in a geocentric coordinate system. Constant thrust will also be used during the heliocentric transfer to and from Mars. Software will be developed to give the position and velocity of the "Bus" at any time during the mission and will be used to determine the required time of flight and initial mass of fuel. The software will also be used to determine the Taxi-Bus docking characteristics, including the orbital transfer trajectory of the Taxi.

2.4.4 Patched Conic Analysis

The software utilized for this analysis will mainly aid in studying phases of the mission involving changes in coordinate systems. It will help determine relative positions and speeds in Earth and Mars coordinate systems and "absolute" positions and speeds in a Heliocentric system. Generally, the patched conic software will provide a continuity in the overall analysis.

3.0 Management Proposal

The Mars Company design staff is led by a Project Manager, a Trajectory Analysis Technical Director, and two Vehicle Analysis Technical Directors. Figure 3.1 shows the organizational structure of the company. The Project Manager's job is to control all administrative and planning functions, including maintaining contact with the Project Supervisor and keeping the project on schedule. The Technical Directors must make sure that all tasks in their analysis branches are being accomplished. In addition, they must resolve and report all problems encountered by the engineers involved in the project. Table 3.1 lists the employees of MARCO, their titles, and their project assignments.

3.1 Design Branches

The company has been split into a Vehicle Design Branch and a Trajectory Design Branch. The Vehicle Design Branch is responsible for studying vehicle systems and for deciding which system options would be most practical for a manned mission to Mars. This branch is studying the propulsion, power, life support, and other systems that will be used on the spacecraft. The Trajectory Design Branch is responsible for studying the possible trajectories for a fast (i.e. 100 to 150 day flight time going one way) trip to and from Mars. This branch will determine the departure dates, delta v's, times of flight, and other trajectory parameters for the mission.

3.2 Task Scheduling

Figure 3.2 shows the task schedule for the Vehicle Design Branch and Figure 3.3 shows the schedule for the Trajectory Design Branch. Figure 3.4 shows the critical design path being followed by the design teams.

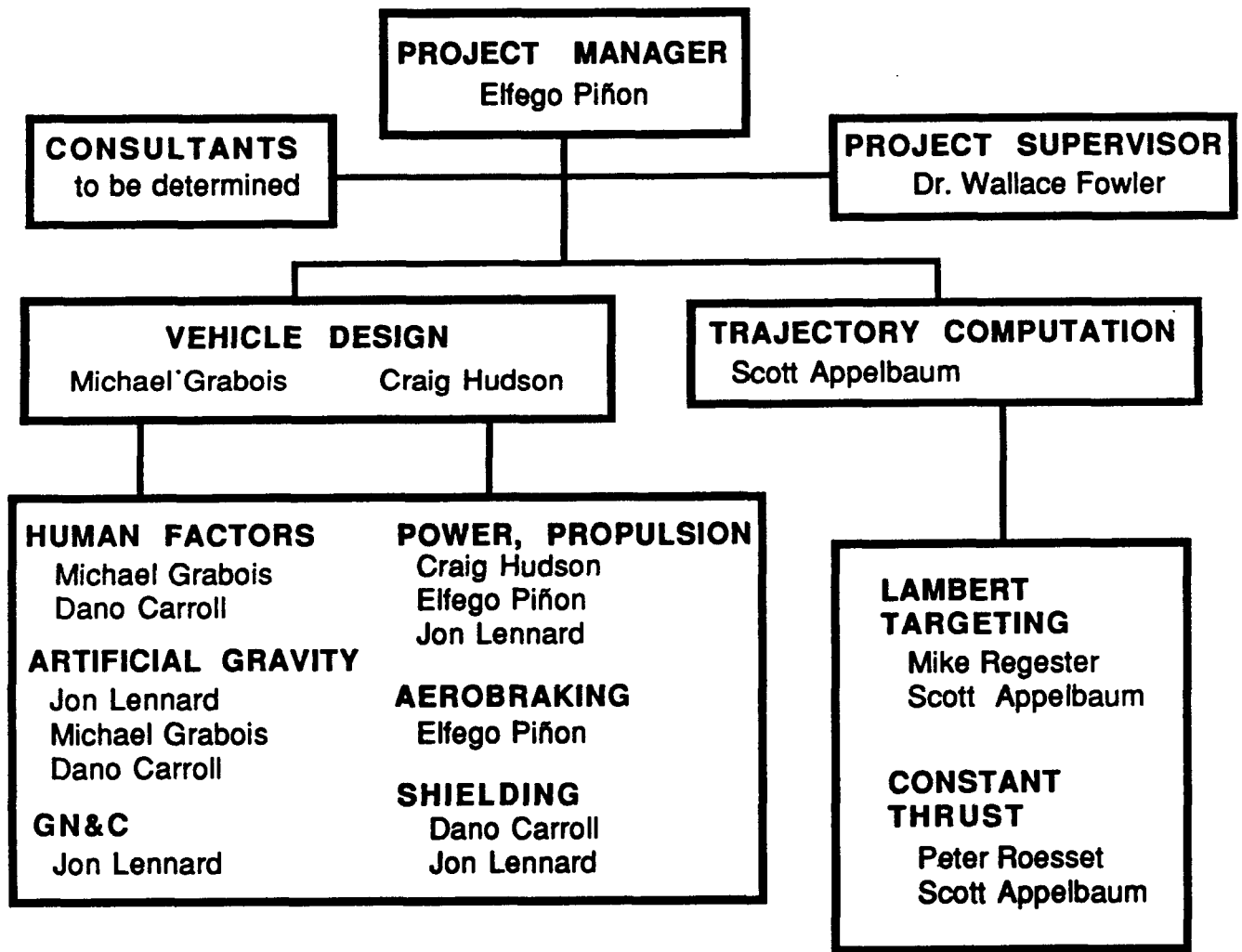
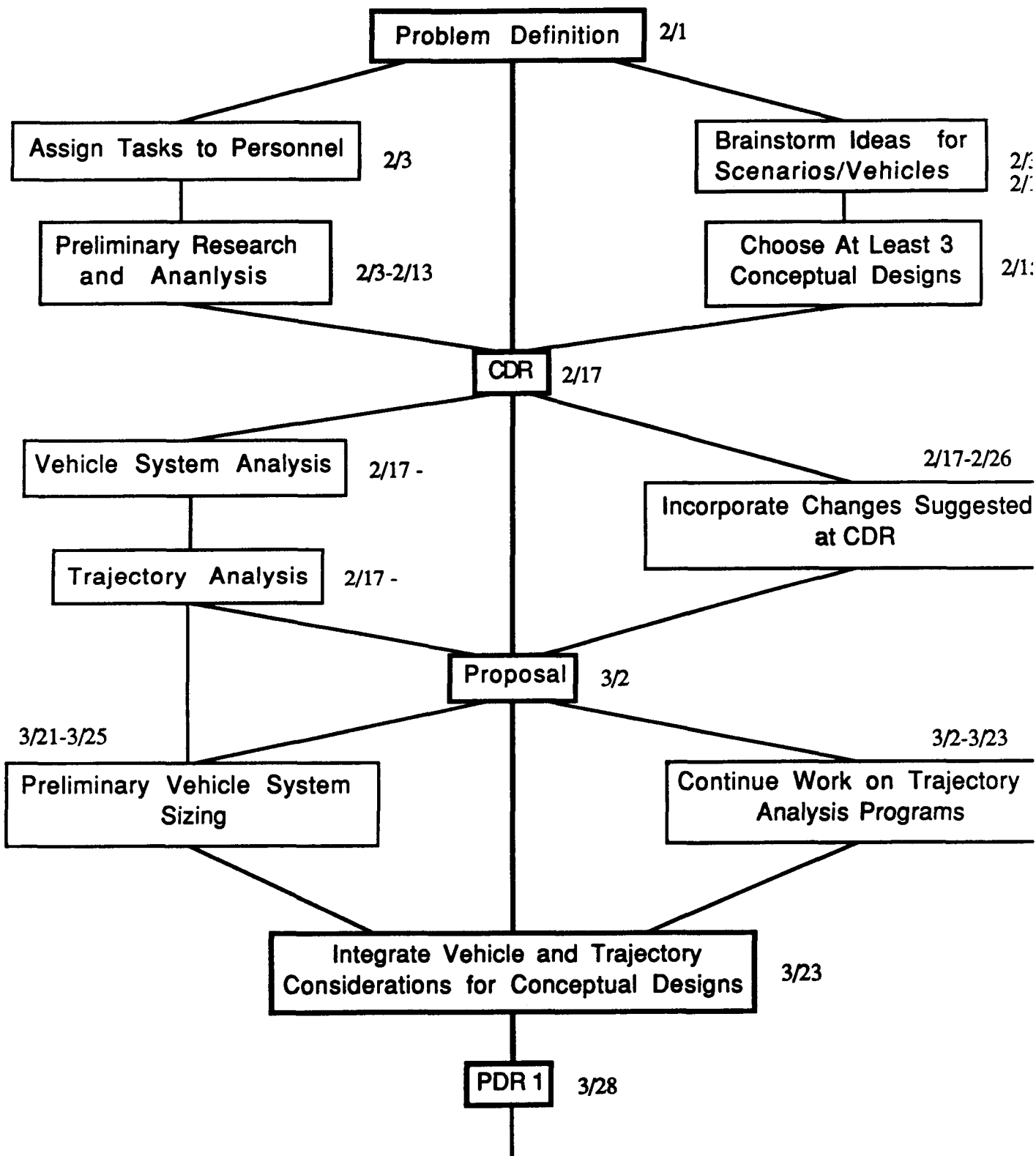

FIGURE 3.1: MARCO ORGANIZATIONAL CHART

Table 3.1: MARCO Design Team

<u>Employee Name</u> <u>Assignment</u>		<u>Title</u>
Scott Appelbaum	Trajectory Branch Technical Director	Trajectory Computation
Dano Carroll	Engineer	Spacecraft Shielding
Michael Grabois	Vehicle Branch Technical Director	Human Factors/Artificial Gravity
Craig Hudson	Vehicle Branch Technical Director	Propulsion/Power
Jon Lennard	Engineer	Propulsion/Shielding
Elfego Piñon	Project Manager	Power/Aerobraking
Michael Register	Engineer	Lambert Targeting
Peter Roesset	Engineer	Trajectory Computation



(Continued On Next Page)

Figure 3.4 (a): Critical Design Path

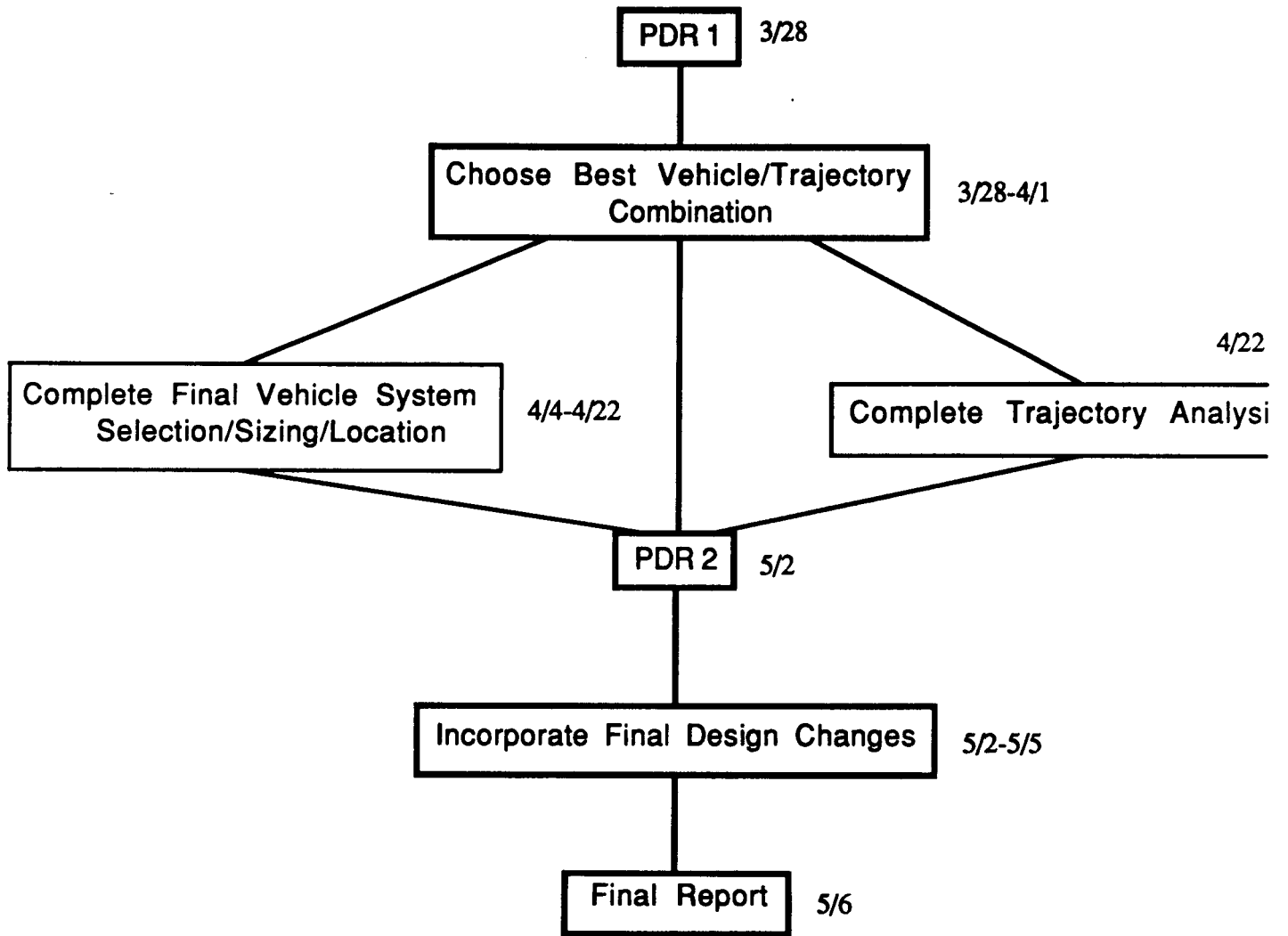

Figure 3.4 (b): Critical Design Path

4.0 Cost Proposal

The estimated personnel costs for the design project are outlined in section 4.1. The estimated hardware and software costs are tabulated in section 4.2. The total estimated cost of the design project is also given in section 4.2.

4.1 Personnel Cost Estimates

The salary figures used in the personnel cost estimates were taken from the RFP package. They are as follows:

Project Manager	\$25.00 /hr
Technical Director	\$22.00 /hr
Engineer	\$17.00 /hr
Technical Consultant	\$75.00 /hr

The estimated weekly costs are based on past design groups' estimates. They are as follows:

1 Project Manager	\$25.00/hr x 16hrs/wk	= \$ 400.00 /wk
3 Technical Directors	3 x \$22.00/hr x 16hrs/wk	= \$1056.00 /wk
4 Engineers	4 x \$15.00/hr x 12hrs/wk	= <u>\$ 720.00 /wk</u>
Total Weekly Cost Estimate		\$ 2176.00/wk

The total estimated personnel costs for the project are based on 14 weeks of actual work. The final figures are:

14 weeks of work @	\$2176.00/wk =	\$30464.00
20 hours of consulting @	\$75.00 /hr =	\$ 1500.00
Total		\$31964.00
10% cost error estimate		<u>\$ 3196.40</u>
Total Personnel Cost Estimate		\$35160.40
FINAL PERSONNEL COST ESTIMATE:		\$35200.00

4.2 Computer/Materials Cost Estimates

Hardware and software cost estimates were also based on past design groups estimates.

Computer related costs:

Apple Macintosh Rental	\$1200.00
IBM PC-AT Rental	\$ 600.00
Software	\$ 50.00
Cyber System Time	\$ 500.00
Cyber System Supplies	<u>\$ 40.00</u>
Total Computer Cost Estimate	\$2390.00

Presentation/Miscellaneous Supplies:

Photocopies (@ 5¢ each)	\$ 250.00
Transparencies (@ 50¢ each)	<u>\$ 90.00</u>
Total Materials Cost Estimate	\$ 340.00

Total Computer/Materials Cost Estimate: \$ 2730.00

10% Error Estimate: \$ 273.00

Final Computer/Materials Cost Estimate: \$3003.00

TOTAL ESTIMATED PROJECT COST: \$38,000.00

5.0 BIBLIOGRAPHY

Trajectory design

Bate, Roger R., et al. Fundamentals of Astrodynamics. Dover Publications: New York, 1971.

Breakwell, J.V., et al. "Researches in Interplanetary Transfer," ARS Journal, vol. 3, no. 2, Feb 1961, p. 201-207.

Fowler, Wallace T. ASE 166M Course Notes, Packets 1 and 2. Kinko's Copies: Austin, TX, Fall 1987.

Galecki, Diane and Micheal J. Patterson. Nuclear Powered Mars Cargo Transport Mission Utilizing Advanced Ion Propulsions. Lewis Research Center: Cleveland, OH, 1987.

Jordan, James F. "Application of Lambert's Theorem to the Solution for Interplanetary Transfer Problems," Jet Propulsion Laboratory report TR-32-521. JPL: Pasadena, CA, 1964.

Planetary Flight Handbook, vol. III, parts 1, 2, and 3 (NASA SP-35). NASA Scientific and Technical Information Branch: Washington, D.C., 1963.

Ruffa, Gregory J. and Bruce M. Cordell. Performance of Electric / Chemical Combination for Manned Mars Missions. General Dynamics Space Systems Division : San Diego, CA, 1987.

Vehicle design

Bilby, Curt. "Extraterrestrial Infrastructure Design Projects." American Astronautical Society publication AAS-86-309, preprint of "33rd Annual Meeting of Aerospace: Century XXI," AAS Publications Office: San Diego, CA, Oct. 1987.

Cheston, T. Stephen and David L. Winter, eds. Human Factors of Outer Space Production (AAAS Selected Symposium 50). Westview Press, Inc.: Boulder, CO, 1980.

Massachusetts Institute of Technology 1986 Space Systems Engineering Class. Mars: A Program for its Exploration and Development, vol. II. MIT: Boston, MA, 1986.

McKay, Christopher P., ed. The Case for Mars II, vol 62: Science and Technology Series. AAS: San Diego, CA, 1985.

Nicogossian, Arnauld E. and James F. Parker. Space Physiology and Medicine (NASA SP-447). NASA Scientific and Technical Information Branch: Washington, D.C., 1982.

Oberg, James E. Mission to Mars. New American Library: New York City, 1982.

Science Applications International Corp. Piloted Sprint Missions to Mars (Report no. SAIC-87/1908, study no. 1-120-449-M26). SAIC: Schaumburg, IL, Nov. 1987.

6.0 List Of Acronyms

CTV	-	Crew Transfer Vehicle
ECLSS	-	Environmental Control/Life Support Systems
EVA	-	Extra-Vehicular Activities
HMF	-	Health Maintenance Facilities
HMO	-	High Mars Orbit
I_{sp}	-	Specific Impulse
LEO	-	Low Earth Orbit
LMO	-	Low Mars Orbit
MARCO	-	the Mars Company
NASA	-	National Aeronautics and Space Administration
NEP	-	Nuclear Electric Propulsion
NERVA	-	Nuclear Electric Rocket Vehicle Acceleration
NSO	-	Nuclear Safe Orbit
OTV	-	Orbital Transfer Vehicle
RTG	-	Radio-isotope Thermoelectric Generator
SEP	-	Solar Electric Power
SRB	-	Solid Rocket Booster