

NASA Technical Memorandum 101480

# Cruise Noise of the SR-2 Propeller Model in a Wind Tunnel

(NASA-TM-101480) CRUISE NOISE OF THE SR-2  
PROPELLER MODEL IN A WIND TUNNEL (NASA.  
Lewis Research Center) 29 p CSCL 20A

N89-24886

Unclas  
G3/71 0204417

James H. Dittmar  
*Lewis Research Center*  
*Cleveland, Ohio*

April 1989

**NASA**

# CRUISE NOISE OF THE SR-2 PROPELLER MODEL IN A WIND TUNNEL

James H. Dittmar  
National Aeronautics and Space Administration  
Lewis Research Center  
Cleveland, Ohio 44135

## SUMMARY

Noise data on the SR-2 model propeller were taken in the NASA Lewis Research Center 8- by 6-Foot Wind Tunnel. The maximum blade passing tone rises with increasing helical tip Mach number to a peak level at a helical tip Mach number of about 1.05; then it remains the same or decreases at higher helical tip Mach numbers. This behavior, which has been observed with other propeller models, points to the possibility of using higher propeller tip speeds to limit airplane cabin noise while maintaining high flight speed and efficiency. Noise comparisons of the straight-blade SR-2 propeller and the swept-blade SR-7A propeller showed that the tailored sweep of the SR-7A appears to be the cause of both lower peak noise levels and a slower noise increase with increasing helical tip Mach number.

## INTRODUCTION

Advanced turboprop-powered aircraft offer the potential for significant fuel savings over equivalent core technology turbofan-powered aircraft. The noise from advanced high speed propellers is of present concern since at cruise it may pose an environmental problem in the airplane cabin. A number of model propellers have previously been tested for acoustics by using pressure transducers embedded in the ceiling of the NASA Lewis 8- by 6-Foot Wind Tunnel (refs. 1 to 5). The noise of the large-scale advanced propfan (LAP) model propeller, SR-7A, was measured in this wind tunnel by embedding pressure transducers in a plate suspended from the tunnel ceiling (refs. 6 and 7). The use of this plate permits better angular determination of the propeller directivity and, because of the thinner plate boundary layer, less boundary layer refraction than the wall measurements. The thickness-to-wavelength ratio for the plate boundary layer-to-model propeller sound is closer to that of the fuselage boundary layer-to-full size propeller-in-flight sound than is that of the ceiling boundary layer-to-model propeller sound. Therefore, the data from the plate can more easily be scaled to airplane conditions.

During the testing of the swept SR-7A model (refs. 6 and 7), a limited amount of data on the straight-blade SR-2 propeller model was taken. By using the suspended plate, data with better resolution and less boundary layer refraction than the previously taken SR-2 data (ref. 1) was obtained. The data were intended to show how the SR-2 propeller noise varies with helical tip Mach number and, by comparison with the SR-7A data, the effect of sweep on propeller noise. This report presents the results of the SR-2 testing.

## APPARATUS AND PROCEDURE

The SR-2 propeller, which is a straight-blade propeller nominally 62.2 cm (24.5 in.) in diameter, was tested for acoustics in the NASA Lewis 8- by 6-Foot

Wind Tunnel. Table I shows some of the design characteristics of this propeller. A plan view of the wind tunnel is shown in figure 1(a), and a photograph of the SR-2 propeller in the test section is shown in figure 1(b). The propeller was tested at its nominal design blade setting angle of  $59^\circ$ , measured at the  $3/4$  radius location. The propeller was operated at nominal advance ratios ranging from 2.75 to 3.85 for tunnel Mach numbers from 0.6 to 0.8, and at nominal advance ratios ranging from 3.06 to 3.65 for tunnel Mach numbers of 0.85 and 0.9.

A plate was firmly attached to the tunnel ceiling, 0.3 propeller diameters from the propeller tip, and transducers were installed flush with the plate surface to measure the noise of the propeller. A photograph of this plate with the SR-7A propeller (refs. 6 and 7) is shown in figure 2(a), and a sketch of the installed plate is shown in figure 2(b). Twelve transducers were installed on the plate centerline, which was directly above the propeller centerline. The transducers' locations are shown in figure 2(b). The signals from the pressure transducers were recorded on magnetic tape, and narrowband spectra were obtained for each of the test points. Typically, the narrowband range was 0 to 10 000 Hz with a bandwidth of 32 Hz.

## RESULTS AND DISCUSSION

Noise data were taken for the experimental test conditions listed in table II. The advance ratio  $J$ , the power coefficient  $C_p$ , and the helical tip Mach number  $M_{ht}$  are presented in this table. Some limited additional aerodynamic data from previous testing is available in reference 8. The acoustic data for the first eight harmonics of the propeller blade passing tone are presented, as measured, in tables III to IX.

### Noise Variation with Helical Tip Mach Number

The propeller was tested at a fixed blade setting angle of  $59^\circ$  for all the various tunnel axial Mach numbers. The peak blade passing tones measured on the plate were plotted as a function of helical tip Mach numbers (see fig. 3). These plots are at a constant advance ratio, so the helical tip Mach number was varied by changing the propeller tip speed and tunnel Mach number. Data for five advance ratios were plotted.

As figure 3 shows, the maximum blade passing tone rises with increasing helical tip Mach number to a peak level; then it remains the same or decreases with increasing helical tip Mach numbers. This behavior has been observed previously, particularly with the swept-blade SR-7A propeller model (refs. 6 and 7). This same noise variation for the straight-blade SR-2 propeller implies that faster rotating propellers may be useful as a method to limit cabin noise while maintaining high flight speed and efficiency.

At some conditions a hump, consisting of the peak, a reduction from the peak, and then an increase with further increases in helical tip Mach number, is seen in the curve, (refs. 6 and 7). This hump is shown in figure 3(b) for an advance ratio of 3.5. As noted in references 6 and 7, the hump may represent a different noise mechanism. Two of the possibilities proposed were a "quadrupole noise" (ref. 9) and shock wave pressure rise (ref. 10). Another

possibility, presented by Hanson in reference 11, is that the flow around the propeller tip changes the noise production in this region.

### Directivity

Blade passing tone levels as functions of angular position (i.e., directivities) for the SR-2 propeller are shown in figure 4 for the design advance ratio ( $J = 3.06$ ) condition at the seven Mach numbers tested. The peak noise levels occur at or just behind the plane of rotation.

The directivities at most of the Mach numbers are similar in shape, with a noted exception at  $M = 0.7$  where the directivity is much flatter. At  $M = 0.7$  the forward noise is higher than at either  $M = 0.65$  or  $M = 0.75$ , and the noise at the forward-most position of around  $50^\circ$  is higher than at any other Mach number. A similar observation was made for the SR-7A propeller (figs. 6 and 7). For both of these propellers, the helical tip Mach number at  $M = 0.7$  was approximately 1.0, so the forward noise increase may be some transient transonic effect. Since the far-forward noise levels are higher at  $M = 0.7$  than at any other Mach number, this may cause a cabin noise peak at far-forward angles during an airplane acceleration to  $M = 0.8$  cruise.

### Comparison with Previous SR-2 Data

Four pressure transducers embedded in the tunnel ceiling (ref. 1) were previously used to gather limited experimental data on the SR-2 propeller at a blade setting angle. In those experiments the propeller was tested only at its design condition; that is, an advance ratio equal to 3.06 and a tunnel Mach number equal to 0.8. Figure 5 shows the four transducer blade passing tones on the present directivity plot. The data from reference 1 were corrected (1) by adding 6 dB to compensate for the calibration error identified in reference 4 and (2) by using  $20 \log$  of the distance from the propeller centerline to adjust the ceiling data to the plate position - an addition of 8 dB to the data noted in reference 4. The effect of boundary layer refraction on the forward transducers is seen in figure 5. The data from the two forward transducers show lower noise levels than the plate data because of the refraction. Reference 4 noted that for aft angles greater than about  $60^\circ$  there is little or no refraction. Here, the ceiling and plate aft data agree very well. For the initial data of reference 1, only four transducers were used; obviously, this set of data missed the peak noise level because there was no transducer at  $100^\circ$ .

### Comparison with SR-7A Data

Noise variation with helical tip Mach number. - The SR-7A propeller's (refs. 6 and 7) leading edge sweep was tailored to provide a noise reduction at the cruise condition (i.e.,  $M = 0.8$  and  $J = 3.06$ ). Comparison of the SR-7A propeller noise with that of the straight blade SR-2 propeller yields a measure of the noise reduction due to the tailored sweep. At design blade setting angles of  $60.1^\circ$  for the SR-7A and  $59^\circ$  for the SR-2, the propeller had similar aerodynamic performances. See, for example, the curves of the power coefficient  $C_p$  as a function of tunnel Mach number, for the SR-2 at  $59^\circ$  and for

the three tested SR-7A blade setting angles, shown in figure 6 for an advance ratio of 3.06. Figure 7 compares the variation of noise with helical tip Mach number for the two propellers for advance ratios of 3.75, 3.5, 3.25, 3.06, and 2.75.

The SR-7A propeller shows less peak blade passing tone noise at all of the advance ratios shown in figure 7, with a maximum difference of about 5 dB at the design advance ratio of 3.06 and helical tip Mach number of 1.1. In most cases the noise for the two propellers starts at about the same level at the lower helical tip Mach numbers. The SR-7A noise rises more slowly as the helical tip Mach number increases, and reaches a lower peak level than the SR-2 propeller noise. The tailored sweep of the SR-7A propeller apparently caused the slower noise increase with speed and the lower peak value.

A previous comparison of the SR-2 propeller and a swept SR-3 propeller showed the noise advantage of the swept propeller extends to a lower Mach number than is shown here for SR-7A (fig. 11 of ref. 1). In figure 6 the SR-7A is shown to have a somewhat higher power coefficient at the lower Mach numbers than does the SR-2. This higher power may be causing a higher loading noise level for the SR-7A, thus masking the sweep advantage at the lower Mach numbers. At the other end of the Mach number range, the SR-7A noise approaches the SR-2 levels at the high helical tip Mach numbers (fig. 7(d),  $M_{ht} = 1.29$ ).

Directivity comparisons. - Comparisons of the SR-7A and SR-2 blade passing tone directivities are shown in figure 8 for the 3.06 design advance ratio at the seven Mach numbers tested.

In general, the directivities for the two propellers have the same shape. At the lower axial Mach numbers,  $M = 0.6$  to  $M = 0.8$ , the SR-2 noise level peaks at a location slightly forward of that of the SR-7A propeller. This might be expected since the SR-7A's swept blades move its tip sections downstream with respect to the SR-2 tip sections. However, at the  $M = 0.85$  axial Mach number, the peak noise location of the SR-7A is slightly forward, and at  $M = 0.9$  significantly forward, of that of the SR-2. The peak noise location for the SR-7A propeller remained at about  $100^\circ$  for the  $M = 0.8$ ,  $0.85$ , and  $0.90$  test conditions, but that of the SR-2 propeller moved rearward from about  $100^\circ$  at  $M = 0.8$  to about  $110^\circ$  at  $M = 0.9$ . A possible explanation for this shift to the rear is related to the shock wave on the SR-2 leading edge. Reference 12 notes such a leading edge shock on the SR-2 blade at these high helical tip Mach numbers, whereas none was exhibited by a swept-blade SR-3, which is similar to the SR-7A. The shift in location of the peak for the SR-2 directivity may be due to this shock front angling more downstream as the Mach number increases. The SR-7A, presumably lacking the leading edge shock, does not exhibit the peak location change.

Harmonics. - The relative levels of the blade passing tone harmonics with respect to the fundamental are also of interest. As was shown in references 6 and 7 for the SR-7A propeller, figure 9 is the plot of the relative levels of the harmonics at  $M = 0.8$  and  $J = 3.06$  (design) with respect to the fundamental at the maximum noise position - transducer number 7 ( $100^\circ$ ). Although individual harmonics differ somewhat, particularly harmonic number 2, the slopes of the general decline in noise with increasing harmonic number are approximately

the same (about 6 dB/harmonic) for both propellers. In general, the harmonic decay is more complex for the SR-7A than for the SR-2.

#### CONCLUDING REMARKS

Noise data on the straight blade SR-2 propeller model were taken in the NASA Lewis 8- by 6-Foot Wind Tunnel. The propeller was tested at its design blade setting angle at seven tunnel Mach numbers and five advance ratios. The maximum blade passing tone occurs in the 100° to 110° range and, at constant advance ratio, rises with increasing helical tip Mach number to a peak level at around 1.05 helical tip Mach number; then it remains the same or decreases with increasing helical tip Mach numbers. This behavior, which has been observed with other propeller models, implies that using faster rotating propellers may be a method of limiting cabin noise while maintaining high flight speed and efficiency.

Noise comparisons of the straight-blade SR-2 propeller and the swept-blade SR-7A propeller showed that the tailoring of the SR-7A sweep appears to have resulted in lower peak noise levels and slower noise increases with increasing helical tip Mach numbers. Comparison of plots of relative levels of the blade passing tone harmonics with respect to the fundamental at 100° as a function of increasing harmonic number showed about the same slope for the two propellers at the design condition.

#### REFERENCES

1. Dittmar, J.H.; Jeracki, R.J.; and Blaha, R.J.: Tone Noise of Three Supersonic Helical Tip Speed Propellers in a Wind Tunnel. NASA TM-79167, 1979.
2. Dittmar, J.H.; and Jeracki, R.J.: Additional Noise Data on the SR-3 Propeller. NASA TM-81736, 1981.
3. Dittmar, J.H.; Stefko, G.L.; and Jeracki, R.J.: Noise of the 10-Bladed, 60° Swept SR-5 Propeller in a Wind Tunnel. NASA TM-83054, 1983.
4. Dittmar, J.H.; Burns, R.J.; and Leciejewski, D.J.: An Experimental Investigation of the Effect of Boundary Layer Refraction on the Noise from a High-Speed Propeller. NASA TM-83764, 1984.
5. Dittmar, J.H.: Preliminary Measurement of the Noise from the 2/9 Scale Model of the Large-Scale Advanced Propfan (LAP) Propeller, SR-7A. NASA TM-87116, 1985.
6. Dittmar, J.H.; and Stang, D.B.: Cruise Noise of the 2/9th Scale Model of the Large-Scale Advanced Propfan (LAP) Propeller, SR-7A. NASA TM-100175, 1987.
7. Dittmar, J.H.; and Stang, D.B.: Cruise Noise of the 2/9 Scale Model of the Large-Scale Advanced Propfan (LAP) Propeller, SR-7A. AIAA Paper 87-2717, Oct. 1987.
8. Mikkelsen, D.C, et al.: Design and Performance of Energy Efficient Propellers for Mach 0.8 Cruise. NASA TM-X-73612, 1977 (SAE Paper 770458).

9. Hanson, D.B.; and Fink, M.R.: The Importance of Quadrupole Sources in Prediction of Transonic Tip Speed Propeller Noise. J. Sound Vibr., vol. 62, no. 1, Jan. 8, 1979, pp. 19-38.
10. Dittmar, J.H.; and Rice, E.J.: A Shock Wave Approach to the Noise of Supersonic Propellers. NASA TM-82752, 1981.
11. Hanson, D.B.: Propeller Noise Caused by Blade Tip Radial Forces. AIAA Paper 86-1892, July 1986.
12. Brooks, B.M.; and Metzger, F.B.: Acoustic Test and Analyses of Three Advanced Turboprop Models. NASA CR-159667, 1972.

TABLE I. - SR-2 PROPELLER DESIGN CHARACTERISTICS

Diameter, cm (in.) . . . . .	62.2 (24.5)
Number of blades . . . . .	8
Design Mach number . . . . .	0.80
Design tip speed, m/sec (ft/sec) . . . . .	244 (800)
Design advance ratio . . . . .	3.06
Design power coefficient . . . . .	1.7
Design power loading kW/m <sup>2</sup> (hp/ft <sup>2</sup> ) . . . . .	301 (37.5)
Activity factor . . . . .	203
Blade setting angle, deg . . . . .	59



TABLE II. - TEST CONDITIONS  
 [Blade setting angle equals 59°.]

Axial Mach number	Advance ratio, J	Helical tip Mach number, $M_{ht}$	Power coefficient, $C_p$
0.90	3.63	1.192	(a)
	3.5	1.209	0.292
↓	3.25	1.250	.786
	3.06	1.289	1.047
	3.70	1.115	(a)
0.85	3.5	1.143	.502
	3.25	1.182	1.022
↓	3.06	1.217	1.335
	3.84	1.034	(a)
	3.75	1.042	.182
0.80	3.5	1.074	.685
	3.25	1.111	1.187
	3.06	1.147	1.514
	2.84	1.191	1.834
↓	3.84	.968	(a)
	3.75	.978	.190
0.75	3.5	1.006	.673
	3.25	1.043	1.143
	3.06	1.074	1.512
	2.75	1.140	2.015
↓	3.84	.904	(a)
	3.75	.915	.174
0.70	3.5	.940	.630
	3.25	.974	1.092
	3.06	1.004	1.432
	2.75	1.061	2.024
↓	3.84	.838	(a)
	3.75	.845	.165
0.65	3.5	.870	.615
	3.25	.901	1.042
	3.06	.928	1.359
	2.75	.980	1.912
↓	3.85	.773	(a)
	3.75	.782	.186
0.60	3.5	.805	.619
	3.25	.833	1.025
	3.06	.857	1.320
	2.75	.907	1.816

<sup>a</sup>Windmill.

TABLE III. - ACOUSTIC DATA FOR FIRST EIGHT HARMONICS AT MACH 0.9

Harmonic number	Transducer											
	1	2	3	4	5	6	7	8	9	10	11	12
	Sound pressure level of harmonic, SPL, dB, ref. $2 \times 10^{-5}$ N/m <sup>2</sup>											
Advance ratio J = 3.06												
a <sub>1</sub>	(b)	(c)	(c)	139.0	149.0	149.5	159.0	161.0	162.0	161.0	161.0	153.5
2	---	---	---	(c)	142.0	146.0	154.0	157.0	160.0	152.5	144.5	146.5
3	---	---	---	---	134.0	142.0	150.0	153.0	153.0	149.0	150.5	134.0
4	---	---	---	---	126.5	139.0	148.5	151.0	151.0	146.0	146.0	131.0
5	---	---	---	---	(c)	136.0	146.0	148.0	146.0	132.5	143.0	132.0
6	---	---	---	---	---	134.0	144.0	146.0	142.5	132.5	131.5	136.0
7	---	---	---	---	---	131.0	142.0	143.5	141.0	139.0	136.5	129.0
8	---	---	---	---	---	128.0	139.5	142.0	137.5	130.0	137.0	131.0
Advance ratio J = 3.25												
a <sub>1</sub>	(b)	(c)	(c)	142.5	150.5	151.5	160.0	161.0	161.0	159.5	159.0	147.0
2	---	---	---	(c)	142.0	146.0	153.5	155.0	156.0	149.0	148.0	134.5
3	---	---	---	---	134.5	144.0	150.5	153.5	149.5	148.0	146.0	143.5
4	---	---	---	---	128.5	141.5	148.5	151.0	144.0	145.0	142.5	139.0
5	---	---	---	---	(c)	138.0	145.0	147.0	141.0	141.0	144.5	132.0
6	---	---	---	---	---	135.5	144.0	146.0	137.0	134.0	141.0	129.0
7	---	---	---	---	---	133.5	143.0	144.5	138.5	128.0	136.0	125.0
8	---	---	---	---	---	131.0	140.0	142.0	133.5	132.5	(c)	126.5
Advance ratio J = 3.5												
a <sub>1</sub>	(b)	(c)	(c)	144.5	151.0	153.5	159.5	160.0	159.0	156.0	155.5	141.5
2	---	---	---	(c)	143.5	147.0	153.0	154.0	149.0	150.5	150.5	143.0
3	---	---	---	---	138.5	145.0	151.0	151.0	142.5	135.5	139.5	141.0
4	---	---	---	---	131.5	142.5	148.5	148.0	140.0	136.0	135.0	139.0
5	---	---	---	---	126.0	139.5	145.5	145.0	138.5	138.0	133.0	135.0
6	---	---	---	---	(c)	138.0	145.0	143.0	131.5	137.5	135.0	131.5
7	---	---	---	---	---	136.0	143.5	142.0	125.0	136.0	137.0	130.0
8	---	---	---	---	---	133.0	142.0	139.0	124.5	132.0	133.0	127.0

<sup>a</sup>Blade passing frequency.

<sup>b</sup>Transducer not functioning.

<sup>c</sup>Not visible above tunnel background noise.

TABLE IV. - ACOUSTIC DATA FOR FIRST EIGHT HARMONICS AT MACH 0.85

Harmonic number	Transducer											
	1	2	3	4	5	6	7	8	9	10	11	12
	Sound pressure level of harmonic, SPL, dB, ref. $2 \times 10^{-5}$ N/m <sup>2</sup>											
Advance ratio $J = 3.06$												
a <sub>1</sub>	(b)	(c)	(c)	143.5	152.0	155.5	161.5	163.0	163.0	161.5	153.0	144.0
2	---	---	---	(c)	141.5	148.0	157.0	158.5	153.0	144.5	147.0	144.0
3	---	---	---	-----	133.5	146.5	155.0	157.0	147.5	149.5	145.5	137.0
4	---	---	---	-----	(c)	143.5	152.0	152.0	147.0	138.0	145.0	133.0
5	---	---	---	-----	-----	139.0	149.0	148.5	137.5	138.0	137.0	130.0
6	---	---	---	-----	-----	137.0	147.5	147.0	135.0	141.0	134.0	(c)
7	---	---	---	-----	-----	134.0	146.0	144.5	132.5	138.0	135.0	-----
8	---	---	---	-----	-----	130.0	142.5	142.0	127.5	129.0	133.0	-----
Advance ratio $J = 3.25$												
a <sub>1</sub>	(c)	(c)	(c)	143.0	152.5	156.0	160.5	161.0	159.5	153.0	154.5	142.0
2	---	---	---	(c)	145.0	149.5	158.0	158.0	148.0	146.0	147.5	138.0
3	---	---	---	-----	137.5	147.5	154.0	152.5	148.0	145.0	135.5	135.0
4	---	---	---	-----	(c)	144.0	152.0	146.0	141.0	143.0	140.0	132.5
5	---	---	---	-----	-----	141.5	150.0	144.0	136.0	134.0	139.5	(c)
6	---	---	---	-----	-----	138.0	147.0	136.0	136.0	130.0	133.5	-----
7	---	---	---	-----	-----	135.5	146.0	137.5	130.0	136.0	127.0	-----
8	---	---	---	-----	-----	133.5	144.0	133.0	129.5	134.5	124.0	-----

<sup>a</sup>Blade passing frequency.

<sup>b</sup>Transducer not functioning.

<sup>c</sup>Not visible above tunnel background noise.

TABLE IV. - Concluded.

Harmonic number	Transducer											
	1	2	3	4	5	6	7	8	9	10	11	12
	Sound pressure level of harmonic, SPL, dB, ref. $2 \times 10^{-5}$ N/m <sup>2</sup>											
Advance ratio $J = 3.5$												
a <sub>1</sub>	(c)	(c)	(c)	143.0	152.5	157.5	157.5	156.5	153.5	151.0	145.0	144.5
2	---	---	---	(c)	144.5	151.0	154.5	152.5	143.0	144.5	137.0	139.0
3	---	---	---	-----	139.5	146.5	149.0	137.0	146.5	138.0	138.5	(c)
4	---	---	---	-----	133.5	144.0	148.0	138.0	136.0	142.0	132.0	-----
5	---	---	---	-----	(c)	142.0	144.5	140.0	125.0	139.5	137.5	-----
6	---	---	---	-----	-----	140.0	142.5	133.0	137.0	132.5	136.0	-----
7	---	---	---	-----	-----	137.0	140.0	133.0	135.0	123.0	132.0	-----
8	---	---	---	-----	-----	134.0	137.5	124.5	130.0	127.0	127.0	-----
Advance ratio $J = 3.70$												
a <sub>1</sub>	(c)	(c)	(c)	146.0	152.5	158.5	156.5	155.5	150.5	151.0	147.5	149.0
2	---	---	---	(c)	145.0	151.5	155.0	153.0	145.0	138.5	142.0	138.5
3	---	---	---	-----	140.5	148.5	148.0	137.0	146.0	139.5	136.5	(c)
4	---	---	---	-----	132.5	144.0	141.0	140.0	141.5	135.5	129.0	135.0
5	---	---	---	-----	(c)	141.5	140.5	132.0	137.0	137.0	131.5	131.0
6	---	---	---	-----	-----	140.0	132.0	135.0	129.0	137.0	133.0	131.5
7	---	---	---	-----	-----	136.0	135.0	126.0	132.0	130.0	131.0	(c)
8	---	---	---	-----	-----	135.0	131.0	(c)	133.5	(c)	129.0	-----

<sup>a</sup>Blade passing frequency.

<sup>b</sup>Transducer not functioning.

<sup>c</sup>Not visible above tunnel background noise.

TABLE V. - ACOUSTIC DATA FOR FIRST EIGHT HARMONICS AT MACH 0.80

Harmonic number	Transducer											
	1	2	3	4	5	6	7	8	9	10	11	12
	Sound pressure level of harmonic, SPL, dB, ref. $2 \times 10^{-5}$ N/m <sup>2</sup>											
Advance ratio J = 2.84												
a <sub>1</sub>	142.0	144.0	144.0	151.5	156.0	162.0	166.0	166.0	163.0	160.0	160.0	150.5
2	(c)	(c)	(c)	138.5	149.5	158.0	162.0	159.0	146.0	154.5	152.0	145.0
3	-----	-----	-----	(c)	141.5	153.5	157.5	151.0	145.5	139.0	137.0	141.5
4	-----	-----	-----	-----	136.0	151.5	155.5	144.0	134.5	138.5	143.0	136.0
5	-----	-----	-----	-----	130.0	146.5	151.0	139.5	133.5	133.0	131.0	130.5
6	-----	-----	-----	-----	(c)	145.5	150.5	138.5	140.0	130.5	136.0	129.0
7	-----	-----	-----	-----	-----	142.0	137.0	134.5	134.0	126.0	132.0	129.0
8	-----	-----	-----	-----	-----	140.5	136.5	132.0	131.0	127.0	125.5	125.0
Advance ratio J = 3.06												
a <sub>1</sub>	142.0	142.0	145.0	152.5	157.0	162.0	165.5	165.0	162.0	159.5	158.0	153.5
2	(c)	(c)	(c)	142.5	150.0	158.0	158.0	151.5	152.5	149.5	150.5	140.5
3	-----	-----	-----	(c)	143.5	153.0	151.5	144.5	139.0	139.0	139.5	139.5
4	-----	-----	-----	-----	139.0	150.5	145.0	136.5	142.5	134.5	137.5	135.5
5	-----	-----	-----	-----	134.5	147.5	140.0	129.0	136.5	136.0	133.0	139.0
6	-----	-----	-----	-----	130.0	146.0	137.0	130.0	130.0	134.5	130.0	135.5
7	-----	-----	-----	-----	(c)	143.0	132.0	129.5	127.0	133.0	126.0	126.0
8	-----	-----	-----	-----	(c)	140.5	128.0	123.0	124.5	127.5	126.5	127.5
Advance ratio J = 3.25												
a <sub>1</sub>	143.0	145.0	144.0	154.0	158.5	163.0	164.0	162.5	157.5	151.5	149.0	155.5
2	(c)	(c)	(c)	144.5	150.5	157.5	152.5	143.0	146.0	145.5	141.5	139.5
3	-----	-----	-----	136.5	145.5	155.0	144.0	144.5	132.0	143.5	138.0	136.5
4	-----	-----	-----	(c)	142.0	151.0	140.0	133.0	140.5	138.5	133.0	131.5
5	-----	-----	-----	-----	137.5	148.5	134.0	132.5	136.5	136.0	131.0	(c)
6	-----	-----	-----	-----	133.0	145.0	134.5	128.0	135.5	133.0	(c)	-----
7	-----	-----	-----	-----	129.0	143.0	132.0	(c)	133.0	131.0	-----	-----
8	-----	-----	-----	-----	(c)	142.0	129.0	(c)	132.5	129.5	-----	-----

<sup>a</sup>Blade passing frequency.  
<sup>b</sup>Transducer not functioning.  
<sup>c</sup>Not visible above tunnel background noise.

TABLE V. - Concluded.

Harmonic number	Transducer											
	1	2	3	4	5	6	7	8	9	10	11	12
	Sound pressure level of harmonic, SPL, dB, ref. $2 \times 10^{-5}$ N/m <sup>2</sup>											
Advance ratio J = 3.5												
a <sub>1</sub>	(c)	142.0	141.0	148.5	152.0	159.0	157.5	156.5	153.5	149.0	151.0	146.0
2	---	(c)	(c)	138.0	146.0	154.5	144.5	150.0	150.0	140.0	139.0	138.5
3	---	-----	-----	(c)	140.0	149.0	144.0	136.5	142.0	137.5	134.5	134.5
4	---	-----	-----	-----	135.5	144.5	129.5	141.0	138.5	133.5	133.0	133.5
5	---	-----	-----	-----	132.0	140.5	135.5	131.5	136.0	131.5	(c)	(c)
6	---	-----	-----	-----	128.0	137.0	130.5	132.0	135.0	(c)	-----	-----
7	---	-----	-----	-----	125.0	134.0	(c)	130.0	132.0	-----	-----	-----
8	---	-----	-----	-----	(c)	130.5	-----	125.5	131.0	-----	-----	-----
Advance ratio J = 3.75												
a <sub>1</sub>	136.0	141.5	143.0	151.0	155.0	157.5	153.0	147.5	141.0	145.5	144.0	142.5
2	(c)	(c)	(c)	134.5	146.5	153.5	146.5	144.0	143.0	137.0	(c)	(c)
3	-----	-----	-----	(c)	(c)	144.0	145.0	146.0	142.0	(c)	-----	-----
4	-----	-----	-----	-----	-----	137.5	134.0	138.5	137.0	-----	-----	-----
5	-----	-----	-----	-----	-----	(c)	139.0	131.0	134.0	-----	-----	-----
6	-----	-----	-----	-----	-----	-----	133.5	135.0	128.0	-----	-----	-----
7	-----	-----	-----	-----	-----	-----	(c)	132.5	128.0	-----	-----	-----
8	-----	-----	-----	-----	-----	-----	-----	125.0	126.5	-----	-----	-----
Advance ratio J = 3.84												
a <sub>1</sub>	137.5	139.0	139.5	146.0	154.0	156.5	151.5	147.5	145.5	146.0	142.5	139.5
2	(c)	(c)	(c)	139.5	146.5	152.5	144.5	141.0	139.0	136.5	(c)	(c)
3	-----	-----	-----	(c)	(c)	139.0	149.0	146.5	138.5	(c)	-----	-----
4	-----	-----	-----	-----	-----	135.0	142.5	144.5	139.5	-----	-----	-----
5	-----	-----	-----	-----	-----	135.5	137.0	132.5	(c)	-----	-----	-----
6	-----	-----	-----	-----	-----	(c)	140.0	135.0	-----	-----	-----	-----
7	-----	-----	-----	-----	-----	-----	135.0	135.5	-----	-----	-----	-----
8	-----	-----	-----	-----	-----	-----	(c)	130.5	-----	-----	-----	-----

<sup>a</sup>Blade passing frequency.

<sup>b</sup>Transducer not functioning.

<sup>c</sup>Not visible above tunnel background noise.

TABLE VI. - ACOUSTIC DATA FOR FIRST EIGHT HARMONICS AT MACH 0.75

Harmonic number	Transducer											
	1	2	3	4	5	6	7	8	9	10	11	12
	Sound pressure level of harmonic, SPL, dB, ref. $2 \times 10^{-5}$ N/m <sup>2</sup>											
Advance ratio J = 2.75												
a <sub>1</sub>	(b)	146.5	148.0	159.0	162.5	167.5	168.5	167.0	165.0	155.0	151.0	155.5
2	---	140.0	140.5	148.0	156.5	162.0	156.0	153.0	152.5	156.0	150.0	145.5
3	---	(c)	136.0	144.0	152.0	158.0	143.0	150.5	142.0	144.0	141.5	143.0
4	---	-----	(c)	133.0	147.0	155.0	140.0	140.5	143.0	135.5	138.0	143.0
5	---	-----	-----	130.0	143.0	152.0	142.0	141.0	137.0	133.0	135.5	138.0
6	---	-----	-----	(c)	139.0	150.0	141.0	135.0	137.0	135.0	138.5	136.0
7	---	-----	-----	-----	133.5	147.0	139.0	126.0	125.0	132.0	132.0	126.5
8	---	-----	-----	-----	131.0	145.0	135.0	129.5	128.0	129.0	130.0	131.0
Advance ratio J = 3.06												
a <sub>1</sub>	(b)	147.5	147.0	161.0	165.0	167.0	164.5	162.0	154.5	157.5	156.5	152.0
2	---	140.0	140.0	152.0	156.5	156.5	153.5	154.0	148.5	153.0	145.5	142.0
3	---	(c)	135.0	145.5	151.0	145.0	148.0	139.0	142.0	137.0	141.0	136.0
4	---	-----	(c)	141.0	146.5	137.5	132.0	136.0	134.5	133.5	133.5	141.5
5	---	-----	-----	136.0	142.5	139.5	136.5	136.0	133.0	131.0	131.5	130.5
6	---	-----	-----	133.5	140.0	138.5	130.0	138.0	127.0	128.0	130.5	128.0
7	---	-----	-----	129.0	137.0	139.0	134.0	131.0	132.0	129.5	132.0	127.0
8	---	-----	-----	125.0	133.0	135.0	128.5	133.0	130.5	128.5	131.0	130.0
Advance ratio J = 3.25												
a <sub>1</sub>	(b)	145.5	144.5	158.0	161.5	162.5	159.0	155.0	156.0	156.5	154.0	149.5
2	---	140.0	140.5	144.5	147.5	143.0	151.0	151.5	147.0	139.5	140.5	143.0
3	---	(c)	(c)	134.5	141.5	148.5	138.0	140.5	137.5	137.0	134.5	137.5
4	---	-----	-----	(c)	136.0	146.0	140.0	135.0	134.0	131.0	132.5	138.5
5	---	-----	-----	-----	(c)	138.5	135.0	129.5	131.0	130.0	133.0	134.0
6	---	-----	-----	-----	-----	132.0	133.5	134.5	128.0	127.0	(c)	(c)
7	---	-----	-----	-----	-----	132.0	131.5	131.0	129.0	124.0	-----	-----
8	---	-----	-----	-----	-----	129.0	127.0	129.5	127.5	125.0	-----	-----

<sup>a</sup>Blade passing frequency.

<sup>b</sup>Transducer not functioning.

<sup>c</sup>Not visible above tunnel background noise.

TABLE VI. - Concluded.

Harmonic number	Transducer											
	1	2	3	4	5	6	7	8	9	10	11	12
	Sound pressure level of harmonic, SPL, dB, ref. $2 \times 10^{-5}$ N/m <sup>2</sup>											
(c) Advance ratio $J = 3.5$												
a <sub>1</sub>	(b)	140.0	145.5	152.5	155.0	156.0	152.0	146.0	142.5	140.5	142.0	139.5
2	---	(c)	(c)	142.5	147.0	137.0	147.0	142.5	143.0	136.5	139.5	131.5
3	---	-----	-----	(c)	138.5	147.0	132.5	138.5	137.0	(c)	(c)	(c)
4	---	-----	-----	-----	136.0	131.0	135.5	132.0	(c)	-----	-----	-----
5	---	-----	-----	-----	131.5	132.0	133.5	128.0	-----	-----	-----	-----
6	---	-----	-----	-----	129.0	130.0	130.5	129.5	-----	-----	-----	-----
7	---	-----	-----	-----	126.0	126.0	129.0	127.0	-----	-----	-----	-----
8	---	-----	-----	-----	(c)	124.0	128.0	122.0	-----	-----	-----	-----
Advance ratio $J = 3.75$												
a <sub>1</sub>	(b)	136.0	138.0	149.0	152.5	151.5	144.5	143.0	142.0	137.5	135.5	134.0
2	---	(c)	(c)	135.0	131.0	143.5	144.5	139.0	136.0	133.0	(c)	(c)
3	---	-----	-----	(c)	(c)	(c)	(c)	(c)	(c)	(c)	-----	-----
4	---	-----	-----	-----	-----	-----	-----	-----	-----	-----	-----	-----
5	---	-----	-----	-----	-----	-----	-----	-----	-----	-----	-----	-----
6	---	-----	-----	-----	-----	-----	-----	-----	-----	-----	-----	-----
7	---	-----	-----	-----	-----	-----	-----	-----	-----	-----	-----	-----
8	---	-----	-----	-----	-----	-----	-----	-----	-----	-----	-----	-----
Advance ratio $J = 3.84^d$												

<sup>a</sup>Blade passing frequency.

<sup>b</sup>Transducer not functioning.

<sup>c</sup>Not visible above tunnel background noise.

<sup>d</sup>Measurements were taken at all transducers for the first eight harmonics, but none was visible above the tunnel background noise.



TABLE VII. - ACOUSTIC DATA FOR FIRST EIGHT HARMONICS AT MACH 0.7

Harmonic number	Transducer											
	1	2	3	4	5	6	7	8	9	10	11	12
	Sound pressure level of harmonic, SPL, dB, ref. $2 \times 10^{-5}$ N/m <sup>2</sup>											
Advance ratio J = 2.75												
a <sub>1</sub>	(b)	155.0	151.0	161.5	166.5	168.0	163.5	162.0	163.0	160.5	155.5	152.5
2	---	148.5	146.5	155.0	159.0	153.0	155.5	156.0	157.0	148.5	151.5	149.0
3	---	140.0	140.5	151.0	155.5	150.0	150.0	144.0	144.0	146.5	143.5	140.5
4	---	135.5	133.5	146.5	151.5	150.0	146.0	145.0	142.0	140.0	139.5	144.0
5	---	(c)	(c)	144.0	148.5	147.0	144.0	136.0	134.5	138.0	136.0	137.5
6	---	-----	-----	140.5	146.0	143.0	139.0	137.0	136.5	135.0	133.5	133.5
7	---	-----	-----	135.5	142.0	138.0	135.0	133.0	133.0	132.0	133.5	132.0
8	---	-----	-----	133.0	141.0	138.0	135.0	135.5	127.0	126.5	128.5	128.0
Advance ratio J = 3.06												
a <sub>1</sub>	(b)	155.5	158.5	157.0	159.5	161.5	158.0	154.5	145.5	152.0	153.0	147.5
2	---	142.0	146.0	145.5	153.5	156.5	153.5	152.0	149.5	141.5	141.0	143.5
3	---	139.0	136.5	145.0	149.5	144.0	144.5	141.5	142.0	139.0	136.0	136.0
4	---	134.0	132.5	139.0	142.5	140.0	136.5	137.0	137.0	138.0	139.5	134.5
5	---	(c)	129.5	133.5	142.0	134.0	137.0	132.0	132.0	133.0	131.0	129.5
6	---	-----	127.0	130.0	138.0	135.0	133.0	129.0	129.0	129.0	128.0	129.0
7	---	-----	(c)	128.0	134.5	130.0	132.0	125.0	126.5	127.0	(c)	(c)
8	---	-----	-----	(c)	132.0	128.5	133.0	123.5	124.0	127.0	-----	-----

<sup>a</sup>Blade passing frequency.

<sup>b</sup>Transducer not functioning.

<sup>c</sup>Not visible above tunnel background noise.

TABLE VII. - Concluded.

Harmonic number	Transducer											
	1	2	3	4	5	6	7	8	9	10	11	12
	Sound pressure level of harmonic, SPL, dB, ref. $2 \times 10^{-5}$ N/m <sup>2</sup>											
Advance ratio $J = 3.25$												
a <sub>1</sub>	(b)	146.5	149.5	154.0	156.5	157.0	150.0	146.5	150.0	149.5	147.5	146.0
2	---	(c)	(c)	141.5	147.5	151.5	148.5	143.5	141.5	138.0	138.5	140.5
3	---	-----	-----	132.5	133.0	139.5	140.5	137.0	132.5	135.5	138.5	139.0
4	---	-----	-----	133.5	139.0	135.5	131.5	130.0	(c)	(c)	(c)	(c)
5	---	-----	-----	130.0	136.5	134.0	(c)	(c)	-----	-----	-----	-----
6	---	-----	-----	127.0	135.0	136.5	-----	-----	-----	-----	-----	-----
7	---	-----	-----	(c)	130.5	132.5	-----	-----	-----	-----	-----	-----
8	---	-----	-----	-----	128.0	129.0	-----	-----	-----	-----	-----	-----
Advance ratio $J = 3.5$												
a <sub>1</sub>	(b)	134.5	136.5	145.5	150.0	151.5	145.5	139.0	135.5	137.5	136.0	130.0
2	---	(c)	132.5	(c)	136.5	144.5	141.5	140.0	136.0	134.0	135.0	135.0
3	---	-----	-----	-----	-----	-----	-----	-----	-----	-----	-----	-----
4	---	-----	-----	-----	-----	-----	-----	-----	-----	-----	-----	-----
5	---	-----	-----	-----	-----	-----	-----	-----	-----	-----	-----	-----
6	---	-----	-----	-----	-----	-----	-----	-----	-----	-----	-----	-----
7	---	-----	-----	-----	-----	-----	-----	-----	-----	-----	-----	-----
8	---	-----	-----	-----	-----	-----	-----	-----	-----	-----	-----	-----
Advance ratios $J = 3.75$ and $3.84^d$												

<sup>a</sup>Blade passing frequency.

<sup>b</sup>Transducer not functioning.

<sup>c</sup>Not visible above tunnel background noise.

<sup>d</sup>Measurements were taken at all transducers for the first eight harmonics, but none was visible above the tunnel background noise.

TABLE VIII. - ACOUSTIC DATA FOR FIRST EIGHT HARMONICS AT MACH 0.65

Harmonic number	Transducer											
	1	2	3	4	5	6	7	8	9	10	11	12
	Sound pressure level of harmonic, SPL, dB, ref. $2 \times 10^{-5}$ N/m <sup>2</sup>											
Advance ratio J = 2.75												
a <sub>1</sub>	(b)	152.0	151.5	158.5	163.0	163.0	157.5	154.5	152.5	154.0	153.5	150.0
2	---	139.0	141.0	149.0	150.5	157.5	155.0	151.0	139.5	143.0	141.0	137.5
3	---	138.5	137.5	145.5	153.0	147.5	136.0	139.0	139.5	138.5	135.0	143.5
4	---	136.0	136.5	141.0	149.5	148.0	135.5	134.5	134.5	140.0	141.0	138.0
5	---	130.5	129.0	138.5	146.0	143.0	136.5	135.0	129.5	133.0	130.5	132.0
6	---	129.0	129.0	138.5	143.0	142.0	128.5	131.5	126.0	127.0	129.0	135.0
7	---	125.0	126.0	134.0	141.5	137.0	130.5	124.5	126.0	130.5	127.0	130.5
8	---	(c)	123.0	131.0	140.0	138.0	126.5	122.0	(c)	123.0	125.5	127.5
Advance ratio J = 3.06												
a <sub>1</sub>	(b)	(c)	136.0	152.0	155.5	155.5	148.5	141.5	136.5	141.0	140.0	140.0
2	---	---	(c)	143.5	148.0	148.0	143.5	142.0	142.5	140.0	139.0	(c)
3	---	---	---	133.0	134.5	138.5	134.0	(c)	135.0	(c)	(c)	---
4	---	---	---	130.5	134.0	131.5	(c)	---	(c)	---	---	---
5	---	---	---	(c)	134.0	130.0	---	---	---	---	---	---
6	---	---	---	---	131.0	129.5	---	---	---	---	---	---
7	---	---	---	---	132.5	127.0	---	---	---	---	---	---
8	---	---	---	---	128.5	126.5	---	---	---	---	---	---
Advance ratio J = 3.25												
a <sub>1</sub>	(b)	139.0	136.0	140.5	145.5	145.5	141.5	138.5	128.5	134.0	136.0	137.5
2	---	(c)	131.5	126.0	133.0	138.0	133.0	128.5	126.5	127.5	(c)	(c)
3	---	---	(c)	(c)	(c)	(c)	(c)	(c)	(c)	(c)	---	---
4	---	---	---	---	---	---	---	---	---	---	---	---
5	---	---	---	---	---	---	---	---	---	---	---	---
6	---	---	---	---	---	---	---	---	---	---	---	---
7	---	---	---	---	---	---	---	---	---	---	---	---
8	---	---	---	---	---	---	---	---	---	---	---	---
Advance ratios J = 3.5, 3.75, and 3.84 <sup>d</sup>												

<sup>a</sup>Blade passing frequency.

<sup>b</sup>Transducer not functioning.

<sup>c</sup>Not visible above tunnel background noise.

<sup>d</sup>Measurements were taken at all transducers for the first eight harmonics, but none was visible above the tunnel background noise.

TABLE IX. - ACOUSTIC DATA FOR FIRST EIGHT HARMONICS AT MACH 0.6

Harmonic number	Transducer											
	1	2	3	4	5	6	7	8	9	10	11	12
	Sound pressure level of harmonic, SPL, dB, ref. $2 \times 10^{-5}$ N/m <sup>2</sup>											
Advance ratio J = 2.75												
a <sub>1</sub>	(b)	136.5	136.5	151.5	154.5	153.5	149.0	147.0	145.0	141.0	139.0	141.0
2	---	139.0	135.5	143.0	146.5	147.0	141.5	137.5	138.5	138.0	135.0	129.5
3	---	134.5	129.0	134.5	142.0	144.5	137.0	135.0	132.0	132.5	133.0	130.5
4	---	130.0	127.0	135.5	140.5	136.5	125.0	123.5	134.5	125.5	130.5	128.5
5	---	(c)	(c)	131.5	136.0	135.0	128.0	124.5	127.0	129.0	125.5	126.5
6	---	-----	-----	127.5	135.0	129.0	121.5	121.0	120.0	(c)	121.0	128.0
7	---	-----	-----	125.0	133.0	128.5	121.0	117.0	121.5	-----	120.0	(c)
8	---	-----	-----	122.0	132.0	124.0	(c)	(c)	(c)	-----	(c)	-----
Advance ratio J = 3.06												
a <sub>1</sub>	(b)	131.5	136.5	140.5	144.0	145.0	143.5	142.0	139.5	136.0	133.5	134.0
2	---	(c)	(c)	127.5	132.0	134.0	129.5	125.0	122.0	124.5	125.0	127.5
3	---	-----	-----	(c)	(c)	(c)	(c)	(c)	(c)	(c)	(c)	(c)
4	---	-----	-----	-----	-----	-----	-----	-----	-----	-----	-----	-----
5	---	-----	-----	-----	-----	-----	-----	-----	-----	-----	-----	-----
6	---	-----	-----	-----	-----	-----	-----	-----	-----	-----	-----	-----
7	---	-----	-----	-----	-----	-----	-----	-----	-----	-----	-----	-----
8	---	-----	-----	-----	-----	-----	-----	-----	-----	-----	-----	-----
Advance ratio J = 3.25												
a <sub>1</sub>	(b)	127.5	128.5	136.5	140.0	141.5	139.0	137.0	133.0	128.5	128.0	131.0
2	---	127.0	124.0	124.5	126.5	127.5	125.5	123.5	122.0	123.0	123.5	123.0
3	---	(c)	(c)	(c)	(c)	(c)	(c)	(c)	(c)	(c)	(c)	(c)
4	---	-----	-----	-----	-----	-----	-----	-----	-----	-----	-----	-----
5	---	-----	-----	-----	-----	-----	-----	-----	-----	-----	-----	-----
6	---	-----	-----	-----	-----	-----	-----	-----	-----	-----	-----	-----
7	---	-----	-----	-----	-----	-----	-----	-----	-----	-----	-----	-----
8	---	-----	-----	-----	-----	-----	-----	-----	-----	-----	-----	-----
Advance ratios J = 3.5, 3.75, and 3.85 <sup>d</sup>												

<sup>a</sup>Blade passing frequency.

<sup>b</sup>Transducer not functioning.

<sup>c</sup>Not visible above tunnel background noise.

<sup>d</sup>Measurements were taken at all transducers for the first eight harmonics, but none was visible above the tunnel background noise.

ORIGINAL PAGE  
BLACK AND WHITE PHOTOGRAPH

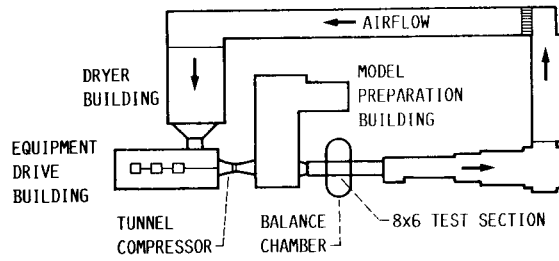

(a) PLAN VIEW OF 8- BY 6-FOOT WIND TUNNEL.

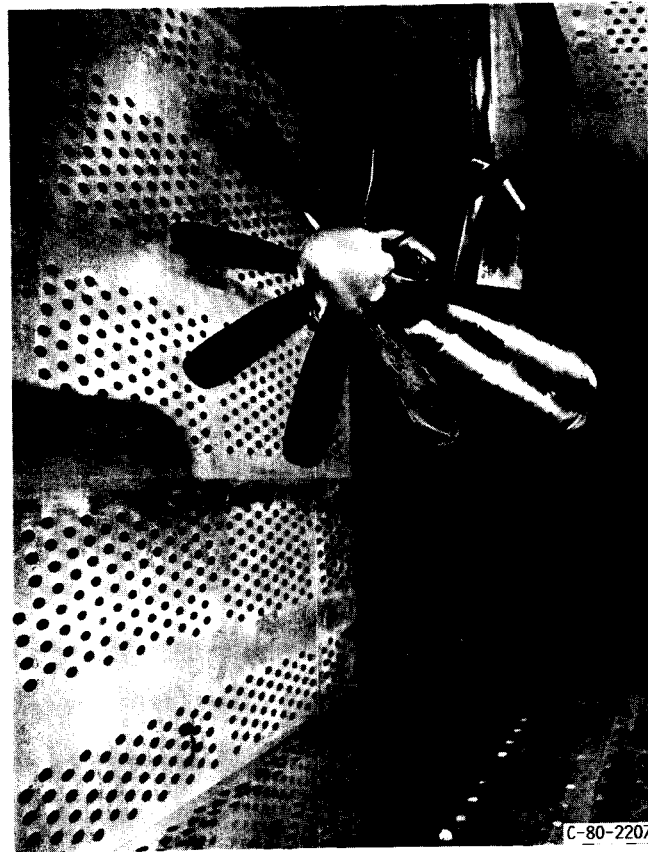

(b) SR-2 PROPELLER IN TEST SECTION.

FIGURE 1. - WIND TUNNEL AND PROPELLER INSTALLATION.

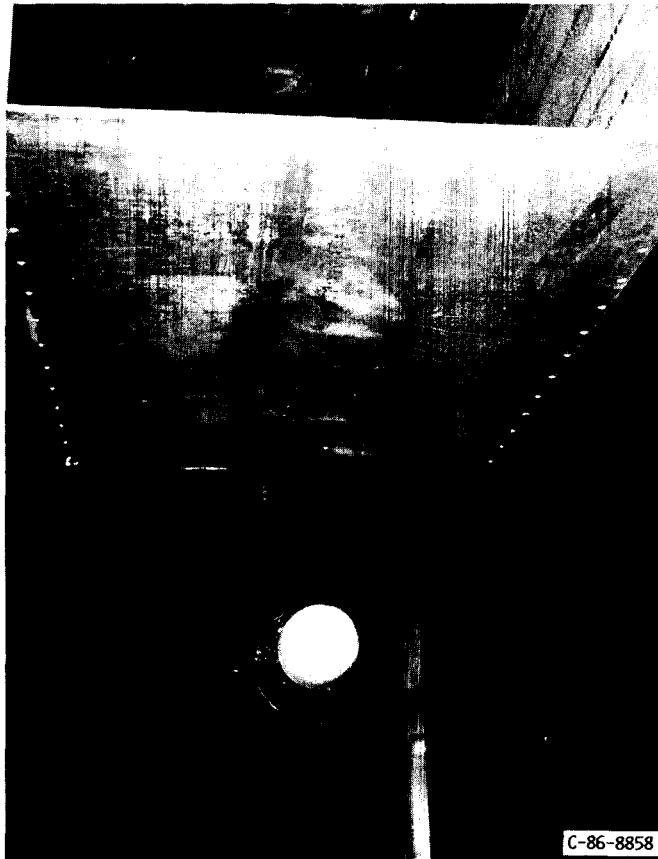

(a) ACOUSTIC PLATE MOUNTED OVER SR-7A PROPELLER.

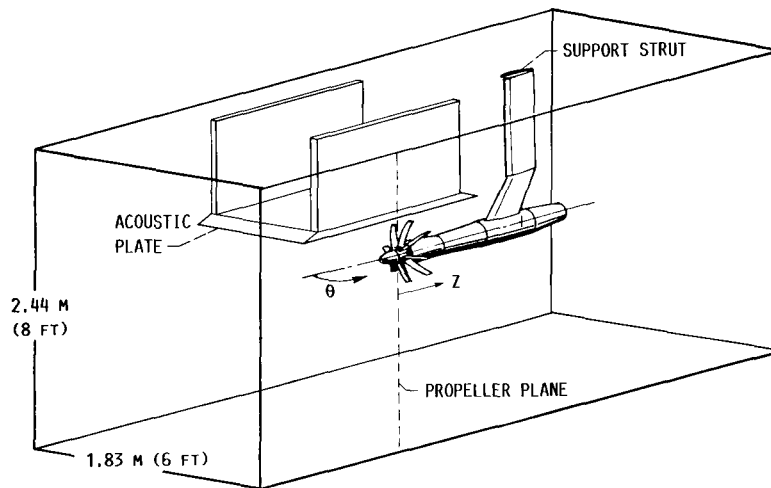

TRANSDUCER (PLATE 0.3 DIAMETER FROM TIP)											
1	2	3	4	5	6	7	8	9	10	11	12
TRANSDUCER DISTANCE FROM PROPELLER PLANE, Z, CM (IN.)											
-46.7 (-18.4)	-41.7 (-16.4)	-30.5 (-12.0)	-16.0 (-6.3)	-8.9 (-3.5)	0.8 (0.3)	8.9 (3.5)	12.4 (4.9)	18.0 (7.1)	25.0 (9.9)	28.7 (11.3)	42.4 (16.7)
ANGLE FROM UPSTREAM, $\theta$ , DEG											
46.8	50.0	58.5	72.2	80	90.9	100	104	110	116.8	120	130.4

(b) TRANSDUCER LOCATIONS.  
FIGURE 2. - ACOUSTIC PLATE.

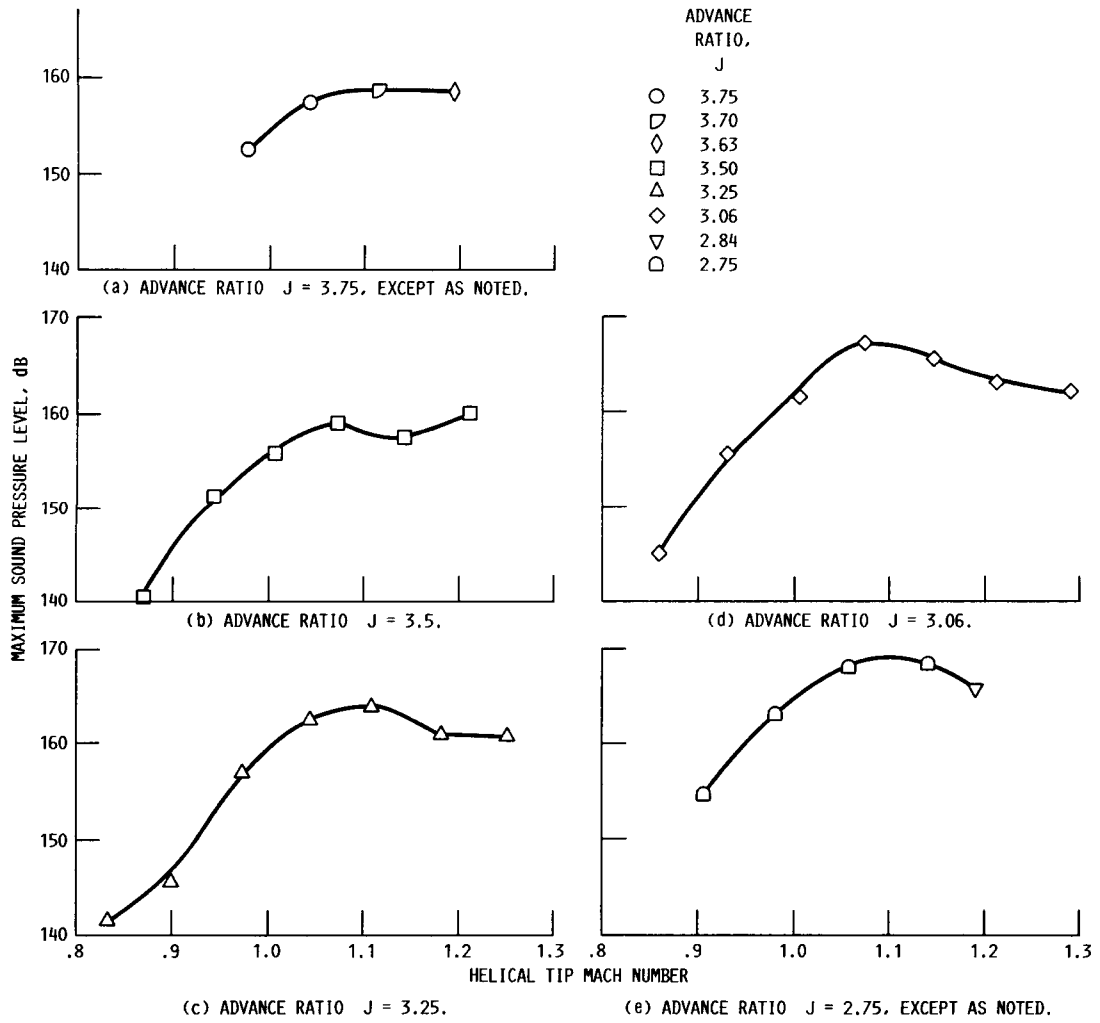

FIGURE 3. - VARIATION OF MAXIMUM BLADE PASSING TONE WITH RESPECT TO HELICAL TIP MACH NUMBER AT VARIOUS ADVANCE RATIOS.

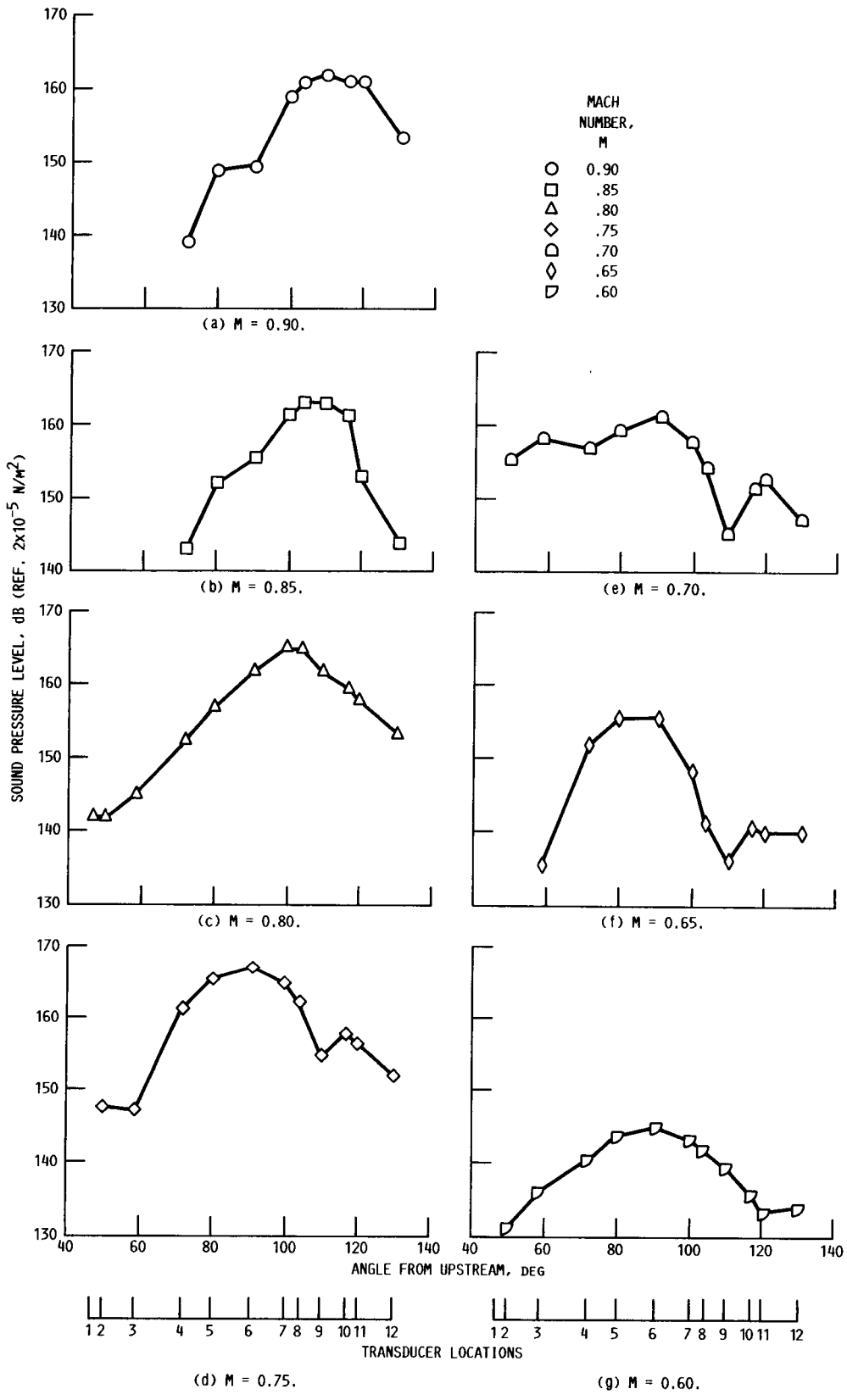

FIGURE 4. - BLADE PASSING TONE DIRECTIVITIES FOR VARIOUS AXIAL MACH NUMBERS FOR  $J = 3.06$ .



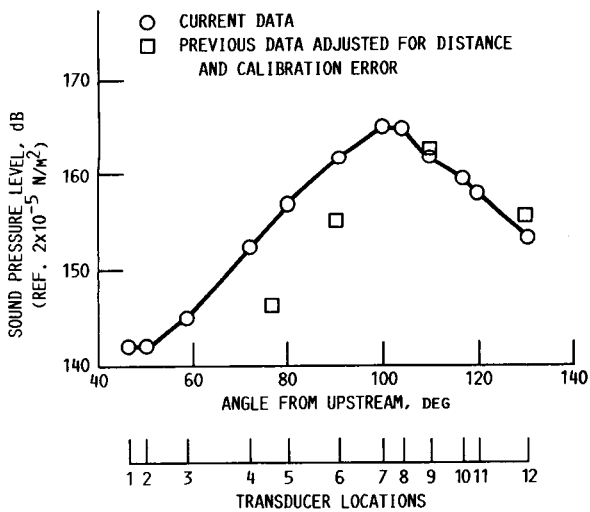

FIGURE 5. - COMPARISON OF SR-2 DIRECTIVITY WITH PREVIOUS DATA CORRECTED BY ADDING 6 dB FOR CALIBRATION ERROR (REF. 4) AND 8 dB FOR DISTANCE FROM CENTERLINE (14 dB TOTAL).

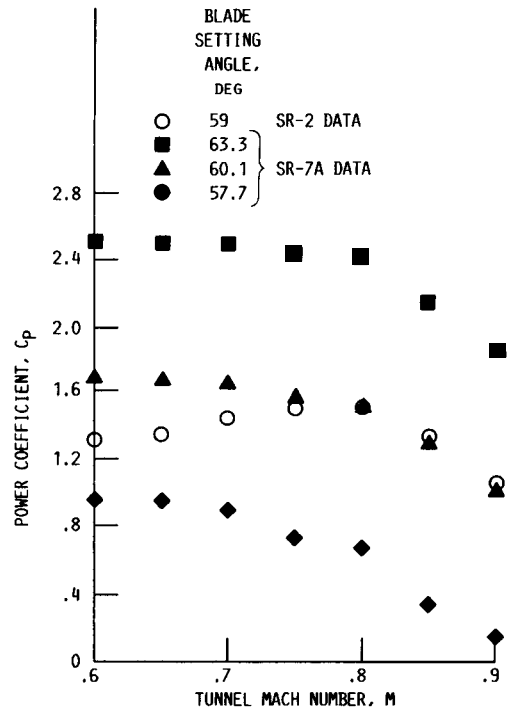

FIGURE 6. - VARIATION OF POWER COEFFICIENT WITH RESPECT TO TUNNEL MACH NUMBER FOR  $J = 3.06$ .

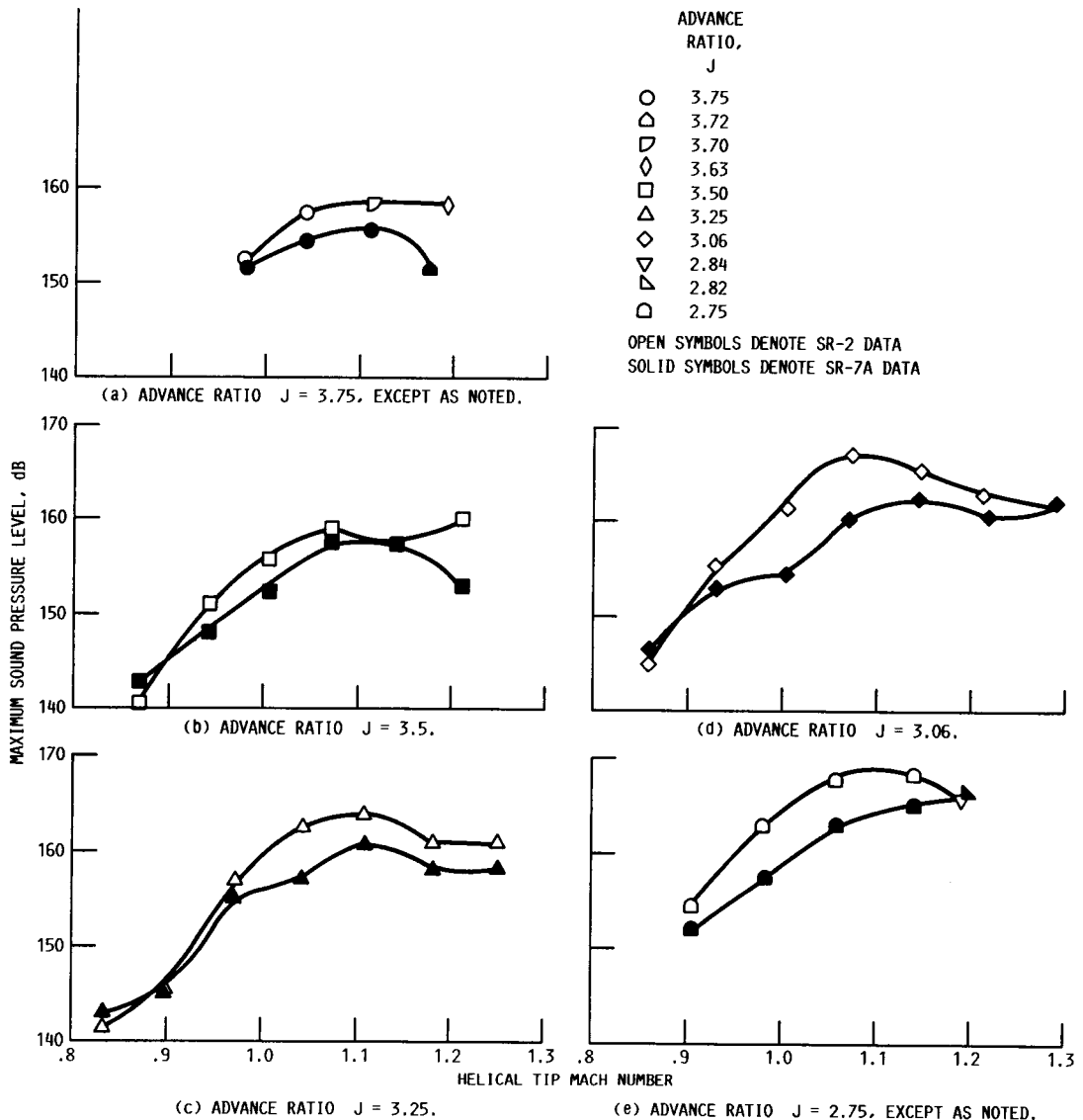

FIGURE 7. - COMPARISON OF SR-2 AND SR-7A BLADE PASSING TONES.

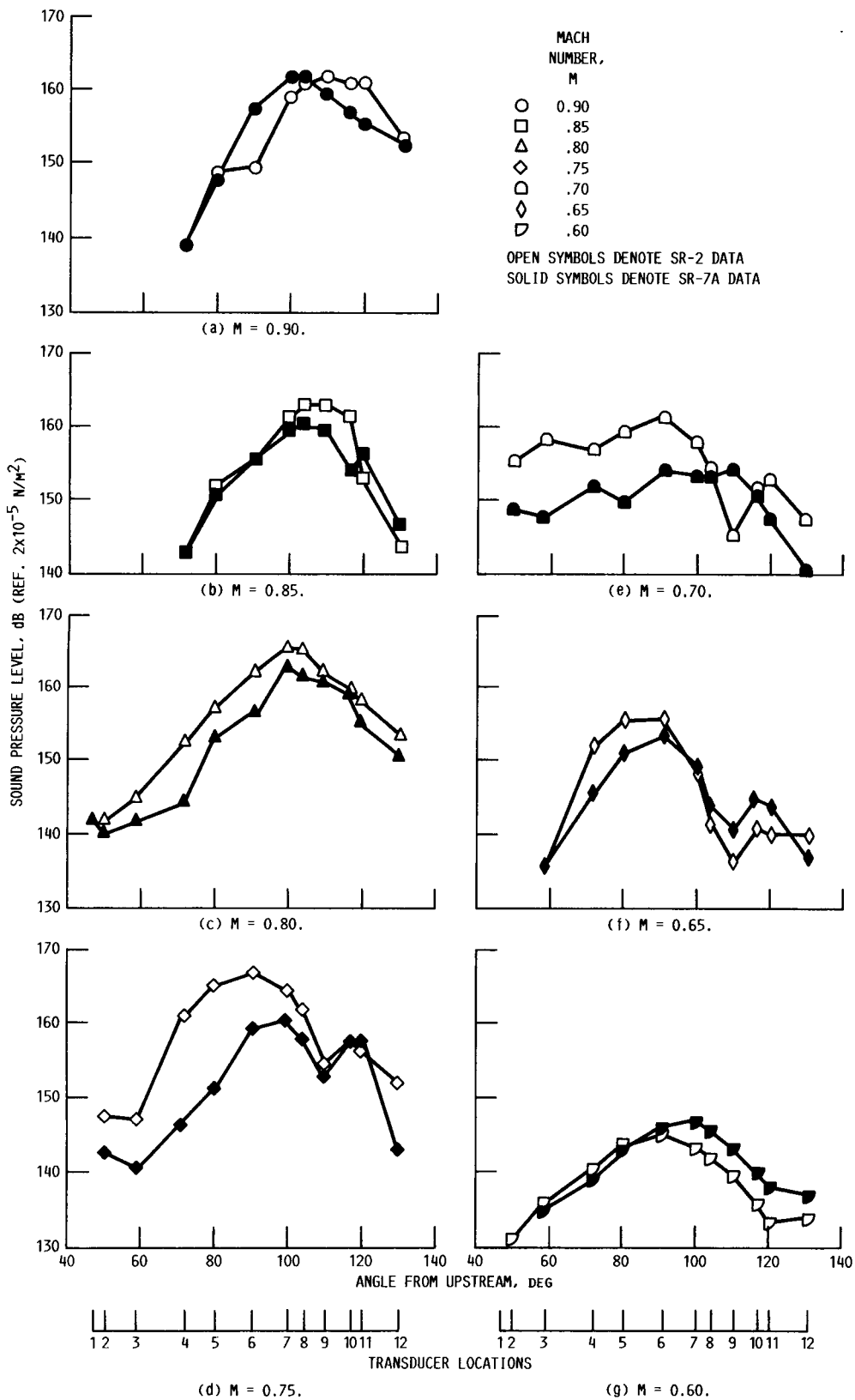

FIGURE 8. - COMPARISONS OF SR-2 AND SR-7A BLADE PASSING TONE DIRECTIVITIES AT VARIOUS MACH NUMBERS FOR  $J = 3.06$ .

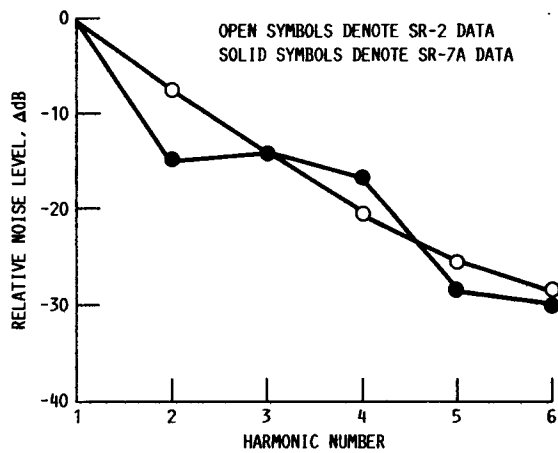

FIGURE 9. - LEVEL OF BLADE PASSING FREQUENCY HARMONICS RELATIVE TO FUNDAMENTAL AT MAXIMUM NOISE LOCATION ( $M = 0.8$ ;  $\theta = 100^\circ$ ).

1. Report No. NASA TM-101480		2. Government Accession No.		3. Recipient's Catalog No.	
4. Title and Subtitle Cruise Noise of the SR-2 Propeller Model in a Wind Tunnel				5. Report Date April 1989	
				6. Performing Organization Code	
7. Author(s) James H. Dittmar				8. Performing Organization Report No. E-4606	
				10. Work Unit No. 535-03-01	
9. Performing Organization Name and Address National Aeronautics and Space Administration Lewis Research Center Cleveland, Ohio 44135-3191				11. Contract or Grant No.	
				13. Type of Report and Period Covered Technical Memorandum	
12. Sponsoring Agency Name and Address National Aeronautics and Space Administration Washington, D.C. 20546-0001				14. Sponsoring Agency Code	
15. Supplementary Notes					
16. Abstract Noise data on the SR-2 model propeller were taken in the NASA Lewis Research Center 8- by 6-Foot Wind Tunnel. The maximum blade passing tone rises with increasing helical tip Mach number to a peak level at a helical tip Mach number of about 1.05; then it remains the same or decreases at higher helical tip Mach numbers. This behavior, which has been observed with other propeller models, points to the possibility of using higher propeller tip speeds to limit airplane cabin noise while maintaining high flight speed and efficiency. Noise comparisons of the straight-blade SR-2 propeller and the swept-blade SR-7A propeller showed that the tailored sweep of the SR-7A appears to be the cause of both lower peak noise levels and a slower noise increase with increasing helical tip Mach number.					
17. Key Words (Suggested by Author(s)) Propeller noise Noise Supersonic tip speed			18. Distribution Statement Unclassified - Unlimited Subject Category 71		
19. Security Classif. (of this report) Unclassified		20. Security Classif. (of this page) Unclassified		21. No of pages 28	22. Price* A03