

**DESIGN SENSITIVITY ANALYSIS OF
BOUNDARY ELEMENT SUBSTRUCTURES**

James H. Kane¹, Sunil Saigal², and Richard H. Gallagher¹

**1 - Clarkson University
Potsdam, New York 13676**

**2 - Computer Aided Engineering Center
Worcester Polytechnic Institute
Worcester Massachusetts 01609**

OUTLINE OF PRESENTATION

This presentation comments on the ability to reduce or condense a three dimensional model exactly, and then iterate on this reduced size model representing the parts of the design that are allowed to change in an optimization loop. The discussion presents the results obtained from an ongoing research effort to exploit the concept of substructuring within the structural shape optimization context using a Boundary Element Analysis (BEA) formulation. The first part of the talk contains a formulation for the exact condensation of portions of the overall boundary element model designated as substructures. The use of reduced boundary element models in shape optimization requires that structural sensitivity analysis can be performed. A reduced sensitivity analysis formulation is then presented that allows for the calculation of structural response sensitivities of both the substructured (reduced) and unstructured parts of the model. It is shown that this approach produces significant computational economy in the design sensitivity analysis and reanalysis process by facilitating the block triangular factorization and forward reduction and backward substitution of smaller matrices. The implementation of this formulation is discussed and timings and accuracies of representative test cases presented.

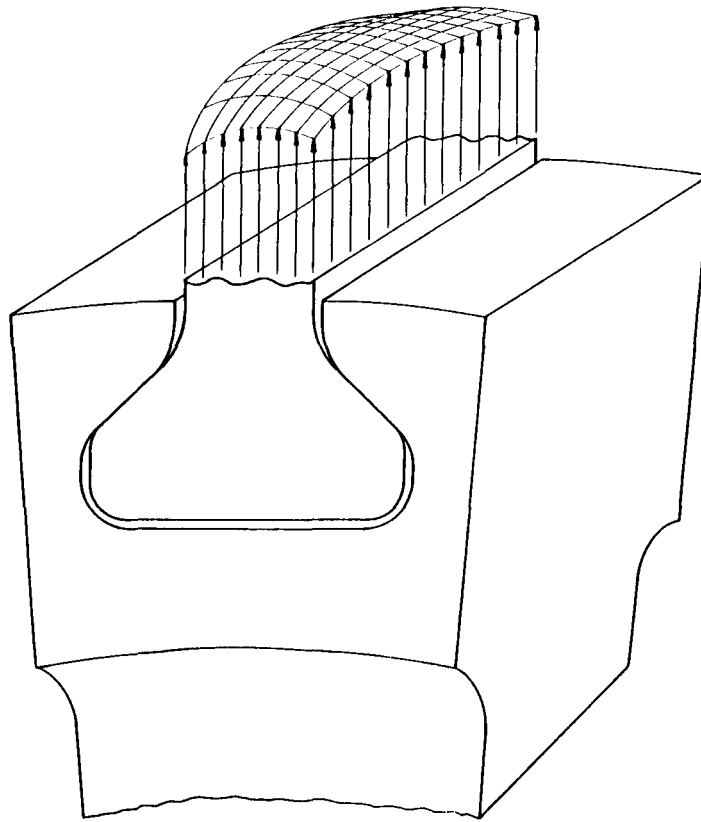

Model of the Attachment of a Compressor or Turbine Blade to its Disk.
The Top of the Blade Has Been Substructured.

THE CONCEPT OF REDUCED MODELS IN SHAPE OPTIMIZATION

Kane, Saigal, et al.¹⁻⁹ have shown that a multi-zone approach significantly impacts the ability to exploit the additional matrix sparsity present in the design sensitivity analysis step occurring during shape optimization of objects with partial geometric sensitivity. They have also shown how the multi-zone capability facilitates the effective utilization of reanalysis techniques in the shape optimization context. In other publications¹⁰⁻¹¹ they describe a sparse blocked equation solver that incorporates a multi-zone boundary element analysis (BEA) capability and boundary element substructuring in a completely arbitrary fashion. The overall algorithm is described that allows for the assembly and solution of arbitrarily connected boundary element zones that may also be arbitrarily either condensed or maintained at their original size. The approach thus allows for both condensed and uncondensed boundary element zones to consistently coexist in the same multi-zone problem. The development of this capability was motivated by an application in shape optimization, where a portion of the design remains geometrically insensitive to the design variables that control the shape. This discussion presents the results obtained from an ongoing research effort to exploit this powerful concept of substructuring within the structural shape optimization context using a boundary element formulation.

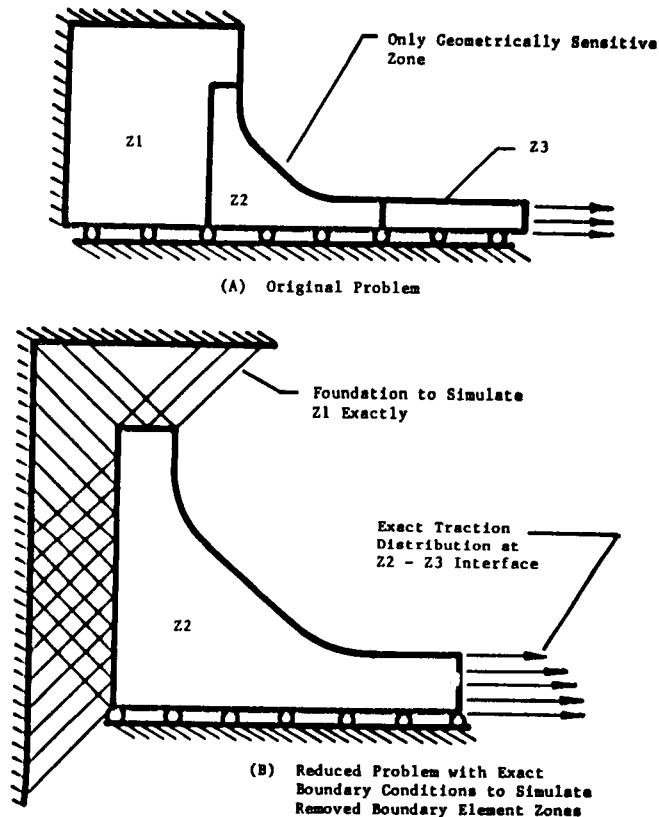

Physical Interpretation of the Condensation of Insensitive Zone Matrices

MULTI-ZONE BOUNDARY ELEMENT ANALYSIS

Multi-zone boundary element analysis¹²⁻¹⁹ is accomplished by first breaking up an entire boundary element model into zones as illustrated by the three zone model shown. The governing boundary integral relationship can then be written for each zone. In elastostatics, for example, Somigliana's identity¹²⁻¹⁴ is the appropriate relationship. Substituting for the actual surface response an approximate surface response interpolated from the node point values of traction and displacement using boundary element interpolation functions, one obtains the discretized boundary integral equations¹²⁻¹⁴. By evaluating this expression at a set of locations of the load point of the fundamental solutions occurring in the boundary integral equation corresponding to the node point locations for the zone in question, one can generate a matrix system of equations for each zone. The matrix relations written for each of the individual zones can be put together for use in an overall analysis¹²⁻¹⁴ by considering the conditions of displacement compatibility and equilibrium of the traction components at all zone interfaces. In these compatibility and equilibrium relations, the double subscript notation is used to convey that the vector in question is a column vector of components entirely on the interface between zone-i and zone-j.

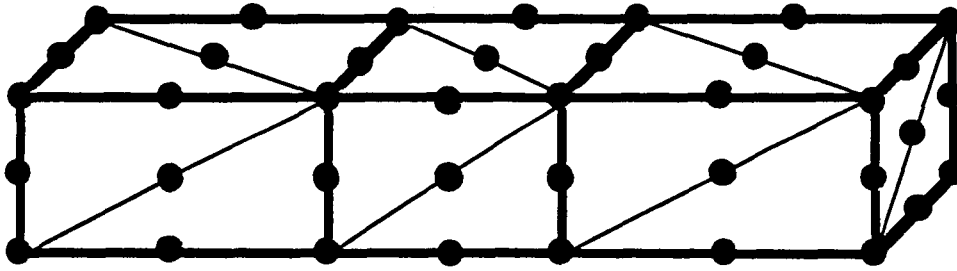

Multi-zone boundary element analysis^{10,11} is accomplished by writing

- 1.) individual zone BIE's

$$[F^i] \{u^i\} = [G^i] \{t^i\}$$

- 2.) coupling them together using compatibility and equilibrium conditions

$$\{u_{ij}^i\} = \{u_{ij}^j\}; \{t_{ij}^i\} = -\{t_{ij}^j\}$$

- 3.) This involves

- 3.1 **Expanding** the size of each zone matrix to the overall system size.

- 3.2 Renumbering, partitioning, and accounting for degrees of freedom in blocks.

- 4.) The result - **Speed, Sparsity, Accuracy**, but programs are more complex

MULTI-ZONE BOUNDARY ELEMENT ANALYSIS - Continued

Expanding the size of the boundary element zone matrix equations to the size of the overall problem, bringing the unknown tractions at zone interfaces to the left hand side of the equation, and using the compatibility and equilibrium relations, one can form the boundary element system equations for the overall multi-zone BEA problem. For example, the equations for the three zone problem shown are given below. It should be noted that this model has no interface between zone-1 and zone-3. In this instance, the final multi-zone BEA system of equations can be produced by simply removing the blocks associated with this 1-3 interface shown in the equation below.

Formal sparse blocked hypermatrix structure associated with three zone model

$$\begin{bmatrix}
 [F_{11}^1] & [F_{12}^1] & [0] & -[G_{12}^1] & [0] & [0] & [0] & [0] & [0] \\
 [0] & [F_{12}^2] & [0] & [G_{12}^2] & [F_{22}^2] & [F_{23}^2] & [0] & -[G_{23}^2] & [0] \\
 [0] & [0] & [0] & [0] & [0] & [F_{23}^3] & [0] & [G_{23}^3] & [F_{33}^3]
 \end{bmatrix}
 \begin{Bmatrix}
 \{u_{11}^1\} \\
 \{u_{12}^1\} \\
 \{u_{13}^1\} \\
 \{t_{21}^1\} \\
 \{u_{22}^2\} \\
 \{u_{23}^2\} \\
 \{t_{31}^1\} \\
 \{t_{22}^2\} \\
 \{t_{32}^2\} \\
 \{u_{33}^3\} \\
 \{t_{33}^3\}
 \end{Bmatrix}
 =
 \begin{bmatrix}
 [G_{11}^1] & [0] & [0] & [0] & [0] & [0] & [0] & [0] & [0] \\
 [0] & [0] & [0] & [0] & [G_{22}^2] & [0] & [0] & [0] & [0] \\
 [0] & [0] & [0] & [0] & [0] & [0] & [0] & [0] & [G_{33}^3]
 \end{bmatrix}
 \begin{Bmatrix}
 \{t_{11}^1\} \\
 \{0\} \\
 \{0\} \\
 \{0\} \\
 \{0\} \\
 \{0\} \\
 \{0\} \\
 \{0\} \\
 \{0\} \\
 \{0\} \\
 \{0\}
 \end{Bmatrix}$$

Actual matrix population results by removing all '13' partitions because they are empty

MULTI-ZONE BOUNDARY ELEMENT MATRIX POPULATIONS

The previous example points out the basic features of multi-zone boundary element matrix equations. The matrix equation shown above is actually a hypermatrix with matrices as its entries. Generally these matrix entries are called blocks or partitions. Likewise, the overall vectors shown have vectors for their entries and these entries are also referred to as blocks or partitions. The blocked sparsity characteristic of the matrices that result from the multi-zone BEA approach is clearly evident from the zero blocks present in the previous equation. A typical boundary element system matrix left hand side population is shown below. This matrix population is for a slightly different model and the smaller of the two matrix population shown results when the individual zones are condensed into boundary element substructures as described in subsequent parts of this presentation.

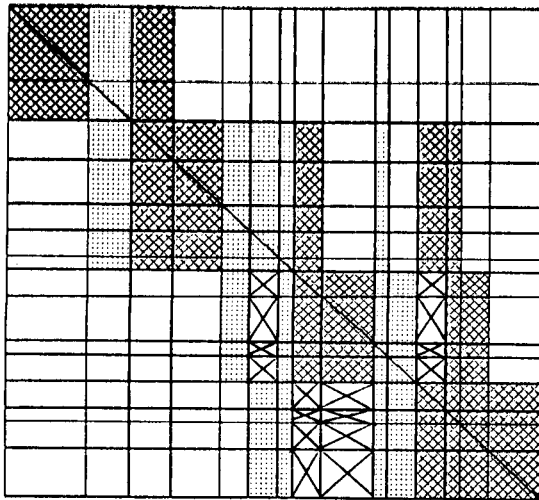

a) MATRIX POPULATION WHEN NO CONDENSATION IS PERFORMED

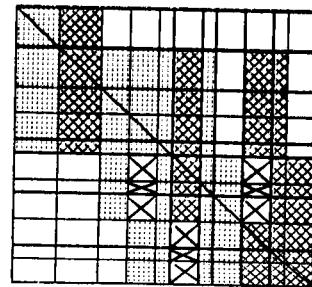

b) MATRIX POPULATION WHEN ALL ZONES ARE CONDENSED



= BLOCK CONTAINING INFORMATION FROM $[F]$ OR $[M_1]$ MATRIX



= BLOCK CONTAINING INFORMATION FROM $[G]$ OR $[M_2]$ MATRIX



= BLOCK THAT IS INITIALLY EMPTY BUT EXPERIENCES FILL IN DURING THE BLOCK TRIANGULAR FACTORIZATION STEP

Left hand side boundary element system matrix populations for a four zone mesh.

SPARSE BLOCKED SOLUTION PROCEDURES

The blocked matrix triangular factorization procedure used in this study is shown below. The procedure starts with the triangular factorization of the first diagonal block. This is performed using a Gauss elimination algorithm with partial pivoting. The triangular factors of this diagonal block are stored in the same location that the original diagonal block was located. This matrix factorization is then used to alter the second block column. This is accomplished by forward reduction and backward substitution of the columns of the matrix block A_{12} to form the matrix D_{12} (in the figure this matrix is symbolized by D). This matrix is then used to alter all the blocks below A_{12} in block column two by the matrix multiplication and subtraction step shown below. All blocks below block A_{13} in column three are then processed in a similar fashion and then the fourth column and so forth until the entire matrix has been altered. This entire process is then repeated using the submatrix consisting of all blocks except those in block row and column one. The second major phase in the algorithm causes the alteration of the submatrix consisting of all blocks except those in block rows and columns one and two. At every stage of this process, checks are made concerning the sparsity of the matrix. Any block operation that can be avoided due to the block sparsity present in the matrix, is avoided. A fundamental characteristic of the block triangular factorization algorithm described above is that it is sequential in nature.

```

START_PROC.  Start block triangular factorization procedure
              I = 0
TOP_DIAG_LOOP.  I = I + 1
                IF ( I > N - 1 ) GO TO LAST_BLOCK
                Factor  $A_{II} = L_{II} U_{II}$  using Gauss elimination with partial
                pivoting
                J = 0
TOP_COL_LOOP.   J = J + 1
                IF ( J > N ) GO TO TOP_DIAG_LOOP
                IF (  $A_{JI} = 0$  ) GO TO TOP_COL_LOOP
                Solve  $A_{II} D = A_{JI}$  For  $D$  by forward reduction and
                backward substitution of the columns of  $D$  using the
                factorization of  $A_{II}$ 
                K = I
TOP_ROW_LOOP.   K = K + 1
                IF ( K > N ) GO TO TOP_COL_LOOP
                IF (  $A_{KI} = 0$  ) GO TO TOP_ROW_LOOP
                Form  $A_{KJ} = A_{KJ} - A_{KI} D$ 
                GO TO TOP_ROW_LOOP
LAST_BLOCK.   Factor  $A_{II} = L_{II} U_{II}$ 
END_PROC.     Return
    
```

Sparse blocked matrix triangular factorization algorithm.

PERFORMANCE OF MULTI-ZONE ANALYSIS

In order to illustrate the advantages associated with multi-zone analysis relative to single-zone boundary element analysis, an example geometry has been selected for study and modeled as both a single zone and as a multi-zone model. Corresponding storage space and CPU times required for the single and multi-zone analyses are shown in the figure below. Comparison of the resources consumed during the equation solving step for both the single zone and the multi-zone analyses shows the dramatic improvements that can be obtained by employing the multi-zone approach in this class of problems. The accuracy of the boundary element method when applied to model such slender objects is also dramatically improved when multi-zone techniques are utilized. Numerical integration times tend to also be less for multi-zone models because only load points corresponding to nodes in the particular zone being integrated are used in the sequence of integrations used to form coefficient matrices. Although this particular problem was chosen to present the multi-zone approach in the most favorable light, it is representative of the much larger class of problems that becomes tractable for boundary element analysis when a multi-zone strategy is included.

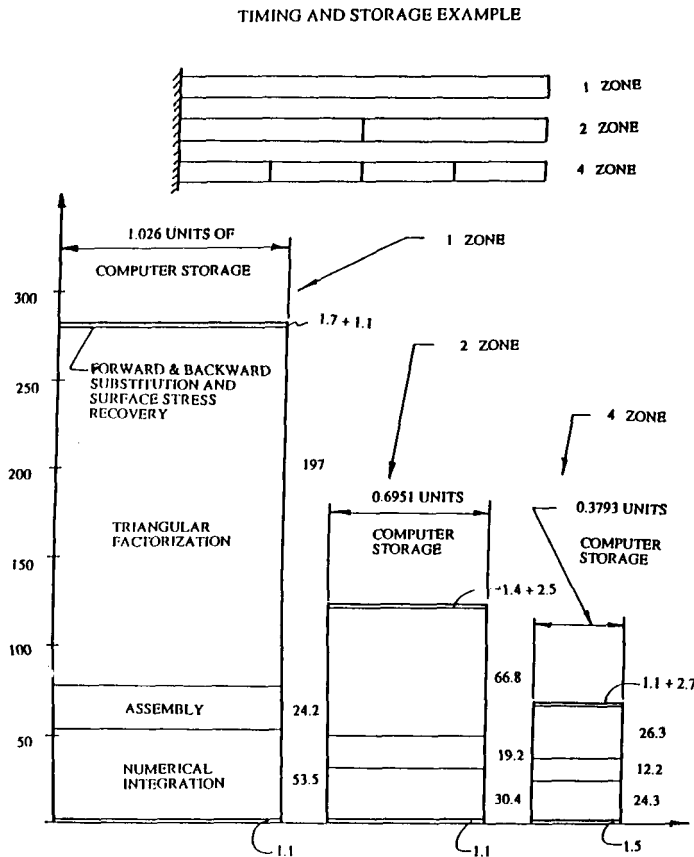

BOUNDARY ELEMENT SUBSTRUCTURES

Reordering the degrees of freedom and partitioning the boundary element system equation for an individual zone into blocks that correspond to master degrees of freedom and also into blocks that correspond to degrees of freedom that could be condensed, one can arrive at the matrix equation shown below. In this equation, the additional right hand side vector is included to consistently account for any body force type of loading that might be present in the analysis, such as gravity, centrifugal, or thermal loading. In these equations the symbolism for $\{u\}$ and $\{t\}$ will be generalized to imply that $\{u\}$ contains the unknown values of the boundary response while $\{t\}$ contains the specified values of the boundary response, regardless of whether they are displacement or traction components. When the specified values are displacement components, then appropriate column exchanges and negations must be performed as explained in References [12-14]. Therefore, whenever $\{t_C\}$ appears in the equations presented below, it is implied to be a column vector of known values of the specified boundary conditions for the particular zone in question. At first inspection, the substructuring process seems to require the inversion of the matrix block $[F_{CC}]$. A closer examination of the formulation, however, reveals that this is not the case. Whenever the matrix $[F_{CC}]^{-1}$ appears in these equations, it always premultiplies either a column vector or a rectangular matrix. As shown below, the use of the matrix inversion notation is purely symbolic, and in the computer implementation of this substructuring approach, no matrix inversion is ever actually performed. Instead, the triangular factorization of the matrix block $[F_{CC}]$ is performed once, and subsequently these factors are reused to solve the matrix equations shown below by forward reduction and backward substitution of the right hand side vector or group of vectors shown below.

Substructuring^{10,11}, in BEA can be accomplished by renumbering d.o.f., partitioning into **master** and **condensed** blocks, and solving for $\{u_C\}$ in the second block row.

$$\begin{bmatrix} [F_{MM}] & [F_{MC}] \\ [F_{CM}] & [F_{CC}] \end{bmatrix} \begin{Bmatrix} \{u_M\} \\ \{u_C\} \end{Bmatrix} = \begin{bmatrix} [G_{MM}] & [G_{MC}] \\ [G_{CM}] & [G_{CC}] \end{bmatrix} \begin{Bmatrix} \{t_M\} \\ \{t_C\} \end{Bmatrix} + \begin{Bmatrix} \{f_M\} \\ \{f_C\} \end{Bmatrix}$$

$$\{u_C\} = [F_{CC}]^{-1}[G_{CM}]\{t_M\} + [F_{CC}]^{-1}[G_{CC}]\{t_C\} - [F_{CC}]^{-1}[F_{CM}]\{u_M\} + [F_{CC}]^{-1}\{f_C\}$$

Substitute this **expansion equation** into the first block row and solve for $\{u_M\}$ to obtain the **exactly condensed equation** for the boundary element model.

$$[M_1]\{u_M\} = [M_2]\{t_M\} + [M_3]\{t_C\} + [M_4]\{f_C\} + \{f_M\}$$

$$[M_1] = [F_{MM}] - [F_{MC}][F_{CC}]^{-1}[F_{CM}]; \quad [M_3] = [G_{MC}] - [F_{MC}][F_{CC}]^{-1}[G_{CC}]$$

$$[M_2] = [G_{MM}] - [F_{MC}][F_{CC}]^{-1}[G_{CM}]; \quad [M_4] = - [F_{MC}][F_{CC}]^{-1}$$

Inversion shown is symbolic. Major computational step involves the triangular factorization of the square block $[F_{CC}]$. Note this can be reused in expansion step.

$$[D] = [F_{CC}]^{-1}[V] \text{ or } [F_{CC}]\{D\} = [V] \text{ where } [D] = [\{d_1\}, \{d_2\}, \dots, \{d_N\}]$$

PARTITIONS IN BOUNDARY ELEMENT ZONE CONDENSATION

The typical sizes and locations of the partitions present in boundary element zone condensation are shown below. This figure also helps to illustrate the first assembly procedure required to form zone partitions prior to the condensation process. It should also be noted that the condensation procedure embodied in the equations presented above is an exact formulation, in that, no terms have been neglected, nor has any approximation been made.

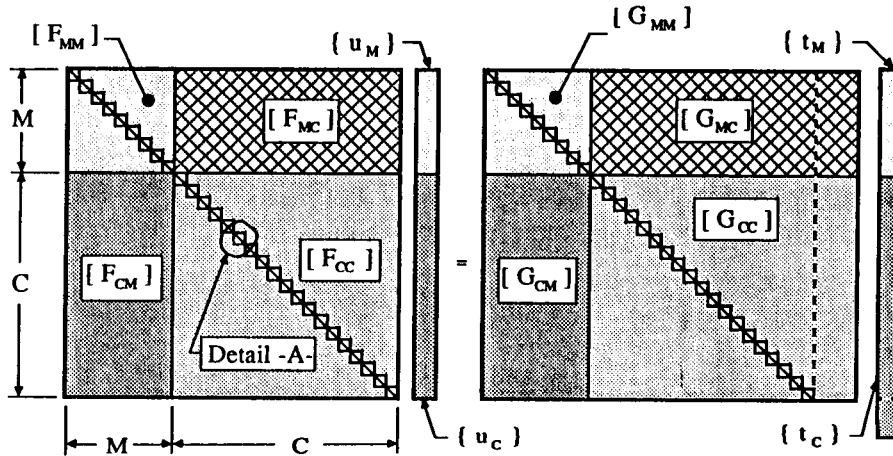

Assembled zone matrix showing master and condensed partitions

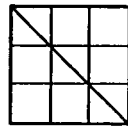

Detail -A- ; The 3 x 3 block of the zone matrices corresponding to singular integration

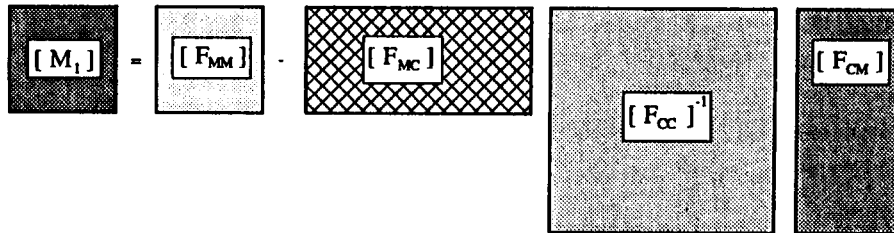

Typical matrix condensation operation with corresponding matrix sizes

Details associated with the assembly, reordering, partitioning, and condensation of a boundary element zone matrix

MULTI-ZONE ANALYSIS WITH SUBSTRUCTURES

Kane and Saigal¹¹ have shown that a very natural way to combine substructuring with multi-zone boundary element analysis capability is to allow for the possible condensation of degrees of freedom that appear exclusively in a particular boundary element zone. In this case the partitions to be eliminated by the condensation process coincide exactly with certain partitions already present in the multi-zone boundary element analysis procedure. This approach is also very natural from a modeling perspective, since entire boundary element zones can be easily and arbitrarily identified for either condensation or no condensation, and also for subsequent expansion if they are to be condensed. Utilization of this strategy requires that a second level assembly procedure for the formation of the overall sparse blocked system of equations must be able to assemble condensed or uncondensed zone contributions to the overall matrix. The algorithm for the second assembly step is very similar to the assembly procedures described in References [15-19], except for the additional complication of dealing with both condensed and uncondensed zone contributions. This procedure takes each column of a zone matrix partition, determines its block destination and column destination within the block, and proceeds to assemble this column. The entire overall matrix is stored in a one dimensional array with appropriate accounting arrays used to indicate the locations and sizes of the individual blocks, along with indicators regarding whether each block is full, empty, or to-be-filled-in in the subsequent block triangular factorization step.

Arbitrary condensing, noncondensing sparse blocked equation solver^{10,11}

- 1.) Natural way to combine both **multi-i-zone** and **substructuring** in same analysis
- 2.) Master and condensed d.o.f. are chosen to exactly coincide with the blocks used in the multi-zone scheme.
 - 2.1 **condensed blocks** correspond to all d.o.f. **exclusively** in a single zone.
 - 2.2 **master blocks** correspond to all zone **interface** d.o.f.
- 3.) **Condensation** and subsequent expansion is **optional**, thus allowing **full and condensed** boundary element zones to consistently **coexist** in the same analysis.
- 4.) Essentially forms an **out of core solver** with reduced sensitivity to zone numbering.
- 5.) Has reduced sensitivity to **zone numbering**.
- 6.) Facilitates the **extension of partial pivoting** outside of diagonal blocks
- 7.) **Key ingredient** in the effective treatment of optimization problems for **partially insensitive** three dimensional shapes via **reanalysis** techniques.

BOUNDARY ELEMENT FORMULATION FOR DSA

A very concise summary of the boundary element sensitivity analysis formulation follows to establish notation and terminology and to serve as a starting point for the discussion of the reduced Design Sensitivity Analysis (DSA) algorithm presented below. In this discussion the concept can first be considered in the single zone context, and then generalized to include multi-zone models. The superscript notation for multi-zone problems is again not explicitly written but rather implied. The implicit differentiation formulation for the boundary displacement- and traction-sensitivities, requires that a partial derivative be taken of the already discretized boundary integral equations, with respect to the design variable, X_L . The vectors $\{u\}$ and $\{t\}$ will be known in the resulting equation, subsequent to the performance of an analysis, and the equation can then be used for the solution of the sensitivity vectors $\{u\}_{,L}$ and $\{t\}_{,L}$. It is noted here that $u_{i,L} = 0$ when u_i is specified and, likewise, $t_{i,L} = 0$ when t_i is specified for any i . The $[L][U]$ decomposition of matrix $[A]$, done for the solution of the analysis equations, can be saved and reused for the solution of this new equation, resulting in considerable economy in computational effort. This is a significant advantage of the implicit differentiation technique. However, the method relies on the ability to determine the fictitious right hand side vector in this equation that includes contributions from the terms $[F]_{,L} \{u\}$ and $[G]_{,L} \{t\}$. In the fully analytical sensitivity analysis approach^{2,4,6-8} the matrices, $[F]_{,L}$ and $[G]_{,L}$, are formed by numerical integration of derivatives of quantities found in the formation of $[F]$ and $[G]$. It has also been shown⁵ that it is possible to obtain the matrices $[F]_{,L}$ and $[G]_{,L}$ by a semi-analytical finite difference procedure.

Implicit differentiation approach¹⁻⁹ to design sensitivity analysis (DSA)

$$\frac{\partial}{\partial X_L} \{ [F] \{u\} = [G] \{t\} \} \Rightarrow [F]_{,L} \{u\} + [F] \{u\}_{,L} = [G]_{,L} \{t\} + [G] \{t\}_{,L}$$

or $[F] \{u\}_{,L} = [G]_{,L} \{t\} + [G] \{t\}_{,L} - [F]_{,L} \{u\}$

When symbolism is generalized, this matrix equation has the **same left hand side** matrix as the analysis. Therefore this **obviates** the need for repeated **triangular factorizations** of perturbed matrices.

Analytical approach^{1-3,5-6,8,10,12,15} for computing the required right hand side vectors.

$$\frac{\partial}{\partial X_L} \left([F] \leftarrow \sum [F]^E = \sum \left\{ \int_{-1}^{+1} [T]^T [h] J da \right\}^E \right) = \sum [F]_{,L}^E$$

$$[F]_{,L}^E = \int_{-1}^{+1} [T]_{,L}^T [h] J da + \int_{-1}^{+1} [T]^T [h]_{,L} J da; \quad [G]_{,L}^E = \int_{-1}^{+1} [U]_{,L}^T [h] J da + \int_{-1}^{+1} [U]^T [h]_{,L} J da$$

Requires numerical integration of **new kernels** containing some familiar terms.
Many elements may be **insensitive**, thereby yielding **sparse sensitivity matrices**.

DSA WITH SUBSTRUCTURES

When boundary element substructuring has been used, as described previously, to condense certain zones in a multi-zone analysis, the design sensitivity analysis matrix equations shown in the previous figure can still be used to symbolize the overall multi-zone system matrix equations. In this instance, the block entries in this equation, contributed by the condensed zones, are assembled from the matrices $[M_1]$ and $[M_2]$ shown in the discussion on boundary element zone condensation. It is also possible to have boundary element zones that have not been condensed to coexist consistently with zones that have been condensed in the same analysis¹⁴. For the uncondensed zones, the appropriate zone $[F]$ and $[G]$ matrices are assembled in the appropriate places in the overall matrix equations. Implicit differentiation of this equation has the same symbolic outcome except that the block entries in this matrix equation for the condensed zones require the formation of $[M_1]_{,L}$, $[M_2]_{,L}$, and $[M_3]_{,L}$, as shown below. In a completely analogous fashion to the implicit differentiation DSA approach described¹⁻⁹ for multi-zone models without substructuring, the terms in the condensed matrix equation can be manipulated to produce the same left hand side matrix as that used in the analysis.

Design sensitivity analysis of substructures¹¹ starts with the implicit differentiation of the condensation and expansion equations.

$$\frac{\partial}{\partial X_L} ([M_1] \{u_M\} = [M_2] \{t_M\} + [M_3] \{t_C\} + [M_4] \{f_C\} + \{f_M\})$$

$$\frac{\partial}{\partial X_L} (\{u_C\} = [F_{CC}]^{-1} [G_{CM}] \{t_M\} + [F_{CC}]^{-1} [G_{CC}] \{t_C\} - [F_{CC}]^{-1} [F_{CM}] \{u_M\} + [F_{CC}]^{-1} \{f_C\})$$

or

$$[M_1] \{u_M\}_{,L} = [M_2] \{t_M\}_{,L} + b_1 \Leftrightarrow \text{Same l.h.s. matrix as in the analysis}$$

where

$$b_1 = - [M_1]_{,L} \{u_M\} + [M_2]_{,L} \{t_M\} + [M_3]_{,L} \{t_C\} + [M_4]_{,L} \{f_C\} + [M_4] \{f_C\}_{,L} + \{f_M\}_{,L}$$

and

$$\begin{aligned} \{u_C\}_{,L} = & ([F_{CC}]^{-1} [G_{CM}])_{,L} \{t_M\} + ([F_{CC}]^{-1} [G_{CM}]) \{t_M\}_{,L} + ([F_{CC}]^{-1} [G_{CC}])_{,L} \{t_C\} \\ & - ([F_{CC}]^{-1} [F_{CM}])_{,L} \{u_M\} - ([F_{CC}]^{-1} [F_{CM}]) \{u_M\}_{,L} + ([F_{CC}]^{-1} \{f_C\})_{,L} \end{aligned}$$

and

DSA WITH SUBSTRUCTURES - Continued

This, in turn, requires what looks like the computation of the sensitivity of the inverse of the matrix $[F_{CC}]$. This apparent requirement at first inhibited the authors from using the substructuring concept in concert with DSA.

$$[M_1]_{,L} = [F_{MM}]_{,L} - \{ [F_{MC}]_{,L} ([F_{CC}]^{-1} [F_{CM}]) + [F_{MC}] ([F_{CC}]^{-1} [F_{CM}])_{,L} \}$$

$$[M_2]_{,L} = [G_{MM}]_{,L} - \{ [F_{MC}]_{,L} ([F_{CC}]^{-1} [G_{CM}]) + [F_{MC}] ([F_{CC}]^{-1} [G_{CM}])_{,L} \}$$

$$[M_3]_{,L} = [G_{MC}]_{,L} - \{ [F_{MC}]_{,L} ([F_{CC}]^{-1} [G_{CC}]) + [F_{MC}] ([F_{CC}]^{-1} [G_{CC}])_{,L} \}$$

The r.h.s. vectors seem to need the sensitivity of the matrix inverse $[F_{CC}]^{-1} ???$

This apparent requirement has delayed the implementation of substructuring techniques in design sensitivity analysis for shape optimization.

OBVIATING THE NEED FOR SENSITIVITIES OF MATRIX INVERSES

The derivation shown below, however, obviates the need to compute the sensitivity of any matrix inverse. The reason that this can be done is because the matrix $[F_{CC}]^{-1}$, appearing in the reduced DSA formulation, is always postmultiplied by another matrix. When the product of the two matrices is considered together, an approach to the computation of the sensitivity of the matrix product becomes clear. This shows that the required term $[D]_{,L}$ can be obtained by 'solving' the resulting equation shown below. Thus, the formation of the matrix term $[D]_{,L}$ can be obtained by forward reduction and backward substitution of the columns of the right hand side matrix shown. This is extremely efficient if the triangular factors of the matrix block $[F_{CC}]$, computed during the condensation step of the analysis, are saved and reused. The sensitivities of the other matrix products shown in the design sensitivity analysis formulation with substructures can be obtained in an analogous fashion. The sensitivity of the matrix $[M_4]$ is not found by itself, but rather, the product of $[M_4] \{f_C\}$ is treated in a manner similar to that discussed above.

Obviating the requirement of computing sensitivities of matrix inverses in DSA of substructures is accomplished by exploiting the fundamental observation that $[F_{CC}]^{-1}$ always premultiplies a vector or rectangular matrix. Notice

$$[F_{CC}]^{-1} [F_{CM}] = [D] \Rightarrow \text{premultiplying by } [F_{CC}] \Rightarrow [F_{CM}] = [F_{CC}] [D]$$

and differentiating

$$[F_{CM}]_{,L} = [F_{CC}]_{,L} [D] + [F_{CC}] [D]_{,L} \text{ or } [F_{CC}] [D]_{,L} = [F_{CM}]_{,L} - [F_{CC}]_{,L} [D]$$

Which was what was wanted !!! $[D]_{,L}$ can be obtained from a forward reduction and backward substitution procedure using the (already computed) triangular factors of the $[F_{CC}]$ block and the right hand side vector shown.

This formulation has been successfully implemented in an overall package for design sensitivity analysis.

SENSITIVITIES AT CONDENSED DEGREES OF FREEDOM

Once traction and displacement sensitivities are known at master degrees of freedom, the differentiated substructure expansion equation, shown above, can be used to optionally recover sensitivities of displacement and tractions at condensed degrees of freedom in a similar fashion without recourse to the computation of sensitivities of matrix inverses. It is thus possible to obtain complete sensitivity information for the boundary element substructures. Again one sees that the approach for expanding sensitivities relies on the ability to compute the sensitivities of matrix products involving $[F_{CC}]^{-1}$. As discussed above, this computation can be done economically using the factorization of $[F_{CC}]$ which has already been computed in the reduction process.

$$\begin{aligned} \{u_C\}_{,L} = & ([F_{CC}]^{-1} [G_{CM}])_{,L} \{t_M\} + ([F_{CC}]^{-1} [G_{CM}]) \{t_M\}_{,L} + ([F_{CC}]^{-1} [G_{CC}])_{,L} \{t_C\} \\ & - ([F_{CC}]^{-1} [F_{CM}])_{,L} \{u_M\} - ([F_{CC}]^{-1} [F_{CM}]) \{u_M\}_{,L} + ([F_{CC}]^{-1} \{f_C\})_{,L} \end{aligned}$$

NUMERICAL RESULTS

The problem considered was that of a hollow circular cylinder, subjected to an external normal traction. The inner radius was selected as the design variable. This problem was chosen partly because a closed form elasticity solution for its response is known. Using the elasticity solution, it is possible to determine a closed form solution for the sensitivity of the response with respect to the design variable. This is accomplished by parameterizing the sample point location and taking a material derivative of the resulting expression. Also, this problem can be thought of as a specific manifestation of the generic situation of a design with partial geometric sensitivity. It is therefore a candidate for the substructuring techniques described in this paper. Two quarter symmetry models of the hollow cylinder, shown below, were used in this study of the accuracy and computational requirements associated with design sensitivity analysis of full size, partially condensed, and fully condensed models. The first model is a single zone model for which no substructuring is performed.

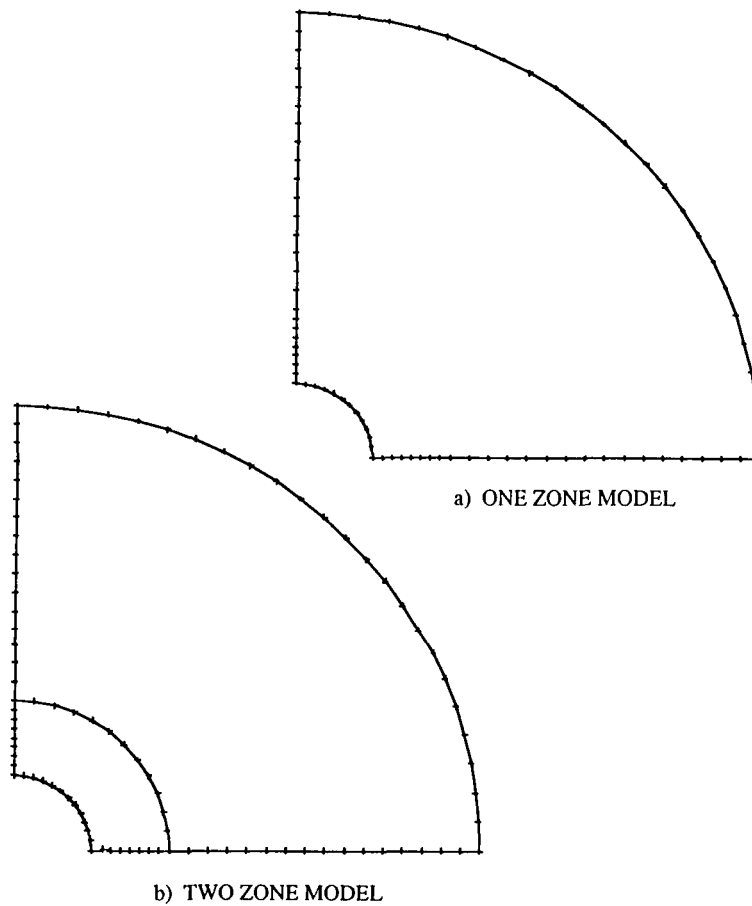

One Zone and Two Zone Boundary Element Models Used as Test Cases.

NUMERICAL RESULTS - Continued

Both this single zone boundary element mesh and the two zone mesh had the geometry of its nodes controlled according to the two schemes shown. These two sets of geometric sensitivities are considered to illustrate how a certain geometric feature of a boundary element mesh, (i.e. the inner radius of the hollow cylinder), can be controlled by one design variable and yet several mesh control strategies may be possible. These different mesh control strategies will be shown to have quite different consequences in terms of the computational requirements of the resulting design sensitivity analysis. In this example, the second set of geometric sensitivities cause significant sparsity in the matrices $[F]_{,L}$ and $[G]_{,L}$. For the two zone models, this second set of geometric sensitivities will cause entire blocks in the multi-zone DSA formulation to be completely empty, thus producing substantial reductions in the resources required to perform DSA.

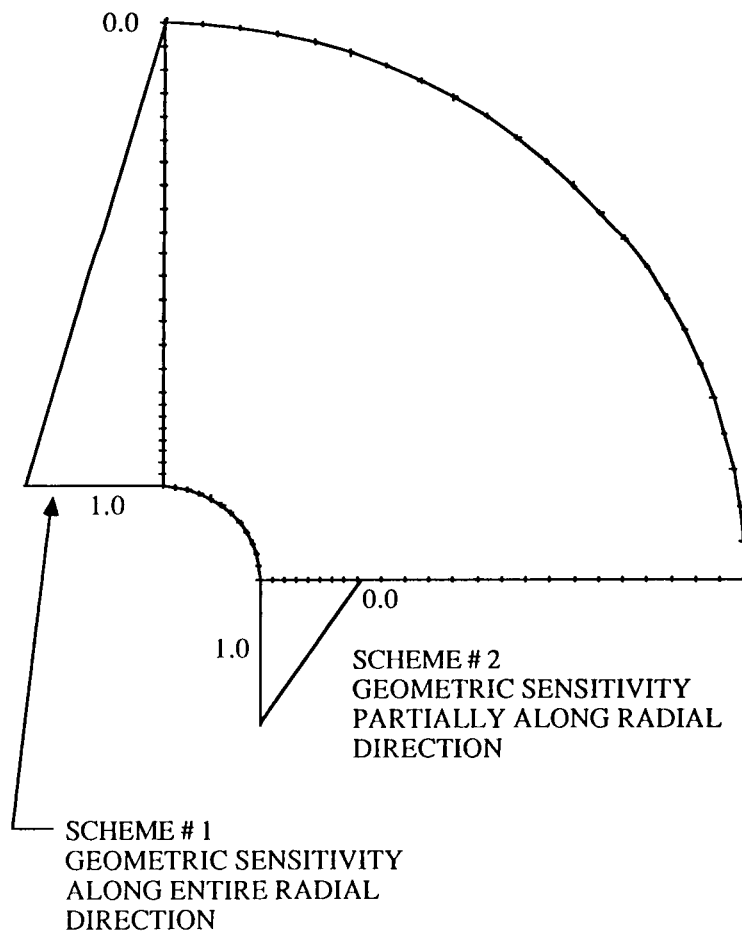

Two different Geometric Sensitivity Schemes Used in this Study.

MATRIX POPULATIONS

The first comparison to be presented in this study concerns the storage required to perform an analysis and a sensitivity analysis of the hollow cylinder employing the various options discussed in this paper. The cases considered are listed below. Case 1.1 is a single zone model with no condensation and its associated left hand side boundary element system matrix is fully populated and therefore not shown. Case 1.2 is a two zone model and its left hand side boundary element system matrix is populated as shown below in Part a. It is seen to require marginally the same amount of computer memory as the single zone model. The Case 1.3 is a two zone model with the largest zone condensed. The left hand side matrix population for this case is depicted in Part c. Case 1.4 has both of its boundary element zones condensed and the resulting matrix population for the left hand side system matrix is illustrated in Part b. From this example one can see that the condensation technique discussed in this paper allows for the analysis and design sensitivity analysis to be performed in much less computer memory. The condensation technique effectively functions as an out of core solver reducing memory requirements to almost one third for case 1.3 and to more than one seventh for case 1.4.

case	zones	zone1	zone2	storage (kwords)
1.1	1	full	-----	261.
1.2	2	full	full	260.
1.3	2	full	condensed	94.
1.4	2	condensed	condensed	37.

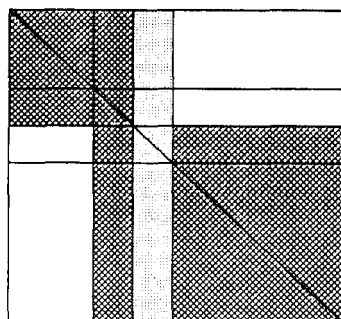

a) MATRIX POPULATION WHEN NO CONDENSATION IS PERFORMED



b) MATRIX POPULATION WHEN ALL ZONES ARE CONDENSED

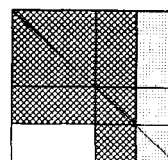

c) MATRIX POPULATION WHEN ZONE TWO IS CONDENSED AND ZONE ONE IS LEFT FULL SIZE

= BLOCK CONTAINING INFORMATION FROM $[F]$ OR $[M_1]$ MATRIX
 = BLOCK CONTAINING INFORMATION FROM $[G]$ OR $[M_2]$ MATRIX

Left hand side boundary element system matrix populations for the two zone mesh shown previously for various combinations of zone condensation options.

CAPITALIZING ON GEOMETRIC INSENSITIVITY

There are frequent occasions when portions of a design are geometrically insensitive to the design variables that control its shape. It is also possible in many instances to enhance the amount of geometric insensitivity that a model possesses through modeling techniques such as the one shown above. Here the inner radius is the design variable and yet two schemes for controlling the boundary element node point geometric sensitivity along the radial edges of the model are shown. Listed below are a series of test cases that help to quantify the ability of the various analysis and sensitivity analysis options discussed in this paper to exploit geometric insensitivity for computational performance improvement. The cases 2.1 through 2.4 reveal that the single zone boundary element method is unable to exploit the additional geometric insensitivity present in the partially geometrically sensitive model, while the multi-zone model (case 2.4) yielded analysis and sensitivity analysis results in less than 75 % of the time used for the fully sensitive model. If one compares the time for the DSA alone, the two zone partially sensitive model (case 2.4) can be used for sensitivity calculation in about 35 % of the time taken by the fully sensitive two zone model (case 2.3), and in less than 45 % of the time spent using either of the single zone models. Cases 2.4 through 2.8 demonstrate that the condensation and expansion procedures discussed in this paper are competitive with the straightforward multi-zone analysis and sensitivity analysis techniques that do not involve substructuring (i.e. case 2.4). These cases also demonstrate that the cost of performing the expansion step in DSA of substructures is not significant. Case 2.9 points out that for designs with total geometric sensitivity the substructuring technique requires more computer time than procedures that do not involve condensation and expansion.

case	zones	geometric sensitivity	condensation option		expansion option		Analysis	DSA	Total
			zone1	zone2	zone1	zone2			
2.1	1	full	full	full	no	no	30.9	16.4	47.3
2.2	1	partial	full	full	no	no	30.9	16.3	47.2
2.3	2	full	no	no	no	no	26.6	19.6	46.2
2.4	2	partial	no	no	no	no	26.6	7.0	33.6
2.5	2	partial	no	yes	no	no	25.5	7.8	33.3
2.6	2	partial	no	yes	no	yes	25.5	8.4	33.9
2.7	2	partial	yes	yes	no	no	25.6	9.4	35.0
2.8	2	partial	yes	yes	yes	yes	25.6	10.9	36.5
2.9	2	full	yes	yes	yes	yes	25.6	31.7	57.3

ACCURACY

In both the analysis and the design sensitivity analysis, there was absolutely no discernable difference in the accuracy of the computed results that was dependent on whether condensation or expansion was performed.

CONCLUSIONS

- 1.) Substructuring technique can dramatically economize shape optimization for partially sensitive models
- 2.) Requires
 - Arbitrary condensing / noncondensing assembly and equation solving procedures
 - Design sensitivity analysis of substructures
- 3.) Formulation presented for DSA of substructures that is efficient because it obviates the need for the computation of sensitivities of matrix inverses
- 4.) Accuracy is exactly the same as when no substructuring is done
- 5.) Procedure can be done in parallel mode
- 6.) Implementation currently being incorporated in the Computer Aided Engineering Center's shape optimization system

Acknowledgments

Research discussed in this paper has been supported by grants from the U. S. National Science Foundation DMC-8708254 and MSM-8707842 to Worcester Polytechnic Institute's Computer Aided Engineering Center and also from the Electric Boat Division of General Dynamics Corp. and United Technologies Corp.

REFERENCES

1. J. H. Kane, " Optimization of Continuum Structures Utilizing a Boundary Element Formulation," Ph.D. Dissertation, University of Connecticut, Storrs Connecticut, 1986.
2. J. H. Kane, " Shape Optimization Utilizing a Boundary Element Formulation," BETECH 86, Proceedings, 1986 Boundary Element Technology Conference, MIT.
3. J. H. Kane and S. Saigal, "Design Sensitivity Analysis of Solids Using BEM," Journal of Engineering Mechanics, ASCE, vol. 114, no. 10, Oct. 1988.
4. S. Saigal and J. H. Kane, "A Boundary Element Shape Optimization System for Aircraft Components," AIAA Journal, to appear, also Worcester Polytechnic Institute paper CAE88-1.
5. S. Saigal, J. H. Kane and R. Aithal, "Semi-Analytical Structural Sensitivity Formulation using a Boundary Elements," AIAA Journal, to appear, also Worcester Polytechnic Institute paper CAE88-2.
6. S. Saigal, J.T. Borggaard and J.H. Kane, "Boundary Element Implicit Differentiation Equations for Design Sensitivities of Axisymmetric Structures," International Journal of Solids and Structures, to appear, also Worcester Polytechnic Institute paper CAE88-3.
7. J. H. Kane, " A Second Generation Structural Shape Optimization Capability Employing a Boundary Element Formulation," Proceedings, NUMETA 87.
8. S. Saigal and J. H. Kane, " Design Sensitivity Analysis of Aircraft Engine Components Subject to Body Forces Using a Boundary Element Formulation," Second NASA / Airforce Symposium on Recent Experiences in Multi Disciplinary Analysis and Optimization, September, 1988, Accepted for presentation..
9. J. H. Kane and M. Stabinsky, " Simultaneous Computation of Multiple Sensitivities by a Boundary Element Structural Analysis Formulation," Proceedings, Third International Conference on CAD / CAM Robotics and Factories of the Future, August 1988, Springer-Verlag, 1989.
10. S. Saigal and J. H. Kane, " Numerical Integration and Sparse Blocked Equation Solution Techniques for Large Scale Boundary Element Analysis," Proceedings, Two-Day Symposium on the Solution of Super Large Problems in Computational Mechanics, Sponsored jointly by: Office of Naval Research, Naval Underwater Systems Center, and Worcester Polytechnic Institute, Connecticut, October 18-19, 1988, (J. H. Kane and A. D. Carlson, Editors, Plenum Press Publishers, 1989)
11. J. H. Kane and S. Saigal, " An Arbitrary Condensing, Noncondensing Solution Strategy for Large Scale, Multi Zone Boundary Element Analysis," International Journal for Numerical Methods in Engineering, submitted for review, also Worcester Polytechnic Institute paper CAE88-4.
12. P. K. Banerjee and R. Butterfield, Boundary Element Methods In Engr. Sci., McGraw Hill Book Co. UK. London, 1981

13. C. A. Brebbia and S. Walker, Boundary Element Techniques in Engineering, Newnes Butterworths, London and Boston, 1980
14. C. A. Brebbia, J. C. F. Telles, and L. C. Wrobel, Boundary Element Techniques, Springer Verlag, Berlin and New York, 1984
15. J. C. Lachat, and J. O. Watson, "A Second Generation Boundary Integral Program for Three Dimensional Elastic Analysis," Chapter in, Boundary Integral Equation Method: Computational Applications in Applied Mechanics (Eds. T.A. Cruse and F. J. Rizzo) Appl. Mech. Div., ASME Vol 11, New York, 1975.
16. J. C. Lachat, "Further Developements of the Boundary Integral Technique for Elasto-statics," Ph.D. Thesis, Southampton Univ., 1975.
17. J. C. Lachat and J. O. Watson, "Progress in The Use of Boundary Integral Equations, Illustrated by Examples," Computational Methodes in Applied Mechanical Engineering, 10, 273-289.
18. J. M. Crotty, "A Block Equation Solver for Large Unsymmetric Matrices Arizing in the Boundary Element Method," International Journal for Numerical Methods in Engineering, Vol 18, pp 997-1017, 1982
19. P. C. Das, "A Disc Based Block Elimination Technique Used for the Solution of Non-Symmetrical Fully Populated Matrix Systems Encountered in the Boundary Element Method," Proc. Int. Symp. On Recent. Dev. In Boundary Element Meth., Southampton Univ. pp 391-404, 1978