

UARS

Upper Atmosphere
Research Satellite



A Program to Study
Global Ozone Change

ORIGINAL CONTAINS
COLOR ILLUSTRATIONS

(NASA-TM-101756) THE UARS (UPPER ATMOSPHERE
RESEARCH SATELLITE): A PROGRAM TO STUDY
GLOBAL OZONE CHANGE (NASA) 32 p C5CL 13B

N89-25520

Unclas

G3/45 0204494

UARS



*The mounting evidence of environmental change affecting the whole Earth as a self-contained ecological system mandates study of the Earth as a planet. This study requires the global perspective of space observations: a **NASA Mission to Planet Earth**. UARS addresses the problem of stratospheric changes linked to human activities that lead to ozone depletion and is the leading element of that Mission.*

**ORIGINAL PAGE
COLOR PHOTOGRAPH**



The Upper Atmosphere: A Crucial Frontier For Space Research.

The Earth's upper atmosphere is thin, fragile, almost invisible. Yet it plays a fundamental role in global climate and provides our shield against harmful ultra-violet radiation from the sun.

The Concern: *Recent and substantial changes in atmospheric composition, caused in part by human activity.*

The people of the world are conducting a continuing, inadvertent experiment with the Earth's atmosphere that is altering its properties on a global scale. The outcome cannot yet be predicted.

The Response: *NASA's Upper Atmosphere Research Satellite (UARS), spearhead of a long-term, national program of space research into global atmospheric change.*

UARS will provide the comprehensive data base needed for an understanding of changes in the upper atmosphere and for informed policy decisions to address the human role in such changes.

CONTENTS

Global Atmospheric Change	2
UARS: The Mandate	4
Structure of the Atmosphere	6
Upper-Atmosphere Processes	8
Atmospheric Research: A Perspective	10
The Upper Atmosphere: Global Study	12
UARS: An Integrated Design	14
Atmospheric Chemistry	16
Atmospheric Composition and Temperature	18
Atmospheric Winds	20
Energy Inputs	22
UARS Data Management	24
UARS Investigations	26
UARS: Research for Our Global Future	28



ORIGINAL PAGE
COLOR PHOTOGRAPH

**GLOBAL
ATMOSPHERIC
CHANGE**

The Earth's atmosphere is changing. Scientific measurements have documented shifts in chemical composition throughout the lower atmosphere, as well as substantial alterations in chemical composition in the upper atmosphere. Both of these findings have important implications for terrestrial life and human societies.

Natural and Human Influences

Some of these changes have a natural origin. Variations in the intensity of solar radiation influence the energy balance, chemistry, and dynamics of the atmosphere, as do fluctuations in the intensity of the solar wind and of cosmic rays from space. Volcanic eruptions inject dust, ash, and a variety of chemical compounds into the atmosphere. Such natural events tend to be either periodic or episodic; their effects, while often dramatic, normally pose little threat to the equilibrium of the global Earth system.

Human activities are also responsible for atmospheric change. By contrast with natural processes, however, these activities are generating long-term trends which, if continued, may lead to large and irreversible effects. For example, the burning of fossil fuels is producing a worldwide increase in the atmospheric concentration of carbon dioxide, which transmits visible light but traps infrared radiation near the Earth's surface. This so-called "greenhouse effect" will produce a global warm-

ing trend. If atmospheric carbon dioxide continues to increase at the present rate, modeling studies estimate that the global average surface temperature will rise some 2° Celsius by the middle of the next century—a climate change greater than any ever experienced by organized human societies.

Moreover, carbon dioxide is only one of several "greenhouse" gases. The others, although individually of less significance, may collectively produce a comparable effect. These include nitrous oxide (resulting from microbial activity, combustion, and use of nitrogen fertilizers), methane (produced by swamps, rice pad-



BOTH NATURAL AND HUMAN-INDUCED PROCESSES generate changes in atmospheric composition. Above, from left: rice paddies produce methane, a "greenhouse" gas that also affects stratospheric chemistry; junked auto air-conditioning units leak CFC refrigerants; deforestation alters the balance between emission and absorption of carbon dioxide and other gases; increased atmospheric transmission

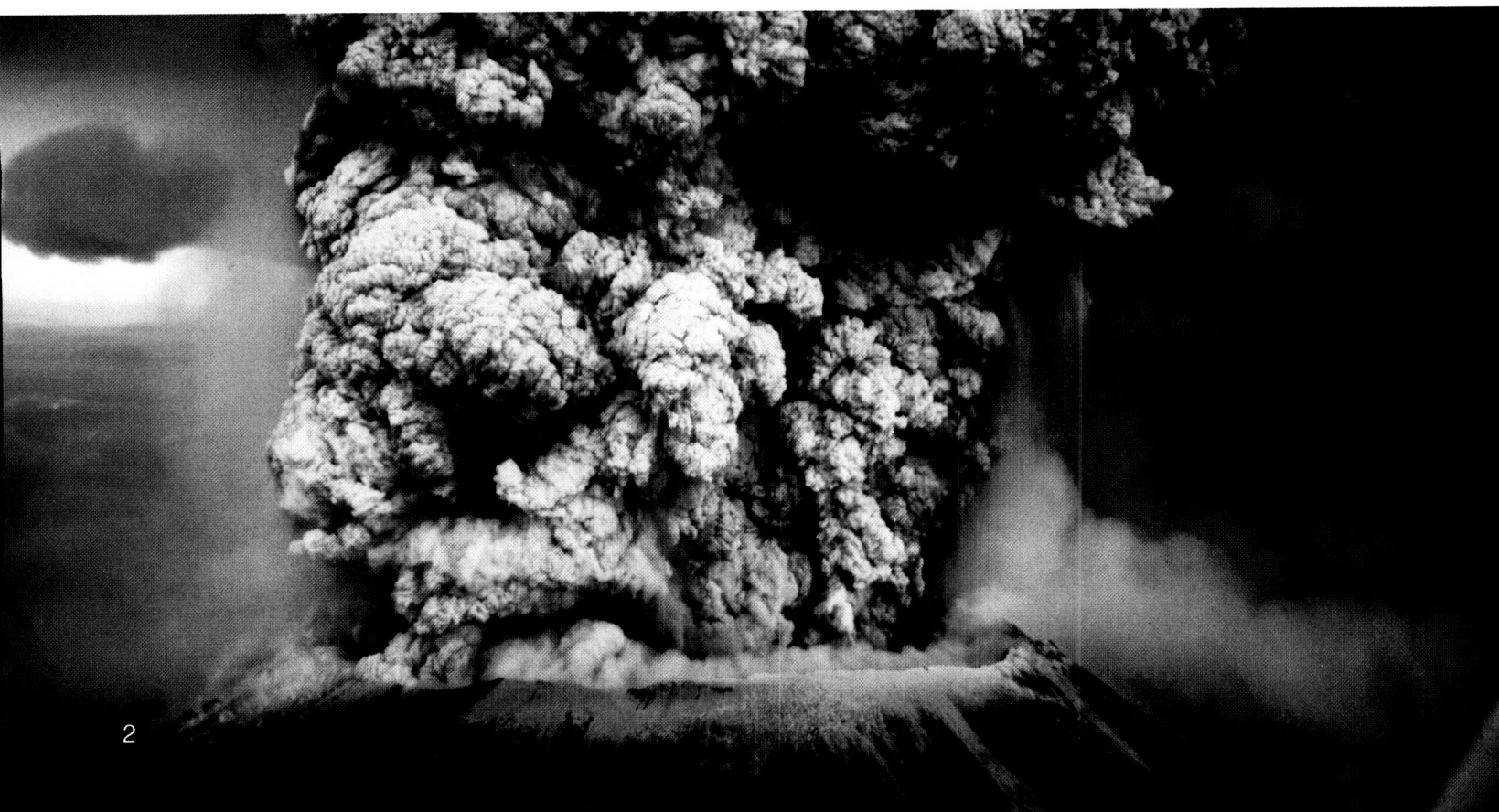

ORIGINAL PAGE
COLOR PHOTOGRAPH

dies, and the digestive systems of termites and ruminant animals), and the chlorofluorocarbons, or CFCs, which are still utilized in some parts of the world as spray-can propellants and throughout the industrialized world in plastic-foam manufacture, cleaning of industrial components, air conditioning, and refrigeration.

CFCs and Stratospheric Ozone

The introduction of CFCs into the atmosphere can ultimately lead to depletion of the Earth's stratospheric ozone layer, which shields terrestrial life from harmful

solar ultraviolet radiation. Once released into the lower atmosphere, the CFCs migrate upward into the stratosphere, where they are decomposed by ultraviolet sunlight. The chlorine thus freed acts as a catalyst to destroy ozone. There is strong evidence that CFCs are largely responsible for the substantial seasonal declines in ozone levels over Antarctica in recent years, and there is mounting concern that global ozone levels are also being affected. Atmospheric concentrations of the two major CFCs are currently increasing at the alarming rate of 5% per year. Other greenhouse gases, such as methane and nitrous oxide, also play roles in the ozone chemistry of the upper atmosphere.

The United States banned CFCs as aerosol propellants in 1978, and many nations have now agreed to further limit CFC use. However, our knowledge of upper-atmosphere chemistry is at present inadequate for detailed study of the ozone problem, as is our understanding of the dynamical processes and energy balances that are closely coupled to chemical effects. Informed policy decisions of the 1990s will need to draw upon a comprehensive data base furnished by a systematic, global research program targeted at the upper atmosphere. NASA's Upper Atmosphere Research Satellite (UARS) is the centerpiece of that program.

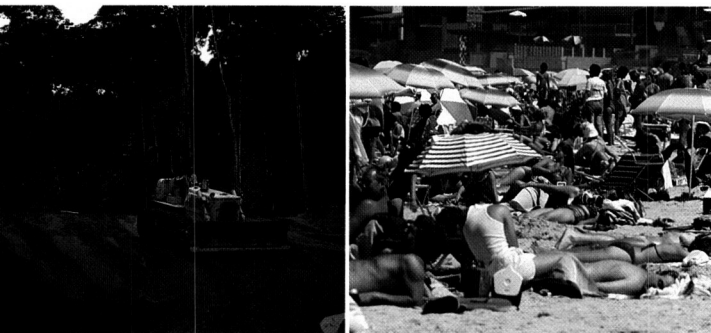

of solar ultraviolet radiation resulting from ozone loss could lead to an increase in human skin cancer from exposure to sunlight. Below, left: volcanic eruptions inject sulfur compounds and other gases and particles into the atmosphere. Below, right: industrial processes alter lower-atmosphere chemistry, eventually affecting upper-atmosphere composition.



ORIGINAL PAGE
COLOR PHOTOGRAPH

**UARS:
THE MANDATE**

We have probed the outer edges of our solar system with automated spacecraft, and Earth-orbiting astronomical observatories have opened new windows on the universe. Yet the Earth's upper atmosphere—beginning only 10-15 km above the surface—remains a frontier largely unexplored from space. NASA's Upper Atmosphere Research Satellite (UARS) will carry out the first systematic, comprehensive study of the stratosphere and furnish important new data on the mesosphere and thermosphere.

A Global Research Program

The processes of importance in the upper atmosphere—energy balance, dynamics, and chemistry—are global in scale. Their study therefore requires the global coverage that can only be achieved by remote sensing from space. In this approach, spacecraft sensors measure the energy radiated by the atmosphere, or the energy absorbed or scattered from sunlight passing through the atmosphere. Analysis of the results furnishes detailed information on chemical constituents, temperature, winds, and the effects of energy inputs from sunlight and the solar wind. These findings will help to reveal the mechanisms that control the structure and variability of the upper atmosphere, to improve the predictability of ozone depletion, and to define the role of the upper atmosphere in the Earth's climate system.

The UARS program builds upon decades of research with rockets, balloons, aircraft, and such satellites as the Television Infrared Operational Satellite (TIROS) and Orbiting Geophysical Observatory (OGO) series, the Solar Mesosphere Explorer (SME), and the Nimbus series. The UARS mission objectives are to provide an increased understanding of:

- Energy input into the upper atmosphere;
- Global photochemistry of the upper atmosphere;
- Dynamics of the upper atmosphere;
- The coupling among these processes; and
- The coupling between the upper and lower atmosphere.

In addition to nine experimental groups, the UARS program includes ten theoretical groups with specific responsibilities for data analysis and interpretation. One important product of these studies will be computer models that simulate processes in the upper atmosphere. These simulations will test our understanding of these processes and provide predictions of changes in atmospheric structure and behavior important to future policy formulation.

Study of Global Change

The national mandate for UARS dates to 1976, when the U.S. Congress, responding to the identification of new causes of ozone depletion, directed NASA to expand its research program related to the upper atmosphere. A vigorous research initiative was soon established involving rockets, aircraft, and balloons, together with

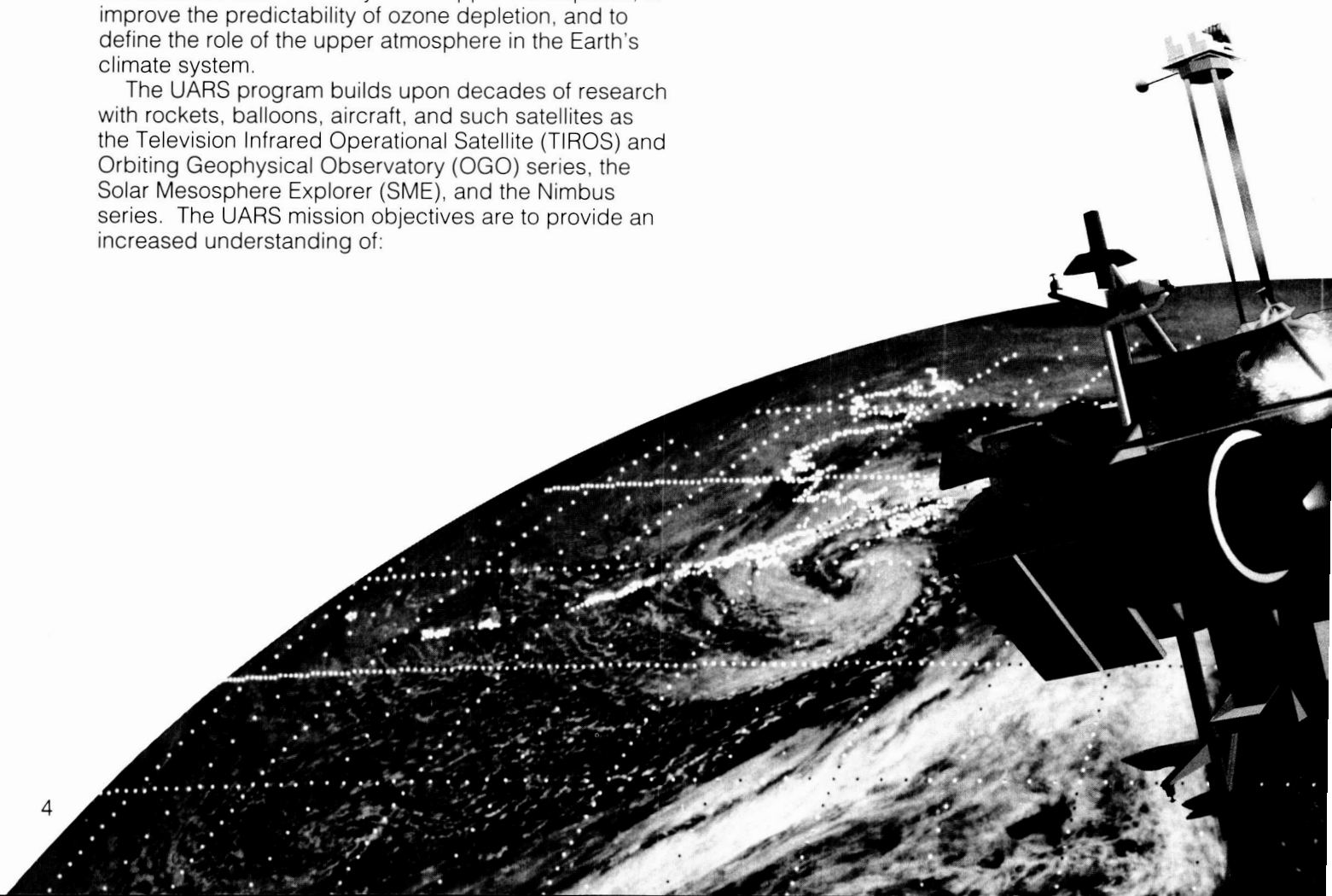

**ORIGINAL PAGE
COLOR PHOTOGRAPH**

laboratory and theoretical studies. These investigations have confirmed that man-made chemicals are indeed depleting stratospheric ozone, heightening concern over the effects of this depletion of life on Earth. In recognition of this concern, NASA has made the timely flight of UARS a key near-term component of a systematic, long-range plan for the study of global change from space.

The Mission

Scheduled for deployment by the Space Shuttle in late 1991, UARS will operate 600 km above the Earth in an orbit inclined 57 degrees to the Equator. This orbit will permit the UARS sensors to "see" up to 80 degrees in latitude—thus providing essentially global coverage of the stratosphere and mesosphere—and to make measurements over the full range of local times at all geographic locations every 36 days.

The nine UARS sensors will provide the most complete data on energy inputs, winds, and chemical composition ever gathered. Taken together, the data sets will yield the first simultaneous, comprehensive,

global coverage of these closely coupled atmospheric properties. These observations thus constitute a highly integrated investigation into the nature of the upper atmosphere. Additional correlative data, as well as theoretical studies linked to specific sensor objectives, will complement the UARS observations to provide a systematic, unified research approach.

An International Legacy

An important aspect of the UARS program is its coordination with additional national and international programs of study and data acquisition. Other nations are contributing to the UARS instruments, and scientists from many nations will ultimately participate in the analysis and utilization of UARS data.

Upon completion of the UARS mission, we will have gained a dramatically expanded and detailed picture of the energetics, dynamics, and chemistry of the upper atmosphere. This information will then be available to governments around the world, enabling them to address more effectively the role of human activities in altering upper-atmosphere properties.

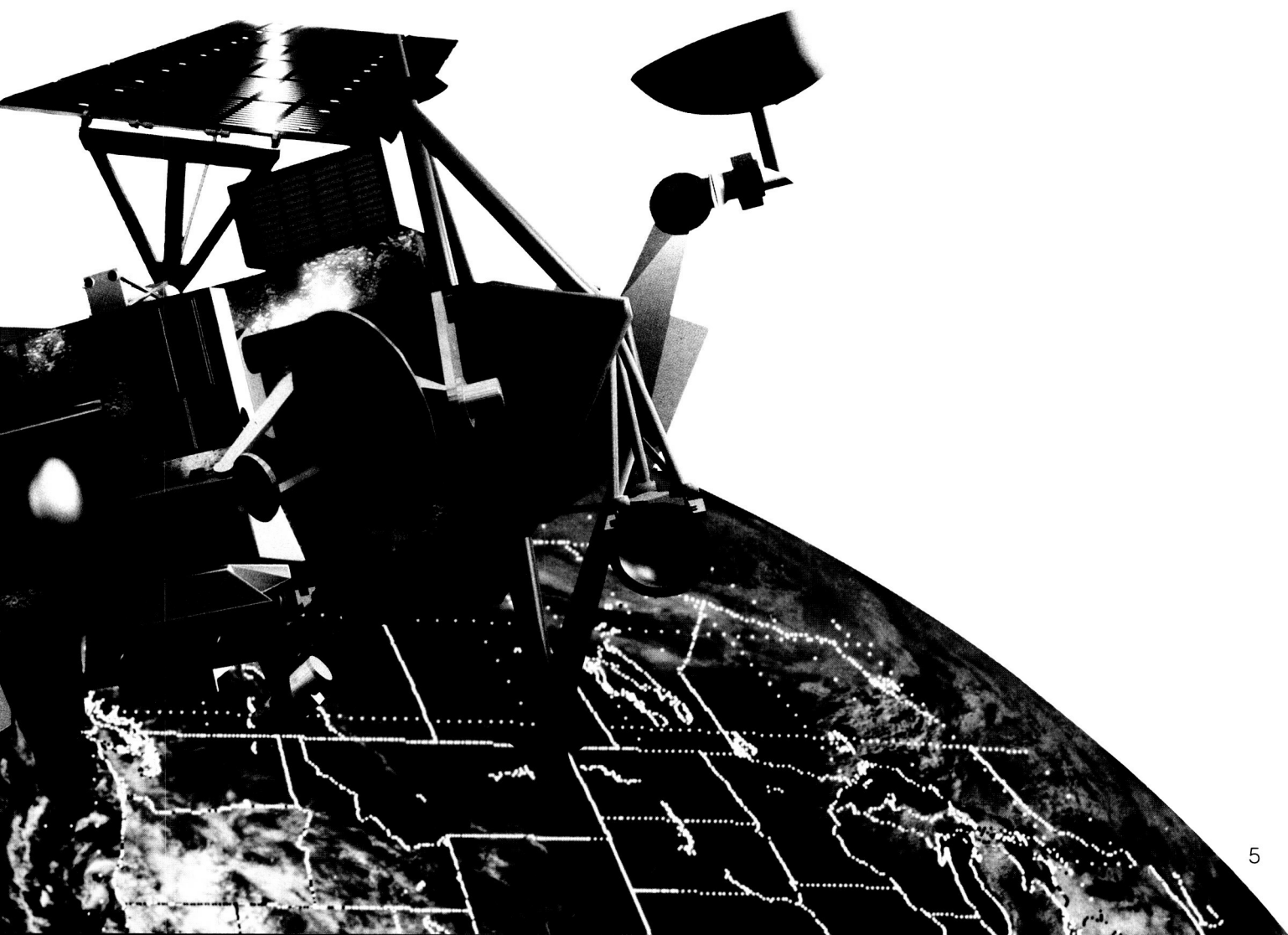

ORIGINAL PAGE
COLOR PHOTOGRAPH

**STRUCTURE
OF THE
ATMOSPHERE**

The Earth's atmosphere is structured in layers, each with characteristic physical and dynamical properties, each interacting with the layers above and below it. For most purposes, it is convenient to classify these atmospheric layers by the variation of temperature with altitude.

The Troposphere

The troposphere is the lowest layer of the Earth's atmosphere, extending to a height of 10-15 km, depending on latitude. This region contains most of the atmosphere's clouds and weather and is the major source and sink for important trace gases for higher atmospheric layers. Early observations showed that temperature declines with altitude in the troposphere, and it was long believed that this relationship held throughout the atmosphere.

The Stratosphere

Toward the end of the 19th century, however, further research revealed a more complex temperature behavior. Leon Phillippe Teisserenc de Bort, a French meteorologist, launched hundreds of balloons that carried thermometers, barometers, and hygrometers to altitudes of 10-15 km. These mid-latitude observations revealed that temperature declines with altitude only up to a

height of about 12 km. De Bort had discovered the tropopause, which marks the limit of the troposphere and the beginning of the upper atmosphere.

De Bort's balloon measurements, which were not particularly sensitive, seemed to show that atmospheric temperature remained roughly constant above the tropopause. If this were the case, atmospheric gases would be expected to become sorted into layers, or "strata," according to their molecular weights; the region above the troposphere was therefore named the stratosphere.

The true structure of the upper atmosphere was revealed by a series of experiments that followed de Bort's pioneering investigations. The stratosphere is now known to be a region of intense interactions among radiative, dynamical, and chemical processes in which horizontal mixing of gaseous components proceeds much more rapidly than vertical mixing. Contrary to de Bort's early conclusion, the stratosphere is warmer than the upper troposphere: temperature above the tropopause increases slowly with height up to about 50 km. However, an explanation for this phenomenon was not found until 1930, when a plausible theory was put forth by Sidney Chapman for the existence of a stratospheric ozone layer. Absorption of solar ultraviolet energy by ozone produces most of the heating in the middle atmosphere.

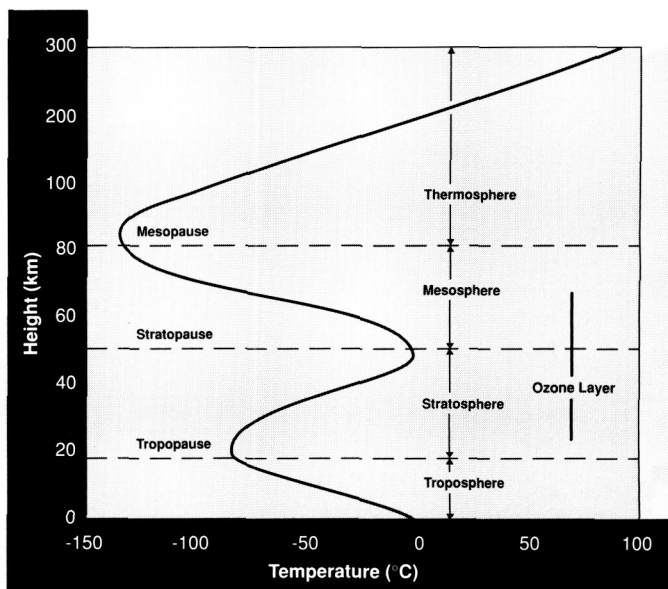

VARIATION OF ATMOSPHERIC TEMPERATURE WITH HEIGHT delineates four atmospheric layers: troposphere, stratosphere, mesosphere, and thermosphere. UARS instruments will study the properties of the upper three layers.

ORIGINAL PAGE
COLOR PHOTOGRAPH

The Mesosphere and Thermosphere

Above about 50 km in altitude, the ozone heating effect diminishes in importance because of falling ozone concentrations, and radiative cooling becomes relatively more important. The temperature thus begins to decline again with altitude. This effect marks the stratopause—the top of the stratosphere and the bottom of the mesosphere. Rocket experiments in the 1940s and 1950s showed that the temperature falls to -70° to -140° Celsius in the upper mesosphere, depending on latitude and season.

In the late 1950s, rocket flights probed a region above the mesosphere—the thermosphere—where temperature again begins to rise with altitude. The mesopause, at an altitude of about 80 km, separates the mesosphere from this outermost layer of the Earth's atmosphere. Heating of the thermosphere is due to absorption of highly energetic solar radiation by the small amount of residual molecular oxygen still present, and temperatures can rise to 2,000° Celsius. At these high altitudes, the residual atmospheric gases do in fact become sorted into strata according to molecular mass, as de Bort had earlier conjectured for the stratosphere.

Since spacecraft in low Earth orbit actually pass through the outer thermosphere, direct sampling of chemical species there has been used extensively to develop an understanding of thermospheric properties. Explorer-17, launched in 1963, was the first satellite to return quantitative measurements of gaseous stratification in the thermosphere. However, the mesosphere and lower layers cannot be probed directly in this way—global observations from space require remote sensing from a spacecraft at an altitude well above the mesopause. The formidable technological challenges of atmospheric remote sensing, many of which are only now being overcome, have delayed detailed study of the stratosphere and mesosphere by comparison with thermospheric research advances.

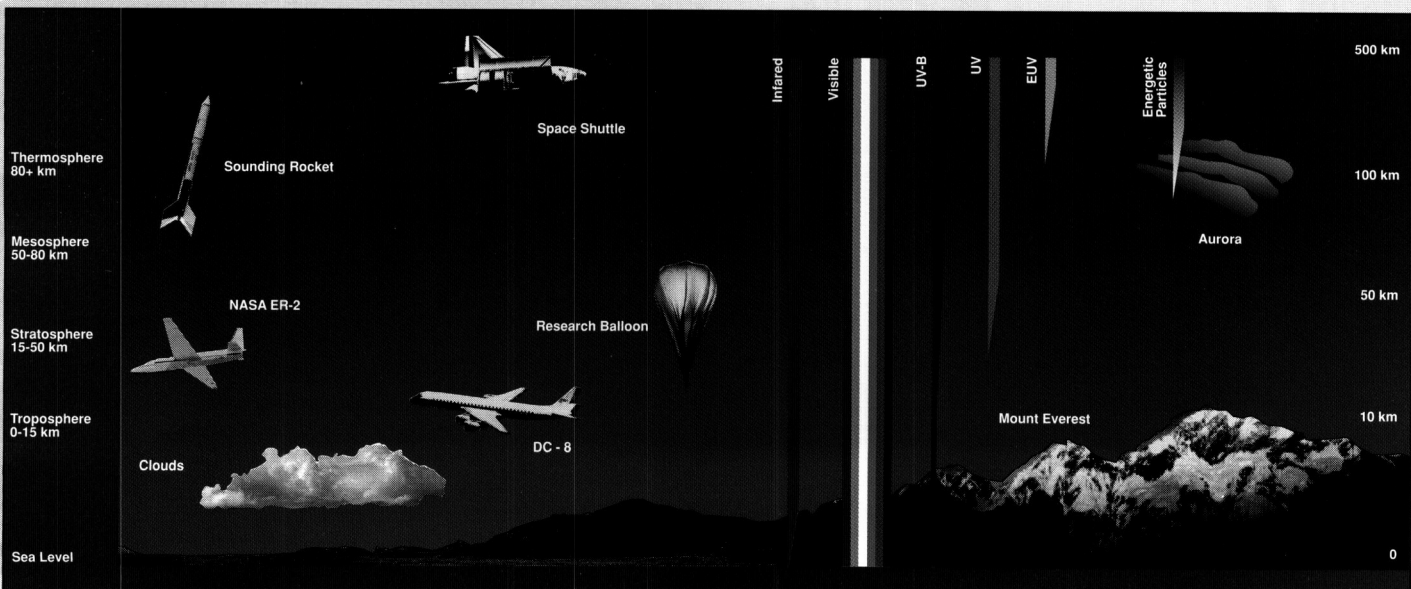

PENETRATION OF ELECTROMAGNETIC RADIATION through the atmosphere is determined by atmospheric absorption within the spectral region in question. The atmosphere is transparent to visible light and some infrared radiation; ultraviolet (UV) and extreme ultraviolet (EUV) radiation are entirely absorbed in the upper atmosphere, although some longer ultraviolet wavelengths (UV-B) penetrate to the surface. Different observational platforms are used to investigate specific atmospheric characteristics over the wide range of altitudes that must be covered.

UPPER-ATMOSPHERE PROCESSES

Chemistry, dynamics, and energy inputs are the processes that determine upper-atmosphere structure and behavior. These processes are closely coupled and must be studied together. Only in this way can we gain an understanding sufficiently detailed to permit accurate predictions of the effects of human influences on the upper atmosphere.

Chemistry

Chemical processes are responsible for the formation and maintenance of the Earth's stratospheric ozone layer, which is in turn responsible for the heating effect that distinguishes the stratosphere from the troposphere. It is the ozone layer that shields terrestrial life from the harmful effects of solar ultraviolet radiation. Upper-atmosphere chemical processes that can alter ozone concentrations are therefore a focal point of the UARS research program.

Ozone is produced naturally in the middle and upper stratosphere through dissociation of molecular oxygen by sunlight. In the absence of chemical species produced by human activity, ozone balance is maintained by a number of competing chemical reactions among naturally occurring species, primarily atomic oxygen, molecular oxygen, and oxides of hydrogen and nitrogen.

In the present-day stratosphere, however, this natural balance has been altered, particularly by the introduction of man-made chlorofluorocarbons (CFCs). There are no known mechanisms for CFC destruction in the lower atmosphere; industrially released CFCs therefore continue to accumulate in the troposphere until they are transported into the stratosphere. There they are dissociated by solar ultraviolet radiation to yield atomic chlorine, which is known to deplete ozone through catalytic reactions powered by sunlight.

A wide variety of other chemical species must also be taken into account in any attempt to understand the highly complex chemistry of the stratosphere and the

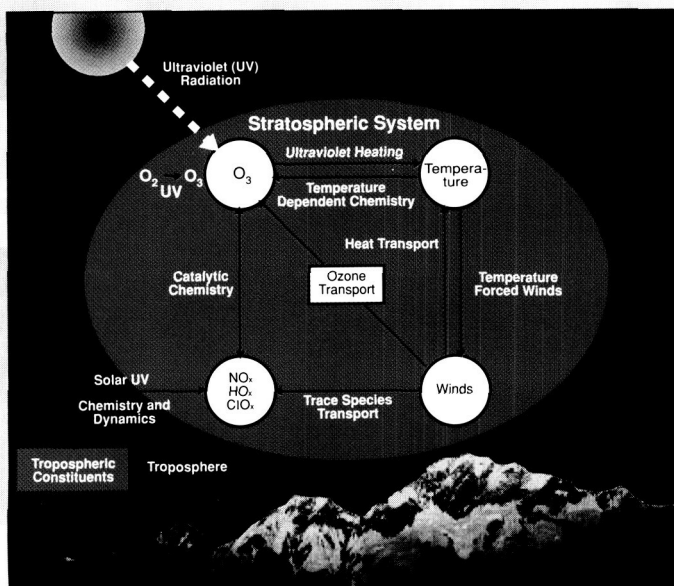

STRATOSPHERIC SYSTEM. Of prime concern is maintenance of the stratospheric ozone layer, which shields terrestrial life from solar ultraviolet radiation.

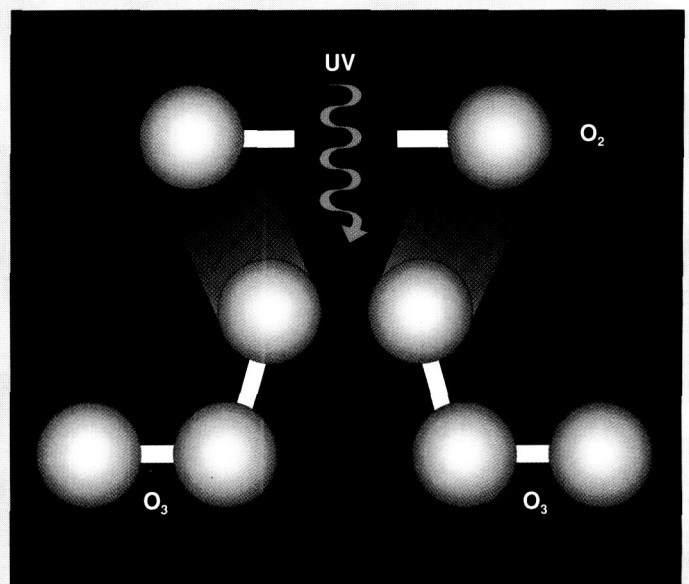

OZONE FORMATION begins with dissociation of diatomic O_2 molecules by ultraviolet radiation; the free oxygen atoms combine with other O_2 molecules to form triatomic ozone (O_3).

ORIGINAL PAGE
COLOR PHOTOGRAPH

fate of the ozone layer (see pages 16-17). UARS will obtain data on a large number of the key chemical species in the upper atmosphere.

Dynamics

Winds play an important role in transporting heat and gases in the upper atmosphere. Global distributions of chemical species are determined primarily by planetary-scale motions with periods of several days and longer. However, smaller-scale motions are important in several contexts, including the exchange of gases between the troposphere and stratosphere. It is estimated that as much as 70% of the total stratospheric air mass is exchanged with the troposphere each year, assuring the continual upward introduction of tropospheric species into the stratosphere and the downward transport of stratospheric reaction products.

The wind fields in the upper atmosphere are closely related to the distributions of certain trace gases, as well as to energy inputs. Since ozone is the most abundant absorber of solar ultraviolet radiation in the stratosphere and mesosphere, its spatial distribution strongly influences the pattern of atmospheric heating in these regions. In addition, the chemical reaction rates

that govern species abundances are sensitive to temperature, generally increasing with higher temperature. Atmospheric heating thus influences chemistry and, through the creation of pressure gradients, the wind fields (see pages 20-21).

Energy Inputs

Radiation from the Sun is the dominant influence on upper-atmosphere processes. Virtually all of the solar ultraviolet radiation in the wavelength range 120-300 nm is absorbed in the stratosphere, mesosphere, and lower thermosphere. This energy, together with magnetospheric energy inputs at high latitudes, is fundamental to the photochemistry and dynamics of the upper atmosphere. Solar irradiance, combined with cooling by emission in the thermal-infrared spectral region, produces most of the seasonal, vertical, and latitudinal variability of the atmosphere's thermal structure, which in turn controls most of the dynamics of the upper atmosphere. A quantitative understanding of atmospheric radiative processes is therefore essential to investigations of upper-atmosphere chemistry and dynamics (see pages 22-23).

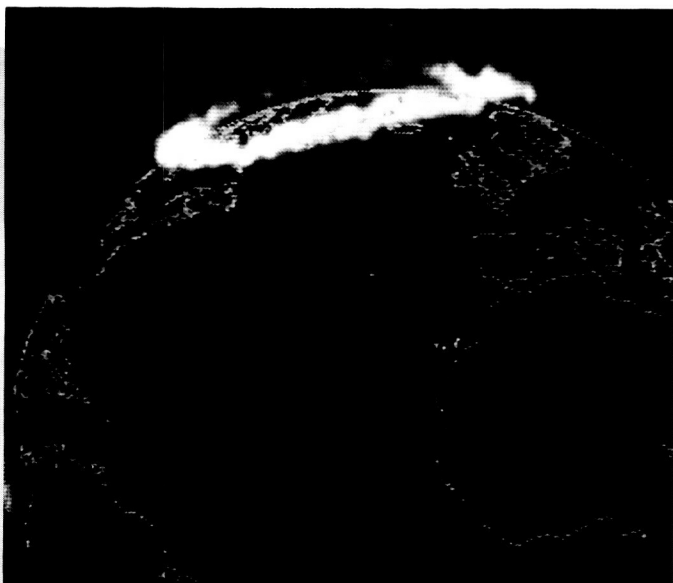

AURORAL OVAL surrounding North Pole, imaged in ultraviolet light by the Dynamics Explorer-1 spacecraft, traces energy deposited into the upper atmosphere by solar-wind particles.

ORIGINAL PAGE
COLOR PHOTOGRAPH

**ATMOSPHERIC
RESEARCH:
A PERSPECTIVE**

Human interest in atmospheric studies reaches back to antiquity. Ancient Greek philosophy held that air was one of the four basic elements (together with earth, fire, and water) of which all things are composed. Democritus even proposed an atomic theory of the atmosphere. Scientific research into the atmosphere during the 17th and 18th centuries laid the foundations for much of modern physics and chemistry and initiated the systematic study of atmospheric properties.

Balloons and Aircraft

Development of the manned hot-air balloon in the late 1700s provided the first platform suitable for research at high altitudes. A wealth of important findings, such as the constancy of the nitrogen-oxygen ratio throughout the lower troposphere, quickly followed. Interest in manned balloon flight had waned by the beginning of the 20th century, but improvements in balloon design, instrumentation, and communication with the ground soon produced renewed research activity. In the 1930s and 1940s, balloons reached above 20 km to gather data on weather patterns, upper-atmosphere phenomena, and cosmic rays. Modern balloons, which can range above 40 km, remain the platforms of choice for many atmospheric studies; although limited in geographic and altitude coverage, they offer extended observing times, launch flexibility, and modest cost. Aircraft specially designed to fly at very high altitudes (up to 22 km) can now provide rapid *in situ* and remote-sensing measurements of stratospheric properties.

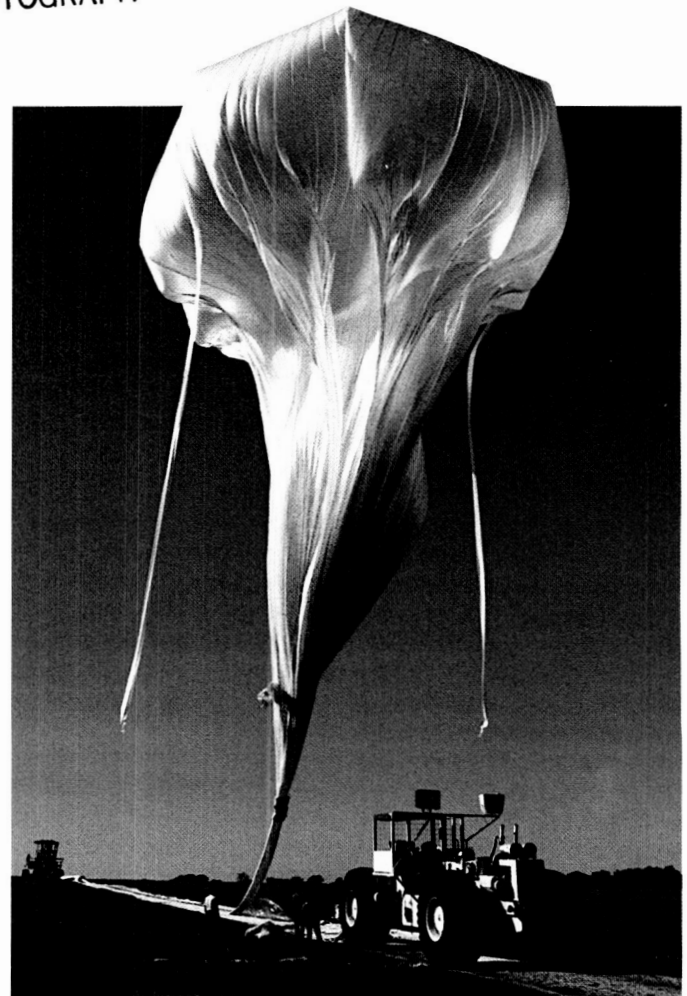

BALLOONS LIFT INSTRUMENTS INTO THE STRATOSPHERE to study the ozone layer important to the habitability of the Earth.

Milestones in Upper-Atmosphere Research



Early Demonstration of Atmospheric Pressure.

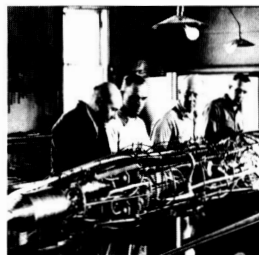

R.H. Goddard.

- 1592** Invention of the thermometer (Galileo)
- 1643** Invention of the barometer (Torricelli)
- 1800s** Balloon measurements of upper-atmosphere oxygen content as a function of altitude

1920s Pioneering rocket studies (R.H. Goddard)

1920s First ground-based measurements of upper-atmosphere ozone concentration and variation with altitude

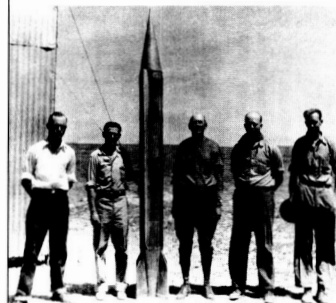

Goddard Rocket, 1931.

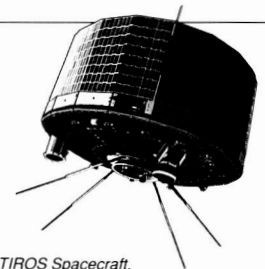

TIROS Spacecraft.

1930 First comprehensive theory of formation and maintenance of stratospheric ozone layer (Chapman)

1946 First upper atmospheric rocket measurement of solar UV radiation

1957 International Geophysical Year (IGY)

ORIGINAL PAGE
COLOR PHOTOGRAPH

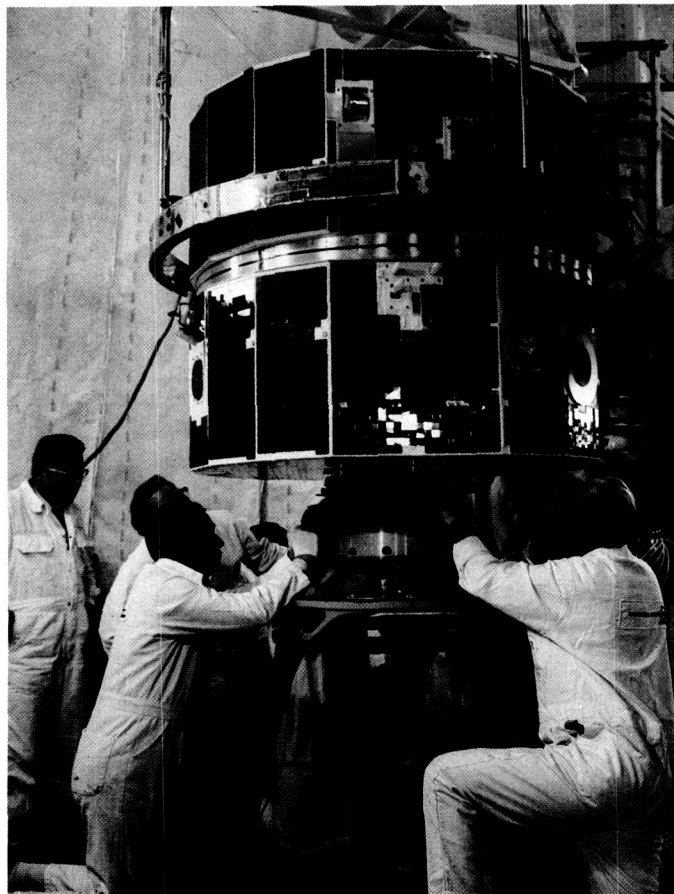

TECHNICIANS READY ATMOSPHERIC EXPLORER-D SATELLITE for 1975 launch to study energy balance of the upper atmosphere.

Rockets

Rockets emerged as important research tools in the early 20th century, and by the 1930s they were producing fundamental new data on the upper atmosphere. Research during World War II greatly increased rocket capability and performance. Despite short observing times and limited geographic coverage, postwar rocket flights delineated the major features of the atmosphere to very high altitudes, helping to establish our present picture of temperature and composition variations with height. They also furnished the first measurements of the solar ultraviolet spectrum virtually free of atmospheric absorption.

Spacecraft

The Space Age, beginning in 1957, opened up a new dimension in atmospheric research. The first satellite images of the Earth's weather patterns and surface features were returned in 1960. Spacecraft in low Earth orbit measured directly the chemical composition and other properties of the upper thermosphere, but space observations of the stratosphere and mesosphere had to await the development of remote-sensing instruments. During the 1970s and 1980s, a series of increasingly refined experiments (e.g., OGO, the Atmospheric Explorers, Nimbus) demonstrated the enormous potential of remote-sensing techniques for upper-atmosphere investigations. UARS will bring these maturing techniques to bear on a wide range of atmospheric properties within a systematic, integrated research program.

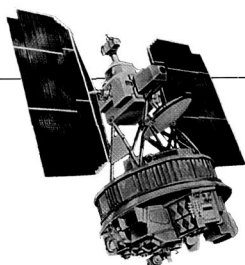

Nimbus-7 Spacecraft.



Antarctic Ozone Distribution.

1960 First operational remote sensing of Earth from space (TIROS)

1963 Launch of Explorer-17 for first *in situ* measurements of thermospheric properties

1964 Launch of Nimbus-1 for atmospheric research

1970s Mounting concern over possible stratospheric ozone loss

1976 Expansion of NASA upper-atmosphere research program mandated by U.S. Congress

1978 Launch of Nimbus-7, last of the Nimbus series

1984 Launch of Earth Radiation Budget Satellite (ERBS) to provide first accurate measurements of the Earth's global energy balance

1984 Congressional approval of UARS development program

1985 Antarctic "ozone hole" discovered

1986 International study of high-latitude ozone depletion by wide variety of measurement techniques begins

1991 UARS launch by the Space Shuttle

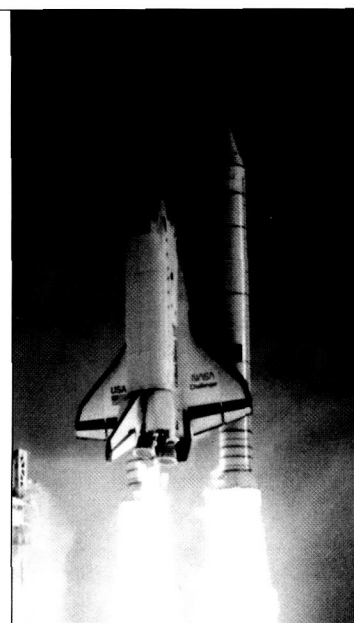

Space Shuttle Launch.

ORIGINAL PAGE
COLOR PHOTOGRAPH

**THE UPPER
ATMOSPHERE:
GLOBAL STUDY**

The inaccessibility of the upper atmosphere has long hindered its global study. Tropospheric absorption impedes direct observation from surface stations, which are in any case largely confined to land areas. Balloons can carry massive instruments, and rockets permit smaller payloads to reach great heights, but extensive geographic coverage by these means is not feasible. Global study of the upper atmosphere requires remote sensing from space, which permits rapid, systematic coverage of atmospheric properties worldwide.

Previous Satellite Observations

The first TIROS spacecraft, launched in 1960, initiated studies of the atmosphere from space. Although designed for weather observations, this pioneering satellite amply demonstrated the potential of atmospheric remote sensing for research. Successive TIROS spacecraft operated by the National Oceanic and Atmospheric Administration (NOAA) have returned data of increasing refinement and relevance to atmospheric studies. However, advances in such operational programs have depended upon experimental instruments developed by NASA for scientific research.

The NASA Nimbus satellites, launched between 1964 and 1978, served as testbeds for new remote-sensing techniques, provided data on upper-atmosphere structure, and paved the way for transfer of proven remote-sensing technology to NOAA operational use. Other NASA satellites utilized remote sensing and in

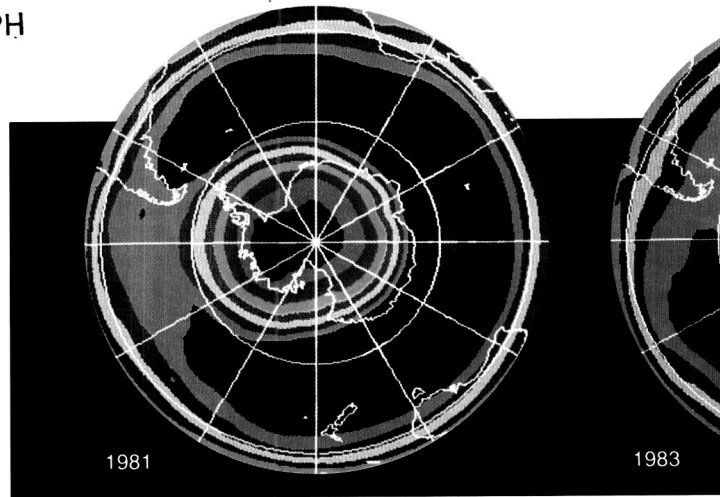

PROGRESSIVE THINNING OF STRATOSPHERIC OZONE LAYER OVER ANTARCTICA documented by time-series of images from the Total Ozone Mapping Spectrometer (TOMS) aboard Nimbus-7. Each

some cases *in situ* techniques to probe the thermosphere and upper mesosphere during the 1970s and early 1980s. These included the Orbiting Geophysical Observatories, the Atmospheric Explorers, the Dynamics Explorers, the Solar Mesosphere Explorer, and the Earth Radiation Budget Satellite.

Present Research Needs

These space investigations have significantly advanced our understanding of the upper atmosphere. However, their findings have also raised important new issues and questions that need to be addressed by a new generation of research satellites.

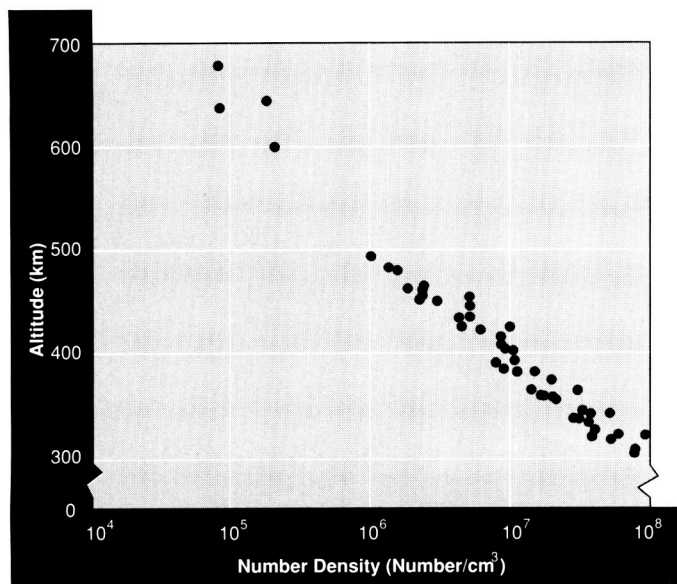

VARIATION OF ATOMIC-OXYGEN DENSITY WITH ALTITUDE recorded in 1963 by Explorer-17, which provided the first global measurements of chemical composition in the thermosphere.

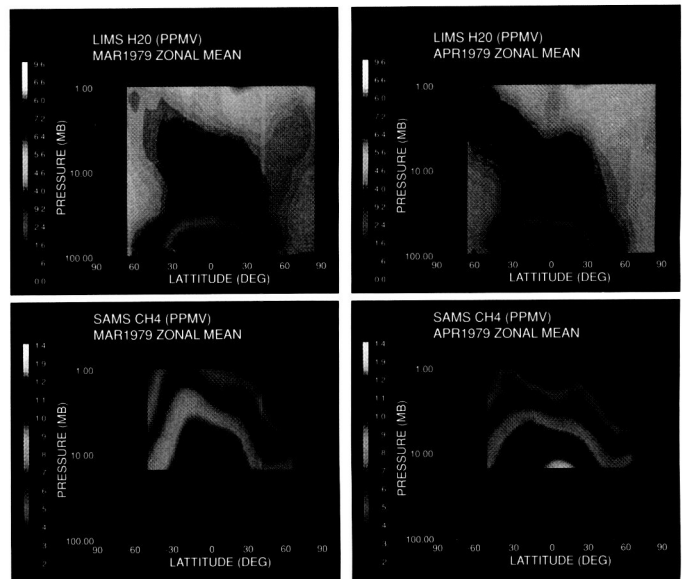

MEAN DISTRIBUTIONS OF UPPER-ATMOSPHERE WATER VAPOR AND METHANE recorded in March-April 1979 by the LIMS and SAMS infrared radiometers aboard Nimbus-7.

ORIGINAL PAGE
COLOR PHOTOGRAPH

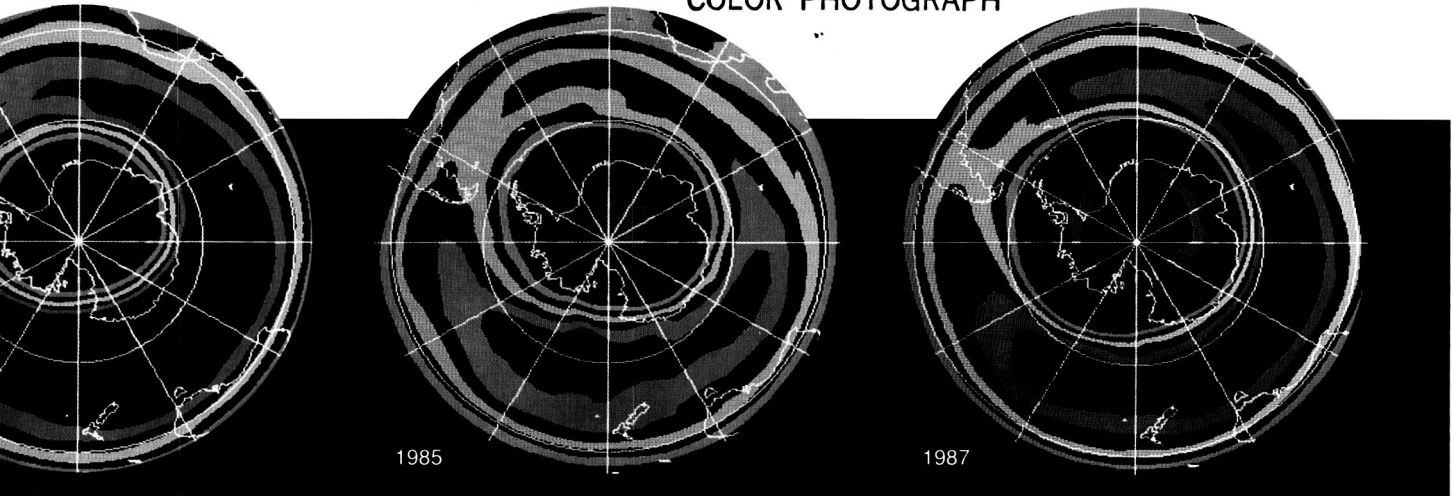
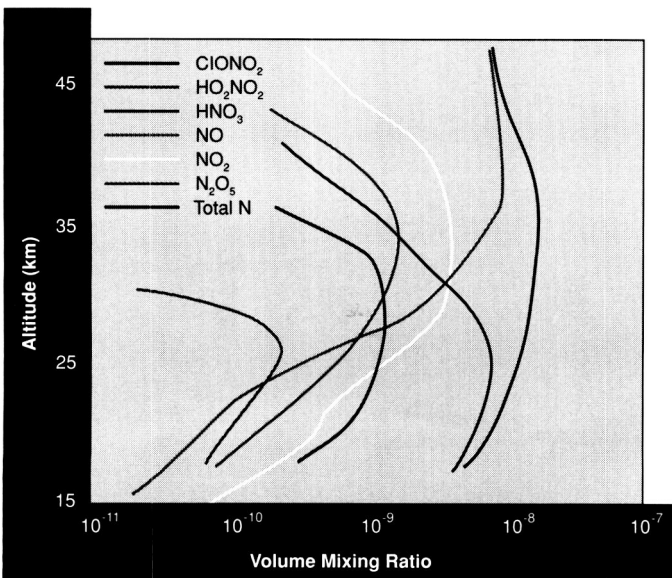

image shows the average ozone concentration for October, at the beginning of the austral spring. Blue and violet represent low ozone levels; yellow, green, brown, and red indicate higher ozone levels.

This "ozone hole," first revealed in 1985 by ground-based measurements, has been tracked by satellite observations back to 1979.

For example, analyses of ozone concentrations above Antarctica measured by the Total Ozone Mapping Spectrometer (TOMS) aboard Nimbus-7 have traced in detail the development of the Antarctic "ozone hole" revealed initially by ground-based observations. The current explanation for this phenomenon stresses chemical mechanisms initiated by man-made chlorofluorocarbons (CFCs), coupled with the extremely low temperatures, protracted night, and unique atmospheric dynamics found in the polar regions. The Antarctic ozone hole thus appears to provide a striking example of the coupling among upper-atmosphere chemistry, dynamics, and energy inputs that is a major area of UARS investigation.

The eventual impact of CFCs on ozone levels worldwide cannot yet be firmly predicted. Because of the complexity of stratospheric chemistry, many more chemical species need to be measured, and measured more accurately, if numerical simulations of global ozone levels are to become reliable. Moreover, because of the importance of dynamical effects, extensive new stratospheric wind data are also essential; direct wind measurements have so far been made only within the troposphere. In addition, a definitive series of energy-input measurements, carried out simultaneously with chemical and dynamical observations, is needed to constrain models of the upper atmosphere. UARS, which builds upon the results of previous satellite experiments, will provide the fundamental data required in all three of these research areas.



DENSITY PROFILES OF UPPER-ATMOSPHERE NITROGEN COMPOUNDS obtained in May 1985 by the Atmospheric Trace Molecule Spectroscopy (ATMOS) experiment aboard the Space Shuttle.

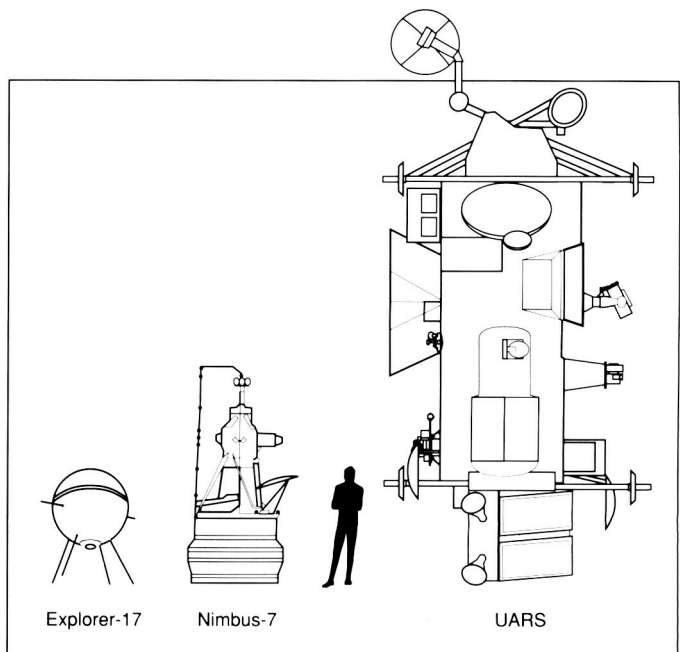

UPPER ATMOSPHERE RESEARCH SATELLITE will extend previous satellite research programs to include a greater number of chemical species and to provide direct wind measurements.



ORIGINAL PAGE
COLOR PHOTOGRAPH

**UARS:
AN INTEGRATED
DESIGN**

The UARS mission is by far the most complex space investigation of the upper atmosphere ever attempted. Yet the design of all major mission components—the UARS observatory, the instrument complement, mission operations, and scientific data analysis—embodies such a high degree of integration that the mission is essentially a single experiment.

The UARS Observatory

The observatory includes the nine UARS instruments, a specially designed instrument module, and the Multi-mission Modular Spacecraft (MMS). The MMS incorporates standard modules for attitude control, communications and data handling, electrical power, and propulsion. These modules offer the capability for on-orbit servicing, and the entire observatory has been designed to permit its retrieval and return to Earth by a Space Shuttle crew if required.

Scientific Instruments

The UARS instruments have been selected to provide the most complete and thoroughly integrated experimental picture ever obtained of the upper atmosphere. These investigations will build upon, extend, and consolidate the results of previous missions, which have already provided some insight into the complexity of upper-atmosphere processes.

Three types of measurements will be carried out: (1) composition and temperature, (2) winds, and (3) energy

inputs. Four UARS instruments are devoted to measurements of the first kind; they will spectroscopically determine the concentrations of many different chemical species and derive the variation of atmospheric temperature with altitude by observing infrared emissions from carbon dioxide. Two instruments, utilizing high-resolution interferometry, will study upper-atmosphere winds by sensing the Doppler shift in light absorbed by or emitted from atmospheric molecules. An additional three investigations will obtain estimates of the energy incident on the atmosphere by measuring solar ultraviolet radiation and the flux of charged particles from the Earth's magnetosphere.

Operating collectively and simultaneously, these nine experiments in effect constitute a single investigation. A tenth instrument, devoted to measurements of total solar irradiance (the "solar constant"), will also be carried to extend a data set of importance to global climate studies.

Mission Operations

Planning for UARS operations has been guided by two fundamental principles. First, effective operation will require the active participation of each instrument investigator and of the mission-control center at NASA's Goddard Space Flight Center (GSFC) in Greenbelt, Maryland. In addition, a high degree of coordination

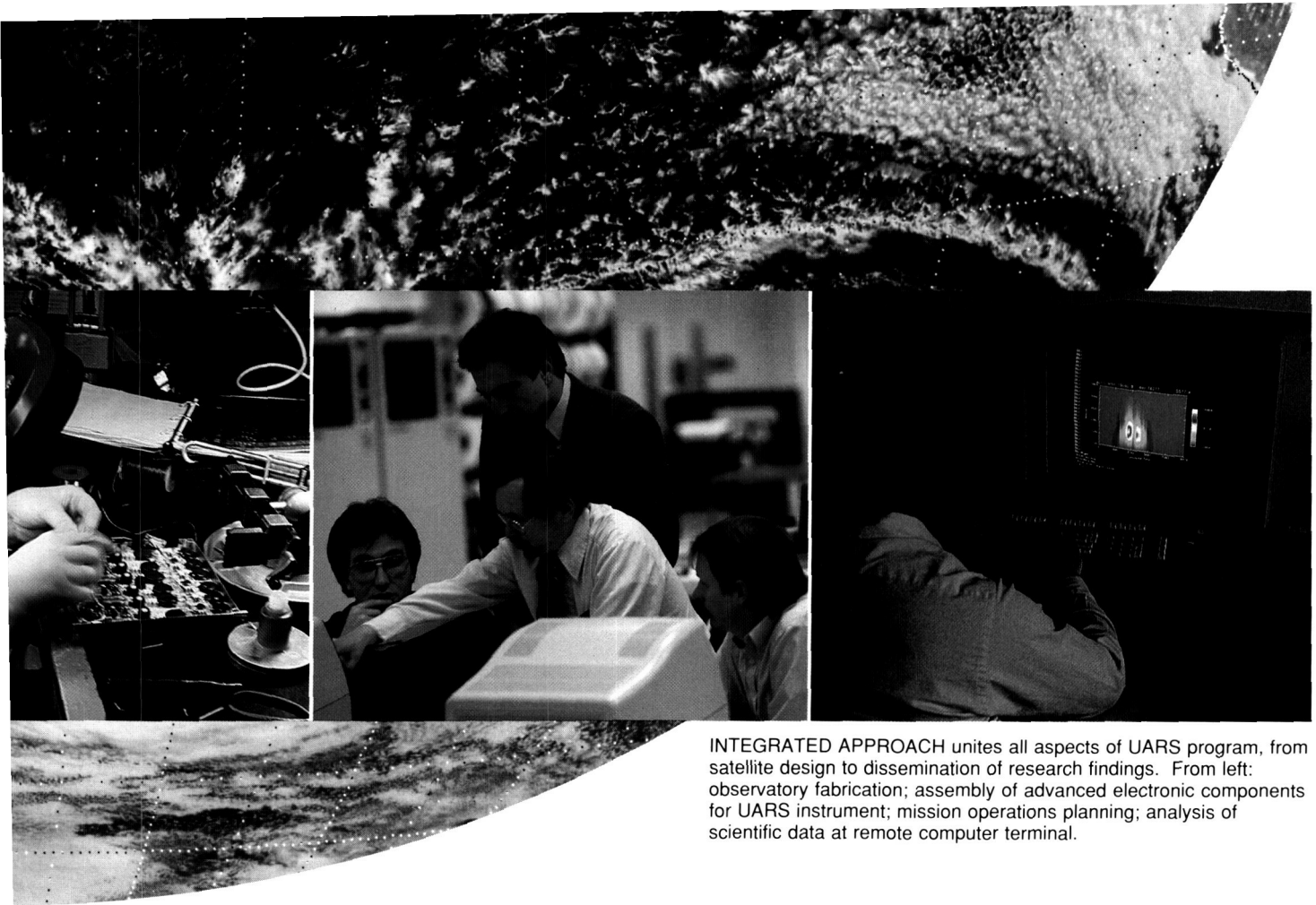

INTEGRATED APPROACH unites all aspects of UARS program, from satellite design to dissemination of research findings. From left: observatory fabrication; assembly of advanced electronic components for UARS instrument; mission operations planning; analysis of scientific data at remote computer terminal.

ORIGINAL PAGE
COLOR PHOTOGRAPH

among measurements by the various instruments will be essential to achieve program goals.

These principles are implemented through a long-term science plan that will guide UARS flight operations. Daily science plans derived from this unified approach will be filed in the Command Management System at the GSFC mission-control center. The scientific investigators, functioning as a coordinated team, will help to guide the day-by-day commanding of the spacecraft to ensure that mission objectives requiring multi-instrument observations will be met. Data on instrument and spacecraft performance will be accessible immediately by Remote Analysis Computers (RACs) operated by scientists at their home institutions, encouraging a high degree of interaction between investigator groups and the scientific operations staff.

Data Analysis

The UARS data system provides a framework that unites the UARS mission and its many data sets. This system, incorporating software developed by the instrument investigators, will convert UARS observations into the processed, catalogued data products essential to facilitate rapid analyses and the understanding of complex atmospheric processes. Consistent with the operation of UARS as a single, integrated experiment, all UARS data will be pooled and made available to all

investigators (both experimental and theoretical) from the beginning of the observing program. This policy, together with the highly interactive linking of mission control to the RAC network and the opportunity to influence mission planning, will permit scientists to detect unusual features immediately and to respond rapidly to such sporadic events as solar flares and volcanic eruptions.

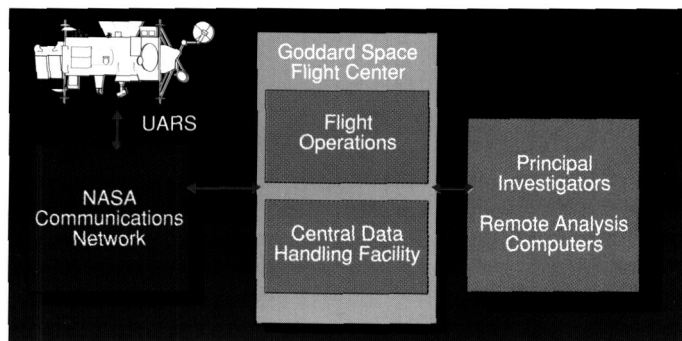

UARS DATA SYSTEM integrates spacecraft data stream with centralized data-handling facility and a network of remote computer terminals at investigating scientists' home institutions.

ORIGINAL PAGE COLOR PHOTOGRAPH

ATMOSPHERIC CHEMISTRY

Mounting, worldwide concern over the depletion of the Earth's protective ozone layer has brought the importance of upper-atmosphere chemistry into sharp relief. A better understanding of the numerous, complex, and interconnected chemical reactions in the stratosphere is a particularly critical research need. It is this challenge that provides the primary driving force for the UARS mission.

The chemistry of the upper atmosphere can be organized into reactions within a few families of constituents containing nitrogen (N), hydrogen (H), or chlorine (Cl), together with the interactions among these families. Each family contains three basic types of species: source molecules, free radicals, and reservoir/sink molecules.

The source molecules are relatively stable compounds derived from biological, geological, or human processes taking place on the Earth's surface. Free radicals are short-lived, highly reactive intermediate species produced by dissociation of the source molecules by solar ultraviolet radiation or by reactions with other stratospheric constituents. The reservoir/sink molecules are longer-lived compounds into which the free radicals can be temporarily combined; they enter into a variety of reactions that produce stable species.

Source Molecules

The source molecules are long-lived in the troposphere and eventually reach the stratosphere, where they are dissociated to yield highly reactive free radicals. The

most important source molecules are:

- Chlorofluorocarbons CFC-11 (CFCl_3) and CFC-12 (CF_2Cl_2), used in refrigeration and air conditioning, in plastic foam manufacture, as solvents, and as spray-can propellants in some countries. They are entirely of industrial origin. In the stratosphere, CFCs are dissociated by solar ultraviolet radiation to produce atomic chlorine, which depletes ozone through an efficient catalytic reaction.
- Nitrous oxide (N_2O), arising mostly from natural processes but also from the use of synthetic nitrogen fertilizers. Tropical forests are a major source. In the stratosphere, N_2O is the chemical parent of the other, more reactive oxides of nitrogen, such as nitric oxide (NO) and nitrogen dioxide (NO_2), that are involved in the depletion of ozone (O_3).
- Methane (CH_4), produced by swamps, marshes, tundra, rice paddies, termites, and ruminant animals. Oil and gas drilling may also release significant amounts. In the stratosphere, methane is the parent of a group of reactive species containing oxygen and hydrogen that play a key role in all of stratospheric chemistry.

Free Radicals

Free radicals are the key intermediate species in many important stratospheric chain reactions in which an ozone molecule is destroyed and the radical is regenerated. For example, atomic chlorine released by

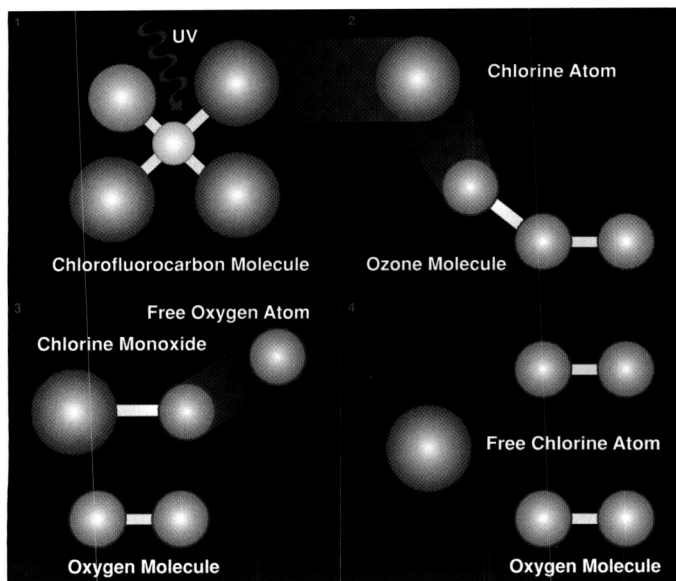

DESTRUCTION OF OZONE BY CHLORINE released from CFC molecules is a catalytic process—chlorine atoms survive the reaction and are free to attack successive ozone molecules.

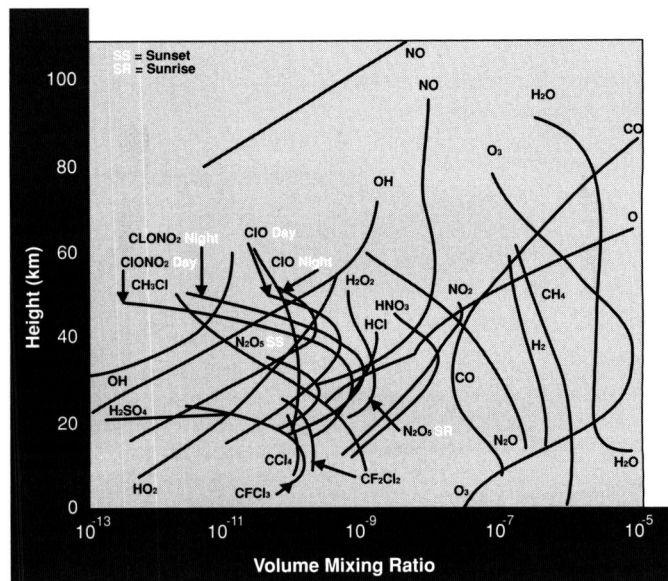

COMPLEXITY OF UPPER-ATMOSPHERE CHEMISTRY is illustrated by variation in the densities of a large number of trace species with altitude and with phase of the sunlight cycle.

the stratospheric dissociation of CFC molecules reacts with ozone (O_3) as follows:



The net effect of this pair of reactions is the conversion of atomic oxygen (O) and ozone into molecular oxygen (O_2):

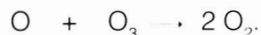

The chlorine, acting as a catalyst, survives the reaction and proceeds to initiate successive reactions.

An analogous catalytic process involves NO and NO_2 which are formed in the stratosphere by reactions involving N_2O . There ensues a similar chain of reactions in which ozone is destroyed and NO is regenerated. The hydroxyl radical, OH, is also a catalytic ozone depleter.

Reservoir/Sink Molecules

After participating in numbers of such reactions, the free radicals are finally recombined into more stable reservoir/sink molecules. These are eventually transported into the troposphere and rained out of the atmosphere. The formation of reservoir/sink molecules thus terminates the catalytic destruction of ozone, but not before a single free radical, such as NO, Cl, or OH, has destroyed many thousands of ozone molecules.

Analysis, Theory, and Modeling

Theoretical analyses and numerical modeling are required to integrate new observations into coherent theoretical frameworks that reflect our understanding of the upper atmosphere. Numerical models also test this understanding by providing results that can be compared with independent data. Some models yield forecasts of future trends.

Present atmospheric models include more than 200 chemical reactions among more than 40 reactive species. One-dimensional models, which embody the most complete chemistry and yield a global average atmospheric chemical composition that varies with altitude, are used for a number of purposes, e.g., to project future ozone levels. Two-dimensional models include latitude as well as altitude variations, thus providing information about geographical and seasonal effects; however, they require approximations of transport processes and place much greater demands upon computing resources. Three-dimensional models are being developed to accommodate longitudinal variations as well, but these at present include only relatively simple chemistry and require the most powerful computers.

Theoretical studies are also essential to the full utilization of UARS data and the refinement of atmospheric models. Such studies are an integral part of UARS research and will help to lay the foundations for policy decisions required to respond to global atmospheric change.

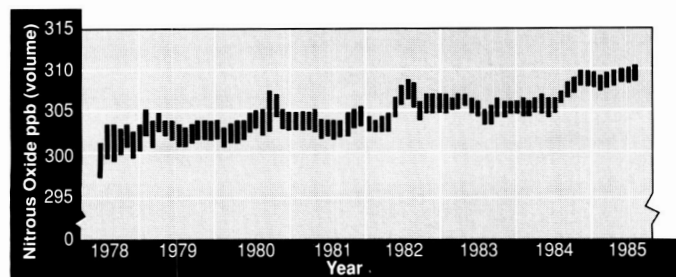
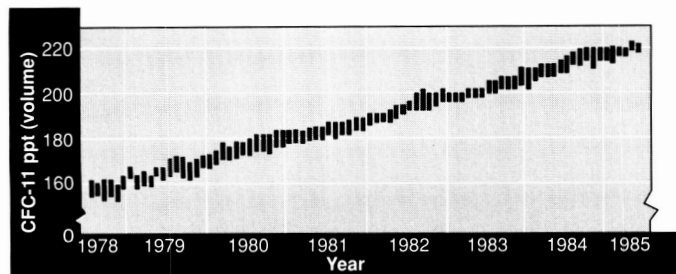

RISING ATMOSPHERIC CONCENTRATIONS of many chemically important trace species have been documented during the past decade, including CFC-11 (top) and nitrous oxide (bottom).

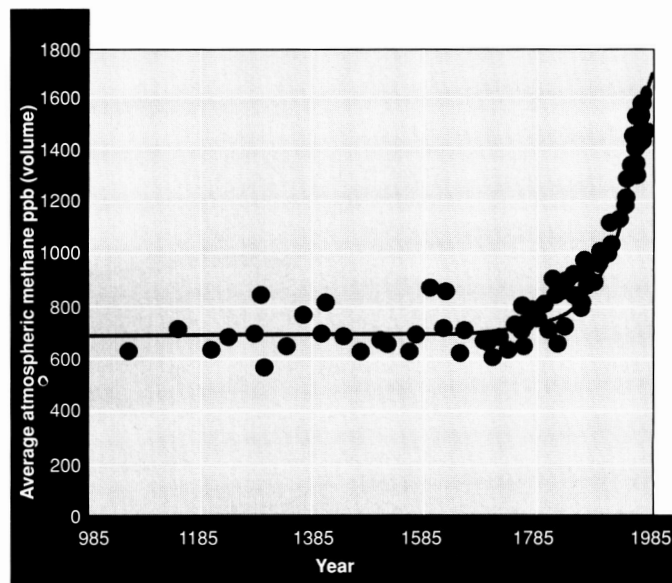

ATMOSPHERIC CONCENTRATION OF METHANE has been increasing for the past 300 years, as shown by ice-core analyses for periods before 1960 and subsequent direct measurements.

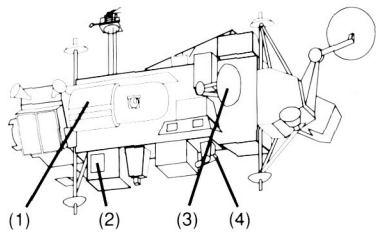

**ORIGINAL PAGE
COLOR PHOTOGRAPH**

**ATMOSPHERIC
COMPOSITION
AND
TEMPERATURE**

The atmospheric concentration of a gas can be measured remotely through observation of characteristic wavelengths of radiation emitted or absorbed by the gas.

In the case of absorption, the Sun or various stars serve as light sources, and the absorption is found from measurements of the decrease of light along the line of sight from the source. Since the amount of radiation emitted or absorbed depends on the gas temperature as well as the concentration, UARS will also carry out temperature measurements to permit quantitative determinations of atmospheric composition from the spectral data.

For the molecular gases to be studied by UARS, the characteristic wavelengths of radiation lie in the infrared and microwave regions of the spectrum. Four UARS sensors will make global measurements of the vertical distributions of ozone, methane, water vapor, and other minor species involved in the chemistry of the ozone layer. In addition, two of these sensors will derive atmospheric temperature profiles through observations of infrared radiation emitted by carbon dioxide, which is assumed to be well mixed throughout the atmosphere.

(1) CLAES

The Cryogenic Limb Array Etalon Spectrometer (CLAES) will determine concentrations of members of the nitrogen and chlorine families, as well as ozone, water vapor, methane, and carbon dioxide, through observations of infrared thermal emissions at

wavelengths from 3.5 to 12.7 microns. To obtain a vertical profile of species concentration, CLAES utilizes a telescope, a spectrometer, and a linear array of 20 detectors to make simultaneous measurements at 20 altitudes ranging from 10 to 60 km.

Because the detectors and optics generate their own thermal emissions, they must be cooled to temperatures which suppress this emission below that of the gases under observation. The CLAES cryogenic system consists of two components: a block of solid neon at $-260\text{ }^{\circ}\text{C}$, which cools the detectors to minimize detector noise, and a surrounding block of solid carbon dioxide at $-150\text{ }^{\circ}\text{C}$ to reduce background emission from the optical system. Although the use of passive, stored cryogens limits the useful observing lifetime of the instrument, it is the only practical way of achieving the very low temperatures required for the CLAES detectors.

(2) ISAMS

The Improved Stratospheric and Mesospheric Sounder (ISAMS), a filter radiometer employing 8 detectors, observes infrared molecular emissions by means of a movable off-axis reflecting telescope. In addition to scanning the atmosphere vertically, the telescope can also be commanded to view regions to either side of the UARS observatory, thus providing increased geographic coverage. The ISAMS instrument utilizes a Stirling-cycle refrigerator to cool its 8 detectors to $-195\text{ }^{\circ}\text{C}$, an approach that yields a potentially long operating lifetime.



EMISSION MEASUREMENT of trace-gas atmospheric concentration employs limb-viewing geometry to detect characteristic wavelengths of radiation emitted by atmospheric molecules along the line of sight. Intensity of emitted radiation is a measure of the gas density.

One of the interesting features of ISAMS is that it carries samples of some of the gases to be measured in cells within the instrument. Atmospheric radiation collected by the telescope will pass through these cells on its way to the detectors. This design allows ISAMS to match the full spectra of the gases in the cells with the spectra observed in the atmosphere. In addition, ISAMS employs broadband filters to isolate portions of the spectrum, thus permitting measurements of those gases which, because of their chemical activity, cannot be confined in cells.

The ISAMS experiment will measure the concentrations of nitrogen chemical species, as well as ozone, water vapor, methane, and carbon monoxide, through observations in the infrared spectral region from 4.6 to 16.6 microns. This instrument is an improved version of one that operated from 1978 to 1983 aboard Nimbus-7.

(3) MLS

The Microwave Limb Sounder (MLS) will measure emissions of chlorine monoxide, hydrogen peroxide, water vapor, and ozone in the microwave spectral region at frequencies of 63, 183, and 205 GHz (i.e., wavelengths of 4.8, 1.64, and 1.46 mm). The observations of chlorine monoxide are of particular importance, since this gas is a key reactant in the chlorine chemical cycle that destroys ozone; microwave measurements are essential for observations of this species, and MLS is unique among the UARS instruments in providing microwave sensitivity. The MLS observations will provide, for the first time, a global data set on chlorine monoxide in the

upper atmosphere.

MLS will also determine the altitudes of atmospheric pressure levels. Because MLS is a microwave instrument, it employs an antenna rather than optical devices to gather radiation.

(4) HALOE

Through measurements of atmospheric infrared absorption at wavelengths from 2.43 to 10.25 microns, the Halogen Occultation Experiment (HALOE) will determine the vertical distributions of hydrofluoric and hydrochloric acids as well as those of methane, carbon dioxide, ozone, water vapor, and members of the nitrogen family. Both of the halogen acids are reservoir species, and HALOE will be especially effective in measuring their concentrations.

The HALOE experiment uses samples of several of the gases to be observed as absorbing filters in front of the detectors to obtain a high degree of spectral resolution. The instrument also utilizes broadband filters to detect gases for which such high spectral resolution is not required.

During every UARS orbit, at times of spacecraft sunrise and sunset, HALOE will be pointed toward the Sun and measure the absorption of energy along this line of sight. There are 28 solar occultation opportunities per day, providing data for 14 different longitudes in each of the Northern and Southern Hemispheres.

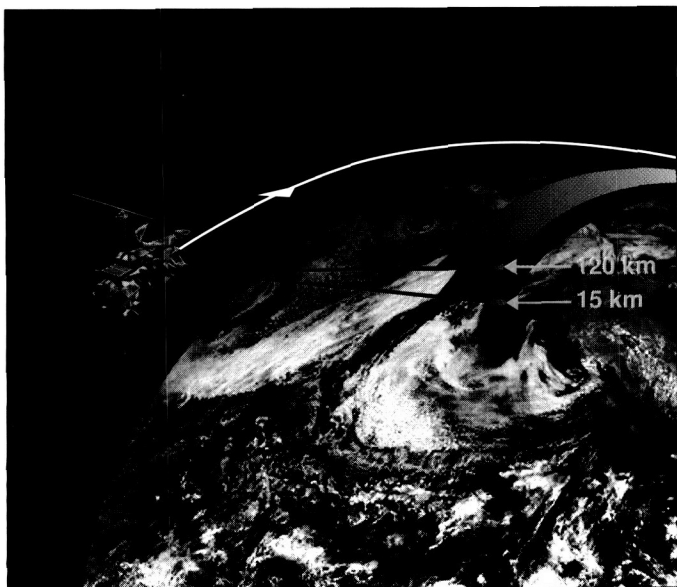

LIMB-VIEWING UARS INSTRUMENTS scan the atmosphere vertically between 15 and 120 km in a direction perpendicular to spacecraft track; typical altitude resolution is about 3 km.

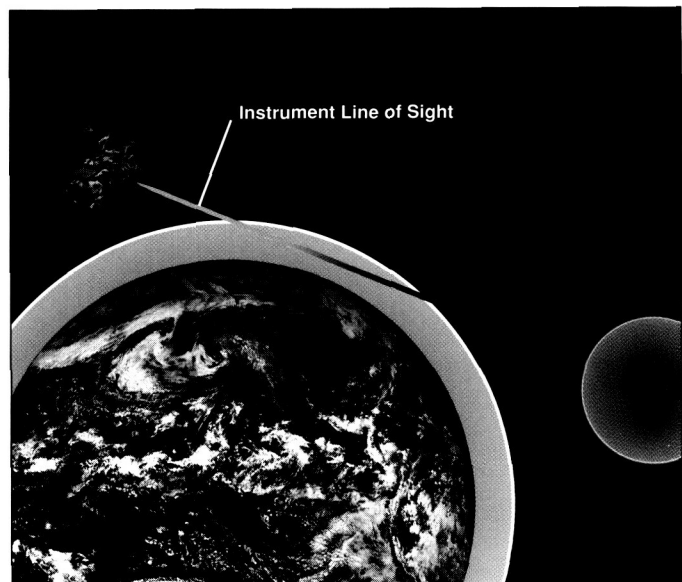

OCCULTATION MEASUREMENT utilizes Sun as a light source at spacecraft sunrise or sunset. Measurement of the amount of energy absorbed by molecules along the line of sight yields the gas density.

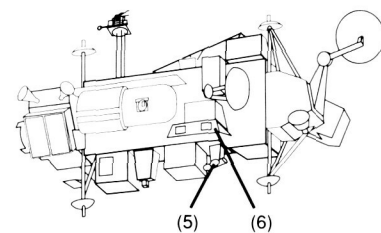

ATMOSPHERIC WINDS

Dynamical processes have a profound effect upon the chemical composition of the upper atmosphere. The high-altitude distribution of chemical species—including ozone and the source molecules, free radicals, and reservoir/sink molecules that enter into ozone reaction chains—therefore cannot be understood through photochemical studies alone. Conversely, the processes of upper-atmosphere dynamics are highly sensitive to variations in chemical composition, being driven by solar heating of the ozone layer as well as by the upward propagation of energy from the troposphere.

Upper-atmosphere winds can be measured directly by ground-based radars and lidars and by balloon- and rocket-borne sounding instruments. Such techniques permit study of small-scale dynamical processes and long-term monitoring of atmospheric dynamics over fixed deployment sites; however, they are intrinsically limited to a few geographic locations. For investigations of the global-scale dynamical processes that determine the distribution of ozone and other upper-atmosphere constituents, satellite data are required.

Wind Measurements by UARS

The UARS mission will provide the first direct, global-scale measurements of the horizontal wind field in the upper atmosphere. With the aid of theoretical investigations and numerical modeling, the UARS data will shed new light on fundamental questions in

stratospheric and mesospheric dynamics. Such questions include the relative importance of various types of wave motion as a function of altitude, the relative roles of tropospheric energy fluxes and *in situ* energy generation by solar heating, the factors affecting the breakdown of polar winter circulation patterns in the stratosphere, and the mechanisms responsible for the warm winter and cold summer mesopause. In combination with UARS measurements of atmospheric composition, these dynamical results may also help scientists to understand the processes responsible for development of the Antarctic "ozone hole" during the Southern Hemisphere spring.

Previous satellite studies have furnished indirect estimates of the upper-atmosphere wind field through a method that utilizes observed temperature profiles and theoretical approximations. The CLAES and ISAMS experiments aboard UARS will also yield indirect wind velocity estimates by this method, as well as observations of chemical constituents.

In addition, two other UARS instruments—a High Resolution Doppler Imager (HRDI) and a Wind Imaging Interferometer (WINDII)—will provide direct observations of wind velocity through measurements of the Doppler shifts of selected emission and absorption lines. These shifts will be measured in two different directions, yielding two components of the wind velocity relative to the spacecraft; the true wind velocity can then be calculated from the observing geometry and a knowledge of the spacecraft velocity. The spacecraft motion combined with vertical scanning by the instruments will produce a three-dimensional global

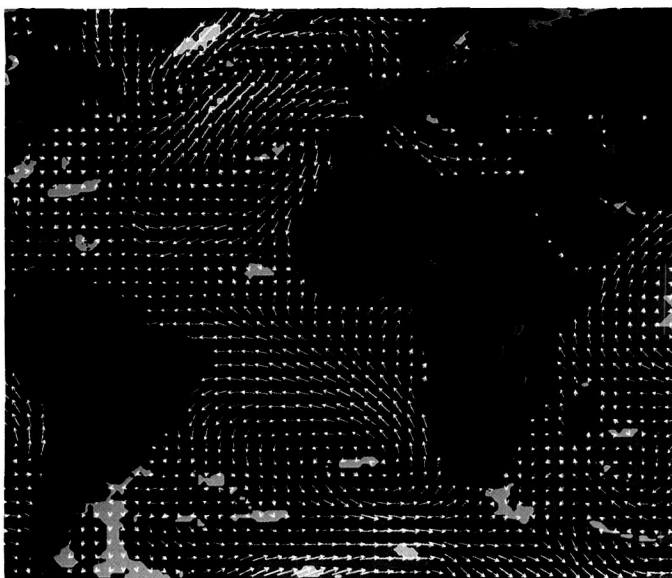

TROPOSPHERIC WIND FIELD OVER THE OCEANS was mapped by Seasat in 1978; UARS measurements will provide similarly detailed wind-field maps for the upper atmosphere over both land and sea.

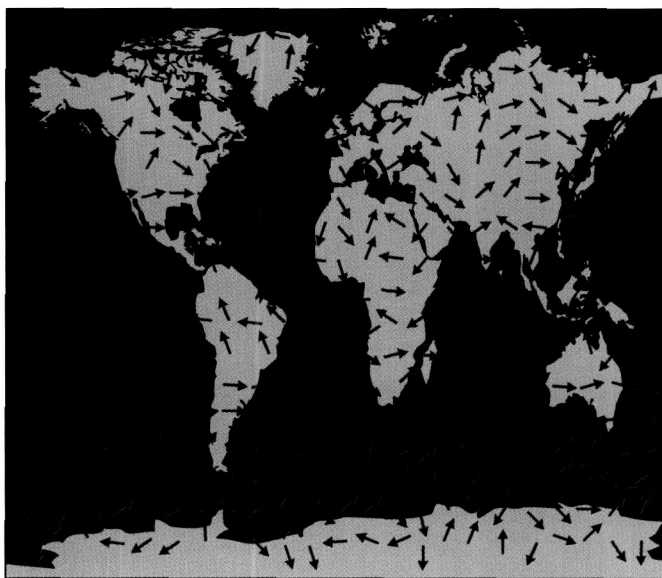

UPPER-ATMOSPHERE WIND FIELDS obtained from observed temperature profiles and the use of theoretical approximations. UARS will measure these fields directly.

ORIGINAL PAGE
COLOR PHOTOGRAPH

map of the upper-atmosphere wind field.

Since atmospheric emission and absorption characteristics vary strongly with altitude, a number of atomic and molecular spectral features must be used to obtain a wide range of altitudes. Moreover, in both experiments, the Doppler shift that arises from spacecraft motion must be separated from the shifts caused by atmospheric motions. High spectral resolution and a stable observing platform are required.

(5) HRDI

At altitudes below about 45 km, the High Resolution Doppler Imager will observe the Doppler shifts of spectral lines within the atmospheric band system of molecular oxygen to determine the wind field. There are no sharp emission lines in the radiance of the Earth's limb at such altitudes, but the oxygen bands contain many lines that appear as deep absorption features in the brilliant spectrum of scattered sunlight. A triple-etalon Fabry-Perot interferometer, serving as a high-resolution spectral filter, will ensure efficient rejection of the intense emission continuum outside the absorption lines. HRDI will exploit these daytime absorption features to provide wind data for the stratosphere and upper troposphere to an accuracy of 5 m/sec or better.

At altitudes above about 60 km, HRDI will observe emission lines of neutral and ionized atomic oxygen in the visible and near-infrared spectral regions by the same interferometric technique. Unlike the molecular absorption lines, however, the emission lines are observable both day and night. These measurements

will furnish the wind field in the mesosphere and thermosphere to an accuracy of 15 m/sec or better.

The HRDI instrument incorporates a baffled, off-axis telescope on a two-axis gimballed structure, whose motion is controlled by a microprocessor. An altitude scan is typically executed first in the direction forward of the spacecraft velocity. The telescope is then rotated backward for a second altitude scan, which yields measurements of the same atmospheric region some 7 minutes after the first scan; this interval is short compared to characteristic timescales for changes in the wind field. The HRDI field of view allows a vertical resolution of 4 km at the Earth's limb.

(6) WINDII

The Wind Imaging Interferometer utilizes emission lines for the basic Doppler-shift measurements. In addition to lines of neutral and ionized atomic oxygen, these include two lines of the OH molecule and a molecular-oxygen line. WINDII will obtain measurements both day and night at altitudes above 80 km.

The WINDII spectral filter is a high-resolution Michelson interferometer. The instrument consists of a telescope, the interferometer, and a detector array. The telescope views 45° and 135° from the spacecraft velocity vector simultaneously. In normal operation, the detector provides a vertical resolution of about 4 km and a horizontal resolution of some 20 km. Wind velocity accuracy within 10 m/sec is expected in the altitude range between 80 and 300 km.

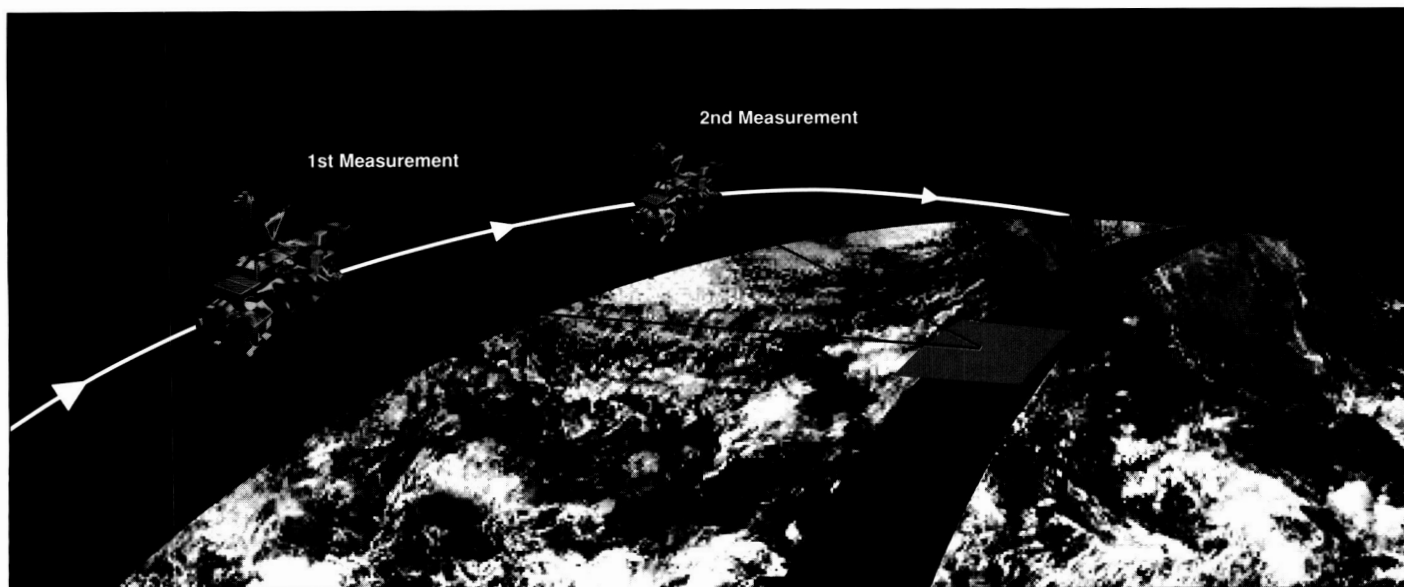

SCANNING GEOMETRY FOR DOPPLER WIND MEASUREMENTS. The UARS wind instruments measure the radial velocity of an air mass first in a direction forward of the observatory, then again 7 minutes later in a backward direction. The wind speed and direction can be calculated from these measurements.

ORIGINAL PAGE
COLOR PHOTOGRAPH

**ENERGY
INPUTS**

The upper atmosphere receives energy from the Sun via two sources: ultraviolet radiation and magnetospheric charged particles. These energy sources are central to the chemical processes that create and destroy ozone, as well as to the heating and dynamics of this region. The UARS observing program will provide the measurements necessary for determining the net effect of the solar energy inputs on the amount and distribution of ozone in the stratosphere.

Solar Radiation

Although ultraviolet radiation constitutes only about 5% of the total energy emitted by the Sun, it is the major energy source for the stratosphere and mesosphere, playing a dominant role in both energy balance and chemical composition. An accurate knowledge of the solar ultraviolet spectrum and its variability with time is therefore necessary to test models of the upper atmosphere. Measurements to date have established absolute solar-flux values within $\pm 30\%$ in the region from 140 to 210 nm, with better accuracy at longer wavelengths. However, these measurements are not accurate enough to permit study of atmospheric responses to changes in solar ultraviolet output arising from flares, solar rotation, or the 11-year solar activity cycle. A new generation of solar ultraviolet observations is urgently needed.

The radiation wavelengths of primary interest lie between 115 and 300 nm which, because of atmospheric absorption, can only be observed above the stratosphere. Spacecraft measurements in this

spectral region are difficult, however, because the radiation itself may degrade instrument and detector performance. The two UARS instruments that will measure the solar ultraviolet spectrum have therefore been specially designed to ensure accurate, long-term calibration.

Charged Particles

The Sun is also a source of high-energy charged particles, primarily electrons and protons, which originate in such events as solar flares and stream outward through the solar system. Many of those reaching the Earth become trapped in the Earth's magnetosphere. When the magnetosphere becomes disturbed—for example, by a magnetic storm—large numbers of these trapped particles are precipitated into the upper atmosphere, producing aurorae as they interact with the tenuous gases of the thermosphere and upper mesosphere. The most energetic of the charged particles can penetrate into the stratosphere, where they initiate some of the same chemical reactions as sunlight. Observations of solar ultraviolet radiation must therefore be supplemented by measurements of the effects of such particles, particularly those of high energy.

(7) SUSIM

The Solar Ultraviolet Spectral Irradiance Monitor (SUSIM), to be mounted on the UARS solar/stellar positioning platform, will measure solar ultraviolet radiation in the wavelength range from 120 to 400 nm with a resolution down to 0.1 nm. The instrument is designed to provide its own long-term, absolute calibration light

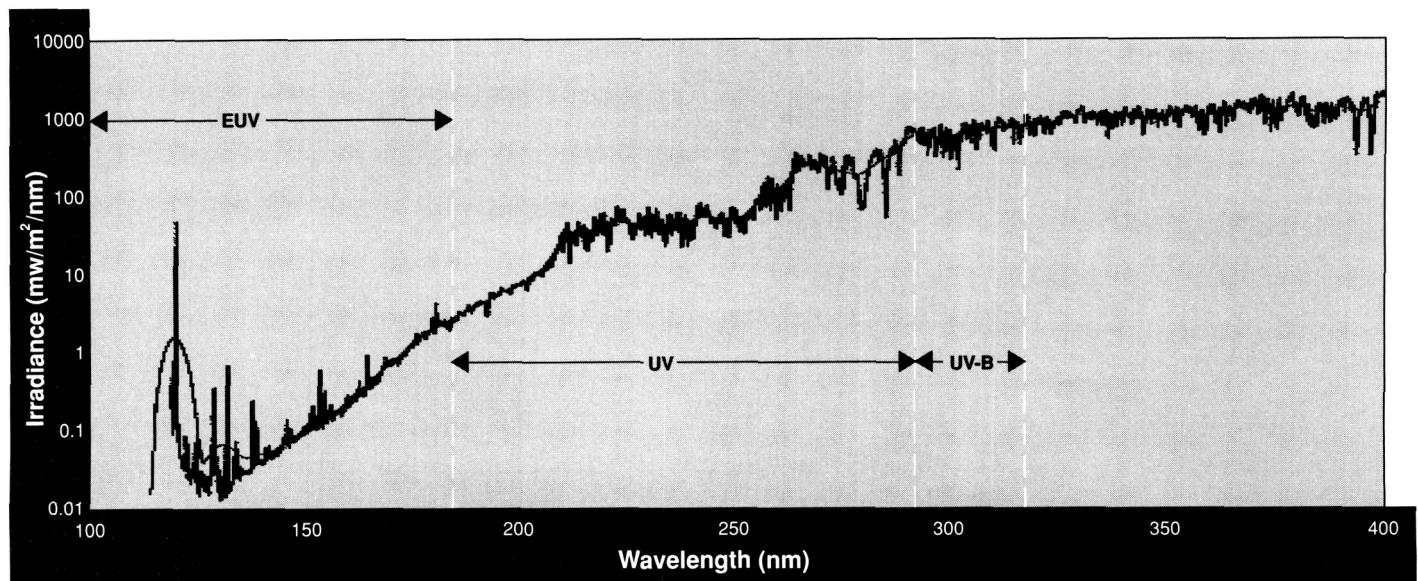

SOLAR ULTRAVIOLET RADIATION. The EUV is absorbed high in the atmosphere by atomic and molecular oxygen. At wavelengths below 290 nm, UV is absorbed by either O_2 or O_3 ; weak O_3 absorption between 290 and 320 nm permits biologically damaging UV-B to reach the surface. As O_3 is depleted, the UV-B at the surface increases rapidly causing increases in skin cancer and other harmful effects.

ORIGINAL PAGE
COLOR PHOTOGRAPH

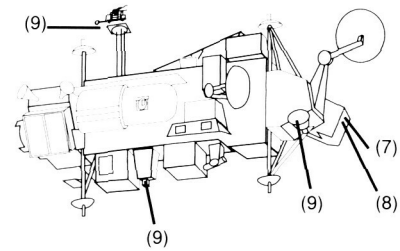

sources to track any change in instrument response during spaceflight.

SUSIM incorporates two spectrometers, seven detectors, and a set of four deuterium ultraviolet calibration lamps. One spectrometer will observe the Sun and measure the variation in solar ultraviolet flux as a function of time, while the second will monitor the calibration lamps. One of the four deuterium lamps within the instrument will serve as a calibration source. Once each day, this ultraviolet lamp will be turned on and positioned sequentially in front of each spectrometer. Stability in the output of this primary deuterium calibration lamp will be verified against the other three lamps, which will be utilized weekly, monthly, and annually for additional confidence in the calibration.

(8) SOLSTICE

Also mounted on the solar/stellar positioning platform, the Solar/Stellar Irradiance Comparison Experiment (SOLSTICE) will measure solar ultraviolet radiation in the wavelength range from 115 to 430 nm with a resolution of 0.12 nm. This instrument has the unique ability to compare the solar ultraviolet output with the ultraviolet radiation of stable bright blue stars, using the same optics. These stars thus constitute the standards against which the solar irradiance is measured. In the future, instruments similar to SOLSTICE can be placed in orbit to continue measurements of the solar output relative to these stellar calibration standards, thus creating a record of the long-term variation of the solar ultraviolet spectrum.

The experiment consists of a spectrometer with three spectral channels, each with a separate grating and photomultiplier tube. SOLSTICE will be pointed toward the Sun during the daylight portion of each orbit, and toward one of the calibration stars during most of the nighttime portion of the orbit. To accommodate the large difference in signal strength between the solar and stellar measurements, SOLSTICE can vary the duration of the measurement from 1 second to 17 minutes, the spectral bandpass from 0.1 to 5.0 nm, and the area of the entrance slit by a factor of 10,000.

(9) PEM

The Particle Environment Monitor (PEM) instrument will determine the type, amount, energy, and distribution of charged particles injected into the Earth's thermosphere, mesosphere, and stratosphere. PEM will utilize three separate boom-mounted sensors to measure electrons with energies from 1 eV to 5 MeV, protons with energies from 1 eV to 150 MeV, and the strength of the Earth's magnetic field—all in the vicinity of the spacecraft.

To complement these *in situ* particle measurements, PEM will include a 16-element array of X-ray detectors to provide wide spatial coverage of the energy injected into the upper atmosphere by high-energy electrons. As these electrons are slowed in their passage through the atmosphere, X rays are emitted and scattered in all directions. PEM will provide X-ray images in the energy range from 2 to 50 keV, leading to the reconstruction of the global, three-dimensional energy input spectrum of electrons up to 1 MeV in energy.

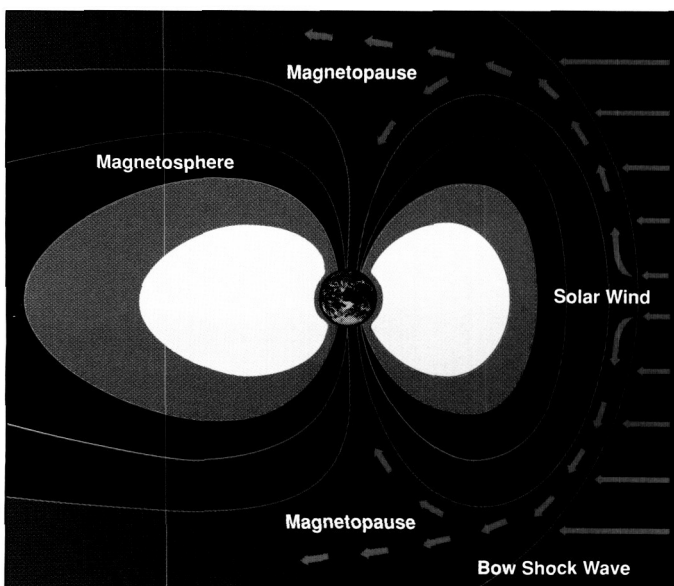

THE MAGNETOSPHERE shields the Earth from the solar wind; however, some energetic particles are trapped within this region and eventually precipitated into the upper atmosphere near the poles.



GLOWING AURORAS, most commonly seen at high latitudes, mark the sites of energy deposition into the upper atmosphere by high-energy electrons and protons from the magnetosphere.

ORIGINAL PAGE
COLOR PHOTOGRAPH

**UARS
DATA
MANAGEMENT**

The UARS data set will furnish by far the most comprehensive and detailed picture yet obtained of the chemistry, dynamics, and energy balance of the upper atmosphere. Optimum utilization of this invaluable resource requires extensive participation by the scientific community and the provision of a highly capable ground data system. A key feature of the UARS data management plan is the linking of NASA central computers with a network of versatile minicomputers—the Remote Analysis Computers, or RACs—located at the scientists' home institutions.

Scientific Analysis

One of the vital elements of the UARS mission is the early involvement and active participation of theoretical scientists representing all aspects of the study of the stratosphere and mesosphere. In addition to the theorists associated with the instrument investigations, there are also ten theoretical groups, each headed by a Principal Investigator, with specific areas of responsibility for data analysis and interpretation.

During the prelaunch phase, these scientists are developing data-analysis techniques and refining theoretical models to simulate upper-atmosphere radiative, chemical, and dynamical processes. Some of the individual models may eventually be combined into more extensive models that will realistically simulate the complex coupling of these processes in the stratosphere and mesosphere.



DATA RECEIVED AT THE CENTRAL COMPUTER FACILITY at NASA's Goddard Space Flight Center will be processed and made available to UARS investigators at their Remote Analysis Computers (RACs).

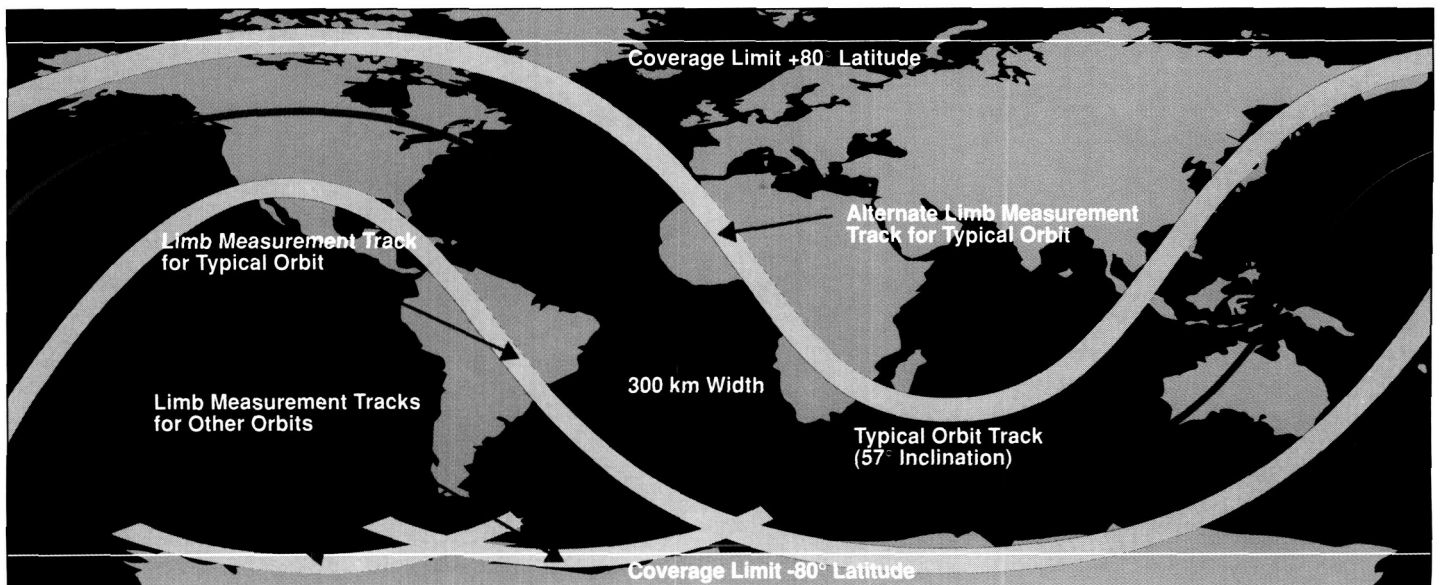

GROUND TRACK OF THE UARS SPACECRAFT is flanked by two bands, each 500 km wide, that trace the regions over which limb-viewing measurements can be made.

**ORIGINAL PAGE
COLOR PHOTOGRAPH**

Throughout the flight phase, the investigators will analyze incoming data and update observing strategies to maximize the scientific return of the mission. This approach will be particularly important for initiating special observations in response to unusual events, such as solar flares, volcanic eruptions, or sudden atmospheric warmings.

After termination of mission operations, scientists will be able to carry out analyses and modeling studies based on a very extensive set of atmospheric data, including comprehensive correlative data as well as results returned by the UARS instrument complement.

The Ground Data System

The UARS ground data system consists of (1) the Central Data Handling Facility (CDHF) located at NASA's Goddard Space Flight Center, (2) minicomputer-based Remote Analysis Computers (RACs) at the sites of the Principal Investigators, and (3) a dedicated electronic communications system to connect the RACs with the CDHF.

Telemetry data from tape recorders aboard the UARS spacecraft will be transmitted through the Tracking and Data Relay Satellite System (TDRSS) to the Data Capture Facility (DCF) at GSFC. The DCF will perform quality checks, time-reverse the tape-recorded signals, remove redundant data, and transmit the results to the CDHF. There, programs that have been developed by the instrument investigators using the RACs and transferred to the CDHF will convert the data into a form suitable for scientific analysis. These processed data

will be catalogued and stored in the data base associated with the CDHF.

The CDHF will be used primarily for (1) production processing of all the scientific data received from the spacecraft, (2) interactive processing and/or analysis of small subsets of the data by investigators using RACs, and (3) maintenance of the UARS data base for access initially by the UARS Principal Investigators and eventually by the scientific community at large. Most of the data at the CDHF will be stored on-line to facilitate rapid access by users. A catalog of data attributes, maintained in a data base management system, will permit searches of such characteristics as measurement parameter, time of observation, instrument, data level, and level of validation.

Prior to launch, the RACs are used to develop the programs needed to convert the telemetry data into scientifically useful information. After launch, the instrument investigators will use their RACs for data validation and refinement of their processing software. All of the investigators will use their RACs to gain access to data at the CDHF and for the geophysical analysis of the data.

In some cases, the RACs will be linked with larger computers for more complicated scientific analyses or for inclusion in sophisticated atmospheric models. The dedicated electronics communications system that connects the RACs with the CDHF will also allow the UARS investigators access to other scientific data networks.

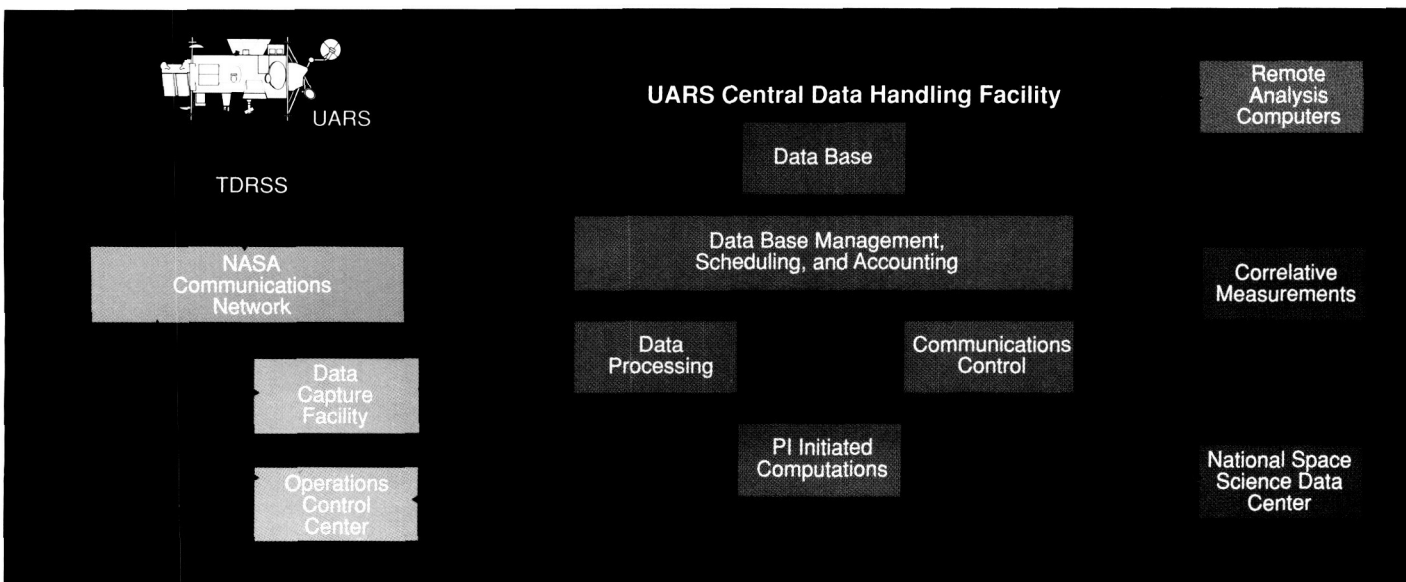

SYSTEMS DIAGRAM FOR UARS INFORMATION NETWORK reflects integration of communications, flight operations, data processing, and scientific data analysis.

ORIGINAL PAGE
COLOR PHOTOGRAPH

Summary of UARS Instrument Investigations

Instrument	Description	Measurement Objectives	Remarks	Principal Investigator, Institution
CLAES: Cryogenic Limb Array Etalon Spectrometer	Scanning spectrometer sensing atmospheric infrared emissions in the spectral range 3.5-12.7 microns	Concentrations of members of the N and Cl families, O ₃ , H ₂ O, CH ₄ , and CO ₂ at altitudes of 10-60 km; atmospheric temperature profiles for indirect wind measurements	Detectors cooled by solid Ne at -260 °C, optics cooled by solid CO ₂ at -150 °C	A. E. Roche, Lockheed Palo Alto Research Laboratory, USA
ISAMS: Improved Stratospheric and Mesospheric Sounder	Radiometer sensing atmospheric infrared emissions in the spectral range 4.6-16.6 microns	Atmospheric temperature structure and variability; minor constituent distributions including the N family, water, methane, carbon monoxide, and ozone.	Pressure modulated gas filters; detectors cooled to -195 °C by closed-cycle Stirling refrigerator	F. W. Taylor, Oxford University, UK
MLS: Microwave Limb Sounder	Radiometer sensing atmospheric microwave emissions at frequencies of 63, 183, and 205 GHz.	Concentrations of ClO, H ₂ O, O ₃ , and atmospheric pressure at various altitudes from 5 to 85 km	Will furnish first global data set on ClO, a key reactant in catalytic O ₃ destruction	J. W. Waters, Jet Propulsion Laboratory, USA
HALOE: Halogen Occultation Experiment	Radiometer sensing atmospheric infrared absorptions from occulted sunlight in the spectral range 2.43-10.25 microns	Vertical distributions of HCl, HF, CH ₄ , CO ₂ , O ₃ , H ₂ O, and members of the N family	Utilizes gas filters, makes 28 solar-occultation measurements per day	J. M. Russell, NASA Langley Research Center, USA
HRDI: High Resolution Doppler Imager	Fabry-Perot interferometer sensing atmospheric emission and absorption in visible and near-infrared spectral ranges	Velocity of upper-atmosphere wind field through measurement of Doppler shifts of molecular absorption lines (below 45 km, daytime only) and atomic emission lines (above 60 km, day/night)	Yields direct measurements of wind field; initial flight demonstration of Doppler measurement technique in the stratosphere	P. B. Hays, University of Michigan, USA
WINDII: Wind Imaging Interferometer	Michelson interferometer sensing atmospheric emissions in visible and near-infrared spectral ranges	Velocity of upper-atmosphere wind field through measurement of Doppler shifts of molecular and atomic emission lines above 80 km	Yields direct measurements of wind field	G. G. Shepherd, York University, Canada
SUSIM: Solar Ultraviolet Spectral Irradiance Monitor	Full-disk solar ultraviolet irradiance spectrometer	Spectrum of solar ultraviolet radiation from 120 to 400 nm, with resolution of 0.1 nm	Incorporates four deuterium calibration lamps to verify long-term instrument and detector stability	G. E. Brueckner, Naval Research Laboratory, USA
SOLSTICE: Solar/Stellar Irradiance Comparison Experiment	Full-disk solar ultraviolet irradiance spectrometer	Spectrum of solar ultraviolet radiation from 115 to 430 nm, with resolution of 0.12 nm	Compares solar ultraviolet output with ultraviolet radiation from bright blue stars for calibration	G. J. Rottman, University of Colorado, USA
PEM: Particle Environment Monitor	Electron, proton, and imaging X-ray spectrometer	Energy spectrum of electrons (1 eV - 5 MeV), protons (1 eV - 150 MeV) and X rays (2-50 keV)	Particle measurements made in vicinity of spacecraft; will also determine energy deposition by high-energy electrons.	J. D. Winningham, Southwest Research Institute, USA

ORIGINAL PAGE
COLOR PHOTOGRAPH

Summary of UARS Theoretical Investigations

Investigation	Investigator	Institution
Impact of ozone change on dynamics	D. M. Cunnold	Georgia Institute of Technology
Dynamics	M. Geller	NASA Goddard Space Flight Center
Transports, budgets, and energetics	W. L. Grose	NASA Langley Research Center
Wave dynamics and transport	J. R. Holton	University of Washington
Response to solar variations	J. London	University of Colorado
Meteorological interpretation	A. J. Miller	National Oceanic and Atmospheric Administration
Analytic-empirical modeling	C. A. Reber	NASA Goddard Space Flight Center
Three-dimensional stratospheric model	P. White	United Kingdom Meteorological Office
Chemical, dynamic, and radiative processes	D. Wuebbles	Lawrence Livermore National Laboratory
Radiative-dynamic balance	R. W. Zurek	Jet Propulsion Laboratory

UARS Mission and Payload Characteristics

Launch Date	Late 1991	Total instrument power	786 W
Design Lifetime	36 months	Total power	1.6 kW
Orbit	600 km circular	Telemetry rate	32 kbps
Inclination	57°	Data storage	Two tape recorders
Period	97 minutes	Tape playback	512 kbps
Latitude Coverage	80° N to 80° S	Data relay	Tracking and Data Relay Satellite System (TDRSS), 10 min/orbit
Global coverage interval for full diurnal measurements	36 days	Thermal range	-10 to 45° C
Weight of instruments	2,500 kg (5,500 lb)	Stabilization	Three-axis to less than 0.1 degree
Total spacecraft weight	6,800 kg (15,000 lb)		
Total launch weight	7,700 kg (17,000 lb)		

For further information on the UARS program, contact:

Program Manager:
Michael R. Luther
Code EED
NASA Headquarters
Washington, D.C. 20546

Program Scientist:
Dr. Robert J. McNeal
Code EEU
NASA Headquarters
Washington, D.C. 20546

Project Manager:
Luis Gonzales
Code 430
Goddard Space Flight Center
Greenbelt, MD 20771

Project Scientist:
Dr. Carl A. Reber
Code 610
Goddard Space Flight Center
Greenbelt, MD 20771

**UARS:
RESEARCH FOR
OUR GLOBAL
FUTURE**

What began with the ancient Greeks' fascination with the air they breathed has today become a complex scientific subject with major implications for the future of human societies.

Global atmospheric change, caused in part by human activity, is part of today's reality. The Upper Atmosphere Research Satellite will provide critically important data on changes in the chemical composition of the upper atmosphere, particularly the structure of the Earth's protective ozone layer in the stratosphere. UARS will also furnish new insights into upper-atmosphere dynamics and energy balance.

The UARS program is:

- ◆ **The first systematic, comprehensive, and detailed satellite investigation of the stratosphere and mesosphere;**
- ◆ **A fulfillment of the 1976 mandate of the U.S. Congress for an expansion in the study of upper-atmosphere processes from space;**
- ◆ **A major driver of new space technology, incorporating many instrument innovations;**
- ◆ **A pioneer in the development of integrated observational, theoretical, and data-management techniques that will characterize future Earth-observing missions; and**
- ◆ **A research endeavor of international proportions that will involve scientists around the world in the interpretation and utilization of the UARS data set.**

UARS will provide a major step toward exploration of a crucial frontier for space research—the upper atmosphere.



ORIGINAL PAGE
COLOR PHOTOGRAPH

Image Credits:

Cover: UARS computer graphic, Angel Studios and NASA; All other computer generated graphics: Ed Coderre, InterNetwork, Inc.; Page 2 (top to bottom, left to right): © Wilson North; © 1988 Masterson Stock; U.S. Geological Survey (USGS); Page 3 (top to bottom, left to right): © Claus Meyer/Black Star; © 1988 Masterson Stock; © Masterson Stock; Pages 4-5: Angel Studios & NASA; Pages 6-7: NASA; Page 9: U.S. Naval Observatory; NOAA; Page 10 (top to bottom, left to right): National Center for Atmospheric Research (NCAR); Smithsonian Institute; all others: NASA; Page 11: all NASA; Page 12 (top to bottom, left to right): NASA; M.R. Schoeberl and A.J. Kruger, Goddard Space Flight Center (GSFC)/NASA; Page 13: C. A. Farmer, Jet Propulsion Laboratory; Pages 14-15 (left to right): General Electric, University of Michigan/Space Physics Research Laboratory, © Bob Krist/Black Star; University of Michigan/Space Physics Research Laboratory; GSFC/NASA; Page 20: P. Woiceshyn, Jet Propulsion Laboratory and M. Wuertle, University of California, Los Angeles; Page 23: © Wilson North; Page 24: Jet Propulsion Laboratory.

Design, Illustration, Production and Coordination: InterNetwork, Inc.
Text and Figure Development: Space Research and Management, Inc.

3/89: 20K

UPPER ATMOSPHERE RESEARCH SATELLITE

Remote Atmospheric Sensors

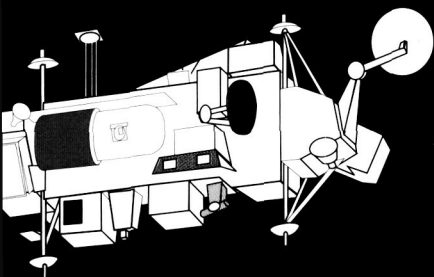

- MLS-Microwave
- CLAES-Infrared
- ISAMS-Infrared
- HALOE-Occultation
- HRDI-Fabry Perot
- WINDII-Michelson

