

NASA Contractor Report 1 8 1 7 2 6

**ADVANCED PILOTED AIRCRAFT FLIGHT
CONTROL SYSTEM DESIGN METHODOLOGY
VOLUME I: KNOWLEDGE BASE**

(NASA-CR-181726-Vol-1) ADVANCED PILOTED
AIRCRAFT FLIGHT CONTROL SYSTEM DESIGN
METHODOLOGY. VOLUME 1: KNOWLEDGE BASE Final
Report (Systems Technology) 285 p CSCL 01C

N89-26013

Unclas
G3/08 0222709

Duane T. McRuer and Thomas T. Myers

**Systems Technology, Inc.
Hawthorne, CA 90250**

Contract No. NAS1-17987

October 1988

NASA

National Aeronautics and
Space Administration

Langley Research Center
Hampton, Virginia 23665-5225

FOREWORD

This report presents and illustrates the development of a comprehensive and eclectic methodology for conceptual and preliminary design of flight control systems. The methodology is focused on the design stages starting with the layout of system requirements and ending when some viable competing system architectures (feedback control structures) are defined. The approach is centered on the human pilot and the aircraft as both the sources of, and the keys to the solution of, many flight control problems. The methodology relies heavily on computational procedures which are highly interactive with the design engineer. To maximize effectiveness these techniques, as selected and modified to be used together in the methodology, form a cadre of computational tools specifically tailored for integrated flight control system preliminary design purposes. The computer aids are all based on IBM PC compatible machines and most are now commercially available. This helps make the methodology as broadly available and useful as possible instead of simply another isolated approach.

As individual computational programs some of the design aids have very great value as system analysis, design and synthesis tools in general. Important contributions to one of the programs were made as part of this NASA Small Business Innovation Research effort. Other additions were inspired by needs of the methodology developments. Systems Technology, Inc., as a Phase III SBIR effort, supported this further development and the extensive efforts needed to make the programs commercially available. The important, now commercial programs, and their origins, are:

Program CC, Version 3 -- developed by Peter Thompson, PhD, with later STI assistance, for educational, STI in-house, government, and industrial use. Several modules were developed under this NASA Phase II SBIR.

Program CC, Version 4 -- developed as an expansion and extension to Version 3 to set an entirely new standard for computer-aided control system design. This was supported entirely by STI and Peter Thompson, PhD as a Phase III effort.

"LSMP", Linear Systems Modeling Program -- an expanded and improved version of an STI-proprietary program developed over a period of many years for larger scale machines, adapted to a PC. The final development was also accomplished as an STI-sponsored Phase III activity.

Peter Thompson is the author of both versions of Program CC. The fore-runners of LSMP have many contributors through the years, although Wade Allen and Theodore Rosenthal made the crucial finishing touches during the STI-sponsored Phase III efforts.

A more limited initial software development was also accomplished as part of the design methodology. This is "FCX", a pioneering attempt to explore the use of expert system techniques, using a commercially available shell program ("LEVEL5") for PCs, for flight control system preliminary design. This was totally supported by the Phase II SBIR, and was accomplished by Thomas T. Myers assisted by Theodore Rosenthal, and David Klyde.

In developing the design methodology and illustrations represented by this report the two named authors were principal contributors. They were ably supported on the software developments by the people noted above. Peter Thompson also contributed to the methodology in the area of robustness assessment as a coauthor of Supplement 1. To help establish and flesh out the design methodology an "expert team" was established early in the project. This comprised the first-named author, and two internationally recognized experts -- Dunstan Graham, formerly of Princeton University, to provide a leavening influence on flight control, and John Wykes, formerly of Rockwell International, as a leading expert on structural dynamics/flight control system interactions. Their aid in formulating important questions and their careful review of the methodology played an important role in the project.

The authors have been greatly assisted in their task by many fruitful technical exchanges with Mr. Jerrell Elliott, of NASA Langley Research Center, who was the NASA Technical Manager for this SBIR. Jerry made many constructive technical suggestions. We had other helpful discussions with others at Langley, including Richard Hueschen and John McMannus on formulation of rules and expert system implementation, and with Dr. Steven Sliwa on functional systems integration.

As a final note in this foreword it is pertinent to express our appreciation to the unknown (to us) people who made it possible for STI to undertake this Phase II SBIR program. It permitted us to develop a methodology for preliminary design which we use in our consulting efforts with industry, to expand our analytical and synthesis computational tools, to develop and apply some new and relevant theory, explore and pioneer an application of the potentially fruitful new technology of expert systems, and has provided some support in developing novel and innovative state of the art computer programs. Perhaps most importantly from the standpoint of those who originated the SBIR idea, the Phase I and Phase II support by NASA inspired STI to extend several of the innovations with its own funds as a Phase III SBIR effort. It is still too early to say whether this last phase will have a happy ending, but we're hoping! In the meantime, STI is grateful to NASA for the opportunity!

TABLE OF CONTENTS
VOLUME I

	<u>Page</u>
I. INTRODUCTION, APPROACH, AND PRELIMINARIES AND OUTLINE OF THE DESIGN METHODOLOGY.....	1
A. General Background.....	1
B. Computational Aids.....	3
C. Preliminaries.....	6
D. Fundamental Considerations.....	7
E. Summary of Features Needed in Methodology.....	11
F. Fundamental Natures of Flight Control Systems [Controlled Element, Controller, and Their Combinations].....	13
G. Steps in the Preliminary Design Process.....	20
H. Level Detail Available at the End of the FCS Architectural Development.....	37
I. Preview of What is to Come.....	40
II. MISSION-BASED REQUIREMENTS FOR LATERAL-DIRECTIONAL FCS OF HIGH PERFORMANCE AIRCRAFT.....	43
A. Mission-Centered Flying Qualities Requirements.....	45
B. Mission-Centered Path and Heading Control Requirements...	46
C. Implied Requirements for Coordinated Maneuvers.....	52
D. Mission-Based Requirements in the Flight Control Design Software.....	53
E. Command and Disturbance Characteristics.....	54
III. HIGH PERFORMANCE AIRCRAFT LATERAL-DIRECTIONAL CHARACTERISTICS.....	59
A. Airplane Equations of Motion.....	60
B. Numerical Characteristics for the Example Airplane.....	62
C. Literal Approximate Factors for the Airplane Characteristics.....	69
IV. IDENTIFICATION OF CONTROL OF LATERAL-DIRECTIONAL CONTROL PROBLEMS DUE TO THE AIRPLANE.....	85
A. General Path and Heading Control Problems.....	85
B. General Roll Control Problems.....	91
C. Pilot Control Problems.....	92
D. Summary of Airplane Dynamic Shortcomings and Equalization Needs.....	94

TABLE OF CONTENTS (CONTINUED)

	<u>Page</u>
V. PROSPECTUS FOR LATERAL-DIRECTIONAL FLIGHT CONTROL SYSTEM ARCHITECTURE.....	97
A. Equalization Requirements for Control Systems in General.....	98
B. Prospectus for Flight Control System Architecture.....	100
C. Prospectus for Augmentation to Alleviate Basic Aircraft Dynamic Deficiencies.....	104
VI. PRELIMINARY DESIGN OF CANDIDATE LATERAL-DIRECTIONAL FIGHTER FLIGHT CONTROL SYSTEM.....	117
A. Actuation and Sensing.....	120
B. Yaw Damper Design.....	120
C. Roll Damper Design.....	127
D. Bank Angle Control Loop.....	134
E. What Next?.....	138
REFERENCES.....	R-1

Note: Supplements have their own pagination.

SUPPLEMENT 1. LITERAL SINGULAR-VALUE-BASED FLIGHT CONTROL SYSTEM DESIGN TECHNIQUES.....	1
Introduction.....	1
Example Problem.....	3
Robustness of Stability with Respect to Input Uncertainties.....	5
Motivation for Literal Formulations.....	13
Literal Approximations of Open-Loop Singular Values.....	15
Literal Formulation of the Robust Stability Criterion.....	20
A Literal Approximation of Structured Singular Values.....	24
Summary and Conclusions.....	25
Acknowledgement.....	26
References.....	27

TABLE OF CONTENTS (CONCLUDED)

	<u>Page</u>
SUPPLEMENT 2. LATERAL FCS REQUIREMENTS-ORIENTED DESIGN KNOWLEDGE BASE FOR AN ADVANCED STOL FIGHTER IN MISSION PHASE CO.....	1
A. General.....	1
B. Topic 1 -- Flight Control System Purpose.....	3
C. Topic 2 -- Command and Disturbance Characteristics.....	11
D. Topic 3 -- Unalterable Characteristics of the Aircraft and Controller.....	16
E. Topic 4 -- Pilot-Centered Requirements.....	22
References.....	27
SUPPLEMENT 3. PILOT-CENTERED REQUIREMENTS AND HUMAN PILOT A/FCS INTERACTIONS.....	1
A. Effective Vehicle Dynamics and Flying Qualities Requirements -- Rigid Body Characteristics.....	3
B. Conditions for Acceptable (or Minimum) Pilot Equalization.....	30
C. Conditions Antithetical to Pilot-Induced Oscillations.....	32
D. Minimization of Remnant Excitation of Flexible Modes.....	33
E. Minimization of Pilot Effective Aircraft System Closed-Loop Excitation of Flexible Modes.....	34
F. Reduction of Vibration Feedthrough.....	35
References.....	37
APPENDIX A. THE MULTI-VARIABLE ANALYSIS METHOD.....	A-1
APPENDIX B. SENSITIVITY VECTORS.....	B-1
APPENDIX C. ELEMENTAL SYSTEMS.....	C-1

LIST OF FIGURES

	<u>Page</u>
1. Fundamental Considerations.....	8
2. Features Needed in Methodology.....	11
3. Airplane Properties.....	15
4. Controller Properties.....	17
5. Generalized Flight Control System for Fighter Aircraft Including Flexible Modes ["Effective Aircraft," as Seen by the Pilot].....	18
6. Typical Design Phases for Multi-variable Flight Control System Synthesis at the Architectural Level.....	22
7. System Preliminary Design Methodology Flow Diagram.....	23
8. Typical Design Phases for Multi-variable Flight Control System Synthesis at the Detailed Design Level.....	24
9. First Step in Flight Control Requirements Evolution.....	25
10. Candidate Flight Control System for a Highly Unstable Fighter Aircraft.....	38
11. System Survey Indicating the Infeasibility of Path Control with a Pure Gain $\lambda \rightarrow \delta_a$ Loop.....	49
12. Survey of Bare Aircraft Response to Roll Control.....	86
13. Generic Roll Control System for Path Control.....	88
14. Survey of Response to Roll Command with High Gain $\phi \rightarrow \delta_a$	90
15. System Survey of Pure Gain $\phi \rightarrow \delta_a$ Closure Around Bare Aircraft.....	93
16. Elements of the Prospectus.....	102
17. Some Opportunities for Aircraft Tailoring.....	105
18. Low Gain Control Prospectus from Sensitivity Vectors.....	107
19. Candidate Lateral FCS Design.....	118
20. Effect of Washout Variations on the Poles in the Yaw Damper Closure.....	122

LIST OF FIGURES (CONCLUDED)

		<u>Page</u>
21.	Effect of Yaw Damper Closure on Denominator.....	123
22.	Effect of Yaw Damper Closure on $N_{\delta_a}^{Pb}$	124
23.	Effect of Pure Gain Roll Damper Closure on Denominator - Yaw Damper Closed.....	128
24.	Effect of Roll Damper Closure with Lead-Lag Compensation on Denominator - Yaw Damper Closed.....	129
25.	Response to 1 deg Aileron Step Yaw and Roll Dampers Closed.....	132
26.	Response to 1 deg Rudder Step.....	133
27.	Response to a 1 deg Aileron Step, Yaw and Roll Dampers Closed, Crossfeed On.....	135
28.	Bank Angle-to-Roll Control Frequency Response.....	136
29.	Closure of the Bank Angle Control Loop.....	137
30.	Bank Angle Response to Bank Angle Command, Complete System.....	138

LIST OF TABLES

		<u>Page</u>
1.	Mission Phase-Control Needs Matrix for Advanced Fighter.....	26
2.	System Architectural Possibilities and Mechanizational Side Effects for Superaugmented Aircraft.....	39
3.	Compilation of Mission-Centered FCS Design-Critical Requirements.....	47
4.	Requirements Window.....	55
5.	Flight Control System Inputs; Application Point and Source (Adapted from Ref. 1).....	57
6.	Lateral Directional Aircraft Equations of Motion.....	61
7.	Reference Flight Condition.....	62

LIST OF TABLES (CONCLUDED)

	<u>Page</u>
8. Summary of Aircraft Alone Characteristics.....	64
9. Aircraft Basic Data.....	65
10. Flight and Trim Conditions.....	65
11. Stability and Control Derivatives.....	66
12. Characteristic Modes.....	66
13. Transfer Function Numerators.....	67
14. Coupling Numerators.....	68
15. Approximate Factors for Lateral-Directional Characteristic Function (Stability Axes).....	71
16. Literal Approximate Factors-Denominator.....	72
17. Approximate Factors for Lateral-Directional Numerators (Stability Axes).....	77
18. Approximate Factors Calculations Spreadsheet Window.....	79
19. Lateral/Directional Essential Feedbacks.....	103
20. Design Assessment.....	139

SECTION I
INTRODUCTION, APPROACH, AND PRELIMINARIES
AND
OUTLINE OF THE DESIGN METHODOLOGY

A. GENERAL BACKGROUND

Our goal in this report is to formulate and illustrate a comprehensive methodology to establish feedback architectures for advanced aircraft flight control systems (FCS). Although the analysis and synthesis tools in the methodology are useful at all stages of FCS design and development, the focus is on the early stages of conceptual and preliminary design. This emphasis comes from a recognition that flight control is a major player in the new age in aeronautical technology wherein the very early integration at a highly dynamic level of many system elements is essential to achieve a well-tempered aircraft. At present, control is commonly used to redress aerodynamic stability and control deficiencies, and to improve overall aircraft performance potential. As Dynamic Systems Integration becomes prevalent, control technology increasingly becomes the glue which ties together many aeronautical technical disciplines to accomplish highly interrelated functions — functions which were hitherto either non-existent or only marginally associated with one another. Future Flight Control Systems will encompass many of the dynamic aspects traditionally associated with airframe stability and control, structures (both quasi-static as in maneuver load control; and dynamic as in flexible mode control and gust alleviation), and propulsion. A wide variety of guidance features such as automatic fire/flight control and four-dimensional en route and terminal navigation, have also acquired a dynamic intimacy with FCS. To cope efficiently with this level of dynamic interaction requires a design methodology which can: illuminate the many interactions between the several subsystems; show the way for configuration tradeoffs between aircraft-alone dynamics and automatic controllers; provide data for comparisons between various controller possibilities; and expose the subtle problems inherent in such high degrees of interconnections — all at the earliest possible time.

The methodology presented is a unified combination of theories, emerging computational technologies, empirical data, lore, and practical experience -- a mixture of science and art. Considering theory first, we should note that many control theories exist, and most have been tried at one time or another in illustrative exercises with aircraft dynamics as the plant. Yet very few are applied to flight control analysis and synthesis in practice. A useful theory must cope with many complexities, as well as often conflicting and incommensurate requirements unique to the flight control problem. These include:

- accommodation of human pilot
- varieties of missions and operating points
- complexity in controlled element dynamics (e.g., flexible modes, nonlinear aerodynamics)
- complex controllers (e.g., multiloop control structures, task-tailored control modes, digital components, control effector limits)
- multiple function controller elements which have both independent and subsidiary status in the total FCS (e.g., controllers for stability augmentation which also supply inner loop equalization for guidance loops)
- multi-task, multi-desires, qualitative and quantitative requirement statements
- a wide cross-section of transient and random commands and disturbance functions

Because of all these complicating factors it is no surprise that many theories are found wanting; indeed no single approach is sufficiently comprehensive to handle everything, especially when major nonlinear features are present. Nonetheless, a primary thrust in this report is the selection and illustration of an eclectic set of theoretical approaches for flight control system synthesis and analysis that specifically address the features intrinsic to such systems. The techniques adopted are based on linear control theory. This is appropriate to the earliest stages of preliminary design in that they apply to the small perturbation dynamics of the airplane-FCS combination which have to be resolved before more

esoteric fundamentally nonlinear phenomena can fruitfully be considered. Also, a factor in selecting the techniques to be used is that they should be capable of extension in later studies to handle many of the important nonlinear phenomena in flight control, e.g., by use of equivalent linearization procedures, such as describing functions.

B. COMPUTATIONAL AIDS

To be viable as a design methodology the theories selected must be accompanied by appropriate computational aids. In this respect emerging concepts and commercially available computer programs from the ever-expanding micro-computer technology base have completely changed the possibilities for design. This is especially true for efficient preliminary design, which requires a combination of experienced and imaginative engineering to accomplish the system-architect function. Because of the interactions with other technical disciplines, the complexities of the FCS subject itself, the incommensurate and often competitive or conflicting criteria and desires, and the unknowns and uncertainties, preliminary design has always been an iterative and artistic process. More often than not it has also been accomplished by a committee, with unavoidable time lags and compromises which can result in less than an optimal overall design. For the forthcoming era of more dynamically-integrated elements and technologies within the purview of flight control the design engineer-architect needs a set of computing tools which are not only capable of interaction among themselves but, most importantly, are suitable for interactive and highly-iterative operations with the engineers involved. The selection, development, and appropriate connection of computer programs for this purpose has been a major goal of the project. It was intended from the beginning that the computer aiding would be accomplished on PC compatible machines, and that the constituent programs would be readily available to potential users. At the time this plan was based on hope and projections of what might become available during the course of the project.

We have been able to "mechanize the design methodology" using a variety of computer tools which are suitable for highly user-interactive

activities on PC class machines. The software developments made in this project constitute a flight control system design package referred to as FCX. This package has two coupled components — a rule-based expert system, the "FCX flight control design expert system" and an algorithmic computer-aided control system design (CACSD) program, Program CC. The FCX flight control design expert system was our first attempt to explore the potential of knowledge-based concepts to control system design and specifically to flight control design. The result is a quite limited prototype, but this effort has answered a number of questions about the potential of expert systems for flight control design, their relation to existing highly developed algorithmic CACSD software, and specific implementation approaches. Our conclusion is that, while a great deal of work must be done, expert system concepts can, should and very likely will make a significant contribution to flight control design.

The FCX rule-base with about 160 rules at this point captures only a small portion of the knowledge base contained in this report. However, this is enough to answer in the affirmative what we believe is the most critical question about this application of expert systems — i.e., can knowledge of the physical principles and design concepts of aircraft flight control systems be implemented in a useful way. That is, can expert systems provide more than just an "intelligent interface" for conventional algorithmic CACSD programs. We are now confident the answer is yes and have a prototype with which to carry this effort forward.

The algorithmic CACSD component which is presently coupled to the FCX expert system is STI's Program CC, Version 3. "Program CC" is a control system analysis, synthesis, and design package originally developed for academic instructional use. It has since been greatly extended to provide a comprehensive selection of the many tools and algorithms essential for control system theory and practice. These include classical (transfer function based) and modern (state space), frequency and time domain, single and multiple input/output, continuous and sampled data control system analysis and design techniques. Observers, Kalman filters, classical Bode and conventional root locus, pole-placement, singular value and structured singular value techniques, etc. are all present. Of particular

importance for advanced flight control system design is the coverage of several multi-variable analysis/synthesis and robustness assessment procedures, as well as multi-rate digital techniques.

Most of the modules in Program CC, Version 3, were developed before the project began. To provide the additional analysis/synthesis/assessment procedures needed for the design methodology it was supplemented with several modules partly supported by this Phase 2 SBIR and partly by Systems Technology, Inc. Program CC, Version 3 is commercially available and has found many users in academe, governments, and industry. Additional modules and improvements which support the design methodology have been added to Version 3 features, along with much other capability, to form Program CC, Version 4. The development of Program CC, Version 4 has been supported by Systems Technology, Inc. and Peter Thompson, PhD, as a Phase 3 SBIR effort. Program CC, Version 4 has recently become available commercially. The FCX expert system was totally developed as part of the Phase 2 SBIR effort using the LEVEL5 expert system shell from Information Builders, Inc. Because of the RAM memory requirements of LEVEL5, the FCX expert system can not yet be coupled to Program CC, Version 4.

In FCX the programs noted above are supplemented with a spreadsheet database element for "SYMPHONY", by Lotus Development Corporation. This program is not fundamental to the exercise of the design methodology (the three programs above, or their equivalent, are essential). The total computing aid package can be supported on an MS-DOS IBM PC compatible personal computer with 20 MB hard disk and 640K RAM. As individual, commercially viable, programs they exhibit a great number of user friendly features, so the expert FCS preliminary design engineer need not be a computer expert as well. The FCX flight control system design package, expert system and associated programs are discussed in detail in Volume 2.

One final program needs to be mentioned here — LSMP, STI's Linear System Modeling Program. This program has specialized features for modeling complex vehicle systems. It was used in the early work on the project, but was not part of the software development. LSMP operates with sets of vehicle and control system equations as simultaneous equations in which any component block can be as complex as a ratio of two second-order

terms. It delivers factored transfer function elements of all kinds — denominators, numerators, "coupling numerators," etc. Thus, vehicle equations of motion, which typically involve second-order terms, are handled naturally in the form in which they were originally derived. Control system elements are also readily incorporated into the same structure. LSMP's outputs include cell displays and matrix listings, transfer function displays, frequency response Bode plots, and single- or multi-trace transient response plots. LSMP can provide transfer function files in Program CC format. While LSMP's specialized features make it the primary vehicle modeling task at STI, Program CC state space modeling capability is more than adequate for the present FCX development.

C. PRELIMINARIES

While theory and associated computational means are an important aspect of the design methodology, the lore, knowledge and experience elements, which guide and govern applications are critical features. This material is presented here as summary tables, outlines, recipes, empirical data, lists, etc., which encapsulate a great deal of expert knowledge. Much of this is presented in topical "knowledge summaries" which are attached to the report as "Supplements." The composite of the supplements and the report main body elements constitutes a first cut at a "Mark 1 Knowledge Base" for manned-aircraft flight control.

The steps in the design methodology are broadly outlined later in this introduction. To help put flesh on this general skeleton the steps are then illustrated in the next sections by a specific concrete example. This will consider a design point for a lateral-directional FCS for a high performance fighter. To keep the flow as easy to follow as possible, pertinent knowledge base elements, picked out of the supplements and key references, are inserted into the example at points where they are most relevant. This development constitutes the next five sections of the report plus the first supplement.

In formulating an adequate flight control system design methodology, we have considered many things. Many of these appear naturally in their own technical context, and will be described in the appropriate technical

sections, supplements, and appendices following. Others are intrinsically introductory to the subject. These will be presented as separate articles in this introduction. The first two topics are philosophical preliminaries which have been considered in laying out the methodology and selecting its constituent analysis and computing tools. These are,

Fundamental Considerations to take into account in selecting the design methodology

What Features are Needed in the Methodology?

Because the design methodology is intended for flight control systems as contrasted to control systems in general it is pertinent to describe some of the peculiar aspects of flight control that require special treatment. This is done in an article on

The Fundamental Natures of Flight Control Systems

Finally, after these preliminaries describing the idiosyncracies of flight control and what special factors need to be accounted for in a suitable design methodology, we turn to the subject of the methodology itself. This is introduced and outlined in,

Phases (Steps) in the Development of a Flight Control System Architecture at the Preliminary Design Level

An immediately following article gives a brief illustration of a longitudinal controller as a typical output from an exercise of the methodology.

This initial chapter is then concluded with a preview of what is to come in the remaining sections, supplements, and appendices of the report.

D. FUNDAMENTAL CONSIDERATIONS

The broad "Fundamental Considerations," set forth to provide a well-defined philosophical base to underlie our approach to the design methodology, are listed in Fig. 1. The considerations and part of their impact on methodology requirements are summarized below.

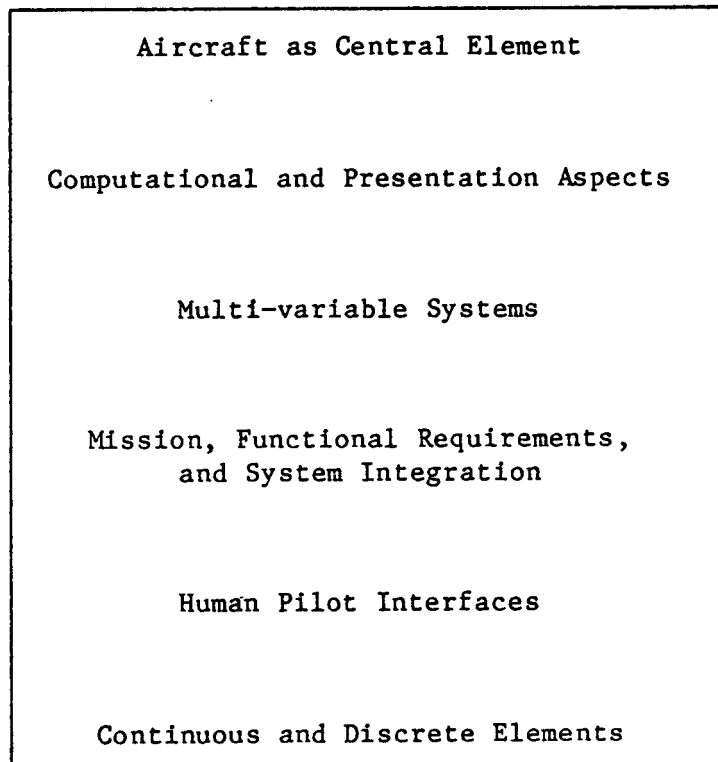

Figure 1. Fundamental Considerations

1. The Aircraft as the Central Element in Flight Control

The primary thesis for the approach adopted here is that AIRCRAFT flight control systems have many peculiar features which differentiate them from most other control systems — and that these features require special treatment in analysis, design, and synthesis. The study of bare aircraft dynamics, stability, and control — described by multi degree-of-freedom dynamics which are non-linear and time-varying, and characterized by parameters which are highly variable and sometimes uncertain — is a technical discipline in its own right. The many interactions and connections between aircraft parameters and dynamic behavior treated in this discipline serve as starting points for control considerations. In this perspective, the aircraft is simultaneously the source of flight control problems, and the key to their solution. Reflecting this central position of the aircraft dynamics in flight control, the control system analysis techniques chosen for the design methodology should be specially selected

to focus on the idiosyncracies of air vehicles, and the effective exposure of the impact their properties have on flight control system behavior.

Consistent with this perspective, procedures are desired which have direct connections with the aircraft stability and control discipline, enhance fundamental physical understanding, help develop insight, and provide enlightenment about the many subtleties and mysteries encountered in the airplane dynamics and their impact on complex flight control systems. For example, the methodology places heavy stress on the ability to relate the airplane's poles and zeros to their physical origins in terms of aerodynamic stability derivatives, preferably in symbolic terms.

2. Computational and Presentation Aspects in Selection of the Methodology

Flight control problems are of such high dimensionality and complexity that simply getting viable answers to design questions has in the past demanded major computational efforts. Now, however, with modern computers calculation no longer poses major difficulties.

But presentation of results, so they can be easily assimilated and understood, remains elusive. Extensive tables of easily computed numerical results can be dreadful hodgepodes without a meaningful graphical presentation. In selecting the elements of the design methodology, great emphasis is placed on pictorial presentations which permit the ready comprehension of results and illuminate and expose key interactions. Provision of insight and understanding, coupled with easy interpretation, are the chief criteria for selecting data presentation formats. For example, for insight-provoking visualization the pictorial forms selected include: transient responses to appropriate inputs; conventional s-plane root loci; and $j\omega$ Bode frequency responses; unconventional Bode root loci and time-vector/sensitivity diagrams. Some of these used to be means to an end — graphically computed answers to then difficult analysis/synthesis questions; they now serve a different but still primary role — as pictures which provide meaningful presentations of a vast array of numerical results.

3. Multi-Variable Systems

Aircraft have many degrees of dynamic freedom so flight control systems are usually multiloop and multi-effector (control point) in nature. Because the aircraft dynamics are the central issue in flight control system design, novel constraints are imposed on the types of multi-variable system analyses which are most useful in the preliminary design stage. Most importantly, the methods should be effective in showing the way to set up possible system architectures, in illuminating the relative benefits and liabilities of competing systems, and in exposing possible problems for future detailed examination. For the detailed design phases, there may also be a role for techniques which are highly efficient computationally, but which may be more specialized and narrow in scope.

4. Interrelationships with Mission and Functional Requirements and Systems Integration

Vehicle control in its most general context translates mission requirements into mission accomplishment. The mission purposes and tasks directly specify part of the FCS architecture and imply other parts. Because of this cause-effect relationship, there are very important, albeit often subtle, tradeoffs between mission requirements and the control system. These explicit and implicit connections between the overall system requirements and the FCS need to be clearly drawn and understood in the context of the methodology.

5. Human Pilot and Flying Qualities Aspects

A major complication in flight control systems for manned aircraft is the presence of the human pilot. The pilot is simultaneously a competitor with, or backup for, the automatic control elements for some controller functions, and the customer for the beneficial effects of automatic control in improving the effective vehicle dynamics. Thus, a major challenge for the methodology is the inclusion of the highly adaptive human pilot as a control element and evaluator of the flying qualities of the aircraft + flight control system. Further, the analysis procedures should

accommodate the compromises associated with dividing assigned functions between the human pilot and automatic equipment.

6. Digital Controllers

Many modern flight control systems contain digital controllers. Also the detailed design phases of flight control system development invariably include extensive real-time simulations with actual FCS hardware and/or human pilots, wherein the aircraft and other continuous system elements are replaced by digital computer surrogates. Consequently, the peculiar behavioral features of discrete as well as continuous system elements must be accommodated and illuminated in the design methodology.

E. SUMMARY OF FEATURES NEEDED IN METHODOLOGY

The fundamental considerations given above describe the broad perspective and underpinnings of our approach. A specification for the design methodology requires more detailed considerations in the several areas listed in Fig. 1-2. The abbreviated general headings given there are elaborated in the following outline "Specification for Methodology Features."

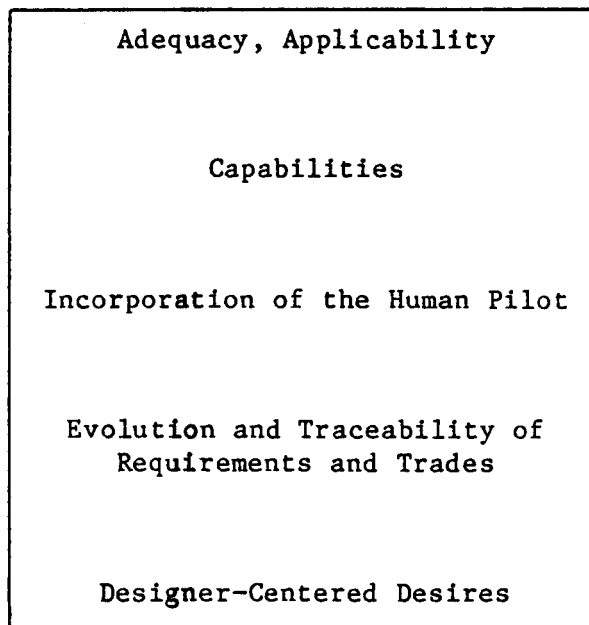

Figure 2. Features Needed in Methodology

1. Adequate for Present and Future Needs, Wide Range of Applications, and Preliminary and Detailed Design.
 - a. Serve as the analytical glue which ties together other technical disciplines which involve control, e.g.,
 - (1) vehicle dynamics which incorporate flexible modes and nonstationary aerodynamics
 - (2) integrated flight/propulsion control
 - (3) integrated flight/fire control
 - (4) effective vehicle flying qualities
 - b. Applicable to a wide variety of aircraft — airplanes, rotorcraft, heavy-lift airships, aerospace planes, etc.
 - c. Techniques appropriate for preliminary and detailed design phases.
 - (1) broad-gauged insight/system architecture/tradeoff intensive procedures for preliminary design and continuing understanding
 - (2) more narrowly constrained, computationally efficient, simplified system procedures for extensive number crunching in detailed design
2. Control System Analysis Procedure Capabilities
 - a. Multiloop/multi-control point.
 - b. Central importance of air vehicle properties, peculiarities, and needs. Maximize use of understanding of special characteristics of aircraft as plant.
 - c. Multiple but interrelated FCS system and subsystem configurations. Mission-phase tailored system dynamics.
 - d. Emphasis on all major vehicle output response properties and their degree of harmony.
 - e. Focus on deducing key uncertainties and sensitivities in controlled element parameters.
 - f. Detailed robustness assessment.

3. Incorporation of the Human Pilot as an Element in the Overall System
 - a. Role allocations between pilot and automatic system elements.
 - b. Coupling of effective vehicle and pilot models for development of pilot-centered requirements on the FCS and assessment of pilot-vehicle system behavior. Interpretation and implementation of flying quality requirements.
 - c. Provide tools to interpret pilot behavioral data and comments from simulations and flight test.
4. Clear Cut Evolution and Traceability of Requirements and Tradeoff/Compromise Possibilities
 - a. Mission-dependent direct and implied requirements and FCS architectural consequences.
 - b. Configuration tradeoffs between airframe and flight control.
5. Designer-Centered Desires
 - a. Easily comprehended pictorial presentations which provide maximum physical insight at each step of design, reveal and treat implicit requirements, help detect conceptual errors, etc.
 - b. Good qualitative and quantitative understanding of tradeoffs.

F. **FUNDAMENTAL NATURES OF FLIGHT CONTROL SYSTEMS [CONTROLLED ELEMENT, CONTROLLER, AND THEIR COMBINATIONS]**

The point has been made as a "Fundamental Consideration" that flight control systems for aeronautical vehicles are a peculiar and unique subset of all control systems, and demand theories and techniques for synthesis and analysis which specifically cater to their peculiar characteristics. In tailoring a methodology for flight control analysis/synthesis purposes, a logical first step is to identify those features and peculiarities of flight control systems and their constituent elements which lead to specialized needs. The following summary provides some of the unusual and/or governing characteristics of the aircraft, the controller,

their combinations which distinguish a FCS as a system apart from other control systems.

1. Controlled Element — The Airframe

As an object of control, the airplane is remarkably contrary. It includes the properties listed in Fig. 3.

The major variations in aircraft dynamic characteristics are known in form and kind as direct functions of the flight condition defining the variables: dynamic pressure (q), Mach number (M), angle-of-attack (α), weight (W), and sometimes wing sweep, sideslip (β), and effector trim positions. To the extent that these variations are known and affect such dominant system characteristics as open-loop crossover-region properties, they can be "compensated" for by virtue of programmed adjustments in the controller (e.g., common airspeed compensation of gains). Sometimes a portion of these known or foreseeable variations can be considered in the design process in the same way as tolerances and unknowns must be; that is, as uncertainties with which the system designer must cope.

Some variations and uncertainties are more important than others. This is true even if the absolute values or the percentage of nominal of the uncertainties are the same. Whether an uncertainty is important or insignificant depends primarily on the poles and zeros of the vehicle transfer functions which the uncertainty affects, and on the closed-loop system architecture. For example, if variation (including nonlinearity) or uncertainty in a particular aerodynamic stability derivative affects poles or zeros which occur where the amplitude ratio of one or more of the control loops is very large (i.e., well away from a crossover region), this variation will be insignificant. (An exception to this rule can occur when a zero is in or can, when uncertainties are included, be driven into the right hand plane.) On the other hand, those variations and uncertainties which affect poles and zeros in the crossover regions of the various loops can be critically important to the stability and robustness of the design. This distinction is extremely important in flight control systems, for it places great emphasis upon a detailed knowledge and understanding of those aircraft dynamic features which have major impact on the

- **COMPLEX DYNAMICS:** at a specific equilibrium flight condition, six degrees of rigid-body freedom and an indefinite number of flexible aeroelastic modes, many potentially subject to control.
- **DELIBERATELY UNSTABLE DYNAMICS:** particularly on modern craft where performance advantages dictate unstable c.g. locations and reduced size stabilizing structures.
- **WIDE RANGE** of nominal **DYNAMIC CHARACTERISTICS** because of:
 - Extent of total flight envelope
 - Nonlinear aerodynamics
- **FURTHER POTENTIAL EXTENDED RANGE OF DYNAMICS** due to **UNCERTAINTIES** because of:
 - Intangible unknowns in estimation and measurement of aerodynamic characteristics
 - Unanticipated additions to the configuration (e.g., new stores, appurtenances, unconventional loadings, etc.)
 - Manufacturing and maintenance tolerances.
 - Operational malalignments (e.g., asymmetric stores, non-flight-critical damage, etc.).
- **LIMITED CONTROL POWER**

Figure 3. Airplane Properties

closed-loop dominant modes. Such understanding permits the flight control designer to determine for a particular design just what aerodynamic and other variations and uncertainties are important, and conversely what types of system architectures may be more or less sensitive to particular aerodynamic variations and uncertainties. Robustness assessment techniques appropriate for multi-variable systems are particularly valuable in improving the designer's understanding of these matters.

2. The Controller

The controller component of a flight control system has many unusual characteristics. A summary listing is given in Fig. 4.

The controller properties noted are in the main similar to those of other control systems in kind, although they have marked differences in degree. By far the most important of these from the standpoint of a comprehensive methodology are the multi-variable and building block natures of flight control systems. All of the features of multiple loop control presented under the first listed item are common in flight control, and the analysis/synthesis techniques must exhibit and provide insight into these vehicle/controller interaction possibilities. Similarly, the building block character, wherein the outer control loops for one operational mode are inner control loops for another, is invariably an important consideration. This is particularly the case with systems which for flight safety require a great deal of redundancy, thereby placing a major premium on simplicity of mechanization for individual channels. Also, for modern superaugmented aircraft, wherein the flight control system is used to redress the stability and control imbalances associated with large airframe-alone instabilities, the actuator rate and position limits can have an importance unparalleled in other control applications.

3. The Closed-Loop Flight Control System

The block diagram of Fig. 5 illustrates a generalized flight control system for longitudinal control of a high performance fighter aircraft. The aircraft dynamics comprise both rigid body and flexible modes excited

- **MULTI-VARIABLE CONTROL**, in that control laws are multiloop (functions of more than one aircraft output variable) and/or multi-control point (applied to one or more control effectors). When contrasted with single loop flight control systems, multi-variable systems exhibit one or more of the following features:
 - Control is imposed on more than one degree-of-freedom, simultaneously and to independent specifications.
 - Decoupling of control inputs and/or controlled element output variables.
 - Adjustment of the poles of the effective controlled element transfer function relating the primary output variable(s) to control input(s). (A feature shared with single loop control.)
 - Adjustment of the zeros of the effective controlled element transfer function relating the primary output variable(s) to control input(s).
 - Adjustment of the zeros of certain effective controlled element transfer functions relating specified output variables to disturbance inputs. (A feature shared with single loop control.)
 - Reduction of unwanted disturbances as they reflect to a given control effector input (e.g., by complementary filtering of two different sensors).
- **WELL-KNOWN AND UNDERSTOOD CONTROLLER ELEMENTS**. These include:
 - Controller elements with very small or essentially no uncertainties (e.g., many sensors, computational elements, etc.).
 - Controller elements in which known parameter variations are present which cannot easily be compensated or neutralized (e.g., actuators in which the effective time constant is a known function of the trim hinge moment).
 - Controller elements which have small uncertainties and/or introduce small noises (e.g., accelerometers with location and orientation uncertainties and vibration pickup; air data probe position, scale factor, and gust input errors, etc.).
- **RATE- AND POSITION-LIMITED CONTROL EFFECTORS**
- **CONTINUOUS AND DISCRETE (digital) CONTROL EQUIPMENT** for equalization, controller parameter compensation, computation, etc.
- **MULTI-MODE (building block) CHARACTER:**
 - Controller architecture tailored to a specific mission segment.
 - Desired compatibility of minimum controller (inner loop) operational FCS modes with more extensive (outer loop) controller mode possibilities to maximize commonality of elements and settings for different operational modes.

Figure 4. Controller Properties

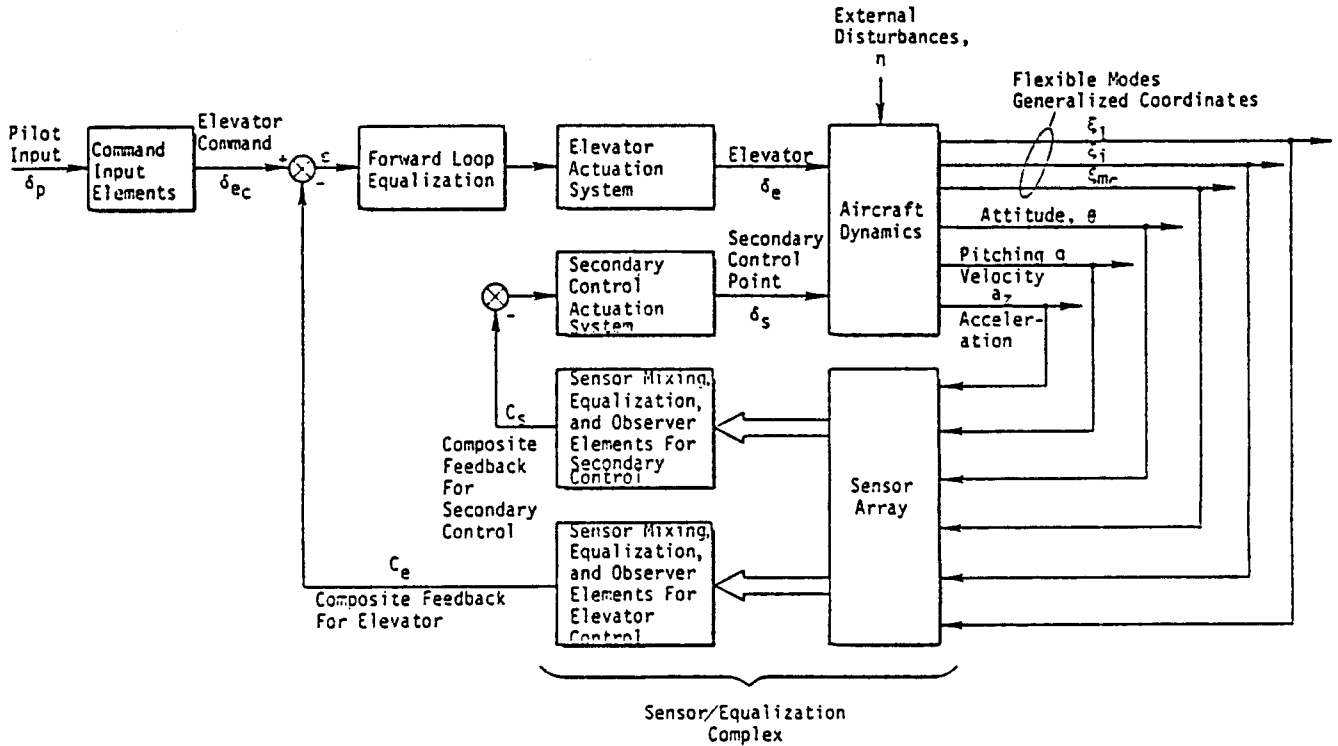

Figure 5. Generalized Flight Control System for Fighter Aircraft Including Flexible Modes ["Effective Aircraft," as Seen by the Pilot]

by control inputs from the elevator and external disturbances from the atmosphere. The vehicle dynamics can also be affected by inputs from secondary control points represented here by the control, δ_s . As already noted above in discussing the nature of the FCS controller, the secondary controls can simultaneously serve several potential purposes. The more obvious are to use the leading and/or trailing edge wing flaps to exert decoupling control, load alleviation, or maneuver enhancement. A conceivable possibility is for damping augmentation for one or more key flexible modes for which the elevator is ill-positioned.

The multi-variable control function which is most often poorly appreciated is the modification of the effective aircraft transfer function numerator properties for those transfer functions involving the primary control (here, the elevator). Just as feedbacks in general modify the effective vehicle poles, so secondary feedbacks to one control point modify the effective vehicle transfer function numerator for another

control point. Thus, the secondary control loops provide numerator as well as denominator effective vehicle changes to serve as equalization for the primary control loop involving the elevator.

The sensor array block can conceivably include attitude, rate gyro, and accelerometer instruments at various locations within the aircraft. The signals from these instruments are, of course, functions of both the rigid-body and flexible motions. They can be operated upon in various ways (e.g., filtered, equalized, combined in observer structures, etc.) to provide a composite feedback signal, C_e , for the elevator and other composite feedbacks, C_s , for secondary controls. The adjustments of sensor locations, signal equalization, weightings of signals, etc., taking place in this overall sensor/equalization complex for the composite elevator feedback signal, C_e , offer another means of modifying the effective vehicle characteristics. Thus, the effective vehicle as seen for elevator inputs is the transfer function, C_e/δ_e . This is a multiloop transfer characteristic since several feedbacks are involved and the subsidiary loop through δ_s is closed.

The remaining elements in the feedback control system provide for additional forward loop equalization on the composite feedback signal to the elevator, and the elevator actuation system dynamics. The controller blocks described thus far exert feedback control on the aircraft, thereby changing its effective dynamics and acting to suppress the effects of any external disturbances. To provide for pilot command inputs, the final block of "command input elements" is added to the system. These permit additional freedom for adjusting the effective vehicle dynamics as seen by the pilot. More often than not for fly-by-wire systems, they consist of elementary high-bandwidth low-pass filters, and amplitude shaping on the stick signals intended primarily to reduce pilot-induced noise (remnant), and to cope with both large and small pilot inputs. Theoretically, however, more elaborate equalization could be used at this input end to make up for any residual effective vehicle dynamic deficiencies not corrected for or adjusted by the feedback elements.

In summary, with the generalized flight control system of Fig. 5, we have three pathways (the command input elements, sensor/equalization

complex, and secondary feedbacks) available for complementary adjustment of the effective vehicle dynamics to achieve good flying qualities for piloted control. On the other hand, external disturbance suppression, ride qualities, and reduction of system sensitivity to parameter variations are adjusted primarily by the combined effects of the sensor/equalization complex feeding composite signals to the elevator and secondary control points.

While the elevator and secondary control pathways are the means generally available for addressing flexible aircraft control, they are not equally desirable. The cost, complexity, reliability, and possible aerodynamic performance degradation features associated with the establishment of secondary control points, make this approach less desirable especially as a potentially multiple-redundant flight crucial item. Also for reasons of simplicity, reliability, minimum propagation of pilot-induced noise (remnant), etc., the command input elements are ideally pure gains of simple low pass filters. Consequently, the major burden for control of the aircraft falls on the sensor/equalization complex and forward loop equalization elements, and it is only when these are insufficient that the flight controls designer will turn to more complex command input elements and/or secondary control points.

G. STEPS IN THE PRELIMINARY DESIGN PROCESS

Thus far in the introduction we have covered the underlying philosophy and summarized the features desired in the methodology, and have described some of the unusual aspects of flight control systems. We turn now to an outline of a design methodology constructed to take all of these considerations into account. In particular, we will emphasize those steps in preliminary design which lead to the flight control system design architecture. This is the most important step in synthesis and the prelude to any analysis. As used here, system architecture means the FCS feedback loops and equalization structures, or in other words, the general form of the control laws. The FCS architecture inherently depends on the aircraft plus flight control overall requirements — form follows

function. There is also the possibility of interaction and tradeoffs between the airframe configuration and the FCS — function defines form.

A typical set of preliminary design phases for multi-variable flight control system synthesis from project initiation to the architectural level will include the major topics listed in Fig. 6. These are described below, in conjunction with the System Preliminary Design Methodology Flow diagram shown in Fig. 7.

In a complete design process these preliminary design phases are succeeded by detail design activities. Some of these are summarized in Fig. 8. Although these steps are beyond the scope of this methodology, they are mentioned here to indicate where conceptual and preliminary design ends in our treatment.

1. Establish Flight Control System Purpose

Mission-Specified Purposes -- The purpose of the FCS is derived from the purpose of the aircraft which is to accomplish one or more missions. Each mission is composed of mission phases consisting of a sequence of steady flight conditions ($\dot{V} \neq 0$) transitions between conditions, and maneuvers ($\dot{V} \neq 0$). Together these define the ideal velocity vector time history but are not necessarily a complete specification of the vehicle attitudes along that trajectory. Some attitude constraints may be directly imposed in particular mission phases or maneuvers (e.g., nominal pitch attitude in carrier approach/landing, θ_{\max} in takeoff rotation, $\beta \neq 0$ for many maneuvers). Complete definition of the attitude time history over a mission phase requires consideration of what the pilot can see (e.g., "situational awareness" factors) and feel, and the number of independent control points. If enough control points are available with sufficient control power (e.g., the lateral "DFC" modes of the AFTI-F16 with three control points: aileron, rudder, and ventral canard), a nominal trajectory may be satisfied with unusual, if not completely arbitrary, attitudes. Otherwise, the ideal trajectory implies a unique solution for one or more attitude angles (e.g., $\phi = \tan^{-1}(U_0 \lambda / g)$ for $\beta = 0$ in a conventional rudder/aileron airplane). The considerations involved

- {1} Establish Flight Control System Purpose
- {2} Determine Command and Disturbance Characteristics
- {3} Determine Unalterable Properties of the Aircraft and Controller Elements
- {4} Pilot-Centered Requirements -- Human Pilot/AFCS Interactions
- {5} Establish Overall System Requirements
- {6} Survey of Aircraft Characteristics
- {7} Comparison of Aircraft Characteristics with Requirements
- {8} General Equalization Requirements, and Prospectus for AFCS Architecture
- {9} Preliminary Design Analysis of System Possibilities
- {10} Formal Competition Among System Possibilities

Figure 6. Typical Design Phases for Multi-variable Flight Control System Synthesis at the Architectural Level

1 FOLDOUT FRAME

2 FOLDOUT FRAME

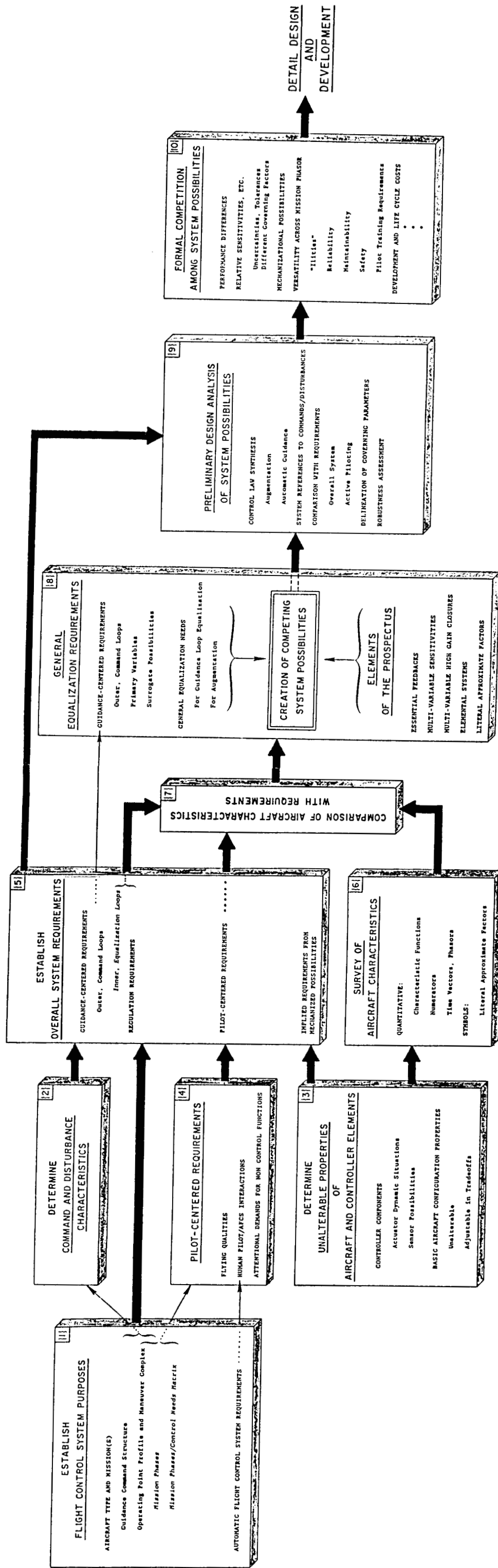

ORIGINAL PAGE IS OF POOR QUALITY

Figure 7. System Preliminary Design Methodology Flow Diagram

ORIGINAL PAGE IS OF POOR QUALITY

1. Final Selection of Actuation, Sensor and Other Components, and Establishment of Redundancy Level. The system requirements and FCS architecture largely determine the redundancy level and characteristics required of the actuating elements; this narrows the field of possible actuators down to a small group of units available (or capable of development in an allowable time span). Therefore, very few versions of sensors and actuators need be considered further. It is the selection of these choice few that is desired in this phase. Final selection may be delayed until after a considerable portion of the next phase is completed for all likely combinations. (Preliminary actuator and sensor characteristics are needed in the earlier PD Phases 9 and 10.)

2. Detailed Study/Design of the Selected System. Once a tentative best system has been selected, it is still necessary to validate it for all nominal and abnormal operating conditions. The most complete available models of the aircraft, actuating elements, etc., including all their important nonlinear features, are included in simulations for both piloted and automatic flight. The effects of unknowns, uncertainties, and tolerances need to be examined in detail. Special attention in testing and simulation should be given to the uncertainties previously determined to be "governing" parameters. The components that do not yet exist as hardware or software must be specified, designed, fabricated and tested as components. As many of these as possible should be assembled in a series of system simulations which culminate in flight tests of the complete system in its actual operating environment. At each stage of the testing process the assumptions that were made in previous phases of the design should be checked for validity. If actual conditions violate the assumptions, a new iteration of the design should be begun at the point at which the incorrect assumption was made.

Figure 8. Typical Design Phases for Multi-variable Flight Control System Synthesis at the Detailed Design Level

in deciding whether an unusual attitude time history is consistent with mission or pilot-centered needs is a topic beyond our current scope.

Once the attitude characteristics are defined over the mission the possible operating point range is established. These may then be considered in company with guidance possibilities to establish feasible operating point profiles. The possibilities include both manual and automatic guidance. The fundamental operational requirements of the FCS are thus to execute the guidance commands to establish and maintain the desired operating point profiles in the presence of any disturbances. Figure 9 illustrates the process in general. An important feature emphasized there by the bi-directional arrows is the possible interplay between the three lower blocks. Thus, for example, desirable changes in "Guidance Possibilities" or "Vehicle Operating Point Profiles" may be accommodated by modification in the Mission Phases definitions. There may be many combinations which can satisfy the mission purposes.

At the conclusion of this design step, a mission-mission phase matrix can be constructed which gives a broad overview of what is generally involved in the mission phases. The mission phase categories should be selected so that the quantities required to define flight control activities are determined once the phase is identified. An example of a mission phase matrix for an advanced fighter is shown in Table 1. The mission phases are the fundamental constituents of the several vehicle operating point profiles and maneuvers which combine together to completely define

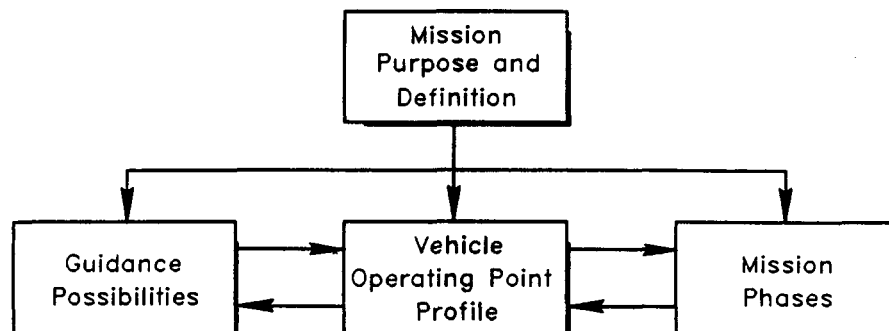

Figure 9. First Step in Flight Control Requirements Evolution

TABLE 1. MISSION PHASE-CONTROL NEEDS MATRIX FOR ADVANCED FIGHTER

MISSION PHASE	PATH CONTROL AND REGULATION	MANEUVERING DEMANDS	ADDITIONAL ASPECTS
<p>MID-COURSE OPERATIONS</p> <p>Climb (CL), Descent (D) Cruise (CR), Loiter</p>	<p>Accurate γ; U Accurate γ; U; h</p>	<p>Gradual, Moderate</p>	<p>Sharp-edged gusts</p>
<p>PRECISION MID-COURSE OPERATIONS</p> <p>Terrain Following (TF) Formation Flying (FF) In-Flight Refueling (RR)</p>	<p>Precision γ_e; Δh Precision γ_e; U; Δx, γ</p>	<p>Rapid to Extreme Rapid Gradual, Moderate</p>	<p>Terrain Fluctuations</p>
<p>COMBAT OPERATIONS</p> <p>Air-to-Ground Attack (GA) Air-to-Air Attack (CO) Evasion</p>	<p>Precision γ; U Precision γ; β Bounded γ; α, β</p>	<p>Rapid Extreme Extreme</p>	<p>Proportional Navigation-like Guidance Lead Pursuit/Proportional Navigation Disturbances include vortex encounter</p>
<p>TERMINAL OPERATIONS (SHORT FIELD)</p> <p>Takeoff (TO) Approach (PA) Landing (L) Touchdown and Rollout</p>	<p>Accurate γ, U Precision θ, γ, U Precision θ, γ, U Precision γ, ψ</p>	<p>Rapid Moderate Rapid Rapid</p>	<p>Backside; Curved Path Guidance Narrow Runway, Reverse Thrust</p>

the mission. The descriptive terms for the mission phases are often designated by abbreviations (e.g., CL for Climb, CO for air-to-air combat) in such military specifications as Ref. 2. Mission phases can be expanded as needed to cover novel maneuvers or conditions.

The command structure indicated in the table provides a qualitative guide to control system execution of the mission profile. Thus, flight path, γ (which here is meant to imply both longitudinal and lateral flight paths), and speed, U , are general objects of control with three levels indicated — "bounded," "accurate," and "precision." The distinction between accurate and precision is associated with the range of input frequencies over which the accuracy is maintained — "precision" control requires a higher control bandwidth than "accurate" with both levels having similar static accuracies. For an actual aircraft design, these qualitative definitions need to be made quantitative very early in the preliminary design. Often, however, the qualitative distinctions are sufficient to pinpoint critical mission phases/maneuver demands on the FCS. These critical conditions and demands are primary drivers for the FCS architectural structure.

Basic Functions

As described above, the system's specific purposes can be equated with the definition of the task(s) it is intended to accomplish in order to satisfy the aircraft's various missions. From a functional standpoint in accomplishing these processes, the flight control system will ordinarily be expected to perform several basic overall functions, that is to provide:

- Stability.
- Desired responses to specific inputs.
- Suppression of the effects of disturbances, component variations, and uncertainties.
- Modification or elimination of certain cross-coupling effects.

Most of these basic functions are quantified in specifications, such as the military specifications for flying qualities (Ref. 2) and flight

control systems (Ref. 3), the Federal Air Regulations, (Ref. 4) etc., and in the lore of good (and bad) practice accumulated through the years (e.g., Refs. 1, 5, Supplement 2).

2. Determine Command and Disturbance Characteristics

The characteristics of the commands and disturbances are largely direct consequences of the flight control task(s), and of the environment in which that task is to be accomplished. These consequences must be made specific by defining the characteristics of a family of representative input signals and disturbances.

As a practical matter, commands and disturbances are not a clearcut dichotomy — some commands are contaminated by unwanted parts which drive the system in a way indistinguishable from disturbances entering at the same point. To be sure that no important forcing or excitation source is overlooked, it is pertinent to consider both commands and disturbances as "inputs," and then to classify them as to source and nature. A convenient set of categories is:

- At the Command Point(s)
 - Desired Inputs (nominal "commands")
 - Unwanted Inputs (nominal "noise" on "Commands")
- At various Controller Locations
 - Internal Disturbances
- At locations External to the Controller
 - Vehicle Induced
 - Environment

Ordinarily the entire range of possibilities — from discrete steps or impulses to periodic and random processes will be represented in the input-disturbances set. This richness of input possibilities is one of the predominant features of FCS as contrasted to many other types of control systems.

3. Determine Properties of the Unalterable Aircraft and Controller Elements

Typically the characteristics of some parts of the system are not easily changed by the flight control system designer, at least during a given design iteration. Such relatively unalterable elements usually include major portions of the aircraft itself, and some actuator and sensor dynamic characteristics. The detailed properties of these system components must be determined or estimated at this stage. Particular emphasis is placed on:

- Identification of aircraft output variables which are candidates as the primary variables to be controlled. These primary variables are usually a direct consequence of the system purpose, e.g., from Table 1 flight path angle. However, other output variables such as altitude or pitch attitude (longitudinally) or heading (directionally) may be coupled sufficiently closely with the nominal primary variables to serve as surrogates.
- Identification of aircraft characteristics which may be considered adjustable in a tradeoff sense. For example, tail size and static margin (as trades against control system bandwidth and complexity), number and nature of control effectors as trades for operating point options (and margins — as in STOL operations using throttle, flaps, and elevators in various ways to trim and to establish either STOL or conventional front side effective aircraft dynamics — or as trades for control system complexity — as in two vs. three control point aircraft), etc. Potential tradeoffs between aircraft configuration and FCS characteristics are major factors in proper overall system integration.
- Establishment of the dynamic modes/characteristics of the unalterable elements which are uncertain and/or highly variable over the range of operating conditions. This focuses attention on these properties which may require special sensitivity considerations.

There are invariably a large number of essentially unalterable "standard" elements in the controller and aircraft. These might include power supplies, guidance elements, cockpit controls, etc. In most cases these elements will be well-defined as to their dynamics and noise properties.

4. Pilot-Centered Requirements -- Human Pilot/AFCS Interactions

In manned aircraft, wherein the pilot is expected to exercise at least some controller functions, sometimes the key "unalterable element" is the pilot. The interactions between the pilot and the effective aircraft are so important and pervasive that they deserve detailed treatment as a separate topic. To avoid interrupting this relatively short outline/discussion of requirements and system evolution, this is handled with the illustrative example in Section II and in a more general vein in Supplement 3, which has the above heading as its title.

5. Establish Overall System Requirements

From the information and considerations developed above, which are often accomplished in parallel during a preliminary design, many of the "Givens" for a particular aircraft configuration are established. The next step is to draw all this together into statements of overall system requirements.

Some of the requirements can be derived explicitly from the functions which must be performed to accomplish the system purposes and mission phases. The primary set of these in manned aircraft are affected greatly by the presence of the pilot. Somewhat modified versions are of increasing importance in modern advanced aircraft where many of the pilot's controller roles are taken over by automation. Thus, there are in a sense two sets of "operational requirements" dictated by the mission — one for piloted control and the other for automatic control. An expanded treatment of requirements for an Advanced Fighter is the subject of Supplement 2.

Besides the "Operational Requirements," other requirements derive from the characteristics of the interconnected components, especially the unalterable controller and aircraft elements, and from the environment in which the entire system operates. These are called "Implied Requirements."

When integrated and appropriately connected, the requirement sets are translated into quantitative specifications which should encompass all of the system functions and purposes. They would include:

- Command input/primary output static and dynamic properties.
- Command input/secondary output static and dynamic properties.
- Primary and secondary responses to disturbances.
- Key sensitivity considerations (unalterable element(s) uncertainties, and variabilities requiring special attention).
- Degree of stability.

The quantitative requirements may be stated in the time domain as dominant mode characteristics, allowable errors, time response boundaries, indicial response measures, etc., or as combinations thereof (such as the Time Response Parameter, TRP) and/or such frequency domain specification measures as closed-loop system bandwidths; phase, gain, and time delay margins; etc.

6. Survey of Aircraft Characteristics

In the past many of the aircraft-alone characteristics were often good enough to satisfy the piloted control portions of the mission. In these cases the key FCS requirements stemmed from a need to correct a few deficiencies in aircraft stability and control characteristics. To some extent this may still be the case for some mission and flight phases. In any event for a particular design iteration, the aircraft-alone properties still serve as a primary starting point in the FCS architectural design competition.

An important feature of the aircraft characteristics survey is an attempt to relate the airplane's dynamics characteristics to airplane stability and control derivatives. Thus is done by developing literal approximate factors for the response parameters which indicate:

- sensitivity to uncertainties in airframe parameters (i.e., non-dimensional stability and control derivatives and mass properties)

- variation in airframe parameters over the flight envelope — primarily due to $\rho(h)$, M , α , U_0 , weight and geometry variations.
- possibilities for augmentation from an "equivalent derivative" standpoint

Because of the third property listed the approximate factors will appear later as an element of the prospectus.

7. Comparison of Aircraft Characteristics with Requirements

The comparison of aircraft characteristics with requirements has two steps.

- a. Preparation of aircraft dynamic descriptive information in forms which permit comparisons, e.g., characteristic function factors, open-loop responses to controls and disturbances, etc.
- b. Identification of problems per the requirements (certain "problems" such as unstable modes due to relaxed static stability will be known to require FCS solution beforehand).

The comparisons provide a direct indication of the airplane dynamics which must be modified by stability augmentation to satisfy pilot desires. They also point the way for parallel (inner loop feedbacks) and/or series equalizations which support the guidance-centered and/or automatic pilot outer-loop closures.

8. General Equalization Requirements and Prospectus for FCS Architecture

General Equalization Requirements

As a prelude to the development of possible FCS architectures, the overall system requirements, operational environment, unalterable element characteristics, etc., are viewed as a framework from which to consider feedback and equalization requirements. The three major considerations are:

- a) The ultimate outer-loop which involves the desired output variable or its surrogate, must have appropriate equalization to meet the overall

system requirements. This ordinarily implies that the closed-loop system exhibits:

- Adequate low-frequency steady-state error responses.
- Specified closed-loop system dominant mode characteristics (for example, bandwidth and damping needed for disturbance suppression, and for the closed-loop dynamics portion of the command/response relationship).
- Specified low-frequency command/response relationships (for example, suitable input, feedback, and feedforward characteristics to achieve desirable values).
- Sufficient phase, gain and delay margins to permit robust controllers.
- Noise rejection (smoothing) at frequencies at and above control action.

This equalization can be obtained from either series elements operating on the primary variable, or from parallel elements involving the feedback of other aircraft output variables, or from a combination of both.

- b) Equalization requirements levied by desired responses of subsidiary variables to commands and disturbances.
- c) Provision of sensitivity constraints and reduction for some selected uncertain/highly variable unalterable element modes by driving them into specially placed low tolerances, compensation zeros.

Prospectus for FCS Architecture

The "Architecture" considered here amounts to the establishment of feedbacks, equalization (adjustment of the effective aircraft dynamics as seen at a particular command or disturbance entry point), compensation (adjustment of particular controller dynamics, usually as a function of flight condition), etc. The architectural drawing is characteristically a detailed block diagram of the overall system.

In progressing to topic 8 of the design process sufficient information has become available to consider two types of equalization in detail:

- a) Series on the primary variable (or its surrogate).
- b) Parallel using controlled element secondary output variables. To establish this part of the prospectus, a search is conducted for favorable effective aircraft transfer function numerator properties.

While "equalization" including the selection of appropriate feedback loops falls conveniently into the two categories (serial and parallel) noted above, the actual details of the feedback selection is much more involved. The general nature of potentially desirable specific feedbacks/controller architectures stems from the organized, but nonetheless artful consideration of the "Elements of the Prospectus" listed in Fig. 7.

The particulars of just what these "Elements of the Prospectus" are and how they are actually used in a preliminary design will be illustrated in Section V for the advanced aircraft design example. Tables showing the literal approximate factors and essential feedbacks summaries (adapted from Ref. 1) will be introduced and used on the spot. The multi-variable sensitivity vector surveys use the techniques described in Appendix B. The multi-variable high gain closure characteristics depend on the effective numerators of the aircraft including coupling numerators. The overall multi-variable analysis technique which covers these aspects is outlined in Appendix A. A catalog of the elemental systems is the subject of Appendix C.

The actual utilization of the elements of the prospectus in the context of the system requirements and other data developed from the previous design phases involves a great deal of integrative engineering. The entire packet of information and the "rules" based on experience for tying it all together and molding the results into feasible system architectures, constitute the knowledge base for an "expert system" for FCS design. "FCX", the prototype first generation FCS expert system developed to cover some phases of the design methodology, is a first attempt to find out how expert system concepts can play a major role in this design phase and those immediately before and after.

9. Preliminary Design Analysis of System Possibilities

At the end of these steps the flight control system synthesis will hopefully have resulted in one or more feasible FCS block diagrams, which show the loop structure and equalization forms. There remains the not insignificant task of synthesizing control laws to meet the quantitative and qualitative requirements in the presence of all the system disturbances, uncertainties, and variabilities. Because the dynamic requirements are not easily cast into terms which can be encapsulated in a comprehensive performance measure, control law synthesis requires iterative operations. This is the case even when the synthesis procedure involves performance indices and optimization processes. In this design methodology matters are somewhat simpler in that the control law synthesis proceeds within the feedback system architectural constraints already established. Thus the fundamental feedbacks and their reasons for being are already known -- the synthesis problem at this stage is merely one of finishing off. This always includes the determination of gains needed to meet the system requirements, and can also involve the introduction of improvements via the insertion of equalization and filtering, etc. The analysis/synthesis procedures and the means to show the system results in terms of input-output dynamic characteristics for the several subsystems, the system(s) responses to various commands and disturbances, etc. in the methodology are all provided in Program CC, Versions 3 and 4.

Results of the analyses are then compared with the system requirements to demonstrate that the synthesis is indeed adequate. When this has been established the next step is to determine the airplane and control system parameters which govern or limit the design. Typically these are the airplane and controller parameters which dominate the system dynamics in the various crossover regions for the several control loops, and the airplane parameters which serve as sensitivities for atmospheric disturbance inputs. These "governing" parameters are of most concern because the design's ability to meet the system requirements will be most sensitive to them. Because they exert so much leverage on the adequacy of the design, uncertainties in these parameters become major items in design assessments, plans for risk reduction, etc.

The final stage of the preliminary design analysis is the assessment of the system(s) robustness. Here the focus is on robustness in general and robustness with respect to the more uncertain of the governing parameters. Modern robustness assessment techniques are available in Program CC, and are used for this part of the design methodology.

10. Formal Competition Among System Possibilities

We espouse an FCS design philosophy where "competition" between system architectural configurations is an appropriate intermediate goal in the synthesis procedure. Just because all of the requirements and desirable features of an FCS cannot be stated in quantitative and commensurate terms, judgment and technological subjective considerations inherently play a role in establishing the best system architecture; yet these artistic factors can best be applied when a number of system alternatives are available as competitive configurations. The competing systems can be compared on a very large number of bases which can be divided into two categories: design quantities and qualities. Design quantities include the dynamic performance (relative stability, accuracy, speed of response or bandwidth, etc.) and the physical characteristics (weight, volume, power or energy consumption, etc.). Design qualities include safety, operational capability, reliability, maintainability, cost, etc. An optimum system is one that has some "best" combination of all these features. At this point the design process passes to the detail design phases starting with the steps listed in Fig. 8.

Before ending this introductory summary of the design methodology we should recapitulate which design phase the computational aids fit in, as follows:

"LSMP", Linear Systems Modeling Program or Program CC:

- {3} Unalterable Aircraft Properties
- {6} Survey of Aircraft Characteristics

"Program CC, Versions 3 and 4":

- {7} Comparison of Aircraft Characteristics with Requirements
- {9} Preliminary Design Analysis

"Program CC, Version 4":

- (9) Robustness Assessment

"FCX", First Generation Flight Control Xpert:

- (7) Comparison of Aircraft Characteristics with Requirements
- (8) Creation of Competing System Possibilities
- (9) Preliminary Design Analysis of System Possibilities

"FCX" actually becomes involved in the earlier design phases with "Overall System Requirements" and "Survey of Aircraft Characteristics" as well, but its principal elements are pertinent to the phases noted.

H. LEVEL OF DETAIL AVAILABLE AT THE END OF THE FCS ARCHITECTURAL DEVELOPMENT

To provide a concrete example of the result and level of detail available at the end of the FCS architectural development, consider a system intended to accomplish all the flight control system purposes (e.g., stability, desired responses to specified inputs for good flying qualities, etc.) for a high performance fighter aircraft designed to be flown highly unstable longitudinally with stabilization accomplished by the FCS. A typical system architecture resulting at the end of the steps described above is shown in Fig. 9a. Another result of such a system preliminary design development would be data and criteria combined in a data package. Yet a third consequence is exemplified by the alternative control laws indicated in Table 2. These alternative control laws may be used to accomplish the same general purposes as the system of Fig. 9a. They differ in the side effects listed in Table 2. They also differ in the kind of sensors and implicitly in their specific advantages/disadvantages for control of flexible modes. Finally, they offer a rich source of possibilities for analytical redundancy in multiple-redundant mechanizations. Thus, great strides have been made toward a synthesis solution, but considerable analysis and detailed synthesis remains. Further, additional attention has to be paid to somewhat more specific criteria associated with the peculiarities of a particular flight control system design.

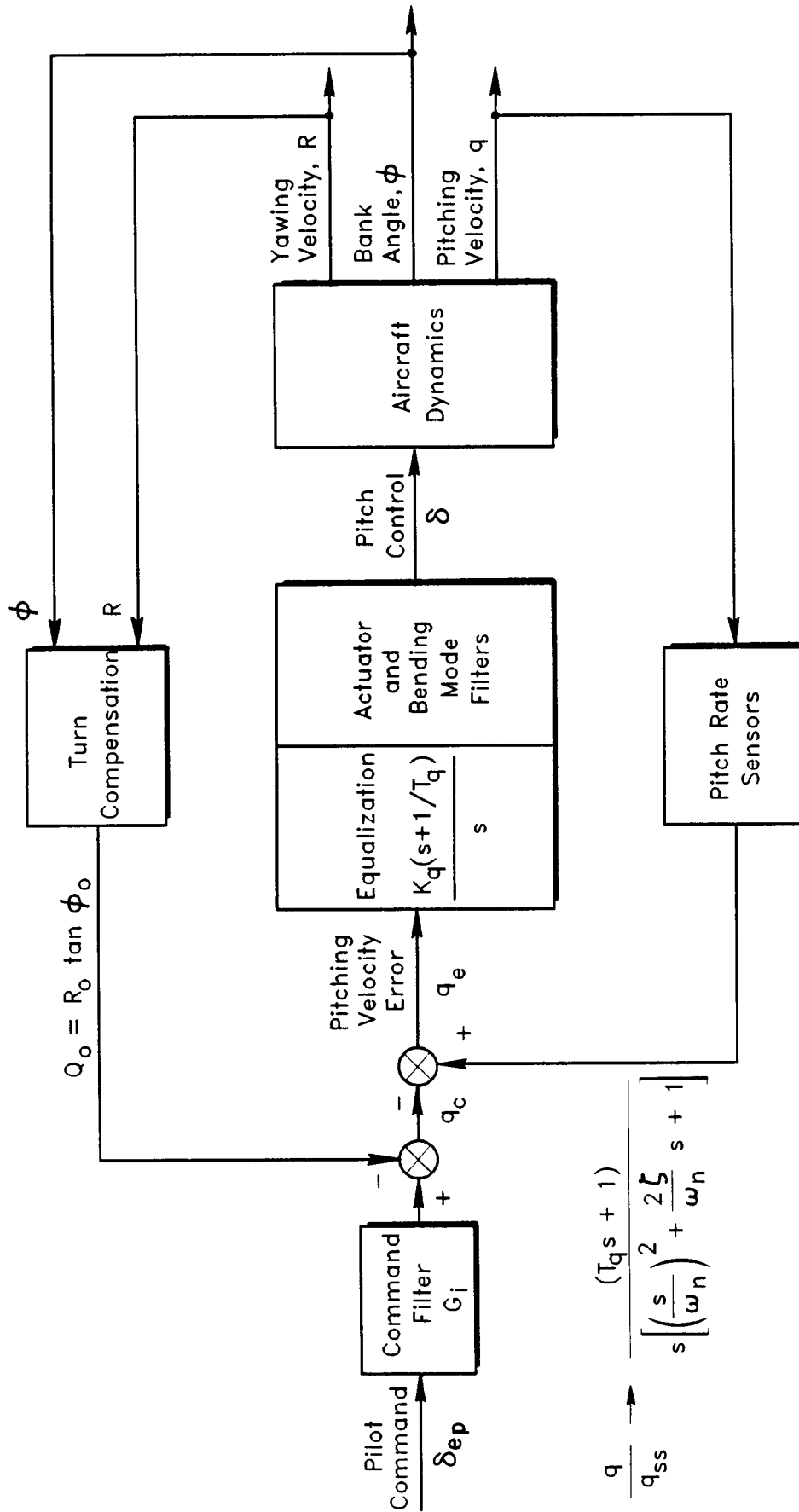

Figure 10. Candidate Flight Control System for a Highly Unstable Fighter Aircraft

TABLE 2. SYSTEM ARCHITECTURAL POSSIBILITIES AND MECHANIZATIONAL SIDE EFFECTS FOR SUPERAUGMENTED AIRCRAFT

$q \rightarrow \delta_e$

Reduces divergences, but does not get all the way to stability.
Requires some up-elevator relief in turns; e.g., $q_e = q - R_o \tan \Phi_o$

$\int q dt, q \rightarrow \delta_e$

Generally suitable for complete correction of instability.
Requires up-elevator relief in turns; e.g., $q_e = q - R_o \tan \Phi_o$

$\int a_z dt, G_{wo}q \rightarrow \delta_e$ (G_{wo} = Washout equalization)

Corrects for instability when $1/T_{h1} > 0$. Can have backside
 $\left. \begin{array}{l} 1/T_{h1} \text{ level flt} < 0 \\ 1/T_{h1} \text{ climb/dive} < 0 \end{array} \right\}$ instability and equivalent backside
in climbs.

Has bias ($a_{z_o} \neq 1 g$) when accelerometer is not oriented along stability axis for level flight; further bias in climbs and dives; yet another bias with a roll limit cycle.

Requires up-elevator relief in turns; e.g., $a_{z_e} = a_z - \cos \theta_o \sec \Phi_o$
plus increment for q feedback in turn entry/exit.

Requires more airspeed compensation than attitude-based systems.

$1/(\hat{T}\theta_2 s + 1) \int Uq dt, G_{wo}q \rightarrow \delta_e$ [Pseudo a_z]

Generally suitable for complete correction of instability (replaces $1/T_{h1}$ -based limitations with $1/T\theta_1$; removes accelerometer bias issues).

Requires up-elevator relief in turns.

Requires more airspeed compensation than attitude-based systems.

$\theta, \dot{\theta} \rightarrow \delta_e$

Generally suitable for complete correction of instability.
Gain changes in turns, with associated F_s/g lightening, etc.
Requires climb-dive steady-state elevator signal relief.

θ, q or $\dot{\theta}, G_{wo}q \rightarrow \delta_e$

Generally suitable for complete correction of instability.

Gain changes in climbing/diving turns.

Climb/dive steady-state signal relief.

Requires up-elevator relief in turn entries/exits, depending on specifics of G_{wo} .

The longitudinal system shown in Fig. 10 as an illustration of what might be available at the end of the FCS architectural development phase, could also be used as the pitch controller for the Advanced Aircraft example. Throttle controls appropriate to operation on the backside of the power curve would be needed for STOL activities, etc. This system could also be cited as an example of the elemental system approach to the approximation of dominant modes. In this case, the dominant mode dynamics of q/q_c are given by the "superaugmented" elemental system in the catalog of Appendix C. A complete research study of this type of system, its dynamics and flying qualities is given in Refs. 6 and 7.

I. PREVIEW OF WHAT IS TO COME

While we have attempted to make the System Design Methodology outlined above and depicted in Fig. 7 as straightforward as possible it is intrinsically complicated. Even at the broad-brush level of detail presented there are many interactions which cannot be exposed in a verbal summary. And the number of detailed considerations needed in such things as the evolution of requirements and the pilot-centered factors can be large. Consequently we have attempted in this report to present the mass of material involved in the design methodology as clearly as possible. To do this the decision was made to provide a fundamental focus on the steps in the methodology and many of the details by actually working through an illustrative example. The thrust in this text is on simplicity and clarity; consequently there are no interruptions to explain the many procedural or computational things that might arise, and the illustrative steps worked out for the example are indicative rather than comprehensive. Some of the more detailed background information is funneled off to supplements.

The example problem is the design of a lateral-directional FCS for a high performance advanced fighter in an interesting and challenging mission phase. When connected with the Design Methodology Flow Diagram of Fig. 7 the illustrative problem proceeds as follows:

Section II — "Mission-Based Requirements for Lateral-Directional FCS of High Performance Aircraft"

Includes:

- (1) Flight Control System Purposes
- (2) Command and Disturbance Characteristics

- (4) Pilot-Centered Requirements
- (5) Overall System Requirements
- Section III — "High Performance Aircraft Lateral-Directional Characteristics"
 - Includes:
 - (6) Survey of Airplane Characteristics
- Section IV — "Identification of Control of Lateral-Directional Control Problems Due to the Airplane"
 - Includes:
 - (7) Comparison of Aircraft Characteristics with Requirements
- Section V — "Prospectus for Lateral-Directional Flight Control System Architecture"
 - Includes:
 - (8) General Equalization Requirements and Elements of the Prospectus leading to Competing System Possibilities
- Section VI — "Preliminary Design of Candidate Lateral-Directional Fighter Flight Control System"
 - Includes:
 - (9) Preliminary Design Analysis
- Supplement 1 — "Literal Singular-Value-Based Flight Control System Design Techniques"
 - Includes:
 - (9) Robustness Assessment

The developments, discussions, and some details in the design example rely on Ref. 1 for background on airplane dynamics, approximate factors, and many FCS features and characteristics, and on Refs. 8-10 for computational operations using "LSMP" and "Program CC, Versions 3 and 4".

One of the major new features in the design methodology is the first generation prototype expert system "FCX", which is coupled with "Program CC, Version 3". FCX actually covers parts of several phases within the design methodology. It attempts to mechanize in expert system terms many of the considerations on which the illustrative design is based. This is a novel application of a new technology. To avoid introducing it and all its peculiar complexities in the very middle of the example, we have worked through the example as if "FCX" didn't exist. Then, "FCX" is discussed in detail in Volume 2 which includes listings of the 18 FCX knowledge bases as they presently exist.

As noted above, some topics of the design methodology are too involved to be exemplified even sketchily as part of a short and balanced

description in working through the example problem. The evolution of mission-centered requirements and the consideration of pilot-centered requirements are typical examples. These too are handled in greater depth in supplements. Supplement 2, "Lateral FCS Requirements-Oriented Design Knowledge Base for an Advanced STOL Fighter in Mission Phase CO" contains a composite outline/summary of specifications, requirements, considerations, lore, good practices, etc., pertinent to design phases (1) through (5). It is a principal support of the briefly stated requirements used in Section II. Similarly, Supplement 3, "Pilot-Centered Requirements and Human Pilot FCS Interactions" supports design phases (4), (5), and (9).

The design example focuses primarily on bringing together the mission and pilot-centered requirements, prospectus elements, aircraft dynamic deficiencies, etc., and then mixing the batch to emerge with a logical preliminary design flight control system architectural structure. In achieving this end, certain non-essential simplifications are introduced to make the processes easier to follow. The most important of these are that the sensor and aircraft flexible mode dynamic properties are neglected, and that the controller is continuous. To expand the methodology to flexible mode stabilization issues the reader is referred to Ref. 11, which considers another preliminary design example where both digital control and flexible dynamics are present. (This reference presents a continuous system design followed by a discrete controller development. The example is preceded by a short discussion of appropriate digital system techniques — the w-domain for direct digital design, and the hybrid frequency response for system response assessments. Both procedures are illustrated in the design example. the digital design techniques used are part of Program CC, and both the direct digital design process and consideration of flexible modes can be considered to be a direct follow on to the present report as a part of the design methodology.)

The detailed work of the design example is based on several techniques and methods which are not necessarily well-known. Consequently, brief summaries are given in appendices. These include:

- Appendix A -- Outline of the Multi-variable Analysis Method
- Appendix B -- Sensitivity Vectors
- Appendix C -- Catalog of Elemental System Characteristics

SECTION II

MISSION-BASED REQUIREMENTS FOR LATERAL-DIRECTIONAL FCS OF HIGH PERFORMANCE AIRCRAFT

Mission-centered requirements on the flight control system are the dynamic form, accuracy, and speed of response which should be exhibited by the Aircraft/FCS in order to accomplish the mission. These properties need to be translated into quantitatively expressed sets of desired command/response relationships (for pilot or guidance system commands) and regulation (against disturbances) requirements for each mission phase. Mission-centered requirements for control stem primarily from two sources:

- Functional

Control and regulation of the aircraft's:

Velocity vector in direction (flight path control) and magnitude (speed);

Attitudes

- earth-referenced (pitch, roll, yaw and heading)
- air mass-referenced (angle-of-attack, aerodynamic sideslip)

- Pilot Desires

Effective vehicle dynamics which enable the pilot to accomplish the mission phases with minimum workload and maximum pilot efficiency

The two sources are intimately related in that a key pilot desire and, indeed, the essence of pilot-in-the-loop flying qualities, is for effective vehicle dynamics which permit the pilot easily to exert control and regulation over the aircraft's velocity vector and attitudes. These effective airplane dynamics permit the pilot, when appropriate cues are available, to readily accomplish guidance tasks by developing internally generated outer-loop "guidance laws". Automatic guidance systems require adjustment of the effective airplane dynamics to similar forms which permit simple automatically-generated outer loops and system actions which are easily monitored by the pilot. So a duality exists between pilot-supplied and automatic guidance in that what is good for the pilot is also good for an automatic system which performs the same kinds of flight

operations. Consequently, the form of the inner loops of the FCS can ordinarily be shared by the pilot or a set of guidance system outer loop(s). The values of particular inner loop control law parameters and minor equalization may, however, differ somewhat for piloted and automatic control.

It might be argued on hypothetical grounds that a "better than good" automatic system could require fundamentally different inner loops than are appropriate for piloted operation in a guidance role. However, pilot needs take priority because the pilot is the ultimate monitor, must always be able to interrupt and take over from the automatics, and is inherently a divided attention controller. Consequently, to assure good pilot-vehicle integration, as well as for design and equipment economy, the flying qualities-based requirements are a primary basis in specifying the feedback control laws which establish the flight control system inner loops.

While the Aircraft/FCS must operate through all mission phases, the pilot-vehicle control precision and pilot attentional demands are most severe in a limited number of flight operations. Similarly, the requirements on form, accuracy and speed of response for automatically guided flight operations are also most severe in only a limited number of mission phases. The requirements stemming from the most-demanding mission phases therefore become critical design drivers for flight control. Usually the design-critical mission phases and associated requirements, as they are reflected into FCS feedback control law forms, are substantially the same for piloted and automatic control. This follows since, as noted above, it scarcely matters whether an automatic system or the pilot is closing the outer, guidance loops. (Performance levels associated with automatic and manual control may, of course, be different.)

The development of mission-centered requirements in this section will follow the logic presented above. The first article will present those based on flying qualities, and the second article follows with path and heading control requirements. Numerical values are summarized in the third article, creating a "Mission-Centered Requirements Data Base."

By their nature most of the mission-centered requirements tend to define the dynamic properties of the airplane plus control system, i.e., as modal response characteristics, time response parameters, etc. But these input/response and stability properties do not exist in a vacuum — they are means to convert applied commands to desired outputs in the presence of disturbances. The command inputs and disturbances depend on the mission phase, and thus are implicit entries into a mission-oriented set of requirements as commands which are to be followed or disturbances which are to be regulated against. A tabular form giving a cross section of commands and disturbances for the hypothetical advanced fighter is given in the final article. Specific entries from this table may serve as candidates for additional requirements leading to system feedback architecture considerations such as the need to provide suitable steady-state accuracy in response to a particular input or to regulate a particular airplane response variable over a disturbance bandwidth. The commands and disturbances may also be used for calculations which exhibit the response properties of possible competing systems.

A. MISSION-CENTERED FLYING QUALITIES REQUIREMENTS

Many of the flight control design-critical mission phases for an advanced fighter are well-defined in flying qualities requirements documents (e.g. MIL-F-8785C, Ref. 2). These include:

Category A

- Rapid Maneuvering, Precision Tracking, Precise Flight Path Control
 - Air-to-Air combat (CO)
 - Ground Attack (GA)
 - Weapon delivery/launch (WD)
 - Terrain following (TF)

- Precision Tracking, Precise Flight Path Control
 - In-flight refueling (RR)
 - Close formation flying (FF)

Category C

- Terminal flight phases requiring accurate flight path control
 - Approach (PA)
 - Landing (L)

If the advanced fighter was also a STOL aircraft there are two other potentially flight control-critical mission phases that should be added to the above, one in each category. In Category A, the CO mission phase might be extended to include conditions outside the aerodynamic envelope to permit evasive or unusual positioning maneuvers (e.g., supermaneuverability). This would imply that special aerodynamic effectors, thrust vector control, or some similar additional effectors be integrated into the "normal" Aircraft/FCS set. The additional Category C mission phase would be introduced for touchdown, nose-down rotation, and roll out control operations on a very narrow (50 ft), short (1500 ft), battle damaged runway in the presence of severe crosswinds.

The numerical requirements for mission-centered lateral-directional control quantities for an advanced fighter (Class IV airplane) in Flight Phase Category A (CO), "Air-to-air combat" can be culled from the military specifications (e.g., Refs. 2 and 3) and conditioned and seasoned by mission and pilot-centered requirements as given, for example, in Supplements 2 and 3. These are summarized in Table 3. All of the "Effective Denominator Quantities" and many of the "Effective Numerator Quantities" given there derive from flying qualities and/or pilot-vehicle integration considerations and thus relate to the aircraft/FCS modes associated with stability augmentation. In closed-loop FCS, higher-order modes will be present and improved pilot-vehicle system characteristics are possible when these minimum specifications are exceeded. Thus, the numerical values are to be interpreted as defining lower-order effective modes and as minimums for Level 1 flying qualities.

B. MISSION-CENTERED PATH AND HEADING CONTROL REQUIREMENTS

Consideration of the FCS designer's charge to "establish desired command/response relationships" starts with the bare airplane lateral-directional control characteristics pertinent to lateral path and heading control. Directional control of the velocity vector (i.e., lateral flight path, λ) and the aircraft x body axis (i.e., azimuth angle, ψ) is the essential ingredient needed for maneuvering, tracking targets, and implementing guidance systems. The following explanation applies generally to

TABLE 3. COMPILATION OF MISSION-CENTERED FCS DESIGN-CRITICAL REQUIREMENTS

EFFECTIVE DENOMINATOR QUANTITY	REQUIREMENT		REFERENCE COMMENTS*
Coupled Roll-Spiral [ζ_{SR} , ω_{SR}]	Not Permitted		3.3.1.4 Flt Phase Cat A [CO,GA]
Spiral Divergence, T_s $1/T_s$	$T_{2/1} > 20$ secs Corresponds to $ T_s > 28.8$ secs $> -0.0347 \text{ sec}^{-1}$		3.3.1.3 Flt Phase Cat B $T_{2/1} > 12$ sec for Cat A
Roll Subsidence, T_R	$T_R < 1$ sec		3.3.1.2 Flt Phase Cat A
Dutch Roll Mode Undamped Natural Frequency, ω_d Damping Ratio ^b	> 1 rad/sec > 0.4		3.3.1.1 Flt Phase Cat A [CO,GA] Flt Phase Cat A [CO,GA]
EFFECTIVE NUMERATOR QUANTITY	REQUIREMENT		REFERENCE, COMMENTS
Roll/Lateral Controller, ω_ϕ^2	$\omega_\phi^2 > 0$		3.3.2.2
Positive Effective Dihedral, $L'_\beta]_{\text{eff}}$	$L'_\beta]_{\text{eff}} < 0$		3.3.6.3
Steady Turn Coordination Piloted Control Automatic Control	$\beta \pm 0$ possible $ \beta \leq 2$ deg $ a_y/g \leq 0.03$		3.3.2.5 3.1.2.4.1*
ROLLING MANEUVER COORDINATION			
Piloted Control	$\beta \pm 0$ possible $\beta \pm 0$ desirable		3.3.2.5 Implied req't for lateral controller
Automatic Control	$ a_y/g \leq 0.2$ $\beta \pm 0$ desirable		3.1.2.4.2* $P_{\text{max}} < 90^\circ/\text{sec}$ Implied req't for lateral controller
BANK ANGLE REGULATION			
Piloted Control	$\omega_\phi/\omega_d \pm 1$		Lateral control purification $\omega_\phi/\omega_d < 1$ next best
Automatic Control	RT < 3 sec Corresponds to $\omega_b\phi > 2$ rad/sec		3.1.2.1* Assume: $\phi_m = 45$ deg; $\zeta_{CL} \pm 1/2$; RT $\pm 3/(\zeta\omega)_{CL} \pm 3$ sec
STABILITY MARGINS			
	$f_m < 1$ st aeroelastic	$f_m > 1$ st aeroelastic	3.1.3.6.1* All closed-loop FCS
Phase Margin, ϕ_m Gain Margin, G_m	45 deg 6 dB	60 deg 8 dB	$G_m > 6$ dB @ zero airspeed

*References are to MIL-F-8785C (Flying Qualities of Piloted Airplanes) and * to MIL-F-9490D (Flight Control Systems).

^bWhen $\omega_d^2|\phi/\beta|_d > 20$ (rad/sec)², the minimum damping $\zeta\omega_d$ shall be increased by $\Delta\zeta\omega_d = 0.014 (\omega_d^2|\phi/\beta|_d - 20)$

either piloted or automatic control unless otherwise indicated by the context.

Going directly to the path control for a typical airplane, Fig. 11 indicates that direct proportional control of path with aileron via a pure gain controller $Y_p = K_p$ is not feasible. This "system survey" shows that the free s at the origin, the (slightly divergent) spiral, and the roll subsidence combine to form an approximate controlled element transfer function,

$$Y_c = \frac{\lambda}{\delta} \cdot \frac{K_\delta^\lambda}{s^2 (s + 1/T_R)} \quad (1)$$

In the illustration the Dutch roll mode is scarcely involved, being nearly cancelled by the quadratic numerator. This is not always the case, but to the extent that it is the simplified formulation of the path control problem given here is quite general and would even apply to cases where the roll subsidence mode is augmented. It should be stated in passing that the spiral and roll subsidence could conceivably be coupled to form a "lateral phugoid" (Ref. 1). As noted in Table 3 this is not permitted in Class IV aircraft in Mission Phase CO. If present the lateral phugoid mode would have to be modified to the uncoupled form (e.g., via inner loops) for starters, and then the present arguments would apply. If heading is used as a surrogate for flight path angle the essential characteristics are very similar to Eq. 1.

Either manual or automatic control of this type of controlled element form with only path angle or heading error as a guidance reference requires a great deal of very low frequency lead equalization. (The pilot can control such difficult controlled elements, but only at the expense of the full attention, extremely high workload operations needed to generate this very low frequency lead.)

To provide the lead equalization for a path or heading outer command loop closure, theoretically one can develop heading rate or path angle rate signals or resort to an efficacious inner loop quantity. For the

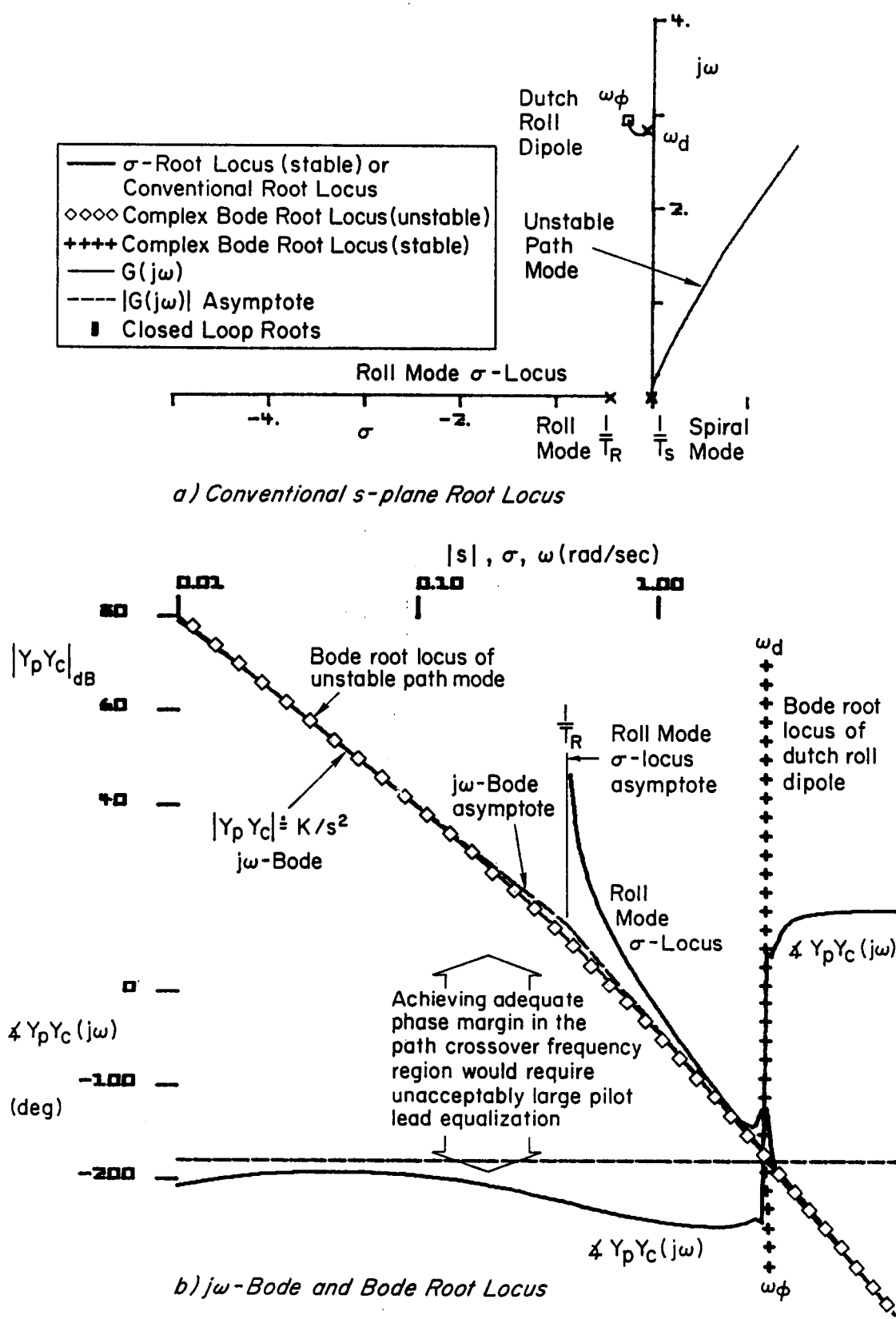

Figure 11 . System Survey Indicating the Infeasibility of Path Control with a Pure Gain $\lambda \rightarrow \delta_a$ Loop

latter an obvious candidate is roll or bank angle. This is further made apparent from the steady-turn relationship assuming perfect coordination (i.e., $\beta_a = \beta - \beta_g = 0$) and insignificant control effector actions.

Then

$$\dot{\lambda} = \frac{g}{U_0} \phi \dot{r} \quad (2)$$

For the dynamics of the path change in a conventional bank-to-turn aircraft, the roll subsidence term dominates as the significant bandwidth/rise time limitation in orienting the lift vector in order to turn. There is, of course, the associated bandwidth/rise time in the longitudinal axis to build up the load factor to sustain altitude in the turn. The fundamental limits which determine the maximum turn rates and path curvatures are seen in this connection. In steady-state, it is set by $C_{L_{max}}$, or in a more complex relationship, by the associated induced drag rise which would lead to critical energy loss in combat maneuvering. At the outset of the maneuver the lateral and longitudinal controller bandwidths and control powers will govern how rapidly the quasi-steady state condition can be achieved. Effective use of the maximum maneuvering capability is limited by the human pilot's normal acceleration limits as assisted by g suits and other aids.

Direct side force designs allow the possibility of independent control of all degrees-of-freedom, and different bandwidths can be achieved since the roll and normal acceleration dynamics are not involved. However, the lower effective control power of feasible direct side force generators (e.g., ventral canards, thrust vectoring) inevitably lead to lower maximum turn rates. Thus, if direct side force control is incorporated in a fighter design, it will probably be used as a precision "vernier" on top of bank-to-turn maneuvering, and generally be limited to specific task-tailoring FCS modes (e.g., wings-level turning adjustments in ground attack to avoid introducing "pendulous" errors). Effective use of direct side force modes requires careful coordination with conventional controls, and is complicated by non-zero lateral acceleration on the pilot. We shall not be concerned further with such designs here.

Besides its fundamental implied requirement as an inner loop for path control to provide path mode damping, roll angle control also has a life of its own as a bank attitude regulating system. Consequently, the fundamental path control requirement for both the piloted and automatically controlled aircraft can be interpreted to include and imply a requirement for roll angle control. When this command and regulation control loop has been established with high integrity, most of the outer-loop control modes imaginable can readily be instrumented. Conversely, without it some are very difficult or are not feasible. These outer loops are the primary domain of guidance, while from the roll loop inward, the airplane dynamics play an increasingly important and dominant role. Consequently, the roll control lateral-directional problem is a suitable starting point for the FCS architectural design process for both piloted and automatic control.

The mission-centered response time requirement for automatic roll attitude control and regulation given in Table 3 is suitable for a fighter automatic-pilot bank angle control. The implied bandwidth, $\omega_{b\phi}$, required to achieve the specified response time (RT) is relatively modest for very tight integrated fire-flight control. Consequently this automatic FCS-based requirement, like many of those based on flying qualities, should be considered a minimum.

Because rolling is centrally involved in path, directional, and lateral-directional maneuvers several other requirements which promote good roll control characteristics are listed in Table 3. They range from restrictions on rolling velocity reversals to conditions which favor pure rolling using a single lateral controller.

There are other requirements which implicitly relate to the ability of the Aircraft/FCS to perform the mission. The most pervasive is stability. The stability criteria listed apply to all Aircraft/FCS situations in which the loops involve aerodynamics (with $G_M > 6$ dB for zero air-speed). Because most, if not all, of the loops in FCS have some status as independent entities (e.g., a yaw-damper may exist on its own as well as an inner loop for a roll control mode which, in turn, may be an inner loop for path control, etc.) the stability criteria tend to apply for each of

the several loops involved. In multiple loop systems the overall system is to be stable when each loop is subjected to variations equal to the margins given, all other loops being closed with nominal values for the control law parameters.

C. IMPLIED REQUIREMENTS FOR COORDINATED MANEUVERS

The flying qualities and FCS specifications place various explicit and implicit limitations on the sideslip responses to pilot or AFCS control actions. For example, Table 3 lists a flying quality requirement that sufficient control power and other capability be present to permit the pilot to conduct coordinated rolling maneuvers (i.e., $\beta \neq 0$ possible). But an explicit requirement for $\beta \neq 0$ maneuvering is not currently in any general specification per se.

At first glance this state of specification affairs is somewhat surprising for mission phases CO and GA, because lead pursuit trajectories needed for gunnery are ideally zero sideslip for ballistic reasons. Coordinated maneuvering can also minimize target acquisition time. There are, however, other factors which need to be weighed, the most important being the desired axis about which rolling should occur. When minimum sideslip is desired the roll axis should be about the flight path or, in other words, about the stability axis. When this incidentally corresponds to the reticle axis (and, perhaps the gun line as well) zero sideslip maneuvering can be ideal for gunnery. If not, initial lineup can require the development of greater pilot skill and/or more elaborate fire control systems to counter various "pendulous effects" on apparent target movements. For instance, a roll axis which is above the sight line causes an initial reversed movement of the target when rolling onto a target. Also, in aircraft where the pilot is located well above the roll axis, the pilot may be subjected to large lateral accelerations when initiating or terminating abrupt rolling maneuvers. Inertial coupling considerations can also enter which tend to push the preferred roll axis to locations which are most favorable in this connection. All of these factors are important, and some may lead to specific requirements to task tailor the FCS in different ways for different mission phases.

While these special circumstances demand attention, in all extreme maneuvers of advanced fighters the danger of exceeding the safe flight envelope is present. Controllable stalled or even supermaneuvering flight well into separated regimes is a desirable attribute for future fighters, but rapid departures and structurally unsound maneuvers are not. The incidence of uncontrollable flight is significantly reduced by maintaining symmetrical loading conditions for both the pilot and the airframe, i.e., sideslip very nearly zero. With this background, and recognizing that a mature task-tailored control system technology is available for lateral control initiated maneuvering tasks, it consequently makes a great deal of sense to cut through the jumble of requirements on sideslip by simply requiring the basic control system to provide for dynamic coordination ($\beta \dot{=} 0$) for all maneuvers commanded by lateral controller action (additional task-tailoring being optional). This would apply for automatic as well as manual control, and is entered as an implied requirement in Table 3. Capability for generating deliberate sideslip using the rudder is, of course, still required.

D. MISSION-BASED REQUIREMENTS IN THE FLIGHT CONTROL DESIGN SOFTWARE

The above discussion covers the primary design-critical requirements for an example advanced fighter in the air-to-air mission phase (CO). The requirements are displayed in tabular form in Table 3. They serve two roles: as fundamental guidelines for the FCS design; and as guideposts in assessments. The first assessment will be to determine what deficiencies are present in the characteristics of the aircraft without any FCS. Then, at successive stages in the evolution of the flight control systems architecture, further assessments are made until satisfactory design closure occurs and a FCS architectural structure is thereby established.

The requirements and the other knowledge elements for flight control design to be discussed in the following sections have been partially implemented in a prototype knowledge-based flight control system design package called "FCX" which is discussed in Volume 2. Requirements, corresponding to Table 3, appear in two elements of FCX — in a spreadsheet database element and in several knowledge bases of the FCX flight control

design expert system. The requirements appear in the "REQUIREMENTS" window of the spreadsheet applied to the bare aircraft dynamics as shown in Table 4. In the FCX expert system the requirements are first particularized for the aircraft and flight condition of interest by the "SPECSET" knowledge base. These requirements are then applied to the open-loop aircraft dynamics by the "SPECHKOL" knowledge base. An analogous knowledge base called "SPECHK" handles requirement comparisons for loop closures in the design process. (Use of distinct SPECHKOL and SPECHK knowledge bases is due to limitations in LEVEL 5 grammar, and they could be combined in a more sophisticated environment).

E. COMMAND AND DISTURBANCE CHARACTERISTICS

The characteristics of the commands are, in the main, direct consequences of the flight control tasks(s) to be performed, while the disturbances depend on the environment in which that task is to be accomplished. These consequences must be made specific by defining the characteristics of a family of representative input signals and disturbances.

As a practical matter, commands and disturbances are not a clearcut dichotomy — some commands are contaminated by unwanted parts which drive the system in a way indistinguishable from disturbances entering at the same point. To be sure that no important forcing or excitation source is overlooked, it is pertinent to consider both commands and disturbances as "inputs," and then to classify them as to source and nature. A convenient set of categories is:

- At the Command Point(s)
 - Desired Inputs (nominal "commands")
 - Unwanted Inputs (nominal "noise on "Commands")
- At various Controller Locations
 - Internal Disturbances
- At locations External to the Controller
 - Vehicle Induced
 - Environment

TABLE 4. REQUIREMENTS WINDOW

REQUIREMENTS, MIL-F-8785C Parameter	Symbol	Value	Units	Assessment	Paragraph	Requirement	Level Limit
Dutch Roll Damping Ratio	Zd#1	0.4		FAIL	3.3.1.1	Lateral directional oscillations	1 Minimum
Dutch Roll Damping	Wd*Zd#1	0.4	r/s		3.3.1.1	Lateral directional oscillations	1
Basic Dutch roll damping *	Wd	1.809	(r/s) ²	--	3.3.1.1	Lateral directional oscillations	1
Phi/beta increment metric	Wd^2IPHI/Bid	0		Incrmt NOT Reqd	3.3.1.1	Lateral directional oscillations	1
Phi/beta increment criterion	DeltaDrd	0.000	r/s	--	3.3.1.1	Lateral directional oscillations	1
Dutch roll damping increment							
Dutch roll damping	Wd*Zd#1 + DeltaDrd	0.400	r/s	FAIL	3.3.1.1	Lateral directional oscillations	1 Minimum
* The increment criterion is used when Wd^2IPHI/Bid > 20 r/s							
Dutch Roll Natural Frequency	Wd#1	1	r/s	PASS	3.3.1.1	Lateral directional oscillations	1 Minimum
Roll Subsidence	TR#1	1	s	FAIL	3.3.1.2	Roll mode	1 Maximum
Spiral Stability							
a) ITs > 0	TS#1			----	3.3.1.3	Spiral stability	1
b) ITs < 0							
Time to double amplitude	TS2	303.78	s	----	3.3.1.3	Spiral stability	1
Minimum time to double amplitude	TS2#1	20	s	PASS	3.3.1.3	Spiral stability	1 Minimum
Positive Effective Dihedral	LB'#1	< 0		PASS	3.3.6.3.2	Positive effective dihedral limit	

A chart using these categories to classify the major flight control system inputs, which require consideration for an Advanced Fighter is given in Table 5.

Table 5 calls specific attention to the many different forms inputs can take. As expected, the entire range of possibilities — from discrete steps or impulses to periodic and random processes — is represented.

The inputs represented in Table 5 pertain to the entire mission. Those pertinent to mission phase CO or GA are made specific by an asterisk. A task that starts in preliminary design and continues unabated throughout the entire system development is the chore of quantifying the major inputs and disturbances. In the preliminary design phase, it is often sufficient to consider nominal and maximum values of the inputs, although the entire spectrum of input types must be covered. In later design and test phases, the data needs intensify and the effects on the system of some inputs need precise definition. A summary of major sources for quantitative descriptions of commands and disturbances is given in Supplement 2.

The atmospheric disturbance models are probably the best example of model refinement as a function of design phase. At the outset these are usually made quite simple in form, but often with oversized (larger than nominal or expected) values. Their basic differences across mission phase are associated primarily with altitude variations. For more detailed design phases, the atmospheric models are ordinarily expanded in detailed form, expected and variation values become predominant, and quantitative estimates of system performance and behavior may be given in probabilistic as well as expected value terms.

TABLE 5. FLIGHT CONTROL SYSTEM INPUTS: APPLICATION POINT AND SOURCE (ADAPTED FROM REF. 1)

INPUT FORM	COMMAND POINT INPUT		INTERNAL DISTURBANCES		EXTERNAL DISTURBANCES	
	DESIRED INPUTS	UNWANTED INPUTS	VEHICLE INDUCED	ENVIRONMENT		
Steps, Pulses Cut-off Ramps	Maneuver Commands* and Operating Point Changes (Altitude, Speed, etc.)	Errors in Operating Point Changes	Mode Switching; Power Supply Variations with Load Switching	Wind; * Wind Shear*		
Initial Conditions or Impulses		Automatic Control Engagement	Mechanical Shocks	Non-simultaneous Release of Restraints; * Shock and Blast Waves;		
Gust Function				Discrete Gust*		
Power Series	Target Motion; * Terrain Variation; Programmed Operating Point Changes	Higher Order Target Motions; * Errors in Operating Point Changes; Reference Drifts	Unbalanced Component Drifts	Wind Shear; * Wind Gradient*		
Periodic or Repetitive	Some Terrain Variations			Dynamic Unbalance; Gun Firing; * Vibration; Flutter; Reference Coordinate Rotation		
Random	Generalization of Target Motions; * Generalization of Terrain Variations; Generalization of Step-pulse Sequences	Generalization of Higher order Target Maneuvers; * Geometry-target Noise (Scintillation, Beam Reflection, etc.); * Guidance System Internal Noise; * Generalization of Errors in Step-pulse Sequences	Power-supply Fluctuations; Sensor Noise; Local Flow Changes on Control Surfaces; Electrical Noise	Random Variations in Ambient Fields; Gusts and Turbulence		

*Inputs applicable to Flight Phase Category A (CO and GA)

SECTION III

HIGH PERFORMANCE AIRCRAFT LATERAL-DIRECTIONAL CHARACTERISTICS

The bases for identification of many potential flight control system problems and the inspiration for some solutions derive directly from considering the airplane as an object of control. Although this can be done in general terms it is much easier to explain and follow with the aid of a concrete example. To this end we have contrived a quantitative mathematical model of an advanced fighter's lateral-directional characteristics. This will be used for numerical work in illustrating the design sequence.

The study airplane has features which represent some of the more troublesome airplane-centered stability and control problems that must be corrected by the FCS. It does not, however, indicate the entire range of possible difficulties; so from time to time in the discussion other awkward or troublesome airplane stability and control considerations will be introduced in passing to extend the coverage. For instance, the example airplane has a stable Dutch roll mode which might become a divergence and subsidence at very high angle-of-attack. Although the numerically defined study airplane will not exhibit such conditions, their possible presence must be considered as part of the FCS design problem of setting up the preliminary FCS architectural possibilities.

The data bases developed in this section define and explore the airplane as a dynamic entity. To begin, the airplane equations of motion for three-degrees-of-freedom lateral-directional control are presented. These include transformations between the two types of body-fixed axis systems used, with associated transformations between the stability derivatives. The second article presents numerical values for stability derivatives representing the contrived example of an advanced fighter, and provides data bases for the characteristic modes, ordinary numerators for control inputs, and coupling numerators (Ref. 1). At this point enough airplane dynamic data in numerical form is available to start identifying some of the airplane deficiencies. This could be accomplished by comparing the airplane's characteristics data bases with corresponding elements in the requirements data base. However, the airplane dynamics are not yet

"understood" in that the origins and connections between the fundamental stability and control parameters and the example airplane dynamics are not well established.

In order to gain a better appreciation of the physical origins of the aircraft properties another data base is developed. This airplane-dynamics interpretative data base is for literal approximate factors. These relate the airplane characteristic modes and numerator factors directly to combinations of stability derivatives expressed in symbolic form. To the extent that numerical values developed from the literal approximate factors are reasonably representative of the actual airplane poles and zeros, the connections between the stability derivatives and the poles and zeros become direct. One then has explicit symbolic formulae relating the airplane's derivatives to its modes, with the accompanying complete understanding of the origins of the bare airplane's dynamic behavior possibilities.

The formulas for the literal approximate factors are from Ref. 1, and comparisons with data calculated using these factors with the actual airplane characteristics constitute the application data base. When the comparisons are very close the understanding is considered complete. If not, we supplement these data with a time-vector/phasor data base which can provide an excellent graphical representation of modal behavior and its connections with the basic forces and moments. For the example problem this step is not indicated.

A. AIRPLANE EQUATIONS OF MOTION

The lateral-directional equations of motion of the airplane perturbed from straight, (wing) level, horizontal flight referred to stability axes are given in Table 6 (see Ref. 1). These equations are expressed in terms of the rolling and yawing angular velocities p and r about body-fixed X and Z axes and the side velocity, v , along the Y axis. The side velocity is converted to an inertial sideslip angle $\beta = v/U_0$. The applied accelerations due to the aerodynamic forces depend on the angular rates, the aerodynamic sideslip $\beta_a = \beta - \beta_g$ (where β_g is a side velocity gust, air mass movement, or asymmetric bias expressed in sideslip terms), and

TABLE 6. LATERAL DIRECTIONAL AIRCRAFT EQUATIONS OF MOTION

Perturbation Equations of Motion (Stability Axes):

$$\dot{\lambda} = Y_v (\beta - \beta_g) + \frac{g}{U_o} \phi + \Sigma Y_\delta^* \delta_i$$

$$\dot{r} = N'_\beta (\beta - \beta_g) + N'_r r + N'_p p + \Sigma N'_\delta \delta_i$$

$$\dot{p} = L'_\beta (\beta - \beta_g) + L'_r r + L'_p p + \Sigma L'_\delta \delta_i$$

δ_i is a generic control surface deflection: aileron, rudder, side force generator, etc.

Kinematic Equations:

$$\lambda = \psi + \beta$$

$$\dot{\phi} = p_b + r_b \tan \alpha_o$$

$$\begin{aligned} a_y &= \dot{v} + U_o r - g\phi \\ &= U_o \dot{\lambda} - g\phi \end{aligned}$$

$$\dot{\psi} = \frac{r_b}{\cos \alpha_o}$$

FRL-Body/Stability Axis Array:

	r	p
r _b	cos α _o	sin α _o
p _b	-sin α _o	cos α _o

Can be read either left to right or down

Derivative Transformations:

$$L'_\beta]_b = L'_\beta \cos \alpha_o - N'_\beta \sin \alpha_o$$

$$N'_\beta]_b = N'_\beta \cos \alpha_o + L'_\beta \sin \alpha_o$$

$$L'_r]_b = L'_r \cos^2 \alpha_o - (N'_r - L'_p) \sin \alpha_o \cos \alpha_o - N'_p \sin^2 \alpha_o$$

$$L'_p]_b = L'_p \cos^2 \alpha_o - (L'_r + N'_p) \sin \alpha_o \cos \alpha_o + N'_r \sin^2 \alpha_o$$

$$N'_p]_b = N'_p \cos^2 \alpha_o - (N'_r - L'_p) \sin \alpha_o \cos \alpha_o - L'_r \sin^2 \alpha_o$$

$$N'_r]_b = N'_r \cos^2 \alpha_o + (N'_p + L'_r) \sin \alpha_o \cos \alpha_o + L'_p \sin^2 \alpha_o$$

the aerodynamic and propulsion effectors δ_i . The kinematic equations for bank angle and azimuth angle rates are also shown.

Stability axes are desirable for insight and analytical simplicity, especially in connection with lateral-directional approximate factors. Also, fuselage reference line (FRL) axes are needed to properly account for the signals picked up by actual sensors. Thus, rate gyros mounted with their sensitive axes along the X and Z FRL axes will measure so-called body axis p_b and r_b , and the c.g. mounted accelerometers directed along the Y axis will pick up the side acceleration, etc. The bank angle, ϕ , is a rotation about the X axis, and the bank angle equation given in Table 6 is suitable for bank angle as measured by a two degrees-of-freedom gyro with its outer gimbal bearing axis directed along the airplane's stability axis. In horizontal flight the X stability axis is horizontal in trimmed flight and the bank angle rate $\dot{\phi}$ is equal to the rolling velocity, p , about the X-axis. Notice, however, that the bank angle rate $\dot{\phi}$, depends on both the rolling and yawing angular velocity components when these are referred to the FRL X and Z axes. Only when the FRL and stability axis systems are coincident (i.e., $\alpha_0 = 0$) is the bank angle rate equal to the rolling velocity, $p_b = p$, and the azimuth angle rate, $\dot{\psi}$, equal to the yawing velocity, $r_b = r$.

B. NUMERICAL CHARACTERISTICS FOR THE EXAMPLE AIRPLANE

The data needed to define the aircraft for the example are based on the flight condition in Table 7.

TABLE 7. REFERENCE FLIGHT CONDITION

Straight and level flight at:
M = 0.6
Altitude = 35,000 ft
True speed = 584 fps
Trim angle-of-attack = 12.4 deg
Flight path angle = 0
Load factor = 1 g

The lateral-directional aircraft characteristics including dimensional stability and control derivatives and transfer functions are given in Table 8. Due to the moderately high AOA, there are some significant differences between fuselage reference line (FRL) and stability axis derivatives. These are reflected in the similarities and differences in the transfer function numerators for the two different body axis systems. For instance, the characteristic function, $\Delta(s)$, called out as the "Denominator," and the transfer functions relating the side acceleration, the sideslip, and the lateral flight path to control effectors are the same for both axis systems. On the other hand, the transfer functions relating the body rates p and r to control effectors are different. Finally, the numerator factors for the roll angle transfer functions are the same for both axis systems although the gains differ because they are given by $L'_\delta + \tan \alpha_0 N'_\delta$. These similarities and differences need to be accounted for later as certain net signals (such as stability axis yaw rate, r) are made up of various sensor combinations (such as body axis roll and yaw ratio, p_b and r_b). Because the example problem considers only a single design point and identical actuator dynamics for all effectors, it is not important here to distinguish between control effectiveness sources, so they may be considered to be composites derived from aerodynamic and thrust vectoring propulsion sources. For the design envelope, however, the mix and blending become central issues.

The information of Tables 7 and 8 appears in the spreadsheet database format in Tables 9 to 14. The database elements include:

<u>Data Base Element</u>	<u>Table</u>	<u>Spreadsheet Window</u>
AIRCRAFT BASIC DATA	9	AIRCRAFT
FLIGHT and TRIM CONDITIONS	10	FLIGHTCOND
STABILITY and CONTROL DERIVATIVES Stability Axes Fuselage Reference Line Body Axes	11	DERIVATIVES
CHARACTERISTIC MODES	12	MODES
TRANSFER FUNCTION NUMERATORS	13	TRANSFERFUNC
COUPLING NUMERATORS	14	COUPLINGNUM

TABLE 8. SUMMARY OF AIRCRAFT ALONE CHARACTERISTICS

Primed Dimensional Derivatives	STABILITY AXES				FRL BODY AXES			
	Y_{β}^i	L_{β}^i	N_{β}^i		Y_{β}^i	L_{β}^i	N_{β}^i	
	-50.69	-31.31	7.971		-50.69	-32.30	1.060	
	L_p^i	N_p^i	L_r^i	N_r^i	L_p^i	N_p^i	L_r^i	N_r^i
	0.13435	-0.08792	2.352	-0.5892	-0.3740	-0.04060	2.40	-0.08090
$Y_{\delta_a}^{\phi}$	$L_{\delta_a}^i$	$N_{\delta_a}^i$		$Y_{\delta_a}^{\phi}$	$L_{\delta_a}^i$	$N_{\delta_a}^i$		
0.0	6.569	0.3064		0.0	6.350	1.710		
$Y_{\delta_r}^{\phi}$	$L_{\delta_r}^i$	$N_{\delta_r}^i$		$Y_{\delta_r}^{\phi}$	$L_{\delta_r}^i$	$N_{\delta_r}^i$		
0.01790	6.251	-2.583		0.01790	6.660	-1.180		
Denominator $\Delta(s)$ (-0.00475)(0.428)(0.0208; 2.84)								
δ_a Numerators	$N_{\delta_a}^{\beta}$	-0.307(0.240)(-3.44)						
	$N_{\delta_a}^p$	6.56(0.0)(0.1275; 3.08)				6.35(-0.01203)(0.1332; 3.09)		
	$N_{\delta_a}^r$	0.306(1.761)(-0.733; 2.51)				1.710(0.250)(0.01064; 2.79)		
	$N_{\delta_a}^{\phi}$	6.56(0.1275; 3.08)				6.73(0.1275; 3.08)		
	$N_{\delta_a}^{ay}$	15.53(0.240)(-3.44)						
	$N_{\delta_a}^{\lambda}$	0.388(0.0865; 2.96)						
δ_r Numerators	$N_{\delta_r}^{\beta}$	0.01790(-0.1434)(0.356)(144.5)						
	$N_{\delta_r}^p$	6.25(0.0)(2.05)(-2.43)				6.66(-0.01203)(1.982)(-2.31)		
	$N_{\delta_r}^r$	-2.58(0.911)(-0.470; 0.852)				-1.180(0.254)(0.0888; 2.36)		
	$N_{\delta_r}^{\phi}$	6.25(2.05)(-2.43)				6.40(2.05)(-2.43)		
	$N_{\delta_r}^{ay}$	10.45(0.298)(-0.504)(-1.730)(2.39)						
	$N_{\delta_r}^{\lambda}$	0.0170(2.11)(-2.29)(0.0715; 4.44)						
δ_a/δ_r Coupling Numerators	$N_{\delta_a/\delta_r}^{\beta p}$	-0.1175(0.0)(161.2)				-0.1136(-0.01206)(162.9)		
	$N_{\delta_a/\delta_r}^{\beta r}$	-0.00548(-0.0732; 13.77)				-0.0306(0.250)(132.4)		
	$N_{\delta_a/\delta_r}^{\beta \phi}$	-0.1175(161.2)				-0.1203(161.2)		
	$N_{\delta_a/\delta_r}^{\beta ay}$	-3.20(0.240)(-3.44)						
	$N_{\delta_a/\delta_r}^{\beta \lambda}$	-0.00548(-0.0732; 13.77)						
	$N_{\delta_a/\delta_r}^p r$	-18.88(0.0)(0.0280)				-18.88(0.0)(0.0280)		
	$N_{\delta_a/\delta_r}^p \phi$	0.0(0.0)				-4.15(0.0280)		
	$N_{\delta_a/\delta_r}^p ay$	68.6(0.0)(-1.802)(2.50)				66.3(-0.01214)(-1.793)(2.53)		
	$N_{\delta_a/\delta_r}^p \lambda$	0.1175(0.0)(-1.802)(2.50)				0.1136(0.0)(-2.21)(2.94)		
	$N_{\delta_a/\delta_r}^r \phi$	18.88(0.0280)				18.88(0.0280)		
	$N_{\delta_a/\delta_r}^r ay$	3.20(-2.73)(0.255; 1.396)				17.87(0.251)(1.912)(-1.940)		
	$N_{\delta_a/\delta_r}^r \lambda$	0.00548(0.0)(-0.0732; 13.77)				0.0306(0.0)(0.0205; 5.43)		
	$N_{\delta_a/\delta_r}^{\phi ay}$	68.61(-1.802)(2.50)				70.3(-1.801)(2.50)		
	$N_{\delta_a/\delta_r}^{\phi \lambda}$	0.1175(-1.802)(2.50)				0.1203(-1.801)(2.50)		
	$N_{\delta_a/\delta_r}^{ay \lambda}$	-3.78(-1.802)(2.50)						

Shorthand notation for transfer function terms: $(s + a) = (a)$; $[s^2 + 2\zeta\omega_n s + \omega_n^2] = [\zeta, \omega_n]$.

Gain terms are "root-locus" gains.

TABLE 9. AIRCRAFT BASIC DATA

Item	Symbol	Value	Units	Axes
Aircraft Type			Advanced Fighter	
Aircraft Class		IV	MIL-F-8785C	
Geometry				
Planform Area	S	196.1	ft ²	
Mean Aerodynamic Chord	MAC	9.55	ft	
Wing Span	SPAN	21.94	ft	
Thrust Inclination	TINCLNE	-2.76	deg	
Mass Properties				
Weight	W	16,300	lbs	
X Center of Gravity	XCGMAC	7	%MAC	body
X Center of Gravity	XCG	0.6685	ft	body
Y Center of Gravity	YCG	0	ft	body
Z Center of Gravity	ZCG	0	ft	body
X Moment of Inertia	IXX	3,679	slug-ft ²	body
Y Moment of Inertia	IYY	58,613	slug-ft ²	body
Z Moment of Inertia	IZZ	59,541	slug-ft ²	body
XY Product of Inertia	IXY	0	slug-ft ²	body
XZ Product of Inertia	IXZ	2,699	slug-ft ²	body
YZ Product of Inertia	IYZ	0	slug-ft ²	body

TABLE 10. FLIGHT AND TRIM CONDITIONS

Item	Symbol	Value	Units
Flight Condition			
Flight Phase	CO		
Category	A		
Mach Number	MACH	0.6	--
Altitude	ALT	35000	ft
True Airspeed	VTRUE	584	fps
Wing Sweep			
Trim Conditions			
Angle of Attack	AOAo	12.4	deg
Angle of Sideslip	Bo	0	
Heading	PSIo	0	
Pitch Attitude	THETAo	12.4	deg
Bank Angle	PHIo	0	
Flight Path Angle	GAMMAo	0	
Roll Rate	Po	0	
Pitch Rate	Qo	0	
Yaw Rate	Ro	0	
Turn Rate	OMEGAo	0	
Normal Load Factor	no	1	g
Lateral Load Factor	nyo	0	
Axial Load Factor	nxo	0	

TABLE 11. STABILITY AND CONTROL DERIVATIVES

Lateral Dimensional Primed Derivatives

Stability Axes		Body Axes		Units
Symbol	Value	Symbol	Value	
YB	-50.69	YBb	-50.69	ft/sec ² -rad
Yv	-0.08679	Yvb	-0.08679	sec ⁻¹
LB'	-31.31	LBb'	-32.3	sec ⁻²
NB'	7.971	NBb'	1.06	sec ⁻²
Lp'	0.13435	Lpb'	-0.374	sec ⁻¹
Np'	-0.08792	Npb'	-0.0406	sec ⁻¹
Lr'	2.352	Lrb'	2.4	sec ⁻¹
Nr'	-0.5892	Nrb'	-0.0809	sec ⁻¹
Yda#	0	Yda#b	0	1/sec-rad
Lda'	6.569	Ldab'	6.35	sec ⁻²
Nda'	0.3064	Ndab'	1.71	sec ⁻²
Ydr#	0.0179	Ydr#b	0.0179	1/sec-rad
Ldr'	6.251	Ldrb'	6.66	sec ⁻²
Ndr'	-2.583	Ndrb'	-1.18	sec ⁻²

TABLE 12. CHARACTERISTIC MODES

Root Code	Parameter Type	Value	Units	Parameter Name
Delta1	realroot	-0.00475	rad/sec	ITS
Delta2	realroot	0.427	rad/sec	ITR
Delta3	Z	0.0208	--	Zd
Delta4	W	2.84	rad/sec	Wd
Delta5	RLgain	1	--	--
Delta6	Bodegain	-0.01635	--	deltass
	Wsr ²			
	2*Zsr*Wsr			

	real poles	complex poles	Config Code
Numerical factors:	2	2	1
Literal approx fac	2	2	1

TABLE 13. TRANSFER FUNCTION NUMERATORS (NUMERICALLY FACTORED)

Out	In	Parameter Type	Parameter Code	Stability Value	Parameter Name	Parameter Code	Body Axis Value	Parameter Name	Units
B	da	RLgain	NBda1	-0.306	KBda	NBda1	-0.306	KBda	rad/rad
B	da	realroot	NBda2	0.24	ITBda1	NBda2	0.24	ITBda1	rad/sec
B	da	realroot	NBda3	-3.44	ITBda2	NBda3	-3.44	ITBda2	rad/sec
P	da	RLgain	Npda1	6.56	Kpda	Npda1	6.56	Kpda	rad/sec-rad
P	da	realroot	Npda2	0	ITpda	Npda2	-0.01203	ITpda	rad/sec
P	da	zeta	Npda3	0.1275	Zpda	Npda3	0.1332	Zpda	--
P	da	omega	Npda4	3.08	Wpda	Npda4	3.09	Wpda	rad/sec
r	da	RLgain	Nrda1	0.306	Krda	Nrda1	1.71	Krda	rad/sec-rad
r	da	realroot	Nrda2	1.761	ITrda	Nrda2	0.25	ITrda	rad/sec
r	da	zeta	Nrda3	-0.733	Zrda	Nrda3	0.01064	Zrda	--
r	da	omega	Nrda4	2.51	Wrda	Nrda4	2.79	Wrda	rad/sec
FHI	da	RLgain	NPHIda1	6.56	KPHIda	NPHIda1	6.72	KPHIda	rad/rad
FHI	da	zeta	NPHIda2	0.1275	ZPHIda	NPHIda2	0.1275	ZPHIda	--
FHI	da	omega	NPHIda3	3.08	WPHIda	NPHIda3	3.08	WPHIda	rad/sec
ay	da	RLgain	Nayda1	15.53	Kayda	Nayda1	15.53	Kayda	ft/sec^2-rad
ay	da	realroot	Nayda2	0.24	ITayda1	Nayda2	0.24	ITayda1	rad/sec
ay	da	realroot	Nayda3	-3.44	ITayda2	Nayda3	-3.44	ITayda2	rad/sec
LBD	da	RLgain	NLBDda1	0.388	KLBDda	NLBDda1	0.388	KLBDda	rad/sec
LBD	da	zeta	NLBDda2	0.0865	ZLBDda	NLBDda2	0.0865	ZLBDda	--
LBD	da	omega	NLBDda3	296	WLBDda	NLBDda3	296	WLBDda	rad/sec
B	dr	RLgain	NBdr1	0.0179	KBdr	NBdr1	0.0179	KBdr	rad/rad
B	dr	realroot	NBdr2	-0.1434	ITBdr1	NBdr2	-0.1434	ITBdr1	rad/sec
B	dr	realroot	NBdr3	0.356	ITBdr2	NBdr3	0.356	ITBdr2	rad/sec
B	dr	realroot	NBdr4	144.5	ITBdr3	NBdr4	144.5	ITBdr3	rad/sec
P	dr	RLgain	Npdr1	6.25	Kpdr	Npdr1	6.66	Kpdr	rad/sec-rad
P	dr	realroot	Npdr2	0	ITpdr1	Npdr2	-0.01203	ITpdr1	rad/sec
P	dr	realroot	Npdr3	2.05	ITpdr2	Npdr3	1.982	ITpdr2	rad/sec
P	dr	realroot	Npdr4	-2.43	ITpdr3	Npdr4	-2.31	ITpdr3	rad/sec
r	dr	RLgain	Nrdr1	-2.58	Krdr	Nrdr1	-1.18	Krdr	rad/sec-rad
r	dr	realroot	Nrdr2	0.911	ITrdr	Nrdr2	0.254	ITrdr	rad/sec
r	dr	zeta	Nrdr3	-0.47	Zrdr	Nrdr3	0.0888	Zrdr	--
r	dr	omega	Nrdr4	0.852	Wrdr	Nrdr4	2.36	Wrdr	rad/sec
FHI	dr	RLgain	NPHIdr1	6.25	KPHIdr	NPHIdr1	6.4	KPHIdr	rad/rad
FHI	dr	realroot	NPHIdr2	2.05	ITPHIdr1	NPHIdr2	2.05	ITPHIdr1	rad/sec
FHI	dr	realroot	NPHIdr3	-2.43	ITPHIdr2	NPHIdr3	-2.43	ITPHIdr2	rad/sec
ay	dr	RLgain	Naydr1	10.45	Kaydr	Naydr1	10.45	Kaydr	ft/sec^2-rad
ay	dr	realroot	Naydr2	0.298	ITaydr1	Naydr2	0.298	ITaydr1	rad/sec
ay	dr	realroot	Naydr3	-0.504	ITaydr2	Naydr3	-0.504	ITaydr2	rad/sec
ay	dr	realroot	Naydr4	-1.73	ITaydr3	Naydr4	-1.73	ITaydr3	rad/sec
ay	dr	realroot	Naydr5	2.39	ITaydr4	Naydr5	2.39	ITaydr4	rad/sec
LBD	dr	RLgain	NLBDdr1	0.017	KLBDdr	NLBDdr1	0.017	KLBDdr	rad/sec-rad
LBD	dr	realroot	NLBDdr2	2.11	ITLBDdr1	NLBDdr2	2.11	ITLBDdr1	rad/sec
LBD	dr	realroot	NLBDdr3	-2.29	ITLBDdr2	NLBDdr3	-2.29	ITLBDdr2	rad/sec
LBD	dr	zeta	NLBDdr4	0.0715	ZLBDdr	NLBDdr4	0.0715	ZLBDdr	--
LBD	dr	omega	NLBDdr5	4.44	WLBDdr	NLBDdr5	4.44	WLBDdr	rad/sec

TABLE 14. COUPLING NUMERATORS

		(Numerically Factored)		Stability Axis		Body Axis				
Out	In	Out	In	Parameter Type	Parameter Code	Parameter Name	Parameter Code	Value	Parameter Name	Units
B	da	P	dr	RLgain	NBdapdr1	-0.117 KBDapdr	NBdapdrb1	-0.1136 KBDapdrb	NBdapdrb1	sec^-1
B	da	P	dr	realroot	NBdapdr2	0 ITBdapdr1	NBdapdrb2	-0.01206 ITBdapdrb1	NBdapdrb2	rad/sec
B	da	P	dr	realroot	NBdapdr3	161.2 ITBdapdr2	NBdapdrb3	162.9 ITBdapdrb2	NBdapdrb3	rad/sec
B	da	r	dr	RLgain	NBdardr1	-0.00548 KBDardr	NBdardrb1	-0.0306 KBDardrb	NBdardrb1	sec^-1
B	da	r	dr	zeta	NBdardr2	-0.0732 Zbdardr	NBdardrb2	0.25 ITBdardrb1	NBdardrb2	rad/sec
B	da	r	dr	omega	NBdardr3	13.77 Wbdardr	NBdardrb3	132.4 ITBdardrb2	NBdardrb3	rad/sec
B	da	PHI	dr	RLgain	NBdaPHIdr1	-0.1175 KBDaPHIdr	NBdaPHIdrb1	-0.1203 KBDaPHIdrb	NBdaPHIdrb1	rad/sec
B	da	PHI	dr	realroot	NBdaPHIdr2	161.2 ITBdaPHIdr	NBdaPHIdrb2	161.2 ITBdaPHIdrb	NBdaPHIdrb2	ft/sec^2-rad
B	da	ay	dr	RLgain	NBdaaydr1	-3.2 KBDaaydr	NBdaaydrb1	-3.2 KBDaaydrb	NBdaaydrb1	rad/sec
B	da	ay	dr	realroot	NBdaaydr2	0.24 ITBdaaydr1	NBdaaydrb2	0.24 ITBdaaydrb1	NBdaaydrb2	rad/sec
B	da	ay	dr	realroot	NBdaaydr3	-3.44 ITBdaaydr2	NBdaaydrb3	-3.44 ITBdaaydrb2	NBdaaydrb3	rad/sec
B	da	LBD	dr	RLgain	NBdaLBDr1	-0.00548 KBDaLBDr	NBdaLBDrb1	-0.00548 KBDaLBDrb	NBdaLBDrb1	sec^-1
B	da	LBD	dr	zeta	NBdaLBDr2	-0.0732 ZBdaLBDr	NBdaLBDrb2	-0.0732 ZBdaLBDrb	NBdaLBDrb2	rad/sec
B	da	LBD	dr	omega	NBdaLBDr3	13.77 WBDaLBDr	NBdaLBDrb3	13.77 WBDaLBDrb	NBdaLBDrb3	rad/sec
P	da	r	dr	RLgain	Npdardr1	-18.88 Kpdardr	Npdardrb1	-18.88 Kpdardrb	Npdardrb1	sec^-2
P	da	r	dr	realroot	Npdardr2	0 ITpdardr1	Npdardrb2	0 ITpdardrb1	Npdardrb2	rad/sec
P	da	r	dr	realroot	Npdardr3	0.028 ITpdardr2	Npdardrb3	0.028 ITpdardrb2	Npdardrb3	rad/sec
P	da	PHI	dr	RLgain	NpdaPHIdr1	0 KpdaPHIdr	NpdaPHIdrb1	-4.15 KpdaPHIdrb	NpdaPHIdrb1	sec^-1
P	da	PHI	dr	realroot	NpdaPHIdr2	0 ITpdaPHIdr	NpdaPHIdrb2	0.028 ITpdaPHIdrb	NpdaPHIdrb2	rad/sec
P	da	ay	dr	RLgain	Npdaaydr1	68.6 Kpdaaydr	Npdaaydrb1	66.3 Kpdaaydrb	Npdaaydrb1	ft/sec^3-rad
P	da	ay	dr	realroot	Npdaaydr2	0 ITpdaaydr1	Npdaaydrb2	-0.01214 ITpdaaydrb1	Npdaaydrb2	rad/sec
P	da	ay	dr	realroot	Npdaaydr3	-1.802 ITpdaaydr2	Npdaaydrb3	-1.793 ITpdaaydrb2	Npdaaydrb3	rad/sec
P	da	ay	dr	realroot	Npdaaydr4	2.5 ITpdaaydr3	Npdaaydrb4	2.53 ITpdaaydrb3	Npdaaydrb4	rad/sec
P	da	LBD	dr	RLgain	NpdalBDr1	0.1175 KpdalBDr	NpdalBDrb1	0.1136 KpdalBDrb	NpdalBDrb1	sec^-2
P	da	LBD	dr	realroot	NpdalBDr2	0 ITpdalBDr1	NpdalBDrb2	0 ITpdalBDrb1	NpdalBDrb2	rad/sec
P	da	LBD	dr	realroot	NpdalBDr3	-1.802 ITpdalBDr2	NpdalBDrb3	-2.21 ITpdalBDrb2	NpdalBDrb3	rad/sec
P	da	LBD	dr	realroot	NpdalBDr4	2.5 ITpdalBDr3	NpdalBDrb4	2.94 ITpdalBDrb3	NpdalBDrb4	rad/sec
r	da	PHI	dr	RLgain	NrdaPHIdr1	18.88 Krdaphidr	NrdaPHIdrb1	18.88 Krdaphidrb	NrdaPHIdrb1	sec^-1
r	da	PHI	dr	realroot	NrdaPHIdr2	0.028 ITrdaphidr	NrdaPHIdrb2	0.028 ITrdaphidrb	NrdaPHIdrb2	rad/sec
r	da	ay	dr	RLgain	Nrdaaydr1	3.2 Krdaaaydr	Nrdaaydrb1	17.87 Krdaaaydrb	Nrdaaydrb1	ft/sec^3-rad
r	da	ay	dr	realroot	Nrdaaydr2	-2.73 ITrdaaaydr	Nrdaaydrb2	0.251 ITrdaaaydrb1	Nrdaaydrb2	rad/sec
r	da	ay	dr	zeta	Nrdaaydr3	0.255 Zrdaaaydr	Nrdaaydrb3	1.912 ITrdaaaydrb2	Nrdaaydrb3	rad/sec
r	da	ay	dr	omega	Nrdaaydr4	1.396 Wrdaaaydr	Nrdaaydrb4	-1.94 ITrdaaaydrb3	Nrdaaydrb4	rad/sec
r	da	LBD	dr	RLgain	NrdalBDr1	0.00548 KrdalBDr	NrdalBDrb1	0.0306 KrdalBDrb	NrdalBDrb1	sec^-2
r	da	LBD	dr	realroot	NrdalBDr2	0 ITrdalBDr1	NrdalBDrb2	0 ITrdalBDrb1	NrdalBDrb2	rad/sec
r	da	LBD	dr	zeta	NrdalBDr3	-0.0732 ZrdalBDr	NrdalBDrb3	0.0205 ZrdalBDrb	NrdalBDrb3	rad/sec
r	da	LBD	dr	omega	NrdalBDr4	13.77 WrdalBDr	NrdalBDrb4	5.43 WrdalBDrb	NrdalBDrb4	rad/sec
r	PHI	da	ay	dr	NPHIdaaydr1	68.60 KPHIdaaydr	NPHIdaaydrb1	70.3 KPHIdaaydrb	NPHIdaaydrb1	ft/sec^2-rad
r	PHI	da	ay	dr	realroot	NPHIdaaydr2	NPHIdaaydrb2	-1.801 ITPHIdaaydrb1	NPHIdaaydrb2	rad/sec
r	PHI	da	ay	dr	realroot	NPHIdaaydr3	NPHIdaaydrb3	2.5 ITPHIdaaydrb2	NPHIdaaydrb3	rad/sec
r	PHI	da	LBD	dr	RLgain	NPHIdalBDr1	NPHIdalBDrb1	0.1203 KPHIdalBDrb	NPHIdalBDrb1	sec^-1
r	PHI	da	LBD	dr	realroot	NPHIdalBDr2	NPHIdalBDrb2	-1.801 ITPHIdalBDrb1	NPHIdalBDrb2	rad/sec
r	PHI	da	LBD	dr	realroot	NPHIdalBDr3	NPHIdalBDrb3	-1.801 ITPHIdalBDrb2	NPHIdalBDrb3	rad/sec
ay	da	LBD	dr	RLgain	NaydalBDr1	-3.78 KaydalBDr	NaydalBDrb1	-3.78 KaydalBDrb	NaydalBDrb1	ft/sec^3-rad
ay	da	LBD	dr	realroot	NaydalBDr2	-1.802 ITaydalBDr1	NaydalBDrb2	-1.802 ITaydalBDrb1	NaydalBDrb2	rad/sec
ay	da	LBD	dr	realroot	NaydalBDr3	2.5 ITaydalBDr2	NaydalBDrb3	2.5 ITaydalBDrb2	NaydalBDrb3	rad/sec

The Aircraft Basic Data and Flight and Trim Conditions Data Bases are set up for general lateral-directional control situations. Thus the former includes provision for product of inertia couplings between the longitudinal and lateral-directional degrees of freedom while the latter contains trim conditions for steady-accelerated and/or constant angular velocity flight. For the example these are all zero. The "English" notation in the Stability Derivative Data Base is plain enough, although the 'b' additions are needed to distinguish between FRL body axis and stability axis quantities.

The data elements noted above are incorporated in the FCX flight control design expert system as explained in Volume 2. The definition of the aircraft including collection of the basic aircraft data is managed by the "AIRCRAFT" knowledge base. The aircraft basic data is read from a file and the user is queried for actuator and high frequency dynamics data. Definition of the flight condition and specification of data which is flight condition dependent is managed by the "FLTCOND" knowledge base. This includes obtaining stability and control derivatives from file, "instantiation" of the bare airframe dynamics model and operation of Program CC to obtain the bare airframe dynamics. From this the bare airframe transfer functions are obtained. Assembly of the open-loop aircraft dynamics, which include the bare airframe, actuator and effective high frequency dynamics, using Program CC is managed by the "ASSESSOL" knowledge base which is consulted by FLTCOND. The "ASSESS" knowledge base performs a similar function during the actual FCS design steps.

C. LITERAL APPROXIMATE FACTORS FOR THE AIRPLANE CHARACTERISTICS

While the airplane equations of motion describe the balance of forces and moments which underlie the airplane's dynamic behavior, the behavior itself depends on the natural modes and dynamic scaling of excitations. The natural modes are the roots of the characteristic function, while the "dynamic scalings" of primary interest are the numerators of the various airplane transfer functions for control effector inputs. For lateral-directional control these are the gains, poles, and zeros of the airplane

transfer functions relating bank angle, ϕ , sideslip, β , and yawing velocity, r , to aileron and rudder. Unfortunately, because of the degree and complexity of the characteristic and some numerator polynomial equations, connections between the stability derivatives and the transfer function poles and zeros can often only be established in numerical terms. Then the development of trends between derivatives and poles/zeros can involve excessive numerical empiricism, and generalization is, therefore, tedious.

To counter this, approximate equations have been developed which relate the airplane characteristic modes and numerator factors directly to combinations of stability derivatives expressed in symbolic form. These literal approximate factors allow the analyst to capture the essence of pole and zero variation with stability derivatives. Even if the approximations are only qualitatively correct considerable insight is gained about the relative importance and influence of particular derivatives on the natural modes and dynamic scalings. To the extent that numerical values developed from the literal approximate factors are reasonably representative of the actual airplane poles and zeros, the connections between the stability derivatives and the poles and zeros become direct. One then has explicit symbolic formulae relating the airplane's derivatives with its modes, with the accompanying complete understanding of the origins of the bare airplane's dynamic behavior possibilities. Further, as will be seen later, the approximate factors can also serve to point the way for automatic control operations to correct deficiencies in particular modes. This article addresses the literal approximate factors for the example airplane.

1. Characteristic Equation Approximate Factors

Table 15 summarizes the approximate factors for the lateral-directional characteristic function. These are computed below using the stability axis stability derivatives from Table 8. The results are compared with the actual modes as also tabulated in Table 8. [Note that in the data base structure for the design methodology the derivative data inhabit cells in Table 11 while the characteristic modes are present in Table 12.

TABLE 15. APPROXIMATE FACTORS FOR LATERAL-DIRECTIONAL CHARACTERISTIC FUNCTION (STABILITY AXES)

FACTORED FORMS	APPROXIMATE FACTORS
$\Delta(s) = \left(s + \frac{1}{T_s}\right) \left(s + \frac{1}{T_R}\right) (s^2 + 2\zeta_d \omega_d s + \omega_d^2)$ <p style="text-align: center;">or</p> $(s^2 + 2\zeta_{SR} \omega_{SR} s + \omega_{SR}^2)$	$\omega_d^2 = N'_\beta$ $2(\zeta\omega)_d = -(Y_v + N'_\beta + N'_r) - \frac{L'_\beta}{N'_\beta} \left(N'_p - \frac{g}{U_o}\right)$ $\frac{1}{T_R} = -L'_p + \frac{L'_\beta}{N'_\beta} \left(N'_p - \frac{g}{U_o}\right)$ $\frac{1}{T_s} = T_R \frac{g}{U_o} \left(\frac{L'_\beta}{N'_\beta} N'_r - L'_r\right)$
	$\omega_{SR}^2 = \frac{g}{U_o} \left(\frac{L'_\beta}{N'_\beta} N'_r - L'_r\right)$ $2(\zeta\omega)_{SR} = -L'_p + \frac{L'_\beta}{N'_\beta} \left(N'_p - \frac{g}{U_o}\right)$

TABLE 16. LITERAL APPROXIMATE FACTORS -- DENOMINATOR

Config: real roll-spiral, complex dutch roll

Parameter Name	Parameter Type	Value	Units
ITS\$	realpole	-0.00485	rad/sec
ITR\$	realpole	0.427576	rad/sec
Zd\$	zeta	0.020201	--
Wd\$	omega	2.823295	rad/sec

Determination of LITERAL Pole Configuration

Omegas ²	-0.00207
Omegad ²	7.9524
Roll-spiral type	0 real
Dutch roll type	1 complex
Pole configuration	1 real roll-spiral, complex dutch roll
# real poles, LAF	2
# real poles, calc	2
Validity check 1	1 VALID

Lookup Tables

type code	type	Confgcode
0	real	0 4 real roots
1	complex	1 real roll-spiral, complex dutch roll
		2 complex roll-spiral, real dutch roll
0	INVALID	3 2 complex pairs
1	VALID	4 Undefined

The actual calculation of the approximate factors is accomplished and the results stored in Table 16 ("APPROX FACT" spreadsheet window and the comparison with exact factors is a subject of the next section). In the FCX flight control expert system (Volume 2), literal approximate factors are handled by the "FLTCOND" knowledge base.

a. Roll Subsidence Mode. (1/T_R)

Using the roll mode approximate factor from Table 15:

$$\begin{aligned} \frac{1}{T_R} &= -L'_p + \frac{L'_\beta}{N'_\beta} \left(N'_p - \frac{g}{U_o} \right) \\ &= -0.134 + \frac{-31.32}{7.97} \left(-0.0879 - \frac{32.2}{584} \right) \\ &= 0.428 \text{ rad/sec (vs. 0.427 rad/sec from} \\ &\quad \text{exact numerical factoring)} \end{aligned} \quad (3)$$

This example is somewhat unusual in that the "roll damping" derivative, L'_p, in stability axes is destabilizing (L'_p = 0.134 > 0). In FRL body axes it is low, but negative (L'_p = -0.374 < 0).*

Constraint of sideslip (transient coordination) may further degrade the roll subsidence mode. This can be verified for the limiting case of perfect coordination achieved by a very high gain, β → δ_r feedback:

$$\begin{aligned} \left. \frac{\phi}{\delta_a} \right|_{\beta \rightarrow \delta_r} &= \frac{N_{\delta_a}^\phi + G_{\beta}^{\delta_r} N_{\delta_a}^\phi \beta}{\Delta + G_{\beta}^{\delta_r} N_{\delta_r}^\beta} \rightarrow \frac{N_{\delta_a}^\phi \beta}{N_{\delta_r}^\beta} \\ &= \frac{0.1175(161.2)}{0.0179(-0.143)(0.356)(144.5)} \\ &\quad \frac{1/T'_s}{1/T'_R} \end{aligned} \quad (4)$$

*Ordinarily both the roll damping derivatives would be negative at low and moderate angles of attack. The loss of roll damping as reflected in the stability axis derivative is related to the decrease in wing C_L at high α. The effective roll damping increment which creates stability for the roll subsidence mode is due to roll-yaw coupling acting through the dihedral L'_β.

b. Dutch Roll Mode. (ζ_d, ω_d)

The undamped natural frequency, ω_d , is given by,

$$\begin{aligned}\omega_d & \doteq \sqrt{N'_\beta} = \sqrt{7.971} \\ & = 2.82 \text{ rad/sec (vs. 2.84 from numerical factoring)}\end{aligned}\quad (5)$$

The damping is,

$$\begin{aligned}2(\zeta\omega)_d & \doteq -(Y_v + N'_r) - \frac{L'_\beta}{N'_\beta} (N'_p - g/U_o) \\ & = -(-0.0868 - 0.5892) - \frac{-31.31}{7.971} (-0.08792 - 32.2/584) \\ & = 0.1141 \text{ rad/sec} \\ \zeta_d & \doteq 0.020 \text{ (vs. 0.0208 from numerical factoring)}\end{aligned}\quad (6)$$

The normally (low α) dominant yaw damping from $Y_v + N'_r$ is nearly offset by the relatively large L'_β/N'_β term. This is the sideslip coupling term which appears in the $1/T_R$ approximate factor, which essentially transfers damping from the Dutch roll to the roll subsidence mode. It is, in fact, the damping component which makes the roll subsidence stable for this flight condition.

c. Spiral Modes. ($1/T_s$)

The approximate factor for the spiral is

$$\frac{1}{T_s} \doteq T_R \frac{g}{U_o} \left[\frac{L'_\beta}{N'_\beta} N'_r - L'_r \right]$$

Using the approximate factor for T_R , this becomes

$$\begin{aligned}\frac{1}{T_s} & \doteq \frac{1}{(0.428)} \left[\frac{32.2}{584} \right] \left[\left[\frac{-31.32}{7.97} \right] (-0.5892) - 2.352 \right] \\ & = -0.00471 \text{ (vs. -0.00475 from numerical factoring)}\end{aligned}\quad (7)$$

For the example airplane the approximate factors for the characteristic function work very well even though the example was not contrived with this in mind. Ordinarily the approximations for the natural modes are generally representative of trends but could not (and are not intended to) serve as an alternative to actually factoring the lateral-directional quadratic as this case might indicate.

When the Table 15 literal approximate factors are seriously deficient there is still hope for developing fairly explicit connections between the derivatives and the modes. The first step is to examine other, more specialized approximate factor formulations, such as those derived from simplified equations for the several modes in Ref. 1. If this fails one can resort to time-vector diagrams (see, e.g., Ref. 1) to determine the most important terms in the equations of motion for each mode. This approach examines the eigenvectors and equations of motion for each of the characteristic modes of the airplane. To provide a graphical and highly insightful presentation, "phasors" for eigenvector ratios are used to characterize the relative motions of the airplane's degrees of freedom, and each of the airplane's equations for each characteristic mode are represented by time vector diagrams. From these plots the analyst can gain a qualitative appreciation of the relative importance of each term in the equations of motion for each characteristic mode. Further, the quantitative importance of a particular stability derivative can be seen. This leads to an impression of the relative significance of particular derivatives and of the most important factors to be viewed as key uncertainties. Finally, the time vector diagrams provide the basis for simplifying the equations of motion, if such simplification is appropriate to develop an understanding of a particular point, and for the subsequent straightforward development of literal approximate factors. Usually, however, the time vectors themselves will permit the analyst to gain sufficient appreciation of the physical origins of the aircraft poles in terms of fundamental properties.

2. Numerator Approximate Factors

Table 17 lists some of the more important airplane numerator approximate factors for aileron and rudder inputs. Notable for their absence in this compilation are approximations for yawing velocity numerators. These numerators are cubics which, across a wide variety of aircraft, exhibit almost all possible forms. They can be three first orders with one or two negative roots, or first order plus quadratic with the possibility that either the first order or the quadratic damping have negative signs. Because of this wide variety of possibilities there are several literal approximate factor possibilities (see, e.g., Refs 1, 12), but because these tend to be specialized we have not presented them here. Also not presented are coupling numerators because these are usually low-order and simple enough in their symbolic form (see Table 6-3, Ref. 1).

For illustrative purposes typical examples will be computed below and compared with the actual results from factoring the complete transfer functions tabulated in Table 8. Just as with the characteristic function approximate factors these steps in the design methodology are actually accomplished within the data base structure. Thus, the derivative data are in cells in Table 11, the exact numerator factors are in Table 13 (via the mediation of an analysis program, such as Program CC, to accomplish the factoring), and the actual calculation and storage of the approximate factors is in Table 18. Finally, the comparison of approximate and exact factors is carried out within the data base as an operation in the next section.

a. Roll-Due-to-Lateral Controller

The roll numerator for aileron inputs is usually a quadratic dipole with an undamped natural frequency which is fairly close to the Dutch roll

TABLE 17. APPROXIMATE FACTORS FOR LATERAL-DIRECTIONAL NUMERATORS (STABILITY AXES)

FACTORED FORMS	APPROXIMATE FACTORS
$N_{\delta_a}^{\phi}(s) = A_{\phi}(s^2 + 2\zeta_{\phi}\omega_{\phi}s + \omega_{\phi}^2)$	$A_{\phi} = L'_{\delta_a}$ $\omega_{\phi}^2 = N'_{\beta} \left[1 - \frac{N'_{\delta_a} L'_{\beta}}{L'_{\delta_a} N'_{\beta}} \right]$ $2\zeta_{\phi}\omega_{\phi} = -(Y_v + N'_r) + \frac{N'_{\delta_a}}{L'_{\delta_a}} L'_r$
$N_{\delta_a}^{\beta}(s) = A_{\beta} \left(s + \frac{1}{T_{\beta_1}} \right) \left(s + \frac{1}{T_{\beta_2}} \right)$	$A_{\beta} = -N'_{\delta_a}$ $\frac{1}{T_{\beta_1}} = \left(\frac{g}{U_o} \right) \frac{L'_r - (L'_{\delta_a} / N'_{\delta_a}) N'_r}{L'_p - (L'_{\delta_a} / N'_{\delta_a}) [N'_p - (g/U_o)]}$ $\frac{1}{T_{\beta_2}} = -L'_p + \frac{L'_{\delta_a}}{N'_{\delta_a}} \left(N'_p - \frac{g}{U_o} \right)$

Aileron Numerators

TABLE 17. (CONCLUDED)

FACTORED FORMS	APPROXIMATE FACTORS
$N_{\delta_r}^{\beta}(s) = A_{\beta} \left(s + \frac{1}{T_{\beta_1}} \right) \left(s + \frac{1}{T_{\beta_2}} \right) \left(s + \frac{1}{T_{\beta_3}} \right)$	$A_{\beta} = Y_{\delta_r}^*$ $\frac{1}{T_{\beta_3}} = -\frac{N'_{\delta_r}}{Y_{\delta_r}^*}$ $\frac{1}{T_{\beta_1}} + \frac{1}{T_{\beta_2}} = -L'_p + \frac{L'_{\delta_r}}{N'_{\delta_r}} \left(N'_p - \frac{g}{U_o} \right)$ $\frac{1}{T_{\beta_1} T_{\beta_2}} = -\frac{g}{U_o} L'_r \left[1 - \frac{L'_{\delta_r} N'_r}{N'_{\delta_r} L'_r} \right]$
<p>General:</p> $N_{\delta_r}^{a_y}(s) = A_{a_y} \left(s - \frac{1}{T_{a_y1}} \right) \left(s + \frac{1}{T_{a_y2}} \right) \times (s^2 + 2\zeta_{a_y} \omega_{a_y} s + \omega_{a_y}^2)$ <p>or</p> $\left(s + \frac{1}{T_{a_y3}} \right) \left(s + \frac{1}{T_{a_y4}} \right)$ <p>where a_y sensor is located x feet ahead of the center of gravity</p>	$A_{a_y} = Y_{\delta_r} + x_a N'_{\delta_r}$ $\frac{1}{T_{a_y1}} = \frac{g}{U_o} \left[\frac{L_r}{L_p} - \frac{N_r (Y_v L_{\delta_r} - Y_{\delta_r}^* L_{\beta})}{L_p (Y_v N_{\delta_r} - Y_{\delta_r}^* N_{\beta})} \right]$ $\frac{1}{T_{a_y2}} = -L_p$ $\omega_{a_y}^2 \text{ or } \frac{1}{T_{a_y3} T_{a_y4}} = \frac{U_o}{\Delta x_a N'_{\delta_r}} (Y_{\delta_r}^* N_{\beta} - Y_v N_{\delta_r})$ $2\zeta_{a_y} \omega_{a_y} \text{ or } \frac{1}{T_{a_y3}} + \frac{1}{T_{a_y4}} = -\frac{Y_{\delta_r}}{\Delta x_a (N'_{\delta_r})^2} \times (Y_{\delta_r}^* N_{\beta} - Y_v N_{\delta_r})$
<p>At the center of rotation:</p> $N_{\delta_r}^{a'}(s) = B_{a_y} \left(s - \frac{1}{T_{a_y1}} \right) \left(s + \frac{1}{T_{a_y2}} \right) \left(s + \frac{1}{T_{a_y3}} \right)$	$B_{a_y} = Y_{\delta_r} \left[-N'_r + Y_v - \frac{Y_{\delta_r}}{N'_{\delta_r}} N'_v \right]$ $\frac{1}{T_{a_y3}} = \frac{-U_o (Y_r N'_{\delta_r} - Y_{\delta_r} N'_r)}{Y_{\delta_r} \left[-N'_r + Y_v - \frac{Y_{\delta_r}}{N'_{\delta_r}} N'_v \right]}$

Rudder Numerators

OPTIMUM VALUE IS
OF ROCK QUALITY

**TABLE 18. APPROXIMATE FACTOR CALCULATIONS
IN SPREADSHEET WINDOW**

Out	In	Parameter Type	Stability Axis Parameter Name	Value	Units
B	da	RLgain	KBda\$	-0.3064	rad/rad
B	da	realroot	ITBda1\$	0.258067	rad/sec
B	da	realroot	ITBda2\$	-3.20139	rad/sec
PHI	da	RLgain	KPHida\$	6.589	rad/rad
PHI	da	zeta	ZPHida\$	0.127920	--
PHI	da	omega	WPHida\$	3.071058	rad/sec
B	dr	RLgain	KBdr\$	0.0179	rad/rad
B	dr	realroot	ITBdr1\$	-0.14363	rad/sec
B	dr	realroot	ITBdr2\$	0.355494	rad/sec
B	dr	realroot	ITBdr3\$	-144.301	rad/sec

undamped natural frequency. An appropriate approximate factor in this connection is,

$$\begin{aligned} \frac{\omega_\phi}{\omega_d} &= \sqrt{1 - \frac{N'_{\delta a}}{L'_{\delta a}} \cdot \frac{L'_{\beta}}{N'_{\beta}}} \quad (\text{stability axes}) \\ &= \sqrt{1 - \frac{0.306}{6.57} * \frac{-31.3}{7.97}} \\ &= 1.088 \quad (\text{vs. } 1.085 \text{ from numerical factoring}) \end{aligned} \quad (8)$$

Thus, for the usual positive "lateral stability" associated with positive dihedral effect ($L_{\beta}' < 0$) and positive "directional stability" ($N_{\beta}' > 0$) the $\omega_\phi/\omega_d > 1$ characteristic may be traced to proverse yaw-due-to-lateral control effector ($N'_{\delta a} > 0$).

At higher angles-of-attack, the directional stability as measured by N'_{β} will become less stable, even negative. This can cause ω_ϕ^2 itself to become negative giving rise to a right half plane zero in the roll numerators, which can lead to very serious control difficulties. Although this effect is not necessary to consider for the point design example it must be borne in mind in considering the final system architecture.

The damping term of the roll numerator is approximated from

$$\begin{aligned} 2\zeta_\phi \omega_\phi &= -(Y_v + N'_r) + \frac{N'_{\delta a}}{L'_{\delta a}} L'_r \\ &= -(-0.0868 - 0.5892) + \frac{0.3064}{6.569} 2.352 = 0.786 \\ \zeta_\phi &= \frac{0.786}{2(1.088)(2.82)} = 0.128 \quad (\text{vs. } 0.1275 \text{ from numerical factoring}) \end{aligned} \quad (9)$$

Here the yaw damping derivative N'_r is more effective than in ζ_d , as it is not offset by the $(L_{\beta}'/N_{\beta}')(N'_p - g/U_0)$ terms.

b. Sideslip-Due-to-Rudder

As a second example of numerator approximate factors, consider the sideslip to rudder transfer function. The largest factor is,

$$\frac{1}{T\beta_3} = \frac{N'_{\delta_r}}{Y^*_{\delta_r}} \quad (10)$$

$$= \frac{-2.583}{0.0179} = 144.3 \quad (\text{contrasted with } 144.5 \text{ from factoring})$$

The other two factors are often quite close together in magnitude. They are, accordingly, treated as a sum and product of inverse time constants which can then be separately determined with the quadratic formula. Thus,

$$\begin{aligned} \frac{1}{T\beta_1} + \frac{1}{T\beta_2} &= -L'_p + \frac{L'_{\delta_r}}{N'_{\delta_r}} \left(N'_p - \frac{g}{U_o} \right) \\ &= -0.13435 + \frac{6.251}{-2.583} \left[-0.08792 - \frac{32.2}{584} \right] \\ &= 0.2118 \text{ rad/sec} \end{aligned} \quad (11)$$

$$\begin{aligned} \frac{1}{T\beta_1 T\beta_2} &= -\frac{g}{U_o} L'_r \left[1 - \frac{L'_{\delta_r} N'_r}{N'_{\delta_r} L'_r} \right] \\ &= -\frac{32.2}{584} (2.352) \left[1 - \frac{(6.251)(-0.5892)}{(-2.583)(2.352)} \right] \\ &= -0.05106 \text{ (rad/sec)}^2 \end{aligned} \quad (12)$$

$$\frac{1}{T\beta_1} = 0.355; \quad (\text{vs. } 0.356 \text{ from factoring})$$

$$\frac{1}{T\beta_2} = -0.144; \quad (\text{vs. } -0.143 \text{ from factoring}) \quad (13)$$

3. Aircraft Characteristics at Other Flight Conditions

One of the great advantages of literal approximate factors is their ability to explicitly show the effects of changes in flight condition. The dimensional derivatives vary directly with density, ρ , times speed, U , or with dynamic pressure, q , so these variations are readily apparent for a particular approximate factor. For example, the Dutch roll undamped natural frequency, ω_d ,

$$\omega_d = \sqrt{N'_\beta} \quad (14)$$

$$= \left[\frac{qSb \left(C_{n\beta} + \frac{I_{xz}}{I_x} C_{l\beta} \right)}{I_z \left(1 - \frac{I_{xz}^2}{I_x I_z} \right)} \right]^{1/2}$$

So

$$\omega_d = \sqrt{q}$$

The primed dimensional derivative N'_β also varies with the dimensionless derivatives $C_{n\beta}$ and $C_{l\beta}$, and with the product of inertia. These quantities all vary with angle of attack, and the dimensionless derivatives may also vary with Mach number.

The flight condition examined here is at 1 g load factor and moderately high angle of attack. Fighters in combat maneuvering will routinely operate at much higher load factors. The first-order effect will be an increase in angle of attack (AOA) with some generic effects that can be anticipated. The dominant effect as AOA increases is a progressive loss of (aerodynamic) directional stability. This is reflected in the stability axis N'_β derivative, which is reduced from a large stable (positive) value through zero to negative values. As can be seen from the approximate factors, the dominant effect on the aircraft dynamics is that the Dutch roll frequency is reduced, usually with minor effect on the total damping, until the mode decomposes into two (low frequency) real roots for

$N\dot{\beta} \neq 0$. As directional stability is further degraded with increasing AOA, the two real roots separate with one moving into the right half plane to generate an aperiodic divergence.

As already noted, the complex roll-due-to-aileron zeros undergo a similar transformation with increasing AOA. The numerator "undamped natural frequency" term ω_ϕ^2 ultimately becomes negative with one zero moving into the right half plane. This zero then creates a roll reversal characteristic in the roll control response. The combination of right-half-plane zeros with rhp poles creates a very difficult and interesting flight control problem.

SECTION IV

IDENTIFICATION OF LATERAL-DIRECTIONAL CONTROL PROBLEMS DUE TO THE AIRPLANE

At this stage the example aircraft characteristics developed in Section III can be compared with many of the mission-based requirements from Section II to define some of the basic aircraft-centered control problems. This will be done below, starting with the path and heading control problems common to the pilot and automatic flight guidance equipment. Then the flying qualities deficiencies of the bare airplane will be examined by comparing the airplane characteristics with the minimum requirements.

A. GENERAL PATH AND HEADING CONTROL PROBLEMS

By transferring the aircraft characteristics from the data base into a controls analysis program (e.g., Program CC), the tabular data can be given more visual and insightful life as response plots. A survey of the aircraft response characteristics to lateral control, δ_a , is shown in Fig. 12. The survey includes pole-zero plots and $j\omega$ -Bode diagrams for sideslip, bank angle, and the FRL-oriented yawing velocity. The transient responses show the same variables plus flight path rate when the airplane is excited by an aileron impulse. The key points indicated by the survey include:

- The very lightly damped dutch roll mode is dominant in the sideslip and FRL rolling velocity responses, while it is scarcely perceptible in the yaw and path rates and bank angle motions. The reasons for these effects are clearly shown by the nearly cancelling quadratic pairs in the bank angle and yaw rate root and Bode plots. For the given input these outputs are practically non-observable.

Conclusion: FRL yaw rate and bank angle feedbacks to aileron are not suitable to correct dutch roll difficulties.

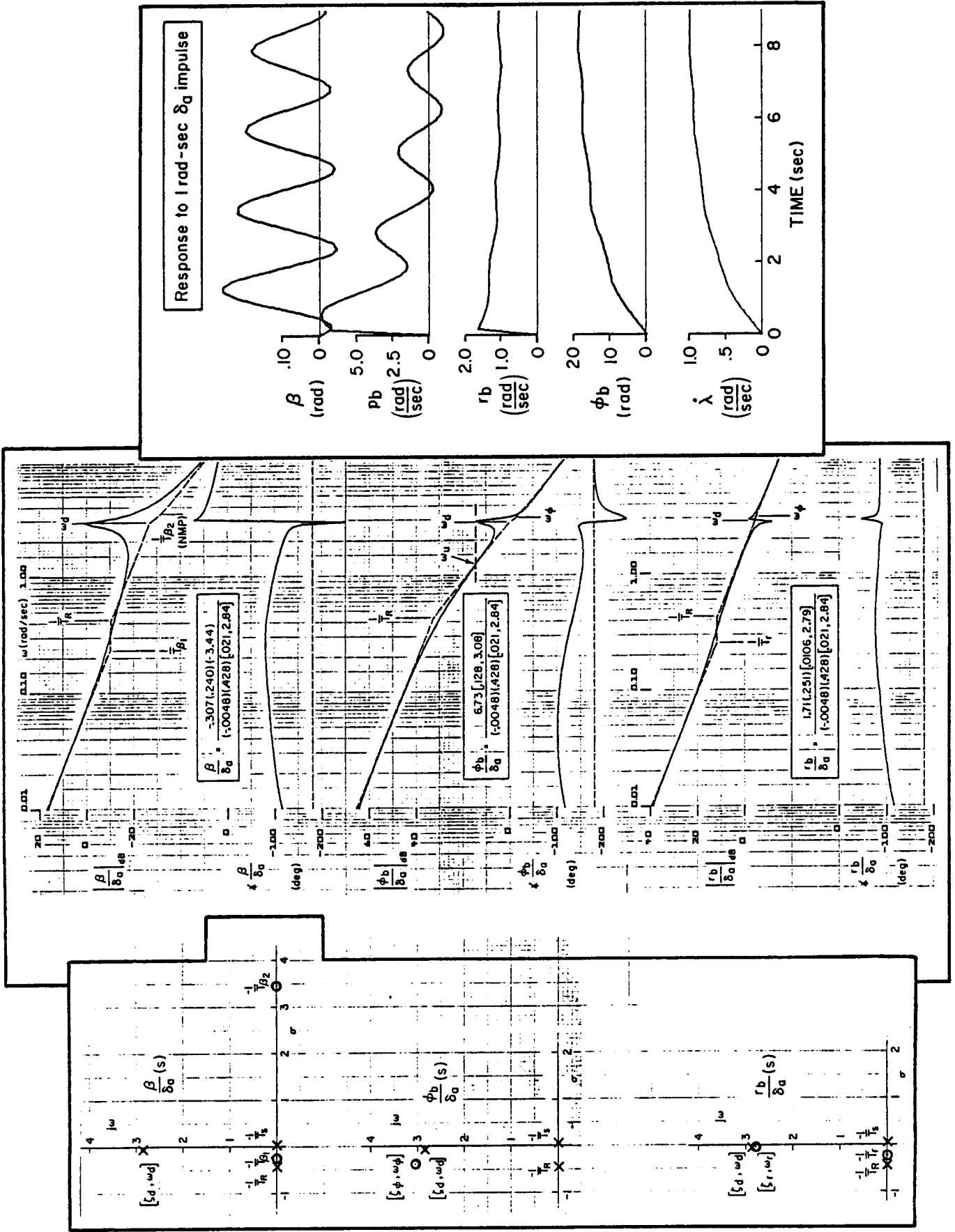

Figure 12. Survey of Bare Aircraft Response to Roll Control

- The bank angle and path rate responses are closely proportional to one another, and reflect primarily the roll subsidence mode.

Conclusion: Bank angle may be a good surrogate for lateral path rate.

- The pole/zero separation in the $[\zeta_\phi, \omega_\phi]/[\zeta_d, \omega_d]$ dipole evidenced by $\omega_\phi/\omega_d > 1$ and $\zeta_\phi/\zeta_d > 1$ produces the large dutch roll residue in FRL rolling velocity (p_b) responses to roll controller input.

Conclusion: FCS designs should be such as to effectively decouple the rolling velocity mode from dutch roll by reducing the separation of the dipole terms.

- A closed-loop pure gain bank angle-to-aileron control law will have a maximum (neutrally stable) crossover frequency (bandwidth) less than $\omega_u \doteq 1.25$ rad/sec.

Conclusion: Pure gain bank angle lateral controllers are severely limited in attainable bandwidth by unfavorable $\omega_\phi/\omega_d > 1$.

The bare airplane dynamic characteristics which affect a bank-to-turn design are revealed by considering the path response to command after a generic high (but finite) bandwidth roll control system has been established. As indicated in Fig. 13, this shows the potential of high bandwidth FCS in which the inner loop dynamics are dominated by the FCS control law design and airplane control effectiveness (within the control power limitations) rather than aerodynamics. The roll response to roll commands approach

$$\frac{\phi}{\phi_c} \rightarrow 1; \quad \omega < \omega_{b\phi} \tag{15}$$

where $\omega_{b\phi}$ is the roll command bandwidth.

Over this same bandwidth the roll command will result in a path rate response given by the ratio of numerators $N_{\delta_a}^\lambda / N_{\delta_a}^\phi$. At frequencies lower than the smaller of ω_λ and ω_ϕ , and assuming that the aileron-induced side-force coefficient $Y_{\delta_a}^* \doteq 0$, the path response to roll command approaches,

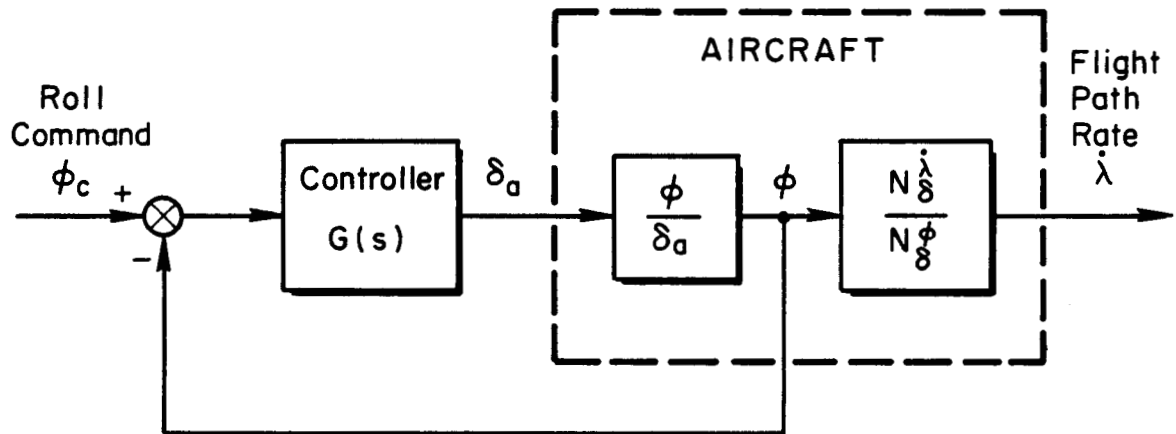

$$\left. \frac{\dot{\lambda}}{\phi_c} \right|_{\phi \rightarrow \delta_a} = \left[\frac{GN \dot{\delta}}{\Delta + GN \phi} \right] \frac{N \dot{\delta}}{N \phi}$$

$$\rightarrow \frac{N \dot{\delta}}{N \phi} \quad (\text{at high gain } \left| G \frac{\phi}{\delta_a} \right| \text{ large})$$

Figure 13. Generic Roll Control System for Path Control

$$\left. \frac{\dot{\lambda}}{\phi_c} \right|_{\phi \rightarrow \delta_a} \rightarrow \frac{N \dot{\delta}}{N \phi} = \frac{g}{U_0}; \quad \omega < \omega_{b\phi}, \omega_{\phi}, \omega_{\lambda} \quad (16)$$

This is the steady turn relation already noted in connection with the heading control requirements discussion in Section II. It indicates that if the turning maneuver is perfectly coordinated and a high bandwidth roll control system can be implemented, there would be no intrinsic path control problem for bank-to-turn operation beyond the control power issues noted previously.

Next the assumption of perfect coordination is relaxed so that the unconstrained sideslip degree-of-freedom is again included. The limiting response to roll command (without rudder input) with a generic high gain

roll control system (Fig. 13) is summarized in Fig. 14. The path response is

$$\begin{aligned}
 \left. \frac{\dot{\lambda}}{\phi} \right|_{\phi \rightarrow \delta_a} &= \frac{GN_{\delta_a}^{\dot{\lambda}}}{\Delta + GN_{\delta_a}^{\phi}} \rightarrow \frac{N_{\delta_a}^{\dot{\lambda}}}{N_{\delta_a}^{\phi}} \\
 &\rightarrow \frac{A_{\lambda}[\zeta_{\lambda}, \omega_{\lambda}]}{A_{\phi}[\zeta_{\phi}, \omega_{\phi}]} \\
 &= \frac{0.388[0.0865, 2.96]}{6.56[0.1275, 3.08]}
 \end{aligned} \tag{17}$$

As expected, at very low frequencies this approaches

$$\left. \frac{\dot{\lambda}}{\phi} \right|_{\phi \rightarrow \delta_a} \rightarrow 0.055 \text{ (rad/sec/rad)} = \frac{g}{U_0}$$

Thus, the steady-state $\left. \frac{\dot{\lambda}}{\phi} \right|_{\phi \rightarrow \delta_a}$ response is again consistent (for small ϕ) with the more general steady coordinated turn relation

$$\dot{\lambda} = \frac{g}{U_0} \tan \phi \tag{18}$$

At this level of approximation: the closed-loop roll subsidence mode ($1/T_R'$) is the governing factor in the roll loop bandwidth $\omega_{b\phi}$ and can be considered to be large (i.e., roll response is "instantaneous" compared with heading change);* the spiral is a pole (kinematic integration) at the origin; and the dutch roll mode goes to the roll zero $[\zeta_{\phi}, \omega_{\phi}]$. The effective dutch roll damping ratio of the closed-loop roll control system,

$$\zeta_d = \zeta_{\phi} = 0.1275$$

*The prime on T_R' indicates that one loop has been closed and that the roll subsidence has been modified thereby from T_R to T_R' . A prime is added for each loop closure which affects a factor present in an open-loop dynamic model.

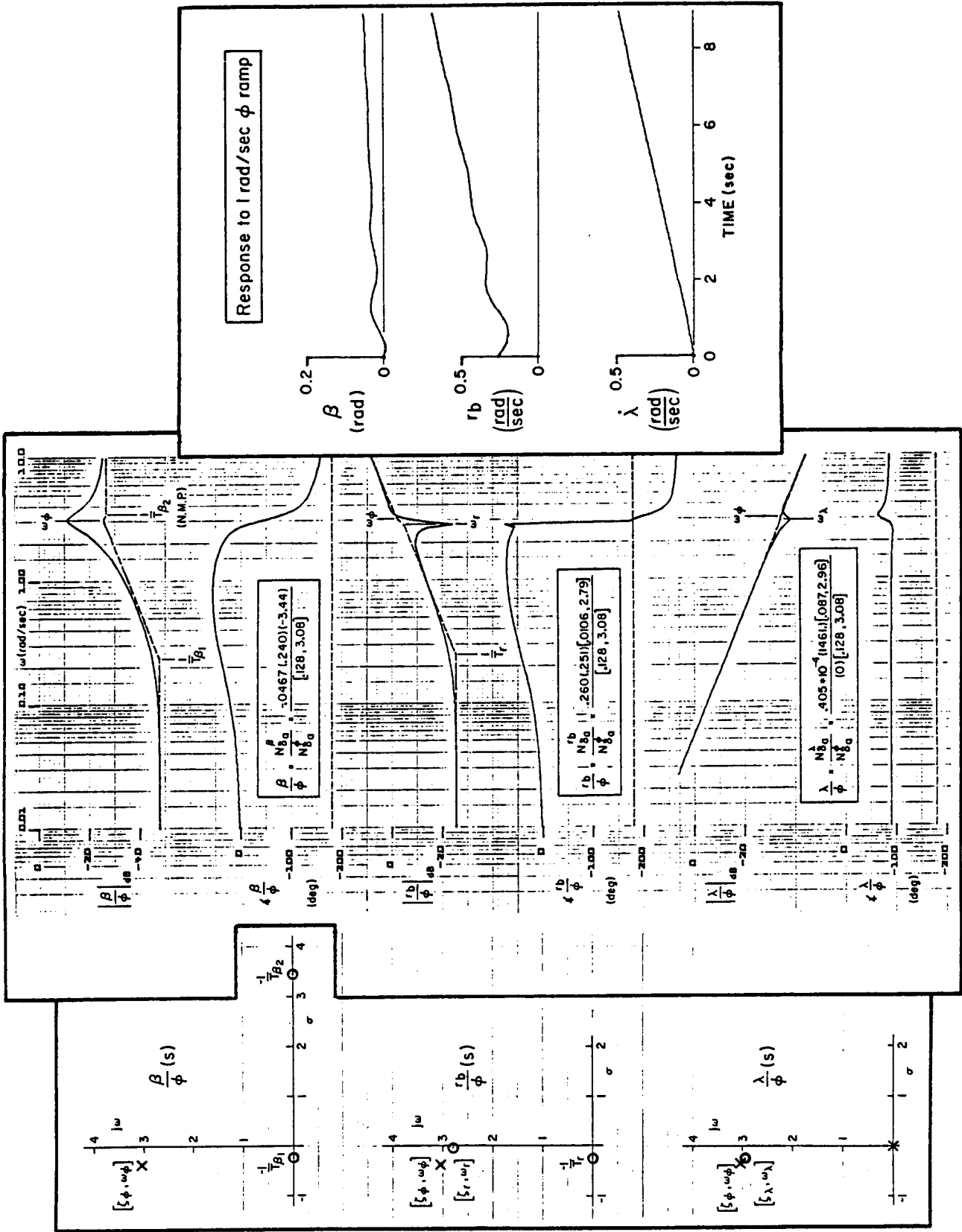

Figure 14. Survey of Response to Roll Command with High Gain $\phi \rightarrow \delta a$

would be improved over the bare airframe ($\zeta_d = 0.021$), but would still be Level 2 in terms of MIL-C-8785C. However, as revealed by the near absence of any dutch roll in the λ time history as well as the root and Bode plots, the dutch roll residue in λ is small due to the typical near cancellation of the $\omega_\lambda/\omega_\phi$ dipole. The $|\lambda/\phi|$ Bode plot shows that the $\omega_\lambda/\omega_\phi$ dipole is minor and favorable such that the path response to roll command closely approaches an ideal K/s-like form over an extensive frequency range, thereby not limiting any reasonable outer (path) loop crossover. Thus, there are no path control problems due to the airplane characteristics once an adequate roll control system is achieved.

While good control of path rate can be achieved with roll control alone, it will be seen in the next section (e.g., Fig. 18) that the dutch roll cannot be significantly modified with aileron based control action. Therefore, at higher frequencies near and including the dutch roll, there can be significant sideslip and attendant uncoordination without additional FCS elements. This will cause flying qualities and tracking problems due to sideslip and yawing velocity excitation at the dutch roll.

B. GENERAL ROLL CONTROL PROBLEMS

To this point, the path and heading problem has been examined without consideration of the details of the roll and yaw dynamics. To start, the roll response to the control effectors will now be addressed. This provides a preview of the response to the pilot's controllers (stick and rudder pedals). The roll response to aileron, assuming perfect coordination (from Table 6 equations with $\beta = 0$ and $\alpha_0 = 0$ for stability axes) is

$$\frac{\phi}{\delta} = \frac{L'_\delta}{s^2 - L'_p s - L'_r (g/U_0)} \quad (19)$$

$$= \frac{6.57}{(+0.299)(-0.433)} \quad (20)$$

$1/T_R \quad 1/T_S$

In this ideal situation, only the roll and spiral modes are present, but the spiral, as expected, has become much more unstable. Despite this,

bank angle feedback to roll control with lead compensation to offset the $1/T_R$ lag could provide adequate roll control for either an automatic system or a pilot in continuous control. However, this would not be desirable for human pilot operations because the pilot generated lead ($T_L \doteq T_R \doteq 3.3$ secs; from Eq. 14, Supplement 3) would be far too large and the spiral is too unstable for unattended operation to be practical.

Without any sideslip constraints the system survey for the pure gain roll controller of Fig. 15 indicates that, while the spiral mode causes no control difficulties, the dutch roll dipole limits stable crossover frequencies to values below about 1 rad/sec. This stems from the proximity of the dipole to the right half plane, and from the pole-zero order ($|\omega_\phi/\omega_d| > 1$), which results in the phase "dip" at the dipole.

The attainable response time for a pure gain controller adjusted to give a dominant mode of [0.7, 0.3] would be greater than 14 seconds, which is far too slow for good roll control.

C. PILOT CONTROL PROBLEMS

The basic path and roll control issues treated above are generic, and apply to both piloted and automatic control. Because the pilot has workload and attentional limitations as a controller, aircraft flying qualities considerations become central in manual control of effective airplane dynamics which are "inner loop" features from the path control standpoint. Fortunately, the Section II requirements set by flying qualities specifications and pilot-vehicle considerations provide some quantitative guidance on the values of many of the particular aircraft features which have already been raised as generic control problems. This permits some of the airplane's deficient dynamic properties to be directly identified and quantitatively tied down.

All of the airplane's natural modes fall into this framework. The characteristic function (denominator) of Table 8 provides all the necessary information.

Spiral (s - 0.00475): This is slightly unstable, but with a time to double amplitude of 146 sec easily meets the MIL-F-8785C

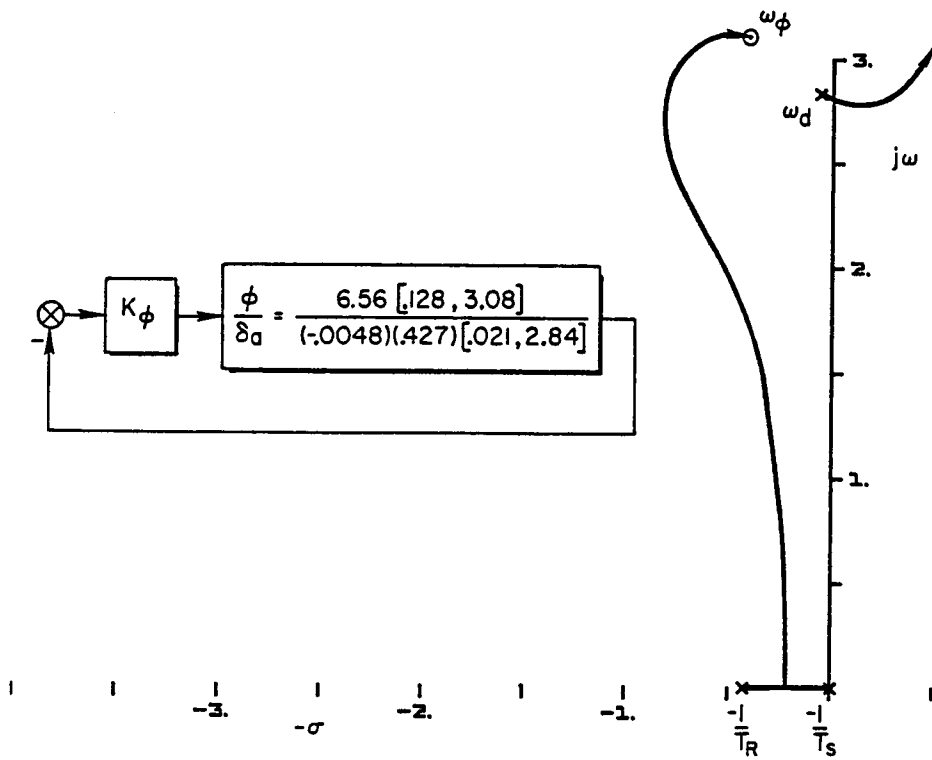

a) Conventional Root Locus

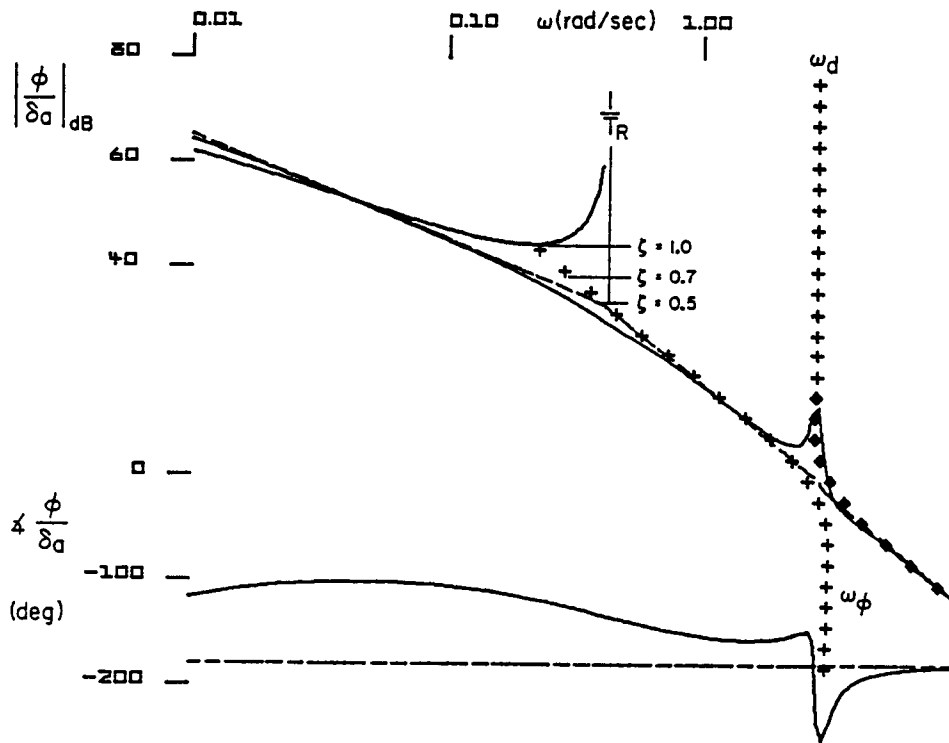

b) $j\omega$ -Bode and Bode Root Locus

Figure 15. System Survey of Pure Gain $\phi \rightarrow \delta_a$ Closure Around Bare Aircraft

Level 1 requirements for CO ($T_2 > 12$ sec) and also for Category B flight ($T_2 > 20$ sec). Further, it is not coupled with the roll mode. A slightly unstable spiral mode is not unusual, and is only a problem for unattended operation (manual control). If outer loop bank angle control is implemented, the spiral will be stabilized even at quite low gains.

Roll Subsidence ($s + 0.427$): The time constant ($T_R = 2.34$ sec) is very high and is MIL-F-8785C Level 3 -- a serious deficiency for a fighter. It should be no greater than 1 sec to be Level 1 for the CO mission phase.

Dutch Roll Mode [$(s^2 + 2(0.0208)2.84s + 2.84^2)$]: The frequency of this mode is adequate (i.e., greater than 1 rad/sec), but the damping ratio is unacceptably low -- almost Level 3. The minimum required is $\zeta_d \geq 0.4$.

D. SUMMARY OF AIRPLANE DYNAMIC SHORTCOMINGS AND EQUALIZATION NEEDS

In the discussion above the airplane has been examined as a source of problems in path and heading control, bank angle control, and flying qualities. The example airplane characteristics developed in Section III have been compared with the requirements of Section II to expose several major shortcomings which will have to be corrected by the flight control system. [All of this has been verbalized in the discussion whereas in the design methodology the comparisons between requirements and characteristics are accomplished within the data base elements -- see Table 4] There are, of course, some comparisons which cannot easily be put into quantitative terms. Therefore, while it may be somewhat repetitive, the following paragraphs will summarize the general equalization requirements which any flight control system design will have to satisfy for the example airplane. These will be presented in an order which starts with the effective airplane as presented to the pilot (basically stability augmentation or FCS inner loop equalization requirements) and progresses to guidance (outer loops) considerations.

1. Modes to Change to Meet Flying Qualities Requirements

Dutch roll -- increase damping ratio (to 0.4 or greater)

Roll mode -- reduce time constant (to 1 second or less)

2. Dynamic Coordination for Piloted Inputs to Lateral Controller

A basic desire for lateral piloted control is to establish a rolling velocity response proportional to the pilot's input to the lateral controller which: approximates a first-order system (dominated by the effective roll subsidence mode); is uncontaminated by dutch roll mode effects; and is ideally nearly free of transient sideslip. If the flight control system employs rolling and yawing velocities and sideslip feedbacks to the rudder (or effective directional control effector combinations) and also incorporates a crossfeed from the lateral to the directional controller, the control law will be,

$$\delta_r = -G_r r - G_p^r p - G_\beta \beta - G_{\delta_a}^r \delta_a \quad (21)$$

Then the effective sideslip to lateral controller numerator transfer function will be

$$N_{\delta_a}^{\beta} \Big|_{\text{eff}} = N_{\delta_a}^{\beta} + G_r N_{\delta_a}^{\beta r} + G_p^r N_{\delta_a}^{\beta p} + G_{\delta_a}^r N_{\delta_r}^{\beta} \quad (22)$$

The r , p , and β feedbacks are typically used to adjust features other than coordination, such as the dutch roll damping and undamped natural frequency, although they may also be useful in enhancing the maneuver coordination. The $\delta_a \rightarrow \delta_r$ crossfeed is usually the last addition made to the system, and then only when needed. To achieve ideal perfect coordination in rolling maneuvers executed by lateral controller action, the ideal crossfeed is,

$$G_{\delta_a}^{\delta_r} = \frac{N_{\delta_a}^{\beta} + G_r N_{\delta_a}^{\beta r} + G_p^r N_{\delta_a}^{\beta p}}{N_{\delta_r}^{\beta}} \quad (23)$$

This ideal $G_{\delta_a}^{\delta_r}$ crossfeed is a useful measure of coordination needs even when a crossfeed is not physically present in the FCS. It indicates, for instance, what the pilot must do with rudder to coordinate rolling maneuvers. Equation 23 is fairly complex expression (a third-order over

third-order in the simplest case), which can vary a great deal with flight condition (all of the N's are airplane numerators). However, when attention is paid to coordination as a secondary requirement in selecting the G_r and G_p feedbacks, an approximation adequate for excellent coordination is usually achieved by nothing more complicated than a lead/lag or lag/lead.

3. Loops to Improve Effective Numerators

The roll-to-aileron numerator damping ratio should be increased and the separation of the effective $[\zeta_\phi, \omega_\phi]/[\zeta_d, \omega_d]$ dipole should be minimized. No loops are required to improve effective numerators for the outer loop variables of path or heading.

4. Inner Loops to Adjust for Outer Loops

Control of heading and lateral path angle requires a tight roll loop closure. In turn, the roll loop requires inner yaw loops and/or cross-feeds to maintain transient coordination, and to minimize dutch roll artifacts. A rolling velocity to lateral controller loop can act as needed roll axis equalization for both piloted and automatic roll control purposes.

5. Series Compensation

In all cases, elementary lead/lag or lag/lead type compensation will suffice. Series compensation is possibly required in the inner roll (rolling velocity loop), and yaw axis loops (for such things as low-frequency washout). For the bank angle automatic control loop, the inner rolling velocity closure common to both auto and manual control may be sufficient to permit a tight high bandwidth bank angle closure. A lead/lag series equalization may be desirable to offset flight conditions where the higher frequency airplane, actuator, and sensor lag terms build up.

SECTION V

PROSPECTUS FOR LATERAL-DIRECTIONAL FLIGHT CONTROL SYSTEM ARCHITECTURE

The previous sections have developed the system requirements, examined the airplane's dynamic properties, and compared these with the requirements. In the comparison several airplane characteristics were found wanting. The correction of these inadequacies is a central flight control system design problem which must be solved for either manual or automatic control. A major leg up on the solution has also been accomplished in that the sources and governing parameters which define the airplane-specific control problems have been identified. That is, the dynamic characteristics have been related to the airplane's stability and control parameters via literal approximate factors. Success with this step leads directly to an appreciation for:

- possibilities for the adjustment of particular aircraft modes by stability augmentation using an "equivalent derivative" approach;
- sensitivity to uncertainties in airframe parameters (i.e., non-dimensional stability and control derivatives and mass properties);
- variation in airframe parameters over the flight envelope -- primarily due to $\rho(h)$, M , α , and U_0 variations.

Correction of the aircraft-centered problems by means of the flight control system is a necessary step in the flight control design process. Unfortunately literal approximate factors do not always work out as well as in the example, so supplementary approaches are needed. The description and illustration of these approaches make up part of this section. Control system principles are used in the process, but the focus is usually on the special features of airplanes as dynamic elements, not as general "controlled elements". Correcting the airplane's deficiencies to create a superior set of "effective airplane" characteristics is an aspect which separates flight control system design from control system design in general. It stems from the nature of manned airplanes as objects of both manual and automatic control.

After the airplane's problems have been corrected via control means, the other central FCS problem, that of appropriate automatic guidance, can be addressed. This is accomplished following general control system design principles and procedures and is not as closely dependent on the airplane's peculiar dynamics. This follows because the feedbacks needed to provide good flying qualities also result in good inner loops for outer-loop automatic control. These inner loops provide appropriate "parallel equalization" on which to base the guidance loops regardless of whether they are mechanized by automatic equipment or formulated internally by the pilot.

This section treats the initial layout of architectural possibilities for the solution of the problems identified previously. The first article describes, in outline form, equalization requirements for control systems in general. The second article is also somewhat general in character, but is directed specifically to flight control. It describes the elements of the flight control system design prospectus. Where possible summary tables of prospectus topics are provided. Finally, the third article illustrates the application of the prospectus topics to the example airplane.

A. EQUALIZATION REQUIREMENTS FOR CONTROL SYSTEMS IN GENERAL

As a prelude to the development of possible FCS architecture, the overall system requirements, operational environment, unalterable element characteristics, etc., are viewed as a framework from which to consider feedback and equalization requirements in general. As noted in the introduction, there are three major considerations:

1. The ultimate outer-loop which involves the desired output variable or its surrogate, must have appropriate equalization to meet the overall system requirements. This implies that the closed-loop system exhibit:
 - Adequate low-frequency steady-state error responses.
 - Specified closed-loop system dominant mode characteristics (for example, bandwidth and damping needed for disturbance suppression, and for the closed-loop dynamics portion of the command/response relationship).

- Specified low-frequency command/response relationships (for example, suitable input, feedback, and feedforward characteristics to achieve desirable responses).
- Approximate reduction to crossover model-like (see Appendix C or Ref. 1) characteristics in the crossover regions with phase, gain and delay margins, and peak magnification ratio values sufficient to assure robust outer loop control.
- Noise rejection (smoothing) at frequencies at and above control action.

This equalization can be obtained from either series elements operating on the primary variable, or from parallel elements involving the feedback of other aircraft output variables, or from a combination of both.

2. Equalization requirements levied by desired responses of subsidiary variables to commands and disturbances.
3. Provision of sensitivity constraints and reduction for some selected uncertain/highly variable unalterable element modes by driving them into specially placed low tolerances, compensation zeros.

These general points can be made more concrete by connecting them to the example airplane FCS. Here the first consideration will refer to the bank angle loop, which should follow bank angle commands (from heading or path outer-loop guidance elements) with no steady-state error, should regulate the airplane's bank angle against lateral-directional disturbances, etc. The equalization needed to permit the bank angle control loop to provide rapid responding, well-damped, responses to command can come both from the inner loops as parallel equalization, and the outer loop as series compensation. The second consideration leads to several inner loops which have their own independent roles as lower-level controllers to correct airplane deficiencies while incidentally providing parallel equalization for the outer loops. The third consideration is a special purpose means to substitute low-tolerance poles and zeros for highly variable ones. A partial example of this will be seen in the roll damper mechanization for the example problem.

B. PROSPECTUS FOR FLIGHT CONTROL SYSTEM ARCHITECTURE

The "Architecture" to be established here amounts to a control system skeleton comprising feedbacks, equalization (adjustment of the effective aircraft dynamics as seen at a particular command or disturbance entry point), compensation (adjustment of particular controller dynamic properties, usually as a function of flight condition), etc. The architectural drawing is characteristically a detailed block diagram of the overall system.

Sufficient information is now available to consider the two general types of equalization in detail:

- a) Series on the primary variable (or its surrogate).
- b) Parallel using controlled element secondary output variables. To establish this part of the prospectus, a search is conducted for favorable effective aircraft transfer function numerator properties.
 - For adjustment of the effective aircraft transfer functions for the primary variable, examine the effects on the primary variable transfer functions of infinite gain closures with secondary variable feedbacks. This amounts to examining the ratios of aircraft secondary-to-primary variable and/or coupling-to-primary variable numerators. Desirable results occur when, for instance, the feedback of a secondary variable damps a nuisance mode or provides a region of K/s-like character in the primary transfer function when it is modified by a secondary variable inner-loop closure, etc.
 - For improvement of disturbance responses the effects of both primary and potential secondary feedbacks in adjusting the disturbance numerators need to be surveyed.

While "equalization," including the selection of appropriate feedback loops, falls conveniently into the two categories (serial and parallel) noted above, the actual details of the feedback selection for parallel equalization is much more involved. In fact, the development of control system possibilities is based on the above factors plus the accumulated knowledge of key features of the aircraft as an object of control. The general nature of potentially desirable specific feedbacks/controller

architectures stems from the organized, but nonetheless artful consideration of the elements of the prospectus listed in Fig. 16.

The particulars of how these "Elements of the Prospectus" are actually used in a preliminary design will be illustrated in the FCS design example presented in the next article. Here we will elaborate on the elements themselves. The Literal Approximate Factors element has already been introduced (in Tables 15 and 17). They were used in Section III to understand the airplane's dynamics and the physical sources of the airplane's modes and transfer functions poles and zeros. Table 19 is a summary of Lateral-Directional Essential Feedbacks adapted from Ref. 1. This table encapsulates a great deal of FCS history in that it contains a cross-section of feedbacks which have been successfully demonstrated throughout the years. They are "essential" in the sense that the controller function(s) listed in the left hand column require them or reasonable surrogates. However, no feedback quantity is universally applicable to a particular function -- all have some problems sometimes. A partial listing is provided in the far right hand column. Finally, the table gives first order information about gain adjustments needed as flight condition and/or non-dimensional stability parameters change.

The next two elements of the prospectus are complementary. The Multi-variable Sensitivity Vector Surveys provide excellent guidance on the low gain effects of the feedback of various airplane output quantities on the airplane's natural modes. The underlying details of the multi-variable sensitivity vectors are presented in Appendix B. The Effective Vehicle Characteristics with High-gain Closures are heavily dependent on the effective numerators of the airplane and on the control system structure. The feedback system structure appears implicitly in the guise of coupling numerators. The high gain characteristics show what happens to some of the modes starting off in the multi-variable sensitivity vector survey as the feedback gains become large. The overall vehicle-dynamics-centered multi-variable analysis technique which covers coupling numerators et al is outlined in Appendix A. The last prospectus item is Properties of Elemental Systems. These are particularly helpful simplifications

- Literal Approximate Factors of the Aircraft
 - Indicating the natural stability derivatives of the aircraft which affect various modes, aircraft numerators, etc. Artificial enhancement of these derivatives via automatic control is one way to achieve some desired effects (e.g., a $K_r r \rightarrow \delta_r$ feedback creates a $\Delta N_r = K_r N_{\delta_r}$).
- "Essential Feedbacks" Summaries
 - These are tables, summaries, etc. of what various feedbacks are good for. They constitute, in the large, the accumulated experience of past FCS designs, developments, and analyses.
- Multi-variable Sensitivity Vector Surveys
 - The examination of the low gain effects of imaginable aircraft output motion or kinematic feedbacks on the various aircraft-alone modes.
- Effective Vehicle Characteristics with High-gain Closures
 - High gain, multi-variable system closures result in effective aircraft poles and zeros governed by coupling numerators of the aircraft. These reveal the higher gain consequences of the same types of feedbacks examined in the low-gain sensitivity surveys.
- Properties of Elemental Systems
 - Low-order transfer characteristics which serve as excellent approximations to dominant or nuisance modes of actual systems viewed through "windows" focused on local frequency regions

Figure 16. Elements of the Prospectus

TABLE 19. LATERAL/DIRECTIONAL ESSENTIAL FEEDBACKS

PRIMARY CONTROLLER FUNCTIONS	FEEDBACKS	COMPENSATION REQUIREMENTS	PRACTICAL PROBLEMS
<ol style="list-style-type: none"> 1. Improve roll response 2. Reduce roll sensitivity to gusts and other inputs 3. Reduce ω_y/ω_d 	$p \rightarrow b_a$	<ol style="list-style-type: none"> 1. Gain inversely proportional to b_a, i.e., $K_p \propto \frac{I_x}{\rho U^2 C_{l_b a}}$ 2. Use p command system so feedback does not oppose pilot inputs and reduce p_{max} 	<ol style="list-style-type: none"> 1. Gain adjustment to compensate for changes in dynamic pressure, Mach no. effects on $C_{l_b a}$, and loading effects on I_x. 2. Effects of flaps, slats, and other aerodynamic devices on I_{b_a}. 3. Failure may result in unstable $r \rightarrow r$ loop.
<ol style="list-style-type: none"> 1. Increase directional stability 2. Increase dutch roll damping 3. Reduce inertial cross coupling 4. Improve turn coordination 	$\beta \rightarrow b_r$	<ol style="list-style-type: none"> 1. Gain inversely proportional to b_r, i.e., $K_p \propto \frac{I_z}{\rho U^2 C_{n\beta r}}$ 2. Lead/lag element 	<ol style="list-style-type: none"> 1. Instrumenting β sensor (type and location) 2. Gain adjustment to compensate for changes in dynamic pressure and Mach no. effects on $C_{n\beta r}$. 3. Lead/lag equalization on sensor possibly sensitive to gusty inputs.
	$\beta \rightarrow b_r$ $r \rightarrow b_r$	<ol style="list-style-type: none"> 1. Both gains inversely proportional to b_r (see above) 2. Washout in $r \rightarrow b_r$ feedback 	<ol style="list-style-type: none"> 1. Instrumenting β sensor 2. Gain adjustments 3. Unless $\omega_y/\omega_d \ll 1$, $r \rightarrow b_r$ does not greatly increase dutch roll damping (may be unstable if $p \rightarrow b_a$ fails). 4. Location of washout time constant; washout effect may be deleterious in spin recovery. 5. Rate gyro inclination effects.
	$a_y \rightarrow b_r$	<ol style="list-style-type: none"> 1. Gain inversely proportional to $Y_{\beta} b_r$, i.e., $K_{a_y} \propto \frac{m I_z}{\rho U^2 C_y C_{n\beta r}}$ 2. Lead/lag element 	<ol style="list-style-type: none"> 1. Severe range requirements on gain adjustments. 2. Finding a sensor location adequate for all flight conditions. 3. Gain limited by high-frequency modes (actuator and structural). 4. Location of lead/lag time constants.
	$a_y \rightarrow b_r$ $r \rightarrow b_r$	<ol style="list-style-type: none"> 1. a_y gain inversely proportional to $Y_{\beta} b_r$ (see above) 2. r gain inversely proportional to b_r 3. Washout in $r \rightarrow b_r$ feedback 	<ol style="list-style-type: none"> 1. Severe range requirements on gain adjustments. 2. Finding an accelerometer location adequate for all flight conditions. 3. a_y gain limited by high-frequency modes but not as much as equalized $a_y \rightarrow b_r$. 4. Unless $\omega_y/\omega_d \ll 1$, $r \rightarrow b_r$ does not greatly increase dutch roll damping (may be unstable if $p \rightarrow b_a$ fails). 5. Location of washout time constant; washout effect may be deleterious in spin recovery. 6. Rate gyro inclination effects.
<ol style="list-style-type: none"> 1. Provide precise turn coordination 2. Eliminate lateral/coupling 	$p \rightarrow b_r$	<ol style="list-style-type: none"> 1. Lead/lag element 2. Gain and lead time constant complex functions of several parameters. 	<ol style="list-style-type: none"> 1. Programming gain and lead time constant for various flight configurations and conditions. 2. May be deleterious near stall and in spins.
	$b_a \rightarrow b_r$	<ol style="list-style-type: none"> 1. Lead/lag or lag/lead element 2. Gain and time constants complex functions of several parameters. 	<ol style="list-style-type: none"> 1. Programming gain and time constants for various flight configurations and conditions. 2. May significantly increase pilot rudder input required for deliberate sidslip maneuvers.

which often provide excellent approximations to dominant modes or, alternatively, frequency domain approximations valid over a limited range of frequencies. A catalog of the elemental systems is the subject of Appendix C.

The actual utilization of the elements of the prospectus in the context of the system requirements and other data developed from the previous design phases can involve a good deal of integrative engineering. Taking the entire packet of information and tying it all together to mold the results into feasible system architectures, constitute the process of preliminary FCS design. At the end the flight control system synthesis will hopefully have resulted in one or more feasible sets of control laws and/or FCS block diagrams which show the loop structure and equalization forms. There remains the not insignificant task of adjusting the parameters in the control laws to meet the quantitative and qualitative requirements in the presence of all the system disturbances, uncertainties, and variabilities.

In much of the above discussion, the aircraft has been considered to be more or less unalterable or given with the FCS then tailored to correct the vehicle's characteristics. In a true integrated system design, the process can also, with some limitations, go the other way. There are major opportunities for vehicle tailoring. Some examples are listed in Fig. 17. In this approach the aircraft is optimized without regard for the stability and control or flying qualities characteristics (except for the provision of adequate control power and effector rates) relying on the FCS to take care of the deleterious aircraft dynamics which might be left over.

C. PROSPECTUS FOR AUGMENTATION TO ALLEVIATE BASIC AIRCRAFT DYNAMIC DEFICIENCIES

With the basic understanding of the aircraft dynamic problems and flight control system requirements established in previous sections the elements of the prospectus listed in Fig. 16 can now be applied to each issue. Many appropriate Literal Approximate Factors have been presented

- **AIRCRAFT PERFORMANCE ENHANCEMENT**
 - Reduced Drag (by adjusting maneuver margin, horizontal and vertical tail size, etc.)
 - Increased L/D (by camber adjustment, or by increasing aspect ratio using active control for wing-root bending relief, etc.)
 - Reduced Structural Weight (by gust and maneuver load alleviation)
 - Reduced Observables (by reduction of tail, tail length, etc.)

- **TOTAL SYSTEM RELIABILITY ENHANCEMENT**
 - Adjusting airframe properties so that minimum FCS is adequate for control. [Examples would include: the adjustment of aircraft roll/aileron effective w_ϕ/w_d to permit aileron-only control; dihedral selection to permit a simple yaw damper -- good w_r/w_d -- as the sole redundant control channel; vehicle designs which permit a wide variety of stability and control problems to be solved using rate gyros alone -- and then using skewed gyro packages; appropriate adjustment of thrust line inclination to provide for good STOL approach characteristics, etc.]

- **VEHICLE DESIGN FOR FCS ROBUSTNESS ENHANCEMENT AND CONTROLS RECONFIGURATION**
 - On multiple-effector aircraft (e.g., flap, canard, strake, thrust vector available for longitudinal control), aspects similar to the above, but with the dimensions of battle damage, maintenance foul ups, etc. included.

Figure 17. Some Opportunities for Aircraft Tailoring

in Tables 15 and 17, and need only be referred to as needed. Similarly, the Essential Feedbacks Summary exists as Table 19. The prospectus element related to Effective Vehicle Characteristics with High-Gain Closures is specific to each candidate system and so is deferred to the detailed discussion.

Only the Multi-variable Sensitivity Vector Surveys need to be derived to complete the introduction of prospectus topics. For the example airplane, the literal approximate factors in terms of stability axis derivatives work exceedingly well. Consequently, an entire prospectus for the improvement via control action of the roll subsidence and dutch roll can be accomplished using these relationships, assuming the airplane's motions are measured or otherwise estimated in stability axis terms. It is not always the case that the approximate factors or the "essential" feedback relationships apply as well as in this example. We are also interested in other sensible quantities, such as body axis rates and accelerations, for which these relationships are more obscure. For this purpose, the multi-variable sensitivity vector survey is an important tool.

Figure 18 shows the gain sensitivity, S_K^x , at low gain ($K_x \rightarrow 0$) for four potential feedback variables $x = p_b, r_b, \beta, a_{y_{cg}}$ to the two possible control points (lateral controller and rudder). With these figures, comparisons can be made of the effects of the candidate feedback among the modes.

The evolution of potential system feedback possibilities will be developed below by examining each airplane deficiency in the context of the prospectus elements. This will be done in sequence, starting with the roll subsidence mode.

1. Roll Subsidence Mode -- Low $1/T_R$

a. Literal Approximate Factor for $1/T_R$ (Table 15)

Augmenting the stability axis L'_p roll damping derivative would directly improve (increase) $1/T_R$.

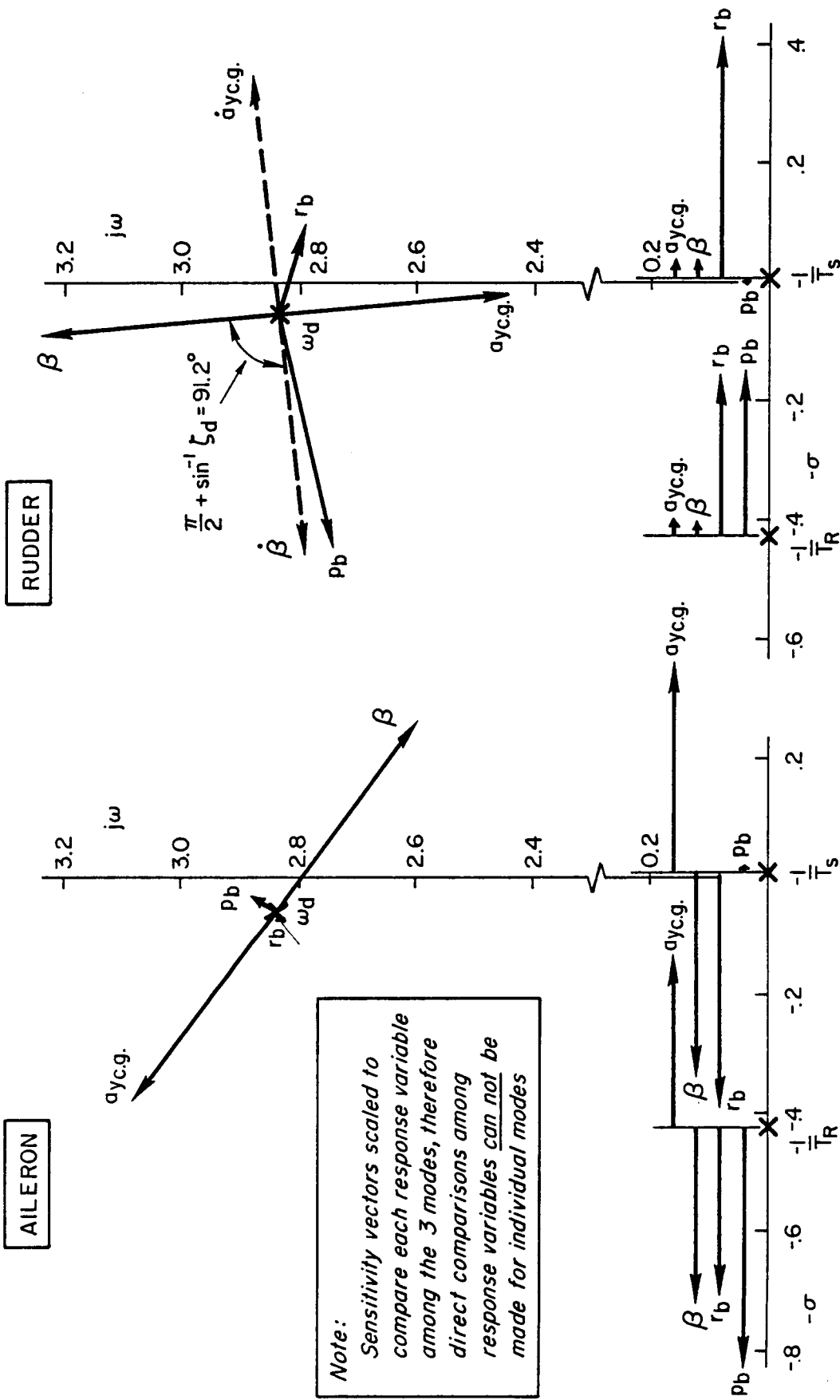

Figure 18. Low Gain Control Prospectus from Sensitivity Vectors

b. Essential Feedbacks (Table 19)

A $p \rightarrow \delta_a$ "roll damper" loop will augment L'_p .

c. Multi-Variable Sensitivity Vector Survey

Figure 5-3 indicates that both of the FRL body-axis oriented angular velocities as well as sideslip and side acceleration, if used as feedback quantities, would have an effect on the roll subsidence. However, only $p_b \rightarrow \delta_a$ can improve (increase) $1/T_R$ without significantly affecting the dutch roll and spiral modes (Note the small P_b vectors at the dutch roll and spiral modes and the large vector at the roll subsidence).

d. Effective Characteristics at High Gain
($p \rightarrow \delta_a$, Gain in Forward Path)

$$\left. \frac{p}{p_c} \right|_{p \rightarrow \delta_a} = \frac{K_p N_{\delta}^p a}{\Delta + K_p N_{\delta}^p a} \rightarrow \frac{N_{\delta}^{\phi} a}{N_{\delta}^{\phi} a} = 1 \quad (24)$$

If such a high gain roll damper is used, then the roll angle response to lateral controller will tend to a K/s -like form. This is ideal for both the pilot and automatic control for regulation of bank angle. High gain in this connection means that the roll damper crossover frequency is well above that of the outer manual or automatic pilot loop. Note that there is no assurance from this high-gain perspective that such high gain closures will be stable!

2. Dutch Roll Mode -- Low Damping Ratio, ζ_d

a. Essential Feedbacks (Table 19)

There are three basic feedback candidates for improving dutch roll characteristics

$$\begin{aligned} r &\rightarrow \delta_r \\ \dot{\beta}, \beta &\rightarrow \delta_r \\ \dot{a}_y, a_y &\rightarrow \delta_r \end{aligned}$$

For moderate to high AOA flight conditions, the axis about which yaw rate is measured becomes very important. Stability axis yaw rate is generally preferable. The forms involving β and a_y can be approximated by lead/lag equalization on the β and a_y loops, respectively. This equalization is necessary if the dutch roll damping is to be improved.

b. Literal Approximate Factor for ζ_d

- 1) $\dot{\beta} \rightarrow \delta_r$ loop
 $r \rightarrow \delta_r$ loop

From the approximate factors either a $\dot{\beta}$ sideslip stability augments or a stability axis yaw damper, corresponding to augmentation of the stability axis N_r' or $N\dot{\beta}$ derivatives, will improve the dutch roll damping ratio.

- 2) $\dot{a}_y, a_y \rightarrow \delta_r$ loop

The $\dot{a}_y, a_y \rightarrow \delta_r$ feedback can be considered conceptually (i.e., aside from mechanizational side effects) as a surrogate for $\dot{\beta}, \beta \rightarrow \delta_r$. This is based on the relation

$$a_y = Y_v v + Y\delta_r \delta_r + x_a \dot{r} \quad (25)$$

for an accelerometer located at distance x_a from the c.g. If the accelerometer is properly located (i.e., at the center of percussion for rudder inputs, see pg. 483, Ref. 1)

$$\frac{a_y}{\delta_r} = Y \frac{\beta}{\delta_r} \quad (26)$$

in the frequency regime of interest about the dutch roll mode. At this level of approximation the primary distinction between $\dot{\beta}, \beta \rightarrow \delta_r$ and $\dot{a}_y, a_y \rightarrow \delta_r$ is one of gain compensation over the flight envelope (see Table 19).

c. Multi-Variable Sensitivity Vector Survey

Figure 18 shows that only β or $a_y \rightarrow \delta_r$ can affect the dutch roll without affecting the roll subsidence and spiral, but they primarily affect ω_d , not ζ_d . Using $\dot{\beta}$ or $\dot{a}_{y_{cg}} \rightarrow \delta_r$ (dashed vectors) could improve ζ_d with little other effect. An $r_b \rightarrow \delta_r$ loop could improve ζ_d but with significant effects on $1/T_R$ and $1/T_S$. The increase in $1/T_R$ would be beneficial, but driving the spiral mode far into the left (stable) half plane would be undesirable for steady turning. The steady-state turn rate $\dot{\lambda}_{SS}$ when the airplane is banked with an aileron pulse is

$$\begin{aligned} \dot{\lambda}_{SS} &= \lim_{s \rightarrow 0} s \frac{\dot{\lambda}}{\delta} = \lim_{s \rightarrow 0} \frac{(0)A_{\lambda}[\zeta_{\lambda}, \omega_{\lambda}]}{(1/T_S)(1/T_R)[\zeta_d, \omega_d]} \\ &\rightarrow \lim_{s \rightarrow 0} s \frac{A_{\lambda} \omega_{\lambda}^2 T_R / \omega_d^2}{(s + 1/T_S)} \end{aligned} \quad (27)$$

Thus, $\dot{\lambda}_{SS}$ will be non-zero only if $1/T_S = 0$ (i.e., the spiral is a pure kinematic integrator). Otherwise, the turn rate will decay to zero for times greater than T_S seconds (assuming a stable spiral). That is, a pure gain $r \rightarrow \delta_r$ can interfere with a steady-turn unless opposing rudder inputs are developed from the system or the pilot. Table 19 indicates that wash-out equalization is a common solution.

d. Effective Characteristics at High Gain

1) $\beta, \dot{\beta} \rightarrow \delta_r$ loop ($G_{\beta}^{\delta_r}(s)$ is a lead/lag)

$$\begin{aligned} \left. \frac{\phi}{\delta_a} \right|_{\beta, \dot{\beta} \rightarrow \delta_r} &= \frac{N_{\delta_a}^{\phi} + G_{\beta}^{\delta_r}(s)N_{\delta_a}^{\phi} \beta}{\Delta + G_{\beta}^{\delta_r}(s)N_{\delta_r}^{\beta}} \\ \rightarrow \frac{N_{\delta_a}^{\phi} \beta}{N_{\delta_r}^{\beta}} &= \frac{A_{\phi\beta}(2/T_{\phi\beta})}{A_{\beta}(1/T_{\beta_1})(1/T_{\beta_2})(1/T_{\beta_3})} \\ &= \frac{0.1175(161.2)}{0.0179(-0.143)(0.355)(144.5)} = \frac{7.32}{(-0.143)(0.355)} \end{aligned} \quad (28)$$

The potential for controlling the dutch roll is clear. However, as seen earlier in the diagnosis of the low $1/T_R$, the roll-spiral characteristics are degraded. This situation is atypical of behavior at lower angles-of-attack, and can be examined from the $N_{\delta_r}^\beta$ literal approximate factors. A good low-frequency approximation may be made by neglecting $Y_{\delta_r}^*$, which is equivalent to treating $1/T_{\beta_3}$ and $1/T_{\beta_\phi}$ as roots at infinity (as above) giving:

$$\left. \frac{\phi}{\delta_a} \right|_{\beta \rightarrow \delta_r} = \frac{N_{\delta_r}^{\phi \beta}}{N_{\delta_r}^\beta} = \frac{L'_{\delta_r} N'_{\delta_r}}{N'_{\delta_r} (1/T_{\beta_1})(1/T_{\beta_2})} = \frac{6.57}{(-0.144)(0.353)} \quad (29)$$

where, from the approximate factors of Table 17

$$\frac{1}{T_{\beta_1}} + \frac{1}{T_{\beta_2}} = -L'_p + \frac{L'_{\delta_r}}{N'_{\delta_r}} \left(N'_p - \frac{g}{U_o} \right) = 0.2118 \text{ rad/sec}$$

$$\frac{1}{T_{\beta_1}} \cdot \frac{1}{T_{\beta_2}} = \frac{g}{U_o} L'_r \left[1 - \frac{L'_{\delta_r}}{N'_{\delta_r}} \frac{N'_r}{L'_r} \right] = -0.05106 \text{ (rad/sec)}^2$$

The fact that these two roots have nearly equal magnitude is due to the relatively low value of the damping term $[1/T_{\beta_1} + 1/T_{\beta_2}]$, which is due in part to the same factors producing low $|1/T_R|$. Thus, this situation is simply another manifestation of the need for increased roll damping.

2) $r_b \rightarrow \delta_r$ loop (FRL body axis yaw rate)

$$\left. \frac{\phi_b}{\delta_a} \right|_{r_b \rightarrow \delta_r} = \frac{N_{\delta_a}^{\phi} + K_r N_{\delta_a}^{\phi r}}{\Delta + K_r N_{\delta_r}^r}$$

$$\rightarrow \frac{N_{\delta_a}^{\phi r}}{N_{\delta_r}^r} = \frac{A_{\phi r} (1/T_{\phi r})}{A_r (1/T_r) [\zeta_r, \omega_r]}$$

$$= \frac{-18.88(0.0280)}{-1.180(0.254)[0.0888, 2.36]} \quad (30)$$

The $r_b \rightarrow \delta_r$ yaw damper has several undesirable features compared to $\dot{\beta}$, $\beta \rightarrow \delta_r$. First, the dutch roll mode is driven to the complex rudder yaw rate zero $[\zeta_r, \omega_r]$, which is very near to $[\zeta_d, \omega_d]$, and thus no improvement in the dutch roll damping results.

This situation is unusual in that ordinarily (low α) $\omega_r \ll \omega_d$ which is the key to success for ordinary yaw dampers. From body axis approximate factors given in Ref. 12

$$\omega_r = \sqrt{-L'_{\beta_b} \sin \alpha \left[1 - \frac{L'_{\delta r_b} N'_{\beta_b}}{N'_{\delta r_b} L'_{\beta_b}} \right]} \quad (31)$$

Thus, ω_r will tend to increase with $\sqrt{\alpha}$ as in this case. Further, ζ_r decreases with AOA since

$$\zeta_r = \left[-(Y_v + L'_{p_b}) + \frac{L'_{\delta r_b} N'_p}{N'_{\delta r_b}} - \frac{g}{V_{T_o} \sin \alpha_o} \right] 2\omega_r \quad (32)$$

A further problem is the significant modification of $[\zeta_\phi, \omega_\phi]$ to two real roots (one of which effectively cancels the spiral pole). Thus, there is no dipole-like near-cancellation of the dutch roll mode, and a large residue will occur in the roll control response.

3) $r_s \rightarrow \delta_r$ loops (stability axis yaw rate)

The yaw rate numerator is very sensitive to effective yaw rate gyro inclination, which can affect the $r \rightarrow \delta_r$ situation significantly. (However, it should be noted that bank angle is quite insensitive to axis inclination, e.g. $N_\delta^\phi s = N_\delta^\phi b$). The angle-of-attack in the above $[\zeta_r, \omega_r]$ approximation can be effectively reduced by inclining the measurement axis toward the stability axis. The primary value of this is reduction of ω_r to well below ω_d . The alternative may be examined by considering $r_s \rightarrow \delta_r$ based on stability axis yaw rate (r_s can be derived from mixing r_b and p_b as a function of AOA).

$$\left. \frac{\phi_s}{\delta_a} \right|_{r_s \rightarrow \delta_r} = \frac{N_{\delta_a} r_s}{r_s N_{\delta_r}} = \frac{-18.88(0.0280)}{-2.58(0.911)[-0.470, 0.852]} \quad (33)$$

This mechanization in the limiting very high gain case appears even worse than $r_b \rightarrow \delta_r$, because the effective dutch roll mode $[\zeta_{r_s}, \omega_{r_s}]$ would be unstable. However, at lower realistic gains good dutch roll damping may be achieved. This will require detailed analysis in the next section.

e. Series Equalization Requirements

$r \rightarrow \delta_r$ — In the dutch roll frequency region where the yaw damper is to have its primary effect, a series compensator should approximate a pure gain. However, at lower frequencies the compensator should have an effective washout characteristic to prevent interference with steady turns.

$\beta \rightarrow \delta_r$ — This loop will require considerable lead ($\dot{\beta}$ content) to damp the dutch roll. As AOA increases and directional stability is reduced increased β content in the feedback controller will be increasingly important.

$a_{y'} \rightarrow \delta_r$ — The considerations for this loop are analogous to those for $\beta \rightarrow \delta_r$. However, this loop has a peculiar requirement for proper location of the accelerometer near the instantaneous center of rotation for rudder inputs. The accelerometer will require more extensive adjustment with flight condition than sideslip, and may also be sensitive to pickup of local vibrations and structural modes.

3. Roll Numerator Zero

The primary FCS design goal for modification of $[\zeta_\phi, \omega_\phi]$ is to maintain this zero near the $[\zeta_d, \omega_d]$ pole. As ζ_d and ζ_ϕ are improved, the significance of the $\omega_\phi/\omega_d > 1$ problem is greatly reduced, and the primary need is to maintain the augmented values of ζ_ϕ and ζ_d close together to minimize the dipole residue in the roll response to δ_a and inputs. A

roll damper will not affect the roll numerator ($N_{\delta_a}^{\phi} P_b = 0$), so only feedbacks to the rudder are of interest. From the approximate factor

$$2\zeta_{\phi} \omega_{\phi} \dot{\phi} = -(Y_v + N'_r - N'_{\dot{\beta}}) + \frac{N'_{\delta_a}}{L'_{\delta_a}} L'_r \quad (34)$$

it may be seen that the incremental effects of the r , $\dot{\beta}$, or $a_y \rightarrow \delta_r$ on ζ_{ϕ} will be favorable, i.e., comparable to the effect on ζ_d .

Finally, for adjustment of a zero (but not for a pole) for commands (but not disturbances) crossfeeds between the control points can be used, if necessary. The lateral to directional controller crossfeed, $G_{\delta_a}^{\delta_r}$, described previously is the most likely to be useful for this example.

4. Summary of Augmentation Prospectus

At this point the architectural elements of the FCS suitable for manual or automatic control are:

- a roll damper
- a yaw damper
- aileron to rudder crossfeed (possible) for $\beta \approx 0$ in rapid rolling maneuvers
- directional stability enhancement (possibly needed to improve coordination and for other flight conditions with higher AOA)

Three competing yaw damper possibilities have been developed, and at this point differences in their relative flight condition compensation and mechanizational side effects become important.

While $r \rightarrow \delta_r$ looks less satisfactory than $\dot{\beta} \rightarrow \delta_r$, there is a compelling reason not to abandon it because it may be implemented simply in a multiple redundant configuration with rate gyro(s). Developing a satisfactory multiple redundant β signal is much more difficult. This sensor problem can be reduced by approximating $\beta \rightarrow \delta_r$ with $a_y \rightarrow \delta_r$ at the expense

of more elaborate gain compensation with flight condition. While accelerometers are common for FCS, their proper location is generally more involved than for rate gyros, and they may be more susceptible to flexible mode and vibration pickup. This factor alone may mitigate against use of an a_y with lead to act as a surrogate for $\dot{\beta}$ because of high frequency noise amplification.

The dynamics of the sensors, computational elements, and actuators in both the lateral and directional axes are clearly required to have effective bandwidths which are much larger than the roll subsidence $1/T_R$, and dutch roll, ω_d , breakpoints.

SECTION VI

PRELIMINARY DESIGN OF CANDIDATE LATERAL-DIRECTIONAL FIGHTER FLIGHT CONTROL SYSTEM

In this section one of the candidate FCS concepts is continued to a preliminary design level for the example flight condition. Preliminary design includes the basic feedback control system architecture (presented as system block diagrams), specification of gains and time constants, and preliminary identification of key parameters to which the design is sensitive. These issues will all be addressed in this section.

A formal assessment of sensitivities and robustness is ordinarily accomplished as a part of the detailed design, and thus is not treated in this section. However, recently developed robustness assessment procedures are sufficiently simple and straightforward to be applied as an early preliminary design step. Consequently we have included preliminary robustness assessment as part of the design methodology. Because the assessment procedures selected depends on relatively new theoretical developments and their tie-ins to more familiar concepts, this phase of the design methodology needs a more extended and tutorial treatment. We have chosen, therefore, to present robustness assessment for the example system as a separate topic in a technical paper. This appears as Supplement 1, and immediately follows this section.

The basic system analyzed here is shown in Fig. 19. It comprises three fundamental FCS modes and two provisional enhancements. The fundamental channels are:

- A redundant ($r_s \rightarrow \delta_r$) yaw damper which is intended to augment the dutch roll damping characteristics and provide favorable adjustment (increase of the damping term) of the rolling velocity transfer function quadratic numerator so that the dutch roll will be Level 1 when a subsequent rolling velocity loop is closed. This yaw damper is also intended to serve as a suitable inner loop for possible directional stability augmentation via sideslip feedback for high angle-of-attack operations. As the key channel of the lateral FCS, this control axis will have the highest level of redundancy with at least a double fail-operational status.

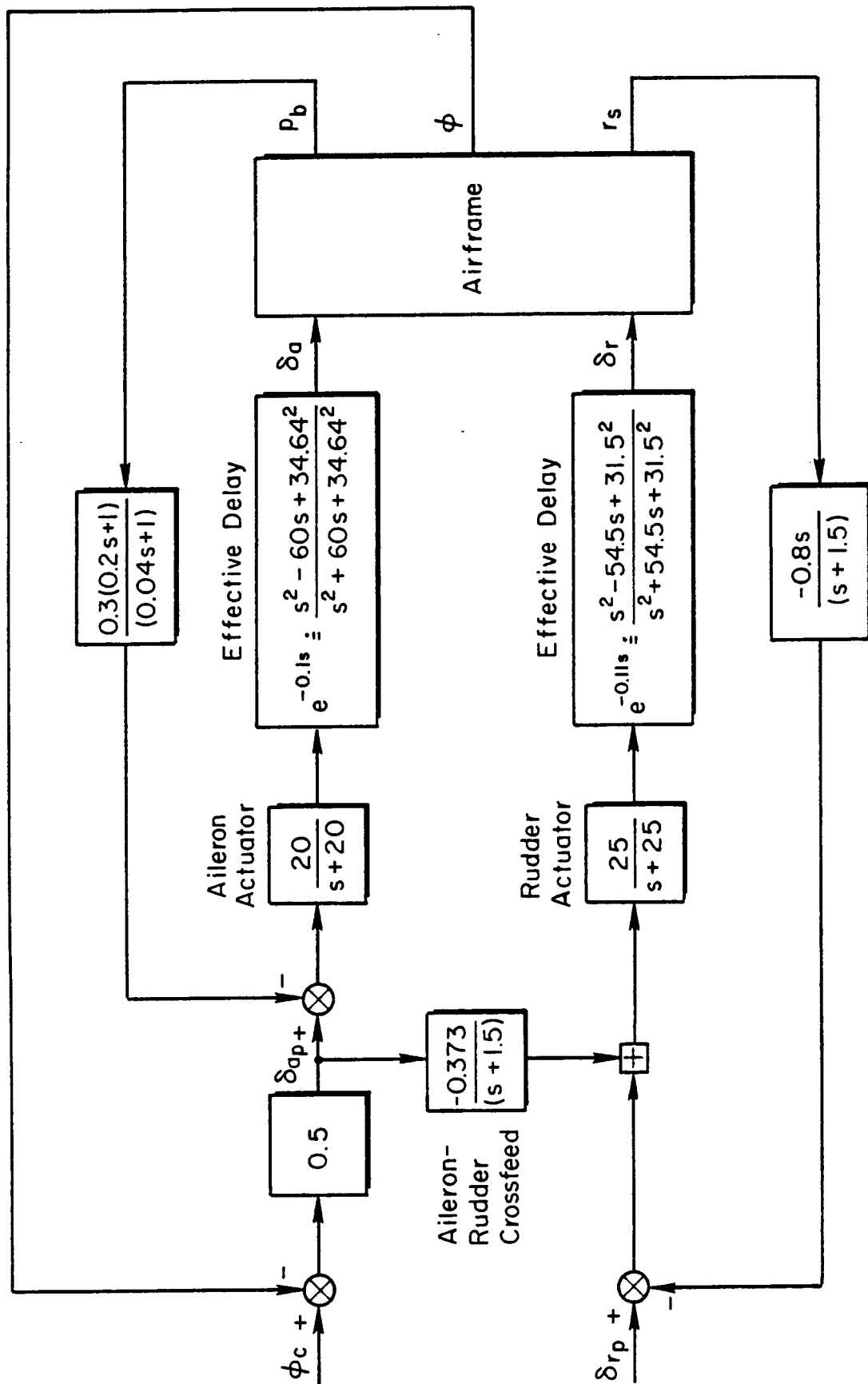

Figure 19. Candidate Lateral FCS Design

- A redundant ($p_b \rightarrow \delta_a$) roll damper which, in conjunction with the yaw damper, is intended to provide Level 1 flying qualities in all conventional lateral control modes. It also serves as the key command element for piloted control and regulation of roll attitude and lateral maneuvering in general, and as an equalizing inner loop for automatic roll control. This FCS mode is also multiple redundant in character at a fail-operational level.
- The basic lateral automatic FCS control mode ($\phi \rightarrow \delta_a$), which provides bank angle command and regulation functions as an entity in itself, and serves as appropriate inner loop equalization for such lower bandwidth guidance functions as heading, lateral path, and lateral position control. The required redundancy level of the bank angle control loop will depend primarily on that of the outer-loop functions. For instance, if the fighter is equipped with a multiple-redundant mission critical automatic fire control system which relies on the bank angle controller as a subsidiary loop, then the bank angle control loop would be mechanized at the same level of integrity. On the other hand, if the bank angle closure is simply part of a cruise or relief autopilot, less redundancy would be required.

The auxiliary or provisional features are:

- Lateral to directional controller crossfeed to improve dynamic coordination in lateral controller initiated maneuvers.
- Directional stability enhancement using sideslip or a lateral acceleration surrogate to cope with high angle-of-attack directional stability problems.

The second provisional feature is not needed for the example aircraft flight condition considered, so it is not addressed in detail below.

Each of the channels involved have an independent status and associated independent integrity as FCS operational modes. Because the several channels must exist operationally with an integrity consistent with a hierarchical control sequence, they will be designed in the appropriate corresponding sequence. Thus, the yaw loop will be closed before the rolling velocity loop, etc. However, this design loop closure sequence should not be viewed as a single-loop-at-a-time design accomplished without looking ahead to the next steps. For instance, in the yaw axis closure an important feature is the adjustment of the rolling velocity/aileron numerator $[\zeta'_\phi, \omega'_\phi]$ to values which will provide both

adequate dutch roll damping and near decoupling of the dutch roll from aileron-initiated rolling maneuvers after the rolling velocity loop is closed. Consequently, both lateral and directional control loops are inherently interrelated in the design, requiring either prescience or iterative calculations to arrive at a reasonable conclusion.

A. ACTUATION AND SENSING

The actuator dynamics, computational and filtering lags, higher frequency aerodynamic and structural mode effects, and sensor dynamics are represented as low frequency approximations comprising a first-order lag for the actuators' primary amplitude ratio breakpoint, and pure time delays for all the other higher frequency effects. This combination is the simplest available to describe bandwidth limitations due to phase lags from higher order dynamic effects, as is appropriate when the rigid body control problems addressed in this example are considered.

To permit the reader to distinguish the effects of loop closures on the actuator modes, the aileron and rudder actuators and pure time delays are represented by slightly different numerical values in the system block diagram of Fig. 19.

B. YAW DAMPER DESIGN

The primary goal of the yaw damper design is to provide a basis for adequate dutch roll damping and minimal dutch roll residue in the roll command response without unduly interfering with rolling maneuvers and steady turns. As described previously, the yaw rate signal must be washed out or otherwise cancelled to eliminate top rudder opposition to turns in the steady-state. However, to damp the dutch roll, a signal proportional to yaw rate is needed at the dutch roll frequency. What is desired in terms of equivalent stability derivatives is a frequency sensitive $\Delta N_r(s)$ which looks like a constant, ΔN_r at ω_d , and becomes zero at very low frequencies. That is, neglecting actuator and higher frequency dynamics,

$$\begin{aligned} \Delta N_r(s) &= \frac{K_r N_{\delta_r} s}{s + 1/T_{wo}} \\ &= \Delta N'_r(\infty) \frac{s}{s + 1/T_{wo}} \end{aligned} \tag{35}$$

For the feedback to appear as an incremental yaw damping, $\Delta N_r(\infty)$, at dutch roll frequencies demands that the washout breakpoint $1/T_{wo}$, be at least an octave below the dutch roll undamped natural frequency. In closer proximity the feedback signal tends to augment the effective yaw axis inertia rather than damping. Thus, proper tuning of the washout relative to the dutch roll undamped natural frequency is required to achieve the desired dutch roll damping augmentation.

The tradeoffs involved are also indicated on the root loci of Fig. 20. This shows the effect on the denominator of the yaw damper closure based on stability axis yaw rate with pure gain (Fig. 20a), and with washout breakpoints at 6, 3, and 1.5 rad/sec. These correspond to approximate $(1/T_{wo})/\omega_d$ ratios of 0, 2, 1, and 0.5, respectively. The basic tradeoff is between reducing the washout breakpoint to low frequencies to cause the $\omega_d - \omega_r$ locus to "bulge" to the left (to maximize the attainable dutch roll damping), and maintaining the breakpoint high enough to prevent the yaw damper from interfering with steady turns. The washout breakpoint was set at 1.5 rad/sec as the maximum value (minimum T_{wo}) consistent with the achievement of a closed-loop damping ratio of $\zeta_d \doteq 0.4$. This also illustrates a rule of thumb for yaw damper systems in which the airplane's ω_r/ω_d ratio is very small. For these systems types, the selection of $(1/T_{wo})/\omega_d < 1/2$ will typically provide maximum closed-loop dutch roll damping ratios near 0.4.

Figure 21 shows the system survey for the denominator. It can be seen that the maximum attainable dutch roll damping ratio just reaches 0.4. Thus, even without the roll damper loop closures the MIL-F-8785C dutch roll damping requirement for air-to-air combat in the CO mission phase could be met with the $(1/T_{wo})/\omega_d$ ratio illustrated here.

Figure 22 shows the corresponding survey for the effect of the yaw damper on the p_b/δ_a numerator to anticipate the roll damper design. The ω_ϕ locus tracks the dutch roll which is ideal for the roll damper development. Thus, the yaw damper gain can be selected to satisfy the dutch roll requirements.

A gain of $K_r = -0.8$ rad/rad/sec was selected. This essentially maximizes the dutch roll damping, $\zeta_d \omega_d$, and the roll numerator damping

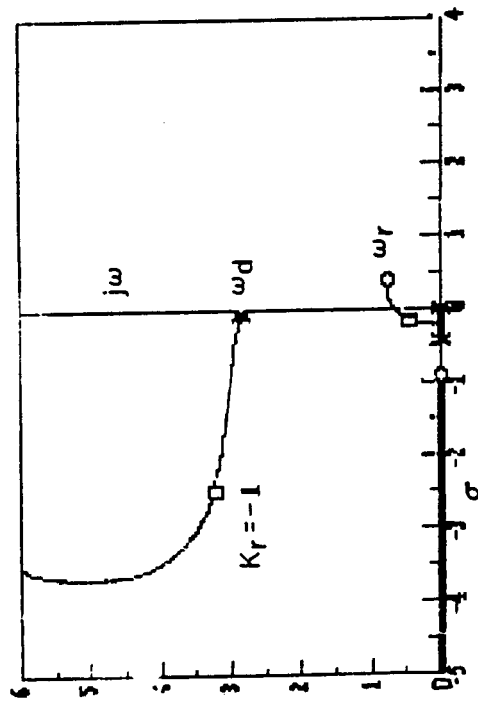

a) No Washout $\left(\frac{1/T_{wo}}{\omega_D} = 0\right)$

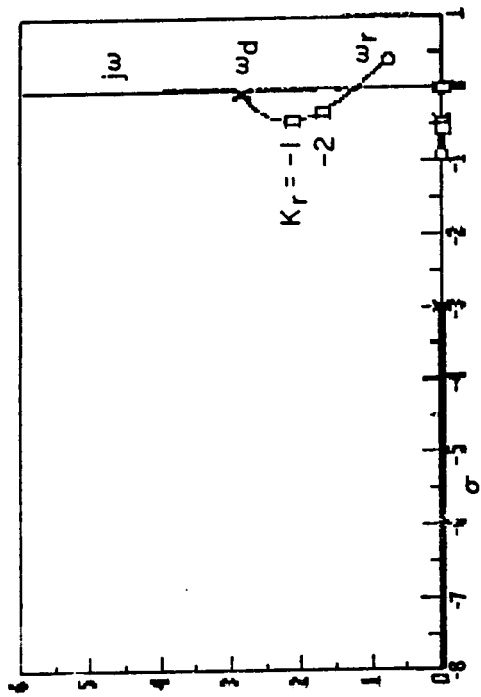

c) $T_{wo}^{-1} = 3 \text{ rad/sec}$ $\left(\frac{1/T_{wo}}{\omega_D} = 1\right)$

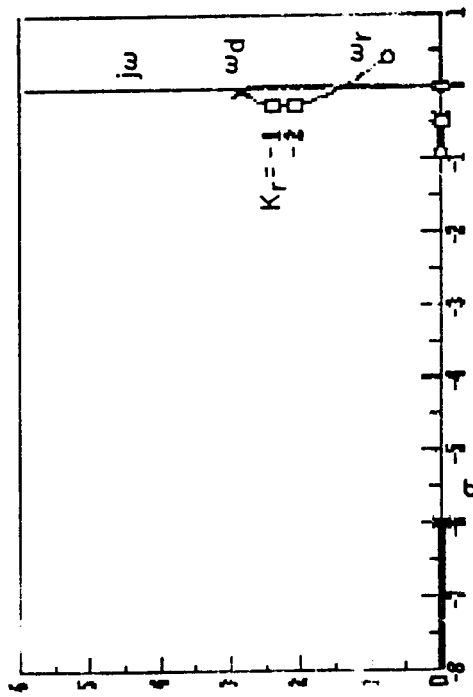

b) $T_{wo}^{-1} = 6 \text{ rad/sec}$ $\left(\frac{1/T_{wo}}{\omega_D} = 2\right)$

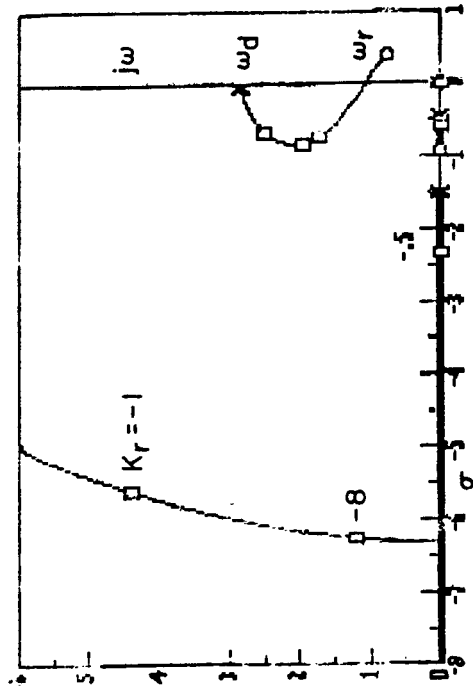

d) $T_{wo}^{-1} = 1.5 \text{ rad/sec}$ $\left(\frac{1/T_{wo}}{\omega_D} = 0.5\right)$

Figure 20. Effect of Washout Variations on the Poles in the Yaw Damper Closure

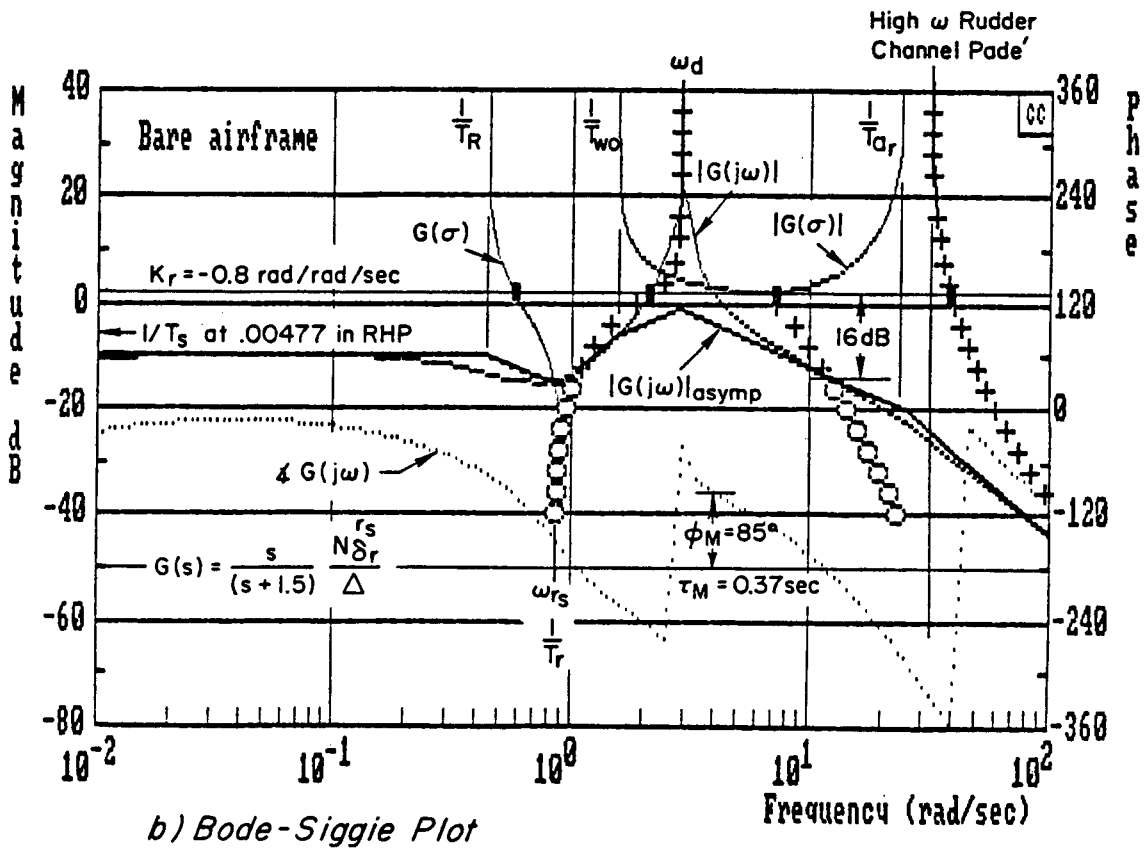
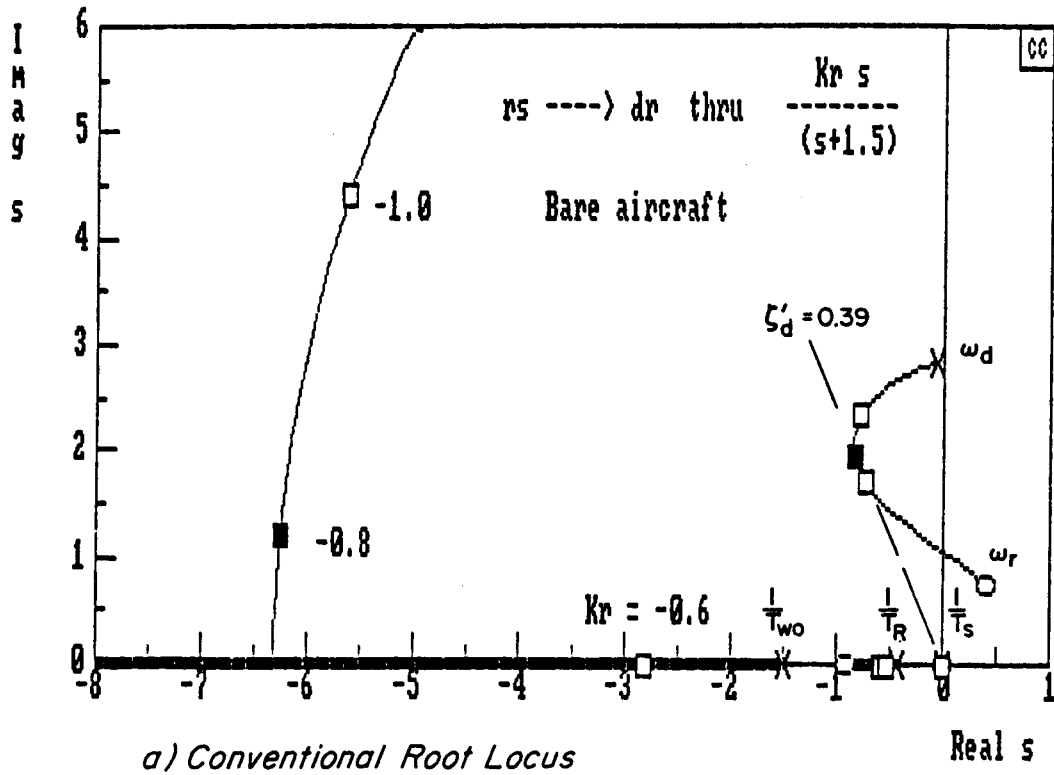

Figure 21. Effect of Yaw Damper Closure on Denominator

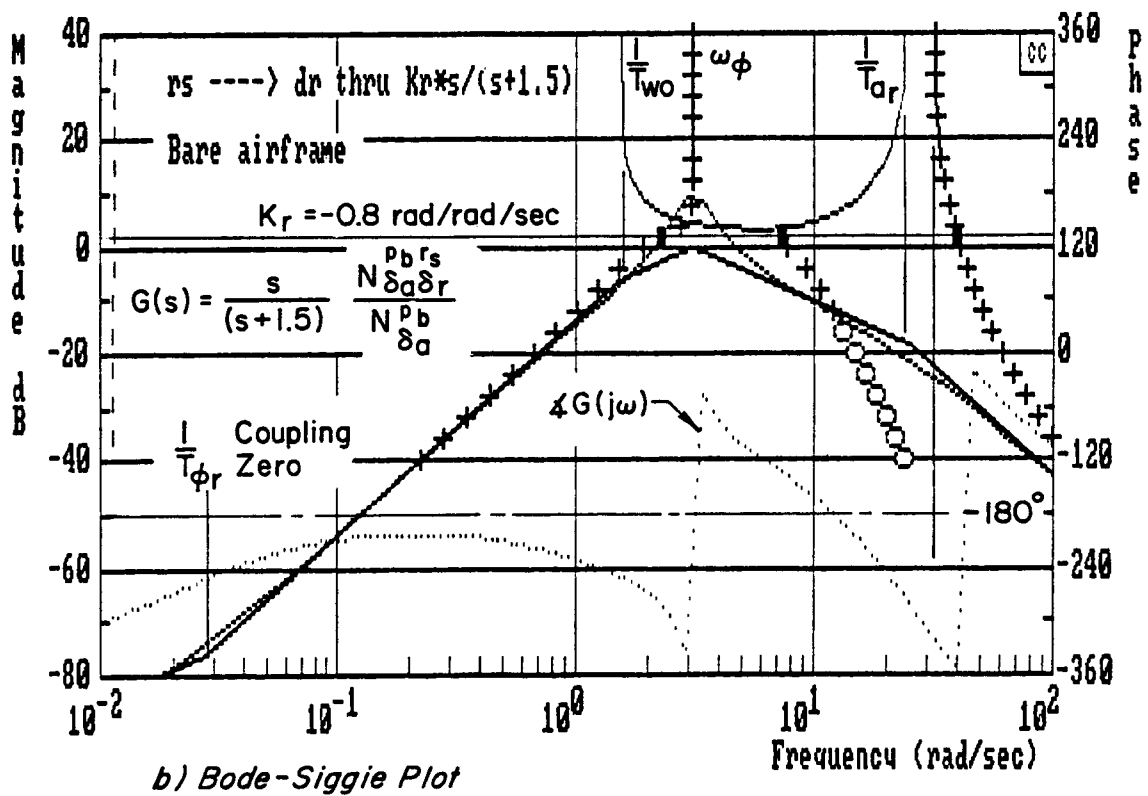
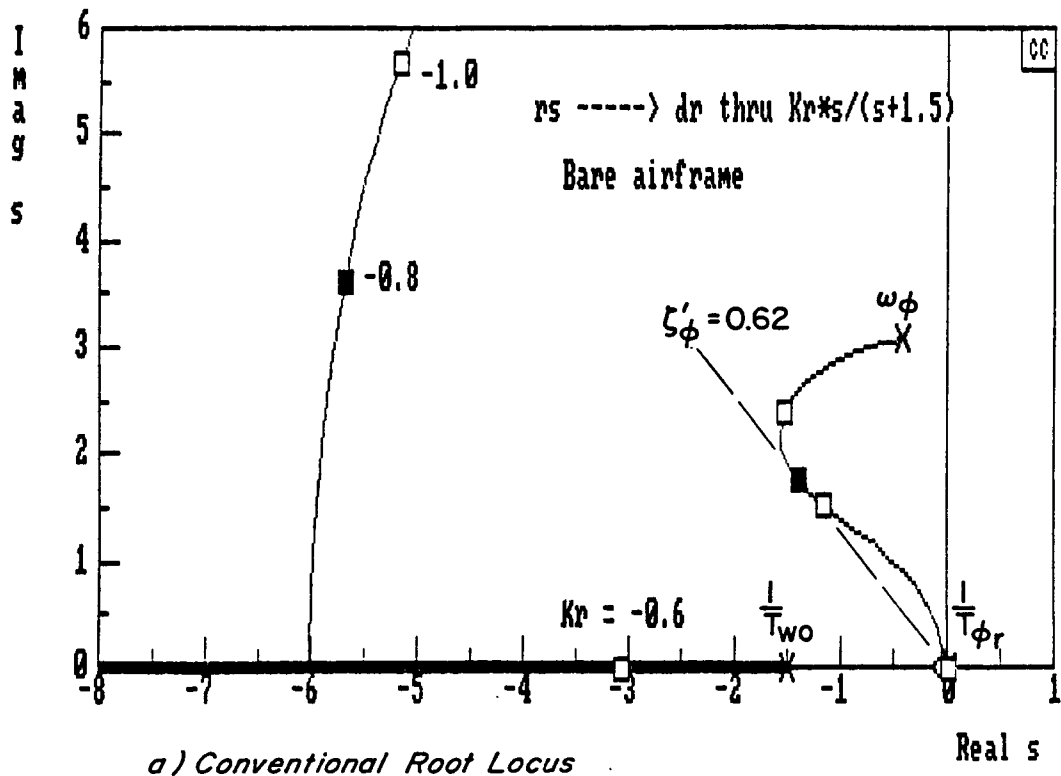

Figure 22. Effect of Yaw Damper Closure on $N_{\delta_a}^{Pb}$

ratio, ζ'_ϕ .* As the ω'_ϕ/ω'_d ratio is less than 1, the latter value assures that the dutch roll damping ratio after the roll loop closure will be greater than that achieved with the yaw damper loop alone if the dutch roll root can be driven to $[\zeta'_\phi, \omega'_\phi]$. Even without this closure the dutch roll damping ratio of 0.39 with an undamped natural frequency of 2.1 rad/sec nearly meets the MIL-F-8785C dutch roll damping ratio requirements for air-to-air combat, and exceeds the MIL-F-9490D damping ratio minimum of 0.3. The roll subsidence mode, $1/T'_R \doteq 0.6$ rad/sec is increased over that of the bare airplane, but is still Level 2 for CO. It is, however, Level 1 for other less stringent flight conditions.

All of these features are apparent in the transfer function relating bank angle to aileron with the yaw damper loop closed. This is,

$$\left. \frac{\phi}{\delta_a} \right|_{r_s \rightarrow \delta_r} = \frac{6.60 [.618, 2.25] [.857, 6.68] [.855, 39.5]}{(-.00378) (.576) [.392, 2.14] [.982, 6.37] [.857, 39.0]} \quad (36)$$

$$\zeta'_\phi, \omega'_\phi$$

$$\doteq \frac{6.80 [.618, 2.25]}{(-.00378) (.576) [.392, 2.14]}$$

$$1/T'_s \quad 1/T'_R \quad \zeta'_d, \omega'_d$$

Notice that at high frequencies that the coupled yaw-axis-actuator, wash-out mode and the Pade approximations for the still-higher frequency effects appear in both the numerator and denominator. The washout-actuator dipole terms have nearly the same natural frequencies, but quite different damping ratios, so they do not completely cancel each other.

Examining Fig. 21 in more detail reveals a 17 dB gain margin with respect to driving the dutch roll mode into the right half plane, and a similar margin (16 dB) for the coupled washout-rudder actuator mode. For the nominal gain, the total open-loop characteristic $G(s)$ is over 10 dB below the effective 0 dB line at low frequencies below the dutch roll so

*The primed notation on these modal parameters indicates the number of loop closures that affect the parameter. After three loop closures the Dutch roll damping ratio will be ζ_d .

the yaw damper will have only a minor effect on steady turns. The phase margin above the dutch roll is 85 deg, corresponding to a 0.37 sec delay margin. This greatly exceeds the (MIL-F-9490D) phase margin requirements.

The primary parameters and dynamics to which the yaw damper design is sensitive include:

Gain, $K_r N'_{\delta_r}$

Washout time constant/dutch roll undamped natural frequency, $(1/T_{w0})/\omega_d$

Yaw numerator zeros, $[\zeta_r, \omega_r]$

Steady-state angle-of-attack, $[\alpha_0]$

The control system gain, K_r , and the washout time constant will have essentially zero uncertainty intrinsically, especially with a digital controller. The primary sources of uncertainty therefore lie with the aerodynamic and propulsion (to the extent thrust vectoring is involved) characteristics associated with the loop gain via N'_{δ_r} , and the dutch roll undamped natural frequency. Referring to the approximate factors, the primary sources of variation in these terms are the stability derivatives N'_{δ_r} and N'_β . The same thing can be said of the yaw numerator zeros using the approximate factors in terms of stability axis derivatives. But here there is a subtle but major difference because the complex yaw zeros are particularly sensitive to the actual angle-of-attack. Indeed the r_s signal is established by mixing body p_b and r_b measurements as a function of angle-of-attack (e.g., $r_s = r_b \cos \alpha_0 + p_b \sin \alpha_0$). When this feedback is mechanized with α measurements it can be very sensitive to AOA measurement error. It is also a potential source of coupling between longitudinal and lateral degrees of freedom, especially for steady rolling maneuvers. If the mechanization depends on estimation of a trim α_0 additional uncertainties can enter as functions of the maneuver. For example, in 360° rolls the angle of attack relating FRL and stability axes may vary sufficiently throughout the roll to be noticeable.

C. ROLL DAMPER DESIGN

The primary purpose of the roll damper is to reduce the roll mode time constant to less than 1.0 sec as required by MIL-F-8785C while further tuning the dutch roll.

A pure gain $p_b \rightarrow \delta_a$ closure is shown in Fig. 23. While this might produce an acceptable system, it is not ideal because the dutch roll root is not driven into the ω_ϕ zero. Indeed, the increased separation between ω_ϕ and ω_d'' will result in a nuisance appearance of the dutch roll mode in rolling responses, and hence a lack of dynamic coordination in maneuvers. This can be corrected by inserting lead-lag compensation in the roll damper. If the only issue was increasing the dutch roll locus departure angle, the lead-lag could be optimized to produce maximum phase lead at the dutch roll. However, there is an additional constraint in that placing the lead at too low a frequency will degrade the improvement needed for roll mode effective time constant decrease.

A compromise compensation of

$$(0.2s + 1)/(0.04s + 1) \tag{37}$$

has the dual effects of directing the dutch roll mode towards the $[\zeta_\phi, \omega_\phi]$ numerator, and maintaining a first-order roll subsidence all the way to 5 rad/sec. This compensation is also an example wherein the uncertainties in the roll subsidence are held in closer control by its limiting value at $T_R'' \rightarrow 0.2$ second. The features are shown in the survey of Fig. 24. There is a good region of K/s slope in which the $p_b \rightarrow \delta_a$ loop can be closed. For $K_p > 0.15$ rad/rad/sec, the roll mode requirements are met with a very satisfactory dutch roll mode. A nominal gain of 0.3 rad/rad/sec was selected. This gives a 12 dB gain margin on the only mode that could be driven unstable -- the aileron actuator coupled with the p-loop compensator lag. The only disadvantage of the p-loop compensation is the reduction in this gain margin with respect to the Fig. 23 pure gain situation, but the 12 dB gain margin is quite adequate. The phase margin near the effective roll mode is 100 deg corresponding to a very high delay

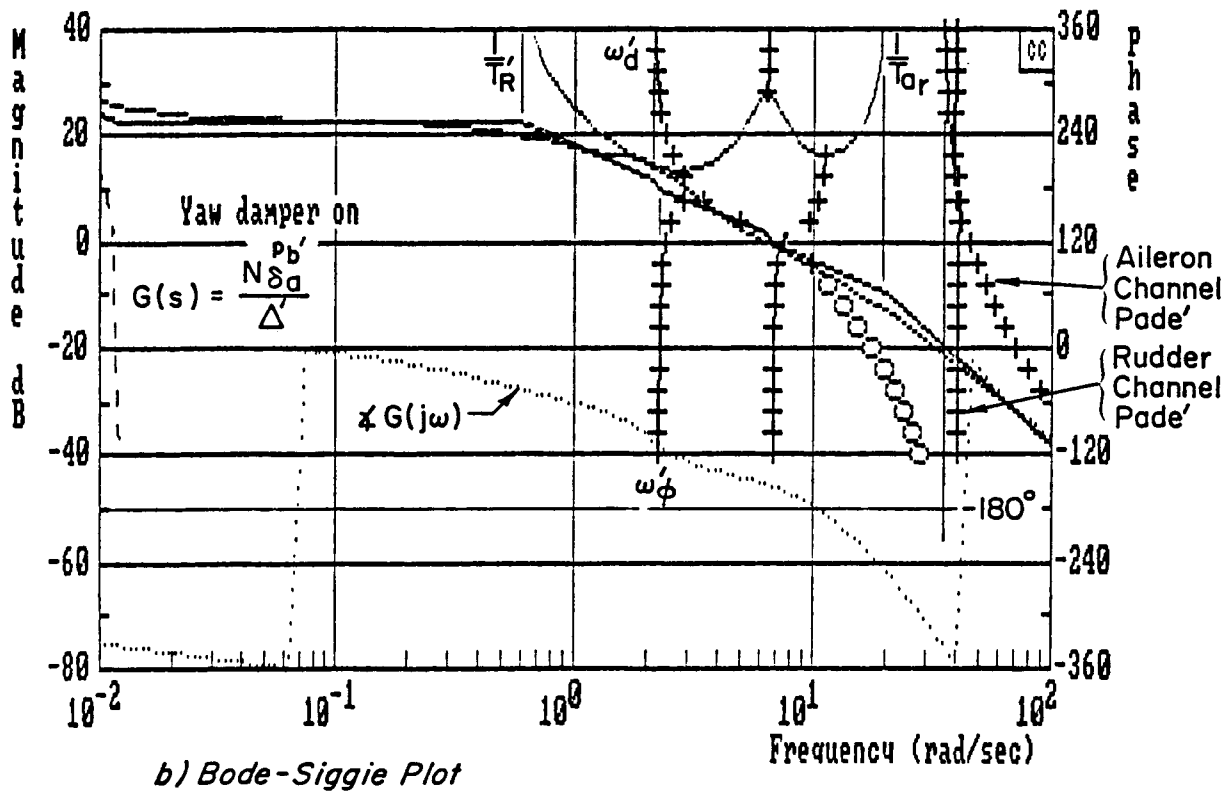
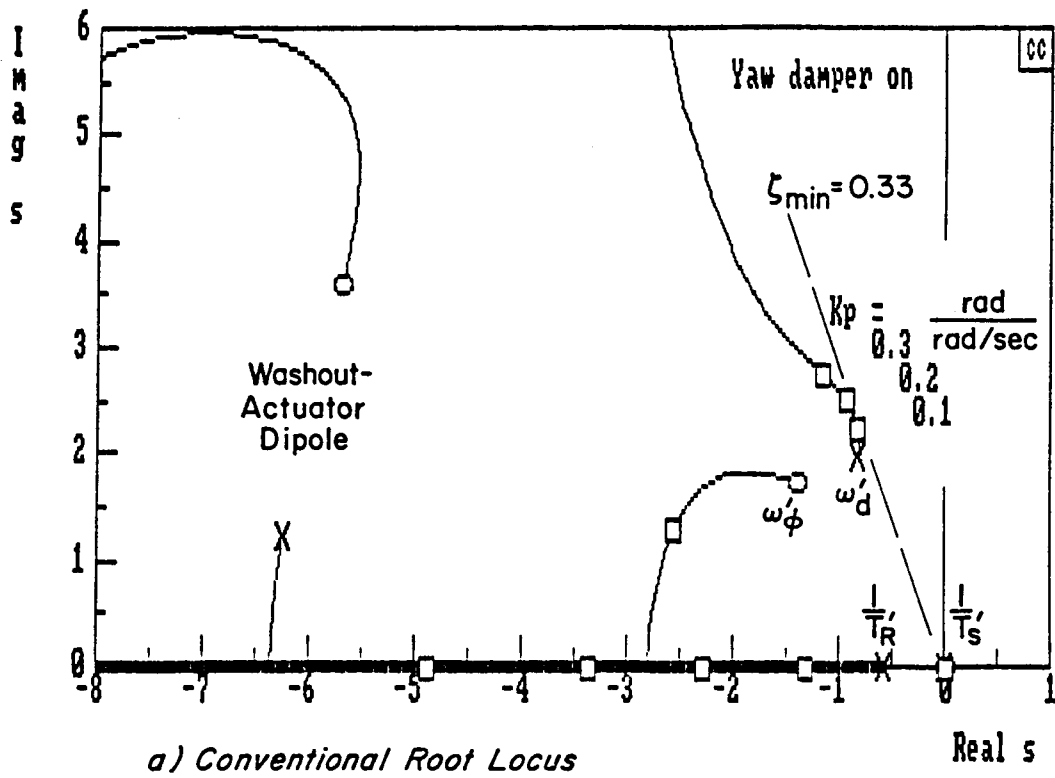

Figure 23. Effect of Pure Gain Roll Damper Closure on Denominator - Yaw Damper Closed

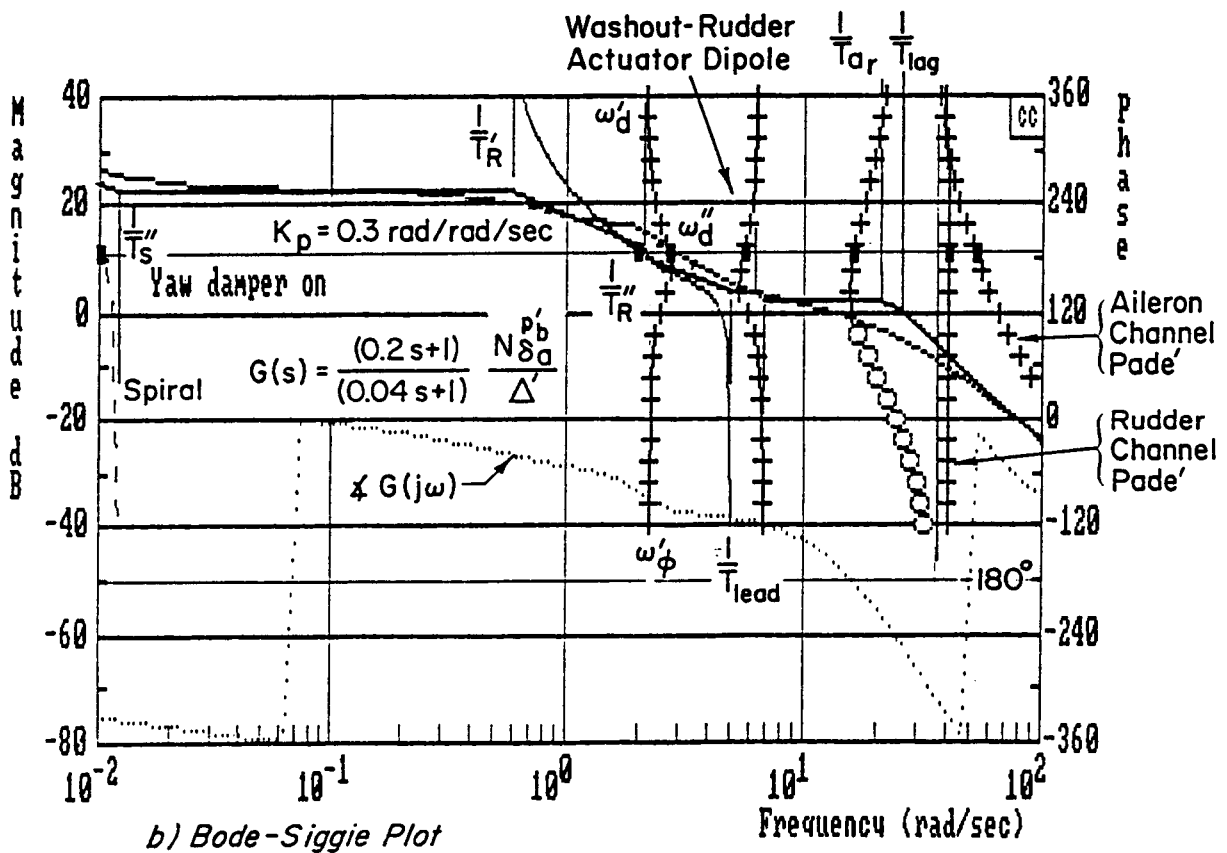
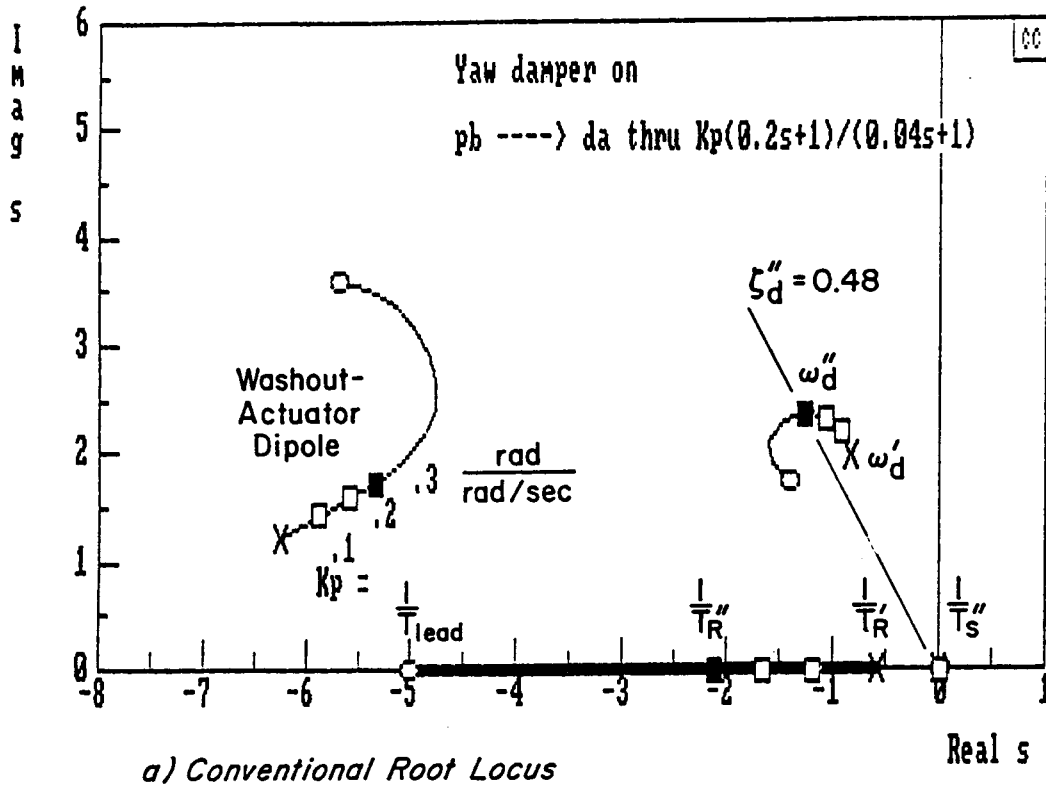

Figure 24. Effect of Roll Damper Closure with Lead-Lag Compensation on Denominator - Yaw Damper Closed

margin of 0.87 sec. This greatly exceeds the MIL-F-9490D phase margin requirements. The closed-loop aircraft characteristics to lateral control are

$$\frac{\phi}{\delta} \bigg|_{\substack{a \\ p}}^n = \frac{131.4 \overbrace{[.618, 2.25]}^{\zeta'_\phi, \omega'_\phi} [.857, 6.68] (25) [-.866, 34.6] [\cancel{.855, 39.5}]}{(-.0104) \underbrace{(2.11)}_{1/T''_s} \underbrace{[.473, 2.67]}_{1/T''_R} \underbrace{[.952, 5.61]}_{\zeta'_d, \omega'_d} [.534, 15.8] [\cancel{.854, 39.6}] [.831, 52.2]}$$

(38)

As far as piloted control is concerned, these effective aircraft characteristics are excellent. They feature a roll subsidence time constant of 0.48 sec, a dutch roll damping ratio of 0.47, and an undamped dutch roll natural frequency of 2.7 rad/sec. The spiral with $T_2 = 67$ sec is more unstable than for the bare airplane, but is still within the Level 1 requirements. Finally, the roll numerator quadratic comes fairly close to the dutch roll quadratic, thereby tending to remove dutch roll effects on lateral controller induced maneuvering.

When these characteristics are examined in conjunction with piloted control, the pilot equalization (via Eq. 14 of Supplement 3) will be a lead of about 0.5 second to essentially cancel the roll subsidence. This is well within the range for excellent ratings near the best end of Level 1 if the effective airplane gain (as seen by the pilot) is properly set (see, e.g., Refs. 13, 14).

The most sensitive parameters and dynamics in the roll damper loop include:

- Gain, $K_p (L'_\delta + \tan \alpha_0 N'_\delta)$
- Compensation time constants
- Roll mode pole, $1/T''_R$

As with the yaw loop, the FCS gain and time constants should have very low uncertainty, but the overall loop gain will reflect the uncertainty in the roll control effectiveness. The airplane roll mode is uncertain as well as low at higher AOA; however, the roll damper has good potential for accommodating this uncertainty. The roll damper loop has low sensitivity to the dutch roll dipole unless the yaw damper channel is off.

The time domain characteristics of this combined set of yaw and roll damper FCS modes are a final consideration. Time histories of roll rate, yaw rate, and sideslip angle for a 1 rad aileron surface command are shown in Fig. 25. The roll rate response shows very little dutch roll contamination, and indicates that the roll control response is quite adequate without use of an aileron-rudder crossfeed to improve the rolling velocity response. The sideslip associated with the 1° step aileron input is about 0.1° until the spiral mode starts to show up significantly. This would permit an aileron-only rolling velocity of almost 30 deg/sec without the sideslip straying beyond the 1° desired requirement. Consequently, an aileron to rudder crossfeed may not be essential for this flight condition if the pilot can easily coordinate maneuvers with rudder.

Time responses for 1 degree rudder steps are shown in Fig. 26. These are generally well-behaved and, in company with the responses of Fig. 25, indicate that classical lateral and directional stability desires are generally met.

Although, as noted above, there is only a weak requirement for an aileron-to-rudder crossfeed for this flight condition, it can provide a final tuning of the effective airplane dynamics as seen by the pilot. The ideal crossfeed which makes $N_{\delta_a}^{\beta}$ " identically zero will be (referring back to Eq. 23) for the case at hand,

$$G_{\delta_a}^{\delta_r} = \frac{-N_{\delta_a}^{\beta''}}{N_{\delta_r}^{\beta'}} \quad (39)$$

For the example flight condition this will be

$$G_{\delta_a}^{\delta_r}(s) = \frac{-6.30(.755)(-.917)(2.72)(10.86)[- .863,34.3][.797,34.8](36.8)}{(-.0104)(2.11)[.473,2.67][.952,5.61][.534,15.82][.854,39.6][.831,52.2]} \quad (40)$$

The ideal crossfeed expression contains non-minimum phase terms which cannot be offset by simple cancellation in a practical system. Many of the other terms are high frequency in nature and/or tend to offset each other. By examining the transient responses of Figs. 25 and 26 it is plain that the most prominent mode present in the sideslip response is the

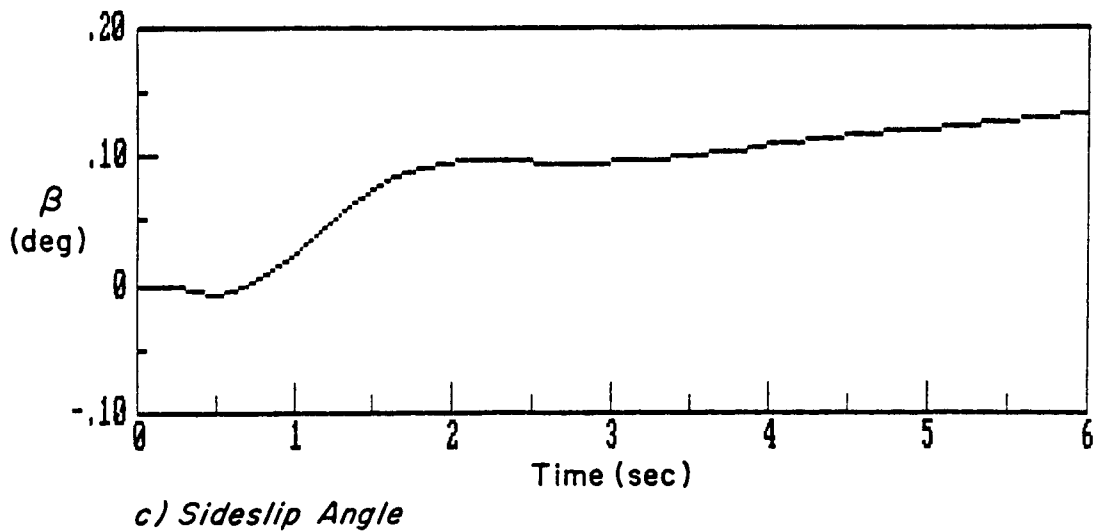
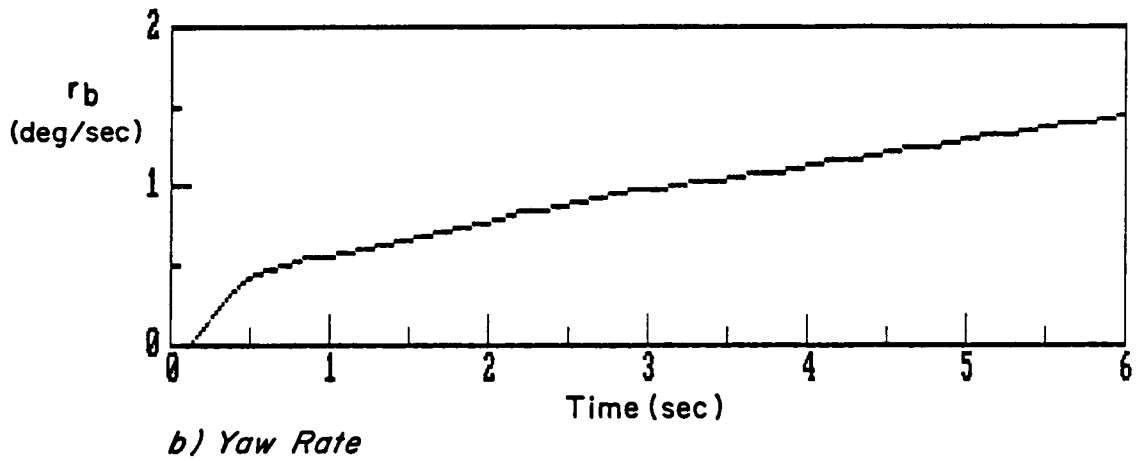
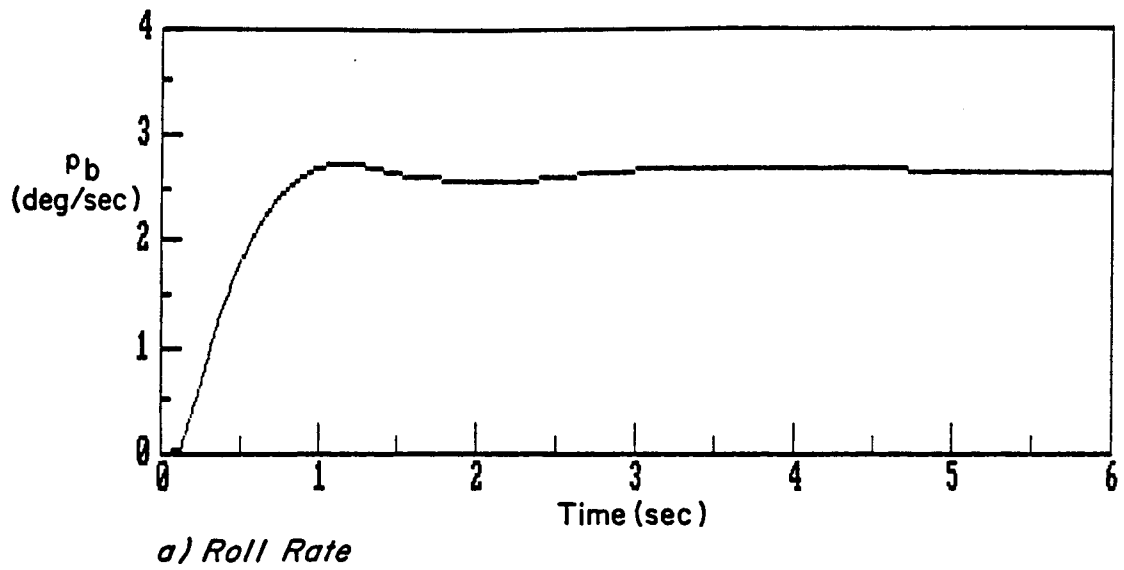
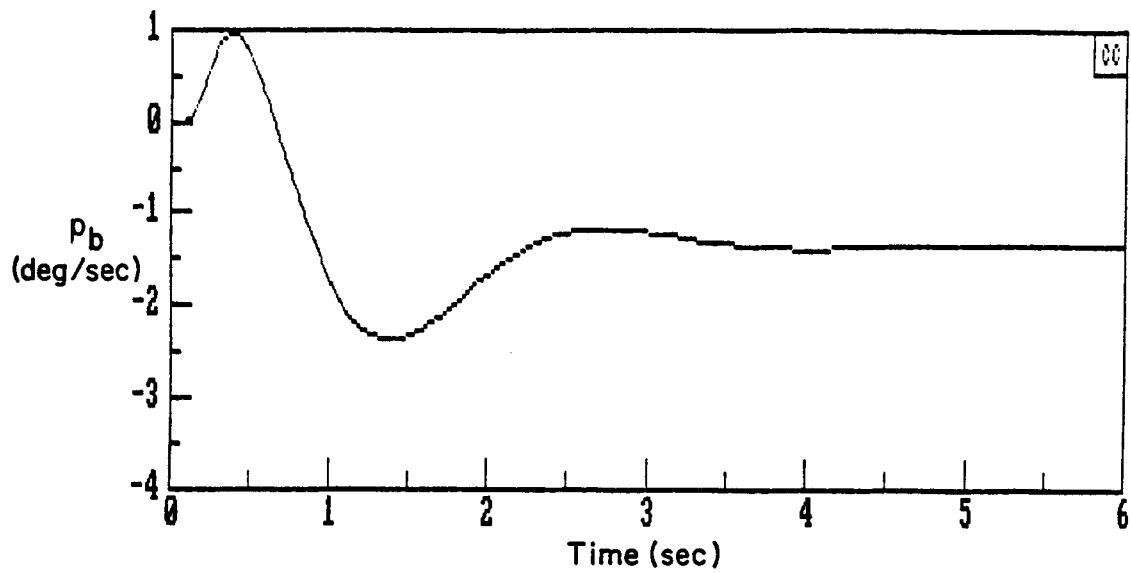
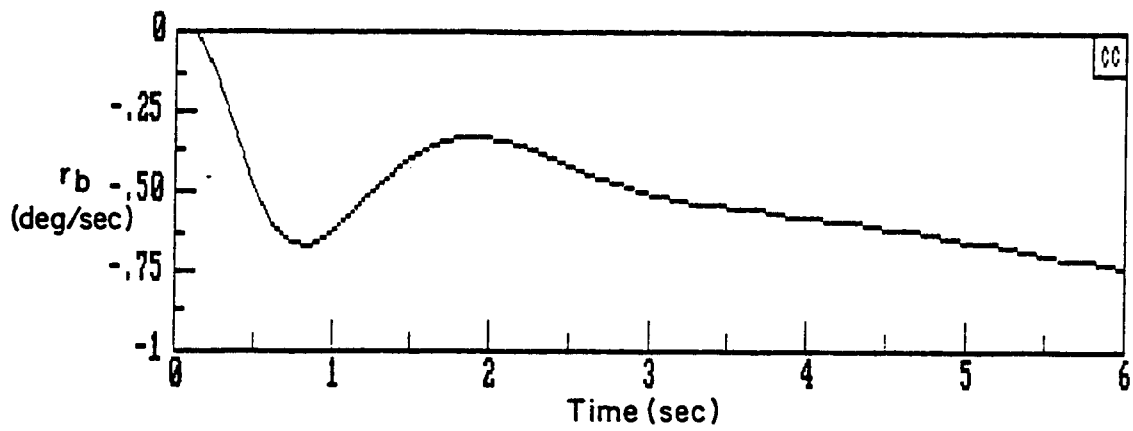

Figure 25. Response to 1 deg Aileron Step Yaw and Roll Dampers Closed
 TR-1228-1-I 132



a) Roll Rate



b) Yaw Rate

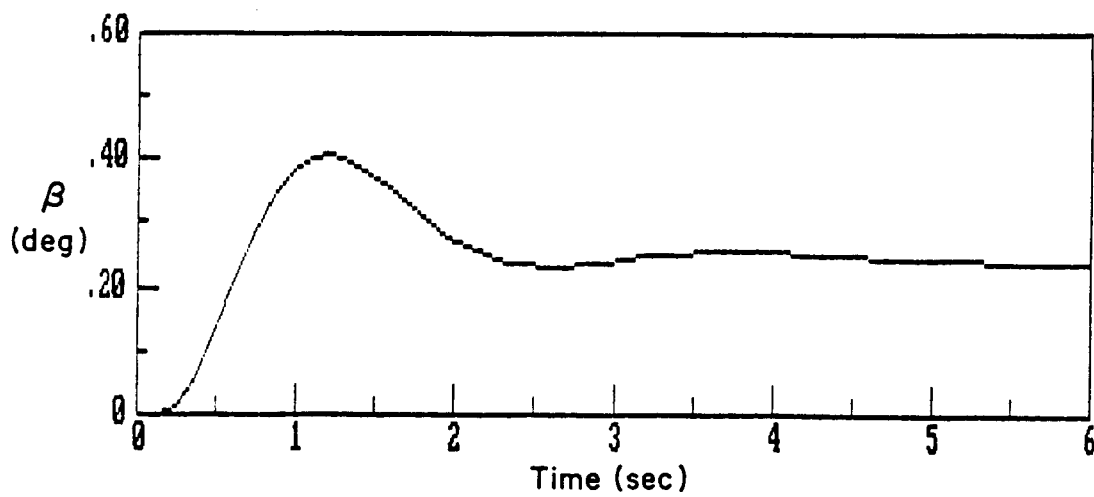

c) Sideslip Angle

Figure 26. Response to 1 deg Rudder Step

modified dutch roll, with the spiral beginning to have an effect after a few seconds. When attention is focused on the frequencies around the dutch roll an approximation to the ideal crossfeed becomes,

$$G_{\delta_a}^{\delta_r} = \frac{-.373}{(s + 1.5)} \quad (41)$$

which corresponds to a low pass filter with a first order rolloff at the yaw damper washout frequency. If this last approximation is used as the basis for an aileron to rudder crossfeed in the control system the response to a 1 deg aileron step will appear as shown in Fig. 27. When contrasted with the responses of Fig. 25 the crossfeed is seen to reduce transient sideslip to about 1/3 of the level without the crossfeed.

D. BANK ANGLE CONTROL LOOP

The bank angle (stability axis ϕ) frequency response for roll control inputs is shown in Fig. 28. This response is K/s-like out to about 3 rad/sec, and will allow a bank angle control loop to be readily closed either by the pilot or by the guidance system at frequencies lower than this.

To the extent that the open-loop characteristics is indeed K/s-like, the bank angle regulation requirement of MIL-F-9490D (which specifies that the bank angle be returned to 1 deg from a 5 deg offset in 3 sec or less) can be interpreted to imply a minimum crossover frequency of 0.54 rad/sec for the bank angle control loop. This low crossover frequency is based on the response being first-order. As given in Table 3 the specification is tightened by taking the 3 seconds as a response time (time to achieve and remain within 5% of the final value in response to a step input) and by assuming a second-order system. This raises the crossover frequency to about 1.4 rad/sec. That either of these interpretations can easily be met is seen by examining Fig. 28. The maximum crossover frequency for a pure gain bank angle controller is about 2 rad/sec, set by the phase margin requirement of 45 deg.

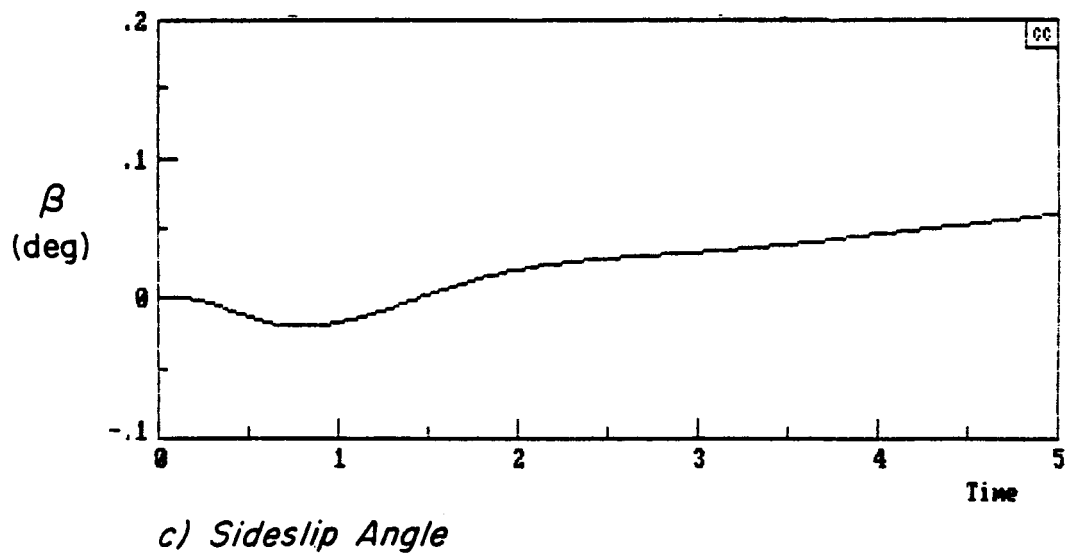
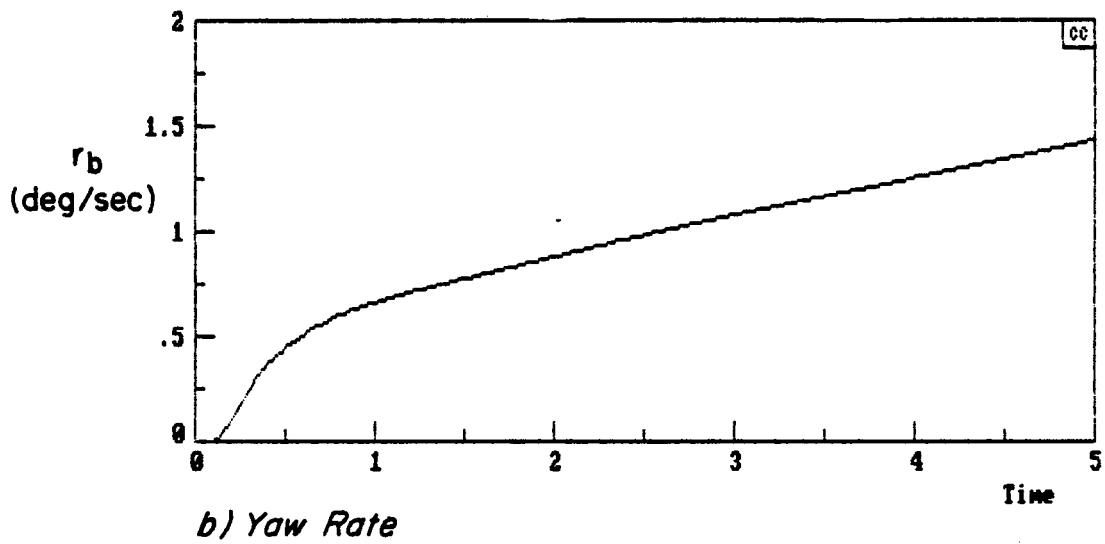
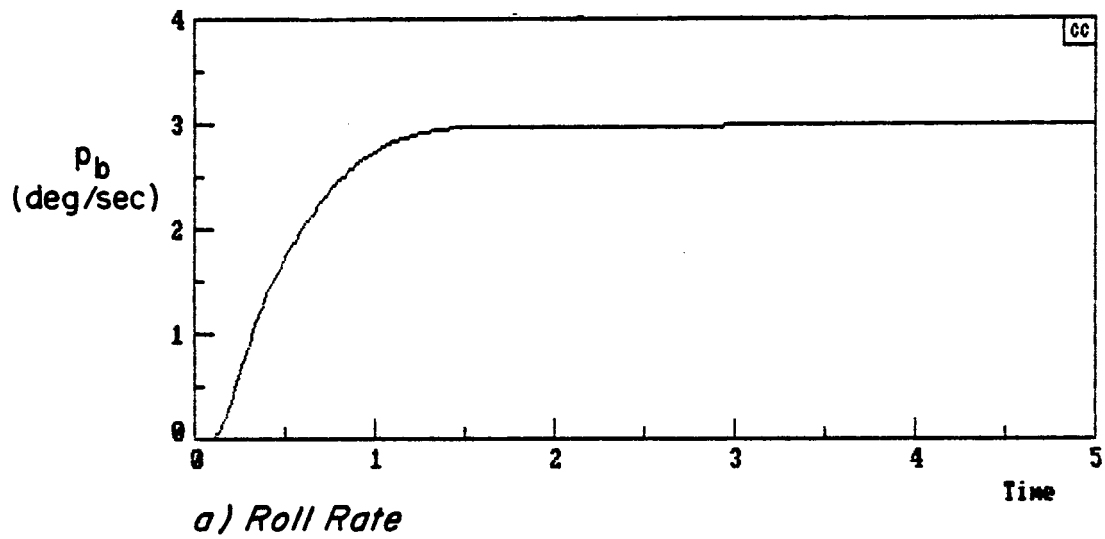

Figure 27. Response to a 1 deg Aileron Step, Yaw and Roll Dampers Closed, Crossfeed On

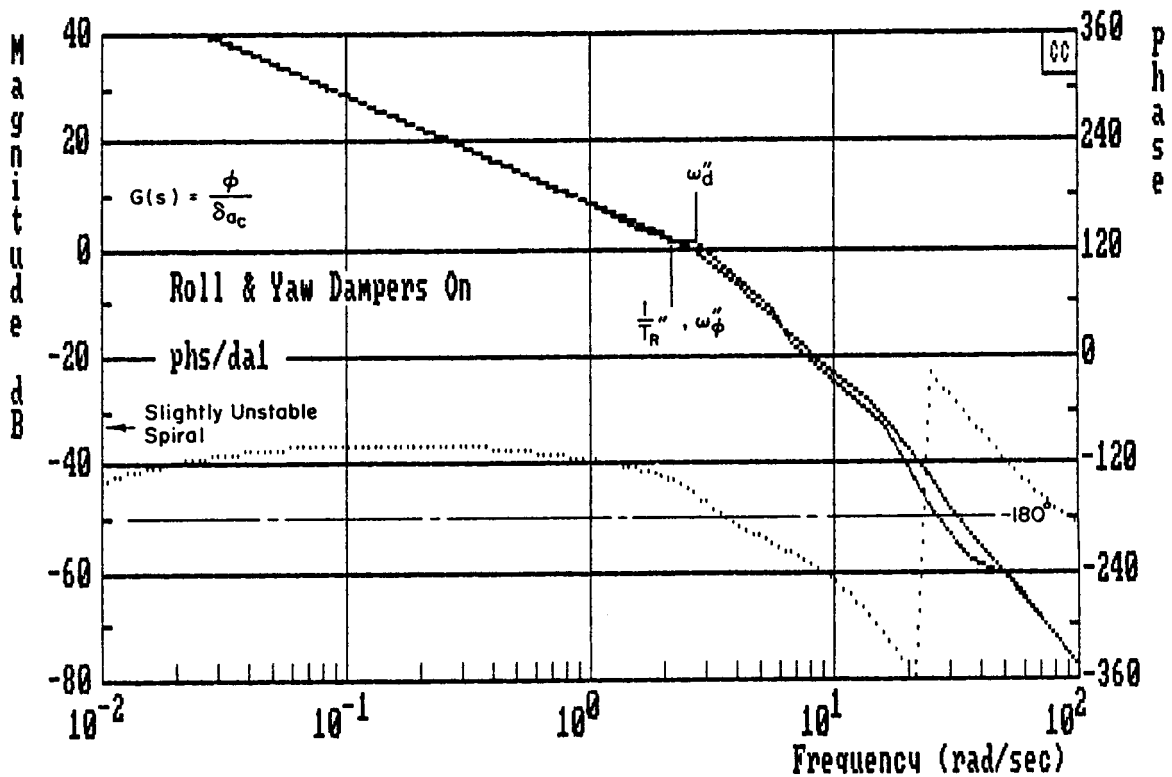

Figure 28. Bank Angle-to-Roll Control Frequency Response

A system survey for pure gain $\phi \rightarrow \delta_a$ loop is shown in Fig. 29. In addition to the specification for response described above, the primary consideration is setting the gain to allow adequate relative stability of the dutch roll mode, while keeping the complex roll-spiral frequency high enough to assure rapid response. A gain of $K_\phi = 0.5$ is a good compromise which emphasizes roll control bandwidth and rise time. This is at the expense of the dutch roll, which just meets the MIL-F-9490D minimum damping ratio requirement. At this gain the crossover frequency is 1.3 rad/sec with a corresponding phase margin of 60 deg, a delay margin of 0.8 sec, and a gain margin of 13 dB with respect to destabilizing the dutch roll. Figure 30 shows the closed-loop bank angle response to a unit step bank angle command. The response is within 4 percent of the steady-state within 2.5 seconds indicating that the MIL-F-9490D bank angle regulation requirements are easily met.

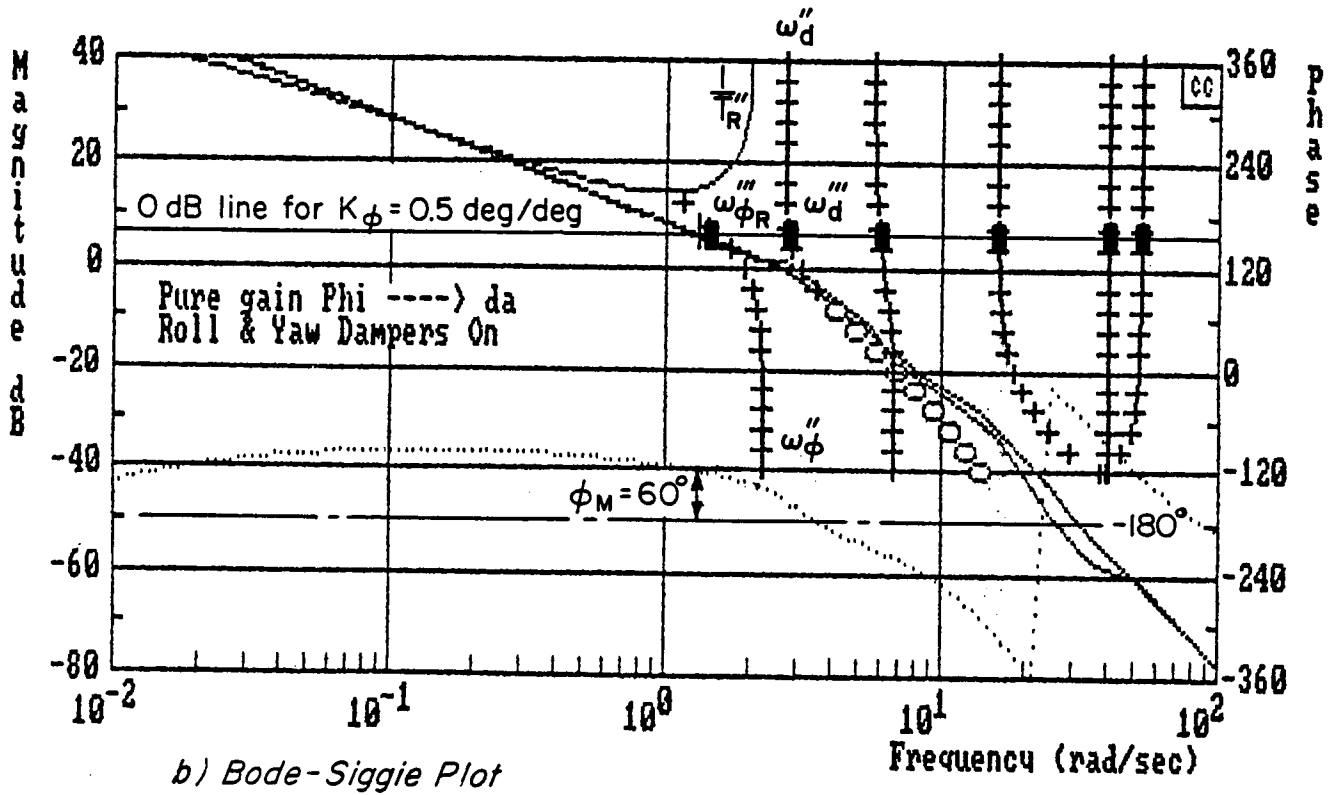
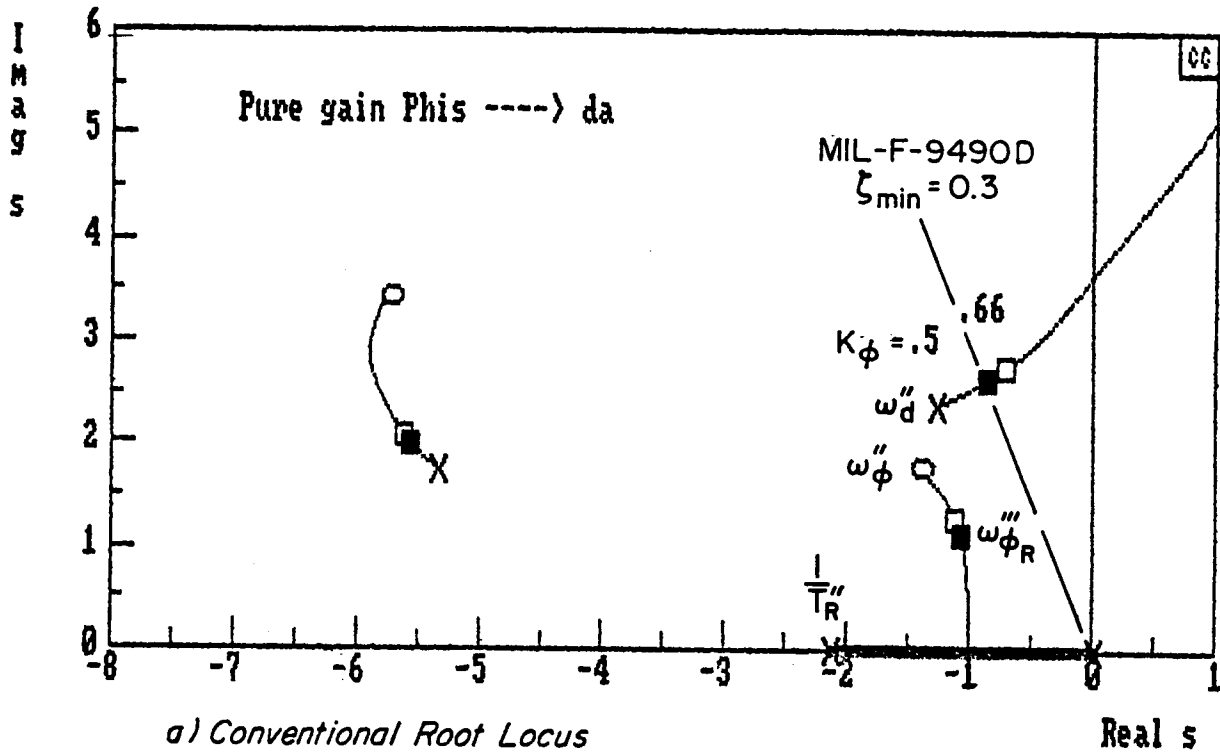

Figure 29. Closure of the Bank Angle Control Loop

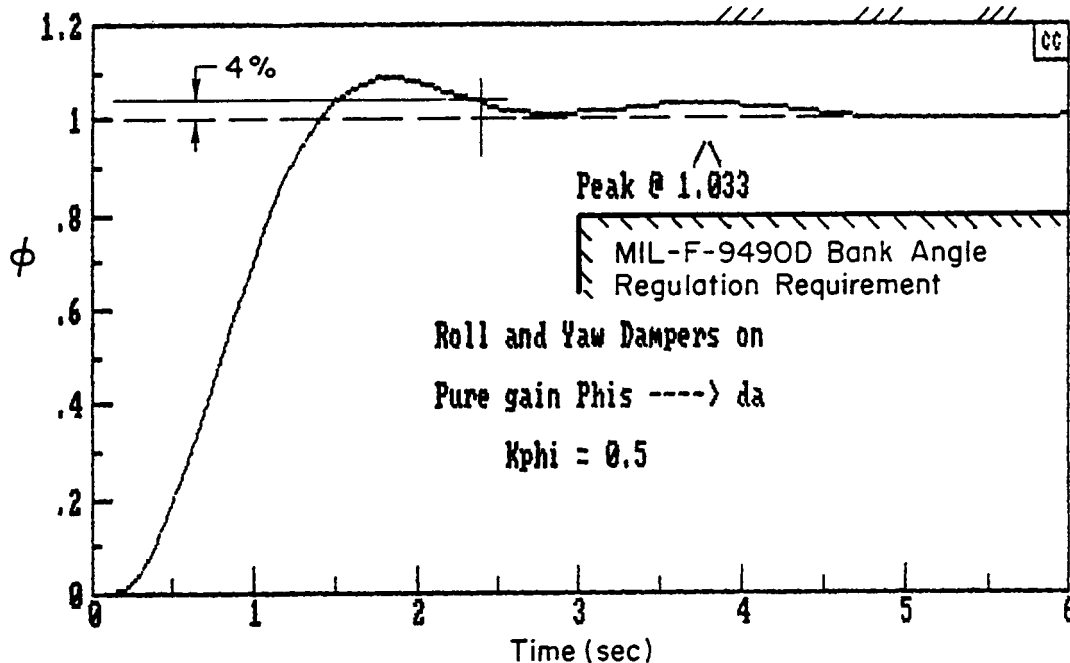

Figure 30. Bank Angle Response to Bank Angle Command, Complete System

With the equalization from inner roll and yaw loops, the bank angle control loop is relatively insensitive to basic airframe parameters. Probably the most critical issue is the sensitivity of the final dutch roll damping to the roll loop gain. Uncertainties in the dutch roll dipole and to some extent the net high frequency lag are also important in insuring adequate dutch roll damping.

E. WHAT NEXT?

The tutorial example worked through in this section is sufficiently complete to illustrate most of the key stages in the design methodology without bogging the reader down in tedious detail. A more comprehensive design assessment would examine in depth most of the topics summarized in Table 20 (adapted from Ref. 15). The major steps left to finish off a preliminary design assessment for the single exemplary flight condition are:

- Examination of responses to a reasonable cross-section of the disturbances represented in Table 4;
- Assessment of robustness.

TABLE 20. DESIGN ASSESSMENT

FEATURE	PROPERTY	ASSESSMENT DATA/TECHNIQUES	CONSIDERATIONS
SYSTEM PROPERTIES			
<u>Stability</u> Nominal modal dampings Margins for key loops	Closed-loop characteristic equations Phase and gain margins for key open-loop characteristics First mode to go unstable as loop gain(s) are varied Singular values	Closed-loop eigenvalues Open-loop frequency responses s-plane/Bode root loci Frequency domain representation of singular values	Can be both high and low gains in conditionally stable situation
<u>Robustness Assessments</u>	Closed-loop characteristic equations Phase and gain margins for key open-loop characteristics First mode to go unstable as loop gain(s) are varied Singular values	Closed-loop eigenvalues Open-loop frequency responses s-plane/Bode root loci Frequency domain representation of singular values	Can be both high and low gains in conditionally stable situation
<u>Response</u> Primary controlled variables Specified command-response relationships	Rapid, well-damped, minimum-tailed time histories for specified transient inputs Good output/command following for specified random inputs Indifference/suppression of effects of unwanted inputs	Indicial, ramp-input responses s-plane/Bode root loci RMS response ratios (covariance matrix) Bandwidths (frequency responses) RMS values (covariances)	Defines time character Defines dominant modes Also relates to command-response accuracy
Disturbance/noise inputs Secondary variables Specified command-response relationships	Desirable phasing and amplitude relative to primary variable Motion harmony, coupling of variables	Indicial responses to commands s-plane root loci with closed-loop modal response ratios RMS values Indicial responses RMS values, exceedances	Defines time character Defines dominant modes for secondary variables Also defines reasonable authority limits
Control activity	Control rates, positions; limiting potential, favorable or negligible cross-coupling	Indicial responses to commands s-plane root loci with closed-loop modal response ratios RMS values Indicial responses RMS values, exceedances	Defines time character Defines dominant modes for secondary variables Also defines reasonable authority limits

(concluded on following page)

TABLE 20. (CONCLUDED)

FEATURE	PROPERTY	ASSESSMENT DATA/TECHNIQUES	CONSIDERATIONS
SYSTEM PROPERTIES (CONCLUDED)			
<u>Sensitivity</u> Sensitivity of key response modes Crucial Dominant primary Dominant secondary Sensitivity to parasitic nonlinearities Threshold Effects Graceful Degradation Conventional loop structure Integrated sensor structure, adaptive filter-observer	Sensitivity to off-nominal conditions, component tolerances/ variations, uncertainties, etc. Different thresholds in various loops No gross instability problems with various loop failures No gross instability problems with various loop failures	First-order gain or parameter sensitivities Comparison of pertinent open-loop frequency responses Use stability analysis techniques on system where one or more loops has failed Use stability analysis techniques on system where one or more sensors has failed	Effects of zero gains on various outer/inner loops Will increase order of filter-observer, and increase rms state estimation error
CONTROLLER PROPERTIES			
<u>Gain Levels</u> Control saturation Minimum increment of control <u>Sensor Complex</u> Equalization economy Commonality of elements/ gain settings for different operational modes	Level of input state which saturates control Level of input state which corresponds to minimum control output Minimum structure controller Common controller elements for each operational mode	RMS values, controller gains Controller gains Structure, architecture Controller gains over many operational modes	Indicates outer extent of control space Indicates inner extent of control space; effective threshold of variable fed to control; dynamic range information; permits elimination of low gain, low effectiveness feedbacks Sensor/computational tradeoff Eliminate low gain, low effectiveness feedbacks

The first item is a straightforward application of Program CC (or similar computer aids) to the three closed-loop systems (yaw damper, yaw damper plus roll damper, bank attitude autopilot). The second subject has received a good deal of attention in recent years. We have evolved an approach to this problem which brings the literal approximate factors idea to singular value-based robustness assessment notions and which thereby falls very nicely into the FCS design methodology. A tutorial on these methods applied to the example problem is given in the form of an AIAA technical paper in Supplement 1 to this report.

In a complete preliminary design three other steps are needed. The first is the establishment of competition by developing other architectures to the same level as illustrated here. The second is to examine all the competing systems for other critical flight conditions. This permits the preliminary establishment of compensation requirements for the controllers in order that they maintain control throughout the total flight regime (e.g., see the example compensation requirements in Table 19). Then, on the basis of the competitive data developed, the several system possibilities are played off against each other taking into account such factors as:

- Relative differences in performance
- Relative differences in sensitivity to uncertainties, tolerances, etc., including possibly different governing factors
- Mechanizational possibilities and their side effects (e.g., as illustrated in Table 2)
- Economy of equalization and simplicity of compensation
- Relative versatility across mission phases, coping with stores loading variations, etc.
- Inherent reliability and maintainability
- Development and life cycle costs

The result of the competition is a baseline FCS system which will be subjected to re-examination in several respects and thoroughly analyzed in much more detail. At the outset the airplane, actuator, sensor, etc.

dynamics will be made more realistically complex. The airplane's dynamic description will be expanded to account for nonlinear features and the lower frequency flexible modes. Some of the important issues brought about by the flexible modes are covered in Supplements 2 and 3. The controller itself, if digital, will be modified to take into account the sampled data aspects. Reference 11 illustrates this step with an example vehicle which includes flexible modes which can, in principle, interact with sampling phenomena.

As the design progresses more and more reliance is placed on more and more detailed analyses and simulations -- all in an attempt to forecast behavior and anticipate potential problems that may arise. Unfortunately, the further along the system development, the more difficult and costly become any corrections needed. This places an extreme emphasis on the earliest preliminary design phases addressed here as the proper time to evolve a system which is solidly based in reality and possesses well-favored features.

REFERENCES

1. McRuer, Duane T., Irving Ashkenas, and Dunstan Graham, Aircraft Dynamics and Automatic Control, Princeton University Press, Princeton, N.J., 1973.
2. "Military Specification -- Flying Qualities of Piloted Airplanes," MIL-F-8785C, Nov. 1980.
3. "Military Specification -- Flight Control Systems Design, Installation and Test of Piloted Aircraft, General Specification For," MIL-F-9790D, June 1975.
4. Federal Aviation Regulations, Part 25, Airworthiness Standards: Transport Category Airplanes, Department of Transportation, Federal Aviation Administration, June 1974.
5. McRuer, Duane T., and Donald E. Johnston, Flight Control Systems Properties and Problems, Vol. 1, NASA CR-2500, Feb. 1975.
6. Myers, Thomas T., Duane T. McRuer, and Donald E. Johnston, Flying Qualities and Control System Alternatives for Superaugmented Aircraft, NASA CR-170419, Dec. 1984.
7. McRuer, Duane T., Donald E. Johnston, and Thomas T. Myers, "A Perspective on Superaugmented Flight Control: Advantages and Problems," J. Guidance, Control, and Dynamics, Vol. 9, No. 5, Sept-Oct. 1986, pp. 530-540.
8. Allen, R. Wade, Theodore J. Rosenthal and Raymond E. Magdaleno, LSMP User's Guide, Version 2.5, Systems Technology, Inc., Hawthorne, CA, 1988.
9. Thompson, Peter M., Program CC Version 3 User's Guide, Systems Technology, Inc., Hawthorne, CA, May 1985.
10. Thompson, Peter M., Program CC Version 4 Tutorial and User's Guide, Systems Technology, Inc., Hawthorne, CA, May 1988.
11. McRuer, Duane T., Richard F. Whitbeck, and Raymond E. Magdelano, Methodologies for the Direct Digital Control of Highly Flexible Vehicles, AFWAL-TR-84-3104, Feb. 1985.
12. Myers, Thomas T., and Donald E. Johnston, Investigation of Potentially Critical Lateral-Directional Flight Conditions for Shuttle Orbiter Entry, Systems Technology, Inc., TR-2143-1, Oct. 1982.
13. McRuer, Duane T., and Ezra S. Krendel, Mathematical Models of Human Pilot Behavior, AGARDograph No. 188, Jan. 1974.
14. McRuer, Duane T., "Pilot Modeling," in Advances in Flying Qualities, AGARD Lecture Series 157, 1988.
15. Hofmann, L. G., Susan A. Riedel, and Duane T. McRuer, Practical Optimal Flight Control System Design for Helicopter Aircraft, NASA CR 3275, May 1980.

SUPPLEMENT 1*
LITERAL SINGULAR-VALUE-BASED FLIGHT CONTROL
SYSTEM DESIGN TECHNIQUES**

Duane T. McRuer, Thomas T. Myers, and Peter M. Thompson

Introduction

Robustness issues for single-input single-output systems have long been understood and appreciated by designers. The objective is to design a controller which is in some sense tolerant and forgiving. Extending these results to multi-variable systems has been the focus of a stream of research in recent years. A hallmark of the new approaches has been a renewed emphasis on frequency domain techniques, after a period in which these methods had often been viewed as mature or even *passee*.

The key to extending the frequency domain robustness methods has been the generalization of gain using singular values of a matrix [1,2]. Reformulations of this metric, notably using structured singular values [3,4], continues to be central to most of the new methods. Most of the work has been done in a general context using abstract $\dot{x} = Ax + Bu$ type linear systems. A byproduct of working at this level of abstraction is that the *tools of the trade* are largely computer programs implementing very general and sophisticated numerical methods. This focus on the computational aspects of the problem is a characteristic that multi-variable frequency domain robustness methods have in common with earlier time domain and optimal control methods.

Aircraft flight control system (FCS) design has been an important motivation for new robustness methods. Flight control related work has been done in industry, at NASA [5,6], the Air Force [7], and at universities [8]. Aircraft manufacturers have also experimented with these methods, but in general they are a long way from routine working tools. This is to be expected in the *hard-nosed* environment of specific aircraft projects, where new

*This supplement treats the robustness assessment for the fighter aircraft illustrative design example. As a technical paper it has been accepted for publication by the AIAA Journal of Guidance, Control, and Dynamics.

**All numbers in this supplement referring to figures, tables, equations, and references are for Supplement 1 only.

theoretical tools have to compete against techniques which have stood the test of time on many successful projects.

An early impediment to the use of singular-value-based robustness tests was the lack of widely available mature software. Commercial packages are now available at a reasonable cost, so this is less of an issue. However there are more subtle factors at work, generally related to incorporating the thinking process and expertise of the flight control designer. General theory is not of any great practical interest to the designer faced with a myriad of quantitative and qualitative requirements.

Of more concern is to expose and bound uncertainties in stability derivatives, actuator and sensor dynamics, and other aircraft parameters. To do this the designer typically studies single variations using a variety of conventional measures such as gain, phase, and time delay margins, peak amplification ratios, dominant mode characteristics, and so on.

Coupling several variations to assess overall robustness is where expertise and experience are most useful. A designer's knowledge of the particulars of a given airframe is the secret weapon which makes this possible. Multi-variable singular-value-based robustness tests present an opportunity to do this traditional job more efficiently and rigorously, but as currently applied these tests are strictly numerical, with the result that the designer loses the physical insight needed to diagnose a robustness problem.

Flight control designs in the future will have larger uncertainties in aircraft operating over greatly expanded flight envelopes. Control systems will be reconfigurable, perhaps even in real time in the presence of failures or

damage. New robustness procedures offer a solid approach to these problems. The need has never been greater for tying together the existing academic generality with the physical insight of a good designer. This paper attempts to improve this relationship; specifically we will:

- Connect multi-variable frequency domain singular value methods to classical coupling numerator based multi-loop methods [9].
- Develop physical insights between the singular values and aircraft and controller dynamics by using literal approximate factors.
- Provide a recipe for the identification of the most important aircraft and controller parameter uncertainties.

Example Problem

Throughout the paper a lateral-directional FCS design for an advanced fighter aircraft is used as an example [10]. A state space model for the aircraft is shown in Table 1 ($M=0.6$, 35,000 ft, 50% fuel). The low frequency effects of the rudder and roll control actuators have been modeled as first order lags (with poles at 20 and 25 rad/sec, respectively). The unaugmented aircraft characteristics were contrived to exhibit several generic problems characteristic of lateral control at moderately high angles-of-attack including:

- High roll subsidence time constant ($T_R = 2.34$ sec, MIL-F-8785C Level 3)
- Low Dutch roll damping ratio ($\zeta_d = 0.0208$, MIL-F-8785C Level 3)

$$\dot{x} = Ax + Bu$$

$$y = Cx + Du$$

$$x = \begin{pmatrix} \beta \\ p_b \\ r_b \\ \phi \end{pmatrix} \quad u = \begin{pmatrix} \delta_a \\ \delta_r \end{pmatrix} \quad y = \begin{pmatrix} p_b \\ \phi \\ r_s \end{pmatrix}$$

β = side slip (rad)

δ_a = aileron angle (rad)

p_b = body axis roll rate (rad/sec)

δ_r = rudder angle (rad)

r_b = body axis yaw rate (rad/sec)

r_s = stability axis yaw rate (rad/sec)

ϕ = body axis roll angle (rad)

$$\left(\begin{array}{cc|cc} A & B \\ \hline C & D \end{array} \right) =$$

$$\left(\begin{array}{cccc|cc} -0.0868 & 0.215 & -0.977 & 0.0539 & 0 & 0.0179 \\ -32.3 & -0.374 & 2.40 & 0 & 6.35 & 6.66 \\ 1.06 & -0.0406 & -0.0809 & 0 & 1.71 & -1.18 \\ 0 & 1 & 0.220 & 0 & 0 & 0 \\ \hline 0 & 1 & 0 & 0 & 0 & 0 \\ 0 & 0 & 0 & 1 & 0 & 0 \\ 0 & -0.215 & 0.977 & 0 & 0 & 0 \end{array} \right)$$

Table 1: Lateral-Directional Airframe Model

- Undesirable roll-due-to-aileron control numerator ($\omega_\phi/\omega_d > 1$, with low damping for the complex zero [9])

A simple FCS design has been formulated which satisfactorily solves the above problems and in addition provides bank angle control. As shown in Fig. 1, this system consists of a washed-out stability axis yaw damper ($r_s \rightarrow \delta_r$), a body axis roll damper ($p_b \rightarrow \delta_a$) and an autopilot bank angle command and hold loop ($\phi \rightarrow \delta_a$). In traditional designs the feedbacks would be the output of three sensors. The inner loop stability augmentation feedbacks would be provided by yaw- and roll-rate gyros, with r_s being a blended combination of r_b and p_b . The outer loop autopilot ϕ would be provided by a distinct vertical gyro. Next generation fighters and other aircraft can be expected to use integrated inertial reference assemblies in which one set of (redundant) gyros provide both attitude and attitude rate information through strapdown calculations.

Robustness of Stability with Respect to Input Uncertainties

An uncertainty model used for the purpose of preliminary flight control design approximates the unmodeled high frequency dynamics of filters, sensors, structural modes, notch filters, etc. with effective time delays. These same effective delays model sampling delays and actuator rate limits. The low frequency approximations will be adequate if these high frequency dynamics are well above the magnitude crossover frequencies that define the bandwidths of

the FCS feedback loops. Thus, in Fig. 1 the rudder and roll control channels each contain a nominal effective time delay (0.11 and 0.10 sec respectively).

From a realistic point of view there are many uncertainties and variations which can occur at many points around the FCS loops. Stability derivatives should be included in the above list, as well as critical parameters in the control system. A complete uncertainty model would account for each source in its appropriate location. Here, for concreteness, we consider only the case of effective time delays at the inputs to the roll control and rudder.

The multi-variable uncertainty model is:

$$y(s) = G(s)[I + E_m(s)]u(s) \quad (1)$$

$$\text{where } I + E_m(s) = \text{diag} \{e^{-s\Delta\tau_a}, e^{-s\Delta\tau_r}\} \quad (2)$$

$$\bar{\sigma}[E_m(s)] = |e^{-s\Delta\tau} - 1|, \quad \Delta\tau = \max(\Delta\tau_a, \Delta\tau_r) \quad (3)$$

Lump the separate controllers together using the multivariable notation:

$$u(s) = K(s)[r(s) - y(s)] \quad (4)$$

It then follows [1,2] that the closed loop system is robustly stable with respect to $E_m(s)$ if:

$$\bar{\sigma}[E_m(j\omega)] < \underline{\sigma} \{I + [KG(j\omega)]^{-1}\} \quad \text{for all } \omega \quad (5)$$

where $\bar{\sigma}$ and $\underline{\sigma}$ respectively denote the maximum and minimum singular values.

The final condition (5) is *not* conservative in the sense that a perturbation $E_m(s)$ is guaranteed to exist which just barely exceeds the frequency domain

$$K_{\phi} = \frac{1.5 [s^2 + 2(.82)3.32s + 3.32^2]}{(s + 25.0)} ; K_r = \frac{k_r s}{(1/T_{w0})} = \frac{-0.8s}{(s + 1.5)}$$

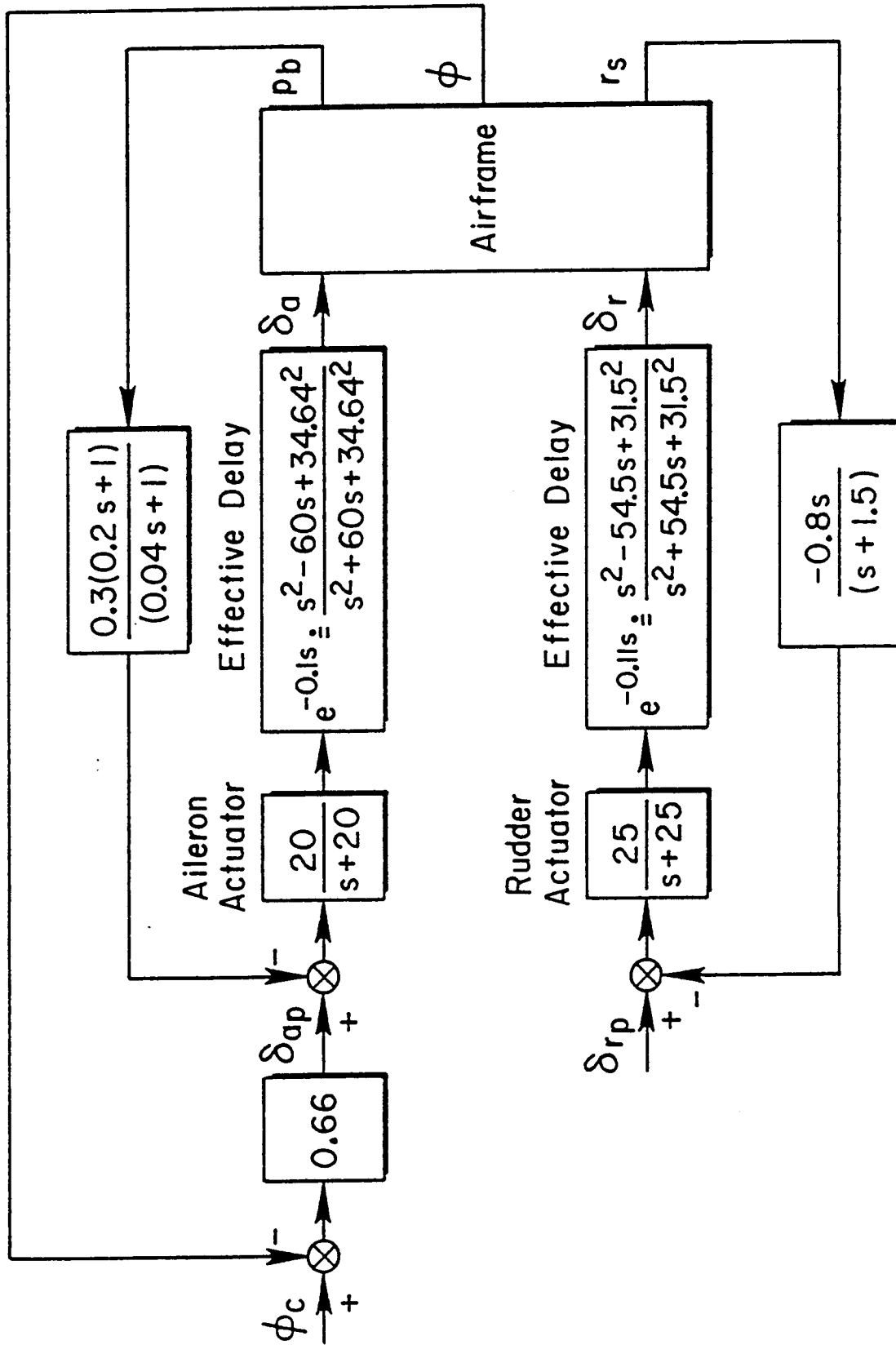

Figure 1. Example Lateral FCS

bound and results in closed loop instability. The same condition, however, is conservative in the sense that a perturbation $E_m(s)$ with a particular structure can violate the frequency domain inequality without causing instability. Additional structure has been imposed in (2) on $E_m(s)$, namely that (a) the uncertainties in the actuator channels are delays and not some other type of dynamic element, and (b) there is no cross-coupling of the uncertainties, e.g. uncertainty in the roll actuator does not directly lead to uncertainty in the rudder position.

A graphical illustration of the robustness condition (5) is shown in Fig. 2a. The perturbation bounds $\bar{\sigma}(E_m)$ are shown for several $\Delta\tau$'s, and it is concluded that any combination of effective delays $\Delta\tau_a$ and $\Delta\tau_r$ such that both are less than about .1 secs is not destabilizing. It is noted that in the critical frequency ranges:

$$\bar{\sigma}[E_m(s)] \approx \Delta\tau s \quad (6)$$

Due to the particular diagonal structure used here it is expected that one or both of the effective delays can exceed this bound without destabilizing the system. Emerging robustness procedures [3,4] help to alleviate the conservativeness by taking advantage of additional structure on E_m . The singular value test (5) assumes no structure. If a diagonal structure is assumed for $E_m(s)$, where each diagonal element is the same, then a spectral radius test can be used:

$$E_m = (e^{-s\Delta\tau} - 1) I$$

$$\bar{\sigma}[E_m] < \rho\{I + [KG(j\omega)]^{-1}\} \quad \text{for all } \omega \quad (7)$$

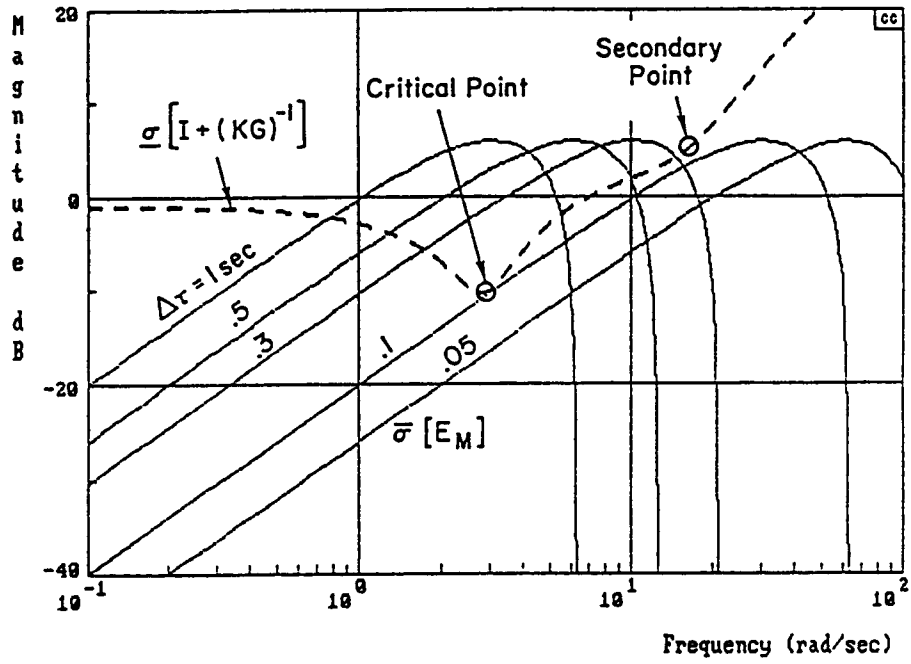

a) Singular Value Test

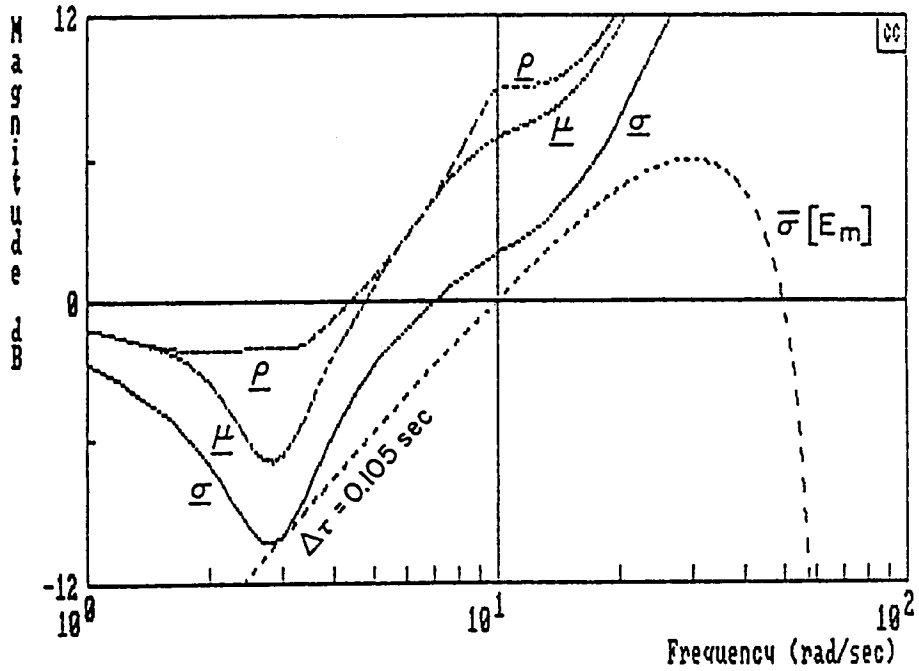

b) Singular Value ($\underline{\sigma}$), Spectral Radius ($\underline{\rho}$), and Structured Singular Value ($\underline{\mu}$)

Figure 2. Graphical Robust Stability Tests

The spectral radius $\underline{\rho}$ is defined as the absolute value of the minimum eigenvalue, i.e. $\underline{\rho}[A] = |\underline{\lambda}[A]|$. (This definition is nonstandard, hence the underline, in order to keep the same basic form as the singular value test (5). More typically $\rho = |\bar{\lambda}[A]|$, in which case $\underline{\rho}[A] = 1/\rho[A^{-1}]$).

If a block diagonal structure is assumed for E_m then the structured singular value is used. In (2) two 1×1 blocks are defined, which results in the following robustness test:

$$\bar{\sigma}[E_m] < \underline{\mu} \{ I + [KG(j\omega)]^{-1} \} \quad \text{for all } \omega \quad (8)$$

A definition of the structured singular value $\underline{\mu}$ which suffices in this case is [3,4]:

$$\begin{aligned} \underline{\mu}(A) &= \underline{\sigma}(\min_e D^{-1}AD) \\ \text{where } D &= \begin{pmatrix} 1 & 0 \\ 0 & e \end{pmatrix} \end{aligned} \quad (9)$$

The parameter e minimizes the Frobinius norm of $D^{-1}AD$, where the Frobinius norm is the square root of the element magnitudes squared. (This definition is again nonstandard, more typically $\mu[A] = \bar{\sigma}(\min_e D^{-1}AD)$ and $\underline{\mu}[A] = 1/\mu[A]$).

The diagonal scaling e can be given the interpretation of scaling the input variable δ_r relative to δ_a . The singular value test is not invariant to this type of scaling, and the innovation of the structured singular value test is to minimize over all possible scalings. This definition and interpretation holds for the cases of 2 and 3 diagonal blocks, but not for more general block structures.

Graphical applications of the robustness tests (5,7,8) are shown in Fig. 2b. For clarity only one uncertainty bound $\bar{\sigma}[E_m]$ is shown. The singular value test guarantees uncertainties $\Delta\tau$ up to 0.105 sec in each channel. The spectral radius test improves this up to 0.24 sec simultaneously in each channel, but nothing formal can be implied from this test for different delays in each channel. The structured singular value test guarantees $\Delta\tau$ up to 0.15 sec in each channel.

To better visualize the conservativeness issue it is useful to compare the guaranteed delays from tests (5,7,8) with the actual stability boundaries shown in the rudder-aileron time delay parameter plane of Fig. 3. The stability boundary is determined by varying the delay (modeled as a 2nd order Pade approximation) in the rudder channel, closing the yaw damper loop, and then determining the delay margin in the roll loop using an open loop Bode plot. Point (A) in Fig. 3 is the nominal condition, and points (B) and (C) represent conventional single axis delay margins. The conservativeness of the singular value test has been pointed out in many previous studies and is apparent from Fig. 3. Perhaps surprising is that in this example the structured singular value test is also conservative. This can be alleviated by using a real parameter singular value test [11] which takes into account the fact that $\Delta\tau$ is a real parameter, but this is beyond the scope of the paper.

The above discussion has focused on how the additional structure of the perturbation can be used to decrease the conservativeness of the robustness tests. Questions like this have been raised and for the most part answered [3,4] by members of the theoretical community. We do not want to minimize

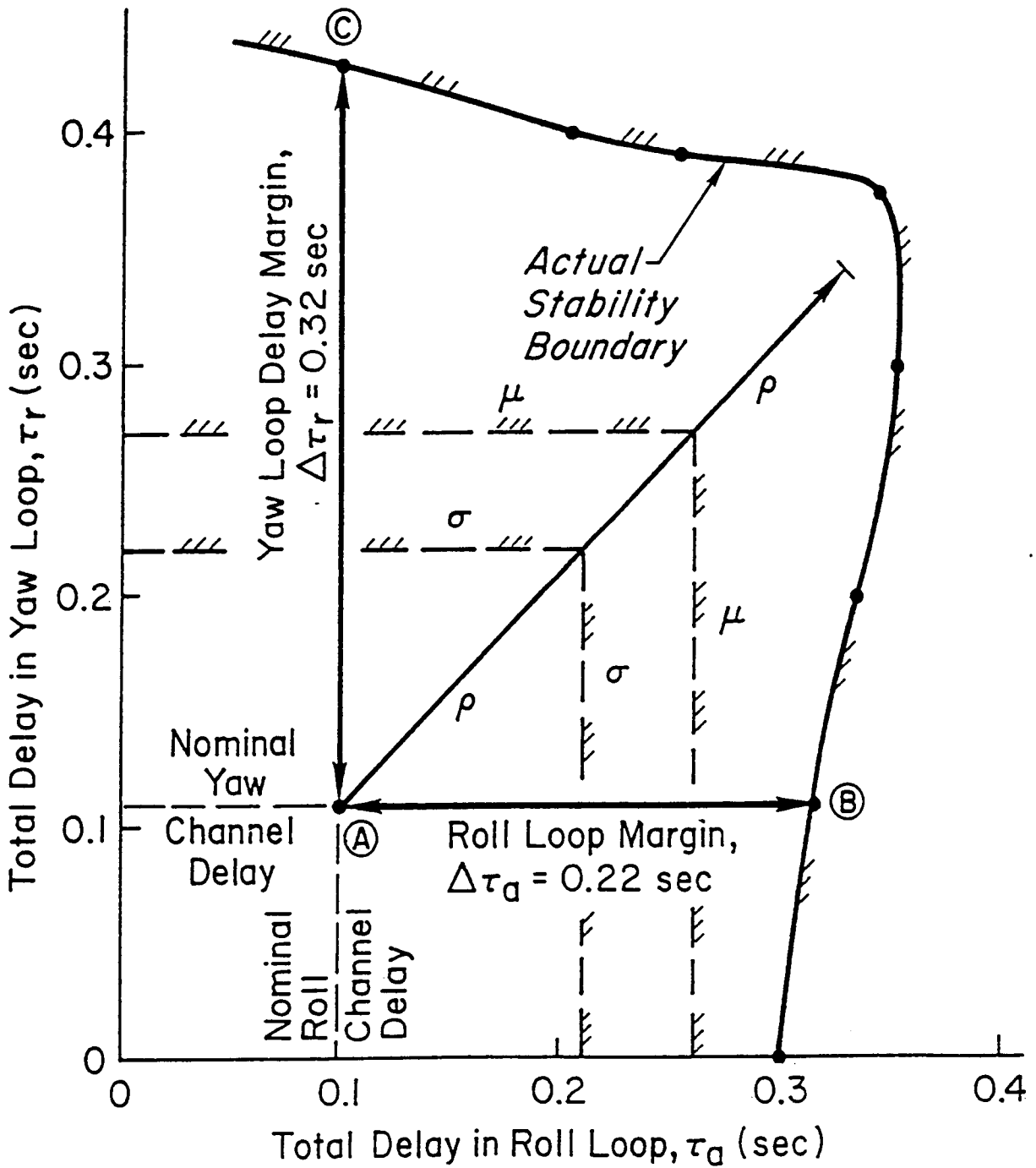

Figure 3. Comparison of Stability Boundaries in Roll-Yaw Time Delay Parameter Plane

the importance of these tests, indeed we want to increase their use, but the types of questions asked by researchers are not the ones which designers are most likely to ask. For starters, given the simple approximation for $\bar{\sigma}[E_m]$ in (6) what is a similar approximation for the other portions of the robustness tests (5,7,8)? What are the low and high frequency approximations? What open loop mode creates the critical point around 3 rad/sec? What is the mode around 13 rad/sec which is close to becoming critical? What are the critical aircraft and controller parameters that determine these critical points? Are the stability difficulties cited in the example responsible for the critical points? How sensitive are these to changes in the nominal flight control system, and how would matters be changed if the aerodynamics were modified? We now turn to an approach to explore these types of questions.

Motivation for Literal Formulations

The objective is to develop greater FCS-engineering insight into the new frequency domain robustness measures. The approach is to give literal (symbolic) expressions for the singular-value-based tests. This approach involves two concepts that have long been used for traditional multi-variable flight control design — literal approximate factors and transfer function numerators of higher kinds, also known as coupling numerators [9].

Over the years, literal approximate factors have been developed for a wide variety of conventional and VSTOL aircraft, rotorcraft, and other vehicles. These expressions give approximate relations for transfer function poles and zeros literally in terms of stability derivatives. This is best appreciated by

an example such as the lateral-directional example being used here, where all of the following derivatives are defined in the stability axes [9]:

Dutch roll pole:

$$\omega_d \approx \sqrt{N'_\beta} \quad (10)$$

$$2(\zeta\omega)_d \approx -(Y_v + N'_r) - \frac{L'_\beta}{N'_\beta} \left(N'_p - \frac{g}{U_0} \right) \quad (11)$$

Roll-due-to-lateral controller dipole:

$$\frac{\omega_\phi}{\omega_d} \approx \sqrt{1 - \frac{N'_{\delta_a}}{L'_{\delta_a}} \cdot \frac{L'_\beta}{N'_\beta}} \quad (12)$$

$$2(\zeta\omega)_\phi \approx -(Y_v + N'_r) + \frac{N'_{\delta_a}}{L'_{\delta_a}} L'_r \quad (13)$$

While expressions such as these are often accurate to a few percent for numerical calculation, this is not the primary purpose for using literal approximate factors. The real value is in viewing the connections between the aircraft poles and zeros and the stability derivatives which are not available from a strictly numerical calculation of system eigenvalues. This knowledge, in turn, indicates:

- the physical origins, nature, vehicle configuration-dependence, and variation with flight condition/configuration of the vehicle poles and zeros;
- the physical origins, nature, etc. of the limiting dynamical characteristics (closed loop modes at high gains) corresponding to a particular choice of FCS feedback architecture;

- possible control law components to adjust particular modes or effective numerators;
- the absolute and relative importance of uncertainties in particular derivatives.

Literal Approximations of Open-Loop Singular Values

With the concepts of literal approximate factors as background, we can now discuss the basic approach for developing literal approximations of singular values. The open loop case is treated first, which is useful in its own right for performance analysis, and which is a starting point for the more complicated closed loop case.

A simplifying change is first made to the aircraft example by assuming that ϕ and p_b are related by the ideal linearized kinematics $p_b = s\phi$ (rather than $p_b = s\phi - r_b \tan \gamma_0$). Compute p_b by differentiating the ϕ measurement, which reduces the number of feedback compensators to K_ϕ and K_r , as noted in Fig. 1. This change is consistent with the use of an integrated sensor package. The open loop combined aircraft controller system is:

$$\begin{aligned}
 KG &= \begin{pmatrix} 0 & K_\phi(s) & 0 \\ 0 & 0 & K_r(s) \end{pmatrix} \frac{1}{\Delta(s)} \begin{pmatrix} N_{\delta_a}^{p_b}(s) & N_{\delta_r}^{p_b}(s) \\ N_{\delta_a}^\phi(s) & N_{\delta_r}^\phi(s) \\ N_{\delta_a}^r(s) & N_{\delta_r}^r(s) \end{pmatrix} \\
 &= \frac{1}{\Delta} \begin{pmatrix} K_\phi N_{\delta_a}^\phi & K_\phi N_{\delta_r}^\phi \\ K_r N_{\delta_a}^r & K_r N_{\delta_r}^r \end{pmatrix} = \begin{pmatrix} a & b \\ c & d \end{pmatrix} \quad (14)
 \end{aligned}$$

The maximum and minimum singular values of KG are given by

$$\bar{\sigma} = \sqrt{\lambda}, \quad \underline{\sigma} = \sqrt{\lambda} \quad (15)$$

where $\bar{\lambda}$ and λ are the maximum and minimum eigenvalues of $[KG]^*[KG]$, and where $*$ denotes the conjugate transpose. The eigenvalues for this type of matrix will always be real positive numbers. They are defined using the determinant identity:

$$\begin{vmatrix} \lambda - |a|^2 - |c|^2 & -a^*b - c^*d \\ -ab^* - cd^* & \lambda - |b|^2 - |d|^2 \end{vmatrix} \\ = \lambda^2 - B\lambda + C = (\lambda - \bar{\lambda})(\lambda - \lambda) \quad (16)$$

$$\text{where } B = \bar{\lambda} + \lambda = |a|^2 + |b|^2 + |c|^2 + |d|^2$$

$$C = \bar{\lambda}\lambda = |ad - bc|^2$$

If the eigenvalues are widely separated (say $\bar{\lambda} > 5\lambda$), as is the usual case for lateral-directional examples such as this, then the following approximations for the minimum and maximum singular values are very good:

$$\bar{\sigma} = \sqrt{\bar{\lambda}} \approx \sqrt{B} \quad \sigma = \sqrt{\lambda} \approx \sqrt{\frac{C}{B}} \quad (17)$$

In the rare cases when the eigenvalues are close together:

$$\bar{\sigma} \approx \sigma \approx \sqrt{\bar{\sigma}\sigma} = \sqrt[4]{\bar{\lambda}\lambda} = \sqrt[4]{C} \quad (18)$$

The geometric mean $\bar{\sigma}\sigma$ can be exactly computed. In all cases the following inequalities are valid:

$$\bar{\sigma}_{approx} \geq \bar{\sigma} \geq \sqrt{\bar{\sigma}\sigma} \geq \sigma \geq \sigma_{approx} \quad (19)$$

The geometric mean is included in this discussion for several reasons: because it can be exactly determined, in some cases it approximates the minimum and

maximum singular values, and it can be used as a definition of multi-variable bandwidth.

Literal approximations of the open loop singular values are obtained by substituting from (14) into (17) and by using the coupling numerator identity [9]:

$$N_{\delta_a \delta_r}^{\phi r} = \frac{1}{\Delta} (N_{\delta_a}^{\phi} N_{\delta_r}^r - N_{\delta_r}^{\phi} N_{\delta_a}^r) \quad (20)$$

Resulting in:

$$[\bar{\sigma}(KG)]^2 \approx \left| \frac{1}{\Delta} \right|^2 \left\{ |K_{\phi}|^2 (|N_{\delta_a}^{\phi}|^2 + |N_{\delta_r}^{\phi}|^2) + |K_r|^2 (|N_{\delta_r}^r|^2 + |N_{\delta_a}^r|^2) \right\} \quad (21)$$

$$[\underline{\sigma}(KG)]^2 \approx \frac{|K_{\phi} K_r N_{\delta_a \delta_r}^{\phi r}|^2}{|K_{\phi}|^2 (|N_{\delta_a}^{\phi}|^2 + |N_{\delta_r}^{\phi}|^2) + |K_r|^2 (|N_{\delta_r}^r|^2 + |N_{\delta_a}^r|^2)} \quad (22)$$

$$[\bar{\sigma} \underline{\sigma}(KG)]^2 = |K_{\phi} K_r N_{\delta_a \delta_r}^{\phi r} / \Delta|^2 \quad (23)$$

Square roots are needed as a final step. Square roots of transfer functions in general require non-integer powers of s , but not so here. The above equations are symmetric about the $j\omega$ axis, and therefore the left-half-plane spectral factors can be used for the square roots.

Figs. 4a and 4b contain Bode plots and transfer functions for the singular value literal approximations. Exact numerical values for $\bar{\sigma}$ and $\underline{\sigma}$ in this airplane example are graphically indistinguishable from their literal approximations. As was the case discussed earlier for literal approximate factors, the importance of having literal approximations is *not* numerical, we would be just as happy with $\pm 10\%$ accuracy. The importance is directly knowing how the singular values depend on the nominal aircraft dynamics. For example, the straightline asymptotes in Fig. 4 very clearly indicate the open loop pole

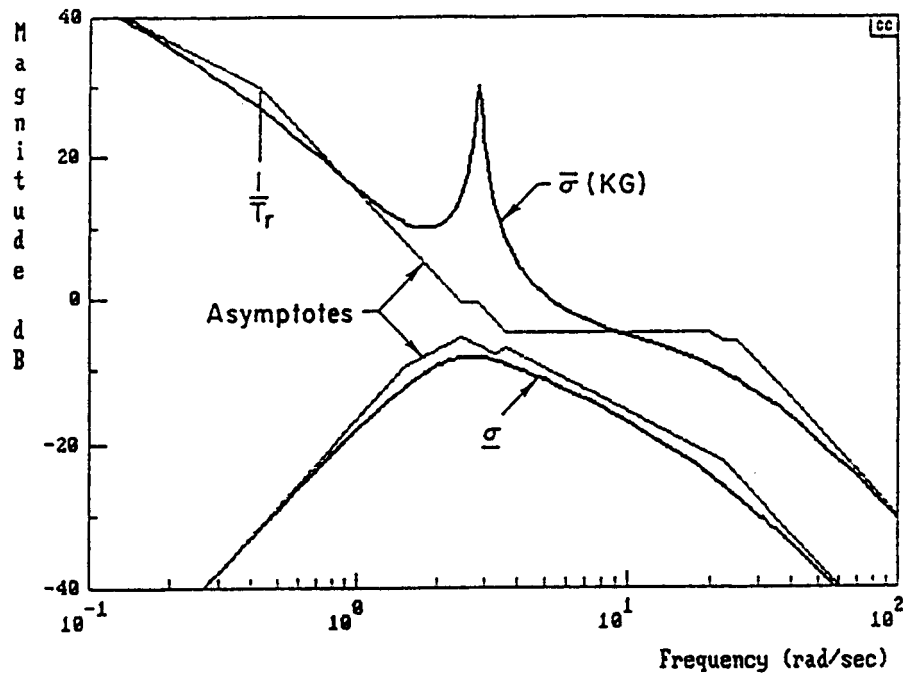

a) Singular Values

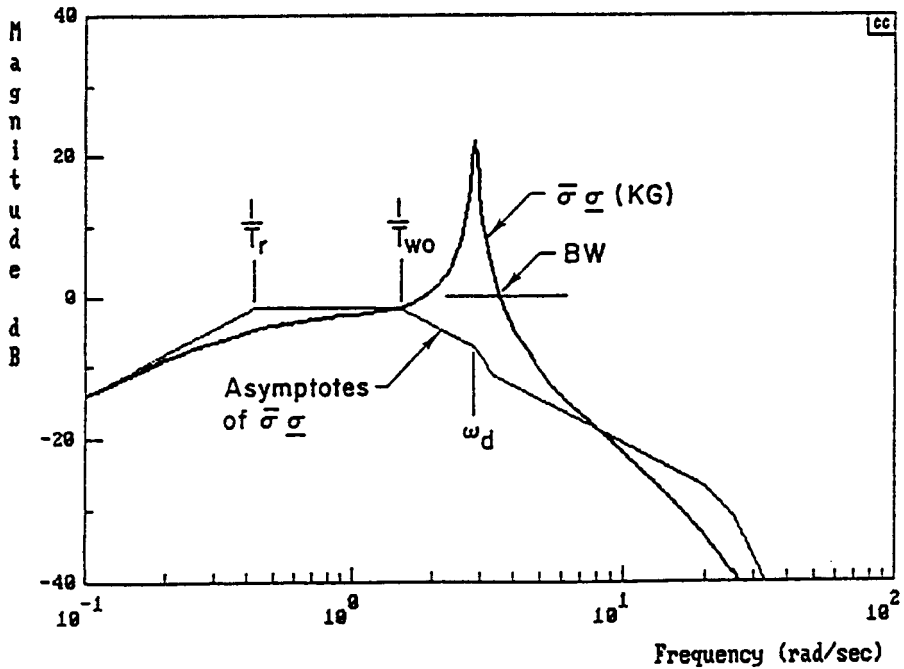

b) Geometric Mean

$$\bar{\sigma} \text{ (KG)} \approx \left| \frac{318 (1.51) [.547, 2.49] [.947, 3.64] (22.3)}{(.0048)(.427)(1.5) [.021, 2.85] (20)(25)^2} \right| \quad \text{(approximate)}$$

$$\underline{\sigma} \text{ (KG)} \approx \left| \frac{36.5 (0) (.028) [.820, 3.32]}{(1.51) [.547, 2.49] [.947, 3.64] (22.3)} \right| \quad \text{(approximate)}$$

$$\bar{\sigma} \underline{\sigma} = \left| \frac{11600 (0) (.028) [.820, 3.32]}{(.0048)(.427)(1.5) [.021, 2.85] (20)(25)^2} \right| \quad \text{(exact)}$$

Figure 4. Literal Approximations for Open Loop Singular Values of KG

and zero locations. Several of the breaks are labeled, and it is seen that the dominant factors influencing the bandwidth are the yaw damper washout time constant T_{wo} and the Dutch roll damping ratio ζ_d . Individual poles and zeros are labeled below for $\bar{\sigma}$. Poles and zeros corresponding to the effective delays do not appear because they cancel when the left half plane spectral factor is computed.

$$\bar{\sigma} = \left| \frac{\begin{array}{cc} & \text{Coupling zero} \\ & 1/T_{\phi r} \quad \text{Lead in } K_{\phi} \\ 11600 (0) & (0.0281) \quad [0.820, 3.32] \end{array}}{\begin{array}{cc} (0.0048) & (0.427) \\ -1/T_s & 1/T_r \end{array}} \frac{\begin{array}{cc} (1.5) & [0.021, 2.85] \\ 1/T_{wo} & \zeta_d, \omega_d \end{array}}{\underbrace{(20)(25)^2}_{\text{Actuators}}} \right| \quad (24)$$

Further insight can be gained by concentrating on asymptotes and particular frequency ranges. Take, for example, the low frequency asymptote of σ . Use the following approximations from [9]: (a) the washed out $K_r(s)$ is insignificant below $1/T_{wo}$ and (b) generally $|N_{\delta_r}^{\phi}| \ll |N_{\delta_a}^{\phi}|$, to obtain:

$$\sigma \approx |K_r| \left| \frac{N_{\delta_a \delta_r}^{\phi}}{N_{\delta_a}^{\phi}} \right| = \frac{k_r N_{\delta_r}^{\phi}}{(N_{\beta}^{\phi}/T_{wo})} s^2 \quad (25)$$

Hence it can be seen that the washout time constant T_{wo} and the airframe dynamics $N_{\delta_r}^{\phi}$ and N_{β}^{ϕ} all contribute to the slope of σ at low frequency.

The intent of the above discussion has been to show that much can be learned about singular values from literal approximations, and that much is to be gained by uniting classical and modern multi-variable techniques for flight control system analysis and synthesis. For the example given, the actual singular values, which can in general only be obtained by assigning numerical

values for all of the parameters the system, are shown to be bounded and/or approximated by relatively simple, highly insightful, literal expressions.

Literal Formulation of the Robust Stability Criterion

To examine the criterion for robust stability as formulated in (5) we must take the additional step of developing literal expressions for the singular values of the inverse return difference. The derivation is similar to (14) through (23), using $I + (KG)^{-1}$ instead of KG :

$$I + (KG)^{-1} = \begin{pmatrix} a & b \\ c & d \end{pmatrix} \quad (26)$$

$$\begin{aligned} & |\lambda I - [I + (KG)^{-1}]^* [I + (KG)^{-1}]| \\ & = \lambda^2 - B\lambda + C = (\lambda - \bar{\lambda})(\lambda - \lambda) \end{aligned} \quad (27)$$

The polynomial coefficients are:

$$\begin{aligned} B & = \bar{\lambda} + \lambda = |a|^2 + |b|^2 + |c|^2 + |d|^2 \\ & = \left| 1 + \frac{1}{K_\phi} \frac{N_{\delta_r}^r}{N_{\delta_a \delta_r}^{\phi r}} \right|^2 + \left| \frac{1}{K_r} \frac{N_{\delta_r}^{\phi}}{N_{\delta_a \delta_r}^{\phi r}} \right|^2 + \left| \frac{1}{K_\phi} \frac{N_{\delta_a}^r}{N_{\delta_a \delta_r}^{\phi r}} \right|^2 + \left| 1 + \frac{1}{K_r} \frac{N_{\delta_a}^{\phi}}{N_{\delta_a \delta_r}^{\phi r}} \right|^2 \end{aligned} \quad (28)$$

$$\begin{aligned} C & = \bar{\lambda}\lambda = |ad - bc|^2 \\ & = \frac{\left| 1 + K_\phi N_{\delta_a}^{\phi} / \Delta + K_r N_{\delta_r}^r / \Delta + K_\phi K_r N_{\delta_a \delta_r}^{\phi r} / \Delta \right|^2}{\left| K_\phi K_r N_{\delta_a \delta_r}^{\phi r} / \Delta \right|^2} \end{aligned} \quad (29)$$

The literal expressions for the max and min singular values follow as before, namely that $\bar{\sigma} \approx \sqrt{B}$ and $\underline{\sigma} \approx \sqrt{C/B}$.

The numerator expression for C is quite interesting — it is precisely the coupling numerator expansion for the multi-loop closed loop characteristic polynomial [9]. (This is demonstrated here for 2×2 systems but is conjectured to hold in general). Hence the closed loop poles are zeros of the literal approximation of $\underline{\sigma}$. This provides a fundamental connection between classical and modern multi-loop approaches, and allows us to dissect the problem in insightful new ways.

Fig. 5a contains a Bode plot of the literal approximations for $\bar{\sigma}$ and $\underline{\sigma}$ (only $\underline{\sigma}$ is of interest for robustness analysis, $\bar{\sigma}$ is included only to show that the separation is large). The approximations are graphically indistinguishable from exact calculations. The straightline asymptotes included on the plot clearly indicate that the robustness *weaklink* is the dipole $[\cdot 26, 2.8]/[\cdot 67, 2.6]$. Improvement can be gained by increasing the $\cdot 26$ damping of the closed loop pole.

Further insight can be gained by examining term-by-term the numerator expression for C . It turns out for this example that all of the terms are significant, which indicates that open loop airplane modal characteristics (roll subsidence and Dutch roll), the system numerators, and the controllers all contribute to the robustness of the system. This contrasts with high gain systems which are dominated by the controller and numerator characteristics.

Perhaps surprisingly, the controller actuators and the time delay characteristics are *not* the limiting robustness feature. If, however, the controllers are changed so that the critical low point in the robustness test around 3 rad/sec is increased, then the secondary critical point seen in Fig. 2 around

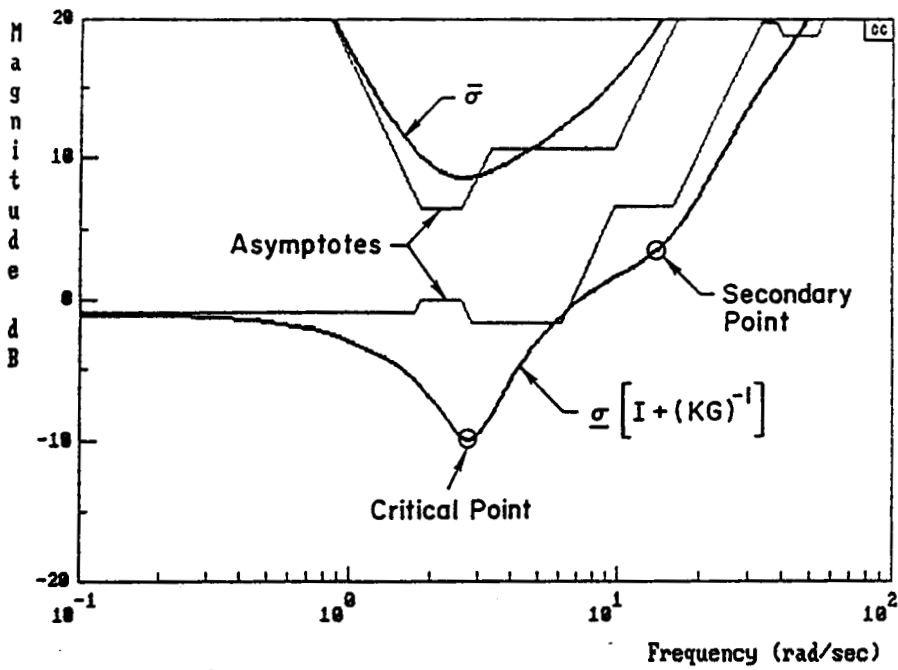

a) Singular Values

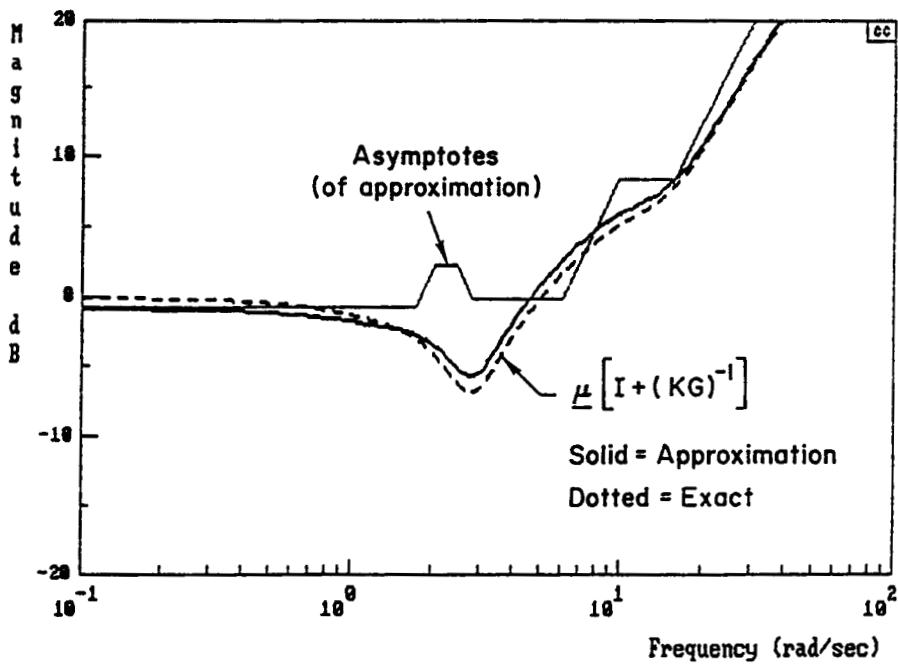

b) Structured Singular Value

$$\underline{\sigma} [I + (KG)^{-1}] \approx \left| \frac{.0031 [.66, 1.7] [.26, 2.8] [.94, 6.0] [.53, 16] [.85, 40] [.83, 53]}{[.81, 1.8] [.67, 2.6] [.93, 9.7] [.87, 33] [.86, 37]} \right|$$

$$\underline{\mu} [I + (KG)^{-1}] \approx \left| \frac{.0048 [.66, 1.7] [.26, 2.8] [.94, 6.0] [.53, 16] [.85, 40] [.83, 53]}{[.81, 2.0] [.50, 2.4] [.72, 9.9] [.86, 34] [.85, 42]} \right|$$

Figure 5. Literal Approximations for Singular and Structured Singular Value Robustness Tests

13 rad/sec would be the limiting factor. Due to its frequency this secondary point is a very strong function of the actuators and other high frequency dynamics.

One of the important features of literal approximations is the ability to connect the analysis with aircraft configuration characteristics. For example, the critical low point in the robustness test occurs around 3 rad/sec, which is approximately the natural frequency of the Dutch roll mode. The feedbacks have changed the Dutch roll damping ζ_d , but not so much the natural frequency ω_d . The location depends primarily on the directional stability N'_β , and secondarily on the aileron induced yawing N'_{δ_a} and the effective dihedral L'_β . Having thus isolated the key aircraft parameters we can also predict first order robustness trends with changes in flight conditions. For example:

$$\omega_d \approx \sqrt{N'_\beta} \approx \sqrt{\rho} U \quad (30)$$

From these relations we can see that the approximate location of the σ dip is proportional to the square root of dynamic pressure (neglecting Mach and aeroelastic variations on the nondimensional derivatives). Another reason for isolating key aircraft parameters is that effort can be focused either on better identification of these parameters or on desensitizing feedbacks.

A Literal Approximation of Structured Singular Values

The same techniques detailed for singular values can be extended to the structured singular values. Repeating for clarity:

$$\underline{\mu}(A) = \underline{\sigma}(\min_e D^{-1}AD) \quad (31)$$

$$\text{where } A = I + (KG)^{-1} = \begin{pmatrix} a & b \\ c & d \end{pmatrix}$$

$$D = \begin{pmatrix} 1 & 0 \\ 0 & e \end{pmatrix}$$

In this 2×2 case the frequency dependent scaling parameter e can be analytically determined: $e = \sqrt{c/b}$. It follows in short order that:

$$\underline{\mu} \approx \sqrt{C/B} \quad (32)$$

$$\text{where } B = |a|^2 + 2|bc| + |d|^2$$

$$C = |ad - bc|^2$$

The numerators of $\underline{\sigma}$ and $\underline{\mu}$ are the same, because C has not changed. The denominator of $\underline{\mu}$ is always smaller, because always $2|bc| < |b|^2 + |c|^2$, hence as expected $\underline{\mu} \geq \underline{\sigma}$. A transfer function approximation (with integer powers of s) is obtained by eliminating $2|bc|$, which is valid in the aircraft example because $2|bc| \ll |a|^2 + |d|^2$.

The resulting literal approximation for $\underline{\mu}$, straightline asymptotes, and transfer function approximation are shown in Fig. 5b. (If $2|bc|$ is included in the literal calculation then straightline and transfer function approximations cannot be made but the frequency response is graphically indistinguishable

from the exact calculation). The use of structured singular values means that crossfeeds are not allowed in the perturbation. It is concluded from Fig. 5b is that if perturbation crossfeeds are not allowed then the system crossfeed numerators $N_{\delta_r}^{\phi}$ and $N_{\delta_a}^r$ (present respectively in b and c) are of reduced importance in determining robustness. This reduced importance is seen as a shift of the *weak* dipole $[.26, 2.8] / [.67, 2.6]$ to $[.26, 2.8] / [.50, 2.4]$.

The literal analysis is concluded by examining the terms which make up B in (28) and (32). Due to the washout in the yaw damper it is expected that the K_r terms a and c are insignificant compared to the K_{ϕ} terms b and d . A numerical test verifies this expectation. In the structured singular value expression b is also insignificant, because as seen above $2|bc| \ll |a|^2 + |d|^2$, leaving only d as the important term:

$$\begin{aligned}
 B &= |a|^2 + |b|^2 + |c|^2 + |d|^2 \\
 &\approx |b|^2 + |d|^2 && \text{(use for } \underline{\sigma} \text{)} \\
 &\approx |d|^2 = |K_r N_{\delta_r}^r / \Delta|^2 && \text{(use for } \underline{\mu} \text{)}
 \end{aligned} \tag{33}$$

Eliminating terms like this, while not true in general, often helps identify key parameters for a particular problem.

Summary and Conclusions

The viewpoint espoused here is that recent advances in frequency domain multi-variable robustness techniques, when combined with classical multi-variable flight control system design procedures, have much to offer as additional means for the assessment of flight control system designs. An example of a lateral-directional flight control system is used to illustrate how regular

singular value and structured singular values are used to determine robustness measures. The example is then used to illustrate the development of various singular-value-based quantities expressed using literal terms which define the aircraft and controller characteristics. The insights and connections exposed in these formulations illuminate the governing and underlying features of the system, and give specific emphasis to key and critical robustness issues present in a particular design.

Acknowledgement

This work was performed in part under Contract NAS1-17987 with NASA Langley Research Center, Mr. Jarrell Elliott, Technical Representative.

References

- [1] Doyle, J.C. and G. Stein, *Multivariable Feedback Design: Concepts for a Classical/Modern Synthesis*, IEEE Trans. Auto. Control, Vol. AC-26, No. 1, Feb. 1981, pp. 4-16.
- [2] Safonov, M.G., A.J. Laub, and G. Hartmann, *Feedback Properties of Multivariable Systems: The Role and Use of the Return Difference Matrix*, *ibid.*, pp. 47-65.
- [3] Doyle, J.C. *Analysis of Feedback Systems with Structured Uncertainties*, IEE Proceedings, Vol. 129, Pt. D, No. 6, Nov. 1982.
- [4] Doyle, J.C., Lecture Notes, 1984 ONR/Honeywell Workshop on Advances in Multivariable Control.
- [5] Mukhopadhyay, V., and J.R. Newsom, *Application of Matrix Singular Value Properties for Evaluating Gain and Phase Margins of Multiloop Systems*, NASA TM-84524, July 1982.
- [6] Newsom J.R. and V. Mukhopadhyay, *A Multiloop Robust Controller Design Study Using Singular Value Gradients*, Journal of Guidance, Control & Dynamics, Vol. 8, No. 4, July-Aug. 1985, pp. 514-519.
- [7] Ridgely, D.B. and S.S. Banda, *Introduction to Robust Multivariable Control*, AFWAL-TR-85-3102, Feb. 1982.
- [8] Herra-Vaillard, A., J. Paduano, and D. Downing, *Sensitivity Analysis of Automatic Flight Control Systems Using Singular Value Concepts*, AIAA

Paper 85-1899, Proceedings of AIAA Guidance, Navigation and Control Conf., Snowmass, Colorado, Aug. 1985, pp. 342-348.

- [9] McRuer, D.T., I.L. Ashkenas, and D. Graham, *Aircraft Dynamics and Automatic Control*, Princeton University Press, Princeton, N.J., 1973.
- [10] Myers, T.T. and D.T. McRuer, *Advanced Aircraft Flight Control Design Methodology, Phase I*, Systems Technology, Inc., TR 1211-1, June 1984.
- [11] Jones, R.D., *Structured Singular Value Analysis for Real Parameter Variations*, Proceedings of AIAA Guidance, Navigation and Control Conf., Monterey, CA, Aug. 1987, pp. 1424-1432.

SUPPLEMENT 2

LATERAL FCS REQUIREMENTS-ORIENTED DESIGN KNOWLEDGE BASE FOR AN ADVANCED STOL FIGHTER IN MISSION PHASE CO*

A. GENERAL

In this supplement we outline a draft knowledge base for the requirements aspects of a lateral FCS. To help make matters concrete, we will select an advanced STOL fighter as an illustrative design example, and then organize specifications, requirements, considerations, elaborations/specializations of material, etc., into a composite document. Many of the knowledge base elements will apply generally, although the specifics are intended for an advanced STOL fighter in a particularly difficult mission phase (air-to-air combat, CO) which exhibits a broad range of features. Because the requirements and considerations for this type of craft in this mission phase are severe, a less stringent set will apply for most other aircraft which are less sophisticated and more conventional. Indeed one reason an advanced STOL fighter was selected as the example was a desire to maximize the coverage, and thereby permit ready extension by parallel constructions or analogy.

The first level of organization follows the FCS design process topics treated previously. These are:

- (1) Flight Control System Purpose
- (2) Command and Disturbance Characteristics
- (3) Unalterable Characteristics of the Aircraft and Controller
- (4) Pilot-centered Requirements
- (5) Overall System Requirements

*References for this supplement appear at the end.

- {6} Aircraft Characteristics
- {7} Comparison of Aircraft Characteristics with Requirements
- {8} General Equalization Requirements
and
Prospectus for FCS Architecture(s)
- {9} Preliminary Design Analysis of System Possibilities
- {10} Competition Among Candidate Architecture(s) and System(s)

The ultimate outcomes of this process are:

- a FCS system structure or architecture (feedback control laws/loops);
- the fleshing out of this skeleton as one or more suitable system configuration(s);
- key sensitivity elements (system parameters/ characteristics which are central to the design suitability);
- design assessments -- predicted nominal and off-nominal properties, design sensitivity, etc.

This section will focus on the requirements-oriented phases of the knowledge base, i.e., ending with step {5} the summary of "Overall System Requirements." Although the emphasis here will be on the CO mission phase, many of the items have a high degree of generality for highly maneuverable aircraft. Thus, with relatively minor changes and additions, these knowledge base summaries for the requirements-oriented phases can be used for other aircraft types, or can be extended to other critical mission phases.

In the development below, the first level headings follow directly from the general outlines of Design Methodology steps given in Section I on each design phase topic. They are further partitioned into subtopics in outline form. Elements of the knowledge base are placed where appropriate under the lowest level in the outline. Each knowledge element is assigned to one of five categories indicated by [] as noted below:

[S] - Specification: quantitative constraints on specified, measured, or calculated aircraft parameters which are formally recognized.

[R] - Requirement: quantitative or qualitative constraints on design parameters; design criterion.

[IR] - Implied Requirement: conditions with accompanying qualitative or quantitative requirements needed to enable a [S] or [R] to be met (i.e., unstated "requirements" implied by a stated requirement); corrections or additions necessary to adjust for non-ideal specific conditions once a mechanizational feature (usually a sensor) is established ("requirements" needed to fix up or idealize a given control system architecture).

[GP] - Good practice: advice based on past experience.

[C] - Consideration: an important issue to think about in the design process for which it may be difficult to make general recommendations.

B. TOPIC {1} -- FLIGHT CONTROL SYSTEM PURPOSE

Data Base Elements -- Mission and function-oriented specification requirements, notably from MIL-F-8785C (Flying Qualities) and MIL-F-9490D (Flight Control Systems); possibly taxonomic/anatomical data.

Knowledge Base Elements -- Cover structure of the Mission, Aircraft type, Aircraft/FCS anatomy, Mission-Centered Requirements.

1. Aircraft/FCS Taxonomy

Information Covered -- Classification of aircraft and its purposes (mission phases, maneuver complexes) for use in determining applicable specifications, and stating other high level requirements and/or considerations which are special and may not otherwise be covered. This knowledge base covers lateral flight control for advanced STOL fighters with emphasis on the air-to-air combat and other flight phases which require precise control in the presence of extreme maneuvering.

[S] Aircraft Type: STOL Fighter (Class IV)

Mission Phases: Category A,

- Air-to-Air Combat (CO)
- Ground Attack (GA)
- Weapon Delivery/launch (WD)

[C] STOL landings on hastily prepared runway segments (50' by 1500') will have a major impact on the aircraft design. This requires precision directional control just before and after touchdown, augmented deceleration, etc.

[IR] Possible thrust reversal capability; directional control capability using thrust vectoring. These capabilities may also be available for Mission Phase (CO).

[R,C] Maneuver Complex Key Situations:

- Precise tracking in lead pursuit gunnery and "wing matchup" in presence of evasive target; entire range of usable AOA conditions.
- Extremely rapid rolling (up to 250 deg/sec) extremely rapid g onset (slightly past "g" suit limits) for evasive maneuvering, acquisition, etc.
- Possible extraordinary maneuvering (e.g., "supermaneuvering") outside of conventional envelope based on aerodynamic control effectors.

[IR] Precise lateral path control rapid rolling with highly constrained sideslip ($\beta \dot{=} 0$) in the presence of rapid changes in aircraft loading.

[R] Precisely controllable, Departure-free High Angle-of-Attack flight:

[IR] FCS must cope with possible closed-loop pilot/vehicle system rolling velocity reversal (e.g., $\omega_{\phi}^2 \leq 0$) and directional divergence (e.g., $\omega_d^2 < 0$) phenomena at high AOA.

2. Aircraft/FCS Anatomy

Information Covered -- The "givens" of the design problem, preliminary or tentative specification of unalterable characteristics of certain aircraft or FCS elements, etc. This knowledge base covers lateral flight control issues for multiple effectors (e.g., directional thrust vectoring, "aileron" and "rudder" aerodynamic controls) resulting in two effectively independent moment application control points producing rolling and yawing moments as primary outputs (side forces are incidentally present but not subject to independent side force control capability). The operating modes of the FCS comprise both manual and automatic control activities with appropriate consideration for compatibility among the modal system elements.

- [C] The fundamental aircraft design has emphasized optimization of dynamic maneuvering and cruise performance aspects, reduced observables, etc.
- [IR] A variety of stability and control deficiencies are sure to be present, and are to be corrected by the flight control system.
- [IR] Adequate control power is available.
- [R] Aircraft control system is fly-by-wire with pertinent multi-redundant elements.
- [GP] FCS is mechanized with digital technology.
- [GP] Multi-redundant sensors should be mature technology, simple, highly reliable, exhibit repeatable and uniform dynamic and scale characteristics, susceptible to cooperative checking/cross checking schemes, etc. (e.g., rate gyros and accelerometers display such properties, so quad- or tri-plex FCS mechanizations containing such devices will be favored by many designers).

[R] The aircraft/FCS will contain the following modes:

- Manual Control Only:
 - Lateral Stability Augmentation
- Automatic Control with Manual Interaction:
 - Bank Angle Control and Regulation
 - Heading Control and Regulation
 - Path Control and Regulation for several specialized modes such as
 - Fire Control
 - Terrain Avoidance
 - Approach/Landing
 - Navigation

[C] The multi-modal aspect of FCS creates two hierarchies

- The FCS system needed to perform a particular function is often an essential subsystem for the FCS needed for another mode (e.g., the lateral stability augmentation system acts as a necessary set of inner loops for an automatic bank angle control system).
- The redundancy levels to support fail safe operations, and hence the flight critical degree for the several FCS modes are potentially different.

[IR] The stability augmentation system is to have

- A high degree of independent integrity while simultaneously providing characteristics suitable as inner loop(s) equalization for the outer loop(s).

3. Mission-Centered Requirements

Information Covered -- These requirements include issues that affect task performance more than workload and safety, although all three aspects may be involved. Additional associated information related to workload and safety are covered in "pilot-centered requirements."

a. Establishment of Trim Conditions

[R] The aircraft must be able to be trimmed throughout the entire aerodynamic flight envelope, including accelerated equilibrium conditions.

b. Control Power

[S] MIL-F-8785C, Para. 3.4.10, Control Margin: "Control authority, rate and hinge moment capability shall be sufficient to assure safety throughout the combined range of all attainable angles-of-attack... and sideslip..."

[S] MIL-F-9490D, Para. 3.2.5.2, Priority: "Essential and flight phase essential flight controls shall be given priority over non-critical controls, and other actuated functions during simultaneous demand operation."

[R] Sufficient lateral and directional effective control power must be available to operate the aircraft with aerodynamic control effectors throughout the entire aerodynamic envelope, and with all control effectors into the extended (low speed) and/or (high AOA) flight regime(s). In particular, sufficient lateral-directional control power must be available to satisfy:

[S] Roll Control Effectiveness and Performance -- MIL-F-8785C, Paras. 3.3.4, 3.3.4.1, 3.3.4.1.1.

[S] Regulation to wings level, zero sideslip flight in all conditions of diving flight -- MIL-F-8785C, Para. 3.3.8.

- [S] Regulation to straight and level flight with asymmetric thrust and/or loadings -- MIL-F-8785C, Paras. 3.3.9, 3.3.5.1.1.
- [R] Regulation to straight and level flight with all engines out or thrust vectoring disabled.
- [S] Avoidance of Inertial Coupling, Regulation to Zero Sideslip in Rolls -- MIL-F-8785C, Para. 3.3.2.5.
- [S] Lateral-directional control in 90 deg, 30 kt Crosswinds -- MIL-F-8785C, Paras. 3.3.7, 3.3.7.1, and 3.3.7.2.
- [S] Recovery from post-stall departures, gyrations, spins.

c. Lateral-Directional Rigid Body Modes

i) Spiral mode

- [C] Spiral mode stability -- If manual or automatic bank angle control can be achieved by a simple proportional bank angle (manual or automatic) controller, a slightly unstable spiral is generally not a critical problem in normal flight. Spiral stability can be very desirable in IMC; high managerial workload, etc. conditions.
- [S] Spiral mode stability -- MIL-F-8785C, Para. 3.3.1.3.

ii) Roll subsidence mode

- [GP] Roll mode characteristic -- the rolling velocity response to lateral control should approximate a first-order characteristic which is substantially uncoupled from other motions.
- [IR] If the flight phase involves significant maneuvering or precise tracking, the roll and spiral modes should not be coupled as a complex mode.

[S] Coupled roll-spiral oscillation, MIL-F-8785C, Para. 3.3.1.4.

[S] Roll rate and Bank Angle oscillations, MIL-F-8785C, Paras. 3.3.2.2, 3.3.2.3.

[S] Sideslip response to roll control ($\Delta\beta/k$), MIL-F-8785C, Paras. 3.3.2.4, 3.3.2.4.1.

[S] Roll mode time constant -- MIL-F-8785C, Para. 3.3.1.2.

iii) Dutch Roll Mode

[GP] Directional control characteristic -- the sideslip and yawing responses to directional control should be proportional to the pilot's command input and should approximate a second-order system characteristic. Rolling induced by sideslipping should be consistent with positive effective dihedral (right sideslips require right roll control deflection to keep wings level).

[S] Minimum frequency and damping, MIL-F-8785C, Para. 3.3.1.1.

[GP] Dutch roll damping -- when the flight phase involves significant maneuvering or precise tracking augmenting the damping ratio above conventional levels may improve performance.

[C] When a "lateral stability aug-
menter" exists as a separate oper-
ating entity of the FCS, the phase
margin requirements of MIL-F-9490D
will apply, and may imply larger
damping ratios of the effective
dutch roll mode.

[S] Magnitude of $|\phi/\beta|$ ratio, MIL-F-8785C, Para. 3.3.1.1.

[C] If the flight phase involves significant maneuvering or precise tracking, and significant turbulence or buffet is present reducing $|\phi/\beta|$ below the MIL-Spec Level 1 maximum may improve performance.

iv) Maneuver Coordination

[G] For rolling maneuvers in response to lateral control action (as contrasted to rolling maneuvers induced by sideslipping initiated using the rudder), the sideslip should be minimized and up-elevator corrections should be automatic.

[S] See "Roll Subsidence Mode" above.

[S] Turn Coordination, MIL-F-8785C, Para. 3.3.2.5.

[S] Coordination in Steady Banked Turns, MIL-F-9490D, Para. 3.1.2.4.1; Sideslip less than 2 deg and lateral acceleration less than 0.03g.

[S] Lateral-Acceleration Limits, Rolling, MIL-F-9490D, Para. 3.1.2.4.1; lateral acceleration at the c.g. less than $\pm 0.5g$ for bank rates up to the maximum obtainable through A/FCS modes (greater than 90 deg/sec).

[GP] For yawing maneuvers in response to directional control action, there should be no sideslip reversal in the operational flight envelope.

[S] Rolling in presence of sideslip, MIL-F-8785C, Paras. 3.3.6.3, 3.3.6.3.2.

C. TOPIC (2) -- COMMAND AND DISTURBANCE CHARACTERISTICS

Data Base Elements -- Quantitative parameter data for generic command and disturbance models -- e.g., parameters in discrete gust, Dryden and/or Von Karman turbulence models, representative sensor noise statistics, etc.

Knowledge Base Elements -- Organized command and disturbance sets; restrictions and qualitative checklists on disturbance/command things to consider -- e.g., limitations of Gaussian turbulence models, and when this is important.

1. Command Inputs and Disturbance Summary

Information Covered -- Exhaustive listing of the types of commands which will be applied by the pilot or automatic control to accomplish the mission phases(s), and of the varieties of disturbances which produce effects the FCS may be required to offset or otherwise reduce. This knowledge base covers lateral flight control for advanced STOL fighters with emphasis on the air-to-air combat, and other flight phases which require similar precise control in the presence of extreme maneuvering.

[C] Desired Command Deterministic Inputs:

- Steps, Pulses, Doublet Pulses, Cut-off Ramps, and Power Series during maneuvers

[C] Desired Command Random Inputs:

- Generalized step/pulse sequences triggered by "random" maneuvering of target

[C] Unwanted Command Deterministic Inputs:

- Pilot -- Weber law "errors" in generation of power series inputs
 - Reversal errors (steps/pulses)
 - Feedthrough of specific forces (including vibratory inputs)

- FCS -- Slight power series "errors" as programmed operating point changes or as task-tailored control law mode changes

[C] Unwanted Command Random Inputs:

- Pilot -- Remnant (pilot-induced noise)
- FCS -- Guidance system internal noise
 - Geometry target noise (scintillation, multi-path, target maneuvers of higher order than accounted for in the fire control computer, etc.)

[C] Internal FCS Disturbances:

- Unbalanced component biases/drifts (includes any steady-state or secular sensor noise components).
- Power supply shifts/fluctuations.
- Sensor noise.
 - Random.
 - Vibratory pickups (periodic and random).
 - Flexible mode(s) (inherently involve feedback, but signals due to modes unimportant in the system feedback control performance may be treated as a noise injection for steady-state performance purposes).

[C] Vehicle-Induced/Associated External Disturbances

- Vehicle Asymmetries (including control effector and thrust malalignments, steady-state aeroelastic distortions, etc.)
- Stores Release (symmetrical and asymmetrical)
- Mechanical shocks
- Gun firing

- Unsteady engine(s) thrust (gas ingestion from missiles/guns firing, foreign object ingestion, extreme sideslip, etc.)
 - Vibration
 - Buffeting
- [C] External Environment-Induced Disturbances
- Wind -- Steady, Shears
 - Gusts -- Discrete, Random
 - Shock/Blast waves
 - Vortex Encounters
- [IR] Command/Response -- The Aircraft/FCS/Pilot System and the Aircraft/FCS System should exhibit good, rapid, well-damped command following responses to doublet pulses, pulses, steps, and ramps which enter at appropriate input points.
- [S] Bank Angle Regulation: plus/minus 1.0 degree (relative to reference) static accuracy achieved and maintained within 3 seconds for a 5 degree bank attitude offset initial condition, MIL-F-9490D, Para. 3.1.2.1.
- [S] A damping ratio of at least 0.3 shall be provided for nonstructural A/FCS controlled mode responses, MIL-F-9490D, Para. 3.1.2.
- [IR] Disturbance Effect Suppression
- Trim -- The FCS must be able to establish nonaccelerated trimmed flight conditions for all vehicle system asymmetries.
 - Regulation -- The Aircraft/FCS should exhibit rapid well-damped returns to trim conditions for all temporary discrete disturbances. (See e.g., [S] for "Bank Angle Regulation" above.)

2. Command/Disturbance Data Base

Information Covered -- The data base includes quantitative descriptions of commands, external disturbances, and internal disturbances including sensor noise. This data base includes information applicable to all types of airplanes.

Major Data Base Sources and Subjects:

- MIL-F-8785C, Flying Qualities of Piloted Airplanes, 5 Nov. 1980 (Ref. 1)
 - Discrete Gust -- Paras. 3.7.1.3 (form), 3.7.2.3 (length), 3.7.2.4 (magnitude)
 - Random -- Paras. 3.7.1 (form), 3.7.1.1 (von Karman form), 3.7.1.2 (Dryden form), 3.7.2.1 (scale), 3.7.2.2 (intensities)
 - Random (low altitude) -- Paras. 3.7.3 et seq
 - Wind Shear (low altitude) -- Paras. 3.7.3.2, 3.7.3.3
 - Carrier Landing Disturbance Model -- Paras. 3.7.4 et seq
- MIL-F-9490D, Flight Control Systems -- Design, Installation and Test of Piloted Aircraft, General Specification for 6 June 1975 (Ref. 2)
 - Discrete Gust -- Paras. 3.1.3.7.2 (form, same as MIL-F-8785C), 3.1.3.7.1 (magnitude)
 - Random -- Para. 3.1.3.7.1
 - Landing and Takeoff -- Para. 3.1.3.7.3 et seq (includes shears)
 - Transients from Failures -- less than +0.5g incremental normal or lateral acceleration at the c.g. or less than +10 deg/sec roll rate (for redundant FCS), Para. 3.1.3.3.4
- ILS Glideslope Standards, FAA-RD-74-119, Vols. I, II (STI TR-1043-1, I & II), June 1975, Oct. 1975 (Ref. 3)

- Glideslope Characteristics -- Glideslope beam alignment, structure, deviations (model and data from 24 sites)
- Automatic Landing Systems, FAA Advisory Circular 20-57A, 12 Jan. 1971 (Ref. 4)
 - ILS Localizer & Glideslope Characteristics
 - Steady and Shear Wind Specifications
 - Wind Model for Approach Simulations
- Stochastic Disturbance Data for Flight Control System Analysis, ASD-TDR-62-347, Sept. 1962 (Ref. 5)
 - Gusts, Winds, Wind Shears -- early data, largely superseded
 - Thrust Irregularities
 - Acoustical Vibration
 - Magnetic Field Variations
- Compilation and Analysis of Control System Command Inputs, AFFDL-TR-65-119, Jan. 1966 (Ref. 6)
 - Overflight Interference in ILS Localizer
 - Approach Coupler Receiver Noise
 - Terrain Following Profile & Spectra
- Terrestrial Environment (Climatic) Criteria Guidelines for Use in Aerospace Vehicle Development, NASA TM-82473, 1982 (Ref. 7)
 - Ground Winds
 - Inflight Winds
 - Precipitation (rain, hail, snow) Fog & Icing
 - Atmospheric Pressure and Density
- Mathematical Models of Human Pilot Behavior, AGARD-AG-188, 1974 (Ref. 8)
 - Pilot-induced Noise

**D. TOPIC (3) -- UNALTERABLE CHARACTERISTICS
OF THE AIRCRAFT AND CONTROLLER**

Data Base Elements -- Some component parameters (e.g., actuator dynamics, sensor dynamics, etc.).

Knowledge Base Elements -- Aircraft properties which are non-alterable by virtue of physical limitations or overall design philosophy, especially those which may be particularly important in establishing the FCS architecture; uncertain or highly variable aircraft features which should impact the FCS architecture, aircraft features which offer tradeoff possibilities, etc. Unalterable control system features may include primary aircraft output variables which must be controlled, sensor and actuator non-ideal properties, generic sensitivities/uncertainties in control system components, etc.

1. Unalterable Characteristics of the Aircraft

Information Covered -- Those features of the aircraft which are fixed by non-FCS considerations but which may still have a major impact on the FCS architecture. The aircraft dynamic properties which are most likely to be uncertain, and which past experience indicates might have substantial effect on the FCS design are also included. Any aircraft characteristics which may be susceptible to adjustment in a tradeoff sense, and the nature of such tradeoffs between the aircraft and the FCS should also be listed.

[C] The fundamental aircraft design has emphasized optimization of dynamic maneuvering and cruise performance aspects, reduced observables, etc.

[IR] A variety of stability and control deficiencies are sure to be present, and are to be corrected by the flight control system.

[IR] Manual FCS must cope with such possible closed-loop pilot/vehicle system problem as rolling velocity reversal (e.g., $\omega_\phi^2 < 0$), and directional divergence (e.g., $\omega_d^2 < 0$) phenomena at high AOA.

[C] Sideslip Sensitivity:

- The presence of a plane of aerodynamic symmetry creates even-function variations of rolling and pitching moments with sideslip. For small perturbations about zero sideslip this permits the conventional separation of lateral and longitudinal equations of motion. At high angles-of-attack this even-function feature tends to become sharper, increasing the importance of such stability derivatives as M_{β}^2 and N_{α} , for small steady or larger sideslip perturbations. When this occurs lateral/longitudinal coupling can become very troublesome (see, e.g., Ref. 11).
- Tendencies for wing-body/tail aerodynamic interference effects to change the sign of the dihedral effect are most severe as sideslip increases.

There is consequent increased susceptibility to lateral/longitudinal couplings, rapid nose slice or roll-off departures, wing rock, etc., at high angles-of-attack and sideslip.

[C] Combat suitability may be improved by permitting maneuvers which are outside the normal service envelope for aerodynamic control effectors, e.g., "supermaneuverability." The primary deficiencies will occur for high angle-of-attack, and/or non-zero sideslip conditions (such as noted above).

[IR] The thrust vectoring control must be appropriately integrated with the aerodynamic controls to permit such maneuvers.

[IR] There are powerful incentives for manual and automatic FCS, which minimize sideslip excursions in heavy maneuvering near the limits of aerodynamic flight.

[C] The lower frequency aircraft flexible modes may potentially be important to the FCS design either as bandwidth restricting nuisances or as legitimate objects of control.

- If modes are to be controlled and/or if filtering time delays are to be minimized:

[IR] Phase stabilization is appropriate -- establish favorable flexible pole/zero order(s) and desirable pole/zero separation by choice and location of sensors. This is an application of the "sawtooth Bode" concept.

- If modes are to be ignored:

[IR] Reduce modal pickup by sensor location; gain stabilize with low pass or notch filtering procedures.

[S] Gain margin > 8 dB for non-stabilized aeroelastic modes, MIL-F-9490D, Para. 3.1.3.6.1.

[C] With a digital FCS, there can be low frequencies generated by the sampling operation, with the lowest being the minimum difference between a flexible mode frequency and a sampling frequency.

[IR] Flexible and vibratory mode frequencies should be compared with the sampling frequencies of the controller to assure that no potential interaction problem exists.

2. Unalterable Characteristics of the Control Elements

Information Covered -- The non-ideal aspects of sensors, actuators, and other control elements which must be corrected or otherwise taken into account in the system design.

[C] Actuators -- The actuators for the control effectors (aerodynamic surfaces and vectoring nozzles) can be approximated by first-order transfer functions and Pade pure time delays as appropriate approximations for the low frequency amplitude ratio and phase characteristics which serve to limit the attainable system bandwidths. (When higher frequency actuator dynamics are important, as in flexible mode control or in further calculations, at least a third-order actuator transfer characteristic is required).

- [GP] A major nonlinearity in the FCS is actuator rate limiting. This has the first-order effect of reducing the effective time delay by up to $T = (\text{actuator amplitude})/2(\text{rate limited velocity})$ seconds. Rate limiting and the consequent reduction of actuator effective bandwidth is a primary sensitivity consideration in the FCS design.
- [C] Sensor Pickup of Unwanted Signals -- Local vibrations and flexible modes (if not to be controlled) are important sources of internal noise picked up by inertial sensors (e.g., rate gyros, accelerometers, position gyros, etc.). The pickup is minimized by proper sensor location and signal filtering.
- [IR] Gain stabilize with low-pass or notch filtering procedures.
- [S] Gain margin > 8 dB for nonstabilized aeroelastic modes, MIL-F-9490D, Para. 3.1.3.6.1.
- [IR] With digital controllers, the presence of a periodic sensor output signal from any source can give rise to frequency spectra lines with the lowest frequency at the difference between the excitation and the sampling frequencies. Anti-aliasing filtering will often take care of this, but some flexible modes may be close enough to the lowest sampling period to create a low frequency signal within the control pass band.
- [C] Flexible Mode Stabilization (Phase Stabilization) -- The possibility often exists to provide some damping augmentation for particular flexible modes by proper location of attitude or rate gyros and accelerometers.
- [C] Accelerometers
- Pick up local specific forces, so are prone to excitation by vibratory and flexible modes.

- Location effects relative to a control effector which generates both forces and moments can have profound effect on the signal sensed and on the stability and performance of any associated feedback loop(s). For lateral acceleration transfer functions, a non-minimum phase zero is present in the a_y/δ_r transfer function when the accelerometer is located aft of the center of rotation. (Similar effects are present for longitudinal accelerometers.)

[IR] Locate accelerometers used in high bandwidth loops so as to minimize these effects and any vibration pickup problems.

- The airplane transfer function for longitudinal acceleration has a non-minimum phase numerator term when flight is on the back side of the thrust required curve (as during slow approaches, nearly optimum climbs, etc.).

[IR] Any automatic trim features using an accelerometer and integrators should be configured so as to avoid closed-loop divergences.

- The usual acceleration desired for feedback control is incremental, whereas an accelerometer picks up the total specific force. Suitable adjustments for steady-state biases may be necessary either by very low frequency washout or trim like cancellation (see, e.g., Table 1-2).
- Certain acceleration measurements contain even-functions, e.g.,

$$a_z = \dot{w} - U_0 g - g \cos \theta \cos \Phi$$

If a limit cycle is present in the even-function (roll axis in the example), there will be a net bias from the accelerometer.

[IR] Integration of such accelerometer signals may not be appropriate.

[S] Residual Oscillations, 0.02g lateral, peak to peak, MIL-F-9490D, Para. 3.1.3.8.

[C] Sideslip and Angle-of-Attack Sensors -- Sideslip and angle-of-attack are often highly desirable feedback quantities. Unfortunately, their application is subject to many caveats. For high bandwidth aerodynamic sideslip and/or angle-of-attack applications, the following considerations can be extremely important:

- Sensor location effects (position error, sensitivity of scale factor and bias to local trim conditions of Mach Number, and angles-of-attack and sideslip, etc.). "Best" aerodynamic locations are often conflicting with radars or other installations, so a significant amount of calibration/compensation is usually needed to offset the location errors.
- External environment effects including pickup of local flow anomalies, turbulence, etc., icing (both on the ground and airborne), aerodynamic heating, damage from careless ground handling, etc.
- Contamination of desired signal by associated mount dynamics, etc.

For the above reasons, angle-of-attack and sideslip are generally difficult to mechanize/install effectively for multiple redundant applications. Consequently, surrogates are often used. These include: properly located and compensated normal accelerometers and pitch rate lagged by $(T_{\theta_2} s + 1)$ for angle-of-attack; properly located and compensated side acceleration, inertial sideslip, composite signals made up of yawing velocity and bank angle, etc., for sideslip.

[C] None of the surrogate measures are directly sensitive to aerodynamic sideslip or AOA. Consequently, they are not as suitable as aerodynamic sensors for the direct reduction of gust excitation sensitivity factors such as L_{β} .

E. TOPIC (4) -- PILOT-CENTERED REQUIREMENTS

Data Base Elements -- Quantitative specs as in MIL-F-8785C; pilot dynamics and modeling data.

Knowledge Base Elements -- Qualitative pilot needs, check lists of good practices, considerations, etc., that are not necessarily hard requirements. Existing data on acceptable force/position features for fly-by-wire system manipulators and recommended test procedures to rule out roll ratchet (e.g., Ref. 9). Note that a very large number of the pilot-centered requirements relating to flying qualities have already been covered in this knowledge base under the mission-centered requirements.

Information Covered -- Pilot-centered requirements including flying qualities features are presented in Supplement 4. Also many of the flying quality aspects have been summarized in the mission-centered knowledge base above. Therefore, the summary below contains only a reference listing to details in Supplement 4 and such additional flying qualities requirements as are needed.

1. Unattended Operation

[C] To minimize the degree of divided attention required of the pilot, a bank angle hold (or even more elaborate outer loops such as heading hold) modes are indicated for normal operations.

[IR] Bank angle control is an essential loop either for its own sake or as an inner loop for heading, lateral position, etc., control.

[C] When in Category B flight under manual control, the spiral mode should ideally be stable or only very slowly diverging.

[S] Minimum time to double amplitude for the spiral is 12 sec for Category A & C (includes mission phases CO, GA, WD, PA and L), and 20 sec for Category B flight, MIL-F-8785B, Para. 3.3.1.3.

2. Lateral Maneuvering

[R] Dynamic coordination requirements -- The ideal aileron -- rudder crossfeed for zero sideslip in rolls initiated with the roll controller should be consistent with the " μ " parameter (Ref. 10).

3. Conditions for Acceptable Pilot Equalization

[C] The primary piloting lateral control tasks are bank angle control, flight path control, target tracking, regulation against gusts, etc.

[IR] Each of these situations define an effective controlled element which should approximate K/s in the region of crossover.

4. Effective Time Delay

[C] The low frequency effect of all the high frequency (above crossover of the pilot/vehicle highest bandwidth loop) leads and lags in the aircraft/FCS (including actuator, sensor, filter, high frequency aerostructural modes, etc.) system can be approximated as a time delay.

[S] For a pilot initiated step control input, the response of the aircraft will not exhibit a (effective) time delay longer than 0.10 sec (for Level 1 flying qualities), MIL-F-8785C, Para. 3.5.3.

5. Conditions Antithetical to Pilot-Induced Oscillations

[S] There shall be no tendency for sustained or uncontrollable lateral-directional oscillations resulting from efforts of the pilot to control the airplane, MIL-F-8785C, Para. 3.3.3.

6. Minimization of Remnant Excitation of Flexible Modes

7. Minimization of Pilot/Vehicle Closed-Loop Excitation of Flexible Modes

8. Reduction of Vibration Feedthrough

[C] Items 5-7 above are strongly affected by the detailed force and position characteristics of the lateral and directional manipulators, and of any pilot command equalization filter elements. For modern fly-by-wire systems, the manipulator characteristics are not yet totally specified.

[GP] Refer to Ref. 9 for guidance on manipulator force/position characteristics.

[GP] Experimental check for roll ratchet tendencies with specific forcing function as outlined in Ref. 9.

[GP] Stick filter to attenuate pilot remnant for manual roll control: the command path should have an effective low pass filter characteristic to attenuate pilot remnant, and the pass bandwidth should generally be below 10 rad/sec.

F. TOPIC {5} -- OVERALL SYSTEM REQUIREMENTS -- GENERAL IMPLIED REQUIREMENTS

Data Base Elements -- Elementary systems (second-order, crossover model, quadratic dipole, lead/lag, etc., properties -- Appendix C), characteristics, quantitative constraints, summary of likely air-plane non-minimum phase zeros.

Knowledge Base Elements -- General and implied requirements, good practices, considerations, pitfalls (e.g., sensor locations, non-minimum phase zeros), quadratic dipole considerations.

1. System Level Rules of Thumb Which May Affect FCS Architectural Considerations

[GP] Primary Rules of Thumb for Frequency Domain Synthesis of High Performance, Low Sensitivity, Feedback Loops.

- Provide low frequency equalization appropriate to the steady-state command following requirements. Ordinarily this means large amplitude ratios to provide good

command following, insensitivity to uncertainties, and disturbance suppression. In other cases it implies very small amplitude ratios (e.g., as with washouts) to minimize steady-state bias effects.

- In the crossover region, which should occur at frequencies greater than those contained in the input and/or disturbance bandwidths, seek or create (by equalization) a fair stretch of -20 dB/decade slope for the amplitude ratio; then adjust the loop gain so as to put the gain crossover frequency (unit-amplitude ratio) near the higher edge of this region while maintaining adequate stability margins.
 - The "equalization" requirements can be satisfied by series compensation, introduction of inner loops, adjustment of effective aircraft numerators by feedbacks to other control effectors, etc.
- [C] Stability Margins -- Closed-loop systems should possess appropriate phase and gain margins consistent with the uncertainties present.
- [S] Phase and Gain Margins in each and every closed-loop (with all but the loop being examined held at nominal values) over the operating envelope shall be:
- 45 deg and 6 dB (considering all aircraft modes in the frequency range $0.06 \text{ Hz} < f_m < 1\text{st}$ (uncontrolled) aeroelastic mode)
 - 30 deg and 4.5 dB ($f_m < 0.06 \text{ Hz}$)
 - Gain Margin of 6 dB at zero airspeed
- [R] Closed-loop system Peak Magnification Ratio, $M_p < 4.8 \text{ dB}$ (assuming the peaking mode is not part of a quadratic dipole pair)
- [S] A damping ratio of at least 0.3 shall be provided for non-structural AFCS controlled mode responses. MIL-F-9490D, Para. 3.1.2

All from MIL-F-9490D, Para. 3.1.3.6.1.

- [GP] Quadratic Dipole Pairs -- For manual or automatic closed-loop control with quadratic dipole pairs superimposed on a K/s -like characteristic in the crossover region, the ratio of the undamped natural frequencies of the complex zero and the complex pole should be less than unity. (Applicable to roll control with aileron, yaw rate control with rudder, etc.)
- [GP] Command Loop Bandwidths -- For a stochastic command input contaminated with noise, a desirable system bandwidth (outer loop crossover frequency) should approximate the frequency where the command input power is equal to the noise power.
- [C] Location of Bending Filters -- Consideration should be given to placing structural mode filters in the feedback rather than the forward path to minimize the effective time delay in response to commands.

REFERENCES

1. "Military Specification -- Flying Qualities of Piloted Airplanes," MIL-F-8785C, Nov. 1980.
2. "Flight Control Systems -- Design, Installation and Test of Piloted Aircraft, General Specification For," MIL-F-9490D(USAF), June 1975.
3. Hofmann, Lee Gregor, Warren F. Clement, Dunstan Graham, et al., ILS Glide Slope Standards, Part I: A Review of Flight Inspection Standards Affecting Landing Performance and Comparison With Limits Evolved From System Analysis, FAA-RD-74-119, June 1975.

Hofmann, Lee Gregor, John J. Shanahan, and Dunstan Graham, ILS Glide Slope Standards, Part II: Validation of Proposed Flight Inspection Filter Systems and Responses of Simulated Aircraft on Coupled Approaches, FAA-RD-74-119, II, Oct. 1975.
4. Automatic Landing System (ALS) Federal Aviation Administration Advisory Circular No. 20-57A, Jan. 1971.
5. Hart, John E., Lowry A. Adkins, and Larry L. Lacau, Stochastic Disturbance Data for Flight Control System Analysis, ASD-TDR-62-347, Sept. 1962.
6. Weir, David H., Compilation and Analysis of Flight Control System Command Inputs, AFFDL-TR-65-119, Jan. 1966.
7. Turner, Robert E. (Comp.), and C. Kelly Hill (Comp.), Terrestrial Environment (Climatic) Criteria Guidelines for Use in Aerospace Vehicle Development, NASA TM-82473, June 1982.
8. McRuer, D. T., and E. S. Krendel, Mathematical Models of Human Pilot Behavior, AGARDograph No. 188, Jan. 1974.
9. Johnston, D. E., and D. T. McRuer, Investigation of Interactions Between Limb-Manipulator Dynamics and Effective Vehicle Roll Control Characteristics, NASA CR 3983, May 1986.
10. Hoh, Roger H., David G. Mitchell, Irving L. Ashkenas, et al., Proposed MIL Standard and Handbook -- Flying Qualities of Air Vehicles. Volume I: Proposed MIL Standard. Volume II: Proposed MIL Handbook, AFWAL-TR-82-3081(I & II), Nov. 1982.
11. McRuer, Duane T., and Donald E. Johnston, Flight Control Systems Properties and Problems, Vol. 1, NASA CR-2500, Feb. 1975.

SUPPLEMENT 3

PILOT-CENTERED REQUIREMENTS AND HUMAN PILOT A/FCS INTERACTIONS*

In this supplement the complex but critical issues of pilot-centered requirements and flying qualities will be considered. This will not be an attempt at an exhaustive treatment of the subject, but will instead be a discussion of selected issues bearing on three broad areas:

- Integration of pilot-centered requirements into the design synthesis.
- Conflicts and ambiguities in requirements and specifications stemming from the presence of the human pilot in the loop.
- The problem of maintaining relevant requirements in the face of rapid changes in aircraft and flight control technology.

The discussion to follow will treat the six topics of Fig. 1 in the sequence shown.

The development of flight control system technology has been paralleled by the development of flying qualities requirements and specifications, which at any point have ranged from explicitly detailed to implicit (or nebulous). In the United States the most formal specifications are the military flying qualities specification, currently MIL-F-8785C and the Federal Air Regulations, Ref. 1. These two documents play a subtle role in the design of many aircraft -- a role which ranges from legal requirement to design guide. Because of this it has been recognized that specifications without a well-documented rationale can be quite unsatisfactory. This point has long been recognized by the U.S. Air Force, and resulted in the "BIUGs" (Refs. 2 and 3) to support MIL-F-8785B and MIL-F-8785C, respectively. Continuing efforts by the

*All numbers in this supplement referring to figures, tables, equations, and references are for Supplement 2 only.

**Effective Vehicle Dynamics and Flying Qualities
Requirements -- Rigid Body Characteristics**

Conditions for Acceptable Pilot Equalization

Conditions Antithetical to Pilot-Induced Oscillations

Minimization of Remnant Excitation of Flexible Modes

**Minimization of Pilot/Effective Aircraft System
Closed-Loop Excitation of Flexible Modes**

Reduction of Vibration Feedthrough

Figure 1. Pilot-Centered Requirements

Air Force to cast flying qualities requirements in the most suitable form for the development of increasingly complex aircraft has led to the proposed MIL Standard and Handbook of Ref. 4. These "background" documents provide a link to the vast literature accumulated in years of aircraft flight control system design and research, which are the ultimate sources of the pilot-centered requirements. Much of this knowledge resides as corporate "group technology" and in the experience of skilled designers.

While the importance of past experience and "lessons learned" is undeniable, one of the most difficult challenges that designers of advanced aircraft must face is that new technology may invalidate specifications and criteria based on historic designs. The rapid introduction of active control technology into operational aircraft in recent years (e.g., the F-16, HIMAT, and Space Shuttle) has made this problem particularly acute at present. There is no simple solution for this problem -- short of effective research programs over the longer term. However, for an aircraft designer faced with an immediate design problem, the most powerful approach will be to take a critical view of all specifications and criteria. This requires a solid conceptual understanding of the basis for the requirements, and a set of tools for insightful analysis of their implications for advanced designs.

A. EFFECTIVE VEHICLE DYNAMICS AND FLYING QUALITIES REQUIREMENTS -- RIGID BODY CHARACTERISTICS

In this discussion, flying qualities issues may be usefully divided into two manual control regimes.

- Maneuvering including closed-loop manual tracking.
- Trim, speed control, and unattended operation.

These regimes correspond to distinct regions of the effective aircraft frequency responses with maneuvering in the higher frequency region, while trim, etc., are featured at the lower frequencies. While these regimes relate naturally to the frequency domain, time domain specifications are also of interest, particularly for advanced aircraft with high order FCS characteristics. Examples of both frequency domain and time domain specifications will be discussed in the following.

1. Longitudinal Maneuvering

a. Conventional Aircraft

In this context, conventional aircraft are unaugmented aircraft with static stability achieved by aerodynamic means, i.e., with a stable static margin. This term can also be reasonably applied to augmented aircraft in which the augmentation gains are sufficiently low that the dynamic effects may be treated as modifications of naturally occurring stability and control derivatives. For conventional aircraft only a single longitudinal control point is ordinarily of interest, e.g., an elevator. Maneuvering can be treated as constant speed under the short period approximation, and thus thrust control is not an issue. Emphasis is on pitch attitude control since dynamic fundamentals require path control by means of inner loop attitude control. Path naturally follows attitude as can be represented by the path to attitude numerator ratio:

$$\frac{\gamma}{\theta}(s) = \frac{N_{\delta}^{\dot{\gamma}}}{U_0 N_{\delta}^{\theta}} = \frac{1}{(T_{\theta 2} s + 1)} \quad (1)$$

where the "path lag" inverse time constant $1/T_{\theta 2}$ is related to the heave damping Z_w by

$$\begin{aligned} \frac{1}{T_{\theta 2}} &= -Z_w + \frac{M_w}{M_{\delta}} Z_{\delta} \\ &= -Z_w \\ &= \frac{\rho S U_0}{2m} C_{L_{\alpha}} \end{aligned} \quad (2)$$

Equation 1 is generally a reasonable approximation except perhaps for atypical configurations (e.g., the Space Shuttle, Refs. 5 and 6) where the pilot is well aft of the center of rotation for elevator inputs.

Historically, the only treatment of path dynamics in the MIL-Spec has been a short period requirement based on the control anticipation parameter (CAP) (Ref. 7). There has been some debate over the years as to whether this specification form is an adequate treatment of path dynamics, or whether an explicit relation to $1/T_{\theta_2}$ is needed (Refs. 2 and 8). In any case for many but certainly not all aircraft, the value of $1/T_{\theta_2}$ appears to be sufficiently high relative to the required path control bandwidth to justify the traditional specification emphasis on pitch attitude control.

1) Effective θ/δ_p Frequency Domain Requirements

Equivalent Vehicle Dynamics

In recent years the effects of control systems have been partially taken into account by defining so-called lower order equivalent system (LOES) dynamics. These models approximate the actual aircraft plus control system over a restricted frequency band by a LOES of the classical short period form, i.e.,

$$\frac{\theta}{\delta_p} \doteq \frac{M_{\delta_e} (s + 1/T_{\theta_2}) e^{-\tau_{eff}s}}{s [s^2 + 2(\zeta\omega)_{sp}s + \omega_{sp}^2]}, \quad \omega \leq \omega_{b1} \quad (3)$$

Here the restricted bandwidth, ω_{b1} , is usually only implied, but is of the order of 10 rad/sec or so. Path/command considerations are not explicit in Eq. 3, however, it is recommended (Ref. 4) that in numerical fitting for equivalent system parameters, $1/T_{\theta_2}$ be fixed consistent with Eq. 2. The effective time delay τ_{eff} is included to account for all the higher frequency (above ω_{b1}) lags, leads, and pure delays. Time delay is a good first approximation since these effects appear primarily as a phase angle decrement ($\Delta\phi \doteq \omega\tau_{eff}$ for $\omega < \omega_{b1}$) in the pilot's pitch control crossover frequency range (1-4 rad/sec).

Desirable values of ζ_{sp} and ω_{sp} are directly stated in Refs. 3, 9, and 10. For transports (Class III aircraft), the latest version of the military specification (Ref. 9) provides current values. Aircraft which

meet these requirements are very likely to have good flying qualities, but several aircraft which do not meet the requirements in all respects make up a substantial part of the operational fleet. Because commercial transports do not have to meet the military specifications to be certified, the aircraft manufacturers have tended to develop their own design criteria. These are often based on comparative characteristics with other aircraft by the same manufacturer, and are not necessarily expressed in equivalent system terms. Consequently, the equivalent system values in the military specification (Ref. 9) are primarily useful as design guides for transports. For fighters they are, of course, a more solid requirement.

Effective time delay, τ_{eff} , is directly specified in Refs. 3, 9, and 11. The data base is still growing and there is, as yet, no real consensus about allowable values, especially for large aircraft (see Table 1 presented later). Further, the usual mix in the τ_{eff} between time lags and pure time delays has not been thoroughly evaluated. For a given τ_{eff} near the allowable boundary limits, existing manual control theory and recent experiments (Refs. 12 and 13) indicate that a system with the τ_{eff} largely due to a pure delay will be less desirable than one where the τ_{eff} is due entirely to time lag components.

Effective Aircraft θ/δ_p Bandwidth

Another approach to defining desirable θ/δ_p properties, particularly useful for unconventional dynamics is to specify an effective "airplane pitch bandwidth" (e.g., Refs. 3 and 14). This "airplane bandwidth" is akin to, but defined differently than that usually used for control systems. It is intended as an effective aircraft dynamic measure, which relates to the amount of lead equalization needed from the pilot to exert tight closed-loop control. To account for pilot aircraft closed-loop control properties, ω_{bc} is defined to be the smaller of the frequencies corresponding to a 45 deg phase margin or a 6 dB gain margin. The actual specification then becomes,

$$\omega_{bc} > \text{Specified Value} \quad (4)$$

The larger ω_{bc} is the less the pilot lead, and hence the smaller the pilot attentional demand requirements.

2) Time Domain Requirements for θ/δ_p

Time domain requirement statements have become more prevalent as control system characteristics have become more dominant factors in the overall system response. These are often given as inequality constraints or as graphical boundaries. The typical pitch rate response to a step pitching velocity command can serve to illustrate most of the time domain measures (Fig. 2). The major differences between Figs. 2a and 2b are in the initial part of the response and in the underlying idealization. Figure 2b shows an indicial response of the particular limiting form given, and does not include the effects of high frequency actuator and other modes. Figure 2a on the other hand shows a gradual initial build up to the maximum velocity, which reflects the higher frequency control system characteristics; further, the remainder of the response is not necessarily confined to the Fig. 2b form. Instead other dynamics, especially some dipole pairs, may be present in Fig. 2a which is intended to represent the actual complete system. At their closest juncture, the two figures would be the same except for the high frequency lags which affect the initial response. The indicial responses shown may be those of the aircraft/flight control system for all time, as in a rate command system with very high dc gain, or for a short time only as with a conventional short period. In the latter case, the phugoid motions will succeed the rapid pitching velocity response to its intermediate and temporary quasi steady-state.

Reference 11 provides recommendations for the rise time ($t_2 - t_1$), transient peak ratio $\Delta q_2/\Delta q_1$, and time delay, t_1 for Supersonic Cruise Research (SCR) aircraft¹. For Level 1 flying qualities ("Flying qualities clearly adequate to perform the tasks... under the most arduous set

¹The conditions for applying the Ref. 11 specification are somewhat different than indicated in Fig. 2a. In particular the specification calls 2 DOF speed constrained equations of motion and pitch response to controller force.

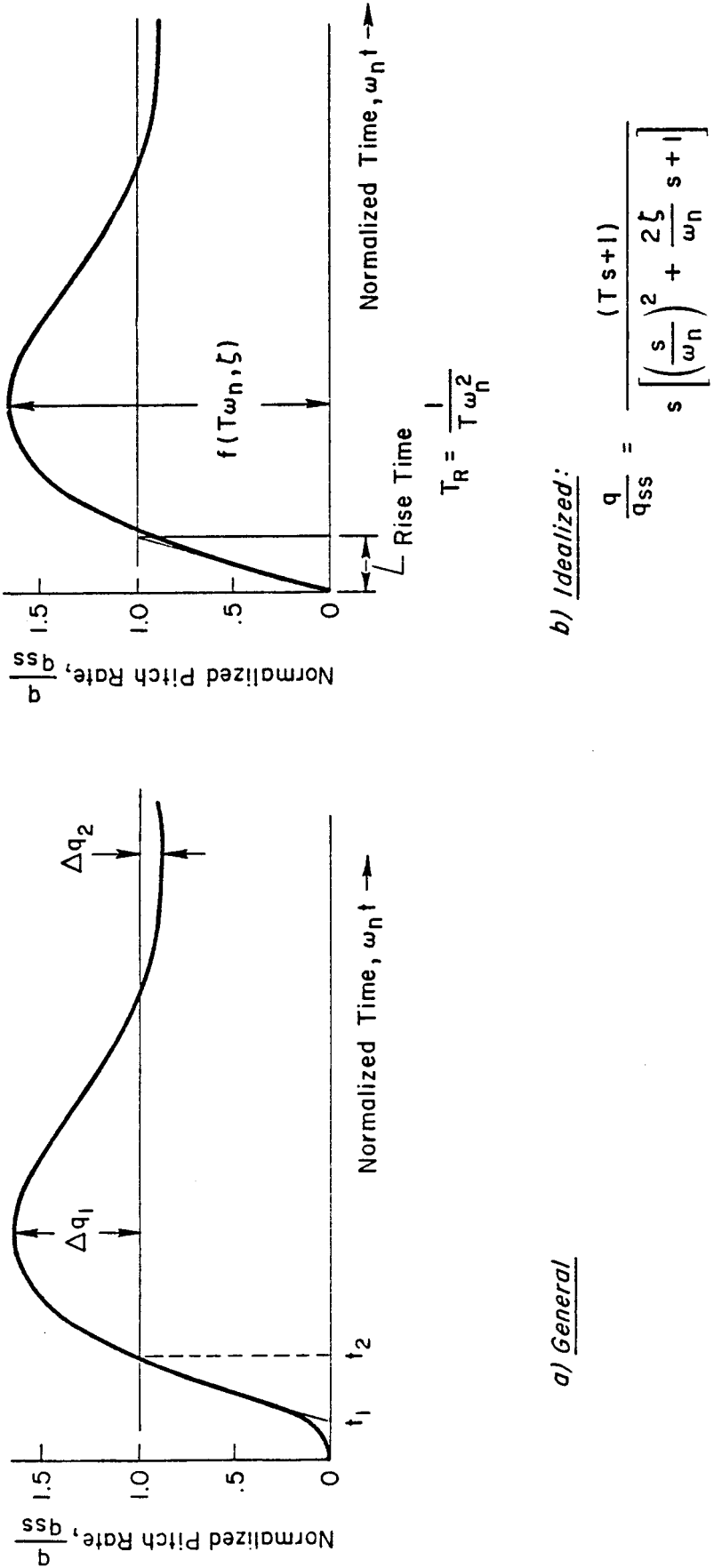

Figure 2. Pitching Velocity Indicial Responses

of environmental conditions likely to be encountered operationally..."
 these are

$$\frac{\Delta q_2}{\Delta q_1} \leq 0.30 \quad (5)$$

$$(9) \quad \frac{2.74}{V_T} \leq (t_2 - t_1) \leq \begin{cases} (200) \\ \frac{61}{V_T} & \text{(Terminal Phases)} \\ (500) \\ \frac{152.4}{V_T} & \text{(Nonterminal Phases)} \end{cases} \quad (6)$$

where V_T is in meters/sec. The constants in parenthesis are used when V_T is expressed in ft/sec. The effective time delay, which can be associated with the τ_{eff} described for the frequency domain criteria does not, as previously mentioned, yet have consensus values. This is emphasized in Table 1 which gives a cross-section. However, the Lockheed recommendations include the direct effect of a lower pilot frequency bandwidth associated with very large aircraft.

TABLE 1. EFFECTIVE TIME DELAY RECOMMENDATIONS

LEVEL	8785C	SCR (PITCH)	LOCKHEED
1	0.10	0.12	0.40
2	0.20	0.17	0.60
3	0.25	0.21	0.70

Other time domain criteria appear as boundaries. A typical set for rate command/attitude hold systems is shown in Fig. 3a. This criterion was established for the space shuttle, and has been noted as in some ways inconsistent with other criteria described above (Ref. 15). The most important differences are the large initial time delay and the low pitch rate overshoot permitted.

Inserted on Fig. 3 are two other bounding criteria for time response to 90 percent of final value and for settling time. These were proposed in Ref. 16 and flight validated in Ref. 17 specifically for transports with rate command/attitude hold systems.

Finally, another version of time response boundaries has been proposed for large advanced supersonic aircraft (Ref. 18). A typical boundary corresponding to the subsonic boundaries given in Fig. 3a for the shuttle is given in Fig. 3b. Comparison of the two boundaries shows that much less initial time delay and much greater response overshoot is permitted by Fig. 3b.

In all of the time domain criteria described thus far, there is no explicit requirement set on the secondary response/command relationships. Two schemes which do take other responses into explicit account are the so-called C^* criterion, which blends both pitch rate and normal acceleration, and the "Time Response Parameter" (TRP) which uses the same two quantities. Comparisons made in Ref. 18 indicate that C^* , in its current formulation does not predict good flying characteristics for advanced transports as well as Fig. 3b does, so we do not include it here. The Time Response Parameter (Refs. 19 and 20) has the form

$$\text{TRP} = \underbrace{\left(\frac{t_d}{t_c}\right)_{\dot{\theta}} + K_1(A_{1\dot{\theta}} - 1)}_{(\text{TRP})_{\dot{\theta}}} + \underbrace{K_2(t_{d_{N_z}}^{-0.7}) + K_3(A_{1_{N_z}}^{-0.3}) + K_4(\tau_{N_z}^{-0.2})}_{(\text{TRP})_{N_z}} \quad (7)$$

The times, t_d and t_c , for $\dot{\theta}$ and $t_{d_{N_z}}$ and τ_{N_z} for the normal acceleration are defined in Fig. 4 as are values for the weighting constants K_i . A $\text{TRP} \leq 0.25$ has been shown in a number of experiments (e.g., Ref. 20) to

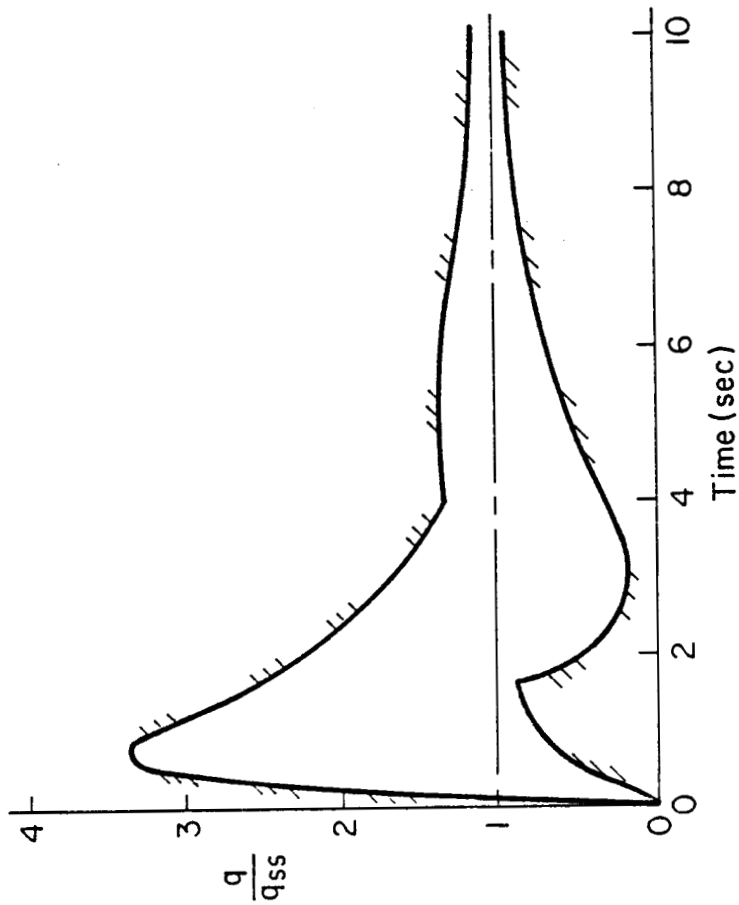

a) Space Shuttle Response Boundaries and NLR Criteria

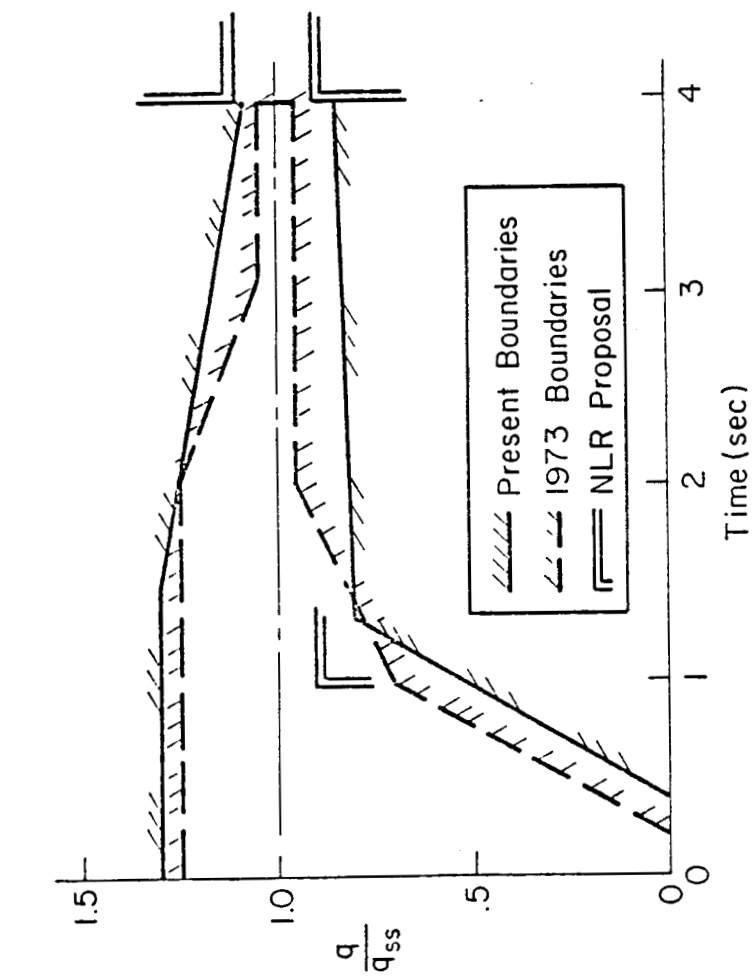

b) SST Low Speed Pitch Rate Response Criterion

Figure 3. Time Domain Pitch Rate Response Boundaries

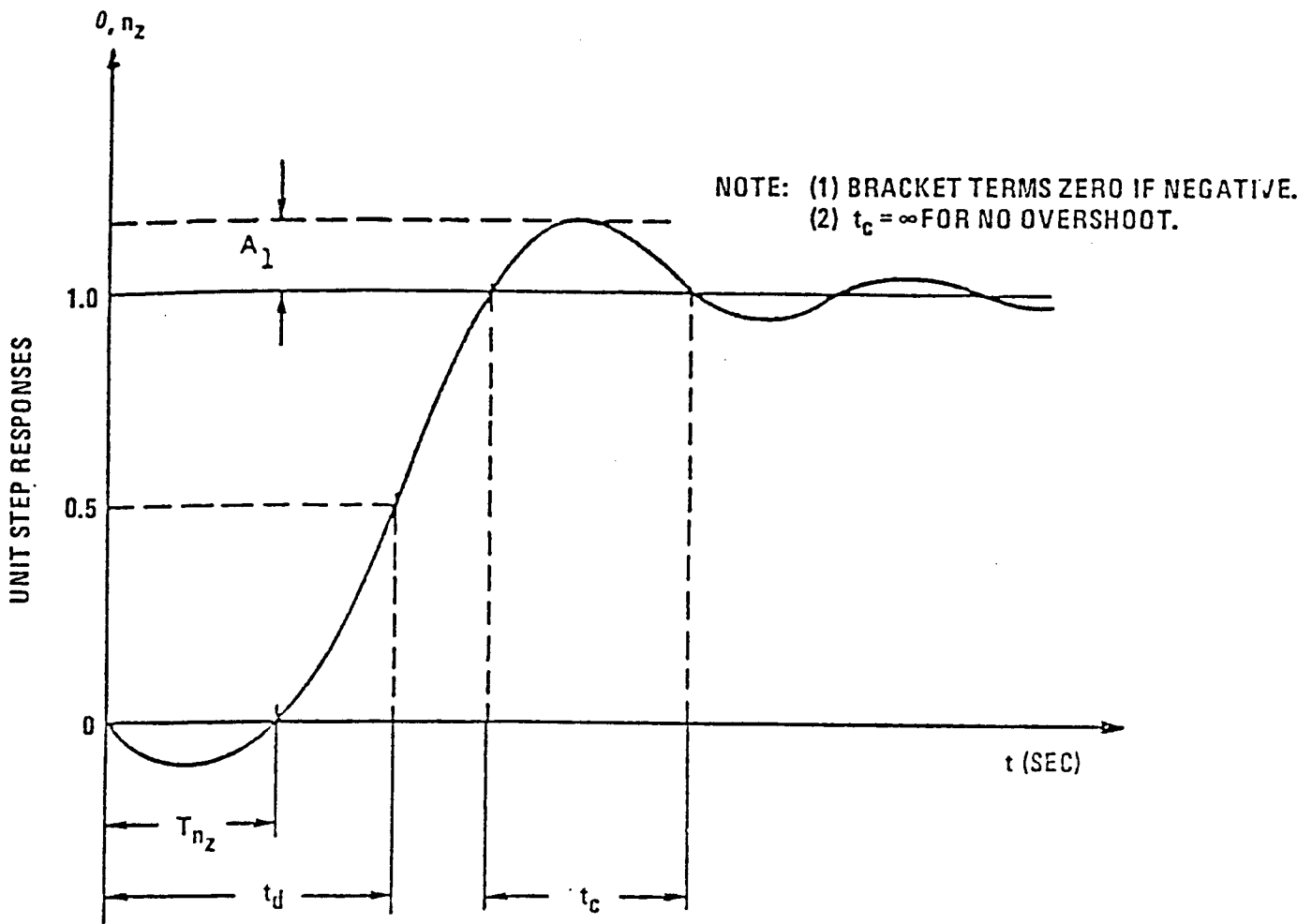

$$\begin{aligned}
 & \left. \begin{aligned}
 K_1 &= 0.08 \\
 K_2 &= 0.5 \\
 K_3 &= 0.3 \\
 K_4 &= 0.2
 \end{aligned} \right\} \text{CAN BE OPTIMIZED} \\
 & \text{TRP} = (\text{TRP})_{\dot{\theta}} + (\text{TRP})_{n_z} + K_4 (\tau_{n_z} - 0.2) \\
 & (\text{TRP})_{\dot{\theta}} = (t_d/t_c)_{\dot{\theta}} + K_1 (A_{1\dot{\theta}} - 1.0) \\
 & (\text{TRP})_{n_z} = K_2 (t_{d_{n_z}} - 0.7) + K_3 (A_{1_{n_z}} - 0.3)
 \end{aligned}$$

NOTE: K4 ONLY REQUIRED FOR SMALL TRP VALUES (≤ 0.23)

Figure 4. Quantities Involved in the Time Response Parameter

be consistent with pilot ratings of 1-2 on the Cooper-Harper scale. For a good aircraft, the most important terms in TRP are the initial cyclic parameter $(t_d/t_c)_\delta$ and the $K_2(t_{dN_z} - 0.7)$ in $(TRP)_{N_z}$. The other terms are, in fact, often zero for systems with $(TRP) \leq 0.25$, since they are included only if the terms in parentheses are positive.

The $(TRP)_\delta$ essentially takes care of the primary response to command input, whereas the $(TRP)_{N_z}$ accounts for the secondary response to command. Accordingly, systems designed to the TRP do consider both good primary flying qualities and appropriate motion harmony. The TRP criterion as it now stands was developed for fighter aircraft.

b. Highly Augmented Aircraft

There is no clear demarcation between "highly augmented" and more conventionally augmented aircraft -- except that the latter are presumed to have basically conventional response characteristics. However, the emergence of high reliability, high authority, high gain flight control systems in operational aircraft, particularly with relaxed static stability (RSS) (e.g., the Space Shuttle and F-16) has resulted in a wider recognition of the need for new requirements and specifications with a flight control system orientation as an alternative to fitting advanced aircraft characteristics to specifications evolved for conventional aircraft (Refs. 12 and 21). The archetype of these new highly augmented aircraft is the "superaugmented" aircraft, which is created by application of a high gain pitch rate to elevator (or equivalent) feedback to a RSS airframe (Ref. 12). Superaugmentation has some appealing practical features compared to other high gain possibilities (such as an angle-of-attack to elevator feedback), and control systems of this general type have been applied to several operational RSS aircraft, e.g., the Space Shuttle and the X-29. The superaugmentation model is an idealization based on an analytical rather than a numerical lower order equivalent system representation. Superaugmented aircraft characteristics were discussed in Section III, but some of their general and unconventional characteristics will be summarized briefly below as a basis

for considering the flying qualities requirements problem for highly augmented aircraft.

- The airframe characteristics are neutral or unstable without augmentation.
- The supraaugmented characteristic modes are unconventional. There is neither a phugoid nor true short period mode, instead the aircraft has first-order speed and heave modes comparable to a neutral airframe and a second-order pure pitch mode (uncoupled from heave) which is largely defined by FCS parameters.
- The pitch response to a pitch rate command is given to a first approximation (see Appendix C) by:

$$\frac{q}{q_c} \doteq \frac{-K_q M_\delta (1/T_q) e^{-\tau s}}{[\zeta', \omega'_n]}$$

where the pitch mode parameters are

$$\zeta' \doteq \frac{1}{2} \sqrt{-K_q M_\delta T_q}$$

$$\omega'_n \doteq \sqrt{-K_q M_\delta / T_q}$$

The effective attitude lead $1/T_q$ is generally near ω'_n which gives $q/q_c(s)$ a "K/s-like" characteristic. This produces a transient pitch response to q_c step inputs with characteristically low overshoot.

- The supraaugmented effective time delays tend to be large often due to structural mode and other FCS filters.
- The unconventional effective attitude lead $1/T_q$ is generally much higher than the path to attitude lag $1/T_{\theta_2} \doteq -Z_w$ -- this indicates unconventional flying qualities. This characteristic appears as an unconventional lag in the γ (path) transient response to q_c commands. The lag time constant is that of the supraaugmented heave mode -- approximately T_{θ_2} sec.

- By varying the prefilter (G_i in Fig. 5) in the command path ($\delta_p \rightarrow q_c$), the superaugmented response to the pilot's controller can be modified extensively. The important research question at the moment is selection of the proper G_i for a given flight condition and task.

While superaugmentation is of great current interest, the empirical data from which requirements and criteria may be formulated is quite limited although relevant research programs are in progress. Data from ground and in-flight simulations is available from Refs. 5 and 16. These experiments and the Space Shuttle design work have lead to the time domain pitch rate response criteria, which were shown previously in Fig. 3a. Examination of operational flight experience with the shuttle (Refs. 6 and 22, 23) has indicated pilot concerns with path control, which were not anticipated in the original (1973) Shuttle flying qualities specification (Ref. 24). The effect is subtle and has been confounded by the issue of unconventional pilot location with respect to the center of rotation for elevator commands.

Current research on this topic will be briefly reviewed here as a case example of the problem of using "old specs for new airplanes," and to illustrate approaches for critically examining such requirement problems. Figure 5 compares the short-term response to the pilot's pitch command of a conventional aircraft (represented by the short period approximation), and a superaugmented aircraft with a pure gain G_i (nominally the Shuttle). For purposes of comparison, the short period frequency of the conventional aircraft has been set equal to the pitch mode frequency of the superaugmented aircraft ω'_n . In the pitch attitude response, the major distinction between the two aircraft is the location of the effective attitude lead -- $1/T_{\theta_2}$ in the conventional and $1/T_q$ in the superaugmented case. The $1/T_{\theta_2} - \omega_{sp}$ separation in the conventional aircraft is the source of the large attitude transient overshoot. The attitude overshoot is much lower in the superaugmented case since $1/T_q \approx \omega'_n$. Comparing the conventional and superaugmented path (γ) responses reveals the superaugmented path lag.

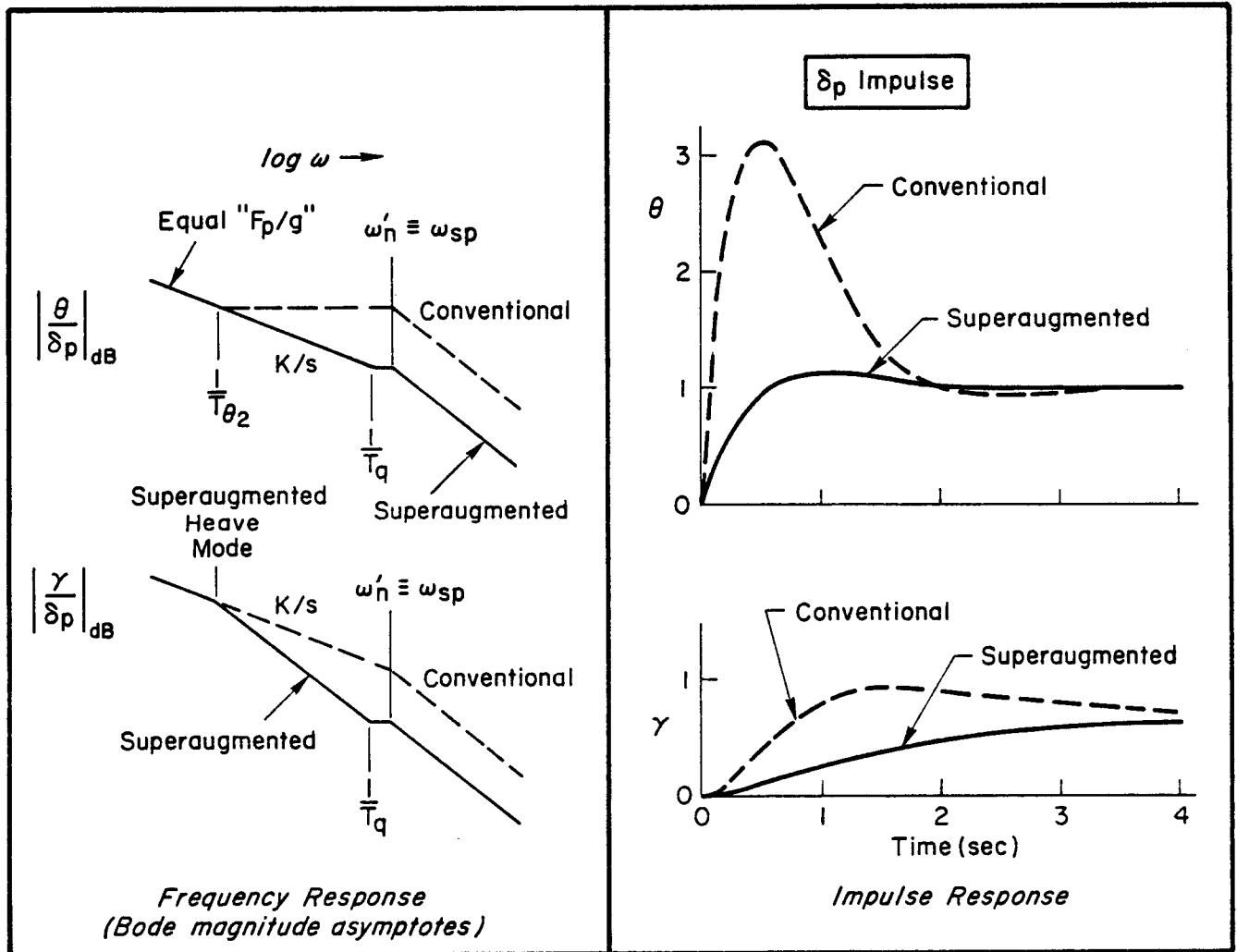

Figure 5. Comparison of Short-Term Response to Pilot Pitch Command—Conventional (Short Period) vs. Superaugmented Aircraft

From the comparisons of Fig. 5 it might be anticipated that pilots of superaugmented aircraft (with G_1 essentially a pure gain) would observe the more sluggish γ/δ_p and downrate its flying qualities. However, the problem is more complex because the pilot may be performing significant closed-loop tracking. When the pilot closes a reasonably high gain inner attitude loop $\theta/\theta_c \rightarrow 1$, and the effective outer loop path response -- for both conventional and superaugmented aircraft -- approaches

$$\frac{\gamma}{\theta_c} = \frac{\gamma}{\theta} \cdot \frac{\theta}{\theta_c} \rightarrow \frac{\gamma}{\theta} \rightarrow \frac{1}{(T_{\theta_2}s + 1)}$$

Thus, if the pilot is performing significant closed-loop tracking, the impact of the superaugmented path lag on the pilot's opinion of flying qualities may be significantly reduced (Ref. 12).

Data with which to examine these effects are quite limited. However, informal pilot comments from the Shuttle astronauts provide some insights (Refs. 6 and 22). Astronauts who have commented on the Shuttle's pitch response to control have generally felt that these characteristics are precise and desirable. This is consistent with the expectation that the broad region of "K/s-like" slope in the superaugmented $|\theta/\delta_p|$ frequency response (Fig. 5 region below $1/T_q$) would require less pilot equalization for attitude control loop closures. There have also been, however, comments by the Shuttle crews about unconventional or sluggish path response. This has prompted considerable examination of the Shuttle pilot location effect, but the anecdotal data are consistent with the superaugmentation path lag hypothesis. The important fact is that these shuttle flying qualities problems occur in the landing flare. In the flare manual closure of a pitch attitude loop is not feasible implying that the superaugmented path lag will be "seen" by the pilot. As a minimum this can be expected to constrain landing technique and probably degrade pilot opinion since altitude control is uniquely critical in the flare.

A formal experiment to test this has not been conducted, although some support is available from Ref. 25. This paper reports on a Space Shuttle simulation conducted on the NASA-Ames VMS simulator. The operational Shuttle pitch FCS was compared to alternative designs with more conventional characteristics (i.e., the effective attitude lead was near $1/T_{\theta_2}$). Evaluations and pilot ratings were obtained from two groups of pilots:

- test pilots with conventional aircraft experience
- Shuttle pilots

Considerable variation in pilot opinion was observed. The study conclusions from Ref. 25 were:

Final Flare and Landing

A control system that had good flight path control response [i.e., conventional γ/δ_e] was preferred by pilots with conventional aircraft background.

The current Shuttle control system, which has good attitude control was preferred by the Shuttle pilots who had extensive training with this system.

Steep Glideslope

No clearcut advantage was seen with either system. There was a general preference for the current shuttle system because of the attitude drop-back (overshoot) characteristics.

These conclusions are consistent with the above hypothesis.

It should be recalled that the above considerations are for a command path filter, G_i , which is effectively a pure gain. More complex filter forms can fundamentally change the effective vehicle response as seen by the pilot -- including restoring a more conventional effective attitude numerator, and thus creating essentially conventional short-term flying qualities. Thus, flying qualities requirements for super-augmented aircraft can be expected to focus on what the form of G_i should be with the potential for considerable task tailoring.

An important task-tailoring example is offered by the flare maneuver. Consider first a flare maneuver intended to be made up of a

sequence of discrete changes in flight path. These correspond to discrete attitude changes so a pitch rate command/attitude hold system would be appropriate. The piloting technique supported by this system would include discrete precognitive inputs to modify the pitch angle in the appropriate sequence with pursuit behavior to fine tune the attitude. The regulation function of attitude maintenance is largely accomplished by the FCS. This form of landing operation is especially pertinent to carrier approaches with large flight path angles continued to touchdown. It is also used on the Shuttle with several steps in the flare.

For the second flare maneuver, consider a spatial exponential as the desired trajectory. To accomplish this, the pilot needs to make the sink rate proportional to the attitude. This can be done by modulating the pitch attitude (as an easily perceived surrogate of sink rate) proportional to altitude. The appropriate flight control system for this type of flare would then be attitude command/attitude hold in character. This follows the K_c/s -like prescription for the task, i.e., $\dot{h}/\delta_p \doteq U_0\theta/\delta_p \doteq K/s$ in the region of pilot-vehicle system crossover. This is approximated in conventional aircraft near the minimum of the thrust required curve. It is also supported for some superaugmented aircraft by flight data in Ref. 26.

One final consideration for superaugmented flying qualities is the effect of disturbances (both internal FCS noise and atmospheric turbulence) interacting with control power limitations and aircraft structural modes. This interaction has potential for producing control saturation nonlinearities, which can degrade the stability and the dominant pitch mode characteristics of superaugmented aircraft because of their unconventionally extreme dependence on flight control system parameters (Ref. 12). While conventional aircraft are affected by atmospheric turbulence, their dynamics (i.e., the aircraft poles and zeros) are not affected. However, for the new class of superaugmented aircraft any turbulence induced control saturation will cause changes in the basic aircraft dynamics.

c. Direct Force Control Aircraft

If an additional control effector (independent of the pitch control) is added to the aircraft (i.e., direct lift control), the flight control system can be mechanized to produce direct force control (DFC). With two independent control points available, path and pitch attitude can be controlled independently (in the short-term). The most elementary implementations of these characteristics are "decoupled modes" such as have been flight tested on the CCV and AFTI F-16 aircraft. The limiting characteristics of these modes are summarized in Table 2. In these modes the aircraft as seen by the pilot has effectively a single degree-of-freedom, and in the normal acceleration or vertical translation modes there is no longer a direct concern with attitude control.

TABLE 2. LIMITING RESPONSES FOR DFC RESPONSE
MODES LONGITUDINAL

MODE	CONSTRAINTS	LIMITING FORMS OF RESPONSES
Direct Lift, or Normal Acceleration ($\alpha = 0$) (A_N)	$w \rightarrow \delta_e, u \rightarrow \delta_T$	$\frac{a_z}{\delta_L} \rightarrow \frac{N_{\delta_L}^{a_z w} u}{N_{\delta_e \delta_T}^w u} = Z_{\delta_L}$
Pitch Pointing (α_1)	$a_z \rightarrow \delta_L, u \rightarrow \delta_T$	$\frac{\theta}{\delta_e} \rightarrow \frac{N_{\delta_L}^{\theta} a_z u}{N_{\delta_T}^{a_z u}} = \frac{M_{\delta_e}}{[s^2 - M_q s - M_{\alpha}]}$
Vertical Translation (α_2)	$\theta \rightarrow \delta_e, u \rightarrow \delta_T$	$\frac{w}{\delta_L} \rightarrow \frac{N_{\delta_L}^{w \theta} u}{N_{\delta_e \delta_T}^{\theta u}} = \frac{Z_{\delta_L}}{(s - Z_w)}$

Thus, the response requirements should deal primarily with the heave or path angle response, which would ordinarily be outer loop considerations. Approaches to the handling qualities criteria for direct force control aircraft are discussed in Ref. 27. In this work it was found that specifications on the "airplane bandwidth" along the lines of those discussed earlier, appear to be the most suitable approach. Proposed DFC flying qualities specifications are presented which specify bandwidth minimums as a function of task and flying qualities level.

2. Lateral Maneuvering

a. Conventional Aircraft

Since conventional aircraft are ordinarily maneuvered laterally in banked turns, an inner bank angle loop is implied to equalize the outer lateral path loop. The equalized outer loop dynamics can be examined from the λ (lateral path of the velocity vector) to bank angle numerator ratio:

$$\frac{\lambda}{\phi} = \frac{N_{\delta a}^{\lambda}}{N_{\delta a}^{\phi}} = \frac{A_{\lambda}[\zeta_{\lambda}, \omega_{\lambda}]}{A_{\phi}(0)[\zeta_{\phi}, \omega_{\phi}]} \quad (\text{see footnote})^* \quad (8)$$

*Here, as elsewhere in the report, the following shorthand notation for transfer function poles and zeros is used

$$(s + a) = (a)$$

$$[s^2 + 2\zeta\omega s + \omega^2] = [\zeta, \omega]$$

The poles and zeros comprising the second-order $\omega_\lambda/\omega_\phi$ dipole will generally be close to cancelling since (typically):

$$\frac{\omega_\lambda}{\omega_\phi} \doteq \left[1 - \frac{U_0}{g} \frac{N'_{\delta_a}}{L'_{\delta_a}} Y_v \right]^{-1/2} \quad (9)$$

$$\doteq 1 - \frac{1}{2} \frac{N'_{\delta_a}}{L'_{\delta_a}} \frac{Y_\beta}{g} \doteq 1$$

$$\frac{\zeta_\lambda}{\zeta_\phi} \doteq 1 \quad (10)$$

Further, this dipole will generally be well above the required path control bandwidth frequency so that in the pilot's outer (path) loop cross-over frequency region,

$$\frac{\lambda}{\phi} \doteq \frac{g/U_0}{s} \quad (11)$$

Thus, if the pilot can achieve good inner loop roll control, the aircraft path response to the pilot's (internal) roll commands will have a nearly ideal "K/s-like" characteristic in the crossover region. Thus, the primary manual control concern is for roll control, which is reflected in the emphasis of conventional flying qualities specifications such as the MIL-Spec.

The conventional bank angle response to roll control inputs is given by

$$\frac{\phi}{\delta_a} = \frac{A_\phi[\zeta_\phi, \omega_\phi]}{\left(\frac{1}{T_s}\right) \left(\frac{1}{T_R}\right) [\zeta_d, \omega_d]} \quad (12)$$

For an "ideal" aircraft, the ω_ϕ/ω_d dipole should cancel exactly, and the spiral root $1/T_s$ should be at the origin. This would eliminate the dutch roll residue in roll response to commands, and produce the simple "1 DOF" roll response of Eq. 13.

$$\frac{\phi}{\delta_a} \dot{=} \frac{L'_{\delta_a}}{(0) \left[1/T_R \right]} \quad (13)$$

At this level there is, aside from control power issues, only one flying qualities parameter -- the roll subsidence mode time constant T_R . Over the years considerable flight and simulator studies have established upper limits on the roll mode response time T_R to achieve acceptable transient roll response (Ref. 28). Figure 6 summarizes some of the data which has been used to establish upper limits on T_R . Criteria from the current MIL-Spec are shown in Fig. 7.

Conventional aircraft do, of course, frequently have dutch roll problems. Three different but related approaches have been used for dutch roll criteria.

- Direct specifications of minimums on dutch roll damping and frequency as in Fig. 7b.
- Constraints on the dutch roll residues in several vehicle response variables, e.g., the " p_{osc}/p_{av} " and " $\Delta\beta/\kappa$ " requirements of the MIL-Spec. The first of these requirements also attempts to promote $\omega_\phi/\omega_d < 1$ to avoid a reduction in dutch roll damping as the roll loop is closed by the pilot (see Appendix C). These specifications apply to rudder fixed dynamics.
- Specification of the rudder control by the pilot required for coordination (Ref. 4).

These dutch roll requirements include both frequency domain and time domain specification forms. For aircraft such as the Space Shuttle, time domain criteria similar to those of Fig. 3, have also been developed for roll control.

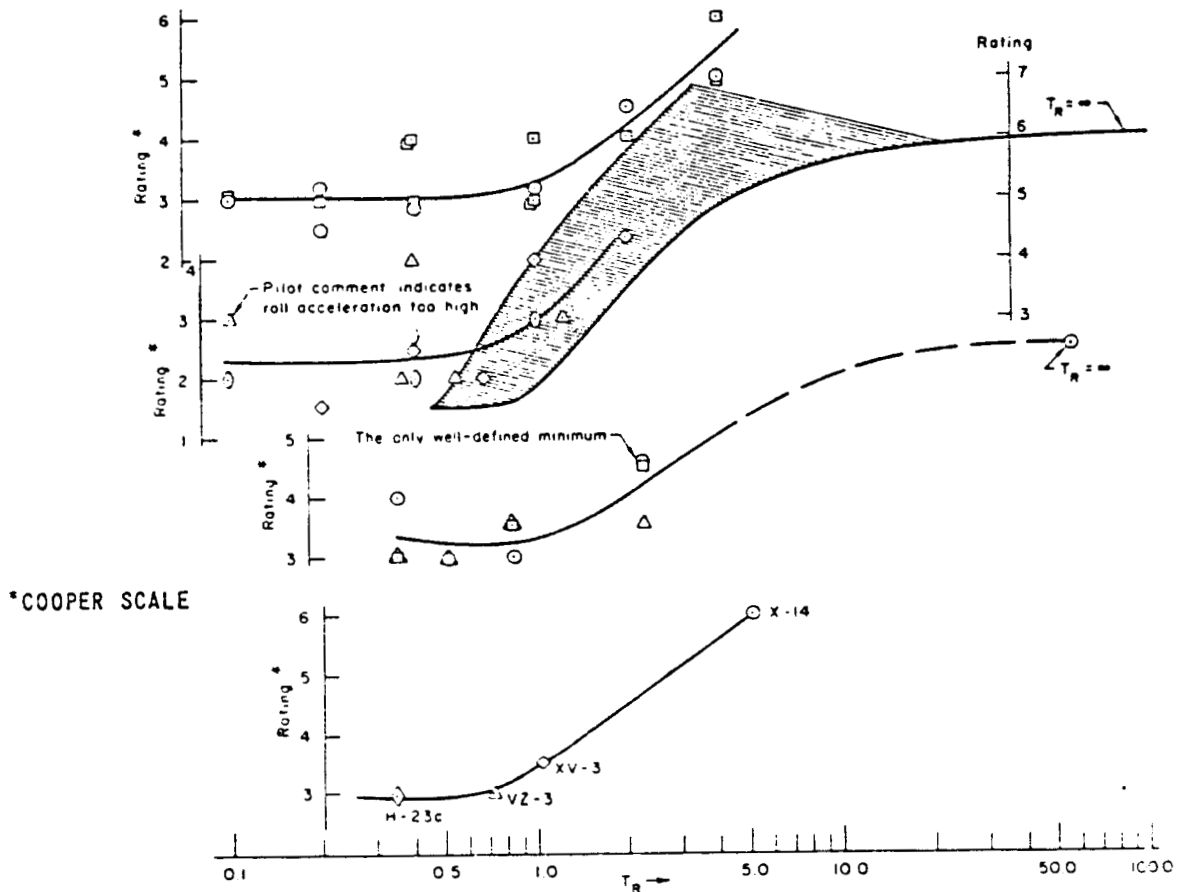

Figure 6. Ratings vs. Roll Damping -- Flight Test, Moving-Base, Fixed-Base with Random Input

b. Highly Augmented and Unconventional Aircraft

Specifications for augmented aircraft have been treated using lower order equivalent system models comparable to those for longitudinal specifications. The lower order equivalent roll response model proposed in Ref. 4, Vol. II, is the transfer function of Eq. 12 with an effective time delay element. High gain command augmentation systems (CAS) are one class of lateral directional FCS which have had flying qualities problems. CAS systems are designed to improve roll control transient response by effectively reducing the roll mode time constant T_R ; however, for unconventionally low values of T_R a PIO phenomenon referred to as "roll ratcheting" has been observed. Data from the LATHOS experiment (Ref. 29) and experience with roll rate command augmentation systems,

ORIGINAL PAGE IS
OF POOR QUALITY

a) RECOMMENDED MAXIMUM ROLL-MODE TIME CONSTANT (Seconds)

FLIGHT PHASE CATEGORY	CLASS	LEVEL		
		1	2	3
A	I, IV II, III	1.0	1.4	
		1.4	3.0	
B	All	1.4	3.0	10
C	I, II-C, IV II-L, III	1.0	1.4	
		1.4	3.0	

b) RECOMMENDED MINIMUM DUTCH ROLL FREQUENCY AND DAMPING

LEVEL	FLIGHT PHASE CATEGORY	CLASS	Min ζ_d^*	Min $\zeta_d \omega_d^*$ (rad/sec)	Min ω_d (rad/sec)
1	A (CO and GA)	IV	0.4	0.4	1.0
	A	I, IV II, III	0.19	0.35	1.0
			0.19	0.35	0.4
	B	All	0.08	0.15	0.4
	C	I, II-C, IV II-L, III	0.08	0.15	1.0
0.08			0.10	0.4	
2	All	All	0.02	0.05	0.4
3	All	All	0	—	0.4

c) SPIRAL STABILITY — RECOMMENDED MINIMUM TIME TO DOUBLE AMPLITUDE

FLIGHT PHASE CATEGORY	LEVEL 1	LEVEL 2	LEVEL 3
A and C	12 sec	8 sec	4 sec
B	20 sec	8 sec	4 sec

*The governing damping requirement is that yielding the larger value of ζ_d , except that a ζ_d of 0.7 is the maximum required for Class III.

Figure 7. Summary of Lateral/Directional Mode Requirements from the MIL-Spec (Reference 9)

indicates that roll control problems can occur for particularly low roll mode time constants (e.g., less than a third of a second). In general these problems appear to be related to lateral stick shaping and sensitivity as affected by the pilot's neuromuscular mode (see Refs. 30, 31). The available evidence indicates that the pilot's limb neuromuscular system has a resonant peak, which can be "tuned to (an undesirable) maximum" by adjusting the effective $T_r + \tau$ to about 0.1 sec.

Incorporation of relaxed directional static stability has not become a significant design trend as evidenced by the number of fighter aircraft with twin vertical tails. There are, however, potential performance benefits from directional RSS for both fixed wing aircraft and helicopters. Unfortunately, there are some accompanying significant difficulties for lateral FCS design. A dominant phenomenon (Ref. 32) is the deterioration of $N_{\delta_a}^{\phi}$ into two real zeros (one potentially in the rhp) as directional stability is reduced. A similar phenomenon can occur at high angle-of-attack.

c. Lateral Direct Force Control Aircraft

With the addition of a third independent lateral-directional control effector, direct force control can be achieved. Lateral DFC modes were implemented on the CCV and AFTI F-16, including decoupled modes analogous to those discussed earlier for the longitudinal case (see Table 3). The manual control and control power issues for these decoupled modes are generally similar to the longitudinal case, but a pilot-centered issue specific to the a_y or "wings level turn" mode should be noted in contrast to a conventional bank-to-turn aircraft. While sideslip is ideally zero for a wings level turn, the side acceleration is not. The turn is not coordinated in that the centrifugal force acting on the pilot is not balanced by a gravity component as in a conventional banked turn. Thus, for combat maneuvering with direct side force control, there is a direct impact on pilot support and cockpit controller design.

TABLE 3. LIMITING RESPONSES FOR DFC RESPONSE
MODES LATERAL DIRECTIONAL

MODE	CONSTRAINTS	LIMITING FORMS OF RESPONSES
Direct Side Force, or Wings Level Turn (A_y)	$\beta \rightarrow \delta_R, \phi \rightarrow \delta_A$	$\frac{a_y}{\delta_{SF}} \rightarrow \frac{N_{\delta_{SF}}^{\beta} \phi}{N_{\delta_R}^{\beta} \phi} = Y_{\delta_{SF}}$
Yaw Pointing (β_1)	$a_y \rightarrow \delta_{SF}, \phi \rightarrow \delta_A$	$\frac{\psi}{\delta_R} \rightarrow \frac{N_{\delta_{SF}}^{\psi} \phi}{N_{\delta_{SF}}^{\psi} \phi} = \frac{N_{\delta_R}'}{[s^2 - N_T' s + N_B']}$
Lateral Translation (β_2)	$\psi \rightarrow \delta_R, \phi \rightarrow \delta_A$	$\frac{\beta}{\delta_{SF}} \rightarrow \frac{N_{\delta_{SF}}^{\psi} \phi}{N_{\delta_R}^{\psi} \phi} = \frac{Y_{\delta_{SF}}^*}{(s - Y_T)}$

*Primes denote effective derivatives that account for cross products of inertia (see Ref. 27, page 257).

3. Trim, Speed Control, and Unattended Operation

Trim, speed control, and unattended operation depend on the long-term dynamics of aircraft and static stability considerations. For example, among the most fundamental provisions of the FAR for stability and control of Part 25 aircraft are those called out in Sections 25.171

(General) and 25.173 (Static Longitudinal Stability). These in essence require that

"The airplane must be longitudinally...stable..."

"A pull must be required to obtain and maintain speeds below the specified trim speed, and a push must be required to obtain and maintain speeds above the specified trim speed."

"The airspeed must return to within 10 percent of the original trim speed for the climb, approach, and landing conditions...and to within 7.5 percent of the original trim speed for the cruising condition...when the control force is slowly released from any speed within the range specified..."

"The average gradient of the stable slope of the stick force vs. speed curve may not be less than 1 lb for each 6 kts."

A strict constructionist reading of the FARs would be that no aperiodic divergences are permitted, and that stick force per mile per hour must have a stable gradient. For a conventional aircraft (with fully powered surface actuators so that stick free and stick fixed characteristics are the same) these statements are consistent (Ref. 21).

Rate command/attitude hold and superaugmented aircraft with the command filter G_1 essentially a pure gain, (e.g., the basic shuttle mechanization) have a longitudinal stick force speed gradient which is zero. However, such aircraft can be completely stable, i.e., all of the characteristic modes are well into the left half complex plane. The cause of the neutral stick force speed gradient is an effective integrator in the command path between the pilot's stick and the elevator command. What this means to the pilot is that he may change the trim by pulsing, and then releasing the stick to pitch the airplane to a new attitude. This is different than for conventional aircraft with parallel trim systems in which the steady-state stick position will change with the trim condition. Given this characteristic of rate command/attitude hold systems, the requirements for stick force speed gradient need to be reconsidered. The FAA is examining this issue (Ref. 21) and MIL-F-8785C states:

"this requirement for longitudinal static stability will be considered satisfied if stability with respect to speed is provided through the flight control system, even though the resulting pitch control force and deflection gradients may be zero"

However, aircraft with neutral stick force speed gradients and their flying qualities continue to be a subject of controversy, particularly in the landing task. As already described, pilot experience and training is at least a part of the issue. Pilots with conventional aircraft background on first experience with rate command/attitude hold aircraft often comment that it feels unnatural to release back pressure on the stick in the landing flare and floating tendencies are a common complaint. There is evidence, however, (Refs. 16, 33) that with experience pilots can come to at least accept neutral stick force gradients.

A recent study of superaugmented aircraft using the TIFS aircraft (Ref. 26), has shown that command prefilters, G_1 , implemented as washouts can significantly improve pilot opinion in landing. If the washout time constant is properly selected, the effective aircraft characteristics will be attitude command/attitude hold, which may be closer than rate command/attitude hold to the characteristics of normal aircraft in landing approach near the "nose" of the trim γ -V curve (Ref. 12).

For superaugmented aircraft based on highly unstable airframes, (e.g., the X-29 with a 35 percent unstable static margin) the interplay of control power, flexible modes, and internal system noise and atmospheric turbulence noted previously can reduce low frequency gain margins, and degrade the stabilization of the basic unstable real airframe root. If the low frequency gain margin becomes critical, there is a possible tradeoff between increasing the effective control limits (reducing the effective nonlinear reduction in q loop gain), and allowing a mildly unstable divergence with a lower bound set on time to double amplitude. This immediately requires grappling with the flying qualities issues for mildly unstable aircraft. Conventional aircraft can be successful with instabilities (e.g., an unstable spiral is permitted by the MIL-Spec requirements of Fig. 8), but there is evidence of unfavorable pilot workload associated with even low stable values of

static margin in conventional aircraft. However, to properly consider this issue it must be remembered that the flying qualities of RSS aircraft with an advanced (e.g., superaugmented) FCS may be fundamentally different than for conventional aircraft (Refs. 12 and 21).

B. CONDITIONS FOR ACCEPTABLE (OR MINIMUM) PILOT EQUALIZATION

There are several approaches which explicitly emphasize the closed-loop piloting features of piloted control. These begin with the notion that the dynamics of the pilot and the effective vehicle should combine to provide good overall system characteristics with minimum pilot workload and compensation. The Neal-Smith approach (Ref. 34) places constraints on allowable pilot dynamics, low frequency closed-loop droop, bandwidth, etc., which are permissible. The criterion works very well on small (fighter) aircraft pitch control for which the data were obtained, and is always a useful check of a particular control system design.

The second criterion based directly on closed-loop pilot-vehicle considerations is based on the so-called crossover model of manual control. An enormous data base, which includes fixed and moving-base simulation, full-scale flight, and other full-scale vehicular control (ranging from automobiles to supertankers) has resulted in the "crossover model" law of manual control (e.g., Ref. 31). This states quite simply that in the frequency region of pilot-vehicle crossover, the product of the open-loop pilot describing function, Y_p , and the controlled element transfer function, Y_c , will have the approximate form,

$$Y_p Y_c(j\omega) \doteq \frac{\omega_c e^{-j\omega\tau}}{\omega}, \quad \omega \doteq \omega_c \quad (14)$$

Minimum pilot effort in active closed-loop control is associated with little or no lead generation (pilot anticipation) to compensate for the dynamic deficiencies of the controlled element. For example, for pitch

attitude control tasks, the crossover law implies that the controlled element dynamics in the region of crossover should be approximated by,

$$|\theta/\delta_p(j\omega)| \dot{=} K/\omega \quad \text{i.e., rate ordering, for } \omega_{b1} < \omega < \omega_{b2} \quad (15)$$

Meeting this condition means that the pilot can adopt a pure gain proportional control action (with of course the inevitable human delays due to perception, central computing, and neuromuscular system lags also present for closed-loop control). The upper limit on the crossover "region," ω_{b2} , is flexible to insure that no gain margin difficulties with higher frequency modes will appear. The lower frequency value, ω_{b1} , is not necessarily zero frequency -- it is only intended to require that $|Y_p Y_c| \gg 1$ at low frequencies. While the pilot will compensate with lead equalization for first-order lags down to about 1/8 sec to make the crossover law hold (Ref. 30), small controlled element time lags beyond the crossover do not necessarily detract from the low workload requirement. For instance, a first-order lag of 1/2 sec or less (calling for a compensating pilot lead of 1/2 sec) causes only a minor pilot rating degradation (Ref. 31).

The pilot's actions in control are not confined to a proportional input/output characteristic; in addition his output contains a broad band random noise -- called pilot generated noise or remnant. The remnant is particularly important as a source of excitation of highly resonant modes in the vehicle dynamics. Remnant is increased markedly when the pilot must generate lead (Ref. 29). Consequently, the requirement of Eq. 15 is consistent with minimizing the pilot equalization dependent remnant.

It is extremely important to emphasize that the controlled element, Y_c , which is made to approximate K_c/s crossover is very task dependent. In the flare, for example, the effective Y_c of interest can be h/δ_p .

C. CONDITIONS ANTITHETICAL TO PILOT-INDUCED OSCILLATIONS

A special set of effective vehicle requirements must be considered to minimize the possibility of pilot-induced oscillations. As detailed in Ref. 35, there are a large number of proximate causes for PIOs. The most common by far is the pilot's temporary use of too-high gains in the attitude or path control loops in highly stressed, untrained, or unfamiliar circumstances. The "solution" to these PIOs is practice and experience with the specific vehicle in the special high stress circumstances. The possibility of PIO can be alleviated, of course, by providing the desirable types of effective vehicle dynamics already discussed -- but high gain PIOs of the type noted above will still occur for some pilots sometimes (currency and practice remain the answer in these circumstances).

The insidious PIOs of major concern are of two kinds and have two causes: "synchronous" precognitive behavior and "PIO syndrome." Synchronous behavior is the capacity of the pilot to lock on to "displayed" periodic signals. "Displayed" can in principle mean either through motion or visual cueing. When a simple periodic signal such as a sinusoidal or square wave is presented to the pilot to follow, he is capable of developing (Ref. 31) an essentially pure gain open-loop block, which reproduces an input signal at his manipulator output without appreciable lag. This "precognitive behavior" characteristic, when excited by an aircraft motion output perceived either visually or proprioceptively, can create a short time quasi closed-loop transmission of the oscillation. It has the peculiar effect of raising the PIO frequency range well beyond the pilot's usual control bandwidth. In circumstances which are especially favorable to the development of such PIOs, the frequency range can be as high as 3 Hz. The circumstances which are "favorable" to induce this decidedly unfavorable effect would include a nearly pure oscillation uncontaminated by other more random appearing motions.

The PIO syndrome is present when the effective form of θ/δ_p in the pilot-vehicle crossover region is given approximately by

$$\frac{\theta}{\delta_p} \approx \frac{Ke^{-\tau s}}{[\zeta, \omega_n]} \quad (16)$$

This can occur, for instance, when $1/T_{\theta_2} \ll \omega_{sp}$. When in active control, the pilot will adjust his characteristics as defined by the crossover model (Eq. 14). For the controlled element form of Eq. 16, this requires the pilot to generate a low frequency lag. This is often described by pilots as a "smoothing low frequency trimming like control action." It is an easy to accomplish low workload pilot behavioral pattern in which the pilot often requires only intermittent control action. There is seldom any control difficulty as long as the pilot's low frequency lag adaptation is maintained. The trouble arises when an upset or other stressful factor such as a system failure occurs. Then in an attempt to regain control of the situation, the pilot may regress to a pure gain type of proportional control. Under these conditions the pilot effective vehicle (with the suddenly changed pilot equalization) may temporarily possess too small a gain margin at the high frequency mode defined by ω_n (which will typically be the short period, but could conceivably be a flexible mode).

The solution to the PIO syndrome is to augment the damping of the $[\zeta, \omega_n]$ mode so that $\zeta > 0.4$ or so. This helps to assure adequate gain margin under any highly stressed conditions where the pilot may regress to a pure gain controller.

D. MINIMIZATION OF REMNANT EXCITATION OF FLEXIBLE MODES

The pilot-induced noise can be an important excitation source for the lower frequency flexible modes since there can be significant

remnant power to about 2 Hz. The effects of remnant excitation are minimized in four ways:

- reduce requirements for any pilot lead generation (by establishing $|Y_C| \dot{=} K/\omega$ in the crossover region), thereby reducing the pilot equalization dependent remnant source;
- provide appropriate manipulator (e.g., control column, side stick) force/displacement characteristics;
- provide appropriate filtering in the pilot Command Input Elements block;
- increase the damping of flexible modes which reside within the remnant bandwidth.

These procedures are very much dependent on specific detailed characteristics of the vehicle's primary control system. Reference 34 provides exemplary guidance as to the profound effects that can occur under worst case circumstances.

E. MINIMIZATION OF PILOT EFFECTIVE AIRCRAFT SYSTEM CLOSED-LOOP EXCITATION OF FLEXIBLE MODES

In the high frequency region of piloted control, θ/δ_p , can be approximated by

$$\frac{\theta}{\delta_p} \dot{=} \frac{K \prod_i [\zeta_N, \omega_N]_i}{s \prod_j [\zeta_D, \omega_D]_j} e^{-\tau_{eff}s}, \quad \omega > \omega_{b1} \quad (17)$$

As a particular example of the phenomena described in Appendix C, pilot control action can drive the closed-loop pilot-vehicle system roots starting at the ω_D 's toward the ω_N 's. In the best of circumstances, the frequency region over which the pilot can exert effective closed-loop control is less than 1 Hz, so the flexible modes which may be involved with this type of control difficulty will be very low indeed. For any flexible modes in or near the region where pilot control action may have an interactive effect, the relative pole zero orders should be properly

adjusted. This closed-loop control condition is different in kind from the vibration feedthrough situation described below.

F. REDUCTION OF VIBRATION FEEDTHROUGH

Another component of pilot control action is direct feedthrough of lightly damped oscillatory motions within the frequency range. This is illustrated for a stiff stick manipulator in Fig. 8. As can be appreciated from these data and Refs. 37 and 38, the amount of the feedthrough can be substantial to frequencies as high as 10 Hz. The phasing and amplification of this "biodynamic feedthrough" may be adverse so that it tends to destabilize flexible modes, which have undamped natural frequencies in this range.

Figure 8 also shows that pilot response to a vibratory environment can excite the resonant modes in the frequency region up to nearly 10 Hz simply because the remnant may be increased by the flexible modes impinging on the pilot.

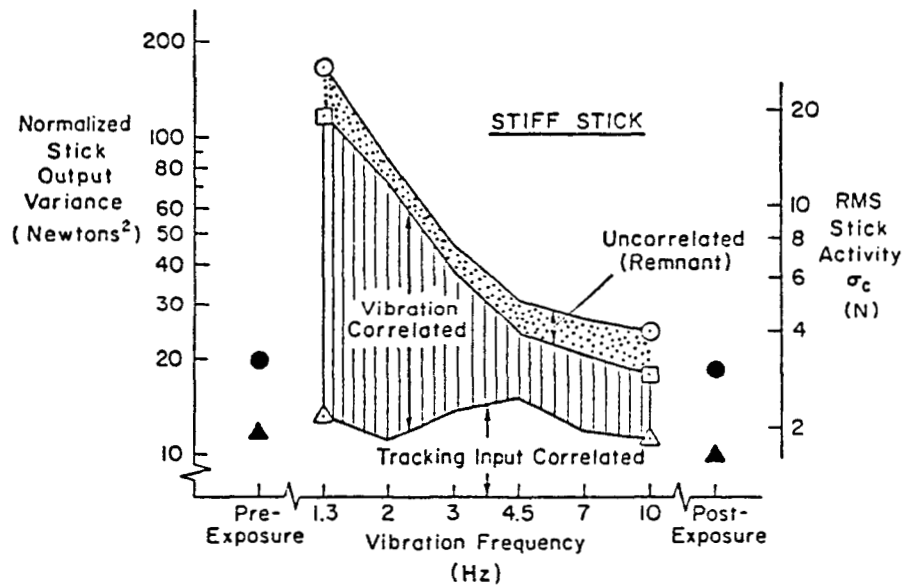

Figure 8. Stick Output Variance Components for Vibratory Forcing (Reference 36)

The primary means to minimize vibration feedthrough and excessive remnant include:

- use of proper force/displacement loading on the manipulator (stiff sticks/columns are a no-no; finite breakout forces are needed, etc);
- reduce the vibration environment at the pilot station by seat design, arm support, etc.;
- increase the flexible mode damping and/or reduce the modal response for all modes, which have significant amplitudes at the pilot station in the 0-10 Hz range;
- consider the residual excitation (after all the above steps have been taken to the extent possible) in the design of the command input elements filters;

Just as with the remnant excitation of the flexible modes, the design requirements are vehicle specific -- in this case specific to the flexible modes at the pilot station.

REFERENCES

1. Federal Aviation Regulations, Part 25, Airworthiness Standards: Transport Category Airplanes, Department of Transportation, Federal Aviation Administration, June 1974.
2. Chalk, C. R., T. P. Neal, and T. M. Harris, et al., Background Information and User Guide for MIL-F-8785B(ASG), "Military Specification - Flying Qualities of Piloted Airplanes", AFFDL-TR-69-72, Aug. 1969.
3. Moorhouse, David J., and Robert J. Woodcock, Background Information and User Guide for MIL-F-8785C, Military Specification -- Flying Qualities of Piloted Airplanes, AFWAL-TR-81-3109, July 1982.
4. Hoh, Roger H., David G. Mitchell, Irving L. Ashkenas, et al., Proposed MIL Standard and Handbook -- Flying Qualities of Air Vehicles. Volume I: Proposed MIL Standard. Volume II: Proposed MIL Handbook, AFWAL-TR-82-3081(I & II), Nov. 1982.
5. Weingarten, Norman C., and Charles R. Chalk, In-Flight Investigation of Large Airplane Flying Qualities for Approach and Landing, AFWAL-TR-81-3118, Sept. 1981.
6. Myers, T. T., D. E. Johnston, and D. T. McRuer, Space Shuttle Flying Qualities and Flight Control System Assessment Study, Phase II, NASA CR-170406, Dec. 1983.
7. Bihrlé, William, Jr., A Handling Qualities Theory for Precise Flight Path Control, AFFDL-TR-65-198, June 1966.
8. Ashkenas, I. L., "Summary and Interpretation of Recent Longitudinal Flying Qualities Results," J. Aircraft, Vol. 8, No. 5, May 1971, pp. 324-328.
9. "Military Specification -- Flying Qualities of Piloted Airplanes," MIL-F-8785C, Nov. 1980.
10. Feather, J. B., "Advanced Supersonic Transport Fixed-Base Simulator Evaluations at Landing Approach," Supersonic Cruise Research '79, Part 1, NASA CP-2108, 1980, pp. 269-284.
11. Chalk, C. R., Calspan Recommendations for SCR Flying Qualities Design Criteria, Calspan Rept. 6241-F-5, 1980.
12. Myers, T. T., D. T. McRuer, and D. E. Johnston, Flying Qualities and Control System Alternatives for Superaugmented Aircraft, NASA CR-170419, Dec. 1984.

13. Hess, Ronald A., "The Effects of Time Delays on Systems Subject to Manual Control," AIAA Paper No. 82-1523, presented at the AIAA Guidance & Control Conference Proceedings, San Diego, CA, 9-11 Aug. 1982, pp. 165-172.
14. Hoh, R. H., D. G. Mitchell, and J. Hodgkinson, Bandwidth -- A Criterion for Highly Augmented Airplanes, AGARD CP-333, 19-22 Apr. 1982.
15. Myers, T. T., D. E. Johnston, and D. McRuer, Space Shuttle Flying Qualities and Flight Control System Assessment Study, NASA CR-170391, June 1982.
16. Mooij, H. A., W. P. DeBoer, and M. F. C. van Gool, Determination of Low-Speed Longitudinal Maneuvering Criteria for Transport Aircraft with Advanced Flight Control Systems, NLR TR-79127 U, Dec. 1979.
17. van Gool, M. F. C., Low Speed Handling Qualities of Advanced Transport Aircraft: A Comparison of Ground-Based and In-Flight Simulator Experiments, NLR TR-82041 U, May 1982.
18. Sudderth, R. W., J. G. Bohn, M. A. Caniff, and G. R. Bennett, Development of Longitudinal Handling Qualities Criteria for Large Advanced Supersonic Aircraft, NASA CR-137635, Mar. 1975.
19. Abrams, C., "V/STOL Digital Flight Control System Technology Interfaces," presented at SAE Guidance and Control Comm. Meeting, Oct. 1977.
20. Abrams, C. R., A Performance Index for Response Evaluation of Highly Augmented Military Aircraft. Phase I -- Inner Loop Requirements for Command Inputs, NADC-AM-7103, 12 Oct. 1971.
21. McRuer, Duane, and Thomas T. Myers, Handling Qualities of Aircraft with Relaxed Static Stability and Advanced Flight Control Systems. Vol. II: Ramifications of Flight-Critical Heavily-Augmented Relaxed Static Stability Airplane Characteristics on Flying Qualities, DOT/FAA/CT-82-130-2, Sept. 1982.
22. Myers, T. T., D. E. Johnston, and D. T. McRuer, Space Shuttle Flying Qualities Criteria Assessment, Phase III, NASA CR-170407, Feb. 1984.
23. Weingarten, Norman C., and Charles R. Chalk, Application of Galspan Pitch Rate Control System to the Space Shuttle for Approach and Landing, NASA CR-170402, May 1983.
24. Klinar, W. J., D. W. Gilbert, Clarke T. Hackler, et al., Flying Qualities Requirements for the Orbiter Utilizing Closed-Loop, Fly-by-Wire Control of Vehicle Response Parameters, NASA Manned Spacecraft Ctr. JSC-07151, Dec. 1973.

25. Powers, Bruce G., "Shuttle Low Speed Control System Tests," presented to the Control and Guidance Advisory Subcommittee, 29 Nov. 1983.
26. Berthe, C. J., C. R. Chalk, and S. Sarrafian, Pitch Rate Flight Control Systems in the Flared Landing Task and Design Criteria Development, NASA CR-172491, Oct. 1984.
27. Hoh, Roger H., Thomas T. Myers, Irving L. Ashkenas, et al., Development of Handling Quality Criteria for Aircraft with Independent Control of Six Degrees-of-Freedom, AFWAL-TR-81-3027, Apr. 1981.
28. Ashkenas, I. L., A Study of Conventional Airplane Handling Qualities Requirements. Part I: Roll Handling Qualities. Part II: Lateral-Directional Oscillatory Handling Qualities, AFFDL-TR-65-138, Parts I and II, Nov. 1965.
29. Monagan, Stephen J., Rogers E. Smith, and Randall E. Bailey, Lateral Flying Qualities of Highly Augmented Fighter Aircraft, AFWAL-TR-81-3171, Vols. I and II, Mar. 1982
30. Johnston, D. E., and D. T. McRuer, Investigation of Interactions Between Limb-Manipulator Dynamics and Effective Vehicle Roll Control Characteristics, Systems Technology, Inc., TR-1212-1, June 1985.
31. McRuer, D. T., and E. S. Krendel, Mathematical Models of Human Pilot Behavior, AGARDograph No. 188, Jan. 1974.
32. Ashkenas, Irving L., and Duane T. McRuer, Competing Flight Control Systems for Entry Glider Lateral Control, ASD-TDR-62-699, Feb. 1964.
33. Stapleford, Robert L., Richard H. Klein, and Roger H. Hoh, Handling Qualities Criteria for the Space Shuttle Orbiter During the Terminal Phase of Flight, NASA CR-2017, Apr. 1972.
34. Neal, T. P., and R. E. Smith, "An In-Flight Investigation to Develop Control System Design Criteria for Fighter Airplanes," AFFDL-TR-70-74, June 1970.
35. Ashkenas, I. L., H. R. Jex, and D. T. McRuer, Pilot Induced Oscillations: Their Cause and Analysis, Systems Technology, Inc., TR-239-2, 20 June 1974.
36. Teper, G. L., H. R. Jex, D. T. McRuer, and W. A. Johnson, A Study of Fully-Manual and Augmented-Manual Control Systems for Saturn V Booster Using Analytical Pilot Models, NASA CR-1079, July 1968.

37. Jex, H. R., and R. E. Magdaleno, "Biomechanical Models for Vibration Feedthrough to Hands and Head for a Semisupine Pilot," Aviation, Space and Environ. Med., Vol. 49, No. 1, Jan. 1978, pp. 304-316.
38. Allen, R. W., H. R. Jex, and R. E. Magdaleno, Manual Control Performance and Dynamic Response During Sinusoidal Vibration, AMRL-TR-73-78, Oct. 1973.

APPENDIX A

THE MULTI-VARIABLE ANALYSIS METHOD

This appendix presents a brief overview of the STI multi-variable analysis method developed for the following properties:

- A formulation which clearly displays controlled-element-alone and controller-alone characteristics in conventional and well-understood terms.
- Analytical operations which can be performed using the most efficient analytical and graphical procedures of feedback systems analysis so as to enhance transfer of skill and intuition from the simpler single loop situations.
- Sequences and procedures which are highly responsive to physical insights and intuition so as to lead to "good" systems with a minimum of iteration.
- A presentation of results which is supplementary as well as equivalent to the results obtained using time responses from computer simulations.

The presentation here is intended only to give a working understanding to interpret the applications in Section VI. More complete developments are given in Refs. A-1 to A-3.

A. TRANSFER FUNCTION MATRICES

A generalized block diagram for a multi-variable (multiloop, multi-control-point) closed-loop system is shown in Fig. A-1 along with a summary of the open- and closed-loop transfer function matrices for commands and disturbances. The elements of the open-loop command transfer function matrix N/Δ are the familiar transfer functions obtained through Cramer's rule. For example (with $m = 3$)

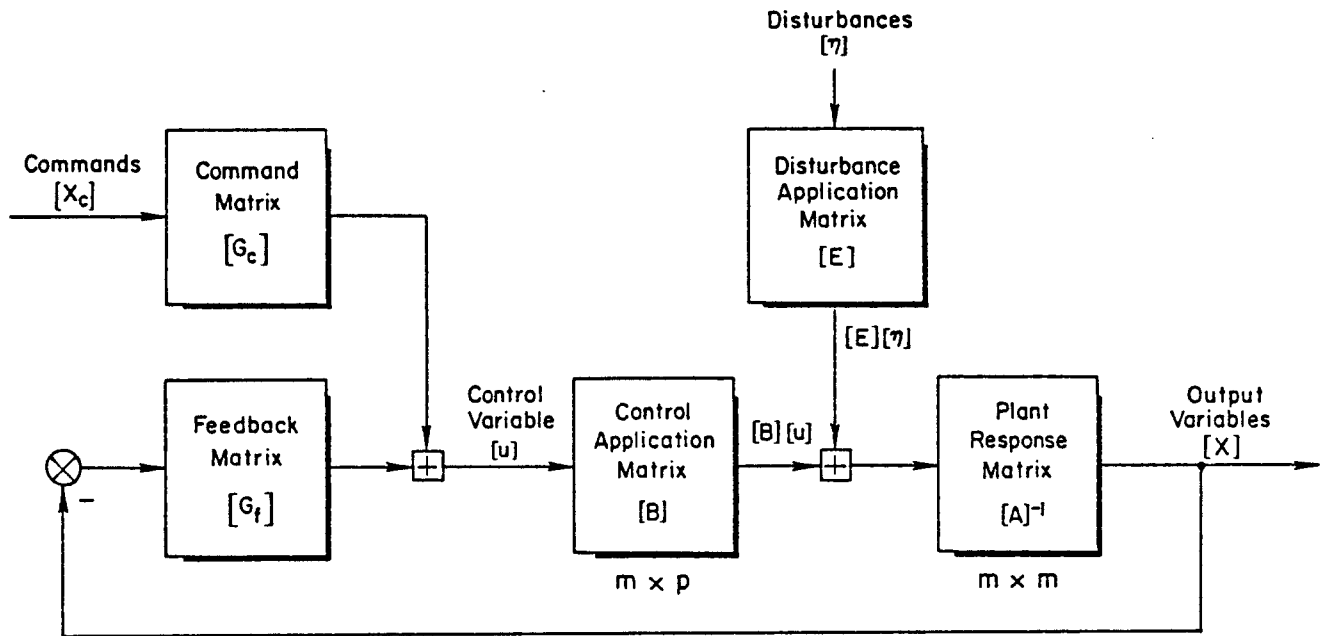

- Linearized Laplace transformed equations of motion for plant: (matrices of polynomials in s)

$$A(s)X(s) = B(s)U(s) + E(s)\eta(s)$$

- Open-loop control input transfer function matrix: (N is matrix of transfer function numerators, Δ is characteristic polynomial)

$$\frac{N}{\Delta} = A^{-1}B = \frac{(\text{adj } A)B}{\det A}$$

- Control law:

$$U = G_c X_c - G_f X$$

- Closed-loop output vector:

$$X = (A + BG_f)^{-1} (BG_c X_c + E\eta)$$

- Closed-loop transfer function matrices for commands:

$$\frac{N' X_c}{\Delta} = (A + BG_f)^{-1} BG_c = \frac{\text{adj } (A + BG_f) BG_c}{\det (A + BG_f)}$$

- Closed-loop transfer function matrices for disturbances:

$$\frac{N'_\eta}{\Delta} = (A + BG_f)^{-1} E = \frac{\text{adj } (A + BG_f) E}{\det (A + BG_f)}$$

Figure A-1. General System Matrix Equations

$$\frac{x_1}{U_1} = \frac{N_{u_1}^{x_1}}{\Delta} = \frac{\begin{vmatrix} b_{11} & a_{12} & a_{13} \\ b_{21} & a_{22} & a_{23} \\ b_{31} & a_{32} & a_{33} \end{vmatrix}}{\begin{vmatrix} a_{11} & a_{12} & a_{13} \\ a_{21} & a_{22} & a_{23} \\ a_{31} & a_{32} & a_{33} \end{vmatrix}} \quad (\text{A-1})$$

where the a_{ij} and b_{ij} 's are functions of s . A similar development can be made for the open-loop disturbance transfer function matrix $\mathbf{A}^{-1}\mathbf{E}$.

B. COUPLING NUMERATORS

A variety of numerical techniques can be used to directly evaluate the open- and closed-loop transfer function matrices for purely computational purposes. The approach to be introduced here is more indirect -- but ultimately leads to a powerful, insightful multi-variable procedure which has some particular numerical advantages as well. This approach is based on literal expansion of the transfer matrices involving generalized transfer function numerators referred to as "coupling numerators" or "numerators of higher kinds."

The familiar transfer function numerator -- a numerator of the first kind -- such as $N_{u_1}^{x_2}$ in Fig. A-2 is constructed according to Cramer's rule by replacing the second column in \mathbf{A} (corresponding to x_2) with the first column of \mathbf{B} (corresponding to u_1) and taking the determinant of the resulting matrix of polynomials in s . The first type of coupling numerator -- a numerator of the second kind -- extends this algorithm by replacing two columns in \mathbf{A} with two columns in \mathbf{B} before taking the determinant. An example is shown in Fig. A-2.

This coupling numerator is denoted by the symbol on the left and defined by the determinant on the right. At the next level, a coupling numerator of the third kind would have three columns in \mathbf{A} replaced by three columns from \mathbf{B} (see Fig. A-2). In a similar way numerators up to the m th kind can be written for systems of arbitrarily large m .

- Plant Equations of Motion

$$\begin{bmatrix} a_{11}(s) & a_{12}(s) & a_{13}(s) \\ a_{21}(s) & a_{22}(s) & a_{23}(s) \\ a_{31}(s) & a_{32}(s) & a_{33}(s) \end{bmatrix} \begin{bmatrix} X_1(s) \\ X_2(s) \\ X_3(s) \end{bmatrix} = \begin{bmatrix} b_{11}(s) & b_{12}(s) \\ b_{21}(s) & b_{22}(s) \\ b_{31}(s) & b_{32}(s) \end{bmatrix} \begin{bmatrix} U_1(s) \\ U_2(s) \end{bmatrix} + \begin{bmatrix} e_{11}(s) & e_{12}(s) \\ e_{21}(s) & e_{22}(s) \\ e_{31}(s) & e_{32}(s) \end{bmatrix} \begin{bmatrix} n_2(s) \\ n_2(s) \end{bmatrix}$$

- Characteristic Polynomial

$$\Delta = \begin{vmatrix} a_{11} & a_{12} & a_{13} \\ a_{21} & a_{22} & a_{23} \\ a_{31} & a_{32} & a_{33} \end{vmatrix}$$

- Representative Numerator (of the first kind)

$$N_{u_1}^{x_2} = \begin{vmatrix} a_{11} & b_{11} & a_{13} \\ a_{21} & b_{21} & a_{23} \\ a_{31} & b_{31} & a_{33} \end{vmatrix}$$

- Representative Coupling Numerator (numerator of the second kind)

$$N_{u_2 u_1}^{x_3 x_1} = \begin{vmatrix} b_{11} & a_{12} & b_{12} \\ b_{21} & a_{22} & b_{22} \\ b_{31} & a_{32} & b_{32} \end{vmatrix}$$

- Representative Coupling-Coupling Numerator (numerator of the third kind)

$$N_{u_2 u_3 u_1}^{x_3 x_2 x_1} = \begin{vmatrix} b_{11} & b_{13} & b_{12} \\ b_{21} & b_{23} & b_{22} \\ b_{31} & b_{33} & b_{32} \end{vmatrix}$$

Figure A-2. Transfer Function Elements ($m = 3$)

Efficient use of the multi-variable method requires knowledge of some basic coupling numerator identities. A basic selection for numerators to the third kind are summarized in Fig. A-3.

C. CLOSED-LOOP CHARACTERISTIC POLYNOMIAL

The procedure for constructing coupling numerators is relatively straightforward, but literal expansion of transfer matrices in terms of them is quite involved so it is best to start with an example. A multi-variable control system that is relatively simple, yet complex enough for our present purposes, is shown in the block diagram of Fig. A-4. It consists of a controlled element and a controller comprising sensing, equalizing, and actuating elements. The plant has three independent degrees-of-freedom. It is subject to control inputs applied at two control points and is also disturbed by two external disturbances. Together the control variables are functions of a command input and feedbacks from two of the three degrees-of-freedom.

The closed-loop characteristic polynomial is

$$\Delta_{\text{sys}} = \det \{A + BG_f\}$$

$$= \begin{vmatrix} a_{11} + b_{12}G_{x_1}^{u_2} & a_{12} + b_{11}G_{x_2}^{u_1} & a_{13} \\ a_{21} + b_{22}G_{x_1}^{u_2} & a_{22} + b_{21}G_{x_2}^{u_1} & a_{23} \\ a_{31} + b_{32}G_{x_1}^{u_2} & a_{32} + b_{31}G_{x_2}^{u_1} & a_{33} \end{vmatrix} \quad (\text{A-2})$$

If the coupling numerator superscripts are the same or subscripts are identical the numerator is identically zero.

$$N_{u_1 u_2}^{x_i x_i} = N_{u_2 u_2}^{x_i x_k} = 0$$

A coupling numerator is not changed by interchange of superscript-subscript pairs. A coupling numerator is not changed by an even number of interchanges of superscripts, subscripts, or both. An odd number of interchanges causes a numerator sign change.

$$N_{u_1 u_2}^{x_i x_k} = -N_{u_2 u_1}^{x_i x_k} = N_{u_2 u_1}^{x_k x_i}$$

$$N_{u_1 u_2}^{x_i x_k} = \frac{1}{\Delta} (N_{u_1}^{x_i} N_{u_2}^{x_k} - N_{u_2}^{x_i} N_{u_1}^{x_k})$$

$$N_{u_1 u_2 u_3}^{x_1 x_2 x_3} = N_{u_3 u_1 u_2}^{x_1 x_2 x_3} = N_{u_2 u_3 u_1}^{x_1 x_2 x_3}$$

A numerator of the third kind is zero if any two of the outputs or any two of the inputs are identical, that is

$$N_{u_k u_\ell u_m}^{x_i x_i x_j} = N_{u_\ell u_\ell u_m}^{x_i x_j x_k} = 0$$

Figure A-3. Some Frequently Used Coupling Numerator Identities

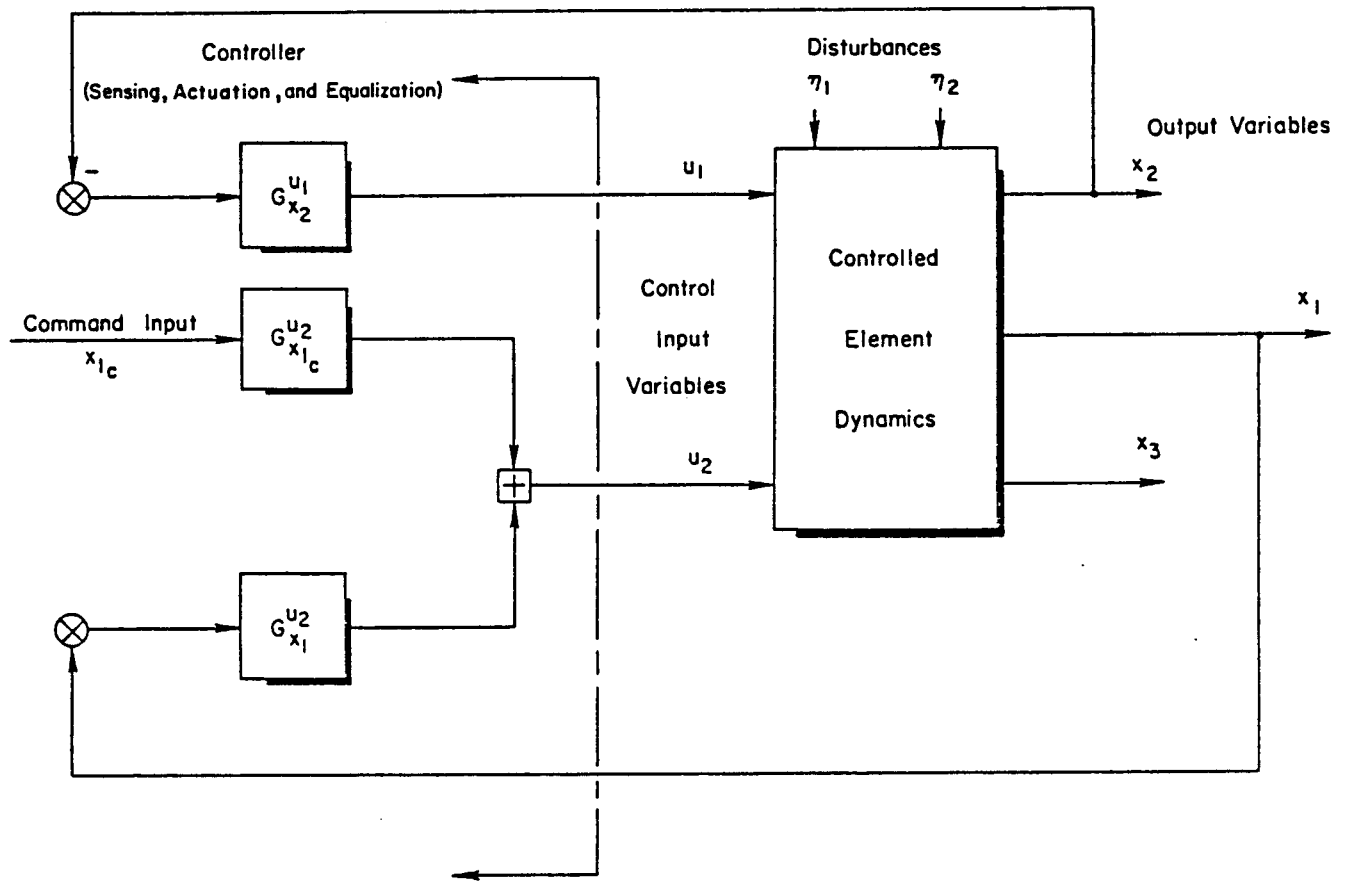

Controlled Element Equations of Motion:

$$\begin{bmatrix} a_{11}(s) & a_{12}(s) & a_{13}(s) \\ a_{21}(s) & a_{22}(s) & a_{23}(s) \\ a_{31}(s) & a_{32}(s) & a_{33}(s) \end{bmatrix} \begin{bmatrix} X_1(s) \\ X_2(s) \\ X_3(s) \end{bmatrix} = \begin{bmatrix} b_{11}(s) & b_{12}(s) \\ b_{21}(s) & b_{22}(s) \\ b_{31}(s) & b_{32}(s) \end{bmatrix} \begin{bmatrix} U_1(s) \\ U_2(s) \end{bmatrix} + \begin{bmatrix} e_{11}(s) & e_{12}(s) \\ e_{21}(s) & e_{22}(s) \\ e_{31}(s) & e_{32}(s) \end{bmatrix} \begin{bmatrix} n_2(s) \\ n_2(s) \end{bmatrix}$$

Figure A-4. Example System ($m = 3$)

Expanding in further, albeit tedious, detail, Δ_{sys} becomes

$$\Delta_{\text{sys}} = \begin{vmatrix} a_{11} & a_{12} & a_{13} \\ a_{21} & a_{22} & a_{23} \\ a_{31} & a_{32} & a_{33} \end{vmatrix} + G_{x_2}^{u_1} \begin{vmatrix} a_{11} & b_{11} & a_{13} \\ a_{21} & b_{21} & a_{23} \\ a_{31} & b_{31} & a_{33} \end{vmatrix} \\ + G_{x_1}^{u_2} \begin{vmatrix} b_{12} & a_{12} & a_{13} \\ b_{22} & a_{22} & a_{23} \\ b_{32} & a_{32} & a_{33} \end{vmatrix} + G_{x_2}^{u_1} G_{x_1}^{u_2} \begin{vmatrix} b_{12} & b_{11} & a_{13} \\ b_{22} & b_{21} & a_{23} \\ b_{32} & b_{31} & a_{33} \end{vmatrix} \\ = \Delta + G_{x_2}^{u_1} N_{u_1}^{x_2} + G_{x_1}^{u_2} N_{u_2}^{x_1} + G_{x_2}^{u_1} G_{x_1}^{u_2} N_{u_1 u_2}^{x_2 x_1} \quad (\text{A-3})$$

The complexity of more general forms is more apparent than real. The numerators of higher kinds are filled primarily with terms from the control application matrix, \mathbf{B} , and these elements are usually constants. Also both \mathbf{B} and the feedback controller matrix \mathbf{G}_f are usually sparse when contrasted with the plant matrix \mathbf{A} . Consequently, numerators become simpler in form as they increase in kind order; and many of the terms in the expansions are zero because the feedback elements are zero.

D. CLOSED-LOOP TRANSFER FUNCTION NUMERATORS

While the system characteristic function, Δ_{sys} , is the denominator for all closed-loop transfer functions, regardless of the command or disturbance input, the numerator of a closed-loop transfer function will depend on the particular command or disturbance. These closed-loop numerators can also be developed in terms of open-loop coupling numerators in manner similar to the Δ_{sys} development (see Ref. A-2). Thus

when the closed-loop numerator and denominator are combined to form a closed-loop transfer function we have for example:

$$\frac{X_1}{X_{1c}} = \frac{G_{x_{1c}}^{u_2} (N_{u_2}^{x_1} + G_{x_2}^{u_1} N_{u_1}^{x_2 x_1})}{\Delta + G_{x_2}^{u_1} N_{u_1}^{x_2} + G_{x_1}^{u_2} N_{u_2}^{x_1} + G_{x_2}^{u_1} G_{x_1}^{u_2} N_{u_1}^{x_2 x_1}} \quad (A-4)$$

The term $(N_{u_2}^{x_1} + G_{x_2}^{u_1} N_{u_1}^{x_2 x_1})$ in Eq. A-4 is referred to as the effective numerator of the controlled element with the $x_2 + u_1$ loop closed.

A similar development would yield the transfer function relating the response x_1 to the disturbance η_1 as

$$\frac{X_1}{\eta_1} = \frac{N_{\eta_1}^{x_1} + G_{x_2}^{u_1} N_{\eta_1}^{x_1 x_2} + [G_{x_1}^{u_2} N_{\eta_1}^{x_1 x_2}]^0}{\Delta + G_{x_2}^{u_1} N_{u_1}^{x_2} + G_{x_1}^{u_2} N_{u_2}^{x_1} + G_{x_2}^{u_1} G_{x_1}^{u_2} N_{u_2}^{x_1 x_2}} \quad (A-5)$$

Here, of course, the disturbance does not go through the block $G_{x_{1c}}^{u_2}$ to get into the doubly closed-loop system. Therefore, the leading numerator term is not multiplied by $G_{x_{1c}}^{u_2}$ in this case. Note also that the term in square brackets is identically zero.

The expansion of Δ and N in the special case above can be generalized for arbitrary m and p . These developments are rather involved and will not be repeated here (see Ref. A-2). However, the general procedure for writing a multi-variable closed-loop transfer function is indicated in Fig. A-5. The expressions of Fig. A-5 may appear to imply an enormous number of terms -- this is not the case for most practical applications since, by the Fig. A-3 identities, many of the terms are zero. However, the secret to the great utility of this approach is that practical applications can be made without the user generating the tedious expansions. However, this does require specialized interactive computer programs for computation of coupling numerators. Appreciation of this facility requires understanding how the technique is applied in practice. This will be illustrated in the next section based on the example used above.

The closed-loop system denominator is equal to:	$A_{sys} =$	$\frac{N_k}{\Delta_{sys}}$	The effective closed-loop numerator (of the controlled element) is equal to:
The controlled element (open-loop plant) denominator:	Δ	N_k	The controlled-element (open-loop plant) numerator:
<u>Plus</u> The sum of all the feedback transfer functions, each multiplied by the appropriate numerator of the first kind.	$+ \sum_j E_j \frac{u_j}{x_1^{n_j}}$	$+ \sum_j E_j \frac{u_j}{x_1^{n_j}}$	<u>Plus</u> The sum of all the feedback transfer functions, each multiplied by the appropriate numerators of the second kind.
<u>Plus</u> The sum of all the feedback transfer functions taken two at a time, each pair multiplied by the appropriate coupling numerator.	$+ \sum_{j_1, j_2} E_{j_1 j_2} \frac{u_{j_1} u_{j_2}}{x_1^{n_{j_1} n_{j_2}}}$	$+ \sum_{j_1, j_2} E_{j_1 j_2} \frac{u_{j_1} u_{j_2}}{x_1^{n_{j_1} n_{j_2}}}$	<u>Plus</u> The sum of all the feedback transfer functions taken two at a time, each combination multiplied by the appropriate numerator of the third kind.
<u>Plus</u> The sum of all the feedback transfer functions taken three at a time, each triplet multiplied by the appropriate numerator of the third kind.	$+ \sum_{j_1, j_2, j_3} E_{j_1 j_2 j_3} \frac{u_{j_1} u_{j_2} u_{j_3}}{x_1^{n_{j_1} n_{j_2} n_{j_3}}}$	$+ \dots$	$+ \dots$
$+ \dots$	$+ \dots$	$+ \dots$	$+ \dots$

NOTES:

- x is any x_i or linear combination of x_i 's
- v is any u_j or n_k
- In general many terms will be zero because:
 - $G_{x_1}^u = 0$
 - (coupling) numerator = 0.

Figure A-5. The General Construction of Transfer Functions in Terms of Coupling Numerators (Shown Explicitly for $m < 3$)

E. APPLICATIONS OF THE METHOD

1. Modification of Closed-Loop Poles and Zeros with Multi-variable Feedback

One of the most fundamental uses of the multi-variable method is in understanding how aircraft numerator zeros with respect to one input are modified by feedback to another control point. This facility lies at the heart of the multi-variable synthesis methodology. To illustrate consider the x_1 response to u_2 with only the $x_2 \rightarrow u_1$ loop closed. This may be written from the rules of Fig. A-5, since we already have it, by setting $G_{x_1}^{u_2}$ to zero in the x_1/x_{1c} expression of Eq. A-4 above.

This modified transfer function is

$$\begin{aligned} \left[\frac{X_1}{U_2} \right]_{x_2 \rightarrow u_1}' &= \left[\frac{N_{u_2}^{x_1}}{\Delta} \right]_{x_2 \rightarrow u_1}' \\ &= \frac{N_{u_2}^{x_1} + G_{x_2}^{u_1} N_{u_1}^{x_2 x_1}}{\Delta + G_{x_2}^{u_1} N_{u_1}^{x_2}} \quad (A-6) \\ &= \frac{\left[\frac{N_{u_2}^{x_1}}{\Delta} \right] \left\{ 1 + G_{x_2}^{u_1} \left[\frac{N_{u_1}^{x_2 x_1}}{N_{u_2}^{x_1}} \right] \right\}}{1 + G_{x_2}^{u_1} \left[\frac{N_{u_1}^{x_2}}{\Delta} \right]} \end{aligned}$$

One (or more) primes are used as in $[X_1/U_2]'$ and $[N_{u_2}^{x_1}/\Delta]'$ above, to indicate that one (or more) loops have been closed.

In the equation above we see that the poles of the effective controlled element have been changed from the roots of Δ to those of $\Delta + G_{x_2}^{u_1} N_{u_1}^{x_2}$. This is the same kind of change due to feedback as is encountered in single loop feedback problems. The difference in this multi-variable system is the change in the zeros of the effective controlled

element numerator from those of $N_{u_2}^{x_1}$ to those of $N_{u_2}^{x_1} + G_{x_2}^{u_1} N_{u_1 u_2}^{x_2 x_1}$. This example shows clearly the previously described plant-zero-modification property unique to multi-variable control.

From the standpoint of synthesis this plant dynamics "modification" made by the first loop closure, $x_2 \rightarrow u_1$, might be contrived so as to compensate or equalize the outer open-loop transfer function, $G_{x_1}^{u_2} [N_{u_2}^{x_1} / \Delta]'$. Of course, the changes in plant poles and zeros accomplished this way are not independent because the controller transfer function $G_{x_2}^{u_1}$ affects both numerator and denominator terms of the effective controlled element transfer function.

2. Limiting Characteristics Approached at High Gain

Over the frequency range where the $x_2 \rightarrow u_1$ feedback action is really dominant, the effective plant transfer function becomes

$$\begin{aligned} \left[\frac{x_1}{u_2} \right]_{x_2 \rightarrow u_1}' &= \left[\frac{N_{u_2}^{x_1}}{\Delta} \right]' \\ &= \frac{N_{u_2}^{x_1} + G_{x_2}^{u_1} N_{u_1 u_2}^{x_2 x_1}}{\Delta + G_{x_2}^{u_1} N_{u_1}^{x_2}} \quad (A-7) \\ &\approx \frac{N_{u_1 u_2}^{x_2 x_1}}{N_{u_1}^{x_2}}, \quad G_{x_2}^{u_1} \frac{N_{u_1}^{x_2}}{\Delta} (j\omega) \gg 1 \text{ and } G_{x_2}^{u_1} \frac{N_{u_1 u_2}^{x_2 x_1}}{N_{u_2}^{x_1}} (j\omega) \gg 1 \end{aligned}$$

Thus, just as the ordinary ("first kind") numerators of a plant are limiting approximations to some of the closed-loop poles in a high-gain single loop feedback system, so the coupling ("second kind") numerators can play the same role for closed-loop zeros in a multi-variable system. Further extensions of this idea are illustrated in Section VI.

3. Implications for FCS Synthesis

The additional design flexibility which comes in multi-variable control from the capability to adjust both the zeros and poles of the effective controlled element has many advantages. Perhaps the most significant is the correction of very undesirable plant numerator right-half-plane zeros. Such non-minimum phase characteristics are sinks which draw some closed-loop left-half-plane pole(s) ever closer as loop gain is increased. The closed-loop instability incurred as the closed-loop poles migrate past the $j\omega$ -axis of imaginaries into the right-half-plane cannot be rectified practically by single loop, or even multiloop single control point techniques. (Attempts to cancel a right-half-plane zero by introducing a right-half-plane pole in a series compensator can be disastrous because of practical system uncertainties and parameter variations.) But the introduction of an appropriate output variable fed to another control point provides coupling numerator zeros toward which the offending plant numerator zeros can be driven by feedback control action.

REFERENCES FOR APPENDIX A

- A-1. McRuer, D. T., I. L. Ashkenas, and H. R. Pass, Analysis of Multi-loop Vehicular Control Systems, ASD-TDR-62-1014, Wright-Patterson Air Force Base, OH, Mar. 1964.
- A-2. McRuer, D., I. Ashkenas, and D. Graham, Aircraft Dynamics and Automatic Control, Princeton University Press, 1973.
- A-3. Hofmann, L. G., G. L. Teper, and R. F. Whitbeck, "Application of Frequency Domain Multi-variable Control Synthesis Techniques to an Illustrative Problem in Jet Engine Control," in Michael K. Sain, Joseph L. Peczkowski, and James L. Melsa, eds., Alternatives for Linear Multi-variable Control, National Engineering Consortium, Inc., Chicago, IL, 1978, pp. 51-70.

APPENDIX B

SENSITIVITY VECTORS

This appendix presents an outline of the sensitivity methods which are an important tool in the "prospectus for control." This development is based on Refs. B-1 and B-2. Sensitivity methods provide a means for consideration of the effects of open-loop system variations on the closed-loop properties. The three measures defined here are called "gain," "(open-loop) pole," and "(open-loop) zero" sensitivities, which relate to changes in the position of closed-loop poles due to shifts or changes in the open-loop gain, poles, and zeros, respectively. In exact terms these sensitivities connect open-loop differential variations with closed-loop differential shifts (Refs. B-2 - B-9). They are especially useful as a means of assessing the effects of system uncertainties and the implications of parameter tolerances on the closed-loop system dynamics. The symbols S_{κ}^i , $S_{z_j}^i$, and $S_{p_j}^i$ denote the gain, pole, and zero sensitivities, respectively. The subscript and superscript notation indicates that a differential increment in the open-loop parameter (defined by the subscript) results in a differential increment of the i th closed-loop root (denoted in the superscript) which is equal to the sensitivity factor times the open-loop parametric variation.

Denoting the i th closed-loop root as λ_i the sensitivities are defined by the relations on the left in Eq. B-1.

$$\begin{aligned}
 \text{Gain: } S_{\kappa}^i &= \frac{\partial \lambda_i}{\partial \kappa / \kappa} = - \frac{\partial G / \partial \kappa}{\partial G / \partial s} \Big|_{s=\lambda_i} \kappa = \frac{1}{\partial G / \partial s} \Big|_{s=\lambda_i} \\
 \text{Zero: } S_{z_j}^i &= \frac{\partial \lambda_i}{\partial z_j} = - \frac{\partial G / \partial z_j}{\partial G / \partial s} \Big|_{s=\lambda_i} \\
 \text{Pole: } S_{p_j}^i &= \frac{\partial \lambda_i}{\partial p_j} = - \frac{\partial G / \partial p_j}{\partial G / \partial s} \Big|_{s=\lambda_i}
 \end{aligned} \tag{B-1}$$

Note that the gain sensitivity is based on a fractional (percentage) change in κ , while the pole and zero sensitivities are based on absolute shifts of p_j and z_j . These definitions were adopted here in order to provide some simplifications in relationships.

Given the open-loop transfer function $G(s)$, the sensitivities may be related to derivatives of $G(s)$ by the expressions on the right in Eq. B-1. These relations are developed in Ref. B-1, pg. 177 and lead to a means of computing the sensitivities through their relation to the modal response ratio Q_i of the i th closed-loop root.

1. Gain Sensitivity

For simple poles the gain sensitivity is the negative of the modal response coefficient as shown in Fig. B-1. The modal response ratio is the partial fraction coefficient (residue) of the i th closed-loop pole for the weighting function (impulse response). Thus the familiar graphical procedure for evaluation of residues could be used to construct S_k^i as illustrated in Fig. B-2. A valuable geometric interpretation of S_k^i as a vector in the complex s -plane can thus be made. Since in $S_k^i = \frac{\partial \lambda_i}{\partial \kappa / \kappa}$, κ is a scalar and the differential change in λ_i is along the root locus, the S_k^i vector is tangent to the locus at λ_i and points in the direction for increasing $|\kappa|$. In modern practice the ideal generation of S_k^i would be by numerical evaluation of the residue with a computer graphic display of the sensitivity vector in the s -plane. However, a computer generated graphical construction like Fig. B-2 could be valuable to the analyst to assess what open-loop poles and zeros dominate the sensitivity.

2. Pole and Zero Sensitivity

Pole and zero sensitivities can also be pictured as vectors in the complex s -plane. As developed in Fig. B-3

$$S_{z_j}^i = \frac{S_k^i}{\lambda_i + z_j}$$

$$S_{p_j}^i = \frac{-S_k^i}{\lambda_i + p_j}$$

Define $Q_i(s)$ as

$$Q_i(s) = \frac{(s + q_i)G(s)}{1 + G(s)}$$

When $s = -q_i$, $Q_i(s)$ becomes simply Q_i , the modal response coefficient for the $(s + q_i)$ mode. Rearranging,

$$[1 + G(s)]Q_i(s) = (s + q_i)G(s)$$

Differentiating with respect to s gives

$$[1 + G(s)] \frac{dQ_i(s)}{ds} + Q_i(s) \frac{dG(s)}{ds} = G(s) + (s + q_i) \frac{dG(s)}{ds}$$

Evaluating at $s = -q_i$, and noting that $G(-q_i) = -1$, gives

$$Q_i \left[\frac{dG(s)}{ds} \right]_{s=-q_i} = -1$$

Therefore, comparing Eq. B-1,

$$Q_i = \left[\frac{-1}{\partial G(s)/\partial s} \right]_{s=-q_i} = -S_k^i$$

Figure B-1. Relation of Gain Sensitivity to Modal Response Coefficient

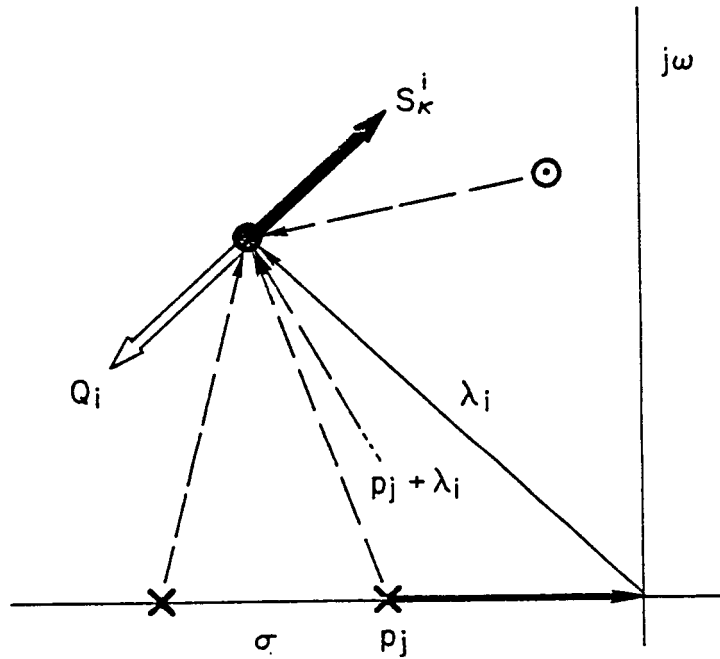

$$s_k^i = \left[\frac{1}{\partial G / \partial s} \right]_{s=\lambda_i} = \left[\begin{matrix} m+n \\ \sum_{j=1} \frac{1}{\lambda_i + p_j} - \sum_{j=1}^n \frac{1}{\lambda_i + z_j} \end{matrix} \right]^{-1} = -Q_i$$

Figure B-2. Graphics Construction of Gain Sensitivity Vector

$$\begin{aligned}
S_{z_j}^i &= - \left[\frac{\partial G / \partial z_j}{\partial G / \partial s} \right]_{s=\lambda_i} = \left[\frac{1}{\partial g / \partial s} \right]_{s=\lambda_i} - \left[\frac{\partial G}{\partial z_j} \right]_{s=\lambda_i} \\
&= s_k^i \left[\frac{-\kappa \prod_{\substack{k=1 \\ k \neq j}}^n (s + z_k)}{m+n \prod_{k=1} (s + p_k)} \right]_{s=\lambda_i} \left[\frac{(s + z_j)}{(s + z_j)} \right]_{s=\lambda_i} \\
&= s_k^i [-G(\lambda_i)] \left(\frac{1}{s + z_j} \right)_{s=\lambda_i} \\
&= \frac{s_k^i}{\lambda_i + z_j}
\end{aligned}$$

Developed similarly, the pole sensitivity will be

$$S_{p_j}^i = - \frac{s_k^i}{\lambda_i + p_j}$$

Figure B-3. Relation of Pole + Zero Sensitivities to Gain Sensitivity

The magnitude of the pole and zero sensitivities thus amount to divisions of the gain sensitivity by a vector sum of the closed-loop pole and the open-loop pole or zero, respectively. A geometric appreciation is gained by considering these as vectors in the s-plane, as in Fig. B-4. Note that the zero sensitivity vector is in a direction tending to pull the locus more toward the zero, whereas the pole sensitivity vector would tend to push the locus away from the pole.

3. Application of Sensitivity Vectors in Control System Synthesis

The geometric interpretation of sensitivity is particularly valuable in initial consideration of the "prospectus" for control of an element such as an aircraft. Since the gain sensitivity vector S_k^i indicates the direction and rapidity with which closed-loop poles move with a gain change, this display on a conventional root locus can be used to quickly assess the potential of a candidate. If the gain along the root locus is allowed to approach zero the S_k^i become vectors indicating the direction and relative rapidity with which the closed-loop roots depart the open-loop poles (which may be the closed-loop poles of a previous closure) for a candidate closure. Figure B-5a shows a hypothetical case. If the loop under consideration is intended to increase $|1/T_2|$ it has good potential since the relative effect on the complex root is small and increases ζ_1 in any case. However, if the intent was to increase ζ_1 with minimal effect on the real pole, this feedback would be a poor choice.

This idea can be extended to produce a quick prospectus survey of the relative merits of feeding back x_1 , x_2 , or x_3 as indicated in Fig. B-5b.

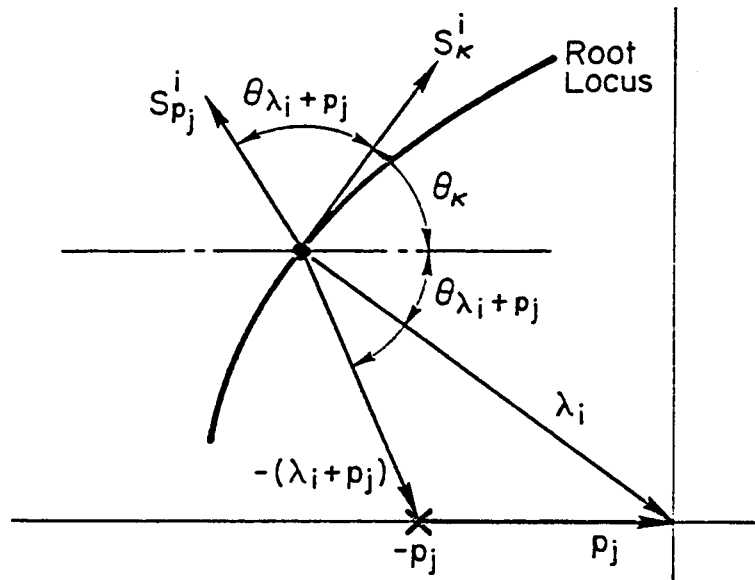

$$S_{p_j}^i = \frac{-S_k^i}{\lambda_i + p_j} = \frac{|S_k^i| \angle \theta_k}{|\lambda_i + p_j| \angle -(\theta_{\lambda_i + p_j})} = \left| \frac{S_k^i}{\lambda_i + p_j} \right| \angle (\theta_k + \theta_{\lambda_i + p_j})$$

a) Pole Sensitivity

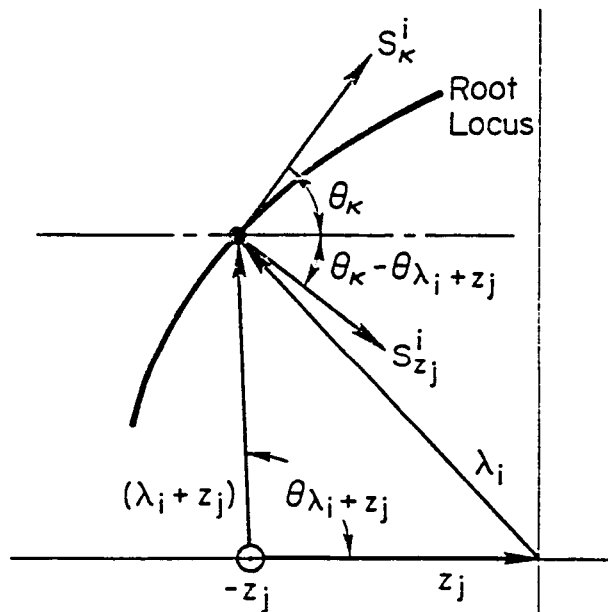

$$S_{z_j}^i = \frac{S_k^i}{\lambda_i + z_j} = \frac{|S_k^i| \angle \theta_k}{|\lambda_i + z_j| \angle \theta_{\lambda_i + z_j}} = \left| \frac{S_k^i}{\lambda_i + z_j} \right| \angle (\theta_k - \theta_{\lambda_i + z_j})$$

b) Zero Sensitivity

Figure B-4. Geometric Illustrations of Pole and Zero Sensitivity Vectors

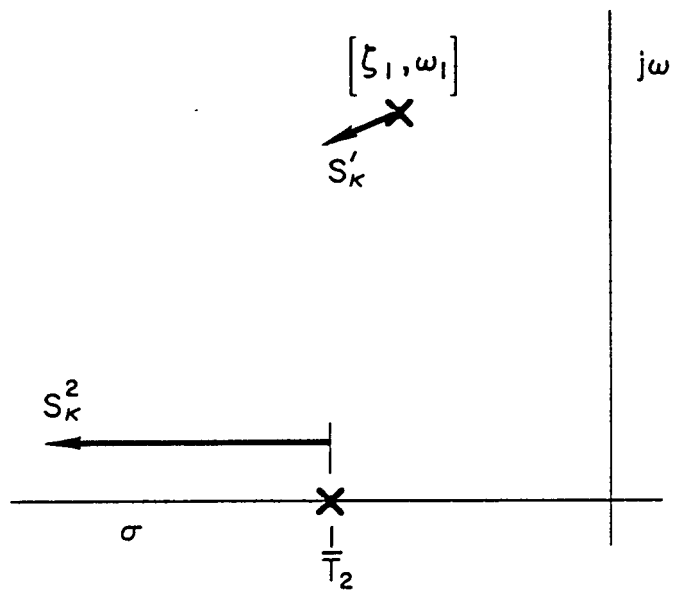

a) Single Loop

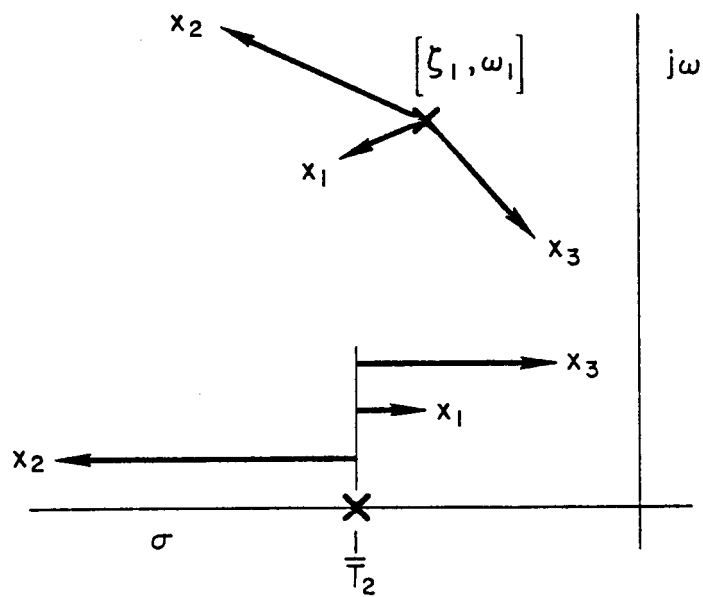

b) Multiloop

Figure B-5. Use of Sensitivity Vectors in Multiloop Control Prospecti

REFERENCES FOR APPENDIX B

- B-1. McRuer, Duane, Irving Ashkenas, and Dunstan Graham, Aircraft Dynamics and Automatic Control, Princeton University Press, Princeton, NJ, 1973.
- B-2. McRuer, D. T., and R. L. Stapleford, Sensitivity and Modal Response for Single Loop and Multiloop Systems, ASD-TDR-62-812, Jan. 1963.
- B-3. Mitchell, K., "Estimation of the Effect of a Parameter Change on the Roots of Stability Equations," Aeronautical Quarterly, Vol. I, May 1949.
- B-4. Gates, Jr., O. B., and C. H. Woodling, A Method for Estimating Variations in the Roots of the Lateral-Stability Quartic Due to Changes in Mass and Aerodynamic Parameters of an Airplane, NACA TN 3134, Jan. 1954.
- B-5. Papoulis, A., "Displacement of the Zeros of the Impedance $Z(p)$ Due to Incremental Variations in the Network Elements," Proceedings of the IRE, Vol. 43, 1955.
- B-6. Huang, R. Y., "The Sensitivity of the Poles of Linear Closed-Loop Systems," Transactions of the AIEE, Pt. II, Vol. 77, 1958, pp. 182-186.
- B-7. Kuo, F. F., Pole-Zero Sensitivity in Network Functions, University of Illinois, Ph.D. Dissertation, 1958.
- B-8. Ur, H., "Root Locus Properties and Sensitivity Relations in Control Systems," Transactions of the IRE, Vol. AC-5, No. 1, Jan. 1960.
- B-9. Horowitz, I. M., Synthesis of Feedback Systems, New York, Academic Press, 1963.

APPENDIX C

ELEMENTAL SYSTEMS

Lower order analytical models of high order augmented aircraft can be of great value in maintaining insight and defining the key parameters in a complex design problem. The two keys to this capability in FCS design is a frequency domain view with a focus on the Bode amplitude asymptotes and an awareness of the first-order effects of feedback.

This appendix presents five elemental system models which arise naturally in FCS design consideration. As transfer function elements these are:

- First-order lag in series with an integrator

$$G(s) = \frac{1}{s(Ts + 1)}$$

- A second-order factor

$$G(s) = \left[\left(\frac{s}{\omega_n} \right)^2 + \frac{2\zeta}{\omega_n} s + 1 \right]^{-1}$$

- The crossover model

$$G(s) = \frac{\omega_c e^{-\tau s}}{s}$$

- The supraaugmented model (open-loop)

$$G(s) = \frac{K(s + 1/T)e^{-\tau s}}{s^2}$$

- A second-order dipole in series with an integrator

$$G(s) = \frac{K \left[\zeta_N, \omega_N \right]}{s \left[\zeta_D, \omega_D \right]}$$

While modern FCS often have a large number of poles and zeros, they are distributed in special ways characteristic of aircraft problems. Specific regions of the frequency response will usually be dominated by a few (often one or two) physically understood poles and zeros whose effects can be "captured" on the Bode amplitude asymptotes. In consideration of the effects of a feedback loop, the lower order model need only be a good approximation in the crossover ($|G(j\omega)| \doteq 1$) region(s) (Ref. C-1, Chapter 9) since:

$$\left| \frac{G(j\omega)}{1 + G(j\omega)} \right| \doteq 1 \text{ for } |G(j\omega)| \gg 1$$

$$\left| \frac{G(j\omega)}{1 + G(j\omega)} \right| \doteq |G(j\omega)| \text{ for } |G(j\omega)| \ll 1$$

and $|G(j\omega)| = O(1)$ for the crossover region.

The art of controlling aircraft and other vehicles is then built around their basic mechanics, which gives them low pass filter characteristics, and the FCS designer's ability to create integrator-like characteristics in the crossover region for the basic (manual or automatic) loops.

1. First-Order Lag in Series with an Integrator

$$G(s) = \frac{1}{s(Ts + 1)}$$

A typical occurrence of this element is as the simplest (1 DOF) representation of bank angle response to roll control.

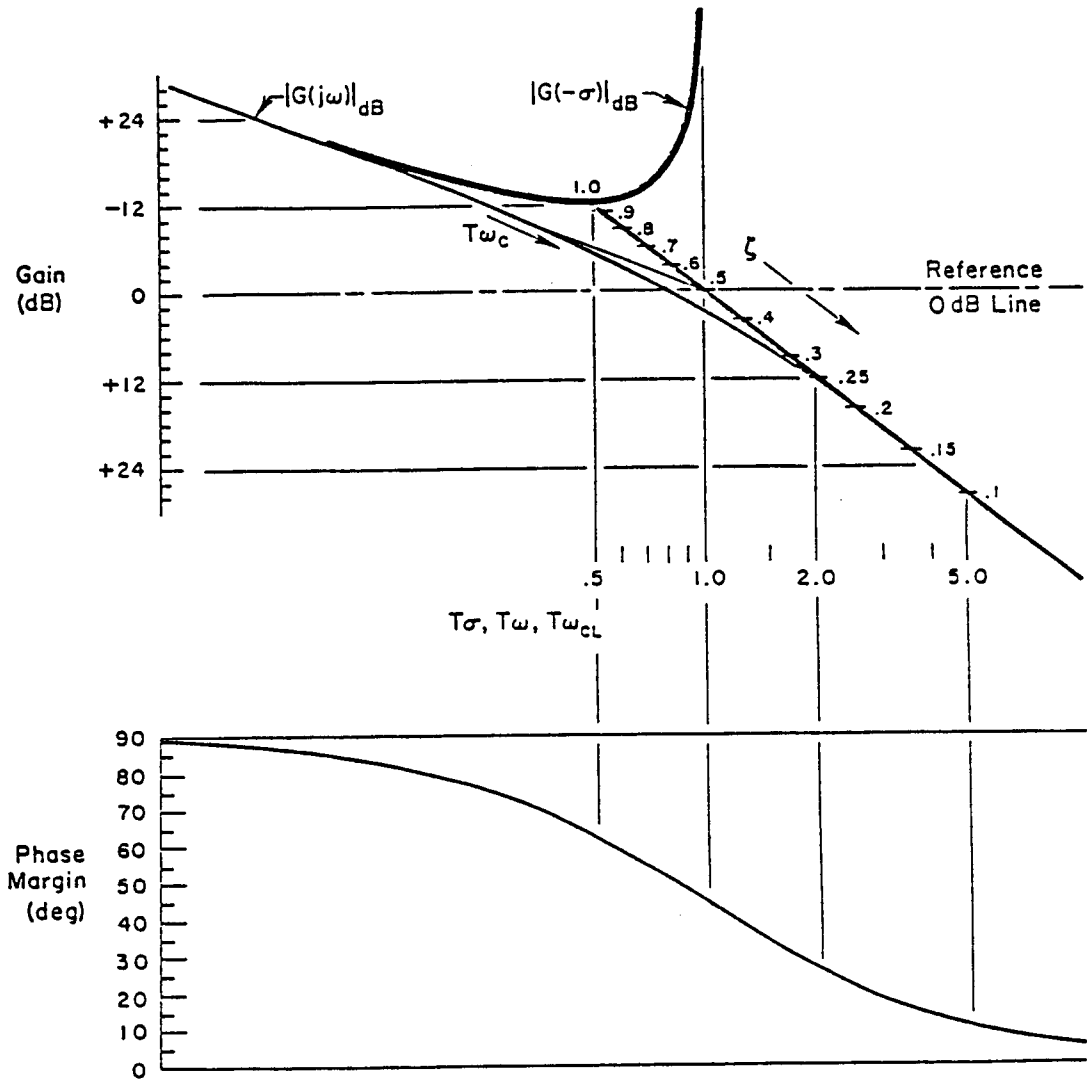

a) Open-Loop Frequency Response and Closed-Loop Bode Root Locus

$$e(t) \Big|_{t \rightarrow \infty} \approx \frac{1}{K} \dot{r}(t) \Big|_{t \rightarrow \infty} + \frac{TK-1}{K^2} \ddot{r}(t) \Big|_{t \rightarrow \infty} + \frac{1-2TK}{K^3} \dddot{r}(t) \Big|_{t \rightarrow \infty} + \dots$$

b) Error Series

Figure C-1. First-Order Lag in Series with an Integrator

2. Second-Order Factor

$$G(s) = \left[\left(\frac{s}{\omega_n} \right)^2 + \frac{2\zeta}{\omega_n} s + 1 \right]^{\pm 1}$$

Damping ratio ζ defines the characteristics:

$$|\zeta| < 1 \quad \text{complex}$$

$$|\zeta| > 1 \quad \text{real}$$

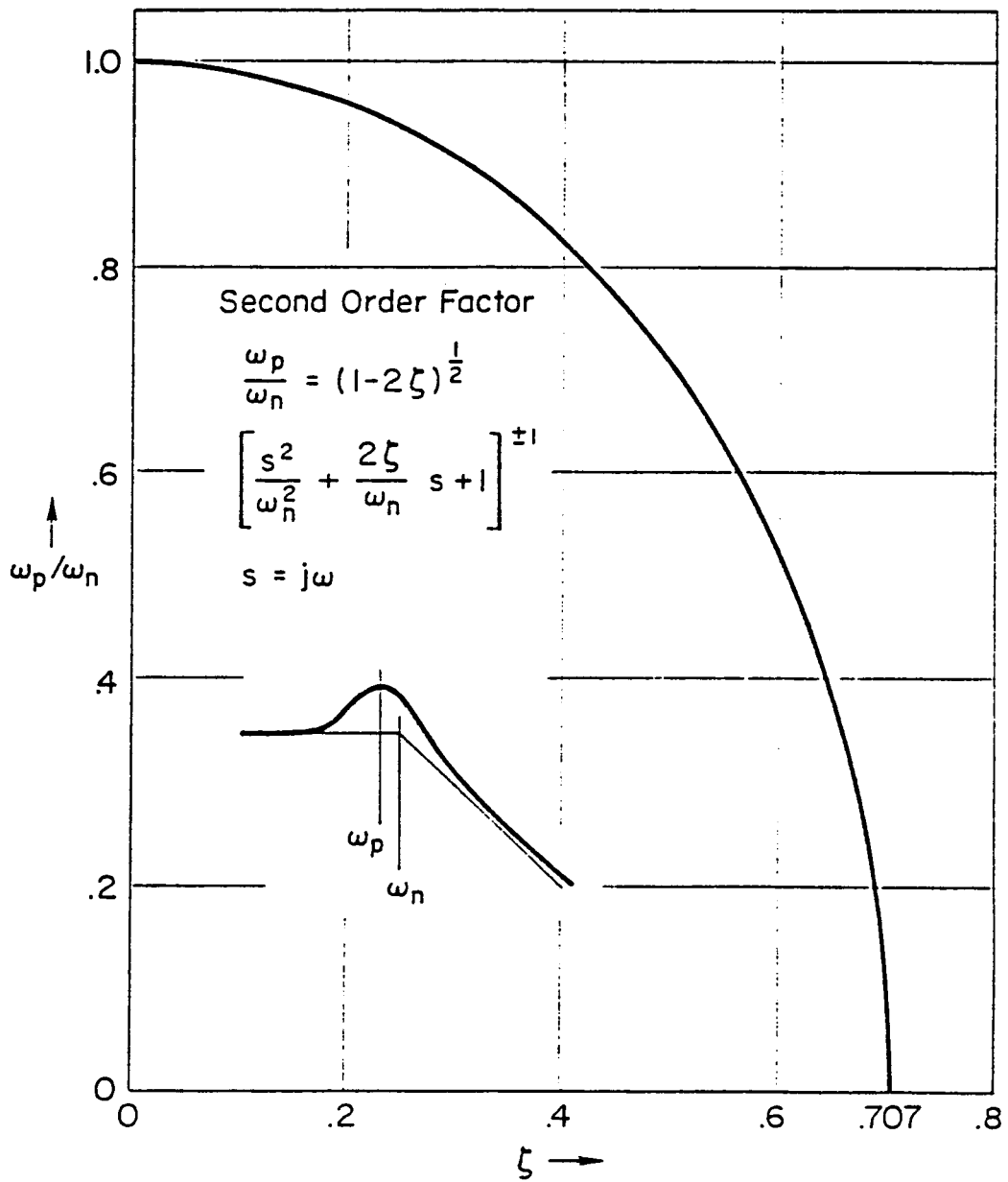
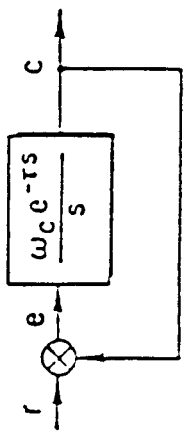

Figure C-3. Frequency at Which AR_{MAX} Occurs for Second-Order Factor

3. The Crossover Model

$$G(s) = \frac{\omega_c e^{-\tau s}}{s}$$

One of the most important applications of this model is as a first-order approximation of manual control. Crossover frequency ω_c and the effective time delay τ can be estimated as a function of the first-order characteristics of the controlled element (Ref. C-2).



a) Block Diagram

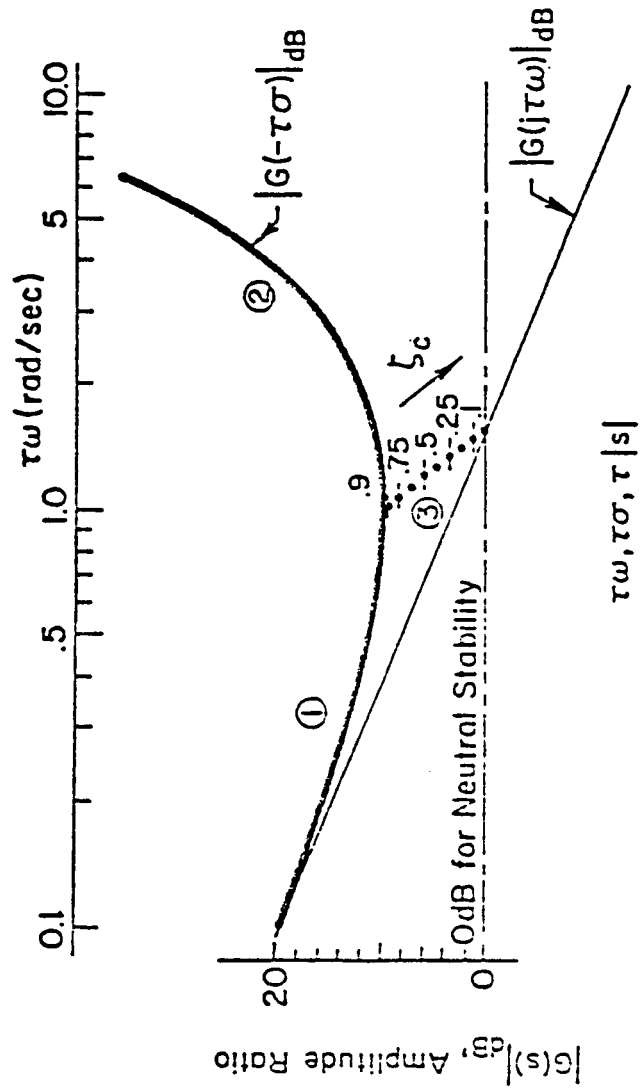

$\tau\omega, \tau\sigma, \tau |s|$
Log Scale

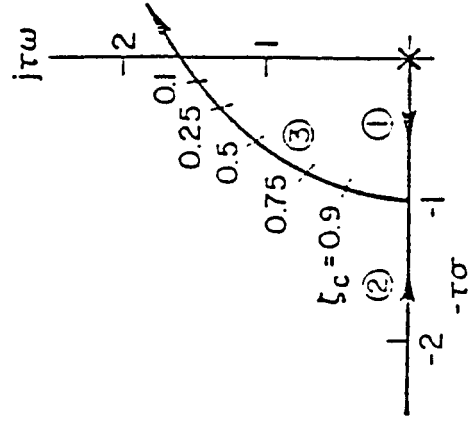

b) Root Locus

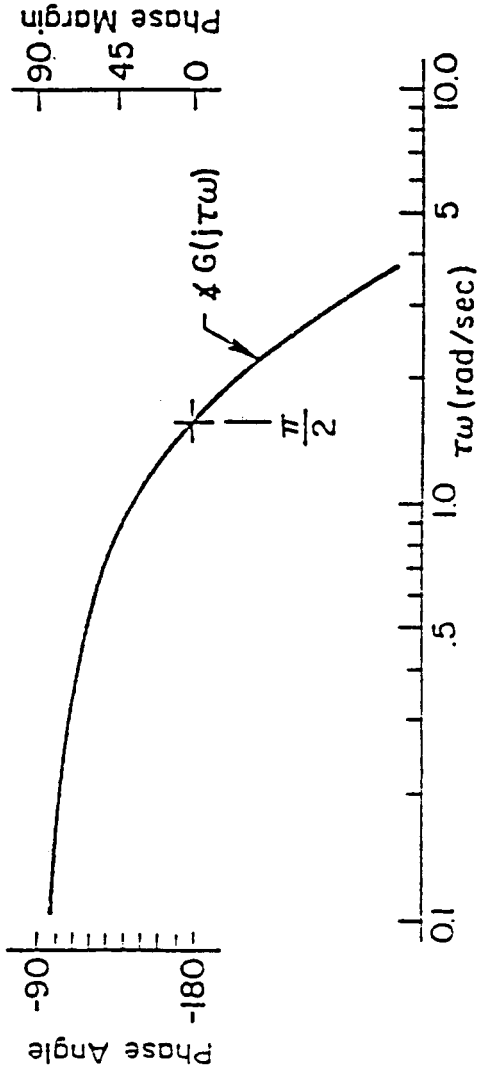

c) Open-loop $j\omega$ Bode and Bode Root Locus Plots

Figure C-4. System Survey of the Crossover Model

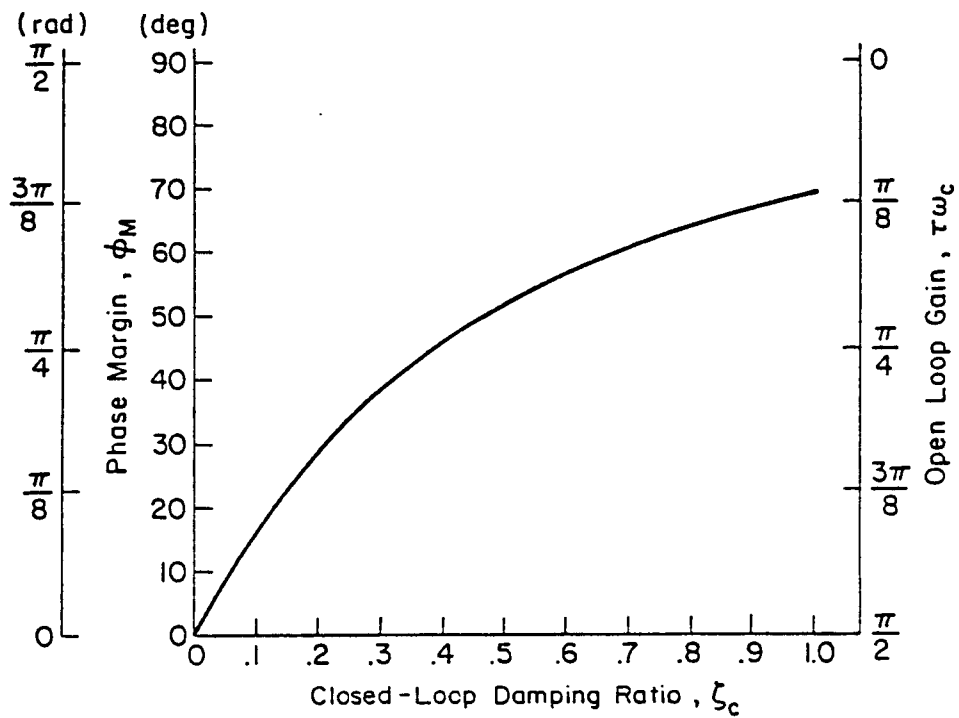

Figure C-5. Phase Margin as a Function of Closed-Loop Damping Ratio

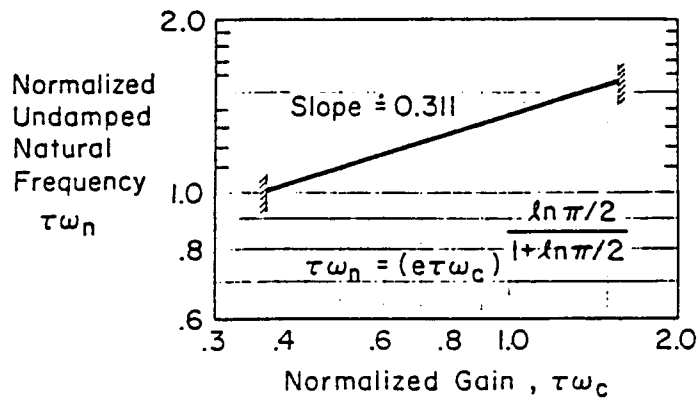

Figure C-6. Closed-Loop Undamped Natural Frequency as a Function of Crossover Frequency

4. The Superaugmented Model

In the closure of the fundamental pitch rate of a supraaugmented aircraft the open-loop transfer function has the form (Ref. C-3)

$$\frac{q}{q_c}(s) \doteq \frac{-K_q M \delta (s + 1/T_q) e^{-\tau s}}{s^2}$$

The closed-loop response to command is

$$\frac{q'}{q_c} \doteq \frac{-K_q M \delta (s + 1/T_q) e^{-\tau s}}{[\zeta', \omega_h']}$$

assuming $\tau \ll \frac{1}{\omega_h} = T_q$

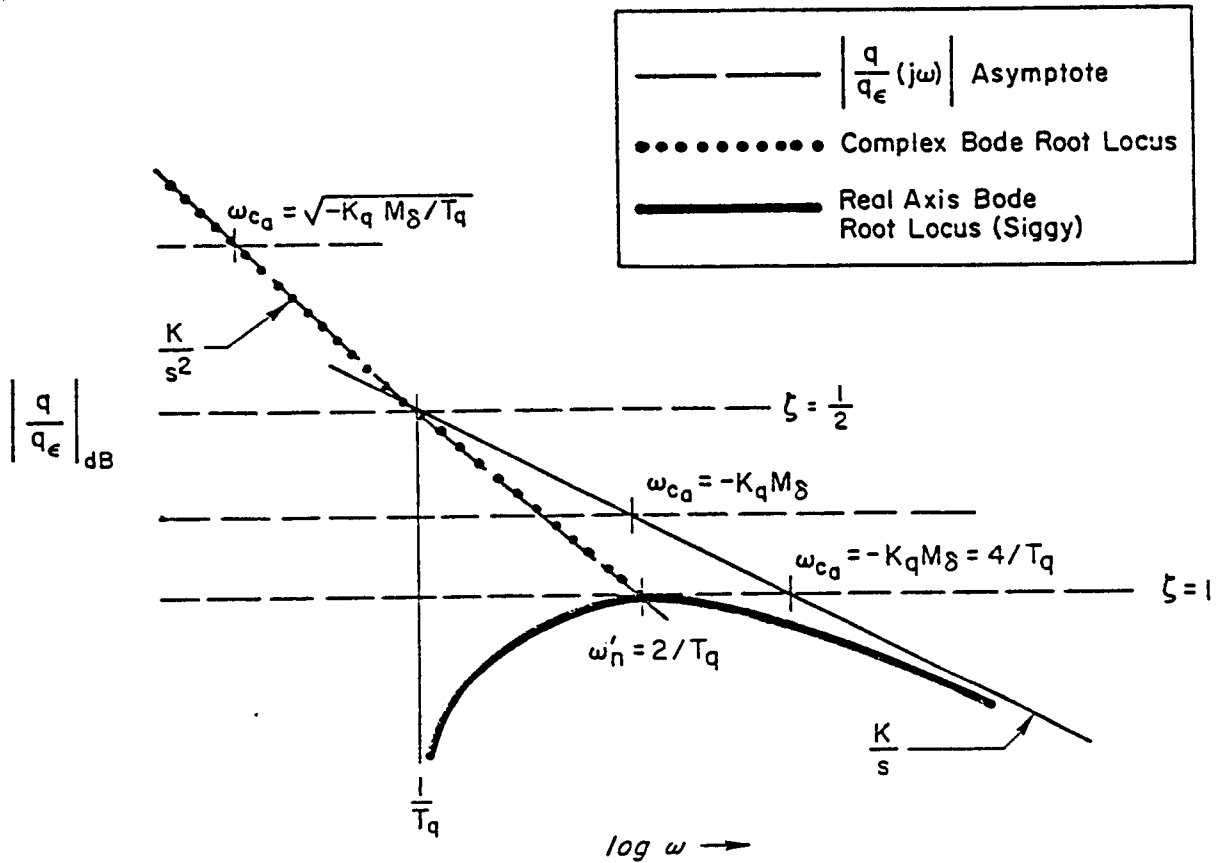

- $$\left. \frac{q}{q_e} \right|_{\text{open loop}} = \frac{-K_q M_\delta (s + 1/T_q) e^{-\tau s}}{s^2}$$

- $$\left. \frac{q}{q_c} \right|_{\text{closed loop}} = \frac{(T_q s + 1)}{\left[\left(\frac{s}{\omega'_n} \right)^2 + \frac{2\zeta'}{\omega'_n} s + 1 \right]}$$

- $$\zeta' = \frac{1}{2} \sqrt{-K_q M_\delta T_q} = \frac{1}{2} \sqrt{\omega_{ca} T_q}$$

$$\omega_n'^2 = -K_q M_\delta / T_q = \omega_{ca} / T_q$$

Figure C-7. Superaugmented Dominant Mode Approximation

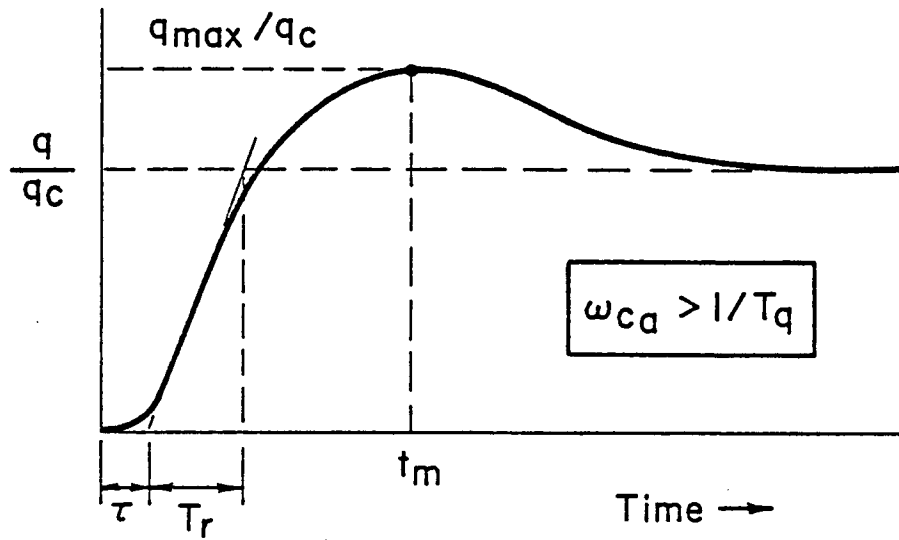

- $T_r = 1/\omega_{ca}$
- $\frac{t_m}{T_q} = \begin{cases} \pi/2 \\ \tan^{-1} \left(\frac{2\sqrt{\hat{K}}\sqrt{1-\hat{K}/4}}{\hat{K}-2} \right) / \sqrt{\hat{K}}\sqrt{1-\hat{K}/4} \end{cases}$

$$\hat{K} = -K_q M_\delta T_R$$

- $R = \frac{q_{max}}{q_c} = 1 + e^{\omega_{ca} t_m / 2} \quad (\zeta < 1)$

$$\leq \frac{q_{max}}{q_c} \Big|_{\hat{K}=1} = 1 + e^{-2\pi/3\sqrt{3}} \doteq 1.30$$

Figure C-8. Superaugmented q/q_c Transient Response

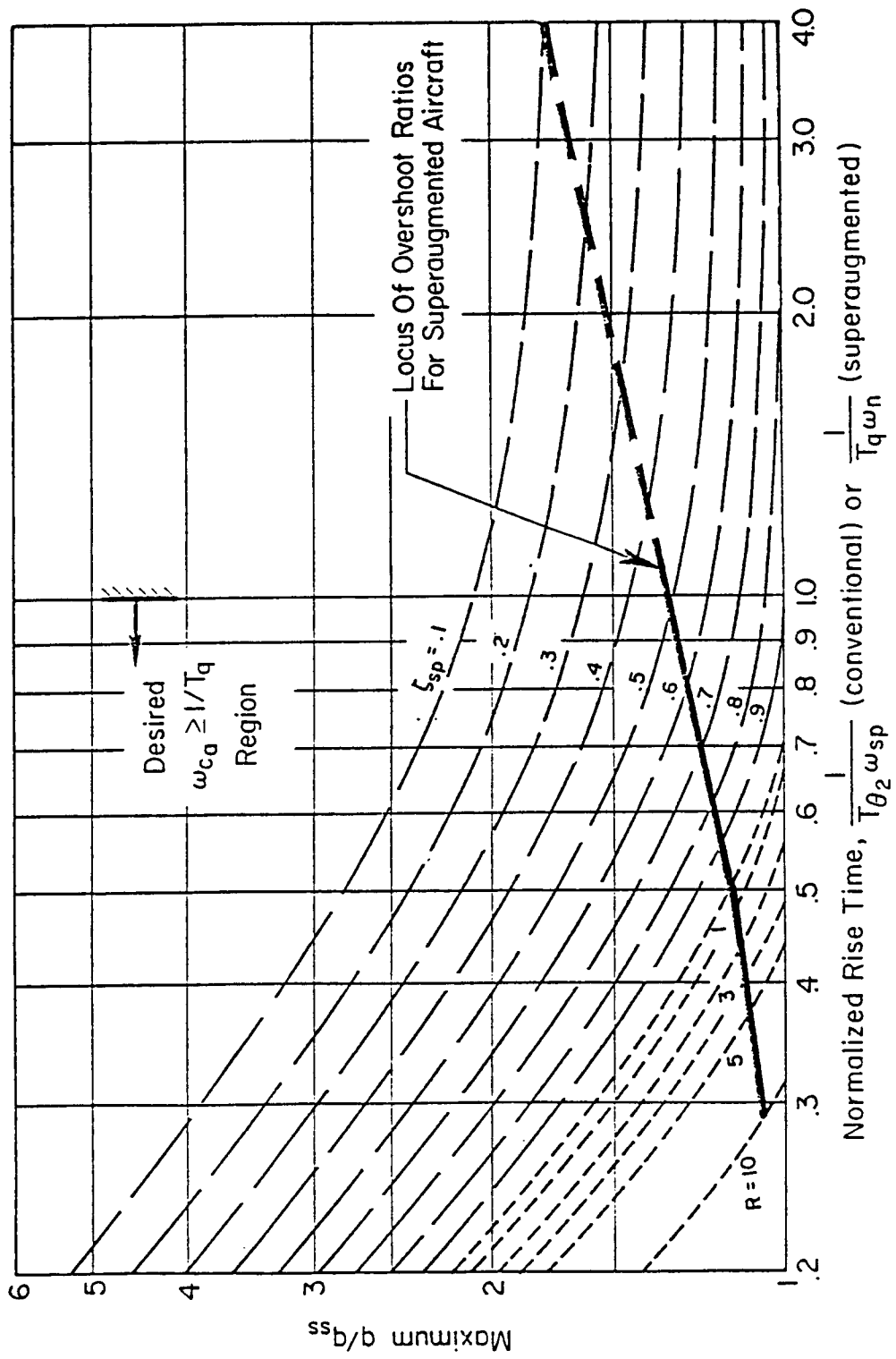

Figure C-9. Maximum Pitch Rate Overshoot Variation for Superaugmented Aircraft

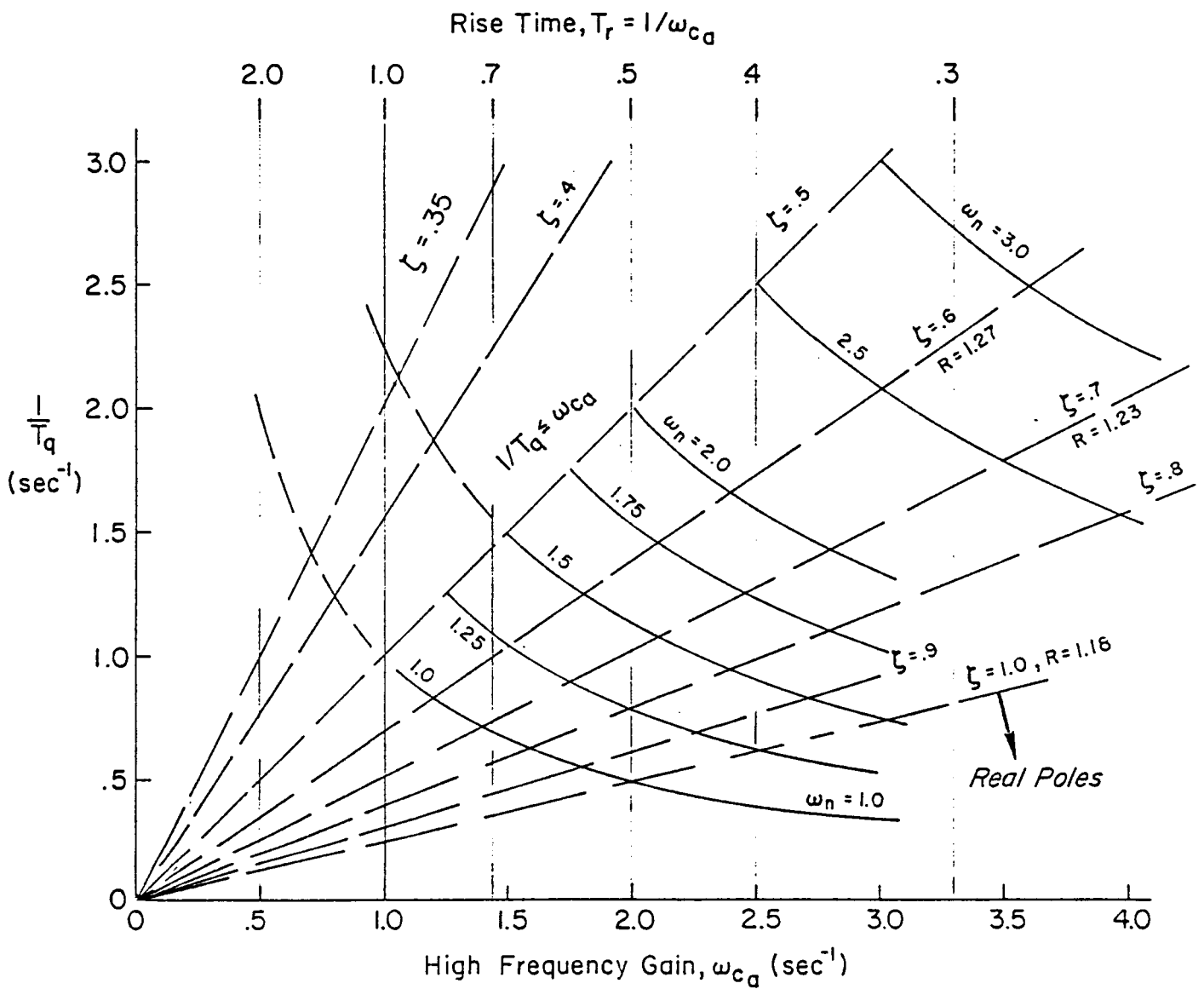
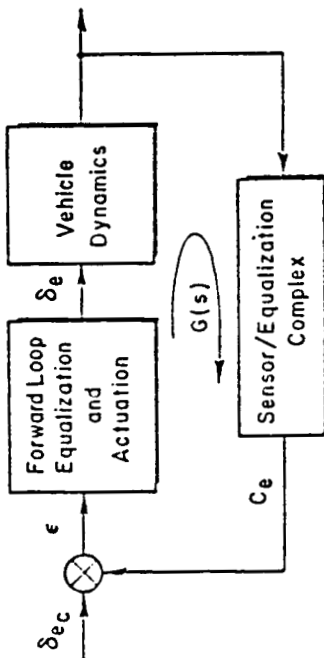

Figure C-10. Superaugmented Dominant Mode Characteristics in the $1/T_q - \omega_{ca}$ Parameter Plane

5. A Second-Order Dipole in Series with an Integrator

$$G(s) = \frac{K[\zeta_N, \omega_N]}{s[\zeta_D, \omega_N]}$$

This characteristic often occurs as the Dutch roll artifact in bank angle response to roll control.



$$G(s) = \frac{C_e}{\epsilon} = \frac{\kappa [s^2 + 2\zeta_N \omega_N s + \omega_N^2]}{s [s^2 + 2\zeta_D \omega_D s + \omega_D^2]}$$

$$= \frac{\kappa [\zeta_N, \omega_N]}{s [\zeta_D, \omega_D]}$$

$$\Delta \phi_{MAX} = -\tan^{-1} \frac{\zeta_N + \zeta_D \left(\frac{\omega_N}{\omega_D} - 1 \right)}{2\zeta_N \zeta_D}$$

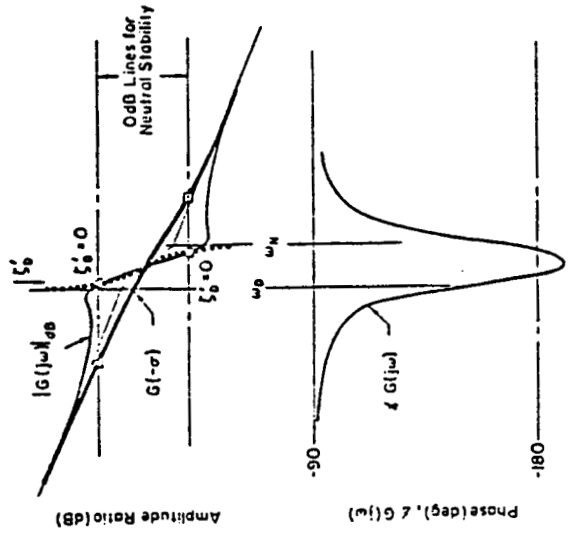

a) Lag-Lead Dipole ($\frac{\omega_N}{\omega_p} > 1$)

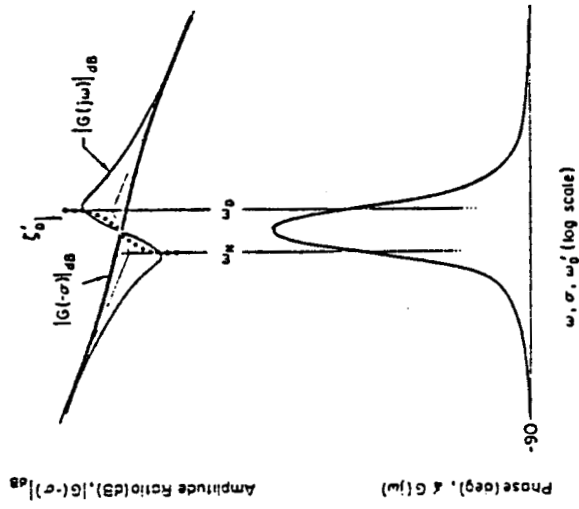
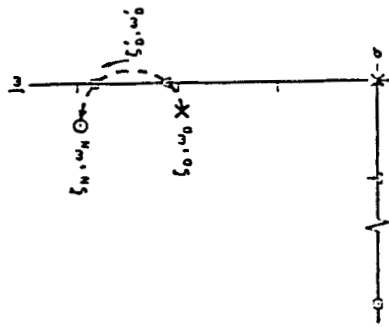

b) Lead-Lag Dipole ($\frac{\omega_N}{\omega_p} < 1$)

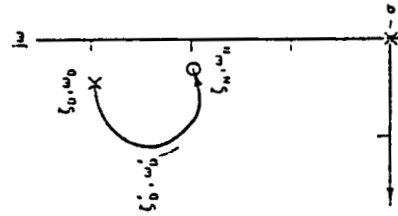

Figure C-11. System Survey for Quadratic Dipole Control

REFERENCES TO APPENDIX C

- C-1. McRuer, Duane, Irving Ashkenas, and Dunstan Graham, Aircraft Dynamics and Automatic Control, Princeton University Press, Princeton, NJ 1973.
- C-2. McRuer D. T., and E. S. Krendel, "Mathematical Models of Human Pilot Behavior," AGARDograph No. 188, Jan. 1974.
- C-3. Myers, T. T., D. T. McRuer, and D. E. Johnston, Flying Qualities and Control Systems Alternatives for Superaugmented Aircraft, NASA CR-170419, Dec. 1984.



Report Documentation Page

1. Report No. NASA CR-181726	2. Government Accession No.	3. Recipient's Catalog No.	
4. Title and Subtitle Advanced Piloted Aircraft Flight Control System Design Methodology Volume 1: Knowledge Base		5. Report Date October 1988	
		6. Performing Organization Code	
7. Author(s) Duane T. McRuer and Thomas T. Myers		8. Performing Organization Report No. STI TR-1228-1	
		10. Work Unit No. 505-66-01-02	
9. Performing Organization Name and Address Systems Technology, Inc. 13766 South Hawthorne Boulevard Hawthorne, CA 90250-7083		11. Contract or Grant No. NAS1-17987	
		13. Type of Report and Period Covered Contractor Report	
12. Sponsoring Agency Name and Address National Aeronautics and Space Administration Langley Research Center Hampton, VA 23665-5225		14. Sponsoring Agency Code	
		15. Supplementary Notes Langley Technical Monitor: Jarrell R. Elliott SBIR Phase II Final Report	
16. Abstract <p>This report presents and illustrates the development of a comprehensive and eclectic methodology for conceptual and preliminary design of flight control systems. The methodology is focused on the design stages starting with the layout of system requirements and ending when some viable competing system architectures (feedback control structures) are defined. The approach is centered on the human pilot and the aircraft as both the sources of, and the keys to the solution of, many flight control problems. The methodology relies heavily on computational procedures which are highly interactive with the design engineer. To maximize effectiveness, these techniques, as selected and modified to be used together in the methodology, form a cadre of computational tools specifically tailored for integrated flight control system preliminary design purposes. The computer aids are all based on IBM PC compatible machines and most are now commercially available. This helps make the methodology as broadly available and useful as possible instead of simply another isolated approach.</p>			
17. Key Words (Suggested by Author(s)) Artificial intelligence (AI) Expert systems Flight control system design Knowledge-based design Natural language interface		18. Distribution Statement Unclassified - Unlimited Subject Category 08	
19. Security Classif. (of this report) Unclassified	20. Security Classif. (of this page) Unclassified	21. No. of pages 288	22. Price