

NASA-CR-182274



ORBIT TRANSFER ROCKET ENGINE TECHNOLOGY PROGRAM

OTVE TURBOPUMP CONDITION MONITORING - TASK E.5

Prepared By:

P.T. Coleman, J.J. Collins
ROCKWELL INTERNATIONAL CORPORATION
Rocketdyne Division

Prepared For:

NATIONAL AERONAUTICS AND SPACE ADMINISTRATION

NASA-Lewis Research Center
Contract NAS3-23773
M. Millis, Task Manager

ROCKETDYNE DIVISION OF ROCKWELL INTERNATIONAL CORPORATION
6633 Canoga Avenue; Canoga Park, CA 91303

{NASA-CR-182274} OTVE TURBOPUMP CONDITION
MONITORING, TASK E.5 Final Report, Oct. 1988
- Sep. 1989 (Rockwell International Corp.)
27 p

CSCL 14D

N89-27204

Unclas

G3/38 0224107

OTVE TURBOPUMP CONDITION MONITORING
FINAL REPORT OCTOBER 3, 1988

INTRODUCTION

The scope of this effort was to provide bearing wear measurements and real time monitoring of shaft speed, shaft axial displacement and shaft orbit of the OTVE Hydrostatic Bearing Tester. These measurements can then be correlated to bearing life, as well as axial and radial loads, thus measuring the performance of hydrostatic bearing materials.

This Integrated Control and Health Monitoring effort was to include 1) fiberoptic deflectometers 2) eddy current probes and 3) isotope wear analysis. These technologies needed application specific studies to be made in order to perform the measurements: a suitable shaft surface pattern to provide shaft dynamic information to two fiberoptic deflectometers, a copper plating process to treat the shaft so that the eddy current probes can also measure shaft speed, and activation product list from candidate bearing materials and activation calibration for isotope wear measurements of the hydrostatic bearing.

In order to provide these optical measurements, a surface pattern that enables shaft axial, radial and speed measurements via fiber optic deflectometer was studied. A suitable pattern was found to be eight triangles of non-reflective material whose change of reflectivity from that of shiny titanium cuts the light intensity received by the deflectometer. This change in intensity and the associated time periods of the drop in intensity indicates shaft axial and radial position and shaft speed. These measurements are accomplished by a signal processing unit that has been designed to take the output of two orthogonal fiberoptic deflectometers viewing this pattern and provide real-time shaft monitoring of speed and displacement.

For redundancy in these shaft measurements, Bently eddy current probes will also be used. In the past Bently eddy current probes have been used to measure shaft displacement and more recently shaft speed. The shaft speed measurements have been made by machining a depression or "glitch" which produces a voltage change in the probe as it passes the glitch. This glitch, however, can cause cavitation

at high shaft speeds, so copper plating onto titanium was investigated for use with Bently eddy current probes to measure shaft speed. The difference in conductivity between copper and titanium resulted in a voltage change in the eddy current probe so that a pulse per revolution speed signal is produced for each copper plated area viewed by the probe. A copper plating filling in the depressions would stop cavitation and still provide a speed signal. A titanium disk was copper plated on four 0.5 inch squares and passed the bend test for adhesion bonding and thermal cycling. The disk was then tested on a rotating demonstrator and was able to provide a four pulse per revolution speed signal up to 8300 rpm.

In addition to shaft monitoring, bearing wear measurements with the isotope wear analysis were also to be performed in this task, measuring hydrostatic bearing wear through the tester walls. A study of activation products of candidate bearing materials was made for determination of desirable isotopes for the isotope wear analysis. Samples of the two materials chosen, Pure Carbon, P5N and Kennametal 162B, were sent to Spire Corporation for activation and calibration but only the P5N was chosen by rotating machinery to be calibrated. The calibration of normalized activity versus wear depth was generated and now it remains to activate an actual bearing.

Continued development and application of those measurement technologies is critical for reliability of engine component testing and evaluation. The fiber optic deflectometer shaft monitor and isotope wear analysis can provide information essential to turbopump studies (i.e., bearing wear measurements, monitoring shaft orbit and shaft speed, etc.).

Technical discussions of the tests and results of the technologies follow.

FIBEROPTIC DEFLECTOMETER SHAFT MONITOR

Two fiberoptic deflectometers viewing the hydrostatic bearing tester shaft will be able to monitor shaft speed, shaft axial and radial displacement. This monitoring technique which has been successfully demonstrated in the Advanced Instrumentation Lab requires a shaft surface pattern and a signal processing unit that has been designed.

The MTI 1000 fiberoptic deflectometer transmits light through fiberoptic cable to a target surface. The intensity of light received back through the fiberoptic cable is converted to a signal proportional to probe-to-target gap. Thus a change of intensity according to shaft position and speed would enable the deflectometer to measure these shaft dynamic parameters. The simplest way of introducing this change is to place a surface pattern on the shaft with severe changes in reflectivity, alternating a non-reflective surface and the shiny surface of the titanium 6-4 shaft.

A suitable geometrical pattern was found to be a binary number of symmetrical triangles along the circumference of the one inch diameter shaft of the tester. This pattern of eight flat black triangles was spray painted onto a titanium disk to spin up to 10,000 RPM on a rotating demonstrator in the AI lab. A 0.125-inch diameter deflectometer probe attached to translation stage viewed the 0.125 inch height, .785 inch base triangles at various axial displacements (the translation stage enabling quantifiable movement of the deflectometer along the shaft axis). Axial displacement was thus measured to within 0.3 mils (see figure 1) with the deflectometer probe tip 20 mils from the shaft surface.

The deflectometers are set to detect changes in reflected optical energy from the triangular pattern. One deflectometer is positioned normal to the shaft in a vertical position, the other deflectometer is normal to the shaft in a horizontal position. The axial position of the sensor relative to the center of the triangular pattern on the shaft is indicated by the ratio of the periods of reflective and nonreflective patterns detected on the shaft (see figures 2 and 3), that is, the signal pulse width is correlated to axial displacement. Shaft speed is measured as the rate of detected triangular patterns. Radial position may be determined from measurement of the magnitude of changes in reflected light intensity, created by the triangular pattern, in each axis. The absolute radial position of the shaft may simultaneously be determined from time delays detected between orthogonal sensors.

Numerous surface treatment processes were evaluated for surface adhesion in cryogenic operations and reflectance. Tiodize, a titanium anodizing process, was selected based upon several tiodized rivet samples provided by Tiodize Co (Huntington Beach, CA) that were tested in the Advanced Instrumentation laboratory.

Samples of Tiodize type I with Ultra VE17 and Tiodize type II were received from Tiodize Co., the type I coupon having a black powder finish while the type II has a smooth dark gray surface. Both samples were thermally cycled in LN₂ and heated by air guns. The type I surface finish flaked and cracked in the cycling while the type II finish was unaffected by the sudden temperature changes. This surface finish cut the reflected light signal by 90% both before and after the thermal cycling. Because the type II finish is unaffected by cryogen it is appropriate for the LH₂ environment of the Hydrostatic Bearing Tester.

A two-inch outer diameter titanium disk was tiodized (type II) according to the triangular pattern mentioned previously. The pattern provided a clean speed signal indicating that the tiodizing process can be applied with sufficient accuracy to provide the desired resolution for shaft monitoring. The signal processing unit that will process the electronic signal from the two deflectometers has been designed (see figure 4). Analog outputs for shaft speed, axial displacement, and orbital displacement are derived from digital arithmetic processors and presented in analog form using digital to analog converters with sixteen bit precision. This output was designed to be able to present the test engineers with real time shaft monitoring.

This application of a surface treatment has demonstrated the feasibility of a real time monitoring of shaft axial displacement, shaft orbit and shaft speed with only two deflectometers. These optical target areas have been included on the drawings for the OIV hydrostatic bearing tester shaft. However the signal processing unit must still be built to implement the optical shaft monitor in the Hydrostatic Bearing Tester, and four LH₂ compatible fiber optic deflectometers must be purchased to complete the optical instrumentation. Further work in the

area of signal processing and placement of surface patterns (such as at the axial face of the shaft rather than the circumferential surface) would yield more results.

ISOTOPE WEAR ANALYSIS

Measuring the changes in radioactivity of an activated pure carbon P5N bearing will provide an in-situ bearing wear monitor for the OTVE hydrostatic bearing tester. Proton activation of the P5N material to two mils depth will produce Co56 and the change in the amount of this radioactivity will correlate to wear in the activated volume of the bearing material.

Initially, there were seven candidate bearing materials for the hydrostatic bearing tester. Based upon the composition of these materials, a study of activation sources and products was conducted (see appendix I). The major component of the materials was carbon, the major isotope product being Beryllium-7 having a 477 keV energy peak and a 70 day half-life. This energy is fairly low, leading to significant attenuation through steels so other isotopes were needed.

Then two materials Kennametal 162B and Pure Carbon P5N were picked by Rotating Machinery as being prime bearing candidates based upon material properties. Samples of the two candidate bearing materials Pure Carbon P5N and Kennametal 162B were sent to Spire Corporation for calibration. A study of material composition and activation products was made identifying Cobalt-56 and

Scandium-46 as isotopes with which to monitor the wear on the P5N and 162B bearing material. It was then decided that since previous data showed no wear for the Kennametal 162B, that the Kennametal would not be used as bearing material, in keeping with the idea that the bearing should be the sacrificial material.

The P5N material was placed in a vacuum at 300°F to bake out moisture prior to bombardment. Based upon a density of 7.85 g/cm the P5N sample was bombarded with a 5.56 Mev proton beam activating the trace amount of iron (<2%) to produce less than one microcurie of Cobalt 56 to depth of two mils. Once that sample was activated, material was removed by lapping several microns at a time and measuring the corresponding decrease in activity. From this data a profile calibration curve was determined and a fourth order polynomial equation was made to model the activity profile in the P5N (see figure 5). The calibration used a five parameter fit to the 1238 KeV peak and the 846 KeV peak and the production rate was measured to be 4.5 and 2.4 nanocuries per millicoulomb respectively.

This is approximately two times lower than is usually available in bearing material such as steel. Consequently, the cost to produce one microcurie of Cobalt-56 under the calibrated conditions will be approximately \$8,000 assuming the beam is uncollimated (about 0.5 cm in diameter).

The maximum wear for the P5N material is estimated to be slightly less than one mil. Therefore an activation to two mils depth will provide sensitivity to wear while being able to measure maximum removal of material. Figure 6 shows resolution of the 1238 keV peak of Co-56, after passing through three inches of steel, vs initial activity.

The next step is design and manufacture of the detector bracket. Dimensional drawings of the NaI detector to be used have been sent to Rotating Machinery to design a bracket fixture to maintain the position of the detector throughout wear measurements.

For the most informative measurements the gamma ray detector should be able to be moved into quadrature positions around the bearing tester walls, lined up with the bearing. Thus for each bearing measurement there would be four measurements of radioactivity to monitor the bearing wear circumferentially. The measurements should also be taken at the same temperature throughout the tests so that temperature will not influence the detector spectrum.

The activated area would be the 2 π r circumference of the inner diameter of the bearing along the entire length of the bearing to an activity of five microcures. Drawings of the bearing have been sent to Spire Corporation to initiate construction of fixtures to hold and rotate the bearing and bearing subassembly while being bombarded. Any additional bearing materials to be monitored with isotope wear analysis would have to be calibrated at Spire Corporation.

BENTLY EDDY CURRENT PROBES

Bently Eddy current probes consist of a coil of wire inside a probe sleeve connected to a proximator. An AC circuit in the probe coil creates an EM field which generates eddy currents in the target material. These target material eddy currents create an EM field opposing that of the probe, altering the current in the probe coil and the change in voltage across the coil measures eddy current as a function of probe-to-target gap. The proximator conditions the probe signal for linear display on a monitor.

Bently probes are traditionally used as shaft orbit monitors by orthogonally connecting two probes to an oscilloscope and observing the Lissajous patterns. In order to monitor shaft speed, a "glitch" (i.e., 5 mil deep depression) is machined in the shaft surface facing the Bently and as the glitch passes the probe face the voltage drops. These glitches however may cause cavitation and unbalance (unless the geometry of the glitches balances out). Plating a material with a conductivity greatly different from that of the substrate material into a glitch will eliminate cavitation but still enable the Bentlys to respond to shaft revolution.

A two inch outer diameter titanium 64 disk had four half-inch square areas machined to 1, 2, 5, and 10 mil depths along its circumference (see figure 7). The disk was then masked and copper-plated by a ENPLATE 112000 plating cycle (see appendix 11). These areas were then ground down to be flush with the titanium surface, then mounted onto the lab rotating demonstrator at various RPM and

viewed by a .190 inch diameter Bently probe. The probe registered a drop in voltage as it passed the copper plating and increased as the titanium surface passed within view. The copper plating has a conductivity approximately five times greater than that of titanium. Because eddy currents penetrate a skin depth into a material and skin depth is inversely proportional to the square root of the electrical conductivity, the eddy currents will penetrate deeply into the titanium but significantly less into the copper. The amplitude of the signal is proportional to the exponential of the negative skin depth. In this way with four copper plated areas the Bently probe will register a voltage change each time the copper passes the probe and provide a four pulse per revolution speed signal. The output of a Bently (triggered on a speed nut) viewing the shaft at 8300 RPM is shown in figure 8. The voltage measured at the copper plating is -14.4 while that of the titanium shaft is -10V.

For application of this copper plating to the hydrostatic bearing tester, the plating must withstand cryogenic temperatures and shaft speed up to 200000 RPM. Several titanium 6-4 coupons were copper-plated as per the above procedure and thermally cycled. The bend test performed according to ASTM E8-779a was performed, as well as a peel test, and the coupons passed showing no surface change.

Electroplating personnel are confident that the copper plating will not peel off due to the temperature gradient or cryogen in the bearing tester although they recommend additional flexural and tension tests.

This process demonstrates the feasibility of using a standard Bently probe to measure shaft speed without producing imbalance and cavitation into the test system. Drawings for the hydrostatic bearing tester shaft already include copper plated targets midway on the shaft. The recommended next step are to perform flexural and tension tests and calibrate the Bently probes using Titanium 64 in LH₂.

CONCLUSION

Continued development and application of these measurement technologies is critical for reliability of engine component testing and evaluation. The fiber optic deflectometer shaft monitor and isotope wear analysis can provide information essential to turbopump studies (i.e., bearing wear measurements, monitoring shaft orbit and shaft speed, etc.).

AXIAL DISPLACEMENT MEASUREMENT

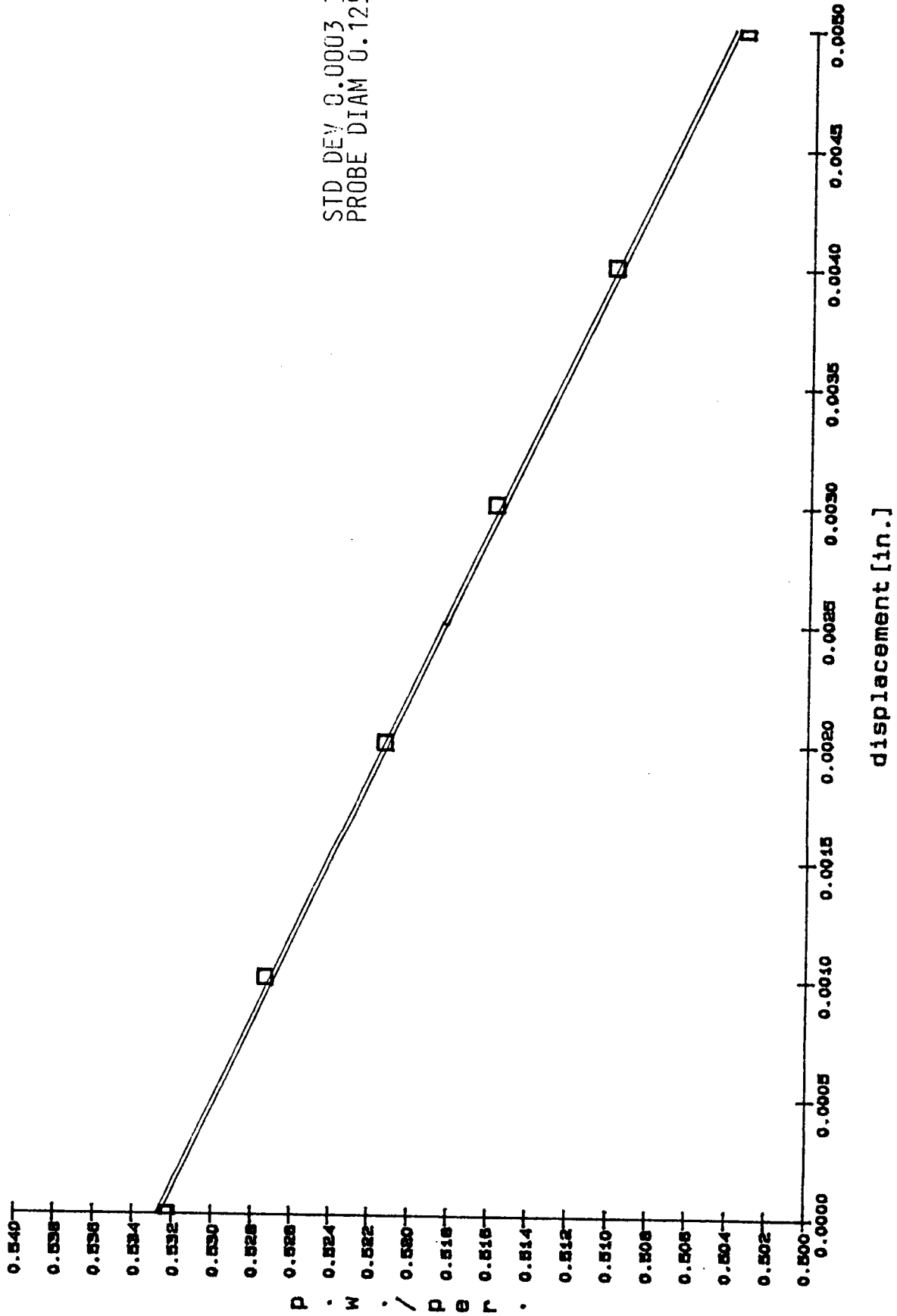

FIGURE 1. AXIAL DISPLACEMENT

ORIGINAL PAGE
BLACK AND WHITE PHOTOGRAPH

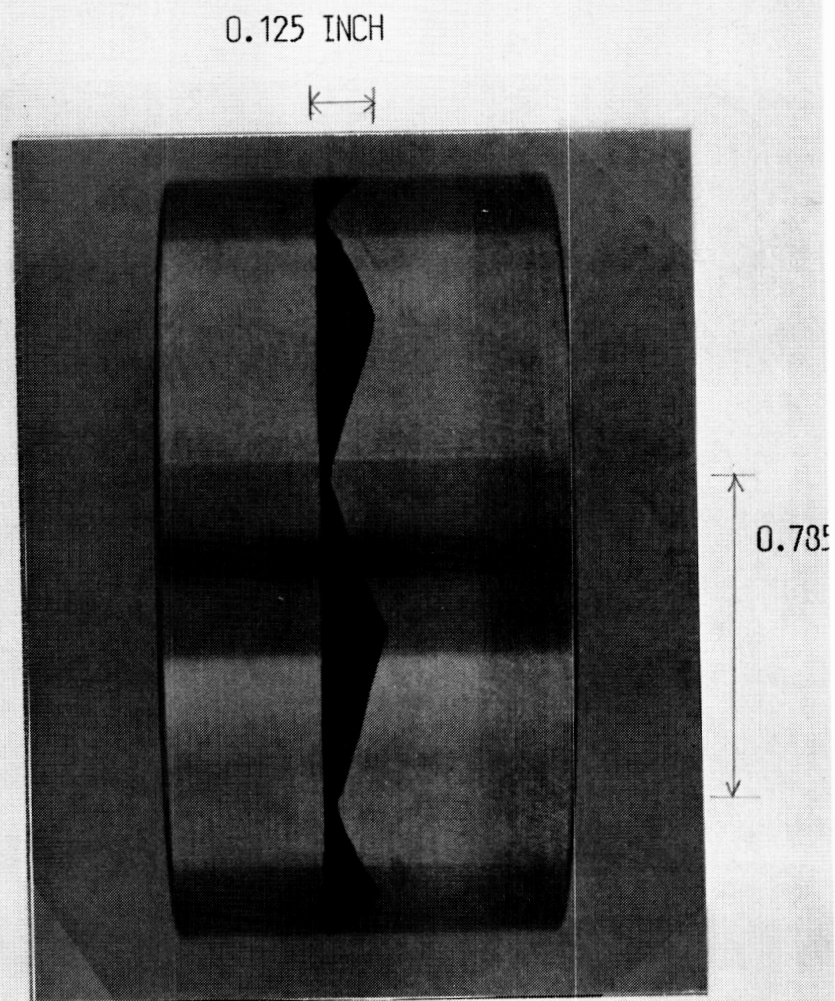
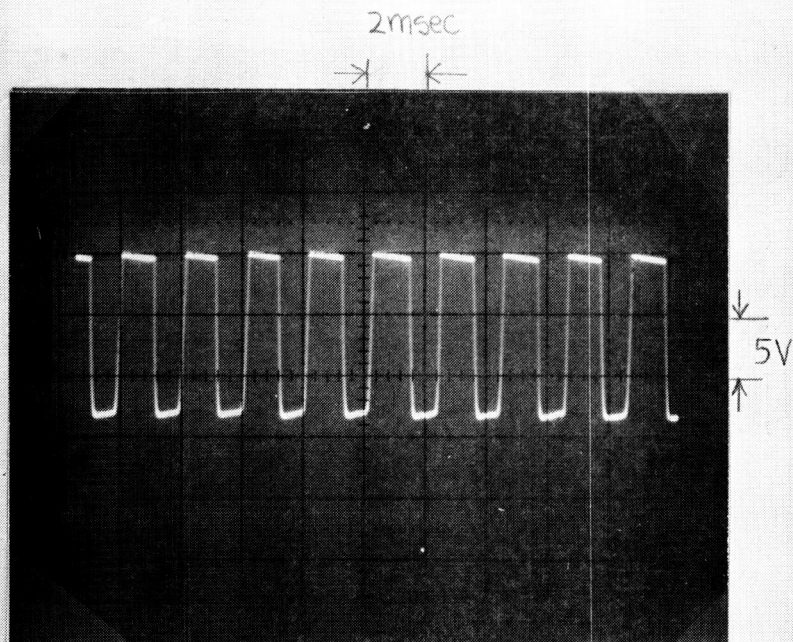
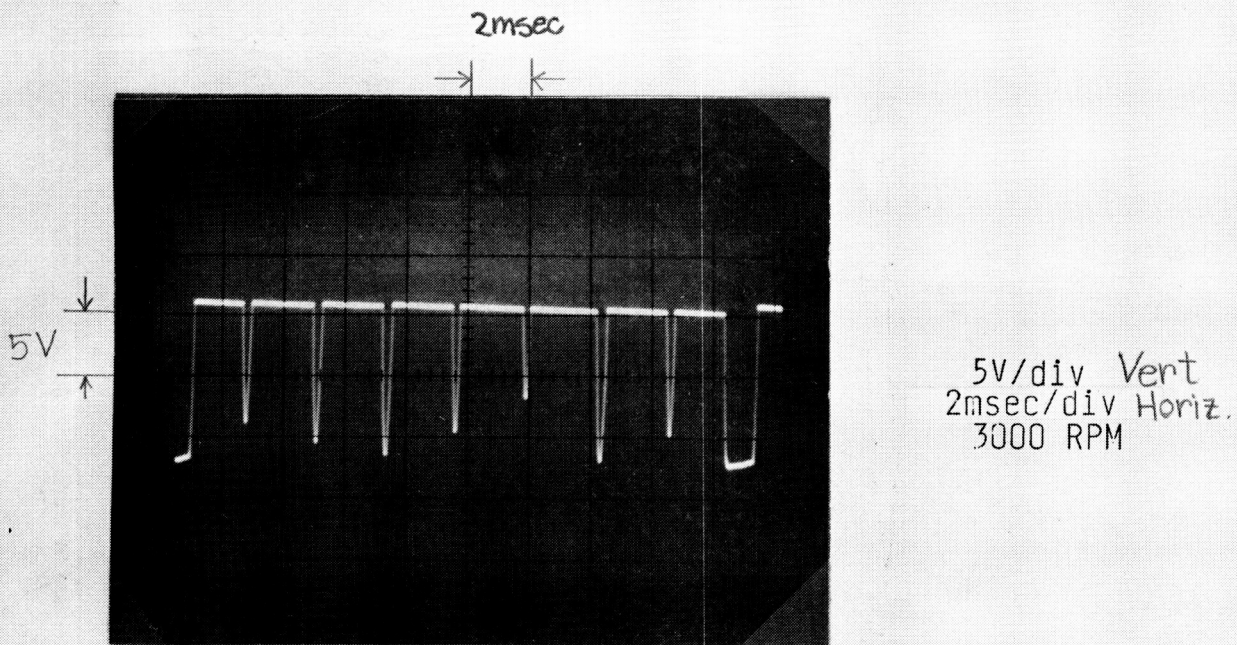

FIGURE 2. TIODIZE TYPE II
SURFACE PATTERN ON 2-INCH
O.D. TITANIUM 64 DISK

ORIGINAL PAGE
BLACK AND WHITE PHOTOGRAPH



A) DEFLECTOMETER PROBE
VIEWING CENTER OF
TRIANGULAR PATTERN



B) DEFLECTOMETER PROBE AXIALLY
DISPLACED 0.125 INCHES TOWARD
TIP OF TRIANGULAR PATTERN

OPTICAL SHAFT SPEED/DISPLACEMENT MONTITOR

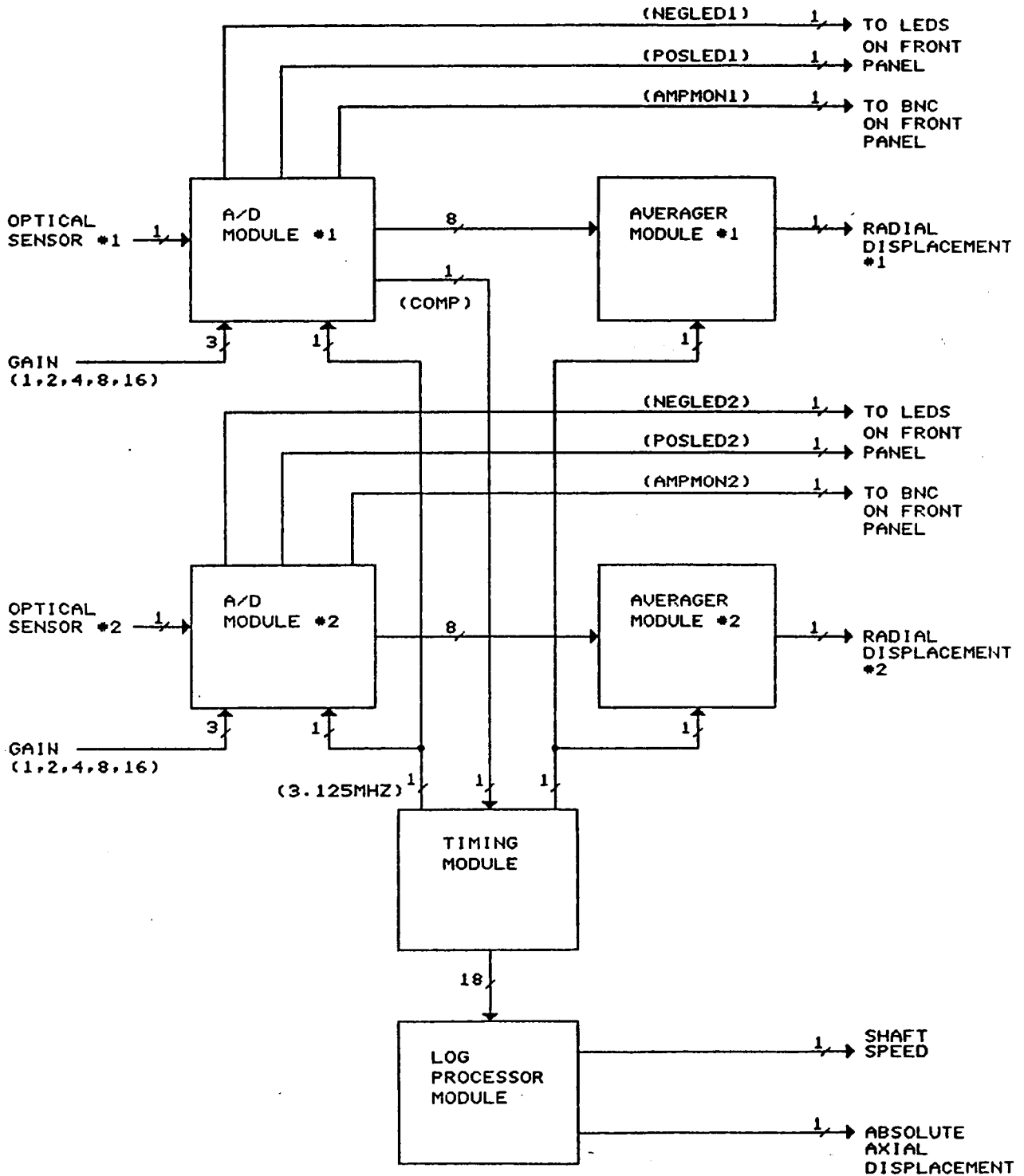

FIGURE 4

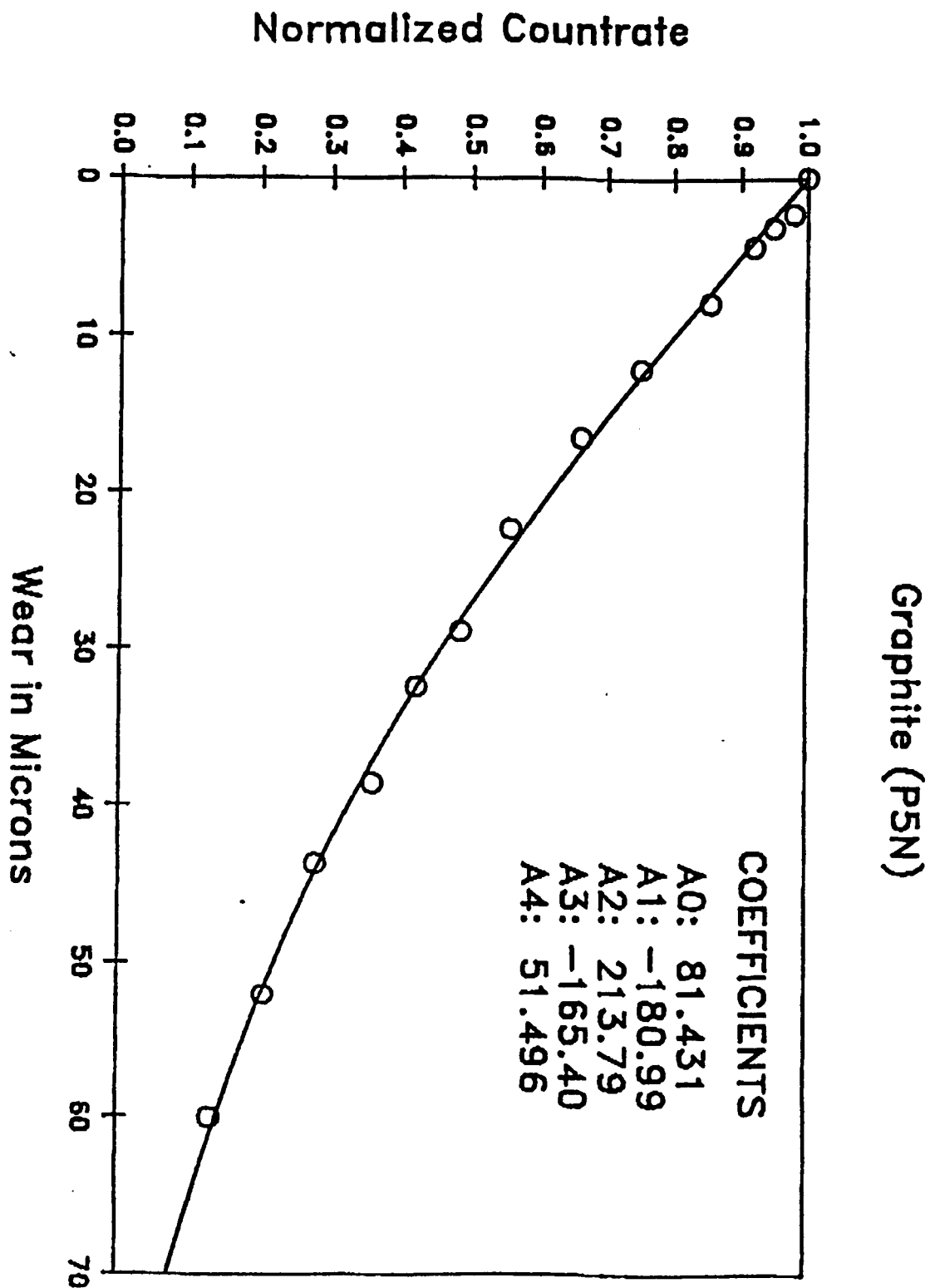

Figure 5
 Calibration Curve of Normalized Activity vs. Wear Depth

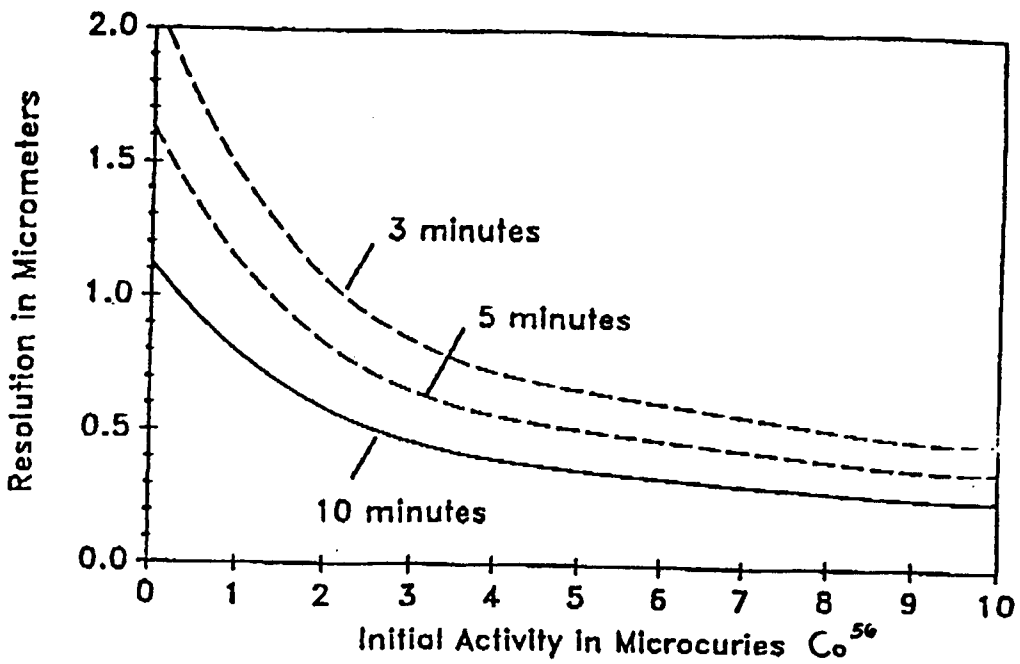
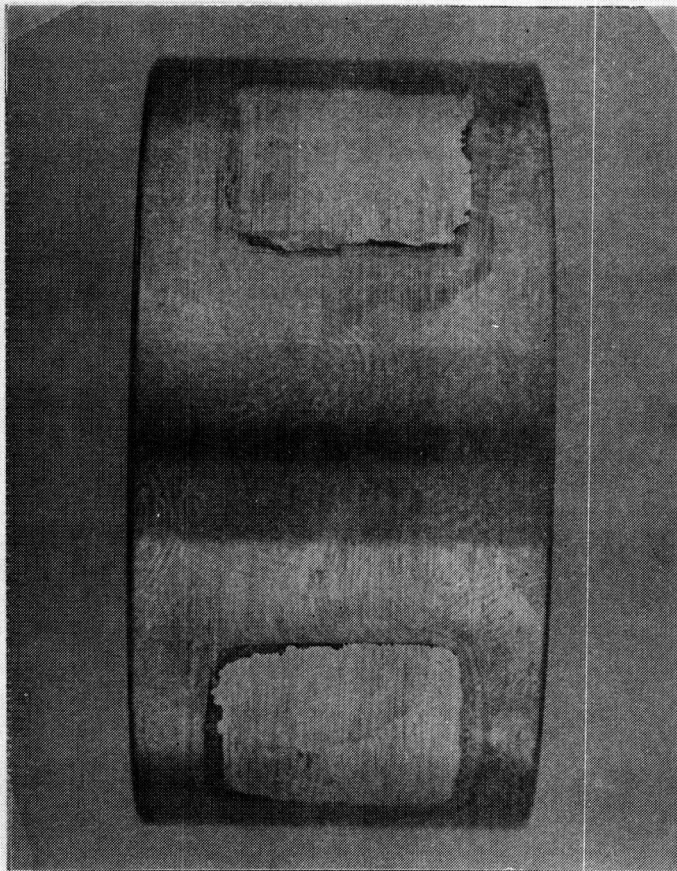

Figure 6
Resolution (Through Three Inches of Steel)
vs
Initial Activity Based on 1 Mil Activation Depth.
Activation to Two Mil Deep Will Double Vertical Scale

ORIGINAL PAGE
BLACK AND WHITE PHOTOGRAPH



0.5 INCH X 0.5 INCH
COPPER PLATE

FIGURE 7. COPPER-PLATED
TITANIUM 6-4 DISK

ORIGINAL PAGE
BLACK AND WHITE PHOTOGRAPH

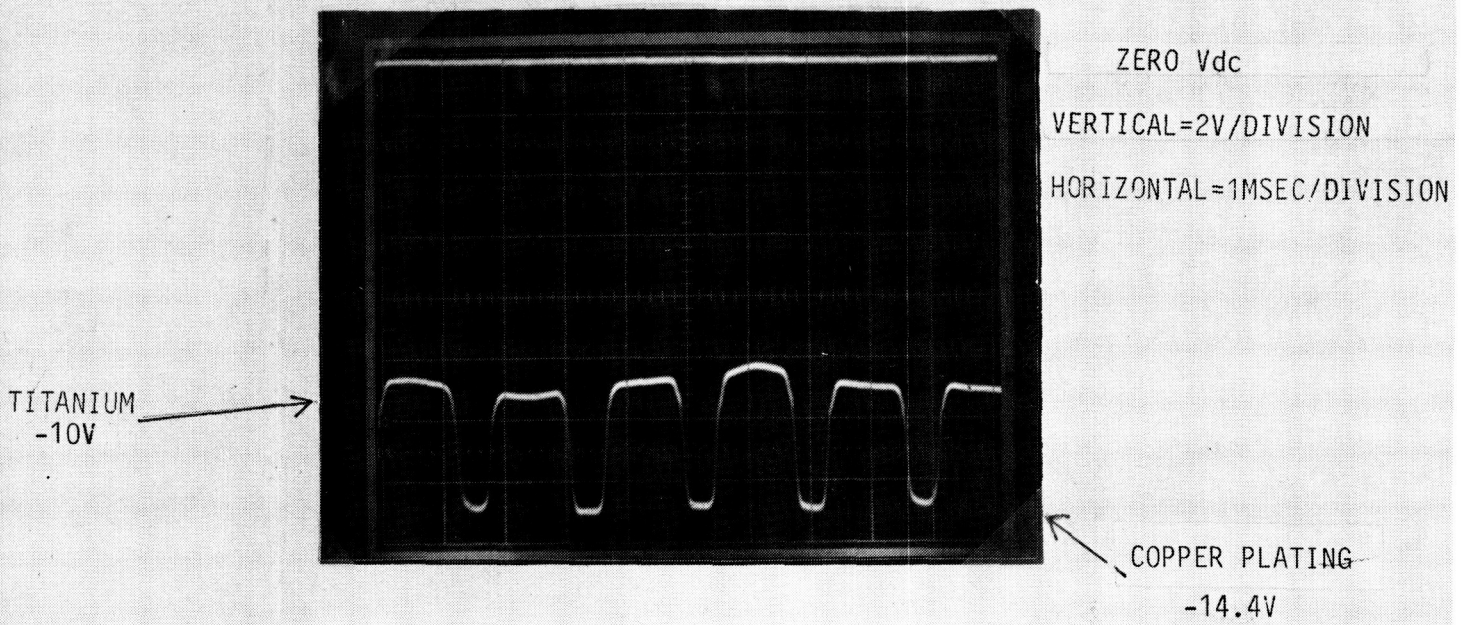

FIGURE 8. COPPER PLATING PROVIDING 4 PULSE PER REVOLUTION SPEED SIGNAL

APPENDIX I

ISOTOPES PRODUCED BY THE OTV
HYDROSTATIC BEARING MATERIALS

ELEMENT ISOTOPE	HALF LIFE (d)	REACTIONS	
** MATERIAL Pure Carbon P5N			
* ACTIVATION SOURCE Alpha			
NONE	0.00		
* ACTIVATION SOURCE Proton			
C	-	0.00 -	
Li	Be7	52.28 Li7(P,A)	
F	-	0.00 -	
* ACTIVATION SOURCE 3He			
C	Be7	53.28 C12(3He,2A)	
Li	Be7	53.28 Li7(P,A)	
F	-	0.00 -	
** MATERIAL Pure Carbon P5-9242			
* ACTIVATION SOURCE Alpha			
C	-	0.00 -	
Si	P32	14.30 Si29(A,P) Si30(A,NP)	No G
Si	P33	25.30 Si30(A,P)	No G
* ACTIVATION SOURCE 3He			
C	Be7	53.28 C12(3He,2P)	
Si	-	0.00 -	
** MATERIAL Kennametal K801			
* ACTIVATION SOURCE Alpha			
W	W185	74.80 W183(A,2P)	
W	W188	69.40 W186(A,2P)	
W	Re183	70.00 W182(A,3N)Os183 B- Re183	
W	Re184	38.00 W182(A,NP)	Isom
		165.00	
W	Re186	3.60 W183(A,P) W186(A,NP)	Isom
W	Os183	0.00 W182(A,3N)	B- d
W	Os185	93.60 W182(A,N) W183(A,2N) W18	
C	-	0.00 -	
Ni	Zn65	243.80 Ni62(A,N)	
* ACTIVATION SOURCE Proton			
W	Ta179	657.00 W182(P,A) W183(P,)	No G
W	Ta183	5.10 W186(P,A)	
W	W181	121.00 W182(P,NP)	
W	W185	0.00 W186(P,NP)	Isom
		74.80	
W	Re183	70.00 W182(P,G) W182(P,N)	
W	Re184	38.00 W183(P,G) W184(P,N)	Isom
		165.00	

ISOTOPES PRODUCED BY THE OTV
HYDROSTATIC BEARING MATERIALS

ELEMENT	ISOTOPE	HALF LIFE (d)	REACTIONS	
C	-	0.00	-	
Ni	Ni57	1.50	Ni58 (P, NP)	
Ni	Co57	27.10	Ni60 (P, A)	
Ni	Co58	0.38	Ni61 (P, A)	Isom
		71.00		
* ACTIVATION SOURCE 3He				
W	Hf179	25.10	W184 (3He, 2A)	
W	Hf181	42.40	W186 (3He, 2A)	
W	W181	121.00	W182 (3He, A)	
W	W185	0.00	W186 (3He, A)	Isom
		74.80		
W	Re183	70.00	W182 (3He, NP)	
W	Re184	38.00	W182 (3He, P)	Isom
		165.00		
W	Re186	3.60	W186 (3He, P)	Isom
		0.00		Half
W	Os185	93.60	W183 (3He, N)	
C	Be7	53.28	C12 (3He, 2A)	
Ni	Ni57	1.50	Ni58 (3He, A)	
** MATERIAL Kennametal 162B				
* ACTIVATION SOURCE Alpha				
Ti	V48	15.98	Ti46 (A, NP)	
Ti	V49	331.00	Ti46 (A, P)	
Ti	Cr51	27.70	Ti48 (A, N) Ti49 (A, 2N) Ti50 (A, 3N)	
C	-	0.00	-	
Ni	Zn65	243.80	Ni62 (A, N)	
Mo	Mo99	2.60	Mo97 (A, 2P)	
Mo	Tc95	61.00	Mo92 (A, P)	Isom
		0.83		
Mo	Tc96	4.30	Mo94 (A, NP)	Isom
		0.00		Seco
Mo	Tc97	90.00	Mo94 (A, P) Mo95 (A, NP)	Isom
		0.00	Mo94 (a, N) Ru97 B- Mo96 (A, 3N) B-	Seco
Mo	Ru97	2.90	Mo94 (A, N) Mo94 (A, 2N) Mo96 (A, 3N)	
Mo	Ru103	39.24	Mo100 (A, N)	
Nb	Tc95	61.00	Nb93 (A, 2N)	
Nb	Nb95	3.60	Nb93 (A, 2P)	Isom
		35.00		
W	Re183	70.00	W182 (A, 3N) Os183 B-	
w	Re184	38.00	W182 (A, NP)	Isom
		165.00		
W	Re186	3.60	W183 (A, P) W186 (A, NP)	Isom
		0.00		Seco
* ACTIVATION SOURCE Proton				
Ti	Sc46	0.01	Ti49 (P, A)	Isom

ISOTOPES PRODUCED BY THE OTV
HYDROSTATIC BEARING MATERIALS

ELEMENT ISOTOPE		HALF LIFE (d)	REACTIONS		
		84.00			
Ti	Sc47	3.34	Ti50(P,A)		
Ti	V48	15.98	Ti47(P,G)	Ti48(P,N)	
Ti	V49	331.00	Ti47(P,N)		
C	-	0.00	-		
Ni	Ni57	1.50	Ni58(P,NP)		
Ni	Co57	271.00	Ni60(P,A)		
Ni	Co58	0.38	Ni61(P,A)		Isom
		71.00			
Mo	Nb91	62.00	Mo94(P,A)		Isom
		0.00			2nd
Mo	Nb92	10.00	Mo95(P,A)		Isom
		0.00			2nd
Mo	Nb95	3.60	Mo98(P,A)		Isom
		35.00			
Mo	Mo99	2.60	Mo100(P,NP)		
Mo	Tc95	61.00	Mo95(P,N)	Mo94(P,G)	
Mo	Tc96	4.30	Mo95(P,G)	Mo96(P,N)	
Mo	Tc97	90.00	Mo96(P,A)	Mo97(P,N)	
Mo	Tc99	0.00	Mo98(P,G)		
Nb	Nb92	10.10	Nb93(P,NP)		
W	Ta179	657.00	W182(P,A)		No G
W	Ta183	5.10	W186(P,A)		
W	W181	121.00	W182(P,NP)		
W	W185	0.00	W186(P,NP)		Isom
		74.80			
W	Re183	70.00	W182(P,G)	W183(P,N)	
W	Re184	38.00	W183(P,G)	W184(P,N)	Isom
		165.00			

* ACTIVATION SOURCE 3He

Ti	Ca45	165.00	Ti50(3He,2A)		
Ti	V48	15.98	Ti46(3He,P)	Ti47(3He,np)	
Ti	V49	331.00	Ti48(3He,NP)		
Ti	Cr51	27.70	Ti49(3He,N)		
Ti	Be7	53.28	C12(3He,2A)		
Ni	Fe55	978.00	Ni60(3He,2A)		No G
Ni	Ni57	1.50	Ni58(3He,A)		

** MATERIAL

* ACTIVATION SOURCE

0.00

** MATERIAL Kennametal 162B

* ACTIVATION SOURCE 3He

Mo	Mo99	2.60	Mo100(3He,A)		
Mo	Tc96	4.30	Mo94(3He,P)	Mo94(3He,NP)	Mo95(3He,NP)

RI/RD 89-214

Page 21

ISOTOPES PRODUCED BY THE OTV
HYDROSTATIC BEARING MATERIALS

ELEMENT	ISOTOPE	HALF LIFE (d)	REACTIONS	
Mo	Tc97	90.00	Mo95 (3He, N)	
Mo	Tc99	0.25	Mo97 (3He, P)	Mo98 (3He, NP)
		0.00		Isom
Mo	Zr89	0.07	Mo94 (3He, 2A)	Isom
		3.30		
Mo	Zr95	64.03	Mo100 (3He, 2A)	
Mo	Nb95	3.60	Mo100 (3He, 2A)	B- Nb95
		35.00		Isom
Nb	Y88	106.60	Nb93 (3He, 2A)	
Nb	Nb92	10.10	Nb93 (3He, NP)	
Nb	Tc95	61.00	Nb93 (2He, N)	
W	Hf179	25.10	W184 (3He, 2A)	
W	Hf181	42.40	W186 (3He, 2A)	
W	W181	121.00	W182 (3He, A)	
W	W185	0.01	W186 (3He, A)	Isom
		74.80		
W	Re183	70.00	W182 (3He, NP)	
W	Re184	38.00	W182 (3He, P)	Isom
		165.00		
W	Re186	3.60	W186 (3He, P)	Isom
		0.00		Seco
W	Os185	93.60	W183 (3He, N)	

** MATERIAL

* ACTIVATION SOURCE

0.00

** MATERIAL P5Z-T5

* ACTIVATION SOURCE Alpha

Zr	Zr89	3.30	Zr90 (A, N)	
Zr	Mo91	0.00	Zr90 (A, 3N)	B- d
Zr	Mo99	2.80	Zr96 (A, N)	
Zr	Nb91	62.00	Zr90 (A, 3N) Mo91	B- Nb91
		0.00		Isom
Zr	Nb92	10.00	Zr90 (A, NP)	Seco
		0.00		Isom
Zr	Nb95	3.60	Zr92 (A, P)	Seco
		35.00		Isom
O	-	0.00	-	

* ACTIVATION SOURCE Proton

Zr	Y87	3.30	Zr90 (P, A)	
Zr	Y88	106.60	Zr91 (P, A)	
Zr	Y91	0.80	Zr94 (P, A)	Isom
		58.00		
Zr	Zr95	65.00	Zr96 (P, NP)	B- D
Zr	Nb91	62.00	Zr91 (P, N)	Zr90 (P, G)

ISOTOPES PRODUCED BY THE OTV
HYDROSTATIC BEARING MATERIALS

ELEMENT ISOTOPE		HALF LIFE (d)	REACTIONS		
Zr	Nb92	10.10	Zr91(P,G)	Zr92(P,N)	
Zr	Nb95	3.60	Zr94(P,G)	Zr96(P,NP)	Zr95 B- Nb95
O	-	0.00	-		
* ACTIVATION SOURCE 3He					
Zr	Sr85	0.04	Zr90(3He,2A)		Isom
		65.00			
Zr	Sr89	50.50	Zr94(3He,2A)		B- D
Zr	Zr95	65.00	Zr96(3He,A)		Isom
Zr	Nb91	62.00	Zr90(3He,NP)		Seco
		0.00			
Zr	Nb92	10.00	Zr90(3He,P)		Isom
		0.00			Seco
Zr	Nb95	3.60	Zr94(3He,NP)	Zr96(3He,A)	Zr95 B- Nb95
Zr	Sr91	0.40	Zr96(3He,2A)		B- D
		0.00			
Zr	Y91	0.83	Mo100(3He,2A)	Zr95 B-	Y91
		58.50			
O	-	0.00	-		
** MATERIAL NC 132					
* ACTIVATION SOURCE Alpha					
Si	P32	14.30	Si29(A,P)	Si30(A,NP)	No G
Si	P33	25.30	Si30(A,P)		No G
N	-	0.00	-		
* ACTIVATION SOURCE Proton					
		0.00			No i
* ACTIVATION SOURCE 3He					
Si	Si29	14.30	Si30(3He,P)		No G
N	-	0.00	-		
** MATERIAL Carbon-Carbon					
* ACTIVATION SOURCE Alpha					
		0.00			No i
* ACTIVATION SOURCE Proton					
		0.00			No i
* ACTIVATION SOURCE 3He					
C	Be7	53.28	C12(3He,2A)		

ISOTOPES PRODUCED BY THE OTV
HYDROSTATIC BEARING MATERIALS

ELEMENT ISOTOPE	HALF LIFE (d)	REACTIONS
** MATERIAL		
* ACTIVATION SOURCE	0.00	
** MATERIAL Kennametal 162B		
* ACTIVATION SOURCE Alpha Nb Nb95	36.30	Nb93(A,2P) Isom
* ACTIVATION SOURCE Proton Ni Co57	271.80	Ni58(P,2P)
* ACTIVATION SOURCE Alpha Ni Co57	271.80	Ni58(A,2P)

APPENDIX II

PLEASE FOLLOW THE FOLLOWING PROCEDURE TO PLATE THE COUPONS.

1. ENBOND 127S BATH

IMMERSE FOR 5 MINUTES

COLD WATER RINSE

COLD WATER RINSE

2. TERNARY ACID PICKLE

IMMERSE FOR 60 SECONDS OR UNTIL UNIFORM GASSING IS OBSERVED.
(PLEASE RECORD THE TIME)

COLD WATER RINSE

3. ACTANE TI 2000

IMMERSE FOR 10 MINUTES OR UNTIL A DARK GREY SURFACE
APPEARANCE IS NOTICED. (PLEASE RECORD THE TIME).

COLD WATER RINSE

4. 10% HYDROCHLORIC ACID

IMMERSE FOR 5 MINUTES

COLD WATER RINSE

5. ULTRASONIC WATER RINSE

100 - 150°F - 5 MINUTES OR UNTIL A UNIFORM SILVER/GREY
SURFACE APPEARANCE.

COLD WATER RINSE

6. WOOD'S NICKEL STRIKE.

COLD WATER RINSE

7. EDCOPPER - 3 TO 5 MIL.

Please make up the following baths.

1. ENBOND HP 127S.

ENBOND HP 127S 70 G/L
TEMPERATURE - 190oF
TANK - MILD STEEL

P.S. SOLUTION IS CAUSTIC

2. TERNARY ACID PICKLE.

ACTANE 70 30 G/L
CONC. SULFURIC ACID 6.5% BY VOLUME
CONC. NITRIC ACID (70%) 12.5% BY VOLUME

ROOM TEMPERATURE
TANK - PLASTIC OR RUBBER LINED.

P.S. SOLUTION CONTAINS FLUORIDE.

3. ACTANE TI2000

USE FULL STRENGTH.
pH 1.7 - 1.8 (USE pH PAPER TO MEASURE THE pH)
TEMPERATURE - 158oF
TANK - POLYPRO OR PLASTIC LINES
HEATER - TEFLON COATED.

P.S. SOLUTION CONTAINS FLUORIDE

4. 10% HYDROCHLORIC ACID.

CONC. HYDROCHLORIC ACID - 10% BY VOLUME.

5. WOOD/S NICKEL STRIKE. (STANDARD)

1. Report No. CR182274		2. Government Accession No.		3. Recipient's Catalog No.	
4. Title and Subtitle OTVE TURBOPUMP CONDITION MONITORING FINAL REPORT TASK E.5				5. Report Date AUGUST 1989	
				6. Performing Organization Code	
7. Author(s) P. COLEMAN J. COLLINS				8. Performing Organization Report No. RI/RD 89-214	
9. Performing Organization Name and Address ROCKWELL INTERNATIONAL- ROCKETDYNE DIVISION 6633 CANOGA AVE. CANOGA PARK, CA. 91303				10. Work Unit No.	
				11. Contract or Grant No. NA53-23773	
12. Sponsoring Agency Name and Address NATIONAL AERONAUTICS AND SPACE ADMINISTRATION WASHINGTON, D.C. 20546-0001				13. Type of Report and Period Covered NASA CONTRACT REPORT FINAL 10/89 - 09/88	
				14. Sponsoring Agency Code	
15. Supplementary Notes					
16. Abstract RECENT WORK HAS BEEN CARRIED OUT ON DEVELOPMENT OF ISOTOPE WEAR ANALYSIS AND OPTICAL AND EDDY CURRENT TECHNOLOGIES TO PROVIDE BEARING WEAR MEASUREMENTS AND REAL TIME MONITORING OF SHAFT SPEED, SHAFT AXIAL DISPLACEMENT AND SHAFT ORBIT OF THE OTVE HYDROSTATIC BEARING TESTER. RESULTS SHOW SHAFT AXIAL DISPLACEMENT CAN BE OPTICALLY MEASURED (AT THE SAME TIME AS SHAFT ORBITAL MOTION AND SPEED) TO WITHIN 0.3 MILS BY TWO FIBEROPTIC DEFLECTOMETERS. EVALUATION OF EDDY CURRENT PROBES SHOWED THAT, IN ADDITION TO MEASURING SHAFT ORBITAL MOTION, THEY CAN BE USED TO MEASURE SHAFT SPEED WITHOUT HAVING TO MACHINE GROOVES ON THE SHAFT SURFACE AS IS USUAL PRACTICE FOR TURBOMACHINERY. THIS PAPER PRESENTS THE INTERIM RESULTS OF THIS CONDITION MONITORING EFFORT.					
17. Key Words (Suggested by Author(s)) ISOTOPE WEAR ANALYSIS, EDDY CURRENT, CONDITION MONITORING, SHAFT POSITION ANALYZER, BEARING WEAR MONITORING.				18. Distribution Statement UNCLASSIFIED - UNLIMITED	
19. Security Classif. (of this report) UNCLASSIFIED		20. Security Classif. (of this page) UNCLASSIFIED		21. No. of Pages 26	22. Price*

* For sale by the National Technical Information Service, Springfield, Virginia 22151