

INDEPENDENT ORBITER ASSESSMENT ✓

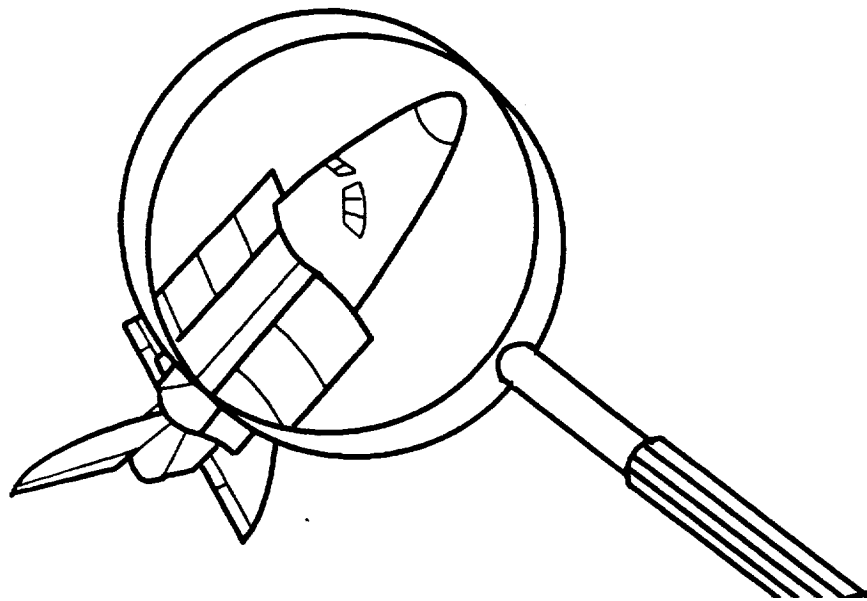

(NASA-CR-185550) INDEPENDENT ORBITER
ASSESSMENT (IOA): FMEA/CIL ASSESSMENT
Interim Report (McDonnell-Douglas
Astronautics Co.) 100 p

N90-11783

ORCL 22B

Unclas

63/16 0211652

MCDONNELL DOUGLAS

INDEPENDENT ORBITER ASSESSMENT

**FMEA/CIL
ASSESSMENT
INTERIM REPORT**

9 MARCH 1988



MCDONNELL DOUGLAS AERONAUTICS COMPANY
ENGINEERING SERVICES

SPACE TRANSPORTATION SYSTEM ENGINEERING AND OPERATIONS SUPPORT

WORKING PAPER NO. 1.0-WP-VA88003-40

INDEPENDENT ORBITER ASSESSMENT
FMEA/CIL ASSESSMENT INTERIM REPORT

9 MARCH 1988

This Working Paper is Submitted to NASA under
Task Order No. VA88003, Contract NAS 9-17650

Prepared by:

M. J. Saïidi
Independent Orbiter
Assessment

Prepared by:

L. J. Swain
Independent Orbiter
Assessment

Prepared by:

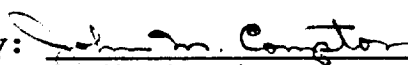
J. M. Compton
Section Manager-FMEA/CIL
Independent Orbiter
Assessment

Approved by:

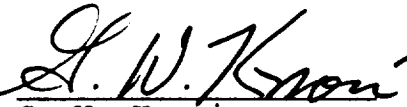
G. W. Knori
Technical Manager
Independent Orbiter
Assessment

Approved by:

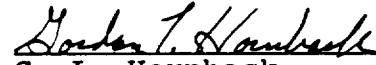
G. L. Hornback
Project Manager
STSEOS

CONTENTS

Section	Title	Page
1.0	EXECUTIVE SUMMARY	1
2.0	INTRODUCTION	5
3.0	RESULTS	7
4.0	GENERAL CONCLUSIONS AND OBSERVATIONS	9
5.0	RECOMMENDATIONS	11
6.0	REFERENCES	12
APPENDIX A ACRONYMS		A-1
APPENDIX B DEFINITIONS, GROUND RULES, AND ASSUMPTIONS		B-1
B.1	Definitions	B-2
B.2	Project Level Ground Rules and Assumptions	B-4
APPENDIX C SUBSYSTEM ASSESSMENT SUMMARIES		C-1
C.1	Fuel Cell Powerplant	C-2
C.2	Hydraulic Actuators	C-2
C.3	Displays and Control	C-10
C.4	Guidance, Navigation and Control	C-10
C.5	Orbiter Experiments	C-10
C.6	Auxiliary Power Unit	C-15
C.7	Backup Flight System	C-15
C.8	Electrical Power, Distribution & Control	C-18
C.9	Landing and Deceleration	C-18
C.10	Purge, Vent and Drain	C-20
C.11	Pyrotechnics	C-24
C.12	Active Thermal Control System and Life Support System	C-24
C.13	Crew Equipment	C-29
C.14	Instrumentation	C-32
C.15	Data Processing System	C-32
C.16	Atmosphere Revitalization Pressure Control System	C-32
C.17	Hydraulics and Water Spray Boiler	C-37
C.18	Mechanical Activation System	C-37
C.19	Manned Maneuvering Unit	C-40
C.20	Nose Wheel Steering	C-40
C.21	Remote Manipulator System	C-42
C.22	Atmospheric Revitalization System	C-45

	Page
APPENDIX C SUBSYSTEM ASSESSMENT SUMMARIES (Cont.)	
C.23 Extravehicular Mobility Unit	C-48
C.24 Power Reactant Supply and Distribution System	C-50
C.25 Main Propulsion System	C-53
C.26 Orbital Maneuvering System	C-53
C.27 Reaction Control System	C-57
C.28 Comm and Tracking	C-60
APPENDIX D COMPARISON OF IOA FINDINGS TO ROCKWELL CIL PACKAGES	D-1

List of Tables

Table	Title	Page
Table 1-1	FMEA/CIL ASSESSMENT OVERVIEW	3
Table 1-2	CIL ISSUES STATUS	4
Table 2-1	ORBITER AND GFE SUBSYSTEMS	6



Independent Orbiter Assessment
FMEA/CIL Assessment Interim Report

1.0 EXECUTIVE SUMMARY

The McDonnell Douglas Astronautics Company (MDAC) was selected in June 1986 to perform an Independent Orbiter Assessment (IOA) of the Failure Modes and Effects Analysis (FMEA) and Critical Items List (CIL). Direction was given by the Orbiter and GFE Projects Office to perform the hardware analysis and assessment using the instructions and ground rules defined in NSTS 22206, Instructions for Preparation of FMEA and CIL.

The IOA analysis features a top-down approach to determine hardware failure modes, criticality, and potential critical items. To preserve independence, the analysis was accomplished without reliance upon the results contained within the NASA and prime contractor FMEA/CIL documentation. The assessment process compares the independently derived failure modes and criticality assignments to the proposed NASA post 51-L FMEA/CIL documentation. When possible, assessment issues are discussed and resolved with the NASA subsystem managers. Unresolved issues are elevated to the Orbiter and GFE Projects Office manager, Configuration Control Board (CCB), or Program Requirements Control Board (PRCB) for further resolution. An issue generally refers to a disagreement between the NASA FMEA/CIL and the IOA failure mode analysis results. This process was reviewed twice by the National Research Council, Shuttle Criticality Review and Hazard Analysis Audit Committee, and was concluded to be acceptable.

As a result of the programmatic requirement to end the IOA task in March 1988, the FMEA/CIL baseline under review was "frozen" as of 1 January 1988. This date allowed for the majority of subsystems to be assessed based upon the proposed post 51-L NASA FMEA/CIL documentation presented to either the CCB or PRCB. However, for those subsystems where the NASA post 51-L FMEA/CIL reviews were still in progress, the assessment used unofficial FMEA/CIL data provided by the subsystem managers or whatever documentation that was available as of 1 January 1988.

The assessment results for each subsystem have been documented in separate assessment reports (Section 6.0 References), and summaries are provided in Appendix C. Table 1-1 presents an overview of the NASA FMEA/CIL documentation assessed, the IOA recommended baseline, and unresolved issues, and Table 1-2 presents the status of CIL issues. A total of 3,193 total FMEA issues and 1,586 CIL issues remain to be resolved. Many issues are, however, "paper" issues attributed to the lack of updated FMEA/CIL documentation, or arise because of the lack of adequate time to pursue resolution with the subsystem managers (a time consuming process). Due to these reasons, the actual FMEA/CIL documentation should be in far better shape than these numbers suggest.

Some of the Orbiter FMEA/CIL assessment issues are attributed to differences in interpreting NSTS 22206 ground rules and instructions. For example, Rockwell occasionally used a very broad redundancy interpretation approach which caused more 1R and 2R functional criticalities than IOA. It appears that the definition of redundancies was expanded to include unrelated multiple failures. IOA on the other hand, limited redundancy to failure items under study, which resulted in less severe functional criticalities.

The most important Orbiter assessment finding was the previously unknown "stuck" autopilot push-button criticality 1/1 failure mode, having a worst case effect of loss of crew/vehicle when a microwave landing system is not active. Rockwell has been directed by the CCB to add the failure mode to the FMEA/CIL documentation and to implement a software change to bypass a stuck "Auto" switch.

SPAR Aerospace conducted their Remote Manipulator System (RMS) failure mode analysis in a manner similar to IOA and consistent with NSTS 22206. One major issue remains open affecting sixty-nine FMEA/CIL items. The issue concerns uncommanded motion of the arm while the arm is within two feet of the Orbiter, payload, or a suited crewman. Arm malfunction detection software cannot guarantee that the arm will be stopped in time to prevent impact when within the two feet envelope. To be technically correct and totally in agreement with NSTS 22206, IOA recommends that uncommanded motion failure modes be assigned a worst case effect criticality of 1/1. Currently, the criticality assignments are 2/1R.

The Extra Vehicular Maneuvering Unit (EMU) FMEA/CIL documentation prepared by Hamilton Standard followed NSTS 22206 ground rules and was in general agreement with IOA. Assessment of the Manned Maneuvering Unit (MMU) was to an old FMEA/CIL baseline due to NASA rescheduling their review to a later date.

In summary, the resolution of the remaining CIL issues is being pursued to finalize and resolve those with possible safety implications.

**TABLE 1-1
FMEA / CIL ASSESSMENT OVERVIEW (INTERIM)**

SUBSYSTEM	FMEA			CIL		
	IOA	NASA	ISSUE	IOA	NASA	ISSUE
Fuel Cell Powerplant (FCP)	50	50	0	24	24	0
Hydraulic Actuators (HA)	112	112	0	59	59	0
Displays and Control (D&C)	171	264	45	21	21	0
Guidance, Navigation & Control (GN&C)	175	148	56	36	36	0
Orbiter Experiments (OEX)	81	191	24	1	1	0
Auxiliary Power Unit (APU)	314	313	2	106	106	0
Backup Flight System (BFS)	33	0	0	25	22	0
Electrical Power, Distribution & Control (EPD&C)	435	435	0	158	158	0
Landing & Deceleration (L&D)	246	260	86	124	120	51
Purge, Vent and Drain (PV&D)	62	46	2	15	8	3
Pyrotechnics (PYRO)	41	37	4	41	37	4
Active Thermal Control System (ATCS) and Life Support System (LSS)	1068	708	402	318	210	141
Crew Equipment (CE)	422	351	123	80	82	4
Instrumentation (INST)	107	96	25	22	18	5
Data Processing System (DPS)	78	78	4	23	25	2
Atmospheric Revitalization Pressure Control System (ARPCS)	273	262	124	73	87	48
Hydraulics & Water Spray Boiler (HYD & WSB)	447	364	68	183	111	23
Mechanical Actuation System (MAS)	713	510	472	512	252	310
Manned Maneuvering Unit (MMU)	204	179	121	95	110	92
Nose Wheel Steering (NWS)	68	58	14	41	34	9
Remote Manipulator System (RMS)	821	585	80	448	390	74
Atmospheric Revitalization System (ARS)	223	311	102	84	113	36
Extravehicular Mobility Unit (EMU)	688	614	113	547	474	40
Power Reactant Supply & Distribution System (PRS&D)	382	278	27	79	89	9
Main Propulsion System (MPS)	1365	1264	399	711	749	191
Orbital Maneuvering System (OMS)	285	243	117	140	117	60
Reaction Control System (RCS)	763	623	376	249	206	241
Comm and Tracking (C&T)	1108	697	407	298	239	294
Total as of 1 January 1988	10735	9077	3193	4513	3898	1637

**TABLE 1-2
CIL ISSUE STATUS (INTERIM)**

SUBSYSTEM	IOA CIL Issues	Accepted By NASA	Withdrawn By MDAC	Total Remaining Open
Fuel Cell Powerplant (FCP)	1	1	0	0
Hydraulic Actuators (HA)	17	2	15	0
Displays and Control (D&C)	0	0	0	0
Guidance, Navigation & Control (GN&C)	0	0	0	0
Orbiter Experiments (OEX)	1	0	1	0
Auxiliary Power Unit (APU)	25	4	21	0
Backup Flight System (BFS)	12	12	0	0
Electrical Power, Distribution & Control (EPD&C)	0	0	0	0
Landing & Deceleration (L&D)	51	0	0	51
Purge, Vent and Drain (PV&D)	3	0	0	3
Pyrotechnics (PYRO)	4	0	0	4
Active Thermal Control System (ATCS) and Life Support System (LSS)	141	0	0	141
Crew Equipment (CE)	4	0	0	4
Instrumentation (INST)	5	0	0	5
Data Processing System (DPS)	2	2	0	2
Atmospheric Revitalization Pressure Control System (ARPCS)	48	0	0	48
Hydraulics & Water Spray Boiler (HYD & WSB)	23	0	0	23
Mechanical Actuation System (MAS)	310	0	0	310
Manned Maneuvering Unit (MMU)	92	0	0	92
Nose Wheel Steering (NWS)	9	0	0	9
Remote Manipulator System (RMS)	74	0	0	74
Atmospheric Revitalization System (ARS)	36	0	0	36
Extravehicular Mobility Unit (EMU)	40	0	0	40
Power Reactant Supply & Distribution System (PRS&D)	9	0	0	9
Main Propulsion System (MPS)	191	0	0	191
Orbital Maneuvering System (OMS)	60	0	0	60
Reaction Control System (RCS)	241	0	0	241
Comm and Tracking (C&T)	294	0	0	294
Totals	1693	21	37	1637

2.0 INTRODUCTION

The 51-L Challenger accident prompted NASA to readdress safety policies, concepts, and rationale being used in the National Space Transportation System (NSTS). The NSTS Office has undertaken the task of reevaluating the FMEA/CIL for the Space Shuttle design. MDAC is providing an independent assessment of the proposed post 51-L orbiter FMEA/CIL for completeness and technical accuracy.

The MDAC was initially tasked in June 1986 to conduct an independent analysis and assessment on twenty subsystems. Subsequently, in April 1987 the additional eight subsystems were also added which provided complete coverage of all the Orbiter subsystems. Table 2-1 provides a listing of the Orbiter and GFE subsystems identified by NASA to the National Research Council, Shuttle Criticality Review and Hazard Analysis Audit Committee.

The IOA analysis approach is summarized in the following steps 1.0 through 3.0. Step 4.0 summarizes the assessment of the NASA and Prime Contractor FMEA/CIL.

Step 1.0 Subsystem Familiarization

- 1.1 Define subsystem functions
- 1.2 Define subsystem components
- 1.3 Define subsystem specific ground rules and assumptions

Step 2.0 Define Subsystem Analysis Diagram

- 2.1 Define subsystem
- 2.2 Define major assemblies
- 2.3 Develop detailed subsystem representations

Step 3.0 Failure Events Definition

- 3.1 Construct matrix of failure modes
- 3.2 Document IOA analysis results

Step 4.0 Compare IOA Analysis Data to NASA FMEA/CIL

- 4.1 Resolve differences
- 4.2 Review in-house
- 4.3 Document assessment issues
- 4.4 Forward findings to Project Manager

As a result of the preceding steps, general project assumptions and ground rules (Appendix B) were developed to amplify and clarify instructions in NSTS 22206. Also, subsystem specific assumptions and ground rules were defined as appropriate for the subsystems. These assumptions and ground rules are presented in each individual subsystem report.

Table 2-1

ORBITER and GFE SUBSYSTEMS

ORIGINAL TWENTY SUBSYSTEMS (JUNE 1986)

- o Guidance, Navigation & Control
- o Data Processing System (DPS)
- o Backup Flight System (BFS)
- o Nose Wheel Steering (NWS)
- o Instrumentation (INST)
- o Electrical Power, Distribution & Control (EPD&C)
- o Main Propulsion System (MPS)
- o Fuel Cell Powerplant (FCP)
- o Power Reactant Supply & Distribution System (PRS&D)
- o Orbital Maneuvering System (OMS)
- o Reaction Control System (RCS)
- o Auxiliary Power Unit (APU)
- o Hydraulics & Water Spray Boiler (HYD & WSB)
- o Atmospheric Revitalization System (ARS)
- o Atmospheric Revitalization Pressure Control System (ARPCS)
- o Extravehicular Mobility Unit (EMU)
- o Manned Maneuvering Unit (MMU)
- o Landing & Deceleration (L&D)
- o Hydraulic Actuators (HA)
- o Remote Manipulator System (RMS)

ADDITIONAL EIGHT SUBSYSTEMS (APRIL 1987)

- o Communication and Tracking (C&T)
- o Displays and Control (D&C)
- o Orbiter Experiments (OEX)
- o Pyrotechnics (PYRO)
- o Purge, Vent and Drain (PV&D)
- o Mechanical Actuation System (MAS)
- o Active Thermal Control System (ATCS), Life Support System (LSS), and Airlock Support System (ALSS)
- o Crew Equipment (CE)

3.0 RESULTS

The IOA task was accomplished in three phases; namely a review of both the NSTS 22206 and RI 100-2G FMEA/CIL Desk Instructions, an independent subsystem failure modes analysis, and an independent assessment of the NASA and Prime Contractor FMEA/CIL documentation. The NSTS 22206 and RI 100-2G documents were first reviewed and evaluated to determine if any omissions and ambiguities existed that impeded the preparation process or prevented the surfacing of major technical issues. This task was completed and a report was published in October 1986 (Reference 1). Many of the recommendations have been incorporated in subsequent versions of NSTS 22206.

The independent failure mode analysis process used available subsystem drawings and schematics, documentation, and procedures. Each of the twenty-eight subsystems was broken down into lower level assemblies and individual hardware components using block diagrams. Each component was then evaluated and analyzed for credible failure modes and effects. Criticalities were assigned based on the worst possible effect of each failure mode consistent with the NSTS 22206. And to preserve independence, the analysis was accomplished without reliance upon the results contained within the NASA FMEA/CIL documentation. The independent analysis of the twenty-eight subsystems was completed and published in separate analysis reports (see Section 6.0 References).

The final phase of the IOA task was to provide an independent assessment of the NASA and Prime Contractor post 51-L FMEA/CIL results for completeness and technical accuracy. This process compared the independently derived analysis results to the proposed NASA post 51-L FMEA/CIL, and investigated any significant discrepancies.

The IOA assessment process resulted in a total of 10,735 FMEAs and 4,482 potential critical items, which resulted in a total of 3,193 FMEA issues and 1,586 CIL issues after being compared with the proposed NASA FMEA/CIL data. An issue generally refers to a disagreement between the IOA and NASA FMEA/CIL results. The assessment results were fully documented in separate assessment reports (Section 6.0 References), and some of the major issues are briefly discussed in Appendix C for each subsystem. Appendix D provides a comparison of IOA recommended CIL items and Rockwell CIL packages.

The most significant Orbiter assessment issue was uncovered by the Nose Wheel Steering (NWS) subsystem assessment team. The failure mode was a "stuck" autopilot push-button causing the worst case effect of loss of crew/vehicle (criticality 1/1). The Orbiter autopilot is used for entry, and manually disengaged before landing. The autopilot is engaged by "Roll/Yaw Auto" and "Pitch Auto" push-button indicators (PBIs). If either "Auto" PBI fails closed, the autopilot cannot be permanently disengaged. With the autopilot remaining engaged, the Orbiter will attempt to

"Autoland", which requires a Microwave Landing System (MLS) on the ground. MLS is not required for day landings, and has not been "available" for four of the last seven STS missions. Without the MLS, use of the autoland alone will cause the Orbiter to miss the runway. A single point failure with no redundancy and which threatens loss of crew/vehicle is categorized by NSTS 22206 as a "criticality 1" item. Rockwell is adding the failure mode to the FMEA/CIL baseline and developing a software change to bypass a failed "Auto" switch.

SPAR Aerospace prepared their RMS FMEAs in a manner similar to IOA and consistent with NSTS 22206. The only major difference is one issue which could not be resolved with the subsystem manager. This issue is the use of software routines as unlike redundancy to downgrade the criticalities on FMEAs. The failure mode was uncommanded arm motion. The failure effect is RMS arm impact with the Orbiter, payload, or suited astronauts. Standard arm operation such as berthing/unberthing, grappling, payload deployment and retrieval, requires the arm to approach the Orbiter or payload closer than two feet. Any malfunction resulting in uncommanded motion while the arm is within this two foot envelope presents the possibility of impact with the Orbiter. Arm malfunction detection software routines or operator action cannot guarantee that the arm can be stopped in time to prevent impact. The software design specification is to stop the arm within a stopping distance of two feet. Consequently, the IOA recommendation is that the sixty-nine uncommanded arm motion failure modes be upgraded from criticality 2/1R to 1/1. This issue has gone before the CCB, but has not been presented to the PRCB.

4.0 GENERAL CONCLUSIONS AND OBSERVATIONS

The number of open issues associated with the subsystem FMEA/CIL assessment is identified and presented in Table 1-1. Some of these issues may be attributed to the lack of updated FMEA/CIL data not being received by 1 January 1988 in order to adequately assess the assigned criticalities. Further, due to the programmatic requirement to end the IOA task in the March 1988 timeframe, adequate time was not always available to resolve credible issues with the subsystem manager (a time consuming process). Consequently, these issues remain for later resolution. All issues are fully discussed for each subsystem in separate assessment reports. The following paragraphs briefly discuss some of the difficulties and observations encountered during the IOA study period:

- A. Late and Incomplete FMEA/CIL Documentation - Due to some NASA/RI FMEA/CIL reviews extending past 1 January 1988, IOA was not always able to assess the most current FMEA/CIL baseline and consequently did not resolve the relevant issues with subsystem managers. For example, the Main Propulsion System (MPS) and Communication and Tracking Subsystems are still in the review process as of 9 March 1988. Many other subsystems have only updated the CILs, and FMEAs that are not CIL items are to be updated at a later date, e.g., Atmospheric Revitalization Subsystem and Display and Control Subsystem.
- B. Ground Rules Interpretation - As a result of ambiguous language used in NSTS 22206, many disagreements were noted analyzing hardware failure modes. Some of the major sources of confusion are discussed briefly below for like and unlike redundancies, redundancy screens, emergency systems, and crew action and its impact on deriving criticalities.
 - a. Like and Unlike Redundancy - The interpretation of like and unlike redundant items and definition of a hardware item function are not clearly defined; however, their impact in assigning functional criticality is significant. A broad interpretation creates more 1R and 2R functional criticalities. And most importantly, the discussion of parallel functional paths is not adequate to clarify redundancies. Two examples are discussed below

Example 1 - One of the single most important difficulties encountered during the assessment of the NASA/Rockwell data was the utilization of multiple scenarios in assigning functional criticalities. In such cases, the Rockwell approach seemed to investigate the redundancies to the effect of the failure of the item under study instead of redundancies to the item. For example, failure of the fill and drain Quick Disconnect (QD) and the drain cap on the supply water system was tied to the failure of the radiators and ammonia boiler systems in

the active thermal control system. This was apparently done since loss of the flash evaporator system was seen as an effect of the failure under study which would therefore be a redundant leg to the radiators and ammonia boiler systems. In these cases, the functional criticalities were assigned for potential loss of life/vehicle. IOA interpretation is to make the QD and the drain cap redundant to each other and then investigate the functional loss (flash evaporator system) arising from loss of these redundancies. In this manner, only a potential for worst case loss of mission was anticipated by IOA instead of loss of crew/vehicle.

Example 2 - In certain cases, the Rockwell analysis used failure of another item to be the cause for the failure of the item under study. This approach assumes a failure is already in progress which is contrary to the hardware criticality requirements stated in the NSTS 22206. Under the hardware criticality requirements only singular direct effect of the identified failure mode of a hardware item is to be investigated.

- b. Redundancy Screens - Language such as "...capable of check out..." for Screen A, and "...from a single credible event..." for Screen C are left for a lot of conjecture on the part of an analyst. Further, the objectives for complying with the screens are not sufficiently defined in order to adequately cover them.
- c. Emergency Systems - The definition of the emergency systems excludes hardware items which are used during nominal mission phases and any intact abort cases. For example, the Launch Entry Helmet oxygen supply panel and the Airlock Support System were assigned emergency status by the subsystem managers. This created a very conservative approach open to personal feelings and not consistent with the NSTS 22206.
- d. Crew Action - Crew action in response to a failure is not clear when assigning hardware criticality as opposed to functional criticality. Also, off-nominal versus nominal versus contingency crew actions are used interchangeably throughout the NSTS 22206 creating confusion.

5.0 RECOMMENDATIONS

Based upon the assessment results and independent study of the twenty-eight subsystems, the following recommendations are drawn:

- A. Consideration should be given to resolving all of the issues identified by IOA to ensure that no item remains with possible safety implications.
- B. The unassociated multiple failure scenarios and failures already in progress as used by Rockwell should be evaluated, since they create a very broad and conservative methodology to the FMEA/CIL process. This approach may reduce visibility into failure modes and effects for some particular items, since the majority of the functional criticality 2s and 3s are replaced by 1Rs and 2Rs respectively.
- C. Consideration should be given in improving NSTS 22206 to eliminate sources of ambiguities. The document should be rearranged to provide step-by-step procedures and instructions for conducting hardware analysis. This would reduce guess work and eliminate differences in philosophy used from one subsystem to another. More specifically, the related topics with redundancies (criticality, screens, like/unlike...etc) should be further expanded to ensure consistent application of methodology and criticality assignments.
- D. Adequate coordination and interface should be established between analysis subsystems to eliminate duplication of effort in interfacing subsystems, and to ensure complete coverage of all hardware items.

6.0 REFERENCES

NSTS 22206 AND RI 100-2G REVIEW

1. Traves, S. T.: FMEA/CIL Instructions and Ground Rules, 1.0-WP-VA86001-01, 14 October 1986

INDEPENDENT ANALYSIS REPORTS

2. Drapela, L. J.: Analysis of the Guidance, Navigation, and Control Subsystem, 1.0-WP-VA86001-16, 19 December 1986
3. Robb, B. J.: Analysis of the Data Processing Subsystem, 1.0-WP-VA86001-02, 24 October 1986
4. Ewell, J. J.: Analysis of the Backup Flight Subsystem, 1.0-WP-VA86001-18, 8 December 1986
5. Hochstein, A. L.: Analysis of the Nose Wheel Steering Subsystem, 1.0-WP-VA86001-03, 1 November 1986
6. Addis, A. W.: Analysis of the Instrumentation Subsystem, 1.0-WP-VA86001-17, 12 December 1986
7. Addis, A. W.: Analysis of the Communication and Tracking Subsystem, 1.0-WP-VA87001-09, 31 December 1987
8. Schmeckpeper, K. R.: Analysis of the Electrical Power Distribution and Control Subsystem, 1.0-WP-VA86001-28, 3 April 1987
9. Schmeckpeper, K. R.: Analysis of the Electrical Power Distribution and Control / Electrical Power Generation Subsystem, 1.0-WP-VA86001-19, 19 December 1986
10. Robinson, W. W.: Analysis of the Electrical Power Distribution and Control / Remote Manipulator Subsystem, 1.0-WP-VA86001-26, 12 February 1987
11. Robinson, W. M.: Analysis of the Pyrotechnics Subsystem, 1.0-WP-VA88001-01, 19 January 1988
12. Marino, A. J.: Analysis of the Main Propulsion Subsystem, 1.0-WP-VA86001-22, 6 January 1987
13. Hiott, M. R.: Analysis of the Electrical Power Generation / Fuel Cell Powerplant Subsystem, 1.0-WP-VA86001-10, 5 December 1986
14. Hiott, M. R.: Analysis of the Electrical Power Generation / Power Reactant Storage and Distribution Subsystem, 1.0-WP-VA86001-11, 5 December 1986

15. Paul, D. J.: Analysis of the Orbital Maneuvering Subsystem, 1.0-WP-VA86001-21, 12 January 1987
16. Paul, D. J.: Analysis of the Reaction Control Subsystem, 1.0-WP-VA86001-27, 19 January 1987
17. Barnes, J. E.: Analysis of the Auxiliary Power Unit Subsystem, 1.0-WP-VA86001-14, 12 December 1986
18. Davidson, W. R.: Analysis of the Hydraulics and Water Spray Boiler Subsystems, 1.0-WP-VA86001-20, 15 December 1986
19. Saiidi, M. J.: Analysis of the Atmospheric Revitalization Subsystem, 1.0-WP-VA86001-13, 1 December 1986
20. Saiidi, M. J.: Analysis of the Atmospheric Revitalization Pressure Control Subsystem, 1.0-WP-VA86001-12, 28 November 1986
21. Saiidi, M. J.: Analysis of the Life Support and Airlock Support Subsystems, 1.0-WP-VA87001-02, 2 November 1987
22. Raffaelli, G. G.: Analysis of the Extravehicular Mobility Unit, 1.0-WP-VA86001-15, 28 December 1986
23. Raffaelli, G. G.: Analysis of the Manned Maneuvering Unit Subsystem, 1.0-WP-VA86001-09, 21 November 1986
24. Weissinger, W. D.: Analysis of the Landing and Deceleration Subsystems, 1.0-WP-VA86001-25, 19 January 1987
25. Riccio, J. R.: Analysis of the Ascent Thrust Vector Control Actuator Subsystem, 1.0-WP-VA86001-06, 21 November 1986
26. Riccio, J. R.: Analysis of the Elevon Subsystem, 1.0-WP-VA86001-07, 21 November 1986
27. Riccio, J. R.: Analysis of the Body Flap Subsystem, 1.0-WP-VA86001-05, 21 November 1986
28. Riccio, J. R.: Analysis of the Rudder/Speed Brake Subsystem, 1.0-WP-VA86001-04, 21 November 1986
29. Grasmeder, R. F.: Analysis of the Remote Manipulator Subsystem, 1.0-WP-VA86001-23, 12 January 1987
30. Drapela, L. J.: Analysis of the Displays and Control Subsystem, 1.0-WP-VA86001-16, 19 December 1986
31. Compton, J. M.: Analysis of the Orbiter and Experiments Subsystem, 1.0-WP-VA87005, 21 August 1987
32. Bynum, M. C.: Analysis of the Purge, Vent, and Drain Subsystem, 1.0-WP-VA87001-04, 18 November 1987

33. Lowery H. J.: Analysis of the Mechanical Actuation Subsystem, 1.0-WP-VA87001-03, 30 November 1987
34. Parkman, W. E.: Analysis of the Active Thermal Control Subsystem, 1.0-WP-VA87001-05, 1 December 1987
35. Sinclair, S. K.: Analysis of the Crew Equipment Subsystem, 1.0-WP-VA87001-01, 2 November 1987

INDEPENDENT ASSESSMENT REPORTS

36. Trahan, W. H.: Assessment of the Guidance, Navigation, and Control Subsystem FMEA/CIL, 1.0-WP-VA88003-06, 23 January 1988
37. Trahan, W. H.: Assessment of the Displays and Control Subsystem FMEA/CIL, 1.0-WP-VA88005-04, 26 January 1988
38. Robb, B. J.: Assessment of the Data Processing Subsystem FMEA/CIL, 1.0-WP-VA86001-08, 28 November 1986
39. Ewell, J. J.: Assessment of the Backup Flight Subsystem FMEA/CIL, 1.0-WP-VA88003-022, 11 March 1988
40. Mediavilla, A. S.: Assessment of the Nose Wheel Steering Subsystem FMEA/CIL, 1.0-WP-VA86001-21, 20 November 1986
41. Addis, A. W.: Assessment of the Instrumentation Subsystem FMEA/CIL, 1.0-WP-VA88003-07, 29 February 1988
42. Addis, A. W.: Assessment of the Communication and Tracking Subsystem FMEA/CIL, 1.0-WP-VA88005-010, 21 March 1988
43. Schmeckpeper, K. R.: Assessment of the Electrical Power Distribution and Control Subsystem FMEA/CIL, 1.0-WP-VA88003-23, 26 February 1988
44. Schmeckpeper, K. R.: Assessment of the Electrical Power Distribution and Control/ Electrical Power Generation Subsystem FMEA/CIL, 1.0-WP-VA88003-34, 1 March 1988
45. Robinson, W. W.: Assessment of the Electrical Power Distribution and Control/ Remote Manipulator Subsystem FMEA/CIL, 1.0-WP-VA88003-35, 8 March 1988
46. Robinson, W. M.: Assessment of the Pyrotechnics Subsystem FMEA/CIL, 1.0-WP-VA88005-05, 5 February 1988
47. McNicoll, W. J.: Assessment of the Main Propulsion Subsystem FMEA/CIL, 1.0-WP-VA88003-33, 26 February 1988

48. Hiott, M. R.: Assessment of the Electrical Power Generation / Fuel Cell Powerplant Subsystem FMEA/CIL, 1.0-WP-VA86001-24, 20 March 1987
49. Ames B. E.: Assessment of the Electrical Power Generation / Power Reactant Supply and Distribution Subsystem FMEA/CIL, 1.0-WP-VA88003-15, 12 February 1988
50. Prust, C. D.: Assessment of the Orbital Maneuvering Subsystem FMEA/CIL, 1.0-WP-VA88003-30, 26 February 1988
51. Prust, C. D.: Assessment of the Reaction Control Subsystem FMEA/CIL, 1.0-WP-VA88003-12, 26 February 1988
52. Barnes, J. E.: Assessment of the Auxiliary Power Unit Subsystem FMEA/CIL, 1.0-WP-VA86001-35, 19 February 1988
53. Davidson, W. R.: Assessment of the Hydraulics and Water Spray Boiler Subsystem FMEA/CIL, 1.0-WP-VA86001-20, 15 December 1986
54. Saiidi, M. J.: Assessment of the Atmospheric Revitalization Subsystem FMEA/CIL, 1.0-WP-VA88003-025, 26 February 1988
55. Saiidi, M. J.: Assessment of the Atmospheric Revitalization Pressure Control Subsystem FMEA/CIL, 1.0-WP-VA88003-09, 19 February 1988
56. Saiidi, M. J.: Assessment of the Life Support and Airlock Support Subsystems, 1.0-WP-VA88003-19, 26 February 1988
57. Saiidi, M. J.: Assessment of the Manned Maneuvering Unit Subsystem FMEA/CIL, 1.0-WP-VA88003-11, 19 February 1988
58. Raffaelli, G. G.: Assessment of the Extravehicular Mobility Unit Subsystem FMEA/CIL, 1.0-WP-VA88003-37, 10 March 1988
59. Weissinger, W. D.: Assessment of the Landing and Deceleration Subsystem FMEA/CIL, 1.0-WP-VA88003-039, 10 March 1988
60. Wilson, R. E.: Assessment of the Ascent Thrust Vector Control Actuator Subsystem FMEA/CIL, 1.0-WP-VA88003-03, 5 February 1988
61. Wilson, R. E.: Assessment of the Elevon Actuator Subsystem FMEA/CIL, 1.0-WP-VA88003-05, 05 February 1988
62. Wilson, R. E.: Assessment of the Body Flap Subsystem FMEA/CIL, 1.0-WP-VA88003-04, 05 February 1988
63. Wilson, R. E.: Assessment of the Rudder/Speed Brake Subsystem FMEA/CIL, 1.0-WP-VA88003-08, 05 February 1988

64. Grasmeder, R. F.: Assessment of the Remote Manipulator Subsystem FMEA/CIL, 1.0-WP-VA88003-16, 26 February 1988
65. Compton, J. M.: Assessment of the Orbiter and Experiment Subsystem FMEA/CIL, 1.0-WP-VA88005-03, 5 February 1988
66. Bynum, M. C.: Assessment of the Purge, Vent, and Drain Subsystem FMEA/CIL, 1.0-WP-VA88005-02, 5 February 1988
67. Lowery H. J.: Assessment of the Mechanical Actuation Subsystem FMEA/CIL, 1.0-WP-VA88003-09, 19 February 1988
68. Sinclair, S. K.: Assessment of the Active Thermal Control Subsystem FMEA/CIL, 1.0-WP-VA88005-06, 12 February 1988
69. Sinclair, S. K.: Assessment of the Crew Equipment Subsystem FMEA/CIL, 1.0-WP-VA88005-07, 12 February 1988

APPENDIX A

ACRONYMS

ACRONYMS

ABS	- Ammonia Boiler System
ACA	- Annunciator Control Assembly
ACIP	- Aerodynamic Coefficient Instrumentation Package
ADI	- Attitude Direction Indicator
ADP	- Air Data Probe
ADS	- Audio Distribution System
ADTA	- Air Data Transducer Assembly
ALCA	- Aft Load Control Assembly
AMCA	- Aft Motor Control Assembly
AOA	- Abort-Once-Around
AOS	- Acquisition of Signal
APC	- Aft Power Controller
APU	- Auxiliary Power Unit
ARCS	- Aft Reaction Control System (Subsystem)
ARPCS	- Atmospheric Revitalization Pressure Control System
ARS	- Atmospheric Revitalization System
ASA	- Aerosurface Servo Amplifier
ATCS	- Active Thermal Control Subsystem
ATO	- Abort-To-Orbit
ATVC	- Ascent Thrust Vector Control
B&AS	- Brakes and Antiskid
BF	- Body Flap
BFC	- Backup Flight Control
BFS	- Backup Flight System
BITE	- Built-In Test Equipment
C&W	- Caution and Warning
CCB	- Change Control Board
CCC	- Contaminant Control Cartridge
CCTV	- Closed-Circuit Television
CCU	- Crew Communications Umbilical
CIL	- Critical Items List
CIU	- Communications Interface Unit
CNTLR	- Controller
COAS	- Crew Optical Alignment Sight
COMM	- Communication
CPU	- Central Processing Unit
CRIT	- Criticality
CWS	- Caution and Warning System
D&C	- Displays and Controls
DAP	- Digital Autopilot
DCM	- Display and Control Module
DCN	- Document Change Notice
DDU	- Display Driver Unit
DEU	- Display Electronic Unit
DFI	- Development Flight Instrumentation
DHE	- Data-Handling Electronics
DMA	- Deployed Mechanical Assembly
DOD	- Department of Defense
DPS	- Data Processing System (Subsystem)
DSC	- Dedicated Signal Conditioner

APPENDIX A

ACRONYMS

ACRONYMS

ABS	- Ammonia Boiler System
ACA	- Annunciator Control Assembly
ACIP	- Aerodynamic Coefficient Instrumentation Package
ADI	- Attitude Direction Indicator
ADP	- Air Data Probe
ADS	- Audio Distribution System
ADTA	- Air Data Transducer Assembly
ALCA	- Aft Load Control Assembly
AMCA	- Aft Motor Control Assembly
AOA	- Abort-Once-Around
AOS	- Acquisition of Signal
APC	- Aft Power Controller
APU	- Auxiliary Power Unit
ARCS	- Aft Reaction Control System (Subsystem)
ARPCS	- Atmospheric Revitalization Pressure Control System
ARS	- Atmospheric Revitalization System
ASA	- Aerosurface Servo Amplifier
ATCS	- Active Thermal Control Subsystem
ATO	- Abort-To-Orbit
ATVC	- Ascent Thrust Vector Control
B&AS	- Brakes and Antiskid
BF	- Body Flap
BFC	- Backup Flight Control
BFS	- Backup Flight System
BITE	- Built-In Test Equipment
C&W	- Caution and Warning
CCB	- Change Control Board
CCC	- Contaminant Control Cartridge
CCTV	- Closed-Circuit Television
CCU	- Crew Communications Umbilical
CIL	- Critical Items List
CIU	- Communications Interface Unit
CNTRLR	- Controller
COAS	- Crew Optical Alignment Sight
COMM	- Communication
CPU	- Central Processing Unit
CRIT	- Criticality
CWS	- Caution and Warning System
D&C	- Displays and Controls
DAP	- Digital Autopilot
DCM	- Display and Control Module
DCN	- Document Change Notice
DDU	- Display Driver Unit
DEU	- Display Electronic Unit
DFI	- Development Flight Instrumentation
DHE	- Data-Handling Electronics
DMA	- Deployed Mechanical Assembly
DOD	- Department of Defense
DPS	- Data Processing System (Subsystem)
DSC	- Dedicated Signal Conditioner

ACRONYMS

ECLSS	- Environmental Control and Life Support System (Subsystem)
EI	- Entry Interface
EIU	- Engine Interface Unit
EMU	- Extravehicular Mobility Unit
EPA	- Environmental Protection Agency
EPDC	- Electrical Power, Distribution and Control
EPG	- Electrical Power Generator
EPS	- Electrical Power System
ET	- External Tank
EVA	- Extravehicular Activity
EVCS	- Extravehicular Communications System
FC	- Fuel Cell
FCA	- Flow Control Assembly
FCL	- Freon Coolant Loop
FCOS	- Flight Control Operating System
FCP	- Fuel Cell Power (Plant)
FCS	- Flight Control System
FDA	- Fault Detection and Annunciation
FDM	- Frequency Division Multiplexing
FES	- Flash Evaporator System
FFSSO	- Forward Fuselage Support System for OEX
FLCA	- Forward Load Control Assembly
FM	- Failure Mode
FMCA	- Forward Motor Control Assembly
FMD	- Frequency Division Multiplexer
FMEA	- Failure Modes and Effects Analysis
FPC	- Forward Power Controller
FRCS	- Forward Reaction Control System (Subsystem)
FSM	- Fault Summary Message
FSS	- Flight Support Structure
FSSR	- Flight Systems Software Requirements
FSW	- Flight Software
GAS	- Get-Away Special
GFE	- Government Furnished Equipment
GMT	- Greenwich Mean Time
GNC	- Guidance, Navigation, and Control
GPC	- General Purpose Computer
GSE	- Ground Support Equipment
GSTDN	- Ground Spaceflight Tracking and Data Network
HDC	- Hybrid Driver Controller
HEX	- Heat Exchanger
HIRAP	- High-Resolution Accelerometer Package
HIU	- Headset Interface Unit
HPFTP	- High-Pressure Fuel Turbopump
HPOT	- High-Pressure Oxidizer Turbopump
HUT	- Hard Upper Torso
HW	- Hardware
HX	- Heat Exchanger
HYD	- Hydraulics

ACRONYMS

ICM	- Interface Control Module
ICMS	- Intercom Master Station
ICOM	- Intercommunications
ICRS	- Intercom Remote Station
IFM	- In-Flight Maintenance
IMU	- Inertial Measurement Unit
IOA	- Independent Orbiter Assessment
IOM	- Input/Output Module
IUS	- Inertial Upper Stage
IVA	- Intravehicular Activity
JSC	- Johnson Space Center
KBD	- Ku-Band Deploy
LCA	- Load Controller Assembly
LCC	- Launch Control Center
LCVG	- Liquid Cooling and Ventilation Garment
LEH	- Launch/Entry Helmet
LNDG/DECEL	- Landing and Deceleration
LPS	- Launch Processing System
LRU	- Line Replaceable Unit
LSS	- Life Support Subsystem
LTA	- Lower Torso Assembly
MADS	- Modular Auxiliary Data System
MAS	- Mechanical Actuation System
MCA	- Motor Control Assembly
MCC	- Mission Control Center (JSC)
MCDS	- Multifunction CRT Display System
MDAC	- McDonnell Douglas Astronautics Company
MDM	- Multiplexer/Demultiplexer
MEC	- Main Engine Controller
MECO	- Main Engine Cutoff
MET	- Mission Elapsed Time
MGSSA	- Main Gear Shock Strut Assembly
MIA	- Multiplexer Interface Adapter
MLG	- Main Landing Gear
MM	- Major Mode
MMU	- Manned Maneuvering Unit
MMU	- Mass Memory Unit
MPL	- Minimum Power Level (65%)
MPM	- Manipulator Positioning Mechanism
MPS	- Main Propulsion System (Subsystem)
MS	- Mission Specialist
MSBLS	- Microwave Scanning Beam Landing System
MSK	- Manual Select Keyboard
MTU	- Master Timing Unit
MUX	- Multiplex
NASA	- National Aeronautics and Space Administration
NGSSA	- Nose Landing Gear Shock Strut Assembly
NGTD	- Nose Gear Touch Down
NLG	- Nose Landing Gear
NSI	- NASA Standard Initiator

ACRONYMS

NSP	- Network Signal Processor
NSTS	- National Space Transportation System
NWS	- Nose-Wheel Steering
OBS	- Operational Bioinstrumentation System
OEX	- Orbiter Experiments
OI	- Operational Instrumentation
OMRSD	- Operational Maintenance Requirements & Specifications Document
OMS	- Orbital Maneuvering System
OTB	- Orbiter Timing Buffer
OWDA	- Operational Water Dispenser Assembly
P/L	- Payload
PASS	- Primary Avionics Software System
PBI	- Push-Button Indicator
PBM	- Payload Bay Mechanical
PCA	- Power Control Assembly
PCI	- Potential Critical Item
PCM	- Pulse Code Modulation
PCMMU	- Pulse Code Modulation Master Unit
PCN	- Page Change Notice
PCS	- Pressure Control System
PDU	- Power Drive Unit
PFR	- Portable Foot Restraint
PHS	- Personal Hygiene Station
PI	- Payload Interrogator
PIC	- Pyro Initiator Controller
PLB	- Payload Bay
PLBD	- Payload Bay Door
PLS	- Primary Landing Site
PLSS	- Portable Life Support Subsystem
PMS	- Propellant Management Subsystem
PRCB	- Program Requirements Control Board
PRCBD	- Program Requirements Control Board Directive
PRCS	- Primary Reaction Control System (jet)
PRD	- Payload Retention Device
PROM	- Programmable Read-Only Memory
PRSD	- Power Reactant Storage and Distribution
PRSDS	- Power Reactant Storage and Distribution System
PSA	- Power Section Assembly
PSA	- Provision Stowage Assembly
PSP	- Payload Signal Processor
PTT	- Push-to-talk
PV&D	- Purge Vent & Drain
QD	- Quick Disconnect
R/BPA	- Rudder/Pedal Brake Assembly
RAM	- Random Access Memory
RCS	- Reaction Control System
RFCAs	- Radiator and Flow Control Assembly
RFI	- Radio Frequency Interference
RGA	- Rate Gyro Assembly

ACRONYMS

RHC	- Rotation Hand Controller
RHS	- Rehydration Station
RI	- Rockwell International
RJD	- Reaction Jet Driver
RM	- Redundancy Management
RMS	- Remote Manipulator System
RPA	- Ruder Pedal Assembly
RPC	- Remote Power Controller
RPTA	- Rudder Pedal Transducer Assembly
RSB	- Rudder Speed Brake
RTD	- Resistance Temperature Device
RTLS	- Return-to-Launch Site
RTS	- Remote Tracking Station
RVDT	- Rotary Variable Differential Transformer
SBTC	- Speed Brake Translation Controller
SCB	- Steering Control Box
SCM	- System Control Module
SCU	- Sequence Control Unit
SCU	- Service and Cooling Umbilical
SDM	- Startracker Door Mechanism
SEADS	- Shuttle Entry Air Data System
SFOM	- Shuttle Flight Operations Manual
SFP	- Single Failure Point
SGLS	- Space Ground Link System
SILTS	- Shuttle Infrared Leaside Temperature Sensor
SM	- Systems Management
SMM	- Solar Maximum Mission
SOP	- Secondary Oxygen Pack
SOS	- Space Operations Simulator
SPA	- Steering Position Amplifier
SPFA	- Single Point Failure Analysis
SPI	- Surface Position Indicator
SRB	- Solid Rocket Booster
SSA	- Space Suit Assembly
SSME	- Space Shuttle Main Engine
SSMEC	- SSME Controller
SSO	- Space Shuttle Orbiter
SSSH	- Space Shuttle Systems Handbook
ST	- Star Tracker
STDN	- Spaceflight Tracking and Data Network
STS	- Space Transportation System
TACAN	- Tactical Air Navigation
TAL	- Transatlantic Abort Landing
TCS	- Thermal Control System (Subsystem)
TD	- Touch Down
TDRS	- Tracking and Data Relay Satellite
THC	- Thruster Hand Controller
THC	- Translation Hand Controller
TPS	- Thermal Protection System
TVC	- Thrust Vector Control

ACRONYMS

UCD	- Urine Collection Device
UEA	- Unitized Electrode Assembly
UHF	- Ultra High Frequency
VDM	- Vent Door Mechanism
VRCS	- Vernier Reaction Control System (jet)
WBSC	- Wide-Band Signal Conditioner
WCCS	- Window Cavity Conditioning System
WCCU	- Wireless Crew Communications Umbilical
WMS	- Waste Management System
WP	- Working Paper
WRS	- Water Removal Subsystem
WSB	- Water Spray Boiler

APPENDIX B

DEFINITIONS, GROUND RULES, AND ASSUMPTIONS

B.1 Definitions

B.2 Project Level Ground Rules and Assumptions

**APPENDIX B
DEFINITIONS, GROUND RULES, AND ASSUMPTIONS**

B.1 Definitions

Definitions contained in NSTS 22206, Instructions For Preparation of FMEA/CIL, 10 October 1986, were used with the following amplifications and additions.

INTACT ABORT DEFINITIONS:

RTLS - begins at transition to OPS 6 and ends at transition to OPS 9, post-flight

TAL - begins at declaration of the abort and ends at transition to OPS 9, post-flight

AOA - begins at declaration of the abort and ends at transition to OPS 9, post-flight

ATO - begins at declaration of the abort and ends at transition to OPS 9, post-flight

CREDIBLE (CAUSE) - an event that can be predicted or expected in anticipated operational environmental conditions. Excludes an event where multiple failures must first occur to result in environmental extremes

CONTINGENCY CREW PROCEDURES - procedures that are utilized beyond the standard malfunction procedures, pocket checklists, and cue cards

EARLY MISSION TERMINATION - termination of onorbit phase prior to planned end of mission

EFFECTS/RATIONALE - description of the case which generated the highest criticality

HIGHEST CRITICALITY - the highest functional criticality determined in the phase-by-phase analysis

MAJOR MODE (MM) - major sub-mode of software operational sequence (OPS)

MC - Memory Configuration of Primary Avionics Software System (PASS)

MISSION - assigned performance of a specific Orbiter flight with payload/objective accomplishments including orbit phasing and altitude (excludes secondary payloads such as GAS cans, middeck P/L, etc.)

MULTIPLE ORDER FAILURE - describes the failure due to a single cause or event of all units which perform a necessary (critical) function

OFF-NOMINAL CREW PROCEDURES - procedures that are utilized beyond the standard malfunction procedures, pocket checklists, and cue cards

OPS - software operational sequence

PRIMARY MISSION OBJECTIVES - worst case primary mission objectives are equal to mission objectives

PHASE DEFINITIONS:

PRELAUNCH PHASE - begins at launch count-down Orbiter power-up and ends at moding to OPS Major Mode 102 (liftoff)

LIFTOFF MISSION PHASE - begins at SRB ignition (MM 102) and ends at transition out of OPS 1 (Synonymous with ASCENT)

ONORBIT PHASE - begins at transition to OPS 2 or OPS 8 and ends at transition out of OPS 2 or OPS 8

DEORBIT PHASE - begins at transition to OPS Major Mode 301 and ends at first main landing gear touchdown

LANDING/SAFING PHASE - begins at first main gear touchdown and ends with the completion of post-landing safing operations

**APPENDIX B
DEFINITIONS, GROUND RULES, AND ASSUMPTIONS**

B.2 IOA Project Level Ground Rules and Assumptions

The philosophy embodied in NSTS 22206, Instructions for Preparation of FMEA/CIL, 10 October 1986, was employed with the following amplifications and additions.

1. The operational flight software is an accurate implementation of the Flight System Software Requirements (FSSRs).

RATIONALE: Software verification is out-of-scope of this task.

2. After liftoff, any parameter which is monitored by system management (SM) or which drives any part of the Caution and Warning System (C&W) will support passage of Redundancy Screen B for its corresponding hardware item.

RATIONALE: Analysis of on-board parameter availability and/or the actual monitoring by the crew is beyond the scope of this task.

3. Any data employed with flight software is assumed to be functional for the specific vehicle and specific mission being flown.

RATIONALE: Mission data verification is out-of-scope of this task.

4. All hardware (including firmware) is manufactured and assembled to the design specifications/drawings.

RATIONALE: Acceptance and verification testing is designed to detect and identify problems before the item is approved for use.

5. All Flight Data File crew procedures will be assumed performed as written, and will not include human error in their performance.

RATIONALE: Failures caused by human operational error are out-of-scope of this task.

6. All hardware analyses will, as a minimum, be performed at the level of analysis existent within NASA/Prime Contractor Orbiter FMEA/CILs, and will be permitted to go to greater hardware detail levels but not lesser.

RATIONALE: Comparison of IOA analysis results with other analyses requires that both analyses be performed to a comparable level of detail.

7. Verification that a telemetry parameter is actually monitored during AOS by ground-based personnel is not required.

RATIONALE: Analysis of mission-dependent telemetry availability and/or the actual monitoring of applicable data by ground-based personnel is beyond the scope of this task.

8. The determination of criticalities per phase is based on the worst case effect of a failure for the phase being analyzed. The failure can occur in the phase being analyzed or in any previous phase, whichever produces the worst case effects for the phase of interest.

RATIONALE: Assigning phase criticalities ensures a thorough and complete analysis.

9. Analysis of wire harnesses, cables, and electrical connectors to determine if FMEAs are warranted will not be performed nor FMEAs assessed.

RATIONALE: Analysis was substantially complete prior to NSTS 22206 ground rule redirection.

10. Analysis of welds or brazed joints that cannot be inspected will not be performed nor FMEAs assessed.

RATIONALE: Analysis was substantially complete prior to NSTS 22206 ground rule redirection.

11. Emergency system or hardware will include burst discs and will exclude the EMU Secondary Oxygen Pack (SOP), pressure relief valves and the landing gear pyrotechnics.

RATIONALE: Clarify definition of emergency systems to ensure consistency throughout IOA project.

APPENDIX C
SUBSYSTEM ASSESSMENT SUMMARIES

<u>Section</u>	<u>Subsystem Assessment Overview</u>	<u>Page</u>
C.1	Fuel Cell Powerplant	C-2
C.2	Hydraulic Actuators	C-2
C.3	Displays and Control	C-10
C.4	Guidance, Navigation and Control	C-10
C.5	Orbiter Experiments	C-10
C.6	Auxiliary Power Unit	C-15
C.7	Backup Flight System	C-15
C.8	Electrical Power, Distribution & Control	C-18
C.9	Landing and Deceleration	C-18
C.10	Purge, Vent and Drain	C-20
C.11	Pyrotechnics	C-24
C.12	Active Thermal Control System and Life Support System	C-24
C.13	Crew Equipment	C-29
C.14	Instrumentation	C-32
C.15	Data Processing System	C-32
C.16	Atmosphere Revitalization Pressure Control System	C-32
C.17	Hydraulics and Water Spray Boiler	C-37
C.18	Mechanical Activation System	C-37
C.19	Manned Maneuvering Unit	C-40
C.20	Nose Wheel Steering	C-40
C.21	Remote Manipulator System	C-42
C.22	Atmospheric Revitalization System	C-45
C.23	Extravehicular Mobility Unit	C-48
C.24	Power Reactant Supply and Distribution System	C-50
C.25	Main Propulsion System	C-53
C.26	Orbital Maneuvering System	C-53
C.27	Reaction Control System	C-57
C.28	Comm and Tracking	C-60

APPENDIX C SUBSYSTEM ASSESSMENT SUMMARIES

The IOA assessments proved a valuable method of ensuring the proper criticality level be assigned to each FMEA/CIL identified. In many cases the assigned criticality level was changed by the appropriate subsystem manager due to the IOA assessment. As a minimum, this assessment created a deeper awareness of the criticality level assigned and better rationale and understanding. Differences in interpretation and level of detail caused many of the issues generated, along with the lack of update NASA FMEA/CIL packages. Many issues remain which should be resolved by the Subsystem Managers.

C.1 Fuel Cell Powerplant

The IOA analysis of the EPG/FCP hardware initially generated 62 failure mode worksheets and identified 32 PCIs before starting the assessment process (See Fig. C.1). In order to facilitate comparison, 5 additional failure mode analysis worksheets were generated. These analysis results were compared to the proposed NASA Post 51-L baseline (22 May 1986) of 46 FMEAs and 22 CIL items and to the updated (22 December 1987) version of 43 FMEAs and 23 CILs. The discrepancy between the number of NASA FMEAs can be explained by the different approach used by NASA and IOA to group failure modes. Upon completion of the assessment, and after a discussion with the NASA Subsystem Manager, an agreement between the NASA FMEAs and IOA failure modes was reached. Seven (7) failure modes generated by the IOA analysis were added to the FMEAs; one being a criticality 2/1R CIL item.

C.2 Body Flap/Rudder Speedbrake/Elevon/ME ATVC/Actuations

C.2.1 Body Flap Actuator

The overview in Fig. C.2a is a summary of the Body Flap actuator assessment and presents a comparison of the Pre 51-L baseline and the proposed Post 51-L baseline, with the IOA recommended failures, and any issues. The main reason for differences was that NASA combined failures, whereas IOA prepared separate failure work-sheets. Minor differences such as fail or pass of screens were readily resolved. As the result of discussions with the Subsystem Manager and review of the updated FMEA/CIL, all initial issues were resolved and changes were made to the FMEA/CIL and IOA work-sheets. The overview further shows the comparison of failures of the major elements of the Body Flap actuators.

The IOA effort first completed an analysis of the Body Flap (BF) hardware, generating draft failure modes and PCIs. To preserve independence, this analysis was accomplished without reliance upon the results contained within the NASA FMEA/CIL documentation.

EPG/FCP ASSESSMENT OVERVIEW

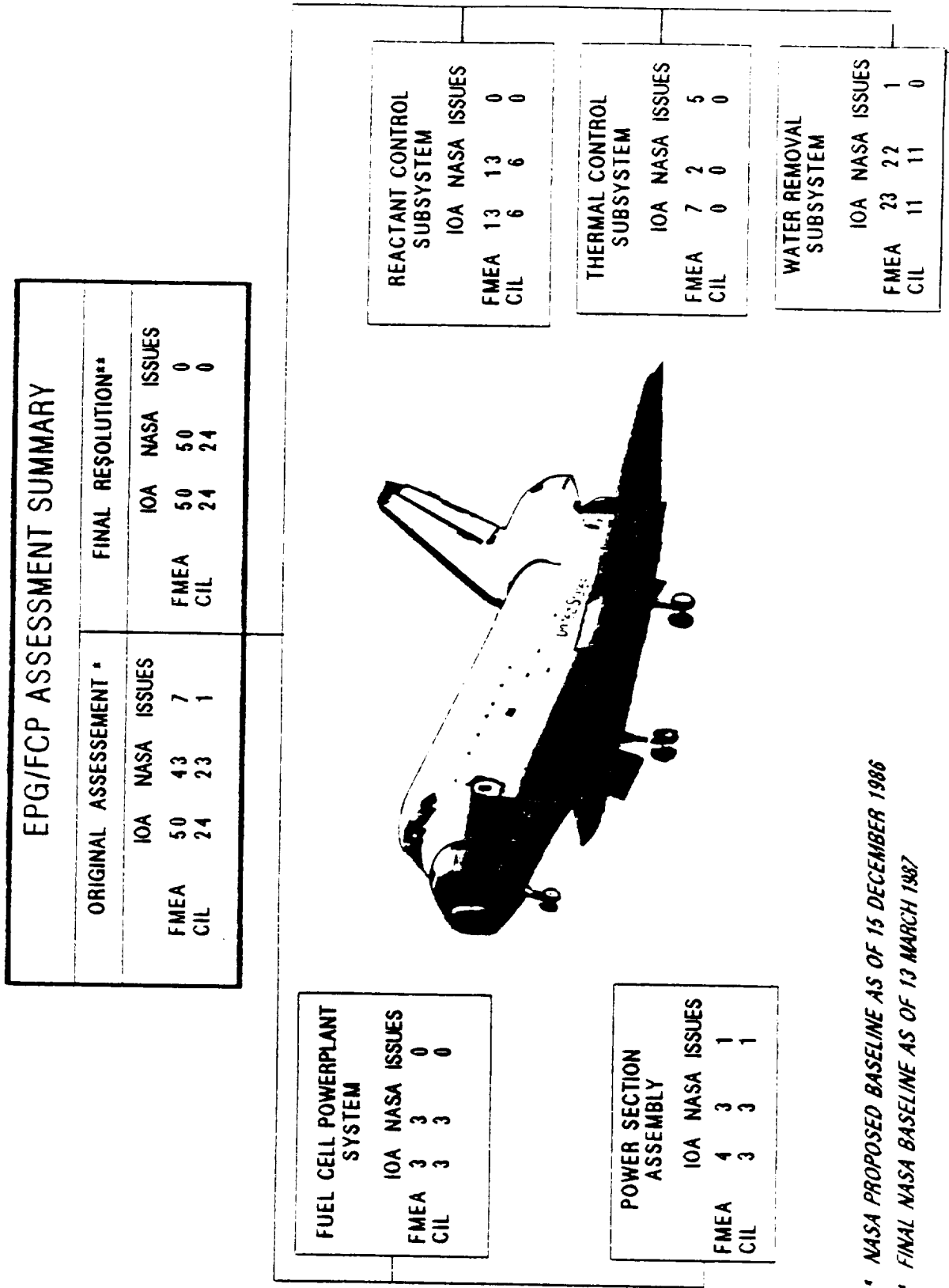

* NASA PROPOSED BASELINE AS OF 15 DECEMBER 1986
 ** FINAL NASA BASELINE AS OF 13 MARCH 1987

Figure C.1 - EPG/FCP FMEA/CIL ASSESSMENT

BODY FLAP ACTUATOR ASSESSMENT OVERVIEW

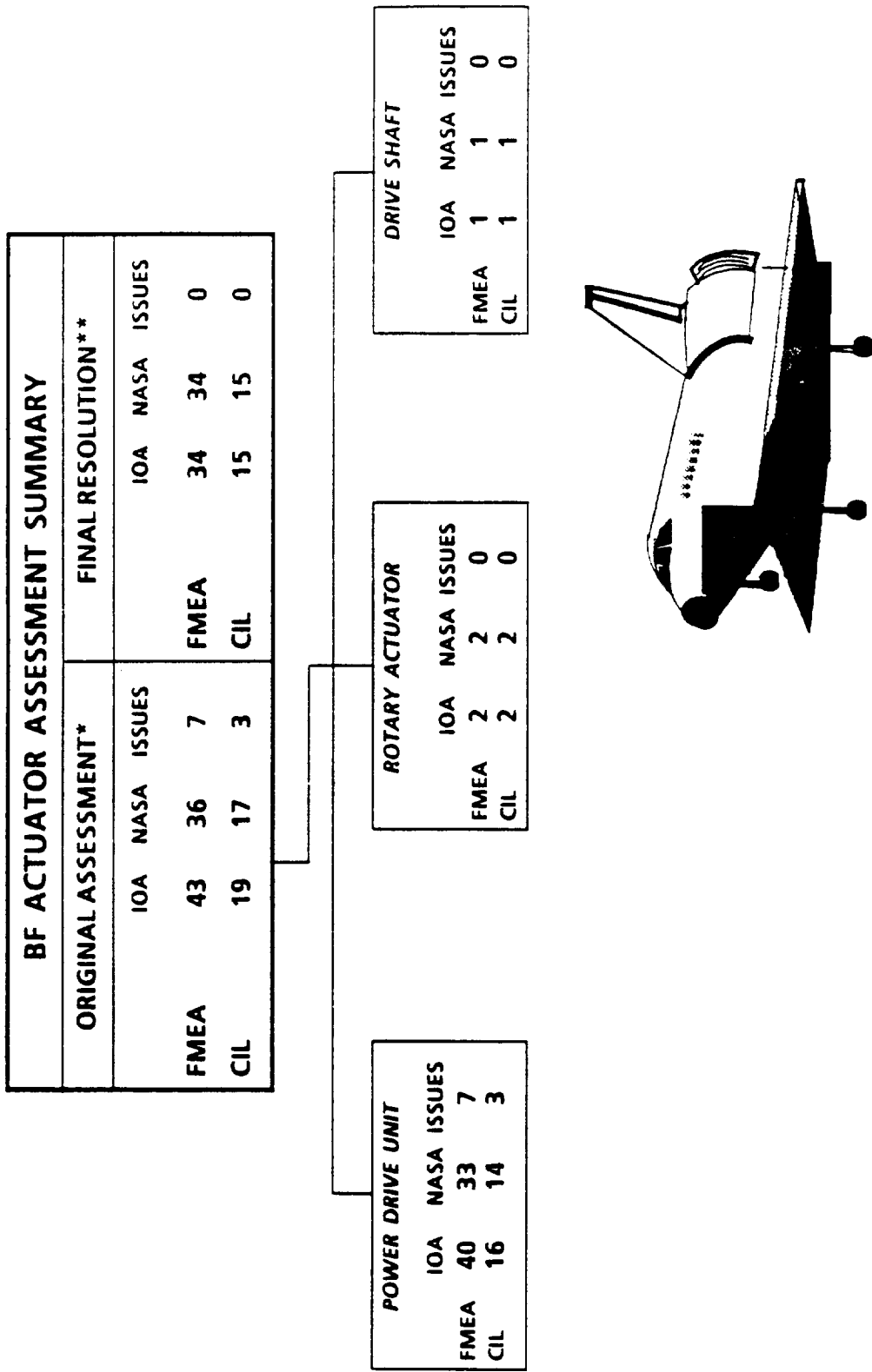

* NASA PROPOSED BASELINE AS OF 20 MAY 1987
 ** FINAL NASA CIL ITEMS BASELINE AS OF 7 DEC 1987 AND NASA NON-CIL FMEAS - PRE 51-L BASELINE

Figure C.2a - BF ACTUATOR ASSESSMENT

The IOA analysis of the BF hardware initially generated 36 failure mode worksheets and identified 19 PCIs before starting the assessment process. In order to facilitate comparison, 7 additional failure mode analysis worksheets were generated.

The IOA results were then compared to the NASA FMEA/CIL baseline with proposed Post 51-L updates included. A resolution of each discrepancy from the comparison was provided through additional analysis as required. Upon completion of the assessment, all of the IOA and NASA failure modes were in agreement.

C.2.2 Rudder/Speedbrake Actuator

The overview in Fig. C.2b is a summary of the RSB actuator assessment and presents a comparison of the Pre 51-L baseline and the proposed Post 51-L baseline, with the IOA recommended failures, and any issues. The main reason for differences was that NASA combined failures, whereas IOA prepared separate failure worksheets. Minor differences such as fail or pass of screens were readily resolved. As the result of discussions with the Subsystem Manager and review of the updated FMEA/CIL, all initial issues were resolved and changes were made to the FMEA/CIL and IOA worksheets. The overview further shows the comparison of failures of the major elements of the RSB actuators.

The IOA effort first completed an analysis of the Rudder/Speed Brake (RSB) hardware, generating draft failure modes and PCIs. To preserve independence, this analysis was accomplished without reliance upon the results contained within the NASA FMEA/CIL documentation.

The IOA analysis of the RSB hardware initially generated 38 failure mode worksheets and identified 27 PCIs before starting the assessment process. No additional failure mode worksheets were generated during the comparison. The IOA results were then compared to the NASA FMEA/CIL baseline along with the proposed Post 51-L CIL updates included. A resolution of each discrepancy from the comparison was provided through additional analysis as required. Upon completion of the assessment, all of the IOA and NASA failure modes were in agreement.

C.2.3 Elevon Actuator

The overview in Fig. C.2c is a summary of the elevon actuator assessment and presents a comparison of the Pre 51-L baseline and the proposed Post 51-L baseline, with the IOA recommended failures, and any issues. The main reason for differences was that NASA combined failures, whereas IOA prepared separate failure worksheets. Minor differences such as fail or pass of screens were readily resolved. As the result of discussions with the Subsystem Manager and review of the updated FMEA/CIL all initial issues were resolved and changes were made to the

RSB ACTUATOR ASSESSMENT OVERVIEW

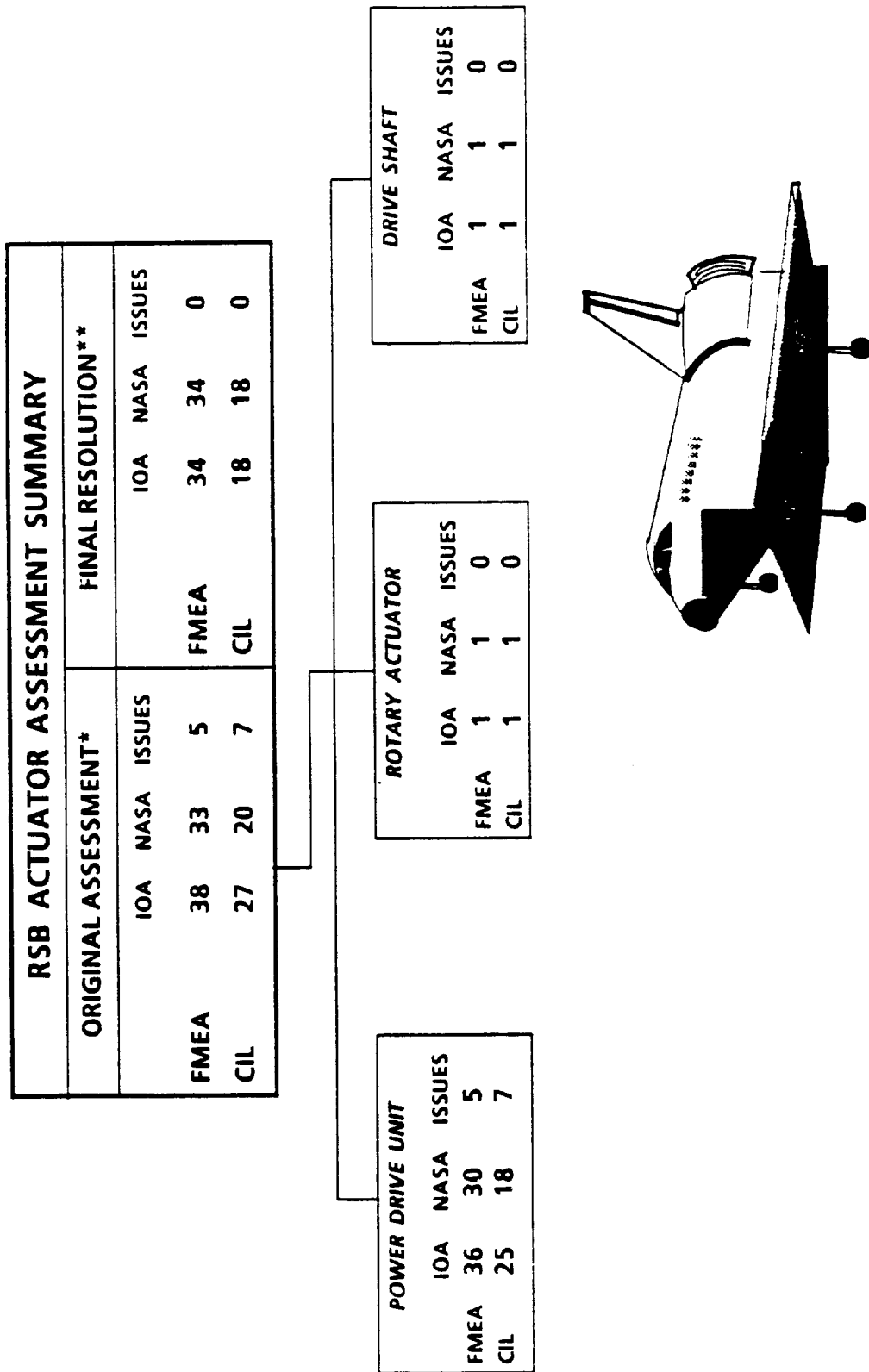

* NASA PROPOSED BASELINE AS OF 20 MAY 1987

** FINAL NASA CIL ITEMS BASELINE AS OF 7 DEC 1987 AND NASA NON-CIL FMEAs - PRE 51-L BASELINE

Figure C.2b - RSB ACTUATOR ASSESSMENT

ELEVEN ACTUATOR ASSESSMENT OVERVIEW

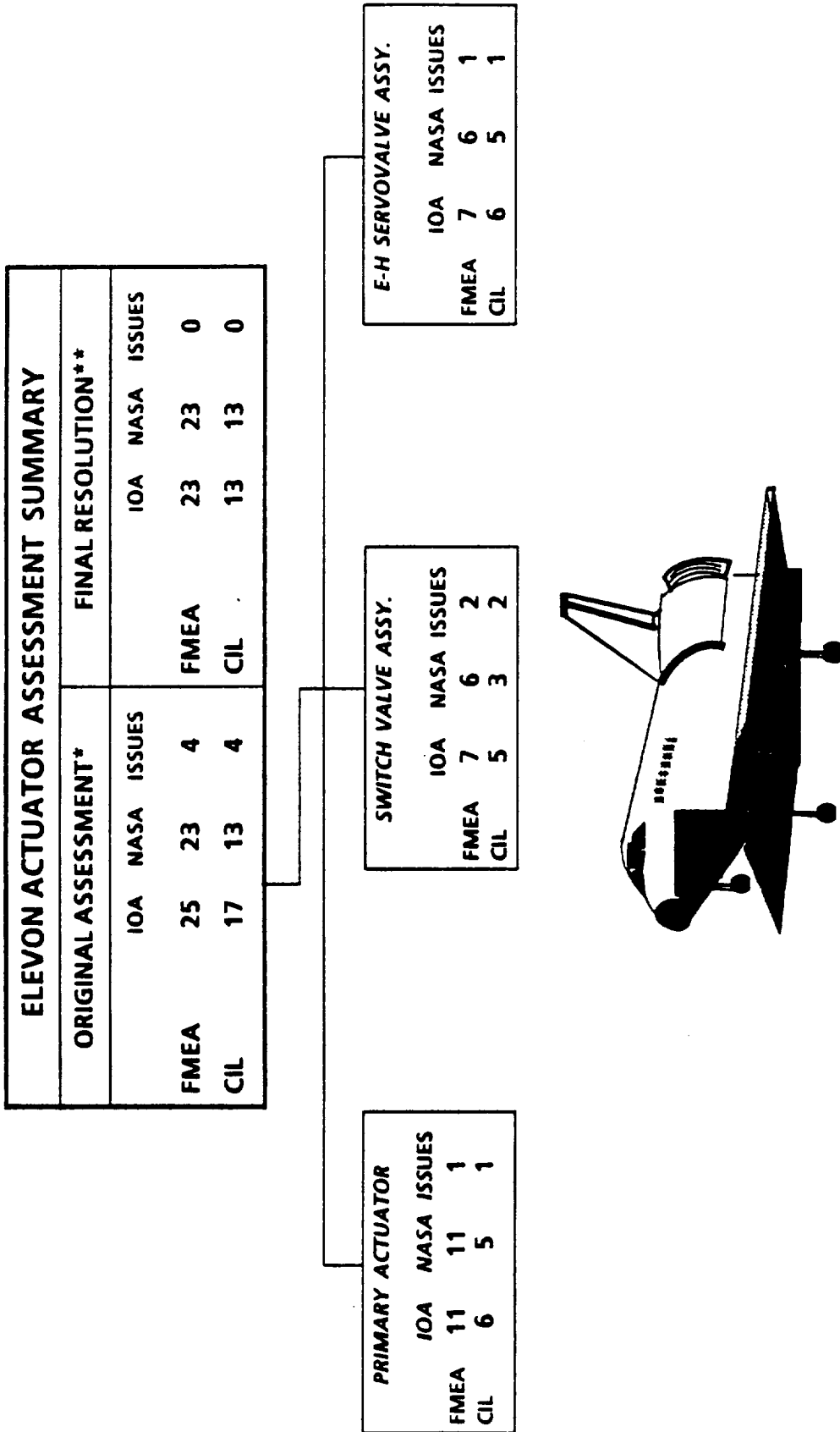

* NASA PROPOSED BASELINE AS OF 5 MAY 1987
 ** FINAL NASA CIL ITEMS BASELINE AS OF 7 DECEMBER 1987 AND NASA NON-CIL FMEAS - PRE 51-L BASELINE

Figure C.2c - ELEVEN ACTUATOR ASSESSMENT

FMEA/CIL and IOA worksheets. The overview further shows the comparison of failures of the major elements of the elevon actuators.

The IOA effort first completed an analysis of the Elevon Subsystem hardware, generating draft failure modes, and PCIs. To preserve independence, this analysis was accomplished without reliance upon the results contained within the NASA FMEA/CIL documentation. The IOA analysis of the elevon actuator hardware initially generated 25 failure modes worksheets and identified 17 PCIs before starting the assessment process. No additional failure mode worksheets were generated during the comparison. The analysis results were compared to the proposed NASA Post 51-L baseline of 23 FMEAs and 13 CIL items. A resolution of each discrepancy from the comparison was provided through additional analysis as required. Upon completion of the assessment, all of the IOA and NASA failure modes were in agreement.

C.2.4 Main Engine (ATVC) Actuator

The overview in Fig. C.2d is a summary of the main engine actuator assessment and presents a comparison of the Pre 51-L baseline and the proposed Post 51-L baseline, with the IOA recommended failures, and any issues. The main reason for differences was that NASA combined failures, whereas IOA prepared separate failures, whereas IOA prepared separate failure worksheets. Minor differences such as fail or pass of screens were readily resolved. As the result of discussions with the subsystem manager and review of the up-dated FMEA/CIL all initial issues were resolved and changes were made to the FMEA/CIL and IOA worksheets. The overview further shows the comparison of failures of the major elements of the elevon actuators.

The IOA effort first completed an analysis of the Ascent Thrust Vector Control Actuator (ATVC) hardware, generating draft failure modes, and PCIs. To preserve independence, this analysis was accomplished without reliance upon the results contained within the NASA FMEA/CIL documentation.

The IOA analysis of the ATVC actuator hardware initially generated 25 failure modes worksheets and identified 16 PCIs before starting the assessment process. The results were compared to the proposed NASA Post 51-L baseline (5 May 1987) of 21 FMEAs and 15 CIL items and the updated (7 December 1987) version of 21 FMEAs and 13 CIL items. A resolution of each discrepancy from the comparison was provided through additional analysis as required. Upon completion of the assessment, all of the IOA and NASA failure modes were in agreement.

MAIN ENGINE (ATVC) ACTUATOR ASSESSMENT OVERVIEW

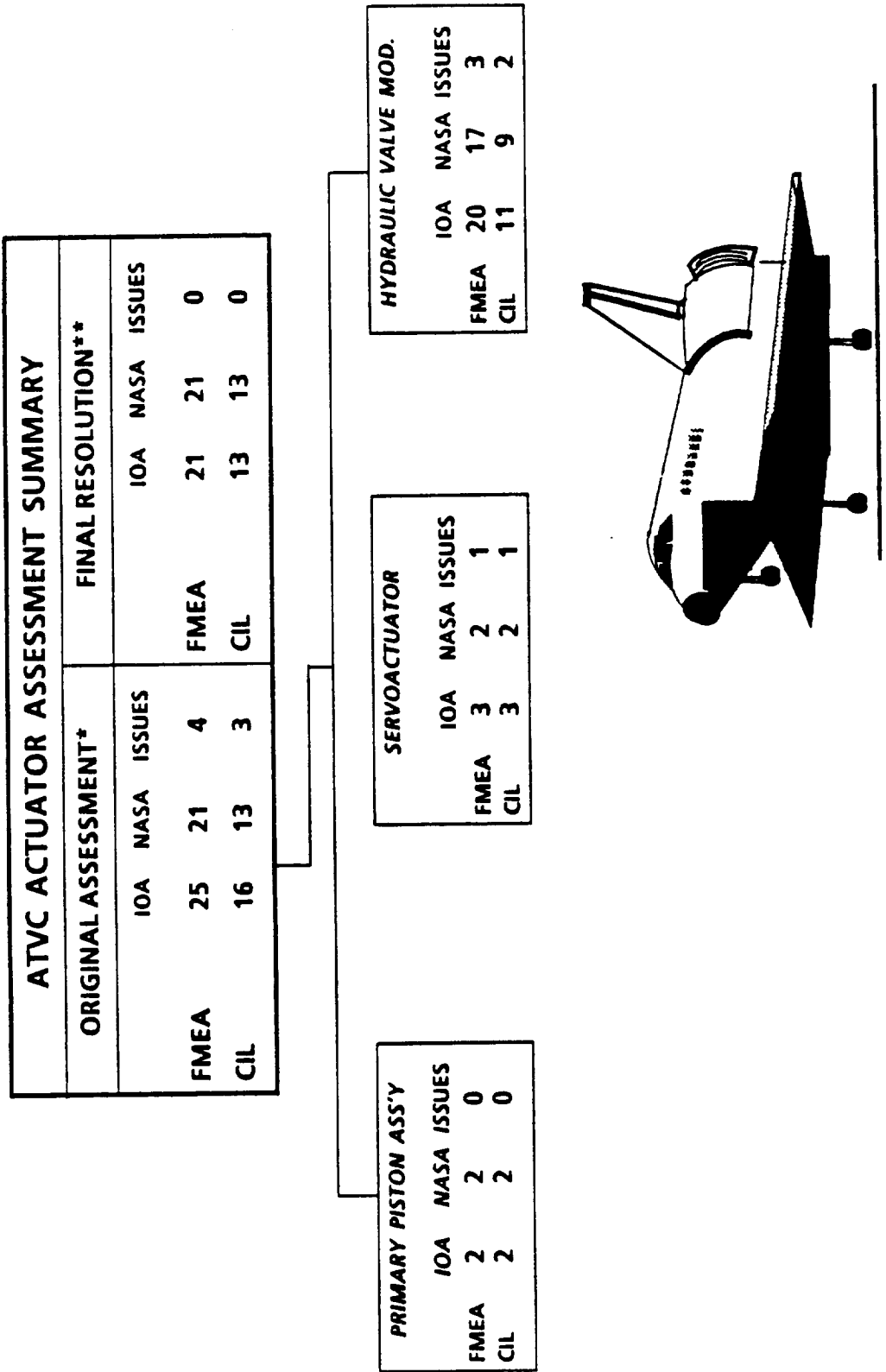

* NASA PROPOSED BASELINE AS OF 5 MAY 1987

** FINAL NASA CIL ITEMS BASELINE AS OF 7 DECEMBER 1987 AND NASA NON-CIL FMEAS - PRE 51-L BASELINE

Figure C.2d - MAIN ENGINE ACTUATOR ASSESSMENT

C.3 Displays and Control Subsystem

The IOA product for D&C analysis consisted of 134 failure mode worksheets that resulted in 8 PCIs being identified. In order to facilitate comparison, 37 additional failure mode worksheets were generated. Comparison was made to the NASA baseline of 4 January 1988, which consisted of 264 FMEAs and 21 CIL items. The comparison determined if there were any results which had been found by the IOA but were not in the NASA baseline. This comparison produced agreement on all but 45 FMEAs, which caused no differences in the CIL items. Reference Figure C.3.

The issues arose due to different interpretation of NSTS 22206, FMEA and CIL preparation instruction. IOA analyzed the electrical circuit as a black box, and NASA analyzed the components of the black boxes. Of the 45 differences with the FMEAs, all were minor and did not affect criticalities assessment. In conclusion, IOA is in full agreement with the revised NASA CIL baseline.

C.4 Guidance, Navigation and Control System

The IOA product for the GNC analysis consisted of 141 failure mode worksheets that resulted in 24 PCIs being identified. In order to facilitate comparison, 34 additional failure mode worksheets were generated. Comparison was made to the NASA baseline (as of 4 January 1988) which consisted of 148 FMEAs and 36 CIL items. The comparison determined if there were any results which had been found by the IOA but were not in the NASA baseline. This comparison produced agreement on all but 56 FMEAs, which caused differences in zero (0) CIL items. Reference Figure C.4a & b.

The issues arose due to different interpretation of NSTS 22206, FMEA and CIL preparation instructions. IOA analyzed the components of the electrical circuits, generating 56 worksheets more than NASA, who treated the electrical circuits as black boxes. Of these 56 differences with the FMEAs, all were minor and did not affect criticalities assessments. Three (3) of the FMEAs' issues were with the SRB RGA's EPD&C. No drawings were available to assess these FMEAs. In conclusion, IOA is in full agreement with the revised NASA CIL baseline.

C.5 Orbiter Experiments

The IOA analysis of the OEX hardware initially generated 82 failure mode worksheets and identified 2 PCIs before starting the assessment process (Fig. C.5). These analysis results were compared to the proposed NASA Post 51-L baseline of 191 FMEAs and 1 CIL item, which was generated using the older FMEA/CIL instructions. Upon completion of the assessment, 167 of the 191 FMEAs were in agreement. Of the 24 that remained, 21 were IOA 3/3 FMEAs on components not addressed by NASA. Of the remaining 3, 2 issues were with FMEAs criticality level. The remaining issue concerns a FMEA on a component which no longer exists, thus

D & C ASSESSMENT OVERVIEW

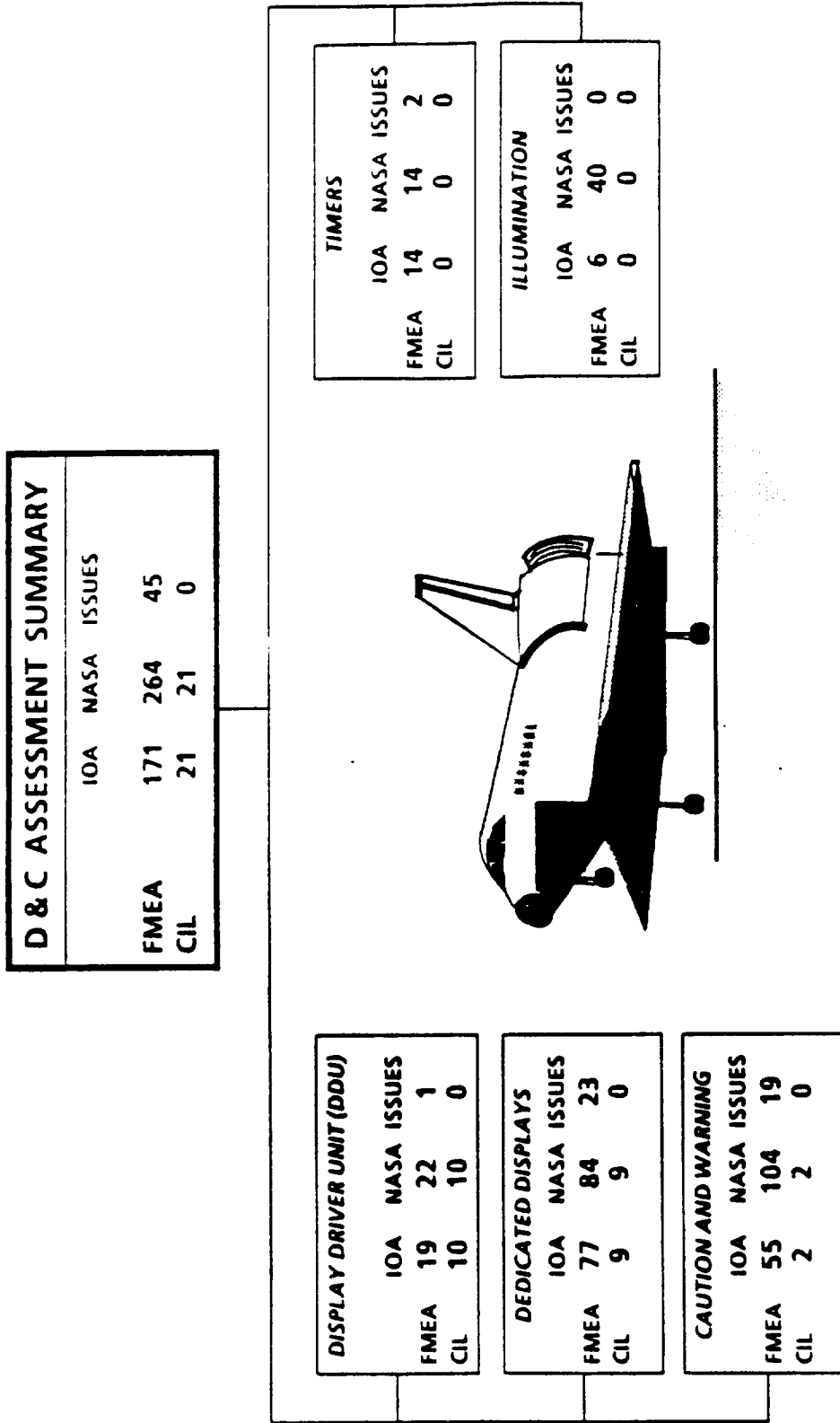

Figure C.3 - D&C OVERVIEW ASSESSMENT

GNC FMEA/CIL ASSESSMENT OVERVIEW

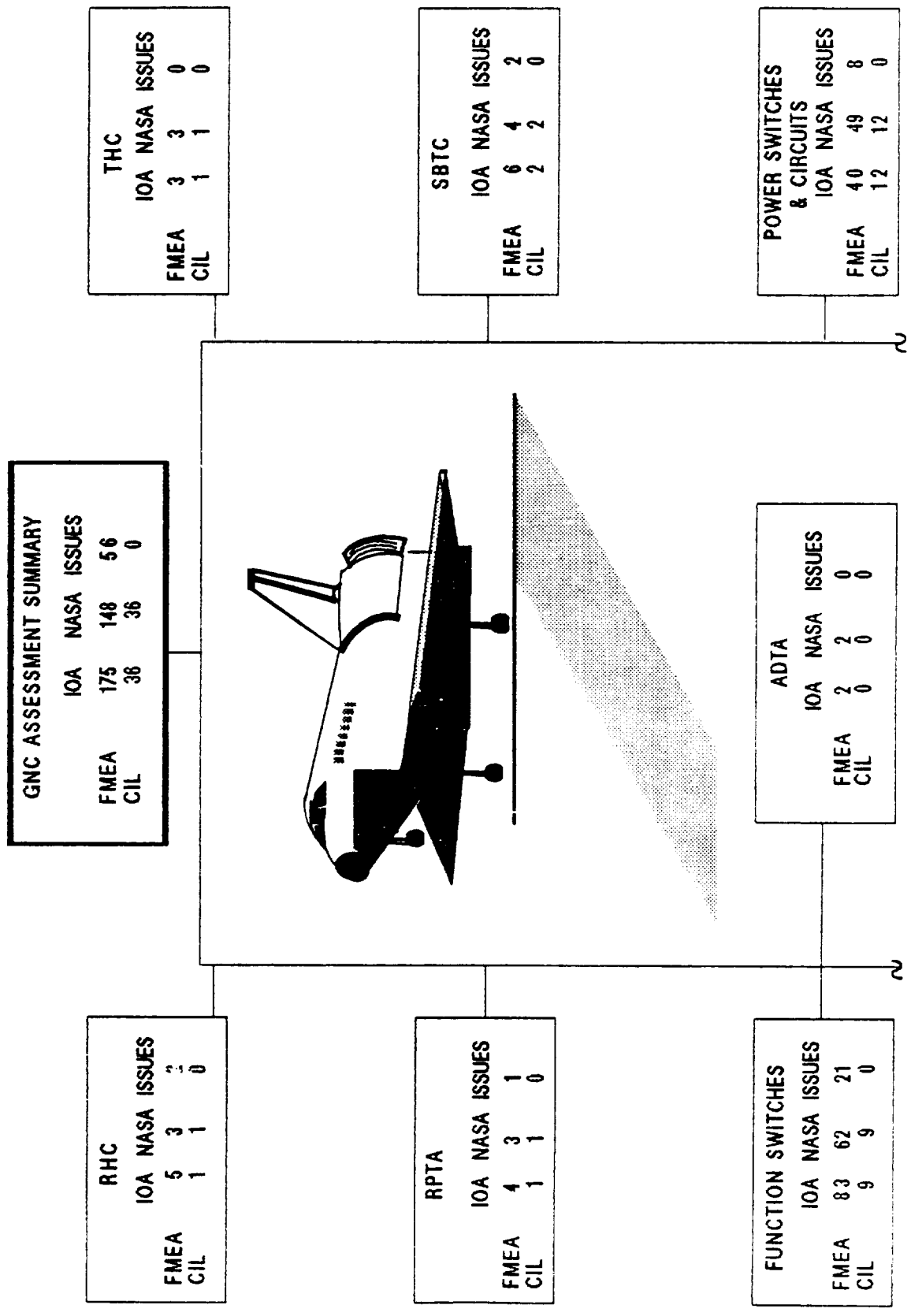

Figure C.4a - GNC FMEA/CIL ASSESSMENT

GNC FMEA/CIL ASSESSMENT OVERVIEW CONTINUED

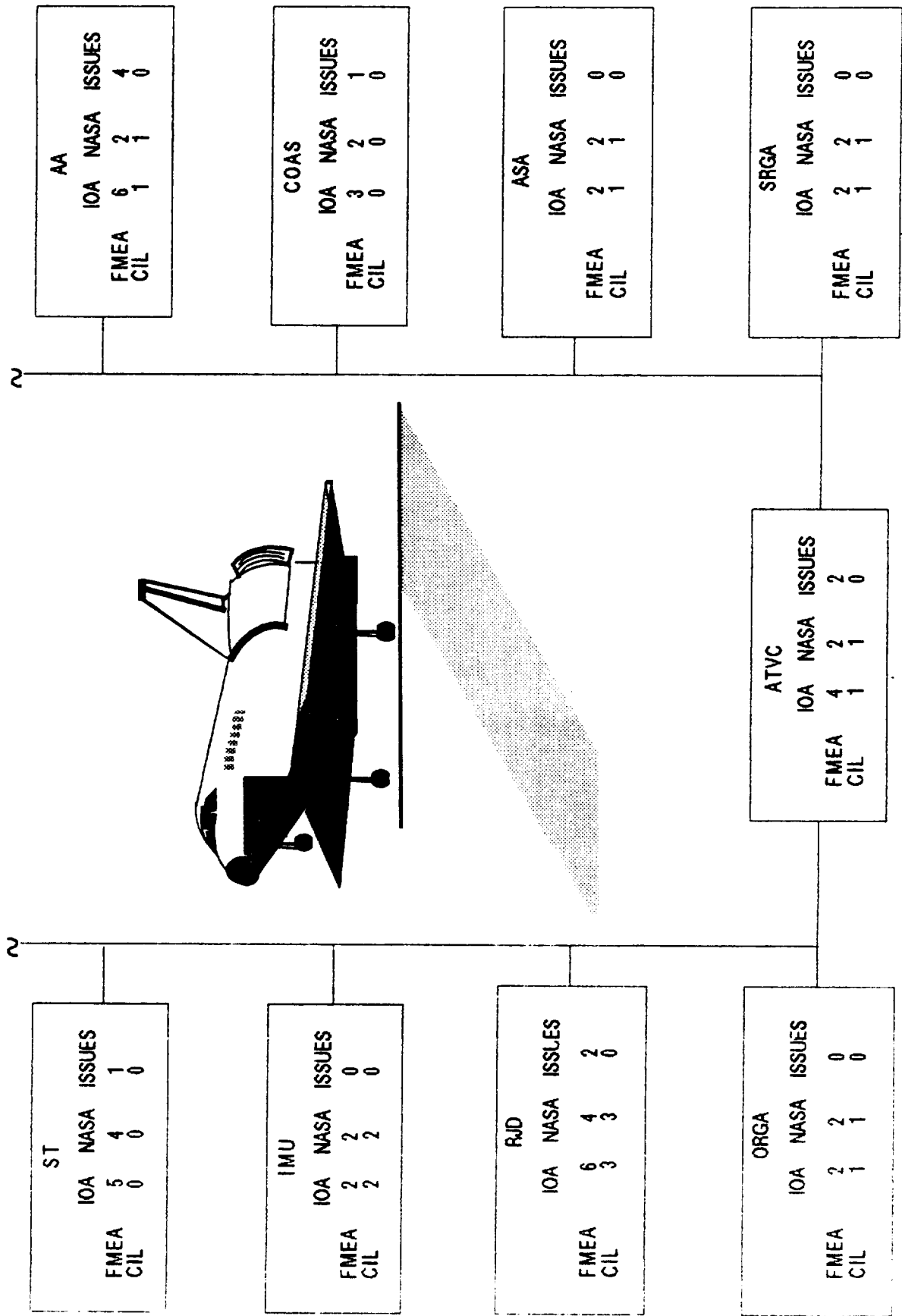
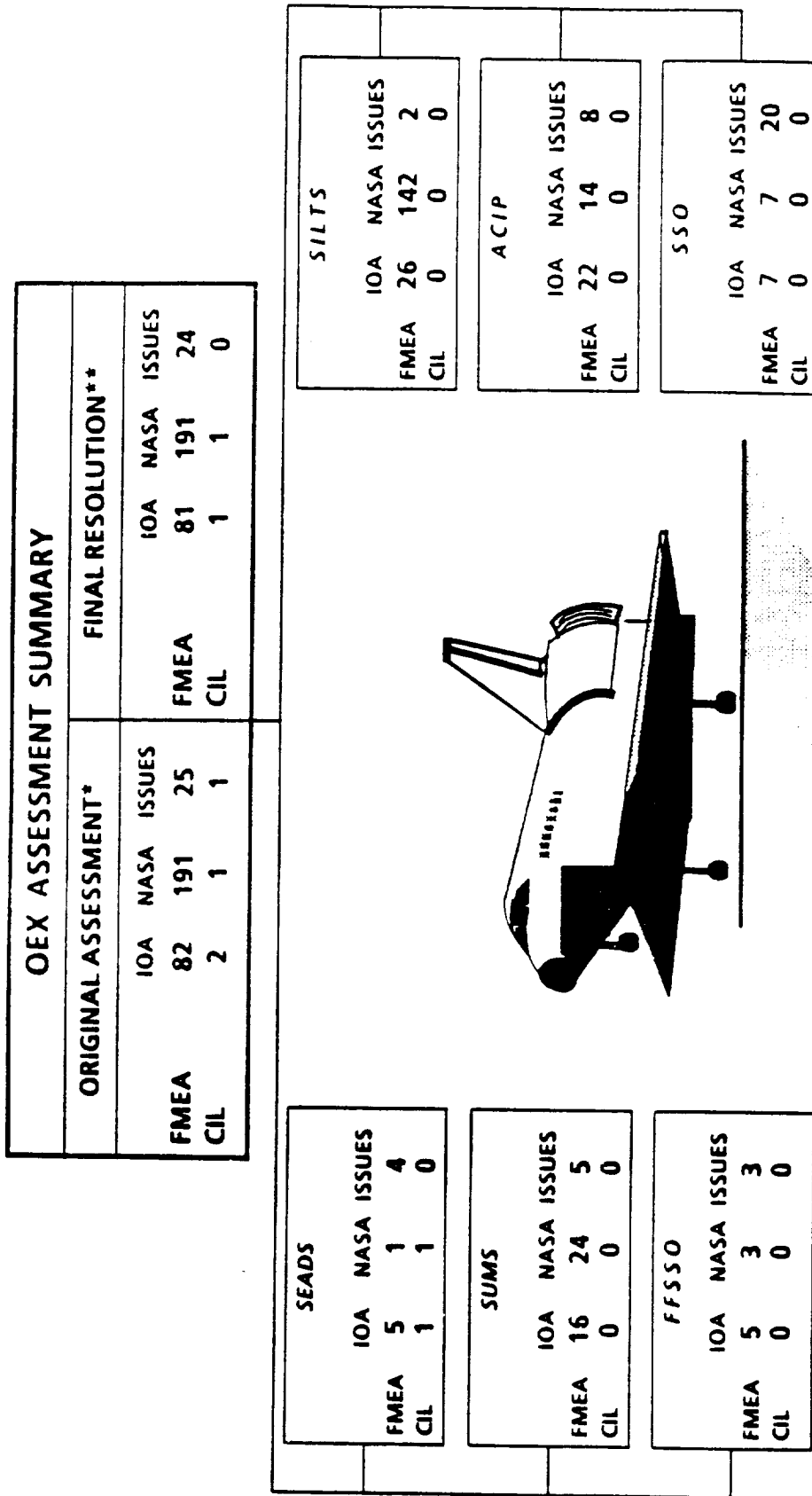

Figure C.4b - GNC FMEA/CIL ASSESSMENT - CONCLUDED

OEX ASSESSMENT OVERVIEW



* NASA PROPOSED BASELINE
 ** FINAL NASA BASELINE AS OF 1 JANUARY 1988

Figure C.5 - OEX FMEA/CIL ASSESSMENT

no FMEA is needed.

C.6 Auxiliary Power Unit

Comparison of the IOA APU analysis product with the NASA APU FMEA/CIL baseline which emerged from the NASA FMEA/CIL review process, produced numerous discrepancies. Discussions of these discrepancies with the NASA Subsystem Manager resulted in the identification of 28 issues, which were taken to the NASA/Rockwell FMEA review working group meetings for consideration. These reviews resulted in the addition of 4 new hardware FMEAs to the APU FMEA baseline, 3 of which are CIL items.

Two (2) IOA issues remain for the APU subsystem at the completion of the assessment (Fig. C.6). The first issue is a carryover from the original 28 issues, and involves a fuel line temperature sensor, which is not covered by the existing FMEA baseline. The APU Sub-system Manager agreed that this sensor, the fuel pump bypass line temperature sensor (MDAC ID 417X) should be covered since loss of it could lead to curtailment of orbit activities (if one other sensor is lost), but stated that consideration of APU instrumentation FMEAs had been deferred indefinitely to allow completion of the review of higher-criticality FMEAs. IOA recommends adding a FMEA to cover failure of this sensor at criticality 3/2R. IOA recommends a criticality of 3/1R for FMEA 04-2-518A-2 (lube oil heater thermostat failed closed), to match the effect of possible loss of an APU due to lube oil overheating cited in APU electrical FMEAs 05-6N-2048-2, 05-6N-2050-2, and 05-6N-2051-2. This discrepancy between hardware FMEAs and electrical FMEAs did not emerge during the initial assessment of the hardware FMEAs.

C.7 Backup Flight System

The IOA product for the BFS analysis consisted of 29 failure mode worksheets that resulted in 21 PCIs being identified. This product was originally compared with the proposed NASA BFS baseline as of October 1986, and subsequently compared with the applicable (as of 19 November 1987) Data Processing System (DPS), Electrical Power Distribution and Control (EPD&C), and Displays and Controls NASA CIL items. The comparisons determined if there were any results which had been found by the IOA but were not in the NASA baseline.

The original assessment determined there were numerous failure modes and PCIs in the IOA analysis that were not contained in the NASA BFS baseline. Conversely, the NASA baseline contained 3 FMEAs (IMU, ADTA, and Air Data Probe) for CIL items that were not identified in the IOA product. The IOA prepared worksheets and agreed with the NASA analysis for the 3 items. This increased the IOA worksheets from 29 to 32 and the PCIs from 21 to 24 for the original assessment as shown in Figure C.7.

NASA and Rockwell conducted several reviews and completed

APU ASSESSMENT OVERVIEW

+ HW = 189, EPDC = 124
+ + HW = 58, EPDC = 48

APU ASSESSMENT SUMMARY		ORIGINAL ASSESSMENT *		FINAL RESOLUTION **	
		IOA	NASA ISSUES	IOA	NASA ISSUES
FMEA	316	314	313	+	2
CIL	101	102	106	++	0

ELECTRICAL SYSTEM	
	IOA NASA ISSUES
FMEA	121 120 9
CIL	39 45 9

STRUCTURE	
	IOA NASA ISSUES
FMEA	1 0 1
CIL	1 0 1

FUEL PUMP/GGVW COOLING SYSTEM	
	IOA NASA ISSUES
FMEA	21 21 0 0
CIL	0 0 0 0

LUBE OIL SYSTEM	
	IOA NASA ISSUES
FMEA	22 16 10
CIL	8 6 3

* NASA PROPOSED BASELINE AS OF
17 DECEMBER 1986 (EPDC BASELINE
AS OF 10 JULY 1987)

** NASA BASELINE AS OF 2 OCTOBER 1987

GG INJECTOR COOLING SYSTEM	
	IOA NASA ISSUES
FMEA	16 16 0
CIL	8 8 0

POWER SYSTEM	
	IOA NASA ISSUES
FMEA	12 12 0
CIL	8 8 0

CONTROLLER	
	IOA NASA ISSUES
FMEA	12 12 0
CIL	6 6 0

FUEL SYSTEM	
	IOA NASA ISSUES
FMEA	54 51 7
CIL	31 29 7

INSTRUMENTATION SYSTEM	
	IOA NASA ISSUES
FMEA	49 48 1
CIL	0 0 0

DISPLAYS	
	IOA NASA ISSUES
FMEA	8 8 0
CIL	0 0 0

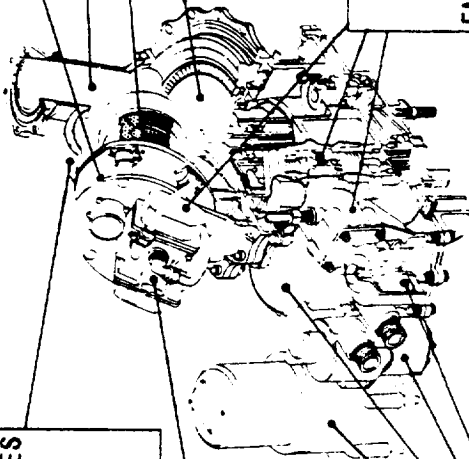
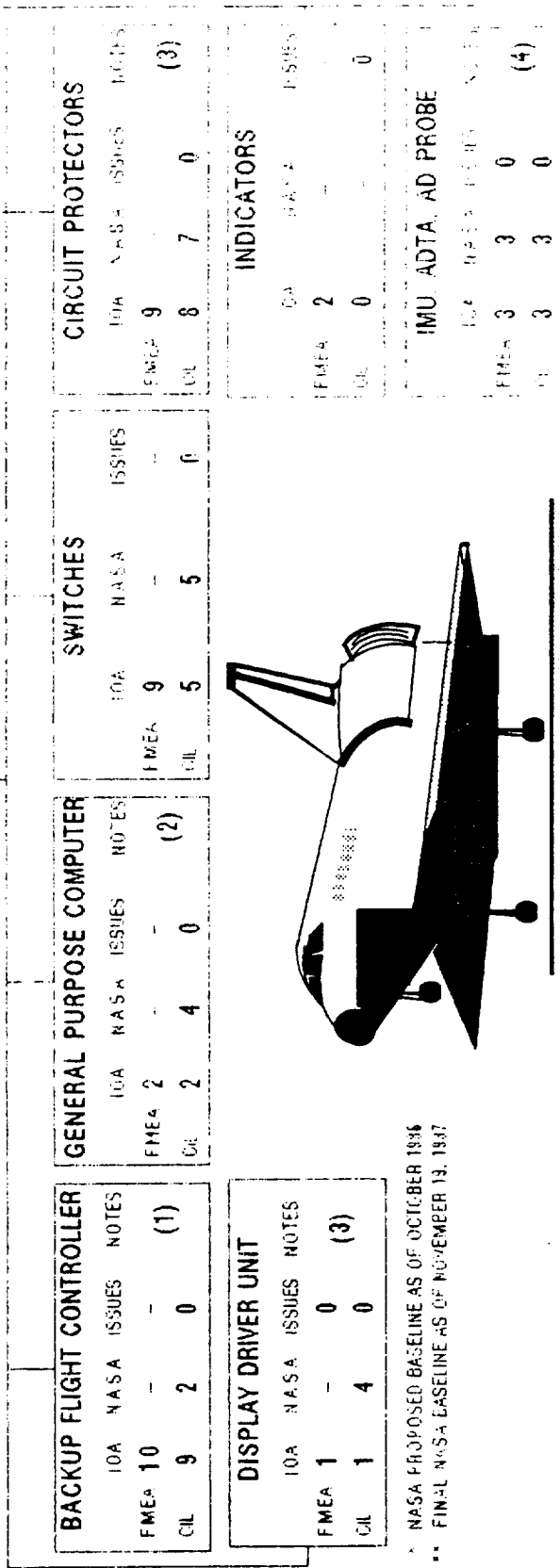

Figure C.6 - APU FMEA/CIL ASSESSMENT

BFS ASSESSMENT OVERVIEW

BFS ASSESSMENT SUMMARY				
ORIGINAL ASSESSMENT *			FINAL RESOLUTION **	
	IOA	NASA ISSUES	IOA	NASA ISSUES
FMEA	32	16	33	
CIL	24	12	25	0



BACKUP FLIGHT CONTROLLER			
	IOA	NASA ISSUES	NOTES
FMEA	10	-	(1)
CIL	9	2	0

DISPLAY DRIVER UNIT			
	IOA	NASA ISSUES	NOTES
FMEA	1	-	(3)
CIL	1	4	0

GENERAL PURPOSE COMPUTER			
	IOA	NASA ISSUES	NOTES
FMEA	2	-	(2)
CIL	2	4	0

SWITCHES			
	IOA	NASA ISSUES	NOTES
FMEA	9	-	
CIL	5	5	0

CIRCUIT PROTECTORS			
	IOA	NASA ISSUES	NOTES
FMEA	9	-	(3)
CIL	8	7	0

INDICATORS			
	IOA	NASA ISSUES	NOTES
FMEA	2	-	
CIL	0	-	0

* NASA PROPOSED BASELINE AS OF OCTOBER 1986
 ** FINAL NASA BASELINE AS OF NOVEMBER 19, 1987

- NOTES:
1. THE IOA BFC ANALYSIS WENT ONE LEVEL DEEPER THAN THE ROCKWELL/NASA ANALYSIS. THEREFORE MULTIPLE IOA FAILURES WERE COVERED BY INDIVIDUAL NASA FAILURES.
 2. THE IOA TREATED THE GPC AS ONE BLACK BOX. THE ROCKWELL/NASA ANALYSIS CONSIDERED BOTH THE GPC AND IOP.
 3. THE IOA AND NASA/ROCKWELL ANALYSES ADDRESS THE SAME FAILURE MODES BUT DOCUMENT THEM DIFFERENTLY.
 4. THE IMU FAILURE IMPACT ON BFS CONTAINED IN THE PROPOSED BASELINE ON 1-1986 WAS DELETED FROM THE IOA. THE ACTUATING PROBE CILS WERE MOVED TO GPRC IN THE FINAL IOA 1987 BASELINE.

ORIGINAL PAGE IS OF POOR QUALITY

Figure C.7 - BFS FMEA/CIL ASSESSMENT

a substantial rewrite of all CILs between December 1986 and November 1987. This effort included eliminating BFS as a unique subsystem by integrating BFS CILs with primary DPS CILs. The revised NASA baseline contained 4 more FMEAs for CIL items that were not identified in the original IOA BFS product, deleted the IMU CIL related FMEA mentioned in the previous paragraph, and moved the ADTA and Air Data Probe CILs also mentioned in the previous paragraph, to the GN&C subsystem. Once again, the IOA prepared worksheets and agreed with the NASA analysis of the additional failures. This increased the IOA worksheets from 32 to 33 and the PCIs from 24 to 25 for the final assessment. The IOA assessment of the final updated baseline (19 November 1987) results in agreement on all BFS CIL items, even though there are differences in number of items and assigned criticalities. Figure C.7 presents an overview of the assessment results.

The differences in assigned criticalities are due to different interpretation and application of the FMEA/CIL preparation instructions contained in NSTS 22206. The IOA analyzed BFS hardware failures with the assumption the BFS had been or would be engaged. NASA analyzed BFS hardware failures as an integral part of the DPS or EPD&C and, therefore, counted generic PASS failures when assigning criticalities to BFS hardware failure modes. The IOA interpretation neither added to, nor subtracted from the CIL.

C.8 Electrical Power Distribution and Control

The IOA product for the EPD&C analysis consisted of 1,671 failure mode analysis worksheets that resulted in 468 PCIs being identified. Comparison was made to the proposed NASA Post 51-L baseline (as of 31 December 1987), which consisted of 435 FMEAs and 158 CIL items. Differences between the number of IOA worksheets and NASA FMEAs resulted from different levels of analysis e.g., grouping components into one FMEA versus a worksheet for each component), failure modes not being identified within the original analysis, and the fact that 2 different schematic sets were used (NASA used Rockwell International assembly drawings and IOA used the Rockwell International integrated schematics). Figure C.8 presents a comparison of the proposed Post 51-L NASA baseline, with the IOA recommended baseline.

The issues arose due to differences between the NASA and IOA interpretation of the FMEA/CIL preparation instructions, definitions of screen detectability, and some ignorance of flight procedures on the part of IOA. After comparison, there were no discrepancies found that were not already identified by NASA, and the remaining issues are the result of the differences in the schematics used by NASA and IOA.

C.9 Landing/Deceleration Subsystem

The IOA analysis of the Landing/Deceleration hardware initially

EPD&C ASSESSMENT SUMMARY			
	IOA	NASA	ISSUES
FMEA	435	435	0
CIL	158	158	0

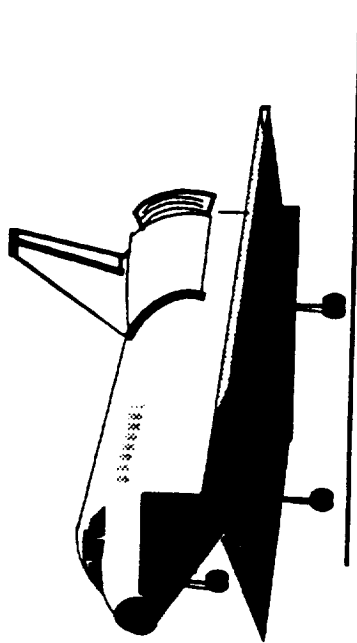

MDDA			
	IOA	NASA	ISSUES
FMEA	57	57	0
CIL	27	27	0

MPCA			
	IOA	NASA	ISSUES
FMEA	44	44	0
CIL	6	6	0

MMCA			
	IOA	NASA	ISSUES
FMEA	28	28	0
CIL	16	16	0

APCA 4-6			
	IOA	NASA	ISSUES
FMEA	30	30	0
CIL	12	12	0

APCA 1-3			
	IOA	NASA	ISSUES
FMEA	16	16	0
CIL	5	5	0

ALCA			
	IOA	NASA	ISSUES
FMEA	12	12	0
CIL	6	6	0

MDPC&D			
	IOA	NASA	ISSUES
FMEA	44	44	0
CIL	24	24	0

AMCA			
	IOA	NASA	ISSUES
FMEA	6	6	0
CIL	3	3	0

FPCA			
	IOA	NASA	ISSUES
FMEA	24	24	0
CIL	7	7	0

FLCA			
	IOA	NASA	ISSUES
FMEA	32	32	0
CIL	7	7	0

FMCA			
	IOA	NASA	ISSUES
FMEA	3	3	0
CIL	0	0	0

AGDA			
	IOA	NASA	ISSUES
FMEA	23	23	0
CIL	4	4	0

FDPC&D			
	IOA	NASA	ISSUES
FMEA	109	109	0
CIL	37	37	0

MISC			
	IOA	NASA	ISSUES
FMEA	12	12	0
CIL	9	9	0

Figure C.8 - EPD&C FMEA/CIL ASSESSMENT

generated 246 failure mode worksheets and identified 124 Potential Critical Items (PCIs) before starting the assessment process (Fig. C.9). In the analysis report, the Landing/Deceleration Subsystem was divided into six separate functional areas according to hardware and function. Difficulty was encountered in the hardware analysis due to the large amounts of proprietary hardware, the tires and wheels, and many of the mechanisms of the landing gear and the hydraulics systems. The initial NASA Document, STS 82-0013, consisted of five separate functional areas which included one hundred eighteen (118) FMEA/CIL's. After the initial definition of the subsystem the thirty two (32) NWS FMEAs were removed and separate group was initiated to prepare the analysis for that subsystem. A decision was made to include the EPD&C data for the subsystem and one hundred twenty two (122) Electrical FMEAs were added to the subsystem, later eight additional FMEAs were added to the EPD&C portion of the subsystem. In November 1986 Forty four (44) Hydraulics FMEA's were added to the subsystem. After the initial IOA Analysis was completed in January 1987, a decision was made to remove the pyrotechnic devices from the subsystem, which removed six FMEA's from the NLG and MLG subsystems. At the time of this report there are six subsystems that have been evaluated including 267 NASA FMEA's and 120 CIL items, there 75 issues between the NASA documentation and the IOA data.

The IOA analysis did not include fourteen of the NASA FMEAs due to the lack of data to support the evaluation, and many of the FMEAs were evaluated using documentation such as training manuals and component procurement specification documents. The general lack of documentation and the proprietary nature of the data were major problems for the analysis.

The majority of the hardware issues were prepared on portions of the subsystem where the NASA FMEAs would cover a whole assembly with a limited number of FMEAs and the IOA analysis concluded that a single NASA FMEA was covering several 1/1 failures that were within the single FMEA. Several major components appeared to be overlooked or considered to be a part of an assembly by the NASA assessment. The IOA assessment also uncovered several functional FMEAs that were discussed with the NASA subsystem manager. Only the initial FMEA data on the hardware subsystems was analyzed and the assessment reflects only the analysis of that data.

The majority of the electrical (EPD&C) issues were prepared due to operational discrepancies or evaluation differences on the criticality of the function or hardware capability. This portion of the document was completely analyzed and the assessment includes the final resolution of the EPD&C data.

C.10 Purge, Vent and Drain System

The IOA product for the PV&D independent analysis consisted of 62

LDG/DEC ASSESSMENT OVERVIEW			
	IOA	NASA	ISSUES
FMEA	259	267	75
CIL	124	120	51

B & AS			
	IOA	NASA	ISSUES
FMEA	28	28	9
CIL	14	15	9

EPD&C			
	IOA	NASA	ISSUES
FMEA	122	135	40
CIL	38	44	16

FLIGHT CONTROLS			
	IOA	NASA	ISSUES
FMEA	3	1	0
CIL	2	1	0

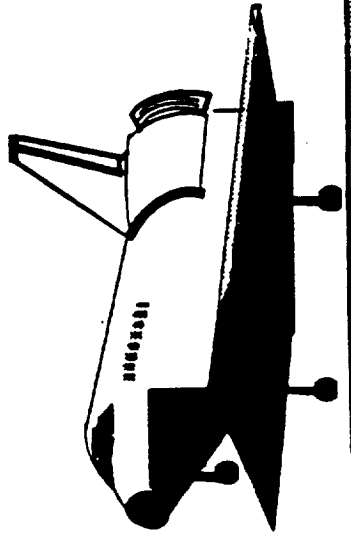

HYD			
	IOA	NASA	ISSUES
FMEA	40	42	2
CIL	16	10	2

MLG			
	IOA	NASA	ISSUES
FMEA	29	40	11
CIL	23	33	11

NLG			
	IOA	NASA	ISSUES
FMEA	31	15	13
CIL	25	11	13

PYRO			
	IOA	NASA	ISSUES
FMEA	6	6	0
CIL	6	6	0

FMEA COUNT INCLUDES CIL'S

Figure C.9 - LDG/DEC ASSESSMENT

failure mode worksheets that resulted in 16 PCIs being identified. A comparison was made of the IOA product to the NASA FMEA/CIL dated 20 November 1987, which consisted of 42 FMEAs and 8 CIL items. The difference in the number of IOA analysis worksheets and NASA FMEAs can be explained by the different levels of analysis detail performed to identify failure modes. The comparison determined if there were any results found by the IOA that were not included in the NASA FMEA/CIL.

The assessment produced agreement on all but 5 failure modes. Three (3) failure modes for components were not identified by the NASA FMEAs, 1 being a CIL item. Two (2) failure modes were identified by IOA and NASA which have differences in criticality resulting in 2 new CIL items. Figure C.10 presents a comparison of the proposed Post 51-L NASA FMEA/CIL baseline with the IOA recommended baseline and any issues. Detailed discussion of IOA issues and recommendations are provided in subsequent paragraphs.

The assessment between the IOA Purge System worksheets and NASA Post 51-L FMEA/CIL baseline produced 1 issue. IOA recommends the addition of a FMEA to the NASA baseline for the failure mode, check valve leakage, as identified in IOA worksheet 9009. The criticality for this failure mode is 3/3.

The assessment between the IOA WCCS worksheets and NASA Post 51-L FMEA/CIL produced 3 issues. IOA recommends the addition of a FMEA to the NASA baseline for the failure mode WCCS outer cavity tubing clogging, as identified in IOA worksheet 9036. The criticality for this failure mode is 1/1 and, therefore, requires NASA to generate a CIL. After further review/analysis, IOA agreed to a 1/1 criticality for NASA Baseline FMEA/CIL 01-5-332404-5, WCCS desiccant filter outer cavity leakage. However, NASA Baseline FMEA/CIL 01-5-332404-6 describes the same component, same failure, and same results, but with different windows with the same design as a criticality 3/3. IOA recommends combining the 2 NASA FMEAs with a criticality of 1/1. IOA disagrees with NASA Baseline FMEA 01-5-332406-5 designated criticality 3/3. IOA worksheet 9037 for the same failure mode, WCCS outer cavity tubing leakage, identifies the criticality as 1/1. NASA Baseline FMEA 01-5-332403-1 identifies the same failure mode for the tubing, but for a different set of windows as a criticality 1/1. After further analysis, IOA determined that the windows are all of the same design. Therefore, the criticality of 1/1 should be consistent. IOA recommends the combination of NASA FMEA/CILs 01-5-332403-1 and 01-5-332406-5 with an identified criticality of 1/1 as presented on NASA Baseline FMEA/CIL 01-5-3320403-1 and IOA worksheet 9037.

The assessment between the ET/ORB Purge Disconnect Network IOA worksheets and NASA Post 51-L FMEA/CIL baseline produced 1 issue. IOA recommends the addition of a FMEA to the NASA baseline for the failure mode, ET/ORB Purge Disconnect external leakage, as identified in IOA worksheet 9060. The criticality for this failure mode is 3/3. IOA recognizes this as a credible failure mode.

PV&D ASSESSMENT OVERVIEW

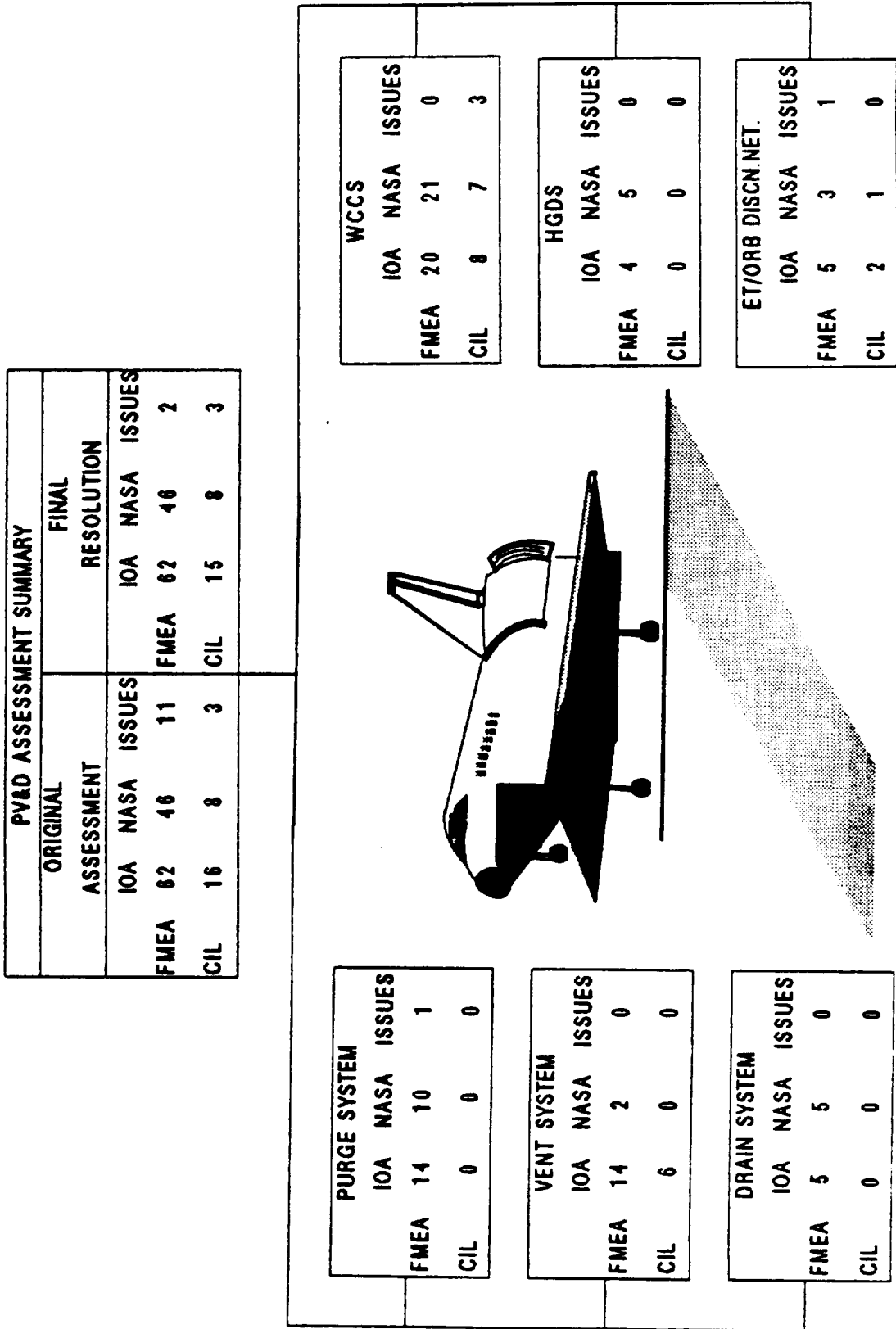

Figure C.10 - PV&D ASSESSMENT

C.11 Pyrotechnics

The IOA analysis of the Pyrotechnics hardware initially generated 41 failure mode worksheets and identified 41 PCIs before starting the assessment process (Fig. C.11). No additional failure mode analysis worksheets were generated to facilitate comparison. These analysis results were compared to the proposed NASA Post 51-L baseline of 37 FMEAs and 37 CIL items, which were generated using the NSTS-22206 FMEA/CIL instructions. Upon completion of the assessment, 27 of the 37 FMEAs were in agreement. Of the 13 that remained, 7 had minor discrepancies that did not affect criticality. Of the remaining 6, 3 were the result of data entry errors and involve the numerical criticality assignment. IOA recommends upgrading the criticalities of 2 IOA FMEAs from 2/1R to 1/1 and downgrading the criticality of 1 IOA FMEA from 1/1 to 2/1R. There are 4 IOA FMEAs for 2 components not analyzed by NASA FMEAs. In summary, IOA recommends that the credible failure modes of "Fail to Function" and "Inadvertent Operation" be included for the respective pressure cartridges in the RMS Guillotine Assembly and the Rendezvous Radar Release Mechanism.

C.12 Thermal Control System

C.12.1 Active Thermal Control System

The ATCS Assessment Overview figure C.12a lists the total number of IOA and NASA FMEA and CIL items along with a comparison of the discrepancies or issues identified during the assessment. For analysis purposes, the ATCS was divided into 4 subsystems: the Freon Coolant Loop (FCL), the Radiator Flow Control Assembly (RFCA), the Flash Evaporator System (FES) and the Ammonia Boiler System (ABS).

The IOA analysis of the ATCS hardware initially generated 310 failure mode worksheets and identified 101 PCIs before starting the assessment process. In order to facilitate comparison, 74 additional failure mode worksheets were generated. Additionally, upon closer examination, IOA deemed 10 of the original failure modes to be non-credible and recommends deleting them. Thus, the final IOA analysis identified 374 FMEAs and 147 potential CILs. The analysis results were compared to the available NASA FMEA/CIL data. A total of 252 NASA FMEAs and 109 NASA CILs were identified. The discrepancy between the number of IOA and NASA FMEAs can be explained by the different approaches used by NASA and IOA to group failure modes. This resulted in multiple IOA FMEAs being mapped to a single NASA FMEA. However, every NASA FMEA is mapped to at least 1 IOA worksheet. A total of 101 FMEA and 30 CIL issues were identified on the ATCS. A number of these issues involved failures which were identified by IOA but not by NASA. These included external leakage of heat exchanger fluid and external leakage of water/steam from the FES ducts. These failures plus the remaining issues should be examined by NASA and included in the FMEA package as required.

PYROTECHNICS ASSESSMENT SUMMARY			
	IOA	NASA	ISSUES
FMEA	41	37	4
CIL	41	37	4

ORIGINAL PAGE
BLACK AND WHITE PHOTOGRAPH

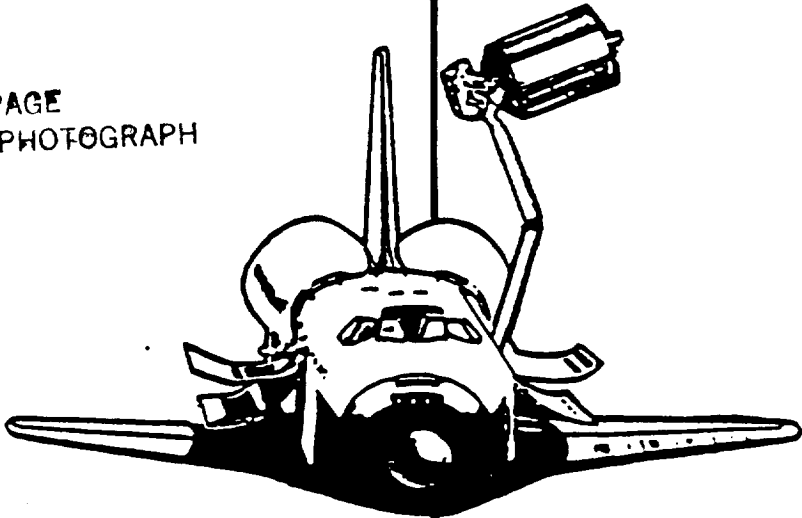

LANDING/DECELERATION			
	IOA	NASA	ISSUES
FMEA	9	9	0
CIL	9	9	0

ORBITER/ET SEPARATION			
	IOA	NASA	ISSUES
FMEA	12	12	0
CIL	12	12	0

CREW STATION & EQUIPMENT			
	IOA	NASA	ISSUES
FMEA	6	6	0
CIL	6	6	0

P/L RETN/DEPLOY			
	IOA	NASA	ISSUES
FMEA	6	6	0
CIL	6	6	0

RENDEZVOUS RADAR ANTENNA			
	IOA	NASA	ISSUES
FMEA	8	4	4
CIL	8	4	4

Figure C.11 - PYROTECHNICS FMEA/CIL ASSESSMENT

ATCS ASSESSMENT OVERVIEW

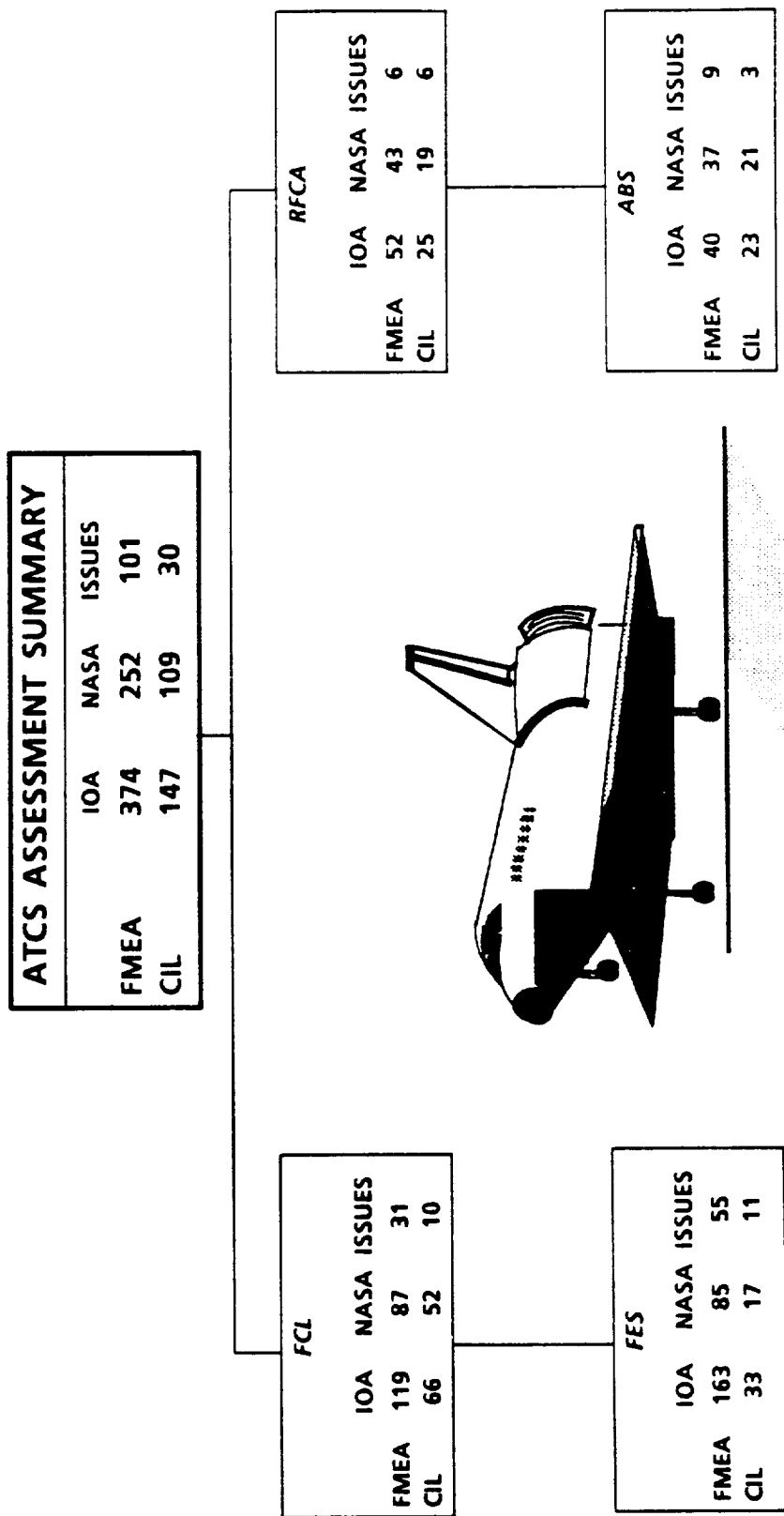

Figure C.12a - ATCS FMEA/CIL ASSESSMENT

C.12.2 Life Support and Airlock Support System

The IOA product for the Lifesupport System (LSS) and Airlock Support System (ALSSL) analysis consisted of 511 failure mode worksheets that resulted in 140 PCIs. Comparison was made to the NASA baseline dated 1 October 1987 which consisted of 456 FMEAs and 101 CIL items. After the assessment process, the number of IOA analysis worksheets rose to 694, with 171 total CIL items. The difference in the number of IOA analysis worksheets and the NASA FMEAs can be explained by the different levels of analysis detail performed to identify failure modes. Figure C.12b presents a comparison of the proposed Post 51-L NASA data, with the IOA recommended baseline, and any issues.

In the Supply Water Subsystem (SWS), one major discrepancy noted between the NASA FMEA approach and the IOA analysis was the use of multiple failure scenarios in assigning the functional criticalities. The IOA approach determined what the redundancies were for the hardware item under study, and then assign the functional criticality consistent with NSTS-22206. The NASA approach seemed to define the redundancy to the effect after the item had failed. Thus, IOA believes that the functional criticalities become so broad that visibility into a particular hardware item will be lost. For example, the NASA assessment of water system leaks relates to loss of the Flash Evaporator System but is further related to loss of this Total Active Thermal Control System (Radiators and Ammonia Boilers) and classified a 1R criticality. The IOA analysis considered the Flash Evaporator System may be deprived of water which was considered a mission loss condition or a 2R criticality. The radiators and the ABS are considered unassociated failures. Another discrepancy was over the determination of functional criticality for total loss of all redundancies in conjunction with the failure mode under study. For example, on the fuel cell outlet lines, the NASA FMEA treated the functional loss to receive fuel cell water due to external leakage the same as the case for restricted line flow. IOA agreed that restricted flow results in "dead-heading" of the fuel cells, thus potentially a loss of life or vehicle condition. However, external leakage was considered only a mission impact for the functional loss.

The Waste Management Subsystem assessment centered on the following 2 issues. First, a potential loss of the WCS was viewed as a 3/2R criticality by IOA for any "off nominal" condition. The condition of "off nominal" was defined as any failure which could potentially require use of contingency waste collection methods if another failure occurred. However, the NASA FMEA listed these as non-mission essential failure criticalities. Second, the IOA analysis viewed a Vacuum Vent Dump Line blockage or loss of the heaters as a potential loss of life/vehicle condition. A potentially hazardous atmosphere of hydrogen and oxygen could occur in the vacuum vent line if it were blocked by debris or ice.

In the Smoke Detection and Fire Suppression (SD/FS) subsystems,

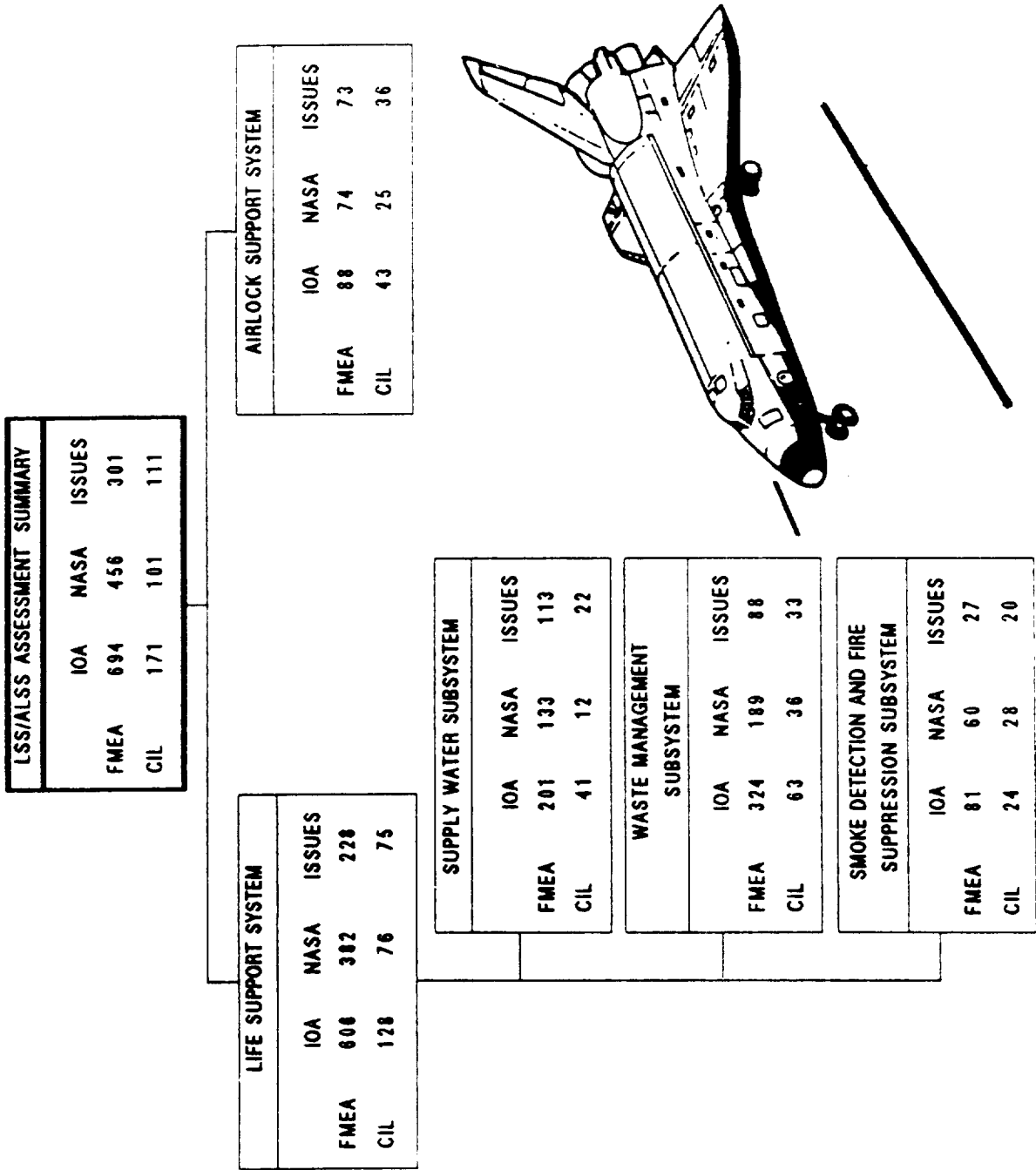

Figure C.12b - LSS and ALSS FMEA/CIL ASSESSMENT

the major outcome of the analysis and assessment points up the criticality of the Avionics Bay Fire Suppressant containers. The concern of these single string circuits is during the ascent and entry phases when the crew has no opportunity to use the portable extinguishers in the event the primary bottles fail to discharge. Another consideration is the common power source for the smoke detectors and the reset signal. Isolation of the 2 should increase the possibilities of bypassing a reset circuit problem. The actual issues defined were related to screen differences and suggest deleting 10 items as CILs while adding 2 items, and modifying 10 criticalities without affecting the CIL count.

The following is a discussion of the Airlock Support System (ALSS) assessment. The principle reason for assessment discrepancies between the NASA FMEA and the IOA analysis centered on the consideration that the Airlock is not, and should not be, a system classified as emergency hardware. It may be true that the crew can use it for emergency EVAs, but this is part of the procedure that has been devised to solve an emergency in another system. To compound that failure, that is, failing the airlock along with the emergency failure, to increase the criticalities is like assigning criticalities to procedures devised to solve the original emergency. With the same logic, the EMU suits will have to be declared an emergency system which is also unacceptable because this was not the original intent for either system, Airlock or EMU.

C.13 Crew Equipment

The IOA analysis of the Crew Equipment hardware initially generated 352 failure mode worksheets and identified 78 PCIs before starting the assessment process. In order to facilitate comparison, 78 additional failure mode analysis worksheets were generated. These analysis results were compared to the proposed NASA Post 51-L baseline of 351 FMEAs and 82 CIL items. The FMEAs that remained had minor discrepancies that did not affect criticality.

An overview of the quantity of NASA FMEAs assessed, versus the recommended IOA baseline, and any issues identified is presented in Figure C.13.

The more significant assessment results for each area within the Crew Equipment Subsystem are addressed in the following discussions:

C.13.1 EVA Equipment Assessment Results

The IOA analysis identified 5 failure modes of the EVA scissors. NASA determined the EVA scissors were non-critical items, so there were no FMEA/CILs available for comparison. The assessment of the EMU light assembly generated 8 new failure modes. One (1)

CREW EQUIPMENT ASSESSMENT OVERVIEW

CREW EQUIPMENT ASSESSMENT SUMMARY					
ORIGINAL ASSESSMENT*			FINAL RESOLUTION**		
	IOA	NASA ISSUES	IOA	NASA ISSUES	
FMEA	422	351	FMEA	422	351
CIL	80	82	CIL	80	82
		4			4

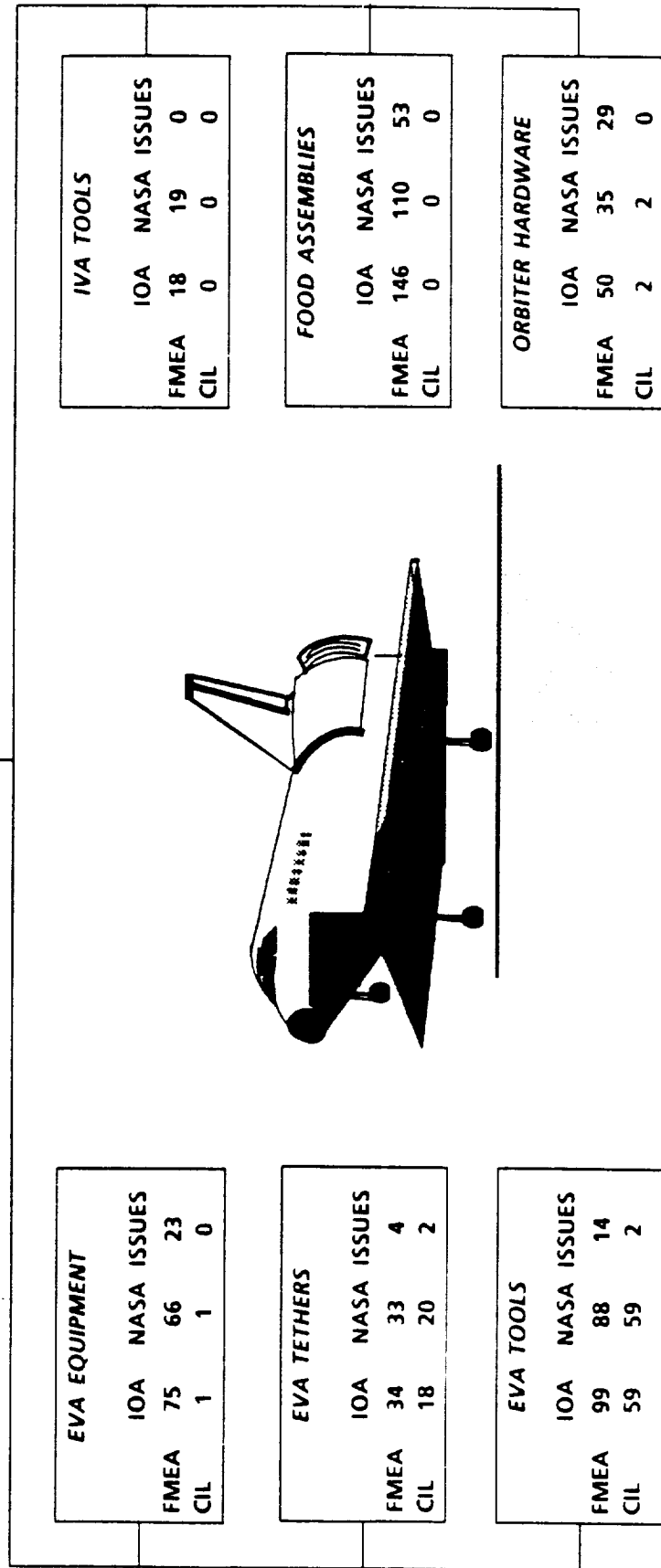

Figure C.13 - CREW EQUIPMENT FMEA/CIL ASSESSMENT

* NASA PROPOSED BASELINE
 ** FINAL NASA BASELINE AS OF 1 JANUARY 1988

of these failure modes (MDAC ID 11216) shows the battery cell as a criticality 1/1 because of the possibility of toxic venting or explosion. Three (3) new FMEAs were generated for the OBS. The IOA analysis of the OBS identified 5 failure modes which were not considered by NASA. The failure modes were not critical, but were included for completeness. The assessment of the PFR generated 1 new FMEA, which was not critical.

C.13.2 EVA Tethers Assessment Results

The IOA disagrees with NASA's analysis of a hook failing to close as criticality 1/1. The failure mode implies to an unrestrained crewmember. The IOA differs with NASA on this issue for both the ERCM safety tether and the waist tether. For all other failure modes, MDAC either agrees with, or accepts NASA's analysis.

C.13.3 EVA Tools Assessment Results

The NASA analysis does not include a failure mode corresponding to a failure of the 3-point latch hook. This failure mode should be added to NASA's FMEA/CIL database. The IOA believes that NASA's analysis of the snatch block hook latch as a criticality 2/1R is too high and should be lowered. If the hook latch fails to close, then the tool is not in use at that time. For the other EVA tools, the IOA either agrees with or accepts NASA's results.

C.13.4 IVA Tools Assessment Results

The FMEA/CIL assessment recommends deleting 3 FMEAs as being non-credible failures (MDAC IDs 4200, 4307, and 4310). With these deletions, IOA agrees completely with NASA on the IVA tools that were analyzed. All of the tools were found to be non-critical primarily because of redundant hardware.

C.13.5 Food Assemblies Assessment Results

The IOA found that none of the hardware which had been analyzed were critical hardware. IOA identified 35 FMEAs which were not analyzed by NASA, and generated 44 new FMEAs to correspond to failure modes NASA identified which had not been analyzed by IOA. The slight differences in criticality ratings of FMEAs between IOA and NASA are primarily due to differences in groundrules. During the assessment process, it was determined that 5 IOA failure modes were non-credible and IOA recommends that these be deleted.

C.13.6 Orbiter Hardware Assessment Results

The IOA found that none of the Orbiter hardware, which had been analyzed, were critical hardware. The assessment did generate 2 new FMEAs for the treadmill and 6 new FMEAs for the COAS. The

assessment recommends accepting NASA's FMEAs and criticalities for the mid-deck stowage lockers.

C.14 Instrumentation

The IOA analysis of the Instrumentation hardware initially generated 88 failure mode worksheets and identified 8 PCIs before starting the assessment process (Fig. C.14). These analysis results were compared to a NASA baseline which was frozen as of 1 January 1988, with 14 Post 51-L FMEAs included in a total of 96 FMEAs and 18 CIL items, which were generated using the referenced FMEA/CIL instructions. Upon completion of the assessment, 82 of the 107 FMEAs were in agreement. Of the 25 that remained, 4 are 2/2 criticality and not currently on the NASA CIL list and 7 new FMEAs were generated which had no NASA match. The remaining 14 FMEAs are of a different criticality than the NASA interpretation. None of these 14 FMEAs affect the CIL listing.

C.15 Data Processing System

The IOA analysis of the DPS hardware initially generated 85 failure mode worksheets and identified 2 PCIs before starting the assessment process. In order to facilitate comparison, 37 additional failure mode analysis worksheets were generated (See Fig. C.15). These analysis results were compared to the proposed NASA Post 51-L baseline of 78 FMEAs and 25 CIL items, which was generated using the Rockwell 100-2G FMEA/CIL instructions. Upon completion of the assessment, 60 of the 78 FMEAs were in agreement. Of the 18 that remained, 14 had minor discrepancies that did not affect criticality. Of the remaining 4, 2 issues were with FMEAs (05-5-B03-1-1 and 05-5-B03-2-1) that had considered failure modes outside the DPS subsystem, and caused inflated criticalities. These criticalities mistakenly placed both FMEAs on the CIL. The other 2 issues were with FMEAs (05-5-B01-1-1 and 05-5-B02-1-1) that also considered failure modes outside the DPS subsystem. However, when the correct failure mode is included, the current criticalities will remain unchanged. In summary, all issues may be attributed to differences between ground rules in Rockwell 100-2G and NSTS 22206 instructions. The IOA recommends correcting the failure modes considered in the 4 FMEAs, which lowers criticality assignments in 2 of the FMEAs, and removes them from the CIL.

C.16 Atmosphere Revitalization Pressure Control System

The IOA analysis of the ARPCS hardware initially generated 266 failure mode worksheets and identified 89 PCIs before starting the assessment process. In order to facilitate comparison, 22 additional failure mode analysis worksheets were generated.

INSTRUMENTATION FMEA/CIL ASSESSMENT OVERVIEW

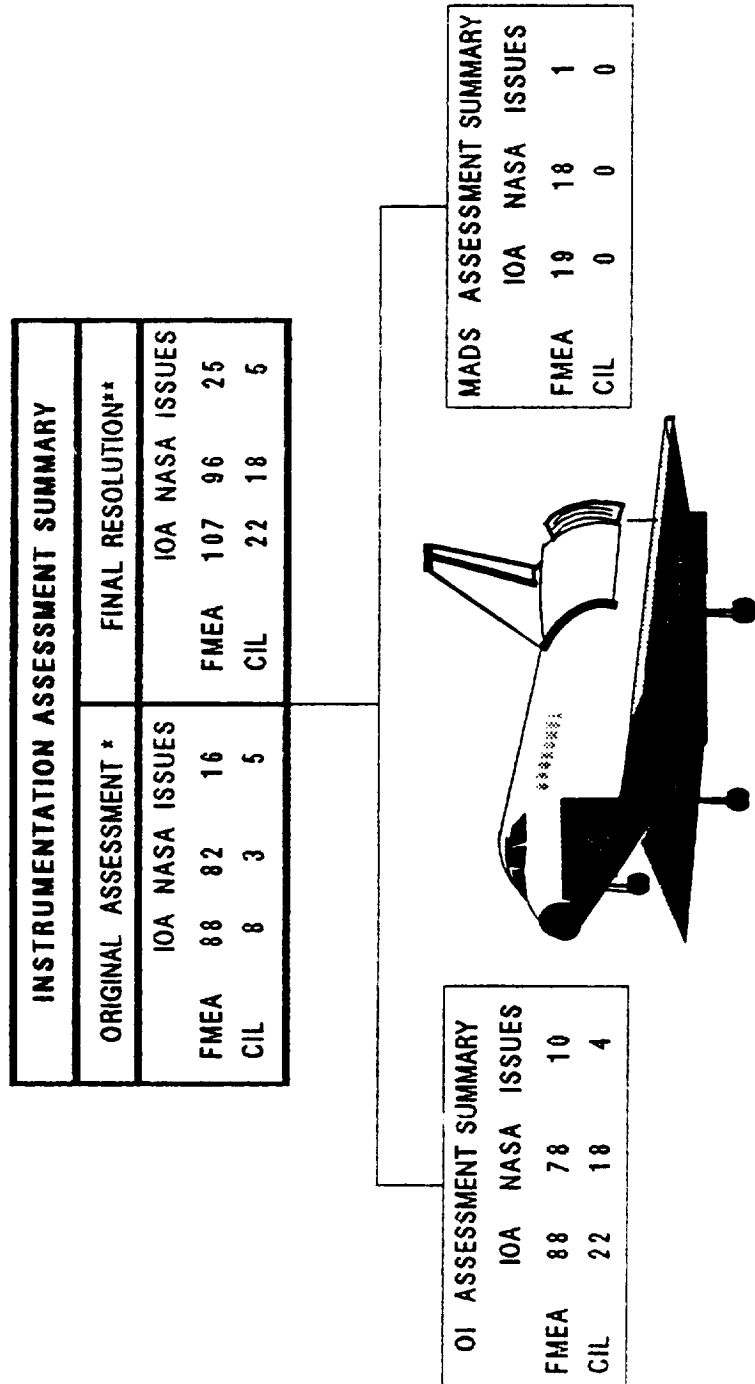
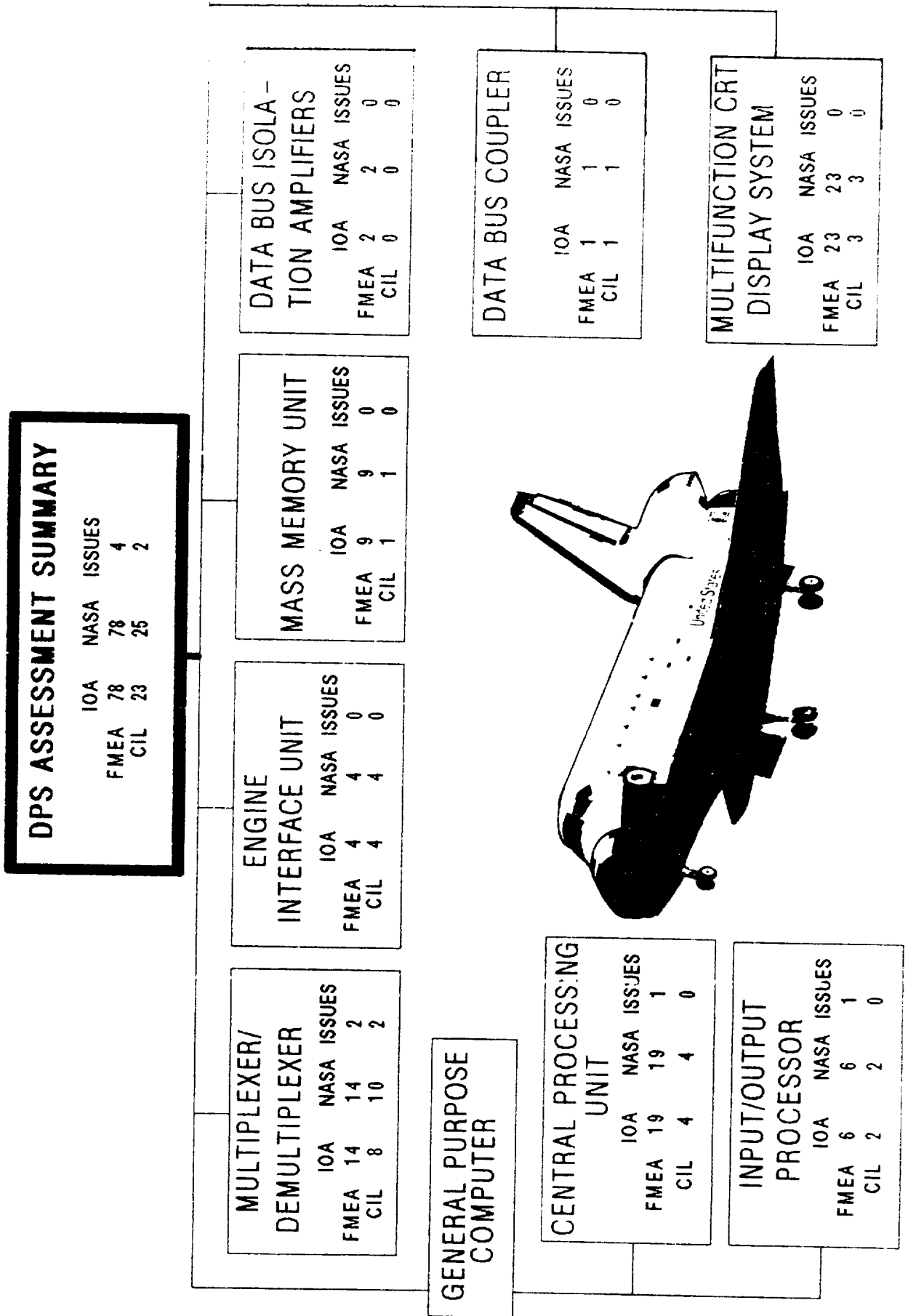

Figure C.14 - INSTRUMENTATION ASSESSMENT

* NASA BASELINE PRE 51 - L
 ** FINAL NASA BASELINE AS OF 1 JANUARY 88

DPS FMEA/CIL ASSESSMENT OVERVIEW



COUNT CORRECT AS OF 11/19/85

Figure C.15 - DPS FMEA/CIL ASSESSMENT

These analysis results were compared to the proposed NASA Post 51-L baseline of 262 FMEAs and 87 CIL items. Upon completion of the assessment, of the 273 total IOA failure modes, 124 remained as issues to be resolved. A summary of the FMEA/CIL counts for IOA and NASA is provided in Figure C.16, and some of the significant issues follow.

The FMEA considered the LEH panels as emergency systems; and, as such, it was seen as potential for loss of life/ vehicle for any failure which resulted in loss of LEH usage. IOA accepted this assumption with some reservations. First, the LEH panels do not fit into the strict definition of the emergency systems stated in the NSTS-22206, Paragraph 2.1.e. This definition excludes hardware (such as LEH panels) which performs a function used during any nominal mission phase or during intact abort.

Second, there is no limitation as to how broad this definition will be used throughout the ARPCS. That is, any failure of an item upstream of the LEH panels which negates the use of the LEHs is compounded by the assumption that an emergency condition exists. This approach seems to be too conservative, which may result in loss of visibility into an item when studied under nominal conditions.

The FMEA studied "craced mounting flange: failure mode for the cabin negative relief valve (FMEA 06-1-0203-3) and cabin positive relief valve (FMEA 06-1-0201-3). The causes are listed as material defect, mechanical shock, and vibration. IOA did not study this failure mode, and considered the failure mode and cause relationship not credible. The material defect is ruled out based on the IOA general project groundrule (Appendix B.2.4), otherwise this failure mode should be included for all hardware items. The mechanical shock and vibration are not realistic since their magnitude must be very high and far beyond the structural integrity of the vehicle in order to cause such a failure. Also, this condition presumes a failure already in progress (vehicle undergoing severe and dangerous condition) contrary to the NSTS-22206 hardware criticality groundrules.

FMEA studied "inability to restrict" as failure of the flow restrictor. IOA considered this failure mode and cause relationship not credible and it was, therefore, not studied. There was no detailed FMEA information to further investigate this failure mode.

FMEA studied "restricted flow" for lines and fittings. IOA studied this failure mode for appropriate hardware items on the line. This was done primarily because the causes of flow restriction (contamination, corrosion) most likely will restrict flow at the hardware items (valves, screens, . . . etc.) before the line. Second, the restricted flow of an item at a particular location on the line may yield different effects and criticalities, and hence is easier to investigate.

IOA studied electrical solenoids and motors separately from their

ARPCS ASSESSMENT SUMMARY			
	IOA	NASA	ISSUES
FMEA	273	262	124
CIL	73	87	48

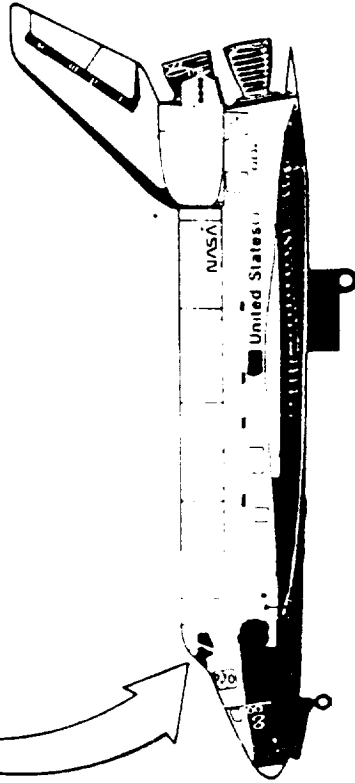

ORIGINAL PAGE
BLACK AND WHITE PHOTOGRAPH

AUXILIARY OXYGEN ASSEMBLY			
	IOA	NASA	ISSUES
FMEA	31	32	6
CIL	2	7	5

OXYGEN ASSEMBLY			
	IOA	NASA	ISSUES
FMEA	76	76	30
CIL	34	43	19

CABIN VENT ASSEMBLY			
	IOA	NASA	ISSUES
FMEA	16	6	13
CIL	3	6	2

NITROGEN ASSEMBLY			
	IOA	NASA	ISSUES
FMEA	128	128	62
CIL	20	17	18

POSITIVE RELIEF VENT ASSEMBLY			
	IOA	NASA	ISSUES
FMEA	14	13	3
CIL	9	9	2

NEGATIVE RELIEF VENT ASSEMBLY			
	IOA	NASA	ISSUES
FMEA	8	7	4
CIL	5	5	2

Figure C.16 - ARPCS FMEA/CIL ASSESSMENT

associated valves, and did not find any reference to them in the FMEA data. However, a match of these items was made based on the FMEA results for the valve. The electrical solenoids and motors may be either covered separately or the failure modes and causes assessed for the valves should address them.

C.17 Hydraulic/Water Spray Boiler

The IOA product for the HYD/WSB analysis consisted of 447 failure mode worksheets that resulted in 183 PCIs being identified. Comparison was made to the NASA baseline (as of 19 November 1986) which consisted of 364 FMEAs and 111 CIL items. The comparison determined if there were any results which had been found by the IOA but were not in the NASA baseline. This comparison produced agreement on all but 68 FMEAs which caused differences in 23 CIL items. Figure C.17 presents a comparison of the proposed Post 51-L NASA baseline, with the IOA recommended baseline, and any issues.

The issues arose due to differences between the NASA and IOA FMEA/CIL preparation instructions. NASA had used an older groundrules document which has since been superseded by the NSTS 22206 used by the IOA. After comparison, there were no discrepancies found that were not already identified by NASA, and the remaining issues may be attributed to differences in groundrules.

C.18 Mechanical Actuation Subsystem

An overview of the quantity of NASA FMEAs assessed, versus the recommended IOA baseline and any identified issues, is presented in Figure C.18. In the analysis and assessment report, the MAS was divided into nine sections according to hardware and function. Each of these sections are identified, with summary assessment results, in Figure C.18.

The IOA analysis of the MAS hardware initially generated 685 failure mode worksheets and identified 476 Potential Critical Items (PCIs) before starting the assessment process. In order to facilitate comparison, 28 additional failure mode analysis worksheets were generated. These analysis results were compared to the proposed NASA Post 51-L baseline (5 February, 1988) of 510 FMEAs and 252 CIL items using available NASA FMEA/CIL data. The discrepancy between the number of IOA and NASA FMEAs can be explained by the different approach used by NASA and IOA to group failure modes. In many cases, multiple IOA FMEAs were mapped to a single NASA FMEA. The MAS assessment identified a total of 472 issues. Many of these issues resulted from failures identified by IOA which could not be matched to available NASA FMEAs. It is believed that other issues resulted from IOA use and interpretation of NSTS-22206 differing slightly from criteria used by RI and NASA, and a difference in criticality assignments for a particular hardware item or function.

HYDRAULICS/WATER SPRAY BOILER ASSESSMENT OVERVIEW

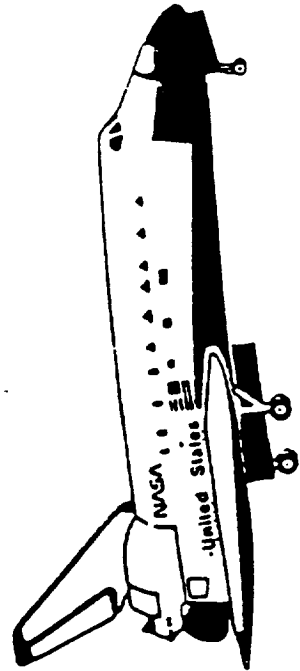
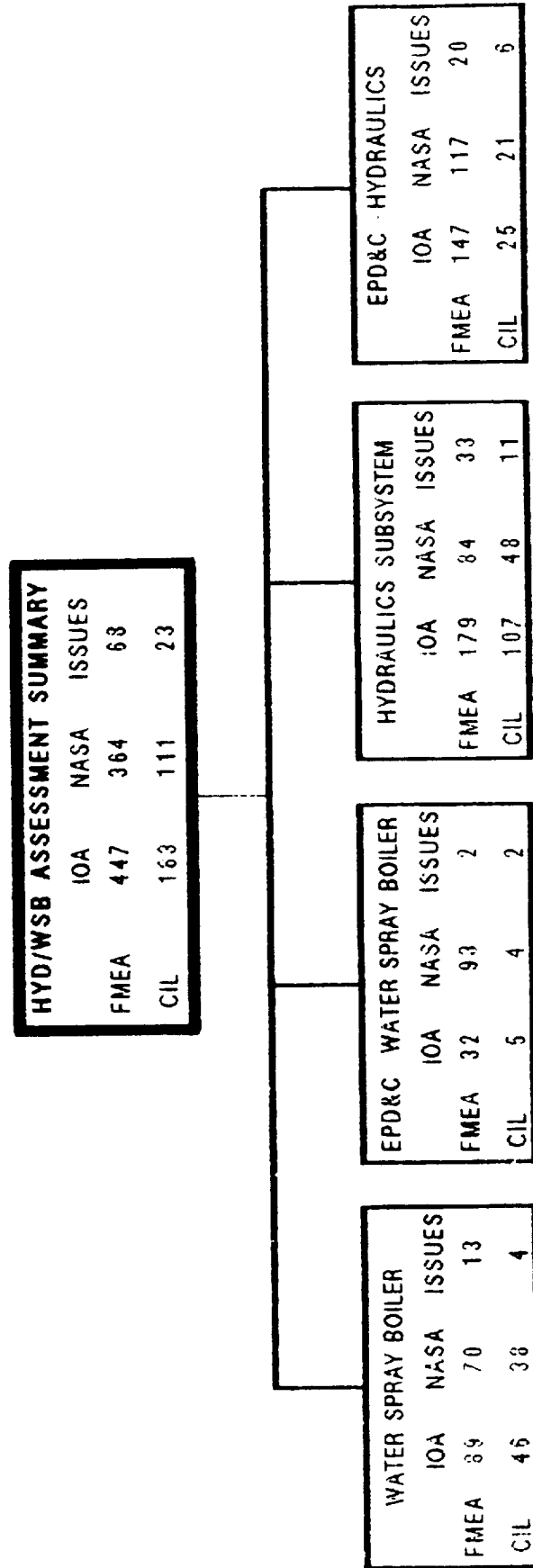
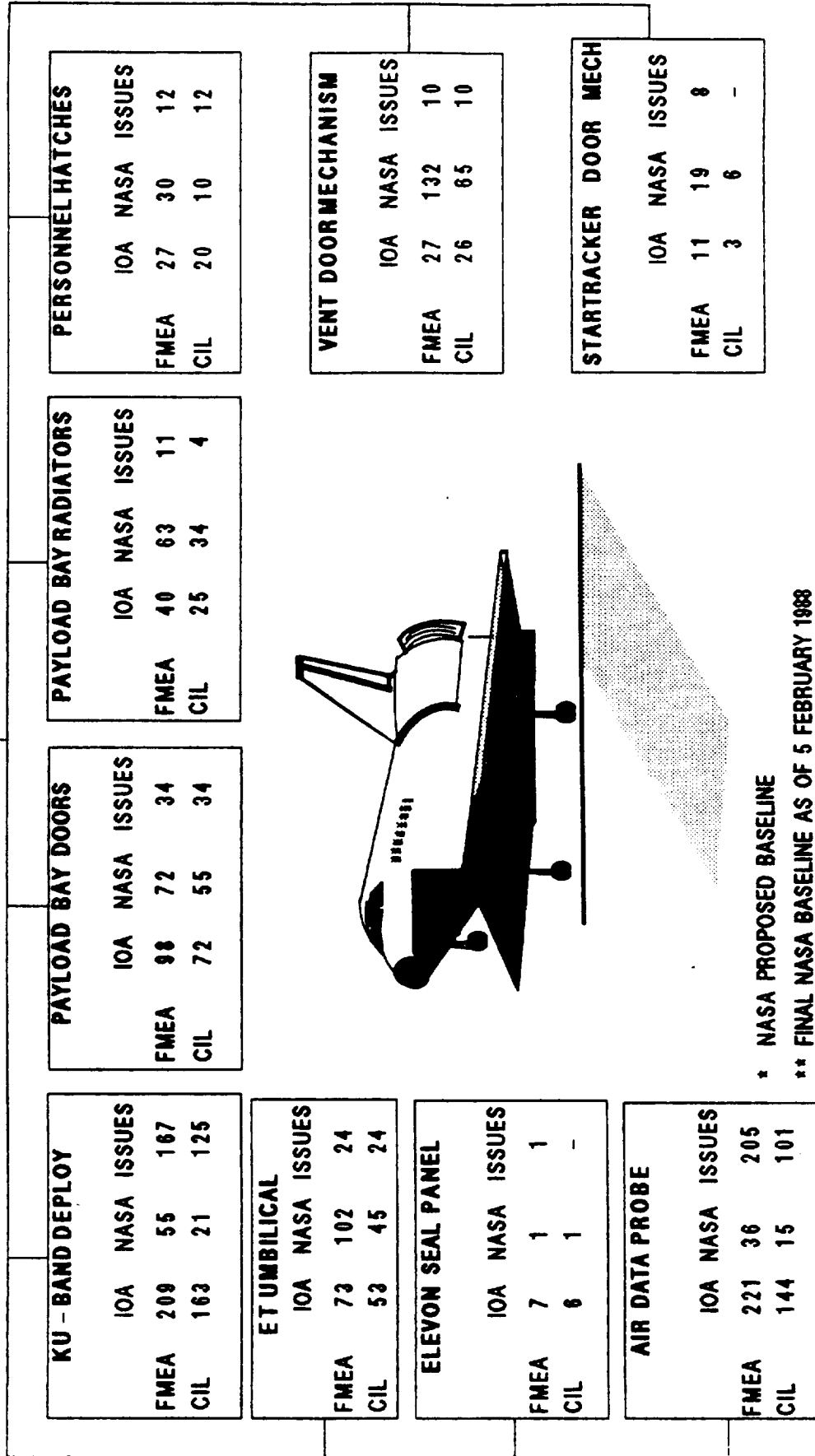

Figure C.17 - HYDRAULICS/WATER SPRAY BOILER
FMEA/CIL ASSESSMENT

MAS OVERVIEW ASSESSMENT SUMMARY

MAS ASSESSMENT SUMMARY		
ORIGINAL ASSESSMENT *	FINAL RESOLUTION **	
IOA NASA ISSUES	IOA	NASA ISSUES
FMEA 685 - -	FMEA 713	510 472
CIL 476 - -	CIL 512	252 310



* NASA PROPOSED BASELINE
 ** FINAL NASA BASELINE AS OF 5 FEBRUARY 1988

Figure C.18 - MAS ASSESSMENT

C.19 Manned Maneuvering Unit

The IOA analysis of the MMU hardware initially generated 136 failure mode worksheets and identified 69 PCIs before starting the assessment process. In order to facilitate comparison, 57 additional failure mode analysis worksheets were generated. These analysis results were compared to the proposed Martin Marietta Post 51-L baseline of 179 FMEAs and 110 CIL items. Upon completion of the assessment, 121 of the 204 IOA failure modes remained as issues to be resolved. A summary of the FMEA/CIL counts for IOA and NASA is provided in Figure C.19, and some of the significant issues follow.

The Martin Marietta analysis format lacked a comprehensive definition of the flight phases, screens, and the item(s) under study. All the flight phases were not always analyzed for prep, ops, and post ops for each failure mode. The screens A and B were not specifically designated per NSTS 22206. IOA had to interpret their status based on very limited information provided. Screen C was not addressed; and it was, therefore, left blank throughout the assessment.

The Martin Marietta analysis did not address a specific hardware item in some cases, but used an assembly instead. This made it very difficult to investigate failure modes and effects of a particular item and its impact on the overall system.

The MMU PREP and POST-OPS definitions were not too clear, and it was consequently difficult to match their criticalities. IOA considered every MMU activity to begin with PRE-OPS activities and end with POST-OPS activities prior to the start of the next MMU OPS. The Martin Marietta definition seems to suggest that the PREP activities start with the first MMU PRE-OPS and stop after the last MMU OPS activity. The period after the last planned MMU OPS will then be POST-OPS.

There were a number of issues related to the treatment of the multi-position switches. Martin Marietta used a more broad and general failure mode approach, such as open or closed. IOA considered and investigated the failure of single contact positions for open and closed and assigned the worst case criticality. Multi-position switches to fail open or closed were, in general, considered to be unreasonable.

Electrical items, such as diodes, resistors, relays, etc. associated with an LRU circuit were not studied by Martin Marietta. IOA provided analysis for these items to be incorporated into the final FMEA/CIL study.

C.20 Nose Wheel Steering Subsystem

The IOA analysis of the NWS hardware initially generated 78 failure mode worksheets and identified 42 Potential Critical Items (PCIs). As a result of the assessment process, 15 NWS

MMU ASSESSMENT SUMMARY		
	IOA	NASA ISSUES
FMEA	204	179
CIL	95	110
		92

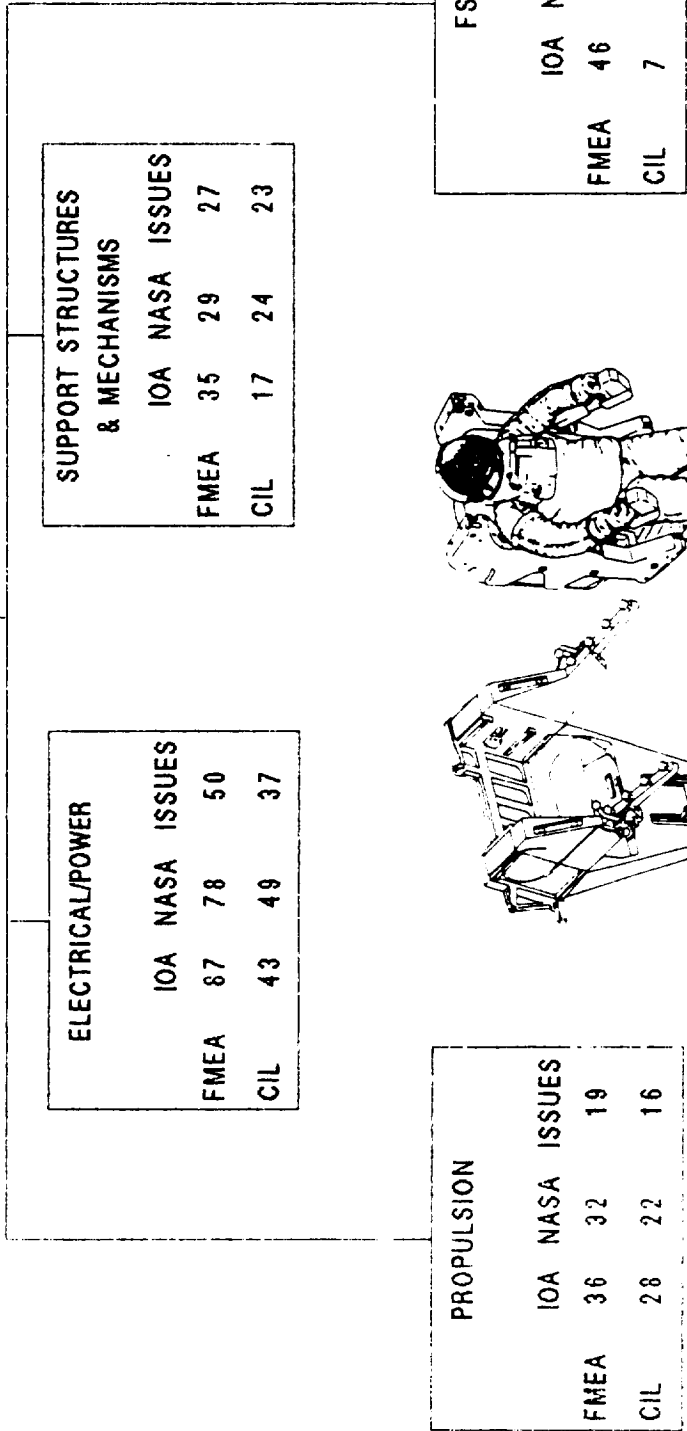

Figure C.19 - MMU FMEA/CIL ASSESSMENT

failure mode worksheets were deleted and an additional 5 analysis worksheets were generated and added to the assessment package. The assessment comparison also gave rise to 14 issues between the IOA NWS analysis and the corresponding NASA FMEAs (Fig. C.20).

Of these issues, 9 are the result of failure modes generated by the IOA that did not have corresponding NASA FMEAs. The remainder of the issues are the result of differences in the NWS subsystem failure mode assigned hardware/functional criticalities.

The most significant Orbiter assessment issue was uncovered during the Nose Wheel Steering (NWS) subsystem analysis. The failure mode was a "stuck" autopilot pushbutton causing the worst case effect of loss of crew/vehicle (criticality 1/1). The Orbiter autopilot is used for entry, and manually disengaged before landing. The autopilot is engaged by "Roll/Yaw Auto" and "Pitch Auto" pushbutton indicators (PBIs). If either "Auto" PBI fails closed, the autopilot cannot be permanently disengaged. With the autopilot remaining engaged, the Orbiter will attempt to "Autoland", which requires a Microwave Landing System (MLS) on the ground. MLS is not required for day landings, and has not been "available" for four of the last seven STS missions. Without the MLS, use of the autoland alone will cause the Orbiter to miss the runway. A single point failure with no redundancy and which threatens loss of crew/vehicle is categorized by NSTS 22206 as a "criticality 1" item. Rockwell is adding the failure mode to the FMEA/CIL baseline and developing a software change to bypass a failed "Auto" switch.

Some of the criticality issues cannot be resolved without performing additional analysis or testing of the NWS system. Other issues can be more easily resolved by establishing official flight rules or crew procedures for certain failure modes. In either case, IOA has recommended upgrading the existing criticalities of the affected NWS components until conclusive test/analysis results or written flight rules/crew procedures are available to support downgrading the criticalities.

The IOA assessment of the existing CILs gave rise to 9 issues. Of these issues, 8 are the result of IOA identifying additional Potential Critical Items. One PCI concerns the generation of independent FMEA/CILs for like critical hardware as recommended by NSTS 22206. A second PCI is the result of an IOA recommended criticality upgrade. The remainder of the 8 PCIs concern hardware or failure modes excluded by the NASA analysis. IOA also recommends the deletion of one NASA CIL.

C.21 Remote Manipulator System

The overview (Fig. C.21a) presents the results of the RMS hardware assessment and the final results. Each component is identified along with the number of FMEAs, CILs, and issues for each. There are 69 issues which remain open. These issues occurred in the

NWS ASSESSMENT OVERVIEW

NWS ASSESSMENT SUMMARY			
	IOA	NASA *	ISSUES
FMEA	68	58	14
CIL	41	34	9

RUDDER PEDAL ASSEMBLY			
	IOA	NASA	ISSUES
FMEA	7	7	-
CIL	5	5	-

NWS CONTROL BOX			
	IOA	NASA	ISSUES
FMEA	6	4	2
CIL	5	4	1

NWS ACTUATOR ASSEMBLY			
	IOA	NASA	ISSUES
FMEA	33	27	9
CIL	25	20	7

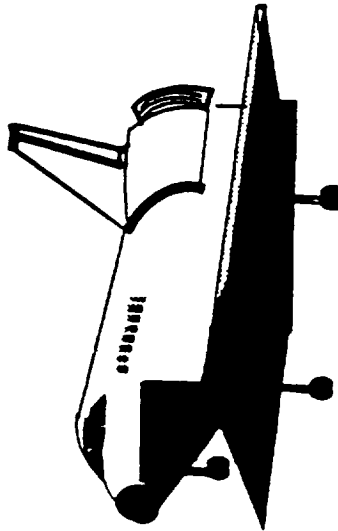

NWS EPD&C: FAILURE ANNUNCIATOR SYSTEM			
	IOA	NASA	ISSUES
FMEA	5	5	-
CIL	-	-	-

NWS EPD&C: ACTIVATION SYSTEM			
	IOA	NASA	ISSUES
FMEA	17	15	3
CIL	6	5	1

* FINAL NASA BASELINE AS OF 1 JANUARY 1988

Figure C.20 - NWS ASSESSMENT

RMS ASSESSMENT OVERVIEW

RMS ASSESSMENT SUMMARY			
	IOA	NASA	ISSUES
FMEA	453	453	69
CIL	324	324	69

DISPLAY & CONTROL			
	IOA	NASA	ISSUES
FMEA	204	204	0
CIL	124	124	0

MCIU			
	IOA	NASA	ISSUES
FMEA	91	91	47
CIL	74	74	47

END EFFECTOR			
	IOA	NASA	ISSUES
FMEA	77	77	0
CIL	62	62	0

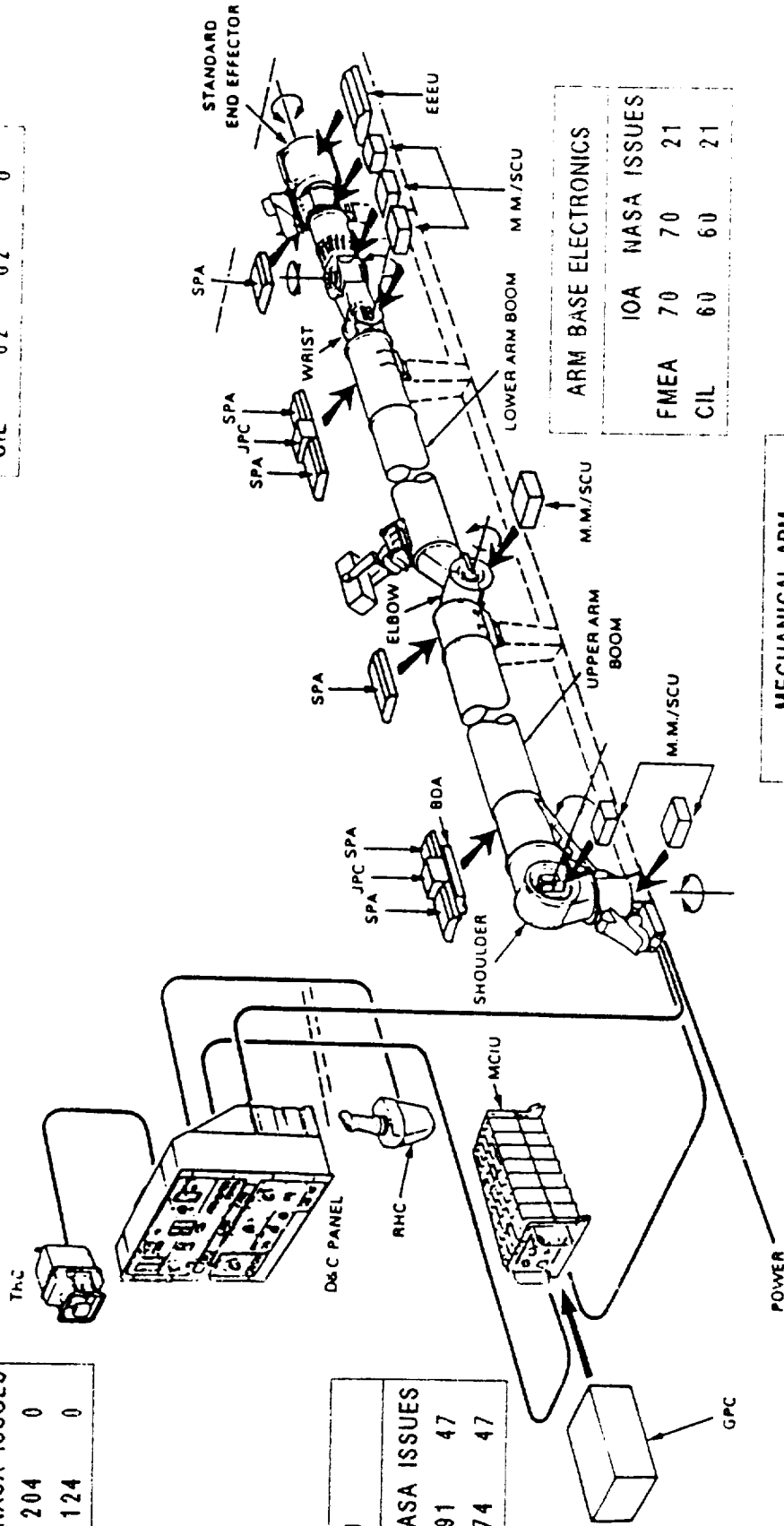

ARM BASE ELECTRONICS			
	IOA	NASA	ISSUES
FMEA	70	70	21
CIL	60	60	21

MECHANICAL ARM			
	IOA	NASA	ISSUES
FMEA	11	11	1
CIL	4	4	1

Figure C.21a - RMS FMEA/CIL ASSESSMENT

MCIU, Arm Based Electronics, and the Mechanical Arm.

The final results of the RMS assessment are that 154 issues were identified. Eighty-five (85) of these issues were resolved with the NASA Subsystem Manager. Of these 85 issues, 64 were resolved without change to the baseline. Twenty-one (21) failures were combined, resulting in 3 new FMEAs and 3 new CIL items. The 15 remaining IOA failure modes were added as additional causes to existing FMEAs. The 69 IOA RMS issues that remain open concern the difference in criticalities due to software routines being classified as unlike redundancy. IOA feels that they should not be used to lower the criticalities of the affected FMEAs.

The IOA analysis of the EPD&C/RMS hardware (Fig. C.21b) initially generated three hundred and forty-five (345) failure mode worksheets and identified one hundred and seventeen (117) Potential Critical Items (PCIs) before starting the assessment process. These analysis results were compared to the proposed NASA Post 51-L baseline of one hundred and thirty-two (132) FMEAs and sixty-six (66) CIL items, which were generated using the NSTS-22206 FMEA/CIL instructions. IOA generated failure mode analysis worksheets for both port and starboard Remote Manipulator Systems whereas the NASA generated FMEAs for only one system (did not specify which). The IOA analysis was performed on a component level for components assigned reference designator numbers on the drawings with one component per worksheet. The NASA analysis was performed with like multiple similar components on one FMEA. In some cases the NASA FMEAs were generated for an entire circuit without necessarily specifying the components included in the circuit by any identification number, thus direct comparisons of the IOA and NASA analyses were not meaningful in the sense of numbers of failures and identification of criticalities that have any uniformity. Efforts to compare the two analyses required consolidation of components in all but a few cases where the items were single point failure items as some of the switches were found to be. Twenty-eight (28) additional IOA failure mode analysis worksheets were generated to facilitate comparison. Upon completion of the assessment, five (5) issue items were identified that involved critical items where IOA recommends that NASA FMEAs generated for that failure mode of the component or where the NASA Criticality for that failure mode of that component be upgraded. There were also six (6) issues identified where IOA recommends upgrading of the NASA assigned criticality but these are not critical items list candidates.

C.22 Atmospheric Revitalization System

The ARS Assessment Overview figure C.22 lists the total number of IOA and NASA FMEA and CIL items, along with a comparison of the discrepancies or issues identified during the assessment. For analysis purposes, the ARS was divided into 6 subsystems: the Pump Package, the Avionics/Water Loop, the Heat Exchanger, the Avionics/Air Loop, the IMU/Air Loop and the Cabin/Air Loop.

The IOA analysis of the ARS hardware initially generated 245

EPD&C/RMS ASSESSMENT OVERVIEW

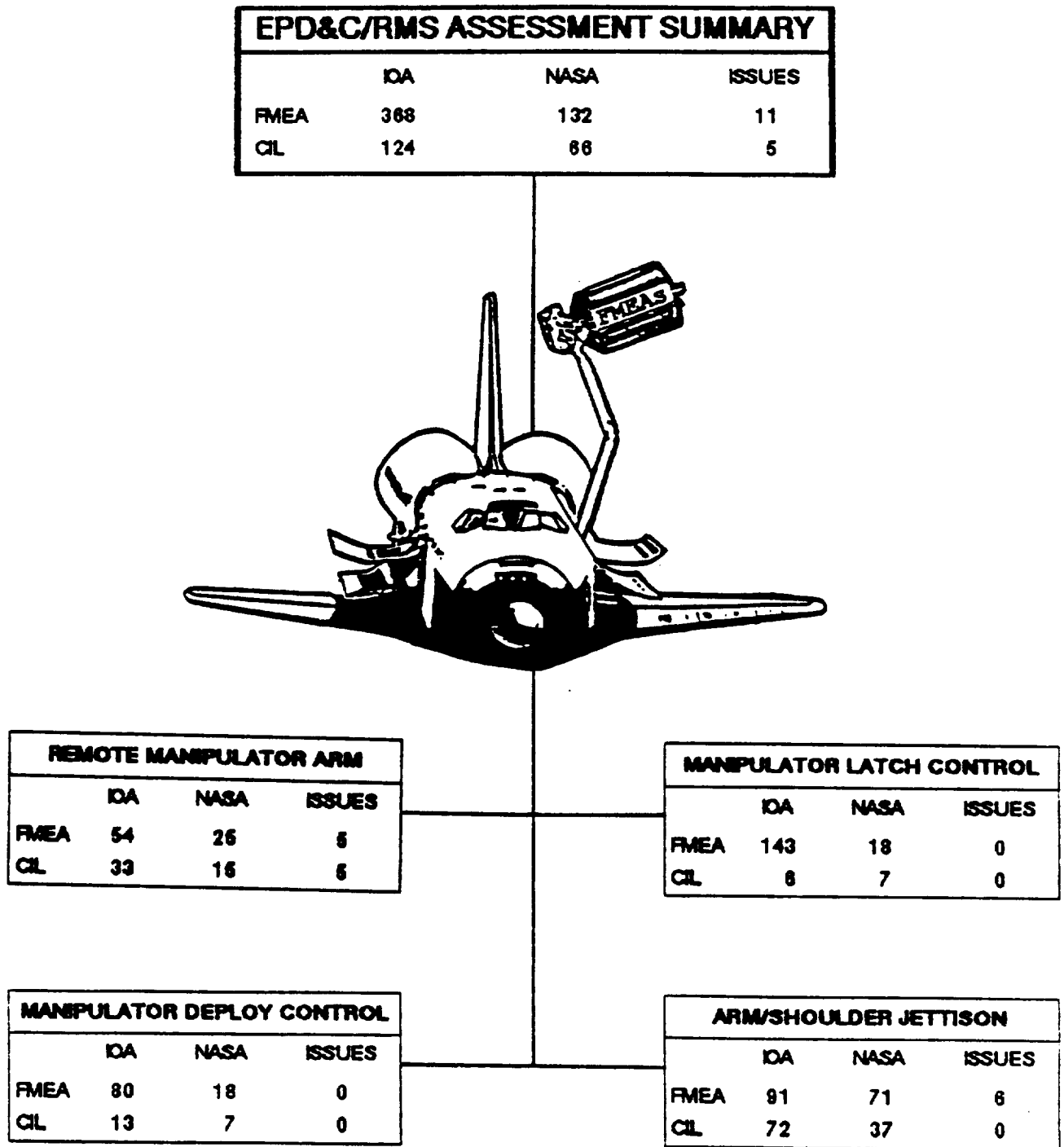

Figure C.21b - EPD&C/RMS FMEA/CIL ASSESSMENT

ARS ASSESSMENT OVERVIEW

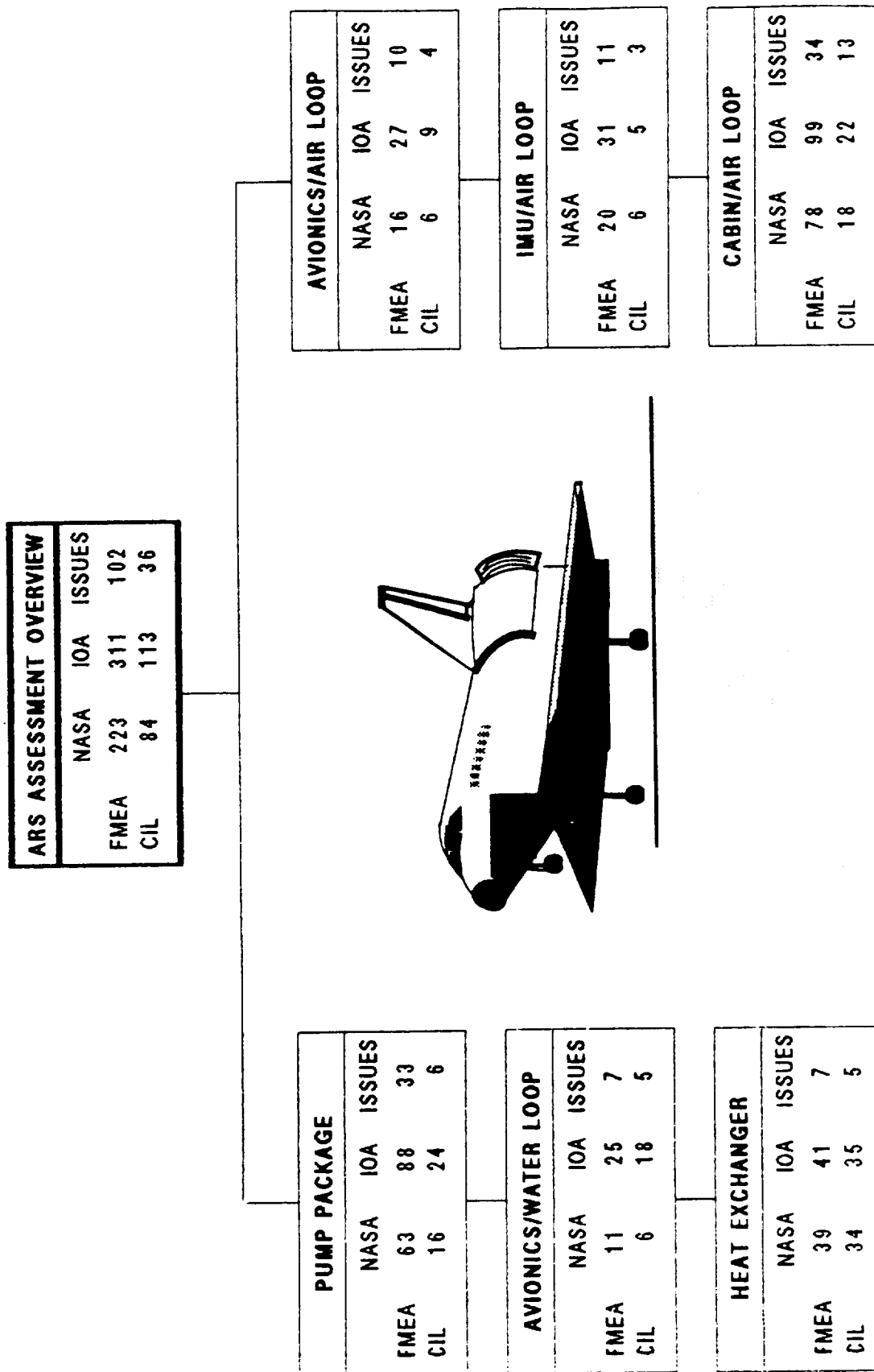

Figure C.22 - ARS ASSESSMENT

failure mode worksheets and identified 84 PCIs prior to starting the assessment process. In order to facilitate comparison, 74 additional failure mode worksheets were generated and 8 of the original worksheets were deleted. Thus, the final IOA analysis identified 311 FMEAs and 84 potential CILs. The analysis results were compared to the available NASA FMEA/CIL data. A total of 223 NASA FMEAs and 84 NASA CILs were identified. The discrepancy between the number of IOA and NASA FMEAs can be explained by the different approaches used by NASA and IOA to group failure modes. This resulted in multiple IOA FMEAs being mapped to a single NASA FMEA. However, every NASA FMEA is mapped to at least 1 IOA worksheet.

A total of 102 FMEA and 36 CIL issues was identified on the ARS. A number of these issues involved failures which were identified by IOA but not by NASA. These issues resulted mainly from insufficient data obtained from NASA.

C.23 Extravehicular Mobility Unit

The IOA analysis of the EMU hardware initially generated 497 failure mode worksheets and identified 390 Potential Critical Items (PCIs) before starting the assessment process. In order to facilitate comparison, additional failure mode analysis worksheets were generated. These analysis results were compared to the proposed NASA Post 51-L baseline (the most recent available as of December 31, 1987) (Fig. C.23). The discrepancy between the number of IOA and NASA FMEAs can be explained by the different approach used by NASA and IOA to identify failure modes or simply by errors of omission 53 failure modes were identified by the IOA analysis that were not covered by the NASA FMEAs; Forty two were considered issues due to CIL impacts.

With regard to the issues, the IOA has identified a total of one hundred and fifty-three (153). Ninety of these are concentrated in the PLSS and the DCM. This was not unexpected due to each subsystem's complexity and significant use of redundancy. These features resulted in different levels of analysis and in different determinations of redundancy by both the IOA and the NASA. Another area of PLSS and CM issues resulted from differing usage of screen B detectability requirements. The NASA established an interpretation that so long as the crewmember

could obtain safe haven upon detection the screen would be passed; however, the IOA disagreed with the use of an emergency system (the SOP) to support obtaining safe haven.

The largest remaining block of issues (40) are distributed throughout the HUT, helmet, air assemblies, gloves, and the LTA. Although many of these issues are similar in cause to those of the PLSS and the DCM (namely different levels of analysis or different interpretation of redundancy), a large group of these resulted from a common failure mode - loss of pressure integrity. The NASA would "qualify" the failure mode as loss of pressure

EMU OVERVIEW ASSESSMENT SUMMARY

EMU ASSESSMENT SUMMARY

LIFE SUPPORT SUBSYSTEM		
IOA	NASA *	ISSUES
FMEA	508	455
CIL	413	365

SPACE SUIT ASSEMBLY		
IOA	NASA *	ISSUES
FMEA	180	159
CIL	134	109

PLSS		
IOA	NASA *	ISSUES
FMEA	227	217
CIL	205	189

DCM		
IOA	NASA *	ISSUES
FMEA	189	156
CIL	126	102

HUT		
IOA	NASA *	ISSUES
FMEA	35	28
CIL	24	17

LTA		
IOA	NASA *	ISSUES
FMEA	46	41
CIL	38	31

SOP		
IOA	NASA *	ISSUES
FMEA	33	31
CIL	28	27

C & W		
IOA	NASA *	ISSUES
FMEA	18	14
CIL	17	14

HELMET		
IOA	NASA *	ISSUES
FMEA	18	17
CIL	13	13

LCVG		
IOA	NASA *	ISSUES
FMEA	17	17
CIL	8	7

SCU		
IOA	NASA *	ISSUES
FMEA	41	37
CIL	37	33

IDB/UCD/CCA		
IOA	NASA *	ISSUES
FMEA	20	12
CIL	11	4

ARMS		
IOA	NASA *	ISSUES
FMEA	23	24
CIL	23	23

GLOVES		
IOA	NASA *	ISSUES
FMEA	21	20
CIL	17	14

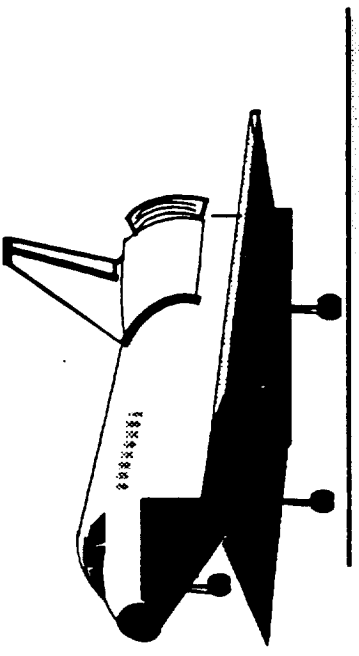

Figure C.23 - EMU ASSESSMENT

* NASA PROPOSED BASELINE AS OF 1 JANUARY 1988

maintenance capability in excess of SOP make-up capability. The IOA's concern was that it automatically assumed loss of the SOP in assigning a 1/1 criticality; the IOA would prefer a 2/1R with a failure of screen B and screen C to reflect the failure scenario.

The IOA also notes that the SOP has been determined to be an emergency subsystem to the EMU. The IOA recommended the SOP to be just that in the IOA analysis report issued in 1986.

C.24 Power Reactant Storage and Distribution System

The IOA analysis of the EPG/PRSD hardware initially generated 162 failure mode worksheets and identified 82 PCIs before starting the assessment process. In order to facilitate comparison, 4 additional failure mode analysis worksheets were generated. These analysis results (Fig. C.24a) were first compared to the proposed NASA Post 51-L baseline of 92 FMEAs and 58 CIL items, and then to the updated version of 66 FMEAs and 39 CIL items, and finally to the 3 baseline configuration of 64 FMEAs and 39 CIL items for the 2 tank baseline, and 67 FMEAs and 42 CIL items for the 3 and 4 tank baselines. The discrepancy between the number of IOA and NASA FMEAs can be explained as follows.

Eight (8) issues arose from inner tank component FMEAs that had not been covered by NASA, but which may have been covered by the tank manufacturer, Beech Aircraft.

Two (2) issues were due to FMEAs the NASA Subsystem Manager thought should be covered under the ground operations FMEAs.

Thirteen (13) issues were caused by the differences between the Rockwell International reliability desk instructions No. 100-2G and the NSTS 22206.

Four (4) issues can be explained by the different approaches used by NASA and IOA to group failure modes.

Upon completion of the assessment, and after discussions with the NASA Subsystem Manager, 19 of the 77 recommended FMEAs were in agreement. Of the 58 that remained, 27 had minor discrepancies that did not affect criticality.

The IOA analysis of the EPD&C/EPG hardware initially generated 263 failure mode worksheets and identified 60 Potential Critical Items (PCIs) before starting the assessment process. In order to facilitate comparison, 42 additional failure mode analysis worksheets were generated. These analysis results were compared to the proposed NASA Post 51-L baseline of 211 FMEAs and 47 CIL items, which was generated using the NSTS 22206 FMEA/CIL instructions (Fig. C.24b). Upon completion of the assessment, all of the 211 FMEAs were in agreement. The difference in the total number of FMEAs between IOA and NASA is due to the analysis level used to assign the failure modes.

EPG/PRSD ASSESSMENT OVERVIEW

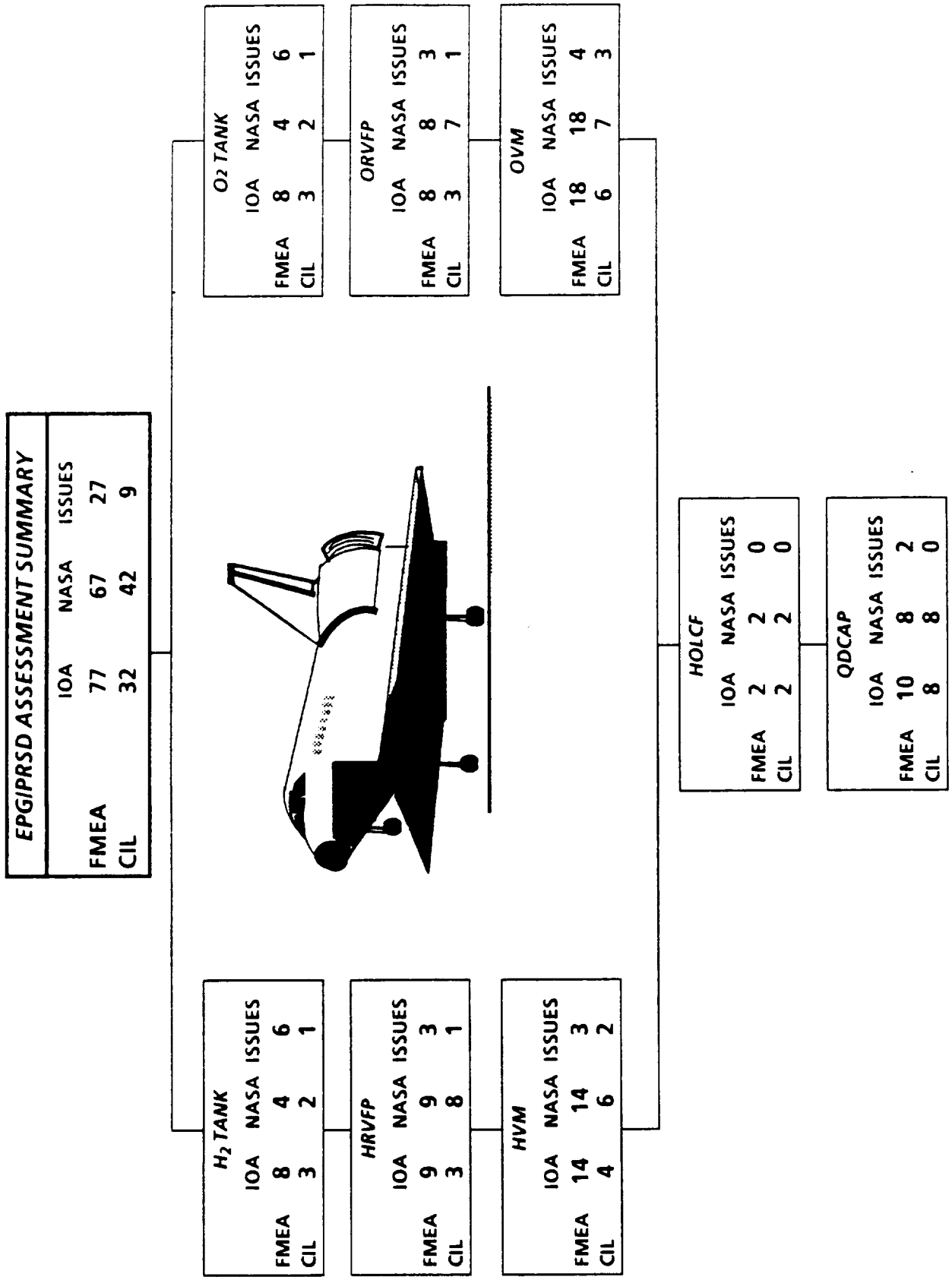

HOLCF - H₂ & O₂ Lines, Components, and Fittings
 HRVFP - Hydrogen Relief Valve/Filter Package
 HVM - Hydrogen Valve Module
 ORVFP - Oxygen Relief Valve/Filter Package
 OVM - Oxygen Valve Module
 QDCAP - H₂ & O₂ Fill and Vent Obs, Horizontal Drain QDs, GSE Fill

Figure C.24a - EPG/PRSD ASSESSMENT

EPD&C / EPG ASSESSMENT OVERVIEW

EPD & C / EPG ASSESSMENT SUMMARY			
	IOA	NASA	ISSUES
FMEA	305	211	0
CIL	47	47	0

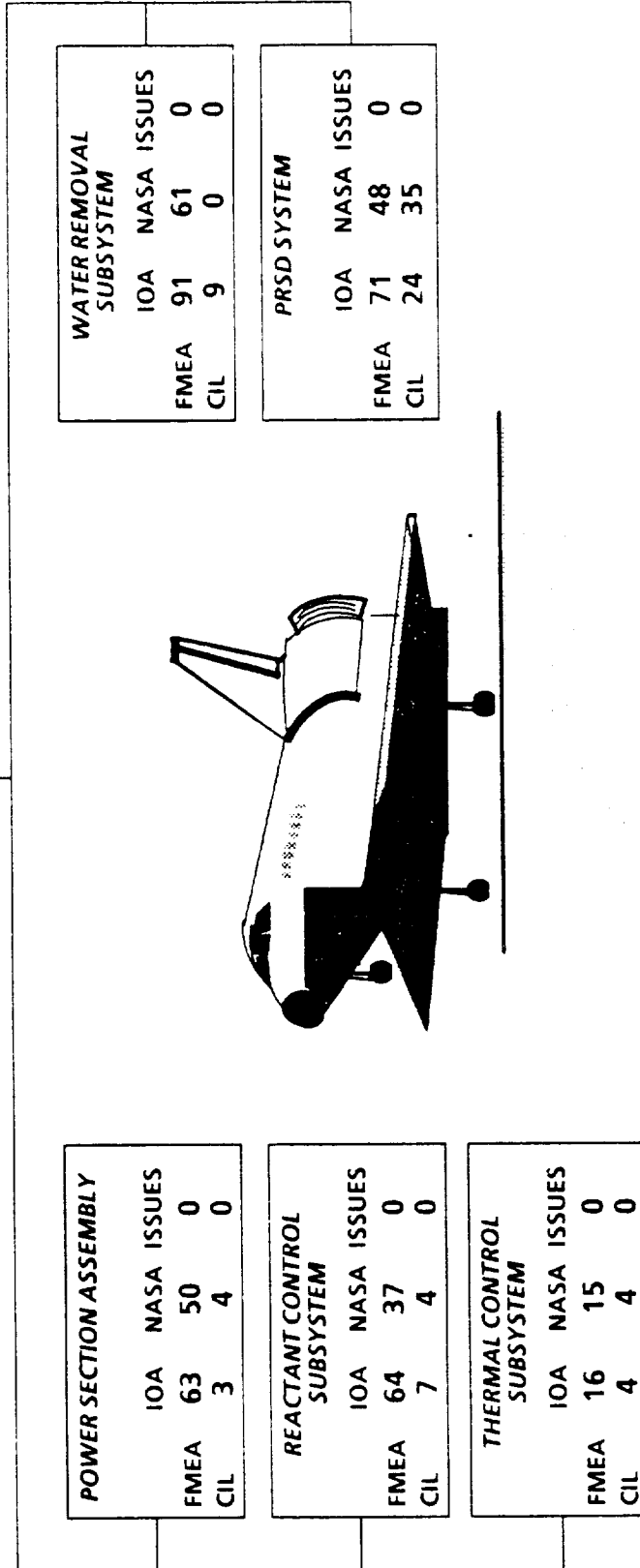

Figure C.24b - EPD&C/EPG ASSESSMENT

C.25 Main Propulsion System

The IOA MPS analysis generated 690 FMEA worksheets, 371 of which were PCIs. Of the total, 438 FMEAs were generated for mechanical components and 252 for electrical components (Fig. C.25).

General differences of opinion and interpretation between the IOA MPS Group and the RI/NASA MPS team resulted in different criticality assignments. The RI/NASA team, for example, tended to have a broader view of an item's function than did IOA. A related difficulty was the matter of redundancy. Again, the RI/NASA team adopted a broader view of redundancy than did IOA. RI/NASA viewed sequential main engine failures as loss of redundancy. IOA believes engines are not redundant to each other because, while they perform identical functions, they do not perform the same function.

Another area of differing opinions was the RI/NASA practice of introducing criticality 1/1 failures, such as line breaks or leaks, as a second failure, thereby creating a 2/1R criticality regardless of the first failure. IOA concludes that, in most cases, this is not consistent with the NSTS 22206 methodology or definitions.

C.26 Orbital Maneuvering System

The IOA product for the EPD&C analysis consisted of 284 hardware and 667 EPD&C failure mode worksheets that resulted in 160 hardware and 216 EPD&C PCIs being identified. A comparison was made of the IOA product to the NASA FMEA/CIL baseline as of 23 December 1987, which consisted of 101 hardware and 142 EPD&C FMEAs, and 68 hardware and 49 EPD&C CIL items. In order to facilitate comparison, additional IOA analysis worksheets were generated as required. IOA mapped 138 hardware and 147 EPD&C FMEAs, and 93 hardware and 47 EPD&C CILs and PCIs into the NASA FMEAs and CILs (Fig. C.26a&b). The IOA and NASA FMEA/CIL baselines were compared and discussions were held with the NASA Subsystem Managers in an effort to resolve the identified issues. A majority of the initial hardware issues was resolved; however, 47 hardware issues, 29 of which concern CIL items or PCIs, 70 EPD&C issues, 31 of which concern CIL items or PCIs, remain unresolved.

Many of the unresolved EPD&C issues result because of differences in interpretation of NSTS 22206. The NASA/RI definition of redundancy allowed the selection of specific unrelated failures which were required to cause known problems; e.g., failures required to cause continuous power to a valve. The IOA redundancy string included only items that were capable of performing the specific function of the item being analyzed. IOA considers many NASA/RI redundancy strings to include multiple unrelated failures.

MPS ASSESSMENT OVERVIEW

MPS ASSESSMENT SUMMARY			
	IOA	NASA	ISSUES
FMEA	1365	1264	399
CIL	711	749	191

MECHANICAL COMPONENTS			
	IOA	NASA	ISSUES
FMEA	623	606	179
CIL	410	475	86

ELECTRICAL COMPONENTS			
	IOA	NASA	ISSUES
FMEA	742	658	220
CIL	301	274	105

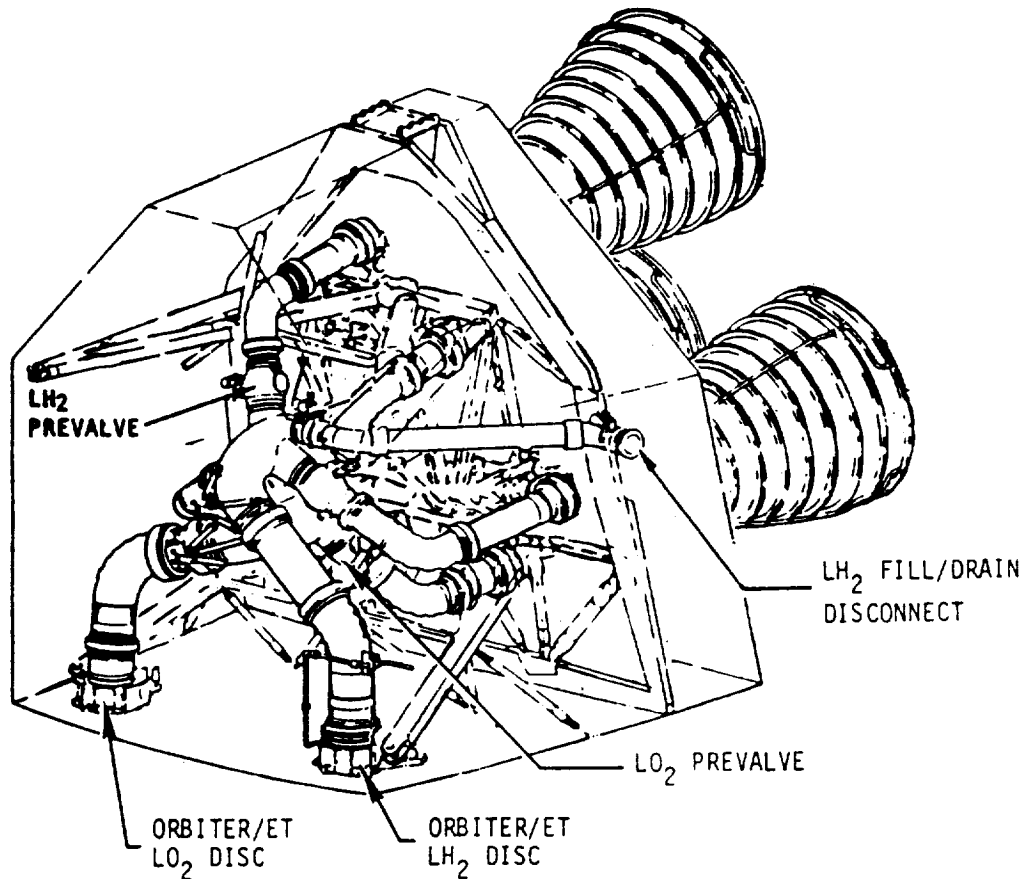
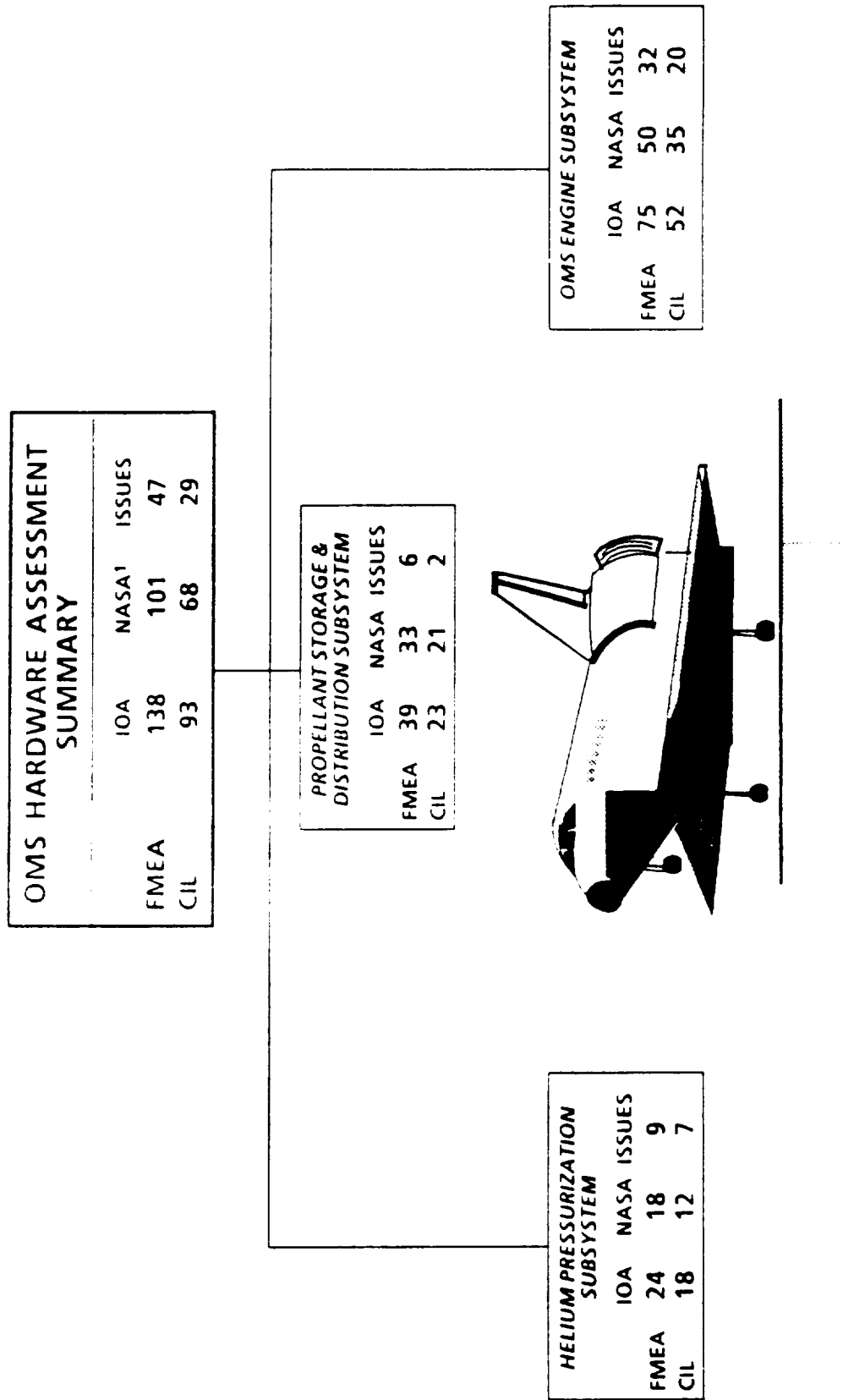

Figure C.25 - MPS FMEA/CIL ASSESSMENT

OMS HARDWARE ASSESSMENT OVERVIEW



¹ NASA BASELINE AS OF 23 DECEMBER 1987

IOA AND NASA TOTALS DO NOT INCLUDE INSTRUMENTATION AND THERMAL CONTROL ITEMS. IOA ANALYZED AND ASSESSED THESE ITEMS AS EPD&C ITEMS.

Figure C.26a - OMS HARDWARE ASSESSMENT

OMS EPD&C ASSESSMENT OVERVIEW

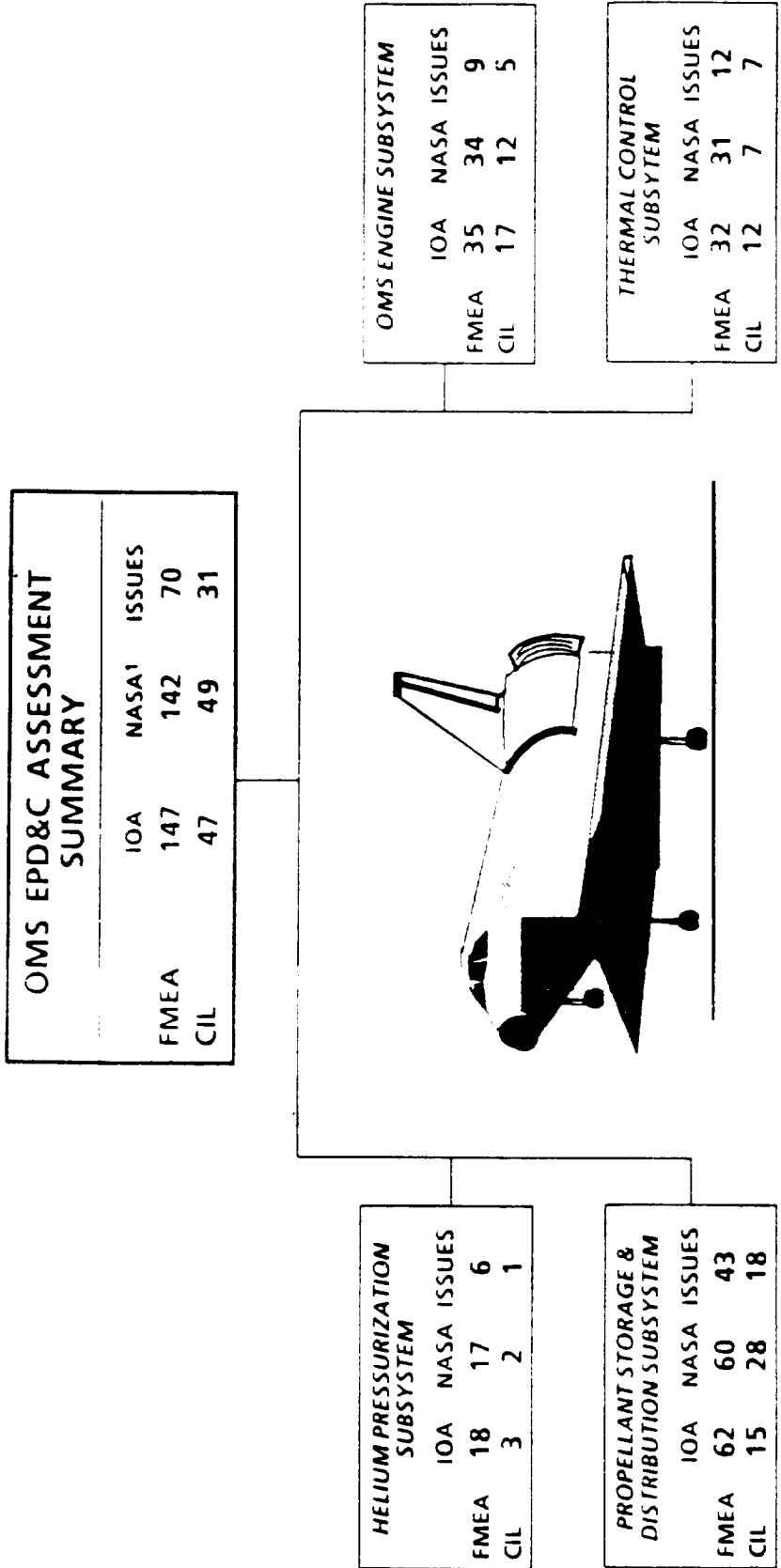

¹ NASA BASELINE AS OF 23 DECEMBER 1987

IOA AND NASA TOTALS INCLUDE INSTRUMENTATION AND THERMAL CONTROL ITEMS.

Figure C.26b - OMS EPD&C ASSESSMENT

A number of the unresolved hardware and EPD&C issues involve failure modes identified by IOA which are not currently addressed on the NASA FMEA/CIL baseline. IOA considers each of these failure modes to be credible, and recommends that they be added.

The remaining unresolved OMS hardware and EPD&C issues result because of differences between the IOA and NASA/RI analyses of the OMS subsystem, which resulted in criticality, redundancy screen, or failure effect differences.

C.27 Reaction Control System

The IOA product for the RCS analysis consisted of 208 hardware and 2,064 EPD&C failure mode worksheets that resulted in 141 hardware and 449 EPD&C PCIs being identified. A comparison was made of the IOA product to the NASA FMEA/CIL baseline as of 23 December 1987, which consisted of 99 hardware and 524 EPD&C FMEAs and 62 hardware and 144 EPD&C CIL items. In order to facilitate comparison, additional IOA analysis worksheets were generated as required. IOA mapped 166 hardware and 597 EPD&C FMEAs, and 133 hardware and 116 EPD&C CILs and PCIs into the NASA FMEAs and CILs (Fig. C.27a&b). After comparison of the IOA baseline to the NASA FMEA/CIL baseline and discussions with the NASA Subsystem Manager, 96 hardware issues, 83 of which concern CIL items or PCIs, and 280 EPD&C issues, 158 of which concern CIL items or PCIs, remain unresolved. These categories: NSTS 22206 interpretation differences, IOA failure modes not currently addressed on the NASA FMEA/CIL, and RCS subsystem analysis differences.

One hundred seven (107) of the unresolved EPD&C issues result because of differences in interpretation of NSTS 22206. The NASA/RI definition of redundancy allowed the selection of specific unrelated failures which were required to cause known problems; e.g., failures required to cause continuous power to a valve. The IOA redundancy string included only items that were also capable of performing the specific function of the item being analyzed. IOA considers many NASA/RI redundancy strings to include multiple unrelated failures, thus making criticalities too severe or masking other critical failures found by IOA.

One hundred twenty-eight (128) of the unresolved hardware and EPD&C issues involve failure modes identified by IOA which are not currently addressed on the NASA FMEA/CIL baseline. IOA considers each of these failure modes to be credible, and recommends that they be added.

The remaining unresolved RCS issues result because of differences between the IOA and NASA/RI analyses of the RCS subsystem. Many of these issues are linked to a few general differences in the analyses performed by IOA and NASA/RI. For example, 17 of the FRCS hardware issues are linked to the fact that IOA considered the inability to deplete (dump) FRCS propellant to be critical for entry. NASA/RI considered it critical only for ET

RCS HARDWARE OVERVIEW

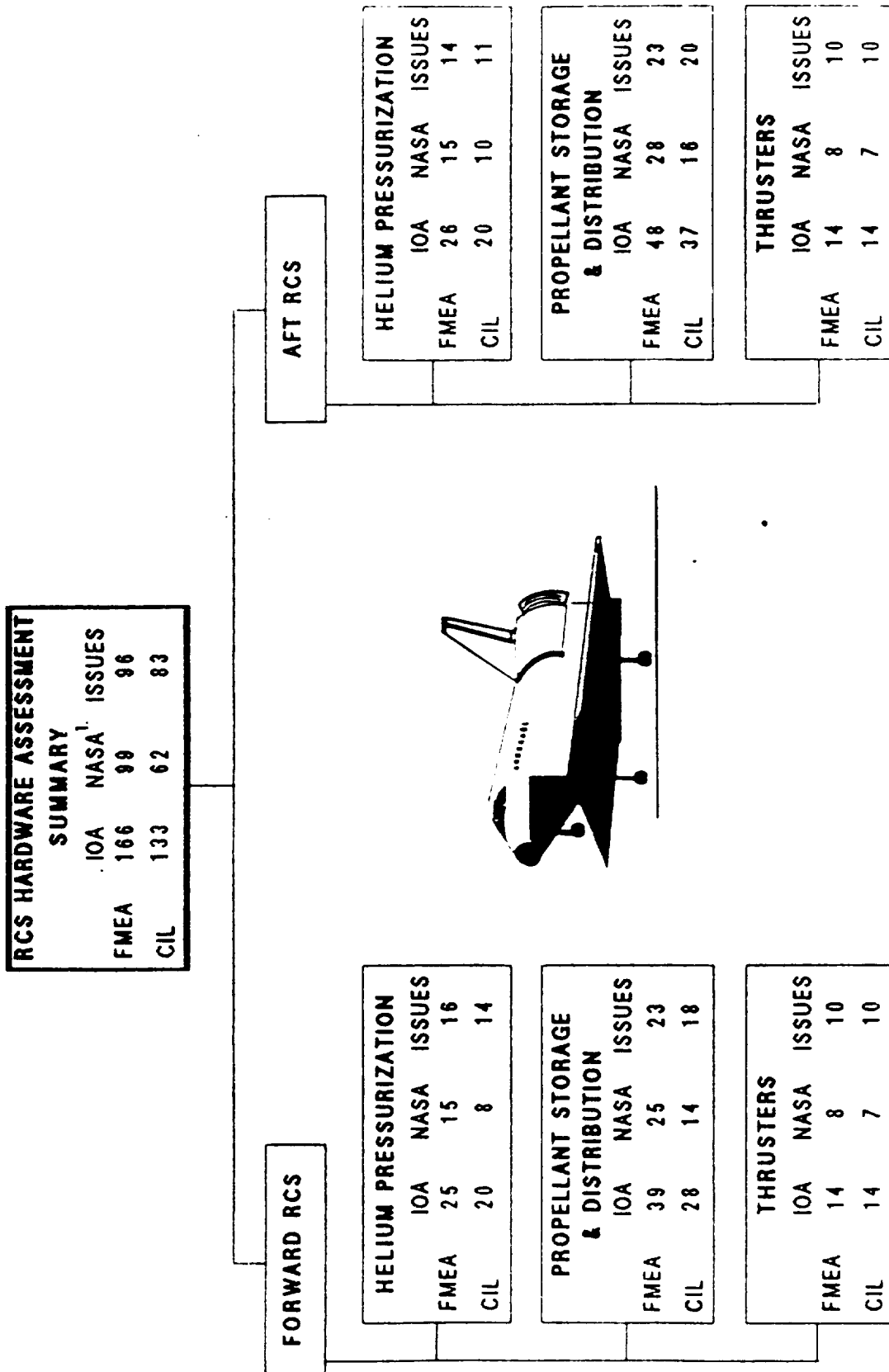

¹ NASA BASELINE AS OF 23 DECEMBER 1987.
 IOA AND NASA TOTALS DO NOT INCLUDE RCS INSTRUMENTATION AND THERMAL CONTROL ITEMS
 IOA ANALYZED AND ASSESSED THESE ITEMS AS EPD&C ITEMS.

Figure C.27a - RCS HARDWARE ASSESSMENT

RCS EPD&C OVERVIEW

RCS EPD&C ASSESSMENT SUMMARY		
	IOA	NASA ¹ ISSUES
FMEA	597	280
CIL	116	158

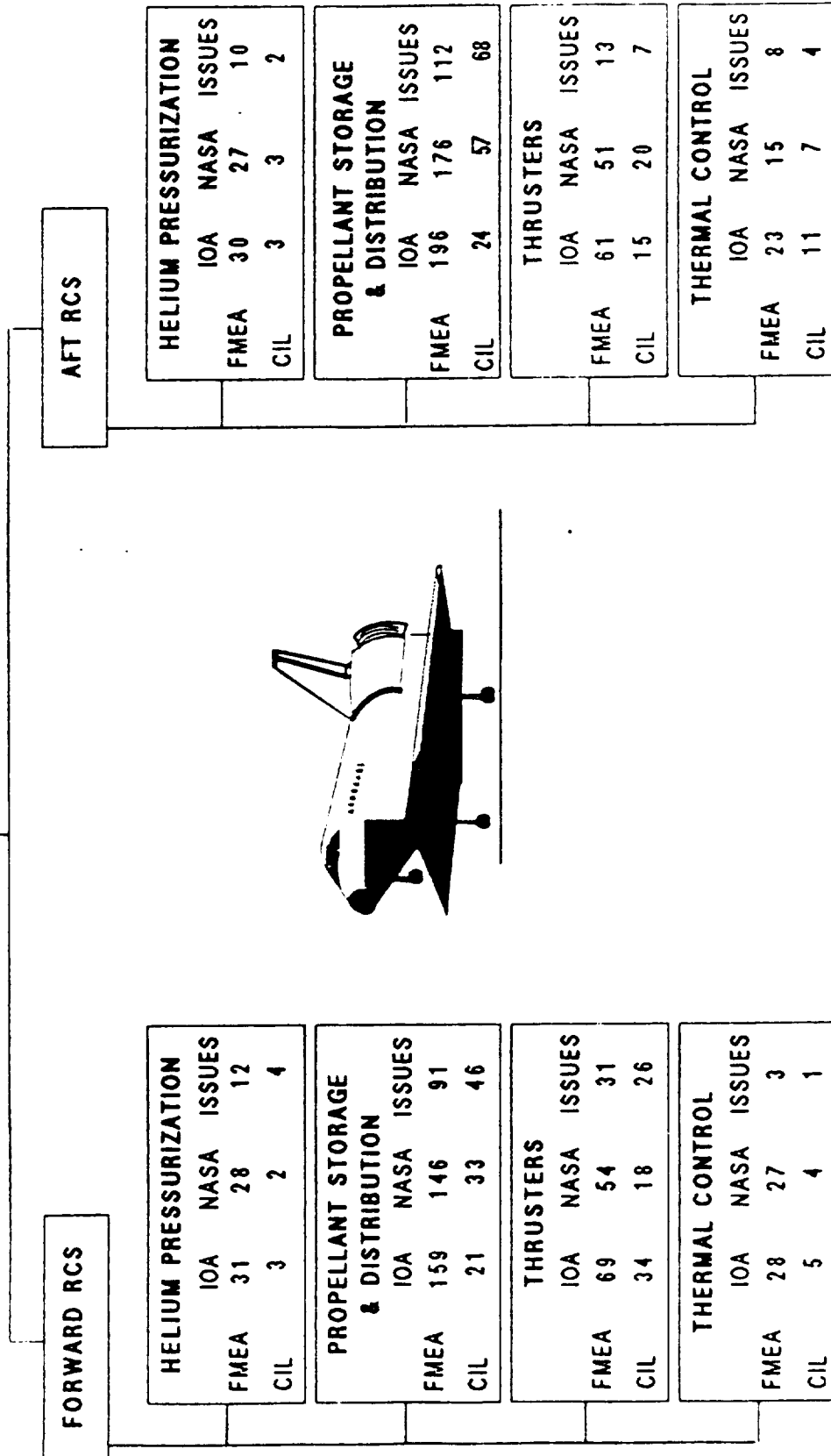

FORWARD RCS

HELIUM PRESSURIZATION		
	IOA	NASA ISSUES
FMEA	31	28
CIL	3	2

PROPELLANT STORAGE & DISTRIBUTION		
	IOA	NASA ISSUES
FMEA	159	146
CIL	21	33

THRUSTERS		
	IOA	NASA ISSUES
FMEA	69	54
CIL	34	18

THERMAL CONTROL		
	IOA	NASA ISSUES
FMEA	28	27
CIL	5	4

AFT RCS

HELIUM PRESSURIZATION		
	IOA	NASA ISSUES
FMEA	30	27
CIL	3	3

PROPELLANT STORAGE & DISTRIBUTION		
	IOA	NASA ISSUES
FMEA	196	176
CIL	24	57

THRUSTERS		
	IOA	NASA ISSUES
FMEA	61	51
CIL	15	20

THERMAL CONTROL		
	IOA	NASA ISSUES
FMEA	23	15
CIL	11	7

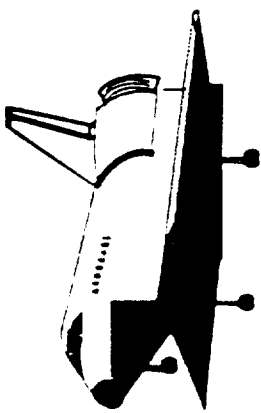

1. NASA BASELINE AS OF 23 DECEMBER 1987

IOA AND NASA TOTALS INCLUDE RCS INSTRUMENTATION AND THERMAL CONTROL ITEMS

IOA ANALYZED AND ASSESSED THESE ITEMS AS EPD&C ITEMS

Figure C.27b - RCS EPD&C ASSESSMENT

separation. Six (6) of the ARCS hardware issues result because IOA considered any failure which resulted in the loss of primary thrusters to be a Crit 1 during RTLS and TAL aborts due to the resulting reduced OMS and RCS propellant dump rates. Several of the RCS hardware issues are related to failures which result in propellant leakage. Per NSTS 22206, IOA considered any leakage of propellant to be critical, regardless of where it occurred. NASA/RI did not apply this philosophy to all propellant leakage failures. Fifty (50) of the unresolved EPD&C issues result because IOA considered the inability to determine the actual position of a valve to be a 3/2R. Loss of all redundancy could lead to falsely failing the valve closed, thus affecting mission operations. NASA/RI classified such failures as 3/3's. The remainder of the unresolved analysis-difference issues exist independently and cannot, for the most part, be linked to any general differences.

C.28 Communication and Tracking

The IOA analysis of the Communication and Tracking hardware and functions resulted initially in generation of 1,039 failure mode and effects analysis (FMEA) worksheets with 269 being assigned as Potential Critical Items (PCIs). An IOA and NASA assessment was made by comparing 697 NASA FMEA worksheets and 239 Critical Items. Discrepancies between the number of IOA and NASA FMEAs and CILs prevented a one to one comparison which required generation of additional FMEA worksheets to facilitate collation. The final IOA count equaled 1,108 FMEAs with 298 PCIs (Fig. C.28).

Discrepancies noted between the IOA and NASA FMEA and PCI counts were attributed to the following factors: different failure modes employed by IOA and NASA, different definition of electronic unit and function configurations and component levels, based criticality assignments on a certain element of subjectivity and interpretation of the NSTS 22206 instructions, there were omissions, levels of unlike redundancy were different, determinations as to the extent of units function or effects on system level function were different and contract revision requiring early submittal missed revised and new FMEA/CILs.

Many of the FMEA and PCI analysis differences and issues could no doubt have been resolved through discussions with Subsystem Managers had the contract not been prematurely cancelled. Also many NASA FMEA worksheets were upgraded after the January 1, 1988 freeze so that much of the assessment was made on initial baseline FMEA's that did not reflect the latest thinking. The most prominent number of PCIs pertained to loss of output and loss of all capability to: obtain State Vector Updates, monitor movement of the RMS, verify payload bay door closure through observation that payload bay door latches did indeed latch, perform Ku-band antenna boom stow and verification, maintain mission support and obtain NAVAIDS data during night time abort landings at unequipped emergency landing sites.

COMMUNICATIONS AND TRACKING FMEA/CIL ASSESSMENT OVERVIEW SUMMARY

COMMUNICATIONS & TRACKING SUBSYSTEM			
	IOA	NASA	ISSUES
FMEA	1108	697	407
CIL	298	239	294

NOTE: CIL COUNT CONTAINED IN FMEA COUNT

COMMUNICATIONS		
	IOA	NASA
ISSUES	1037	643
FMEA	273	221
CIL		286

EXPANDED IN
FIGURE 1.1B

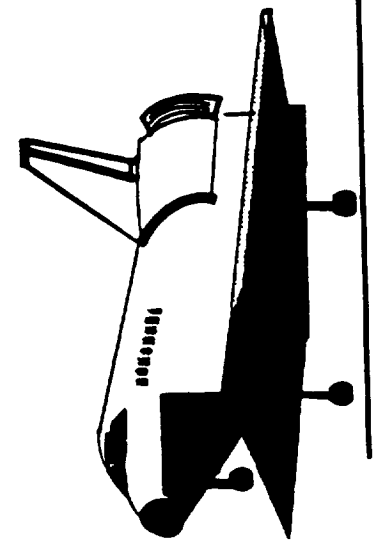

TRACKING (NAVAIDS)			
	IOA	NASA	ISSUES
FMEA	71	54	13
CIL	25	18	18

EXPANDED IN
FIGURE 1.1C

Figure C.28 - COMM & TRACKING ASSESSMENT



APPENDIX D

Comparison of IOA Findings To Rockwell CIL Packages

A comparison of IOA recommended CIL items and Rockwell CIL Packages is presented in Table D-1. The Rockwell CIL count corresponds to 1 March 1988. Individual IOA subsystem CIL counts are those that existed at each subsystem assessment completion, which occurred from March 1987 through January 1988. Consequently, this comparison should be used only as general information.

No comparison is available for FMEAs because the Rockwell review packages do not contain this information for all non-CIL items. A general comparison of FMEA results is available in Table 1-1 (page 3), where the IOA suggested failure modes are compared to the NASA baseline. The results shown in the following Table D-1 do not always resemble those previously presented in Table 1-2. The numbers do not agree in all cases because the Rockwell packages do not include GFE such as the RMS, EMU, MMU and OEX. In addition, some differences may arise because the IOA baseline was frozen on 1 January 1988, while some of the Rockwell reviews were still in progress and the numbers fluid. The number of issues varied in time in some cases as IOA findings were accepted by Rockwell or NASA and incorporated into the program baseline. This is documented in Table 1-2, page 4.

**TABLE D-1
IOA TO ROCKWELL CIL PACKAGE COMPARISON (INTERIM)**

SUBSYSTEM	Rockwell CIL Package ID	CIL		
		IOA*	Rockwell**	Issues
Fuel Cell Powerplant (FCP)	55	24	22	2
Hydraulic Actuators (HA)	14,15	59	56	3
Displays and Control (D&C)	79,80	21	22	1
Guidance, Navigation & Control (GN&C)	61,62	36	34	2
Orbiter Experiments (OEX)	N/A	(1)	-	-
Auxiliary Power Unit (APU)	59,60	106	106	0
Backup Flight System (BFS) / DPS	83,84	48	38	10
Electrical Power, Distribution & Control (EPD&C)	85	158	158	0
Landing & Deceleration (L&D)	5,6,7,8,12,13	124	121	3
Purge, Vent and Drain (PV&D)	2	15	8	7
Pyrotechnics (PYRO)	108-112	41	42	1
Active Thermal Control System (ATCS) and Life Support System (LSS)	91-96,99-101	318	122	196
Crew Equipment (CE)	102,103	80	6	74
Instrumentation (INST)	81,82	22	15	7
Data Processing System (DPS) - Included in BFS	-	-	-	-
Atmospheric Revitalization Pressure Control System (ARPCS)	89,90	73	28	45
Hydraulics & Water Spray Boiler (HYD & WSB)	41,42,97,98	183	111	72
Mechanical Actuation System (MAS)	3,4,16,18-30	512	246	266
Manned Maneuvering Unit (MMU)	N/A	(95)	-	-
Nose Wheel Steering (NWS)	9-11	41	30	11
Remote Manipulator System (RMS)	N/A	(448)	-	-
Atmospheric Revitalization System (ARS)	86-88	84	19	65
Extravehicular Mobility Unit (EMU)	N/A	(547)	-	-
Power Reactant Supply & Distribution System (PRS&D)	56,105,106	79	85	6
Main Propulsion System (MPS)	43-50	714	692	22
Orbital Maneuvering System (OMS)	53,54	140	111	29
Reaction Control System (RCS)	51,52	249	212	37
Comm and Tracking (C&T)	65-75,77,78	281	98	183
Not in IOA Scope	1,17,32-40, 57,58,76,104, 107			
Totals		3408	2382	1042

*As of 1 January 1988

**As of 1 March 1988



