

N90-12504

**LAMINAR FLOW: CHALLENGE AND
POTENTIAL**

**M. E. Kirchner
Boeing Commercial Airplane Company
Seattle, Washington**

PRECEDING PAGE BLANK NOT FILMED



INTRODUCTION

Commercial air transportation has experienced revolutionary technology advances since WWII. These technology advances have resulted in an explosive growth in passenger traffic. Today, however, many technologies have matured, and maintaining a similar growth rate will be a challenge. We have come to the point where more complex technology must be addressed. At the Boeing Company we see the potential benefits of laminar flow as being worthy of the challenge.

A brief history of the technology and its application to subsonic and supersonic air transportation is presented.

- Laminar flow—the potential
 - Subsonic
 - Supersonic
- Laminar flow perspective
- Laminar flow at Boeing
- Laminar flow—the challenge

LAMINAR FLOW POTENTIAL - SUBSONIC

Many claims have been made over the past several decades regarding the potential advantages of "laminarizing" a transport-type airplane. These claims have ranged from wildly optimistic projections to the pessimistic prognosis that it is technically feasible but economically and operationally absurd.

To place these views in perspective, consider the results of a limited number of trade-studies relating to the fuel savings anticipated from full and partial laminarization of transport aircraft. As shown in this figure, the increments in projected fuel savings are significant. The projections vary considerably depending on the nature of the laminar-flow control concept employed, the extent of the airframe components to be laminarized, and the mission range of the vehicle. The conclusion one draws from these limited data is that, for long range subsonic transports, the potential fuel saving from laminar flow control (LFC) is worth investigating.

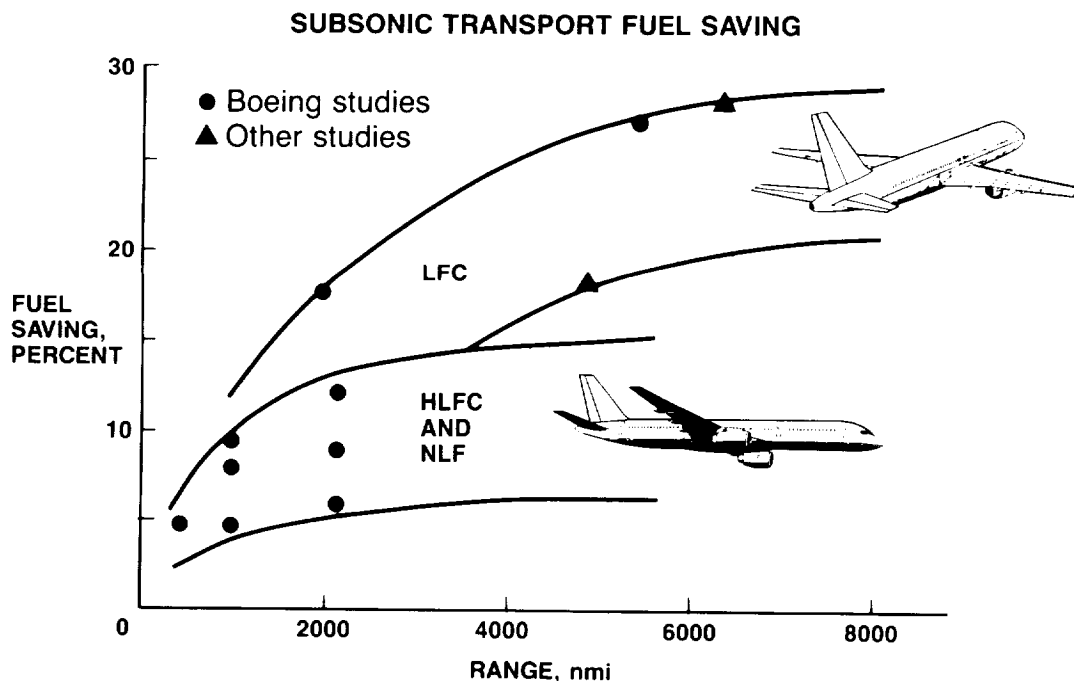

LAMINAR FLOW POTENTIAL - SUPERSONIC

While fuel saving benefits for subsonic transport applications may be substantial, the advantages of laminar flow technology in high speed transport applications may be even greater. From a purely aerodynamic viewpoint, past studies of typical SST configurations have illustrated the potential increases in cruise lift-drag ratio obtainable as a function of the extent of laminar flow achieved. Results of this type are shown in the left hand portion of the figure for both older and advanced SST configurations.

The graph on the right hand side of the figure displays the experimental data (refs. 1-2) upon which present performance improvement estimates can be based. The data are limited and suggest the need for improved supersonic wind tunnels with quiet test sections to supplement flight experiments. Such further work is essential to address the following two major questions for high speed civil transports (HSCT):

- What is the achievable transition Reynolds number (RN) on realistically complex configurations?
- What are the structural requirements of candidate laminarized configurations?

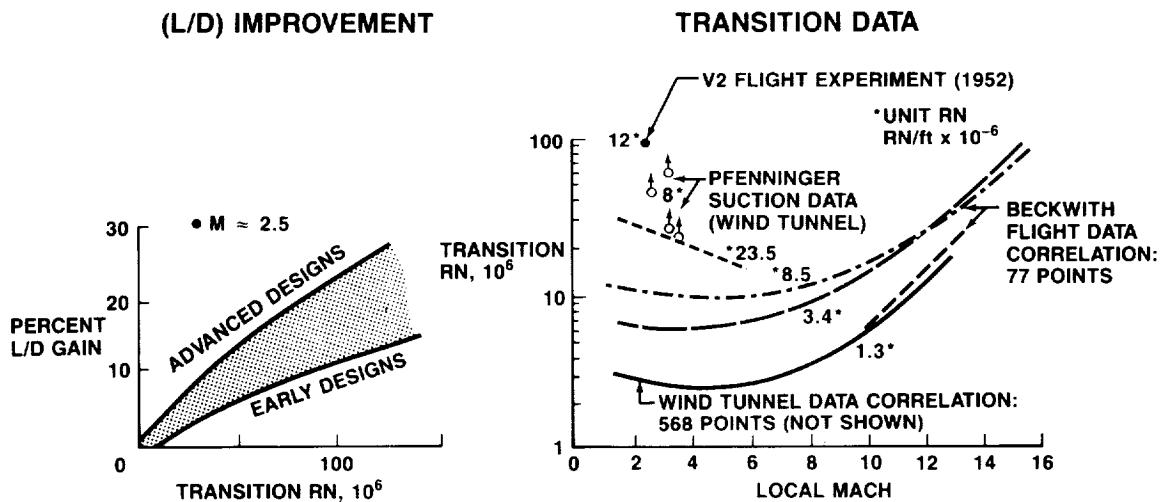

MAJOR UNKNOWNNS

- Achievable transition RN on complex HSCT configuration
- Structural feasibility of LFC on HSCT

LAMINAR FLOW POTENTIAL - SUPERSONIC (conc.)

While the performance advantages of laminarizing a high speed transport can be readily identified, other more subtle advantages may also be exploited to make the overall airframe system more attractive.

As listed in this figure, an important benefit in laminarization may be the substantial reductions obtainable in both skin temperature and fuel temperature as a function of mission time. Reduced aerodynamic heating has many important implications. In high speed transport applications this must be considered at the outset of a design feasibility study. Besides the immediate impact on materials selection, the feasibility of structural concepts to be employed must also be assessed. Further, major choices in a whole range of aircraft systems will be significantly influenced by the degree to which laminar flow can reduce the net heat load on the airframe.

If the aerodynamic gains anticipated from laminarization of a significant portion of the airframe can be achieved, then associated reductions in airplane gross weight and sonic boom intensity can be expected.

Work remains to be done to clarify the important benefits as well as the possible problems encountered in thermal cycling.

- Aerodynamic heating reduced
- Structural/materials/systems benefits
- Reduced load on fuel heat sink
- Gross weight reduced
- Sonic boom reduction

-
- Thermal cycling possible problem

LFC PERSPECTIVE

The previous figures have shown some of the reasons for our interest in laminar flow. With potential gains of the magnitude shown, the obvious question is why laminar flow control isn't being applied? To put this matter in context, the data for long range transport aircraft shown in this figure have been assembled from several sources (Dept. of Transportation and ref. 3).

Since the era of the DC-3 we have seen dramatic improvements in commercial airplane performance and direct operating cost (DOC) reduction. For several decades fuel costs remained low and the contribution of the fuel to DOC remained relatively small. Only since the early 1970s has this equation changed, and, with the advent of OPEC and other related factors, we have entered an era where fuel prices have fluctuated dramatically. While detailed predictions of future fuel costs are controversial, the probability of a generally upward trend over time seems certain. From the viewpoint of our commercial airline customers, the cost of fuel is a major element of their overall DOC and will continue to influence their purchase decisions.

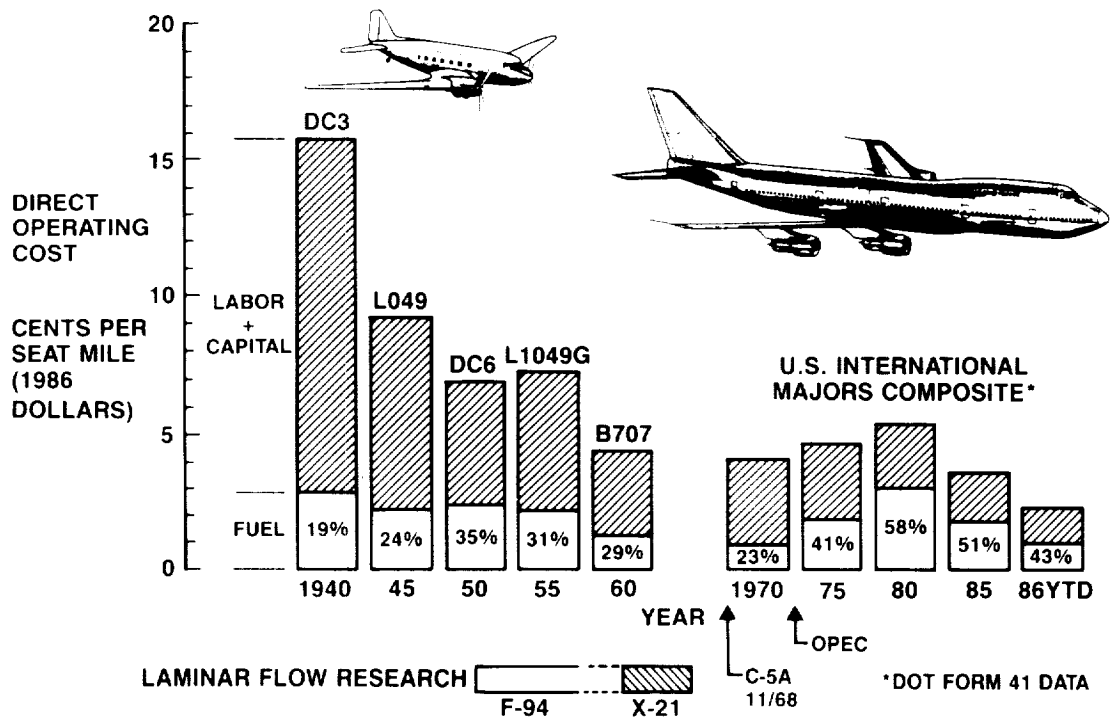

WHY LAMINAR FLOW HAS NOT BEEN USED

While the economics of long range transport operation does much to explain the lack of emphasis on laminar flow technology development, it does not fully address the question of why this technology has not been used.

One reason is that early experience with natural laminar flow airplanes was rather negative. There was not enough appreciation for the effects of skin surface condition and waviness. Smooth structure simply could not be built in those days. Recently, however, when we carefully smoothed the wing of a 30-year old T-33 trainer, we got extensive runs of laminar flow over almost the entire flight envelope.

The unfortunate history of the X-21 is another factor. Perhaps this program occurred too soon but it was driven by the potential application to the C-5. According to a summary (ref. 4) given at the 1974 NASA Langley laminar flow workshop, the X-21 "failed" in spite of many impressive accomplishments. Due to an incorrect design detail, that in retrospect appears easily avoidable, primary objectives of the test program were not met. Progress on the C-5 program could not wait for the design of a new wing and thus, laminar flow lost a major opportunity to display its real potential. The technical community recommended continuing a research program, but funds could not be made available. For laminar flow research this began a hiatus which was to last a decade.

Given its history, laminar flow technology was clearly not ready for application in a commercial environment. The risk was much too great, and necessary performance gains were more easily achievable through other, more conventional technologies such as propulsion, structures, materials, and avionics. Generally speaking, the risk-benefit ratio for laminar flow had to be improved.

Failures of early application
+
Low cost of fuel
+
Competing technologies
+
Competition for funds

High risk/reward ratio

WHAT IS NEW IN LAMINAR FLOW

What factors are operative today to alter the previous risk-benefit ratio for laminar flow applications. The two major factors are 1) a greater need for performance improvements in today's increasingly competitive market, and 2) technological advances that have significantly reduced the risks of application.

To illustrate the advances in laminar flow technology, we have selected the three examples in the figure:

- o Better understanding of laminar flow problems.

A resurgence of interest in laminar flow, in connection with the NASA ACEE program, led to a number of very constructive flight test programs. These programs have given us a far better basis for assessing the potential for achieving practical laminar flow systems for subsonic aircraft. Typified by the NASA Leading Edge Flight Test (LEFT) program, these efforts have given us a much better understanding of laminar flow problems and how to address them.

- BETTER UNDERSTANDING OF LAMINAR FLOW PROBLEMS

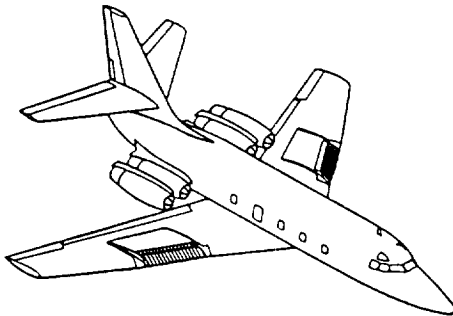

- NEW MATERIALS AND PROCESSES

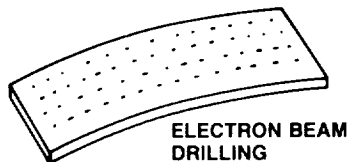

- BETTER COMPUTATIONAL AERODYNAMIC METHOD

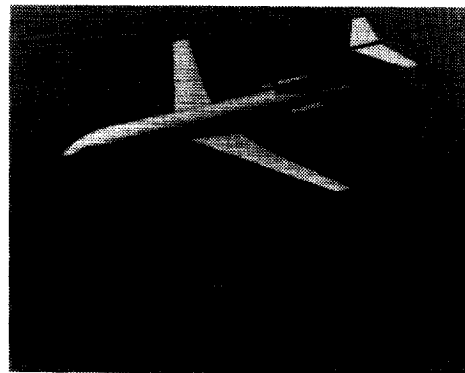

- TRANSONIC, VISCOUS FLOW WING ANALYSIS AND DESIGN
- BOUNDARY LAYER STABILITY AND TRANSITION ANALYSIS

ORIGINAL PAGE
BLACK AND WHITE PHOTOGRAPH

WHAT IS NEW IN LAMINAR FLOW (conc.)

- o New materials and processes.

Significant advances have been made in both materials and, perhaps more significantly, manufacturing processes. For example, electron beam drilling of titanium sheet stock now permits large scale fabrication of porous laminar flow surfaces which are economically viable and corrosion resistant.

- o Better computational aerodynamic methods.

Advances in computational aerodynamics enable improvements in two of the major risk/cost reducing factors of laminar flow development. First, we now have the capability to both analyze and design realistically complex wing-body combinations in a transonic flow. This enables the efficient development of wing and tail surfaces capable of meeting the requirements of either natural laminar flow (NLF), hybrid laminar flow control (HLFC), or full LFC systems. Second, mechanization of sophisticated boundary-layer-stability analyses allows the routine evaluation of a wide range of wing geometries. Such analyses simply were not performed in the past because of the unacceptable amounts of time and money they required.

CURRENT SITUATION

Our continued efforts to develop commercially acceptable laminar flow technology is dictated by the improved risk-benefit relationship. We need answers to a relatively few, but important, technical questions such as flight data at Reynolds numbers and wing sweep representative of subsonic transports to determine aerodynamic and operational effectiveness.

In the remainder of this presentation, I would like to discuss laminar flow work done by the Boeing Company under NASA contract and Company funded investigations.

- Technical advances/competitive pressures dictate continued effort
- Questions needing answers now
 - How much NLF aft of suction surface?
 - Operational reliability/maintainability?
 - Economics?
- It is time to address these issues

T-33 NATURAL LAMINAR FLOW FLIGHT TESTING

A Boeing-funded research program was undertaken to supplement the experiments conducted in the NASA sponsored LEFT program and to provide Boeing with experience in laminar flow flight testing. A series of tests were conducted in two sequential phases between 1984 and 1986 utilizing a T-33 jet trainer. The program had the following basic objectives:

Phase I. Testing of Baseline T-33 Wing (Smoothed) -1984

- o Develop testing techniques and instrumentation for laminar flow flight research.
- o Study the behavior of natural laminar flow on an unswept wing at high subsonic speeds (i.e. Mach numbers up to approx. 0.7 at altitudes up to 35,000 feet).

Phase II. Testing of a 20 Degree Swept NLF Glove-1985/86

- o Verify NLF wing design philosophy.
- o Verify transition prediction methods.
- o Refine surface smoothness criteria.
- o Perform in-flight measurements of extent of laminar flow and surface pressure distributions.
- o Determine effects of selected surface protuberances (e.g. rivet heads, skin joints).

BOEING FUNDED TESTS (1984-86)

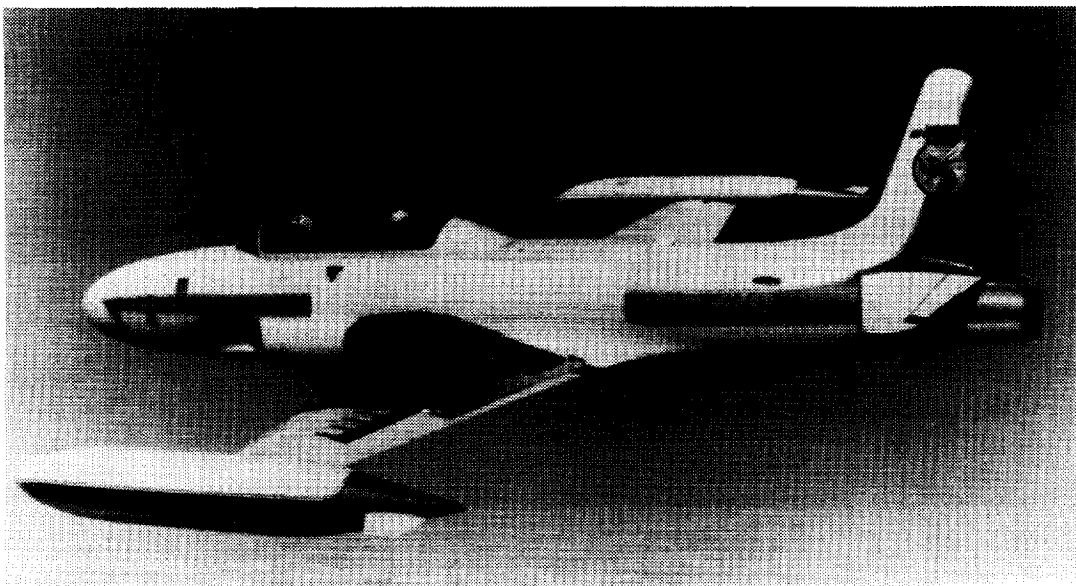

T-33 NATURAL LAMINAR FLOW FLIGHT TESTING (cont'd)

The program was highly successful. It demonstrated the cost effectiveness of using a fairly small and relatively inexpensive airplane to acquire large quantities of very useful experimental data. In this manner, key decisions could be made prior to commitment to a more sophisticated and complex test program requiring a modern transport-sized airplane.

In almost all respects, the T-33 program met or exceeded its objectives. While the achievable flight test envelope for an airplane like a T-33 is limited, the following observations were made:

Phase I. Basic (Smoothed) Wing

- Extensive natural laminar flow was present over the smoothed test section of the basic T-33 wing throughout a wide range of test conditions.
- A hot-film gage technique was found to be more informative and more reliable in detecting boundary layer transition than flow visualization using evaporative coatings or pressure sampling probes.

T-33 NATURAL LAMINAR FLOW FLIGHT TESTING (conc.)

Phase II. Boeing Designed and Fabricated 20 Degree Sweep NLF Glove

- o Extensive laminar flow (in excess of 40% chord on the upper surface at some test conditions) was achieved on both upper and lower surfaces of the glove.
- o The extent of laminar flow was more sensitive to off-design conditions on the swept glove than on the basic (unswept) wing.
- o Transition predictions based on stability theory (ref. 5) were verified reasonably well.
- o Wing pressure distributions were predicted by three-dimensional transonic flow theory.
- o Critical rivet heights in the region of the wing leading edge are dependent on unit Reynolds number, location and pressure distribution.
- o Transition indication by liquid crystal coatings (as shown in the figure and described in ref. 6) was demonstrated. While highly promising as an in-flight flow visualization technique, the success of the method is sensitive to a number of variables and requires further development.

T-33 WITH NLF GLOVE
FALL 1986

~~ORIGINAL PAGE IS
OF POOR QUALITY~~

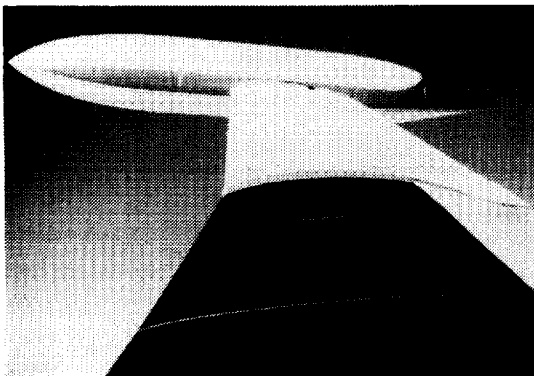

MACH NO. = 0.61
20,000 ft

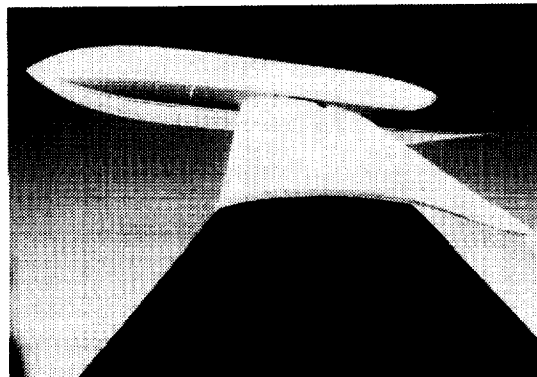

MACH NO. = 0.65
20,000 ft

ORIGINAL PAGE
BLACK AND WHITE PHOTOGRAPH

LAMINAR FLOW AIRFOIL TEST (1977-78)

While the T-33 flight experiments just described are among the latest Boeing Company efforts in laminar flow research, the company has been involved in exploring the basic issues for many years. As an example, an important test series, jointly funded by Boeing and NASA, was conducted in 1977-78 in the Boeing Research Wind Tunnel (BRWT). The large scale 30° swept airfoil model developed for these test is shown in the figure. The airfoil section was specially designed to provide an upper surface pressure distribution in the presence of the wind tunnel walls that is typical of a laminar flow airplane's outboard wing at cruise conditions ($M=0.8$, $C_L=0.5$). Provision was made for slot suction over the first 30% of the chord on the upper surface and 15% of chord on the lower surface.

The principal aims of these tests (ref. 7) were to demonstrate that the suction system would function properly, to establish the required suction distribution for maximum efficiency and to explore the sensitivity to changes in suction intensity. Subsequent testing was performed to explore the sensitivity of the LFC system to various disturbance effects such as surface imperfections, off-design operating conditions and tunnel noise.

These tests gave us considerable confidence in our design and analysis tools and provided needed experience with a variety of techniques for monitoring and diagnosing the state of a boundary layer. Additional wind tunnel tests under contract to NASA are planned.

- Boeing IR&D and NASA contract
- 20-ft chord model
- Model tailored for free air pressure distribution

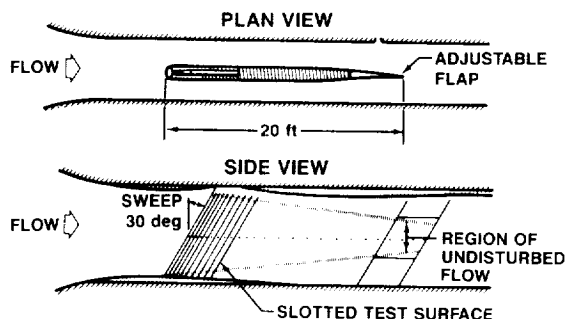

$V_{MAX} \approx 215 \text{ ft/s}$
 $R_{e_{max}} \approx 25 \times 10^6$
TURBULENCE LEVEL: $t \approx 0.15\%$

MODEL IN
BOEING RESEARCH WIND TUNNEL

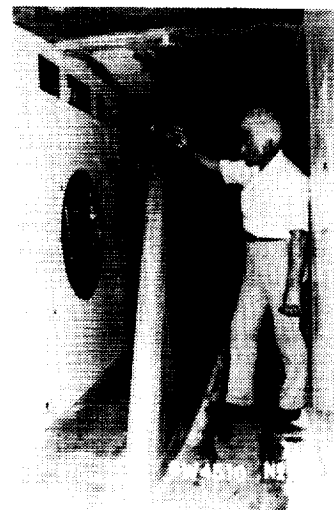

F-14 VSTFE PROGRAM SUPPORT

The F-14 Variable Sweep Test Flight Experiment (VSTFE) program is the latest in an important NASA-funded sequence of experiments with variable sweep aircraft to systematically explore the important effect of wing sweep on boundary-layer stability and transition - an effect not sufficiently understood when the X-21 program began. Boeing participation in these later programs has been continuous, with emphasis on developing and refining the computer-based capability to analyze and predict three-dimensional boundary-layer stability characteristics over a wide range of wing geometries and flight conditions. Details of the most recent work on this fundamentally important enabling technology for laminar flow are described in the paper by Rozendaal (ref. 5).

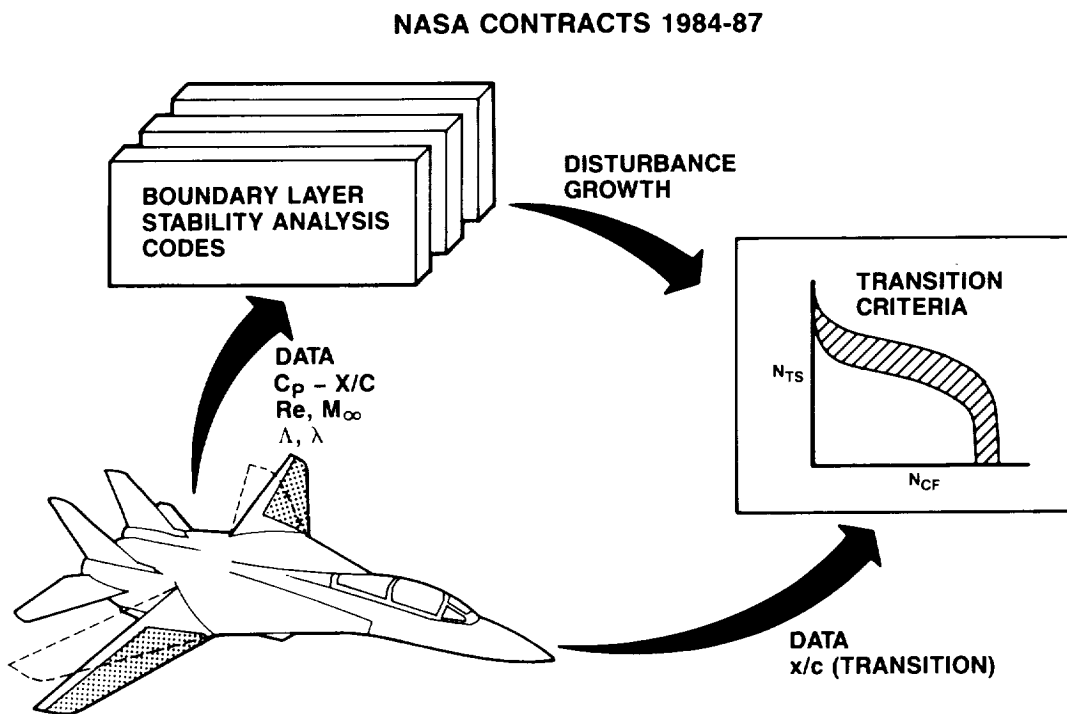

BOEING 757 NLF GLOVE

These tests of a Boeing designed and fabricated NLF glove were performed during 1985 under NASA contract. A fundamental objective was to determine possible adverse effects of engine noise impingement on an NLF surface under realistic operational conditions. The results of the tests are described in detail in ref. 8.

The important result of these experiments has been the demonstration that engine noise effects are limited to the under-surface of the wing. This opens a configuration option of major significance in a range of possible future hybrid laminar flow applications.

- FLIGHT TESTS 1985
- NASA CONTRACT



~~ORIGINAL PAGE IS~~
OF POOR QUALITY

KRUEGER FLAP/INSECT SHIELD DESIGN AND TEST

Two important concerns in deriving a practical laminar flow airplane system are the provision for an adequate high-lift system and a means of protecting the relevant aerodynamic surfaces from insect contamination during low altitude operations. As part of our recent laminar flow efforts, the design and validation of an appropriate leading-edge high-lift device/insect shield was undertaken. The objectives of this work were to:

- o Develop a shielding device that would protect a wing upper surface from insect contamination during ground roll, take-off, initial climb and landing approach.
- o Develop such a leading-edge shielding device that also produces high-lift performance equivalent to existing slat/Krueger flap devices used on our present product line.
- o Develop computational and experimental techniques for design and validation of such a leading-edge device.

KRUEGER FLAP/INSECT SHIELD DESIGN AND TEST (conc.)

This work during 1986 involved design of a "foldable bullnose" Krueger leading-edge flap, development of a computer code capable of predicting insect trajectories within the flow field associated with a multi-element airfoil, and the conduct of a wind tunnel test in the Boeing Research Wind Tunnel. Typical results are shown in the figure. The conclusions drawn from this work include:

- o A practical leading-edge device, which is both an adequate insect shield and high-lift device, can be developed.
- o Such a Krueger device is mechanically compatible with existing transport wings with slat-type leading-edge devices.
- o High-lift performance need not be seriously compromised in providing adequate insect shielding.
- o Experimental techniques (e.g. means of injecting live insects into a wind tunnel test section) now exist to allow experimental validation of insect impact predictions.

• BOEING IR&D

LOW ANGLE OF ATTACK ($\alpha = 0$ deg)
LARGE INSECTS

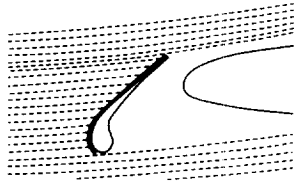

HIGH ANGLE OF ATTACK ($\alpha = 8$ deg)
SMALL INSECTS

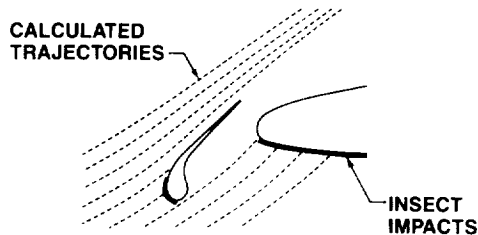

BOEING 5-ft by 8-ft RESEARCH WIND TUNNEL

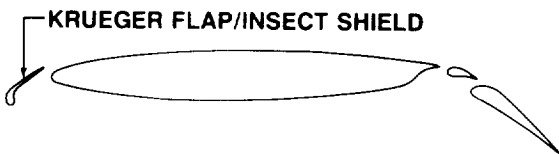
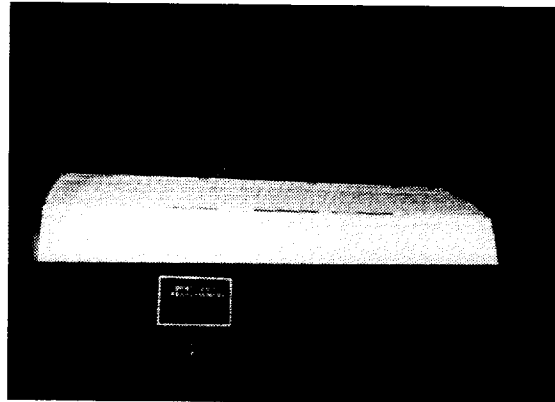

- Krueger is an effective insect shield
- Foldable bullnose type Krueger has good high-lift performance

LAMINAR FLOW - THE CHALLENGE

As shown in the figure, the development in laminar flow has been systematic and the results obtained are impressive.

Based on the enormous amount of laminar flow work to be reported in this Symposium it is clear that the technical community is making progress toward establishing technical feasibility. Our next research challenge is the attainment of the predicted extents of laminar flow on an HLFC aircraft with the characteristics of a modern transport.

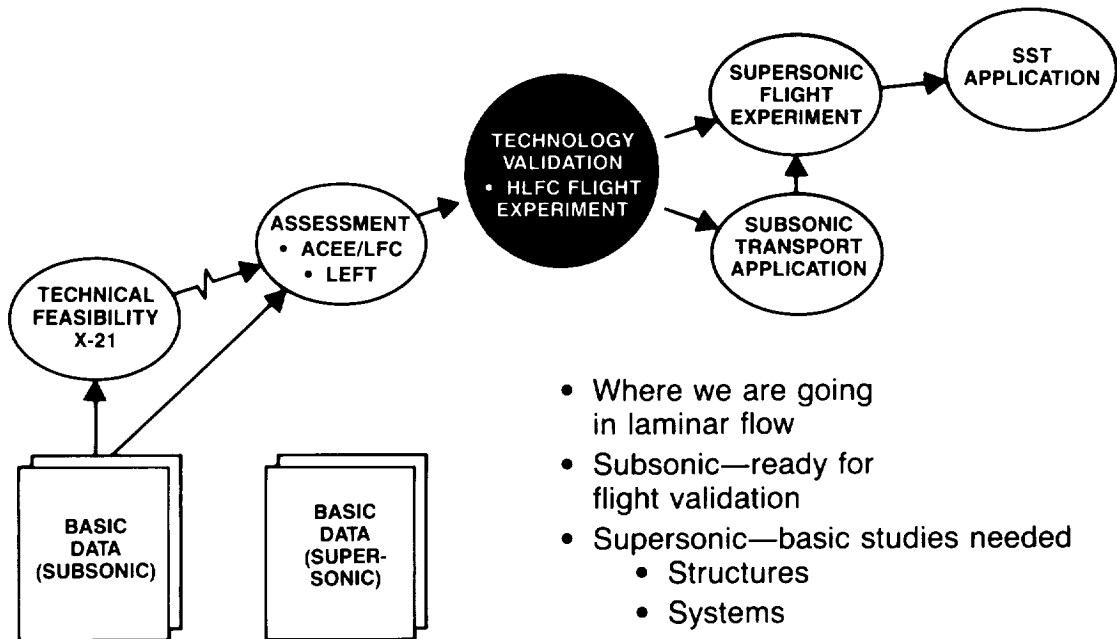

ACKNOWLEDGMENT

The author gratefully acknowledges the assistance of the following individuals in the preparation of this presentation: D. M. Goerge-Falvy, D. W. Lund, J. H. McMasters, A. L. Nagel, A. Roosne, R. A. Rozendaal, L. J. Runyan.

REFERENCES

1. Beckwith, I. E., "Development of High Reynolds Number Quiet Tunnel for Transition Research", AIAA Journal, Vol 13, No. 3, March 1975, pp. 300-6.
2. Pfenninger, W., "USAF and Navy Sponsored Northrop LFC Research Between 1949 and 1967", in "Workshop on Laminar Flow Control", compiled by C. T. D'Aiutolo, NASA-Langley Research Center, April 6-7, 1976, pp. 14-50.
3. Montle, L. K. and Steiner, J. E., "Post World War II Commercial Transport Design History", presented at AIAA Aircraft Systems and Technology Meeting, Dayton, Ohio, August 11, 1981.
4. Kitowski, J. V., "USAF Review of the X-21A Program", in "Workshop on Laminar Flow Control" compiled by C. T. D'Aiutolo, NASA-Langley Research Center, April 6-7, 1976, pp. 239-73.
5. Rozendaal, R. A., "VSTFE-Stability Code Development and Clean-Up Glove Data Analysis", Symposium on Natural Laminar Flow Control Research, NASA-Langley Research Center, NASA CP 2487, March 16-19, 1987, pp. 845-859.
6. Holmes, B. J., Croom, C. C., Gall, P. D. Manuel, G. S., and Carraway, D. L., "Advanced Transition Measurement Methods for Flight Applications", AIAA-86-9786, Las Vegas, NV, April 2-4, 1986.
7. BCAC Preliminary Design Department, "Evaluation of Laminar Flow Control System Concepts for Subsonic Commercial Transport Aircraft", NASA CR 158976, December, 1978.
8. Runyan, L. J., Bielak, G. W., Behbehani, R., Chen, A. W., and Rozendaal, R. A., "757 NLF Glove Flight Test Results", Symposium on Natural Laminar Flow and Laminar Flow Control Research, NASA-Langley Research Center, NASA CP 2487, March 16-19, 1987, pp. 795-818.