

# **NASA Contractor Report 182013**

## **Bi-Directional Thruster Development and Test Report**

A.D. Jacot  
G.S. Bushnell  
T.M. Anderson

(NASA-CR-182013) BI-DIRECTIONAL THRUSTER  
DEVELOPMENT AND TEST REPORT Final Report,  
Jul. - Oct. 1989 (Boeing Aerospace Co.)  
94 p CSCL 22B

N90-21785

Unclas  
G3/18 0277715

**Boeing Aerospace & Electronics**  
20403 68th Ave South  
18-26 bldg Kent, WA 98032

Contract NAS1-18762

February 1990

The NASA logo, consisting of the word "NASA" in a bold, sans-serif font.

National Aeronautics and  
Space Administration

**Langley Research Center**  
Hampton, Virginia 23665-5225



# TABLE OF CONTENTS

	<u>Page</u>	
<b>1.0</b>	<b>SUMMARY</b>	<b>4</b>
<b>2.0</b>	<b>CIRCUIT WIRING AND DESIGN DESCRIPTION</b>	<b>10</b>
2.1	ELECTRONICS DESIGN DESCRIPTION	10
2.2	CONNECTIONS NECESSARY BEFORE POWER-UP	18
2.3	MECHANICAL DESIGN DESCRIPTION	19
<b>3.0</b>	<b>OVERVIEW OF THE BI-DIRECTIONAL THRUSTER TEST DATA</b>	<b>27</b>
3.1	OPEN LOOP FREQUENCY RESPONSE DATA	27
3.2	CLOSED LOOP STEP RESPONSE DATA	27
3.3	CLOSED LOOP FREQUENCY RESPONSE DATA	34
3.4	CLOSED LOOP THRUST, LINEARITY, AND HYSTERESIS	39
3.5	SUMMARY OF PERFORMANCE	41
<b>4.0</b>	<b>SYSTEM INTEGRATION AND TESTING</b>	<b>69</b>
<b>APPENDIX 1</b>	<b>AUDIBLE NOISE</b>	<b>77</b>
<b>APPENDIX 2</b>	<b>THRUSTER FORCE SPECTRUMS</b>	<b>87</b>
<b>APPENDIX 3</b>	<b>MOUNTING SURFACE FORCE TEST</b>	<b>91</b>

# LIST OF FIGURES

Figure	Description	Page Number
1.1	Assembled Thruster	5
1.2	Disassembled Thruster & Electronics	6
1.3	Thruster & Card Cage	7
1.4	Thruster Force Test Set-Up	8
1.5	Thruster 9 Test Results	9
2.1-1	Closed Loop Block Diagram	11
2.1-2	Control Board Schematic	12
2.1-3	Unmodified DyVal Control Amplifier	13
2.1-4	System Configuration	15
2.1-5	System Wiring	16
2.3-1	Photo of Disassembled Thruster	20
2.3-2	Manifold	21
2.3-3	Nozzle	22
2.3-4	Vent	23
2.3-5	Bracket	24
2.3-6	Perf Board	25
2.3-7	Face Plate	26
3.1-1	Open Loop Block Diagram	28
3.1-2	Off Null Open Loop Freq. Response	29
3.1-3	Across Null Open Loop Freq. Response	30
3.1-4	Open Loop Test Results	31
3.2-1,2	Closed Loop Step Responses	32-33
3.3-1,2	10 Hz Responses	35-36
3.3-3	Off Null Closed Loop Freq. Response	37
3.3-4	Across Null Closed Loop Freq. Response	38
3.4-1	Press. Feedback VS Press. Command	42
3.4-2	Press. Feedback VS Press. Command (Zoomed)	43
3.4-3	TPB VS TPA with 100 Filter	44
3.4-4	TPB VS TPA with 100 Filter (Zoomed)	45
3.4-5	Force VS Command Without Filter	46
3.4-6	Linearity Difference Without Filter	47
3.4-7	Force VS Command With 100 Hz Filter	48
3.4-8	Linearity Difference With 100 Hz Filter	49
3.4-9	Force Response Without Filter	50
3.4-10	Force Impulse Response Without Filter	51
3.4-11	Force Response Without Plate	52
3.4-12	Linearity Difference Without Plate	53
3.4-13	Force Response With Plate	54
3.4-14	Linearity Difference With Plate	55
3.4-15	0.2 Hz Time Response	56
3.4-16	Maximum Thrust	57
3.4-17	0.2 Hz Time Response	58
3.4-18	Force VS 0.2 Hz Command	59
3.4-19	Linearity Difference	60
3.4-20	Pressure VS 0.2 Hz Command	61
3.4-21	Pressure VS 0.2 Hz Command, (Zoomed)	62
3.4-22	0.05 Hz Time Response	63
3.4-23	Force VS 0.05 Hz Command	64

Figure	Description	Page Number
3.4-24	Linearity Difference, 0.05 Hz	65
3.4-25	Pressure VS 0.05 Hz Command	66
3.4-26	Pressure VS 0.05 Hz Command, (Zoomed)	67
3.5-1	Closed Loop Test Results	68
4.1	System Test #1	71
4.2	System Test #1, Pressure Feedback	72
4.3	System Test #2	73
4.4	System Test #2, Pressure Feedback	74
4.5	System Test #3	75
4.6	System Test #3, Pressure Feedback	76

#### Appendix 1:

A1.1	Microphone 90 deg, 3 feet	79
A1.2	Microphone 45 deg, 3 feet	80
A1.3	Microphone 45 deg, 6 feet	81
A1.4	Microphone 45 deg, 3 feet, Table	82
A1.5	Microphone 45 deg, 6 feet, Table	83
A1.6	Microphone 45 deg, With Plate	84
A1.7	Microphone 45 deg, With Step Input	85
A1.8	Microphone 45 deg, With Step Input, Table	86

#### Appendix 2:

A2.1	Force Noise, 0.2 Hz Full Command	88
A2.2	Force Noise, 0.2 Hz 0.25V Command	89
A2.3	Force Noise, Full DC Command	90

#### Appendix 3:

A3	Mounting Surface Force Test Setup	92
----	-----------------------------------	----

#### List of Tables

2.2-1	Pin-out for Centronix 22 Pin Connector	17
2.2-2	10-Conductor Ribbon Cable Connections	17
2.2-3	SenSym Pressure Transducer Connections	18

#### List of Acronyms

TPA	Test Point A (Command Input; 5V is full scale)
TPB	Test Point B (Press. Feedback; 5V is full scale)
DUT	Device Under Test

## 1.0 SUMMARY

This report describes the design, calibration, and testing of a cold gas, bi-directional throtttable thruster. Figures 1.1, 1.2, and 1.3 show photographs of the assembled and disassembled bi-directional thruster, and the electronics control board card cage and interface cable. The thruster consists of a electro-pneumatic servovalve, exhausting thru opposite nozzles with a high gain pressure feedback loop to optimize performance.

The thruster force was measured as shown in the test setup in Figure 1.4 to determine hysteresis and linearity. In addition, a correlation was made between the thruster force and differential nozzle chamber pressure. This allowed the higher response, low noise pressure measurement to be used to determine the dynamic response. Integral gain was used to maximize performance for linearity, hysteresis, and minimum thrust requirements. Proportional gain provided high dynamic response (bandwidth and phase lag). Figure 1.5 shows the summary performance sheet for a typical thruster. The thruster performance exceeded all specification requirements. Such performance is very important since the thrusters are intended to be used for active control.

Section 2.0 contains a design description of the thruster, followed by an overview of the test results in section 3.0. System integration test results are given in section 4.0. Appendices 1 and 2 contain the audible and thruster force noise measurement data, and appendix 3 the mounting surface force test data.

ORIGINAL PAGE  
BLACK AND WHITE PHOTOGRAPH

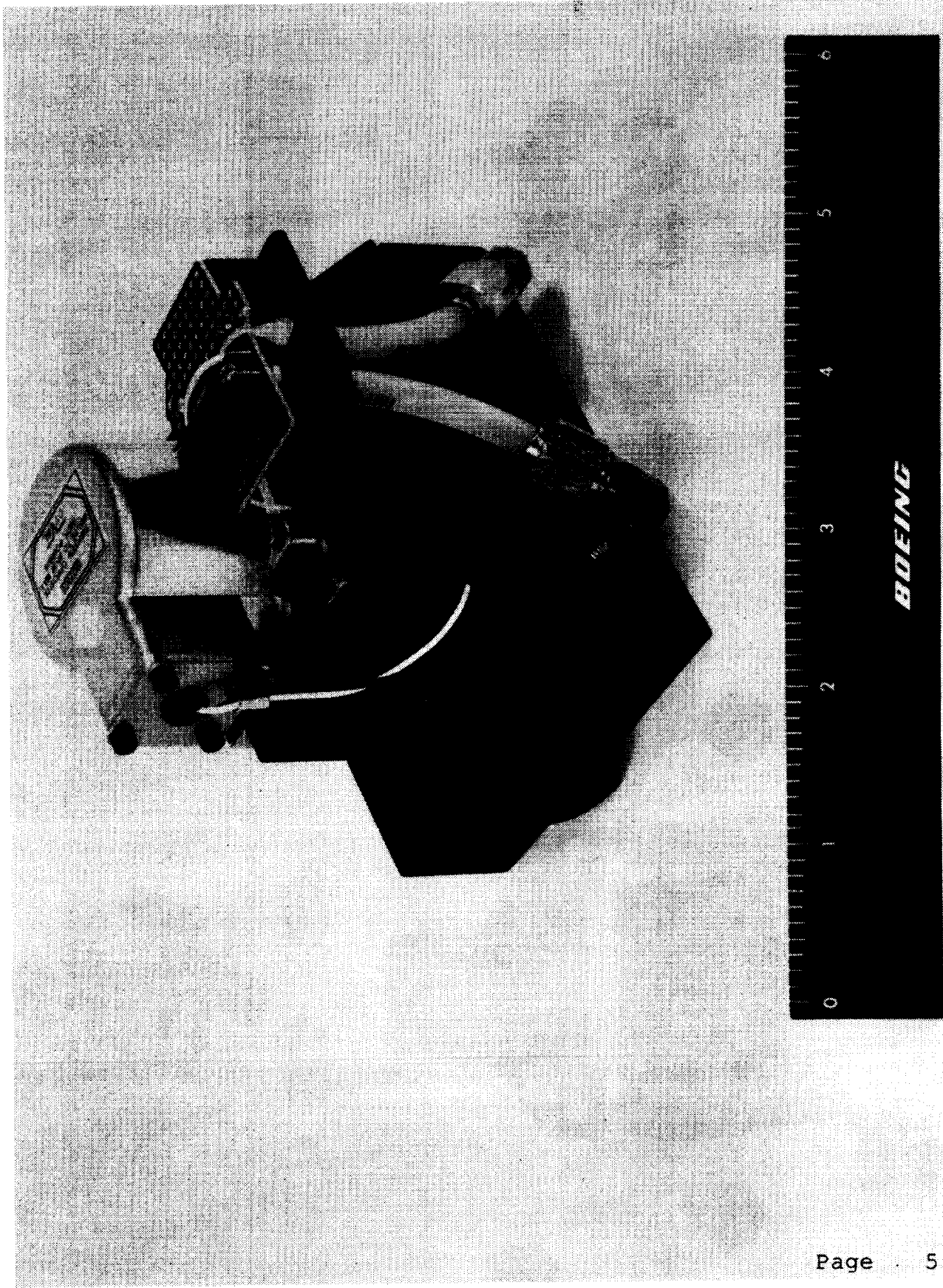

FIGURE 1.1 - ASSEMBLED THRUSTER

ORIGINAL PAGE  
BLACK AND WHITE PHOTOGRAPH

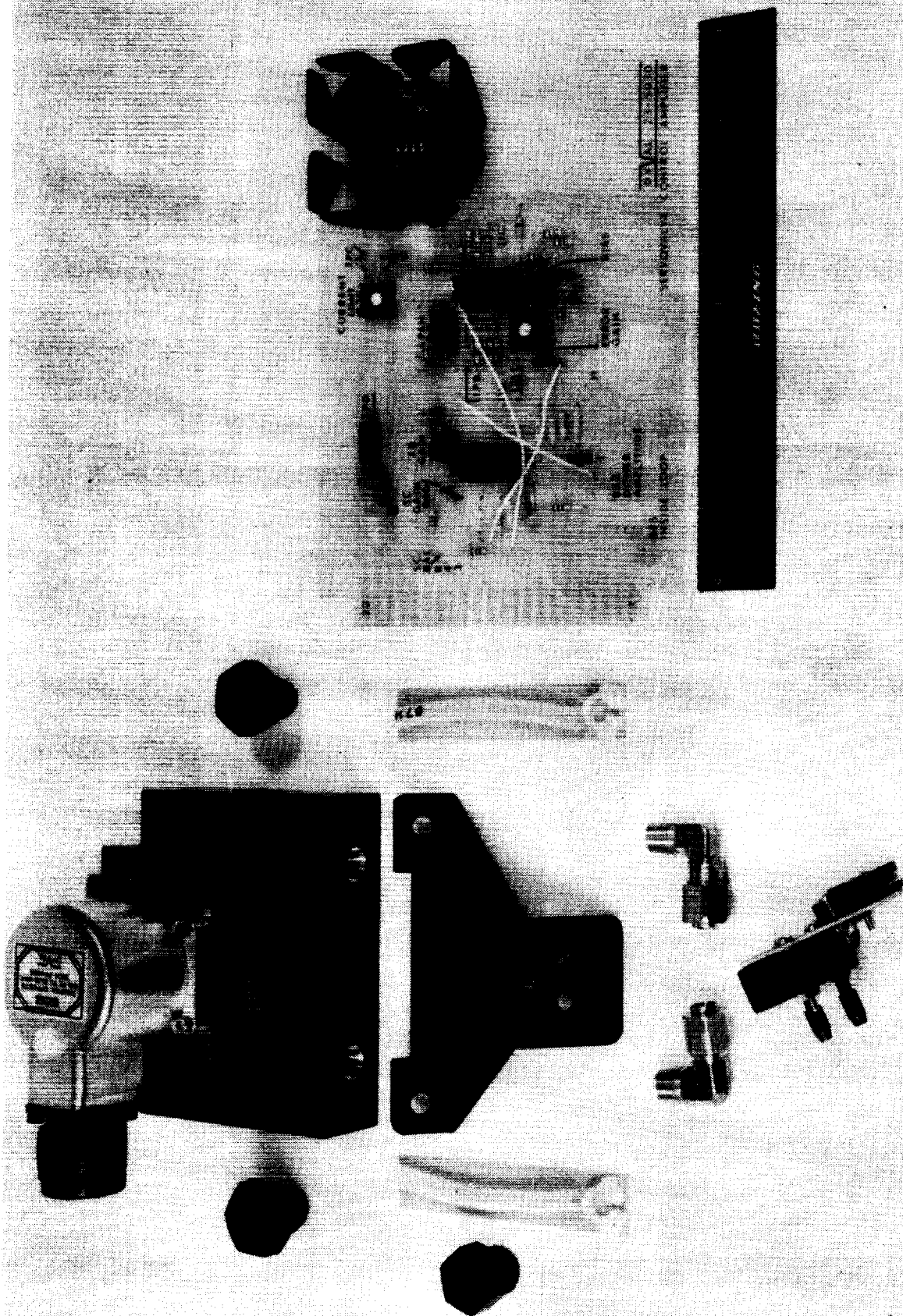

FIGURE 1.2 - DISASSEMBLED THRUSTER



ORIGINAL PAGE  
BLACK AND WHITE PHOTOGRAPH

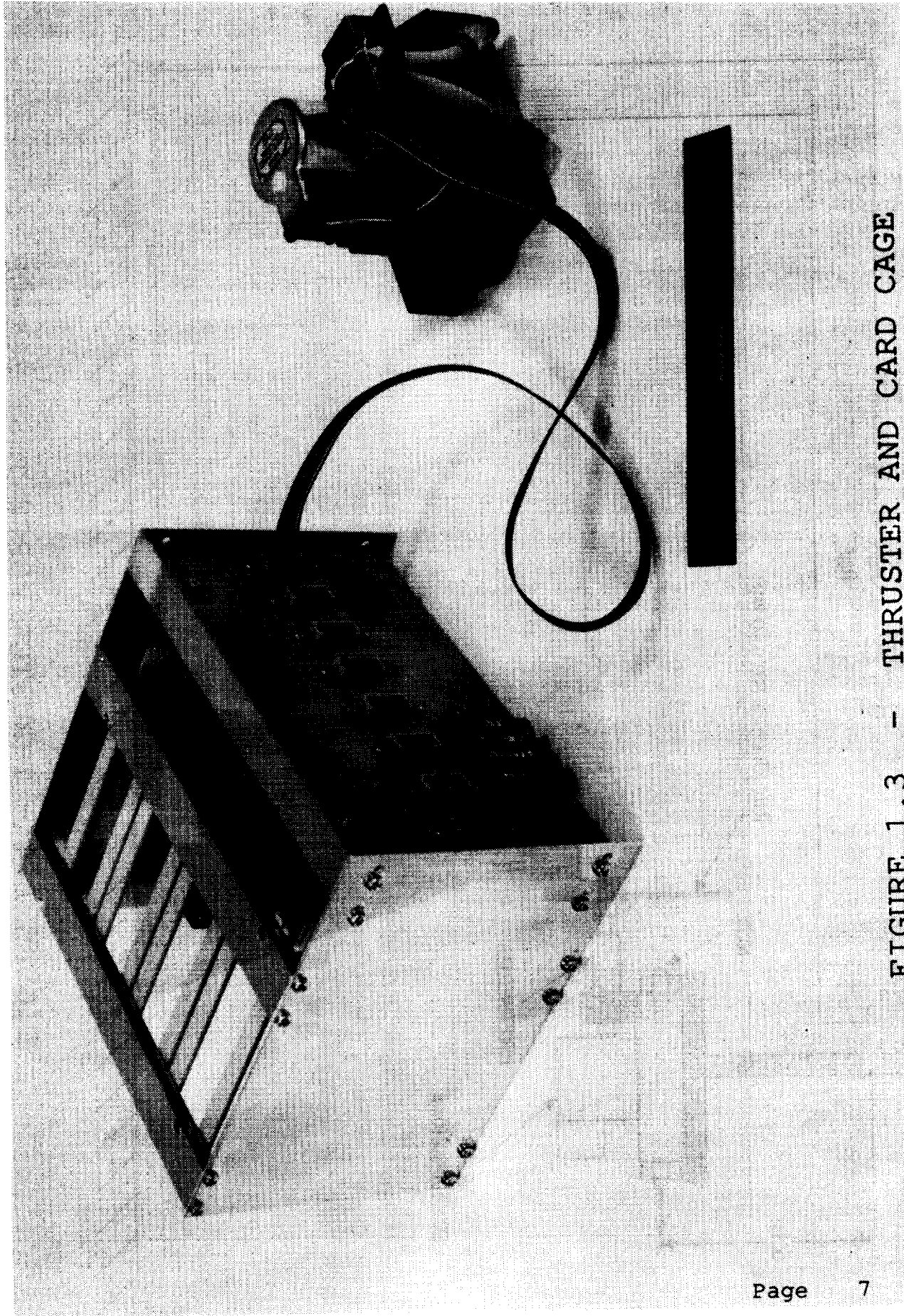

FIGURE 1.3 - THRUSTER AND CARD CAGE

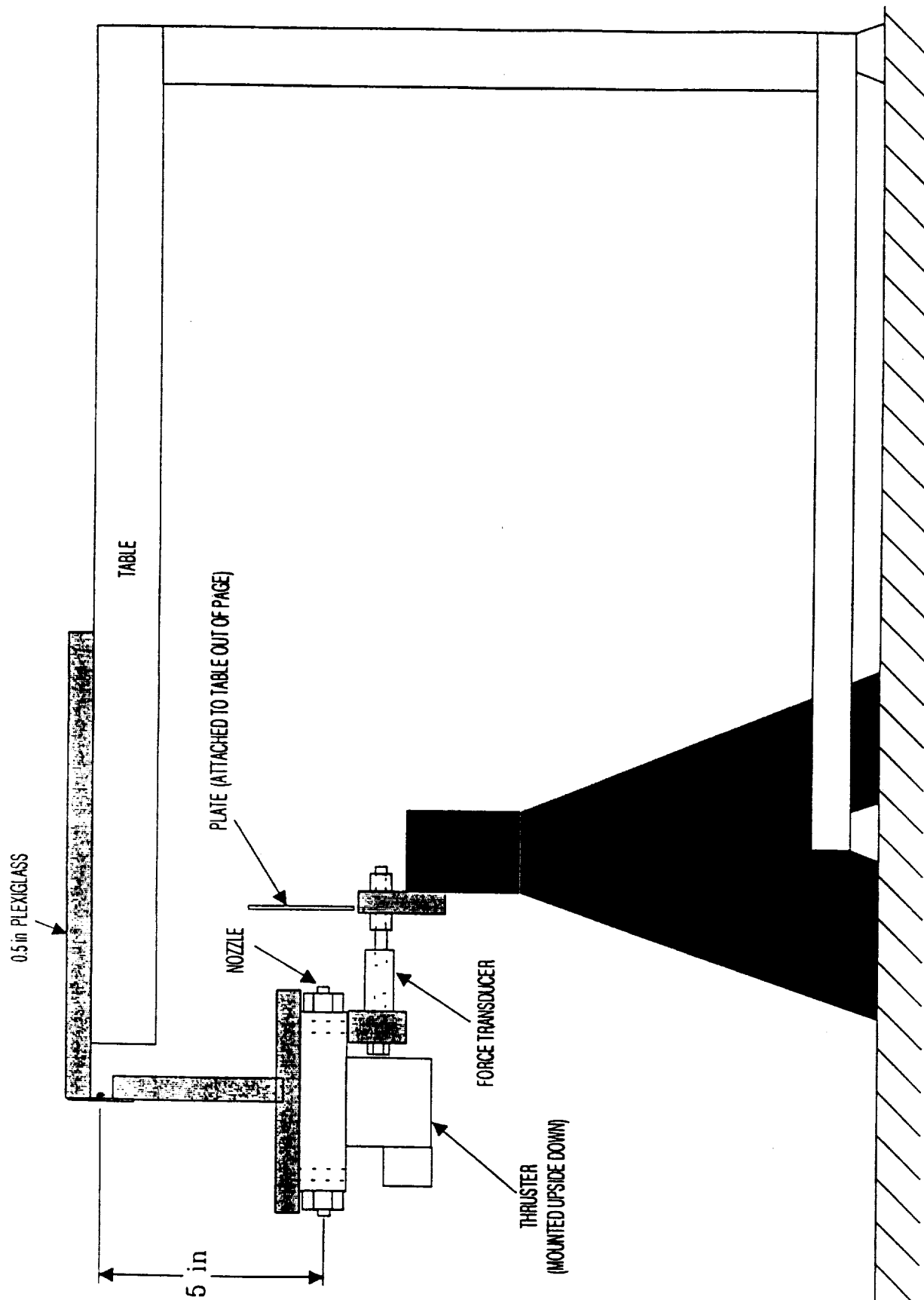

FIGURE 1.4 - THRUSTER FORCE TEST SET-UP

	<u>ACHIEVED</u>	<u>SPEC</u>
Weight	3.95 lbs (with electronics)	< 5 lbs
Proof Pressure	226 PSIG	225 PSIG
Peak thrust level	+/- 2.1 lbs	+/- 1.5 lbs
10 Hz phase lag (1 lb thrust command)	12 degrees (at 10 Hz)	< 30 deg (up to 10 Hz)
Bandwidth	OFF NULL : 144 Hz ACROSS NULL : 65 Hz (3.0 db attenuation)	0 to 10 Hz
Linearity	3.3% at 0.2 Hz 3.3% at 0.05 Hz	< +/- 5%
Hysteresis	2.3% at 0.2 Hz 0.3% at 0.05 Hz	< 5%
Minimum Thrust	0 lbs	< 0.15 lbs

Above performance measurements  
at 125 PSIG bottled air.

FIGURE 1.5 - Thruster Test Results

## 2.0 - Circuit Wiring And Design Description

### 2.1 Electronics Design Description

This section describes the thruster electrical and mechanical design. Figure 2.1-1 shows the block diagram of the system and control law, as well as the low frequency (< 500 Hz) thruster dynamics and controller parameters which were derived from analysis and development testing. Input command scaling is 10 volts for 75 psi differential nozzle pressure which corresponds to 2.1 pounds thrust. The pressure error is sent through a proportional/integral controller and then to a low-pass (482 Hz) filter to avoid exciting nozzle flapper resonances. A high bandwidth (1200 Hz) current driver converts the voltage to proportional current, which drives the servovalve. Proportional gains shown were selected to maximize dynamic response. The integral gain minimizes effects of valve nonlinearity (hysteresis, threshold).

The controlling electronics for the linear thruster is based upon the DyVal 23-5030 Control Amplifier. As delivered, this board provided only proportional control of the thruster servovalve. In addition, it included a built-in dither generator, independent signal conditioner circuit and derivative inner loop capability. The 23-5030 Control Amplifier provided a good starting point for the thruster controller design but several modifications have been made to it, however, to implement the necessary thruster control law and pressure feedback amplification. These changes are described in the following paragraphs. Figure 2.1-2 shows the final controller schematic identifying the individual component functions of proportional/integral control, filtering, and pressure transducer amplification. Terminology is the same as that shown in figure 2.1-1.

Figure 2.1-3 shows the original DyVal 23-5030 Control Amplifier. All electrical modifications to the DyVal Control Amplifier necessary to achieve the aforementioned functions are described below.

1. The nozzle air pressure feedback is provided by a SenSym SCX150 precision differential pressure sensor mounted on the thruster. This transducer is powered by +/- 15 volts and delivers approximately 1.48 mV/psi difference between the two nozzles, thus requiring amplification. To accomodate this requirement, the 23-5030's built-in dither generator, which was not needed for this application, was transformed into a differential input amplifier. Output from this first stage is then amplified again by a second stage before it is subtracted from the thruster command input.

2. To incorporate integral control in the electronics design, the 23-5030's signal conditioner circuit, (not

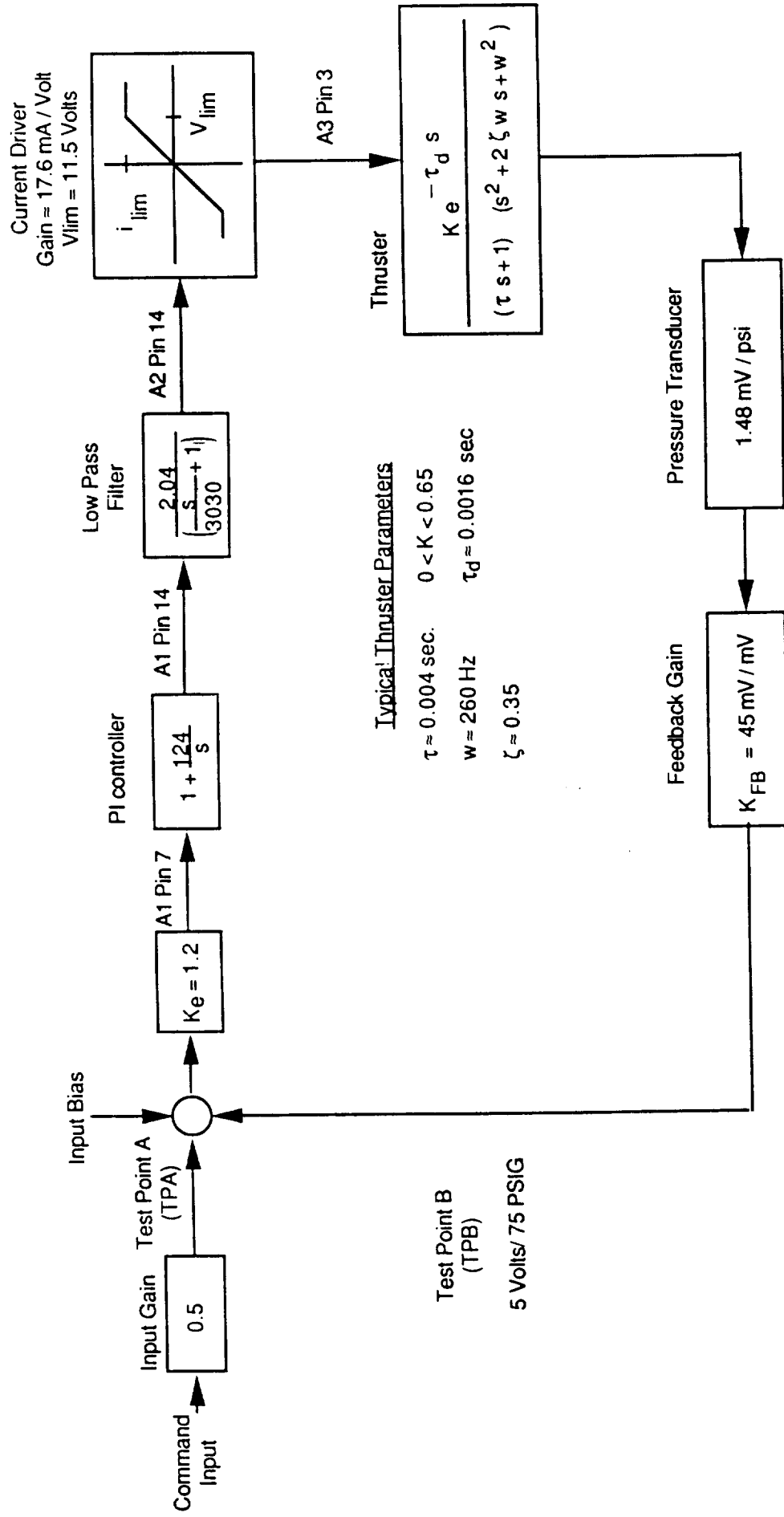
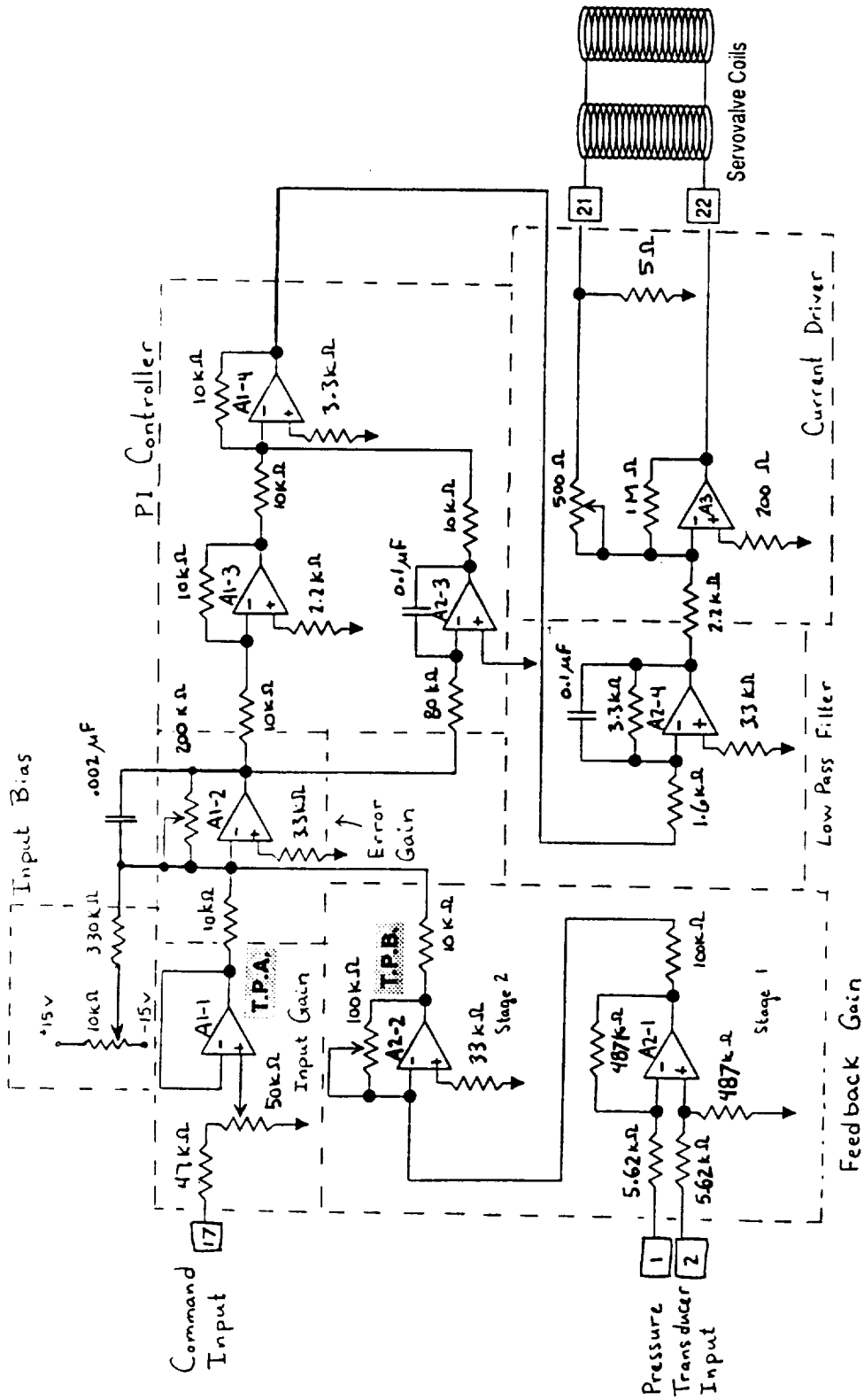
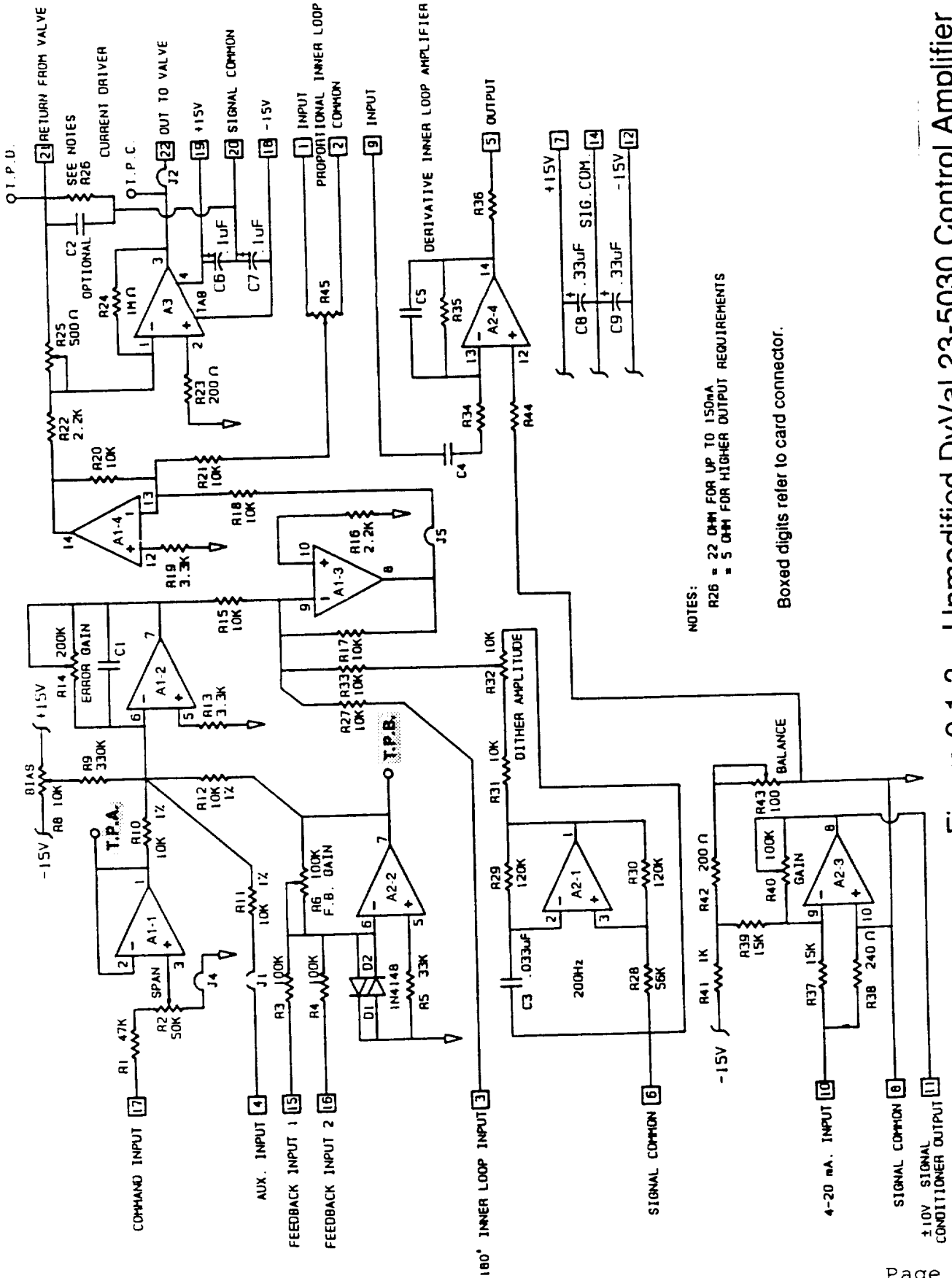

FIGURE 2.1-1 - CLOSED LOOP BLOCK DIAGRAM



Boxed digits refer to card connector.

Figure 2.1-2 Control Board Schematic



NOTES:  
 R26 = 22 OHM FOR UP TO 150mA  
 = 5 OHM FOR HIGHER OUTPUT REQUIREMENTS  
 Boxed digits refer to card connector.

Figure 2.1-3 Unmodified DyVal 23-5030 Control Amplifier

needed), was changed to an integrator and patched into the control circuitry.

3. To eliminate high-frequency noise, the derivative, inner-loop amplifier was transformed into a first-order low pass filter and inserted into the forward loop of the controller.

4. An optional .002 uF capacitor was added to the error gain op-amp. This was necessary due to the extremely high gain of the input stage of the pressure transducer feedback. Previously, the high gain was amplifying a great deal of high frequency noise, which the capacitor now filters out above approximately 8000 Hz.

5. An adjustment was made by moving the biggest part of the pressure transducer feedback from stage 2 to stage 1. Before the switch, any small changes in the offset of stage 1 were greatly amplified by stage 2. This problem caused great consternation but was easily remedied by the changing the gains of each stage. The modification was made by replacing the 60K ohm resistors with 5.6K ohm resistors and the 120K ohm resistors with 487K ohm resistors while readjusting the feedback gain potentiometer on stage 2.

A picture of a sixteen thruster system is shown in Figure 2.1-4 where a diagram of the card cages' back panel is shown. Both card cages are powered with +/- 15 volts from an Acopian Dual Power Supply. A DA-15 connector on the lower right of each back panel provides the interface to command the thrusters via an analog signal varying between -10 and +10 volts. The 8 connectors along the top of the back panel of each card cage, mate with the 16 10-conductor ribbon cables that go to thrusters. Figure 2.1-5 along with Tables 2.2-1,2,3 depict system and servovalve wiring. The labels, A thru D on the servovalve coils, refer to the factory labels for the coil wires assigned by DyVal. The pinout for each Centronix edge card connector (inside card cage) is shown in Table 2.1-1. Pinout for the ribbon cable connectors is shown in Table 2.1-2. Table 2.1-3 shows pressure transducer pinout and connection.



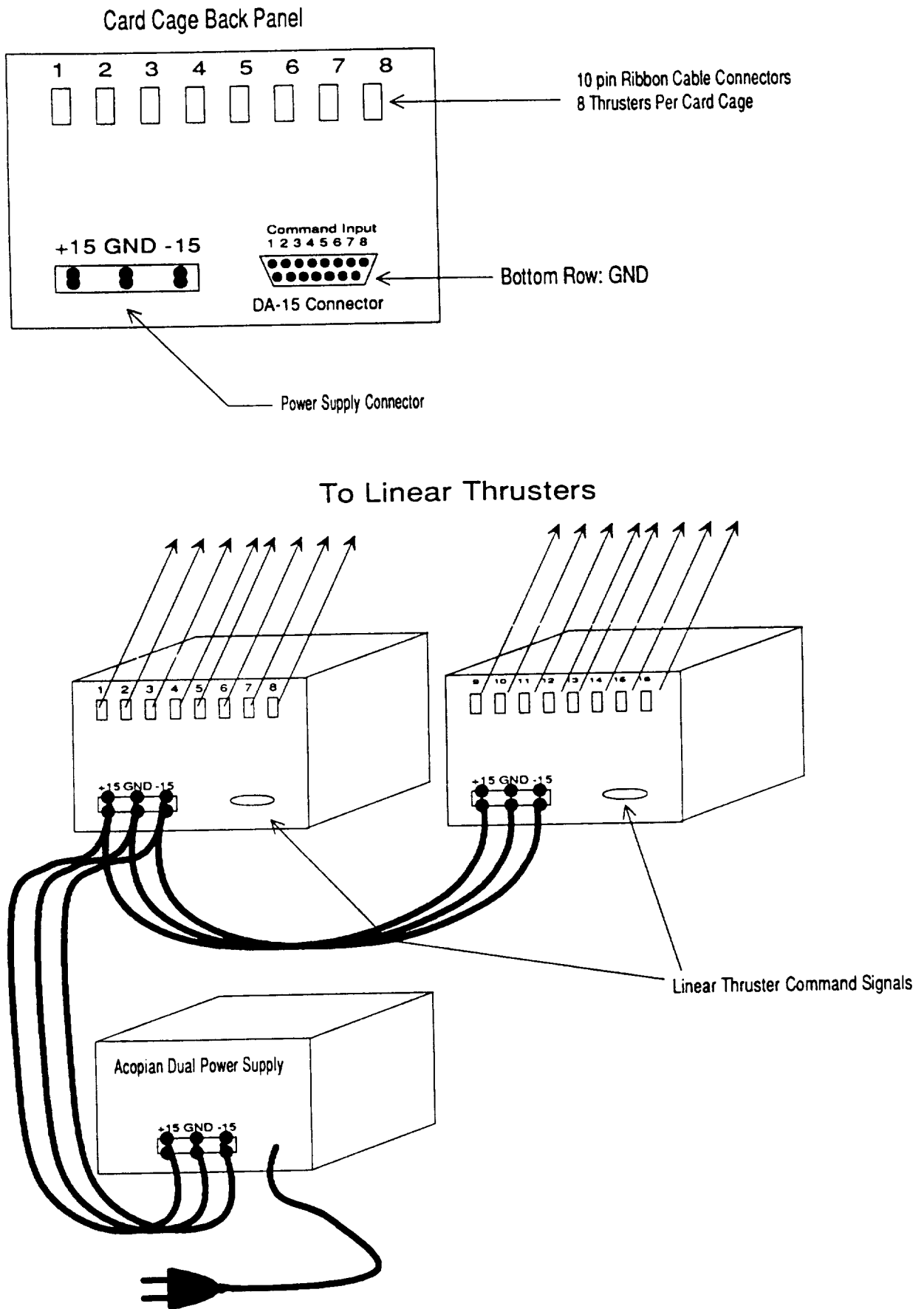

Figure 2.1-4 - System Configuration

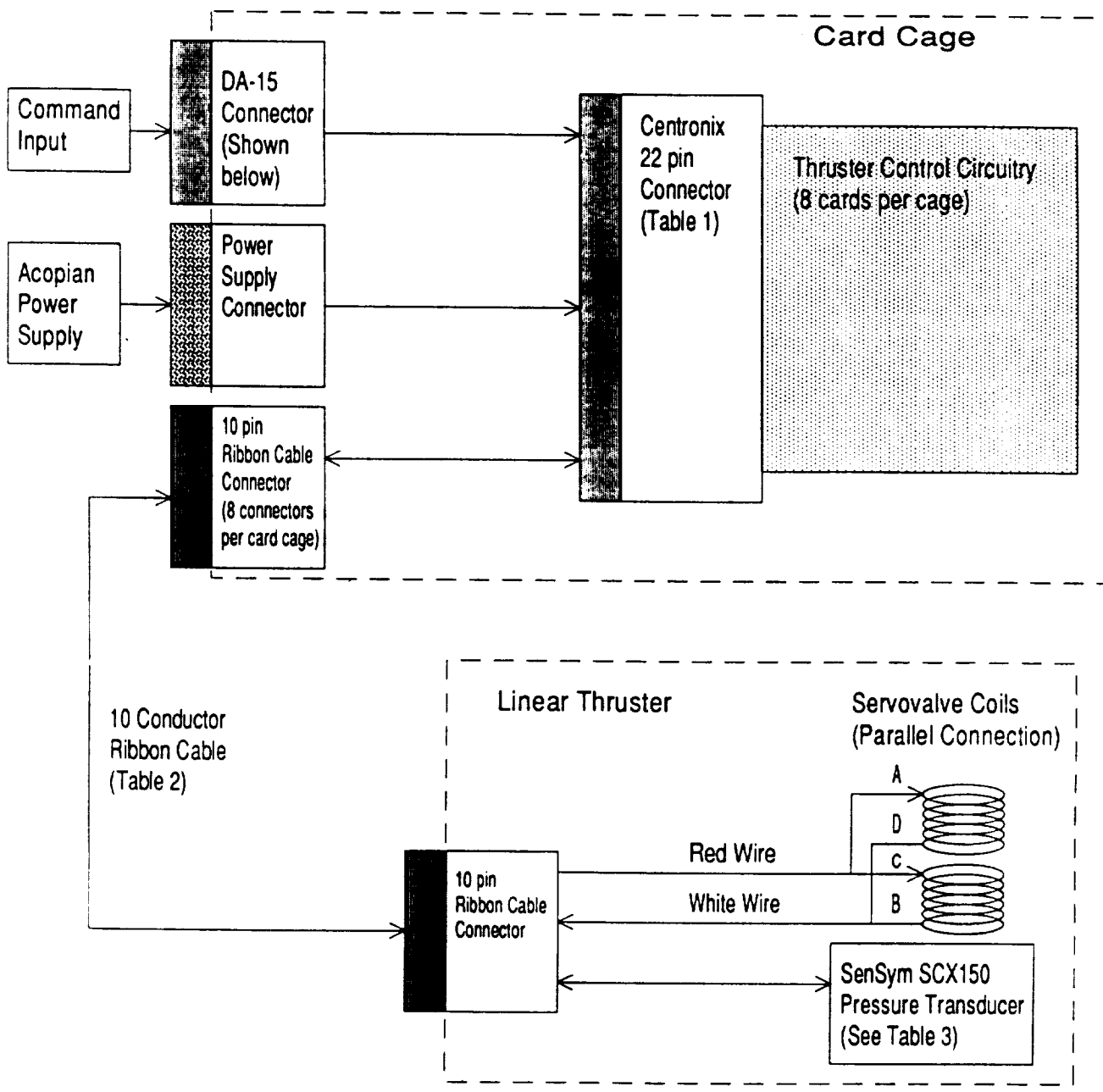

Figure 2.1-5 - System Wiring

**Table 2.1-1  
Pin-out for Centronix 22 pin connector**

1	Pressure Transducer (Ribbon Cable conductor #7)
2	Pressure Transducer (Ribbon Cable conductor #8)
3	N.A.
4	N.A.
5	N.A.
6	GND
7	+15 V
8	GND
9	N.A.
10	N.A.
12	-15 V
13	N.A.
14	GND
15	N.C.
16	N.C.
17	Command Input (+10 V to -10 V)
18	-15 V
19	+15 V
20	GND
21	Return From Valve (Ribbon Cable pin #1)
22	Out To Valve (Ribbon Cable pin #2)

Note: The 22-pin Centronix connectors are the edge-card connectors located inside each card cage.

**Table 2.1-2  
10-Conductor Ribbon Cable Connections**

1	Valve Coil #1 White Wire, (Centronix #21)
2	Valve Coil #2 Red Wire, (Centronix #22)
3	N.C.
4	N.C.
5	-15 V
6	+15 V
7	Pressure Transducer (to Centronix #1)
8	Pressure Transducer (to Centronix #2)
9	+15 V
10	N.C.

N.A. = Not Applicable

N.C. = Not Connected

Part Numbers:

Ribbon Cable connector:	Dupont 66900-010
Thruster-end ribbon cable socket:	Dupont 65496-005
Chassis-end ribbon cable socket :	Dupont 822-A010P-AF300

**Table 2.1-3**  
**Sensym SCX150 Pressure Transducer Connections**

1	N.C. (Temperature Output +)
2	+15 V
3	Ribbon Cable Connector pin 7 (Output +)
4	-15 V
5	Ribbon Cable Connector pin 8 (Output -)
6	N.C. (Temperature Output -)

N.C. = No Connection

## 2.2 Connections Necessary Before Power-up

To install the system, connect ribbon cables between valves and card cages. It must be remembered that Thruster #1 needs to be connected to Controller Board #1, etc, since each controller board and thruster make up a matched pair. Secondly, the +/- 15 volt power supply must be connected to each card cage. **(Note: controller boards should never be installed or removed while the power is on. Furthermore, all command inputs to the DA-15 connectors should be zero volts when power is off.)**

The linear thruster should now be ready for use. To test the unit, connect a command signal, the magnitude of which should not exceed 10 volts, to the appropriate pin of the top row of the DA-15 connector on the back of the card cage. Valve thrust can be monitored at Test Point B (TPB) on the controller board where +/- 5 volts is full scale. Command can be monitored at Test Point A where +/- 5 volts is full scale. If a thruster fails to operate, check to make sure that the ribbon cable is installed properly.

### 15 pin DA-15 connector

On the back of each chassis (shown in Figure 2.1-4) there is a DA-15 connector for the command signals to each thruster. The top row (8 conductors) is directly connected to the Centronix connector pin #17 which is the command input for each board. The bottom row (7 conductors) is entirely grounded.

### 2.3 Mechanical Design Description

This section includes thruster part descriptions and design drawings. The following parts can be seen in Figure 2.3-1.

1. Servo Valve: Dynamic Valves, Inc; Model Number 10-S with 0.022 inch spool stroke.
2. Manifold: Dynamic Valve, Inc; P/N 55-0100-2. Modified as per drawing in Figure 2.3-2.
3. Nozzle: Spencer Aircraft; AN919-6D Reducer. Small end has been shortened to remove threads. Modified as per drawing in Figure 2.3-3. Painted flat black.
4. Vent Fitting: Parker Fluid Connectors; Hex Head Plug Straight Thread O-Ring. P/N 6-P50N-S. Modified as per drawing shown in Figure 2.3-4. Mounted so that the vent hole centerline is colinear with the thrust direction. Painted flat black.
5. Tubing: Imperial Eastman Poly-Flo Tubing; 44-P-1/4, 2.375 inches long.
6. Tube Clamp: Tyton Snappers from SenSym; Stock # SNP-1, inside dia=0.228-0.256 inches.
7. Bracket: Made from 0.030 in. aluminum sheet metal per drawing in Figure 2.3-5. Painted flat black.
8. Male Elbow: Parker Fluid Connectors; P/N 4-CBI-B.
9. Pressure Transducer: SenSym; P/N SCX150DN
10. Ribbon Cable Socket: Dupont; P/N 65496-005.
11. Blue Epoxy Glass Perf Board: Vector; 0.062 in. thick, 0.042 in. diameter holes, 0.1 in. hole centers. Also 4-40 3/4in and 2-56 1/2in bolts and locking nuts. Made per drawing in Figure 2.3-6.
12. Replaced connector supplied with servovalve with Face Plate made per drawing in Figure 2.3-7.

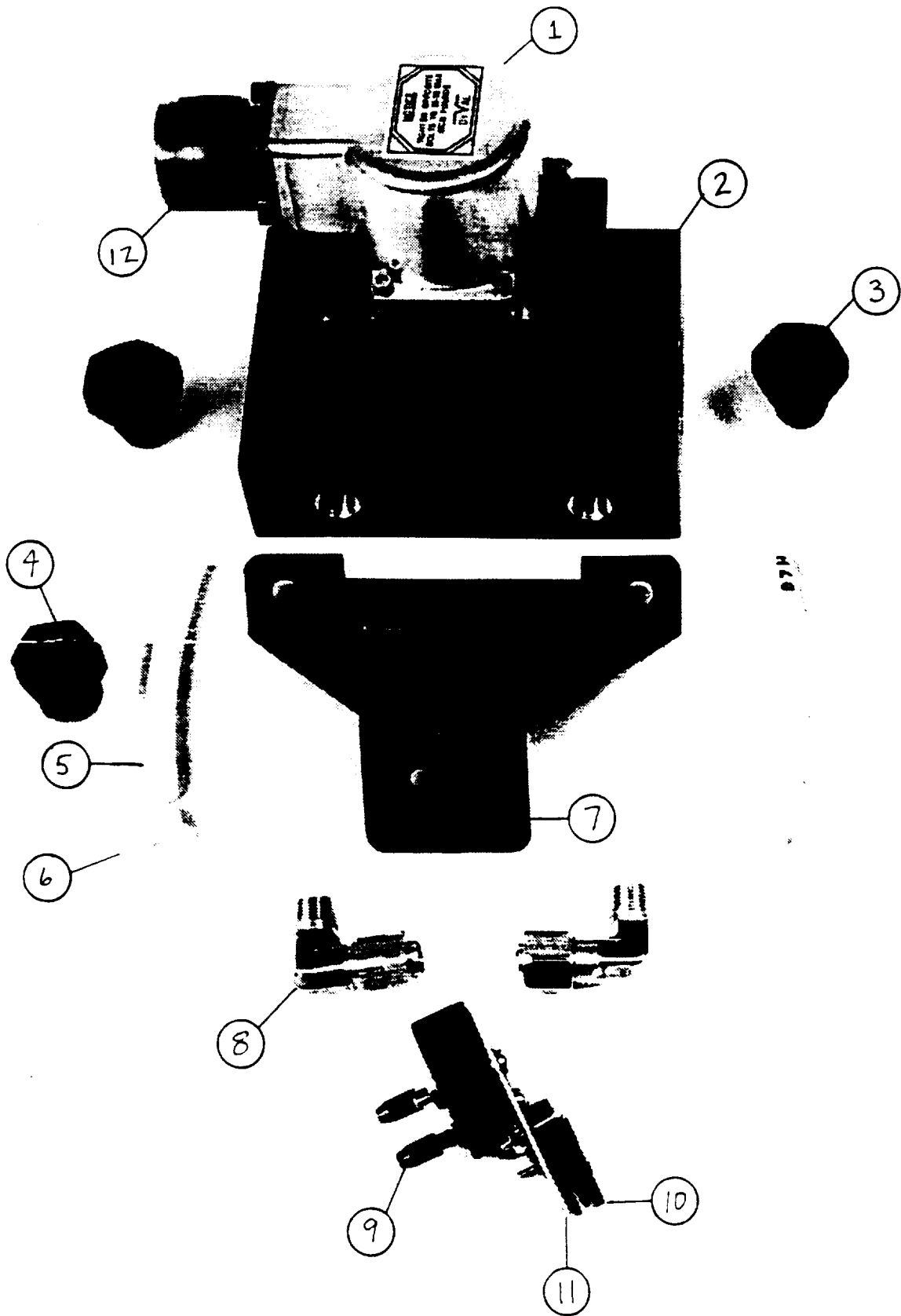
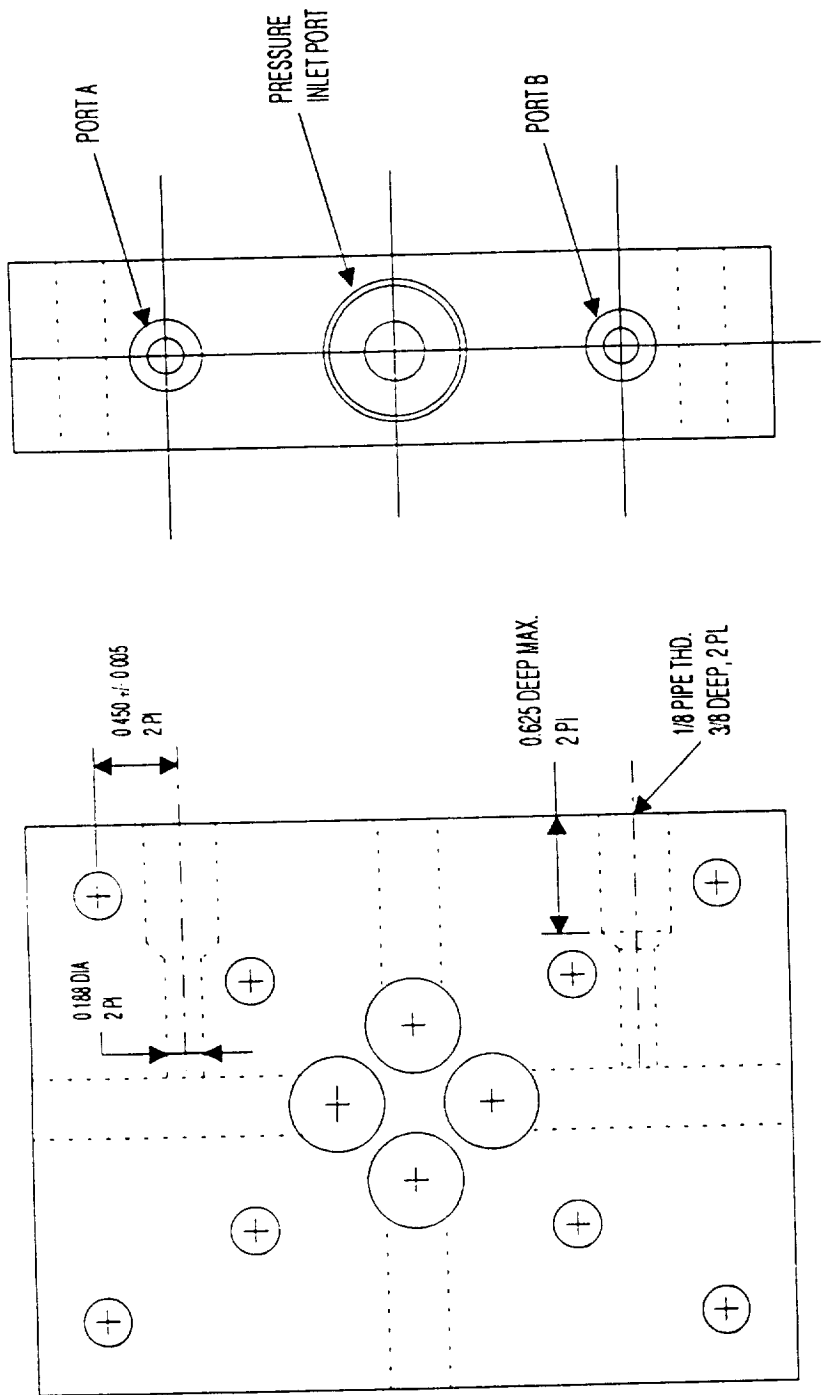
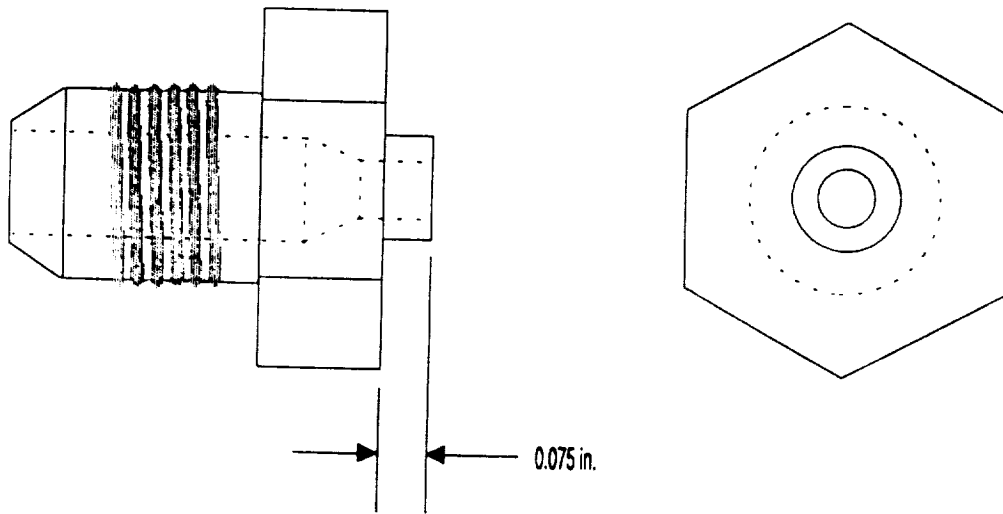

FIGURE 2.3-1 - THRUSTER EXPLODED VIEW



NOTE : Ports A and B are modifications to DyVal P/N 55-0100-2 for connection to differential pressure transducer. These two ports are the only modifications made.

FIGURE 2.3-2 - MANIFOLD



NOTE : AN919-6D REDUCER MODIFIED PER ABOVE DRAWING.  
RETAIN REDUCERS INSIDE DIAMETERS.  
(NOZZLE DIAMETER = 0.017 IN.)

FIGURE 2.3-3 - NOZZLE



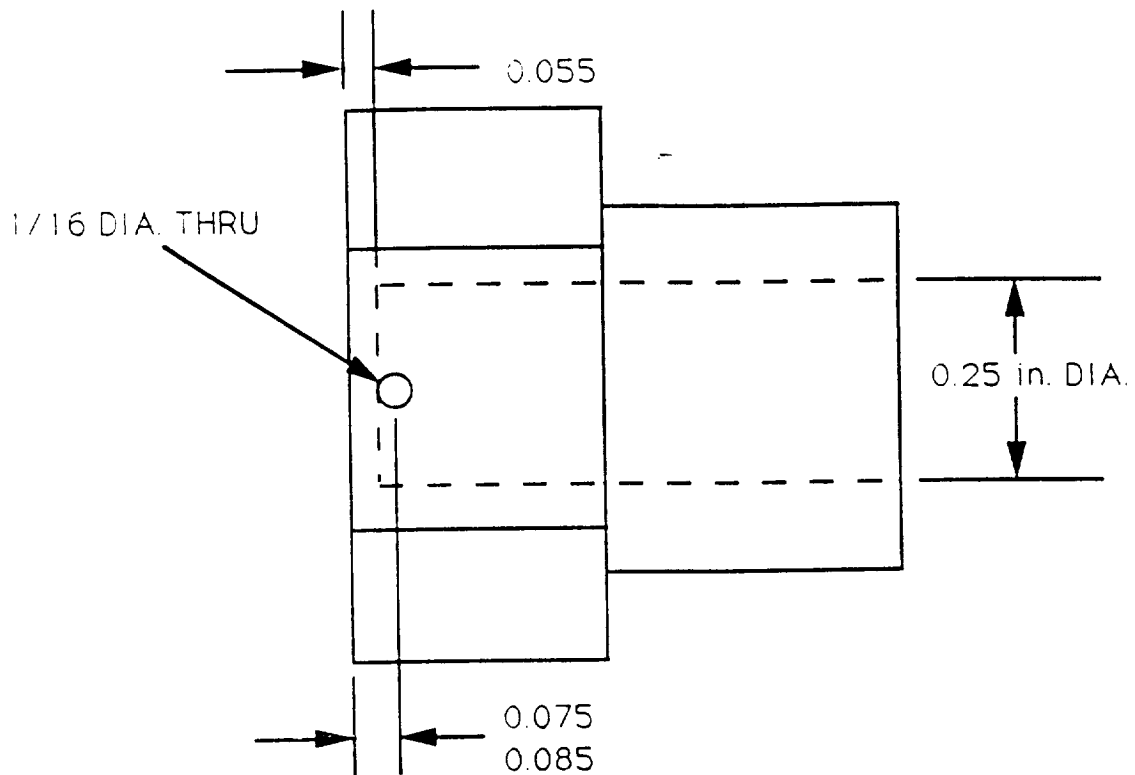

MACHINE AS FOLLOWS

1. ASSEMBLE PART INTO THRUSTER MANIFOLD. LOCATE AND MARK ONE OF THE TWO HEX NUT EDGES THAT FACE A CONTROL PORT DIRECTION.
2. DISASSEMBLE AND DRILL 1/16 DIA THRU MARKED HEX NUT EDGE PER THE ABOVE DRAWING.
3. DRILL 0.25 DIA INTO PLUG AS SHOWN ABOVE TO ALLOW VENTING THRU 1/16 DIA HOLE.

FIGURE 2.3-4 - VENT

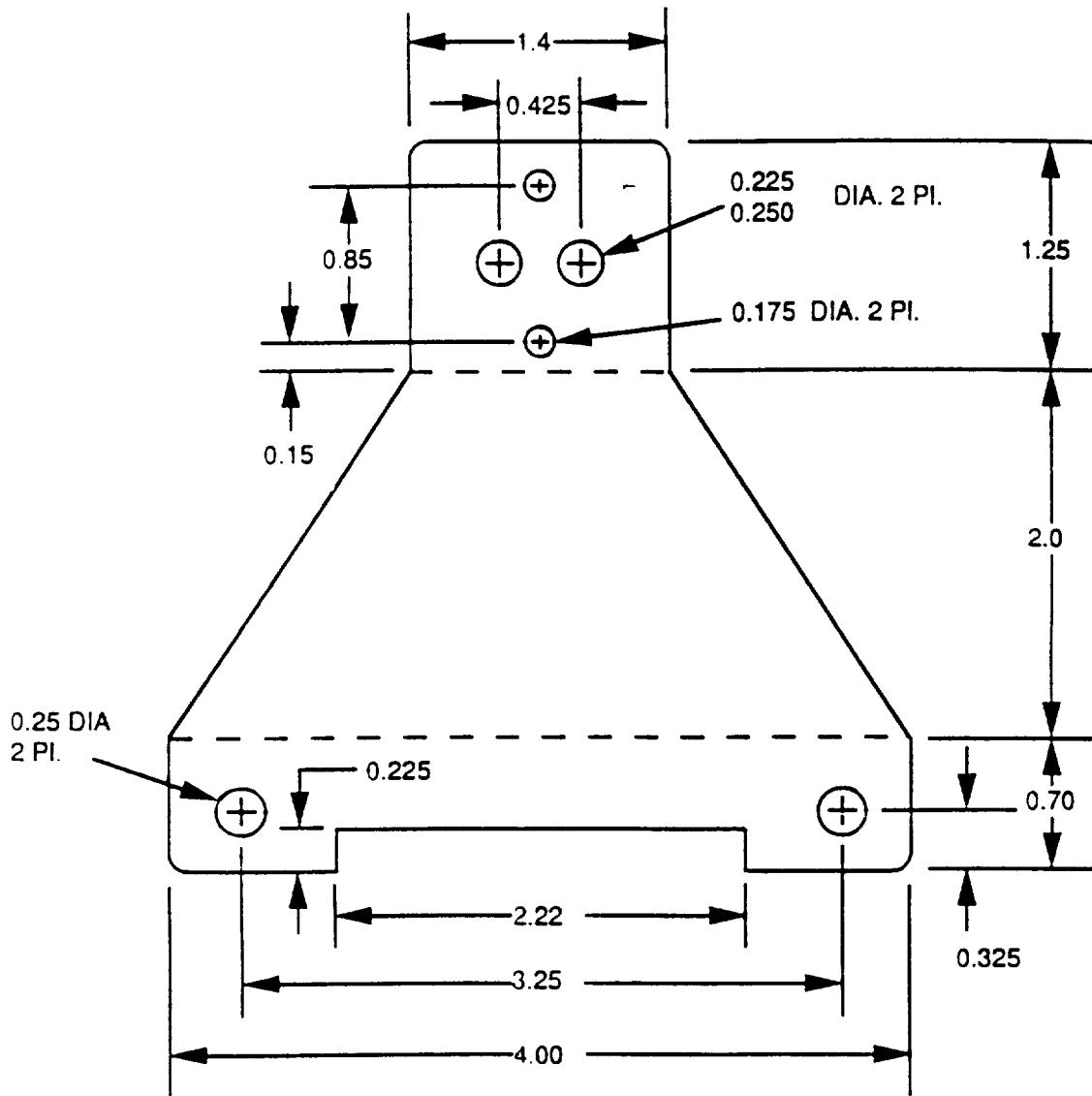

NOTE : 90 DEGREE BENDS AT DOTTED LINES, 0.15 RADIUS

FIGURE 2.3-5 - BRACKET

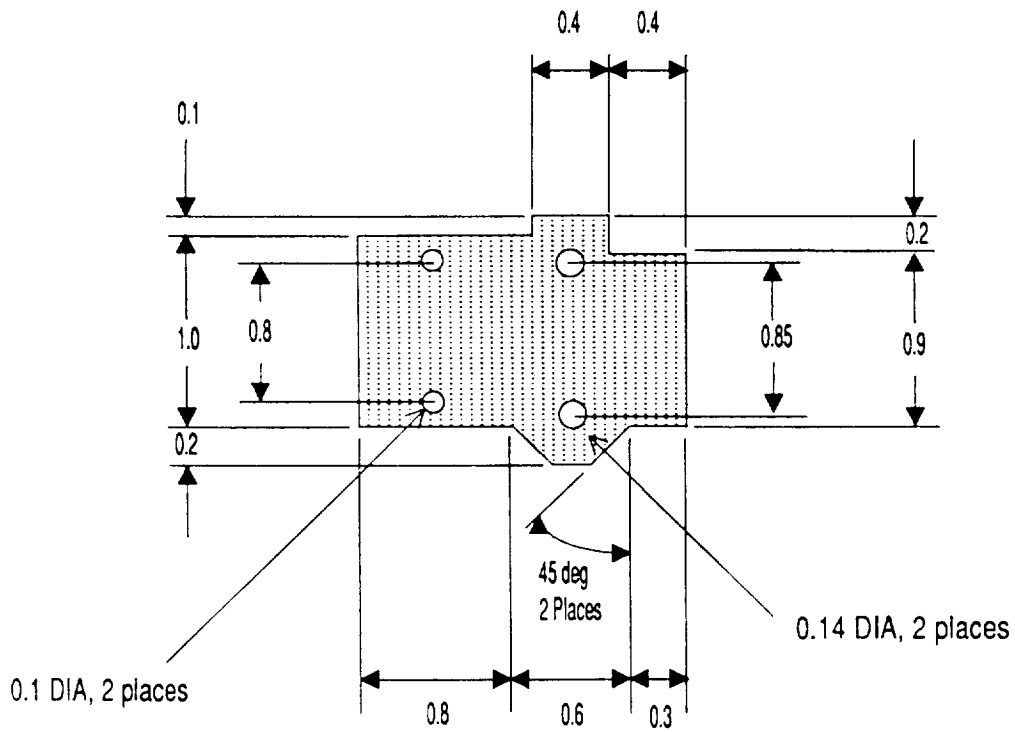

Pressure transducer and connector mounted as shown below.

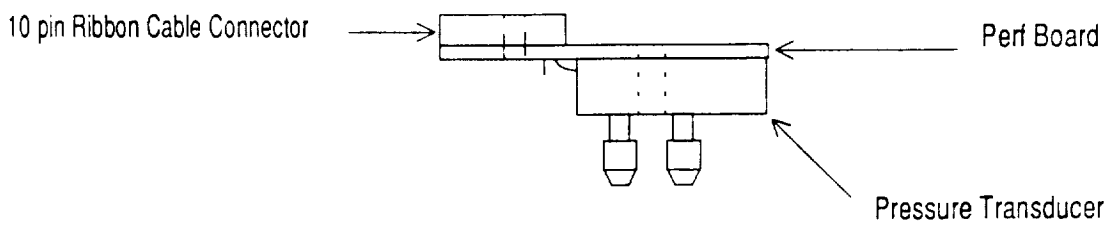
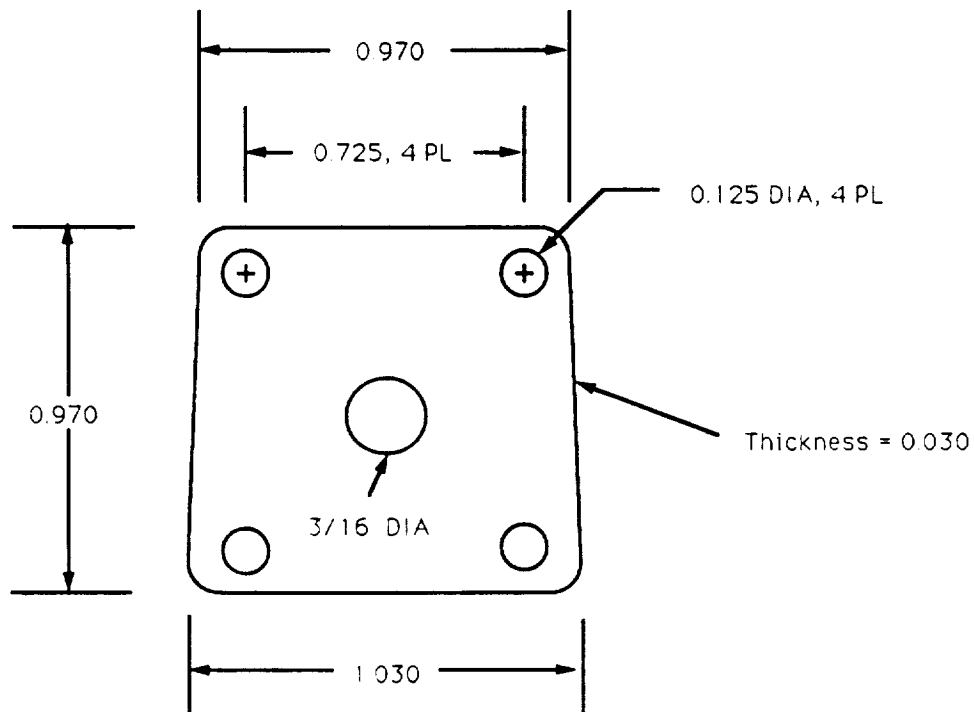

FIGURE 2.3-6 - PERF BOARD



NOTE A 1/16 X 1/8 GROMMET IS INSERTED INTO THE 3/16 HOLE.  
 (1/16 SLOT, 1/8 in. DIA THRU, 1/4 in. OUTSIDE DIAMETER GROMMET)

FIGURE 2.3-7 - FACE PLATE

## 3.0 - OVERVIEW OF THE BI-DIRECTIONAL THRUSTER TEST DATA

Typical thruster data is presented in this chapter. Section 3.1 summarizes the open loop test results for thruster unit #5. Closed loop step and 10 Hz frequency responses are examined in section 3.2 and 3.3. Hysteresis & linearity is discussed in section 3.4. Section 3.5 summarizes the performance characteristics of the thruster. A summary of the closed loop test results for the thruster is given in Figure 3.5-1.

### 3.1 Open Loop Frequency Response Data

The open loop block diagram is shown in Figure 3.1-1. Unity gain without frequency compensation was used in the forward loop so that the frequency response characteristics of the thruster could be determined. Examples of the open loop frequency response are shown in Figures 3.1-2 and 3.1-3. The break frequency (-3 db) for "off null" and "across null" is approximately 47 Hz and 42 Hz respectively. The servovalve spool pneumatic resonance is around 260 Hz. Figures 3.1-2 and 3.1-3 show this. The servovalve flapper resonance is around 776 Hz with a peak of -26 db. The maximum attenuation before reaching the flapper resonance peak was -33.5 db and occurs around 496 Hz. A 482 Hz low pass filter is used to attenuate the flapper resonance peak to avoid any high frequency thruster resonances.

A summary of the open loop test results is given in Figure 3.1-4. Statistical results determined from test data taken from 16 different thrusters is also given in Figure 3.1-4.

### 3.2 Closed Loop Step Response Data

Step responses with three different input command magnitudes are shown in Figures 3.2-1 and 3.2-2. The pressure command, which is measured at test point A, and the pressure feedback (measured at test point B) is plotted in each figure. The inlet pressure was also plotted and was 125 PSIG for these tests.

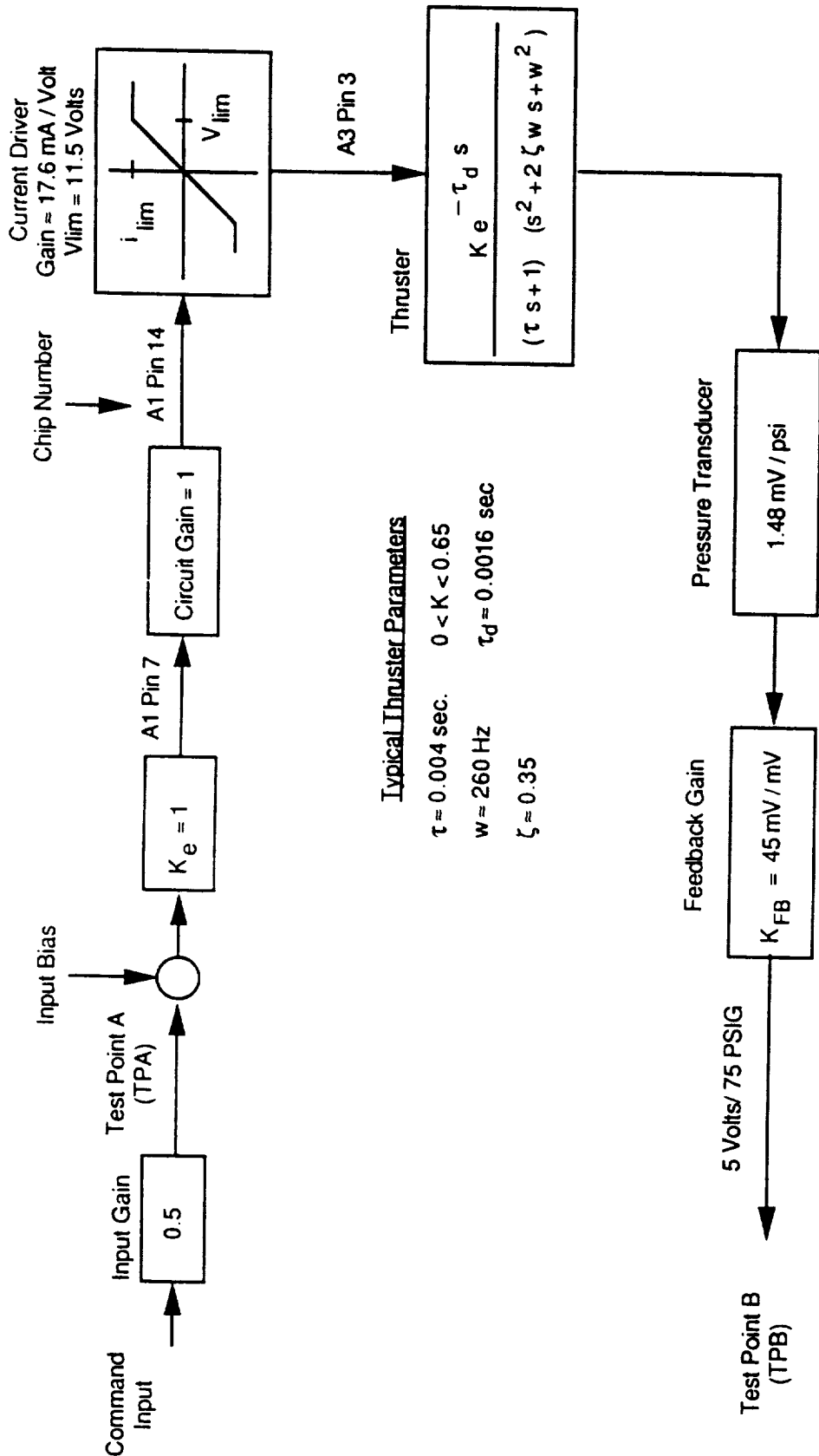

FIGURE 3.1-1 - OPEN LOOP BLOCK DIAGRAM

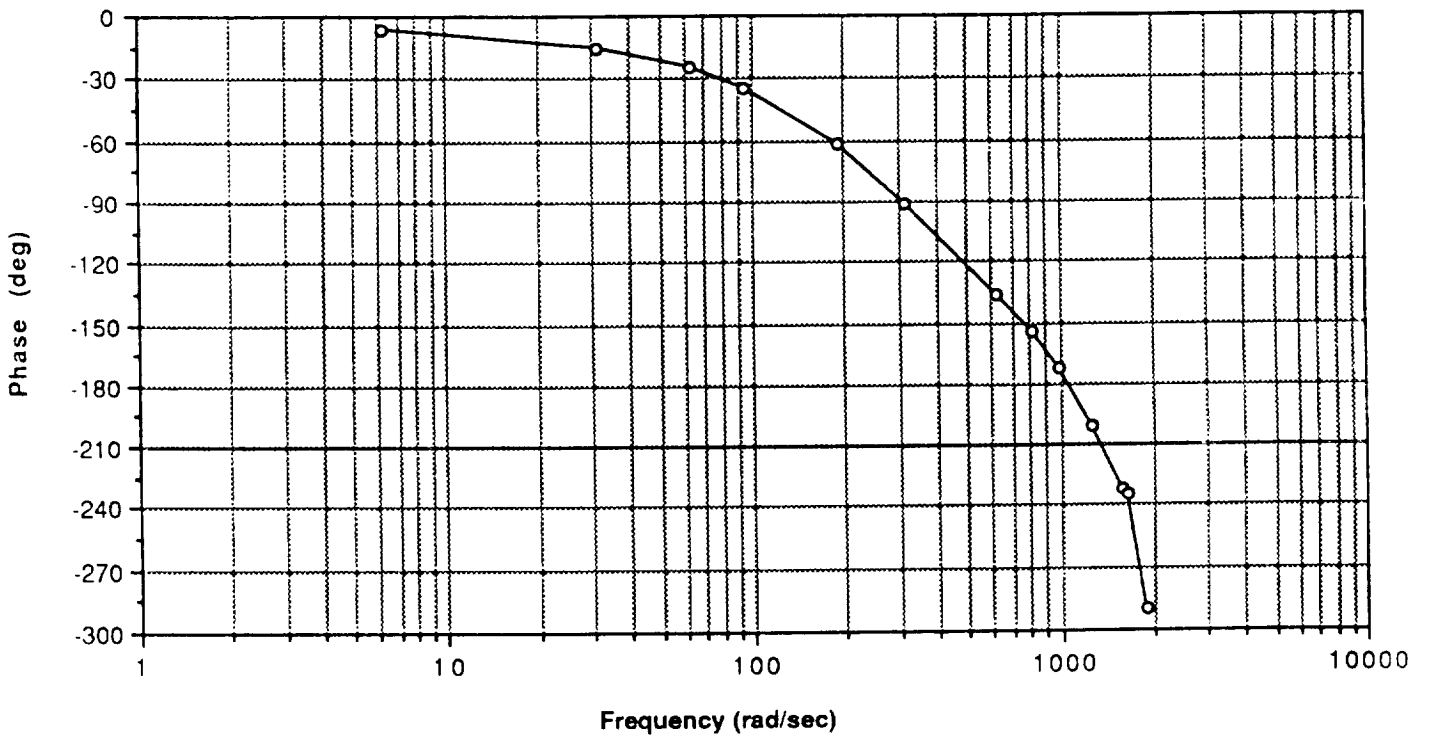
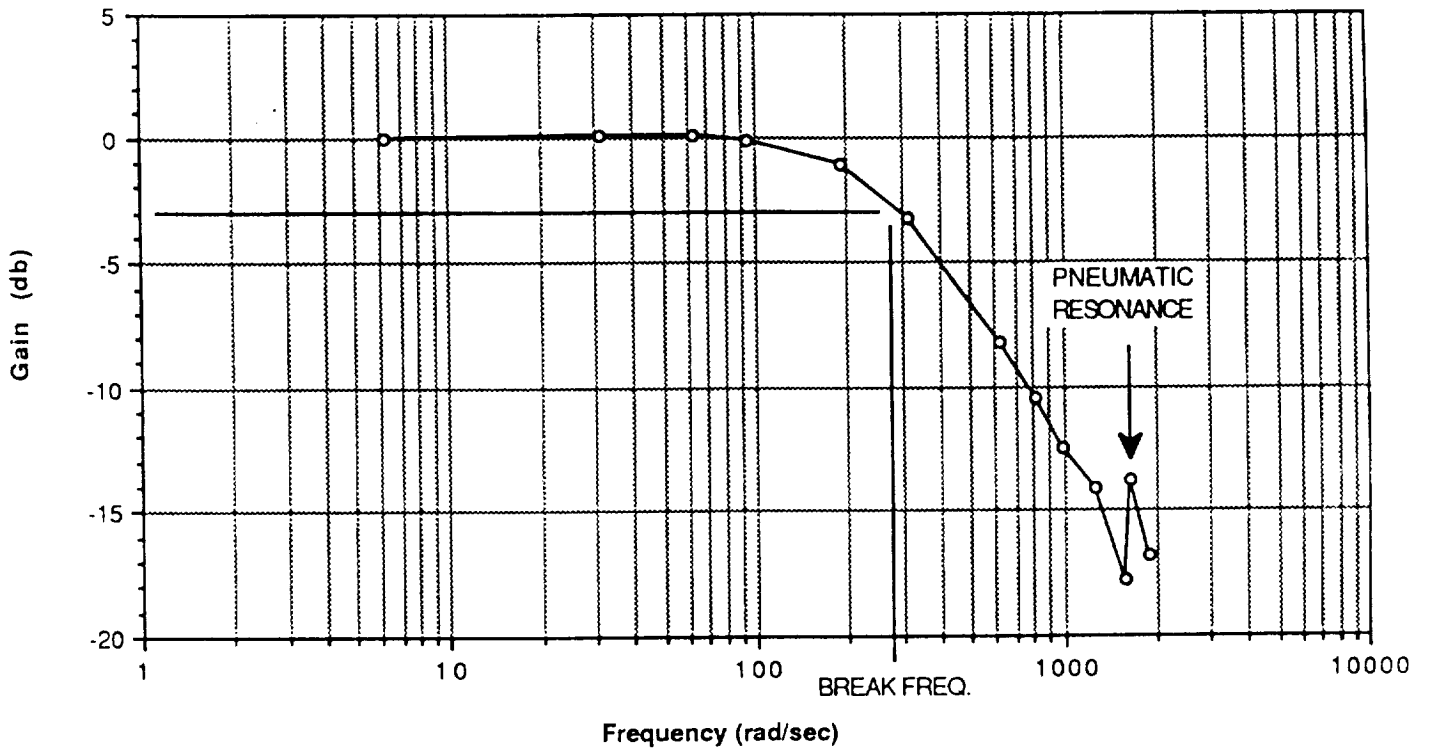

FIGURE 3.1-2 - OFF NULL OPEN LOOP  
FREQUENCY RESPONSE

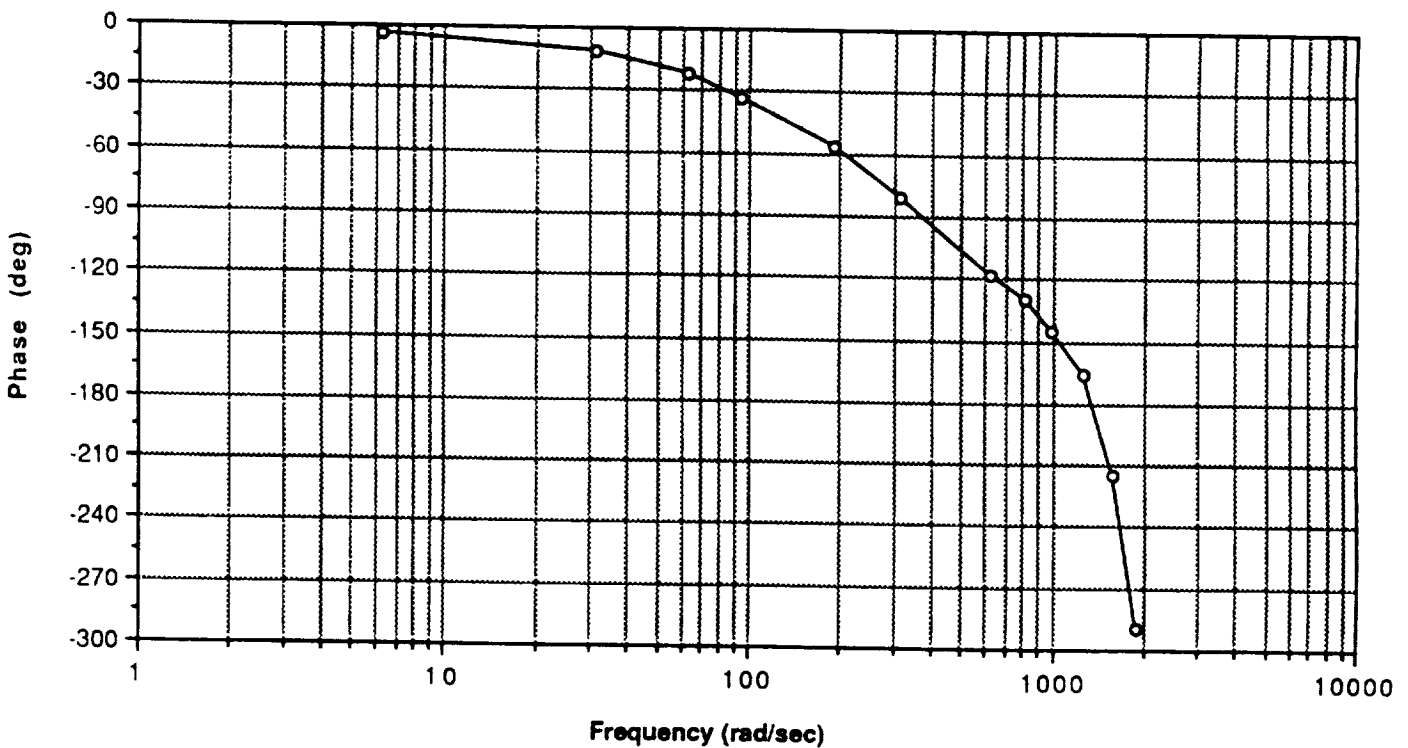
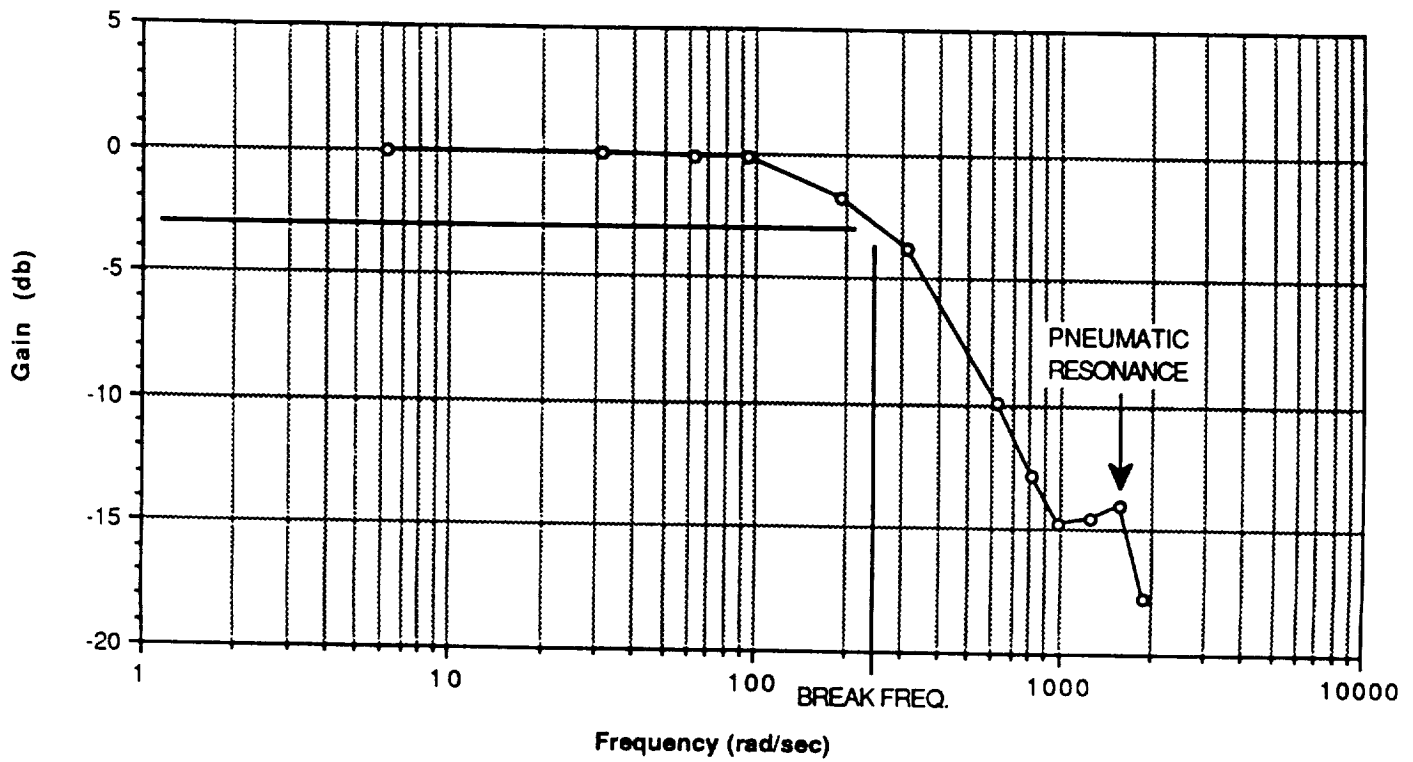

FIGURE 3.1-3 - ACROSS NULL OPEN LOOP  
FREQUENCY RESPONSE



### TYPICAL OPEN LOOP TEST RESULTS

BREAK FREQ (Hz at -3 db)		PNUEMATIC RES.	FLAPPER RES.	TIME DELAY (msec)	
OFF	ACROSS	(Hz)	(Hz)	AT NULL	OFF NULL
47.3	42	260	776	1.4	1.8

### STATISTICAL RESULTS FOR 16 TESTED THRUSTERS

BREAK FREQ (Hz at -3 db)		PNUEMATIC RES.	FLAPPER RES.	TIME DELAY (msec)	
OFF	ACROSS	(Hz)	(Hz)	AT NULL	OFF NULL
$\bar{X} = 45.2$	$\bar{X} = 33.0$	$\bar{X} = 260$	$\bar{X} = 745$	$\bar{X} = 1.44$	$\bar{X} = 1.61$
$\sigma = 4.2$	$\sigma = 4.6$	$\sigma = 24$	$\sigma = 40$	$\sigma = 0.12$	$\sigma = 0.19$

FIGURE 3.1-4 - OPEN LOOP TEST RESULTS

MAX. OPEN LOOP GAIN  
 0 TO 5 VOLT THRUST COMMAND

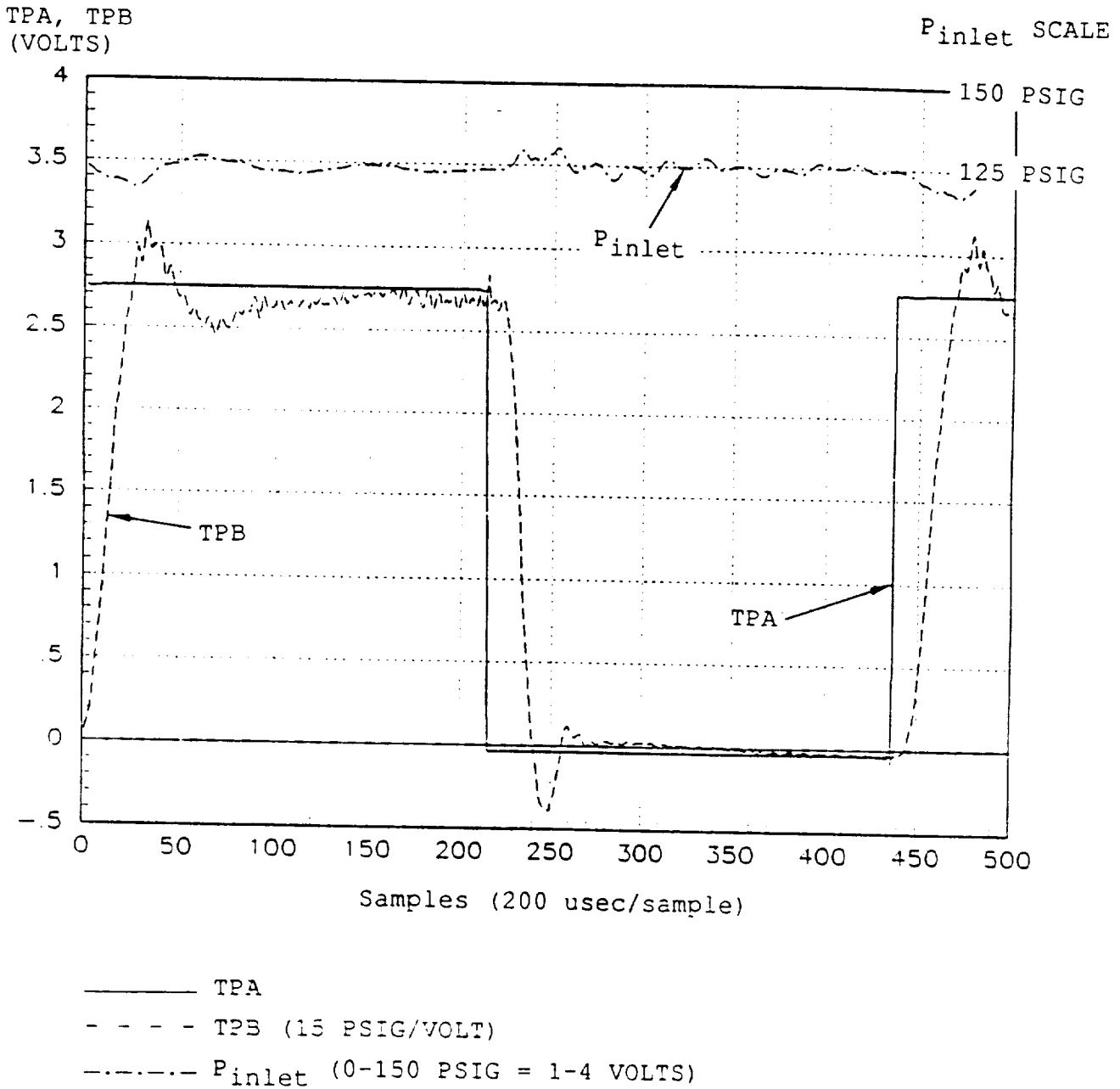
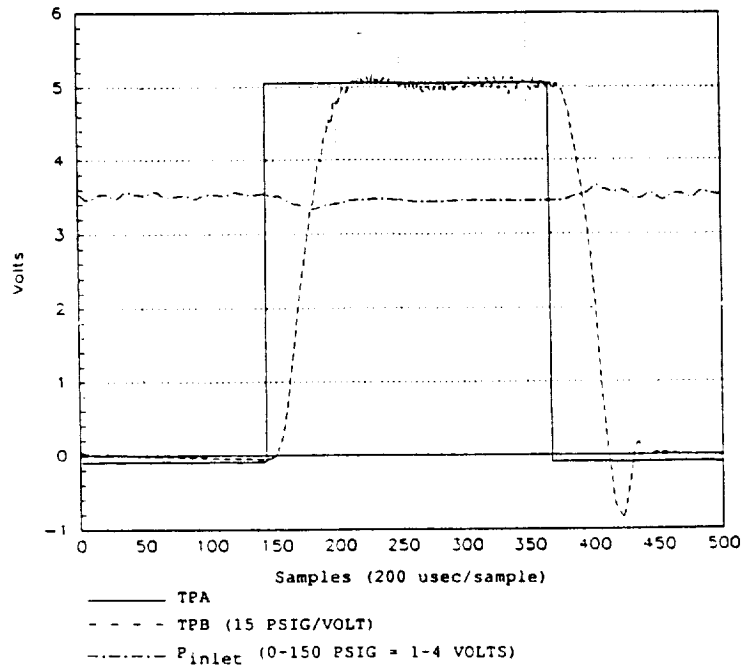

FIGURE 3.2-1 - CLOSED LOOP STEP RESPONSE

FULL SCALE  
0 TO 10 VOLT THRUST COMMAND



MINIMUM THRUST  
0 TO 0.75 VOLT THRUST COMMAND

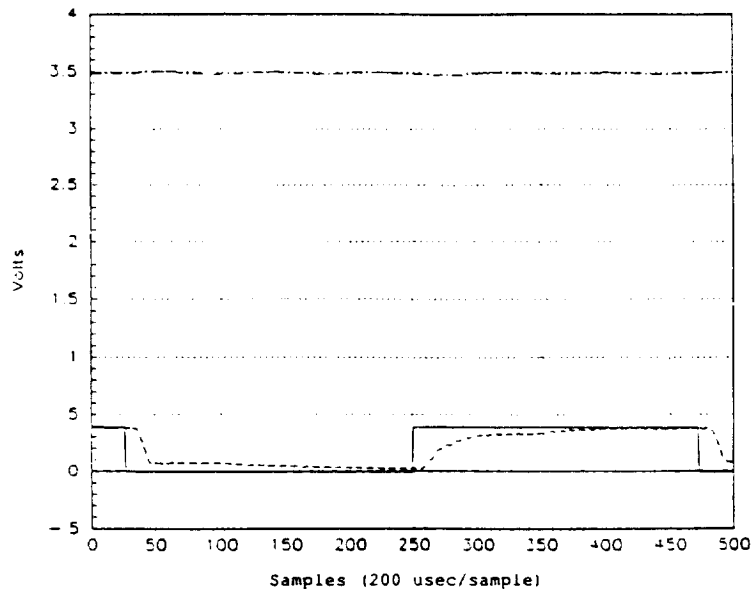

FIGURE 3.2-2 - CLOSED LOOP STEP RESPONSES

### 3.3 Closed Loop Frequency Response Data

10 Hz responses with three different input command magnitudes are shown in Figures 3.3-1 and 3.3-2. The phase lag and attenuation corresponding to each command input magnitude is summarized below.

Maximum Open Loop Gain : 0 to 5 volt command. The phase lag was 15 degrees and the attenuation was -0.6 db for this command.

Full Scale : 0 to 10 volt command. The phase lag was 16 degrees and the attenuation was -0.7 db for this command.

Minimum Thrust : 0 to 0.75 volt command (0 to 0.15 lbs) The phase lag was 30 degrees and the attenuation was -2.0 db for this command.

Examples of the closed loop frequency responses are shown in Figures 3.3-3 and 3.3-4. The magnitude of the input command sine wave was held at 0 to 5 volts (off null) or +/- 5 volts (thru null). The bandwidth (-3 db) was 146 Hz when operating off null and 80 Hz when operating across null.

MAX. OPEN LOOP GAIN  
0 TO 5 VOLT THRUST COMMAND

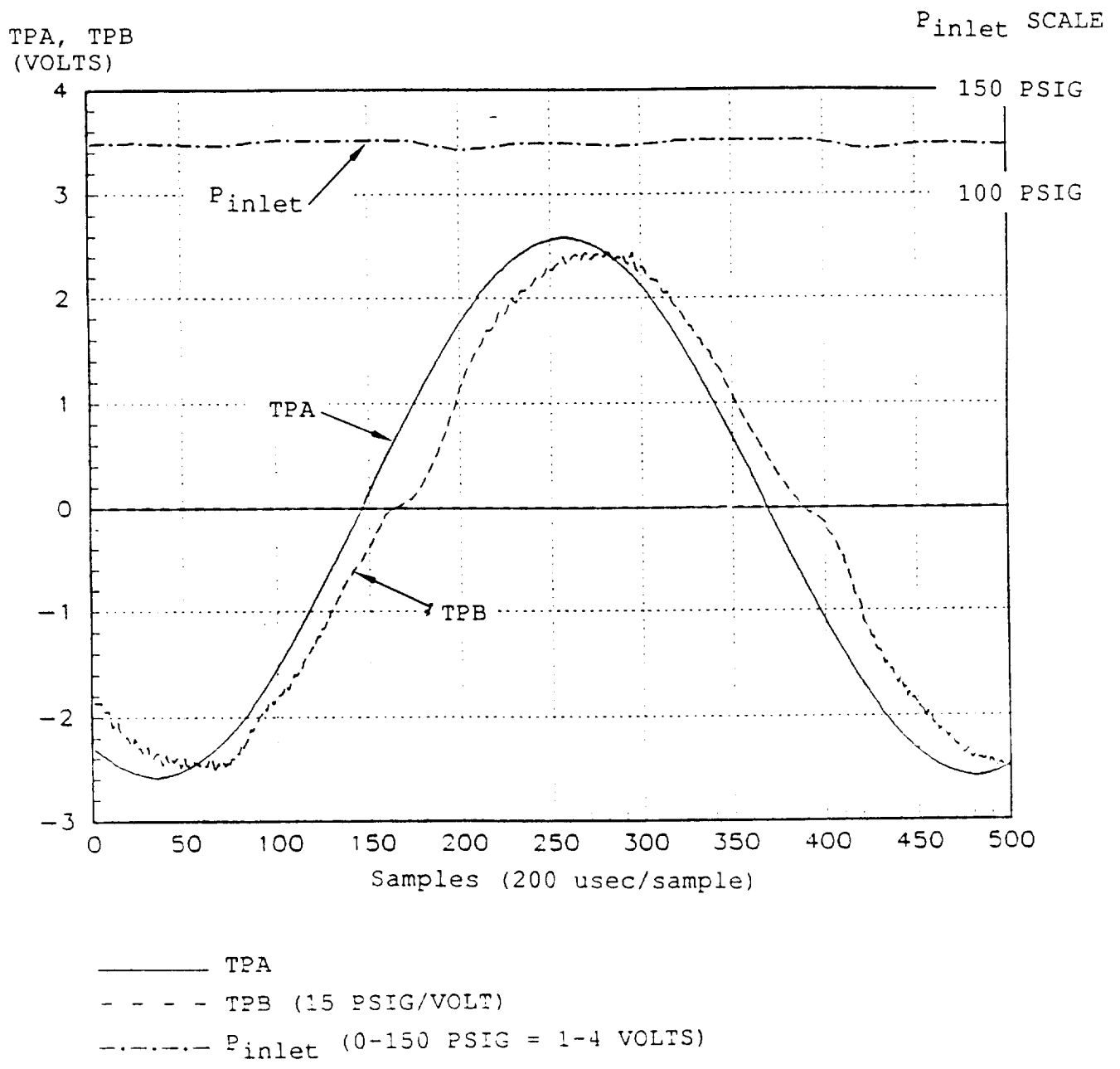

FIGURE 3.3-1 - CLOSED LOOP 10 Hz RESPONSE

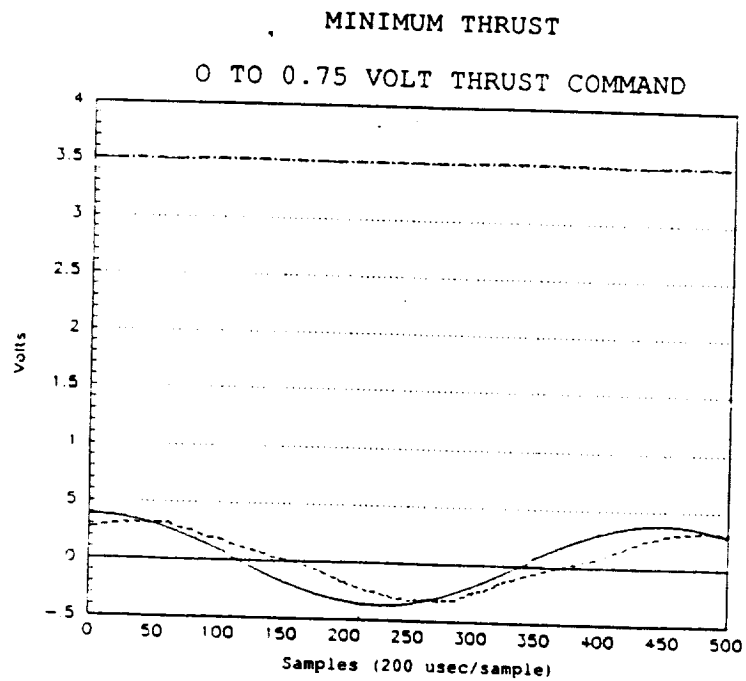
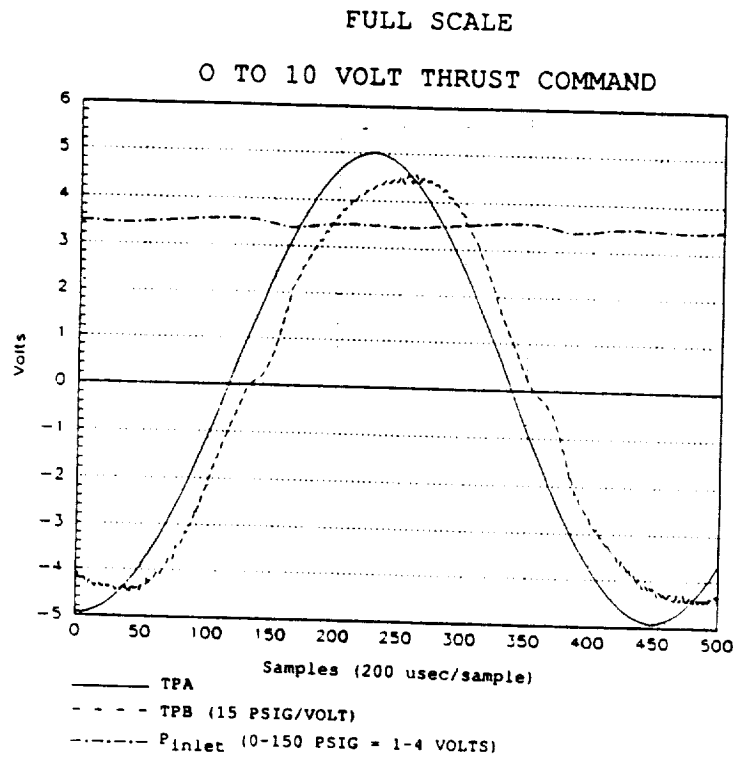

FIGURE 3.3-2 - CLOSED LOOP 10 Hz RESPONSES

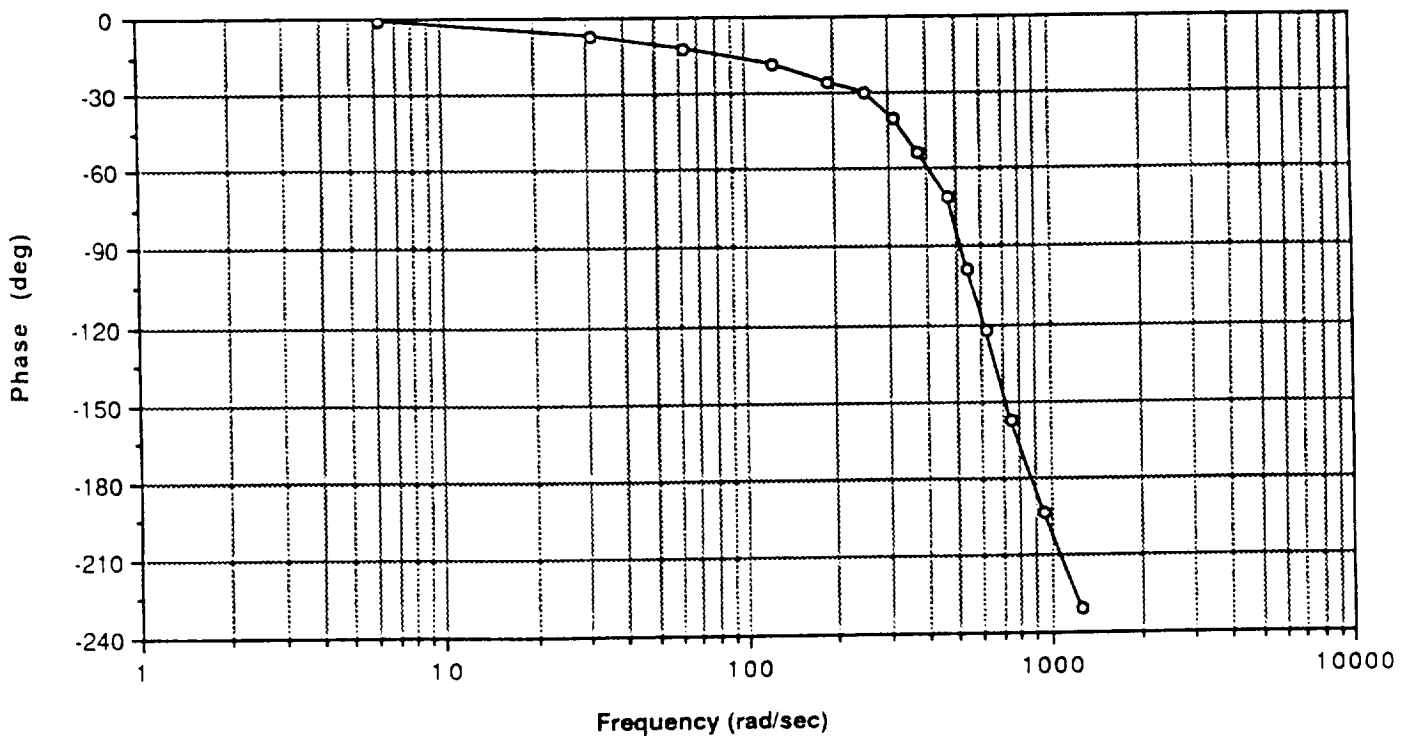
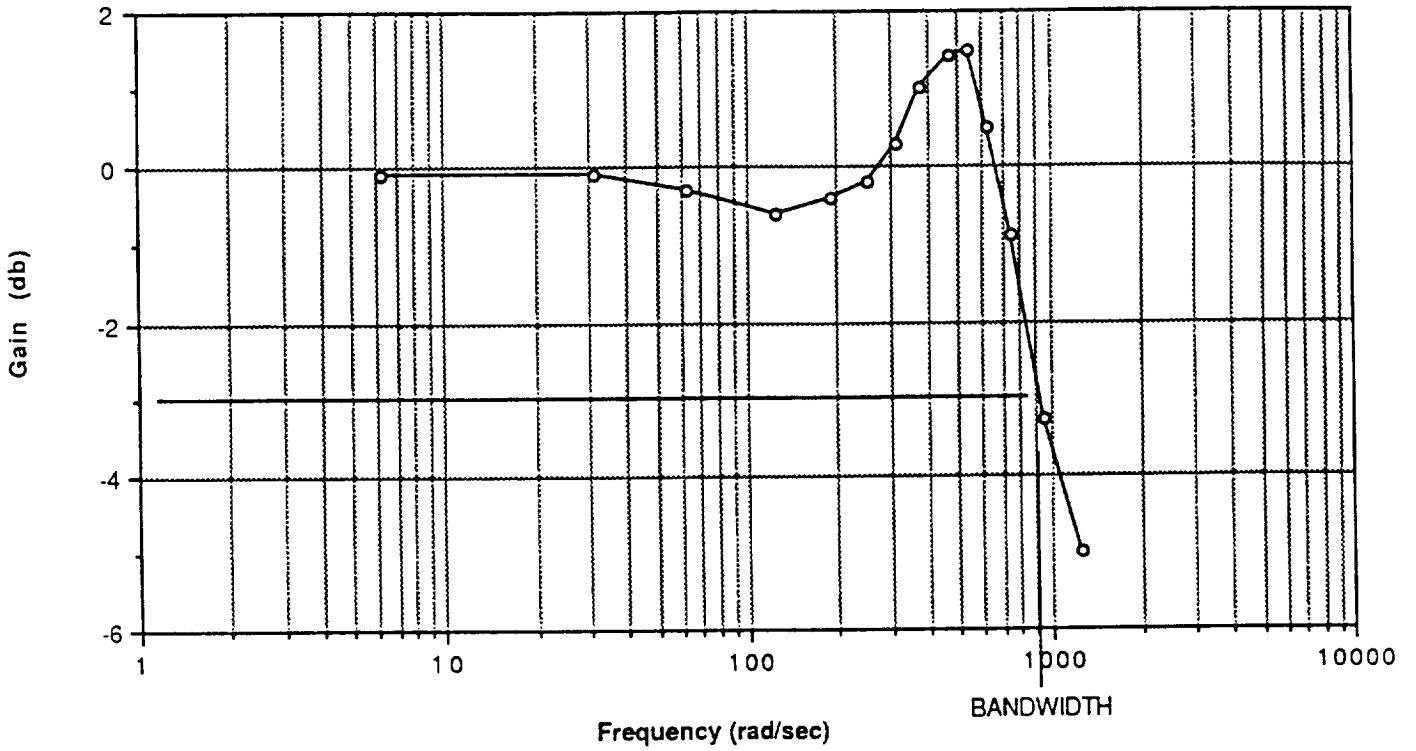

FIGURE 3.3-3 - OFF NULL CLOSED LOOP FREQUENCY RESPONSE

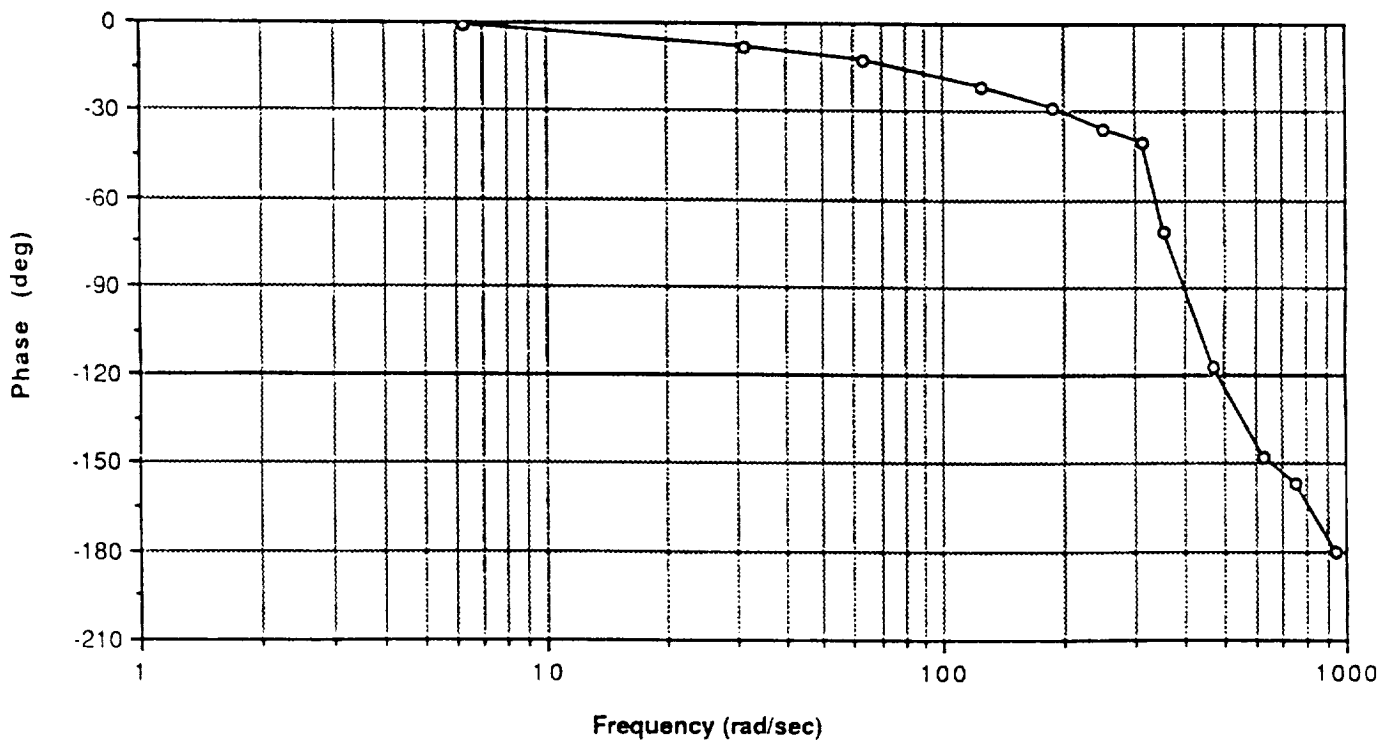
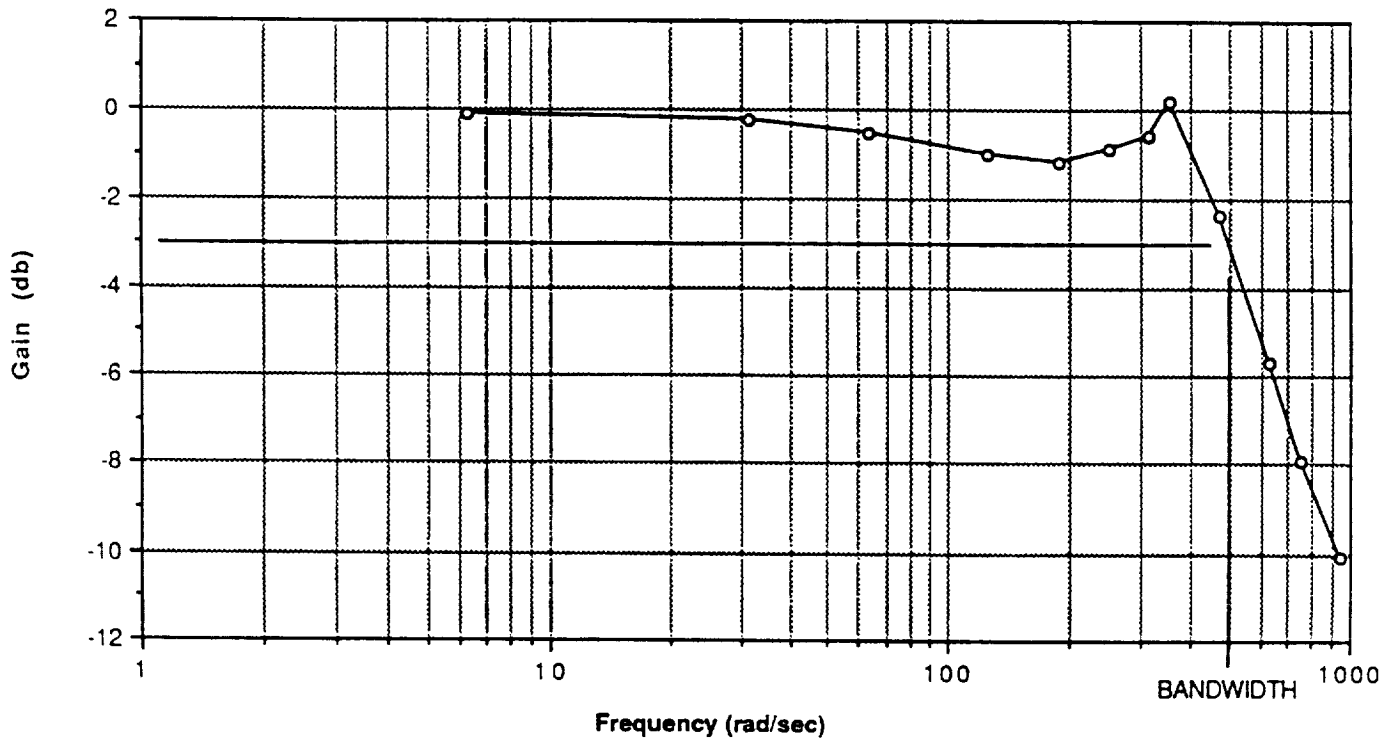

FIGURE 3.3-4 - ACROSS NULL CLOSED LOOP FREQUENCY RESPONSE



### 3.4 Closed Loop Thrust, Linearity, and Hysteresis

#### 3.4.1 Test Setup

Thrust force data was taken with the thruster mounted as shown in Figure 1.4. The thrust output was measured with a force transducer which was calibrated while mounted in the test setup by applying a force thru the centerline of the nozzle with a calibrated force gage. To determine thrust, linearity, and hysteresis the thruster was commanded at full scale with a 0.2 Hz thrust command. Measurements at a command frequency of 0.05 Hz were also recorded for comparison (all data is at 0.2 Hz unless noted as 0.05 Hz data). To obtain useful measurements, it was found that analog filtering and deflection of exiting thrust gas away from the test structure were required to reduce the effects of measurement noise and structural vibrations. The improvements in the test to remedy these problems is first presented followed by the thrust, linearity, and hysteresis test results.

To reduce the effects of noise the measured outputs were analog filtered with a 100 Hz passive low pass first order RC filter. The effects of the filter on the output can be seen in Figures 3.4-1 to 3.4-8. Non-filtered results are shown in Figures 3.4-1 and 3.4-2 where the pressure feedback voltage (TPB) is plotted against the commanded pressure voltage (TPA). The relationship between pressure command and input or thrust command was illustrated in Figure 2.1-1. The corresponding plots with the filter are given in Figures 3.4-3 and 3.4-4. In Figures 3.4-5 and 3.4-6 the thruster force without the filter is plotted against TPA. The corresponding plots with the filter in place are given in Figures 3.4-7 and 3.4-8. It can be seen that the filter improves the resolution of the data without significantly altering the hysteresis and linearity characteristics of the thruster.

It was also found that the structural mode of the test set-up was excited by the valve thrusting into the test structure. This mode has a frequency of approximately 60 Hz and can be seen in the force versus time response in Figure 3.4-9. The impulse response of the force transducer and test setup is shown in Figure 3.4-10. This illustrates that the 60 Hz oscillation is a structural resonance, not electrical noise.

A plate was placed between the negative thrust nozzle and the structure to minimize the excitation of the test setup as illustrated in Figure 1.4. The plate was approximately 3 inches from the nozzle. Results shown in previous figures were with this plate in place. Even though data was not taken without the plate in place for this particular thruster, typical results from a different thruster are shown in Figures 3.4-11,12 and 3.4-13,14. These figures show the effects without and with the plate respectively. Figure 3.4-11 is the force output of the force transducer versus test point A and Figure 3.4-12 shows the corresponding deviation from linearity. Here the oscillations on the negative side (negative TPA) can be seen. The same plots with the plate are shown in Figures 3.4-13 and 3.4-14. It can be seen that the plate improves the negative side without significantly

altering the hysteresis and linearity characteristic of the thruster.

### 3.4.2 Thrust Data

Figure 3.4-15 shows the thrust output with a full scale command. 1.95 lbs thrust is achieved at 75 PSIG chamber pressure (TPB=5 volts). Figure 3.4-16 shows the maximum thrust capability of the thruster. At TPB=5.25 volts, or 78.7 PSIG chamber pressure, 2 lbs thrust is obtained. To avoid integrator wind-up the input command should not exceed 11 volts. We suggest that the command be no greater than 10.5 volts.

### 3.4.2 Linearity and Hysteresis

To determine linearity and hysteresis the thruster was commanded a full scale 0.2 Hz sine wave as illustrated in Figure 3.4-17. The force versus TPA data was linear curve fit as shown in Figure 3.4-18. The linearity difference was then plotted as shown in Figure 3.4-19. From this plot the force hysteresis and linearity was calculated as follows:

$$\text{Force Hysteresis} = \frac{0.07 + 0.02}{2 (2)} = 2.3\%$$

$$\text{Linearity} = \frac{0.09 + 0.04}{2 (2)} = 3.3\%$$

where (2) = force full scale

The pressure hysteresis was determined by plotting TPB versus TPA as shown in Figure 3.4-21. From this plot the pressure hysteresis was calculated as follows:

$$\text{Pressure Hysteresis} = \frac{0.11 + 0.8}{2 (5)} = 1.9\%$$

where (5) = TPA full scale

For comparison, a full scale 0.05 Hz sine wave was also commanded. The results are shown in Figures 3.4-22 thru 3.4-26. It can be seen from Figures 3.4-23 and 3.4-24 that the force hysteresis is almost eliminated when the command frequency is reduced to 0.05 Hz. The pressure hysteresis is similarly reduced as can be seen in Figures 3.4-25 and 3.4-26. The near zero hysteresis is a positive attribute for active control since hysteresis causes phase lag even at low frequencies. The linearity, however, is not improved (compare Figure 3.4-19 to

3.4-24). The nonlinearity will represent a change in gain in the control system which can easily be countered in the control law if necessary.

Another important note is that the thrust slope appears to decrease when the thruster is given a negative command. This can be clearly seen in Figure 3.4-23. It has been concluded that this change in slope is due to the test setup and not the thruster since the only thing common in all of the force tests is the fact that negative command thrusts into the test structure and positive command does not. If this is the case then the maximum deviation from linearity would be about half as large. In either case the linearity is within the 5% specification.

### 3.5 Summary of Performance

A complete summary of the closed loop test results is found in Figure 3.5-1. Statistical results determined from test data taken from 16 different thrusters is also given in Figure 3.5-1. In addition to exceeding the bandwidth, linearity and hysteresis requirements, the linear thruster weighs less than 4 pounds and is capable of exerting 2.0 pounds of force in either direction. It can be seen from the chart that the thruster meets or exceeds the requirements specified in the Statement Of Work.

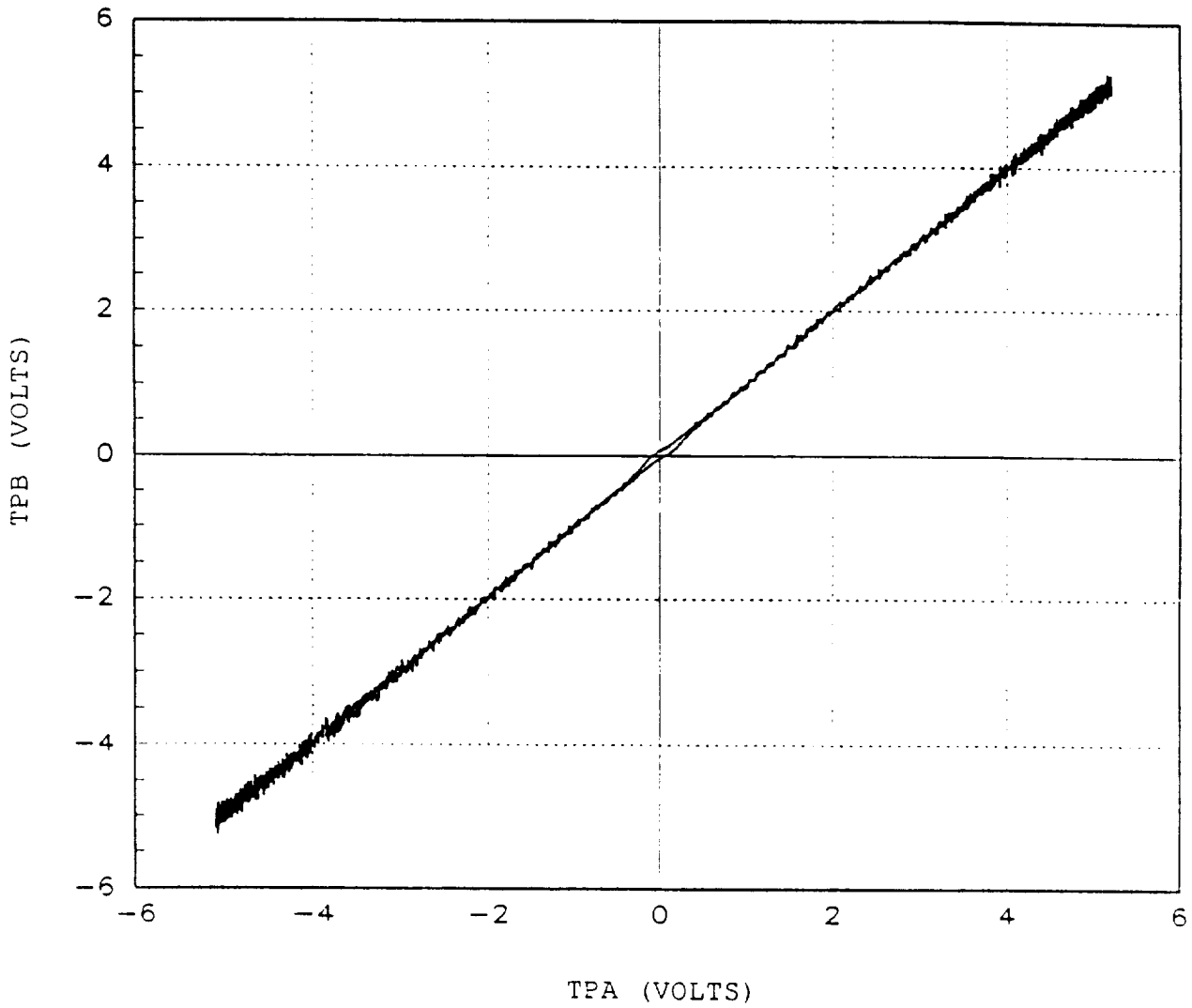

Figure 3.4-1  
PRESSURE FEEDBACK VS PRESSURE COMMAND  
(TPB VS TPA)  
WITHOUT FILTER

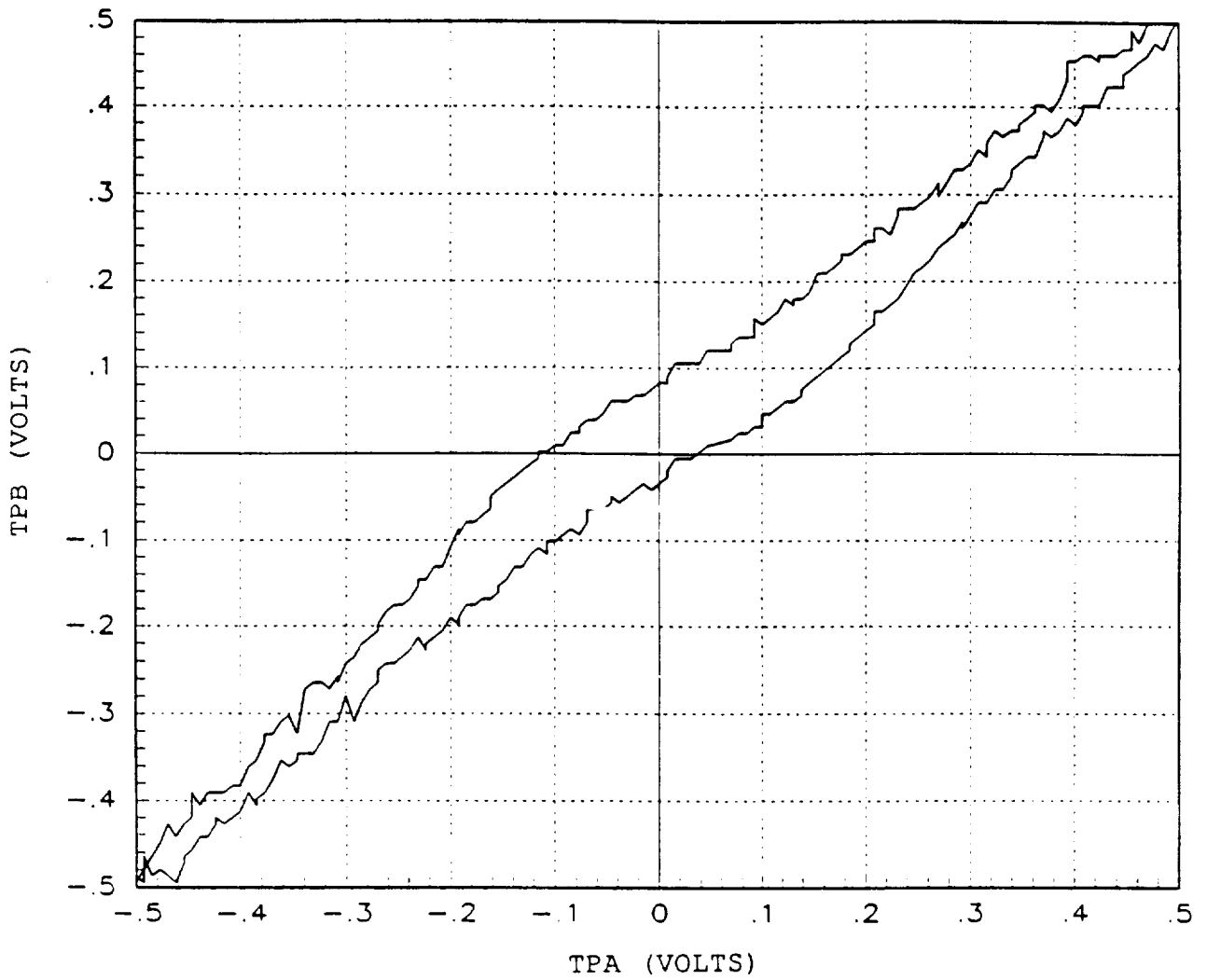

Figure 3.4-2  
PRESSURE FEEDBACK VS PRESSURE COMMAND  
(TPB VS TPA)  
WITHOUT FILTER

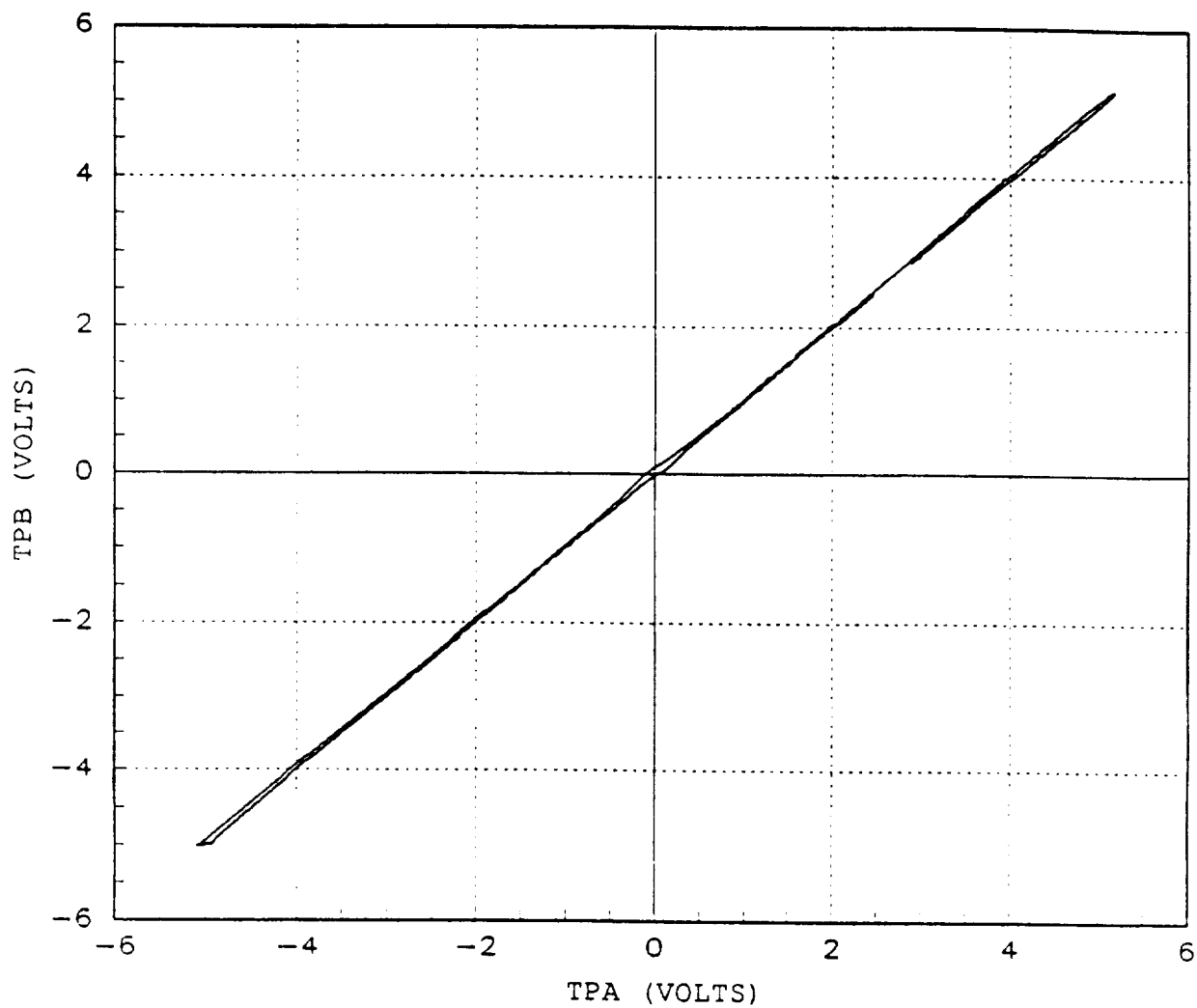

Figure 3.4-3  
PRESSURE FEEDBACK VS PRESSURE COMMAND  
(TPB VS TPA)  
WITH FILTER

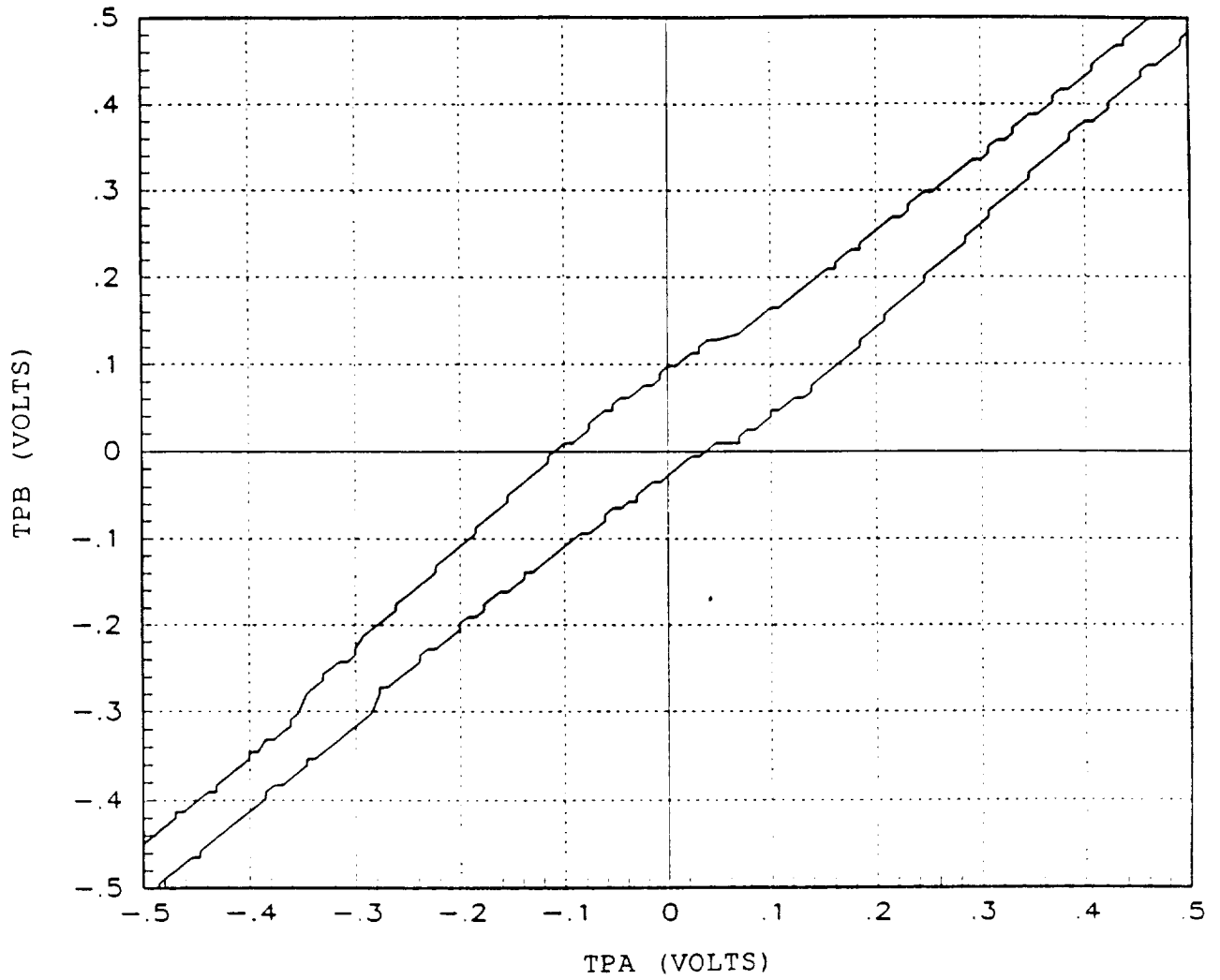

Figure 3.4-4  
PRESSURE FEEDBACK VS PRESSURE COMMAND  
(TPB VS TPA)  
WITH FILTER

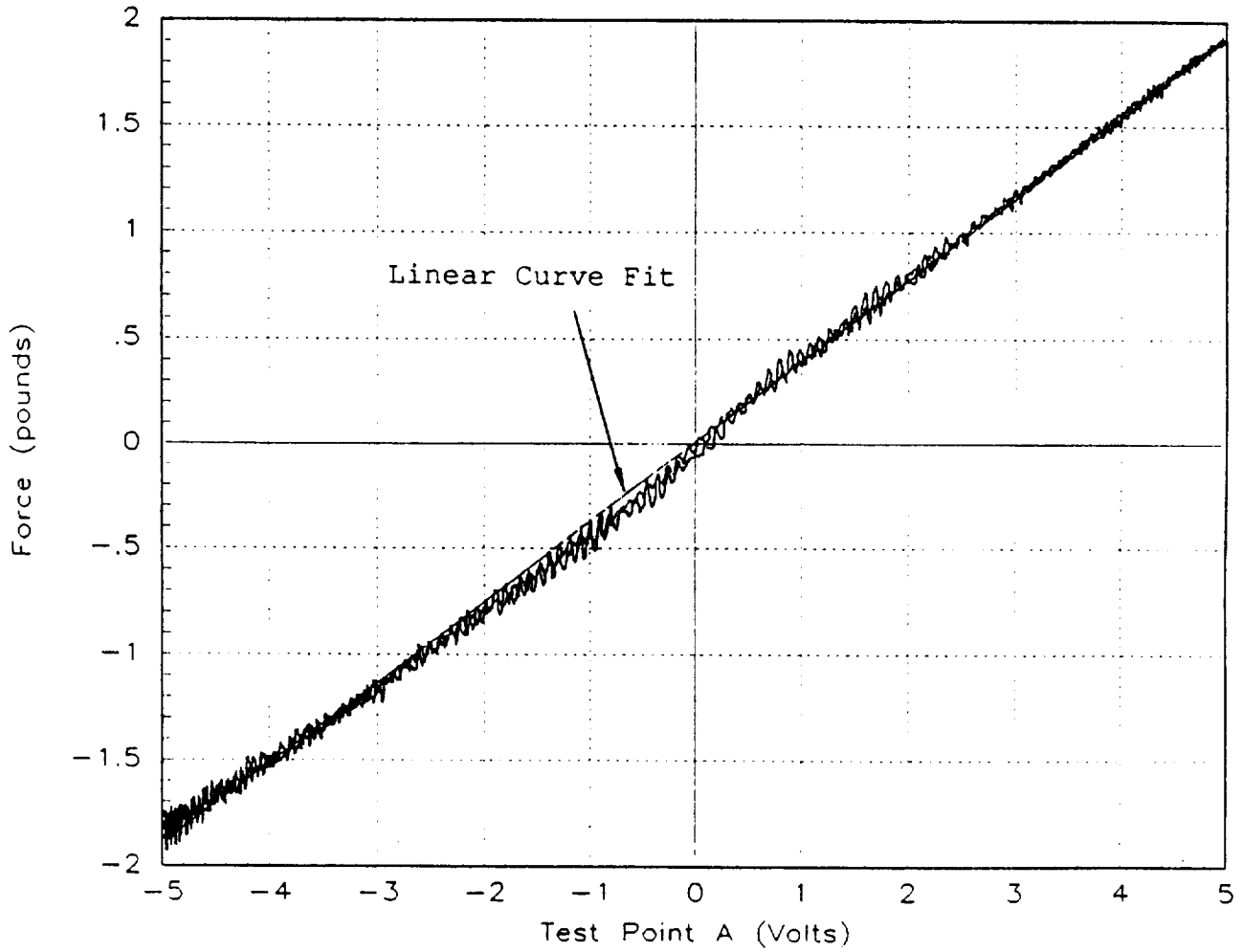

Figure 3.4-5

FORCE VS TPA

WITHOUT FILTER



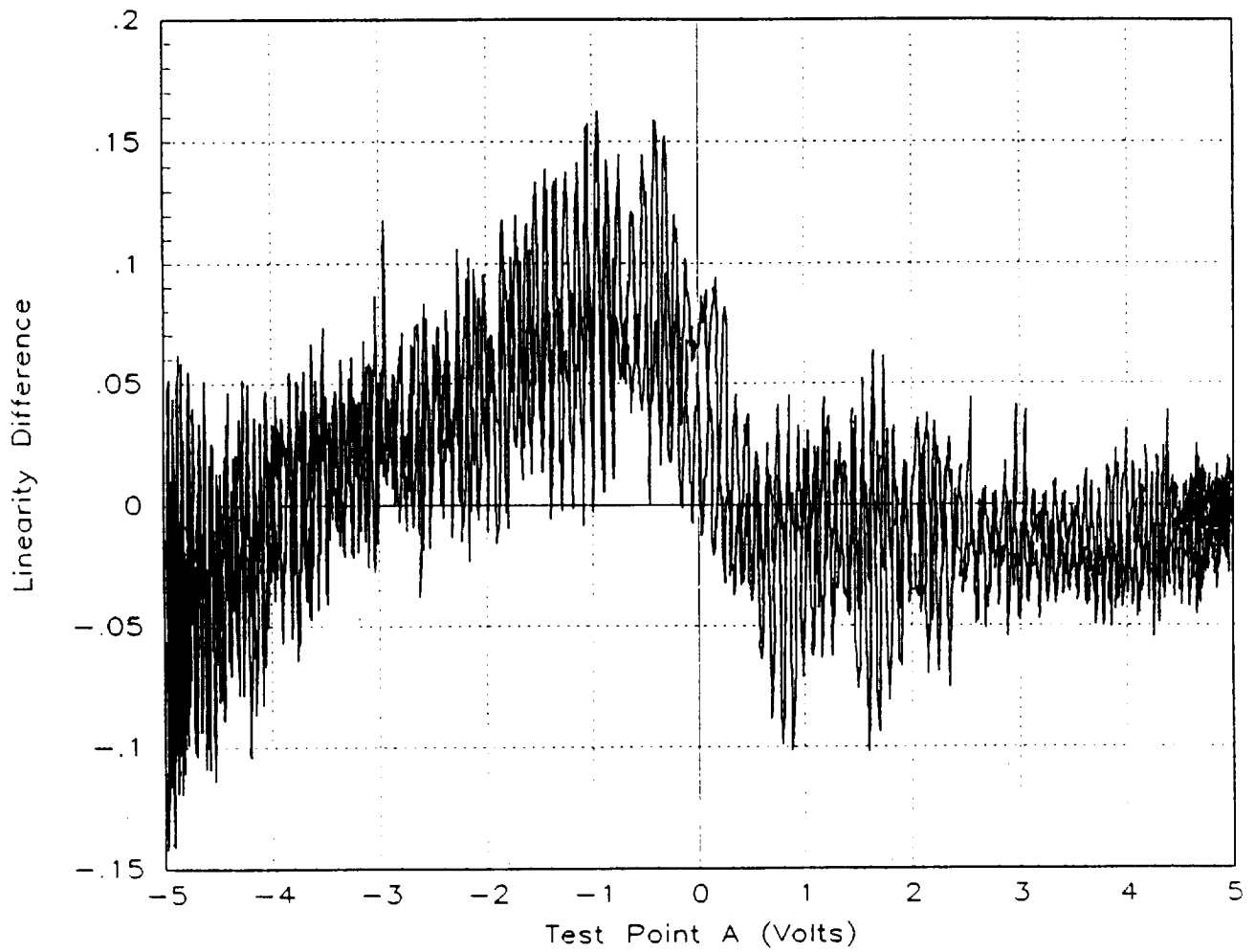

Figure 3.4-6

LINEARITY  
WITHOUT FILTER

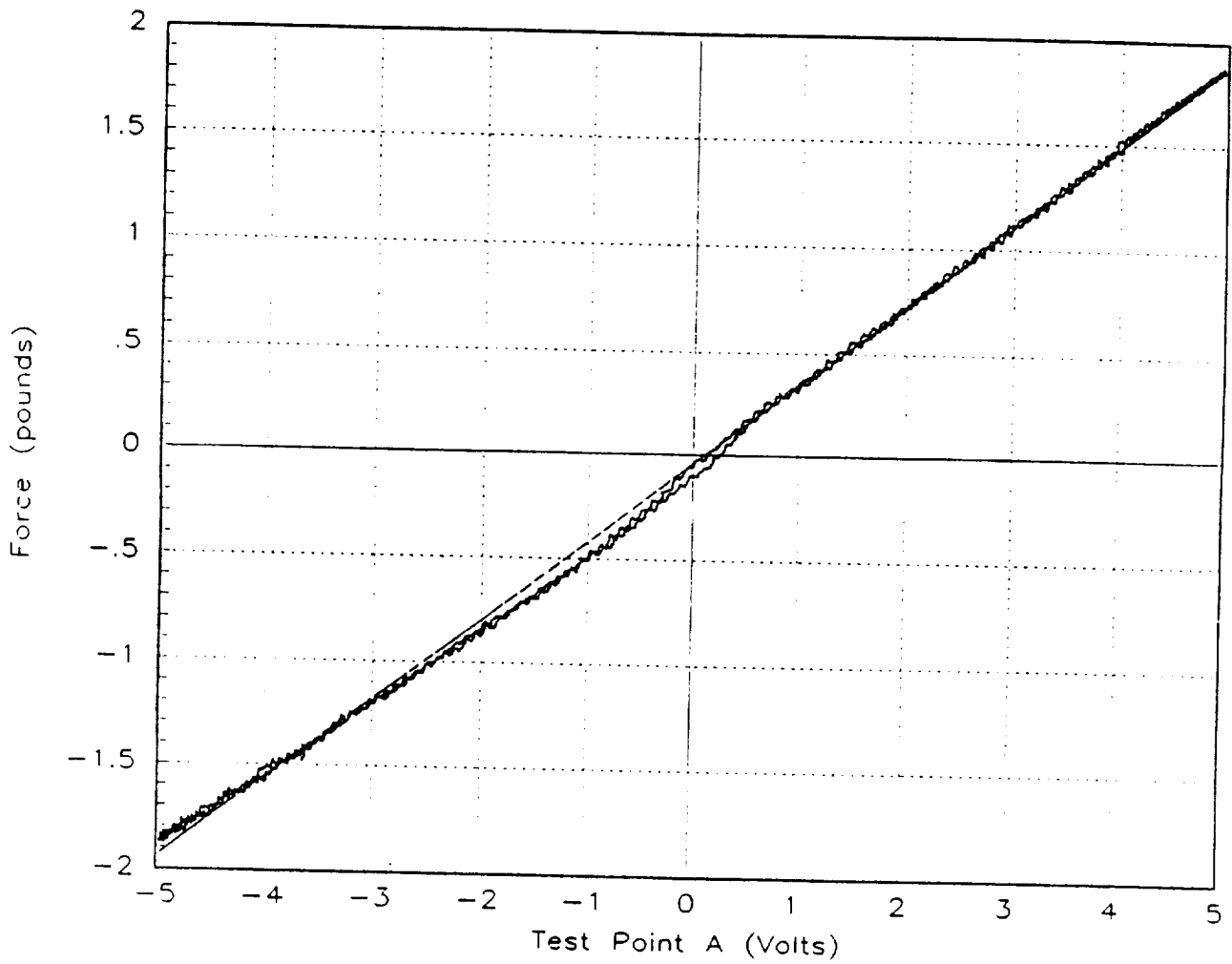

FIGURE 3.4-7  
FORCE VS TPA  
WITH FILTER

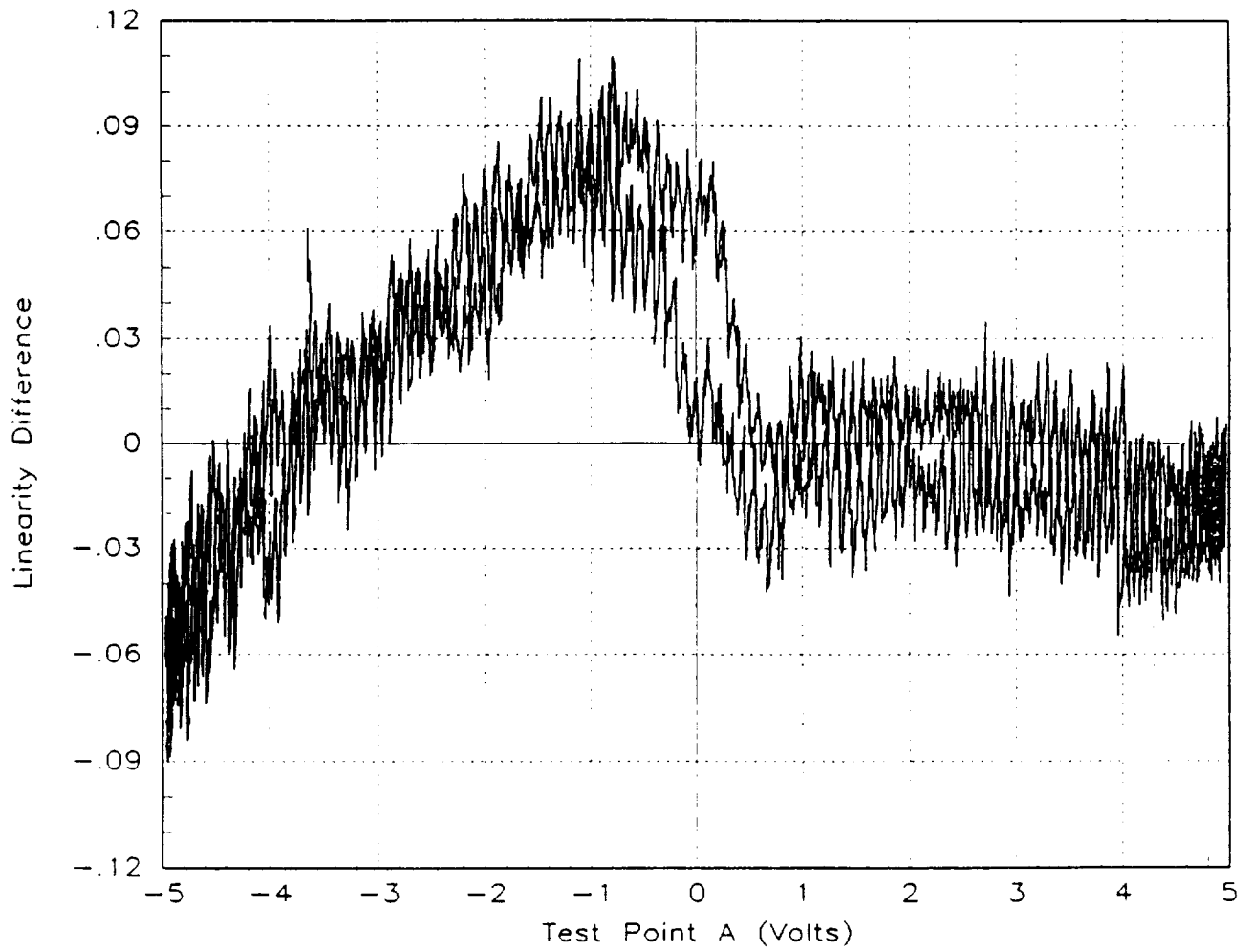
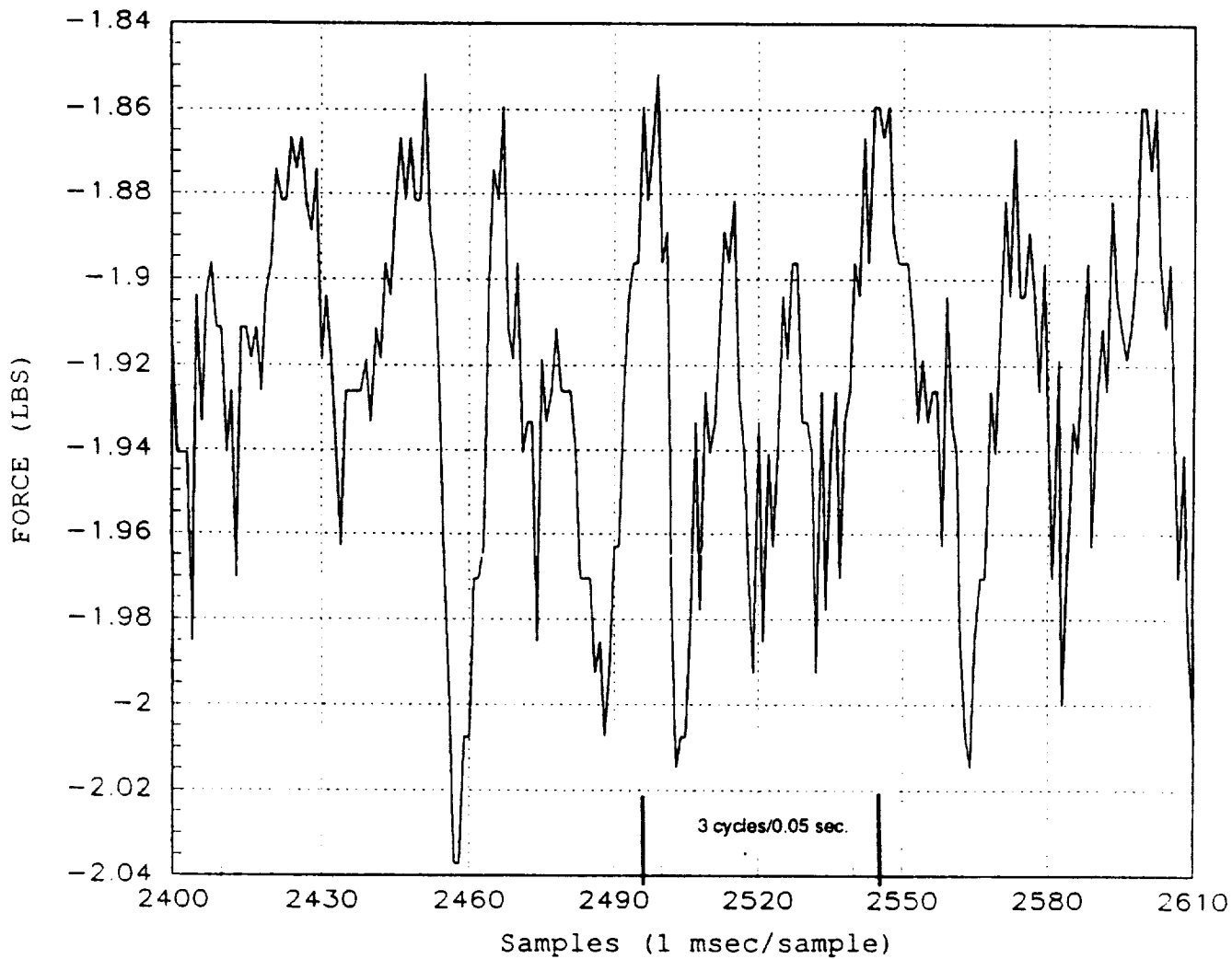
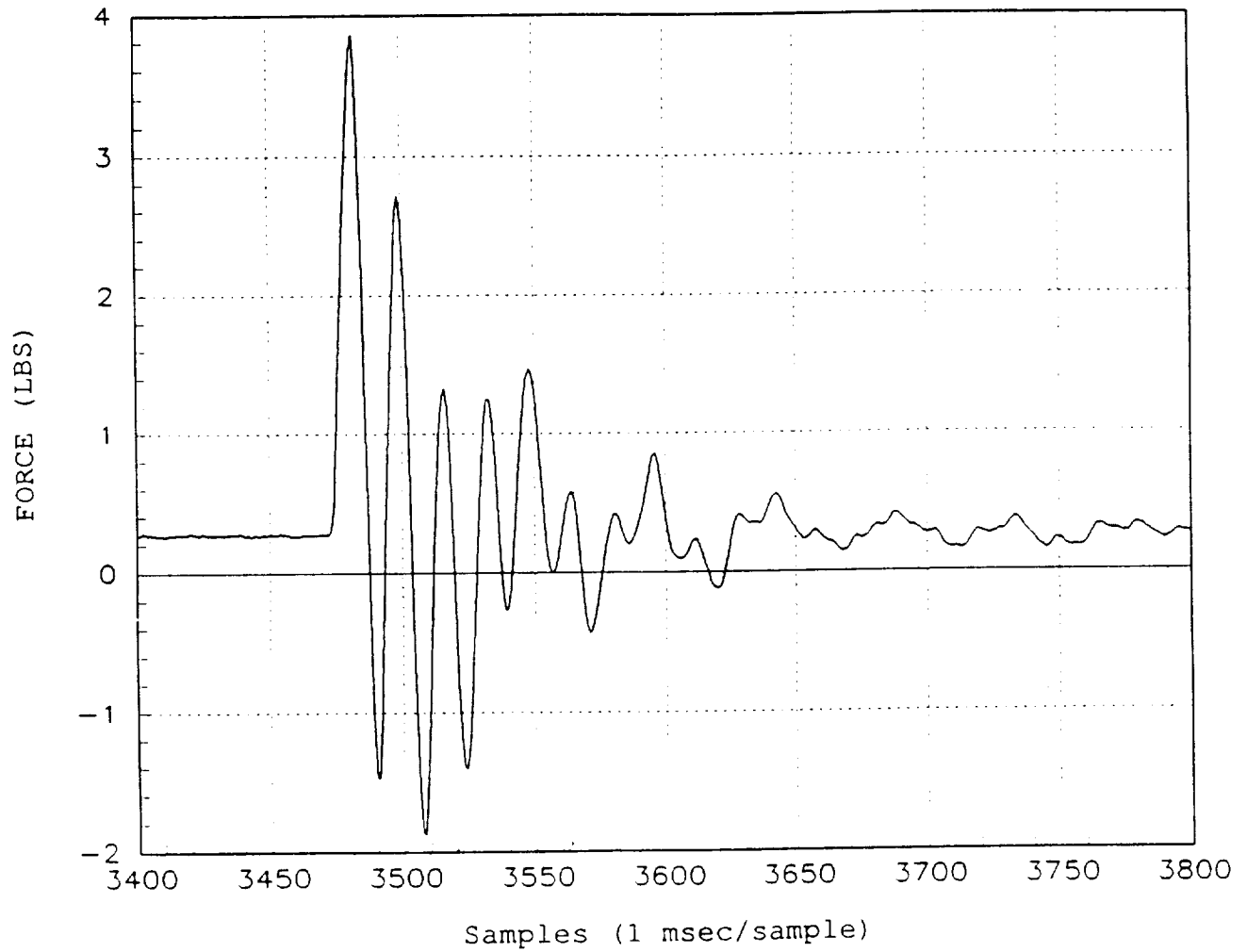

FIGURE 3.4-8  
LINEARITY  
WITH FILTER



APPROX. 60 Hz OSCILLATION

FIGURE 3.4-9  
FORCE RESPONSE  
WITHOUT FILTER



APPROX. 60 Hz OSCILLATION

FIGURE 3.4-10  
IMPULSE RESPONSE OF TEST STRUCTURE

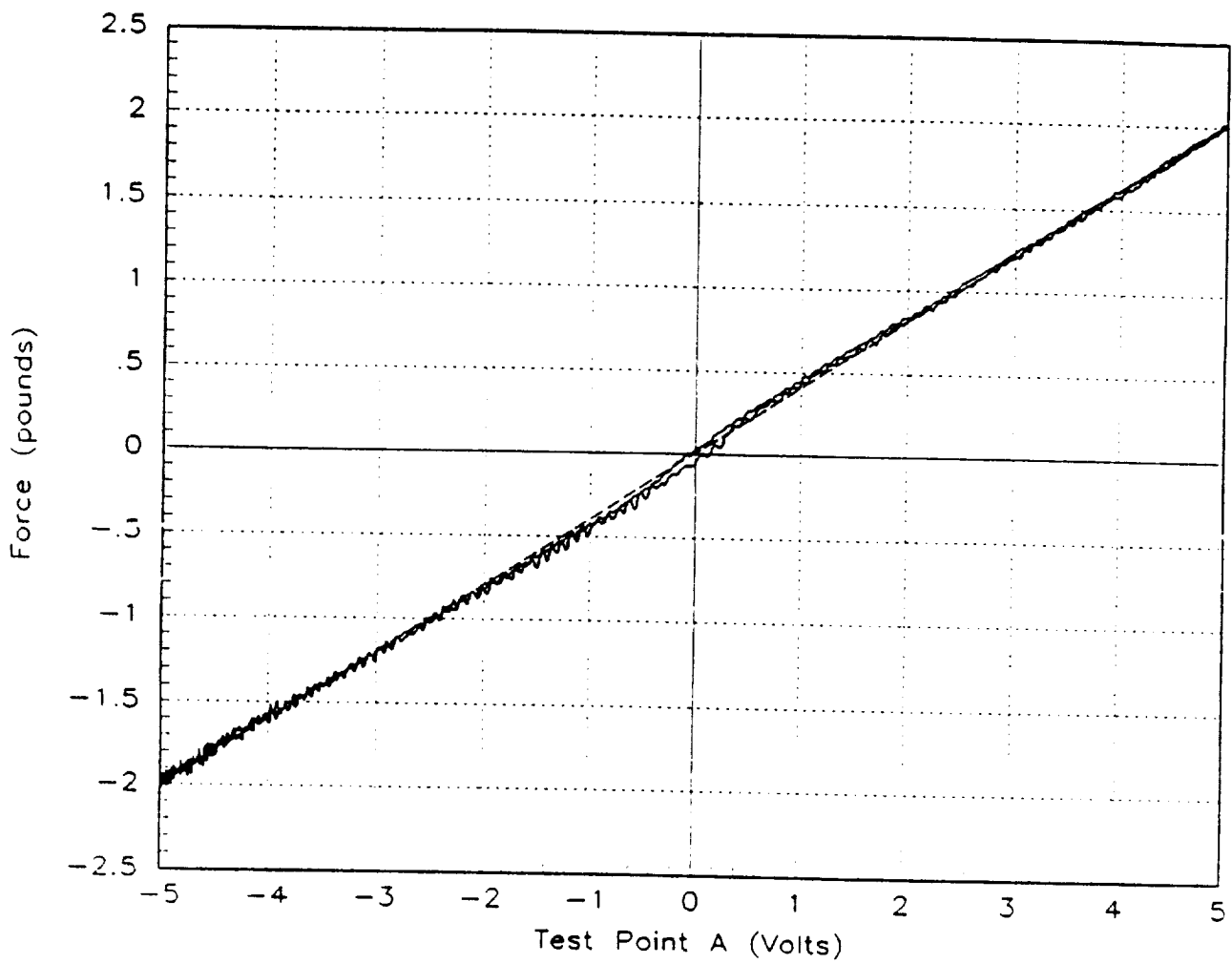

FIGURE 3.4-11  
FORCE VS TPA  
WITHOUT PLATE

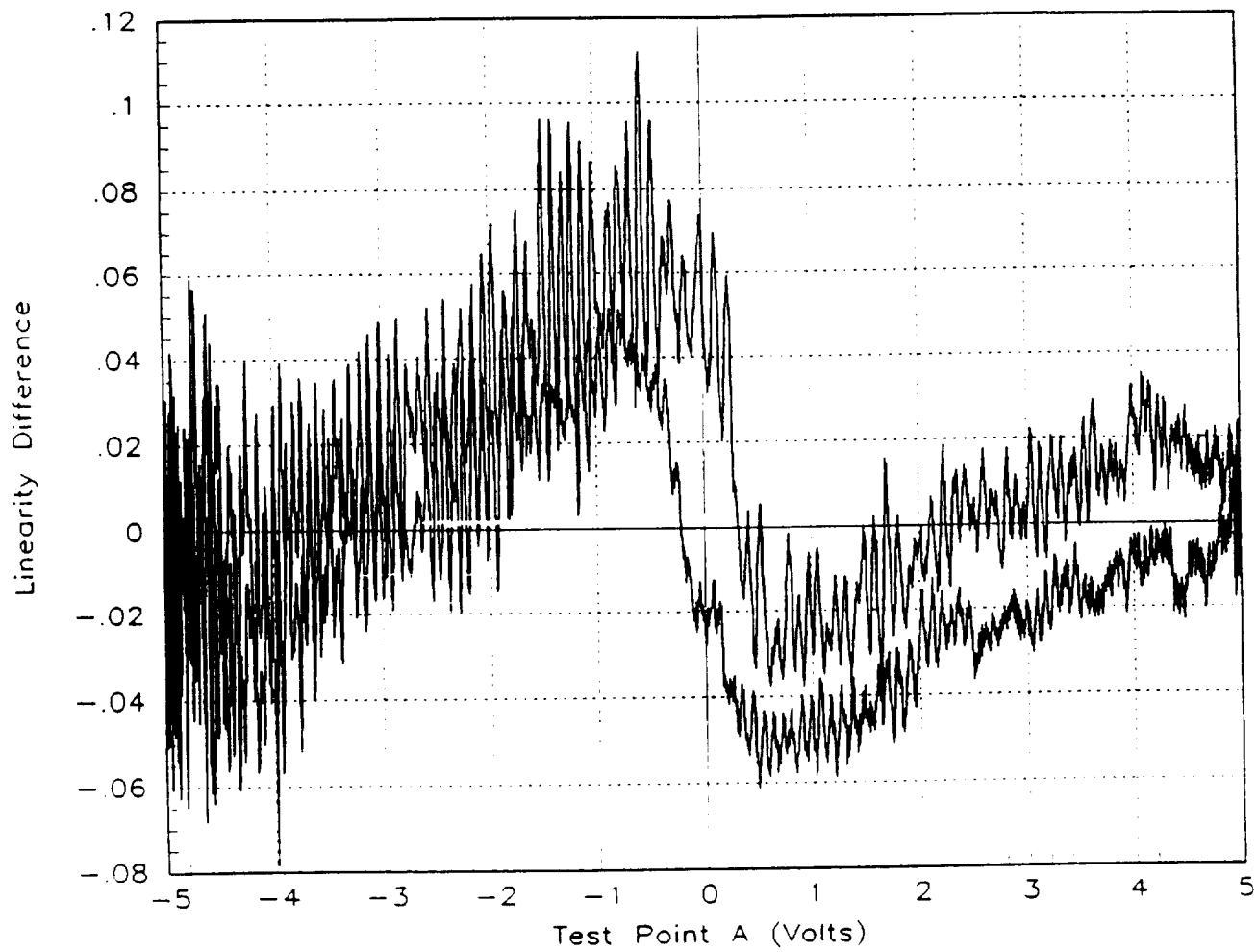

FIGURE 3.4-12  
LINEARITY  
WITHOUT PLATE

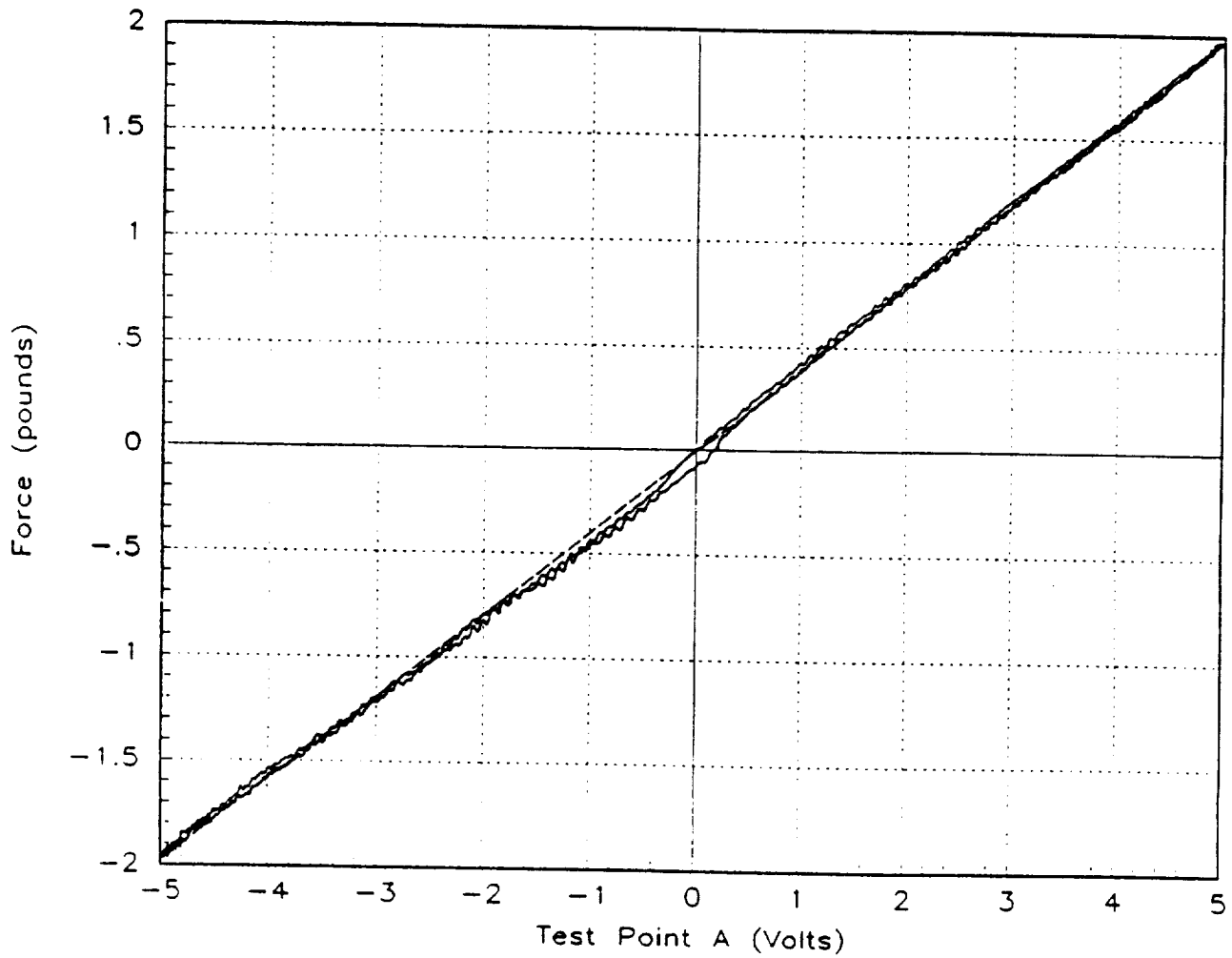

FIGURE 3.4-13  
FORCE VS TPA  
WITH PLATE



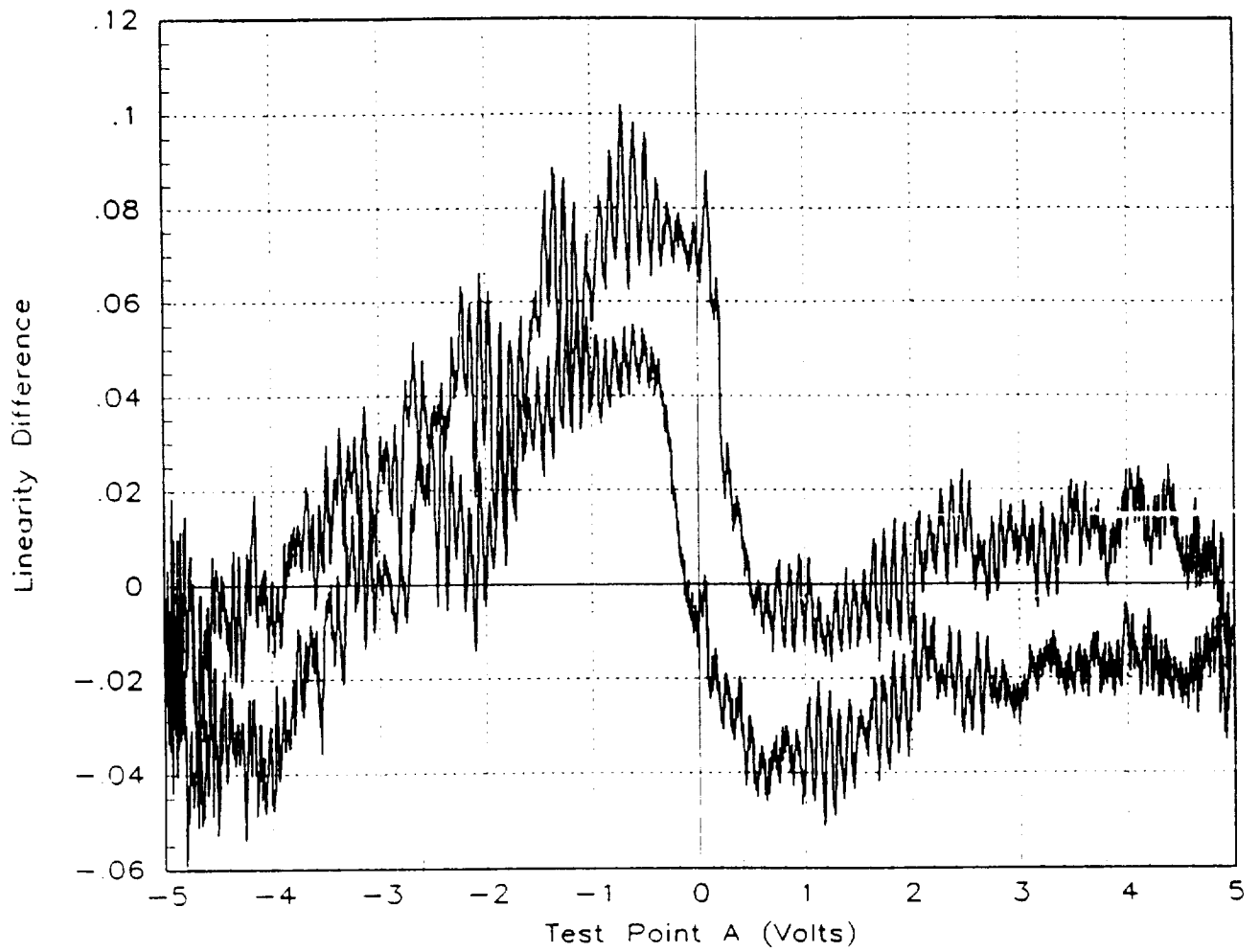
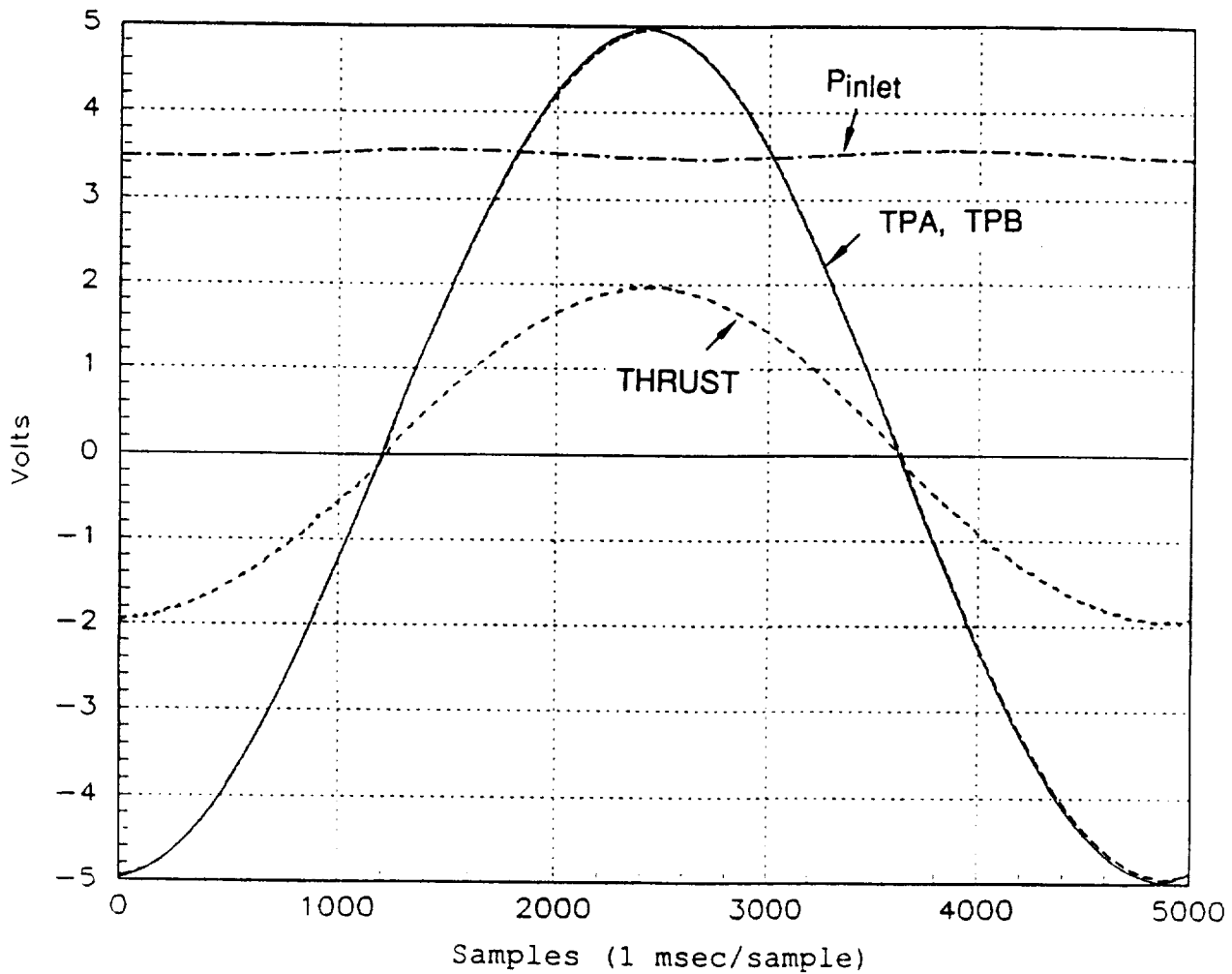
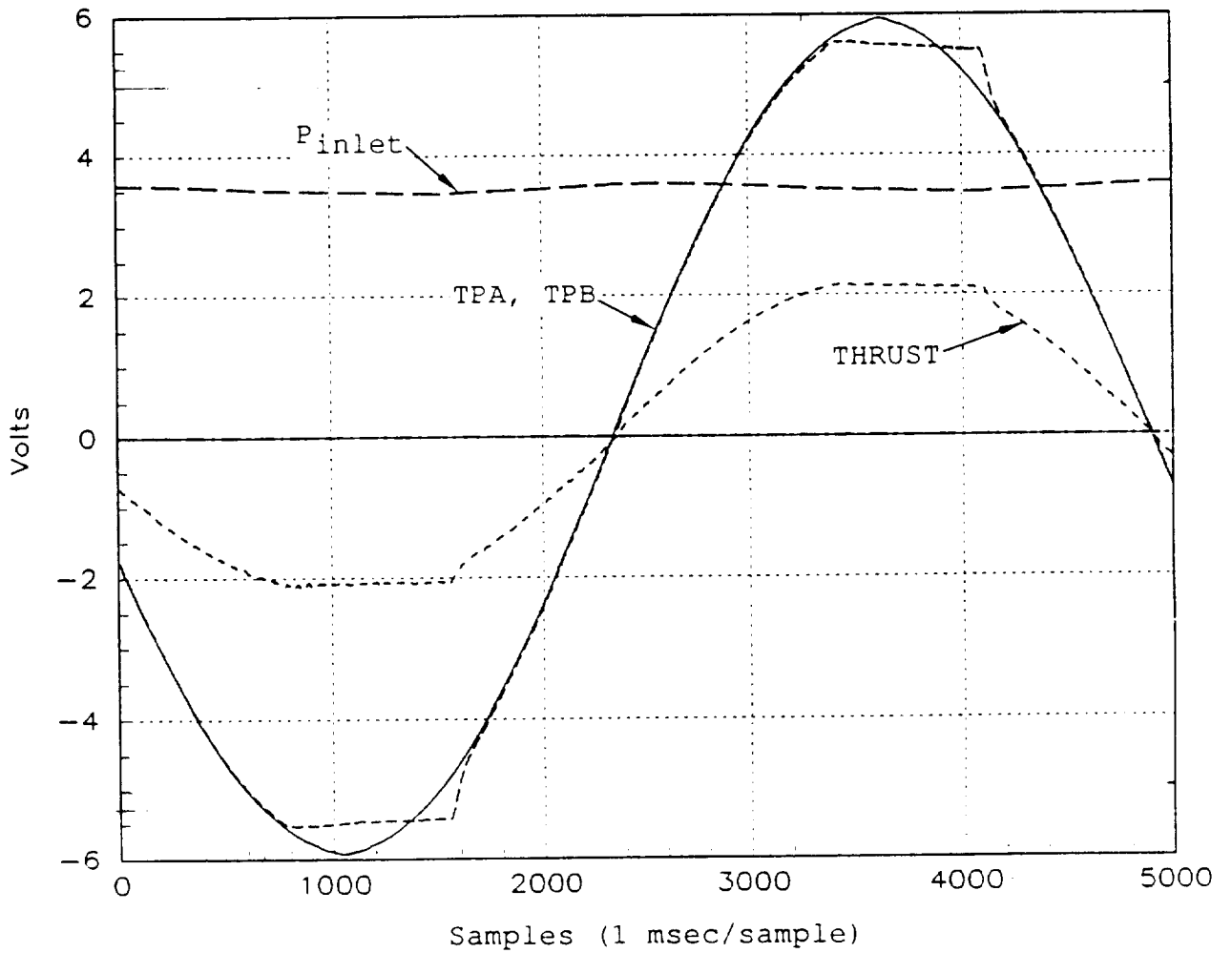

FIGURE 3.4-14  
LINEARITY  
WITH PLATE



OUTPUT	SCALE
TPB	15 PSIG/VOLT
$P_{inlet}$	0-150 PSIG = 1-4 VOLTS
THRUST	1 lb/VOLT

FIGURE 3.4-15  
0.2 Hz TIME RESPONSE



OUTPUT	SCALE
TPB	15 PSIG/VOLT
P <sub>inlet</sub>	0-150 PSIG = 1-4 VOLTS
THRUST	1 lb/VOLT

FIGURE 3.4-16  
MAXIMUM THRUST

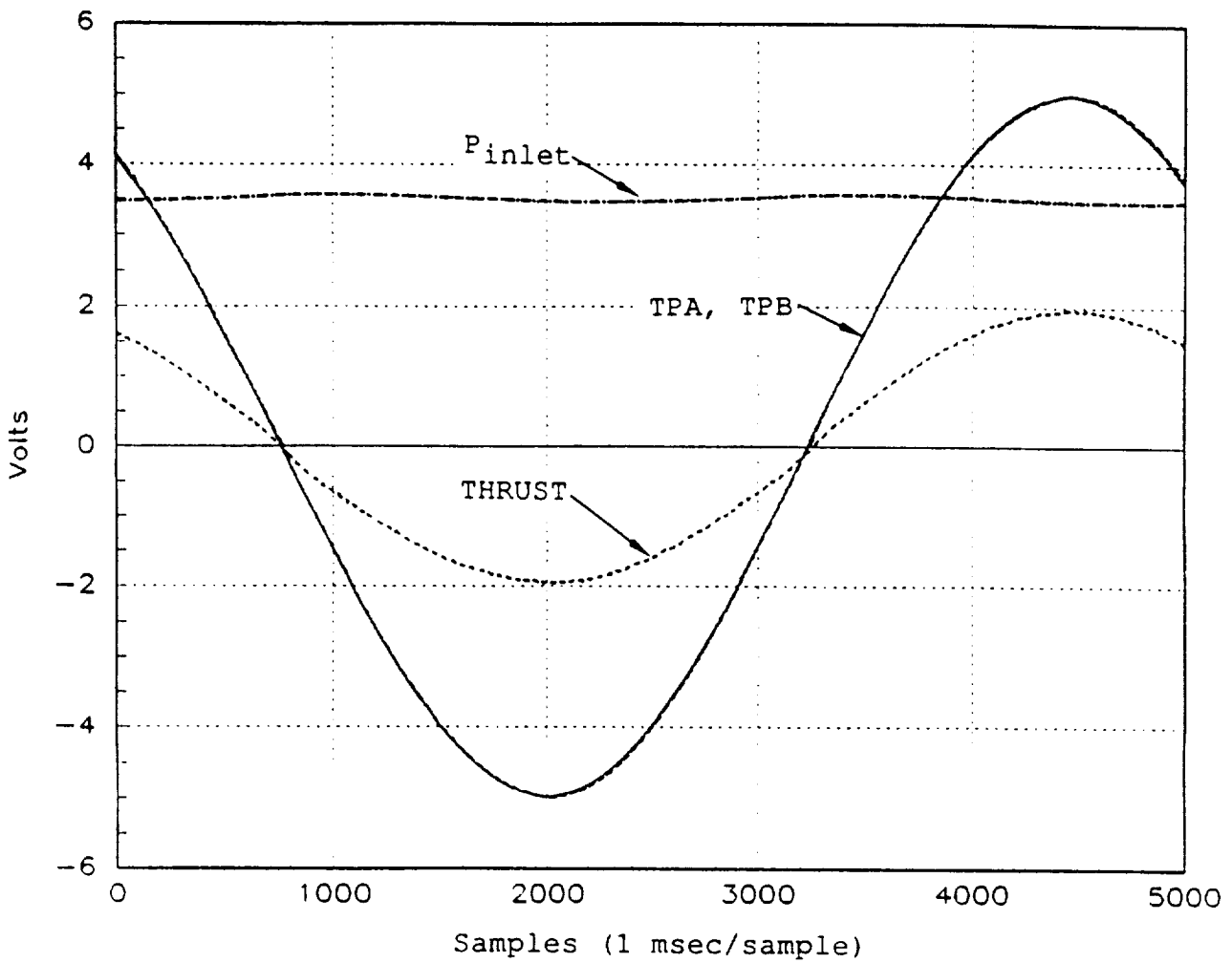

OUTPUT	:	SCALE
TPB	:	15 PSIG/VOLT
$P_{inlet}$	:	0-150 PSIG = 1-4 VOLTS
THRUST	:	1 lb/VOLT

FIGURE 3.4-17  
 TIME RESPONSE  
 (0.2 Hz)

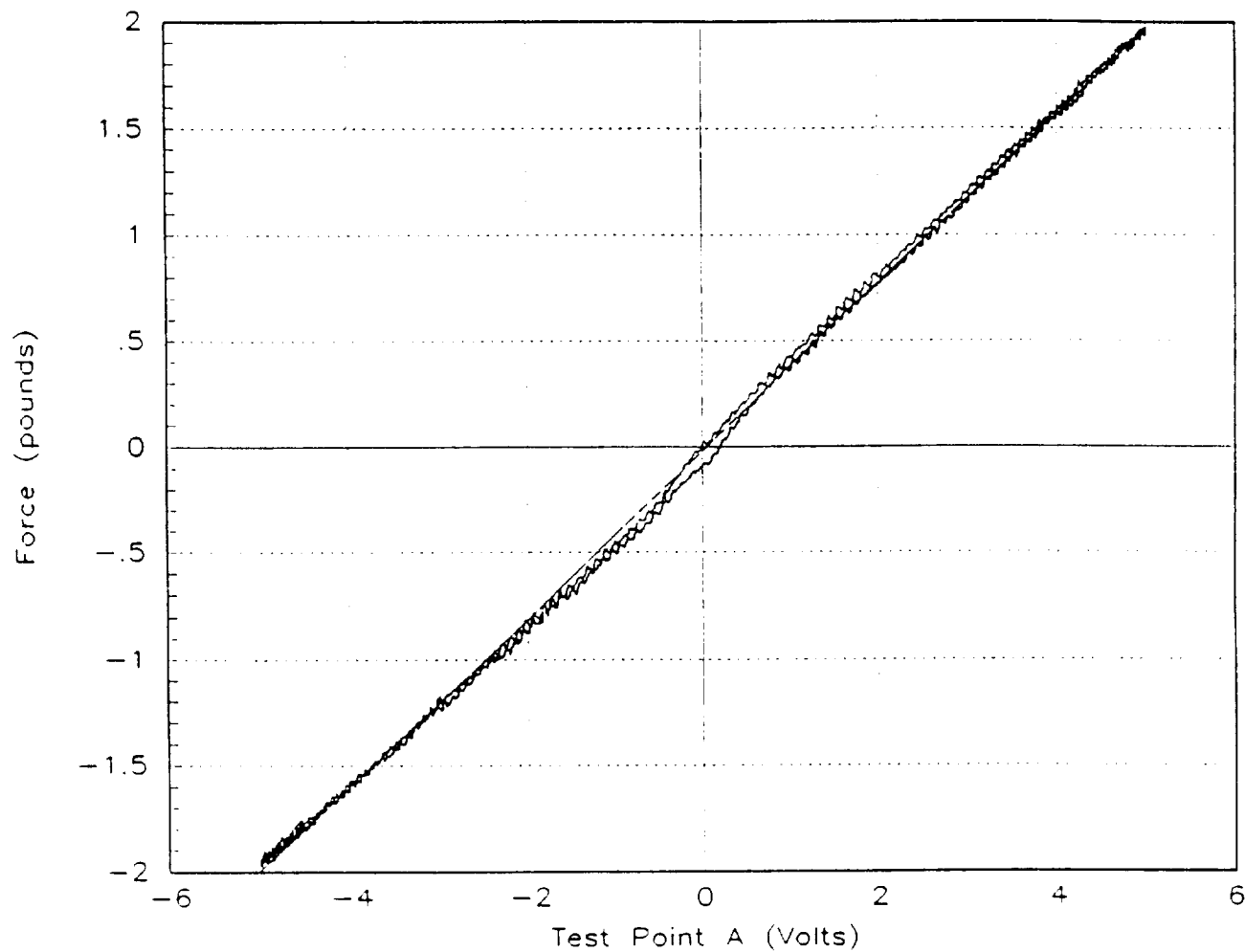

FIGURE 3.4-18  
FORCE VS TPA  
(0.2 Hz)

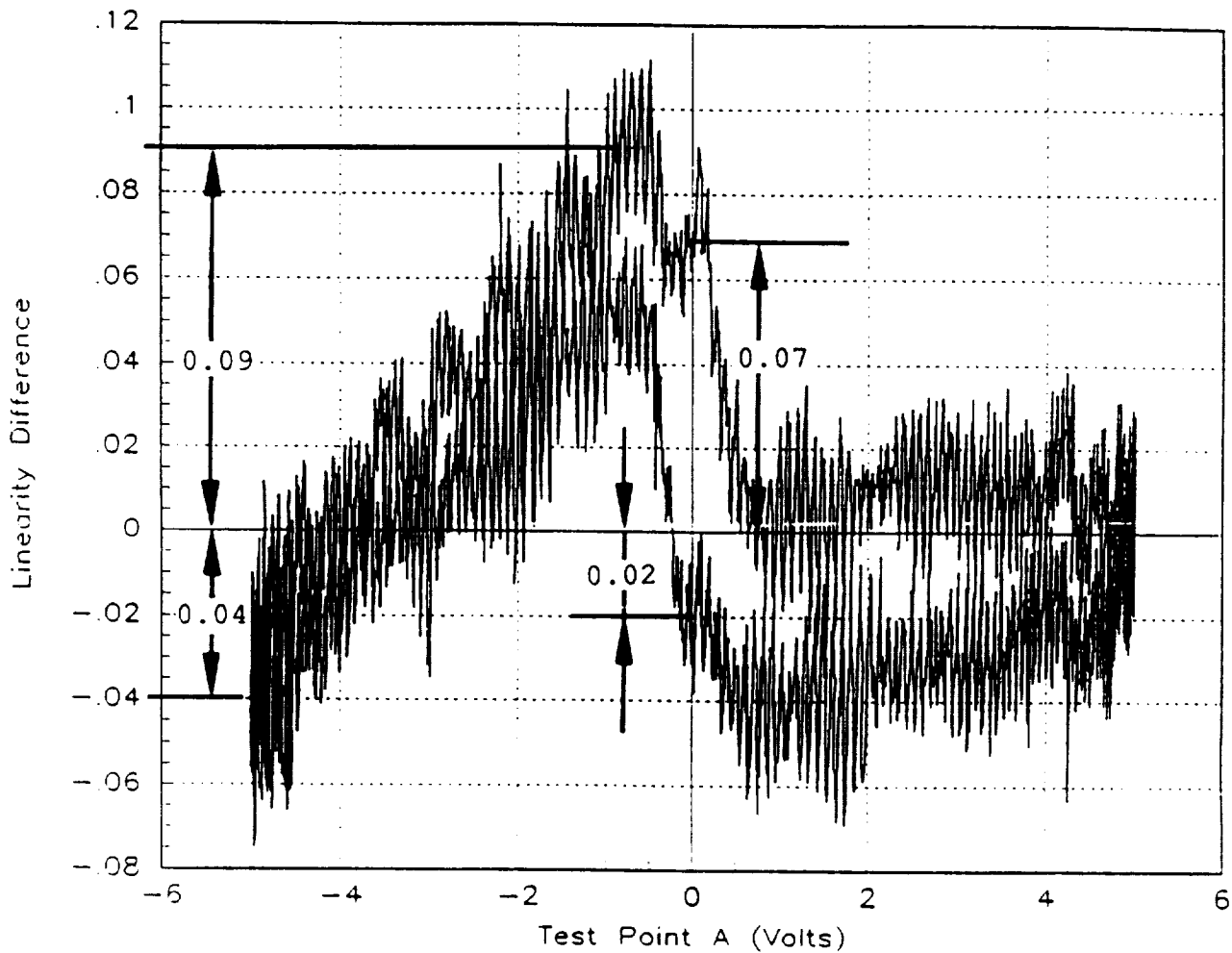

FIGURE 3.4-19  
LINEARITY  
(0.2 Hz)

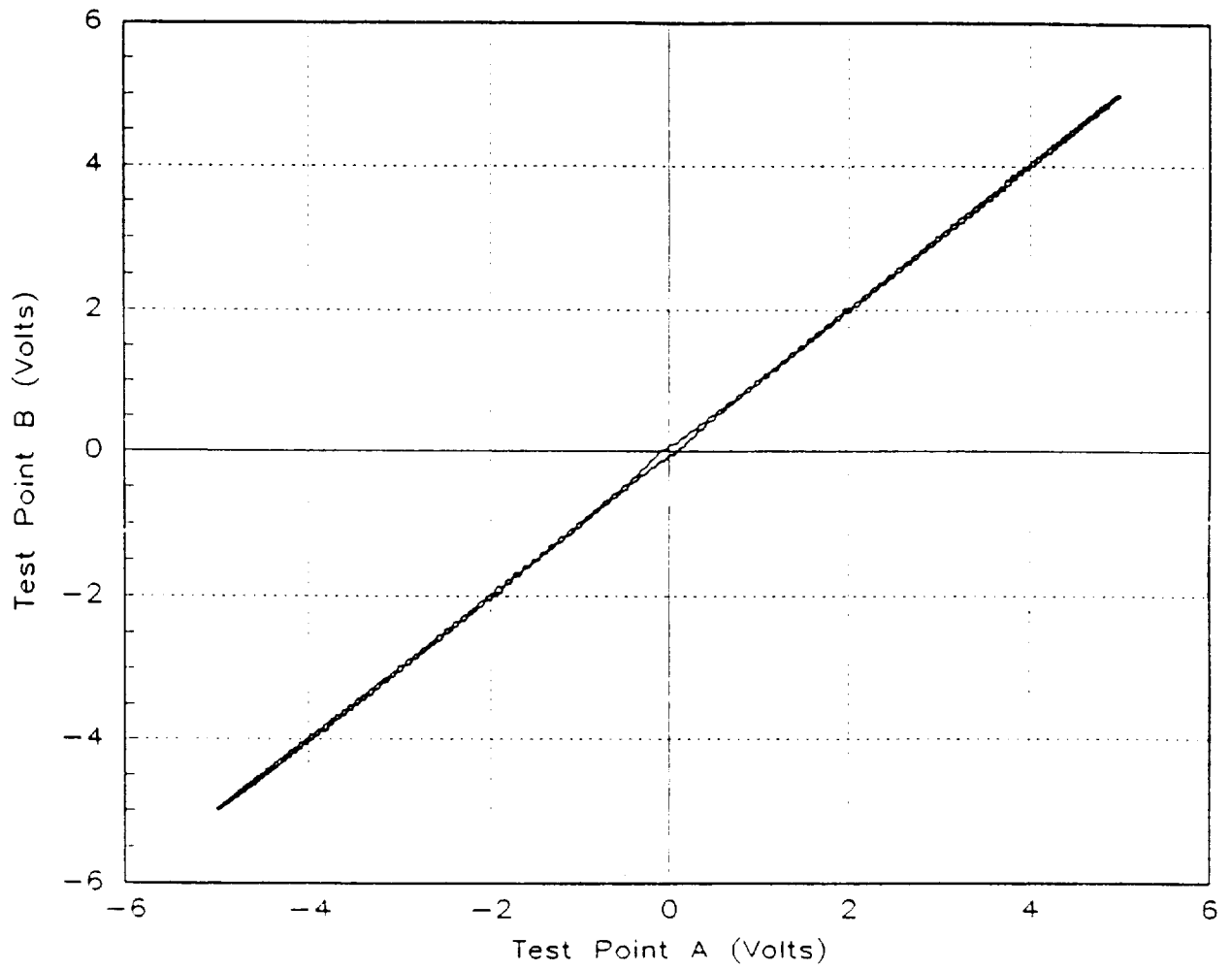

FIGURE 3.4-20  
TPB VS TPA  
(0.2 Hz)

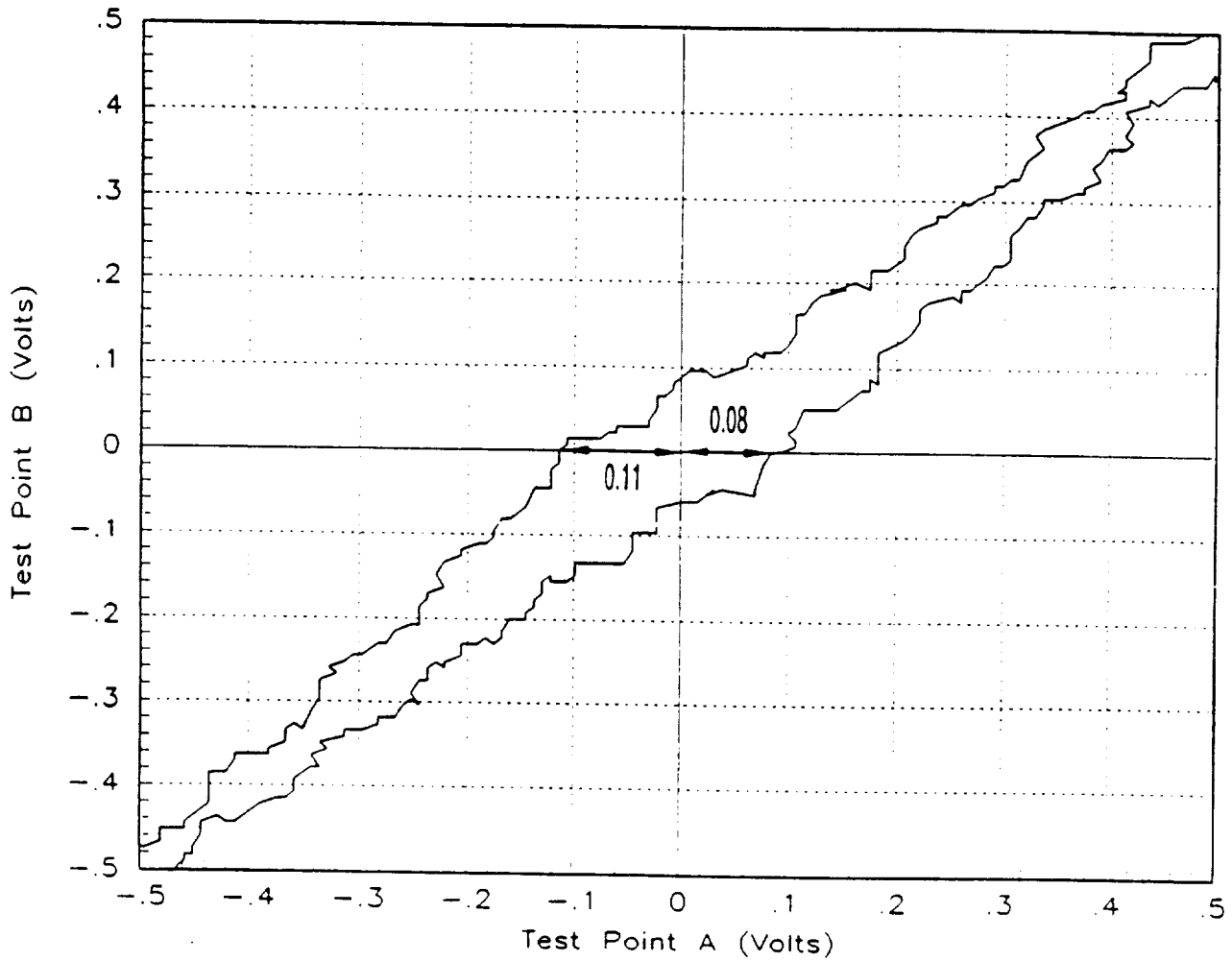
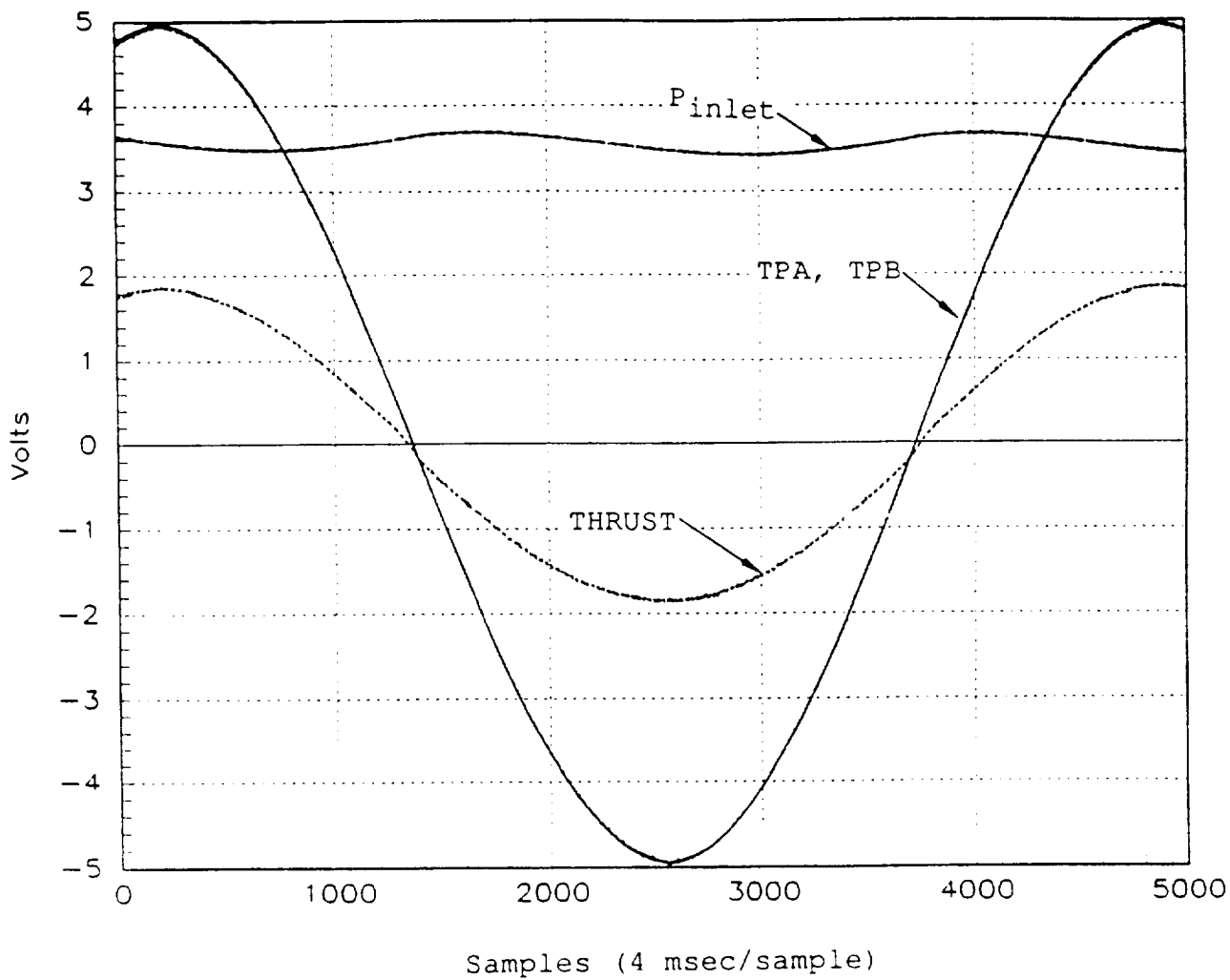

FIGURE 3.4-21  
 TPB VS TPA  
 (0.2 Hz)





OUTPUT	:	SCALE
TPB	:	15 PSIG/VOLT
P <sub>inlet</sub>	:	0-150 PSIG = 1-4 VOLTS
THRUST	:	1 lb/VOLT

FIGURE 3.4-22  
 TIME RESPONSE  
 (0.05 Hz)

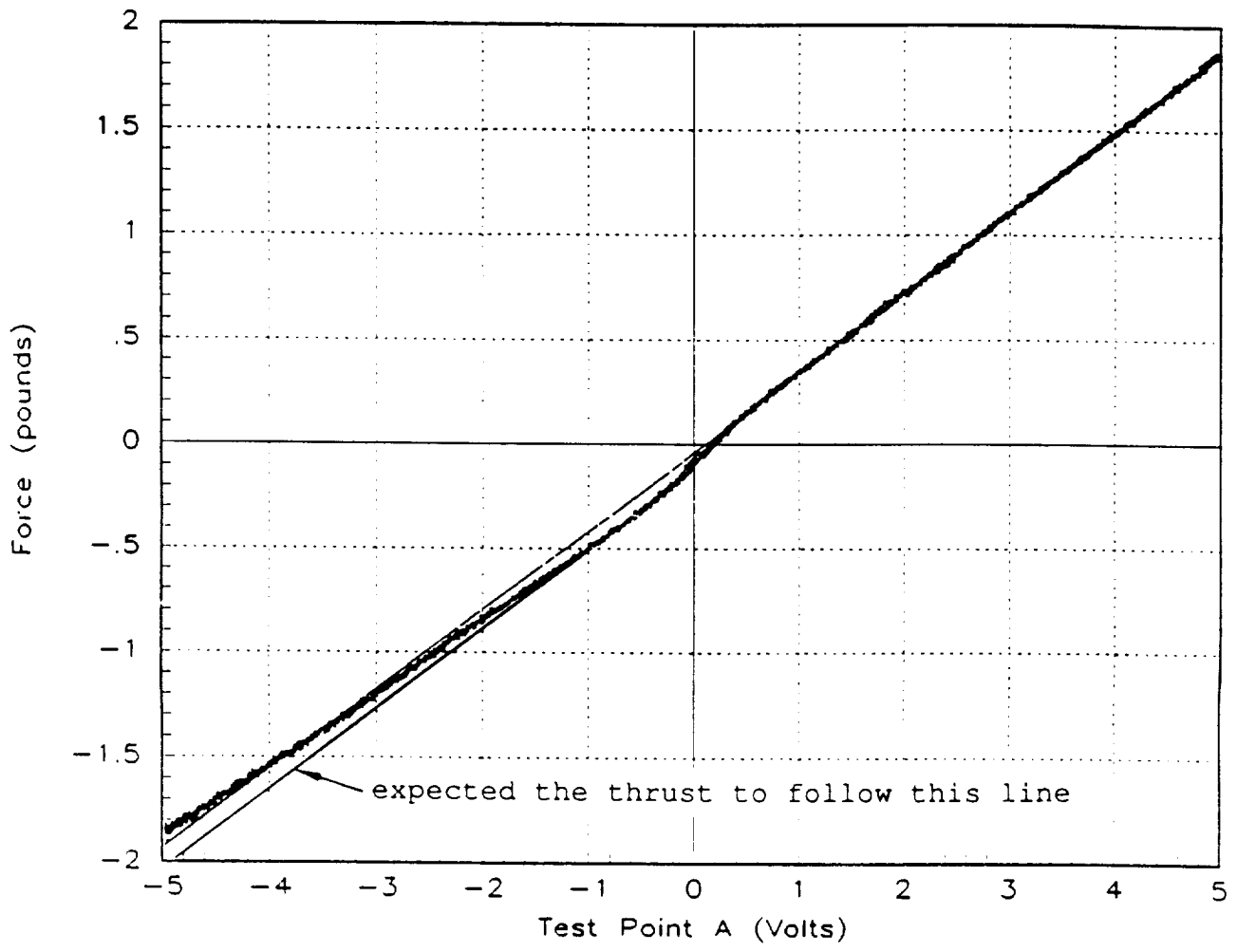

FIGURE 3.4-23  
FORCE VS TPA  
(0.05 Hz)

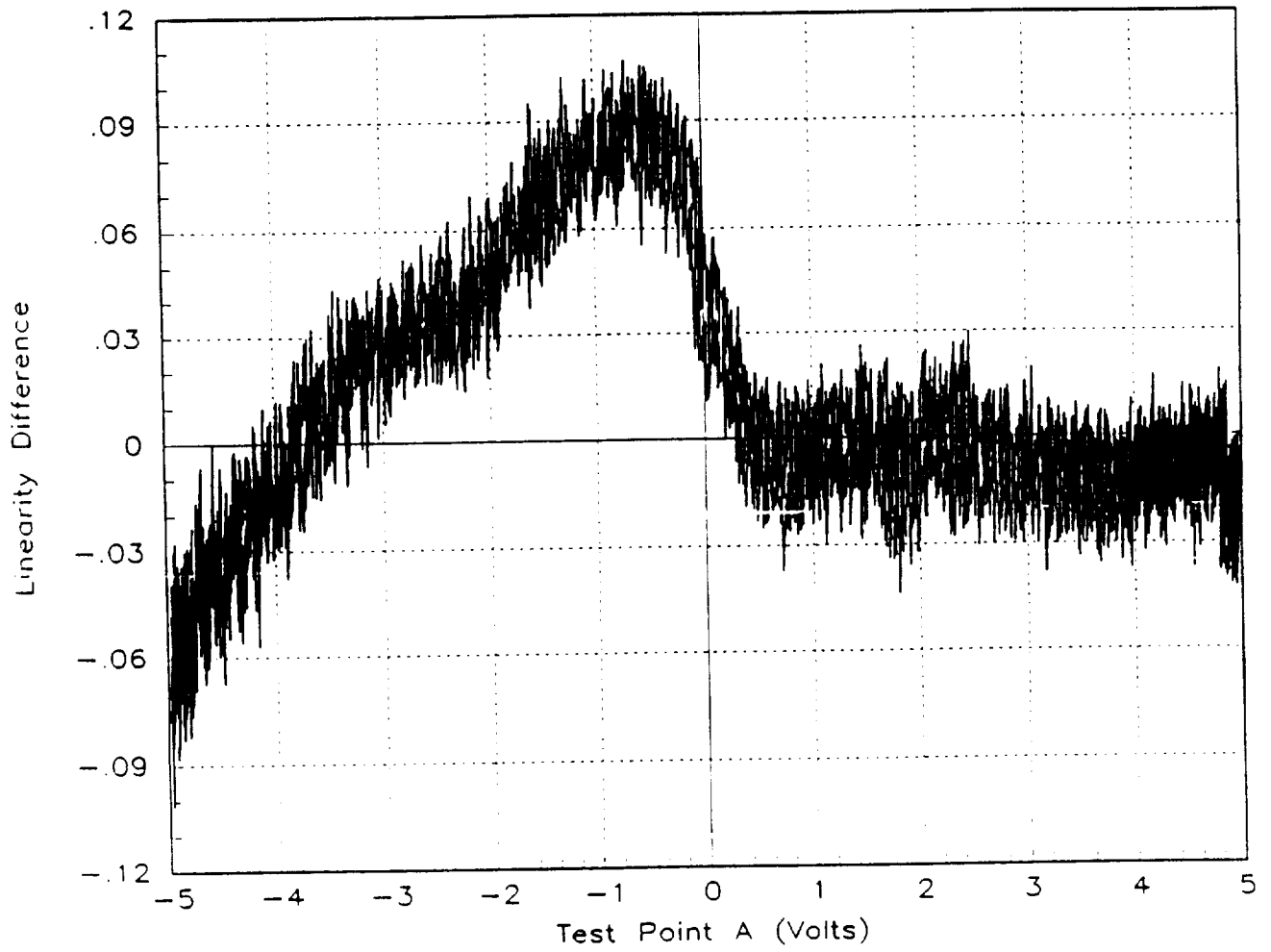

FIGURE 3.4-24  
LINEARITY  
(0.05 Hz)

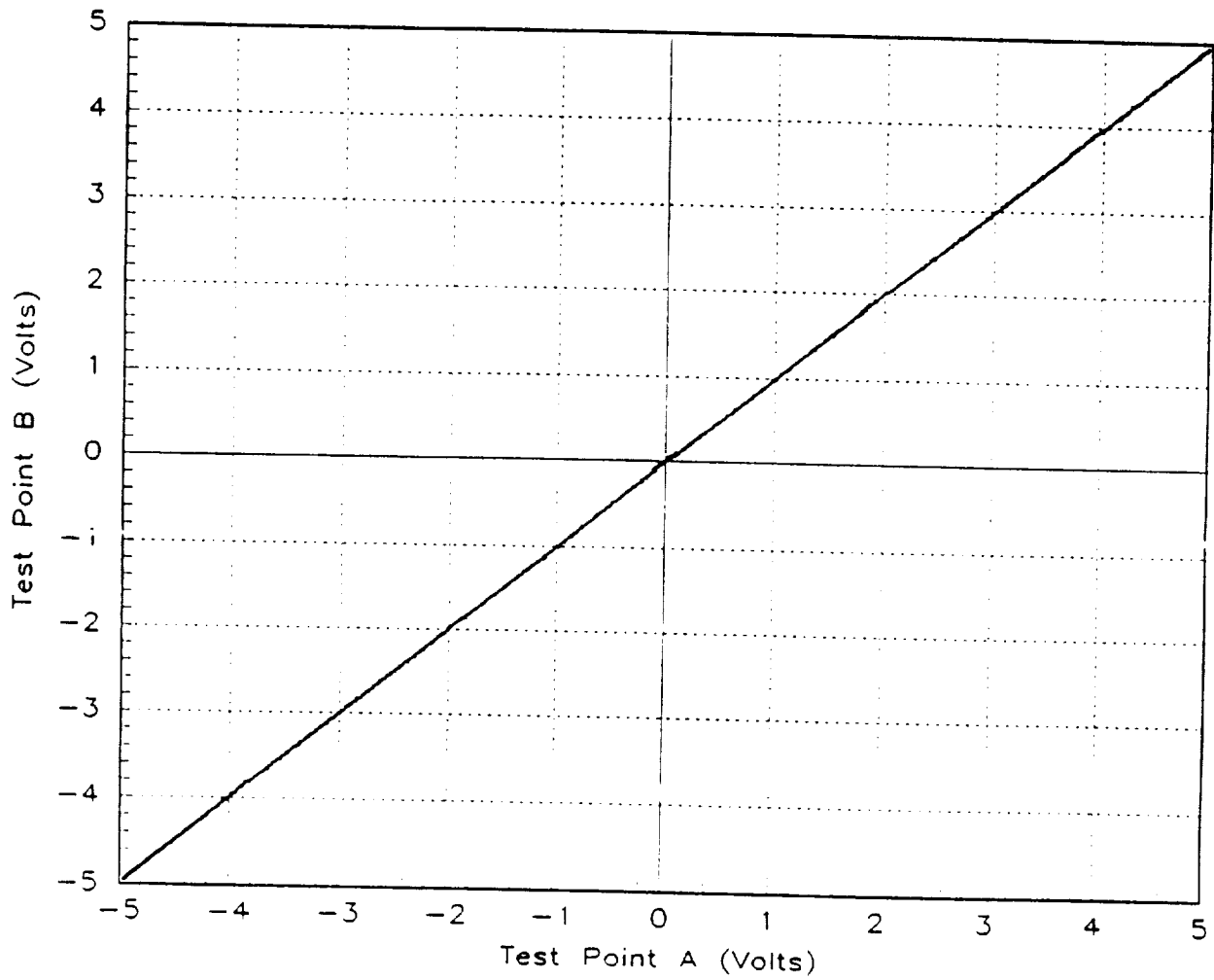

FIGURE 3.4-25  
TPB VS TPA  
(0.05 Hz)

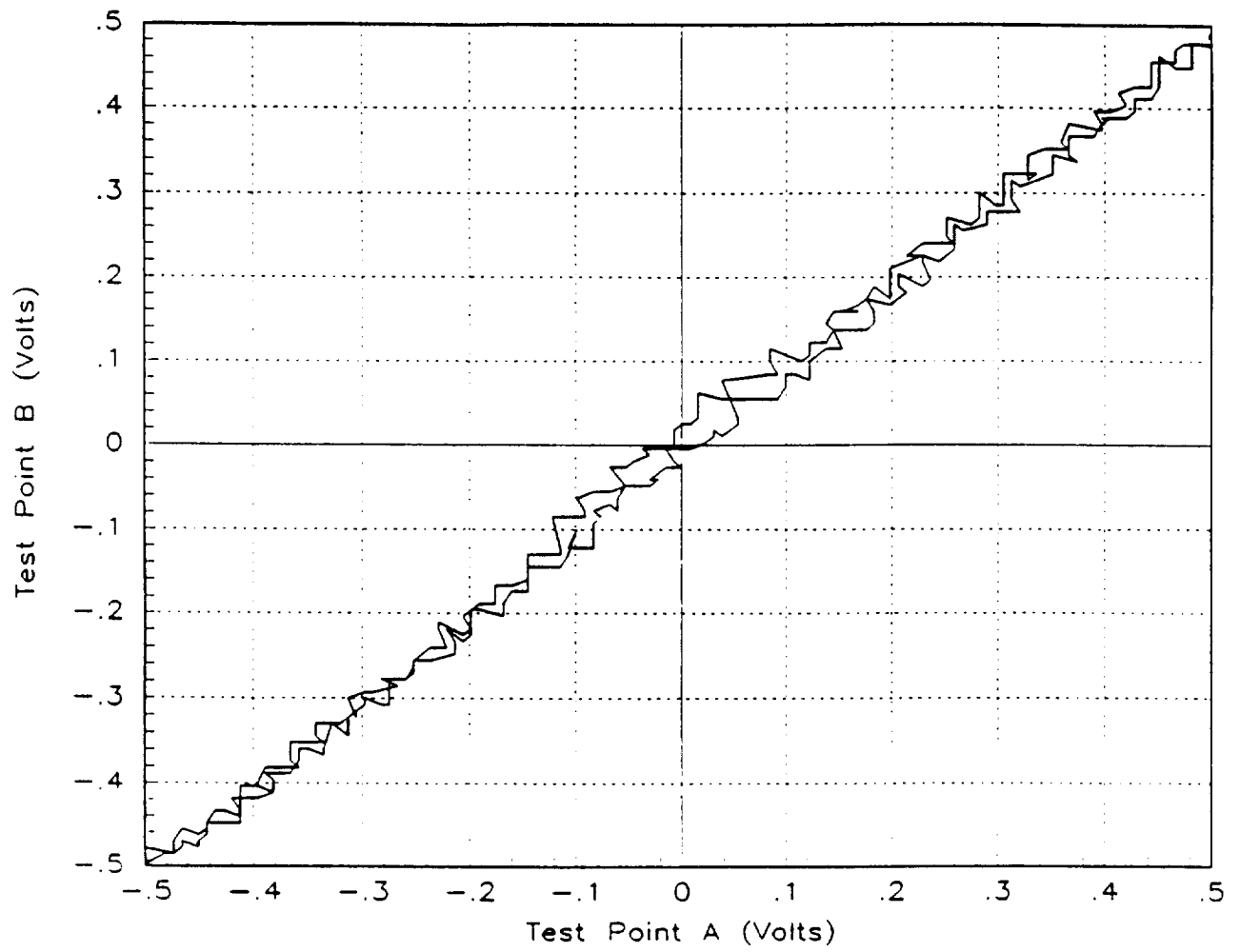

FIGURE 3.4-26  
TPB VS TPA  
(0.05 Hz)

# TYPICAL CLOSED LOOP TEST RESULTS

Ke	BANDWIDTH (Hz at -3 db)		10 Hz Attenuation & Lag		
	OFF	ACROSS	Min Thrust	Max Gain	Full Scale
1.2	146	80	-2.0 db, -30°	-0.6 db, -15°	-0.7 db, -16°

PRESSURE HYSTERESIS	FORCE HYSTERESIS	FORCE LINEARITY
1.9% (at 0.2 Hz)	2.3% (at 0.2 Hz)	3.3%

# STATISTICAL RESULTS FOR 16 TESTED THRUSTERS

Ke	BANDWIDTH (Hz at -3 db)		10 Hz Attenuation & Lag		
	OFF	ACROSS	Min Thrust	Max Gain	Full Scale
$\bar{X}$ 1.34	130	71	-1.61 db, -28.3°	-0.48 db, -13.4°	-0.61 db, -14.9°
$\sigma$ 0.20	19	12	-0.40 db, -2.9°	-0.13 db, -1.2°	-0.13 db, -1.5°

PRESSURE HYSTERESIS	FORCE HYSTERESIS	FORCE LINEARITY
$\bar{X}$ 1.7% (at 0.2 Hz)	1.8% (at 0.2 Hz)	3.1%
$\sigma$ 0.2%	0.2%	0.3%

FIGURE 3.5-1 - CLOSED LOOP TEST RESULTS

## 4.0 - SYSTEM INTEGRATION AND TESTING

### System Description

The entire linear thruster system consists of the following:

1. 16 bilinear pneumatic thrusters.
2. 16 thruster electronic control cards.
3. 2 card cages to house the control cards. (8 cards each)
4. 1 +/- 15V, 7A Acopian Power Supply, model TD15-850.
5. 16 thirty foot long, 10-conductor ribbon cables.

### System Tests

The purpose of the system tests was to verify that performance of the thrusters is not degraded when all 16 units operate simultaneously from a single power supply. They also confirmed the functionality of the card cages and that the use of 30' ribbon cables to connect the thrusters to the controller boards did not effect performance.

### Test Set-up

Because pneumatic operation of all 16 linear thrusters simultaneously to full thrust potential would require an expensive and elaborate test set-up, a different approach was taken. The two keys items that needed to be checked were the power supply's ability to supply the current demands of all 16 thrusters and the ribbon cable's ability to preserve the integrity of the currents and voltages it conducts. Instead of installing each individual thruster, 10 ohm, 1/2 watt resistors were installed in place of 14 of the thrusters, while a single thruster was used as the device-under-test (DUT). 10 ohm resistors were used because the effective impedance of the thruster coil is 10 ohms. Thus, an equivalent current scenario is induced in the ribbon cables via this substitution. In all system tests, all 14 resistor loads were driven with a common command, while the DUT was examined under a zero command condition. In addition, all 15 ribbon cables were strung-out in close proximity to each other in order to produce a "worst case" environment. Under these conditions, three simple tests were performed:

Test #	Frequency	Command	Figures
#1	10 Hz	5 volt (1 lb), step	4.1, 4.2
#2	100 Hz	5 volt (1 lb), step	4.3, 4.4
#3	10 Hz	10 volt (2 lb), step	4.5, 4.6

## Conclusions

In every case, Test Point B (TPB) of the DUT was monitored, as well as both supply voltages and the common input command. Also in every case, no adverse effects were noticed. TPB of the DUT (pressure transducer feedback), which is the most sensitive to ribbon cable cross-talk, varied by no more than a few millivolts, demonstrating a remarkable system robustness in regards to ribbon cable cross-talk and supply voltage variation. Absolutely no effects were noticed in the DUT's nozzle air flow, which would indicate a change in applied force.



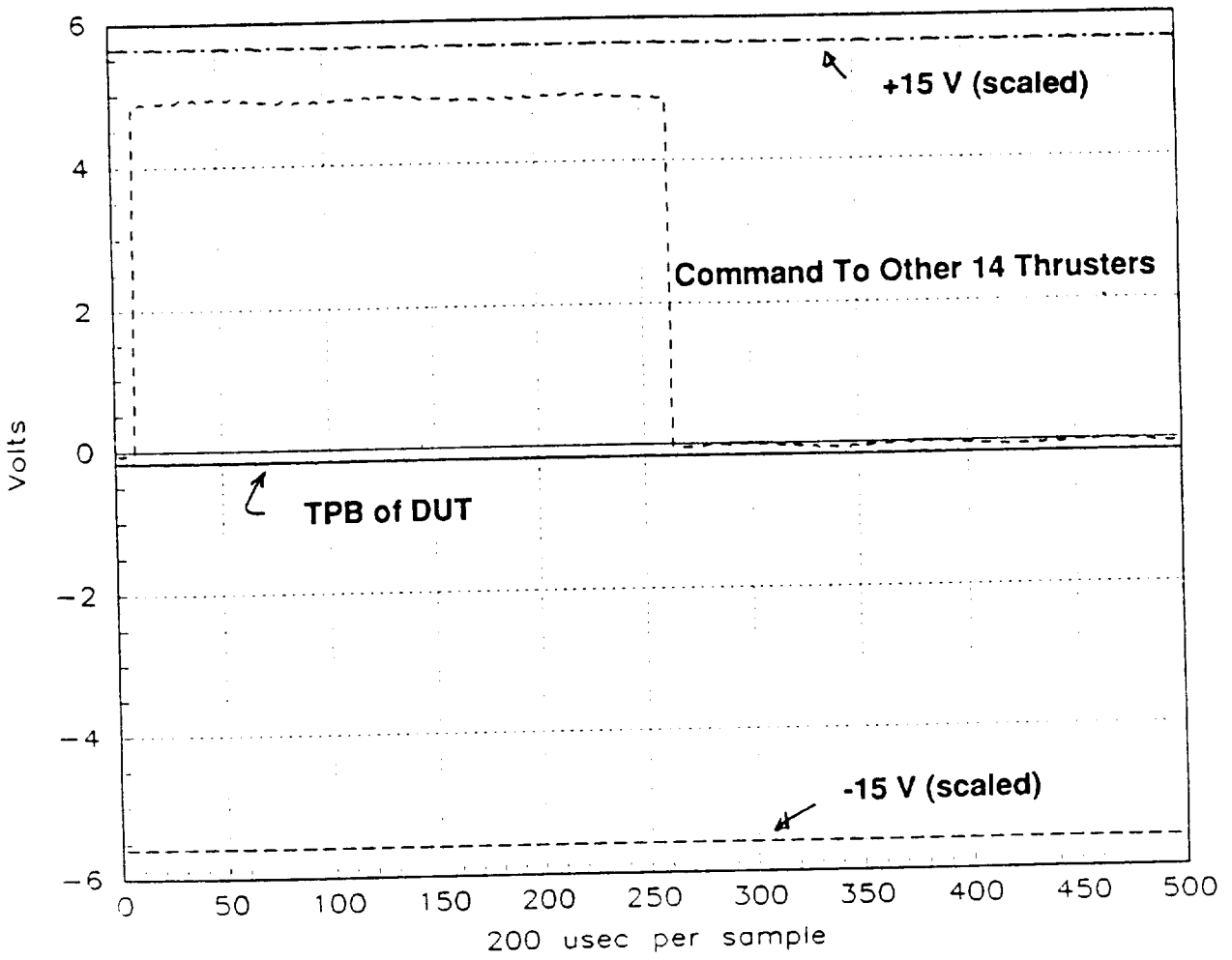

TPB = Pressure Transducer Feedback

Figure 4.1 - System Test #1

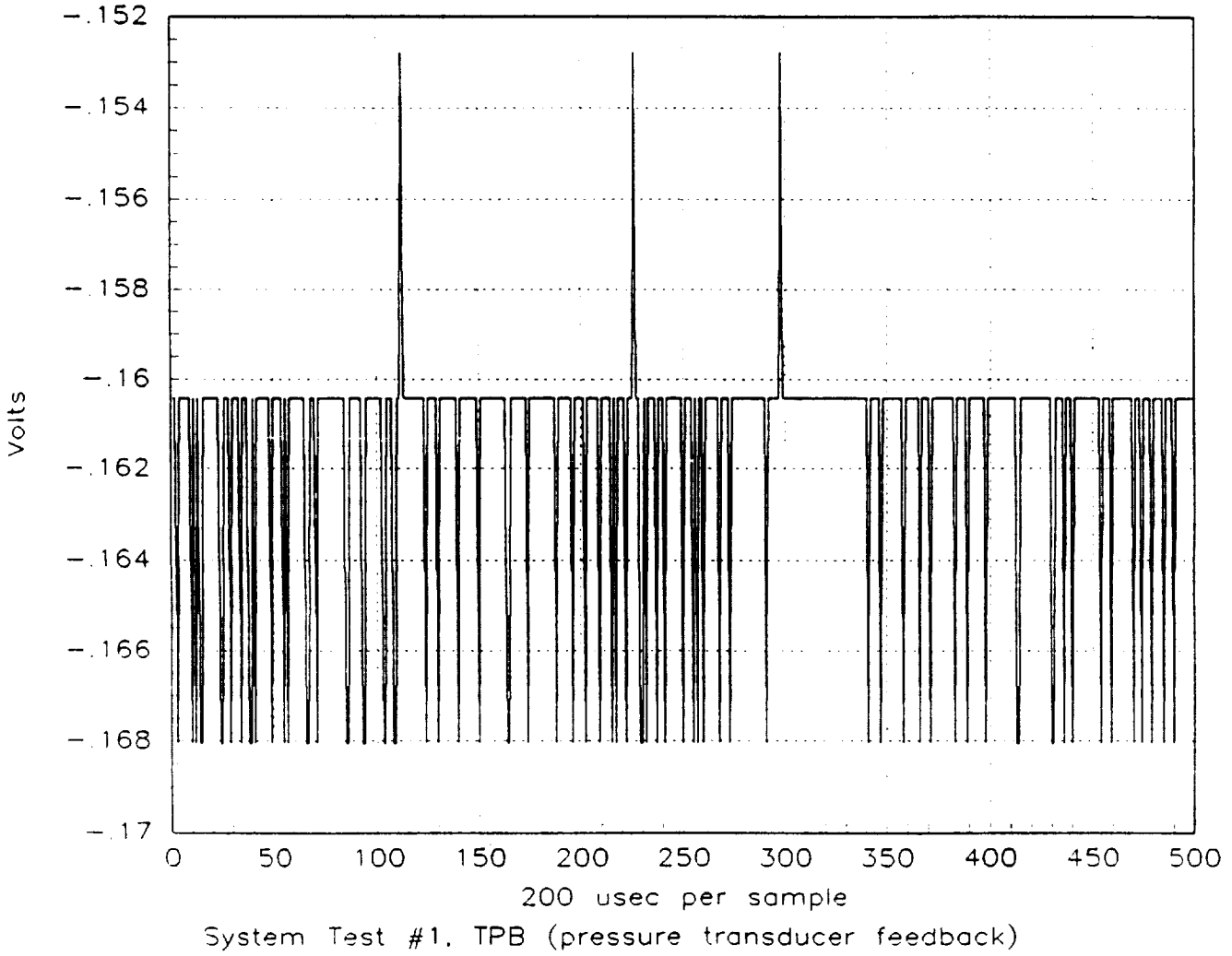
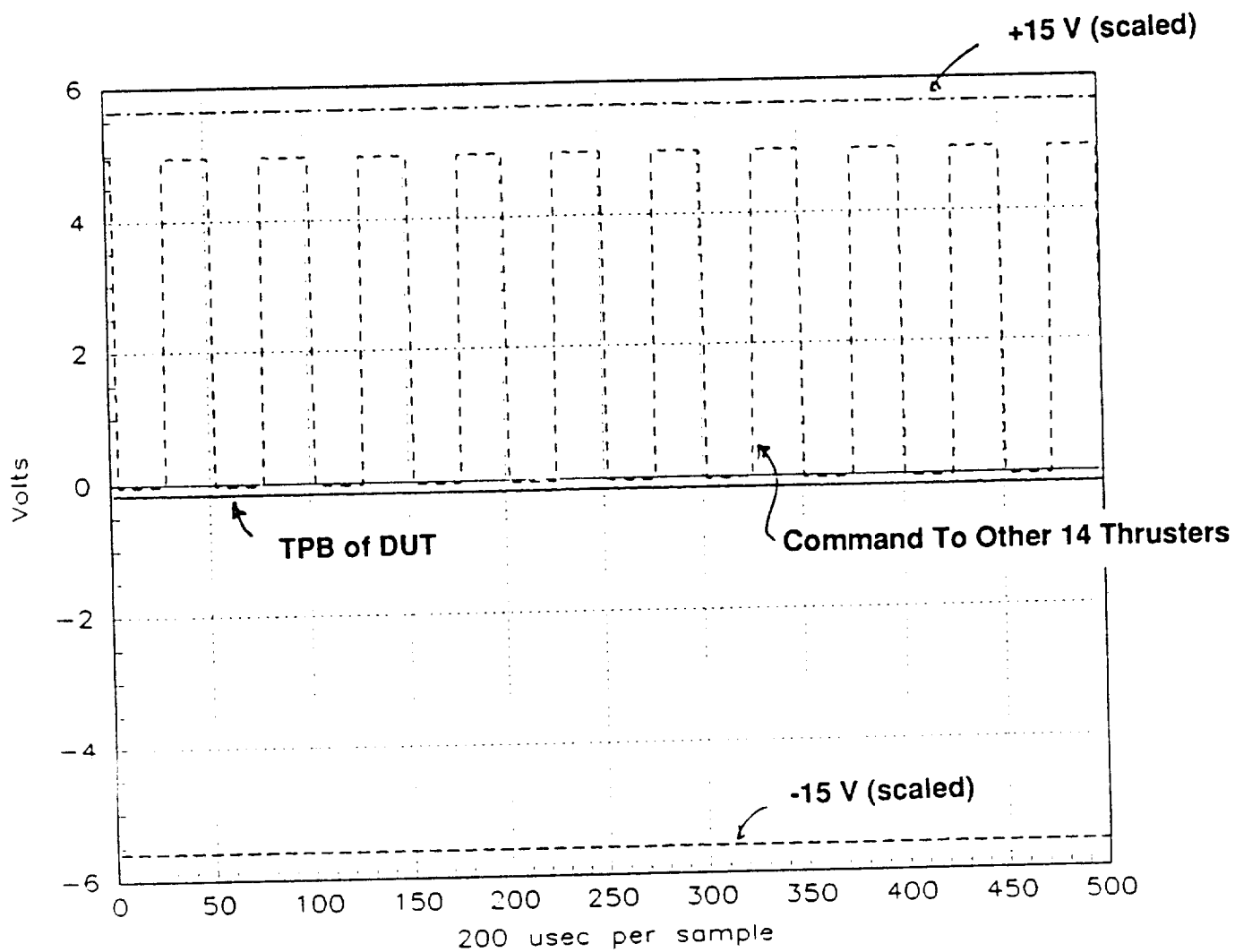
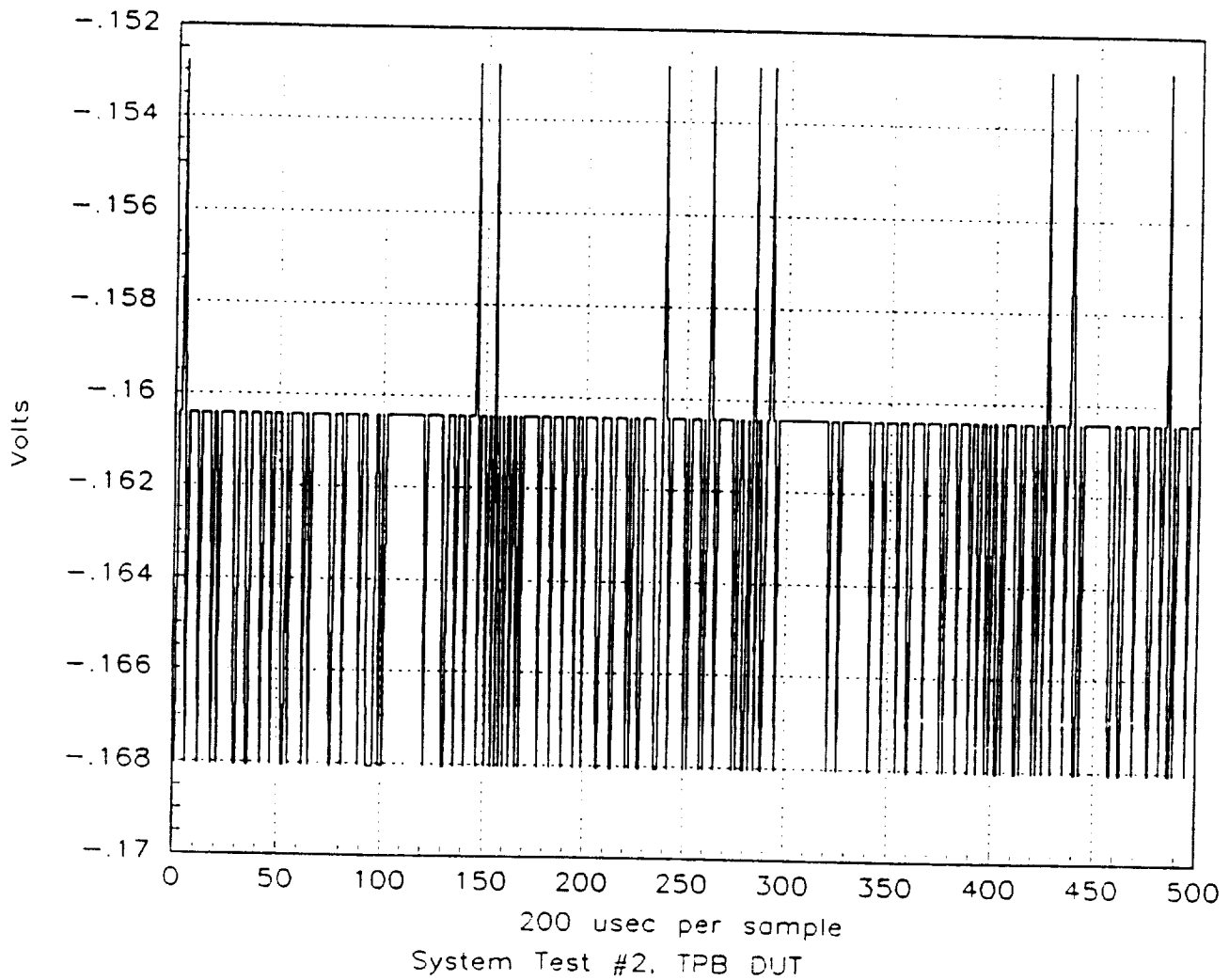

Figure 4.2 - System Test #1, TPB



**TPB = Pressure Transducer Feedback**

**Figure 4.3 - System Test #2**



The small variations in voltage at TPB appear as the two least significant bits (LSB) toggle on and off giving the waveform above a "digital" appearance. Upon close inspection, it can be seen that TPB varies by more than  $\pm 4\text{mV}$  but less than  $\pm 12\text{mV}$ , which is very good under this "worst case" condition.

**TPB = Pressure Transducer Feedback**

Figure 4.4 - System Test #2, TPB

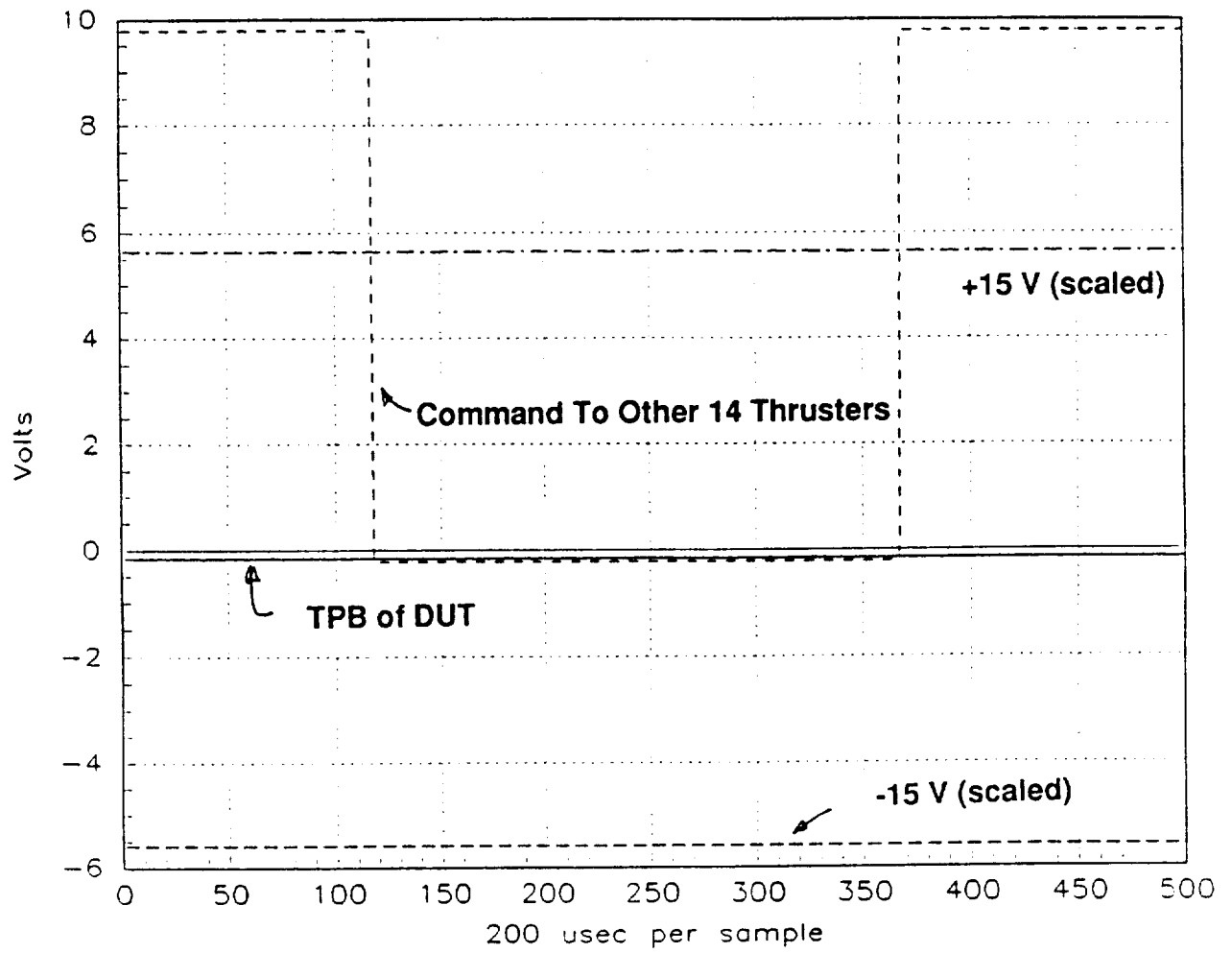

TPB = Pressure Transducer Feedback

Figure 4.5 - System Test #3

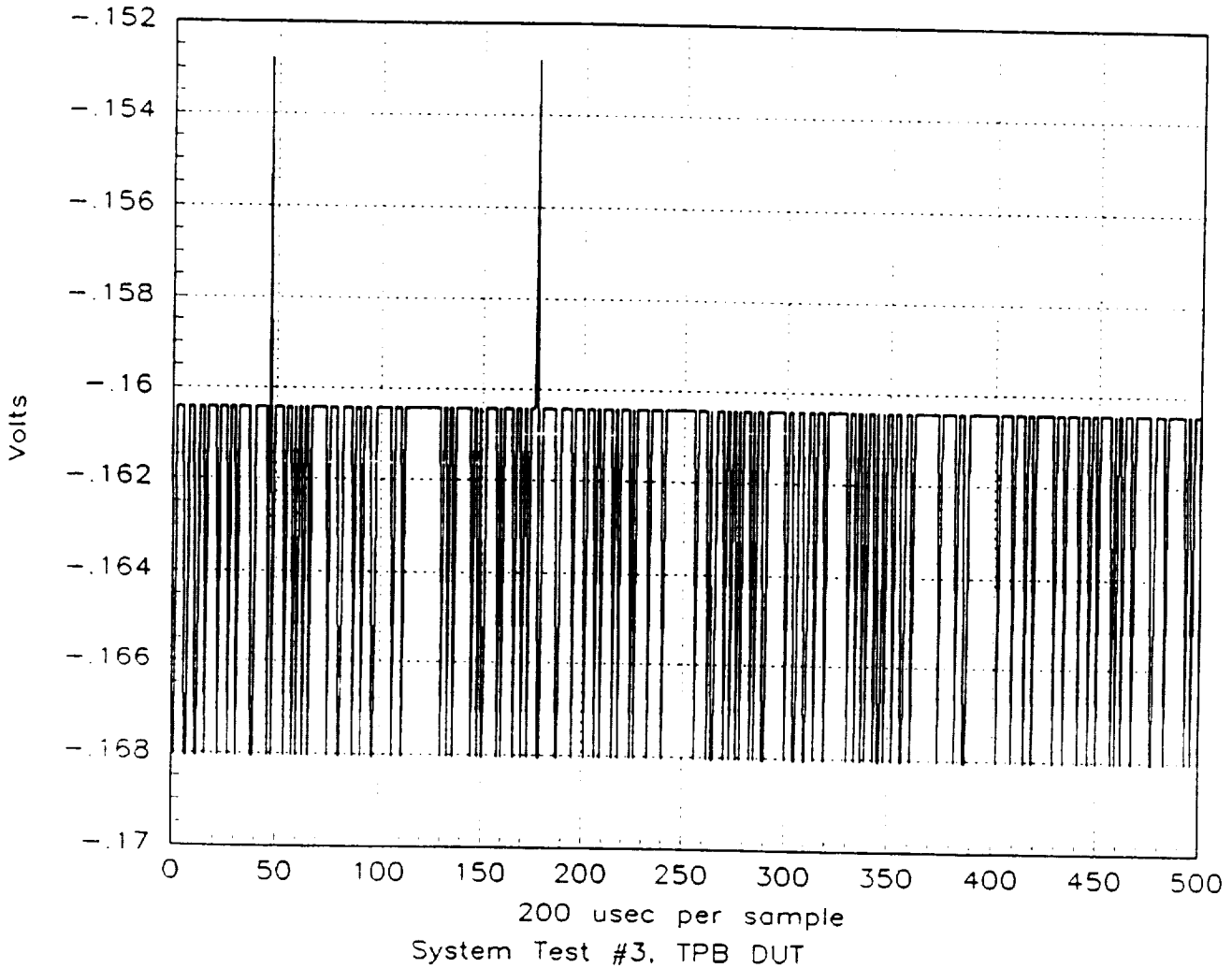

Again, it can be seen that TPB varies by more than  $\pm 4\text{mV}$  but less than  $\pm 12\text{mV}$ , which is very good under this "worst case" condition.

**TPB = Pressure Transducer Feedback**

Figure 4.6 - System Test #3, TPB

## Appendix 1 - Audible Thruster Noise

On December 8, 1989, several tests were performed in the Dynamics and Controls Laboratory (DCL) to determine the amount of audible noise generated by the linear thrusters. A specialized spectrum analyzer and a precision 1/2" condensor microphone, with essentially flat transfer functions over the frequencies of interest, were used to obtain the data before it was plotted. The "narrow-band" spectrums produced are a measure of the voltage produced by the microphone expressed in dB. 0 dB on all of the plots is equivalent to 20 micro-pascals or 0.0002 microbar. The bandwidth is approximately 0.98 Hz and the spectrums cover frequencies up to 750 Hz. The following tests were performed with a single thruster pressurized to 125 psi:

1. Microphone at 90 degrees from thrust direction at a distance of 3 feet from nozzle. (Figure A1.1) Here, the microphone was held at approximately 90 degrees from the nozzle air flow, while the thruster was given full command to one side. In Figure A1.1, a relatively flat spectrum near 50 dB is displayed. The "flatness" of the spectrum is expected because of the characteristic "white" sound of the thruster. Except for a couple of small "spikes" at 115 Hz and 176 Hz, there appear to be no real conspicuous frequencies.
2. Microphone at 45 degrees, 3 feet. (Figures A1.2 and A1.4) The microphone was held at an angle of approximately 45 degrees from nozzle flow while the thruster was commanded full to one side. Once again the spectrum is relatively flat in the neighborhood of 50 dB with small spikes at 115 and 176 Hz. Figure A1.4 tabulates various points on Figure A1.2.
3. Microphone at 45 degrees, 6 feet. (Figures A1.3 and A1.5) This test was identical to the previous one except that the microphone was held 3 feet further out. At 6 feet, the levels are reduced by approximately 5 dB but the general shape of the spectrum remains the same. Figure A1.5 tabulates various points on Figure A1.3.
4. Microphone at 45 degrees, 3 feet, w/plate. (Figure A1.6) For this test an aluminum plate was installed parallel to, and approximately 2" from, the nozzle flow. Comparing Figure A1.6 with A1.2, it is readily seen that the plate tends to increase the sound levels slightly and flatten out the spectrum even more.

**ORIGINAL PAGE IS  
OF POOR QUALITY**

5. Microphone at 45 degrees, 3 feet, with 10 Hz Step Response. (Figures A1.7 and A1.8) A 10 Hz, full scale step command was applied to the thruster. Figure A1.7 shows the full spectrum up to 750 Hz and the 10 Hz square wave frequency components are quite evident. Figure A1.8 is tabulation of these results at the peaks which occur at frequencies that are multiples of 10, as expected. (Only columns 2 and 3 convey significant information.)

Conclusions

Finally, in addition to the above tests, general noise levels were measured at 3 and 6 feet, 45 degrees from nozzle stream, at 125 psi inlet to the thruster. The noise levels were measured at 112.9 and 107.3 dBA, respectively. These measurements are a better standard by which to judge the effect of the noise on the human ear. It uses a different sampling method (A-weighting) which is more sensitive in the KHz frequency range. Since the above readings are a measure of the noise energy above 750 Hz, they cannot be correlated with the plots in Figures A1.1-A1.8. The general consensus produced by the multiple tests performed indicate a relatively flat spectrum over a variety of positions and configurations.



INP

Hanning

N=25

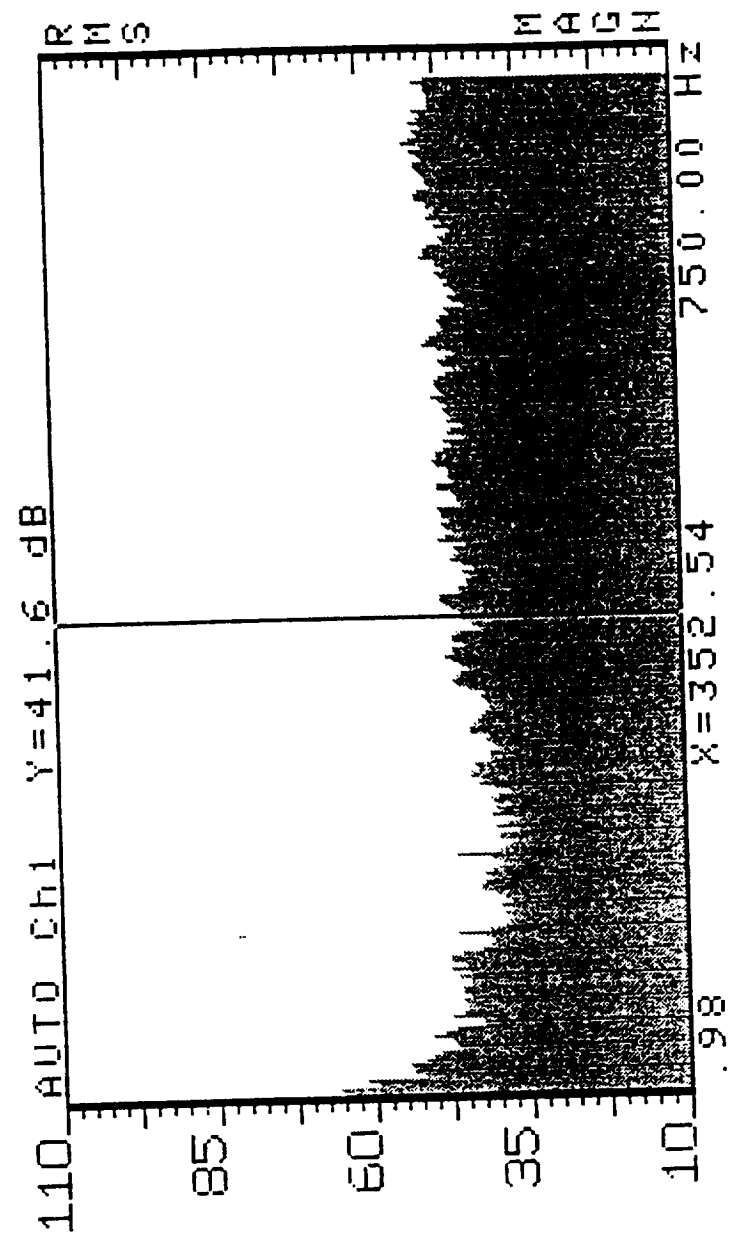

RIA 830  
8 DEC -89 11:37:51

Figure A1.1 - Microphone @ 90°, 3'

IMP

Hanning

N=25

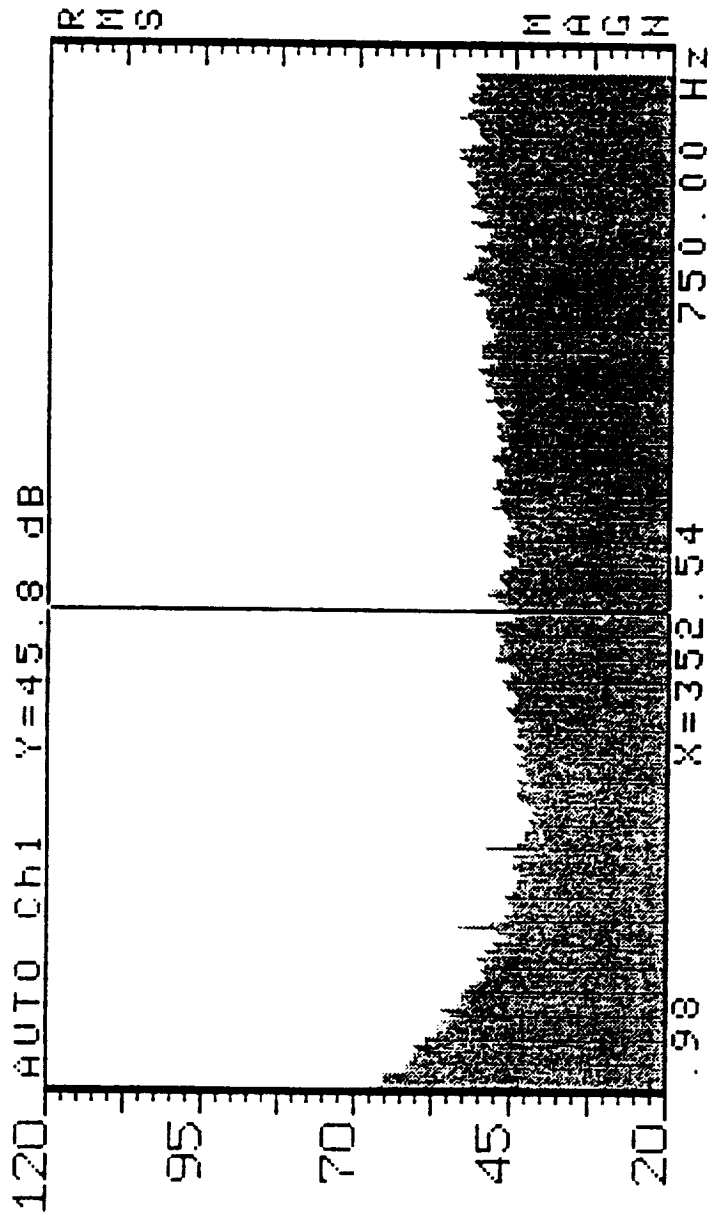
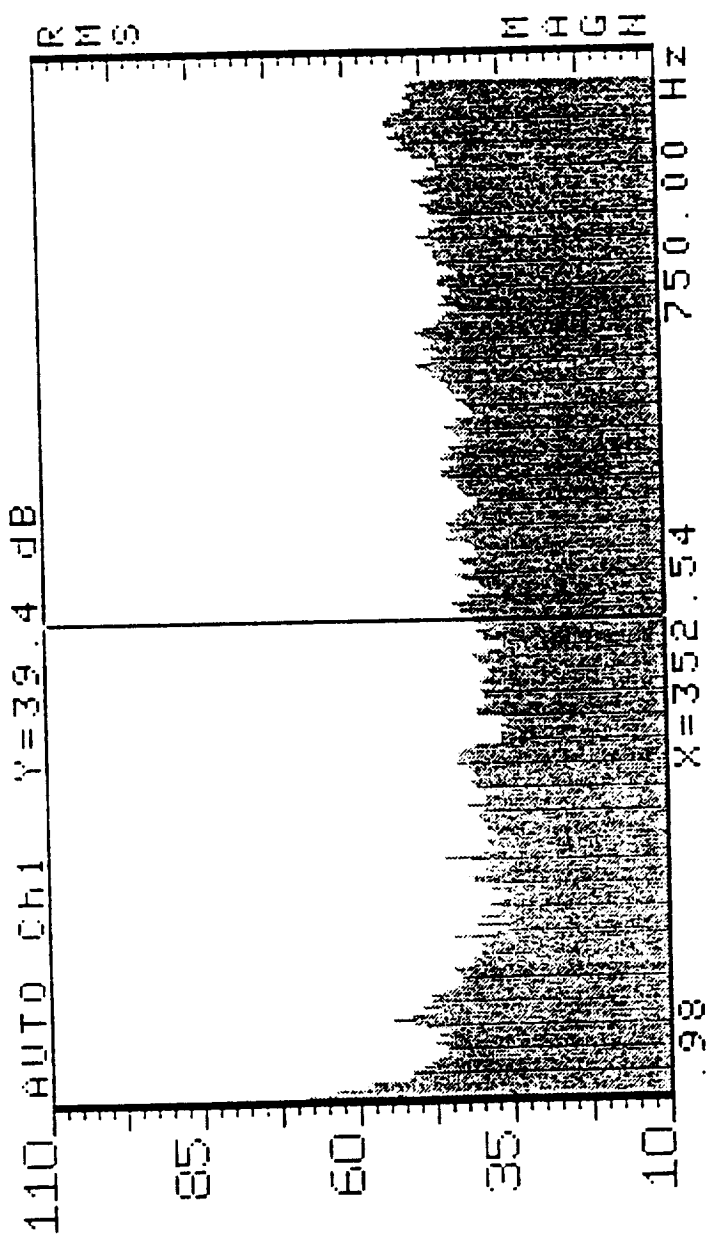

Figure A1.2 - Microphone @ 45°, 3'

IMP

Hanning

N=25



RTA 830  
8 DEC -89 11:50:20

Figure A1.3 - Microphone @ 45°, 6'

 RTA 830  
 8.DEC.-89 12:02:03  
 LAST 12:02:02 0:10  
 Title: VALVE AT 45 deg @ 3'  
 N= 1  
 FREQ. Leq1 Max1 Leq2 Max2

FREQ.	Leq1	Max1	Leq2	Max2
5.00	65.5	74.5		
6.30	63.6	71.3		
8.00	62.6	67.6		
10.0	64.4	71.7		
12.5	63.2	71.2		
16.0	61.6	69.3		
20.0	61.6	66.8		
25.0	61.0	65.8		
31.5	58.4	64.7		
40.0	57.9	66.4		
50.0	56.4	63.3		
63.0	59.3	64.6		
80.0	57.1	61.3		
100	56.8	61.1		
125	55.6	60.2		
160	54.5	59.5		
200	55.6	61.1		
250	57.9	63.2		
315	59.5	64.7		
400	63.0	67.4		
500	65.4	70.1		
630	69.0	73.8		
800	72.3	77.4		
1.00k	75.9	80.3		
A	77.7	82.3		
LIN	79.5	84.8		

Figure A1.4 - Microphone @ 45°, 3': Tabulated Data

 RTA 830  
 8.DEC.-89 12:03:04  
 LAST 12:03:03 0:10  
 Title: VALVE AT 45 deg @ 6'  
 N= 1

FREQ.	Leq1	Max1	Leq2	Max2
5.00	64.3	67.3		
6.30	60.4	64.4		
8.00	57.6	60.2		
10.0	58.8	61.1		
12.5	57.4	60.5		
16.0	57.2	60.4		
20.0	58.0	59.8		
25.0	55.4	57.3		
31.5	53.6	55.8		
40.0	55.0	56.9		
50.0	56.8	58.4		
63.0	60.7	62.8		
80.0	56.8	58.2		
100	53.7	55.2		
125	52.8	53.8		
160	52.5	53.9		
200	54.0	55.4		
250	56.1	57.0		
315	56.3	57.0		
400	59.6	60.1		
500	62.9	64.3		
630	66.4	67.4		
800	70.4	71.0		
1.00k	71.7	72.0		
A	74.3	74.5		
LIN	76.3	76.6		

Figure A1.5 - Microphone @ 45°, 6': Tabulated Data

N=25 Hanning IMP

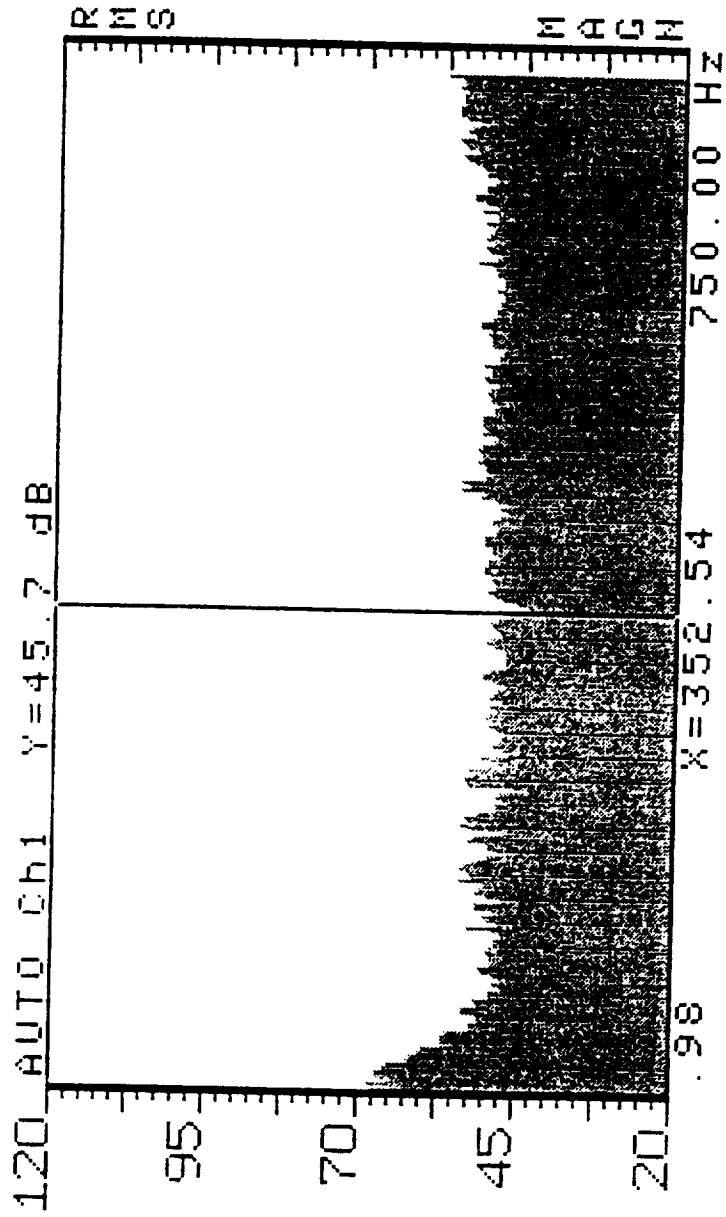

RTA 830  
8 DEC -89 12:16:50

Figure A1.6 - Microphone @ 45°, w/plate

IMP

Hanning

N=25

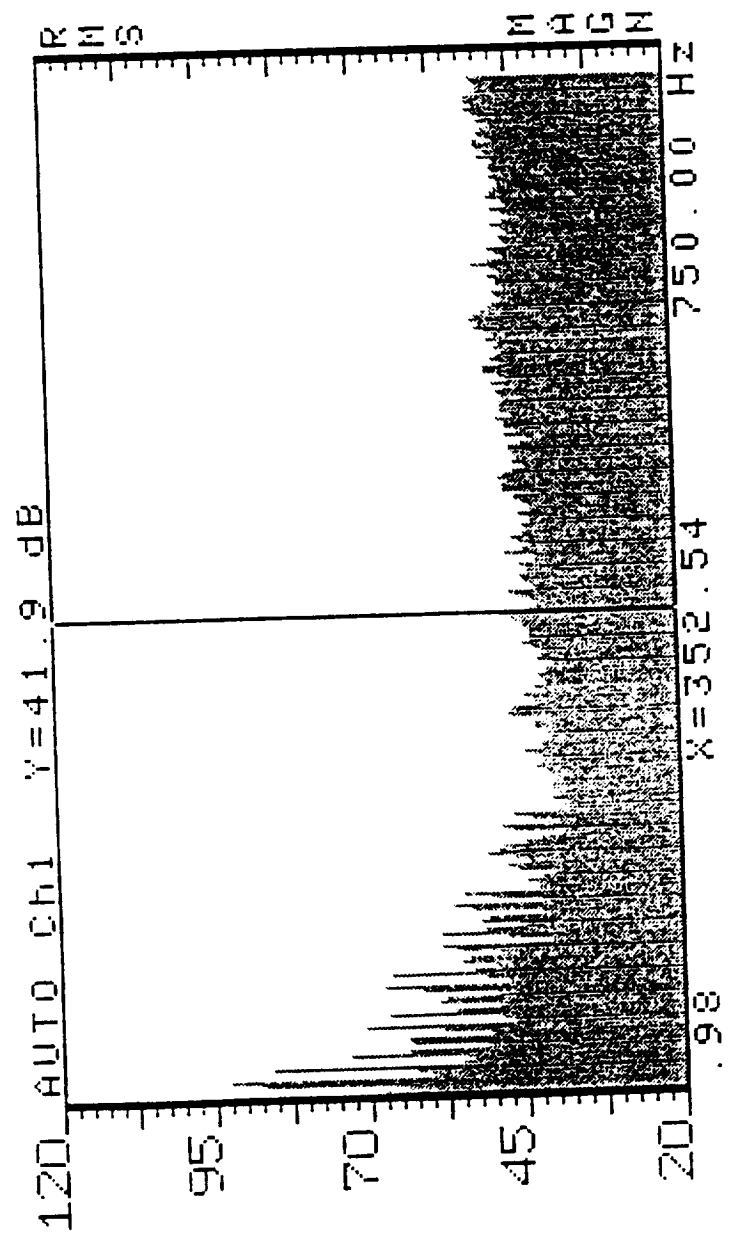

RTA 830  
8 DEC -89 12:20:07

Figure A1.7 - Microphone @ 45°, 10 Hz Step @ 125 psi

Harmonic cursors, numerical readout

No	x[Hz]	y[dB]	yr[dB]
0			
1	109.74000	56.400	19.000
1	110.97000	56.400	19.000
1	112.20000	56.400	19.000
1	113.43000	56.400	19.000
1	114.66000	56.400	19.000
1	115.89000	56.400	19.000
1	117.12000	56.400	19.000
1	118.35000	56.400	19.000
1	119.58000	56.400	19.000
1	120.81000	56.400	19.000
1	122.04000	56.400	19.000
1	123.27000	56.400	19.000
1	124.50000	56.400	19.000
1	125.73000	56.400	19.000
1	126.96000	56.400	19.000
1	128.19000	56.400	19.000
1	129.42000	56.400	19.000
1	130.65000	56.400	19.000
1	131.88000	56.400	19.000
1	133.11000	56.400	19.000
1	134.34000	56.400	19.000
1	135.57000	56.400	19.000
1	136.80000	56.400	19.000
1	138.03000	56.400	19.000
1	139.26000	56.400	19.000
1	140.49000	56.400	19.000
1	141.72000	56.400	19.000
1	142.95000	56.400	19.000
1	144.18000	56.400	19.000
1	145.41000	56.400	19.000
1	146.64000	56.400	19.000
1	147.87000	56.400	19.000
1	149.10000	56.400	19.000
1	150.33000	56.400	19.000
1	151.56000	56.400	19.000
1	152.79000	56.400	19.000
1	154.02000	56.400	19.000
1	155.25000	56.400	19.000
1	156.48000	56.400	19.000
1	157.71000	56.400	19.000
1	158.94000	56.400	19.000
1	160.17000	56.400	19.000
1	161.40000	56.400	19.000
1	162.63000	56.400	19.000
1	163.86000	56.400	19.000
1	165.09000	56.400	19.000
1	166.32000	56.400	19.000
1	167.55000	56.400	19.000
1	168.78000	56.400	19.000
1	170.01000	56.400	19.000
1	171.24000	56.400	19.000
1	172.47000	56.400	19.000
1	173.70000	56.400	19.000
1	174.93000	56.400	19.000
1	176.16000	56.400	19.000
1	177.39000	56.400	19.000
1	178.62000	56.400	19.000
1	179.85000	56.400	19.000
1	181.08000	56.400	19.000
1	182.31000	56.400	19.000
1	183.54000	56.400	19.000
1	184.77000	56.400	19.000
1	186.00000	56.400	19.000
1	187.23000	56.400	19.000
1	188.46000	56.400	19.000
1	189.69000	56.400	19.000
1	190.92000	56.400	19.000
1	192.15000	56.400	19.000
1	193.38000	56.400	19.000
1	194.61000	56.400	19.000
1	195.84000	56.400	19.000
1	197.07000	56.400	19.000
1	198.30000	56.400	19.000
1	199.53000	56.400	19.000
1	200.76000	56.400	19.000
1	202.00000	56.400	19.000
1	203.23000	56.400	19.000
1	204.46000	56.400	19.000
1	205.69000	56.400	19.000
1	206.92000	56.400	19.000
1	208.15000	56.400	19.000
1	209.38000	56.400	19.000
1	210.61000	56.400	19.000
1	211.84000	56.400	19.000
1	213.07000	56.400	19.000
1	214.30000	56.400	19.000
1	215.53000	56.400	19.000
1	216.76000	56.400	19.000
1	218.00000	56.400	19.000
1	219.23000	56.400	19.000
1	220.46000	56.400	19.000
1	221.69000	56.400	19.000
1	222.92000	56.400	19.000
1	224.15000	56.400	19.000
1	225.38000	56.400	19.000
1	226.61000	56.400	19.000
1	227.84000	56.400	19.000
1	229.07000	56.400	19.000
1	230.30000	56.400	19.000
1	231.53000	56.400	19.000
1	232.76000	56.400	19.000
1	234.00000	56.400	19.000
1	235.23000	56.400	19.000
1	236.46000	56.400	19.000
1	237.69000	56.400	19.000
1	238.92000	56.400	19.000
1	240.15000	56.400	19.000
1	241.38000	56.400	19.000
1	242.61000	56.400	19.000
1	243.84000	56.400	19.000
1	245.07000	56.400	19.000
1	246.30000	56.400	19.000
1	247.53000	56.400	19.000
1	248.76000	56.400	19.000
1	250.00000	56.400	19.000

Figure A1.8 - Microphone @ 45°, 10 Hz Step (Tabulated)



## Appendix 2 - Thruster Force Spectrums

On December 7, 1989, tests were performed in the Dynamics and Controls Laboratory (DCL) to measure the frequency spectrum of the force produced by the linear thrusters. The purpose of the testing was to determine the effects of the test set-up on measured force and to contrast the filtered measurements with the unfiltered measurements. (A passive first-order low-pass filter with a cutoff at 100 Hz was used to "clean-up" the measured force data in order to determine hysteresis and linearity).

The frequency spectrums were measured by commanding the linear thruster in various ways while recording the force gage output via a Transducer Techniques Inc. ultra precision mini load cell model MDB-10-T, an HP Frequency Spectrum Analyzer, and a camera. A total of 12 photos were taken and are displayed in a matrix on the following pages. Figure A2.1 records the spectrums produced while commanding a 0.2 Hz, full-scale sine wave to one side of the thruster. Column 1 shows the frequency spectrums when exhausting away from the force test hardware; column 2, into the force test hardware. Row 1 shows the unfiltered spectrums; row 2, the filtered. Figure A2.2 is the same as Figure A2.1 except that a 0 to 0.25 volt, 0.2 Hz sine wave is commanded at test point A (TPA), where 5V is full scale. Similarly, Figure A2.3, is identical to Figures A2.1 and A2.2 except that the thruster is given a full-scale DC command.

The horizontal axis in each plot is a linear scale of frequency up to 1 KHz and the vertical axis is force transducer voltage plotted in dB. All spectrums were obtained by RMS averaging of 32 samples of the force transducer voltage. Plots were made using a Hanning window which produced a bandwidth of 6.0 Hz as can be seen in the photographs.

### Conclusions

Comparing the plots of the filtered and unfiltered spectrums, it can be seen that the filtered data is significantly attenuated. More importantly, however, there seems to be a significant dissimilarity between the spectrums of thrusting away from the test set-up and those thrusting into it. Thrusting into the test set-up seems to generate more "noise". In particular, two "humps" at about 380 Hz and 590 Hz are evident on all spectrums taken when thrusting into the test set-up. In addition, there is another peak at 60 Hz on all plots which reveals the structural mode of the test set-up as described in section 3.4.

Unfiltered

Filtered

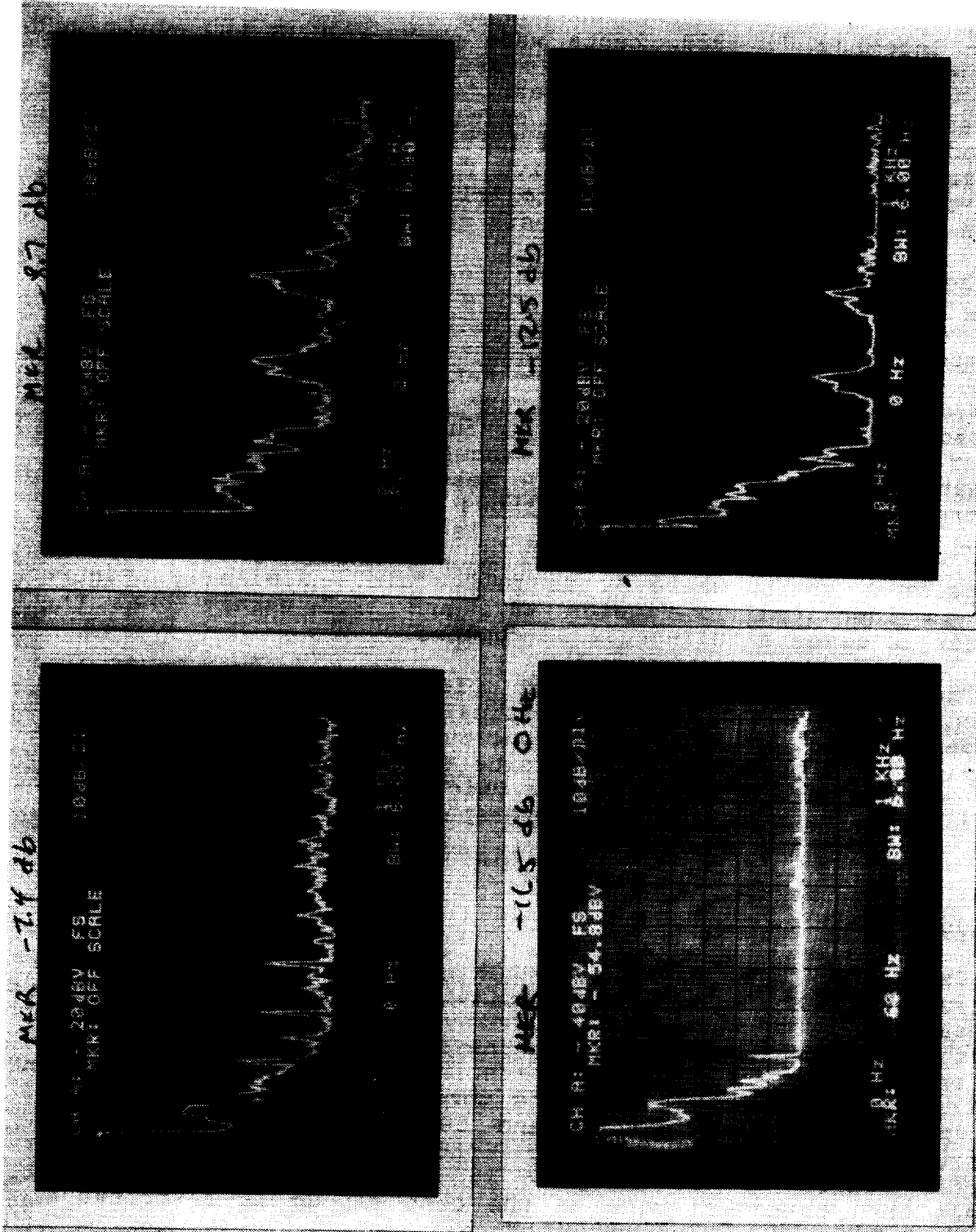

Into Structure

Away From Structure

Figure A2.1 - 0.2 Hz Sine, 0 to 5 Volts at TPA

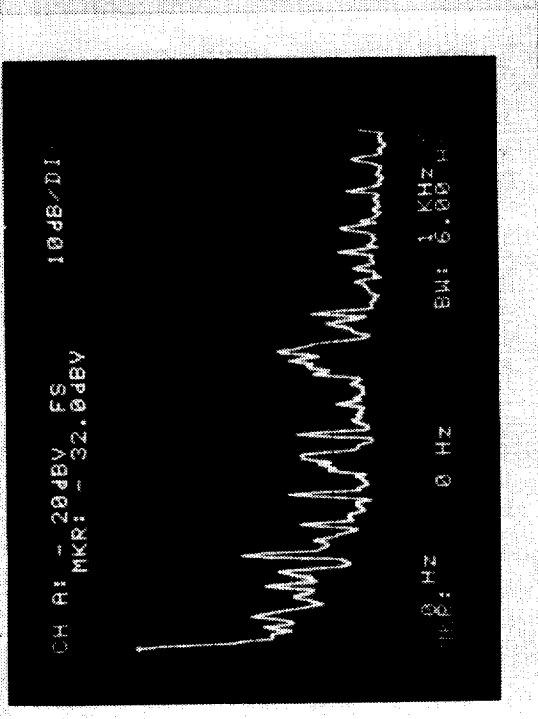
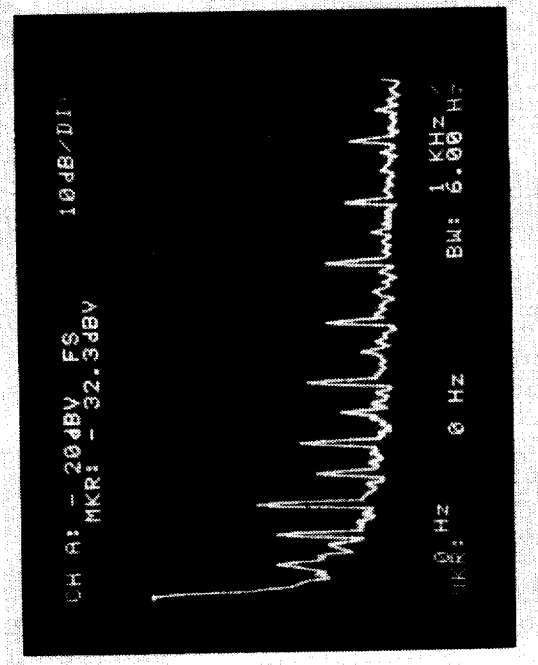

Unfiltered

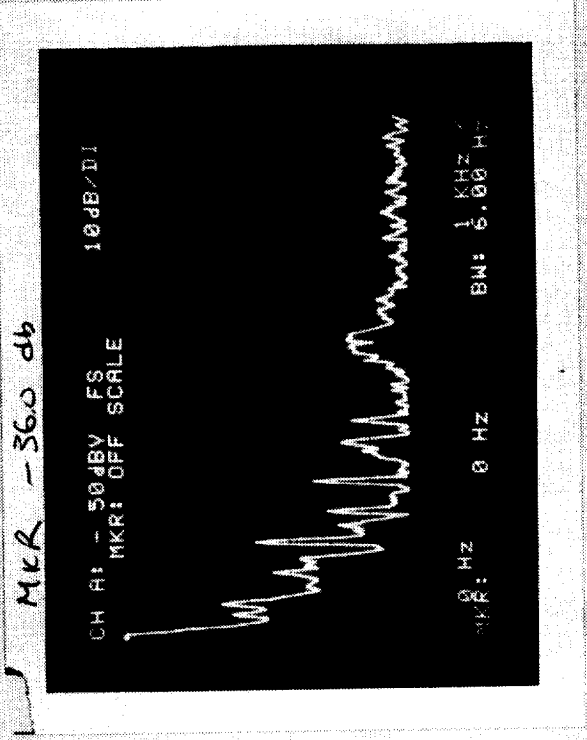
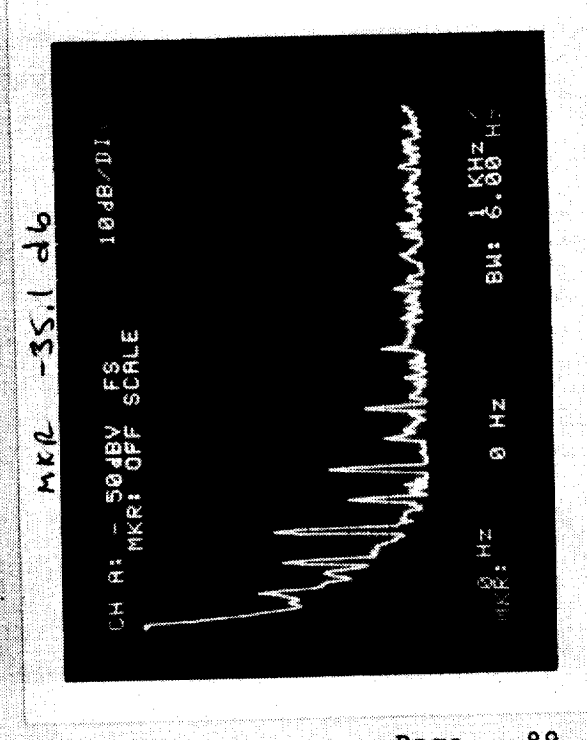

Filtered

MKR -36.0 db

MKR -35.1 db

Away From Structure Into Structure  
Figure A2.2 - 0 to 0.25 Volt, 0.2 Hz Sine at TPA

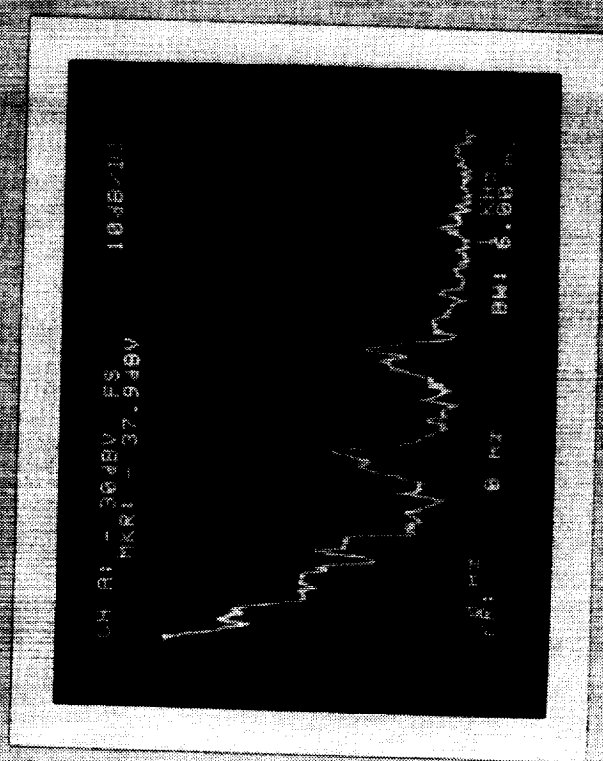
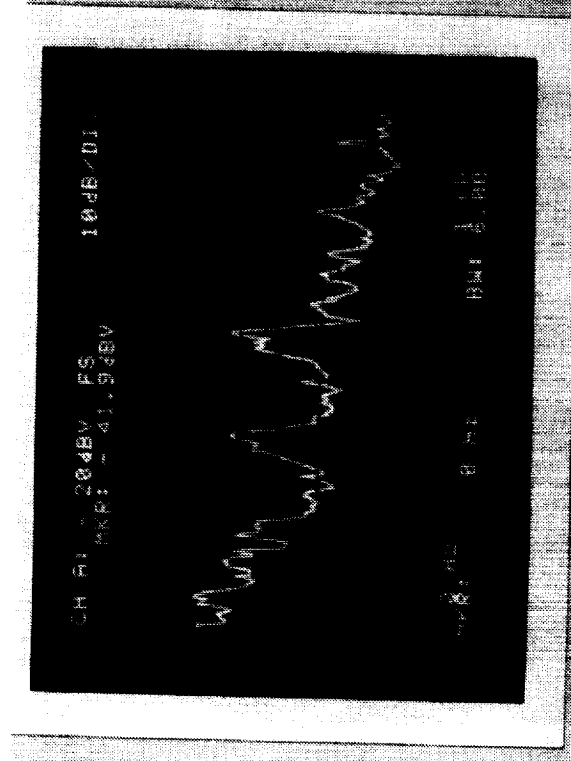
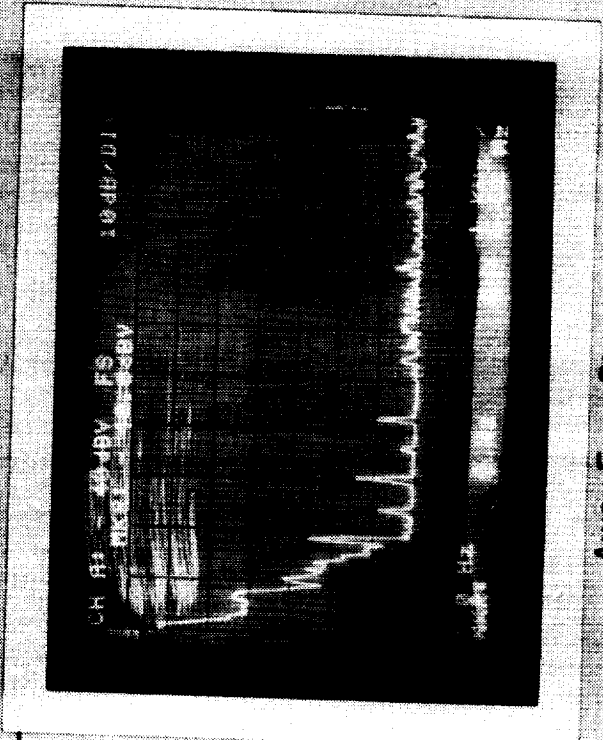
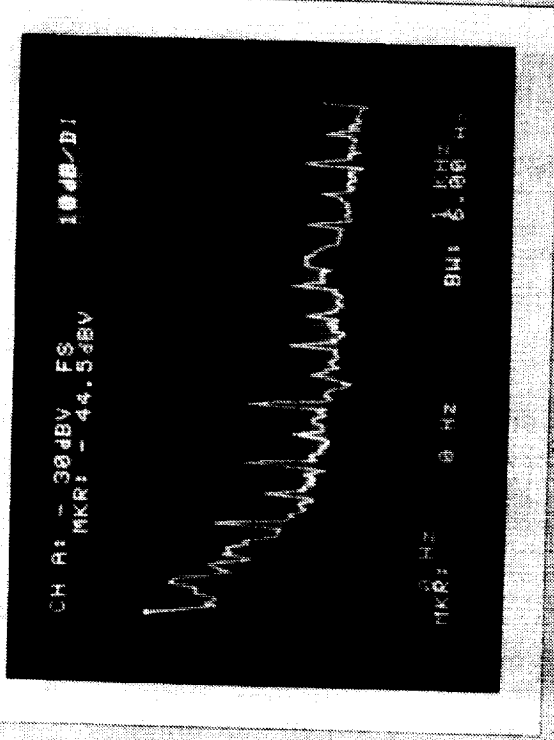

Unfiltered

Filtered

Away From Structure

Into Structure

Figure A2.3 - 5 Volt DC Command at TPA

# APPENDIX 3

## MOUNTING SURFACE FORCE TEST

The purpose of this test is to determine the magnitude of the force exerted by the bi-directional thruster on the mounting surface. A flat 6 inch by 8 inch thin aluminum plate was placed below the thruster nozzle as shown in Figure A3. The thruster was given a full 2 lb thrust command and both perpendicular and in-plane forces were measured with a force gage. The perpendicular force versus distance between the plate and nozzle is given below. The in-plane force for all plate distances was less than the least scale increment of 0.01 pounds.

<u>DISTANCE BETWEEN PLATE AND NOZZLE</u>	<u>FORCE EXERTED PERPENDICULAR TO THE PLATE SURFACE</u>
0.5 in.	0.03 lbs
1.0 in.	0.01 lbs
1.5 in.	< 0.01 lbs

### RECOMMENDATIONS

As is the nozzle is 0.5 inches above the mounting surface due to the manifold and the perpendicular plate force would be 0.03 lbs. Stand offs of at least 0.5 inches should be used to reduce the perpendicular force to be no more than 0.01 lbs.

TOP VIEW

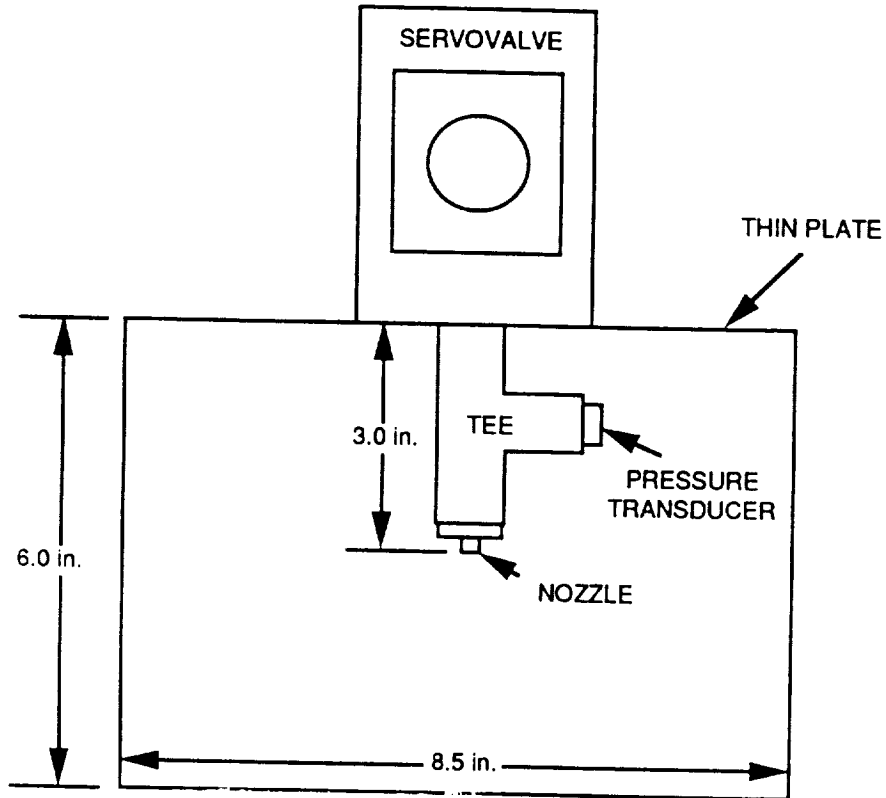

FRONT VIEW

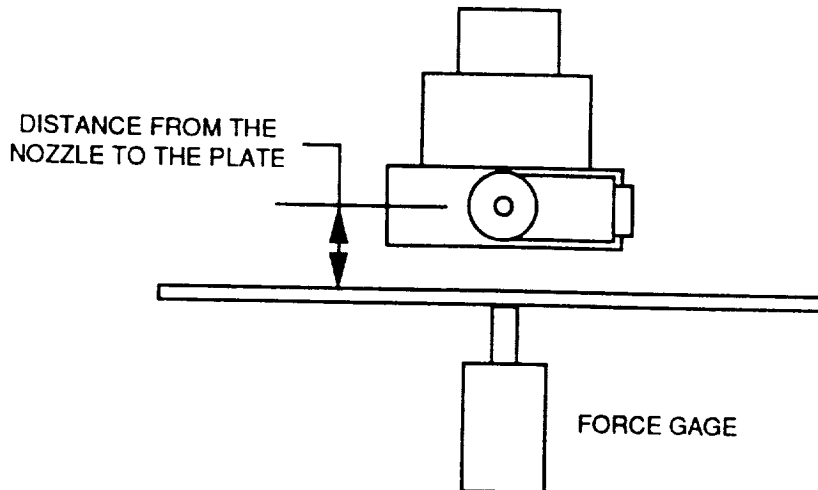

FIGURE A3 - MOUNTING SURFACE FORCE TEST SET-UP



# Report Documentation Page

1. Report No. NASA CR-182013		2. Government Accession No.		3. Recipient's Catalog No.	
4. Title and Subtitle Bi-Directional Thruster Development and Test Report			5. Report Date February 1990		
			6. Performing Organization Code		
7. Author(s) A. D. Jacot, G. S. Bushnell, T. M. Anderson			8. Performing Organization Report No.		
			10. Work Unit No. 590-14-41-04		
9. Performing Organization Name and Address Boeing Aerospace & Electronics 20403 68th Ave South 18-26 Bldg Kent, WA 98032			11. Contract or Grant No. NAS1-18762		
			13. Type of Report and Period Covered Contractor Report Final - July 1989 - Oct. 1989		
12. Sponsoring Agency Name and Address National Aeronautics and Space Administration Langley Research Center Hampton, VA 23665-5225			14. Sponsoring Agency Code		
			15. Supplementary Notes Technical Monitor - Garnett C. Horner, Langley Research Center		
16. Abstract <p>This report describes the design, calibration, and testing of cold gas, bi-directional throttlable thruster. The thruster consists of a electro-pneumatic servovalve, exhausting thru opposite nozzles with a high gain pressure feedback loop to optimize performance.</p> <p>The thruster force was measured to determine hysteresis and linearity. Integral gain was used to maximize performance for linearity, hysteresis, and minimum thrust requirements. Proportional gain provided high dynamic response (bandwidth and phase lag). Thruster performance is very important since the thrusters are intended to be used for active control.</p>					
17. Key Words (Suggested by Author(s)) Jets, Thrusters, Actuators, Active Controllers, electro-pneumatic servosystem			18. Distribution Statement unclassified - unlimited subject category - 18		
19. Security Classif. (of this report) unclassified		20. Security Classif. (of this page) unclassified		21. No. of pages 93	22. Price A05







