

NASA-CR-183940

TWR-18898

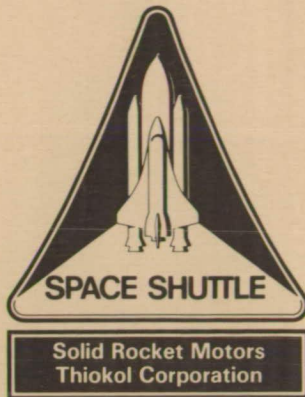

Qualification of the RSRM Case Membrane Case-to-Insulation Bondline Inspection Using the Thiokol Corporation Ultrasonic RSRM Bondline Inspection System

Final Test Report

April 1990

ORIGINAL CONTAINS
COLOR ILLUSTRATIONS

Contract No. NAS8-30490
DR No. 5-3
WBS No. 4B102-10-10
ECS No. SS2412

Thiokol CORPORATION
SPACE OPERATIONS

P.O. Box 707, Brigham City, UT 84302-0707 (801) 863-3511

Publications No. 90509

(NASA-CR-183940) QUALIFICATION OF THE RSRM
CASE MEMBRANE CASE-TO-INSULATION BONDLINE
INSPECTION USING THE THIOKOL CORPORATION
ULTRASONIC RSRM BONDLINE INSPECTION SYSTEM
Final Test Report (Thiokol Corp.) 43 p

N90-22602

Unclas
0278782

H1/20

Qualification of the RSRM Case Membrane
Case-to-Insulation Bondline Inspection
Using the Thiokol Corporation Ultrasonic
RSRM Bondline Inspection System
Final Test Report

**ORIGINAL CONTAINS
COLOR ILLUSTRATIONS**

Prepared by:

Mark Cook 27 MAR 90
Test Planning and Reports
Systems Engineer

Approved by:

J.R. Gauey
Requirements Manager

Paul Kainer 27 Mar 90
Design Engineer

A. Marsh
Program Management

S.B. Thompson
Program Management

J.W. LeBaron
System Integration Engineer

Kerry Sample 3-29-90
System Safety

Fred Dunsch 29 March 90
Reliability

P.C. Lydeck 3-29-90
Data Management
ECS No. SS2412

**ORIGINAL PAGE IS
OF POOR QUALITY**

ABSTRACT

Qualification testing of Combustion Engineering's Amdata Intraspect/98 Data Acquisition and Imaging System that applies to the redesigned solid rocket motor case membrane case-to-insulation bondline inspection was performed on ~~29 Jan 1990~~. Testing was performed at M-67, the Thiokol Corporation RSRM Assembly Facility. The purpose of the inspection is to verify the integrity of the case membrane case-to-insulation bondline.

The case membrane scanner was calibrated on the redesigned solid rocket motor case segment calibration standard, which had an intentional 1.0 by 1.0-in. case-to-insulation unbond. The case membrane scanner was then used to scan a 20 by 20-in. membrane area of the case segment. Calibration of the scanner was then rechecked on the calibration standard to ensure that the calibration settings did not change during the case membrane scan. This procedure was successfully performed five times to qualify the unbond detection capability of the case membrane scanner.

CONTENTS

<u>Section</u>		<u>Page</u>
1	INTRODUCTION	1
	1.1 TEST ARTICLE DESCRIPTION	1
2	OBJECTIVES	5
3	EXECUTIVE SUMMARY	6
	3.1 SUMMARY	6
	3.2 CONCLUSIONS	6
	3.3 RECOMMENDATIONS	8
4	INSTRUMENTATION	9
5	PHOTOGRAPHY	9
6	RESULTS AND DISCUSSION	10
	6.1 TEST ARTICLE COMPONENT DESCRIPTION	10
	6.2 INSPECTION SCAN PARAMETERS	10
	6.3 TEST DESCRIPTION, RESULTS, AND DISCUSSION	11
7	APPLICABLE DOCUMENTS	37

FIGURES

<u>Figure</u>		<u>Page</u>
1	Case Membrane Scanner (without transducer assembly)	2
2	Case Membrane Scanner Transducer Configuration	3
3	Case Membrane Scanner Configuration	12
4	Calibration Block Setup	13
5	Case Membrane Scanner Installation	14
6	Case Membrane Scanner Calibration Run	15
7	Workstand and Segment	16
8	Couplant Recovery System Configuration	17
9	Vacuum Track Installation on Segment	18
10	Case Membrane Scanner Installation on Vacuum Track	19
11	Case Membrane Scanning Sequence on Segment	20
12	Calibration-in Sequence--Scan Run No. 1	21
13	Scanning Sequence--Scan Run No. 1	22
14	Calibration-out Sequence--Scan Run No. 1	23
15	Calibration-in Sequence--Scan Run No. 2	24
16	Scanning Sequence--Scan Run No. 2	25
17	Calibration-out Sequence--Scan Run No. 2	26
18	Calibration-in Sequence--Scan Run No. 3	27
19	Scanning Sequence--Scan Run No. 3	28
20	Calibration-out Sequence--Scan Run No. 3	29
21	Calibration-in Sequence--Scan Run No. 4	30
22	Scanning Sequence--Scan Run No. 4	31
23	Calibration-out Sequence--Scan Run No. 4	32
24	Calibration-in Sequence--Scan Run No. 5	33
25	Scanning Sequence--Scan Run No. 5	34
26	Calibration-out Sequence--Scan Run No. 5	35

ACRONYMS

RF radio frequency
RSRM redesigned solid rocket motor
URBIS ultrasonic RSRM bondline inspection system

INTRODUCTION

This report presents the procedures, performance, and results of the qualification test for Combustion Engineering's Amdata Intraspect/98 Data Acquisition and Imaging System that apply to the redesigned solid rocket motor (RSRM) case membrane case-to-insulation bondline inspection. The purpose of the inspection is to verify the integrity of the case membrane area case-to-insulation bondline. The inspection is performed at Thiokol Corporation's Space Operations facility in Utah. The Intraspect/98 system is referred to as the Thiokol Corporation Ultrasonic RSRM Bondline Inspection System (URBIS) (C77-0479).

Testing was conducted in accordance with CTP-0088, Qualification Plan for the Ultrasonic Inspection of the RSRM Membrane Case/Insulation Bondline Utilizing the Thiokol Corporation Ultrasonic RSRM Bondline Inspection System. Testing was performed on 30 Jan 1990 at M-67, Thiokol's RSRM Assembly Facility.

The URBIS functions by transmitting ultrasonic signals (pulse-echo) from the transducer surface to the case surface through a liquid couplant. A return signal is then received by the transducer. This return signal is amplified, filtered, digitized, and processed for display. During an inspection, a well-bonded case-to-insulation interface will reflect a small signal, while an air-backed unbonded region will reflect a larger signal.

Qualification testing of the URBIS components that are generic to all inspections (capture feature, clevis, pinholes, and membrane) has been performed under CTP-0100 and is documented in TWR-18894. It is recommended that these documents and CTP-0088 be referred to for additional explanation of URBIS components and test procedures.

1.1 TEST ARTICLE DESCRIPTION

The case membrane scanner consists of a transducer assembly and the Amaps 2090 scanner (scanner arm and drive mechanism) (Figures 1 and 2). An ultrasonic

Top View

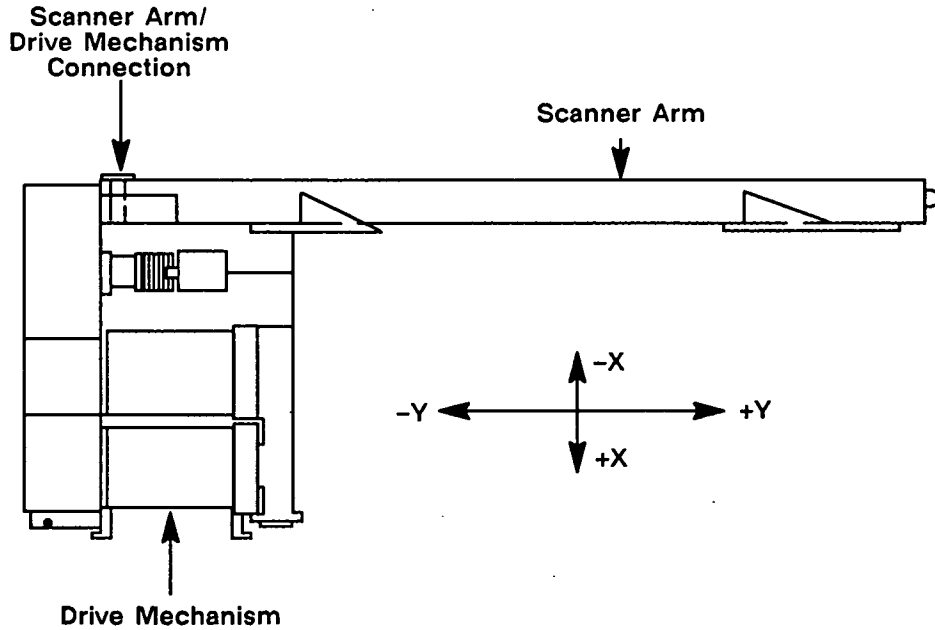

Side View

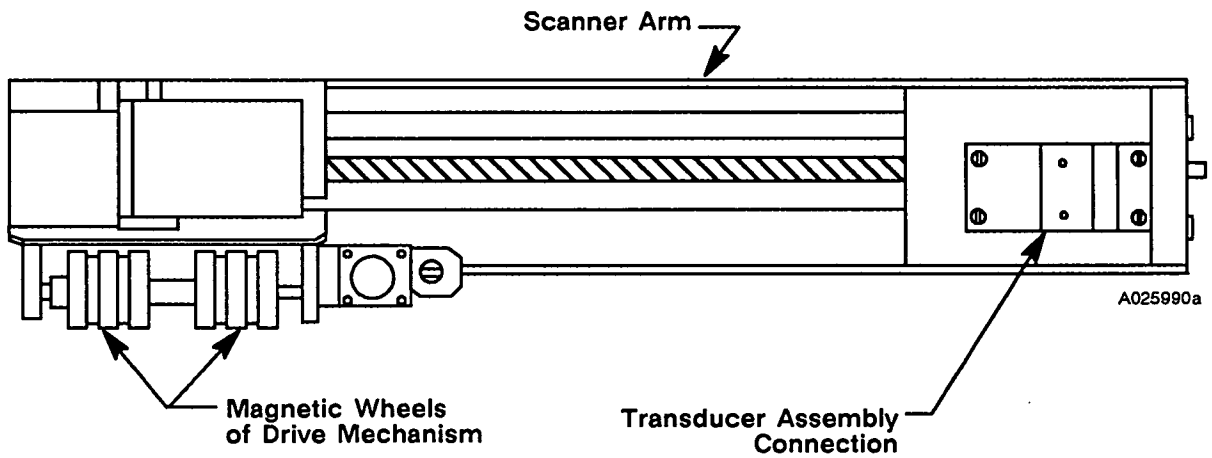

Note: Not to scale

Figure 1. Case Membrane Scanner (without transducer assembly)

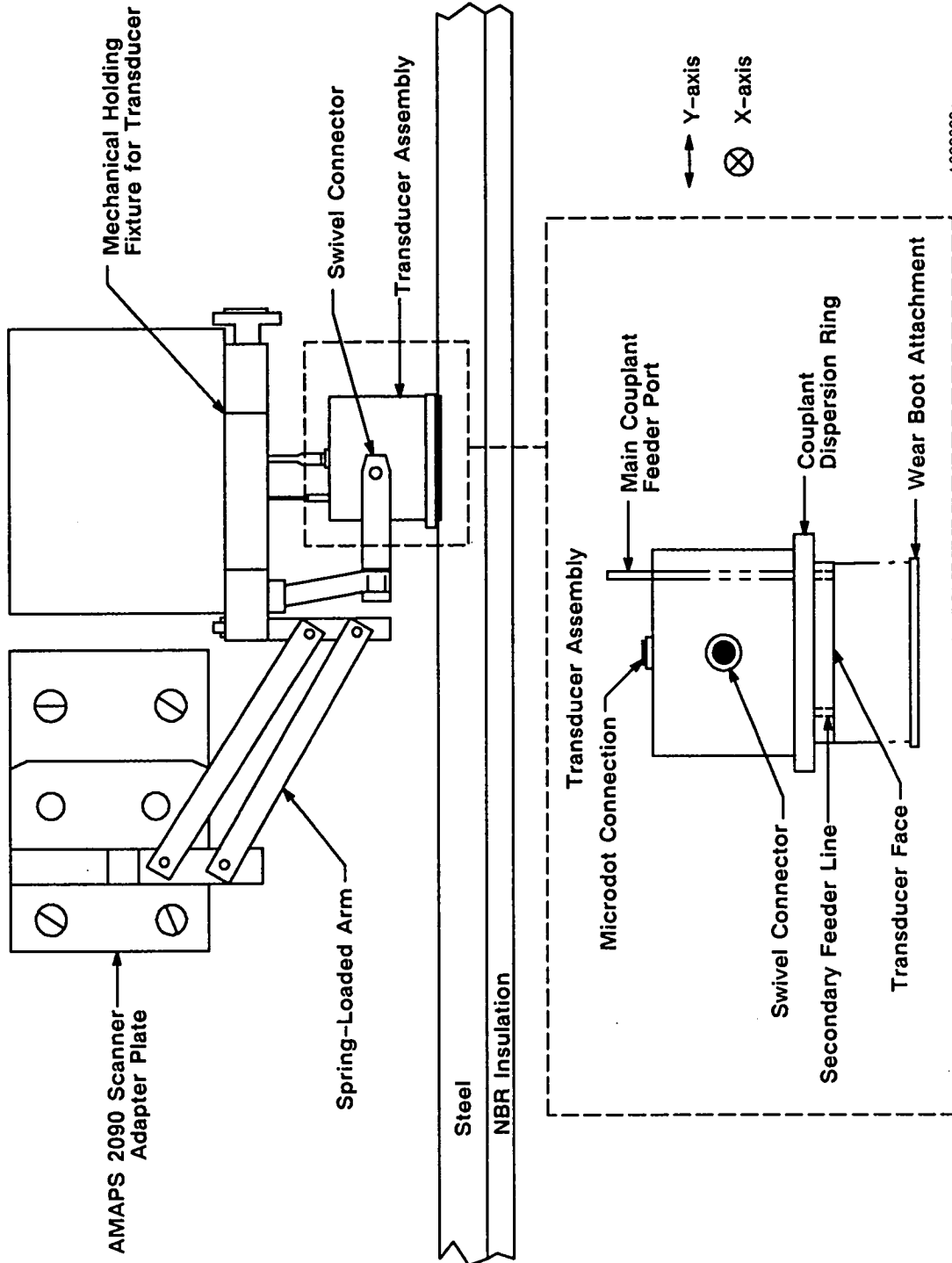

A022823a

Figure 2. Case Membrane Scanner Transducer Configuration

transducer is positioned and held in place within the transducer assembly. The 0.50-in.-diameter broadband transducer has a center frequency of 5.0 MHz. Couplant feeder ports are integrated directly into the transducer assembly to provide a conductive interface between the transducer and the RSRM case. During a case scan, couplant is captured by a plastic retrieval system. The transducer is coil spring-loaded within the nylon transducer assembly. A vacuum track is attached directly to the case to guide the scanner. The case membrane scanner is part of the URBIS (C77-0479). The URBIS was assembled under 2U129431.

Testing was performed on the RSRM Flight 13A aft loaded segment (P/N 1U76676-07, S/N 0000005) (newly designated as the Flight 12B aft loaded segment). A calibration standard consisting of a section of RSRM case with intentional case-to-insulation unbonds was used to calibrate the case membrane scanner/URBIS. The calibration standard was assembled under 2U129702.

A detailed configuration of the generic URBIS components (Amdata Intraspect 98/Data Acquisition and Imaging System) used in association with the URBIS case membrane case-to-insulation bondline inspection qualification is documented in CTP-0100.

2

OBJECTIVES

The objectives of CTP-0088 were intended to qualify the tooling and techniques used in the RSRM case membrane case-to-insulation bondline inspection. The objectives were:

- a. Verify that the ultrasonic inspection kit has the capability of detecting 1.0 by 1.0-in. unbonded surfaces, which are not detectable by visual inspection (CDW2-3452, Para. 3.2.1.1).
- b. Verify that the ultrasonic inspection kit interfaces with the membrane region of the segment and requires no special tools for attachment and release (CDW2-3452, Para. 3.2.1.2).
- c. Verify that the ultrasonic inspection kit can be transported (CDW2-3452, Para. 3.2.8).

3

EXECUTIVE SUMMARY

3.1 SUMMARY

This section contains an executive summary of the key results from test data evaluation. Additional information and details can be found in Section 6.

The case membrane scanner was calibrated on the RSRM case segment calibration standard, which had an intentional 1.0 by 1.0-in. case-to-insulation unbond. The case membrane scanner was then used to scan a 20 by 20-in. membrane area of the case segment. Calibration of the scanner was then rechecked on the calibration standard to ensure that the calibration settings did not change during the case membrane scan. This procedure was successfully performed five times to qualify the unbond detection capability of the case membrane scanner. No unbonds were detected on the case membrane. During the test, the case membrane scanner and the case segment were not degraded.

3.2 CONCLUSIONS

The following columns list the conclusions as they relate specifically to the objectives. Additional information to support each conclusion can be found in Section 6.

<u>Objective</u>	<u>CDW2-3452 Paragraph</u>	<u>Conclusion</u>
a. Verify that the ultrasonic inspection kit has the capability of detecting 1.0 by 1.0-in. unbonded surfaces that are not detectable by visual inspection.	Para. 3.2.1.1, General Performance. This inspection tool provides a means of detecting subsurface bondline failures that are not detectable by visual inspection. (Compressed "kissing" unbonds are not detectable.) The ultrasonic tool shall have the capability of detecting unbonds of 1.0 by 1.0-in. Use of this tool shall permit unbonds to be detected and repaired before stacking. Use of the inspection kit shall not affect the reusability requirements for the case segment and associated equipment denoted in CPW1-3600, Table IV.	<i>Verified.</i> The case membrane scanner was calibrated over an intentional 1.0 by 1.0-in. unbond, then used to scan a 20 by 20-in. area of a case membrane, and then checked for calibration accuracy. This procedure was successfully performed five times. This test qualified the unbond detection capability of the case membrane scanner/URBIS.
b. Verify that the ultrasonic inspection kit interfaces with the membrane region of the segment and requires no special tools for attachment and release.	Para. 3.2.1.2, Installation Function. The ultrasonic case to insulation bondline inspection kit shall interface with the field joint (membrane) of segment. Attachment and release of fixture shall be efficient and require no special tools.	<i>Verified.</i> The case membrane scanner successfully interfaced with the case membrane throughout the scanning procedure, without the aid of additional tools. During the test, the case membrane scanner and the case segment were not degraded.
c. Verify that the ultrasonic inspection kit can be transported.	Para. 3.2.8, Transportability/Transportation. The case-to-insulation bondline inspection kit, ultrasonic, shall be capable of being handled and transported manually. The kit shall also be capable of being handled and transported by any suitable means during transportation to the launch site. The RSRM segment case-to-insulation bondline inspection kit, ultrasonic, shall be packaged in accordance with NHB 6000.1 to protect it from the shipping environment.	<i>Verified.</i> The complete URBIS is designed to be broken down into components which are placed in protective cases for transportability. This testing verified the transportability of the case membrane scanner/URBIS.

3.3 RECOMMENDATION

Based on the successful completion of testing under CTP-0088, the case membrane scanner/URBIS should be considered qualified for RSRM inspections at Thiokol Corporation's Utah Space Operations.

4

INSTRUMENTATION

Test instruments were electrically zeroed and calibrated in accordance with MIL-STD-45662.

5

PHOTOGRAPHY

Still black and white photographs of the test setup were taken. Copies of the photographs taken (series No. 115650) are available from the Thiokol Corporation Photographic Services department.

6

RESULTS AND DISCUSSION

6.1 TEST ARTICLE COMPONENT DESCRIPTION

The following inspection components were used during the CTP-0088 qualification:

<u>Component</u>	<u>Part No.</u>	<u>Serial No.</u>
URBIS	2U129431-01	S-A51868
Amaps 2090 scanner		S-A51869-7
Ultrasonic transducer	TS-196	T8353

Prior to testing, the URBIS used in conjunction with the case membrane inspection was qualified under CTP-0100. The URBIS qualification consisted of routine maintenance, calibration, and an evaluation of the performance of the system.

6.2 INSPECTION SCAN PARAMETERS

The scan parameters used during the calibration sequences and during the case membrane scan are described below. (Additional information on unbond detection is presented in CTP-0100.)

C-scan: This inspection scan presents a planar view of the bondline, giving both unbond size and location within this view. This scan is performed first, primarily to show the location of unbonds.

B-scan: The B-scan inspection presents a cross-sectional view of the test article with respect to the depth of the unbond. This inspection scan is used to measure the intensity of a signal response, enabling the operator to clearly distinguish between bonded and unbonded surfaces. The B-scan is also used to size unbonds.

Radio frequency (RF) waveform: This waveform presents the transducer response signal, in which larger amplitudes indicate unbonds.

6.3 TEST DESCRIPTION, RESULTS, AND DISCUSSION

Qualification of the case membrane tool and inspection technique consisted of the following three steps:

1. The case membrane scanner and the inspection technique were calibrated on the ultrasonic calibration standard (P/N 2U129702), which contained an intentional 1.0 by 1.0-in. case-to-insulation unbond. This calibration, known as "calibration in," enabled operators to clearly distinguish the 1.0 by 1.0-in. unbond from the bonded regions.
2. The case membrane scanner was then used to scan a 20 by 20-in. membrane area of the RSRM-13A aft/center segment (P/N 1U76676-07, S/N 0000005). The 20 by 20-in. area was located at the top dead center of the case to allow gravity-induced loads to assist in revealing potential unbonds.
3. Calibration of the case membrane scanner and technique (on the calibration standard) was repeated upon completion of the case membrane scanning. This calibration, known as "calibration out", ensured that the initial calibration settings did not change during the case scan.

The three stages of the case membrane scan sequence were successfully performed five times over the same 20 by 20-in. case membrane area to qualify the unbond detection capability of the case membrane scanner. No unbonds were detected on the case membrane.

Photographic coverage of the qualification test is shown in Figures 3 through 11 (photographs of the calibration-out were not taken because this sequence is the same as the calibration-in sequence).

The inspection results are presented in Figures 12 through 26. Each scan sequence run includes the C-scan, the B-scan, and the RF waveform for the calibration-in, the segment scan, and the calibration-out. Figure 12 shows the C and B-scan presentations (unbonded regions shown in red) and the RF waveform unbond signal response for the run No. 1 calibration-in sequence. Figure 13 shows the same information for the 20 by 20-in. case scan (no unbonds were detected). Figure 14 shows the C and B-scan presentations and the RF waveform unbond signal response for the run No 1 calibration-out sequence. Figures 15 through 26 present

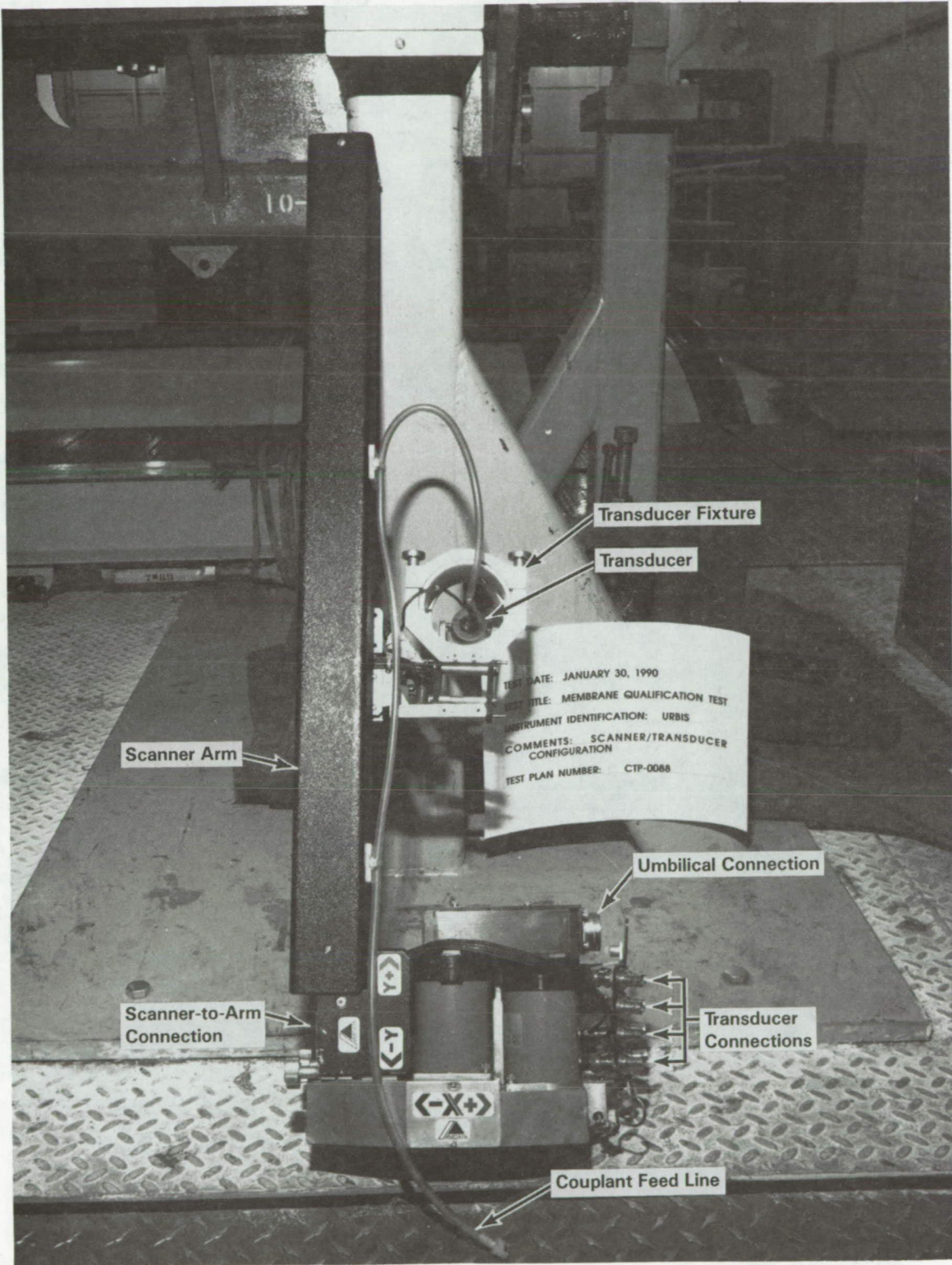

N115697-1

Figure 3. Case Membrane Scanner Configuration

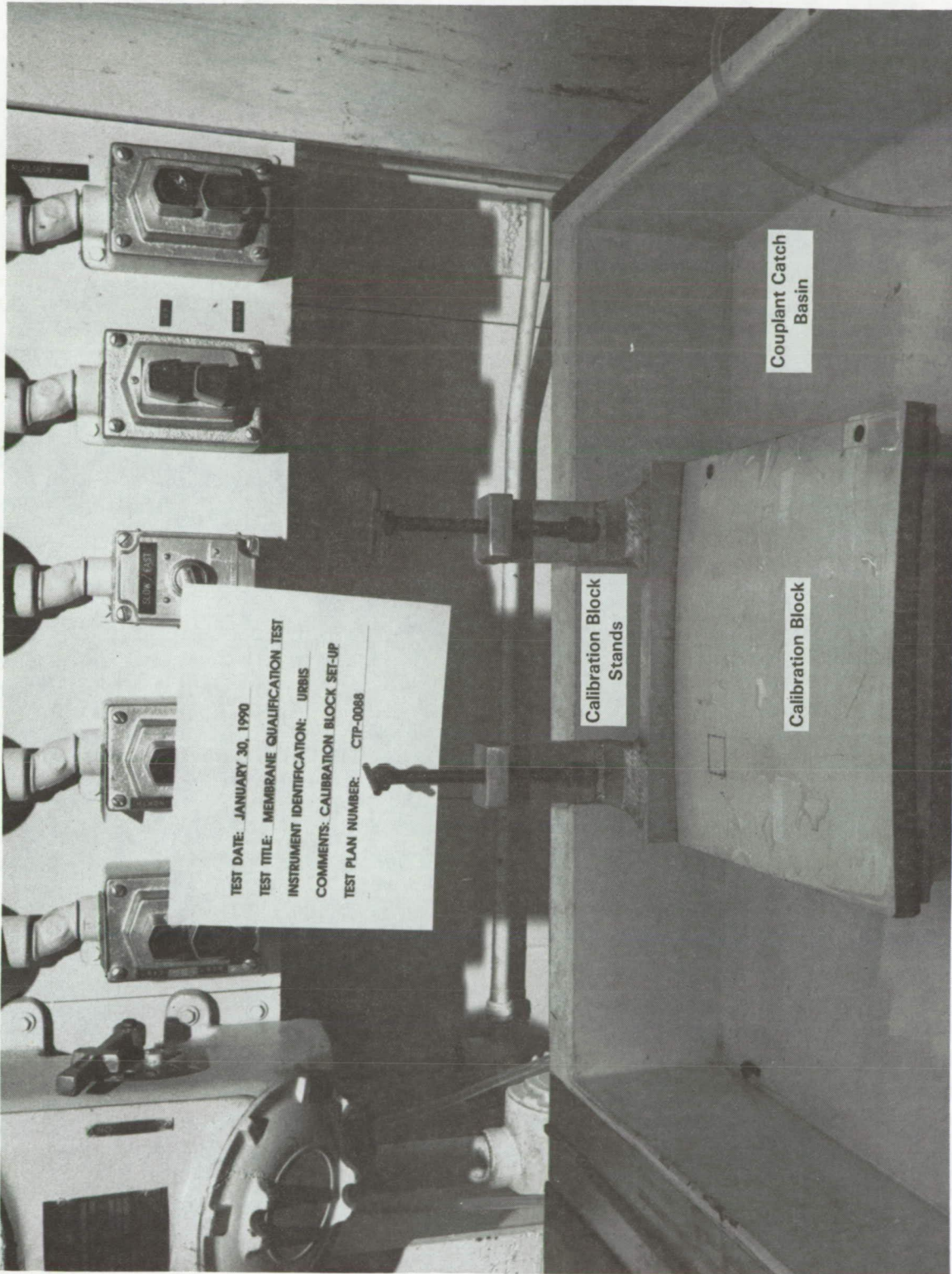
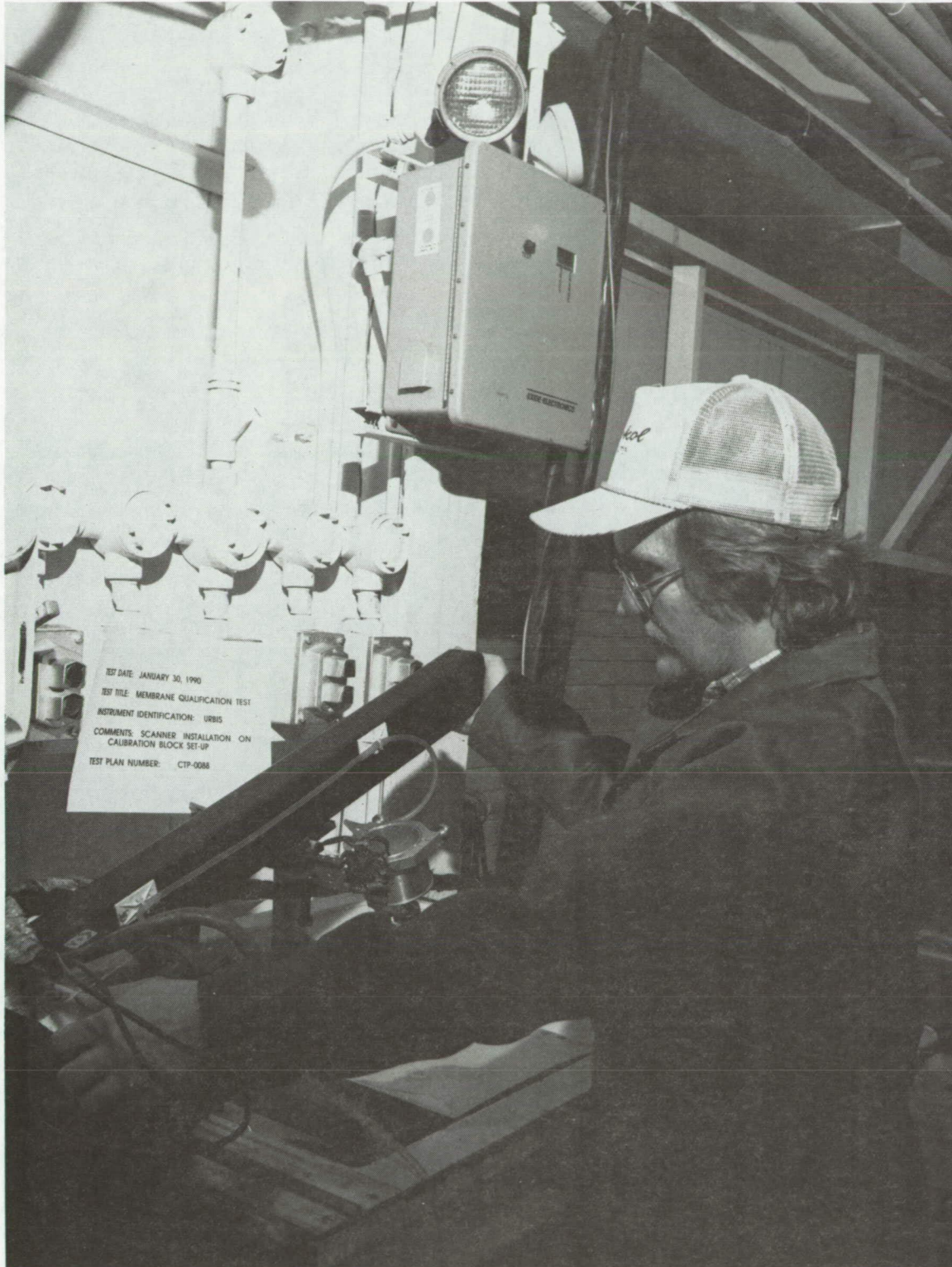

Figure 4. Calibration Block Setup



N115697-3

Figure 5. Case Membrane Scanner Installation

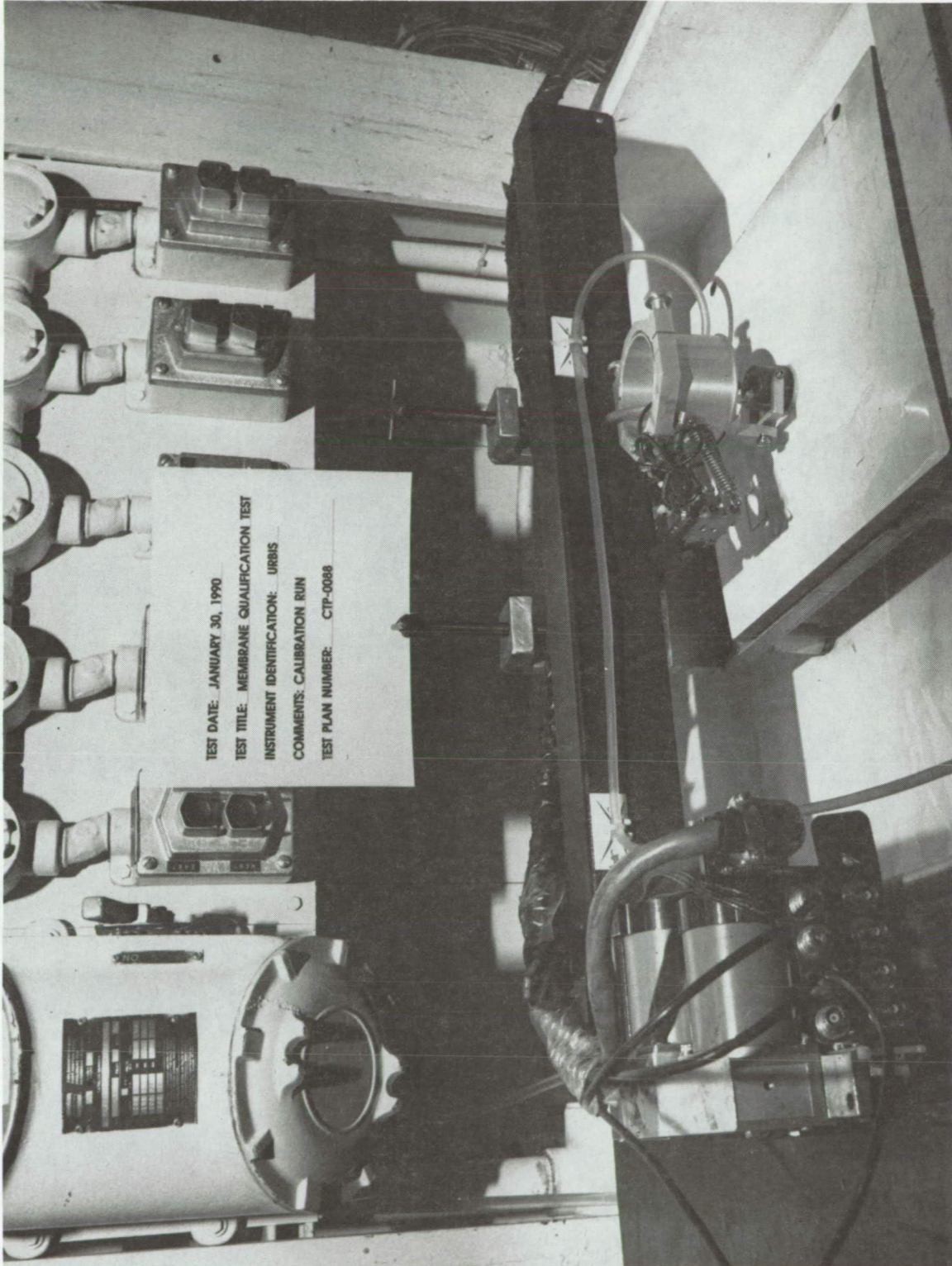

Figure 6. Case Membrane Scanner Calibration Run



Figure 7. Workstand and Segment

REVISION _____

ORIGINAL PAGE IS
OF POOR QUALITY

DOC NO.	TWR-18898	VOL	
SEC		PAGE	16

90509-2.20

ORIGINAL PAGE
BLACK AND WHITE PHOTOGRAPH

9-L69511N

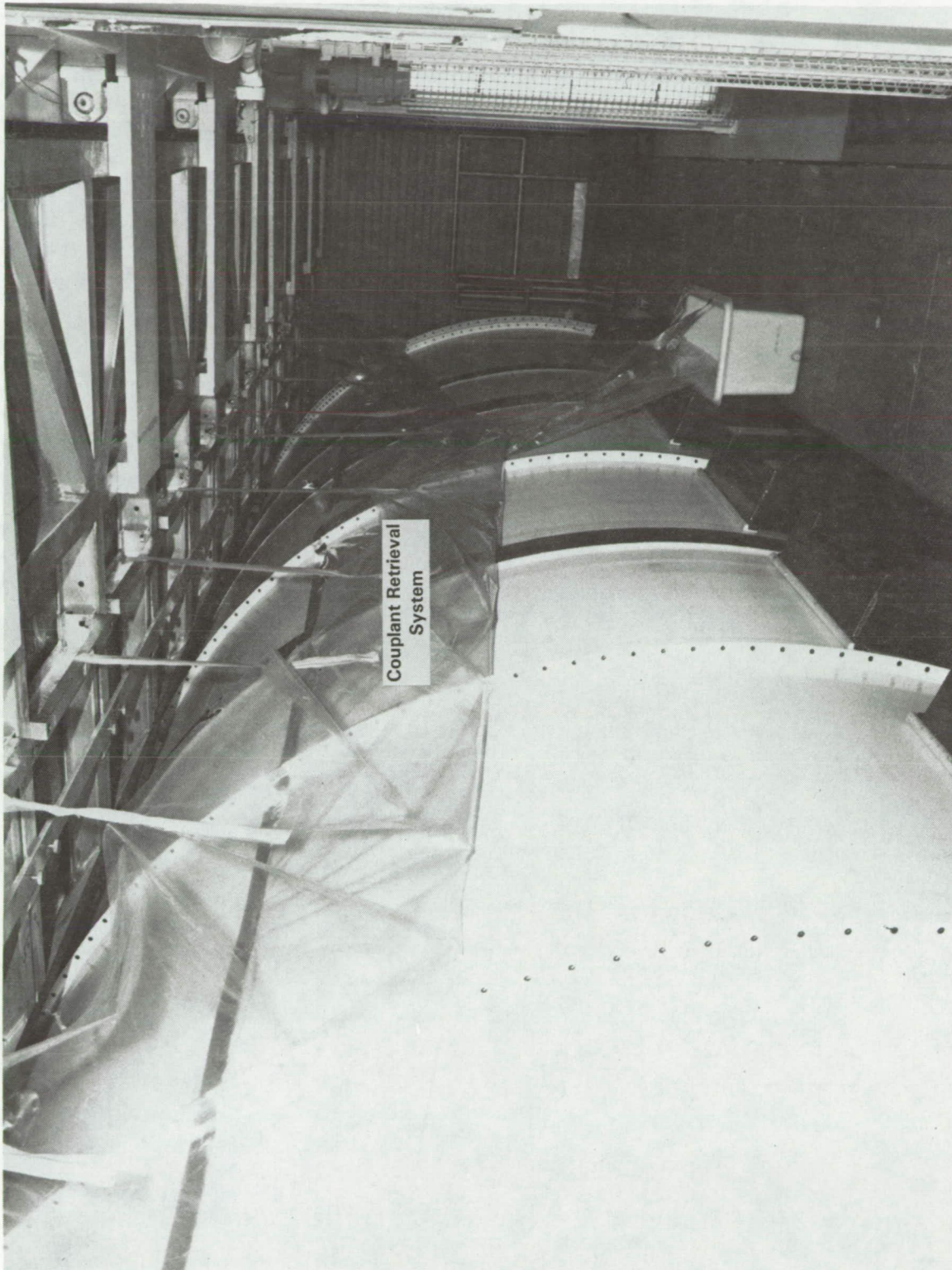

Figure 8. Couplant Recovery System Installation

REVISION _____

ORIGINAL PAGE IS
OF POOR QUALITY

DOC NO. TWR-18898	VOL
SEC	PAGE 17

90509-2.21



Figure 9. Vacuum Track Installation on Segment

90509-2.22

REVISION _____

ORIGINAL PAGE IS
OF POOR QUALITY

DOC NO.	TWR-18898	VOL	
SEC		PAGE	18



Figure 10. Case Membrane Scanner Installation on Vacuum Track

ORIGINAL PAGE
BLACK AND WHITE PHOTOGRAPH

N15697-9

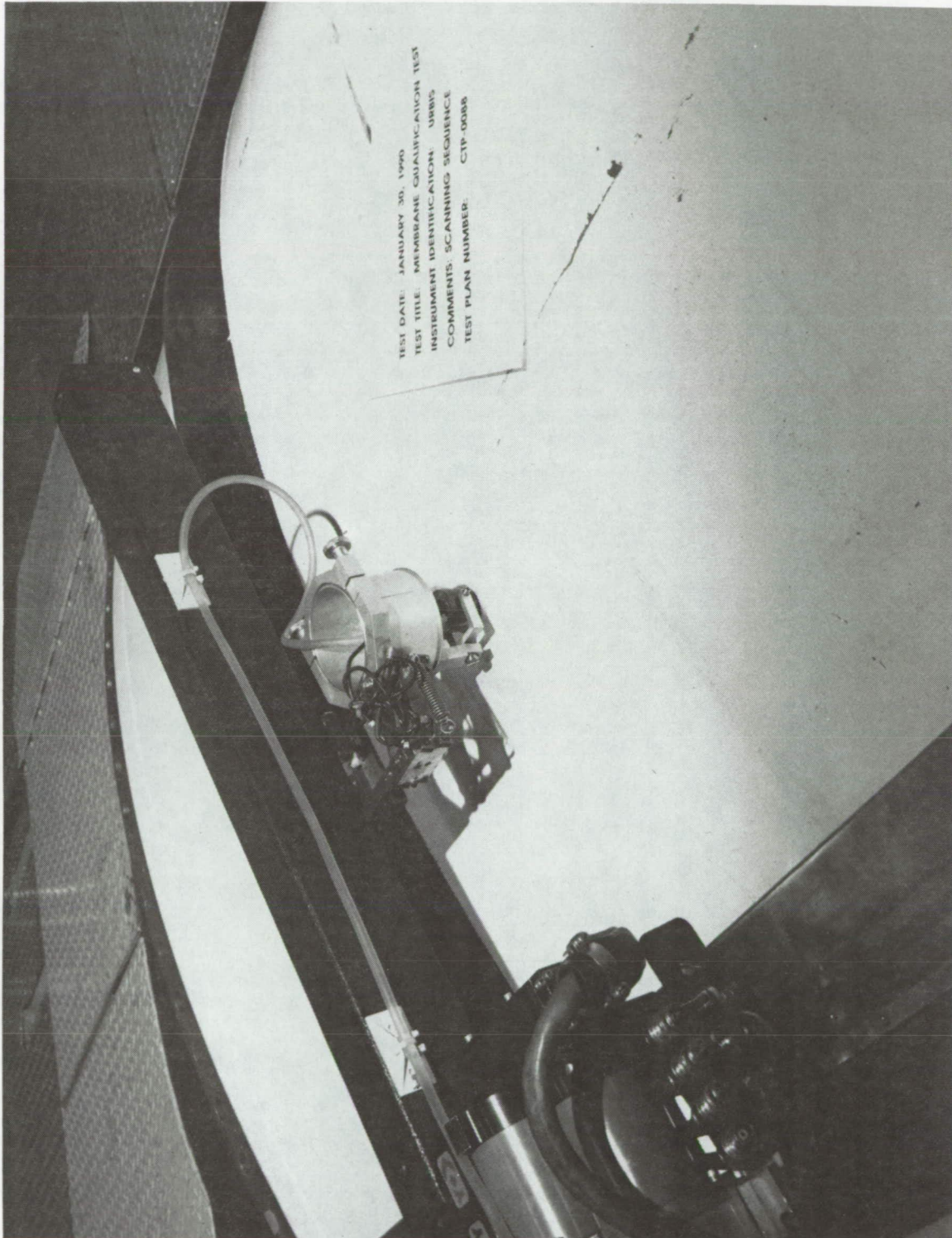

Figure 11. Case Membrane Scanning Sequence on Segment

REVISION _____

ORIGINAL PAGE IS
OF POOR QUALITY.

DOC NO.	TWR-18898	VOL
SEC	PAGE	20

90509-2.24

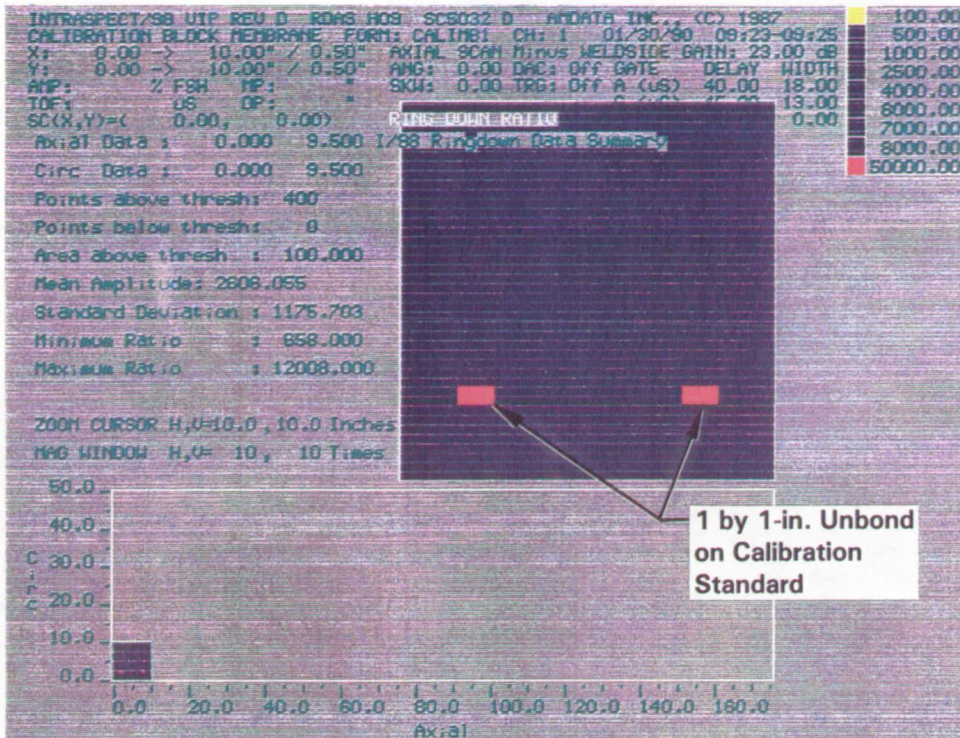

C-scan Presentation

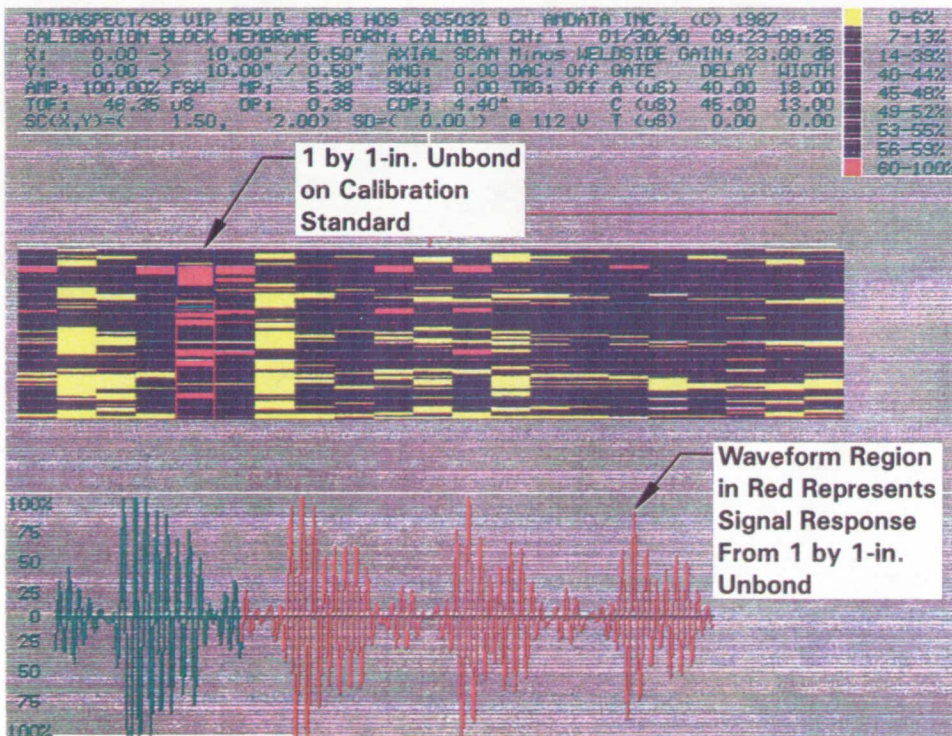

B-scan Presentation

Figure 12. Calibration-in Sequence — Scan Run No. 1

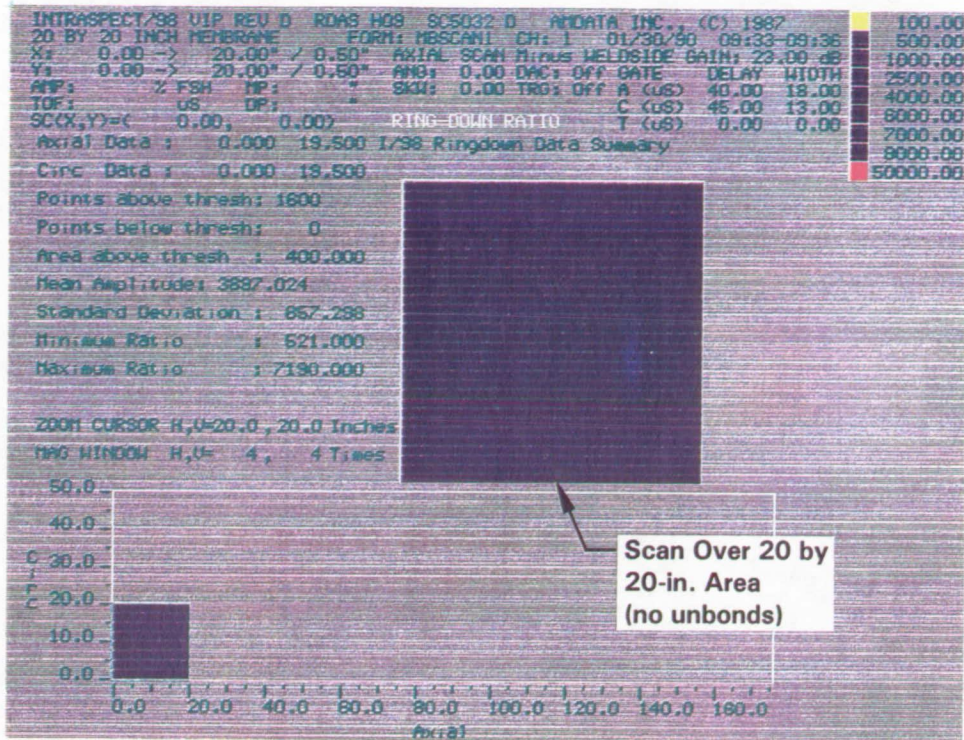

C-scan Presentation

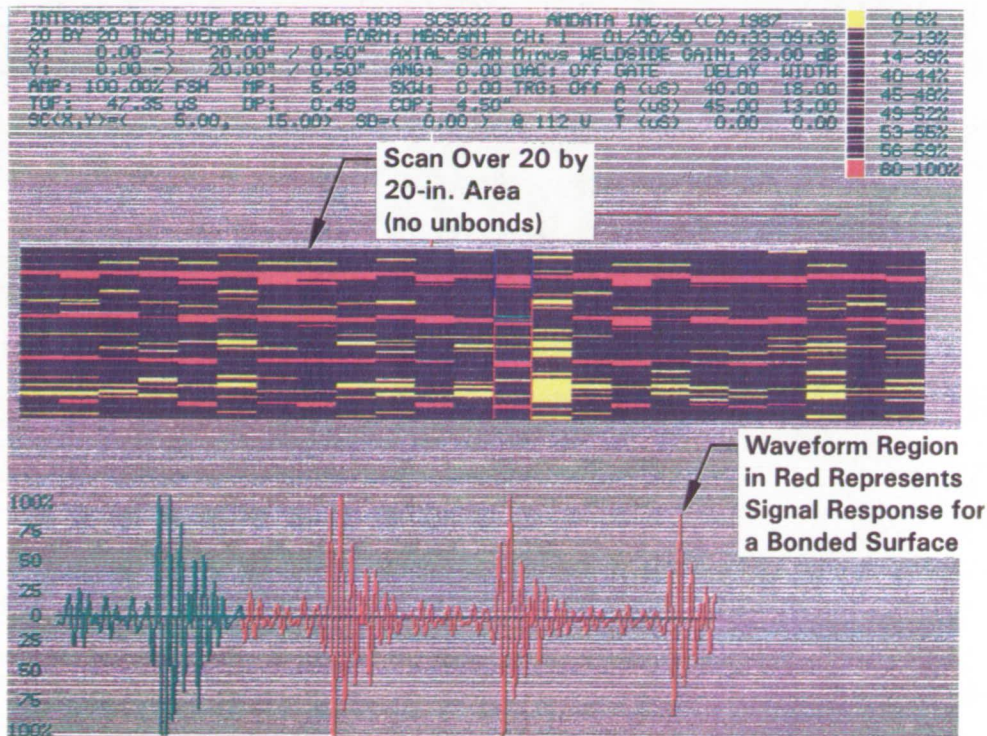

B-scan Presentation

Figure 13. Scanning Sequence—Scan Run No. 1

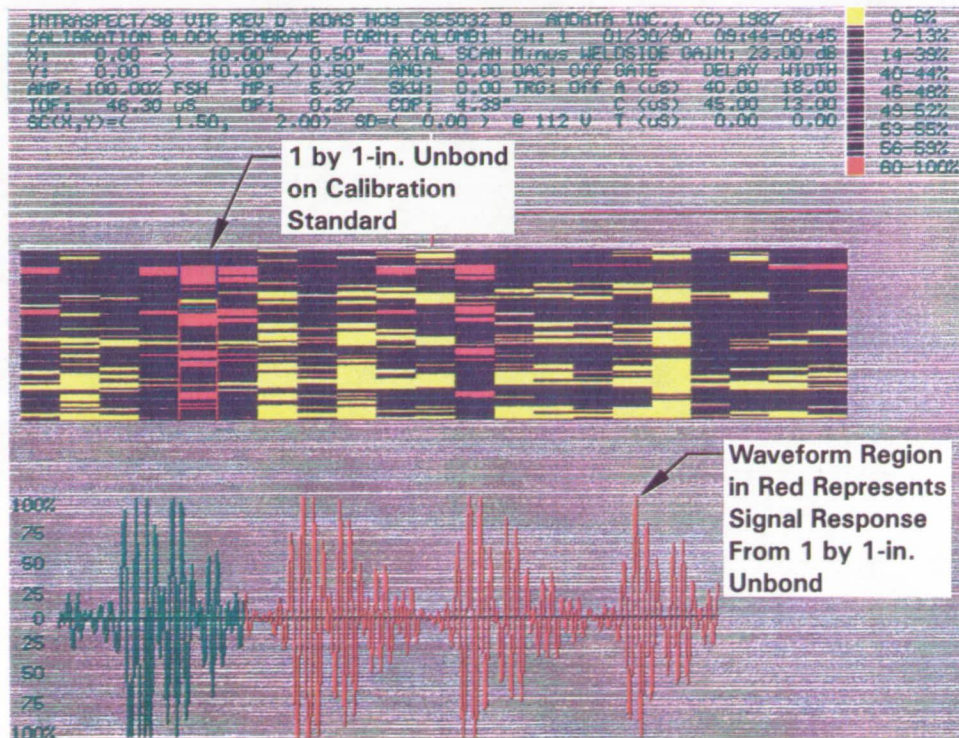
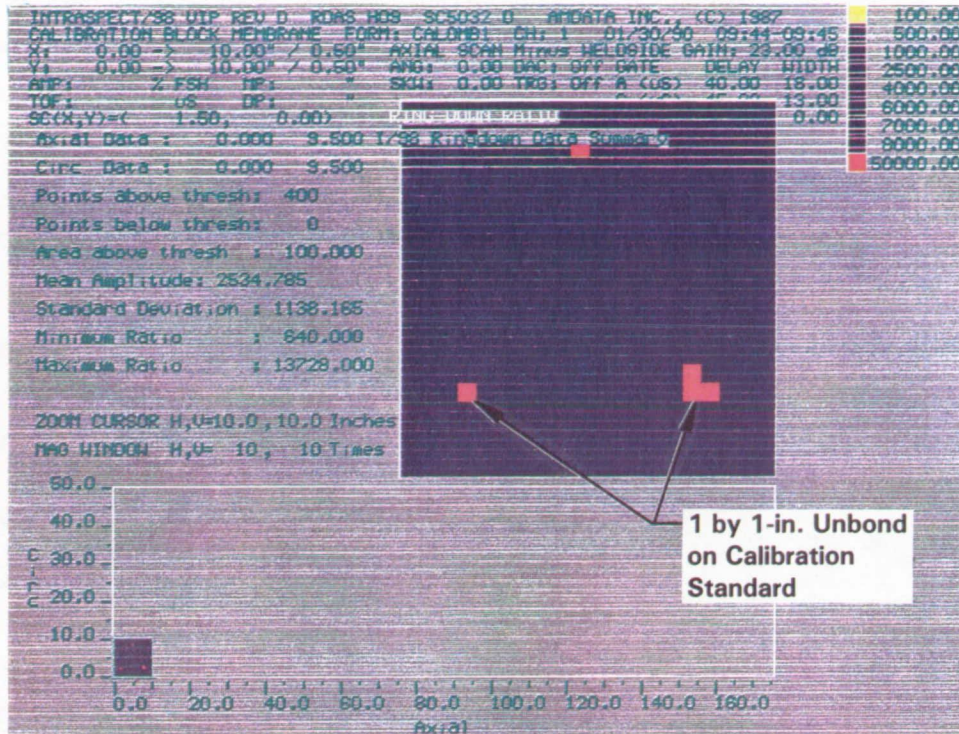
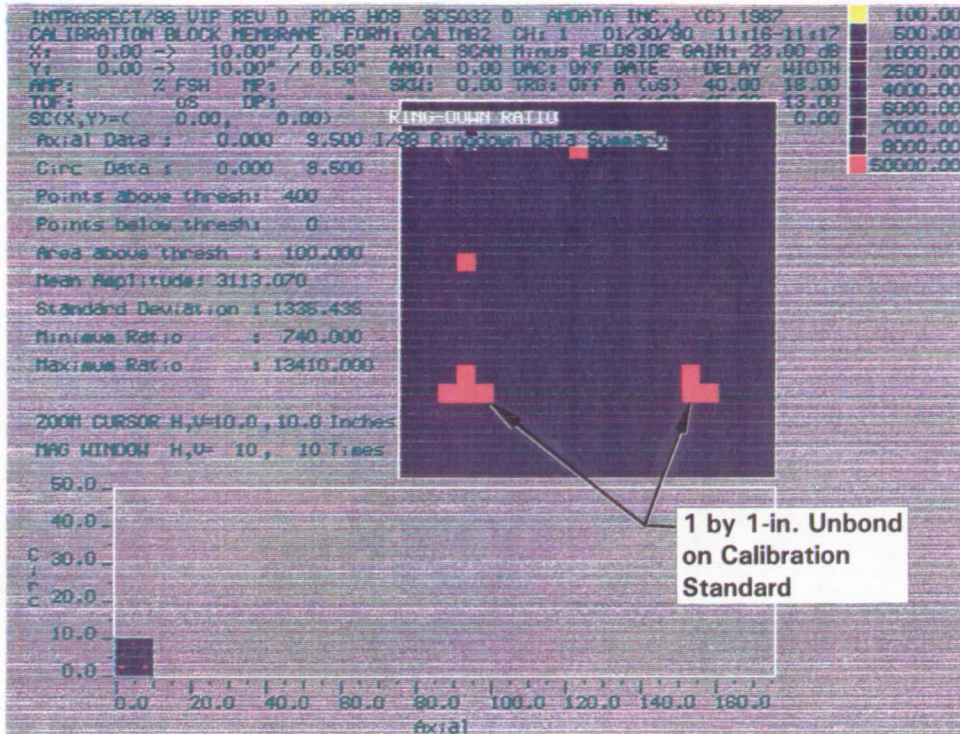
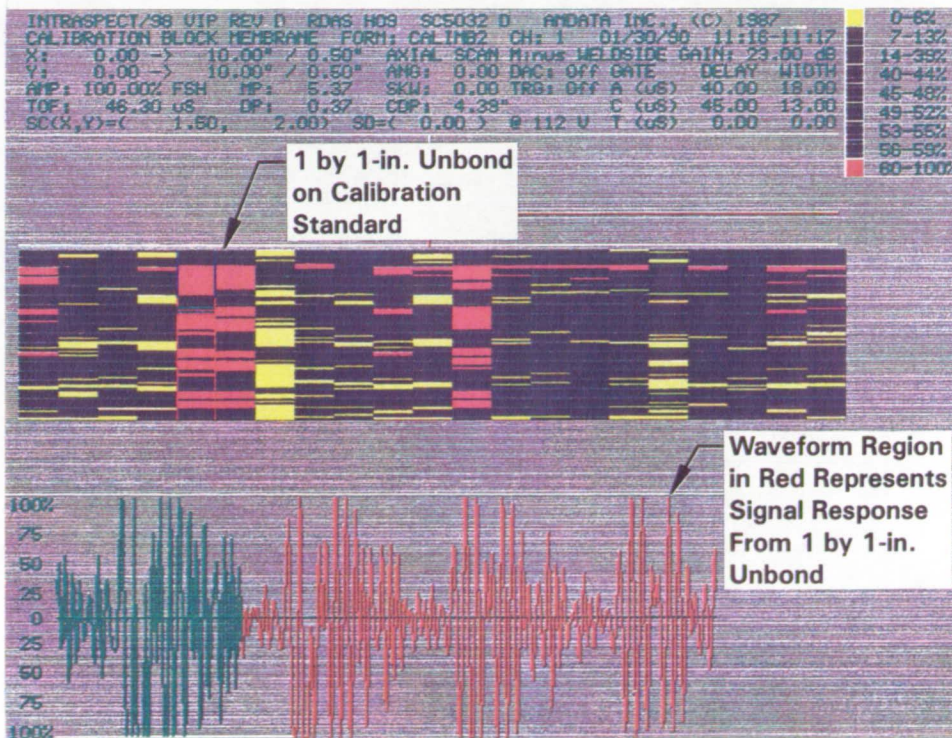

Figure 14. Calibration-out Sequence — Scan Run No. 1



C-scan Presentation



B-scan Presentation

Figure 15. Calibration-in Sequence — Scan Run No. 2

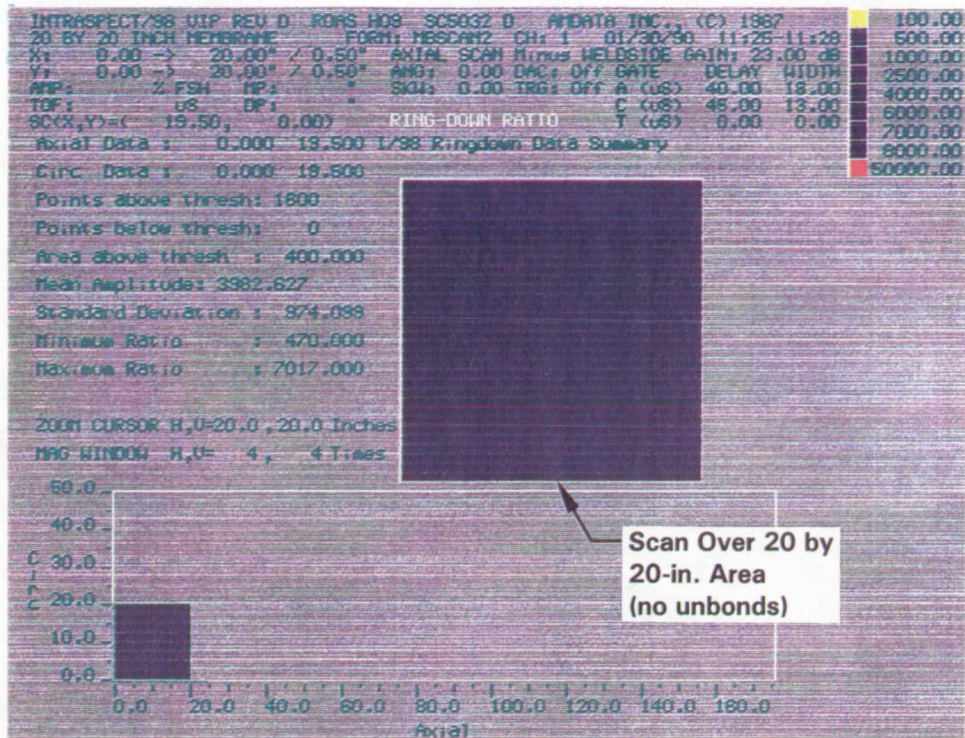

C-scan Presentation

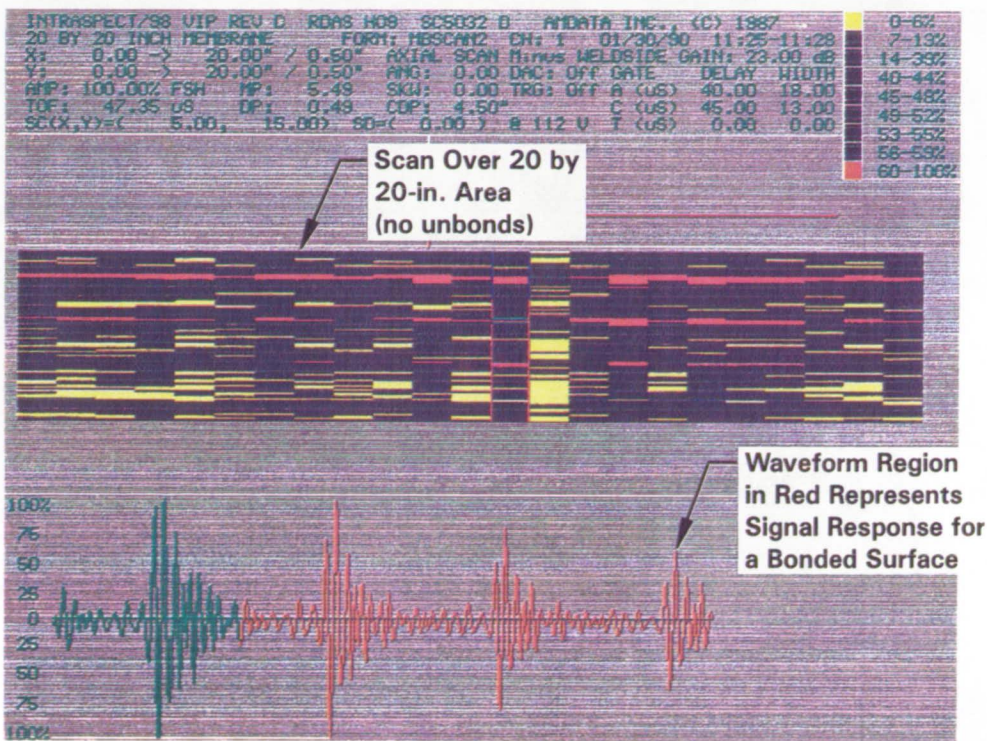

B-scan Presentation

Figure 16. Scanning Sequence—Scan Run No. 2

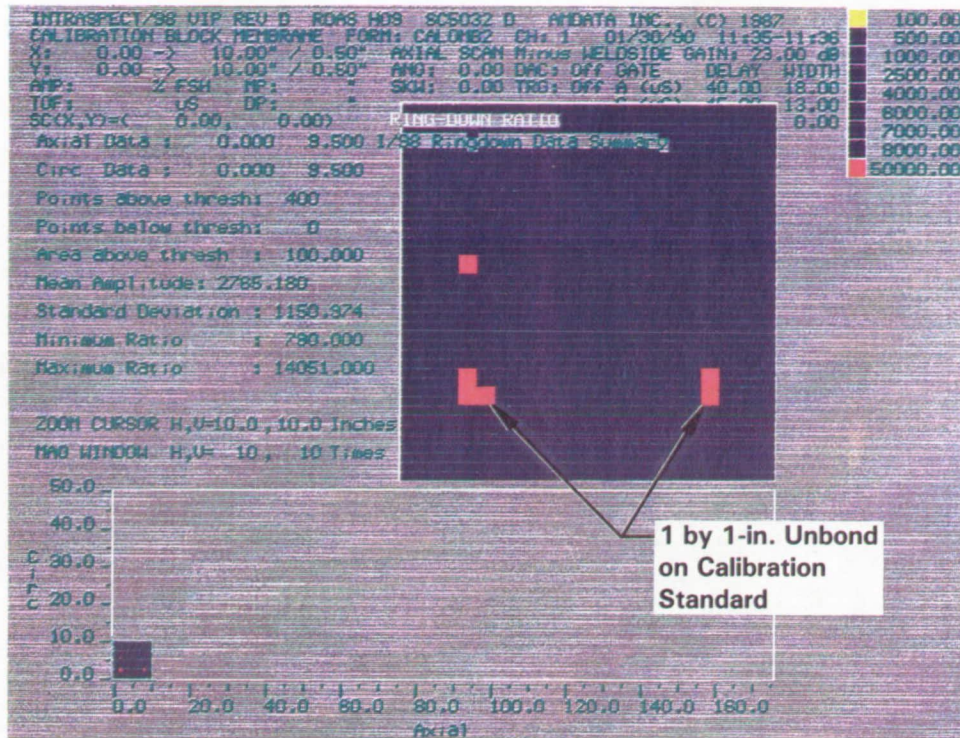

C-scan Presentation

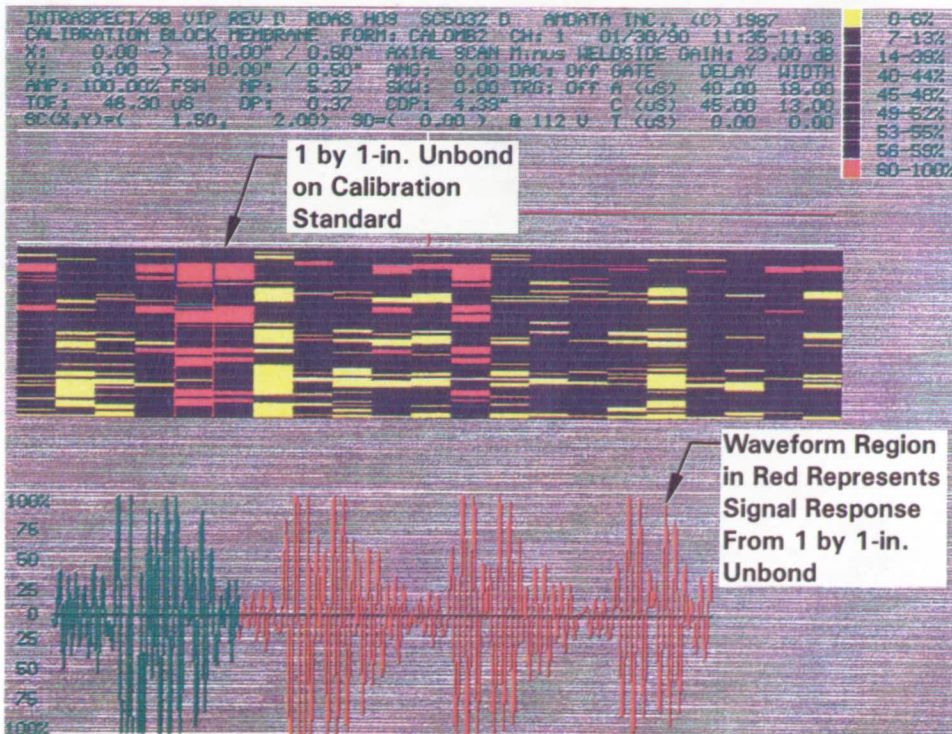

B-scan Presentation

Figure 17. Calibration-out Sequence — Scan Run No. 2

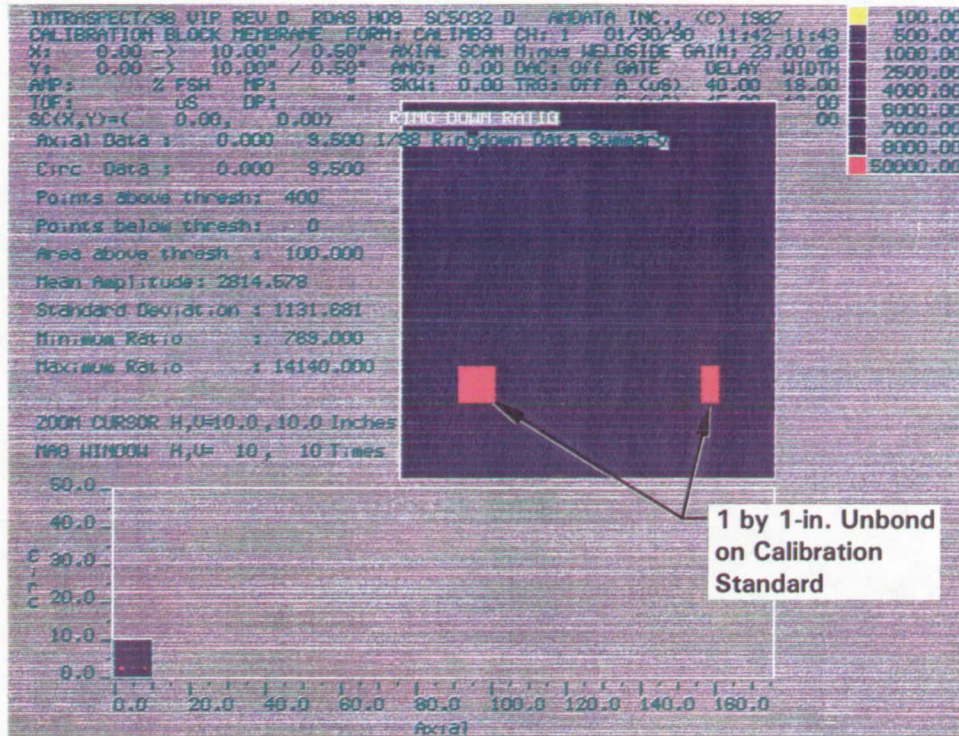

C-scan Presentation

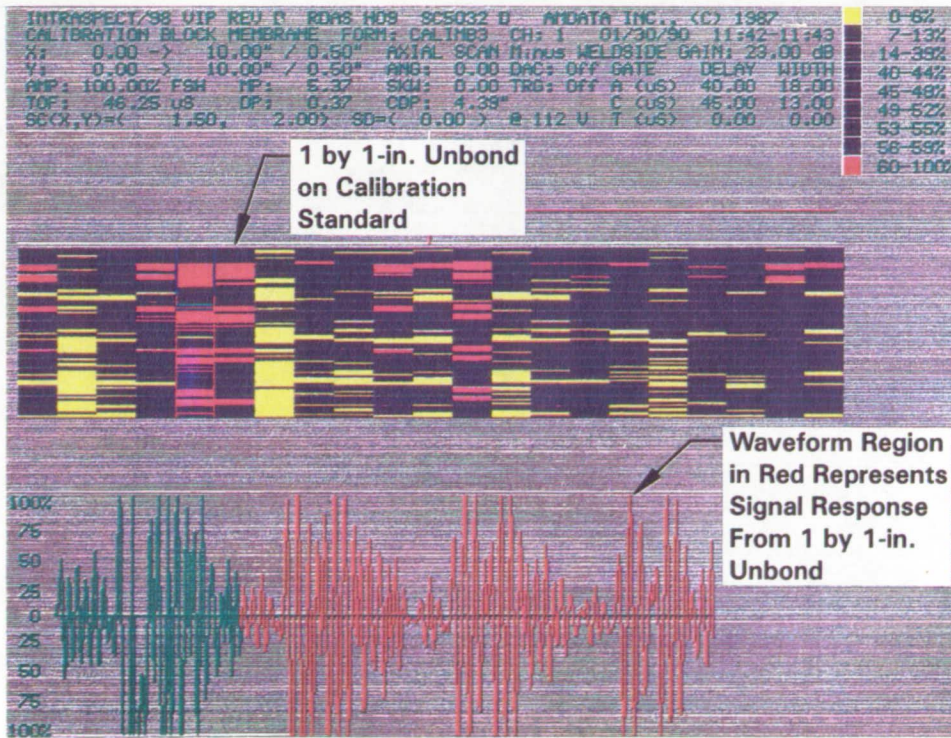

B-scan Presentation

Figure 18. Calibration-in Sequence — Scan Run No. 3

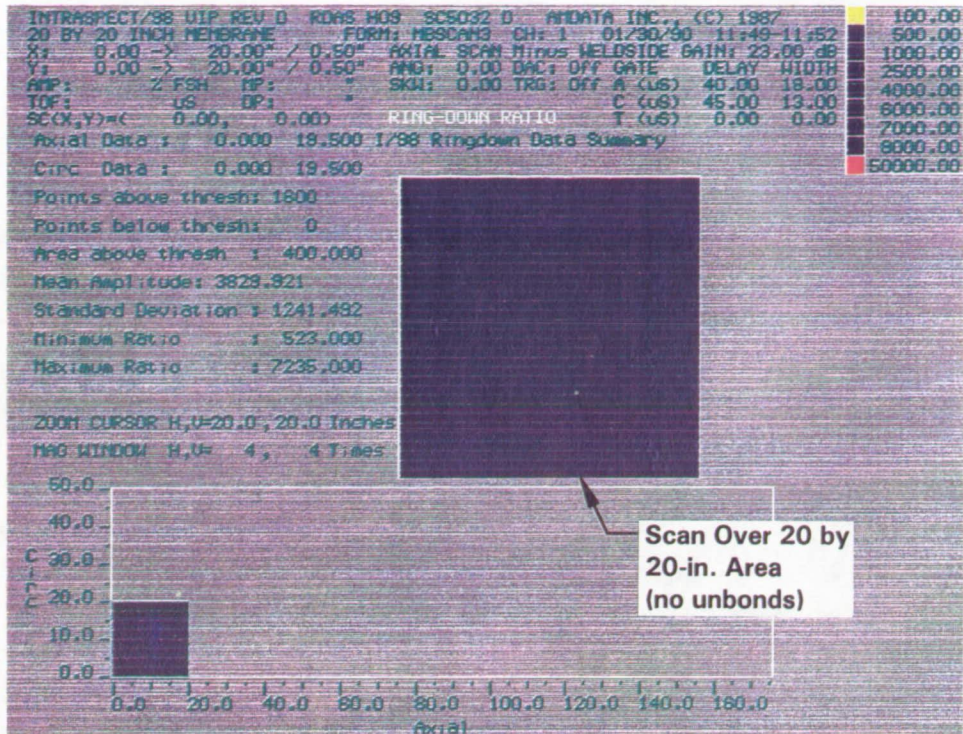

C-scan Presentation

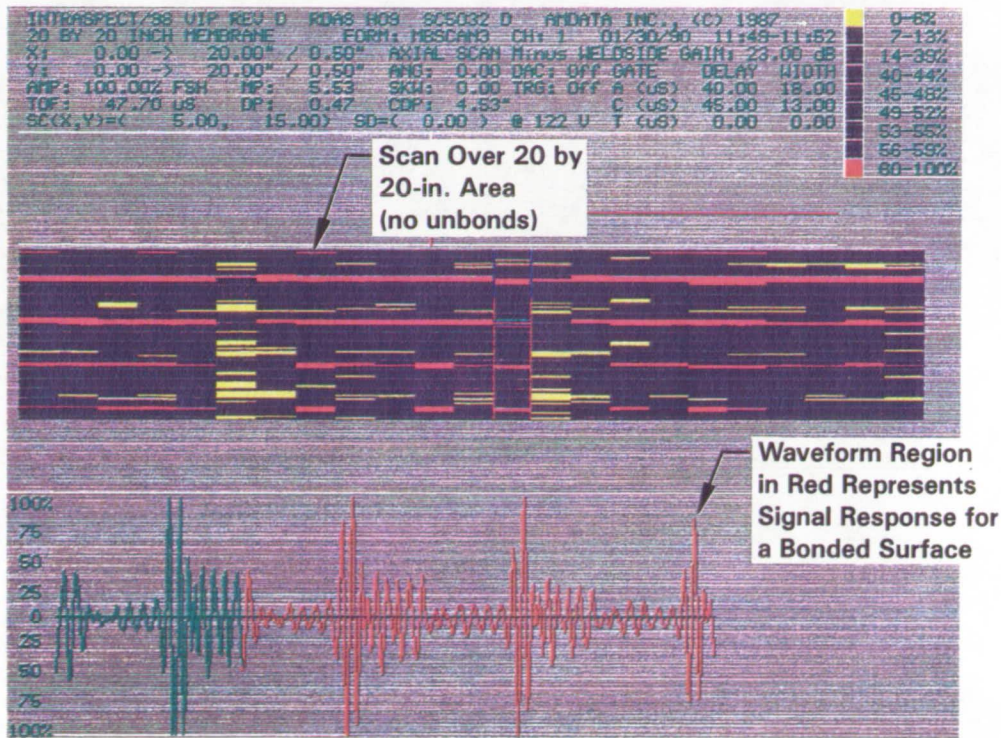

B-scan Presentation

Figure 19. Scanning Sequence — Scan Run No. 3

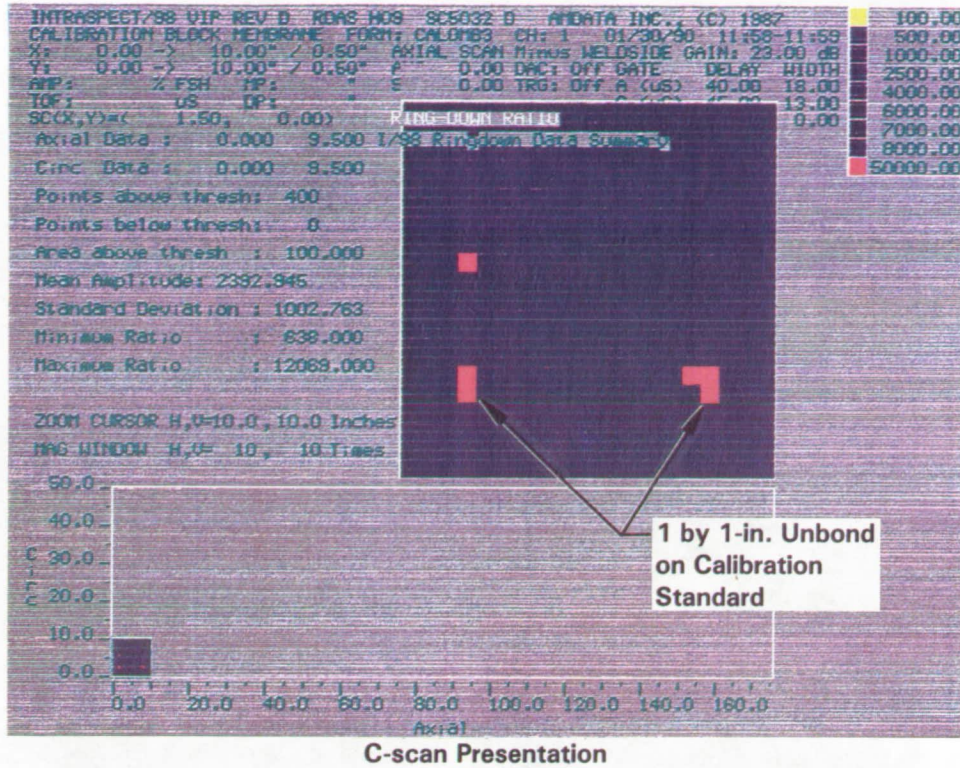

C-scan Presentation

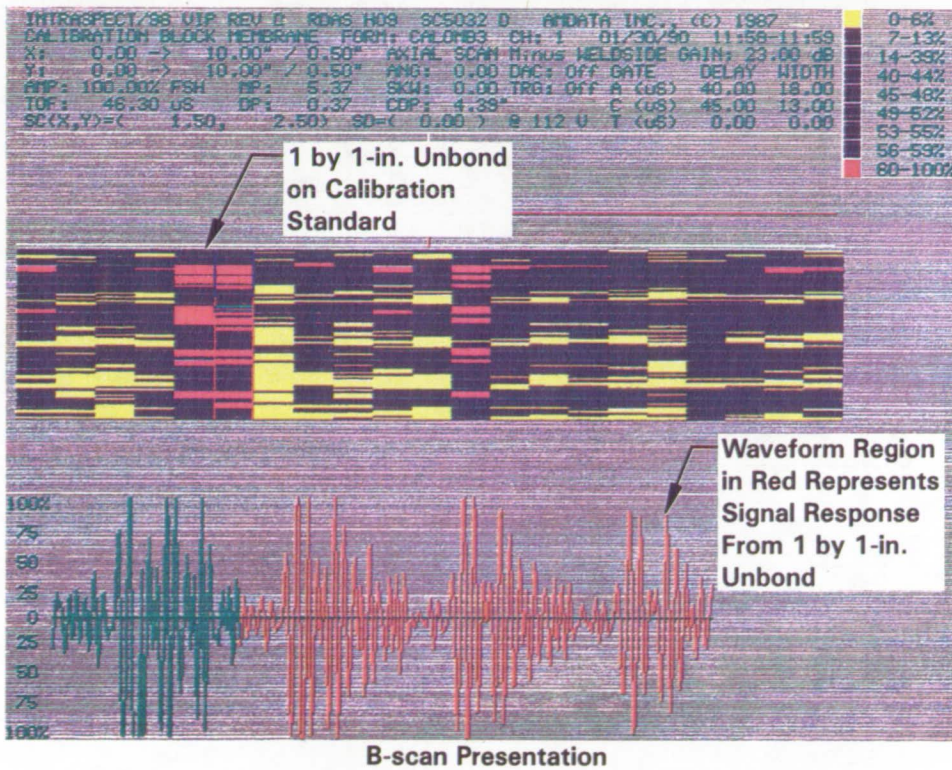

B-scan Presentation

Figure 20. Calibration-out Sequence—Scan Run No. 3

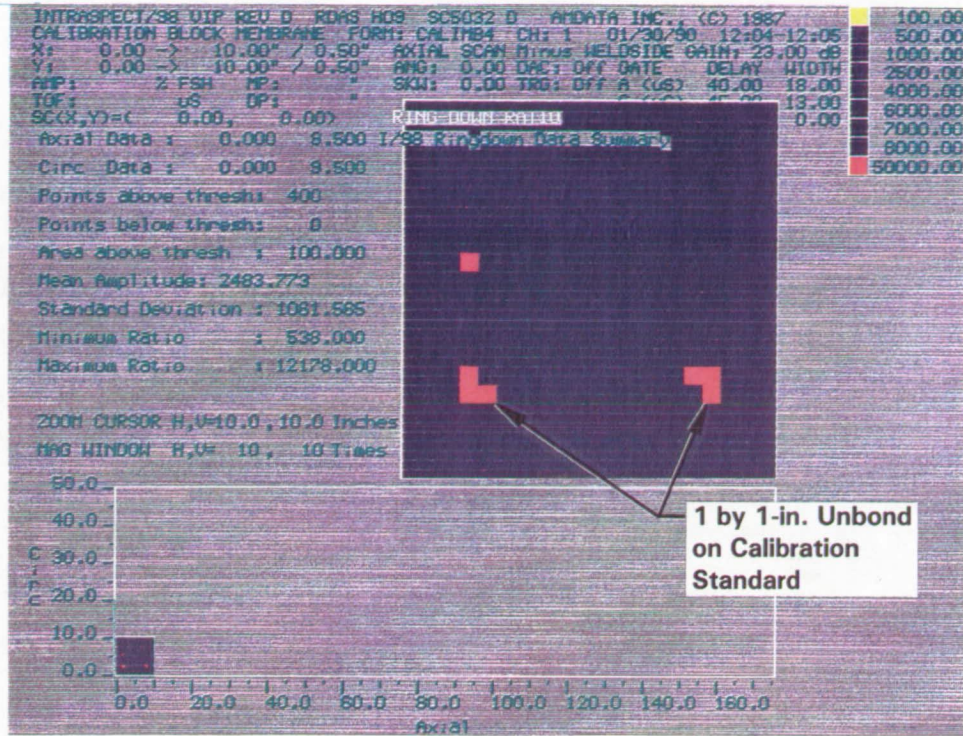

C-scan Presentation

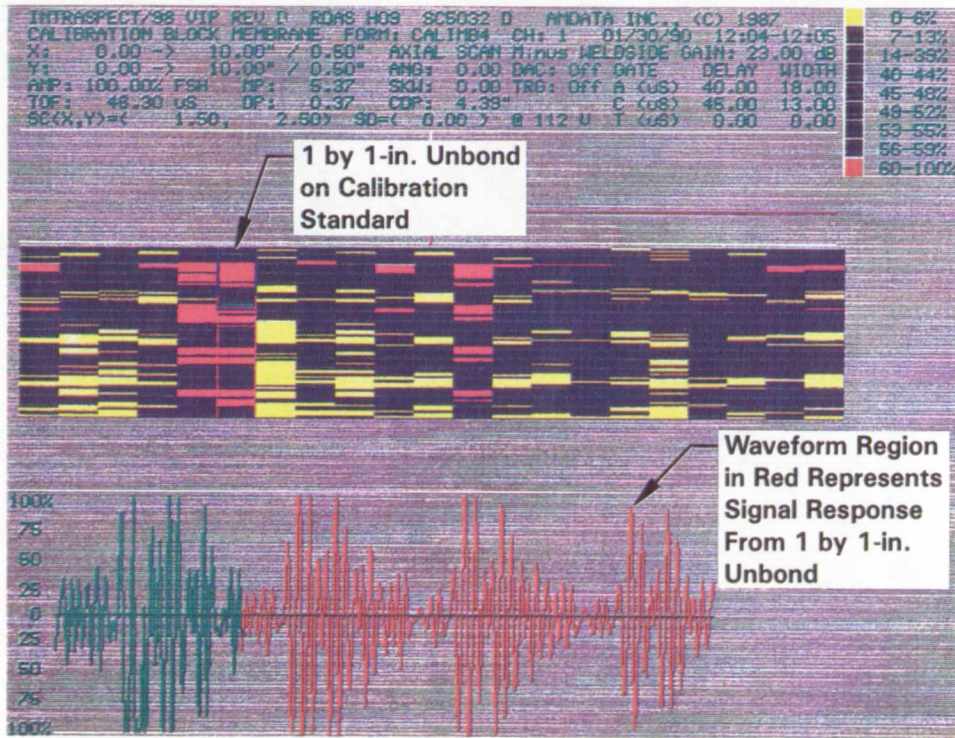

B-scan Presentation

Figure 21. Calibration-in Sequence—Scan Run No. 4

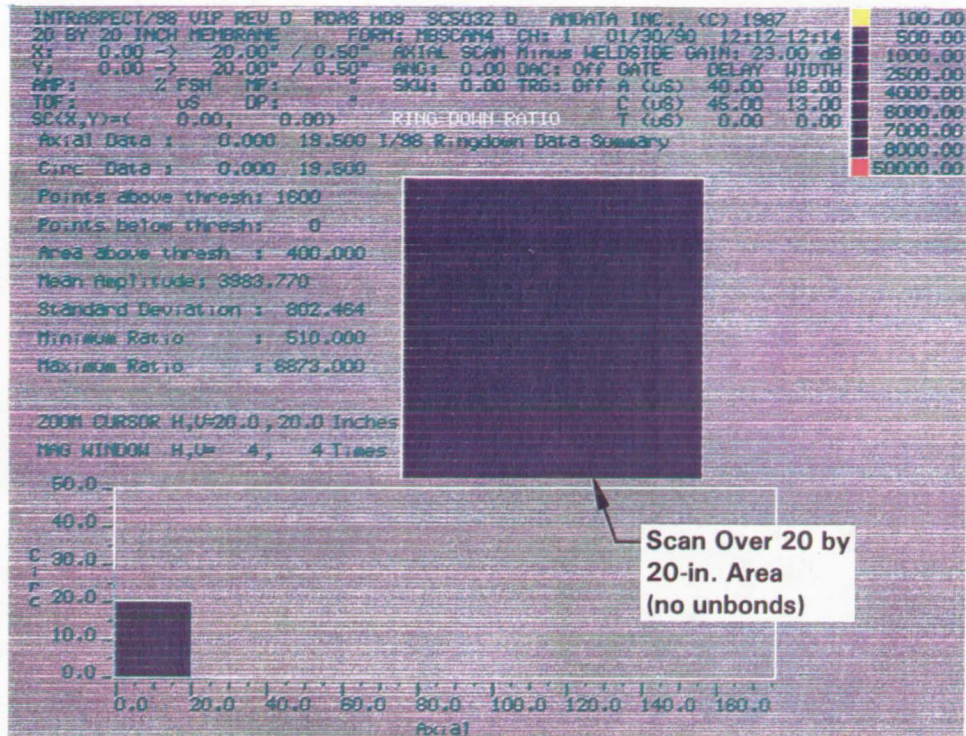

C-scan Presentation

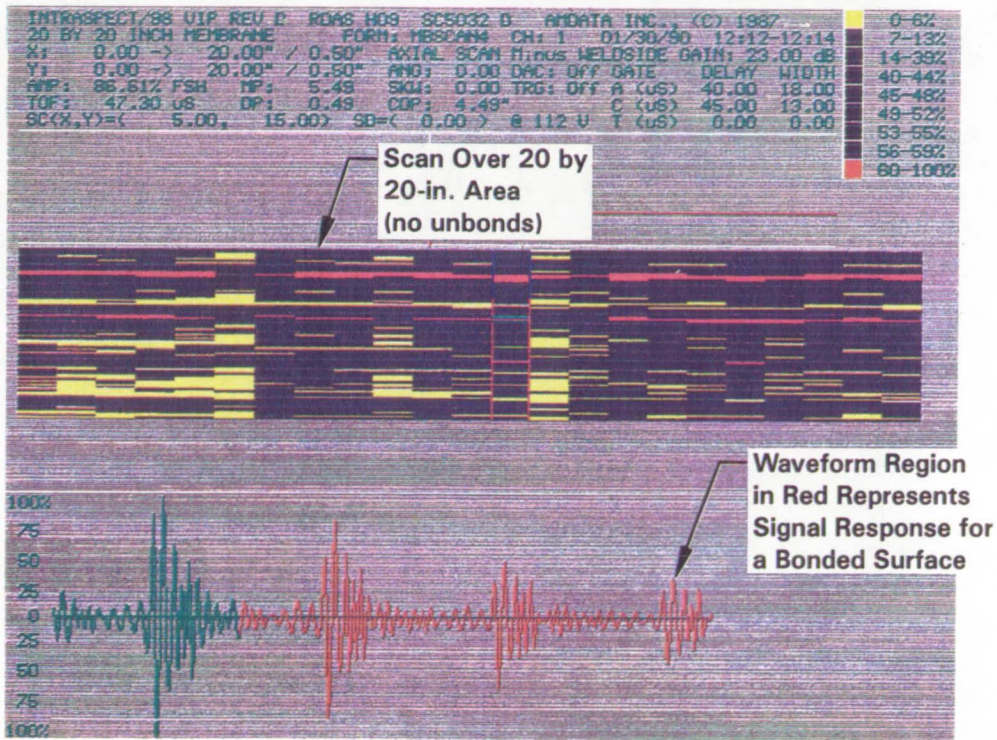

B-scan Presentation

Figure 22. Scanning Sequence—Scan Run No. 4

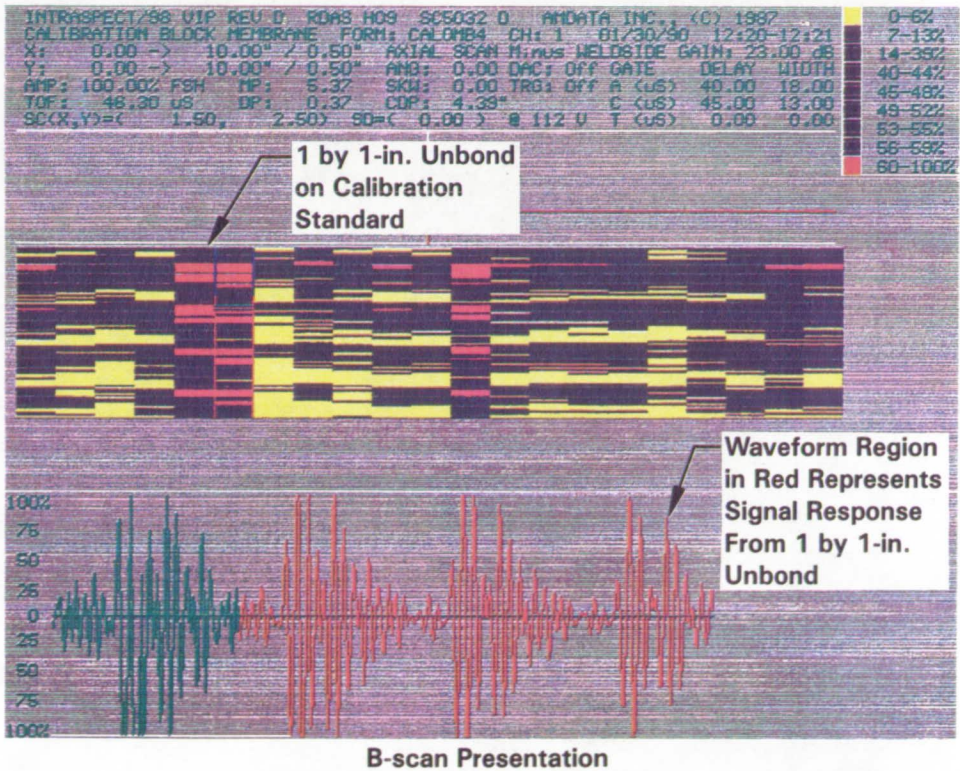
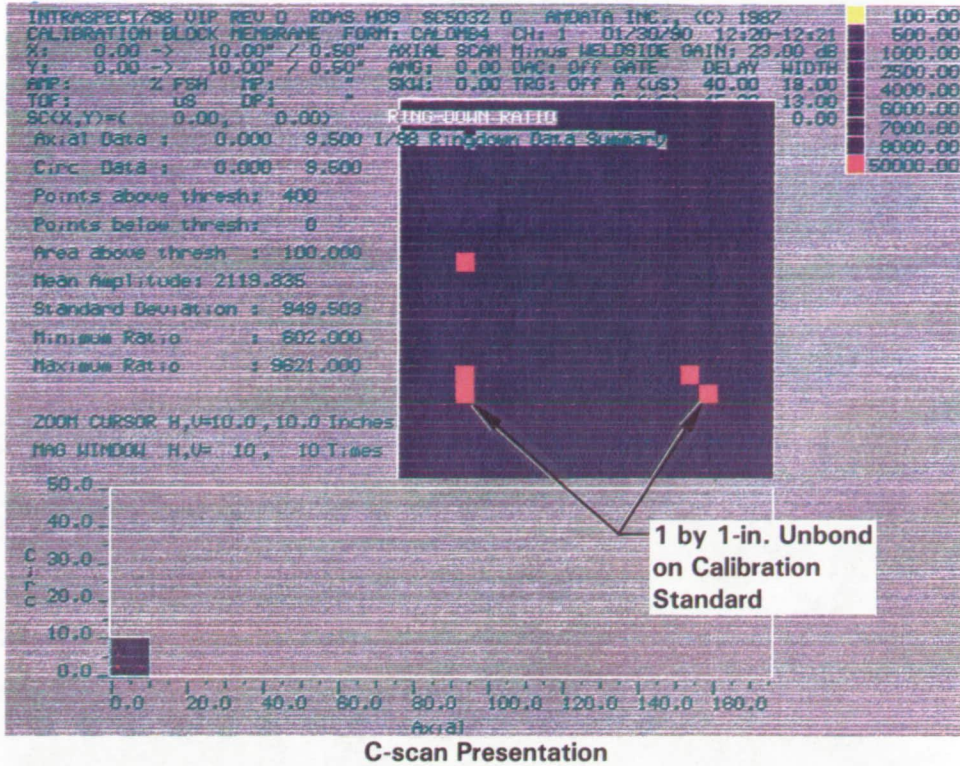
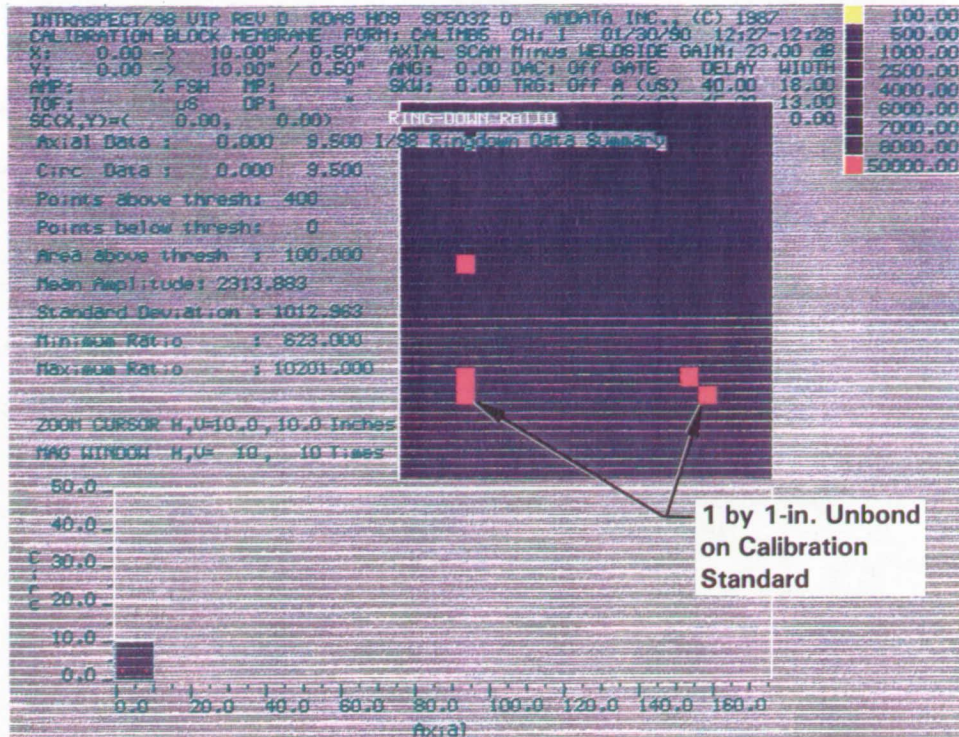
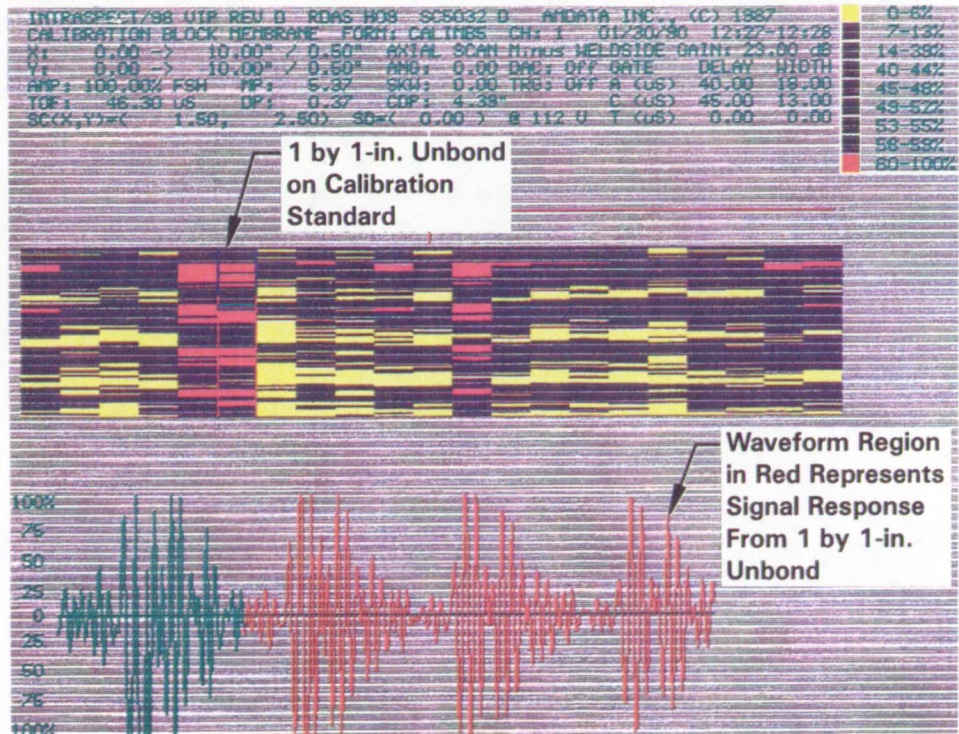

Figure 23. Calibration-out Sequence — Scan Run No. 4



C-scan Presentation



B-scan Presentation

Figure 24. Calibration-in Sequence — Scan Run No. 5

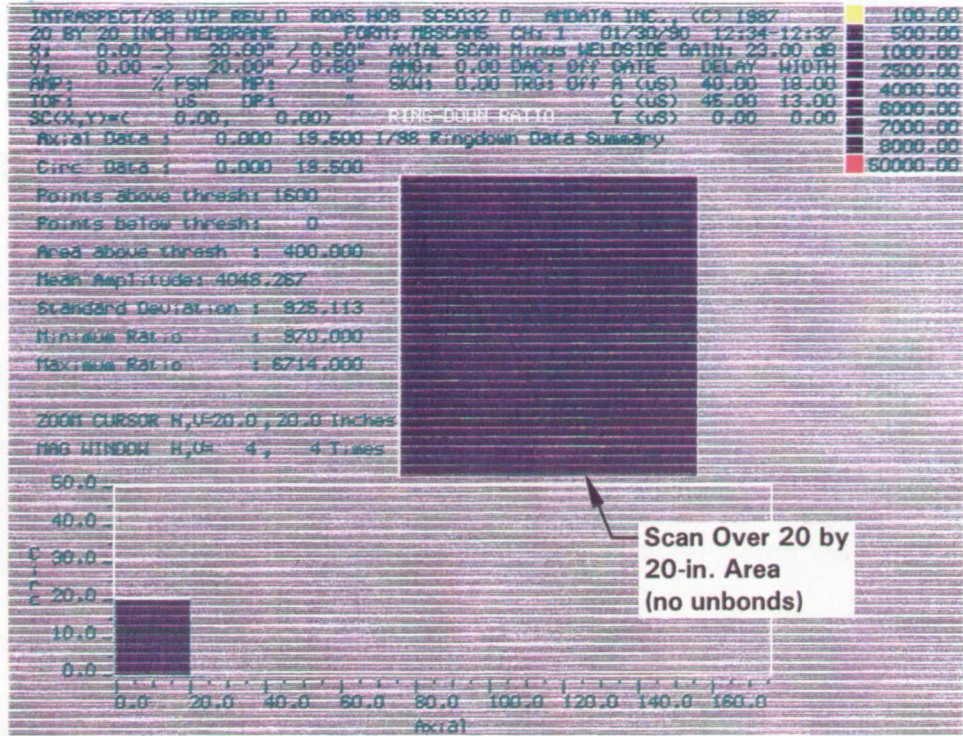

C-scan Presentation

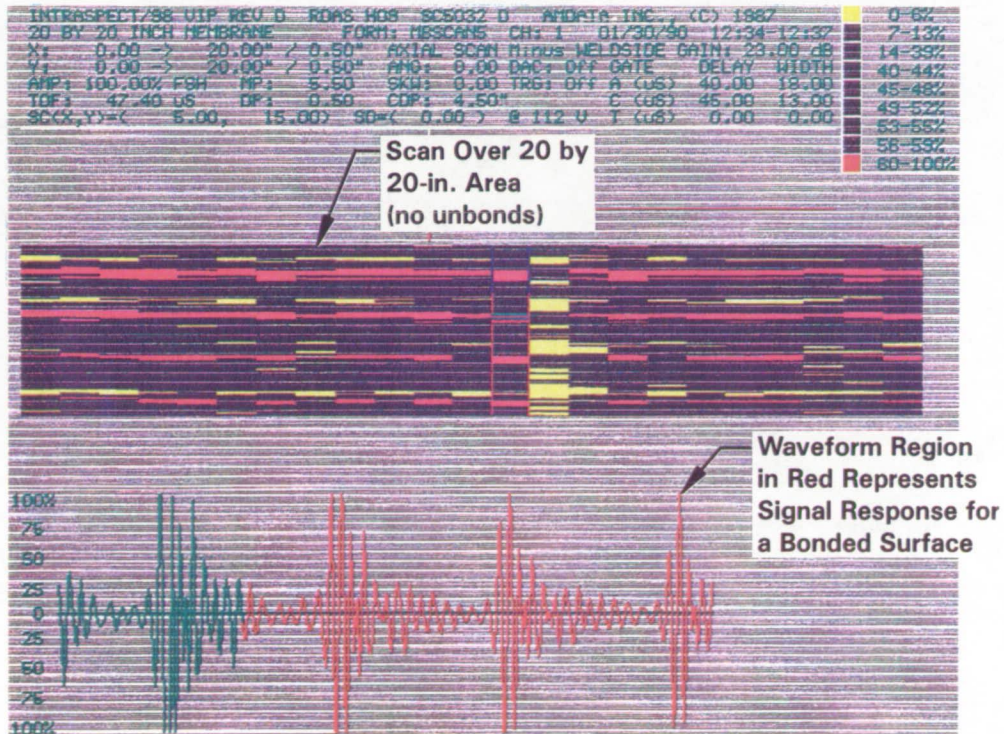

B-scan Presentation

Figure 25. Scanning Sequence—Scan Run No. 5

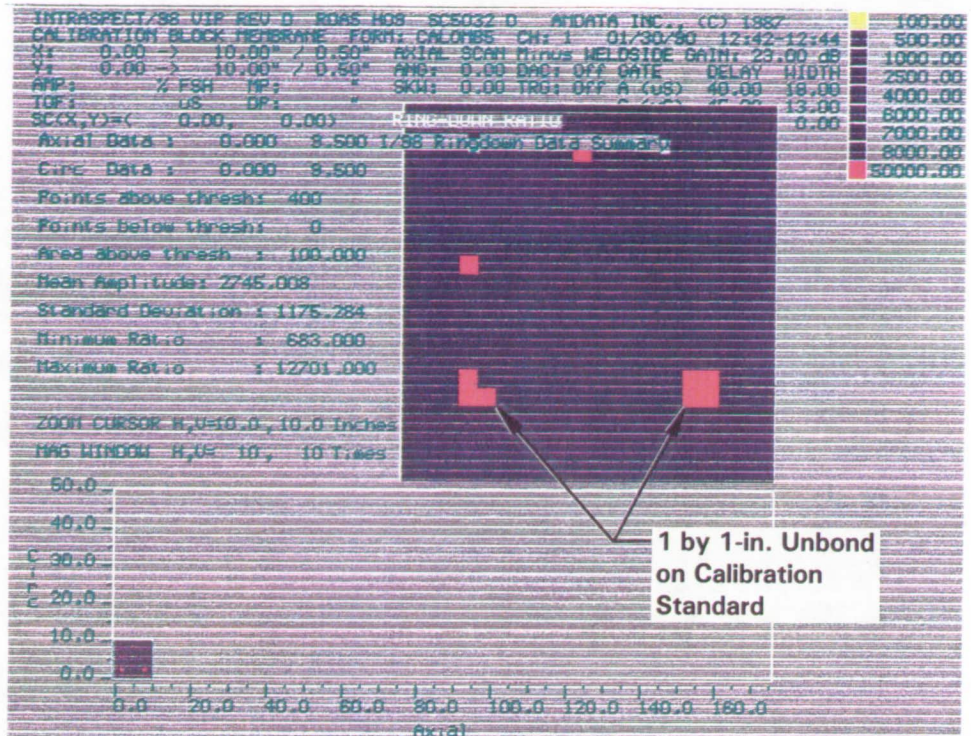

C-scan Presentation

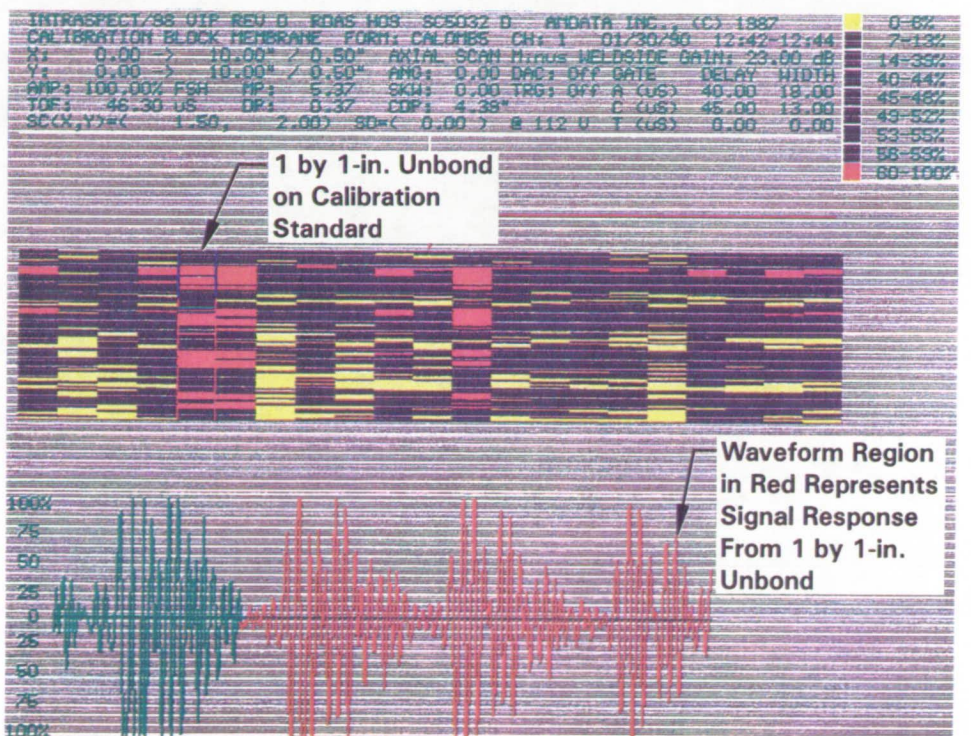

B-scan Presentation

Figure 26. Calibration-out Sequence — Scan Run No. 5

identical information for qualification runs 2 through 5. Measurement repeatability of the case membrane scanner/URBIS was demonstrated by the identical results from each test run.

The case membrane scanner successfully interfaced with the case membrane throughout the scanning procedure. Figure 11 shows the scanner/case membrane interface. During the test, neither the case membrane scanner nor the case membrane were degraded.

The complete URBIS is designed to be broken down into components which are placed in protective cases for transportability. This testing verified the transportability of the case membrane scanner/URBIS.

APPLICABLE DOCUMENTS

<u>Document No.</u>	<u>Title</u>
CPW1-3600	Prime Equipment Contract End Item (CEI) Detail Specifications
CDW2-3452	Performance, Design, and Verification Requirements Case-to-Insulation Bondline Inspection Kit, Ultrasonic Model Designator, C77-0479
CTP-0088	Qualification Plan for the Ultrasonic Inspection of the RSRM Membrane Case/Insulation Bondline Utilizing the Thiokol Corporation Ultrasonic RSRM Bondline Inspection System
CTP-0100	Qualification Test Plan for the Generic System Components of the MTI Ultrasonic RSRM Bondline Inspection System (URBIS)
NHB 6000.1	NASA Requirements for Packaging, Handling, and Transportation (for aeronautical and space systems, equipment, and associated components)
TWR-18894	Generic System Components of the RSRM Case-to-Insulation Bondline Inspection System Final Test Report
<u>Military Standard</u>	
MIL-STD-45662	Calibration System Requirements
<u>Drawing No.</u>	
2U129702	NDE Calibration Kit, SRM
2U129431	SRM PLI/Case UT Inspection Tool Arrangement

DISTRIBUTION LIST

<u>Name</u>	<u>No. of Copies</u>	<u>Mail Stop</u>
L. Allred	1	L72
D. Anderson	1	827
N. Black	1	L71
B. Bruce	1	E06
M. Cook	4	L71
G. Donikowski	1	877
F. Duersch	1	851
P. Karner	1	827
G. Lebaron	1	L72
D. Marsh	1	E63
M. Martersteck	1	827
D. Noble	1	THI-711 (KSC)
R. Papasian	45	E05
G. Paul	1	L71
H. Reed	1	827
K. Sanofsky	1	851
Print Crib	5	282
Data Management	5	L74B

CN22
TURNER J/PUBLICATION
?IGHT CENTER
HUNTSVILLE AL.

(0) (2)

9?????????????????????????????????IMM?