

Georgia Tech

**THE GEORGE W. WOODRUFF SCHOOL OF
MECHANICAL ENGINEERING**

Georgia Institute of Technology
Atlanta, Georgia 30332-0405

**ME 4182
DESIGN GROUP 6**

FALL QUARTER 1988

LUNAR RATED FASTENERS

**LINDSEY GUPTON
STEVE HYDE
DAN McKILLIP
BRYAN PLAYER
GREG SMITH**

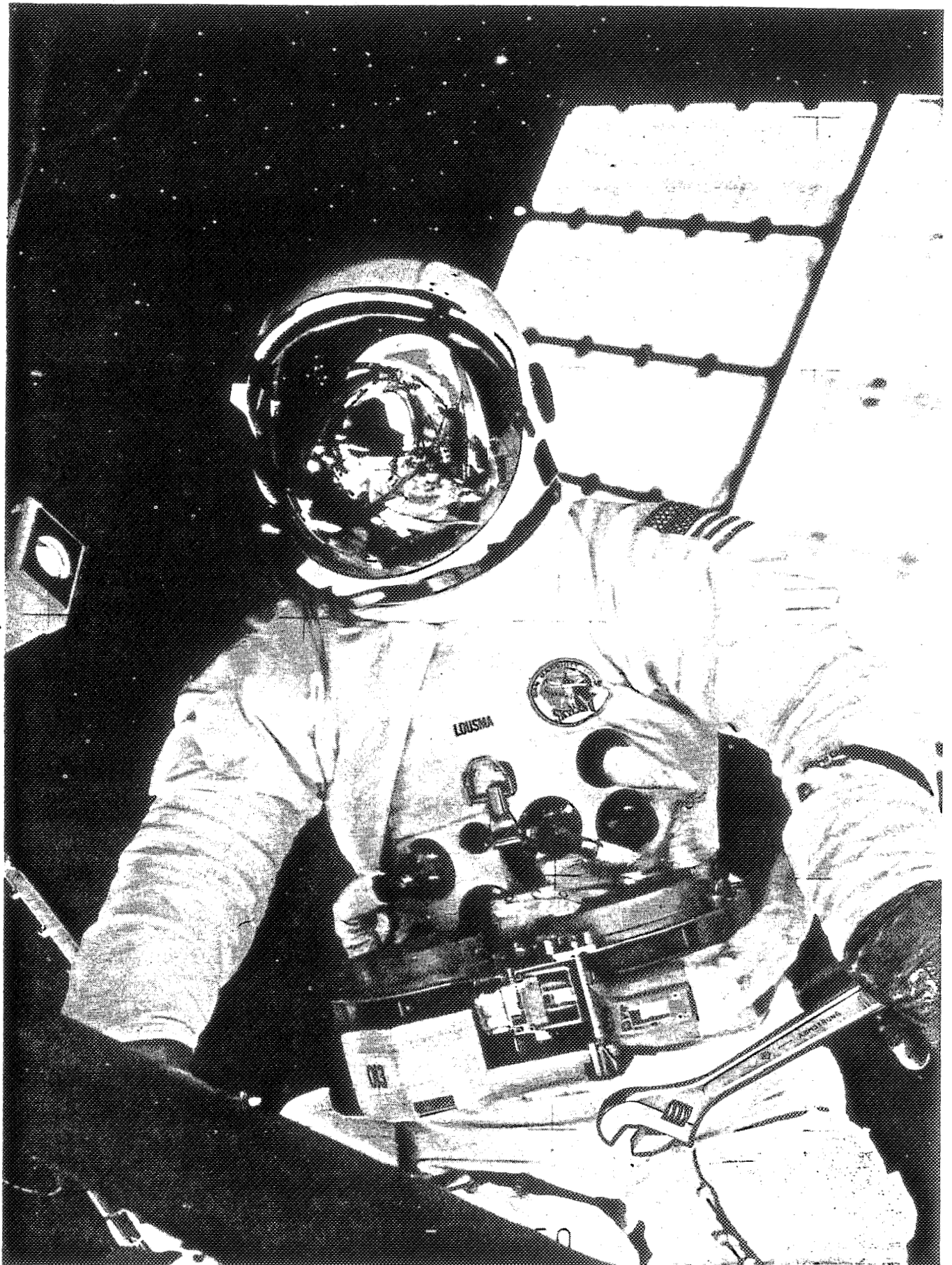

Skylab EVAs usually took the form of two astronauts actually performing the work outside the station while the third followed them with TV and still cameras through the windows. Here, Jack Lousma is pictured during Skylab 3's EVA to erect a new Sunshade.

TABLE OF CONTENTS

ABSTRACT	1
PROBLEM STATEMENT	2
DESCRIPTION	2
A) BACKGROUND	2
B) PERFORMANCE	2
C) CONSTRAINTS	4
ANALYSIS	7
A) FASTENER SELECTION	9
B) MATERIALS	20
C) LUBRICATION	21
CONCLUSIONS AND RECOMMENDATIONS	21
ACKNOWLEDGEMENTS	24
REFERENCES	29
BIBLIOGRAPHY	26
APPENDIX	28
A: FASTENER CATALOG	28
B: EVALUATION SPREADSHEETS	49
C: CALCULATIONS	55
D: PROGRESS REPORTS	60
E: DISCLOSURE FORMS	69
F: DESIGN ALTERNATIVES	

ABSTRACT

A catalog of fasteners is presented for a variety of applications to be used in a lunar environment. The fastening applications targeted include: covers, panels, hatches, bearings, wheels, gears, pulleys, anchors for the lunar surface and structural fasteners (general duty preloadable). The robotic installation and removal of each fastener is presented along with a discussion of failure modes. Structural performance data is tabulated for various configurations. Potential materials for the space environment are presented along with recommendations of appropriate solid film lubricants.

Three original fastener designs were found suitable for the lunar environment. A structural analysis is presented for each original design.

PROBLEM STATEMENT

Compile a catalog of fasteners suitable for the lunar environment that covers a practical range of applications. Design one or more fasteners for applications where existing fastening systems do not meet required constraints.

DESCRIPTION

BACKGROUND

With the United States pressing for a manned space station on the surface of the moon, a need for lunar rated fasteners has been recognized. Equipment for the operation of the manned space station will require a long life due to the expense of sending equipment to the moon. Therefore, a robotically actuated maintenance program is inevitable. An integral part of this program includes a pool of reuseable fasteners for both temporary and semi-permanent applications.

Suitable fasteners have been determined through a selection process which accounts for the extreme environment on the moon's surface. These conditions include [11]:

- 1) Hard Vacuum
- 2) Gravitational attraction of $1/6$ g
- 3) Intense Radiation
- 4) Highly Abrasive Lunar Soil
- 5) Large Thermal Stresses (-170 to 130 degrees C)

PERFORMANCE

The performance objectives for lunar rated fasteners consist of long life and reliability. In an extreme environment, the performance of a mechanical fastener relies on a number of factors. The most important of these factors are considered below.

Controlling thermal expansion of the fastener material relative to the structural material is crucial for a sound joint [5]. If the fastener has a coefficient of expansion considerably less than the structural material, the stress on the fastener will exceed intended

values and a decreased fatigue life and vacuum welding are likely to occur. If the coefficient of expansion of the fastener is greater than the structural material, a loss of preload would ensue. Therefore, fastener materials and the corresponding structural materials should be chosen to have close expansion coefficients. (A low coefficient of thermal expansion is desired for resistance to thermal fatigue.)

Resistance to vacuum welding is required for temporary fasteners in an extreme environment [8]. Fasteners that have sliding surfaces or surfaces in close tolerances will tend to vacuum weld. The use of an appropriate lubricant coating applied to the bearing surfaces will help prevent galling, seizing and vacuum welding. Vacuum welding is also hindered by using different materials for fastener and structure. This hinderance is due to differences in crystal structures and atom sizes. Therefore, with proper choice of materials, vacuum welding can be controlled.

Stability of the fastener material over the temperature range encountered on the moon should be considered. Materials displaying a ductile to brittle transition temperature may be brittle at lower temperatures. This embrittlement of fastener material due to thermal conditions could lead to catastrophic failure. At higher temperatures, adhesion between fastener and structure increases due to the corresponding change in mechanical properties and possibly an increase in chemical reactivity [8].

Radiation stability is required to maintain fastener integrity. Radiation can introduce microstructural changes [6] (vacancies and interstitials) into a material's crystal lattice. This, in turn, will cause a restriction in the amount of plastic flow (Radiation hardening). Other effects of irradiation on materials include void swelling, creep and solid state phase transformations [6], [7]. Above room temperature, radiation damage tends to anneal out, while at cryogenic temperatures, the defects are frozen into place. Therefore, material stability under cryogenic irradiation, which causes a decrease in tensile strength and elongation, must be considered when choosing materials.

A high tolerance fit between fastener and structure is desired due to the dusty environment. When fasteners are removed and reinstalled for maintenance, a fair amount of dust might accompany the fastener in remaking the joint. A low tolerance fit could render the dust covered fastener useless, so high tolerance fits are desirable [11]. Tolerances should permit fastener operation in environments where dust particle size is on the order of 25 microns.

CONSTRAINTS

The following constraints were used in selecting the most desirable fastener for a specific application. Each constraint was weighted differently for each application. The weighting factors are listed on selected spreadsheets in Appendix B.

A: Thermal Stresses

Thermal stresses on the fasteners affect several functions of the fastener. The first is the size of the fastener. With a change in temperature, the size of the fastener changes. This will affect the tolerance of the fastener. If one part of the fastener is relatively hotter than another, binding may occur.

As the fastener cycles from darkness to light on the moon it will undergo thermal fatigue. This will shorten the life of the fastener. Therefore fasteners should be made from materials with low coefficients of thermal expansion, and few parts.

In different fastening applications, the importance of thermal stress varies. For fastening with a required preload, for example, the effects of thermal stresses are augmented; for fastening a panel, the thermal stresses are less important.

B: Vacuum Welding

Vacuum welding can occur when two surfaces of unprotected similar metals are moved relative to each other while under a load in a vacuum.

This is important for all temporary and semi-permanent fastening applications. If a fastener vacuum welds its service life will end when it has to be removed. To avoid this the parts of the fastener which make contact with any surface and undergo relative

motion must be made of dissimilar metals (atomic size and crystal structure) and/or lubricated with a solid film lubricant.

C: Abrasive Environment

The abrasive environment of the moon will affect all fasteners by shortening their service life . To counter this, all pieces that move while in contact with another part of the fastener must be sealed from lunar dust.

D and E: Robotic Manipulation

Since robots will do the field servicing of the equipment, all fasteners must be easily manipulated by a robot.

The robots will be remotely controlled. To simplify the fastening maneuvers, installation will consist of few operating movements, high tolerance fits, blind installations, low torque requirements, and a minimal amount of torque required for installation. All fasteners must be designed with this in mind.

F: Size

The size factor is less important than most other criteria. The size affects the cost of getting a fastener to the moon. But small fasteners may be hard to install by robots, have lower strengths and a shorter service life. Therefore, The size criterion was weighted less than other criteria.

G: Service Life

To save money in the area of transportation costs, the service life must be long. In considering NASA's goal of a ten year service life, a strict maintenance schedule which would require the fastener to be operated several times a week and still be able to perform its specified duties to its design limits is desired. To avoid transporting an excessive amount of fasteners to the moon, successful operation under the above service conditions is required.

H, I, and J: Strength

Strength of the fastener is a very important part of the fastener design. Tension and shear strength are the most important. Torsion can be handled by using more than one fastener and transfer a

torsional load to a shear load.

The strengths of the fasteners in each category vary in importance for the overall fastener. For preloadable applications, strength is very critical since the anticipated loads will be higher than non-preloadable applications. Failure of a preloadable fastener will very likely be catastrophic in nature; for example, a crane boom joint failing as opposed to a cover panel falling off.

K: Reusability

Reusability takes into account the extent to which a fastener can be reused after removal. For example, a blind rivet has no reusability since it must be drilled out.

L: Maintainability

Maintainability is how easily the fastener can be replaced if it breaks. This, for example, is more important on latches since part of the latch may also be attached to structural components. If the fastener fails but replacing or repairing the fastener is easy, then it would score high in this category.

M: Vibrational Resistance

This is how well a fastener will perform under vibration from equipment operation. This is especially important for fasteners that hold together preloaded joints used for wheels, bearings, gears, pulleys on shafts, and other structural connections.

N: Versatility

This was used in the general preloadable case to give a weight to the fastener's versatility. To score highly, the fastener must have the potential to fasten several types of joints so that fewer specific fasteners will have to be taken to the moon.

O: Preloadability

This category takes into account how easily a fastener can be preloaded, how precise a preload can be achieved, and how much preload it can apply. This is most important in preloadable fastener applications.

ANALYSIS

Of the many fasteners already available for use here on earth, it is necessary to determine which ones would function under the adverse conditions of the lunar environment. The applications of fasteners on the moon were broken down into six categories. Certain constraints were determined for the specific application and weighted according to importance on a scale from zero to ten. In each category, a list of possible fasteners was formulated from both existing and original designs and then evaluated (Appendix B). Assigning actual numbers to each fastener for each constraint helped to define the best candidates for robotic installation in a lunar environment. The numbering system follows a convention where the best performance for a given constraint would merit a ten, while the worst performance earns a zero.

The six categories analyzed will encompass many applications for fasteners to be used on the moon. Each category has certain constraints which will be more important to it than it will be to others.

The most general category is the preloadable structural general-duty fasteners. Here, the strength of the fastener will be very important since it will be under constant load for long periods of time. Also, the robotic operation in installing and removing the fastener will be important since a considerable amount of torque or a tight fit may be needed to get the desired preload.

A category for fasteners used on covers and hatches was created to cover the panels, electrical covers, access hatches, and other plate-like covers that will be used on the equipment or buildings on the moon. Here, the importance of vacuum welding was weighted as the most important constraint due to the probability of a panel getting permanently stuck due to a fastener that vacuum welds into place. Again, the robotic operation of the fastener was given a high priority because the fasteners will probably have to be lined up to fit in an array of holes (one in each corner of the panel). The strength of the fastener in shear will be the most important since the panel will probably be hanging vertically and the fastener holding it up will be inserted horizontally.

Fasteners for securing wheels, gears, and pulleys to shafts were analyzed with vacuum welding and vibration resistance ranking as the most important constraints. Robotic applications were given high priority because if a fastener cannot be installed or removed from a machine to get to the gear or wheel, the machine may be rendered useless.

Most of the moving machinery will use some kind of bearings in their operation. Methods of securing these bearings to shafts were analyzed according to their ability to secure the bearing effectively. The thrust of the bearing against the securing device was rated as the most important constraint, while robotic operation, thermal stresses, and vacuum welding also ranked as high in priority.

A category for dealing with the hoses used on the machinery was broken into two sections. The first deals with the connection of these hoses to one another, while the second deals securing the hoses and keeping them out of the way of moving parts or dragging the ground. In the connection section, the tension strength, robotic operation, and the reusability ranked most important.

In the securing section, the same constraints were given the highest priority. Here, the vacuum welding and thermal stresses are not as important as in the connection section because the securing device could be designed to flex under thermal stresses and still do the intended task and a vacuum weld would not render the hose useless.

In designing a device to exert a force perpendicular to the lunar surface (i.e. a lunar drill), it is necessary to provide enough force to counter the opposing force that the moon will supply. Fasteners for anchoring things such as guy lines or anchoring cables to the lunar surface were analyzed and weighted for their performance in an environment consisting entirely of abrasive lunar regolith. Hence, the ability to operate in dust was rated among the most important constraints along with strength in tension and robotic installation.

After the values were assigned, the total score for each fastener was arrived at by taking the sum of all the products of importance factor and category value for all of the categories.

The original fasteners that proved to be worthy for lunar use were analyzed to see if they would work as designed. These calculations are given in Appendix C.

FASTENER SELECTION

SEALED-THREAD BLIND FASTENER

Refer to Figure 1, Appendix A. Intended to be a general-duty, preloadable fastener, the sealed-thread blind fastener is an original design which eliminates many of the problems of conventional preloadable fasteners when used in the lunar environment. It was designed specifically for this environment and for ease of robotic installation.

The fastener utilizes a threaded design for maximum precision in torque application as well as for reasons of strength. However, since conventional threaded designs are impractical for lunar robotic use, due to dust fouling problems and potential for stripping, this uses a sealed thread principle. Dust penetrability is eliminated, and o-ring seals can be incorporated for an additional factor of security. The fastener is pre-threaded, eliminating this difficult robotic operation as well as the potential for stripping the nut.

The unit incorporates an internally-threaded sleeve unit, an externally-threaded inner bolt with a semi-hollow cone bottom, and an expanding wing unit with three leaves and an o-ring type spring. The inner bolt is tightened against the wing unit, causing it to expand and grip the bottom side of the material. Upon removal, the inner bolt is loosened, and the wing pieces retract due to the pressure of the o-ring and the unit can be removed from the hole.

The fastener is completely blind, requiring no engagement of the opposite side of the material, and can be installed by one robotic arm in one operation. The sleeve piece is round and can be installed in conventionally-drilled holes. Its top incorporates a crescent head, and the robot holds this to prevent the fastener from spinning freely in the hole as it is tightened. The sleeve crescent head can be held in place by the same arm that spins the inner bolt with a simple attachment. The inner bolt has a reverse-blade head (see drawing), and is spun to tighten. It is completely flush with the outer sleeve top, and the reverse-blade design was chosen to minimize the effect of dust accumulation in its recess. However, an allen-type head could be used if desired.

The advantages of this design over conventional blind fasteners

are several. First, it is easily removed and completely reusable, because no pieces are deformed in the tightening process. Additionally, the fastener can be used with material of various thicknesses - its length does not have to be specifically matched to the material thickness as in some designs. This is due to the free-floating wing piece, which after expansion can be tightened within a reasonable length (one-half inch or so, depending on outer diameter). Furthermore, its smooth outer bore and tapered bottom insure easy low-tolerance robotic installation and easy potential for magazine loading, speeding up the installation process.

There was no device existing similar to this proposal found after an exhaustive patent and literature search. NASA presented the closest alternative found, incorporating a sealed-thread configuration but utilizing a deformable lower shank, requiring a bottom counterbore, incorporating very little latitude in material thickness, and requiring a special hole to prevent the fastener from spinning while tightening. Turn to the appendix on alternative designs for an illustration.

The proposed design will perform very similarly to a bolt of similar dimensions in shear and tension. It may fail first at the wing unit either at the o-ring spring or a wing piece itself if loading forces are too great. However, if the spring (the weakest link) should fail in operation, the fastener's performance would not be compromised; in removal the wing pieces would simply fall off.

In choosing the sealed-thread blind fastener, the relevant criteria considered were the general constraints previously mentioned. Refer to the evaluation matrix presented as Table 7, Appendix B .

QT CAM FASTENER

Refer to Fig. 2, Appendix A. The QT (quarter turn) Cam fastener is intended for use in preloadable joints where threaded fasteners would be used on Earth. This is a general use fastener for blind preloadable operation. The fastener consists of a shaft with two keys at one end of the shaft and two offset circular disks on hinge pins at the other end. The eccentricity of the circles cause the preload on the fastener. The fastener is inserted into a keyed hole

and pushed through to the other side until it clears the material. Then the fastener is turned one quarter turn to provide a bearing surface from the keys on the fastener shaft. The cams are then rotated past the peak load position to the stop which is at 5° past center. A spanner wrench hole is provided for extra torque applications.

To install the QT Cam robotically, the robot must first grasp the fastener by the shaft and the cams. Then the robot must insert the keyed shaft into the keyed hole and push it through to the other side. Then it must turn the fastener one quarter turn and push the cam past the peak load point to the stop at 5° past center. The removal is the opposite of installation.

The possible areas of failure in the QT cam are at the keys and at the hinge pins. The hinge pins will shear off before the shaft breaks because of the way they are loaded. If the seals to the hinge pins fail and dust gets into the cavity then the pins can seize.

In choosing the QT Cam the relevant criteria considered were the general constraints considered above. Refer to the evaluation matrix presented in Table 1, Appendix B. The advantages to this fastener are its ease of application, blind fastening ability, preloadable to a high preload, high tensile and shear load capabilities, and an over-center lock to counter loosening by vibration. The cams will be coated to counter vacuum welding.

DISENGAGEABLE MAGNETIC FASTENER

Refer to Figures 3, Appendix A. This hatch and panel fastener is an original design which incorporates a magnet to provide holding force and can be completely disabled through a quarter-turn of its wing handle. Robotic installation and removal is extremely easy, and its performance in the lunar environment should be excellent.

The magnetic forces can be disabled through a mechanism similar to that found on dial gauge-holding tools for the machine shop. Basically, there is a magnetic core which the 1/4-turn handle brings in and out of contact with two conductor pieces, effectively engaging or separating the two poles of the magnet. The result is that when "off", the magnet provides virtually no force and can be easily disengaged.

The two parts of the fastener incorporate pre-installed

housings, attached by small screws, rivets, or similar device. They are to be constructed of a non-magnetic material such as aluminum. In the female piece, there is a circular steel (or other magnetic material) insert to correspond with the magnet on the male unit. The male unit includes the wing piece to engage the magnet. The different materials allow easy robotic lining-up of the fastener; the two pieces will only be attracted to each other in the area intended.

The magnet itself can easily provide enough force in a small size; one disengageable magnet found exerted 175 lbs of force (in perfect tension) in a 2x2 inch package. Much less total force would be required for the applications foreseen in the lunar environment, and therefore the size required can be minimized. Additionally, the fastener would be impervious to the ferric regolith particles; since the magnet is "off" when disengaged, and completely sealed when "on", it cannot attract the dust particles. Radiation coatings could be applied to the magnet if necessary, and vacuum welding would not be a factor in its operation. The Curie temperatures of the magnetic materials considered all far exceeded any found on the moon, and thermal stresses are negligible. Furthermore, the fastener's reusability and service life is indefinite.

Failure would first occur in the wing handle mechanism itself from excessive application force. The housing retaining screws are also subject to failure under high loads. The magnet itself should have good service life and provide plenty of tensile strength.

The criteria involved in our choosing the magnetic panel fastener are outlined above. Refer to the evaluation matrix presented as Table 2 in Appendix B. The advantages of this proposal over existing designs are several. Its installation/removal is as simple as possible. Its tolerance to the lunar environment is excellent, and its reusability is great. It is relatively simple in design and can provide great strength in a reasonable size.

T-HANDLE LATCH

Refer to Fig. 4, Appendix A. The T-handle latch is intended for use in securing panels, covers and hatches. The latch itself is pre-installed in the panel that is to be secured. The latch essentially consists of a shaft on which one end is a T-shaped handle and on the other, a bar. The object that the panel is to be secured to has a

receptacle to accept the bar at the end of the latch shaft. To apply the latch, the latch is positioned so that the bar at the end of the latch shaft enters the receptacle. Once the bar has fully entered the receptacle, the shaft is then turned (via the T-handle) ninety degrees. This in turn rotates the bar into the receptacle, forcing the bar to bear against the interior surface of the receptacle, here by preventing the latch (and therefore the panel) from being removed. This provides the fastening action of the latch.

To install the T-handle latch robotically, the robotic device must first grasp the T-handle of the latch, position it over the receptacle, insert the bar end into the receptacle, turn the T-handle ninety degrees, and then release the T-handle. Removal is the opposite of the above.

The T-handle latch may fail by some defect or fatigue in the material of the latch, by exerting too large a force while inserting the bar into the receptacle, which may promote plastic deformation or fracture of one or more fastener parts.

In choosing the T-handle latch, the relevant criteria considered were the general constraints mentioned above. Refer to the evaluation matrix presented as Table 2 in Appendix B. The advantages of the T-handle latch are that it is relatively simple in theory and operation, is potentially small in size, is reasonably dirt tolerant depending on the design of the receptacle, and is tolerant of thermal stresses. It is also very reusable. As can be seen from the evaluation matrix referred to above, the T-handle latch seems to be the best compromise with respect to optimum performance within the required constraints.

INTERNAL AND EXTERNAL SNAP RING

Refer to Figs 5a & 5b, Appendix A. The internal and external snap rings are intended for use in fastening bearings, wheels, gears and pulleys to shafts. The interior snap ring is designed to work in the inner radius of hollow shafts. The internal snap ring is applied by inserting the proper tool into the semi-circular notches at the ends of the ring. A force is then applied, through the tool, such that the notches are brought toward each other reducing the diameter of the ring. The ring is then inserted into a machined groove. The force on the notches is removed, thereby allowing the ring to expand into the groove. The groove is smaller in diameter than the unstressed ring, therefore, when the force on the ring due to the tool is released the ring will exert a spring force on the inside surface of the groove, thereby preventing the ring from working its way out of the groove. The inner portion of the ring also protrudes out of the groove preventing the bearing from moving past the ring and effectively restricting the bearing to a particular position along the shaft. The external snap ring works similarly, except that it is designed to work on the outer radius of shafts.

To install the snap ring robotically, the robotic device must grasp the ring, insert the proper tool into the notches at the ends of the ring, apply the appropriate force to the ends, position the ring with respect to the machined groove, remove the force on the ends and release the ring. Removal is the opposite of the above.

The snap ring may fail by some defect or fatigue of the ring material, or by exerting too great a force on the ring ends during installation/removal, causing the ring to either plastically deform or break. The ring may also fail by the bearing exerting too great a thrust force on the ring, causing the ring to either plastically deform or break.

In choosing the snap ring, the relevant criteria considered were the general constraints mentioned above, with the exception of strengths in tension and shear being replaced with strength in thrust. Refer to the evaluation matrix presented as Table 3 & 4, Appendix B. The advantages of the snap ring are that it is small in size, simple in theory and operation, and reasonably tolerant of dust contamination and thermal stresses. It is also very reusable. As

can be seen from the evaluation matrix referred to above, the snap ring seems to be the best compromise with respect to optimum performance within the required constraints.

GIB KEY

Refer to Fig. 6, Appendix A. The Gib key is intended for use in securing wheels, gears and pulleys to shafts. To apply, the wheel is placed on the shaft to which it must be secured. The Gib key is then placed into a machined groove in the shaft, with the small end of the key facing the wheel. The key is then forced toward and under the wheel. Wedging the key between the shaft and the wheel and fastens the wheel to the shaft. The wheel may also have a machined groove in it to receive the key if alignment of the wheel with respect to the shaft is critical. The key is installed so that there is a gap between the wheel and the large end of the key. This facilitates removal of the wheel from the shaft by providing a bearing surface by which the wheel can be pried free from the key using an appropriate tool.

To apply robotically, the robotic device must grasp the wheel, position the wheel on the shaft it is to be secured to, grasp the key, position it in the machined groove, apply a force to the key such that the key is forced toward and under the wheel and wedged between the wheel and the shaft. Removal is the opposite of the above; if the key is difficult to remove, the wheel may be pried off of the key by inserting a tool between the wheel and the key and applying the necessary force.

The Gib key may fail by defect or fatigue of the key material or by exerting too great a force to the key during installation/removal, causing the key to either elastically deform or break. The key may also fail due to the wheel exerting too great a thrust force on the key, causing the key to either plastically deform or break.

In choosing the Gib key, the relevant criteria considered were the general constraints mentioned above, with the exception of strength in tension and torsion being replaced with strength in thrust and shear. Refer to the evaluation matrix presented as Table 3, Appendix B. The advantages of the Gib key are its simplicity of theory and operation, its small size, and some degree of reusability.

It is also tolerant of thermal stresses and dust contamination, provided the design tolerances between the key and the machined groove are reasonably large. A small amount of dust may actually improve the fastening ability of the key. As can be seen from the evaluation matrix, the Gib key seems to be the best compromise with respect to optimum performance within the required constraints.

ANCHOR STAKE

Refer to Fig 7, Appendix A. The anchor stake is intended for use in securing objects such as drilling devices to the lunar surface. The stake has a cable pre-attached to its large end; the cable is in turn fastened to the object to be secured. To apply the anchor stake, position the stake at a desired angle to the lunar surface (the angle depends on the nature and slope of the lunar surface and the position of the object) with the pointed end pointing toward the lunar surface, and apply force to the stake such that the pointed end of the stake is driven into the lunar surface while maintaining the cable taught. The stake is driven into the lunar surface to a sufficient depth so that the friction force applied by the lunar surface material on the stake is greater than the retracting force on the stake due to the tension in the cable. This friction force supplies the fastening action of the stake.

To apply robotically, the robotic device must grasp the stake, position it relative to the lunar surface, apply a force driving the stake a sufficient depth into the surface while maintaining tension in the cable, and releasing the stake. Removal is the opposite of the above.

The anchor stake may fail either by defect or fatigue of the stake material. Exerting too great a force on the stake during installation (in the effort to overcome the repelling friction force due to the surface material or after striking some hard object under the surface) may cause the stake to either plastically deform or break. The stake may also fail due to tension force in the cable exceeding the friction force due to the surface material, causing the stake to pull out of the surface, or by the resultant forces on the stake exceeding the specified strength of the stake material,

causing the stake to either plastically deform or break.

In choosing the anchor stake, the relevant criteria considered were the general constraints mentioned above. Refer to the evaluation matrix presented as Table 5, Appendix B. The advantages of the anchor stake are its simplicity of theory and operation, its reusability, dust contamination (it is designed to operate in essentially a 100% contaminated environment) and thermal stresses (irrelevant to its method of operation). As can be seen from the evaluation matrix, the anchor stake seems to be the best compromise with respect to optimum performance within the required constraints.

GLAD-HANDS COUPLING

Refer to Fig. 8, Appendix A. The glad-hands coupling is intended for use in connecting the ends of pneumatic and hydraulic lines and hoses that may or may not require maintenance of pressure within the lines. The glad-hands coupling consists of two pieces. One piece is pre-attached to the end of one of two lines to be connected together; the other piece is pre-attached to the end of the other line. The two pieces are then positioned together so that the seals contained within each piece are in contact with each other. The follower of each piece is then aligned with the receiving groove in the other piece, and the pieces are rotated in such a way as to engage the followers in their respective grooves until the stops at the ends of the grooves are contacted by the followers. This action compresses the seals together, providing an effective seal between the two pieces, while the reaction force provided by the compressed seals clamps the two pieces together, preventing the followers from slipping out of their respective receiving grooves. This clamping force provides the fastener action.

To apply robotically, the robotic device must grasp the two pieces, position them together so that the seals contained within the two pieces are in contact with each other, and apply a force to rotate the pieces with respect to each other until the followers are fully engaged in their respective receiving grooves, and then release the pieces. Removal is the opposite of the above. The coupling piece presented in the drawing in Figure 8 of Appendix A entails a slight

modification to the typical glad-hand piece to better enable a robotic device to grasp it.

The glad-hands coupling may fail by defect or fatigue of the material in the pieces (especially in the follower and groove areas). Wear in the groove and follower bearing surfaces and the seal bearing surfaces, may cause a reduction in the pressure sealing capability. The sealing capability may also be affected if the coupling is exposed to temperatures cold enough to cause the seal material to freeze or hot enough to cause the seal material to melt.

In choosing the glad-hands coupling, the relevant criteria considered were the general constraints mentioned above. Refer to the evaluation matrix presented as Table 6 in Appendix B. The advantages of the glad-hands coupling are its good resistance to thermal stresses, its reusability and its simple operation. It is also reasonably tolerant of dust, although a particularly large accumulation of dust on the seal surfaces may adversely affect the sealing capability of the coupling. The rotation required to apply the coupling with the seal surfaces in contact may provide enough cleaning action should such an accumulation occur. As can be seen from the evaluation matrix referred to above, the glad-hands coupling seems to be the best compromise with respect to optimum performance within the required constraints.

SPRING CLIP

Refer to Fig 9, Appendix A. The spring clip is intended for use in securing hoses, lines and cables. The back face of the clip is pre-attached to the object that it is desired the hose be secured to. To apply the spring clip, the hose is placed against the front face of the clip between the outwardly protruding ends, and then pushed against the front of the clip with sufficient force that the two prongs of the clip are spread outward and around the hose until the hose contacts the back of the clip. The distance between the unstressed prongs is less than the diameter of the hose to be secured, resulting in a spring force exerted by the prongs on the hose. This force provides the fastening action of the clip.

To apply robotically, the robotic device must grasp the hose to be secured, position it against the front of the clip, and push the

hose into the clip with sufficient force to snap the hose into place. Removal is the opposite of the above.

The spring clip may fail by defect or fatigue of the material of the clip, or of the material of the object the clip is pre-attached to. The clip may also fail due to improper positioning of the hose during installation/removal, causing excess force to be brought against one of the prongs, causing the clip to either plastically deform or break.

In choosing the spring clip, the relevant criteria considered were the general constraints mentioned above. Refer to the evaluation matrix presented as Table 7, Appendix B. The advantages of the spring clip are its small size, its tolerance of thermal stresses and dust, its simplicity of theory and operation, and its reusability. As can be seen from the evaluation matrix, the spring clip seems to be the best compromise with respect to optimum performance within the required constraints.

OVER-CENTER LIVING HINGE

Refer to Fig. 10, Appendix A. The over-center living hinge is intended for use in securing hoses, lines and cables. The back face of the hinge is pre-attached to the object it is desired the hose be secured to. To apply the hinge, the hinge must initially be in the open position. The hose is then positioned between the protruding ends and against the back of the hinge. A hose is pushed into the hinge forcing it to clamp around the hose. The ends of the hinge simultaneously close around the hose until the ends of the hinge completely surround the hose. The hinge is then in the closed position. The material of the hinge, polypropylene, is highly elastic, providing a spring action keeping the hinge closed. This force provides the fastening action of the hinge.

To apply robotically, the robotic device must grasp the hose that must be secured, position it between the ends of and against the back of the hinge, apply a force such that the hose is pushed into the hinge until the hinge is closed, and then release the hose. Removal is the opposite of the above.

The over-center living hinge may fail by fatigue or defect of the material of the hinge or of the object the hinge is pre-attached to. The hinge may also fail during installation of the hose due to

improper alignment of the hose between the open ends of the hinge, or attempting to install the hose with the hinge in the closed position, causing the hinge to either plastically deform or break.

In choosing the over-center living hinge, the relevant criteria considered were the general constraints mentioned above. Refer to the evaluation matrix presented as Table 7, Appendix B. The advantages of the over-center living hinge are its simplicity of operation, its tolerance of thermal stresses and dust, and its reusability. As can be seen from the evaluation matrix mentioned above, the over-center living hinge seems to be the best compromise with respect to optimum performance within the required constraints.

MATERIALS

The more popular materials for space applications today fall into three general categories: alloys, plastics and composites. The most promising alloys for fastener applications are beryllium, molybdenum or nickel based [10], [12]. Beryllium and Molybdenum alloys are both seeing applications in deep space (Space Shuttle brake systems, satellite structures, lubricants) because they have excellent dimensional stability, high strength to weight ratio (for Beryllium, five times that of ultra-high strength steels) and vacuum stability [2]. Monel, a Nickel-Copper alloy, is strong and tough at sub-zero temperatures and has excellent anti-seizing and non-galling properties.

Nickel-based superalloys (Incoloy) are good choices for high temperature applications (Space Shuttle engine parts: heat exchanger liners, housing supports) [2]. Incoloy 903 exhibits a nearly constant coefficient of thermal expansion (thus resistant to thermal fatigue).

Aluminum-Boron, Carbon-Phenolic and Epoxy-Boron composites illustrate high-strength, high-temperature, light-weight materials for aerospace applications.

Poly(amide-imide) is especially used in applications where strength at high temperature is required. This engineering thermoplastic is characterized by good impact resistance, excellent dimensional stability, high strength at high temperatures and good

radiation resistance. Numerous grades of Poly(amide-imide) are currently available. The type of fiber reinforcement and its volume fraction percent are variables that can be developed to meet special designs. Aerospace applications include fasteners, bushings, brackets and housings.

LUBRICATION

In virtually all of our fastening applications, the tendency for vacuum welding of bearing surfaces or sliding parts can be reduced by an increase in the lubricity of mating surfaces. Liquid lubricants were not considered because they vaporize in a vacuum, they trap abrasive particles and they require complex robotic maneuvers for application and removal. The following solid lubricants prevent galling and have anti-seize properties and are satisfactory for the space environment [3].

- | | |
|----------------------------|---|
| 1) Lube - Lok 4306, | Electrofilm, Inc. |
| specification: | NASA-A-D-66A |
| composition: | MoS ₂ in phenolic binder (no graphite) |
| usable temperature: | -184 to 316 degrees C (air) |
| used on: | Plastics, Fibers, Ceramics, Metals |
| remarks: | Good outgassing properties, poor radiation properties, widely tested and approved for deep space and high vacuum applications |
|
 | |
| 2) Bps 18.07, | Ball Aerospace Systems (vac kote process) |
| specification: | not available |
| composition: | MoS ₂ lube solids, organic binder |
| usable temperature: | -184 to 288 degrees C (vacuum) |
| used on: | Glass, Ceramics, Metals |
| remarks: | May be applied to most metals, space environment, load capacity > 100,000 psi |
|
 | |
| 3) Drilube 805 N, | Drilube Company |

specification: MIL-L-81329
composition: MoS₂ and graphite in a sodium silicate binder.
usable temperature: -240 to 649 degrees C (vacuum)
used on: Glass, Ceramics, Metals
remarks: Very good load capacity

4) **Everlube 811** E/M Lubricants, Inc.
specification: MIL-L-81329
composition: MoS₂ and graphite in sodium silicate binder.
usable temperature: -240 to 649 degrees C (air)
used on: Glass, Ceramics, Metals
remarks: Very good radiation properties
negligible vacuum weight loss

CONCLUSIONS AND RECOMMENDATIONS

An ideal fastener rated for the lunar environment should be small, dirt tolerant and simple. Six of the 10 fasteners herein recommended for use in a lunar environment illustrate these aspects (snap ring, over-center living hinge, glad hands coupling, spring clip, anchor stake, Gib key). In choosing the material for a specific application, the physical, mechanical and thermal properties can be specified to meet criterion stated in the report (i.e. lightweight, strong and long-lived). With an appropriate solid lubricant, adhesion can be avoided. In the design or redesign of existing fasteners, blind installation (robotically actuated) can be achieved along with dust seals to protect threads. The fastener design incorporating dissimilar metals has potential for anti-seizing and non-galling characteristics.

Further studies geared toward the design of a lunar-based station should include the production of an in-depth materials selection catalog. The design of composite materials and materials testing for the extreme environment might accompany materials selection.

ACKNOWLEDGEMENTS

We gratefully acknowledge Mr. J. W. Brazell, our instructor, along with teaching assistants Mr. Brice Maclaren and Ms. Jill Harvey. We would also like to acknowledge Dr. Alan V. Larson for his valuable advice.

REFERENCES

- [1] Flinn, R.A., Trojan, P.K., *Engineering Materials and Their Applications*, Houghton Mifflin Company, Boston, Mass., 1986, pp. 682-685.
- [2] Dreger, D.R., Kacala, J. (eds.), NONFERROUS METALS, *Machine Design*, Vol. 59, No. 8, 1987, pp. 203-226.
- [3] McMurtrey, E.L. , *High Performance Solid and Liquid Lubricants*, Noyes Data Corporation, Park Ridge, N. J., 1987, pp. 2-140.
- [4] Clauss, F. J., chp.1-4, *Solid Lubricants and Self-Lubricating Solids*, Acedemic Press, Inc., New York, N.Y., 1972, pp.1-112.
- [5] Howell, J.N., MECHANICAL FASTENERS FOR HIGH TEMPERATURE APPLICATIONS, National SAMPE Technical Conference, Vol.1, Western Periodicals Company, North Hollywood, Cal., 1969.
- [6] Garner, F.A., Peckan, N.H., Kumar, A.S., (eds.), *Radiation-Induced Changes in Microstructure*, ASTM, STP No. 955, Philadelphia, Pa.,1987.
- [7] Garner, F.A., Peckan, N.H., Kumar, A.S., (eds.), *Influence of Radiation on Material Properties*, ASTM, STP No. 955, Philadelphia, Pa., 1987.
- [8] *Adhesion or Cold Welding of Materials In Space environments*, ASTM, STP No. 431, Philadelphia, Pa., 1967.
- [9] Salkind, M.J., Holister, G.S., *Applications of Composite Materials*, ASTM, STP No. 524, Philadelphia, Pa., 1973.
- [10] AEROSPACE STRUCTURAL METALS HANDBOOK, Belfour Stolen Inc., 1988.
- [11] Regel, L.L., *Materials Science In Space*, Halsted Press Inc., New York, N.Y., 1987.
- [12] Fenn, R. W., Jr.,NEW DUCTILE BERYLLIUM-ALUMINUM WROUGHT ALLOYS , *Newer Structural Materials for Aerospace Vehicals*, ASTM, STP No. 379, Philadelphia, Pa., 1964.

BIBLIOGRAPHY

- (1) Shackelford, J. F., *Introduction to Material Science for Engineers*, Macmillan Publishing Company, New York, N. Y., 1985.
- (2) Guide to Selecting Engineered Materials, *Advanced Materials and Processes*, vol.2, No.1, 1987.
- (3) Catalog and Service Guide, Phillips Manufacturing Company, Montebello, Cal., 1983.
- (4) Maintenance Catalog, Bowman Products Division, Associated Spring Corporation, Cleveland, Ohio, 1975.
- (5) Georges, J.M. (ed.), *Microscopic Aspects of Adhesion and Lubrication*, Vol.7, Elsevier Science Publishing Company, Inc., New York, N.Y., 1982.
- (6) Kato, I., Sadamoto, K. (eds.), *Mechanical Hands Illustrated*, revised edition, Hemisphere Publishing Corporation, New York, N. Y., 1987.
- (7) Frandel, J.W., *Lunar Mineralogy*, John Wiley & Sons, New York, N.Y., 1975.
- (8) Schultz, P.H., *Moon Morphology*, University of Texas Press, Austin, Tx., 1972,1976.
- (9) Mutch, T.A., *Geology of the Moon* Princeton University Press, Princeton, N.J., 1970, 1972.
- (10) *Bushings and Beyond*, Catalog 187, HEYCO Molded Products catalog, Kenilworth, N.J., 1987.
- (11) *Tinnerman brand fasteners*, Catalog 383-8, Eaton Corporation, Cleveland, Ohio, 1985.
- (12) *Thousands of Fastex Solutions that Work!*, TWFastex, Des Plaines, Ill., 1987.
- (13) *Aerospace and Military Hardware*, Industrial Fasteners Corporation, Port Washington, N.Y.
- (14) *Industrial Retaining Rings*, Catalog A-4-c, Industrial Retaining Ring Company, Irvington, N.J., 1986.
- (15) *Southco Fasteners Handbook 37*, Southco Inc., Concordville, Pa., 1987.
- (16) Fenn, R. W., Jr., *NEW DUCTILE BERYLLIUM-ALUMINUM WROUGHT ALLOYS* , *Newer Structural Materials for Aerospace Vehicles*, ASTM, STP No. 379, Philadelphia, Pa., 1964.

- (17) Crañor, M., ed., *Chouinard Equipment*, Catalog 1988, Ventura, California, 1988.
- (18) Shigley, J. E., and Mitchell, L. D., *Mechanical Engineering Design*, fourth edition, McGraw-Hill, New York, N. Y., 1983.
- (19) Pollack, H. W., *Applied Physics*, Prentice-Hall, Englewood Cliffs, N. J., 1971.
- (20) Soled, J., *Fasteners Handbook*, Reinhold Publishing Corp., New York, N. Y., 1957.
- (21) Dzik, Stanley J., *Aircraft Hardware Standards Manual and Engineering Reference*, Aviation Publications, Milwaukee, WI., 1971.
- (22) *Fasteners and Fastening Techniques: NASA SP-5906(01)*, NASA, Washington, D. C., 1967.
- (23) *Fasteners and Fastening Techniques: NASA SP-5906(02)*, NASA, Washington, D. C., 1968.
- (24) *Fasteners and Fastening Techniques: NASA SP-5906(03)*, NASA, Washington, D. C.
- (25) *NASA Technical Report #N82-26673*, NASA, Washington, D.C., 1983.

APPENDIX A

LUNAR RATED FASTENER CATALOG

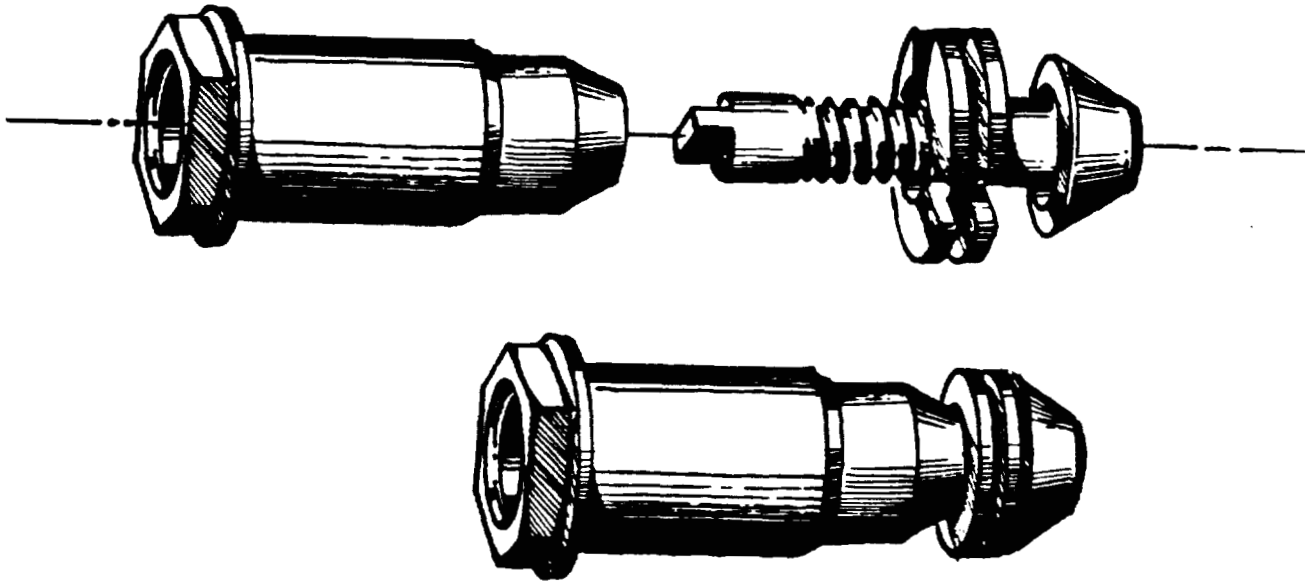

SEALED-THREAD BLIND FASTENER

Intended to be a general-duty, preloadable fastener (Figure 1), the sealed-thread blind fastener is an original design which eliminates many of the problems of conventional preloadable fasteners when used in the lunar environment. It was designed specifically for this environment and for ease of robotic installation.

The fastener utilizes a threaded design for maximum precision in torque application as well as for reasons of strength. However, since conventional threaded designs are impractical for lunar robotic use, due to dust fouling problems and potential for stripping, this uses a sealed thread principle. Dust penetrability is eliminated, and o-ring seals can be incorporated for an additional factor of security. The fastener is pre-threaded, eliminating this difficult robotic operation as well as the potential for stripping the nut.

The unit incorporates an internally-threaded sleeve unit, an externally-threaded inner bolt with a semi-hollow cone bottom, and an expanding wing unit with three leaves and an o-ring type spring. The inner bolt is tightened against the wing unit, causing it to expand and grip the bottom side of the material. Upon removal, the inner bolt is loosened, and the wing pieces retract due to the pressure of the o-ring and the unit can be removed from the hole.

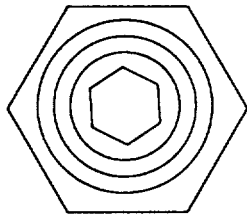

ALLEN HEAD
INNER BOLT

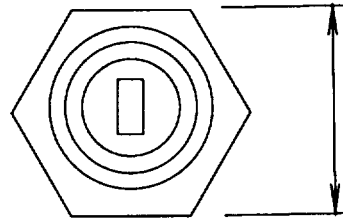

INVERSE-BLADE HEAD

(ALTERNATE HEAD DESIGN)

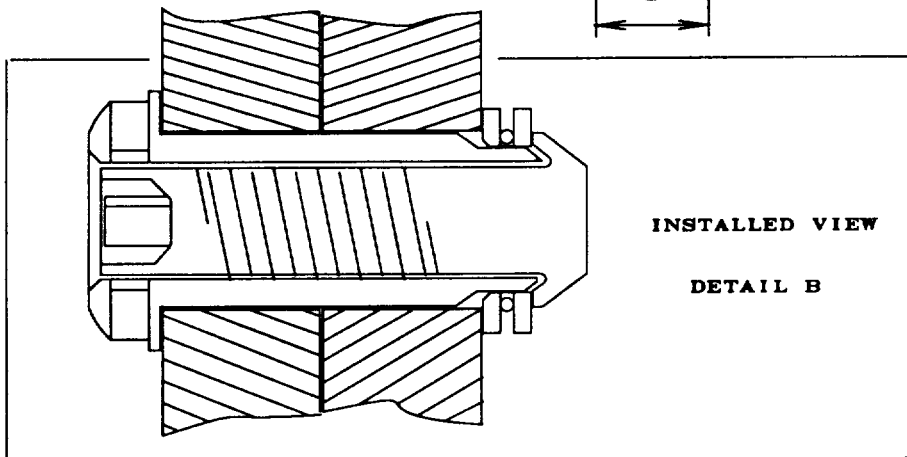
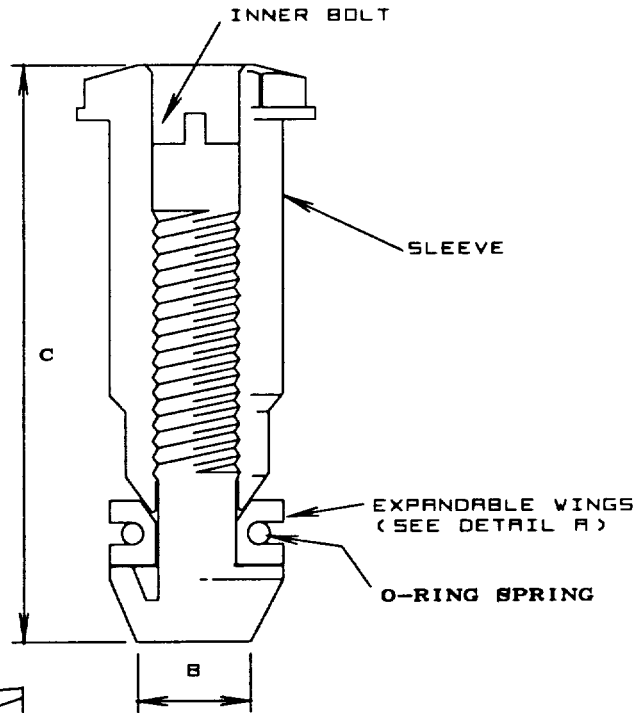
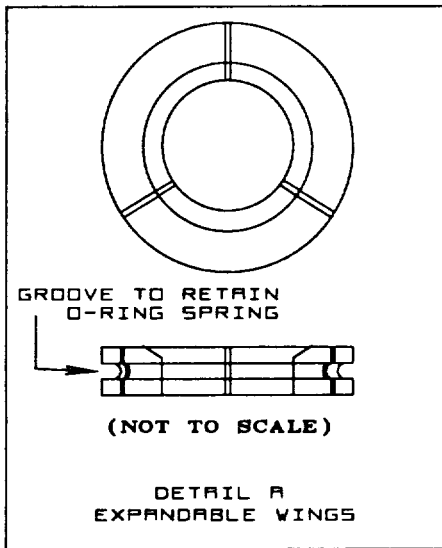
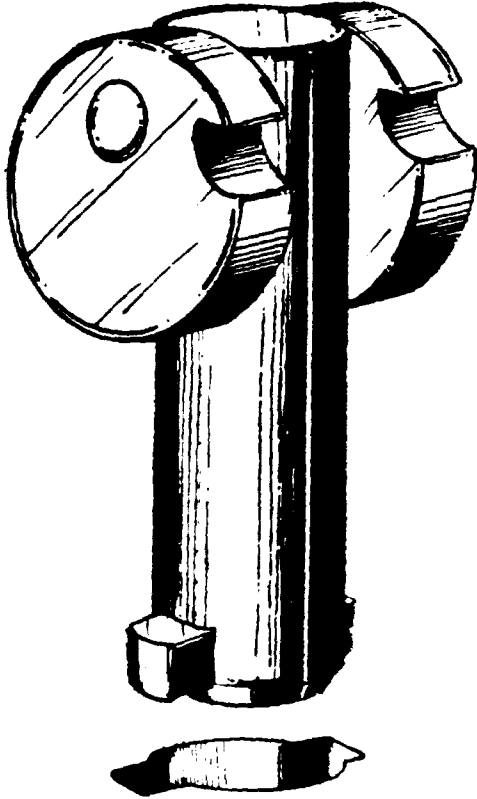

Figure 1
SEALED-THREAD
BLIND FASTENER



QT CAM FASTENER

The QT (quarter turn) Cam fastener (Figure 2) is intended for use in preloadable joints where threaded fasteners would be used on Earth. This is a general use fastener for blind preloadable operation. The fastener consists of a shaft with two keys at one end of the shaft and two offset circular disks on hinge pins at the other end. The eccentricity of the circles cause the preload on the fastener. The fastener is inserted into a keyed hole and pushed through to the other side until it clears the material. Then the fastener is turned one quarter turn to provide a bearing surface from the keys on the fastener shaft. The cams are then rotated past the peak load position to the stop which is at 5° past center. A spanner wrench hole is provided for extra torque applications.

To install the QT Cam robotically, the robot must first grasp the fastener by the shaft and the cams. Then the robot must insert the keyed shaft into the keyed hole and push it through to the other side. Then it must turn the fastener one quarter turn and push the cam past the peak load point to the stop at 5° past center. The removal is the opposite of installation.

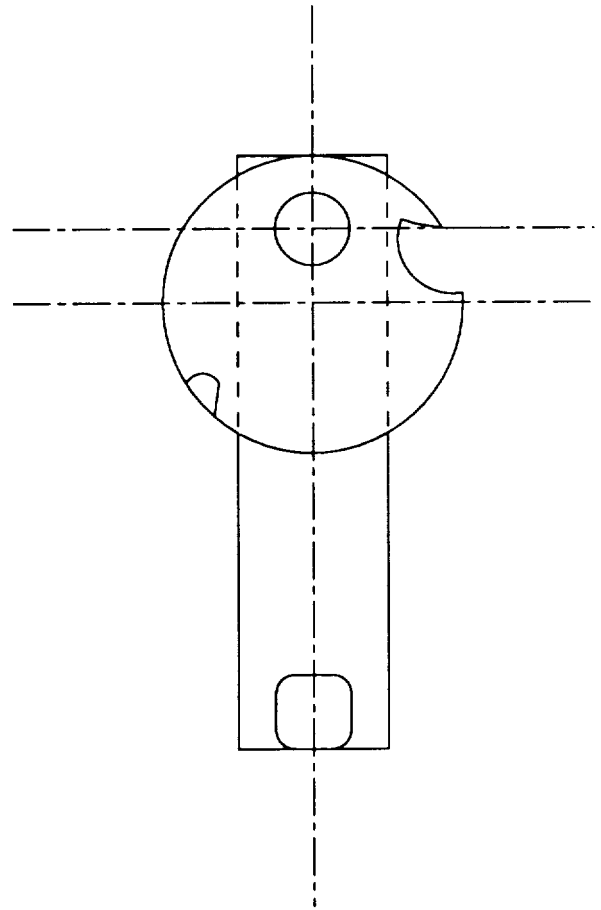
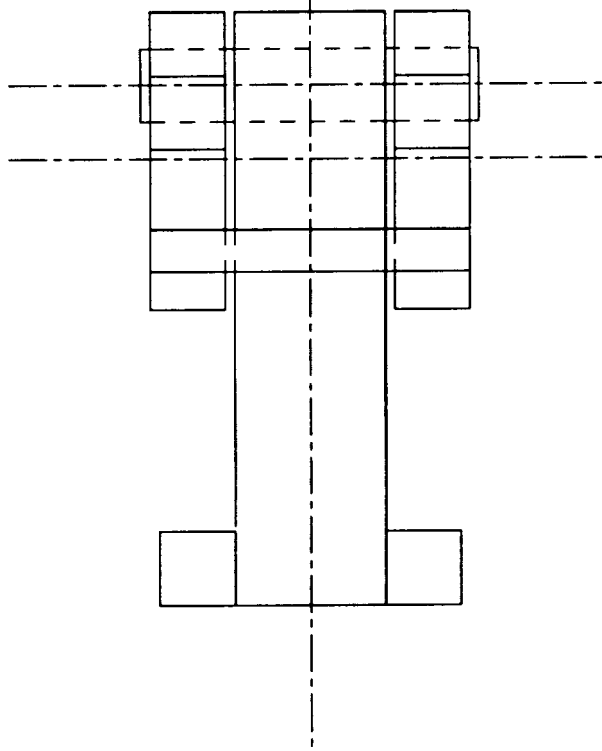
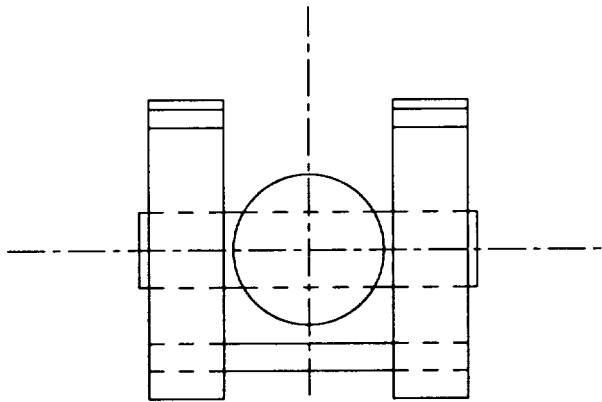
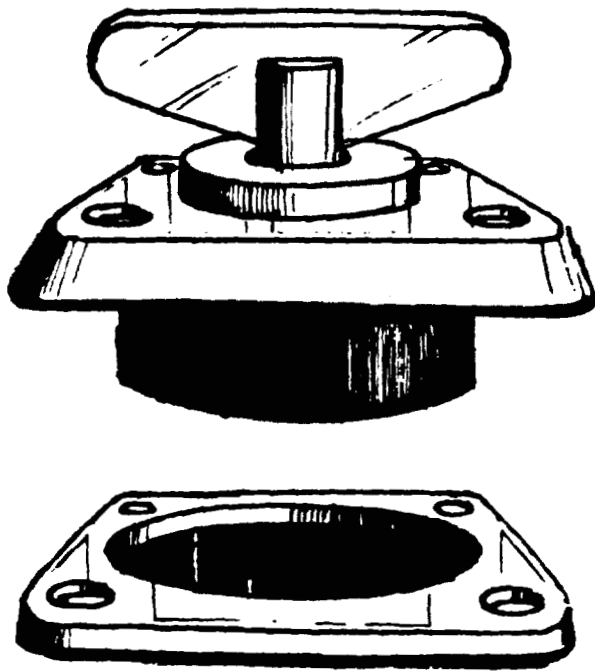

Figure 2
QT CAM FASTENER



DISENGAGEABLE MAGNETIC FASTENER

This hatch and panel fastener (Figure 3) is an original design which incorporates a magnet to provide holding force and can be completely disengaged through a quarter-turn of its wing handle. Robotic installation and removal is extremely easy, and its performance in the lunar environment should be excellent.

The magnetic forces can be disengaged through a mechanism similar to that found on dial gauge-holding tools for the machine shop. Basically, there is a magnetic core which the 1/4-turn handle brings in and out of contact with two conductor pieces, effectively engaging or separating the two poles of the magnet. The result is that when "off", the magnet provides virtually no force and can be easily disengaged.

The two parts of the fastener incorporate pre-installed housings, attached by small screws, rivets, or similar device. They are to be constructed of a non-magnetic material such as aluminum. In the female piece, there is a circular steel (or other magnetic material) insert to correspond with the magnet on the male unit. The male unit includes the wing piece to engage the magnet. The different materials allow easy robotic lining-up of the fastener; the two pieces will only be attracted to each other in the area intended.

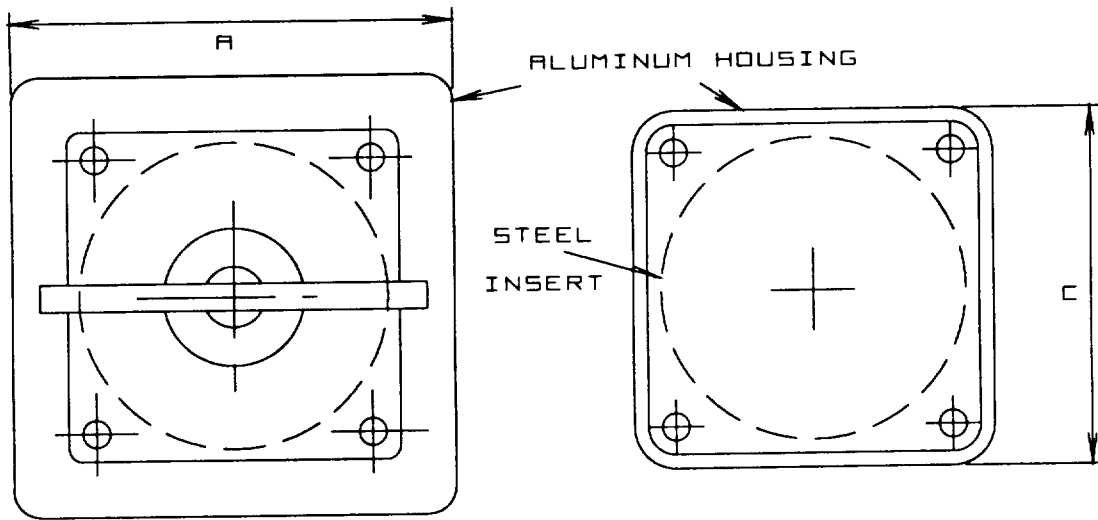

MALE

FEMALE

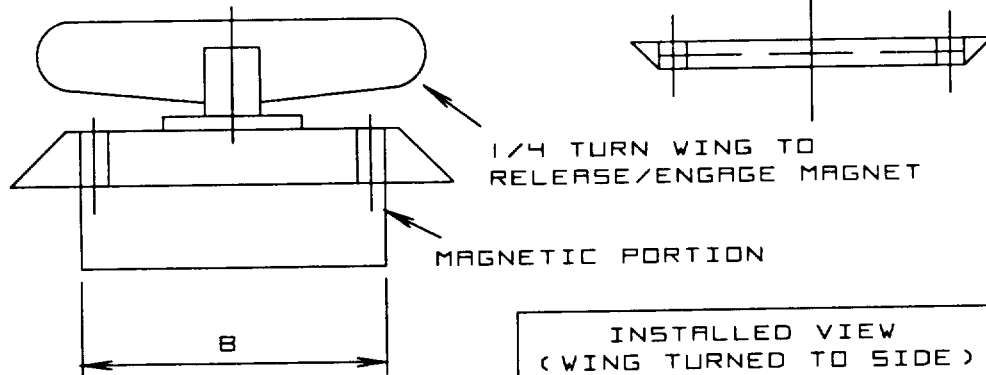

INSTALLED VIEW
(WING TURNED TO SIDE)

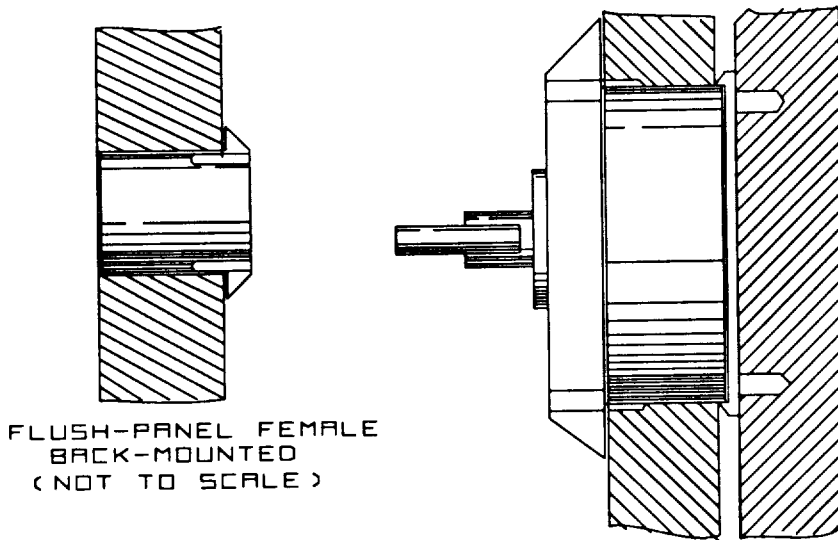

FLUSH-PANEL FEMALE
BACK-MOUNTED
(NOT TO SCALE)

Figure 3
DISENGAGABLE
MAGNETIC FASTENER

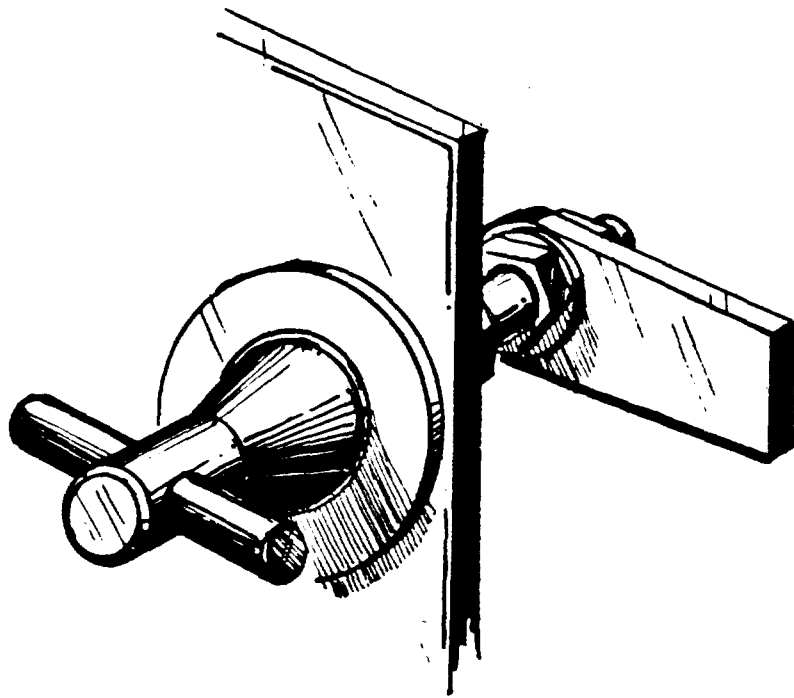

T-HANDLE LATCH

The T-handle latch (Figure 4) is intended for use in securing panels, covers and hatches. The latch itself is pre-installed in the panel that is to be secured. The latch essentially consists of a shaft on which one end is a T-shaped handle and on the other, a bar. The object that the panel is to be secured to has a receptacle to accept the bar at the end of the latch shaft. To apply the latch, the latch is positioned so that the bar at the end of the latch shaft enters the receptacle. Once the bar has fully entered the receptacle, the shaft is then turned (via the T-handle) ninety degrees. This in turn rotates the bar into the receptacle, forcing the bar to bear against the interior surface of the receptacle, here by preventing the latch (and therefore the panel) from being removed. This provides the fastening action of the latch.

To install the T-handle latch robotically, the robotic device must first grasp the T-handle of the latch, position it over the receptacle, insert the bar end into the receptacle, turn the T-handle ninety degrees, and then release the T-handle. Removal is the opposite of the above.

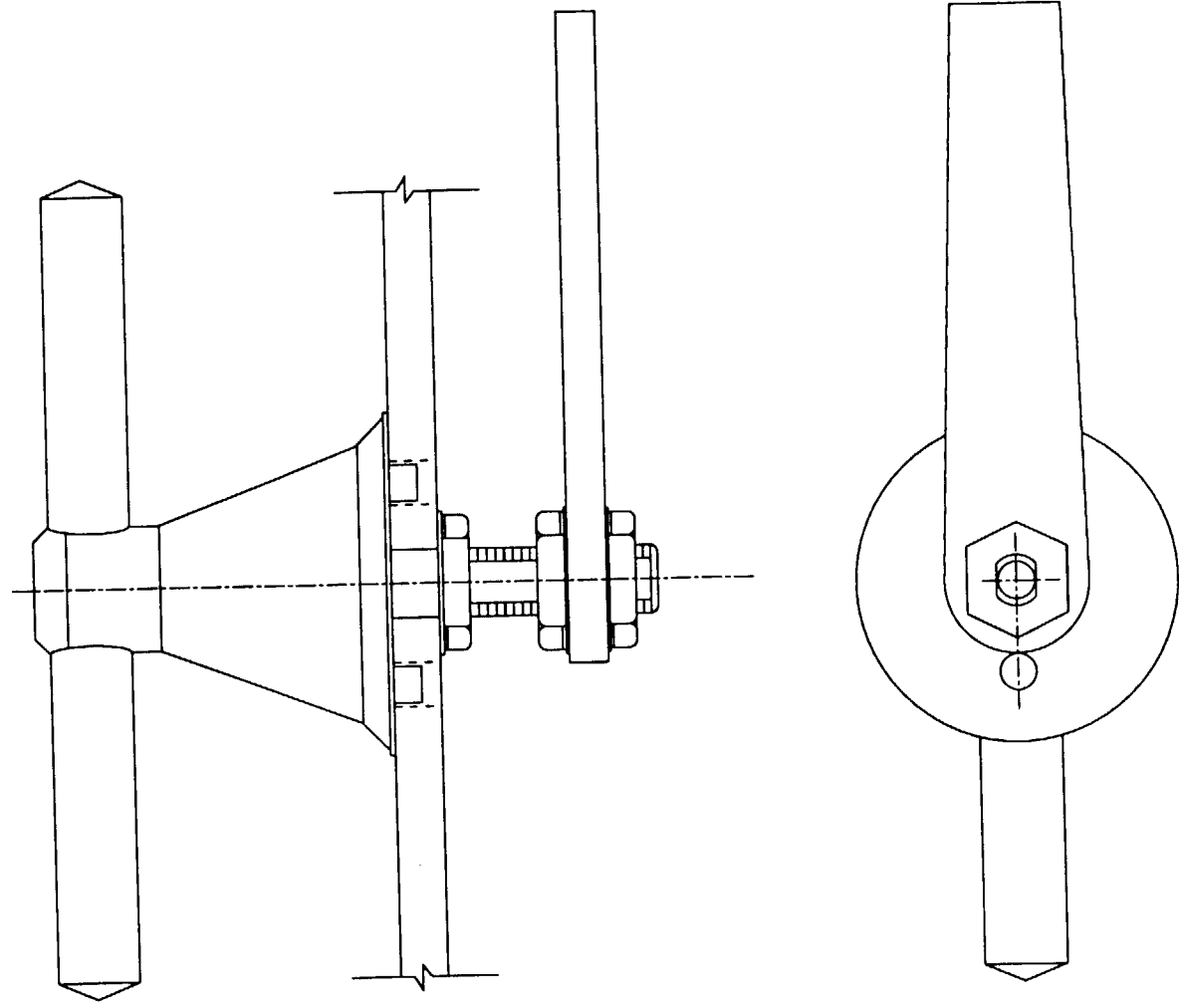
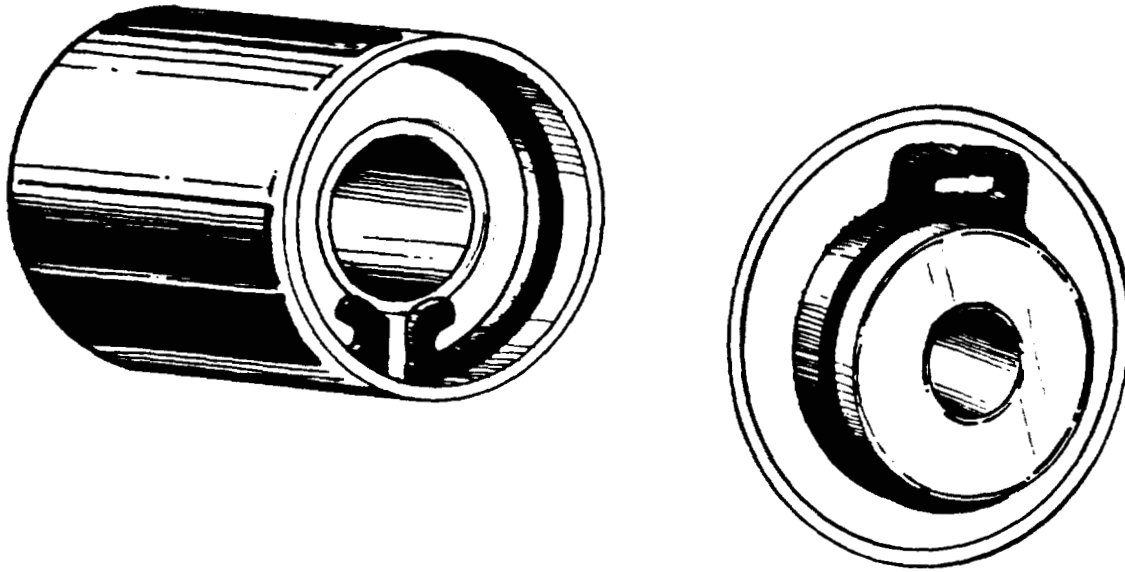

Figure 4
T - HANDLE LATCH



INTERNAL AND EXTERNAL SNAP RING

The internal and external snap rings (Figures 5a & 5b) are intended for use in fastening bearings, wheels, gears and pulleys to shafts. The interior snap ring is designed to work in the inner radius of hollow shafts. The internal snap ring is applied by inserting the proper tool into the semi-circular notches at the ends of the ring. A force is then applied, through the tool, such that the notches are brought toward each other reducing the diameter of the ring. The ring is then inserted into a machined groove. The force on the notches is removed, thereby allowing the ring to expand into the groove. The groove is smaller in diameter than the unstressed ring, therefore, when the force on the ring due to the tool is released the ring will exert a spring force on the inside surface of the groove, thereby preventing the ring from working its way out of the groove. The inner portion of the ring also protrudes out of the groove preventing the bearing from moving past the ring and effectively restricting the bearing to a particular position along the shaft. The external snap ring works similarly, except that it is designed to work on the outer radius of shafts.

To install the snap ring robotically, the robotic device must grasp the ring, insert the proper tool into the notches at the ends of the ring, apply the appropriate force to the ends, position the ring with respect to the machined groove, remove the force on the ends and release the ring. Removal is the opposite of the above.

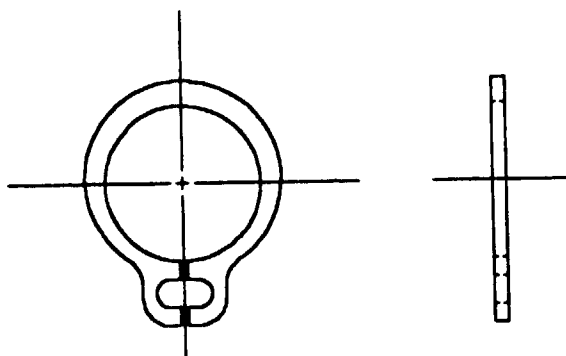

Figure 5a

EXTERIOR SNAP RING
MIL-R-21248B

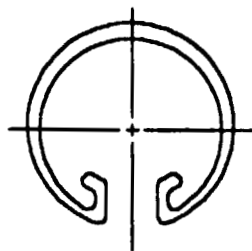
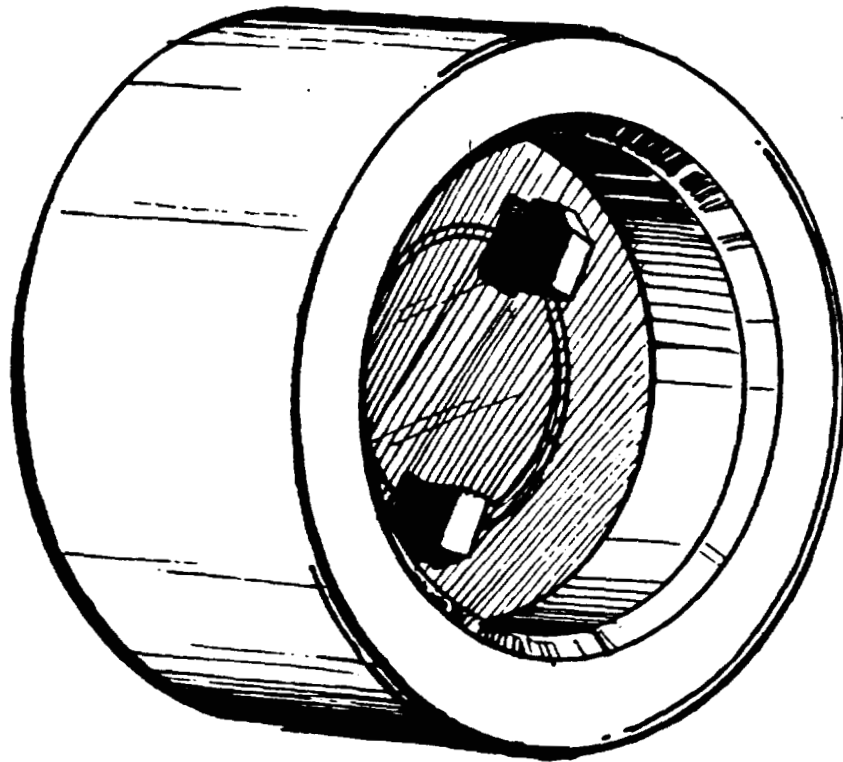

Figure 5b

INTERIOR SNAP RING
MODIFICATION OF
MIL-R-21248B



GIB KEY

The Gib key (Figure 6) is intended for use in securing wheels, gears and pulleys to shafts. To apply, the wheel is placed on the shaft to which it must be secured. The Gib key is then placed into a machined groove in the shaft, with the small end of the key facing the wheel. The key is then forced toward and under the wheel. Wedging the key between the shaft and the wheel and fastens the wheel to the shaft. The wheel may also have a machined groove in it to receive the key if alignment of the wheel with respect to the shaft is critical. The key is installed so that there is a gap between the wheel and the large end of the key. This facilitates removal of the wheel from the shaft by providing a bearing surface by which the wheel can be pried free from the key using an appropriate tool.

To apply robotically, the robotic device must grasp the wheel, position the wheel on the shaft it is to be secured to, grasp the key, position it in the machined groove, apply a force to the key such that the key is forced toward and under the wheel and wedged between the wheel and the shaft. Removal is the opposite of the above; if the key is difficult to remove, the wheel may be pried off of the key by inserting a tool between the wheel and the key and applying the necessary force.

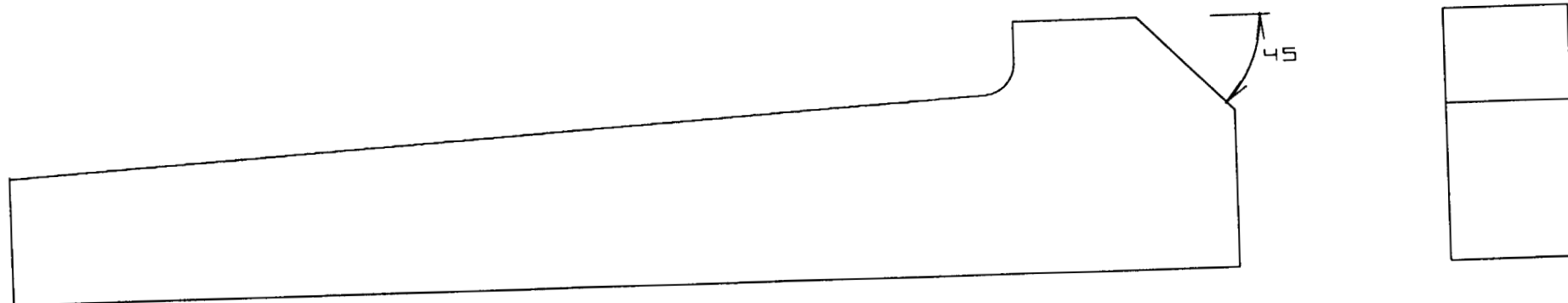
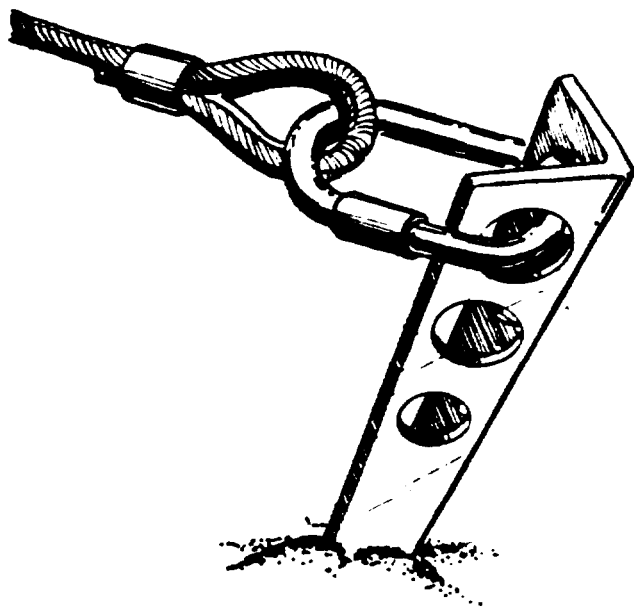

Figure 6
GIB KEY



ANCHOR STAKE

The anchor stake (Figure 7) is intended for use in securing objects such as drilling devices to the lunar surface. The stake has a cable pre-attached to its large end; the cable is in turn fastened to the object to be secured. To apply the anchor stake, position the stake at a desired angle to the lunar surface (the angle depends on the nature and slope of the lunar surface and the position of the object) with the pointed end pointing toward the lunar surface, and apply force to the stake such that the pointed end of the stake is driven into the lunar surface while maintaining the cable taut. The stake is driven into the lunar surface to a sufficient depth so that the friction force applied by the lunar surface material on the stake is greater than the retracting force on the stake due to the tension in the cable. This friction force supplies the fastening action of the stake.

To apply robotically, the robotic device must grasp the stake, position it relative to the lunar surface, apply a force driving the stake a sufficient depth into the surface while maintaining tension in the cable, and releasing the stake. Removal is the opposite of the above.

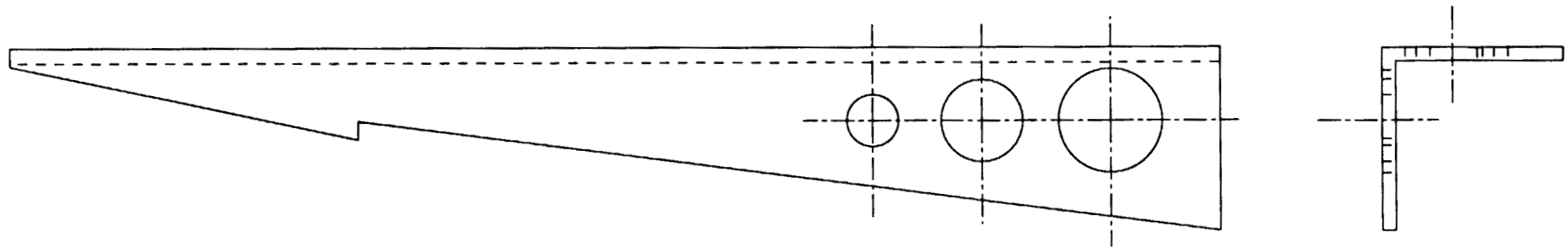
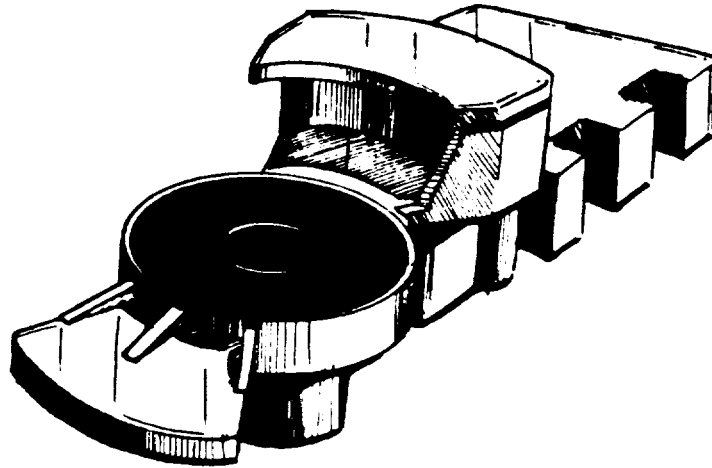

Figure 7
ANCHORING STAKE



GLAD-HANDS COUPLING

The glad-hands coupling (Figure 8) is intended for use in connecting the ends of pneumatic and hydraulic lines and hoses that may or may not require maintenance of pressure within the lines. The glad-hands coupling consists of two pieces. One piece is pre-attached to the end of one of two lines to be connected together; the other piece is pre-attached to the end of the other line. The two pieces are then positioned together so that the seals contained within each piece are in contact with each other. The follower of each piece is then aligned with the receiving groove in the other piece, and the pieces are rotated in such a way as to engage the followers in their respective grooves until the stops at the ends of the grooves are contacted by the followers. This action compresses the seals together, providing an effective seal between the two pieces, while the reaction force provided by the compressed seals clamps the two pieces together, preventing the followers from slipping out of their respective receiving grooves. This clamping force provides the fastener action.

To apply robotically, the robotic device must grasp the two pieces, position them together so that the seals contained within the two pieces are in contact with each other, and apply a force to rotate the pieces with respect to each other until the followers are fully engaged in their respective receiving grooves, and then release the pieces. Removal is the opposite of the above. The coupling piece presented in the drawing in Figure 8 of Appendix A entails a slight modification to the typical glad-hand piece to better enable a robotic device to grasp it.

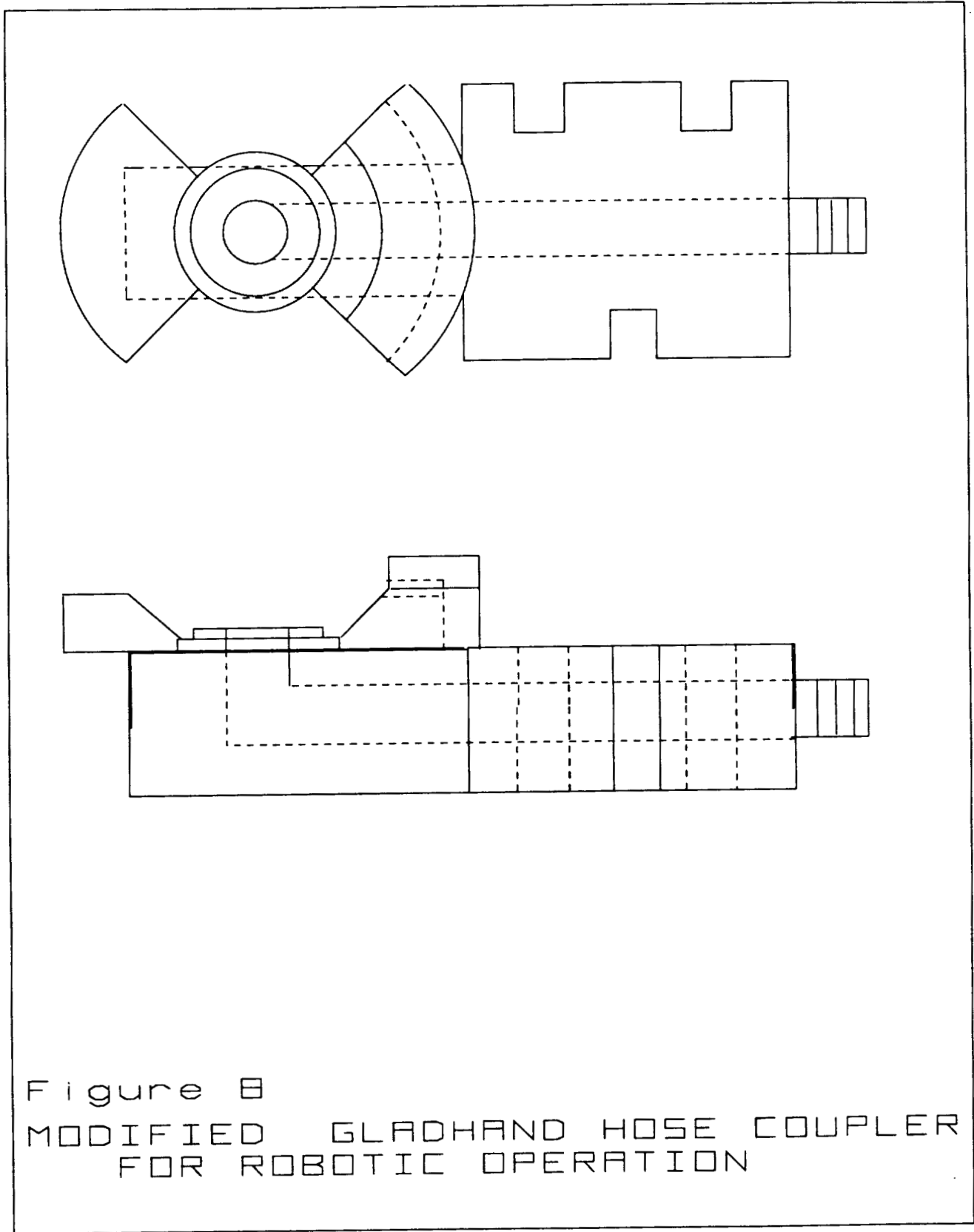
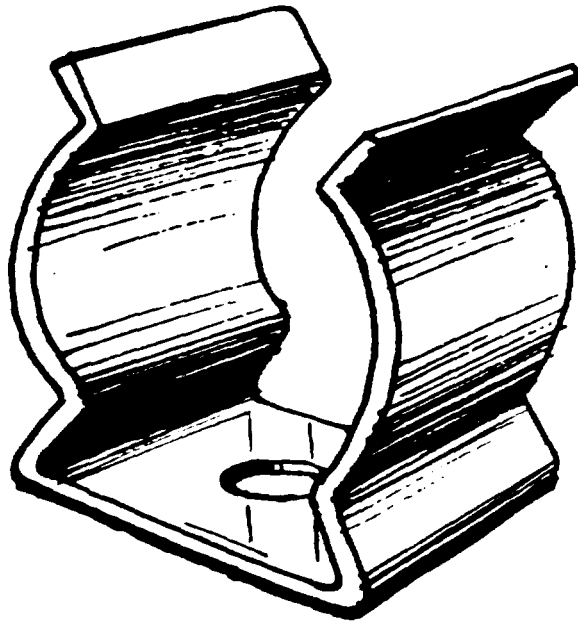

Figure 8

MODIFIED GLADHAND HOSE COUPLER
FOR ROBOTIC OPERATION



SPRING CLIP

The spring clip (Figure 9) is intended for use in securing hoses, lines and cables. The back face of the clip is pre-attached to the object that it is desired the hose be secured to. To apply the spring clip, the hose is placed against the front face of the clip between the outwardly protruding ends, and then pushed against the front of the clip with sufficient force that the two prongs of the clip are spread outward and around the hose until the hose contacts the back of the clip. The distance between the unstressed prongs is less than the diameter of the hose to be secured, resulting in a spring force exerted by the prongs on the hose. This force provides the fastening action of the clip.

To apply robotically, the robotic device must grasp the hose to be secured, position it against the front of the clip, and push the hose into the clip with sufficient force to snap the hose into place. Removal is the opposite of the above.

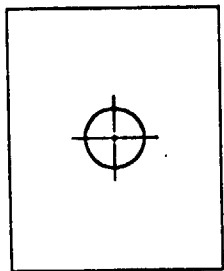
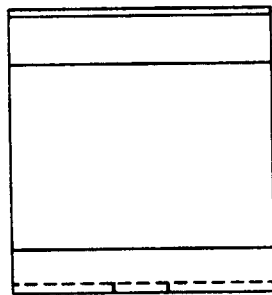
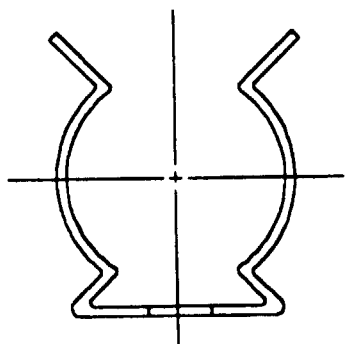

SPRING CLIP
MIL-C-24066/3-101

Figure 9

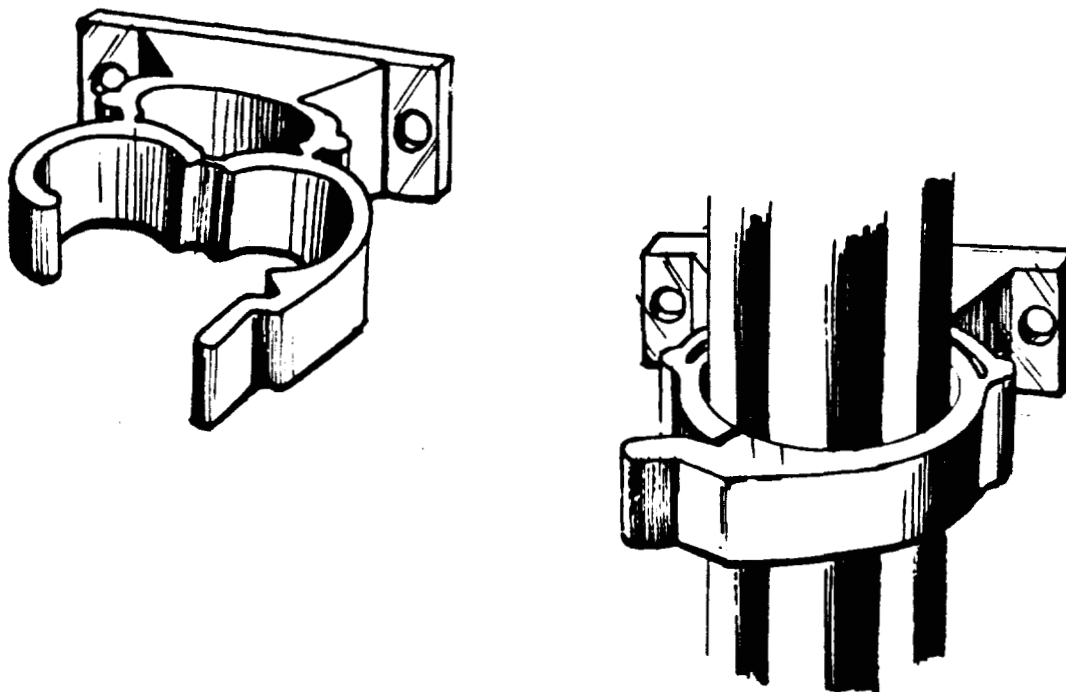

OVER-CENTER LIVING HINGE

The over-center living hinge (Figure 10) is intended for use in securing hoses, lines and cables. The back face of the hinge is pre-attached to the object it is desired the hose be secured to. To apply the hinge, the hinge must initially be in the open position. The hose is then positioned between the protruding ends and against the back of the hinge. A hose is pushed into the hinge forcing it to clamp around the hose. The ends of the hinge simultaneously close around the hose until the ends of the hinge completely surround the hose. The hinge is then in the closed position. The material of the hinge, polypropylene, is highly elastic, providing a spring action keeping the hinge closed. This force provides the fastening action of the hinge.

To apply robotically, the robotic device must grasp the hose that must be secured, position it between the ends of and against the back of the hinge, apply a force such that the hose is pushed into the hinge until the hinge is closed, and then release the hose. Removal is the opposite of the above.

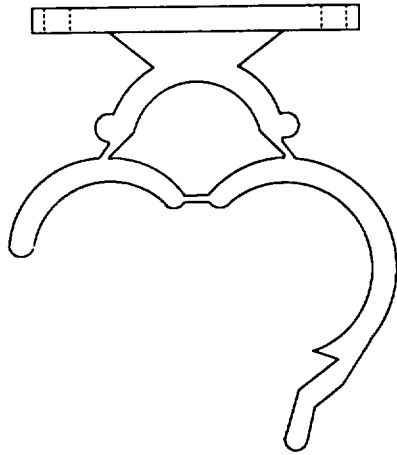

OPEN
POSITION

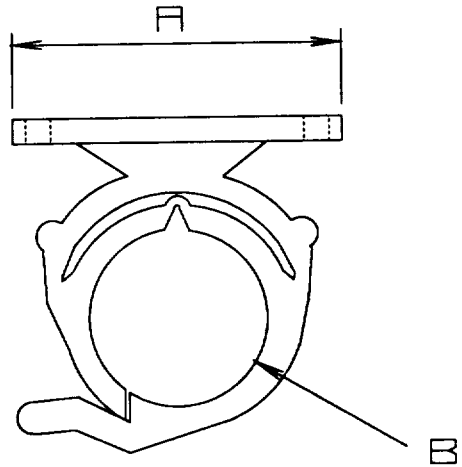

CLOSED
POSITION

Figure 10
OVER-CENTER LIVING HINGE
FASTENER

APPENDIX B

FASTENER EVALUATION MATRICES

The fasteners chosen for inclusion in this report were selected according to their overall qualifications with respect to performance in a number of predetermined design criteria. To facilitate the selection process, evaluation matrices were created, one matrix per general category of fastener type. The column headings are comprised of the design criteria against which the candidate fasteners are to be judged. Directly above each criterion is a number representing its weighting, or intended application. The row headings are comprised of the names or descriptions of the candidate fasteners themselves. The elements of the matrix are numbers representing individual candidate fasteners' performance with scores for the candidate fasteners are recorded in the rightmost column of the matrix. These scores are determined by taking the criteria performance scores of a particular candidate fastener, multiplying each individual criterion score by the weighting for that criterion, and then summing the results. The candidate fastener with the highest resulting overall score is deemed the most satisfactory fastener for use in its general application category.

FASTENER EVALUATION MATRIX

TABLE 1 PRELOADABLE STRUCTURAL GENERAL-DUTY FASTENERS

IMPORTANCE	6	7	8	8	8	4	6	5	9	9	7	6	5	5	TOTAL SCORE
	THERMAL STRESSES	VACUUM WELDING	DUST IN ENVIRONMENT	ROBOTIC INSTALLATION	ROBOTIC REMOVAL	SIZE	SERVICE LIFE	STRENGTH-TORSION	STRENGTH-TENSION	STRENGTH-SHEAR	VERSATILITY	PRELOAD PRECISION	REUSABILITY	MAINTENANCE	
BOLT	7	3	4	2	5	5	8	3	8	8	9	9	7	4	550
1/4 TURN CAM	7	6	8	7	8	5	7	3	7	8	5	6	8	8	631
RIVET	4	4	7	8	3	6	4	4	7	9	6	6	0	5	511
SEALED THREAD BLIND	4	3	8	9	8	8	7	6	7	7	7	9	9	4	643
HUCK PIN	5	5	7	5	7	7	4	4	7	9	6	7	0	8	557
SELF-TAPPING	6	5	8	9	8	8	5	4	6	7	6	7	7	4	609
NAIL	7	5	9	7	4	8	2	3	5	7	2	2	3	5	470
1/4 TURN: ORIGINAL	7	4	8	8	8	7	6	9	7	6	4	6	8	6	622
RATCHET LOCK 1/4 TURN	7	6	7	8	8	7	7	3	7	5	5	5	8	8	606
SHAKER WEDGE	6	5	8	6	7	6	6	3	7	6	5	4	7	7	560
DZUS	7	7	9	8	8	7	8	6	6	6	6	5	8	2	627
INTERFERENCE FIT	6	5	8	8	7	9	4	6	6	8	5	4	6	6	590

FASTENER EVALUATION MATRIX

TABLE 2 FASTENERS USED ON COVERS AND HATCHES

IMPORTANCE	6	9	7	8	8	4	6	2	7	8	7	5	TOTAL SCORE
	THERMAL STRESSES	VACUUM WELDING	DUST IN ENVIRONMENT	ROBOTIC INSTALLATION	ROBOTIC REMOVAL	SIZE	SERVICE LIFE	STRENGTH: TORSION	STRENGTH: TENSION	STRENGTH: SHEAR	REUSABILITY	MAINTENANCE	
1/4 TURN DZUS	8	7	8	8	9	6	8	1	5	5	8	2	518
INTEGRAL TABS	8	8	9	6	7	9	2	1	1	1	2	1	371
RIVETS	7	8	9	8	3	8	1	3	4	8	0	3	416
QUICK RELEASE PINS	7	7	3	8	9	5	7	0	2	7	7	4	463
SNAP IN FASTENERS	5	6	8	9	8	7	7	3	3	5	8	9	514
MAGNETIC	9	8	8	9	9	3	8	4	5	4	8	6	547
VELCRO	4	10	3	9	6	9	6	6	5	6	8	9	523
S-CLIPS	8	6	8	9	9	8	6	3	3	1	7	9	499
TOGGLE LATCHES	5	7	8	7	7	5	8	1	6	3	8	3	468
T-HANDLE LATCHES	7	7	8	8	8	5	8	1	6	5	8	6	527
LEVER LATCHES	5	7	8	6	8	5	8	2	6	3	8	4	475
FLUSH-SLAM LATCHES	4	5	5	9	8	4	5	2	6	3	7	2	415
PADDLE LATCHES	4	6	5	7	7	4	5	2	6	3	7	3	405
DRAW LATCHES	5	7	8	7	7	5	8	1	6	3	8	3	468
SLAM SHUT TOUCH OPEN	3	5	6	7	7	5	6	2	3	5	7	2	397

FASTENER EVALUATION MATRIX

TABLE 3 FASTENERS FOR SECURING WHEELS, GEARS, AND PULLYS

IMPORTANCE	6	9	8	8	8	3	9	7	7	6	6	TOTAL SCORE
	THERMAL STRESSES	VACUUM WELDING	DUST IN ENVIRONMENT	ROBOTIC INSTALLATION	ROBOTIC REMOVAL	SIZE	VIBRATION RESISTANCE	SERVICE LIFE	STRENGTH THRUST	REUSABILITY	MAINTENANCE	
SNAP RINGS	8	6	8	7	7	9	10	7	9	7	9	603
HOLES W/WEDGES & GROOVED PINS	6	2	9	7	5	7	8	8	9	7	2	488
ROLL PINS	6	3	8	6	4	7	7	8	9	7	3	470
PUSH ON STAR LOCKS	6	7	9	8	7	8	5	4	5	6	9	513
LARGE QUICK RELEASE PIN SHAFT	7	6	4	9	9	9	8	5	7	8	1	509
THREAD SERTS	6	6	3	6	8	4	7	3	9	6	9	475
LARGE DZUS TYPE SHAFT & WHEEL	8	6	8	7	7	9	5	6	6	8	3	500
GIBB KEY	8	3	9	8	7	7	7	7	7	8	9	551
AXLE SLOT & WHEEL KEY INTEGRAL PIN	7	5	7	8	8	8	5	7	8	8	8	541
LUG NUT/ LUG BOLT	5	2	2	2	6	5	8	7	9	7	3	387

FASTENER EVALUATION MATRIX

TABLE 4 METHODS FOR ATTACHING BEARINGS

IMPORTANCE	8	8	6	8	8	4	6	5	9	5	5	TOTAL SCORE
	THERMAL STRESSES	VACUUM WELDING	DUST IN ENVIRONMENT	ROBOTIC INSTALLATION	ROBOTIC REMOVAL	SIZE	SERVICE LIFE	STRENGTH TORSION	STRENGTH THRUST	REUSABILITY	MAINTENANCE	
PRESS FIT	5	1	6	5	2	5	8	8	8	0	10	370
SNAP RINGS: INTERIOR	8	5	5	7	6	9	7	0	5	9	8	446
SNAP RINGS: EXTERIOR	8	5	5	7	6	9	7	0	5	9	7	441
NYLON: SELF-THREADING	0	10	7	7	7	8	3	3	3	0	3	341
INTERFERENCE FIT	5	1	8	6	7	5	7	5	7	9	8	435
MEIBUHR RETAINING RINGS	5	5	4	3	4	3	8	5	7	6	9	383

TABLE 5 FASTENERS FOR ANCHORING THINGS TO THE LUNAR SURFACE

IMPORTANCE	5	7	9	8	5	5	6	2	9	3	6	4	TOTAL SCORE
	THERMAL STRESSES	VACUUM WELDING	DUST IN ENVIRONMENT	ROBOTIC INSTALLATION	ROBOTIC REMOVAL	SIZE	SERVICE LIFE	STRENGTH TORSION	STRENGTH TENSION	STRENGTH SHEAR	REUSABILITY	MAINTENANCE	
CONCRETE ANCHORS	5	4	4	4	6	8	4	5	7	7	2	5	351
MOUNTAIN CLIMBING PROTECTION	8	7	4	7	6	4	7	0	8	7	8	6	418
WEDGE-LIKE STAKES	9	10	9	7	6	6	6	7	7	7	4	7	488

FASTENER EVALUATION MATRIX

TABLE 6 FASTENERS FOR CONNECTING HOSES

IMPORTANCE	6	7	7	8	8	4	7	2	9	5	8	5	TOTAL SCORE
	THERMAL STRESSES	VACUUM WELDING	DUST IN ENVIRONMENT	ROBOTIC INSTALLATION	ROBOTIC REMOVAL	SIZE	SERVICE LIFE	STRENGTH: TORSION	STRENGTH: TENSION	STRENGTH: SHEAR	REUSABILITY	MAINTENANCE	
QUICK RELEASE	7	7	3	8	9	5	7	0	2	7	8	4	454
GLADHAND	7	7	3	8	8	5	7	0	5	7	8	4	473

TABLE 7 FASTENERS FOR SECURING HOSES

IMPORTANCE	3	3	7	8	8	4	5	2	8	5	4	5	TOTAL SCORE
	SPRING CLIPS	TWIST-TIE	ZIP-TIES	ONE-WAY TIES: BEADED	STRAIN RELIEF BUSHINGS	VELCRO	SPRING LOCK	OVER-CENTER LIVING HINGE	PURSE LOCK				
SPRING CLIPS	7	8	9	5	5	7	6	1	5	2	6	8	362
TWIST-TIE	8	10	8	5	5	8	3	1	4	2	3	7	328
ZIP-TIES	3	10	6	5	6	8	6	2	6	3	0	7	333
ONE-WAY TIES: BEADED	3	10	6	4	6	8	6	2	7	3	0	7	333
STRAIN RELIEF BUSHINGS	3	10	7	8	8	7	7	1	4	2	5	8	383
VELCRO	3	10	3	8	7	7	6	6	5	5	8	8	387
SPRING LOCK	7	8	8	9	9	5	7	1	3	2	8	8	408
OVER-CENTER LIVING HINGE	4	10	7	8	8	6	6	2	4	3	8	8	396
PURSE LOCK	3	10	8	8	8	5	5	1	3	3	7	8	377

Appendix C

QT cam calculations

Preload comparison calculations:

Comparison of a 1/2" bolt and a 1/2" QT cam made of the same materials.

bolt: 1/2-20 UNF

Preload depends on extension of bolt and compression of material in joint.

bolt extends a distance δ_b and a material compression distance of δ_m

1/8" turn on nut after snug - nut travel = 0.00625" = δ_{total}

$$\delta_{total} = \delta_b + \delta_m$$

$$F_i = K_b \delta_b \quad 2K_b \approx K_m \quad - \quad 2\delta_m \approx \delta_b \quad \delta_{total} = 3/2 \delta_b = 0.00625"$$

$$\text{Therefore, } \delta_b = 0.00417"$$

For the same preload as the bolt, δ_b (shaft extension) of the QT cam fastener must also equal 0.00417".

1/2 QTcam specs for comparison (refer to Figure 2, Appendix A)

cam dia. = 1.0" hinge pin offset = 1/4"
total cam width = 1/2" hinge pin dia. = 1/4"
shaft dia. = 1/2"

$$K_{bbolt} = K_{bQTcam shaft}$$

$$\text{for equal preload; } \delta_{bbolt} = \delta_{bQT} = 0.00417"$$

δ_c is compression of cam of QT

$$\text{assume } \delta_c \approx \delta_b \quad 2\delta_m \approx \delta_c$$

$$\delta_c + \delta_b + \delta_m = \delta_{total}$$

$$\delta_{total} = 0.01042$$

$$2.5\delta_c = \delta_{total}$$

$$2.5(0.00417) =$$

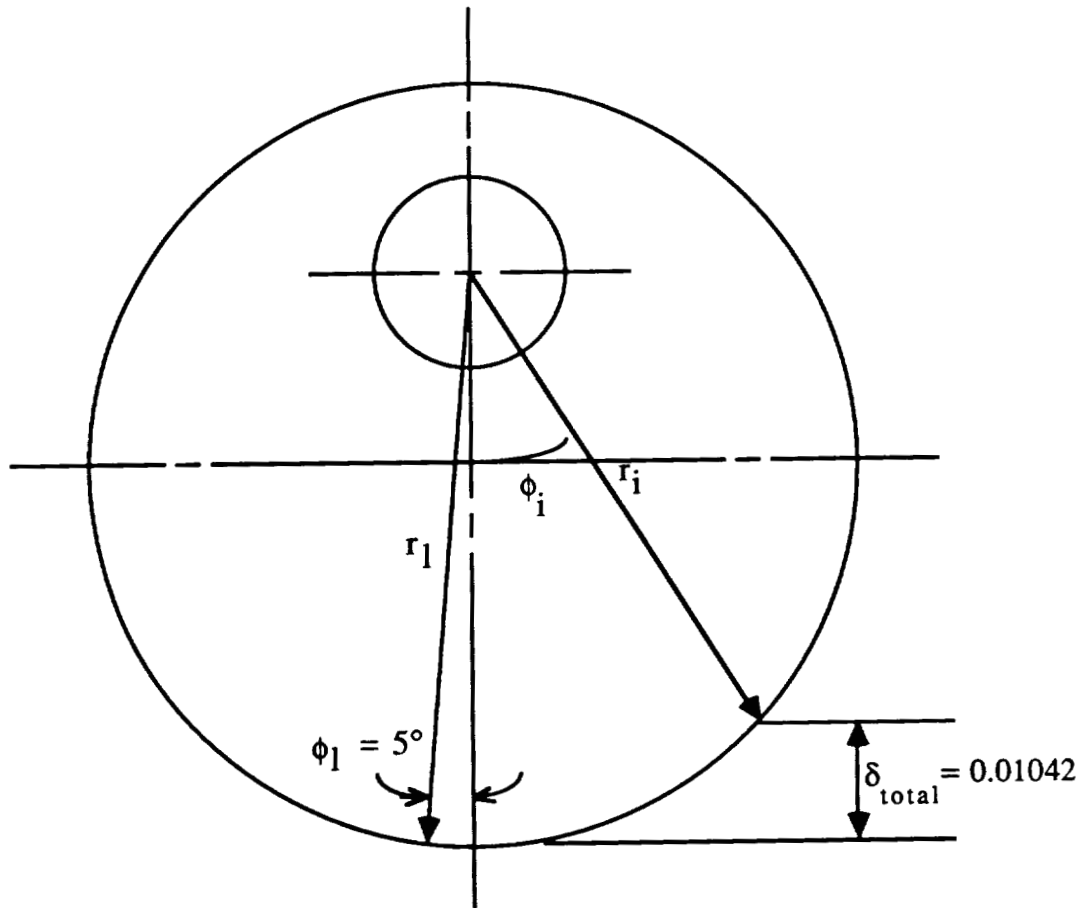

Cam geometry from QT cam fastener.

$$r_l - r_i = \delta_{total} = 0.01042$$

$$(r_l \cos 5 - .25)^2 + r_l^2 \sin^2 5 = 0.25$$

$$0.0625 - 0.25 + r_l^2 0.9924 + 0.0076 r_l^2 - 0.4981 r_l = 0$$

$$r_l^2 - 0.4981 r_l - 0.1875 = 0$$

Since r_i is determined by the lock angle, $\phi_i = 5^\circ$, $r_i = 0.7486$
then
 $r_i = 0.7382$

$$-1/2r_i \cos \phi_i + 0.0625 + r^2 \cos^2 \phi_i + r^2 \sin^2 \phi_i = 0.25$$

$$0 = -1/2r_i \cos \phi_i + 0.0625 - .25 + r^2$$

$$-1/2(0.7382) \cos \phi_i - 0.1875 + (0.7382)^2 = 0$$

Thus,

$$\phi_i = \cos^{-1}(0.3574/0.3691) = 14.48^\circ$$

The QT can achieve the same preload as that of a comparably sized bolt by using a moderately sized cam and small range of motion.

Sealed Thread Blind Fastener

This fastener is essentially a prethreaded bolt in a sleeve with an expandable nut for blind side bearing surface. Thus the preload for this bolt is the same as for a normal bolt.

$$\Phi_t = K\beta\delta_b$$

$$K_{b\text{seal thread}} = K_{b\text{bolt}}$$

Therefore the preload depends on the bolt extension δ_b past snug.

$$\delta_b \cong 2\delta_m \quad \delta_b + \delta_m = \delta_{\text{total}}$$

$$3/2\delta_b = \delta_{\text{total}} \quad \delta_b = 2/3 \delta_{\text{total}}$$

$$\delta_{\text{total}} = (\text{number of turns on the head})(\text{threads per inch})$$

Therefore the preload on a sealed thread blind fastener adheres to the same equations as bolts do.

Calculations for Magnetics

Pulling force for a Disengagable Magnet Latch:

Force of the magnet depends on the volume of the magnetic material, maximum BH Product of the magnetic material from the hysteresis loop characteristics, and the distance separating the surfaces.

$$F = \frac{(BH)(Vol)}{(r)}$$

For Iron Cobalt Sinter max BH product = 7000 N/m²

Typical fastner magnet volume = 5.53 * 10⁻⁵m³

Typical distance between surfaces including dust = .0013 m

$$F = \frac{(7000)(5.53 \cdot 10^{-5})}{(.0013)} = 304.8 \text{ N} = 68.8 \text{ lbs}$$

Therefore a magnet of moderate size has enough holding force even with a dust layer.

APPENDIX D

PROGRESS REPORTS

lunar-rated FASTENERS

**ME 4182 Progress Report
3 October 1988**

**Steve Hyde
Dan McKillip
Lindsay Gupton
Bryan Player
Greg Smith**

The topic of this group project - lunar-rated fasteners - is outlined in detail in the problem statement submitted today. Generally, it includes the research into any and all existing fasteners and classification as to suitability for lunar-based use, taking into account the many unique design constraints inherent to the moon; and the development and proposal for a general-duty fastener applicable for construction equipment on the lunar surface.

During the first week of group meetings, a tentative schedule of project goals and progress was developed. The various stages of the effort can be categorized into data accumulation and categorization, design development and refinement, and project finalization, including the technical paper and presentation. The time schedule is only an estimate, however, and is subject to revision.

To date, all team work has been focused on research and accumulation of a data base of any information related to fasteners, the lunar environment, suitable materials, and so forth. The depth and variety of information on fasteners themselves is substantial and is now being compiled from various sources, which include textbooks, handbooks, NASA technical publications, and vendor catalogs. The lunar environment, surface condition, and material composition is being studied through a series of geotechnical publications and maps as well as test results of the Apollo regolith samples. Specific attention is being focused on radiation characteristics and regolith particulate size and their effects on the performance of fasteners. However, at this time this research has only served to substantiate the existing general lunar design conditions, without many new developments. Additionally, the subject of materials appropriate to the design criteria is being investigated, again through a general literature search and vendor catalogs / interviews.

MECHANICAL DESIGN ENGINEERING

ME 4182

LUNAR RATED FASTENERS

This week, the focus of our group was on new fastener designs. The designs centered around the limitations of robotic installation of the fasteners. These confines include: one sided operation (i.e. no need to reach around and hold a nut), low tolerance fit of fasteners to fastening medium, and the exclusion of high torque requirements.

In a brainstorming session, the group came up with a few ideas for a fastener that would meet the confines of robotic installation. The main style of fastener we talked about is one that could be inserted into a hole and then twisted or somehow activated as to catch in a machined groove or the back surface of the hole. The fastener could be tightened (or preloaded) by a cam, wedge, or screw method. One design we came up with can be seen in this weeks graphic. The device is inserted in a hole, turned a quarter turn, and then the two wedge pieces are driven between the top pegs and the surface of the metal. The fastener can be removed by splitting the wedges with a chisel and then pried out from under the pegs.

As far as individual activity goes; Steve, Greg, and Bryan tried to get familiar with the Versacad package on the Macintosh. Lindsey came up with a number of renderings of possible fasteners that were evaluated during the brainstorming session. Dan went to some local fastener distributors and obtained some catalogs and other information that we could add to our fastener database.

LUNAR RATED FASTENERS

This week, team effort was concentrated on refining last weeks fastener designs, introducing new ideas for lunar rated fasteners and preparing for the mid-term presentation.

A team meeting resulted in approximately three fasteners that have the potential to meet our design criteria. Two of the possibilities are essentially structural fasteners for applications that require a preload. The preload on one is cam actuated, and the other is wedge actuated. These two fasteners represent refinements of ideas discussed in last weeks brainstorming session. We are also considering a light duty blind fastener that would possibly supplant the need for lunar rated rivets. This light duty fastener fastens by a simple push in and turn ninety degrees type action. It locks on a pin on the blind side of the connection.

Along with the individual imagineering of fasteners by each of the team members, Brian obtained a catalog of fasteners and continued his vendor catalog search. Dan has been researching the available high performance solid lubricants. Greg is sifting through the vendor catalogs and is continuing to get familiar with the Versacad package. Lindsey is designing the visuals for this weeks presentation, and Steve is continuing to get familiar with Versacad.

LUNAR RATED FASTENERS

This week, our group focused on several major tasks, including adding to our database of existing fasteners, more effectively categorizing our database according to mode of application, finalizing our selection criteria and weeding out unsuitable designs from our existing database. Our data search of library sources is now well under way, and of course the team is continuing to develop fastener designs of its own.

We have begun to categorize our expanding database by application. These categories include: covers and hatches, wheels, gears and pulleys, bearings, hydraulic and pneumatic couplings, and drilling anchors, along with the usual general-purpose light-duty and preloaded structural fasteners. We are now also beginning the preliminary selection process according to criteria which include thermal stresses and reaction to temperature extremes, resistance to dust contamination, ease of robotic use, resistance to vacuum seizure, availability and cost. Some examples of existing designs which at the moment look promising are presented in this week's graphic.

With regard to individual activity, Dan is keeping tabs on the database search and is researching lubrication methods and materials, Greg and Bryan are continuing to obtain catalogs and along with Steve and Dan are working on categorizing and weeding out designs, and everyone is working on original designs. Lindsey had to go to California and was not able to meet with the group for most of this week.

lunar-rated FASTENERS

ME 4182 Group # 6

Progress Report W/E 8 November 1988

McKillip • Player • Smith • Hyde • Gupton

.....

The group efforts this week have been concentrated on the compilation of a spreadsheet-based comprehensive analysis and rating of fastening methods, as well as the utilization of the results of the on-line data base search. Additionally, work continues into original fastener design and development, now with an eye towards verification of the designs' uniqueness, as well as CAD practice and ongoing research.

The spreadsheet analysis and rating is being conducted for existing fasteners in a variety of categories and for a variety of criteria. The various factors are rated on a scale of 1 to 10, the results weighed appropriately, and totals determined to provide a more comprehensive picture of the viability of fasteners considered for the specific applications. The categories include: panels, hatches, bearings, fabrics, structural, etc. The evaluation criteria includes: thermal properties; vacuum welding potential; robotic installation/removal ease; tension, torsion, and shear strength; relative size; effect of dust particles; maintenance/servicability; and reusability; among others.

The results of the on-line data base search were received this week and include some thirty-four pages of material ranging from technical abstracts to patents. The criteria used in the search were: robotic application, blind fasteners, and extreme environment, with the majority of information turning up positive in the first two categories. One hundred thirty-four patents were found relating to fasteners and their applications as well as other descriptions of NASA-sponsored patent applications and research. Robotic installation design criteria and lists of approved robotic-capable fasteners were found, as well as specifics into robotic tool design and operational algorithms. Composite material fastening received a good deal of coverage, as well as repair techniques and on-site maintenance. Extreme environment design guidelines, including various fasteners which operated by vacuum-welding properties, were also encountered.

Individual efforts into various topics include: Dan, working with database and research into solid-film applications; Steve, research into out-gassing properties and the NASA material received; Greg, work into the computer-based spreadsheet analysis; Bryan, spreadsheet and CAD work; and Lindsay, original fastener development and patent research.

This week's graphic illustrates one promising type of fastener encountered during the evaluation and analysis efforts, the Dzus quarter-turn fastener. Manufactured in a very wide variety of stud and head designs, spring-loaded receptacle types, materials and applications, the Dzus scored relatively well due principally to its installation ease.

Progress Report: Week ending Nov 15, 1988

Design Group #6: Dan McKillip
Lindsay Gupton
Steve Hyde
Bryan Player
Greg Smith

We have made significant progress toward completion of a final project. We have identified several possible fasteners for several different specific fastening applications. We have also identified the individual parameters from which to objectively select certain fasteners.

Greg Smith and Steve Hyde have worked on putting this output onto a spread sheet for easier reading and for reference on the final report. Our specific categories have been broken down to: Panels, hatches, and covers; wheels, gears, and pulleys; bearings, anchors for the items needed to be fastened to the surface of the moon, and general joint fasteners that can be preloaded. For the categories used for rating the fasteners individually refer to the spreadsheets.

Steve Hyde has also looked into the area of outgassing and the effects that it may have on load bears fasteners and non-metal fasteners.

Lindsay Gupton is continuing the patent search along with Dan McKillip on the data base search concentrating on blind fasteners and robotic applications.

Bryan Player is looking into more information on anchors and is looking for more technical specifications and drawings for the Chounard Camalot.

The Graphic of the week is of a snap ring. Upon first inspection it appears that snap rings have fair well in the selection process.

As a whole, the group has set a goal of having the report finished before the Thanksgiving break due to the final report deadline of November 29, 1988.

lunar-rated FASTENERS

ME4182 Group #6 22 November 88

McKillip•Player•Smith•Hyde•Gupton

.....

Attention this week has been concentrated on finalizing all aspects of the project and preparation of the final document. The fastener ratings were tabulated and recommendations made from the results of this finding. Research continued into areas necessary to answer various questions, including patent and technical report searches. Additionally, the evaluation study was used to provide criteria for the development and/or refinement of original fastener designs, in areas where a marked improvement over existing fastener designs was possible.

The effects of this week's work will be seen in a rough draft presented for appraisal today. The group has been working to prepare the CAD drawings and text necessary for the final document, which will be comprised of two volumes: a catalog of suitable lunar-rated fasteners for a variety of applications, and an accompanying volume with summaries, research findings, and more detailed explanations of our recommendations.

This week's graphic is an example of the CAD drawings being prepared for the final document. Although the entire group has been involved in the compilation of the document this week, individual efforts include: Dan, research into materials specifications and document text; Bryan, fastener development and CAD drawings; Greg, CAD drawings and spreadsheet compilation; Steve, text development and materials research; and Lindsay, fastener development/CAD and patent research.

APPENDIX E

DISCLOSURE FORMS

GEORGIA INSTITUTE OF TECHNOLOGY

A. DISCLOSURE OF INVENTION

1. Title (Caution: titles may be published. Do not reveal unique details.)

Technical Title: LUNAR-RATED FASTENERS

Layman's Title (34 characters maximum, including spaces): SAME

Inventor(s): (Correspondence, patent questions, etc. will be directed to the first-named inventor)

A. Signature *Lindsay Lee Gupton* Revenue Share % - Date 29 NOV 88
 Printed Name LINDSAY LEE GUPTON S.S. No. [REDACTED]
First Middle Last
 Home Address 729 CAMINO LAKES CIRCLE Citizenship USA
 City BOCA RATON State FL Zip Code 30386
 School or Laboratory MECH. ENGINEERING Campus Phone 404-876-5239

B. Signature *Dan McKillop* Revenue Share % - Date 11/29/88
 Printed Name DANIEL MILLOS MCKILLIP S.S. No. [REDACTED]
First Middle Last
 Home Address 445 Milledge Hgts. Citizenship USA
 City Athens State GA Zip Code 30606
 School or Laboratory Mech. Engineering Campus Phone 404-872-3957

C. Signature *Lewis Gregory Smith* Revenue Share % - Date 11/29/88
 Printed Name LEWIS GREGORY SMITH S.S. No. [REDACTED]
First Middle Last
 Home Address 1706 KILRENNY RD Citizenship USA
 City MIDLOTHIAN State VA Zip Code 23113
 School or Laboratory MECHANICAL ENGINEERING Campus Phone 404 676-1500

A. DISCLOSURE OF INVENTION (continued)

2. Statement of Invention:

Give a complete description of the invention. If necessary, use additional pages, drawings, diagrams, etc. Description may be by reference to a separate document (copy of a report, a preprint, grant application, or the like) attached hereto. If so, identify the document positively and be sure it is signed and witnessed. Base the description on the best mode presently contemplated for making the apparatus or material invented or for carrying out the process invented.

SEVERAL DESIGNS ARE PRESENTED FOR FASTENERS APPROPRIATE FOR USE IN THE LUNAR ENVIRONMENT. SEE THE ATTACHED REPORT, LUNAR RATED FASTENERS, FOR COMPLETE DETAILS AND SPECIFICATIONS

Inventor(s)	<u>Lindsay L. Coyle</u>	Date	<u>11/29/88</u>	_____	Date	_____
	<u>Don M. McKelvey</u>	Date	<u>11/29/88</u>	_____	Date	_____
Witnesses*	<u>L. Greg Smith</u>	Date	<u>11/29/88</u>	_____	Date	_____

* Witnesses must be technically competent and must understand the invention.

A. DISCLOSURE OF INVENTION (continued)

3. Results Demonstrating the Concept Is Valid:

Cite specific results to date. Indicate whether preliminary research, laboratory model, or prototype testing has been completed.

AT THIS POINT ONLY PRELIMINARY RESEARCH HAS BEEN ACCOMPLISHED. NO LABORATORY MODEL OR PROTOTYPE TESTING HAS BEEN COMPLETED, AND ALL CALCULATIONS AND PREDICTIONS ARE BASED ON THEORY.

4. Variations and Alternative Forms of the Invention:

State all of the alternate forms envisioned to be within the full scope of the invention. List all potential applications and forms of the invention, whether currently proven or not (For example, chemical inventions should consider all derivatives, analogues, etc.) Be speculative in answering this section. Indicate what testing, if any, has been conducted on these alternate forms.

- SEALED-THREAD BLIND-INSTALLATION PRELOADABLE FASTENER
- QUARTER-TURN CAM-TIGHTENED PRELOADABLE BLIND FASTENER
- DISENGAGABLE MAGNETIC FASTENER WITH HANDLE RELEASE AND VARIATIONS THEREOF. SEE REPORT ATTACHED AND "ALTERNATE DESIGNS", APPENDIX F.

ALL FASTENERS ARE INTENDED FOR ROBOTIC INSTALLATION IN LUNAR CONSTRUCTION USE, FOR A VARIETY OF APPLICATIONS DESCRIBED IN THE ATTACHED REPORT.

Inventor (s)	<u><i>Walter L. Copton</i></u>	Date	<u><i>11/29/88</i></u>	Date	_____
	<u><i>Ly Greg Smith</i></u>	Date	<u><i>11-29-88</i></u>	Date	_____
Witnesses	<u><i>Dan M. McKillop</i></u>	Date	<u><i>11.29-88</i></u>	Date	_____

A. DISCLOSURE OF INVENTION (concluded)

5. **Novel Features:** (An inventor is under duty by law to disclose to the U.S. Patent and Trademark Office any prior art known to him or her.)

a. Specify the novel features of the invention. How does the invention differ from present technology?

(SEALED-THREAD BLIND): FULLY REUSABLE BLIND ROBOTIC INSTALLATION WITH LATITUDE FOR DIFFERING MATERIAL THICKNESS. FULLY SEALED THREADS AND NO DEFORMING MEMBERS.

(1/4-TURN CAM): ECCENTRIC-WHEEL ACTUATED TIGHTENING, INSTALLATION WITH OR WITHOUT SPANNER WRENCH, 1/4-TURN TO TIGHTEN/REMOVE

(MAGNETIC): FULLY DISENGAGABLE MAGNETIC PROPERTIES, ACTUATED BY 1/4 TURN OF WING

b. What deficiencies or limitations in the present technology does the invention overcome?

THEY ALL ATTEMPT TO SOLVE DEFICIENCIES IN PERFORMANCE IN THE LUNAR ENVIRONMENT IN THE FOLLOWING AREAS:
REGOLITH-FOULING RESISTANCE, VACUUM WELDING RESISTANCE, THERMAL STRESS PROPERTIES, EASE OF ROBOTIC INSTALLATION, RADIATION RESISTANCE, LOW-GRAVITY COMPATIBILITY.

c. Has the scientific literature been searched with respect to this invention? Yes No _____
Has a patent search been performed? Yes No _____ If yes in either case, indicate what pertinent information was found and enclose copies if available. Also indicate any other art of which you are aware, either in the literature or the technology used by others, that is pertinent to the invention. Enclose copies of descriptions if available.

SEE REFERENCES AND DATA-BASE SEARCH RESULTS FOR PERTINANT INFORMATION.

Inventor(s)	<u>Linkal Cedar</u>	Date	<u>11/29/88</u>	Date	_____
	<u>Don M. McKillop</u>	Date	<u>11/29/88</u>	Date	_____
Witnesses	<u>J. Deeg Smith</u>	Date	<u>11-29-88</u>	Date	_____

B. SUPPORTING INFORMATION

- 1. On what date was the invention first conceived? 10/16/88 Where is this date documented? IN REPORT
Give physical location and reference numbers of laboratory records, but do not enclose.

LABORATORY RECORDS / DESIGN LOGS ARE EACH DATED

- 2. List, with publication dates, any publications such as theses, reports, preprints, reprints, etc. pertaining to this invention. Include manuscripts (submitted or not), news releases, feature articles and items from internal publications. Supply copies if possible.

THE REPORT, LUNAR-RATED FASTENERS, IS SUBMITTED WITH THIS DISCLOSURE AND CONTAINS COMPLETE DETAILS.

- 3. Should this invention be reviewed from the standpoint of federal security regulations?

NO

- 4. Give date, place, and circumstances of any disclosure. If disclosed to specific individuals, give names and dates.

CONCURRENT WITH THIS REPORT

- 5. Was the work that led to the invention sponsored by an entity other than Georgia Institute of Technology? Yes No _____

a. If yes, have sponsors been notified of the invention? Yes No _____

b. Sponsor Name (s): *NASA* GIT Project No.(s):

- 6. What firms may be interested in the invention and why? Name specific persons within the companies if possible.

NASA

B. SUPPORTING INFORMATION (continued)

7. List all products you envision resulting from this invention. For each, indicate whether the product could be developed in the near term (less than 2 years) or would require long-term development (more than 2 years).

SEVERAL FASTENER TYPES AND DERIVATIVES, FOR LUNAR USE OR OTHERWISE. SHORT-TERM DEVELOPMENT IS POSSIBLE.

8. From a strictly objective viewpoint, what are the greatest obstacles to the adoption of this invention?

COMPLETE TESTING AND FUNDING FOR PROTOTYPING.

9. Alternate technology and competition:

- a. Describe alternate technologies which accomplish the purpose of the invention.

SEE REPORT FOR DETAILS.

- b. List the companies and their products currently on the market which make use of these alternate technologies.

SEE REPORT FOR DETAILS.

- c. List any research groups currently engaged in research and development in this area.

UNKNOWN

B. SUPPORTING INFORMATION (concluded)

10. Future research plans:

a. What additional research is needed to complete development and testing of the invention? What time frame and estimated budget is needed for the completion of each step?

PROTOTYPING AND TESTING IN AN APPROPRIATE ENVIRONMENT.

b. Is this additional research presently being undertaken? Yes _____ No

c. If yes, is it being externally sponsored? Yes _____ No _____

d. Should corporate sponsorship be pursued? Yes No _____

Suggested corporation(s) *NASA*

11. Attach any additional materials that would assist in understanding or marketing this invention. Enclose sketches, drawings, photographs and other materials that help illustrate the description. (Rough artwork, flow sheets, Polaroid photographs and penciled graphs are satisfactory as long as they tell a clear and understandable story.) Please identify.

INCLUDED IN ACCOMPANYING REPORT, LUNAR RATED FASTENERS

12. For student inventors: provide the name of the faculty member most closely related to the invention.

PROFESSOR J. W. BRAZELL

13. Please print names and addresses of witnesses.

L. GREGORY SMITH
11906 KILRENNY RD.
MIDLOTHIAN, VA 23113

Don McKelley
445 Milledge HTS
Atlanta, Ga. 30606

14. This invention is presumed to be the property of the Georgia Institute of Technology in accordance with the Patent Policy as stated in the Faculty Handbook. If the inventors believe that this invention should not be the property of the Institute, please explain below to provide a basis for further review.

APPENDIX F

DESIGN ALTERNATIVES

ORIGINAL PAGE IS
OF POOR QUALITY

N 82-26673

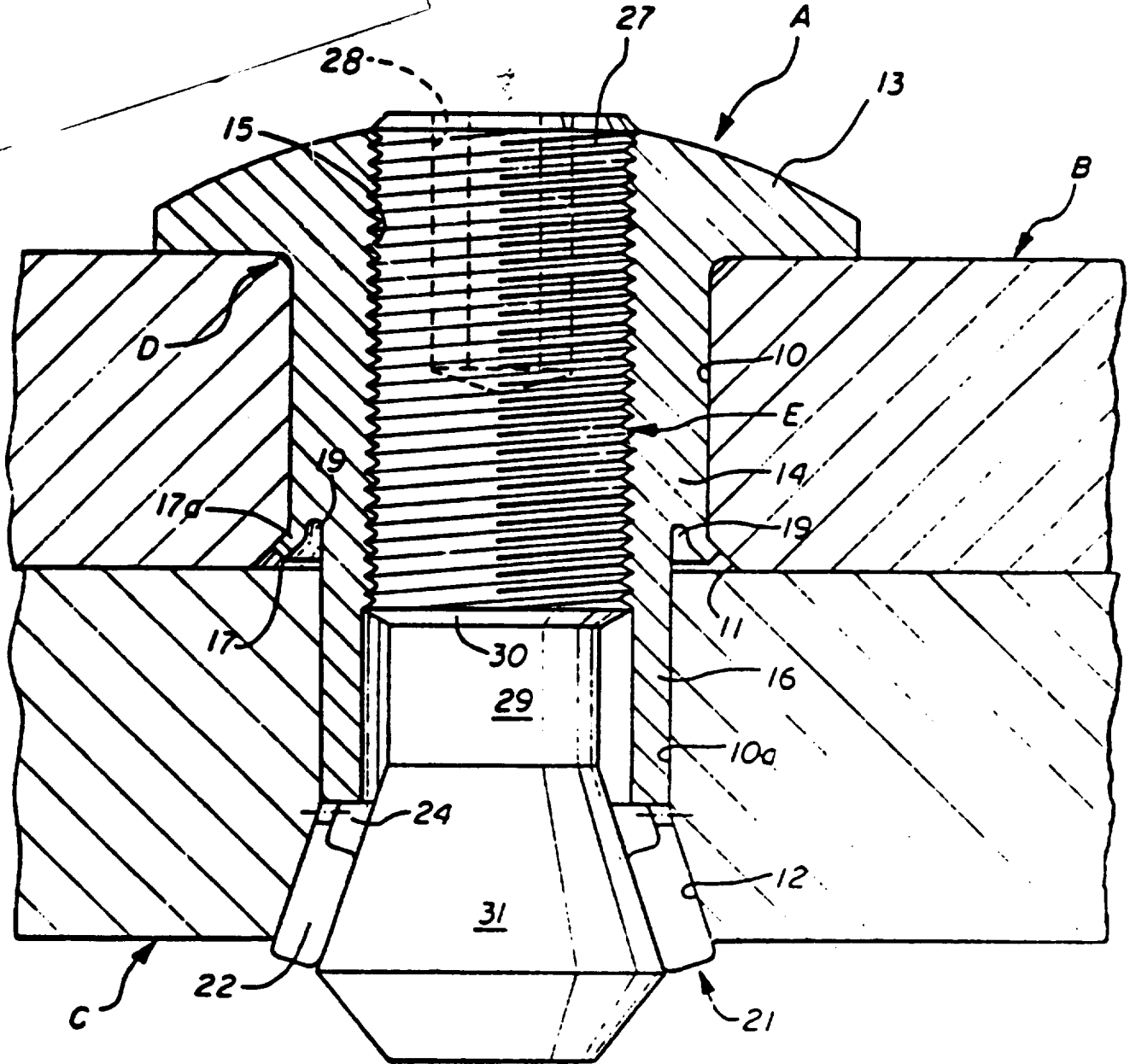

SEALED-THREAD BLIND FASTENER

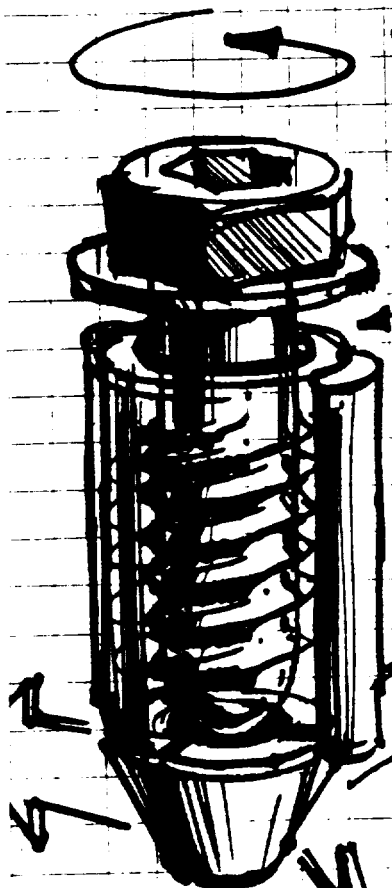

INTERNAL ALLEN HEAD
EXTERNAL CRESCENT

SEAL (NYLON)

SIDE BOSSES KEEP
SLEEVE FROM SPINNING

ONLY INTERNAL THREADS
SEALED FROM DUST

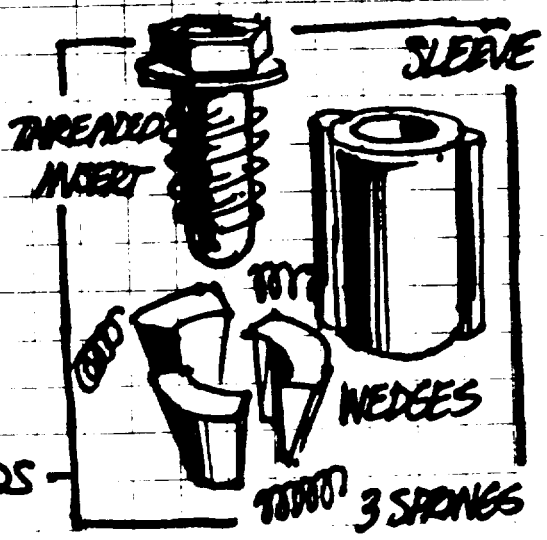

THREADED
INSERT

SLEEVE

WEDGES

3 SPRINGS

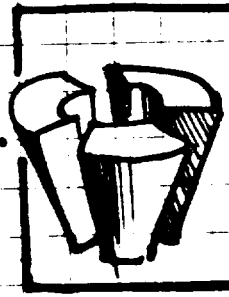

BOTTOM WEDGE EXPANDS WHEN
INTERNAL "BOLT" PASSES
OUT. ACTS AS NUT TO SECURE
BOTTOM

• FULLY REMOVABLE / REUSABLE

FINISHED
BOTTOM...
HIGH-PRECISION
REQUIRED TO
INSTALL



3-HOLES PROVIDE KEYWAY FOR
BOSSES

BOTTOM & HOLE



RECESSED ALLEN
HEAD
(CRESCENT FOR ROBOT TO
HOLD)

• WEDGE PULLS UP,
PULLS APART
WINGS

ALLEN HEAD FLUSH WITH
TOP WHEN TIGHTENED

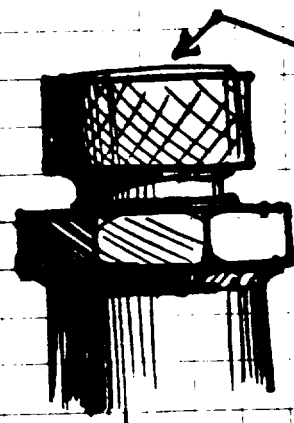

ALLEN HEAD

OPTIONAL HEAD
DESIGN: ROBOT
ARM HOLDS CRESCENT
TO KEEP SLEEVE
STATIONARY,
ROTATES ALLEN
TOP BOLT.

ELIMINATES NEED FOR
SPECIAL HOLE.

CAM-TIGHTENED 1/4 TURN

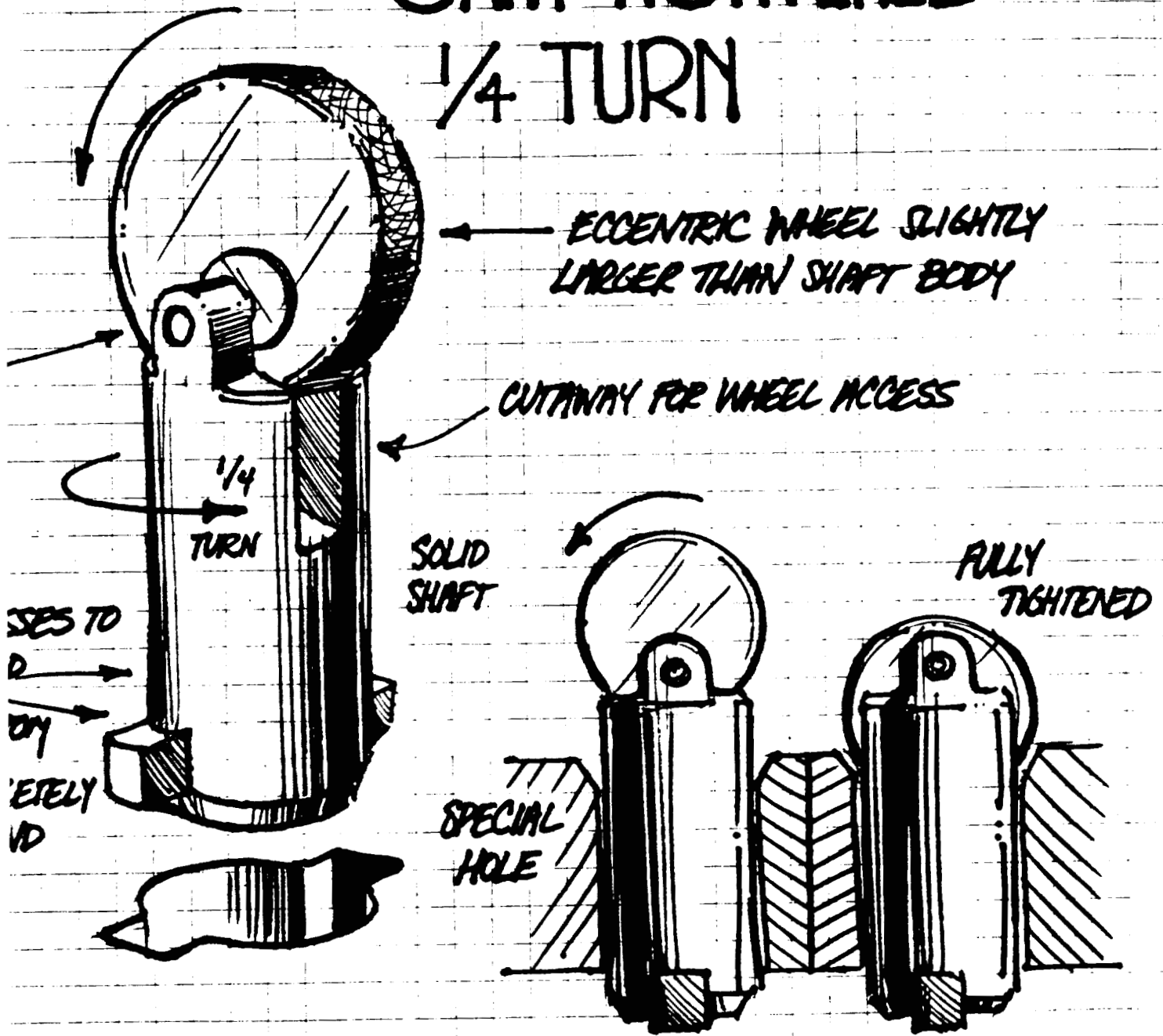

NO THREADS TO FOUL
USES VACUUM WELDING TO
ITS ADVANTAGE
QUICK INSTALLATION / RELEASE

WEDGE-LOCK FASTENER

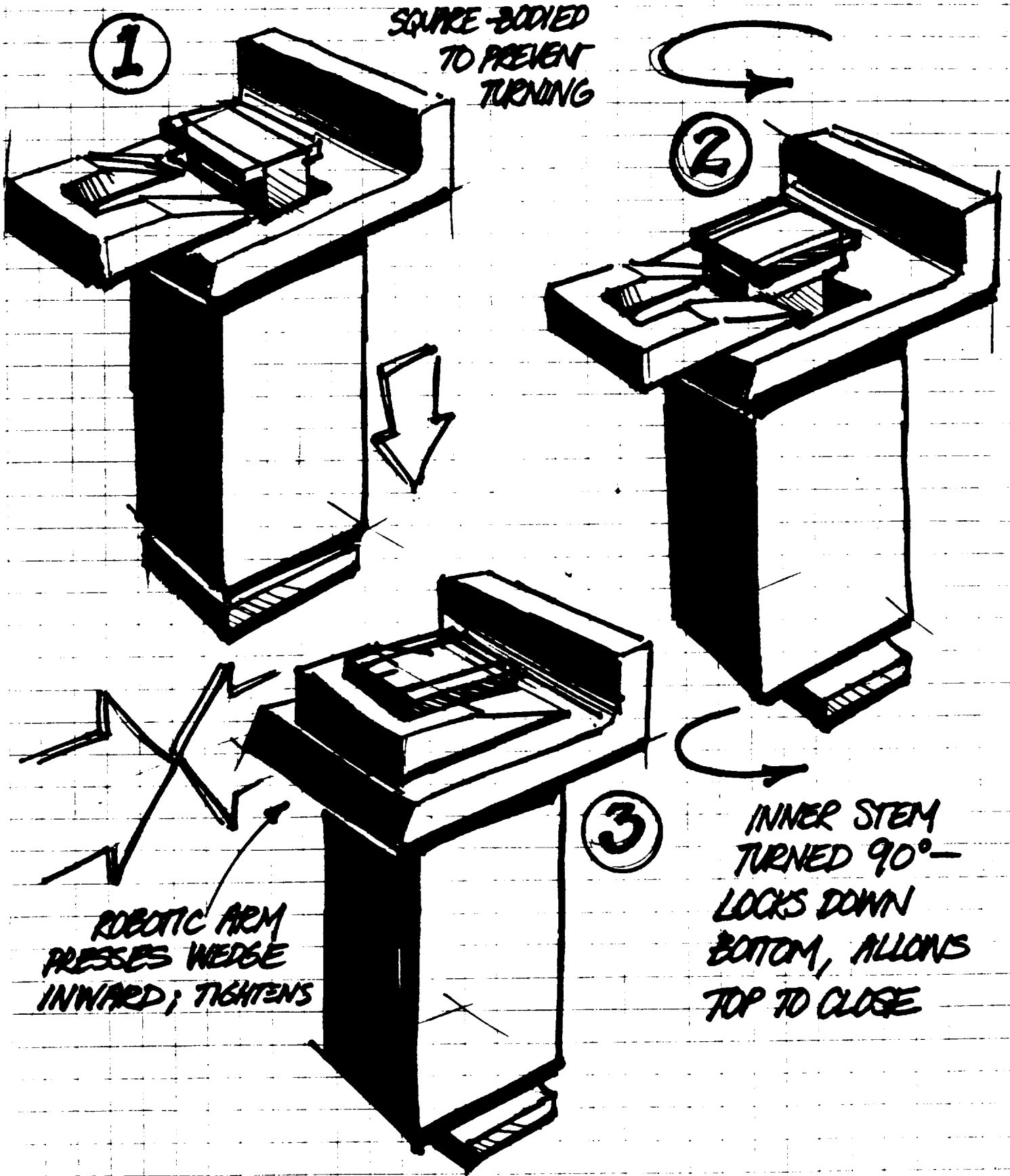

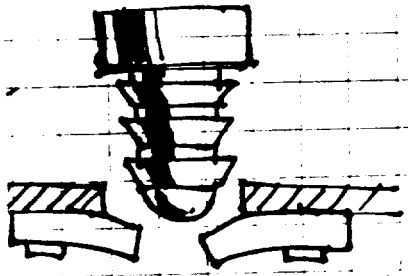

SEMI-FLEXIBLE LEAVES

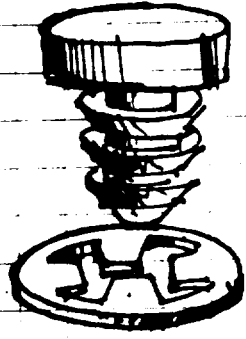

DEZUS
1/4 (DZUS)
TURN
FASTENERS

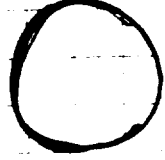
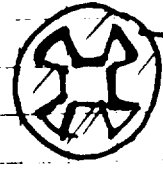

CONSTANTLY-VARIABLE DRIVE: SCREEN-ACTION
CAM-ACTION
PNEUMATICS / HYDRAULICS

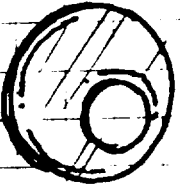
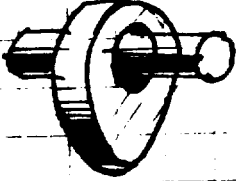

ECCENTRIC WHEEL

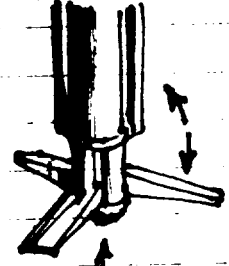
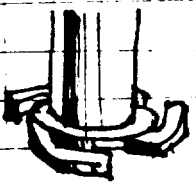
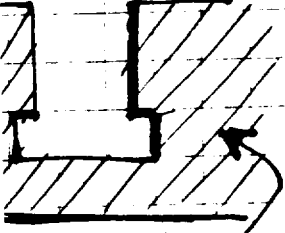
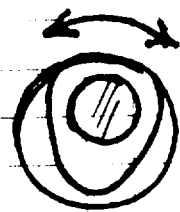

INTERNAL TIGGLE-BOLT ACTION

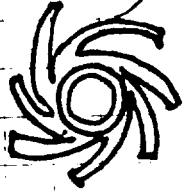

ROBOTIC CHARACTERISTICS:

- KEEP ACTIONS TO MINIMUM
- OPERATE FROM ONE SIDE OF MATERIAL ONLY
- USE ONLY ONE ARM
- MAKE FASTENER MAGAZINE-LOADABLE
- KEEP TORQUES REQ'D DOWN
- INSTALLATION PRECISION LOW

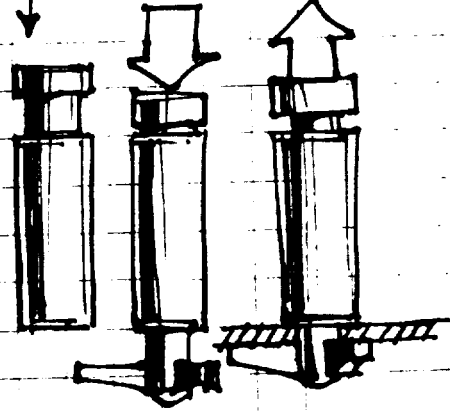

PLUNGER
PUSHED
THROUGH
MATERIAL

THEN
TIGHTENED
AS BROUGHT
BACK (HOW?)

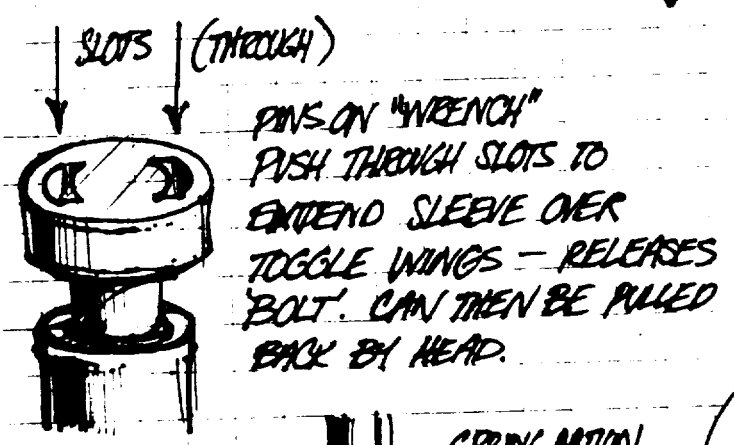
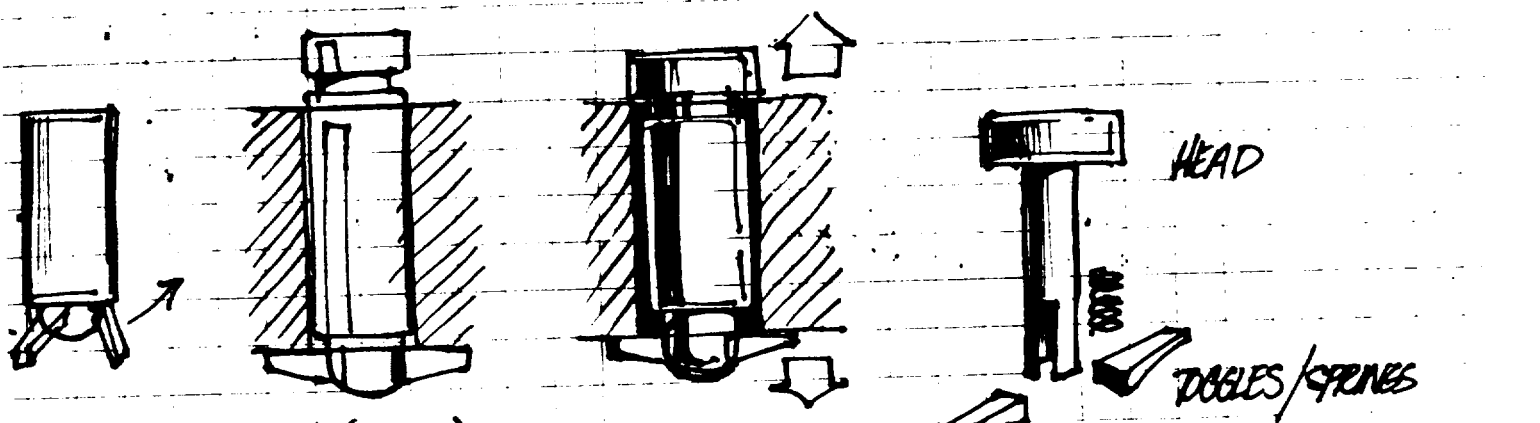

PINS ON "WRENCH"
 PUSH THROUGH SLOTS TO
 EXTEND SLEEVE OVER
 TOGGLE WINGS - RELEASES
 BOLT. CAN THEN BE PULLED
 BACK BY HEAD.

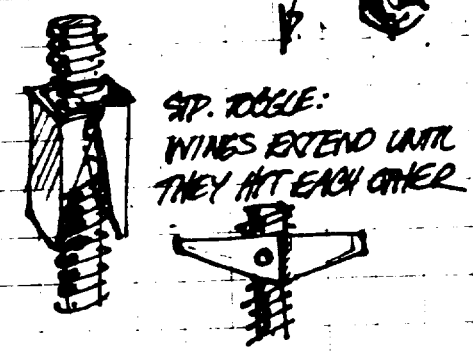
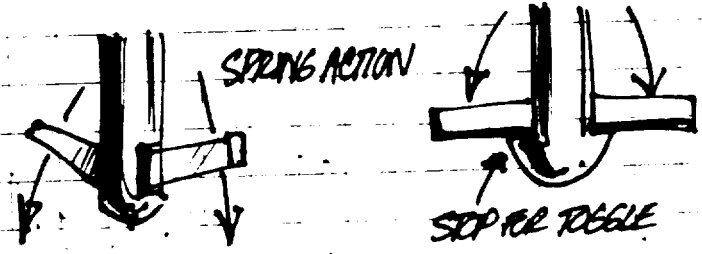

SP. TOGGLE:
 WINGS EXTEND UNTIL
 THEY HIT EACH OTHER.

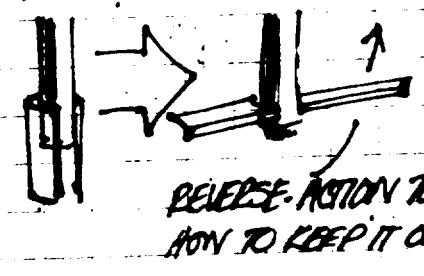

REVERSE ACTION TOGGLE.
 HOW TO KEEP IT OPEN?

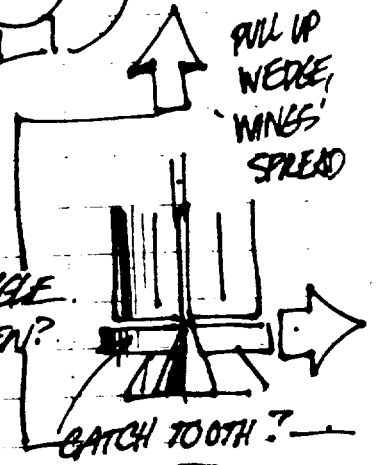

PULL UP
 WEDGE,
 WINGS
 SPREAD

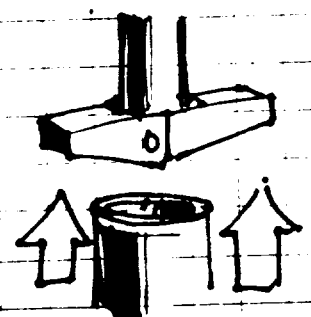

TO RETRACT
 WINGS

RETRACT by DISABLING SPRING?

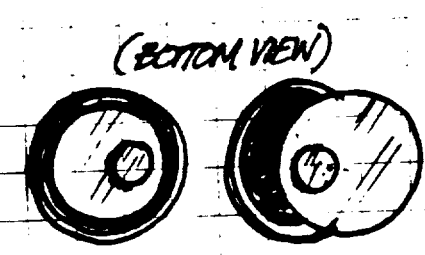

(BOTTOM VIEW)

ROTATE ECCENTRIC DISC
 TO CLAMP ON MATERIAL?

PROBLEM: 1-SIDED HOLD
 (FINE FOR TIGHT TOLERANCES)

BOLT ONLY AS STRONG AS PIN

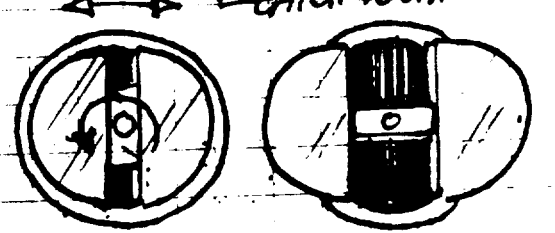

DOUBLE WINGS
 CAM-DRIVEN

← SPRING
 CONNECTED

16 OCTOBER 88

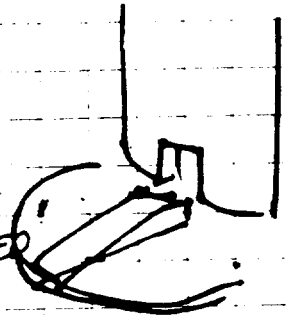
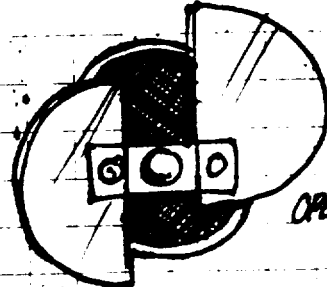
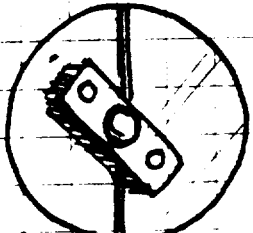
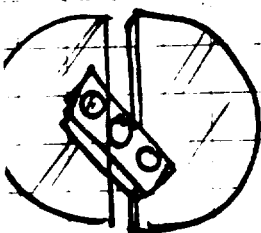

2-PIN CONNECTION

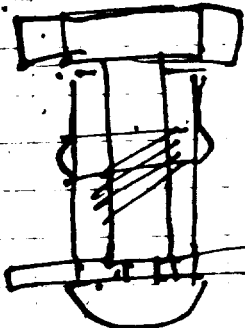
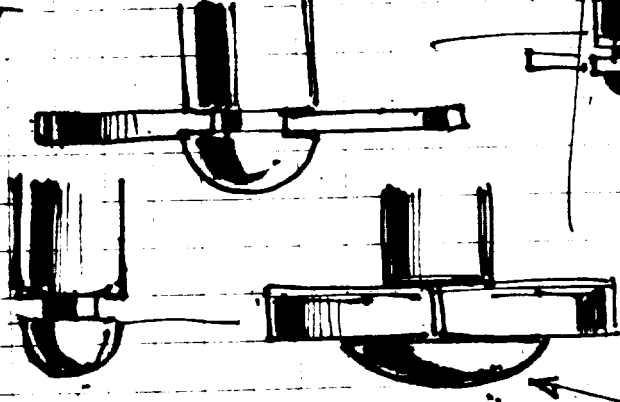
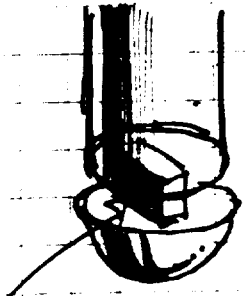
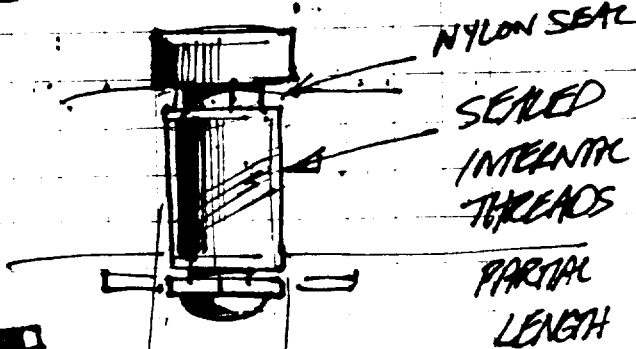
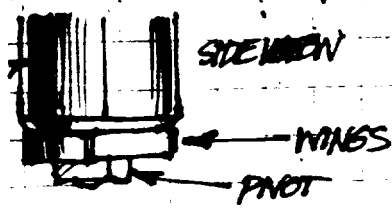

LARGER HEAD TO BETTER WINGS - HIGHER STRENGTH



NEED FOR SPRING?

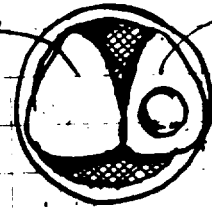
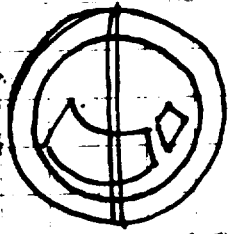

DUAL CAM / SINGLE DOVE

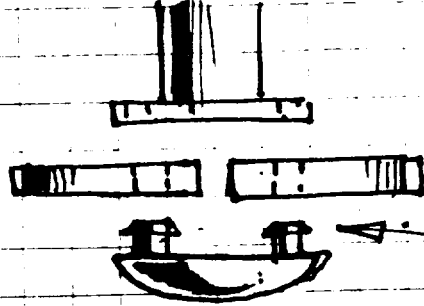
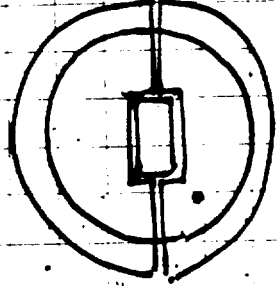
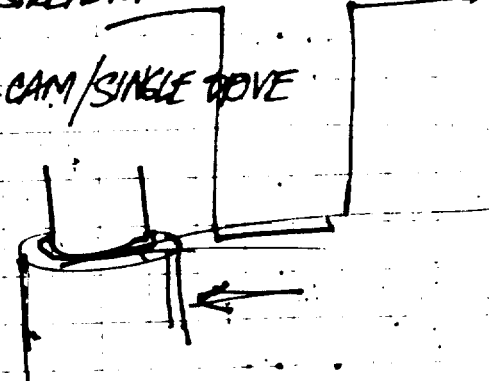

WING PIECES

PINS PERMANENT SNAP-FIT PRE-ASSEMBLED

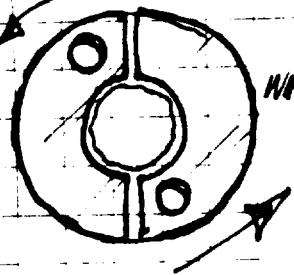

WING PIECES

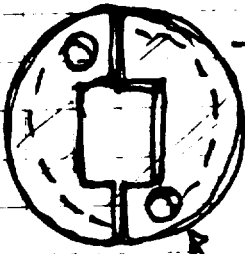

PIN (NON-RIGID) CONNECTION

FIRST PULL TO ENGAGE WEDGE TO STOP SLEEVE MOVEMENT; THEN TURN TO TIGHTEN. EASY OP FOR 1 ARM.

NEED FOR 2 ARMS

RED DEVIL

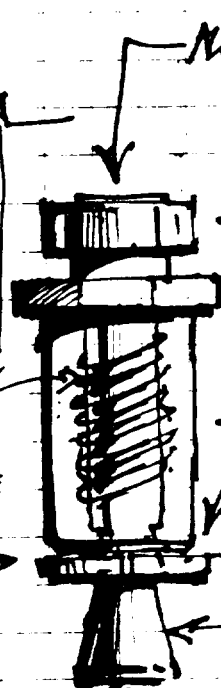
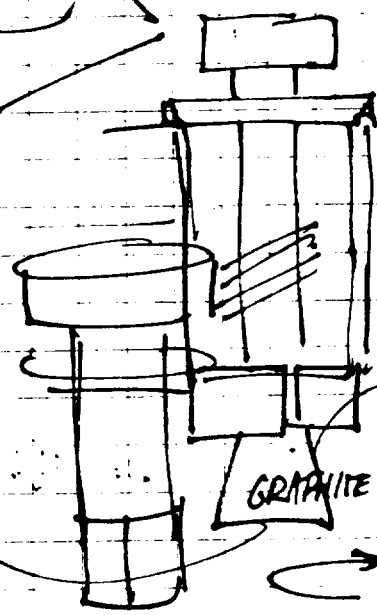
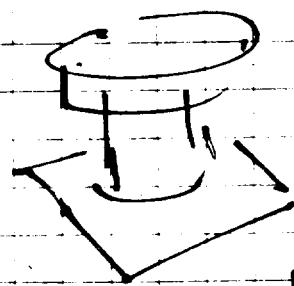
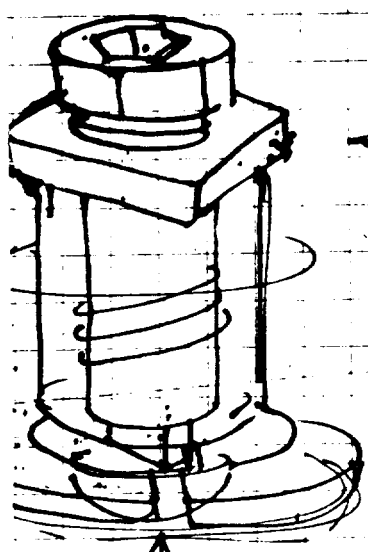

MLEN HEAD

CRESENT?

RETAINING CLIP

INTERNAL THREADS

INTERNAL SPRING/O-RING

WINGS

WEDGE

[ELIMINATE SLEEVE?]

DRILL HEAD

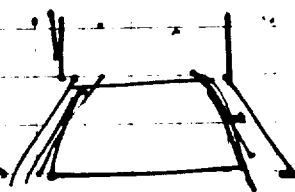
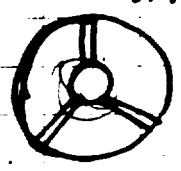

WEDGE FIRST SPREADS WINGS, THEN TIGHTENS - STILL NEED TO RETAIN SLEEVE

PULL TO ACTIVATE (NO TURNING)

RATCHET ACTION

INTERNAL O-RINGS USE TO SEAL?

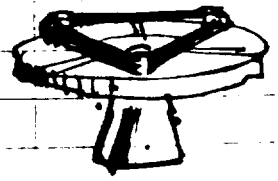
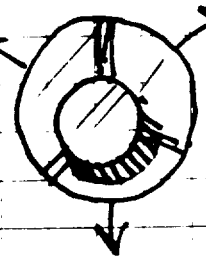
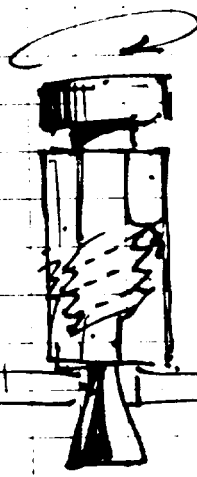
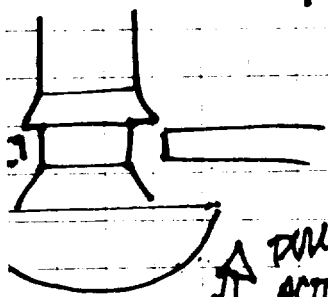

CONSTANT SEAL ON BOTTOM DUE TO WEDGE

17 OCTOBER 2008



ROBOTIC ARM PULLS UPWARD, ENGAGES WEDGES THEN SPINS TO ENGAGE THREADS - 1 ARM (2 OPS)

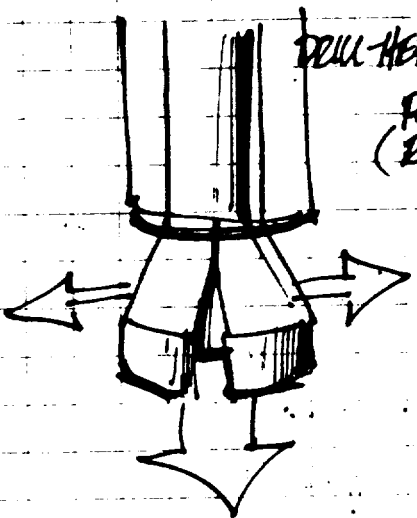
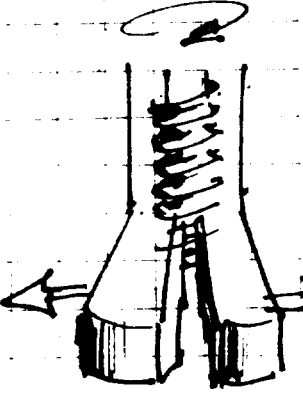
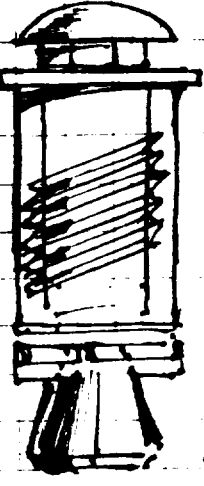

DRILL-HEAD WEDGE POPS OUT WHEN PUSHED (RETRACTS WHEN PULLED)

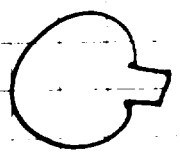

INTERNAL T-RODS SPINS DOWN TO OPEN WEDGE RETRACTS AND WEDGE CLOSES SPIN UPDOWN



ALLEN HEAD / CRESCENT DRIVE
 SEAL (ORING? NYLON?)
 INTEGRAL WASHER / PUSH-STOP (FOR ROBOTICS)
 SLEEVE / INTERNAL THREADS

THREADED INNER BOLT IN GRAPHITE

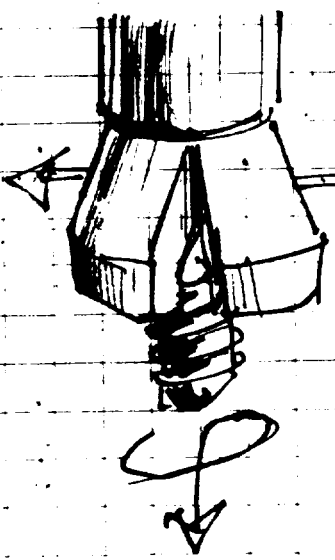

DRILL-HEAD BOTTOM EXPANDS AS ROD THREADS THROUGH.
 GRABS BOTH IN-HOLE (TO PREVENT TURNING) AND WEDGE ALLOWS FOR TENSION LOCKING

PROBLEM: WITH BOLT ROD DESIGN AS IS, BOLT LENGTH MUST BE VERY CLOSE TO HOLE LENGTH.



INTERNAL HOLE SHAPE

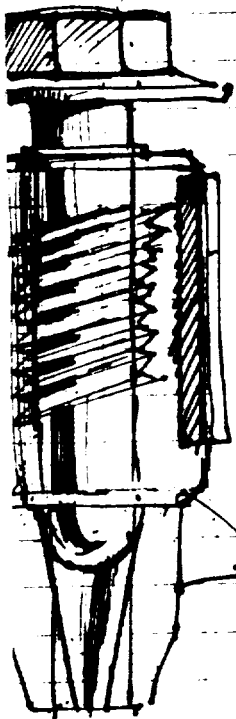

STILL PROBLEM OF
FREE SPINNING
HEAD SHIPT

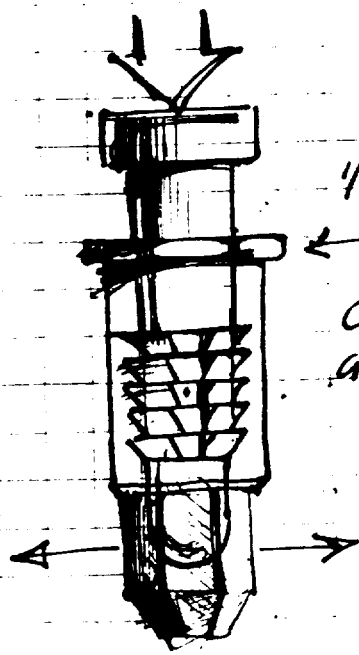

1/4 TO REMOVE
CRESCENT TO HOLD FOR REMOVAL
CAN BE PRELOADED WITH WEDGES
ON BOTTOM?

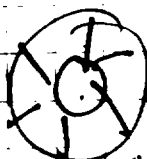

"INGENIOUS MECHANISMS FOR ENGINEERS/DESIGNERS"
5 VOLUMES

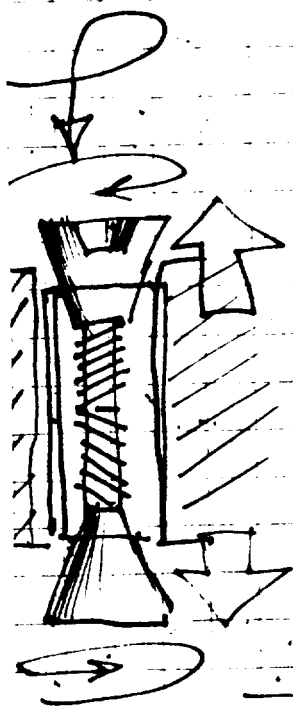

WEDGES EXPAND
IN 2 DIRECTIONS

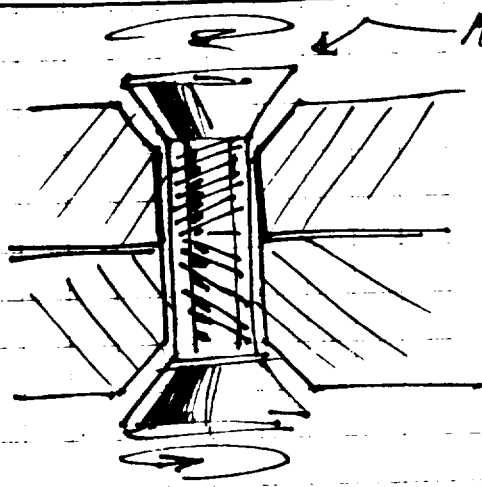

ALLEN

DOUBLE
COUNTER-SUNK
'COMPARS' - THREADS
(INTERNAL?)

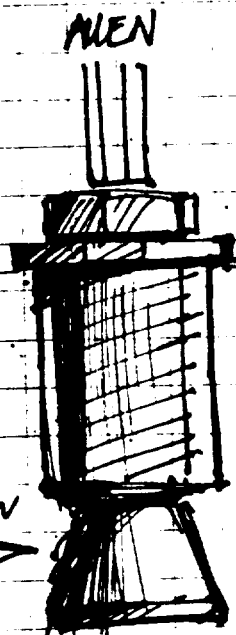

ALLEN

FIXED POSITION

CRESCENT... SAME ROBOTIC ARM

INTERNAL THREADS

WATE ON WHAT?
LEADING WINGS
& ALLOW FOR UP/DOWN
MOVEMENT



NEED SOMETHING
TO TRAVEL UP/DOWN

SLIDING OUT INSIDE OF SLEEVE HEAD (CRESCENT)

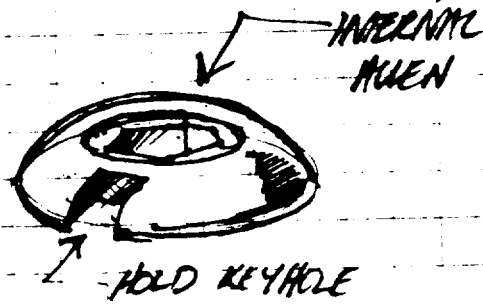
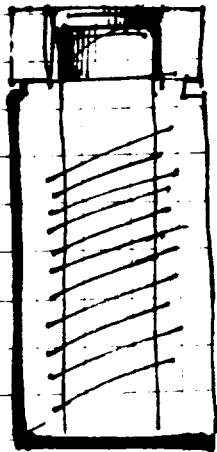
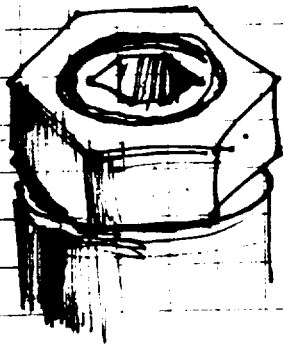

USE WELDING PROPERTIES TO ADVANTAGE:



PRESS-FIT WEDGE

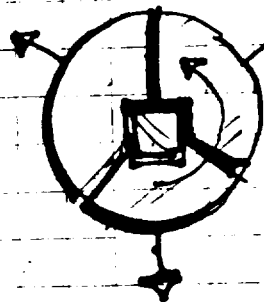
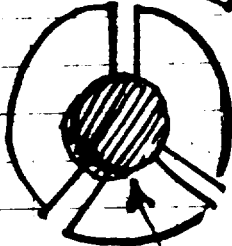
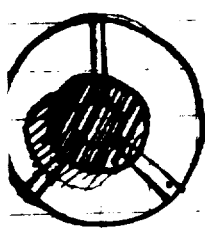
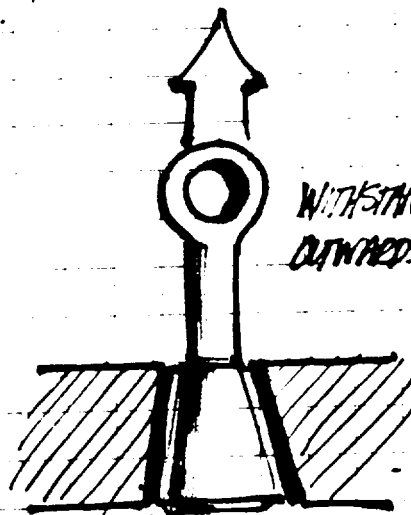
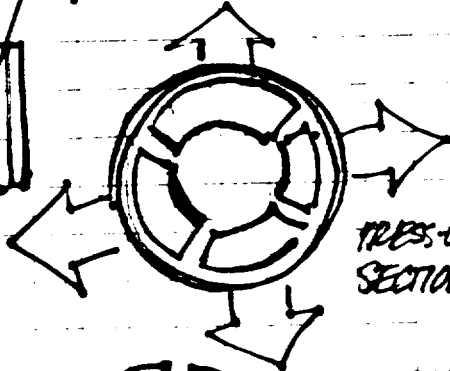

SQUARE PIN TURNS, PUSHES SIDES OUT

WEDGE DRIVES AGAINST EDGE?

MOTHER WELD HERE. TOUGHER TO REMOVE

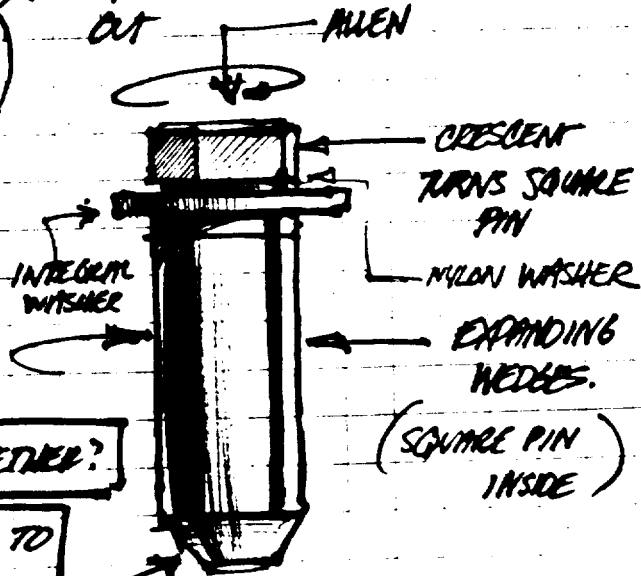

HOW TO HOLD TOGETHER?

STILL NEED SOMETHING TO HOLD WHILE TURNING

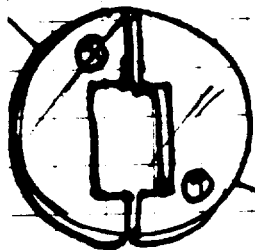

PINS AGAIN?

POINTED FOR OFFSET (LEVEL TOLERANCE) FIT IN HOLE

DRIVE SMALLER WEDGE TO SPREAD
LARGER WEDGES. REMOVAL?
DRILL-OUT?

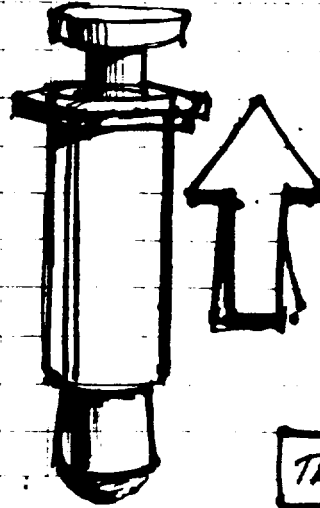
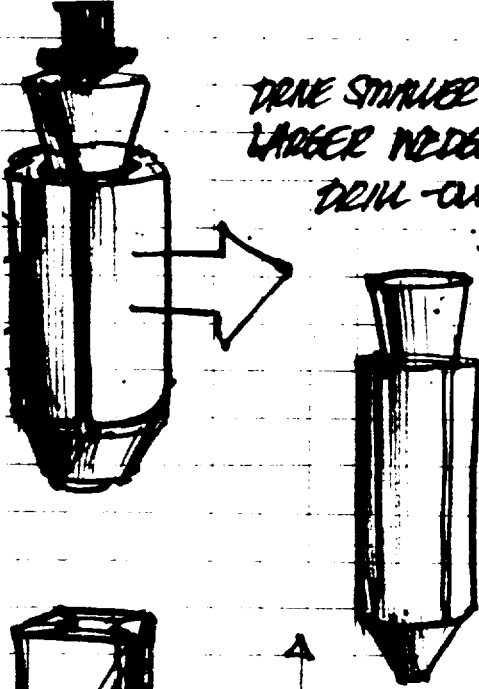

WEDGE PULLED UP FROM BOTTOM,
REMOVED BY POUNDING ON
TOP.
NO TURNING.
NEED TO HOLD BODY STILL
WHILE PULLING ON TOP

TEMPERATURE VARIANCES...?

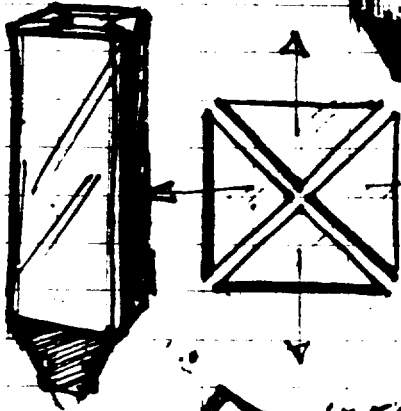

SQUARE HOLED?
EASY TO MAKE TURNABLE

ROUNDED

LEVER ACTION?

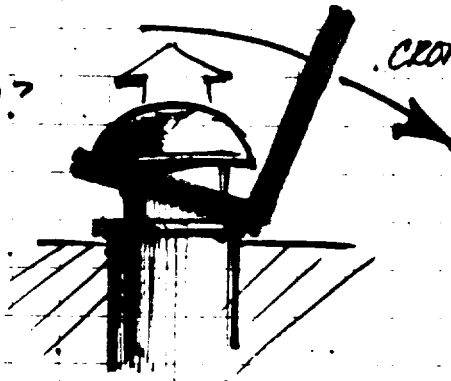
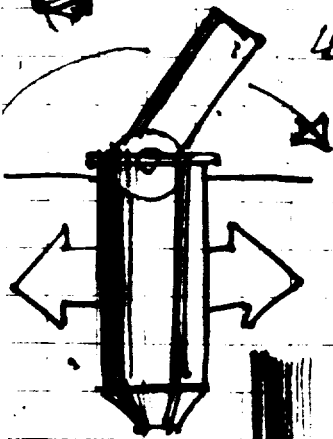

LEVER BAR APPROACH

SLEEVE
CRACKING
DOWN
SIDES

SPRING

SLEEVE IS REMOVED
AND INNER PIECES
SPRING OUT?

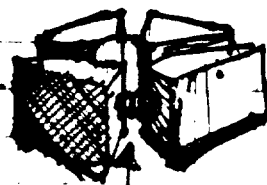

SPRINGS?

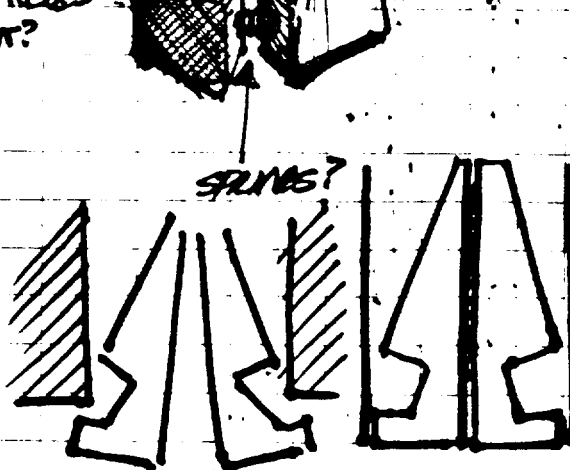
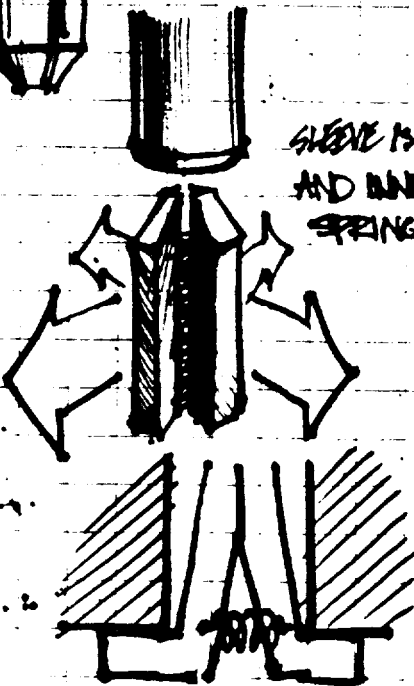

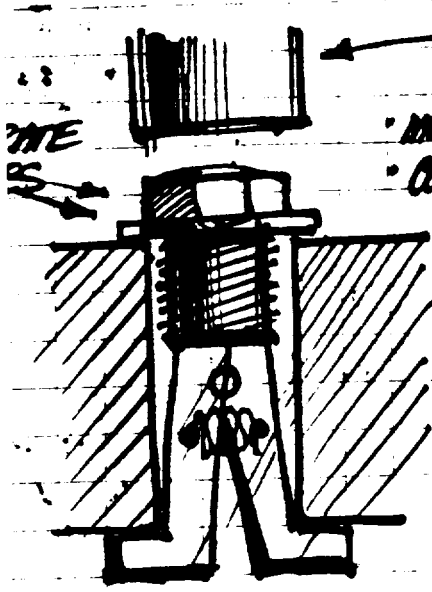

SLEEVE -- PART OF ROBOTIC ARM -- TO INSERT OVER / CLOSE SPRINGS.
 INVT THREAD SCREW
 COMPLICATED
 PROBLE IN TERMIN?

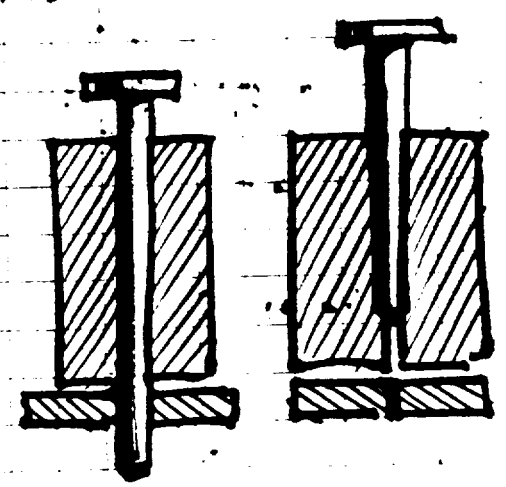

ENDY TO CLOSE...
 OPEN?

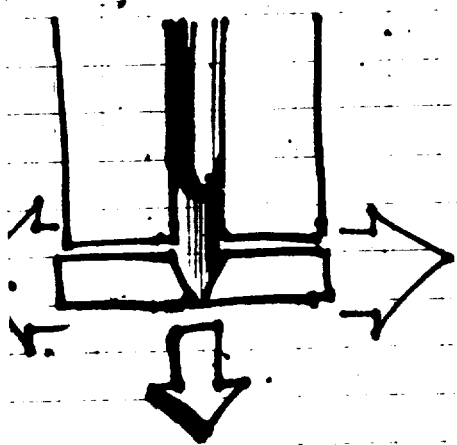

PUSH PLUNGER,
 HANDS OPEN.
 TIGHTENING?

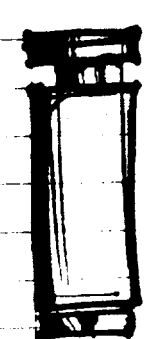

PIN TO CATCH IN
 I-RING TYPE
 THING (BUT)
 TO HOLD W/
 HANDS OPEN
 NO TENSILE STRENGTH

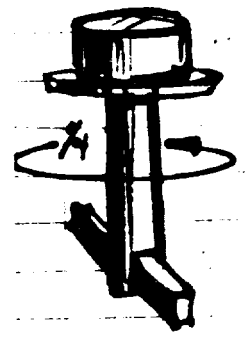

WHY NOT USE A 1/4 TURN PIN?
 • VIBRATION-PRONE (USE VACUUM; LOCTITE) (1/4 TURN + LOCK? VIBRATION PROOF)
 • NON-ADJUSTABLE
 • SEPERATE LENGTH NEEDED for EACH APPLICATION
 • NO ABILITY TO PULL PARTS TOGETHER
 • MACHINED HOLE REQ'D

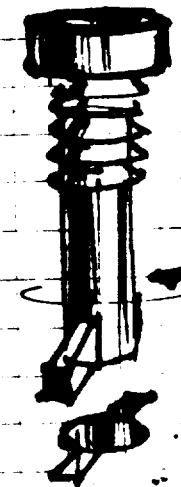
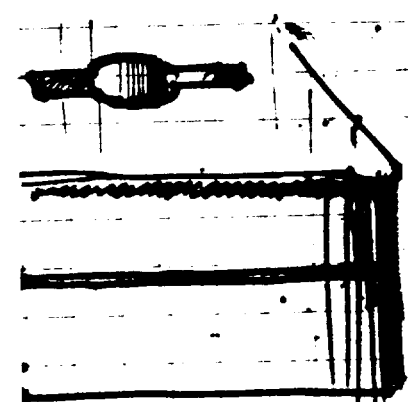

INSERT, 1/4 TURN
 APPLY CAP
 (PRE-SET)



2 DRILLED HOLES

PROBLEM STATEMENT

- CATALOG OF USABLE EXISTING FASTENERS
- ORIGINAL FASTENERS

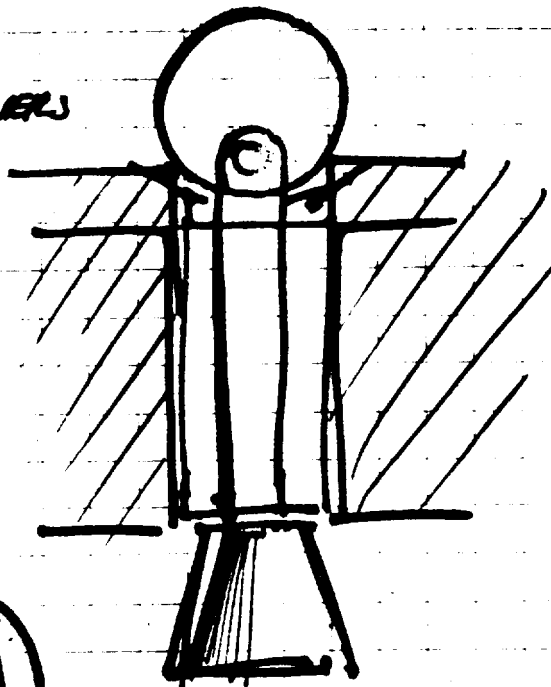

- INTERNAL THREADS - SLEEVES
- CAP FASTENER
- THE WEDGE
- PLASTIC TIE-WRAP ACTION?

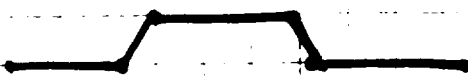
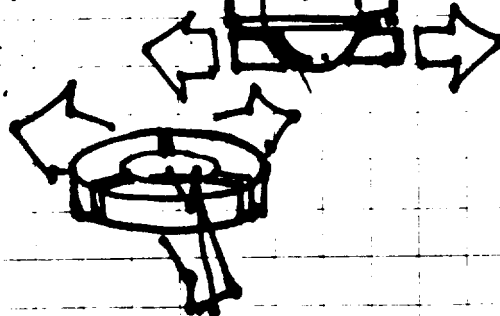
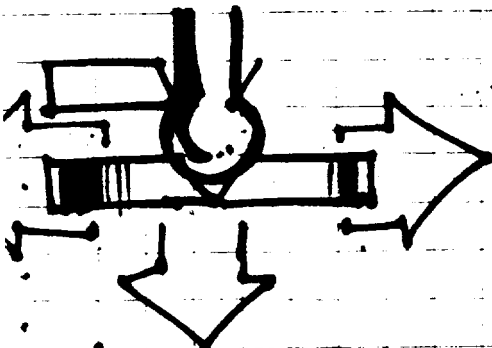
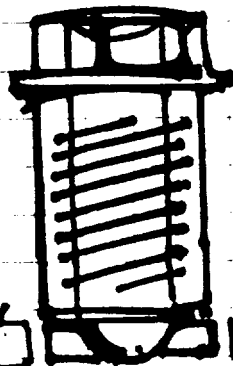
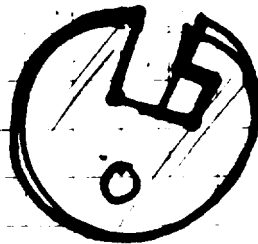
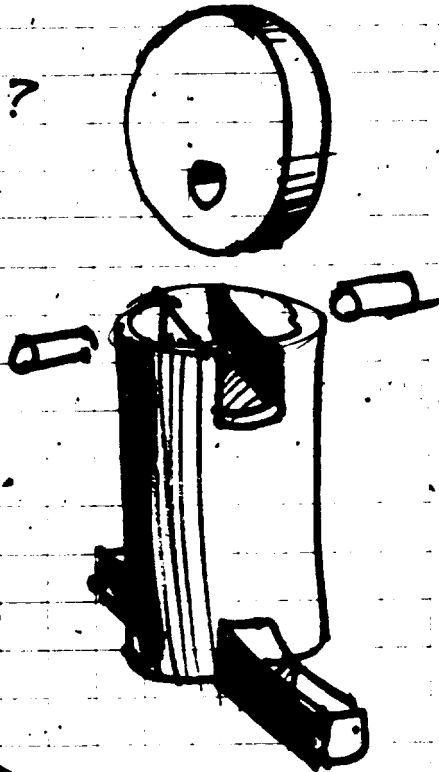
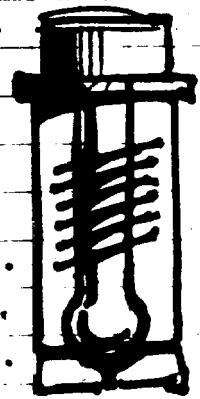

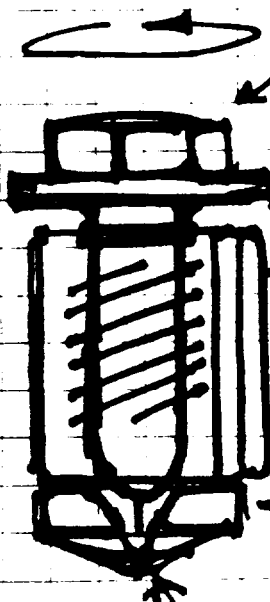
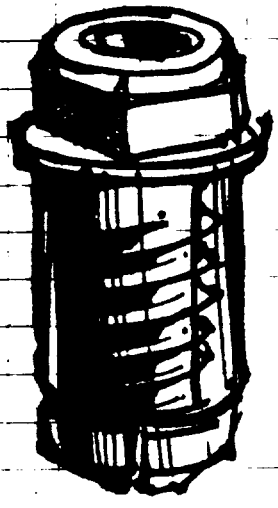

ALLEN WOOD / CASSETTE OUTER
INTEGRAL WASHER
SEAL

WINGS TO HOLD STEADY

SPREAD OUT ON BOTTOM

POINTED (LOW-TOLERANCE FIT)

COVER

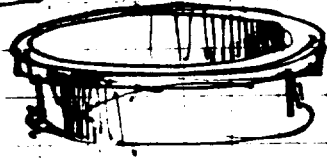
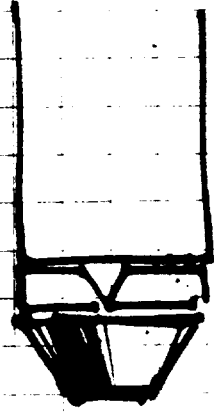
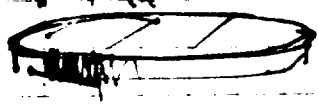

HITCH

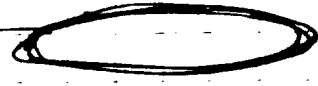

ORING

POOL PUMP ATTACHMENT O-RING AIR/WATER SEALED
LATCH / SPRING CATCH

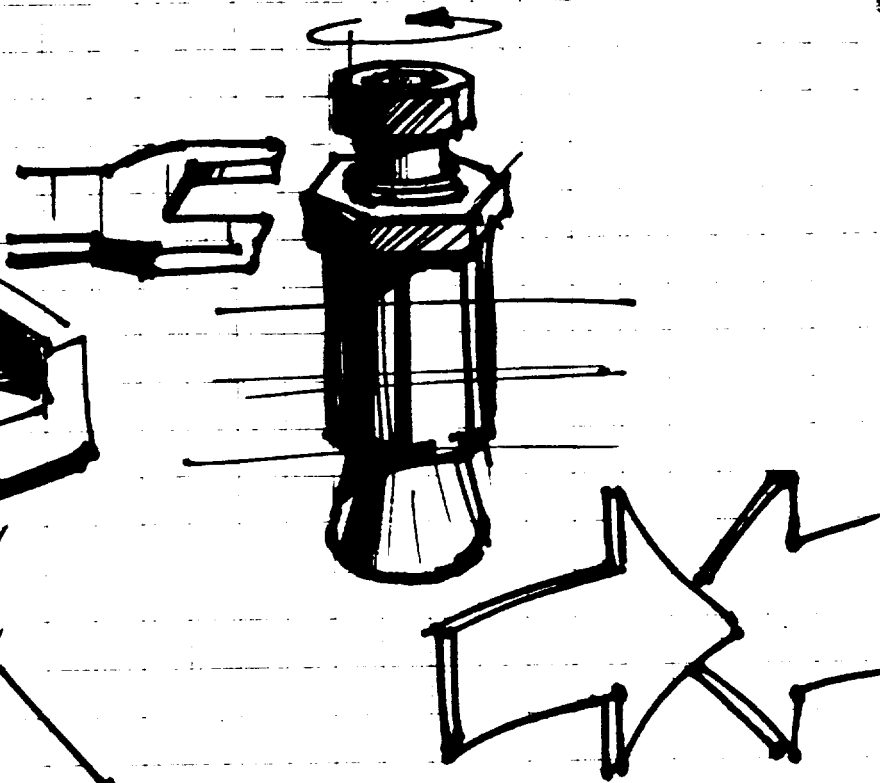
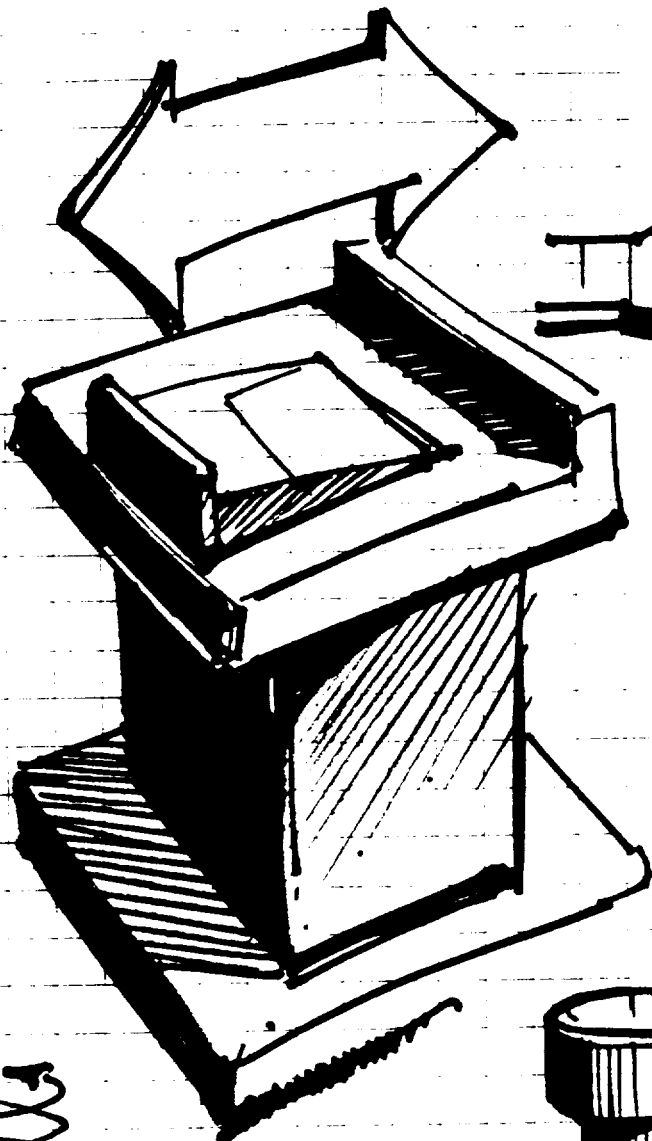

ALLEN HEAD INTERNAL
BOLT ALWAYS INSIDE
OVER

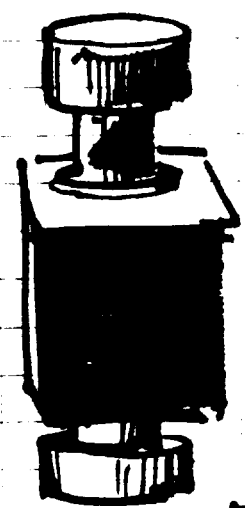
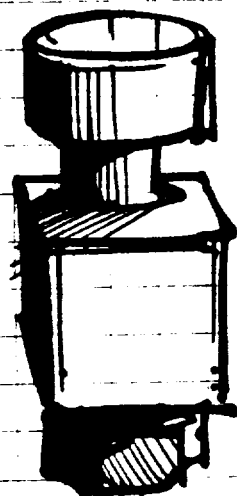
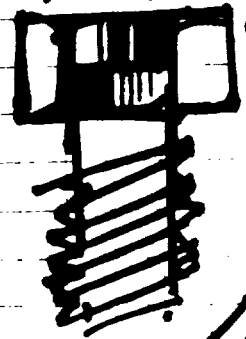

COUNTERSINK TOP FOR
LOW-PRECISION FIT

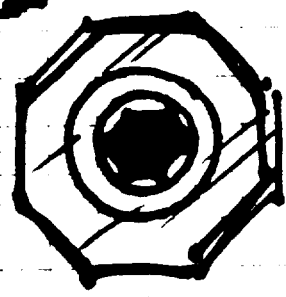
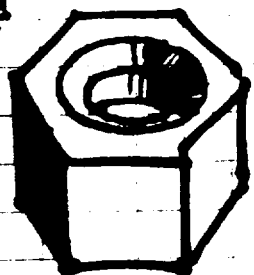

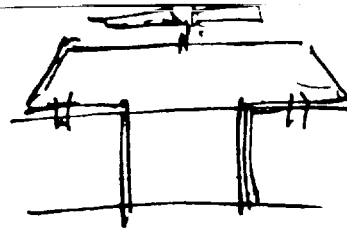

MINIMIZE DUST-BUILD-UP

MALE/FEMALE?

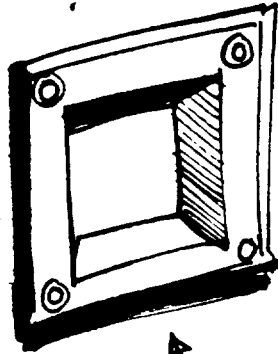
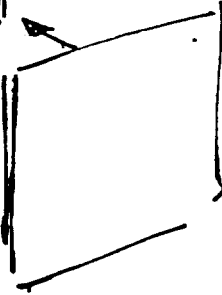
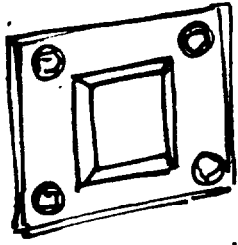

FEMALE PIECE

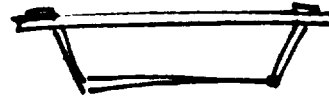

MAXIMIZES TORSION

HOLES FOR DUST?

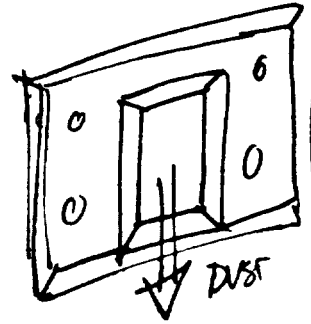
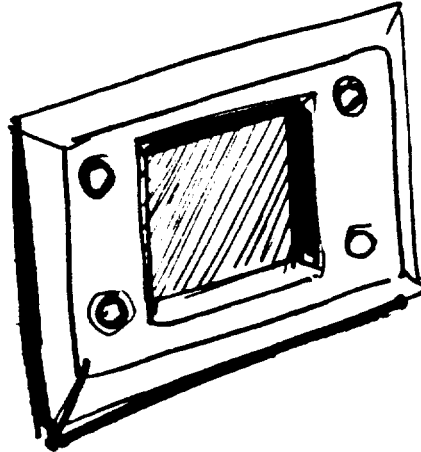
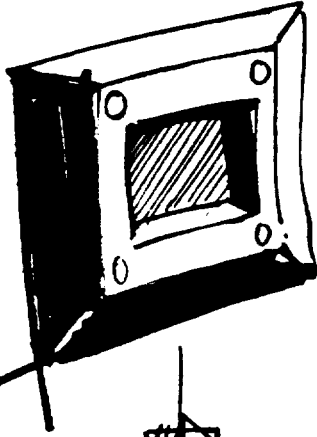

MALE/FEMALE AIDS IN SEATING

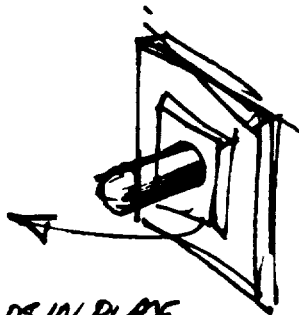
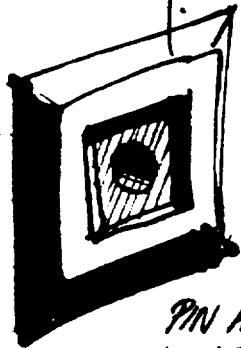
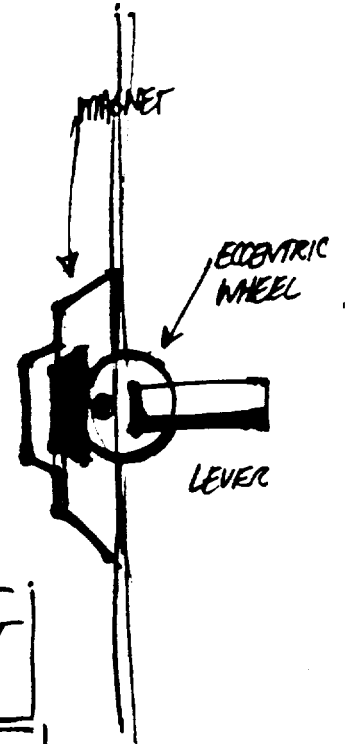
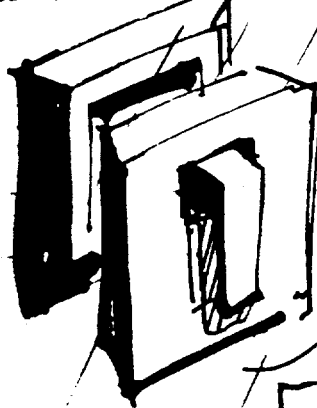

PIN HOLDS IN PLACE WHILE MAGNET ACTIVATED

SPRING RELEASE? CAM?

HOW TO RETRACT MAGNET?

HOLD PANEL IN PLACE WHILE MAGNET SEATS?

Lead Packaging

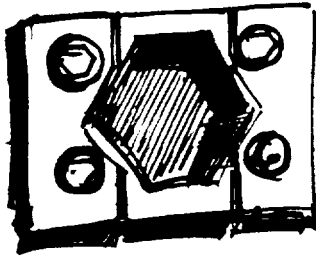
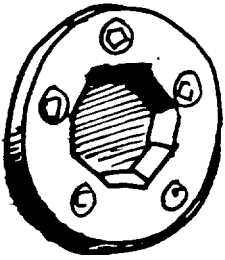

HEX SHAPED MAGNET

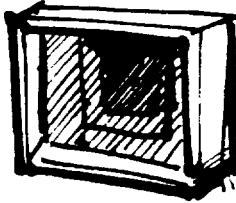
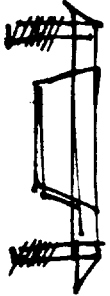

WILL NEED TO HOLD AROUND OTHER PART

MAGNET

FEMALE

MAGNET

FEMALE

SLOTS FOR PINS? DEFERS IDEA & EASY, LOW TOL INSTALLATION

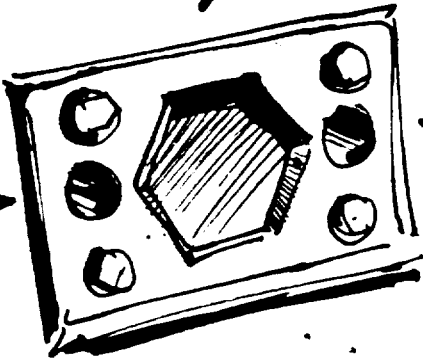

MAKE HINGED PANEL TO ELIMINATE NEED FOR HOLDER?

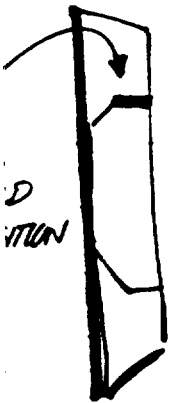

BEVELS FOR LOW-TOL INSTALLATION

INSTALLATION

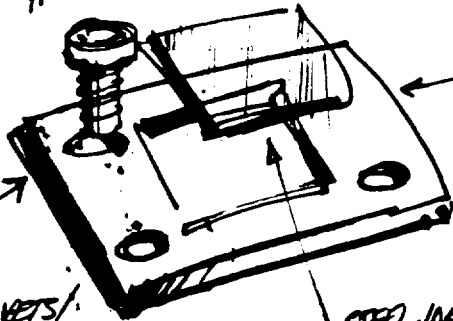

ALUMINUM FACIA PLATE

4 RIVETS/SCREWS

STEEL INSERT FOR MAGNET

STAMPED or CAST DEPENDING ON STRENGTH REQ'D

LEVER-PULL MAGNET RELEASE



SPACE TO GRAB HANDLE

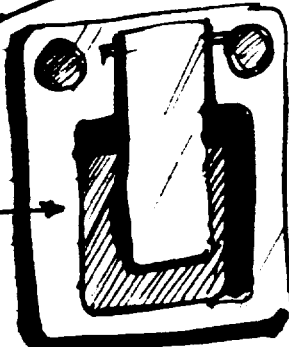

Need Packaging

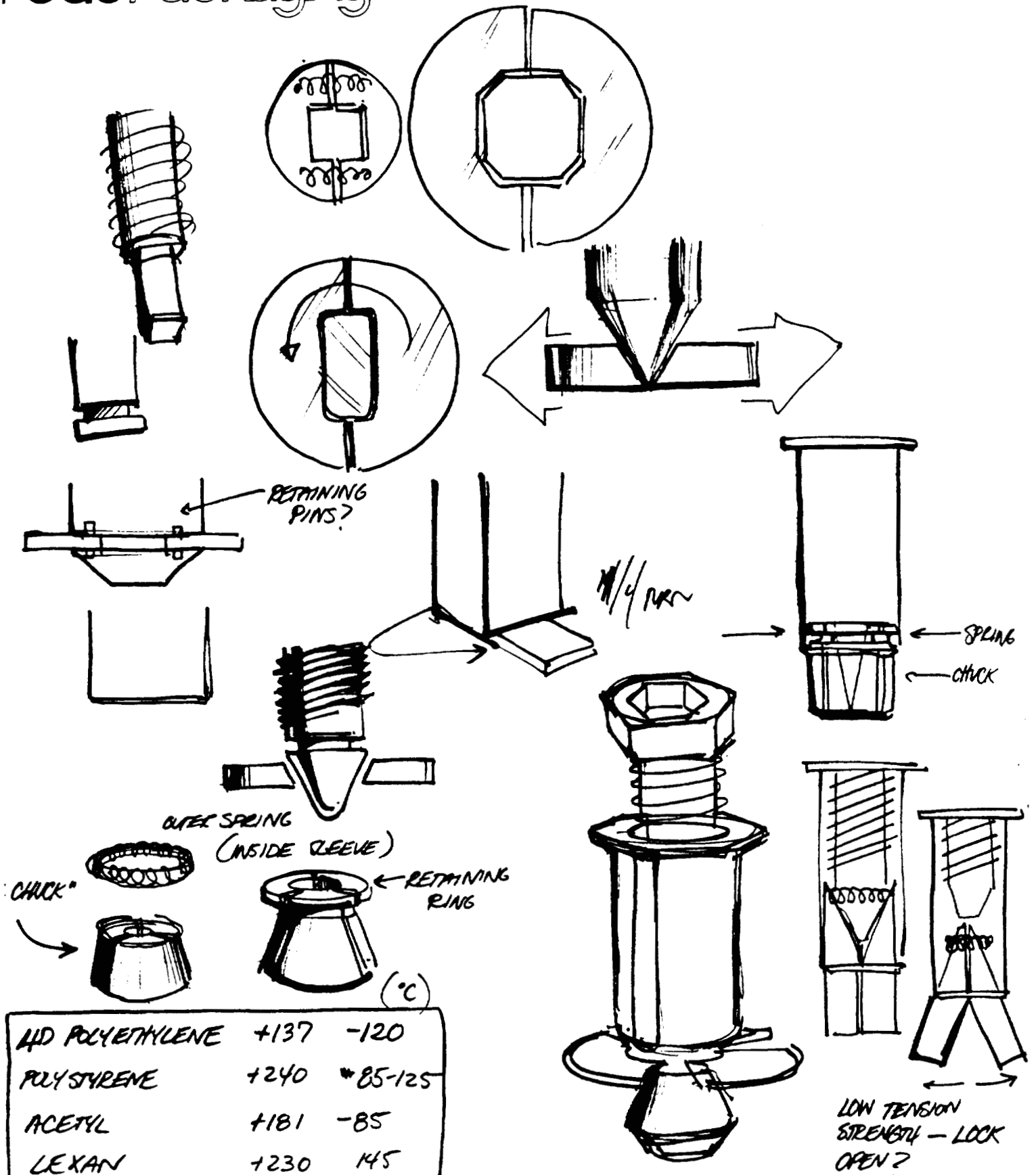

HD POLYETHYLENE	+137	-120
POLYSTYRENE	+240	*85-125
ACETYL	+181	-85
LEXAN	+230	145

MELTING & GLASS TRANSITION TEMPS

Head Packaging

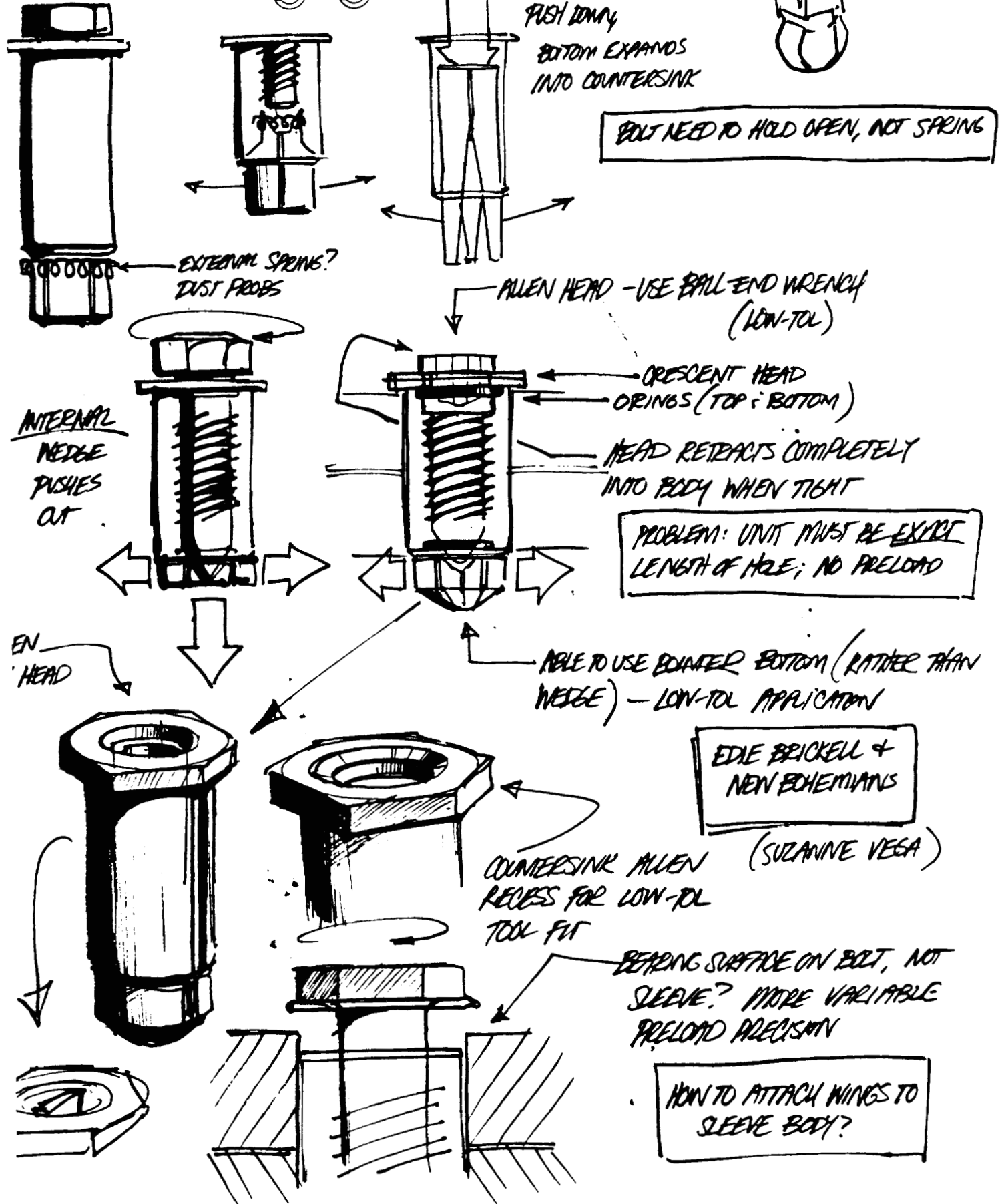

ALL THE BOLT DOES IS EXPAND WINGS, NOT TIGHTEN

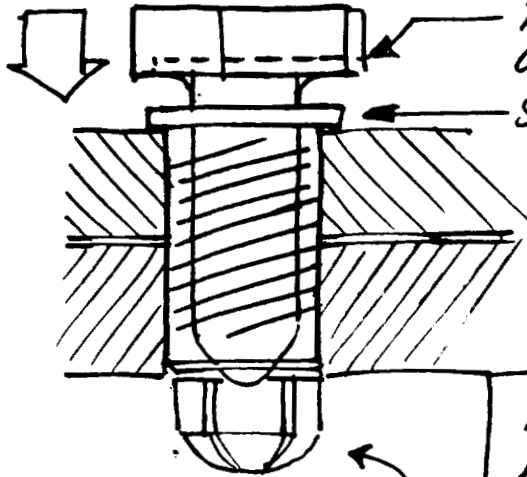
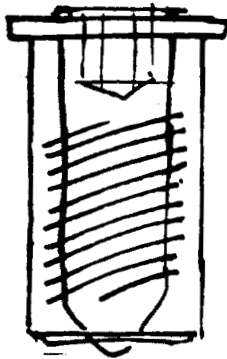

TOP HEAD W/ CUTAWAYS - SLIDES OVER SLEEVE HEAD
SLEEVE STILL HOLDS IN HOLE

KEYS REQ'D

STILL NEED CLOSE DIMENSION TO HOLE SIZE

MUST MAKE EITHER TOP OR BOTTOM MOVABLE

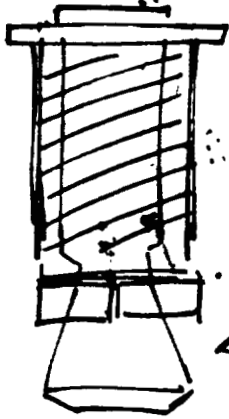

MOVABLE BOTTOM

MOVABLE TOP

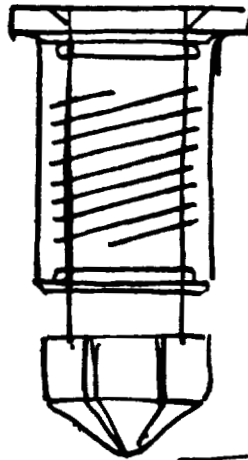

SCREEN THISTS UPWARDS - ENDS UP FLUSH

FEED: BOTTOM PIECE THAT EXPANDS OUT & MOVES IN

- DRILL CHUCK
- SPRING-LOADED HEAD (ROGEE BOLT)
- 1/4 TURN IN-OUT

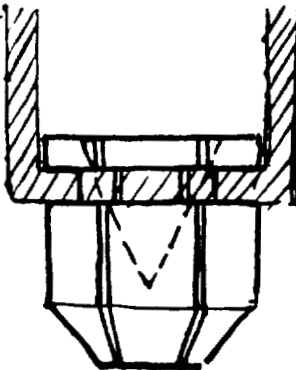

STILL - ONLY EXPANDS DOESN'T TIGHTEN

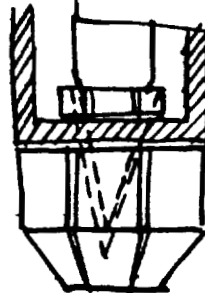

Need Packaging

NBZ-26673 - NASA FAST.

RELATED PATENTS

3,878,766	FROM
3,922,947	NASA
3,958,408	T.R.
3,812,756	

- GLAD-HANDS
- [SPRING-LOCK HARNESS] HOSES
- LIVING HINGE
- SEALED-THREAD
- 1/4 CAM
- DRUS - ?
- INT/EXT SNAP RINGS
- MAGNETIC (CABINET / SHOP)
- T-HANDLE LATCH
- WEDGE STAKES
- SNAP-RING (WHEELS)
- 61B KEY

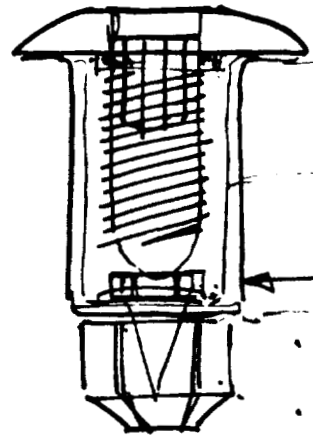

(OF CHUCK PIECE)

DOES INNER PART HAVE THREADS?



THREADED INSIDE TO RAISE

CHUCK PART EXTENDS DOWN (1/2"?)
RETRACTS UP TO TIGHTEN

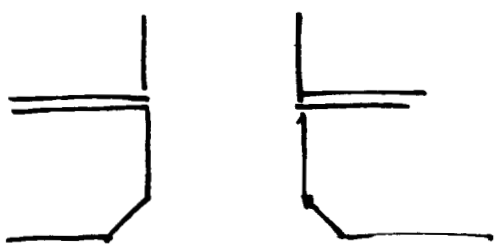
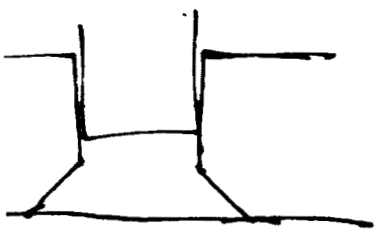

- o SEALING PROBLEMS
- o RETRACTION / REUSABILITY PROBLEMS

SLITS IN SLEEVE EXPAND WHEN PULLED BACK

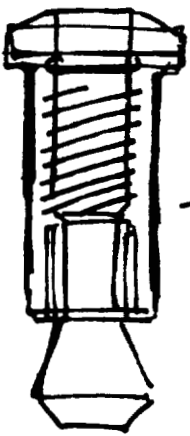

BEND POINTS

NEEDS VARIABLE BEND POINTS (CONSTANT) TO BE VERSATILE IN DIFFERENT HOLE SIZES -

SPRING-LOADED

HOW TO MAKE IT RETRACT?



SPRING-LOADED
(GLOTTIFIED TOGGLE
BOLT).



INTERFERES WITH
THREADS

NEEDS TO BE ATTACHED TO BOLT

- DETENT ON SLEEVE RETRACTS WINGS
(UNINTENTIONAL RETRACTION)
- LOCK DEVICE (NUT, BOLT)
- TOO COMPLICATED

'NUT' HAS TO BE A PART OF BOLT (NOT SLEEVE) IF IT IS TO BE LENGTH-ADJUSTABLE,
UNLESS NUT BEARS ON TOP AND SLEEVE RETRACTS/EXTENDS. EASY TO
USE CHUCK DESIGN (OR WEDGE) → BUT PROBLEMS WITH HOW TO TIGHTEN.

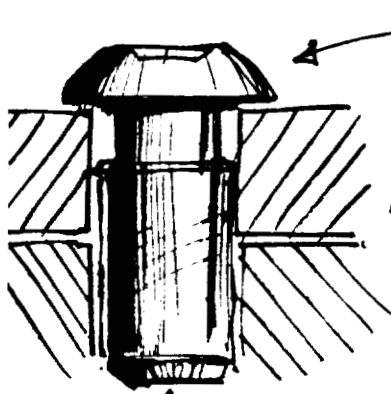

REQ'S KEYWAY IN SHAFT.

IT'S A DAMN
BOLT

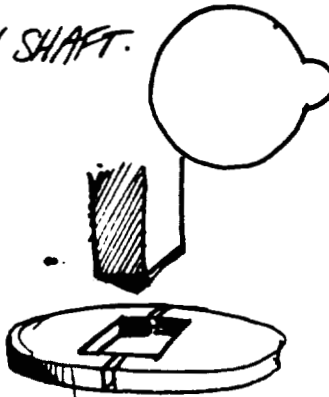

GOOD 'NUT'.

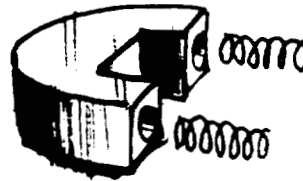

INTERNAL SPRINGS
(LIKE TRILL CHUCK)
EXPAND WHEN
KEYWAY PULLED
OUT

EXPANSION MEANS ON BOTTOM

OFF-CENTER
CIRCLE SECTIONS
SPRING-EXPAND WHEN KEY PULLED
STILL HAVE HOLE FOR POINTED
T-POD TO CLOSE AGAIN

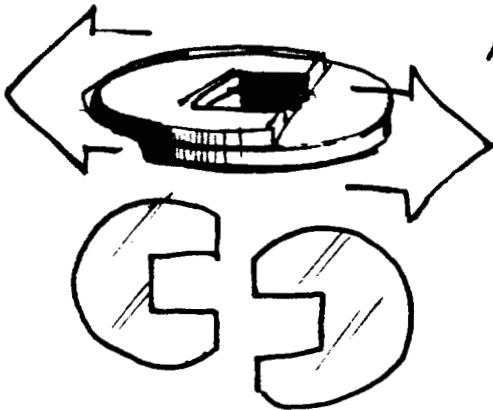

Need Packaging

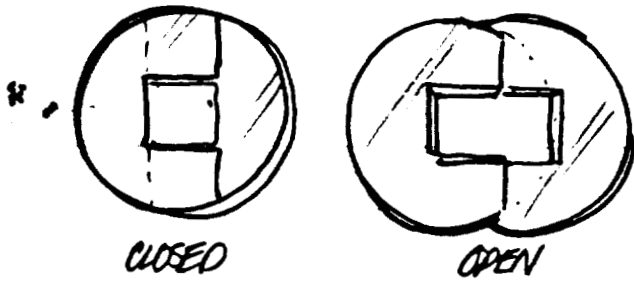

HOW TO CLOSE A HOLE?

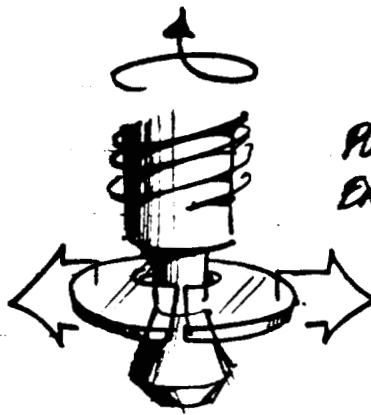

PULLING UP ON WEDGE
EXPANDS WINGS

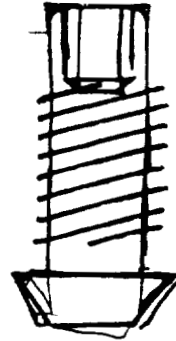

BEVEL ON SLEEVE BODY EXPANDS AT BOLT DRIVES UP.
DISTANCE DEPENDS ON ANGLE OF BEVEL, STRENGTH OF SPRING.

FREE FLOATING WING
NO NEED FOR WEDGE HERE

MATED / CUT PIECE?

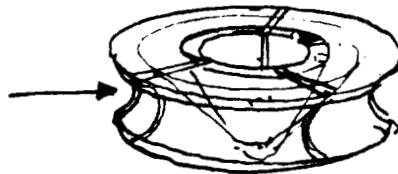

TRACK FOR EXTERIOR SPRING
OR ORING TO PULL BACK IN



DEEP GROOVE FOR SPRING
RETENTION

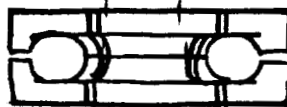

2-PIECE PRESS FIT ASSY - TOTAL
ENCLOSURE OF SPRING
(EXCEPT WHEN OPENED)

FREE FLOATING

PART OF
BOLT

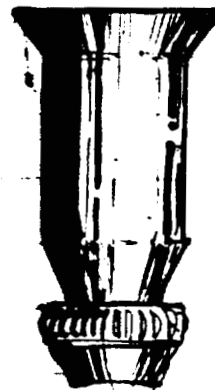
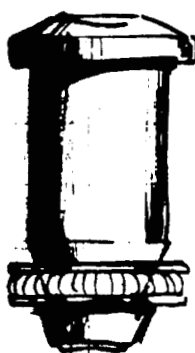
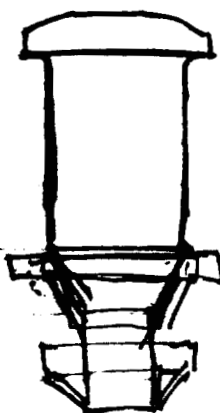

COUNTERSUNK VERSION

Head Packaging

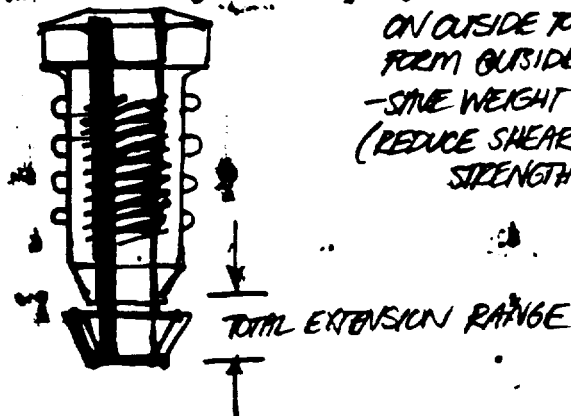
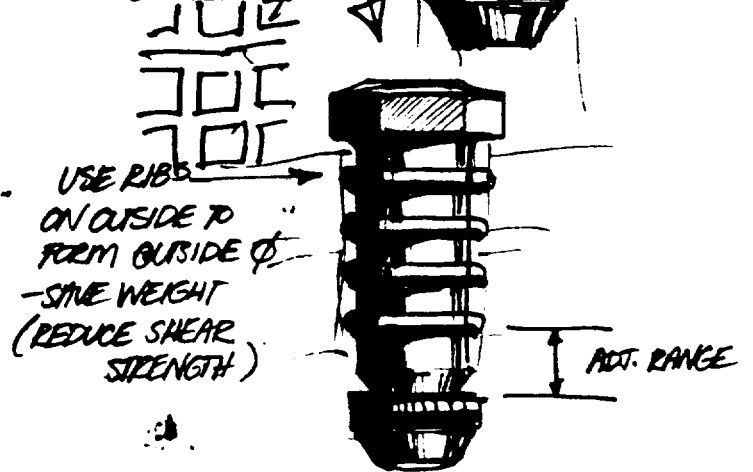
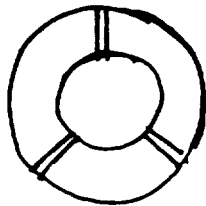
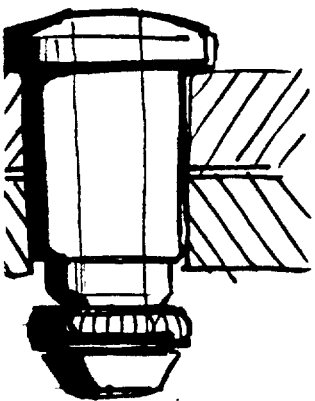
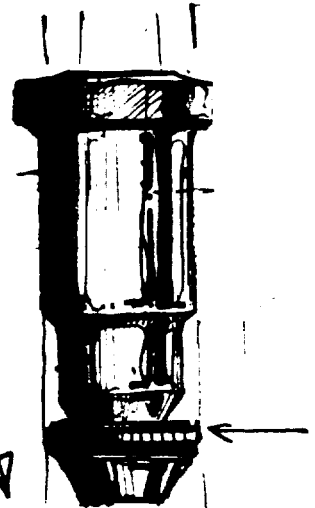
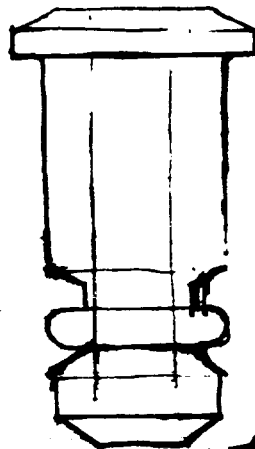
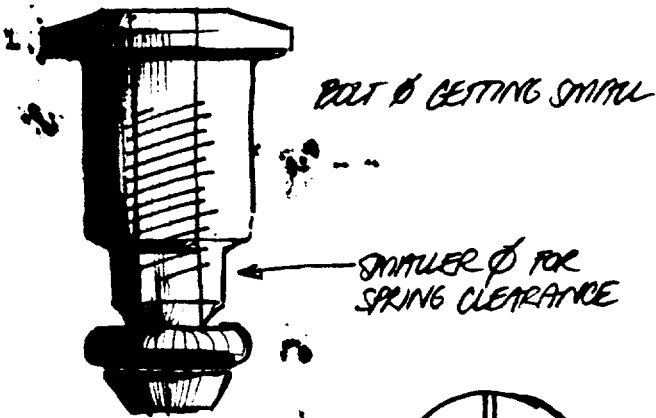
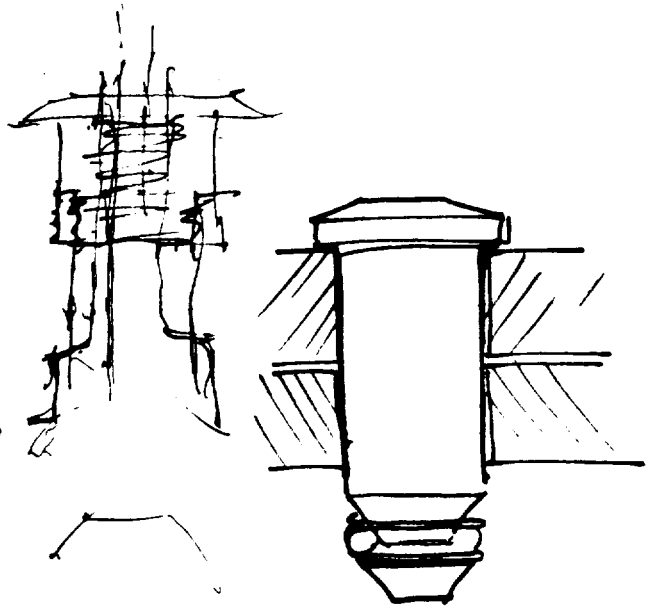
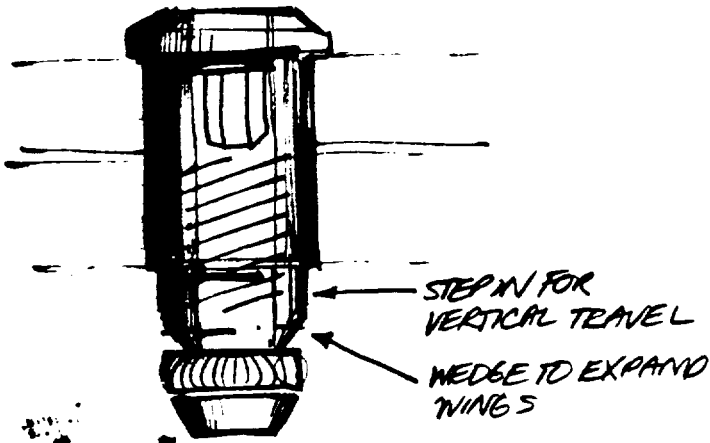

Nead Packaging

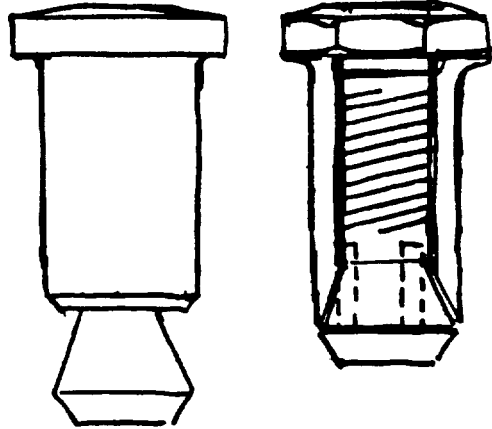
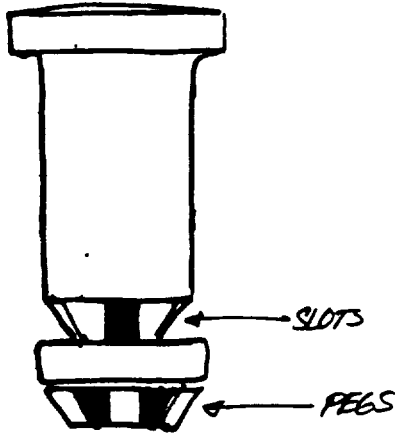

EXPANDING SLEEVE

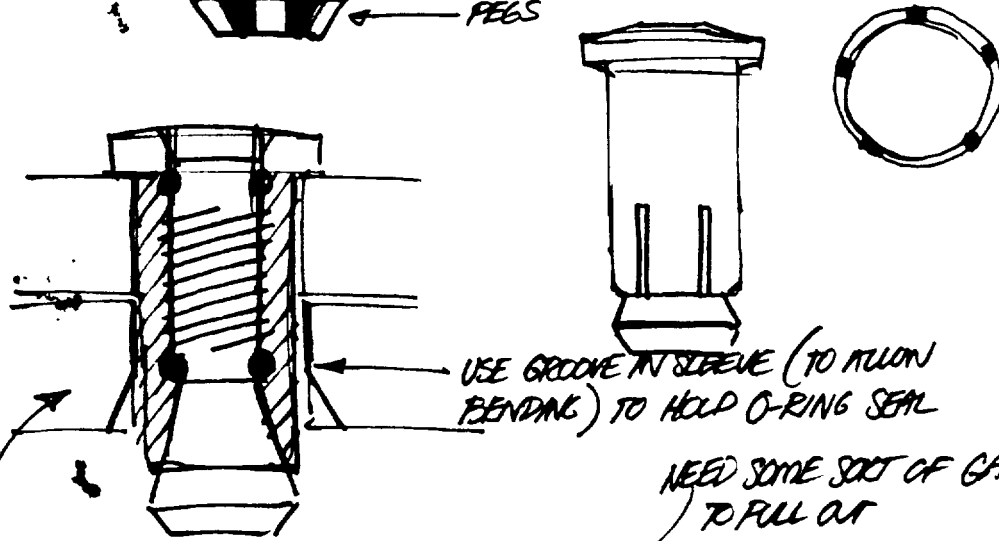

REQ'S DUNTERSINK

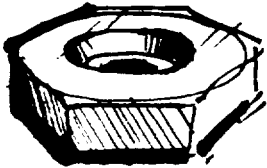
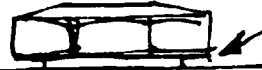

HOW TO GRAB
(IS FULL?)

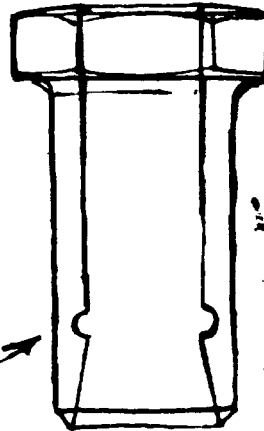

2 SLOTS IN SIDES
TO GRAB

SLEEVE SHAPE

VARIABLE
"MSTH"
UTS

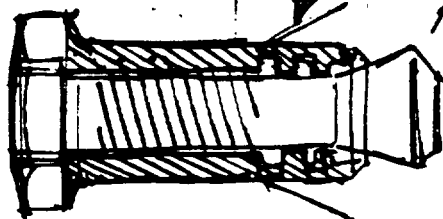
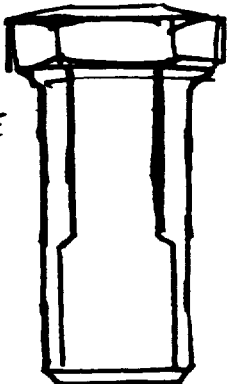

RIBS ALLOW FOR SLEEVE TO BE DEFORMED
'AS NEEDED' WHILE STILL PROVIDING CONTACT
FOR BOLT PIECE

Head Packaging

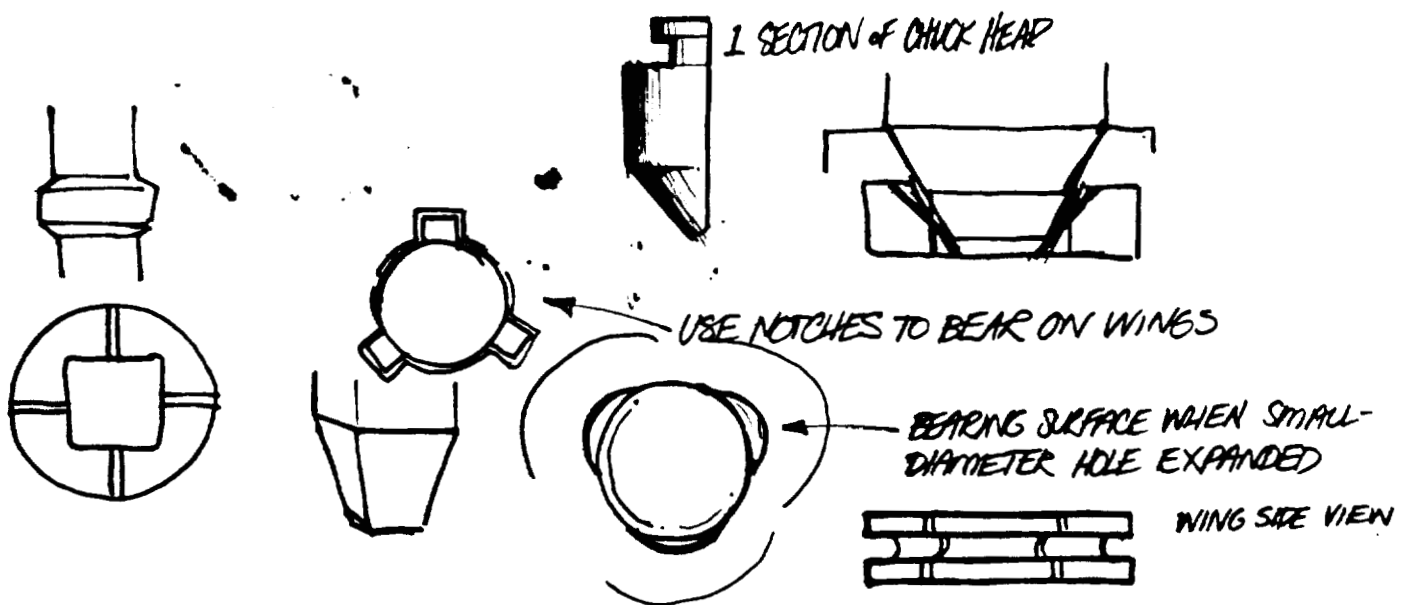
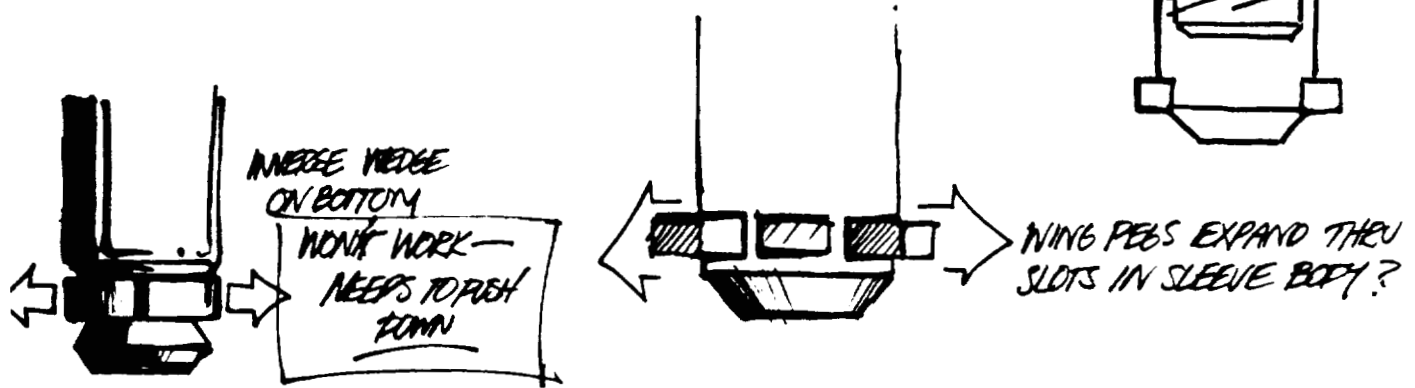
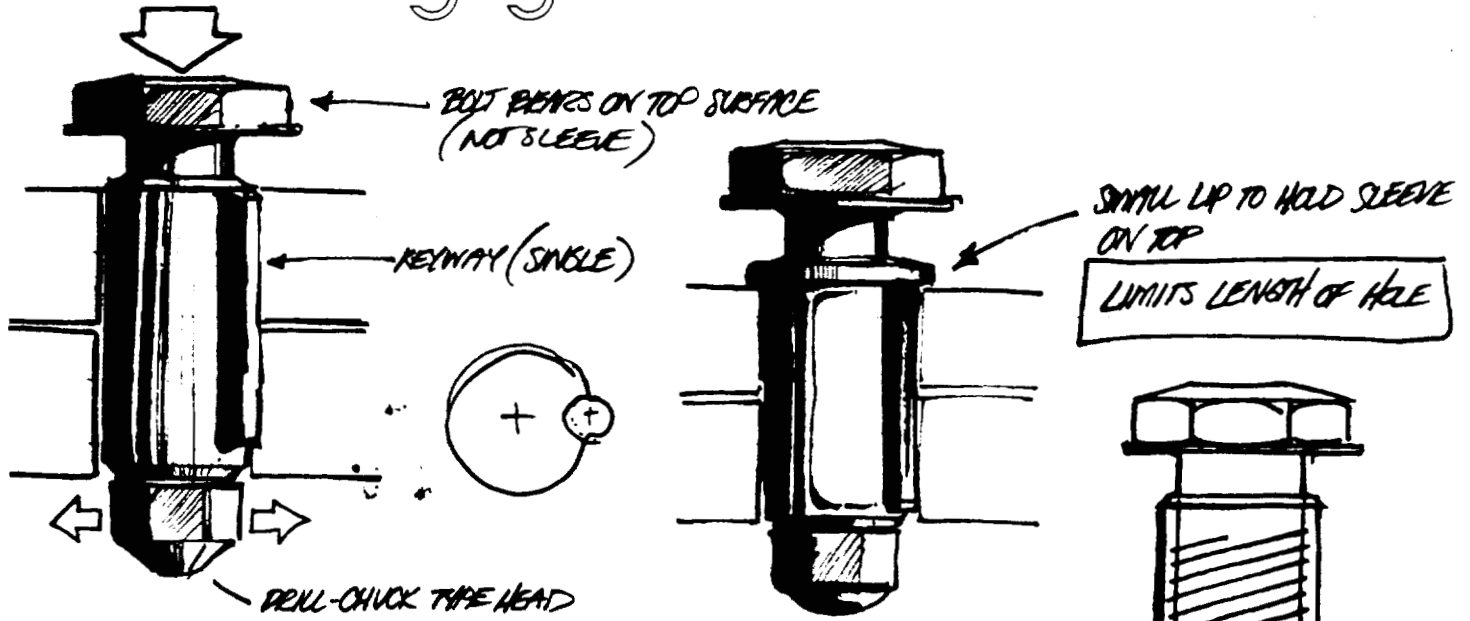

Lead Packaging

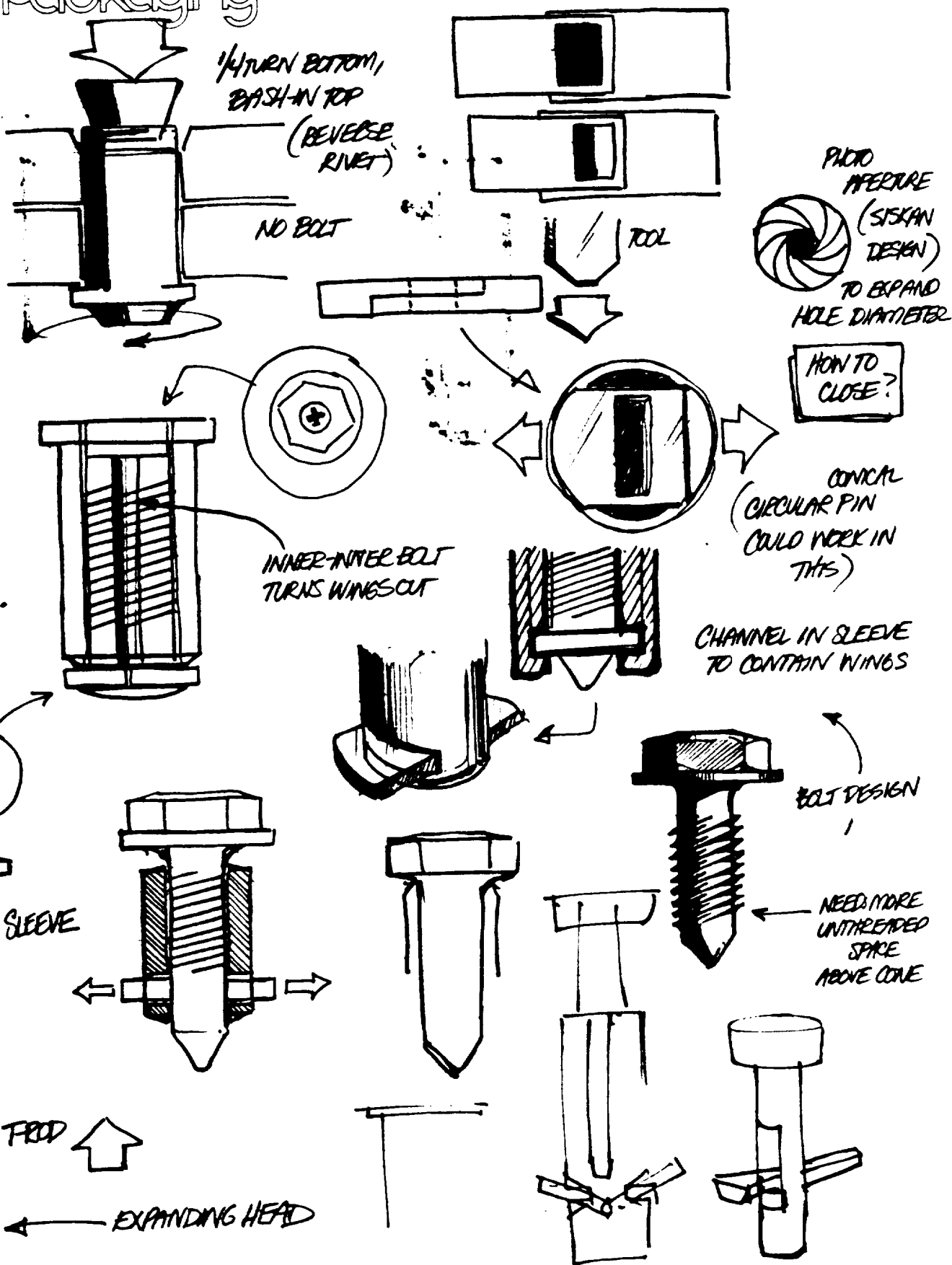

#

Head Packaging

1037 Piedmont
4th Bldg on Right
Grey House, Pink trim
upstairs

SHRIMP SPRING

PROBLEMS WITH ABILITY OF THREADED
INSERT CLOSING TOGGLE IF IT CAN SPIN
FREELY INSIDE IT

INNER ALLEN HEAD
OUTER CRESCENT

