

NASA Contractor Report 182054

ICASE Report No. 90-43

ICASE

APPROXIMATIONS OF THERMOELASTIC AND VISCOELASTIC CONTROL SYSTEMS

**J. A. Burns
Z. Y. Liu
R. E. Miller**

**Contract No. NAS1-18605
June 1990**

**Institute for Computer Applications in Science and Engineering
NASA Langley Research Center
Hampton, Virginia 23665-5225**

Operated by the Universities Space Research Association

NASA

**National Aeronautics and
Space Administration**

**Langley Research Center
Hampton, Virginia 23665-5225**

**(NASA-CR-182054) APPROXIMATIONS OF
THERMOELASTIC AND VISCOELASTIC CONTROL
SYSTEMS Final Report (ICASE) 70 p CSCL 12A**

N90-24834

**Unclas
63/64 0290753**



APPROXIMATIONS OF THERMOELASTIC AND VISCOELASTIC CONTROL SYSTEMS

J. A. Burns¹

Interdisciplinary Center for Applied Mathematics
Department of Mathematics
Virginia Polytechnic Institute
Blacksburg, VA 24061

and

Center for Applied Mathematical Sciences
Department of Mathematics
University of Southern California
Los Angeles, CA 90089

Z. Y. Liu²

Department of Mathematics
University of Minnesota at Duluth
Duluth, MN 55811

R. E. Miller³

Center for Applied Mathematical Sciences
University of Southern California
Los Angeles, CA 90089

ABSTRACT

This paper deals with the development and analysis of well-posed models and computational algorithms for control of a class of partial differential equations that describe the motions of thermo-viscoelastic structures. We first present an abstract "state space" framework and a general well-posedness result that can be applied to a large class of thermo-elastic and thermo-viscoelastic models. This state space framework is used in the development of a computational scheme to be used in the solution of an LQR control problem. A detailed convergence proof is provided for the viscoelastic model and several numerical results are presented to illustrate the theory and to analyze problems for which the theory is incomplete.

¹Research supported by the National Aeronautics and Space Administration under NASA Contract No. NAS1-18605 while the author was in residence at the Institute for Computer Applications in Science and Engineering (ICASE), NASA Langley Research Center, Hampton, VA 23665. Research also supported in part by the Air Force Office of Scientific Research under grant AFOSR 89-0001 and the Defense Advanced Research Projects Agency under contracts F49620-87-C-0116 and N00014-88-K-0721.

²This research was supported in part by the Defense Advanced Research Projects Agency under contract F49620-87-C-0116.

³This research was supported in part by the Air Force Office of Scientific Research under grant AFOSR 90-0091 and the Defense Advanced Research Projects Agency under contract F49620-87-C-0116.

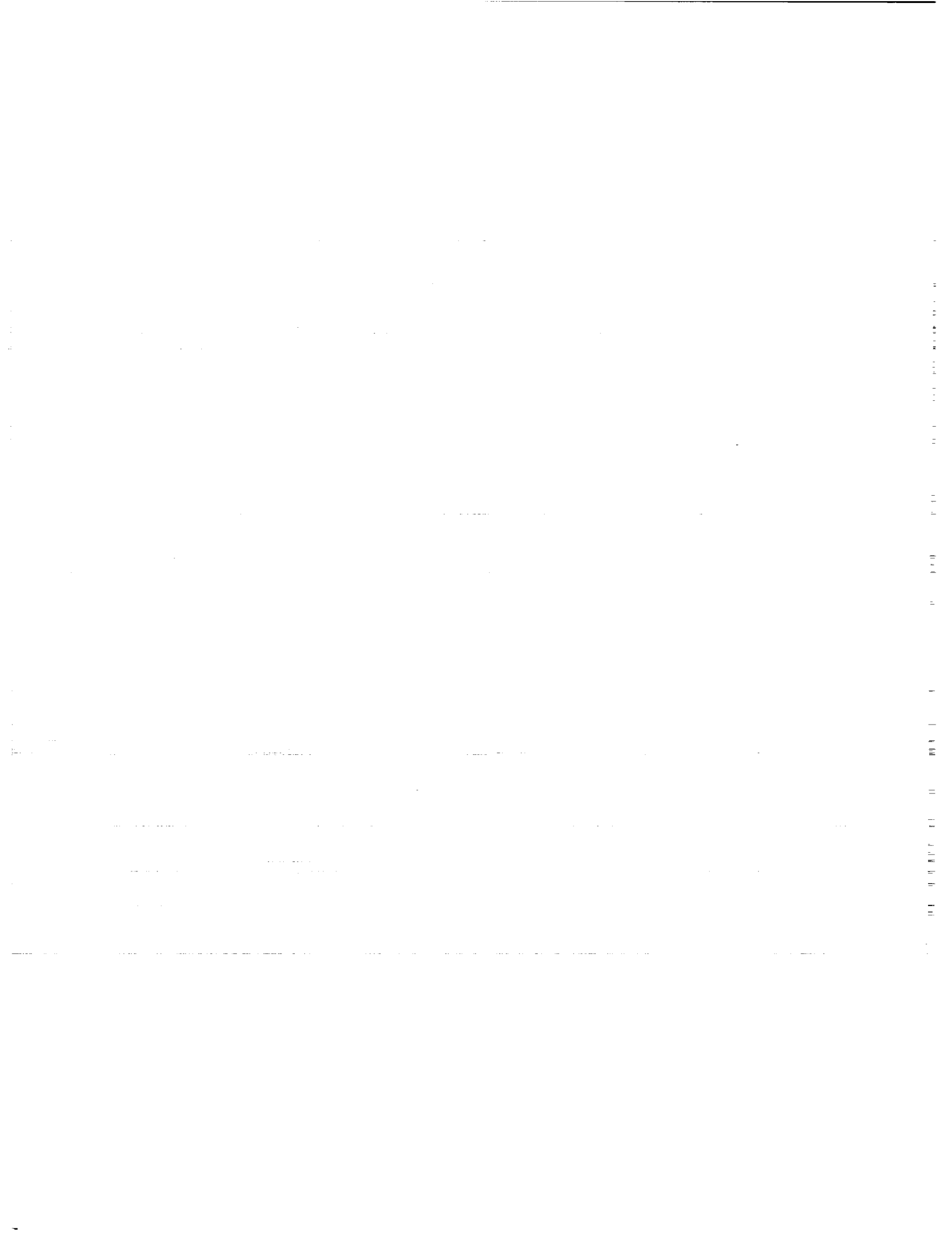

1. Introduction. During the past few years considerable attention has been devoted to the development of smart materials and structures (see [B]). One approach to this class of problems is to use shape memory alloys as actuators in active control designs. These alloys are best described by thermo-mechanical models consisting of coupled (and nonlinear) hyperbolic and parabolic partial differential equations. The development of computational algorithms for designing controllers for such systems is an immensely complex problem and the subject of several ongoing research projects. In addition to the obvious difficulties related to the nonlinearities, the basic thermo-elastic coupling often gives rise to nonstandard mathematical models and leads to several problems in developing computational algorithms for control. Therefore, the computational methods for controlling a linear thermo-elastic system may be viewed as a first step toward the ultimate nonlinear problem. With this motivation in mind, we consider the problem of controlling a class of coupled partial differential equations that describe the linearized motions of a thermo-mechanical structure. The basic approach is to combine approximation theory with state space modelling to develop convergent computational algorithms for LQR control designs.

In this paper we consider the questions of well-posedness and convergence of approximation schemes for a class of abstract linear systems of the form

$$\dot{z}(t) = \mathcal{A}z(t) + \mathcal{B}u(t), \quad z(0) = z_0 \quad (1.1)$$

on a Hilbert space Z . The main concern of this paper is with a general class of partial functional differential equations (PFDEs) arising in the modeling of viscoelastic and

thermo-viscoelastic systems, for example (see [BCLM], [BMC], [MH]), coupled equations of the form

$$\sigma \frac{\partial^2}{\partial t^2} y(t, x) = \frac{\partial}{\partial x} \left[\tau \frac{\partial}{\partial x} y(t, x) + \int_{-r}^0 g(s) \frac{\partial}{\partial x} y(t + s, x) ds \right] - \gamma \frac{\partial}{\partial x} \theta(t, x) + b(x)u(t), \quad (1.2)$$

$$\frac{\partial}{\partial t} \theta(t, x) = \kappa \frac{\partial^2}{\partial x^2} \theta(t, x) - \gamma \theta_0 \frac{\partial^2}{\partial x \partial t} y(t, x) \quad (1.3)$$

where y represents displacement and θ is the deviation from the reference temperature θ_0 . Equations of viscoelasticity (e.g., (1.2) with $\gamma = 0$) have a special structure which has been used by Fabiano and Ito [FI] to formulate a general well-posedness theorem and convergence results. Observe that (1.2) with $\gamma = 0$ can be written as

$$\sigma \frac{\partial^2}{\partial t^2} y(t, x) = \frac{\partial^2}{\partial x^2} \left[\tau y(t, x) + \int_{-r}^0 g(s) y(t + s, x) ds \right] + b(x)u(t), \quad (1.4)$$

or, in abstract form, as

$$\ddot{y} + \tilde{A} \left[\tau y + \int_{-r}^0 g(s) y(t + s) ds \right] = f(t), \quad (1.5)$$

where \tilde{A} is a positive definite, self-adjoint, closed linear operator on a Hilbert space Y . In [FI] Fabiano and Ito consider equations of this form with singular kernels (i.e., $g \in L^1(-r, 0)$) and establish well-posedness when the state space is taken to be $\mathcal{D}(A^{1/2}) \times Y \times L_g^2(-r, 0; \mathcal{D}(A^{1/2}))$. In this paper, we also consider equations of the form (1.5), but the approach we take also applies to the thermo-viscoelastic equations (1.2) - (1.3) which cannot be written in the form of (1.5).

In Section 2 we develop an abstract framework and a generalized well-posedness theorem which we apply to the thermo-viscoelastic system (1.2) - (1.3) with zero

boundary conditions and to the general viscoelastic system given by equation (1.5). Our approach allows a singular kernel, and it also has the advantage that it does not require explicit knowledge of the domain of $A^{1/2}$ in order to write down the state space. This property can be useful in applications where $A^{1/2}$ is not a differential operator. We also remark that our general framework can be applied to certain finite delay systems similar in form to the infinite delay systems considered by Miller and Desch in [MD]. Miller and Desch prove well-posedness for a class of equations in which the kernel is completely monotonic.

Approximation of such systems generally consists of two steps: first approximate the spatial variable (e.g., by means of splines) to reduce the system to a hereditary differential system on \mathbf{R}^n , then approximate the “history” or “memory” term (i.e., the integral term in (1.5)). In this paper we will use a variation introduced by Fabiano and Ito ([FI]) of the averaging scheme considered by Banks and Burns ([BB]) for the second stage. The idea of the “AVE” scheme is essentially to approximate the kernel $g(s)$ by a step function: partition $[-r, 0]$ into M subintervals and take the integral average in each subinterval. Fabiano and Ito show that the approximation scheme converges for an L^1 kernel using a uniform partition of $[-r, 0]$, but they give numerical results which indicate that a different partition using a finer mesh near the singularity at zero yields much faster convergence. In Section 3 we modify the proof given by Fabiano and Ito for singular kernels and a uniform mesh to include singular kernels and the non-uniform mesh.

Although we prove convergence in this paper only for the abstract viscoelastic system, the proof we give can be modified to include the thermo-viscoelastic model. In Section 4 we give some numerical results comparing the viscoelastic and thermo-viscoelastic models.

We will use the following notation. For a function $g \in L^1(a, b; Z)$, we denote by $L^2_g(a, b; Z)$ the set $\left\{ f \in L^2(a, b; Z) \mid \int_a^b g(s) \|f(s)\|_Z^2 ds < \infty \right\}$. We denote by the symbol $H^1_L(a, b; Z)$ the set of all H^1 functions which vanish at the left end-point of the interval; i.e., $H^1_L(a, b; Z) = \{f \in H^1(a, b; Z) \mid f(a) = 0\}$. Similarly, $H^1_R(a, b; Z) = \{f \in H^1(a, b; Z) \mid f(b) = 0\}$. For a function $x : [-r, \alpha) \rightarrow X$, $r, \alpha > 0$, the symbol x_t for $t \in [0, \alpha)$ represents the function $x_t : [-r, 0] \rightarrow X$ defined by $x_t(s) = x(t + s)$. If A is the infinitesimal generator of a C_0 semigroup $T(\cdot)$ on a Hilbert space Z satisfying $\|T(t)\|_Z \leq Me^{\beta t}$, then we write $A \in G(M, \beta)$. Finally, $z_n \xrightarrow{s} z$ means that z_n converges strongly to z .

2. Well-Posedness. A standard technique for establishing well-posedness of a system governed by a PFDE is to cast the problem in the form of (1.1) and show that \mathcal{A} generates a C_0 semigroup on Z , for example, by means of the Lumer-Phillips theorem (see [P]). We will use the following version of this theorem:

THEOREM 2.1. *Let A be a closed densely defined linear operator on a Hilbert space H . If there exists $\beta \in \mathbf{R}$ such that $\langle Ax, x \rangle \leq \beta \langle x, x \rangle$ for all $x \in \mathcal{D}(A)$, and $\mathcal{R}(\lambda_0 I - A)$ is dense in H for some $\lambda_0 > \beta$, then A is the infinitesimal generator of a C_0 semigroup*

$T(t)$ on H satisfying $\|T(t)\| \leq e^{\beta t}$.

2.1. A General Theorem on Well-Posedness. Suppose that X, Y, Θ and W are Hilbert spaces, and set $Z_\Theta = X \times Y \times \Theta \times W$. Let S be a subspace of Y , and suppose we have the following linear operators:

$$\begin{aligned} A_0 : \mathcal{D}(A_0) \subseteq Y &\rightarrow Y, & A_1 : \mathcal{D}(A_1) \subseteq X &\rightarrow Y, \\ G_1 : \mathcal{D}(G_1) \subseteq \Theta &\rightarrow Y, & G_2 : \mathcal{D}(G_2) \subseteq Y &\rightarrow \Theta, \\ G_3 : \mathcal{D}(G_3) \subseteq \Theta &\rightarrow \Theta, & C_1 : \mathcal{D}(C_1) \subseteq W &\rightarrow Y, \\ D : \mathcal{D}(D) \subseteq W &\rightarrow W, & i : X &\rightarrow W, & j : S &\rightarrow X. \end{aligned}$$

Define A, C and G by $A = A_0A_1, C = A_0C_1$ and $G = A_0G_1$, and define F_Θ by

$$\begin{aligned} \mathcal{D}(F_\Theta) &= \left\{ \begin{pmatrix} x \\ \theta \\ w \end{pmatrix} \in X \times \Theta \times W \mid \begin{array}{l} x \in \mathcal{D}(A_1), \theta \in \mathcal{D}(G_1), w \in \mathcal{D}(C_1), \\ A_1x + G_1\theta + C_1w \in \mathcal{D}(A_0) \end{array} \right\}, \\ F_\Theta \begin{pmatrix} x \\ \theta \\ w \end{pmatrix} &= A_0(A_1x + G_1\theta + C_1w). \end{aligned}$$

Define \mathcal{A}_Θ by

$$\begin{aligned} \mathcal{D}(\mathcal{A}_\Theta) &= \left\{ \begin{pmatrix} x \\ y \\ \theta \\ w \end{pmatrix} \in Z_\Theta \mid \begin{array}{l} y \in S \cap \mathcal{D}(G_2), \theta \in \mathcal{D}(G_3), \\ w \in \mathcal{D}(D), \begin{pmatrix} x \\ \theta \end{pmatrix} \in \mathcal{D}(F_\Theta) \end{array} \right\}, \\ \mathcal{A}_\Theta \begin{pmatrix} x \\ y \\ \theta \\ w \end{pmatrix} &= \begin{pmatrix} jy \\ F_\Theta \begin{pmatrix} x \\ \theta \\ w \end{pmatrix} \\ G_2y + G_3\theta \\ ijy + Dw \end{pmatrix}. \end{aligned}$$

Finally, suppose that j is injective and, for $\lambda \in \rho(D) \cap \rho(G_3)$, define $L_\lambda : \mathcal{D}(L_\lambda) \subseteq$

$X \rightarrow Y$ by

$$\mathcal{D}(L_\lambda) = \{x \in \mathcal{R}(j) \mid (x, \lambda j^{-1}x, (\lambda I - G_3)^{-1}G_2\lambda j^{-1}x, (\lambda I - D)^{-1}i\lambda x)^T \in \mathcal{D}(\mathcal{A}_\Theta)\},$$

$$L_\lambda x = \lambda^2 j^{-1}x - F_\Theta \begin{pmatrix} (\lambda I - G_3)^{-1}G_2\lambda j^{-1}x \\ (\lambda I - D)^{-1}i\lambda x \end{pmatrix}.$$

We are now ready to state the main result of this chapter.

THEOREM 2.2. *Suppose*

- (1) i and j^{-1} are continuous,
- (2) $\mathcal{D}(A)$ is dense in X , $S \subseteq \mathcal{D}(G_2)$ and S is dense in Y , $\mathcal{D}(G) \cap \mathcal{D}(G_3)$ is dense in Θ , and $\mathcal{D}(C) \cap \mathcal{D}(D)$ is dense in W ,
- (3) $j(S)$ is closed in X ,
- (4) F_Θ , G_3 and D are closed,
- (5) for $y \in S$, $\|G_2 y\|_\Theta \leq k \|j y\|_X$ for some $k > 0$,
- (6) there exists $\beta \in \mathbf{R}$ such that $\langle \mathcal{A}_\Theta z, z \rangle_{Z_\Theta} \leq \beta \langle z, z \rangle_{Z_\Theta}$ for all $z \in \mathcal{D}(\mathcal{A}_\Theta)$,
- (7) there exists $\lambda_0 > \beta$, $\lambda_0 \in \rho(D) \cap \rho(G_3)$, such that $\mathcal{R}(L_{\lambda_0})$ is dense in Y , and
- (8) $(\lambda_0 I - D)[\mathcal{D}(C) \cap \mathcal{D}(D)]$ is dense in W , and $(\lambda_0 I - G_3)[\mathcal{D}(G) \cap \mathcal{D}(G_3)]$ is dense in Θ .

Then \mathcal{A}_Θ is the infinitesimal generator of a C_0 semigroup $S_\Theta(t)$ on Z_Θ satisfying

$$\|S_\Theta(t)\| \leq e^{\beta t}.$$

PROOF: Set $\mathcal{D} = \mathcal{D}(A) \times S \times (\mathcal{D}(G) \cap \mathcal{D}(G_3)) \times (\mathcal{D}(C) \cap \mathcal{D}(D))$. Then $\mathcal{D} \subseteq \mathcal{D}(\mathcal{A}_\Theta)$ and

\mathcal{D} is dense in Z_Θ , so $\mathcal{D}(\mathcal{A}_\Theta)$ is dense in Z_Θ . For $n = 1, 2, \dots$, let $\begin{pmatrix} x_n \\ y_n \\ \theta_n \\ w_n \end{pmatrix} \in \mathcal{D}(\mathcal{A}_\Theta)$, and

suppose $\begin{pmatrix} x_n \\ y_n \\ \theta_n \\ w_n \end{pmatrix} \rightarrow \begin{pmatrix} x \\ y \\ \theta \\ w \end{pmatrix}$ and $\mathcal{A}_\Theta \begin{pmatrix} x_n \\ y_n \\ \theta_n \\ w_n \end{pmatrix} = \begin{pmatrix} \varphi_n \\ \psi_n \\ \gamma_n \\ h_n \end{pmatrix} \rightarrow \begin{pmatrix} \varphi \\ \psi \\ \gamma \\ h \end{pmatrix}$ as $n \rightarrow \infty$. Then

$y_n \in S$ and $jy_n = \varphi_n \rightarrow \varphi$. Since $j(S)$ is closed, there exists $\hat{y} \in S$ such that $j\hat{y} = \varphi$.

But j^{-1} is bounded, so $\|\hat{y} - y\| \leq \|j^{-1}\| \cdot \|\varphi - \varphi_n\| + \|y_n - y\| \rightarrow 0$ as $n \rightarrow \infty$.

Therefore, $y = \hat{y}$; i.e., $y \in S$ and $jy = \varphi$. Now, $\begin{pmatrix} x_n \\ \theta_n \\ w_n \end{pmatrix} \in \mathcal{D}(F_\Theta)$, $\begin{pmatrix} x_n \\ \theta_n \\ w_n \end{pmatrix} \rightarrow \begin{pmatrix} x \\ \theta \\ w \end{pmatrix}$,

and $F_\Theta \begin{pmatrix} x_n \\ \theta_n \\ w_n \end{pmatrix} = \psi_n \rightarrow \psi$ as $n \rightarrow \infty$. Since F_Θ is closed, $\begin{pmatrix} x \\ \theta \\ w \end{pmatrix} \in \mathcal{D}(F_\Theta)$ and

$F_\Theta \begin{pmatrix} x \\ \theta \\ w \end{pmatrix} = \psi$. Since $jy_n \rightarrow jy$ and i is continuous, we have $ijy_n \rightarrow ijy$. We also

have $ijy_n + Dw_n \rightarrow h$. Thus, $Dw_n \rightarrow h - ijy$. But D is closed, so $w \in \mathcal{D}(D)$ and

$Dw = h - ijy$ which implies that $ijy + Dw = h$. Next, $\theta_n \rightarrow \theta$, $\theta_n \in \mathcal{D}(G_3)$ and

$G_2y_n + G_3\theta_n = \gamma_n \rightarrow \gamma$. By (5), $\|G_2(y_n - y)\|_\Theta \leq k\|j(y_n - y)\|_X = k\|jy_n - jy\|_X \rightarrow$

0, so $G_2y_n \rightarrow G_2y$ which implies that $G_3\theta_n \rightarrow \gamma - G_2y$. Since G_3 is closed, $\theta \in \mathcal{D}(G_3)$

and $G_3\theta = \gamma - G_2y$, or $\gamma = G_2y + G_3\theta$. Therefore, \mathcal{A}_Θ is closed. Finally, let

$$\begin{pmatrix} \varphi \\ \psi \\ \gamma \\ h \end{pmatrix} \perp \mathcal{R}(\lambda_0 I - \mathcal{A}_\Theta); \text{ i.e.,}$$

$$\begin{aligned} \langle \varphi, \lambda_0 x - jy \rangle_X + \left\langle \psi, \lambda_0 y - F_\Theta \begin{pmatrix} x \\ \theta \\ w \end{pmatrix} \right\rangle_Y \\ + \langle \gamma, (\lambda_0 I - G_3)\theta - G_2y \rangle_\Theta + \langle h, (\lambda_0 I - D)w - ijy \rangle_W = 0 \end{aligned}$$

for all $\begin{pmatrix} x \\ y \\ \theta \\ w \end{pmatrix} \in \mathcal{D}(\mathcal{A}_\Theta)$. Let $x \in \mathcal{D}(L_{\lambda_0})$. Then $\begin{pmatrix} x \\ \lambda_0 j^{-1}x \\ (\lambda_0 I - G_3)^{-1}G_2\lambda_0 j^{-1}x \\ (\lambda_0 I - D)^{-1}i\lambda_0 x \end{pmatrix} \in$

$\mathcal{D}(\mathcal{A}_\Theta)$, so $\left\langle \psi, \lambda_0^2 j^{-1}x - F_\Theta \begin{pmatrix} x \\ (\lambda_0 I - G_3)^{-1}G_2\lambda_0 j^{-1}x \\ (\lambda_0 I - D)^{-1}i\lambda_0 x \end{pmatrix} \right\rangle_Y = \langle \psi, L_{\lambda_0}x \rangle_Y = 0$ for

all $x \in \mathcal{D}(L_{\lambda_0})$, which implies $\psi = 0$ by (7). If $x = 0$, $y = 0$ and $\theta = 0$, then

$\langle h, (\lambda_0 I - D)w \rangle_W = 0$ for all $w \in \mathcal{D}(C) \cap \mathcal{D}(D)$, and hence $h = 0$ by (8). Now for $x \in \mathcal{D}(A)$, $\begin{pmatrix} x \\ 0 \\ 0 \\ 0 \end{pmatrix} \in \mathcal{D}(\mathcal{A}_\Theta)$, so $\langle \varphi, \lambda_0 x \rangle_X = 0$ for all $x \in \mathcal{D}(A)$. By (2) this implies that $\varphi = 0$. Finally, for $\theta \in \mathcal{D}(G) \cap \mathcal{D}(G_3)$, $\begin{pmatrix} 0 \\ \theta \\ 0 \\ 0 \end{pmatrix} \in \mathcal{D}(\mathcal{A}_\Theta)$, so $\langle \gamma, (\lambda_0 I - G_3)\theta \rangle_\Theta = 0$ which implies that $\gamma = 0$ by (8). Therefore, $\mathcal{R}(\lambda_0 I - \mathcal{A}_\Theta)$ is dense in Z_Θ , and this completes the proof. ■

We wish to apply this theorem to thermo-viscoelastic systems (equations (1.2) – (1.3)) and to the abstract viscoelastic system (equation (1.5)). Before we proceed with any examples, however, we will make some general comments about the kernel function g and the space W .

HYPOTHESIS 2.3. *The function g satisfies the following conditions.*

- (1) $g \in L^1(-r, 0)$,
- (2) $g < 0$ and $g' \leq 0$ on $[-r, 0)$, and
- (3) $\alpha \equiv \tau + \int_{-r}^0 g(s) ds > 0$.

Set $g_\alpha(s) = -\frac{1}{\alpha}g(s)$, and suppose the space X is given. We will take W to be the space $L_g^2(-r, 0; X)$ with inner product given by

$$\langle w_1, w_2 \rangle_W = \int_{-r}^0 g_\alpha(s) \langle w_1(s), w_2(s) \rangle_X ds.$$

Define the operator D by $\mathcal{D}(D) = H_R^1(-r, 0; X)$, $D = \frac{\partial}{\partial s}$. The following lemma is proved in [FI]. Since it is the crucial step which allows a singular kernel, we reproduce its proof here.

LEMMA 2.4. *The operator D is dissipative in W .*

PROOF: For $w \in \mathcal{D}(D)$,

$$\langle Dw, w \rangle_W = \int_{-r}^0 g_\alpha(s) \left\langle \frac{\partial}{\partial s} w(s), w(s) \right\rangle_X ds = \frac{1}{2} \int_{-r}^0 g_\alpha(s) \frac{\partial}{\partial s} \|w(s)\|_X^2 ds.$$

Let $\epsilon > 0$ and consider

$$\begin{aligned} I_\epsilon &\equiv \frac{1}{2} \int_{-r}^{-\epsilon} g_\alpha(s) \frac{\partial}{\partial s} \|w(s)\|_X^2 ds \\ &= \frac{1}{2} g_\alpha(-\epsilon) \|w(-\epsilon)\|_X^2 - \frac{1}{2} g_\alpha(-r) \|w(-r)\|_X^2 - \frac{1}{2} \int_{-r}^{-\epsilon} g'_\alpha(s) \|w(s)\|_X^2 ds \\ &\leq \frac{1}{2} g_\alpha(-\epsilon) \|w(-\epsilon)\|_X^2. \end{aligned}$$

Since $w(-\epsilon) = w(0) - \int_{-\epsilon}^0 Dw(s) ds = - \int_{-\epsilon}^0 Dw(s) ds$, by the Cauchy-Schwarz inequality

$$\|w(-\epsilon)\|_X^2 \leq \int_{-\epsilon}^0 \frac{ds}{g_\alpha(s)} \int_{-\epsilon}^0 g_\alpha(s) \|Dw(s)\|_X^2 ds.$$

Note that $g_\alpha(-\epsilon) \int_{-\epsilon}^0 \frac{ds}{g_\alpha(s)} = \int_{-\epsilon}^0 \frac{g_\alpha(-\epsilon)}{g_\alpha(s)} ds \leq \epsilon$. Thus, we obtain

$$I_\epsilon \leq \frac{\epsilon}{2} \int_{-\epsilon}^0 g_\alpha(s) \|Dw(s)\|_X^2 ds$$

for all $\epsilon > 0$. Therefore $\langle Dw, w \rangle_W = \lim_{\epsilon \downarrow 0} I_\epsilon \leq 0$. ■

For $h \in W$, if $w(s) = e^s \int_s^0 e^{-\sigma} h(\sigma) d\sigma$, then $w \in \mathcal{D}(D)$ and $(I - D)w = h$. Since D is densely defined, D generates a C_0 semigroup of contractions on W by the Lumer-Phillips Theorem. In particular, D is closed, and $\lambda \in \rho(D)$ for all $\lambda > 0$.

2.2. A Thermo-Viscoelastic System. We consider the system governed by equations (1.2) - (1.3) with boundary conditions given by $y(t, 0) = y(t, 1) = \theta(t, 0) =$

$\theta(t, 1) = 0$. If we set $w(t, s, x) = y(t, x) - y(t + s, x)$ and use g_α as defined above, then

we can rewrite equation (1.2) as

$$\frac{\partial^2}{\partial t^2} y(t, x) = \frac{\alpha}{\sigma} \frac{\partial}{\partial x} \left[\frac{\partial}{\partial x} y(t, x) + \int_{-r}^0 g_\alpha(s) \frac{\partial}{\partial x} w(t, s, x) ds - \frac{\gamma}{\alpha} \theta(t, x) \right] + \frac{1}{\sigma} b(x) u(t).$$

Define the spaces X , Y and Θ as follows:

$$X = H_0^1(0, 1) \quad \text{with} \quad \langle x_1, x_2 \rangle_X = \alpha \int_0^1 x_1' x_2',$$

$$Y = L^2(0, 1) \quad \text{with} \quad \langle y_1, y_2 \rangle_Y = \sigma \int_0^1 y_1 y_2,$$

$$\Theta = L^2(0, 1) \quad \text{with} \quad \langle \theta_1, \theta_2 \rangle_\Theta = \frac{1}{\theta_0} \int_0^1 \theta_1 \theta_2.$$

Set $Z_\Theta = X \times Y \times \Theta \times W$ where $W = L_g^2(-r, 0; X)$ is as above, and let $S \subseteq Y$ be

given by $S = H_0^1(0, 1)$. Define the following operators:

$$\mathcal{D}(A_0) = H^1(0, 1), \quad A_0 y = \frac{\alpha}{\sigma} y' \in Y,$$

$$\mathcal{D}(A_1) = X, \quad A_1 x = x' \in Y,$$

$$\mathcal{D}(G_1) = \Theta, \quad G_1 \theta = -\frac{\gamma}{\alpha} \theta \in Y,$$

$$\mathcal{D}(G_2) = H^1(0, 1), \quad G_2 y = -\gamma \theta_0 y' \in \Theta,$$

$$\mathcal{D}(G_3) = H_0^1(0, 1) \cap H^2(0, 1), \quad G_3 \theta = \kappa \theta'' \in \Theta,$$

$$\mathcal{D}(C_1) = W, \quad C_1 w = \int_{-r}^0 g_\alpha(s) w'(s) ds \in Y,$$

$$[ix](s) \equiv x \in W, \quad j : H_0^1 = S \rightarrow X = H_0^1 \text{ is the identity operator.}$$

With the above definitions, we have

$$\mathcal{D}(A) = H_0^1 \cap H^2, \quad \mathcal{D}(C) = L_g^2(-r, 0; \mathcal{D}(A)), \quad \mathcal{D}(G) = H^1(0, 1),$$

and the operator \mathcal{A}_Θ is given by

$$\mathcal{D}(\mathcal{A}_\Theta) = \left\{ \begin{pmatrix} x \\ y \\ \theta \\ w \end{pmatrix} \in Z_\Theta \mid \begin{array}{l} y \in H_0^1, \theta \in H_0^1 \cap H^2, \\ x' - \frac{\gamma}{\alpha}\theta + \int_{-r}^0 g_\alpha(s)w'(s)ds \in H^1 \end{array} \right\},$$

$$\mathcal{A}_\Theta \begin{pmatrix} x \\ y \\ \theta \\ w \end{pmatrix} = \begin{pmatrix} \frac{\alpha}{\sigma} \frac{d}{dx} \left(x' - \frac{\gamma}{\alpha}\theta + \int_{-r}^0 g_\alpha(s)w'(s)ds \right) \\ -\gamma\theta_0 y' + \kappa\theta'' \\ y + \frac{\partial w}{\partial s} \end{pmatrix}.$$

We now verify the conditions of Theorem 2.2.

- (1) Clearly i and j^{-1} are continuous.
- (2) Clearly $\mathcal{D}(A)$ is dense in X , $S \subseteq \mathcal{D}(G_2)$ and S is dense in Y , $\mathcal{D}(G) \cap \mathcal{D}(G_3) = \mathcal{D}(G_3)$ is dense in Θ , and $\mathcal{D}(C) \cap \mathcal{D}(D) = H_R^1(-r, 0; \mathcal{D}(A))$ is dense in W .
- (3) Since $j(S) = X$, $j(S)$ is closed.
- (4) We already know that D is closed. It is easy to see that G_3 is densely defined and dissipative, and for any $\varphi \in \Theta$ there exists $\theta \in \mathcal{D}(G_3)$ such that $(I - G_3)\theta = \varphi$ (see [K, p. 147]). Thus, G_3 is closed. Let $\begin{pmatrix} x_n \\ \theta_n \\ w_n \end{pmatrix} \in \mathcal{D}(F_\Theta)$, $\begin{pmatrix} x_n \\ \theta_n \\ w_n \end{pmatrix} \rightarrow \begin{pmatrix} x \\ \theta \\ w \end{pmatrix}$, and $F_\Theta \begin{pmatrix} x_n \\ \theta_n \\ w_n \end{pmatrix} = \psi_n \rightarrow \psi$. Observe that $F_\Theta \begin{pmatrix} x_n \\ \theta_n \\ w_n \end{pmatrix} = \frac{\alpha}{\sigma} \frac{d}{dx} \left(x'_n - \frac{\gamma}{\alpha}\theta_n + \int_{-r}^0 g_\alpha(s)w'_n(s)ds \right)$. Now, $x_n \rightarrow x$ in X implies that $x'_n \rightarrow x'$ in Y , $\theta_n \rightarrow \theta$ in Θ implies that $\theta_n \rightarrow \theta$ in Y , and $w_n \rightarrow w$ in W implies that $\int_{-r}^0 g_\alpha(s)w'_n(s)ds \rightarrow \int_{-r}^0 g_\alpha(s)w'(s)ds$ in Y . Thus, $x'_n - \frac{\gamma}{\alpha}\theta_n + \int_{-r}^0 g_\alpha(s)w'_n(s)ds \rightarrow x' - \frac{\gamma}{\alpha}\theta + \int_{-r}^0 g_\alpha(s)w'(s)ds$ in Y . Since A_0 is closed, F_Θ is closed.
- (5) It is easy to check that $\|G_2 y\|_\Theta^2 = \frac{\gamma^2 \theta_0}{\alpha} \|jy\|_X^2$. Set $k = \sqrt{\frac{\gamma^2 \theta_0}{\alpha}} > 0$.

(6) For $z = (x, y, \theta, w)^T \in \mathcal{D}(\mathcal{A}_\Theta)$,

$$\begin{aligned} \langle \mathcal{A}_\Theta z, z \rangle &= \alpha \int_0^1 y' x' + \sigma \int_0^1 \frac{\alpha}{\sigma} \frac{d}{dx} \left(x' - \frac{\gamma}{\alpha} \theta + \int_{-r}^0 g_\alpha(s) w'(s) ds \right) y \\ &\quad + \frac{1}{\theta_0} \int_0^1 (-\gamma \theta_0 y' + \kappa \theta'') \theta + \int_{-r}^0 g_\alpha(s) \int_0^1 y' w' + \langle Dw, w \rangle_W \\ &= \kappa \langle G_3 \theta, \theta \rangle_\Theta + \langle Dw, w \rangle_W \leq 0 \end{aligned}$$

since G_3 and D are dissipative.

(7) We will take $\lambda_0 = 1$. Let $x \in \mathcal{D}(L_1)$. If we set $w(s) = (1 - e^s)ix$, then

$(I - D)w = ix$, so $(I - D)^{-1}ix = (1 - e^s)ix = (1 - e^s)x$. Note that

$$\begin{aligned} L_1 x &= x - \frac{\alpha}{\sigma} \frac{d}{dx} \left(x' + \frac{\gamma^2 \theta_0}{\alpha} (I - G_3)^{-1} x' + \int_{-r}^0 g_\alpha(s) (1 - e^s) x ds \right) \\ &= x - \frac{\alpha}{\sigma} \frac{d}{dx} \left(\alpha_1 x' + \frac{\gamma^2 \theta_0}{\alpha} (I - G_3)^{-1} x' \right) \end{aligned}$$

where $\alpha_\lambda = \frac{1}{\alpha} \left[\alpha - \int_{-r}^0 g(s) (1 - e^{\lambda s}) ds \right] = \frac{1}{\alpha} \left[\tau + \int_{-r}^0 g(s) e^{\lambda s} ds \right] > 0$ for $\lambda >$

0. Since $X \subseteq Y$, we can think of L_1 as being defined on a subspace of Y .

Observe that $\mathcal{D}(L_1) = \left\{ y \in H_0^1(0, 1) \mid \alpha_1 y' + \frac{\gamma^2 \theta_0}{\alpha} (I - G_3)^{-1} y' \in H^1 \right\}$ is dense

in Y . Define the operators T_1 and T_2 as follows:

$$\mathcal{D}(T_1) = H^1(0, 1), \quad T_1 y = y',$$

$$\mathcal{D}(T_2) = H_0^1(0, 1), \quad T_2 y = y'.$$

Note that T_1 and T_2 are adjoint to each other. With this notation we can write

L_1 as follows:

$$L_1 = I - \frac{\alpha}{\sigma} T_1 \left[\alpha_1 I + \frac{\gamma^2 \theta_0}{\alpha} (I - G_3)^{-1} \right] T_2.$$

Since $G_3^* = G_3$, we have $[(I - G_3)^{-1}]^* = (I - G_3)^{-1}$. Thus,

$$\begin{aligned} L_1^* &= I - \frac{\alpha}{\sigma} T_2^* \left[\alpha_1 I + \frac{\gamma^2 \theta_0}{\alpha} (I - G_3)^{-1} \right]^* T_1^* \\ &= I - \frac{\alpha}{\sigma} T_1 \left[\alpha_1 I + \frac{\gamma^2 \theta_0}{\alpha} (I - G_3)^{-1} \right] T_2 = L_1; \end{aligned}$$

that is, L_1 is self-adjoint. Now, for $y \in \mathcal{D}(L_1)$,

$$\begin{aligned} \langle L_1 y, y \rangle_Y &= \langle y, y \rangle_Y - \alpha \int_0^1 \frac{d}{dx} \left(\alpha_1 y' + \frac{\gamma^2 \theta_0}{\alpha} (I - G_3)^{-1} y' \right) y \\ &= \|y\|_Y^2 + \alpha \int_0^1 \left(\alpha_1 y' + \frac{\gamma^2 \theta_0}{\alpha} (I - G_3)^{-1} y' \right) y' \\ &= \|y\|_Y^2 + \alpha_1 \|jy\|_X^2 + \frac{\gamma^2 \theta_0}{\sigma} \langle (I - G_3)^{-1} y', y' \rangle_Y \geq \|y\|_Y^2 \end{aligned}$$

since $I - G_3 \geq 0$ implies that $(I - G_3)^{-1} \geq 0$. Thus, L_1 is one-to-one. Hence by Theorem 13.11 in [R], $\mathcal{R}(L_1)$ is dense in Y .

(8) Since $\mathcal{D}(G_3) \subseteq \mathcal{D}(G)$, we have $(I - G_3)[\mathcal{D}(G) \cap \mathcal{D}(G_3)] = (I - G_3)\mathcal{D}(G_3) = \Theta$ from (4). Next, for $h \in \mathcal{D}(C)$, if we set $w(s) = e^s \int_s^0 e^{-\sigma} h(\sigma) d\sigma$, then $w \in H_R^1(-r, 0; \mathcal{D}(A)) = \mathcal{D}(C) \cap \mathcal{D}(D)$ and $(I - D)w = h$. Thus, $\mathcal{D}(C) \subseteq (I - D)[\mathcal{D}(C) \cap \mathcal{D}(D)]$, and $\mathcal{D}(C)$ is dense in W .

Since (1) – (8) hold, \mathcal{A}_Θ generates a C_0 semigroup on Z_Θ .

2.3. The Abstract Viscoelastic System. Next we wish to apply Theorem 2.2 to equation (1.5). Since the space Θ corresponds to the heat equation (1.3), we first formulate a version of the theorem using only the spaces X , Y and W . Set

$Z = X \times Y \times W$, and define the operator F by

$$\mathcal{D}(F) = \left\{ \begin{pmatrix} x \\ w \end{pmatrix} \in X \times W \mid x \in \mathcal{D}(A_1), w \in \mathcal{D}(C_1), A_1x + C_1w \in \mathcal{D}(A_0) \right\},$$

$$F \begin{pmatrix} x \\ w \end{pmatrix} = A_0(A_1x + C_1w),$$

define \mathcal{A} by

$$\mathcal{D}(\mathcal{A}) = \left\{ \begin{pmatrix} x \\ y \\ w \end{pmatrix} \in Z \mid \begin{array}{l} y \in S, w \in \mathcal{D}(D), \\ \begin{pmatrix} x \\ w \end{pmatrix} \in \mathcal{D}(F) \end{array} \right\},$$

$$\mathcal{A} \begin{pmatrix} x \\ y \\ w \end{pmatrix} = \begin{pmatrix} jy \\ F \begin{pmatrix} x \\ w \end{pmatrix} \\ ijy + Dw \end{pmatrix},$$

and define \tilde{L}_λ by

$$\mathcal{D}(\tilde{L}_\lambda) = \{x \in \mathcal{R}(j) \mid (x, \lambda j^{-1}x, (\lambda I - D)^{-1}i\lambda x)^T \in \mathcal{D}(\mathcal{A})\},$$

$$\tilde{L}_\lambda x = \lambda^2 j^{-1}x - F \left((\lambda I - D)^{-1}i\lambda x \right).$$

We have the following special case of Theorem 2.2.

THEOREM 2.5. *Assume that all the hypotheses of Theorem 2.2 except those involving the space Θ hold. In addition, assume that F is closed, that \mathcal{A} satisfies the inequality in (6), and that there exists $\lambda_0 > \beta$, $\lambda_0 \in \rho(D)$, such that $\mathcal{R}(\tilde{L}_{\lambda_0})$ is dense in Y . Then \mathcal{A} generates a C_0 semigroup $S(t)$ on Z satisfying $\|S(t)\| \leq e^{\beta t}$.*

PROOF: Let $\Theta = \{0\}$, and define $G_1 = 0$, $G_2 = 0$ (with $\mathcal{D}(G_2) = Y$) and $G_3 = 0$. Define $\mathcal{D}(F_\Theta) = \left\{ \begin{pmatrix} x \\ 0 \\ w \end{pmatrix} \in X \times \Theta \times W \mid \begin{pmatrix} x \\ w \end{pmatrix} \in \mathcal{D}(F) \right\}$, $F_\Theta \begin{pmatrix} x \\ 0 \\ w \end{pmatrix} = F \begin{pmatrix} x \\ w \end{pmatrix}$,

and define \mathcal{A}_Θ by $\mathcal{D}(\mathcal{A}_\Theta) = \left\{ \begin{pmatrix} x \\ y \\ 0 \\ w \end{pmatrix} \in Z_\Theta \mid \begin{pmatrix} x \\ y \\ w \end{pmatrix} \in \mathcal{D}(\mathcal{A}) \right\}$, $\mathcal{A}_\Theta z_\Theta = TAT^{-1}z_\Theta$

where $T : Z \rightarrow Z_\Theta$ is given by $T \begin{pmatrix} x \\ y \\ w \end{pmatrix} = \begin{pmatrix} x \\ y \\ 0 \\ w \end{pmatrix}$ (and $T^{-1} : Z_\Theta \rightarrow Z$ is given by

$T^{-1} \begin{pmatrix} x \\ y \\ 0 \\ w \end{pmatrix} = \begin{pmatrix} x \\ y \\ w \end{pmatrix}$). Note that if we define L_λ as before, then $\mathcal{D}(L_\lambda) = \mathcal{D}(\tilde{L}_\lambda)$

and $L_\lambda x = \lambda^2 j^{-1} x - F_\Theta \begin{pmatrix} x \\ 0 \\ (\lambda I - D)^{-1} i \lambda x \end{pmatrix} = \lambda^2 j^{-1} x - F \begin{pmatrix} x \\ (\lambda I - D)^{-1} i \lambda x \end{pmatrix} = \tilde{L}_\lambda x$.

It is easy to see that (1) – (8) of Theorem 2.2 are satisfied, so \mathcal{A}_Θ generates a C_0 semigroup $S_\Theta(t)$ on Z_Θ . Set $S(t)z = T^{-1}S_\Theta(t)Tz$. Then $S(t)$ is a C_0 semigroup on Z whose infinitesimal generator is \mathcal{A} . ■

We wish to apply Theorem 2.5 to the equation (1.5). If we set $\tilde{w}(s) = y - y_s$ and substitute into (1.5) we obtain an equation of the form

$$\ddot{y} + \alpha \tilde{A} \left[y + \int_{-r}^0 g_\alpha(s) \tilde{w}(s) ds \right] = f(t). \quad (2.1)$$

We assume that \tilde{A} is a closed, densely defined, positive, self-adjoint, injective linear operator. As we shall see in the example considered below, these assumptions are easily verified in actual applications.

A standard technique (see e.g., [FI]) for reformulating (2.1) as an abstract Cauchy problem is essentially to set $X = \mathcal{D}(\tilde{A}^{1/2})$ where the inner product on X satisfies $\langle x_1, x_2 \rangle_X = \langle \tilde{A}^{1/2} x_1, \tilde{A}^{1/2} x_2 \rangle_Y$ and to take the state space to be

$$Z = X \times Y \times L_g^2(-r, 0; X).$$

The approach we take here is similar but it allows more flexibility in the choice of state space in that X is not necessarily contained in Y , but X will be in one-to-one

correspondence with a subspace of Y . We remark that explicit knowledge of the square root of \tilde{A} is not required; it is only necessary to know that it exists.

With this discussion in mind, let S be a subspace of Y containing $\mathcal{D}(\tilde{A})$, and let $\sigma(\cdot, \cdot)$ be a symmetric bilinear form on S such that $\sigma(y_1, y_2) = \langle \alpha \tilde{A} y_1, y_2 \rangle_Y$ whenever $y_1 \in \mathcal{D}(\tilde{A})$ and $y_2 \in S$. Let X be a Hilbert space and $j : S \rightarrow X$ a bijective linear operator such that $j^{-1} : X \rightarrow Y$ is continuous and $\langle x_1, x_2 \rangle_X = \sigma(j^{-1} x_1, j^{-1} x_2)$. Define $A : \mathcal{D}(A) \subseteq X \rightarrow Y$ by

$$\mathcal{D}(A) = \left\{ x \in X \mid j^{-1} x \in \mathcal{D}(\tilde{A}) \right\}, \quad A = -\alpha \tilde{A} j^{-1}.$$

With W as defined above, set $Z = X \times Y \times W$. Then $z(t) \in Z$ satisfies

$$\frac{d}{dt} z(t) = \mathcal{A} z(t) + \text{col}(0, f(t), 0),$$

where \mathcal{A} is given by

$$\begin{aligned} \mathcal{D}(\mathcal{A}) &= \left\{ \begin{pmatrix} x \\ y \\ w \end{pmatrix} \in Z \mid \begin{array}{l} y \in S, \quad w \in \mathcal{D}(D), \\ \left(x + \int_{-r}^0 g_\alpha(s) w(s) ds \right) \in \mathcal{D}(A) \end{array} \right\}, \\ \mathcal{A} \begin{pmatrix} x \\ y \\ w \end{pmatrix} &= \begin{pmatrix} A \left(x + \int_{-r}^0 g_\alpha(s) w(s) ds \right) \\ jy \\ jy + Dw \end{pmatrix}. \end{aligned} \tag{2.2}$$

THEOREM 2.5. *The operator \mathcal{A} generates a C_0 semigroup on Z .*

PROOF: Let A , D and j be as above and consider the operators:

$$\mathcal{D}(\tilde{C}) = W, \quad \tilde{C}w = \int_{-r}^0 g_\alpha(s) w(s) ds;$$

$$i : X \rightarrow W \text{ given by } [ix](s) \equiv x.$$

In order to apply Theorem 2.5, we must show that A can be factored as $A = A_0A_1$. Since $\tilde{A} : \mathcal{D}(\tilde{A}) \subseteq Y \rightarrow Y$ is positive and self-adjoint, it has a positive square root $\tilde{A}^{1/2}$. Define A_0 and A_1 by

$$\begin{aligned} \mathcal{D}(A_0) &= \mathcal{D}(\tilde{A}^{1/2}), & A_0 &= -\alpha\tilde{A}^{1/2} \\ \mathcal{D}(A_1) &= \{x \in X \mid j^{-1}x \in \mathcal{D}(\tilde{A}^{1/2})\}, & A_1 &= \tilde{A}^{1/2}j^{-1}. \end{aligned}$$

Clearly, $A = A_0A_1$. Set $C_1 = A_1\tilde{C}$. We now verify the conditions of Theorem 2.2.

- (1) Clearly i is continuous. By assumption, $j^{-1} : \mathcal{R}(j) = X \rightarrow Y$ is continuous.
- (2) Since $S \supseteq \mathcal{D}(\tilde{A})$ and \tilde{A} is densely defined, S is dense in Y . Suppose $\hat{x} \perp \mathcal{D}(A)$.

Then for all $x \in \mathcal{D}(A)$,

$$0 = \langle x, \hat{x} \rangle_X = \sigma(j^{-1}x, j^{-1}\hat{x}) = \alpha \left\langle \tilde{A}j^{-1}x, j^{-1}\hat{x} \right\rangle_Y,$$

which implies that $\left\langle \tilde{A}y, j^{-1}\hat{x} \right\rangle_Y = 0$ for all $y \in \mathcal{D}(\tilde{A})$. But \tilde{A} is self-adjoint and one-to-one, so $\mathcal{R}(\tilde{A})$ is dense in Y ([R, Theorem 13.11]). Thus $j^{-1}\hat{x} = 0$ which implies that $\hat{x} = 0$. Therefore, $\mathcal{D}(A)$ is dense in X . Finally, $\mathcal{D}(C) \cap \mathcal{D}(D) = \mathcal{D}(A\tilde{C}) \cap \mathcal{D}(D) = H_{\mathbb{R}}^1(-r, 0; \mathcal{D}(A))$ which is dense in W .

- (3) Obvious since $\mathcal{R}(j) = X$.
- (4) We already know that D is closed. To show that F is closed, let $\begin{pmatrix} x_n \\ w_n \end{pmatrix} \in \mathcal{D}(F)$ for $n = 1, 2, \dots$, let $\begin{pmatrix} x_n \\ w_n \end{pmatrix} \rightarrow \begin{pmatrix} x \\ w \end{pmatrix}$, and $F\begin{pmatrix} x_n \\ w_n \end{pmatrix} = y_n \rightarrow y$ as $n \rightarrow \infty$. Set $\hat{y}_n = j^{-1}\left(x_n + \int_{-r}^0 g_\alpha(s)w_n(s)ds\right)$ and $\hat{y} = j^{-1}\left(x + \int_{-r}^0 g_\alpha(s)w(s)ds\right)$. Then $\hat{y}_n \in \mathcal{D}(\tilde{A})$ and $-\alpha\tilde{A}\hat{y}_n = F\begin{pmatrix} x_n \\ w_n \end{pmatrix} = y_n \rightarrow y$ as $n \rightarrow \infty$. Since \tilde{A} is closed and

$$\|\hat{y}_n - \hat{y}\|_Y \leq \|j^{-1}\| \cdot \left[\|x_n - x\|_X + \left(\int_{-r}^0 g_\alpha(s)ds \right)^{1/2} \|w_n - w\|_W \right] \rightarrow 0,$$

$\hat{y} \in \mathcal{D}(\tilde{A})$ and $-\alpha\tilde{A}\hat{y} = y$. But this implies that $x + \int_{-r}^0 g_\alpha(s)w(s)ds \in \mathcal{D}(A)$

and $A\left(x + \int_{-r}^0 g_\alpha(s)w(s)ds\right) = y$, so F is closed.

(5) Does not apply since $\mathcal{R}(G_2) \subseteq \Theta$.

(6) Let $\begin{pmatrix} x \\ y \\ w \end{pmatrix} \in \mathcal{D}(\mathcal{A})$. Then, using the definition of $\langle \cdot, \cdot \rangle_X$,

$$\begin{aligned} \left\langle \mathcal{A} \begin{pmatrix} x \\ y \\ w \end{pmatrix}, \begin{pmatrix} x \\ y \\ w \end{pmatrix} \right\rangle_Z &= \langle jy, x \rangle_X + \left\langle A \left(x + \int_{-r}^0 g_\alpha(s)w(s)ds \right), y \right\rangle_Y \\ &\quad + \int_{-r}^0 g_\alpha(s) \left\langle jy + \frac{\partial}{\partial s} w(s), w(s) \right\rangle_X ds \\ &= \int_{-r}^0 g_\alpha(s) \left\langle \frac{\partial}{\partial s} w(s), w(s) \right\rangle_X ds \leq 0 \end{aligned}$$

by Lemma 2.4.

(7) Again we take $\lambda_0 = 1$. For $x \in \mathcal{D}(L_1)$, $\begin{pmatrix} x \\ j^{-1}x \\ (1 - e^s)x \end{pmatrix} \in \mathcal{D}(\mathcal{A})$, and

$$\tilde{L}_1 x = j^{-1}x - A \left(x + \int_{-r}^0 g_\alpha(s)(1 - e^s)x ds \right) = j^{-1}x - \alpha_1 A x$$

where $\alpha_1 > 0$ is as defined above. Define T by

$$\mathcal{D}(T) = \{y \in S \mid jy \in \mathcal{D}(\tilde{L}_1)\}, \quad T = I + \alpha_1 \alpha \tilde{A}.$$

It is easy to see that $\mathcal{D}(\tilde{A}) = \mathcal{D}(T)$ and $\mathcal{R}(T) = \mathcal{R}(\tilde{L}_1)$. By the Cauchy-Schwarz Inequality, for $y \in \mathcal{D}(T)$, $\|Ty\| \cdot \|y\| \geq |\langle Ty, y \rangle| = \|y\|^2 + \alpha_1 \alpha \langle \tilde{A}y, y \rangle \geq \|y\|^2$ which implies $\|Ty\| \geq \|y\|$, and so T is one-to-one. Also, $T^* = T$ so $\mathcal{R}(T)$ is dense in Y .

(8) The proof that $(I - D)[\mathcal{D}(C) \cap \mathcal{D}(D)]$ is dense in W is the same as the proof given in Section 2.1. ■

EXAMPLE. *A viscoelastic shaft with tip-mass.*

Consider a viscoelastic shaft of length l fixed at one end and with a tip-mass at the free end. The equation describing the motion of the shaft (see [BMC] where the kernel $g(s)$ is assumed to be in H^1) is

$$\sigma \frac{\partial^2}{\partial t^2} y(t, x) = \frac{\partial}{\partial x} \left[\tau \frac{\partial}{\partial x} y(t, x) + \int_{-\tau}^0 g(s) \frac{\partial}{\partial x} y(t + s, x) ds \right] + b(x) u_1(t), \quad (2.3)$$

while the boundary conditions are given by

$$y(t, 0) = 0, \quad (2.4)$$

$$I_m \frac{\partial^2}{\partial t^2} y(t, l) = - \left[\tau \frac{\partial}{\partial x} y(t, l) + \int_{-\tau}^0 g(s) \frac{\partial}{\partial x} y(t + s, l) ds \right] + u_2(t). \quad (2.5)$$

Here y is the angular displacement, σ is the product of the density of the shaft with its polar moment of inertia, τ is the product of the shear modulus and the polar moment of inertia, I_m is the moment of inertia of the tip mass, and the delay $\tau > 0$ is assumed to be finite. Let $Y = \mathbf{R} \times L^2(0, l)$ with

$$\|y\|_Y^2 = \left\| \begin{pmatrix} \gamma \\ \psi \end{pmatrix} \right\|_Y^2 = I_m \gamma^2 + \sigma \int_0^l \psi^2.$$

Then (2.3) - (2.5) can be written as

$$\ddot{y} + \tilde{A} \left[\tau y + \int_{-\tau}^0 g(s) y_s ds \right] = f(t)$$

where $f(t) = \begin{pmatrix} \frac{1}{I_m} u_2(t) \\ \frac{1}{\sigma} b(x) u_1(t) \end{pmatrix}$, and

$$\mathcal{D}(\tilde{A}) = \left\{ \begin{pmatrix} \gamma \\ \psi \end{pmatrix} \in Y \mid \psi \in H_L^1(0, l) \cap H^2(0, l), \psi(l) = \gamma \right\},$$

$$\tilde{A} \begin{pmatrix} \gamma \\ \psi \end{pmatrix} = \begin{pmatrix} \frac{1}{I_m} \psi'(l) \\ -\frac{1}{\sigma} \psi'' \end{pmatrix}.$$

Clearly, $\mathcal{D}(\tilde{A})$ is dense in Y . Let $\begin{pmatrix} \gamma \\ \psi \end{pmatrix} \in \mathcal{D}(\tilde{A})$. Then

$$\begin{aligned} \left\langle \tilde{A} \begin{pmatrix} \gamma \\ \psi \end{pmatrix}, \begin{pmatrix} \gamma \\ \psi \end{pmatrix} \right\rangle &= \psi'(l)\psi(l) - \int_0^l \psi''\psi = \int_0^l (\psi')^2 \\ &\geq \frac{2}{2I_m l + \sigma l^2} \left\| \begin{pmatrix} \gamma \\ \psi \end{pmatrix} \right\|^2 \geq 0. \end{aligned}$$

Thus, \tilde{A} is positive and $\frac{2}{2I_m l + \sigma l^2} \left\| \begin{pmatrix} \gamma \\ \psi \end{pmatrix} \right\|^2 \leq \left\| \tilde{A} \begin{pmatrix} \gamma \\ \psi \end{pmatrix} \right\| \cdot \left\| \begin{pmatrix} \gamma \\ \psi \end{pmatrix} \right\|$, so \tilde{A} is one-to-one (and \tilde{A}^{-1} is continuous). Let $\begin{pmatrix} \gamma_1 \\ \psi_1 \end{pmatrix}, \begin{pmatrix} \gamma_2 \\ \psi_2 \end{pmatrix} \in \mathcal{D}(\tilde{A})$. Then

$$\begin{aligned} \left\langle \tilde{A} \begin{pmatrix} \gamma_1 \\ \psi_1 \end{pmatrix}, \begin{pmatrix} \gamma_2 \\ \psi_2 \end{pmatrix} \right\rangle &= \psi_1'(l)\psi_2(l) - \int_0^l \psi_1''\psi_2 = \int_0^l \psi_1'\psi_2' \\ &= \psi_1(l)\psi_2'(l) - \int_0^l \psi_1\psi_2'' = \left\langle \begin{pmatrix} \gamma_1 \\ \psi_1 \end{pmatrix}, \tilde{A} \begin{pmatrix} \gamma_2 \\ \psi_2 \end{pmatrix} \right\rangle, \end{aligned}$$

so \tilde{A} is symmetric. Let $\begin{pmatrix} \hat{\gamma} \\ \hat{\psi} \end{pmatrix} \in Y$. Define $\psi(x) = \int_0^x \left[\int_t^l \sigma \hat{\psi}(\xi) d\xi + I_m \hat{\gamma} \right] dt$. Then $\begin{pmatrix} \psi(l) \\ \psi \end{pmatrix} \in \mathcal{D}(\tilde{A})$, and $\tilde{A} \begin{pmatrix} \psi(l) \\ \psi \end{pmatrix} = \begin{pmatrix} \hat{\gamma} \\ \hat{\psi} \end{pmatrix}$, so $\mathcal{R}(\tilde{A}) = Y$. Therefore, by Theorem 13.11 in [R], $\tilde{A}^* = \tilde{A}$. Finally, $\mathcal{D}(\tilde{A}^{-1}) = \mathcal{R}(\tilde{A}) = Y$, so \tilde{A}^{-1} is closed, and hence \tilde{A} is closed. Now let $S = \left\{ \begin{pmatrix} \gamma \\ \psi \end{pmatrix} \in Y \mid \psi \in H_L^1(0, l), \psi(l) = \gamma \right\}$, and define $\sigma \left(\begin{pmatrix} \gamma_1 \\ \psi_1 \end{pmatrix}, \begin{pmatrix} \gamma_2 \\ \psi_2 \end{pmatrix} \right) = \alpha \int_0^l \psi_1'\psi_2'$ for $\begin{pmatrix} \gamma_1 \\ \psi_1 \end{pmatrix}, \begin{pmatrix} \gamma_2 \\ \psi_2 \end{pmatrix} \in S$. Then, $S \supseteq \mathcal{D}(\tilde{A})$ and $\sigma(y_1, y_2) = \langle \alpha \tilde{A} y_1, y_2 \rangle_Y$ whenever $y_1 \in \mathcal{D}(\tilde{A})$, $y_2 \in S$. Let $X = H_L^1(0, l)$ with $\langle x_1, x_2 \rangle_X = \alpha \int_0^l x_1' x_2'$, and define $j : S \rightarrow X$ by $j \begin{pmatrix} \psi(l) \\ \psi \end{pmatrix} = \psi$. Clearly j is a bijective linear operator, and

$$\langle x_1, x_2 \rangle_X = \alpha \int_0^l x_1' x_2' = \sigma \left(\begin{pmatrix} x_1(l) \\ x_1 \end{pmatrix}, \begin{pmatrix} x_2(l) \\ x_2 \end{pmatrix} \right) = \sigma(j^{-1}x_1, j^{-1}x_2).$$

For $x \in X$, $\|j^{-1}x\|_Y^2 = I_m x^2(l) + \sigma \int_0^l x^2 \leq \left(\frac{2I_m l + \sigma l^2}{2\alpha} \right) \|x\|_X^2$. Thus, j^{-1} is continuous.

Now, define $Z = H_L^1(0, l) \times \mathbf{R} \times L^2(0, l) \times L_g^2(-r, 0; H_L^1(0, l))$ with

$$\left\| \begin{pmatrix} \varphi \\ \gamma \\ \psi \\ w \end{pmatrix} \right\|_Z^2 = \alpha \int_0^l (\varphi')^2 + I_m \gamma^2 + \sigma \int_0^l \psi^2 + \int_{-r}^0 g_\alpha(s) \int_0^l \left(\frac{\partial}{\partial x} w(s) \right)^2 dx ds,$$

and define

$$\mathcal{D}(\mathcal{A}) = \left\{ \begin{pmatrix} \varphi \\ \gamma \\ \psi \\ w \end{pmatrix} \in Z \mid \begin{array}{l} \psi \in H_L^1(0, l), \quad \psi(l) = \gamma, \\ w \in H_R^1(-r, 0; H_L^1(0, l)), \\ (\varphi'(x) + \int_{-r}^0 g_\alpha(s) \frac{\partial}{\partial x} w(s, x) ds) \in H^1(0, l) \end{array} \right\},$$

$$\mathcal{A} \begin{pmatrix} \varphi \\ \gamma \\ \psi \\ w \end{pmatrix} = \begin{pmatrix} \psi \\ -\frac{\alpha}{I_m} \left[\varphi'(l) + \int_{-r}^0 g_\alpha(s) \frac{\partial}{\partial x} w(s, l) ds \right] \\ \frac{\alpha}{\sigma} \frac{\partial}{\partial x} \left[\varphi'(x) + \int_{-r}^0 g_\alpha(s) \frac{\partial}{\partial x} w(s, x) ds \right] \\ \psi + \frac{\partial w}{\partial s} \end{pmatrix}.$$

The operator \mathcal{A} generates a C_0 semigroup on Z by Theorem 2.5.

3. Approximation. In this section we consider the problem of finding approximate solutions to equations of the form (1.1). Let $S(t)$ be the C_0 semigroup generated by \mathcal{A} . We construct a sequence $(Z^n, P_Z^n, \mathcal{A}^n)$ where Z^n is a finite dimensional subspace of Z , P_Z^n is the orthogonal projection of Z onto Z^n , and \mathcal{A}^n generates a C_0 semigroup $S^n(t)$ on Z^n . We then show that $S^n(t)P_Z^n z \rightarrow S(t)z$ as $n \rightarrow \infty$ for all $z \in Z$ using the following version of the Trotter-Kato theorem which follows from Theorem 4.2 in [P, Chapter 3].

THEOREM 3.1. *Let $A \in G(M, \beta)$ be the infinitesimal generator of a C_0 semigroup $S(t)$ on a Hilbert space Z . For $n = 1, 2, \dots$, let Z^n be a finite dimensional subspace of Z such that $P^n \xrightarrow{S} I$ as $n \rightarrow \infty$ where P^n is the orthogonal projection of Z onto*

Z^n . Suppose

(H1) $A^n \in G(M, \beta)$ is the infinitesimal generator of a C_0 semigroup $S^n(t)$ on Z^n for

$n = 1, 2, \dots$, and

(H2) for all $z \in Z$, $(\lambda I - A^n)^{-1}P^n z \rightarrow (\lambda I - A)^{-1}z$ as $n \rightarrow \infty$.

Then for all $z \in Z$, $S^n(t)P^n z \rightarrow S(t)z$ as $n \rightarrow \infty$, and the convergence is uniform on bounded t -intervals.

We would like to construct a convergent approximation scheme for the thermo-viscoelastic system considered in Section 2.2. Nevertheless, for the approximation scheme and convergence proof presented below, we restrict our attention to the abstract viscoelastic system (equation (1.1)) for which the operator \mathcal{A} is given by (2.2). The convergence proof for the complete thermo-viscoelastic system involves a modification of the proof we give here and can be found in the thesis [L]. This modification is rather technical, and yet is a straight forward extension of the proof we present below. Therefore, in order to conserve space we present only the proof for the viscoelastic model. If we define the operator $A_0 : \mathcal{D}(A_0) \subseteq X \times Y \rightarrow X \times Y$ by

$$\mathcal{D}(A_0) = \left\{ \begin{pmatrix} x \\ y \end{pmatrix} \in X \times Y \mid x \in \mathcal{D}(A), y \in S \right\},$$

$$A_0 \begin{pmatrix} x \\ y \end{pmatrix} = \begin{pmatrix} j y \\ A x \end{pmatrix},$$

then we can write \mathcal{A} in the form

$$\mathcal{A} \begin{pmatrix} x \\ y \\ w \end{pmatrix} = \begin{pmatrix} A_0 \left[\begin{pmatrix} x \\ y \end{pmatrix} + \int_{-\tau}^0 g_\alpha(s) \begin{pmatrix} w(s) \\ 0 \end{pmatrix} ds \right] \\ j y + \frac{\partial w}{\partial s} \end{pmatrix},$$

which suggests a two-stage approximation of \mathcal{A} : We first approximate A_0 by discretizing the spatial variable, typically by means of spline functions. We then approximate $\frac{\partial w}{\partial s}$ by discretizing the delay variable. In this paper we will use an averaging scheme for the second stage. We follow the construction given in [FI] except that we do not require a uniform partitioning of the interval $[-r, 0]$.

Let us now proceed with the first stage of the approximation. Define the bilinear form $\sigma_0(\cdot, \cdot)$ on $X \times S$ by

$$\sigma_0 \left(\begin{pmatrix} x_1 \\ y_1 \end{pmatrix}, \begin{pmatrix} x_2 \\ y_2 \end{pmatrix} \right) = \sigma(y_1, j^{-1}x_2) - \sigma(j^{-1}x_1, y_2)$$

where σ is the bilinear form on S discussed in Section 2.3. Observe that for $\begin{pmatrix} x_1 \\ y_1 \end{pmatrix} \in \mathcal{D}(A_0)$ and $\begin{pmatrix} x_2 \\ y_2 \end{pmatrix} \in X \times S$,

$$\left\langle A_0 \begin{pmatrix} x_1 \\ y_1 \end{pmatrix}, \begin{pmatrix} x_2 \\ y_2 \end{pmatrix} \right\rangle_{X \times Y} = \sigma_0 \left(\begin{pmatrix} x_1 \\ y_1 \end{pmatrix}, \begin{pmatrix} x_2 \\ y_2 \end{pmatrix} \right).$$

Now for each positive integer N , let X^N and Y^N be finite dimensional subspaces of X and Y with $Y^N \subseteq S$, and define $W^N = L^2(-r, 0; X^N)$. We define $A_0^N : X^N \times Y^N \rightarrow X^N \times Y^N$ by restricting σ_0 to $X^N \times Y^N$; i.e.,

$$\langle A_0^N u^N, v^N \rangle_{X \times Y} = \sigma_0(u^N, v^N) \quad \text{for } u^N, v^N \in X^N \times Y^N.$$

Now set $Z^N = X^N \times Y^N \times W^N$ and define $\mathcal{A}^N : \mathcal{D}(\mathcal{A}^N) \subseteq Z^N \rightarrow Z^N$ by

$$\mathcal{D}(\mathcal{A}^N) = X^N \times Y^N \times H_R^1(-r, 0; X^N),$$

$$\mathcal{A}^N \begin{pmatrix} x^N \\ y^N \\ w^N \end{pmatrix} = \begin{pmatrix} A_0^N \left[\begin{pmatrix} x^N \\ y^N \end{pmatrix} + \int_{-r}^0 g_\alpha(s) \begin{pmatrix} w^N(s) \\ 0 \end{pmatrix} ds \right] \\ jy^N + \frac{\partial}{\partial s} w^N \end{pmatrix}.$$

For each positive integer M partition the interval $[-\tau, 0]$ into subintervals $[t_j^M, t_{j-1}^M]$, $j = 1, 2, \dots, M$, where

$$-\tau = t_M^M < t_{M-1}^M < \dots < t_1^M < t_0^M = 0. \quad (3.1)$$

We will say more later about how the t_j^M are chosen. Set $\alpha_j^M = t_{j-1}^M - t_j^M$ for $j = 1, 2, \dots, M$, let χ_j^M denote the characteristic function of $[t_j^M, t_{j-1}^M)$ for $j = 2, \dots, M$, and let χ_1^M denote the characteristic function of $[t_1^M, 0]$. Let $B_i^M(t)$, $i = 0, 1, \dots, M$ be the usual linear spline functions satisfying $B_i^M(t_j^M) = \delta_{ij}$. Define the finite dimensional subspaces $W^{N,M}$ and $\widetilde{W}^{N,M}$ of W by

$$W^{N,M} = \left\{ w \in W \mid w = \sum_{i=1}^M a_i^M \chi_i^M, a_i^M \in X^N \right\},$$

$$\widetilde{W}^{N,M} = \left\{ w \in W \mid w = \sum_{i=1}^M b_i^M B_i^M, b_i^M \in X^N \right\}.$$

Define $\widetilde{D}^{N,M} : \widetilde{W}^{N,M} \rightarrow W^{N,M}$ by $\widetilde{D}^{N,M} w^{N,M} = \sum_{i=1}^M \frac{1}{\alpha_i^M} (b_{i-1}^M - b_i^M) \chi_i^M$ where $w^{N,M} = \sum_{i=1}^M b_i^M B_i^M$ and $b_0^M = 0$. Define the isomorphism $i^{N,M} : \widetilde{W}^{N,M} \rightarrow W^{N,M}$ by $i^{N,M} w^{N,M} = \sum_{i=1}^M b_i^M \chi_i^M$. Now define $D^{N,M} : W^{N,M} \rightarrow W^{N,M}$ by $D^{N,M} = \widetilde{D}^{N,M} (i^{N,M})^{-1}$. To complete the approximation, set $Z^{N,M} = X^N \times Y^N \times W^{N,M}$, and for $z^{N,M} = (x^N, y^N, w^{N,M})^T \in Z^{N,M}$, define

$$A^{N,M} z^{N,M} = \begin{pmatrix} A_0^N \left[\begin{pmatrix} x^N \\ y^N \end{pmatrix} + \int_{-\tau}^0 g_\alpha(s) \begin{pmatrix} w^{N,M}(s) \\ 0 \end{pmatrix} ds \right] \\ jy^N + D^{N,M} w^{N,M} \end{pmatrix}.$$

If $w^{N,M} = \sum_{i=1}^M w_i^M \chi_i^M$, then

$$\mathcal{A}^{N,M} z^{N,M} = \begin{pmatrix} A_0^N \left(x^N + \sum_{i=1}^M (g_\alpha)_i^M w_i^M \right) \\ y^N \\ jy^N + \sum_{i=1}^M \frac{w_{i-1}^M - w_i^M}{\alpha_i^M} \chi_i^M \end{pmatrix}$$

where $(g_\alpha)_i^M = \int_{t_i^M}^{t_{i-1}^M} g_\alpha(s) ds$.

In order to prove convergence of this approximation scheme, we must impose conditions upon the spaces X^N and Y^N and upon the partitions of $[-r, 0]$. Thus, we make the following assumptions:

(A1) Let P_X^N and P_Y^N be the orthogonal projections of X and Y onto X^N and Y^N , respectively. Then $P_X^N \xrightarrow{s} I_X$, and $P_Y^N \xrightarrow{s} I_Y$ where I_X and I_Y are the identity operators on X and Y , respectively.

(A2) For each positive integer M let $\Pi^M = \{t_j^M \mid j = 0, 1, \dots, M\}$ be a partition of $[-r, 0]$ satisfying (3.1), and set $\Lambda^M = \{1, 2, \dots, M\}$. Then there exist positive constants ϵ_1 , ϵ_2 and C independent of M such that $\Lambda^M = \Lambda_1^M \cup \Lambda_2^M$ where

$$\Lambda_1^M = \left\{ j \in \Lambda^M \mid \alpha_j^M \leq rM^{-(1+\epsilon_1)/2} \right\}.$$

If $j \in \Lambda_2^M$, then $(g_\alpha)_j^M \leq \frac{C}{M}$, and Λ_2^M contains at most $M^{1-\epsilon_2}$ elements of Λ^M . Furthermore, $\alpha_{j-1}^M (g_\alpha)_j^M \leq (g_\alpha)_{j-1}^M \alpha_j^M$ for $j = 2, 3, \dots, M$, and if $j \in \Lambda_1^M$, then $1, 2, \dots, j-1 \in \Lambda_1^M$.

EXAMPLE 3.2. Suppose $t_j^M = \frac{-jr}{M}$ for $j = 0, 1, \dots, M$. Then $\alpha_j^M = \frac{r}{M}$ for all

$j \in \Lambda^M$, so (A2) is satisfied with $\epsilon_1 = 1$, $\epsilon_2, C > 0$ arbitrary since $\Lambda_2^M = \emptyset$ and $(g_\alpha)_j^M \leq (g_\alpha)_{j-1}^M$.

EXAMPLE 3.3. Let $C = \int_{-r}^0 g_\alpha(s) ds$, and suppose that the t_j^M are chosen so that $(g_\alpha)_j^M = \frac{C}{M}$ for $j = 1, 2, \dots, M$. Then it is easy to check that for $\epsilon_1 = \frac{1}{2}$, $\epsilon_2 = \frac{1}{4}$ the partition Π^M satisfies (A2) for all positive integers M .

We will refer to these partitions as the “uniform mesh” and the “non-uniform mesh,” respectively. The non-uniform mesh of Example 3.3 is the partition suggested by Fabiano and Ito in [FI]. The convergence proof we give below is a modification of the proof given in [FI]. The major difference is that we must handle each estimate in two parts: one where the length of the interval is small (in this case our argument is the same as that of Fabiano and Ito), and the other where the integral of g is small.

Let $P_Z^{N,M}$ denote the orthogonal projection of Z onto $Z^{N,M}$. In order to apply Theorem 3.1, we must show that $P_Z^{N,M} \xrightarrow{s} I_Z$ as $N, M \rightarrow \infty$. For $z = (x, y, w)^T \in Z$, $P_Z^{N,M} z = \left(P_X^N x, P_Y^N y, P_W^{N,M} w \right)^T$, where $P_W^{N,M}$ is the orthogonal projection of W onto $W^{N,M}$. Since we assume (A1) it is sufficient to show that $P_W^{N,M} \xrightarrow{s} I_W$.

LEMMA 3.4. For all $h \in W$, $P_W^{N,M} h \rightarrow h$ as $N, M \rightarrow \infty$.

PROOF: For $w \in W$ and $t \in [-r, 0]$, set $w^N(t) = P_X^N w(t)$, and define $w^{N,M}$ by $w^{N,M}(t) = \sum_{i=1}^M w^N(t_{i-1}^M) \chi_i^M(t)$. For $w \in \mathcal{D}(D^2)$

$$\|w - w^{N,M}\|_W \leq \|w - w^N\|_W + \|w^N - w^{N,M}\|_W,$$

where the first term on the right-hand side tends to zero by the Dominated Con-

vergence Theorem. We write the second term as $\|w^N - w^{N,M}\|_W^2 = S_1 + S_2$ where $S_j = \sum_{i \in \Lambda_j^M} \int_{t_i^M}^{t_{i-1}^M} g_\alpha(s) \|w^N(s) - w^N(t_{i-1}^M)\|_X^2 ds$ for $j = 1, 2$. Following Fabiano and Ito (but replacing r/M , the length of each interval using the uniform mesh, by $r/M^{(1+\epsilon_1)/2}$) we get

$$S_1 \leq r \|D^2 w\|_W^2 \cdot M \cdot \frac{1}{3} \left(\frac{r}{M^{(1+\epsilon_1)/2}} \right)^3 \rightarrow 0 \text{ as } M \rightarrow \infty.$$

Now, for $s \in [-r, 0]$,

$$\begin{aligned} \|w^N(s)\|_X^2 &\leq \|w(s)\|_X^2 = \left\| \int_s^0 Dw(\xi) d\xi \right\|_X^2 = \left\| \int_s^0 \frac{1}{\sqrt{g_\alpha(\xi)}} \sqrt{g_\alpha(\xi)} Dw(\xi) d\xi \right\|_X^2 \\ &\leq \int_s^0 \frac{1}{\sqrt{g_\alpha(\xi)}} d\xi \int_s^0 g_\alpha(\xi) \|Dw(\xi)\|_X^2 d\xi \leq \frac{r}{g_\alpha(-r)} \|Dw\|_W^2. \end{aligned}$$

Thus,

$$\begin{aligned} S_2 &\leq 2 \sum_{i \in \Lambda_2^M} \int_{t_i^M}^{t_{i-1}^M} g_\alpha(s) \left[\|w^N(s)\|_X^2 + \|w^N(t_{i-1}^M)\|_X^2 \right] ds \\ &\leq \frac{4r \|Dw\|_W^2}{g_\alpha(-r)} \sum_{i \in \Lambda_2^M} \int_{t_i^M}^{t_{i-1}^M} g_\alpha(s) ds \leq \frac{4rC \|Dw\|_W^2}{g_\alpha(-r)M^{\epsilon_2}} \rightarrow 0 \text{ as } M \rightarrow \infty. \end{aligned}$$

Hence, for $w \in \mathcal{D}(D^2)$, $\|w - P_W^{N,M} w\|_W \leq \|w - w^{N,M}\|_W + \|P_W^{N,M}(w - w^{N,M})\|_W \leq 2 \|w - w^{N,M}\|_W \rightarrow 0$ as $N, M \rightarrow \infty$. Since $\mathcal{D}(D^2)$ is dense in W and $\|P_W^{N,M}\| \leq 1$, $\|h - P_W^{N,M} h\|_W \rightarrow 0$ as $N, M \rightarrow \infty$ for all $h \in W$. ■

From Theorem 2.5 we know that $\mathcal{A} \in G(1, 0)$. In order to show that $\mathcal{A}^{N,M} \in G(1, 0)$ for all N, M , it is sufficient to show that $\mathcal{A}^{N,M}$ is dissipative in $Z^{N,M}$ since $Z^{N,M}$ is

finite dimensional. Let $z^{N,M} = \begin{pmatrix} x^N \\ y^N \\ w^{N,M} \end{pmatrix}$ with $w^{N,M} = \sum_{i=1}^M w_i^M \chi_i^M$. Then

$$\begin{aligned}
\langle \mathcal{A}^{N,M} z^{N,M}, z^{N,M} \rangle_Z &= \sigma_0 \left(\begin{bmatrix} x^N + \sum_{i=1}^M (g_\alpha)_i^M w_i^M \\ y^N \end{bmatrix}, \begin{bmatrix} x^N \\ y^N \end{bmatrix} \right) \\
&\quad + \int_{-r}^0 g_\alpha(s) \left\langle jy^N + \sum_{i=1}^M \frac{w_{i-1}^M - w_i^M}{\alpha_i^M} \chi_i^M, \sum_{i=1}^M w_i^M \chi_i^M \right\rangle_X ds \\
&= \sum_{i=1}^M \frac{1}{\alpha_i^M} (g_\alpha)_i^M \langle w_{i-1}^M - w_i^M, w_i^M \rangle_X \\
&\leq \sum_{i=1}^M \frac{(g_\alpha)_i^M}{\alpha_i^M} \left[\|w_{i-1}^M\|_X \cdot \|w_i^M\|_X - \|w_i^M\|_X^2 \right] \\
&\leq \frac{1}{2} \sum_{i=1}^M \frac{(g_\alpha)_i^M}{\alpha_i^M} \left[\|w_{i-1}^M\|_X^2 - \|w_i^M\|_X^2 \right] \\
&= \frac{1}{2} \left[\sum_{i=1}^{M-1} \|w_i^M\|_X^2 \left(\frac{(g_\alpha)_{i+1}^M}{\alpha_{i+1}^M} - \frac{(g_\alpha)_i^M}{\alpha_i^M} \right) - \|w_M^M\|_X^2 \frac{(g_\alpha)_M^M}{\alpha_M^M} \right] \leq 0
\end{aligned}$$

where we used the Cauchy-Schwarz Inequality and the inequality $2ab \leq a^2 + b^2$, and from (A2) the fact that $(g_\alpha)_{i+1}^M/\alpha_{i+1}^M \leq (g_\alpha)_i^M/\alpha_i^M$ for $i = 1, 2, \dots, M-1$. Thus, we have established the following result.

LEMMA 3.5. *If $\mathcal{A}^{N,M}$ is as defined above, then $\mathcal{A}^{N,M} \in G(1, 0)$ for all N, M .*

All that remains to be done in order to establish convergence is to show that $(\lambda I - \mathcal{A}^{N,M})^{-1} P_Z^{N,M} z \rightarrow (\lambda I - \mathcal{A})^{-1} z$ for all $z \in Z$. For $\text{Re} \lambda > 0$ and $z = \begin{pmatrix} \varphi \\ \psi \\ h \end{pmatrix}$, consider

the equation $(\lambda I - \mathcal{A})^{-1}z = \begin{pmatrix} x \\ y \\ w \end{pmatrix}$, or equivalently,

$$\lambda x - jy = \varphi, \quad (3.2)$$

$$\lambda y - A \left(x + \int_{-r}^0 g_\alpha(s)w(s)ds \right) = \psi, \quad (3.3)$$

$$\lambda w - jy - \frac{\partial w}{\partial s} = h. \quad (3.4)$$

From (3.4), $w(s) = \int_s^0 e^{\lambda(s-\xi)}(jy + h(\xi))d\xi$, and from (3.2), $jy = \lambda x - \varphi$, or $y = \lambda j^{-1}x - j^{-1}\varphi$. Substituting into (3.3) and using α_λ as defined above and the fact that $\int_s^0 \lambda e^{\lambda(s-\xi)}d\xi = 1 - e^{\lambda s}$ we obtain

$$\lambda^2 j^{-1}x - A \left(\alpha_\lambda x - \int_{-r}^0 g_\alpha(s)(\lambda I - D)^{-1}[\varphi - h(s)]ds \right) = \psi + \lambda j^{-1}\varphi. \quad (3.5)$$

If we define $\Delta(\lambda) = \lambda^2 j^{-1} - \frac{1}{\alpha}A \left(\tau + \int_{-r}^0 e^{\lambda s}g(s)ds \right) = \lambda^2 j^{-1} - \alpha_\lambda A$, then for $x \in \mathcal{D}(A)$,

$$\Delta(\lambda)x = \psi + \lambda j^{-1}\varphi - A \int_{-r}^0 g_\alpha(s)(\lambda I - D)^{-1}[\varphi - h(s)]ds.$$

Now, let $P_Z^{N,M}z = \begin{pmatrix} \varphi^N \\ \psi^N \\ h^{N,M} \end{pmatrix}$, and consider the equation $(\lambda I - \mathcal{A}^{N,M})^{-1}P_Z^{N,M}z = \begin{pmatrix} x^N \\ y^N \\ w^{N,M} \end{pmatrix}$. If we define $A^N : X^N \rightarrow Y^N$ by $\langle A^N x^N, y^N \rangle_Y = -\sigma(j^{-1}x^N, y^N)$, then it is easy to see that $A_0^N \begin{pmatrix} x^N \\ y^N \end{pmatrix} = \begin{pmatrix} jy^N \\ A^N x^N \end{pmatrix}$ for $\begin{pmatrix} x^N \\ y^N \end{pmatrix} \in X^N \times Y^N$. Thus, we have

the equations

$$\lambda x^N - jy^N = \varphi^N, \quad (3.6)$$

$$\lambda y^N - A^N \left(x^N + \sum_{i=1}^M (g_\alpha)_i^M w_i^M \right) = \psi^N, \quad (3.7)$$

$$\lambda w_i^M - jy^N - \frac{1}{\alpha_i^M} (w_{i-1}^M - w_i^M) = h_i^M \text{ for } i = 1, 2, \dots, M, \quad (3.8)$$

where $w^{N,M} = \sum_{i=1}^M w_i^M \chi_i^M$ and $h^{N,M} = \sum_{i=1}^M h_i^M \chi_i^M$. From (3.8),

$$\left(\lambda + \frac{1}{\alpha_i^M} \right) w_i^M = \frac{1}{\alpha_i^M} w_{i-1}^M + jy^N + h_i^M,$$

or

$$w_i^M = (1 + \alpha_i^M \lambda)^{-1} [w_{i-1}^M + \alpha_i^M (jy^N + h_i^M)] \text{ for } i = 1, 2, \dots, M,$$

where $w_0^M = 0$. By induction, $w_i^M = \sum_{k=1}^i \left[\prod_{l=k}^i (1 + \alpha_l^M \lambda)^{-1} \right] \alpha_k^M (jy^N + h_k^M)$. From (3.6), $jy^N = \lambda x^N - \varphi^N$ which implies $y^N = \lambda j^{-1} x^N - j^{-1} \varphi^N$. Substituting into (3.7)

we obtain

$$\begin{aligned} & \lambda^2 j^{-1} x^N - A^N \left(x^N + \lambda \sum_{i=1}^M (g_\alpha)_i^M \sum_{k=1}^i \left[\prod_{l=k}^i (1 + \alpha_l^M \lambda)^{-1} \right] \alpha_k^M x^N \right) \\ &= \psi^N + \lambda j^{-1} \varphi^N - \sum_{i=1}^M (g_\alpha)_i^M A^N \sum_{k=1}^i \left[\prod_{l=k}^i (1 + \alpha_l^M \lambda)^{-1} \right] \alpha_k^M (\varphi^N - h_k^M). \end{aligned} \quad (3.9)$$

By induction, $\lambda \sum_{k=1}^i \left[\prod_{l=k}^i (1 + \alpha_l^M \lambda)^{-1} \right] \alpha_k^M = 1 - \prod_{k=1}^i (1 + \alpha_k^M \lambda)^{-1}$. Define

$$\Delta^{N,M}(\lambda) = \lambda^2 j^{-1} - A^N \left[1 + \sum_{i=1}^M (g_\alpha)_i^M \left(1 - \prod_{k=1}^i (1 + \alpha_k^M \lambda)^{-1} \right) \right].$$

Then, since $\sum_{i=1}^M (g_\alpha)_i^M = -\frac{1}{\alpha} \int_{-\tau}^0 g(s) ds = \frac{\tau}{\alpha} - 1$,

$$\Delta^{N,M}(\lambda) = \lambda^2 j^{-1} - \frac{1}{\alpha} A^N \left[\tau + \int_{-\tau}^0 g(s) e^{M(\lambda, s)} ds \right] \quad (3.10)$$

where

$$e^M(\lambda, s) = \sum_{i=1}^M \left(\prod_{k=1}^i (1 + \alpha_k^M \lambda)^{-1} \right) \chi_i^M(s).$$

Let $(\lambda I - D^{N,M})^{-1} (\varphi^N - h^{N,M}) = \sum_{i=1}^M \xi_i^M \chi_i^M$. Then

$$\varphi^N - h^{N,M} = (\lambda I - D^{N,M}) \sum_{i=1}^M \xi_i^M \chi_i^M = \sum_{i=1}^M \left[\lambda \xi_i^M - \frac{1}{\alpha_i^M} (\xi_{i-1}^M - \xi_i^M) \right] \chi_i^M$$

which implies $\varphi^N - h_i^M = \lambda \xi_i^M - \frac{1}{\alpha_i^M} (\xi_{i-1}^M - \xi_i^M)$ for $i = 1, 2, \dots, M$. Thus, $\xi_i^M = (1 + \lambda \alpha_i^M)^{-1} [\xi_{i-1}^M + \alpha_i^M (\varphi^N - h_i^M)]$, or, by induction,

$$\xi_i^M = \sum_{k=1}^i \left[\prod_{l=k}^i (1 + \lambda \alpha_l^M)^{-1} \right] \alpha_k^M (\varphi^N - h_k^M).$$

Now, $\int_{-\tau}^0 g_\alpha(s) \sum_{i=1}^M \xi_i^M \chi_i^M = \sum_{i=1}^M (g_\alpha)_i^M \xi_i^M$, so

$$\begin{aligned} \int_{-\tau}^0 g_\alpha(s) (\lambda I - D^{N,M})^{-1} (\varphi^N - h^{N,M}) ds \\ = \sum_{i=1}^M (g_\alpha)_i^M \sum_{k=1}^i \left[\prod_{l=k}^i (1 + \lambda \alpha_l^M)^{-1} \right] \alpha_k^M (\varphi^N - h_k^M). \end{aligned} \quad (3.11)$$

Therefore, from (3.9), (3.10) and (3.11) we obtain

$$\Delta^{N,M}(\lambda)x^N = \psi^N + \lambda j^{-1} \varphi^N - A^N \int_{-\tau}^0 g_\alpha(s) (\lambda I - D^{N,M})^{-1} (\varphi^N - h^{N,M}) ds. \quad (3.12)$$

In order to complete the proof of convergence, we must show that $x^N \rightarrow x$, $y^N \rightarrow y$ and $w^{N,M} \rightarrow w$ as $N, M \rightarrow \infty$. First we need the following lemmas.

LEMMA 3.6. For $\lambda > 0$, $(\lambda I - D^{N,M})^{-1} P_W^{N,M} h \rightarrow (\lambda I - D)^{-1} h$ for all $h \in W$.

PROOF: Let $w = (\lambda I - D)^{-1} h$ and $w^{N,M} = (\lambda I - D^{N,M})^{-1} P_W^{N,M} h$. Set $\tilde{w}^{N,M} = (i^{N,M})^{-1} w^{N,M}$, and take $\hat{w}^{N,M} = \int_0^s P_W^{N,M}(Dw)d\xi$. It now follows that

$$\|i^{N,M} (\hat{w}^{N,M} - \tilde{w}^{N,M})\|_W \leq \lambda \left\| P_W^{N,M} (w - i^{N,M} \hat{w}^{N,M}) \right\|_W. \quad (3.13)$$

Now,

$$\|w - i^{N,M} \widehat{w}^{N,M}\|_W \leq \|w - \widehat{w}^{N,M}\|_W + \|\widehat{w}^{N,M} - i^{N,M} \widehat{w}^{N,M}\|_W$$

where

$$\begin{aligned} \|w - \widehat{w}^{N,M}\|_W^2 &= \left\| \int_0^s [Dw - P_W^{N,M}(Dw)] d\xi \right\|_W^2 \\ &\leq \frac{r^2}{2} \|Dw - P_W^{N,M}(Dw)\|_W^2 \rightarrow 0 \text{ as } N, M \rightarrow \infty \end{aligned}$$

by Lemma 3.4. If we set $P_W^{N,M}(Dw) = \sum_{i=1}^M \xi_i^M \chi_i^M$, then we get

$$\|\widehat{w}^{N,M} - i^{N,M} \widehat{w}^{N,M}\|_W^2 = \sum_{i=1}^M \int_{t_i^M}^{t_{i-1}^M} g_\alpha(s) \|\xi_i^M\|_X^2 (s - t_i^M)^2 ds = S_1 + S_2.$$

To estimate the term S_1 we again follow Fabiano and Ito (replacing the term r/M

by $r/M^{(1+\epsilon_1)/2}$) to get $S_1 \leq \frac{r^2}{M^{1+\epsilon_1}} \|Dw\|_W^2 \rightarrow 0$ as $M \rightarrow \infty$. Define the norm $\|\cdot\|_1$

on W by $\|w\|_1^2 = \int_{-r}^0 \|w(s)\|_X^2 ds$. Then $\|P_W^{N,M}(Dw)\|_1^2 = \int_{-r}^0 \left\| \sum_{i=1}^M \xi_i^M \chi_i^M \right\|_X^2 ds =$

$$\sum_{i=1}^M \int_{t_i^M}^{t_{i-1}^M} \|\xi_i^M\|_X^2 ds = \sum_{i=1}^M \alpha_i^M \|\xi_i^M\|_X^2. \text{ For } w \in W,$$

$$\|w\|_1^2 = \int_{-r}^0 \|w(s)\|_X^2 ds \leq \frac{1}{g_\alpha(-r)} \int_{-r}^0 g_\alpha(s) \|w(s)\|_X^2 ds = \frac{1}{g_\alpha(-r)} \|w\|_W^2,$$

and so, for all j ,

$$\alpha_j^M \|\xi_j^M\|_X^2 \leq \|P_W^{N,M}(Dw)\|_1^2 \leq \frac{1}{g_\alpha(-r)} \|P_W^{N,M}(Dw)\|_W^2 \leq \frac{1}{g_\alpha(-r)} \|Dw\|_W^2.$$

Thus, for $s \in [t_j^M, t_{j-1}^M)$, $\|\xi_j^M\|_X^2 (s - t_j^M)^2 \leq (\alpha_j^M)^2 \|\xi_j^M\|_X^2 \leq \frac{r}{g_\alpha(-r)} \|Dw\|_W^2$.

Hence,

$$S_2 \leq \sum_{i \in \Lambda_2^M} \frac{r}{g_\alpha(-r)} \|Dw\|_W^2 \int_{t_i^M}^{t_{i-1}^M} g_\alpha(s) ds \leq \frac{r \|Dw\|_W^2 C}{g_\alpha(-r) M^{\epsilon_2}} \rightarrow 0 \text{ as } M \rightarrow \infty,$$

and so $\|w - i^{N,M} \widehat{w}^{N,M}\|_W \rightarrow 0$ as $N, M \rightarrow \infty$. Thus, from (3.13) it follows that

$\|w^{N,M} - i^{N,M} \widehat{w}^{N,M}\|_W \rightarrow 0$ as $N, M \rightarrow \infty$. Therefore,

$$\begin{aligned} \|w - w^{N,M}\|_W &\leq \|w - i^{N,M} \widehat{w}^{N,M}\|_W \\ &\quad + \|i^{N,M} \widehat{w}^{N,M} - w^{N,M}\|_W \rightarrow 0 \text{ as } N, M \rightarrow \infty. \quad \blacksquare \end{aligned}$$

LEMMA 3.7. For $\lambda > 0$, $\int_{-r}^0 g_\alpha(s) |e^{\lambda s} - e^M(\lambda, s)| ds \rightarrow 0$ as $M \rightarrow \infty$.

PROOF: By definition of $e^M(\lambda, s)$,

$$\int_{-r}^0 g_\alpha(s) |e^{\lambda s} - e^M(\lambda, s)| ds = \sum_{i=1}^M \int_{t_i^M}^{t_{i-1}^M} g_\alpha(s) \left| e^{\lambda s} - \prod_{j=1}^i (1 + \alpha_j^M \lambda)^{-1} \right| ds$$

$= S_1 + S_2$. Let $\epsilon > 0$, and choose M_0 large enough that if $M \geq M_0$, then $\frac{2C}{M\epsilon_2} < \epsilon$,

$e^{\lambda(\tau/M^{(1+\epsilon_1)/2})} - 1 < \frac{\epsilon}{2}$ and $\frac{(r\lambda)^2 e^{r\lambda}}{2M\epsilon_1} < \frac{\epsilon}{2}$. For $M \geq M_0$,

$$S_2 \leq 2 \sum_{i \in \Lambda_2^M} \int_{t_i^M}^{t_{i-1}^M} g_\alpha(s) ds \leq \frac{2C}{M\epsilon_2} < \epsilon.$$

Let $\Lambda_1^M = \{1, 2, \dots, n\}$ and suppose $s \in [t_n^M, 0]$. Then for some $i \in \Lambda_1^M$, $t_i^M \leq s \leq t_{i-1}^M$

which implies that $e^{\lambda t_i^M} \leq e^{\lambda s} \leq e^{\lambda t_{i-1}^M}$, so $0 \leq e^{\lambda s} - e^{\lambda t_i^M} \leq e^{\lambda t_i^M} (e^{\lambda \alpha_i^M} - 1) < \frac{\epsilon}{2}$.

But, $t_i^M = -\sum_{j=1}^i \alpha_j^M$ which implies

$$\begin{aligned} \left| e^{\lambda t_i^M} - \prod_{j=1}^i (1 + \alpha_j^M \lambda)^{-1} \right| &= \left| \prod_{j=1}^i e^{-\lambda \alpha_j^M} - \prod_{j=1}^i (1 + \alpha_j^M \lambda)^{-1} \right| \\ &\leq \left| \prod_{j=1}^i (1 + \alpha_j^M \lambda) - \prod_{j=1}^i e^{\lambda \alpha_j^M} \right|. \end{aligned}$$

Now, $e^{\lambda \alpha_j^M} = (1 + \lambda \alpha_j^M) + \frac{1}{2} e^{\lambda \xi_j} (\lambda \alpha_j^M)^2$ for some ξ_j between 0 and α_j^M . Set $a_j =$

$(1 + \lambda\alpha_j^M)$ and $b_j = \frac{1}{2}e^{\lambda\xi_j} (\lambda\alpha_j^M)^2$. Then

$$\left| \prod_{j=1}^i (1 + \alpha_j^M \lambda) - \prod_{j=1}^i e^{\lambda\alpha_j^M} \right| = \left| \prod_{j=1}^i a_j - \prod_{j=1}^i (a_j + b_j) \right|.$$

By induction, $\prod_{j=1}^i a_j - \prod_{j=1}^i (a_j + b_j) = -\sum_{j=1}^i b_j \prod_{k=j+1}^i (a_k + b_k) \prod_{l=1}^{j-1} a_l$. Thus,

$$\begin{aligned} \left| \prod_{j=1}^i (1 + \alpha_j^M \lambda) - \prod_{j=1}^i e^{\lambda\alpha_j^M} \right| &= \sum_{j=1}^i \frac{1}{2} e^{\lambda\xi_j} (\lambda\alpha_j^M)^2 \prod_{k=j+1}^i e^{\lambda\alpha_k^M} \prod_{l=1}^{j-1} (1 + \alpha_l^M \lambda) \\ &\leq \frac{1}{2} e^{\lambda r} \sum_{j=1}^i (\lambda\alpha_j^M)^2 \leq \frac{1}{2} e^{\lambda r} \cdot M \cdot \left(\frac{\lambda r}{M(1+\epsilon_1)/2} \right)^2 = \frac{e^{\lambda r} (\lambda r)^2}{2M\epsilon_1} < \frac{\epsilon}{2}, \end{aligned}$$

since $e^{\lambda\xi_j} \prod_{k=j+1}^i e^{\lambda\alpha_k^M} \prod_{l=1}^{j-1} (1 + \alpha_l^M \lambda) \leq e^{\lambda\alpha_j^M} \prod_{k=j+1}^i e^{\lambda\alpha_k^M} \prod_{l=1}^{j-1} e^{\lambda\alpha_l^M} = e^{\lambda t_i^M} \leq e^{\lambda r}$. Hence,

$$\begin{aligned} S_1 &\leq \sum_{i \in \Lambda_1^M} \int_{t_i^M}^{t_{i-1}^M} g_\alpha(s) \left[\left| e^{\lambda s} - e^{\lambda t_i^M} \right| + \left| e^{\lambda t_i^M} - \prod_{j=1}^i (1 + \alpha_j^M \lambda)^{-1} \right| \right] ds \\ &\leq \epsilon \sum_{i=1}^M \int_{t_i^M}^{t_{i-1}^M} g_\alpha(s) ds = \epsilon \int_{-r}^0 g_\alpha(s) ds. \quad \blacksquare \end{aligned}$$

We are now ready to prove the main result of this section.

THEOREM 3.8. *For all $z \in Z$, $e^{A^{N,M}t} P_Z^{N,M} z \rightarrow S(t)z$ as $N, M \rightarrow \infty$, uniformly on bounded t -intervals.*

PROOF: As remarked above, we have only to establish (H2) of Theorem 3.1. Furthermore, it is sufficient to show that $x^N \rightarrow x$. If we define the bilinear forms $\mu(\cdot, \cdot)$ on X by $\mu(x_1, x_2) = \lambda^2 \langle j^{-1}x_1, j^{-1}x_2 \rangle_Y + \alpha_\lambda \langle x_1, x_2 \rangle_X$ (it is easy to verify that $\mu(x_1, x_2) = \langle \Delta(\lambda)x_1, x_2 \rangle_Y$ if $x_1 \in \mathcal{D}(A)$), and $\mu^M(\cdot, \cdot)$ on X^N by $\mu^M(x_1, x_2) =$

$\langle \Delta^{N,M}(\lambda)x_1, j^{-1}x_2 \rangle_Y$, then for $x_1, x_2 \in X^N$,

$$|\mu^M(x_1, x_2) - \mu(x_1, x_2)| \leq \left(\int_{-\tau}^0 g_\alpha(s) |e^{\lambda s} - e^M(\lambda, s)| ds \right) \|x_1\|_X \cdot \|x_2\|_X, \quad (3.14)$$

and for $x \in X^N$,

$$\mu^M(x, x) = \lambda^2 \|j^{-1}x\|_Y^2 + \alpha_\lambda \|x\|_X^2. \quad (3.15)$$

By (3.5), we have for all $u \in X$,

$$\begin{aligned} \mu(x, u) &= \langle \psi + \lambda j^{-1}\varphi, j^{-1}u \rangle_Y \\ &\quad + \sigma \left(j^{-1} \int_{-\tau}^0 g_\alpha(s) (\lambda I - D)^{-1} (\varphi - h(s)) ds, j^{-1}u \right), \end{aligned}$$

and by (3.12), for all $u^N \in X^N$,

$$\begin{aligned} \mu^M(x^N, u^N) &= \langle \psi^N + \lambda j^{-1}\varphi^N, j^{-1}u^N \rangle_Y \\ &\quad + \sigma \left(j^{-1} \int_{-\tau}^0 g_\alpha(s) (\lambda I - D^{N,M})^{-1} (\varphi^N - h^{N,M}(s)) ds, j^{-1}u^N \right). \end{aligned}$$

Let $\hat{x}^N = P_X^N x$. Then, taking $u = u^N = \hat{x}^N - x^N$ in the above two equations, we get

$$\begin{aligned} &\mu^M(\hat{x}^N - x^N, \hat{x}^N - x^N) \\ &\leq |\mu^M(\hat{x}^N - x, \hat{x}^N - x^N)| + |\mu^M(x, \hat{x}^N - x^N) - \mu(x, \hat{x}^N - x^N)| \\ &\quad + \|\psi - \psi^N\|_Y \cdot \|j^{-1}\| \cdot \|\hat{x}^N - x^N\|_X + \lambda \|j^{-1}\|^2 \cdot \|\varphi - \varphi^N\|_X \cdot \|\hat{x}^N - x^N\|_X \\ &\quad + \int_{-\tau}^0 g_\alpha(s) \left\| (\lambda I - D)^{-1} (\varphi - h) \right. \\ &\quad \quad \left. - (\lambda I - D^{N,M})^{-1} P_W^{N,M} (\varphi - h) \right\|_X ds \cdot \|\hat{x}^N - x^N\|_X. \end{aligned}$$

If we set $\alpha_\lambda^M = \frac{1}{\alpha} \left(\tau + \int_{-\tau}^0 g(s) e^M(\lambda, s) ds \right)$, then by Lemma 3.7, $\alpha_\lambda^M > 0$ for M large enough. Estimating the right-hand side of the above equation and using (3.14) and

from (3.15) the fact that $\alpha_\lambda \|\widehat{x}^N - x^N\|_X^2 \leq \mu^M(\widehat{x}^N - x^N, \widehat{x}^N - x^N)$, we get

$$\begin{aligned} & \|\widehat{x}^N - x^N\|_X \\ & \leq \frac{1}{\alpha_\lambda} \left[(\lambda^2 \|j^{-1}\|^2 + \alpha_\lambda^M) \|\widehat{x}^N - x\|_X + \left(\int_{-r}^0 g_\alpha(s) |e^{\lambda s} - e^M(\lambda, s)| \right) \|x\|_X \right. \\ & \quad + \|j^{-1}\| \cdot \|\psi - \psi^N\|_Y + \lambda \|j^{-1}\|^2 \cdot \|\varphi - \varphi^N\|_X + \left(\int_{-r}^0 g_\alpha(s) ds \right)^{1/2} \\ & \quad \cdot \left. \left\| (\lambda I - D)^{-1}(\varphi - h) - (\lambda I - D^{N,M})^{-1} P_W^{N,M}(\varphi - h) \right\|_W \right] \rightarrow 0 \end{aligned}$$

as $N, M \rightarrow \infty$ by Lemmas 3.6 and 3.7, so $\|x - x^N\|_X \rightarrow 0$ as $N, M \rightarrow \infty$. ■

We are interested in applying this approximation scheme to the optimal LQR problem, but it is well known that convergence of the forward problem (i.e., Theorem 3.8) is not sufficient to ensure convergence of the gain functionals (see [G], [BIP]). Convergence of the adjoint semigroups as well as other properties (uniform stabilizability, etc.) play a central role in the development of convergent methods for LQR problems. If $g(\cdot) \in L^2(-r, 0)$ then Z can be re-normed by using the weight $e(s) \equiv 1$ in place of $g(s)$. If Z_e denotes the resulting equivalent space, one can establish the following adjoint convergence (see [M] for a proof).

THEOREM 3.9. *If $g(s) \in L^2(-r, 0)$, then for each $z \in Z_e$,*

$$e^{[A^{N,M}]^* t} P_{Z_e}^{N,M} z \rightarrow S^*(t)z \quad \text{as } N, M \rightarrow \infty.$$

Moreover, this convergence is uniform on bounded t -intervals.

Recently, K. Ito has announced [I] a proof of this result that does not require the additional assumption that $g(\cdot) \in L^2(-r, 0)$. In general, the question of preservation

of stabilizability uniformly under these approximations is not answered. However, for certain special forms of $g(\cdot)$ and for problems with additional damping terms (Kelvin-Voigt), one can establish uniform stabilizability. More will be said about this problem in the next section.

4. Numerical Results. We turn now to an optimal control problem governed by the basic thermo-elastic equations with viscoelastic and Kelvin-Voigt damping terms.

For a rod of length 1 the equations of motion become

$$\rho c \frac{\partial^2}{\partial t^2} y(t, x) = \frac{\partial}{\partial x} \left[(\lambda + 2\mu) \frac{\partial}{\partial x} y(t, x) + \frac{1}{b} \int_{-r}^0 g(s) \frac{\partial}{\partial x} y(t + s, x) ds - \beta \frac{\partial^2}{\partial t \partial x} y(t, x) \right] - \alpha(3\lambda + 2\mu) \frac{\partial}{\partial x} \theta(t, x) + b(x)u(t) \quad (4.1)$$

$$\rho c \frac{\partial}{\partial t} \theta(t, x) = \kappa \frac{\partial^2}{\partial x^2} \theta(t, x) - \theta_0 \alpha(3\lambda + 2\mu) \frac{\partial^2}{\partial t \partial x} y(t, x) \quad (4.2)$$

where for $0 < \beta < +\infty$, the term $\beta \frac{\partial^3}{\partial t \partial x^2} y(t, x)$ provides Kelvin-Voigt damping. If $\beta = 0$ and $g(s) = 0$, then (4.1) - (4.2) become the classical equations of thermo-elasticity. If $g(s) \neq 0$ satisfies Hypothesis 2.3, then the integral term provides a type of “viscoelastic damping” to the system.

Gibson, Rosen and Tau [GRT] considered the problem with $g(s) \equiv 0$ and with Dirichlet boundary conditions on displacement and Neumann boundary conditions on the temperature. In this case it can be shown that the thermo-elastic model (i.e., $\beta = 0$ and $g(s) \equiv 0$) has zero as an exponentially stable equilibrium, provided of course that one subtracts out the constant temperature distribution. Moreover, the elastic and thermal modes decouple, and one can use modal expansions in analyzing

this system. Therefore, if $\beta = 0$ and $g(s) = 0$, then (4.1) – (4.2) with Dirichlet-Neumann boundary conditions is exponentially stabilizable (again, after “subtracting” the constant temperature states), and the standard LQR control problem has a unique solution. The same clearly holds for the corresponding systems with $\beta \neq 0$ and $g(s) \neq 0$.

We shall consider the more complex problem governed by (4.1) – (4.2) with Dirichlet boundary conditions on displacement and temperature. In particular, we impose the boundary conditions

$$y(t, 0) = y(t, 1) = 0 = \theta(t, 0) = \theta(t, 1). \quad (4.3)$$

If $\beta > 0$, then (4.1) – (4.3) is exponentially stable. If $\beta = 0$ and $g(s)$ satisfies the basic assumptions in Section 2 with

$$\epsilon_0 = (\lambda + 2\mu) + \frac{1}{b} \int_{-r}^0 g(s) ds > 0, \quad (4.4)$$

then it is known that (4.1) – (4.3) has zero as a globally asymptotically stable equilibrium (see [W, pp. 203–210]). It is important to observe that, in general, results of this type do not extend to problems in two or more space dimensions. If $\beta = 0$ then it is still not known if (4.1) – (4.3) is exponentially stable. There are positive results for infinite delay problems with completely monotone kernels $g(\cdot)$ (see [HW]).

Recently Hanson [H] has shown that for $\beta = 0$ and $g(s) = 0$, the open loop eigenvalues of (4.1) – (4.2) are bounded away from the imaginary axis. However, the eigenfunctions for this problem do not form a Riesz basis for the natural state space,

and hence the question of exponential stability remains unresolved.

These theoretical issues can have considerable impact on computational algorithms and need to be addressed in order to complete the convergence theory for control applications. Some progress has been made for the thermo-viscoelastic problem with kernels of the form

$$g(s) = -e^{qs}/p\sqrt{-s}, \quad (4.5)$$

for $q > 0$, $p > 0$ (see [L]), although no results exist for the classical thermo-elastic model $\beta = 0$, $g(s) = 0$. In summary, if $\beta > 0$ or $g(\cdot)$ has the form (4.5) with (4.4) satisfied, then (4.1) - (4.3) is exponentially stable (hence stabilizable), and if $\beta = 0 = g(s)$, it is not known if (4.1) - (4.3) is stabilizable.

We shall present several numerical experiments for LQR control of (4.1) - (4.3) with various values of β and b when $g(\cdot)$ is given by (4.5). The numerical constants are chosen to be the same as used in [GRT] for an aluminum rod of length 1. In particular,

$$\begin{aligned} \rho &= 9.82 \times 10^{-2}, & \lambda &= 2.06 \times 10^{-1}, \\ \mu &= 1.11 \times 10^{-1}, & \alpha &= 1.29 \times 10^{-3}, \\ c &= 5.40 \times 10^{-1}, & \kappa &= 7.02 \times 10^{-7}, \\ \theta_0 &= 68, & q &= 30, \\ p &= 1, & r &= 1. \end{aligned}$$

Observe that for these values, the constant $\gamma = \alpha(3\lambda + 2\mu)$ takes the value 1.085×10^{-3} , and hence the coupling between (2.1) - (2.2) is "small." Note also that the kernel

(4.5) has a weak singularity at $s = 0$. We selected constants $\beta = 1.8 \times 10^{-7}$ and $b = 6.0 \times 10^4$ so that the first elastic mode has open-loop damping of the same order of magnitude as the classical thermo-elastic model. The control input function $b(x)$ is given by

$$b(x) = \begin{cases} 1, & .4 \leq x \leq .435; \\ 0, & \text{elsewhere,} \end{cases}$$

and is the same as used in [GRT].

The LQR problem for the system (4.1) - (4.3) is to choose a control function $u_0(t)$ to minimize

$$\mathcal{J} = \int_0^\infty [\mathcal{E}^2(t) + u^2(t)] dt \quad (4.6)$$

where $\mathcal{E}(t)$ is defined by

$$\mathcal{E}(t) = \left\{ \rho \int_0^1 \left[\frac{\partial}{\partial t} y(t, x) \right]^2 dx + \epsilon_0 \int_0^1 \left[\frac{\partial}{\partial x} y(t, x) \right]^2 dx + \frac{1}{\theta_0} \int_0^1 [\theta(t, x)]^2 dx \right\}^{1/2}, \quad (4.7)$$

and $y(t, x)$, $\theta(t, x)$ is the solution to (4.1) - (4.3) with initial data

$$\begin{aligned} y(0, x) &= y_0(x), \quad \frac{\partial}{\partial t} y(0, x) = v_0(x), \quad \theta(0, x) = T_0(x) \\ y(0, x) - y(s, x) &= w_0(s, x). \end{aligned} \quad (4.8)$$

For $g(s)$ defined by (4.5) and $b > 0$ such that (4.4) holds, there exists a unique optimal control law in feedback form

$$\begin{aligned} u_0(t) &= \epsilon_0 \int_0^1 \frac{d}{dx} K_1(x) \frac{\partial}{\partial x} y(t, x) dx + \rho \int_0^1 K_2(x) \frac{\partial}{\partial t} y(t, x) dx + \frac{1}{\theta_0} \int_0^1 K_3(x) \theta(t, x) dx \\ &\quad - \frac{1}{b} \int_{-r}^0 \int_0^1 \left[\frac{\partial}{\partial x} K_4(s, x) \right] \left[\frac{\partial}{\partial x} y(s, x) - \frac{\partial}{\partial x} y(t + s, x) \right] g(s) dx ds. \end{aligned} \quad (4.9)$$

If $g(s) = 0$ and $\beta > 0$, then again there exists a unique optimal control law in feedback form (4.9) with $g(s) = 0 = K_4(s, x)$. If $\beta = 0$ and $g(s) = 0$, then the most one can say is that if an optimal control exists, then it will have the form (4.9) with $g(s) = 0 = K_4(s, x)$. The existence of the optimal control has not yet been established. We had hoped that the numerical results presented below would shed some light on this question. However, as will become evident from these numerical experiments, we seem to have raised more questions than we have answered.

The objective of the computational scheme is to produce numerical approximations of the optimal functional gains $K_1(\cdot)$, $K_2(\cdot)$, $K_3(\cdot)$ and $K_4(\cdot, \cdot)$. In particular, the general idea is to introduce an approximation method (such as in Section 3), and then to use this method to compute approximating (sub-optimal) gains $K_1^N(\cdot)$, $K_2^N(\cdot)$, $K_3^N(\cdot)$ and $K_4^N(\cdot, \cdot)$. The basic questions are *i*) Do the optimal gains exist? and *ii*) Does the particular approximation scheme lead to convergence of the sub-optimal gains; i.e., does $K_i^N(\cdot) \rightarrow K_i(\cdot)$, $i = 1, 2, 3, 4$ as $N \rightarrow \infty$?

The computational results presented below are based on the numerical approximation scheme presented in Section 3. We used the non-uniform mesh as described by Example 3.3 for the thermo-viscoelastic model. In particular, all runs presented below were based on $M = 8$ subdivisions of $[-1, 0]$, and the corresponding approximating finite dimensional system becomes

$$\dot{z}^N(t) = \mathcal{A}^{N,8} z^N(t) + \mathcal{B}^{N,8} u(t) \quad (4.10)$$

where $\mathcal{B}^{N,8} = P_Z^{N,8} \mathcal{B}$ and $\mathcal{B} : \mathbf{R}^1 \rightarrow Z$ is defined by $\mathcal{B}u = (0, b(x)u, 0, 0)^T$. The results are the same for $M = 16$ sub-divisions of $[-1, 0]$ (a nice feature of the non-uniform mesh algorithm).

In the cases where $i)$ holds, Theorems 3.8 and 3.9 imply convergence of the functional gains provided one can establish that this scheme preserves stabilizability uniformly in N (see [G]). For the thermo-viscoelastic model with $g(\cdot)$ given by (4.5) and the thermo-elastic model with $\beta > 0$, preservation of stabilizability can be shown.

In order to see the effect of the damping models on the open-loop system, in Figure 1 we plot the open-loop poles for the first 8 elastic modes using only thermal damping (i.e., $\beta = 0, g(s) = 0$), thermo-viscoelastic damping ($\beta = 0, g(s)$ given by (4.5) and $b = 6.0 \times 10^4$) and Kelvin-Voigt damping ($\beta = 1.8 \times 10^{-7}$), respectively. Observe that the damping is extremely small in all three cases. On the other hand, Table 1 shows that at the higher frequencies the damping provided by the thermo-viscoelastic model is an order of magnitude more than the thermo-elastic model, and the damping predicted by the Kelvin-Voigt model is two orders of magnitude greater than the thermo-elastic model.

Elastic Mode	Thermo-Elastic $\beta = 0 = g(s)$	Thermo-Viscoelastic $b = 6.0 \times 10^4$	Kelvin-Voigt $\beta = 1.8 \times 10^{-7}$
1	$-0.0000054 + 6.58i$	$-0.0000091 + 6.58i$	$-0.0000093 + 6.58i$
2	$-0.0000060 + 13.17i$	$-0.0000184 + 13.17i$	$-0.0000216 + 13.17i$
3	$-0.0000071 + 19.79i$	$-0.0000325 + 19.79i$	$-0.0000423 + 19.79i$
4	$-0.0000086 + 26.47i$	$-0.0000501 + 26.47i$	$-0.0000715 + 26.47i$
5	$-0.0000106 + 33.20i$	$-0.0000699 + 33.20i$	$-0.0001095 + 33.20i$
6	$-0.0000129 + 40.02i$	$-0.0000905 + 40.02i$	$-0.0001566 + 40.02i$
7	$-0.0000157 + 46.93i$	$-0.0001113 + 46.93i$	$-0.0002133 + 46.93i$
8	$-0.0000189 + 53.95i$	$-0.0001317 + 53.95i$	$-0.0002800 + 53.95i$
9	$-0.0000224 + 61.10i$	$-0.0001514 + 61.10i$	$-0.0003574 + 61.10i$
10	$-0.0000263 + 68.39i$	$-0.0001705 + 68.39i$	$-0.0004460 + 68.39i$
15	$-0.0000491 + 107.5i$	$-0.0002565 + 107.5i$	$-0.0010866 + 107.5i$
20	$-0.0000662 + 151.5i$	$-0.0003257 + 151.5i$	$-0.0021294 + 151.5i$

TABLE 1. OPEN LOOP POLES; SMALL DAMPING

We also considered cases where $b = 6.0 \times 10^2$, $b = 6.0 \times 10^1$ and $\beta = 1.8 \times 10^{-5}$, $\beta = 1.8 \times 10^{-4}$. The models with $\beta = 0$ and $b = 6.0 \times 10^2$ and $\beta = 1.8 \times 10^{-4}$, $g(s) = 0$ show considerable increases in open-loop damping (especially at the higher modes) as illustrated in Table 2.

Elastic Mode	Thermo-Elastic $\beta = 0 = g(s)$	Thermo-Viscoelastic $b = 6.0 \times 10^2$	Kelvin-Voigt $\beta = 1.8 \times 10^{-5}$
1	-0.0000054 + 6.58i	-0.0003812 + 6.57i	-0.0003934 + 6.58i
2	-0.0000060 + 13.17i	-0.0012388 + 13.16i	-0.0015617 + 13.17i
3	-0.0000071 + 19.79i	-0.0025453 + 19.78i	-0.0035214 + 19.79i
4	-0.0000086 + 26.47i	-0.0041601 + 26.45i	-0.0062913 + 26.47i
5	-0.0000106 + 33.20i	-0.0059423 + 33.19i	-0.0098982 + 33.20i
6	-0.0000129 + 40.02i	-0.0077757 + 40.00i	-0.0143768 + 40.02i
7	-0.0000157 + 46.93i	-0.0095789 + 46.91i	-0.0197699 + 46.93i
8	-0.0000189 + 53.95i	-0.0113034 + 53.93i	-0.0261290 + 53.95i
9	-0.0000224 + 61.10i	-0.0129269 + 61.08i	-0.0335142 + 61.10i
10	-0.0000263 + 68.39i	-0.0144449 + 68.37i	-0.0419944 + 68.39i
15	-0.0000491 + 107.5i	-0.0207916 + 107.5i	-0.1038004 + 107.5i
20	-0.0000662 + 151.5i	-0.0260228 + 151.5i	-0.2063817 + 151.5i

TABLE 2. OPEN LOOP POLES; MEDIUM DAMPING

The LQR problem for the approximating system (4.10) is solved (by Potter's method) and approximating functional gains $K_1^N(\cdot)$, $K_2^N(\cdot)$, $K_3^N(\cdot)$ and $K_4^N(\cdot, \cdot)$ are constructed by the standard Galerkin scheme (see [M] for details). Convergence of these sub-optimal functional gains as $N \rightarrow \infty$ to the optimal gains can be established for $\beta > 0$ and $g(s) = 0$ by methods similar to those in [G]. If $g(s)$ is defined by (4.5), then this convergence can be established by a modification of Ito's recent results [I]. Nothing is known about the classical thermo-elastic problem. We treat this problem numerically.

Example 4.1. In this problem we set $g(s) = 0 = \beta$ and compute the gains $K_1^N(\cdot)$,

$K_2^N(\cdot)$ and $K_3^N(\cdot)$. Note that the finite dimensional system (4.10) is exponentially stable (all open-loop poles are in the left half plane) so that these sub-optimal functional gains do exist. Figures 2, 3 and 4 contain the plots of $K_i^N(\cdot)$, $i = 1, 2, 3$ for $N = 24, 28, 32$ and 36 . Although these plots are similar to those found in [GRT], and for the boundary conditions in [GRT] one can prove convergence of the gains, it is not clear from Figures 3 - 4 that these gains are converging. We will return to this issue later.

Example 4.2. In this problem we consider the thermo-viscoelastic problem defined by $\beta = 0$ and $b = 6.0 \times 10^1$, $b = 6.0 \times 10^2$. Figures 5, 6 and 7 contain the plots of $K_i^N(\cdot)$, $i = 1, 2, 3$ for $N = 24, 28, 32$ and 36 where $b = 6.0 \times 10^1$. Figures 8, 9 and 10 contain the same plots for $b = 6.0 \times 10^2$. Observe three important features: *i*) For $b = 6.0 \times 10^1$ the system is more heavily damped than for $b = 6.0 \times 10^2$; *ii*) the functional gains for the case $b = 6.0 \times 10^1$ are smoother than for $b = 6.0 \times 10^2$; and *iii*) the convergence of the functional gains is faster in the problem with the most open-loop damping. The plots of $K_4^N(\cdot, \cdot)$ for $b = 6.0 \times 10^1$ and $N = 24, 28, 32$ and 36 are shown in Figures 11 - 14. Note that these gains converge rather rapidly. This was typical of all the thermo-viscoelastic runs.

Example 4.3. In this problem we consider only the thermo-elastic model with Kelvin-Voigt damping so that $g(s) = 0$ and $\beta = 1.8 \times 10^{-4}$ and $\beta = 1.8 \times 10^{-5}$. Figures 15, 16 and 17 contain the plots of $K_i^N(\cdot)$, $i = 1, 2, 3$ for $N = 24, 28, 32$ and 36

for $\beta = 1.8 \times 10^{-4}$, and Figures 18, 19 and 20 show the same plots for $\beta = 1.8 \times 10^{-5}$. Observe that as in Example 4.2 above, the damping affects the smoothness and rate of convergence of the functional gains. Also note that when $\beta = 1.8 \times 10^{-5}$ the first elastic mode has the same damping factor (i.e., open-loop pole is $-0.00039 + 6.58i$) as the problem in Example 4.2 with $b = 6.0 \times 10^2$ (i.e., open-loop pole is $-0.00038 + 6.58i$).

Figures 21, 22 and 23 contain the plots of $K_1^{32}(\cdot)$ for the thermo-elastic and thermo-viscoelastic models and the thermo-elastic model with Kelvin-Voigt damping for various values of b and β . The functional gains for the thermo-viscoelastic problem “converge” to the functional gains for the thermo-elastic problem as $b \rightarrow \infty$. The same convergence applies as the Kelvin-Voigt parameter $\beta \rightarrow 0$. As illustrated in Figure 23, the functional gain $K_1^{32}(\cdot)$ computed by using the thermo-elastic model is the same as the gain computed by using the same model with Kelvin-Voigt damping parameter $\beta = 1.8 \times 10^{-7}$. Likewise, if $b = 6.0 \times 10^4$ in the thermo-viscoelastic model, then the functional gain $K_1^{32}(\cdot)$ is also identical to the gain computed by using the thermo-elastic model. This “basic” observation applies to $K_i^{32}(\cdot)$ for $i = 1, 2, 3$ and for $K_i^{64}(\cdot)$ also. In particular, as shown in Figure 24, the functional gain $K_1^{64}(\cdot)$ computed from the thermo-elastic model is remarkably close to the functional gain computed by adding Kelvin-Voigt damping. Although convergence of the functional gains for the thermo-elastic model with Kelvin-Voigt damping is assured by theory, Figures 23 and 24 illustrate that this convergence can be extremely slow if the damping parameter β is small.

Figures 23 and 24 also raise the possibility that even in the thermo-elastic problem (no structural damping) where there is no proof of convergence, the gains might converge if N is sufficiently large. The jagged nature of $K_i^N(\cdot)$ occurs because of the small damping. Moreover, comparing the open-loop and closed-loop poles, one sees that the optimal feedback law introduces considerable damping at all frequencies.

Figure 25 compares the first 8 open-loop poles (+) to the closed-loop poles (*) for the thermo-elastic model. It is interesting to note that the same pattern holds for all of the higher poles (see Table 3 below), and the thermal damping alone does not appear to be a major aid in controlling the higher modes.

Mode	Open-Loop	Closed-Loop
1	$-0.0000054 + 6.58i$	$-0.1078901 + 6.58i$
2	$-0.0000060 + 13.17i$	$-0.0552142 + 13.17i$
3	$-0.0000071 + 19.79i$	$-0.0792251 + 19.79i$
4	$-0.0000086 + 26.47i$	$-0.0953868 + 26.47i$
5	$-0.0000106 + 33.20i$	$-0.0298920 + 33.20i$
6	$-0.0000129 + 40.02i$	$-0.1097076 + 40.02i$
7	$-0.0000157 + 46.93i$	$-0.0264249 + 46.93i$
8	$-0.0000189 + 53.95i$	$-0.0946583 + 53.95i$
9	$-0.0000224 + 61.10i$	$-0.0742450 + 61.10i$
10	$-0.0000263 + 68.39i$	$-0.0549855 + 68.39i$
15	$-0.0000491 + 107.5i$	$-0.0707290 + 107.5i$
20	$-0.0000662 + 151.5i$	$-0.0731157 + 151.5i$

TABLE 3. OPEN-LOOP VS. CLOSED-LOOP POLES

THERMO-ELASTIC MODEL

As illustrated by Figures 26 and 27, the first 8 closed-loop poles for the moderately damped (Kelvin-Voigt) thermo-elastic and the thermo-viscoelastic models are essentially the same as the corresponding closed-loop poles for the thermo-elastic model.

In view of these numerical results, we first conjectured that although no theoretical results exist to prove the existence of the optimal feedback gain for the classical thermo-elastic model (with boundary conditions (4.3)), existence and convergence of the suboptimal gains do hold. Since the damping for the realistic model is so small, the numerical evidence provided by the previous plots is not strong. In order to test this conjecture we investigated the convergence of the gains for the problem with “artificial” parameters. In particular, we considered the equations in dimensionless form

$$\begin{aligned}\frac{\partial^2}{\partial t^2}y(t, x) &= \frac{\partial^2}{\partial x^2}y(t, x) - \gamma \frac{\partial}{\partial x}\theta(t, x) + b(x)u(t) \\ \frac{\partial}{\partial t}\theta(t, x) &= c^2 \frac{\partial^2}{\partial x^2}\theta(t, x) - c^2 \gamma \frac{\partial^2}{\partial t \partial x}y(t, x)\end{aligned}$$

with $b(x)$ as above and $c^2 = \gamma = 1.0$. The uncontrolled system has considerable damping. The first two elastic modes have eigenvalues $-.0939 + 3.15i$ and $-.4066 + 6.47i$, respectively. The functional gains for this set of parameters are slightly smoother than the corresponding gains for the aluminum rod. Figures 28, 29 and 30 show the “convergence” of these gains for $N = 24, 28, 32$ and 36 . It appears that the scheme may produce convergent gains (at least for $K_1^N(\cdot)$ and $K_3^N(\cdot)$); however, the behaviour of $K_2^N(\cdot)$ is not clear-cut. Based on our numerical experience, we do *conjecture* that

the classical thermo-elastic model with Dirichlet boundary conditions is in fact stabilizable. However, we also conjecture that the computational scheme does not produce convergent gains (we believe that this scheme does not preserve stabilizability uniformly). We have not been able to provide proofs of these conjectures, and we leave them as open problems.

REFERENCES

- [BB] Banks, H. T., and J. A. Burns. "Hereditary Control Problems: Numerical Methods Based on Averaging Approximations." *SIAM J. Control Optimization*, 16, No. 2, (1978), 169–208.
- [BFWIC] Banks, H. T., R. H. Fabiano, Y. Wang, D. J. Inman, and H. Cudney. "Spatial Versus Time Hysteresis in Damping Mechanisms." *27th IEEE Conference on Decision and Control*, 1988, 1674–1677.
- [BK] Banks, H. T., and F. Kappel. "Spline Approximations for Functional Differential Equations." *J. Differential Equations*, 34, (1979), 496–522.
- [B] Brown, A. S., "Materials Get Smarter." *Aerospace America*, March, 1990, 30–36.
- [BCLM] Burns, J. A., E. M. Cliff, Z. Y. Liu, and R. E. Miller. "Control of a Thermoviscoelastic System." *27th IEEE Conference on Decision and Control*, 1988, 1249–1252.
- [BF] Burns, J. A., and R. H. Fabiano. "Feedback Control of a Hyperbolic Partial-Differential Equation with Viscoelastic Damping," LCDS/CCS Report No. 88-5, Brown University, Providence, R.I., February, 1988.
- [BIP] Burns, J. A., K. Ito and G. Propst. "On Nonconvergence of Adjoint Semigroups for Control Systems with Delays." *SIAM J. Control Optimization*, 26, No. 6, (1988), 1442–1454.
- [BMC] Burns, J. A., R. E. Miller, and E. M. Cliff. "Control of a Viscoelastic Shaft with Attached Tip Mass." *26th IEEE Conference on Decision and Control*, 1987, 997–

1001.

- [FI] Fabiano, R. H., and K. Ito. "Semigroup Theory and Numerical Approximation for Equations in Linear Viscoelasticity," LCDS/CCS Report No. 88-12, Brown University, Providence, July, 1988.
- [G] Gibson, J. S. "Linear-Quadratic Optimal Control of Hereditary Differential Systems: Infinite Dimensional Riccati Equations and Numerical Approximations." *SIAM J. Control Optimization*, 21, No. 1, (1983), 95-139.
- [GA] Gibson, J. S. and A. Adamian. "Approximation Theory for LQG Optimal Control of Flexible Structures." ICASE Report No. 88-48, August, 1988, NASA Langley Research Center, Hampton, VA.
- [GRT] Gibson, J. S., I. G. Rosen and G. Tau. "Approximation in Control of Thermoelastic Systems." 1989 IEEE ACC, June 21-23, Pittsburg, PA.
- [HW] Hannsgen, K. B. and R. L. Wheeler. "Uniform L_1 Behavior in Classes of Integro-differential Equations with Completely Monotone Kernels." *SIAM J. Math. Anal.*, 15, (1984), 579-594.
- [H] Hansen, S. W. "Exponential Energy Decay in a Linear Thermoviscoelastic Rod." Preprint.
- [I] Ito, K. Preprint.
- [K] Kato, T. *Perturbation Theory for Linear Operators*. Berlin: Springer-Verlag, 1976.
- [L] Liu, Z. Y. "Approximation and Control of a Thermoviscoelastic System." Ph. D. Dissertation, Virginia Polytechnic Institute and State University, August, 1989.
- [MH] Marsden, J. E., and T. J. R. Hughes. *Mathematical Foundations of Elasticity*. Englewood Cliffs, New Jersey: Prentice-Hall, 1983.
- [M] Miller, R. E. *Approximation of the LQR Control Problem for Systems Governed by Partial Functional Differential Equations*. Ph. D. Dissertation, Virginia Polytechnic Institute and State University, November, 1988.
- [MD] Miller, R. K., and W. Desch. "Exponential Stabilization of Volterra Integral Equa-

tions with Singular Kernels.” to appear.

- [P] Pazy, A. *Semigroups of Linear Operators and Applications to Partial Differential Equations*. New York: Springer, 1983.
- [R] Rudin, W. *Functional Analysis*. New York: McGraw-Hill, 1973.
- [S] Schultz, M. H. *Spline Analysis*. Englewood Cliffs: Prentice-Hall, 1973.
- [W] Walker, J. A., *Dynamical Systems and Evolution Equations*. New York: Plenum Press, 1980.

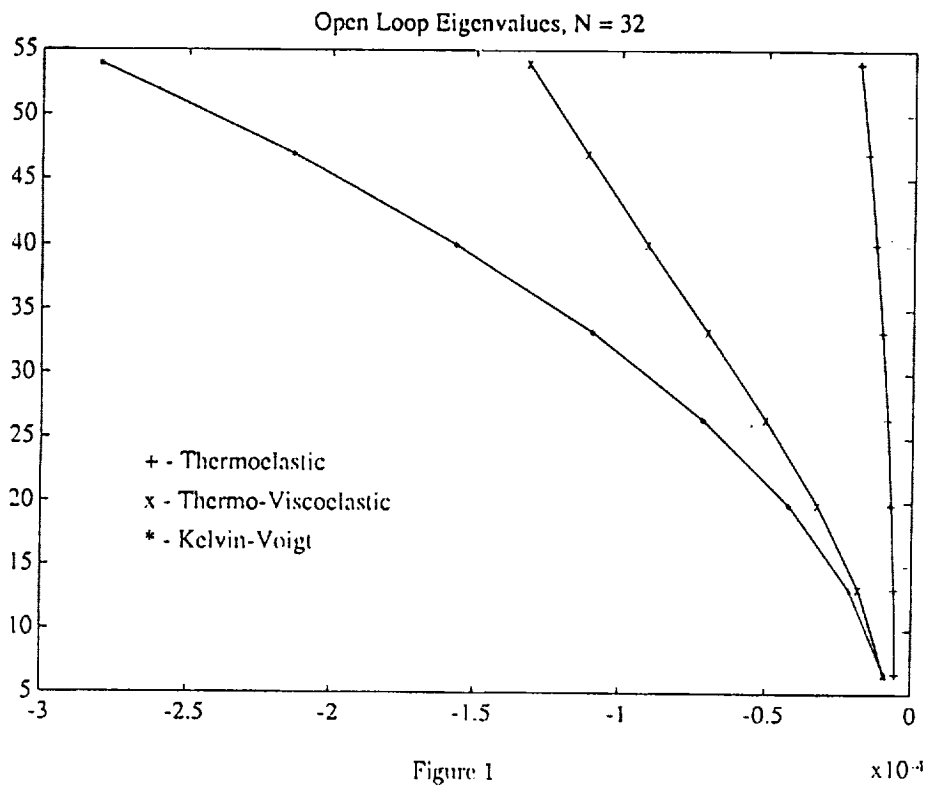

Figure 1

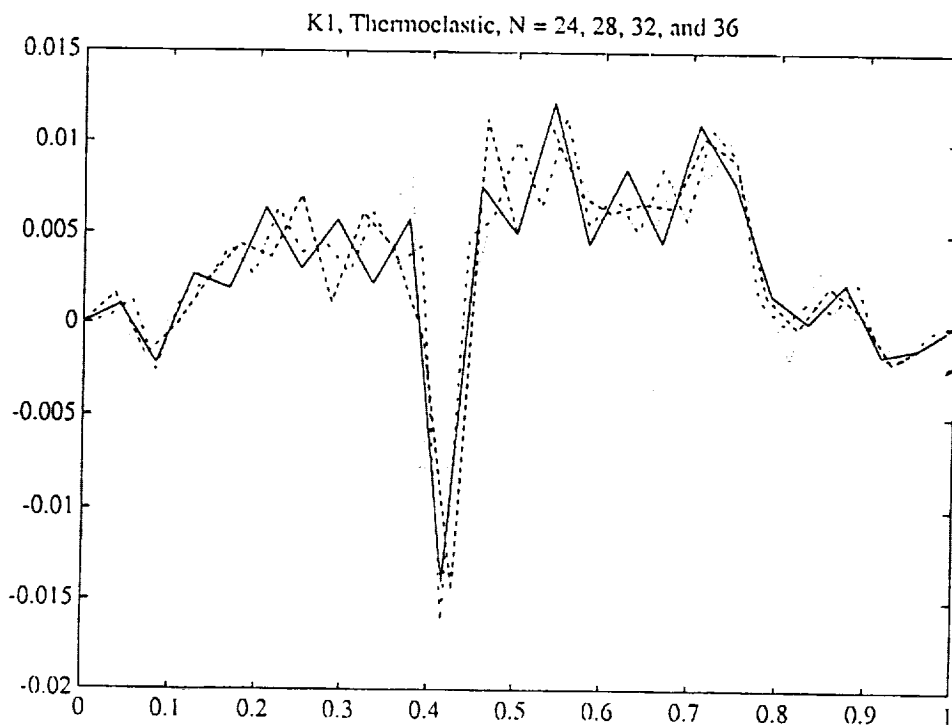

Figure 2

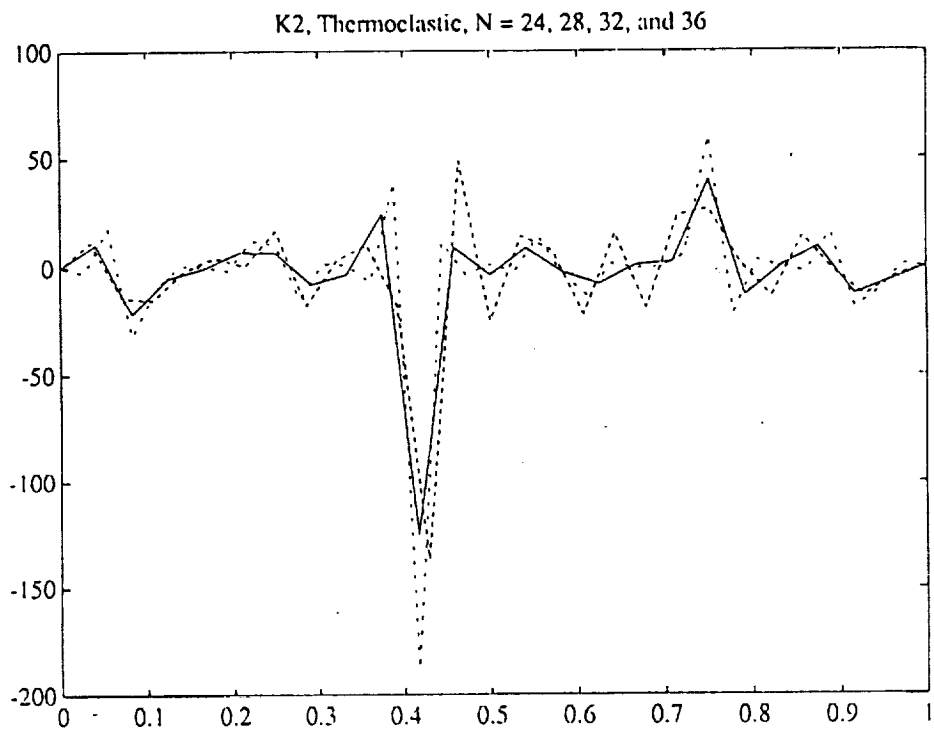

Figure 3

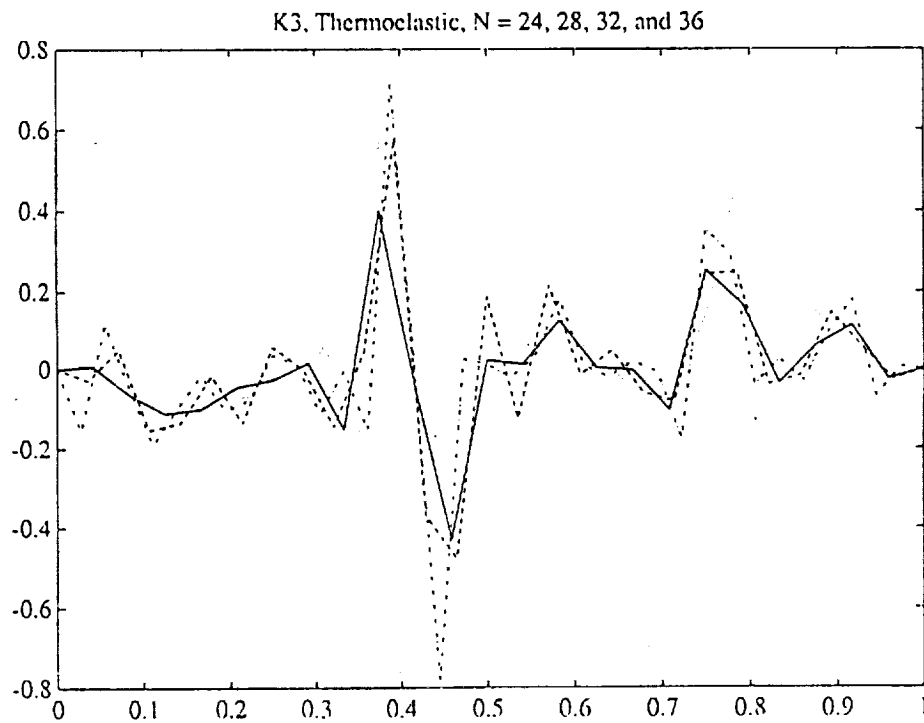

Figure 4

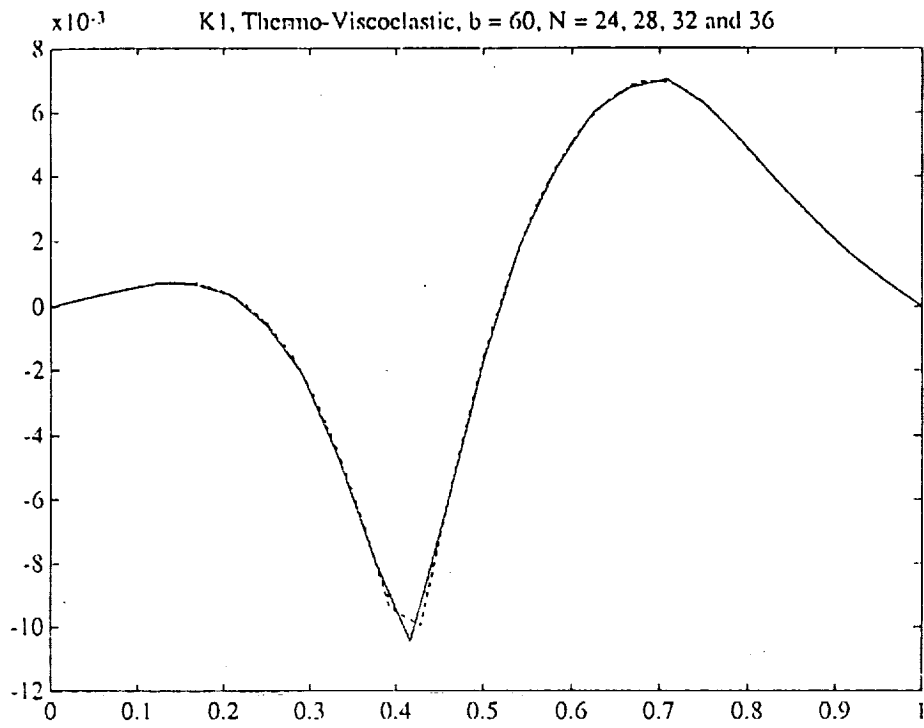

Figure 5

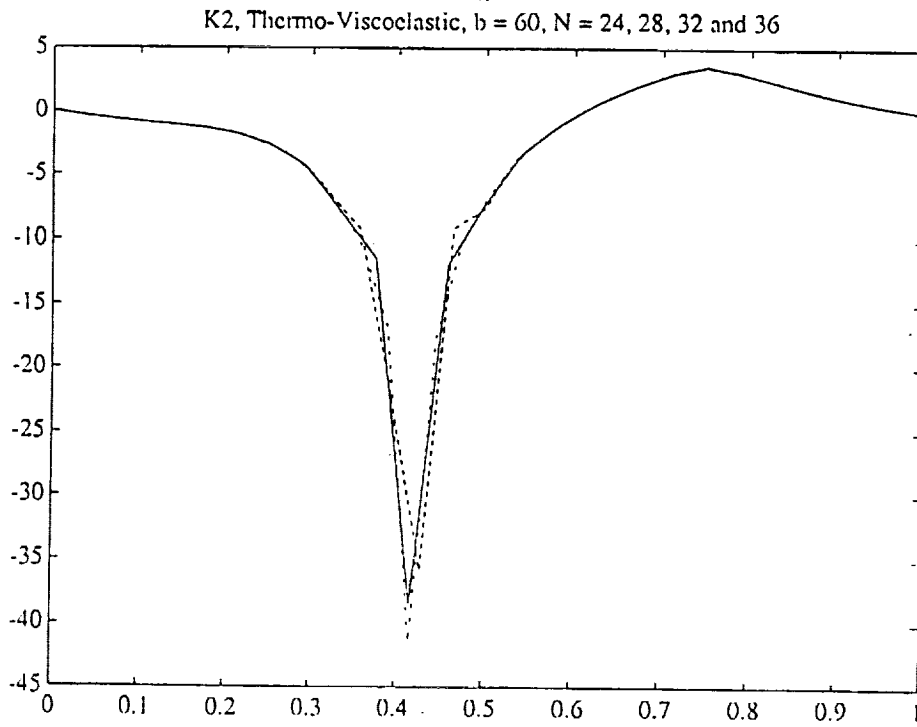

Figure 6

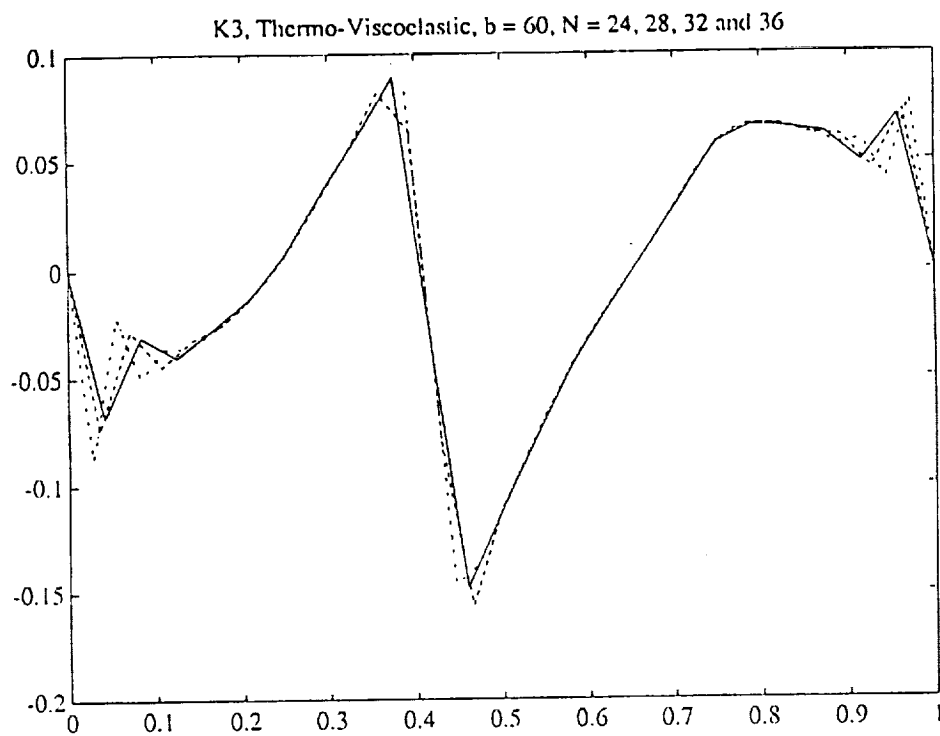

Figure 7

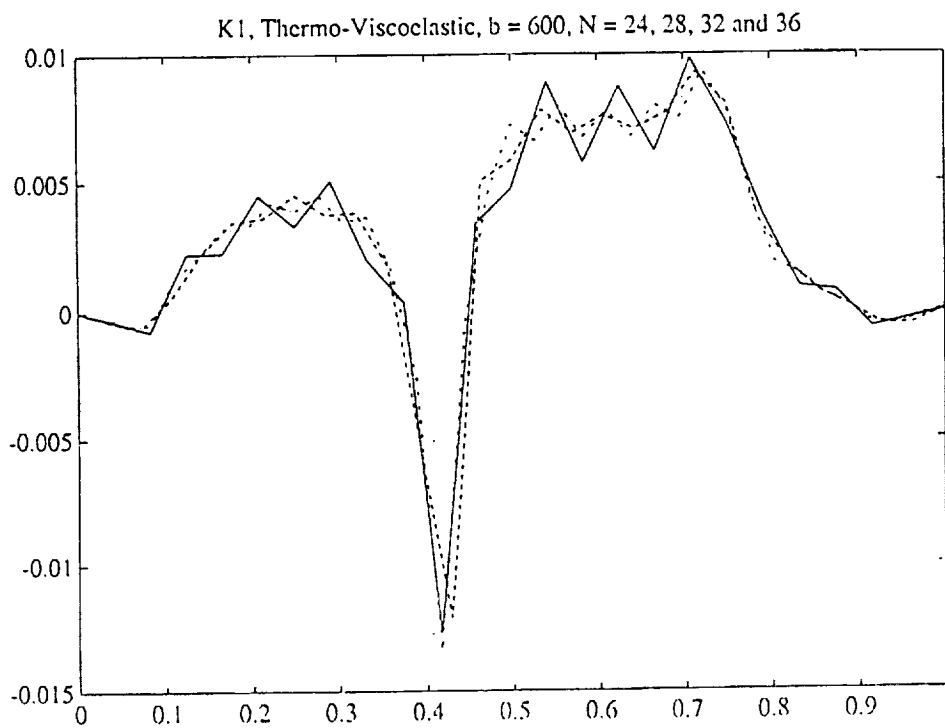

Figure 8

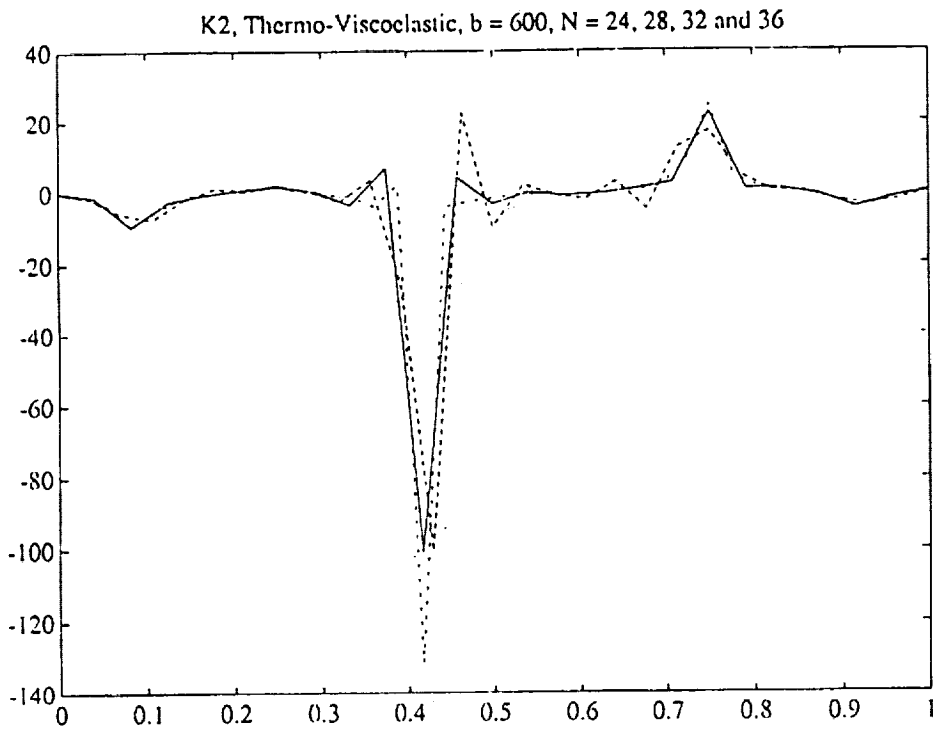

Figure 9

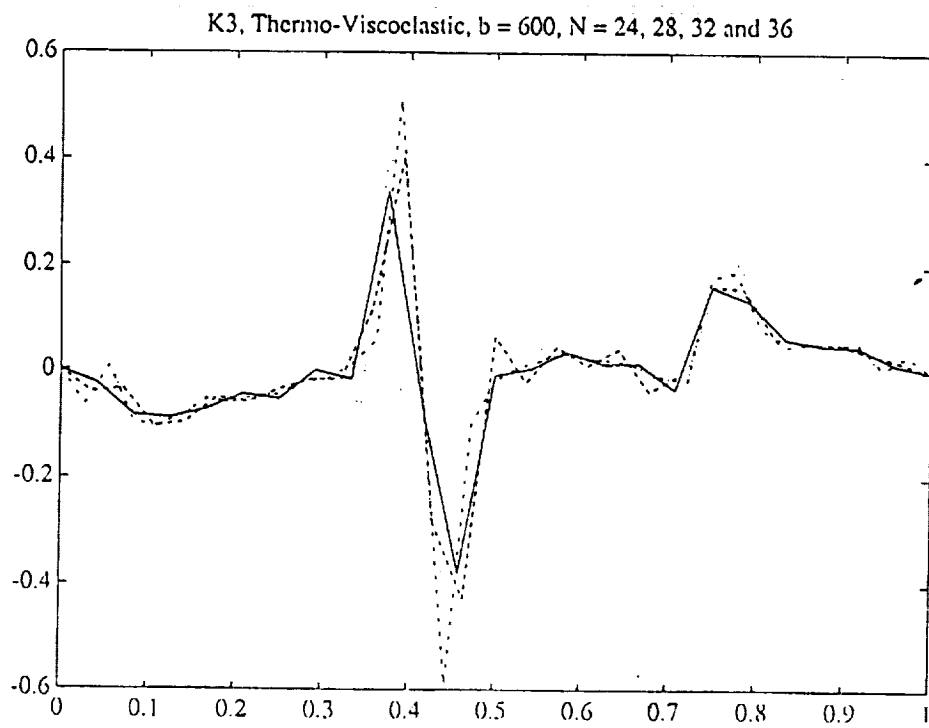

Figure 10

K4, N = 24, b = 80

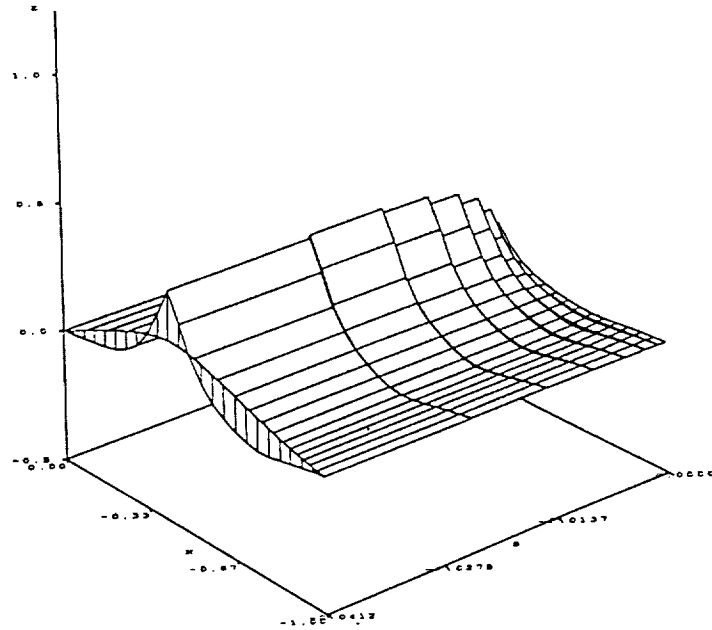

Figure 11

K4, N = 28, b = 60

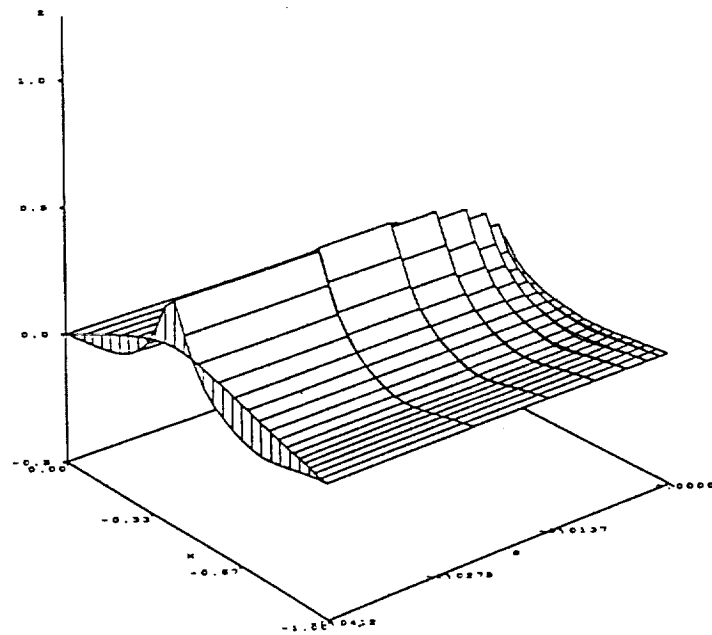

Figure 12

K4, N = 32, b = 60

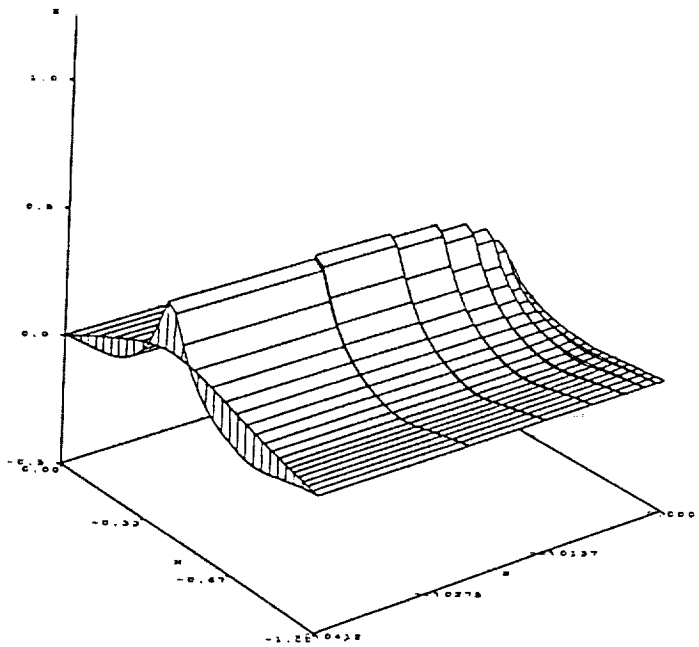

Figure 13

K4, N = 36, b = 60

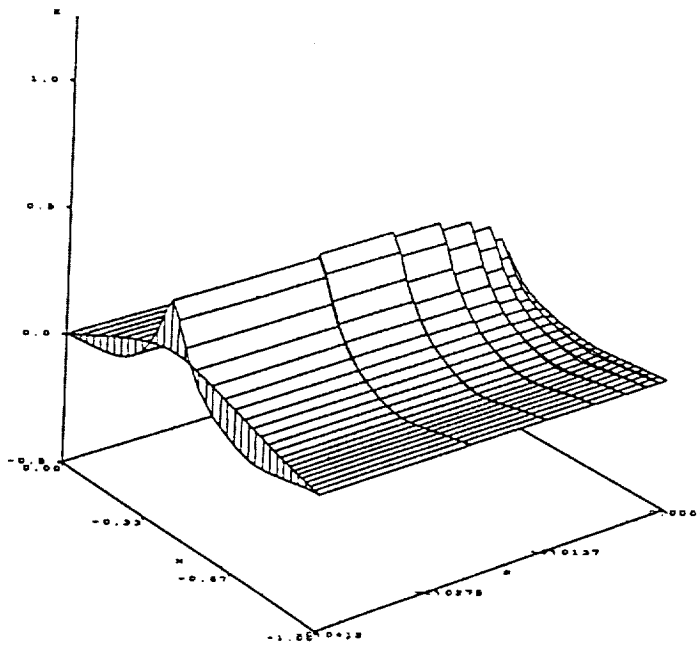

Figure 14

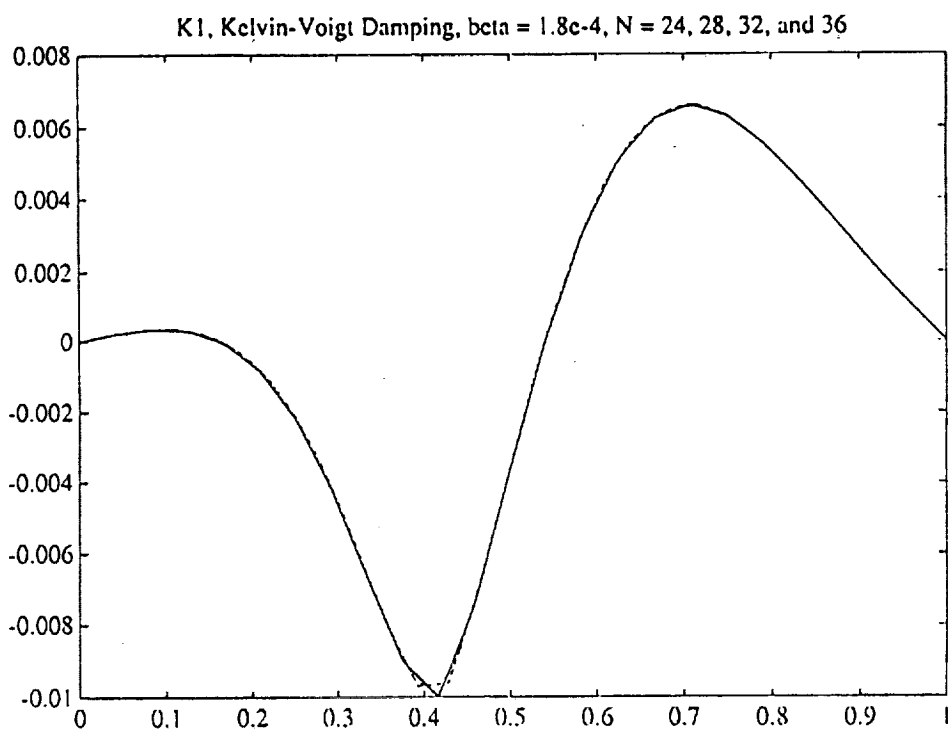

Figure 15

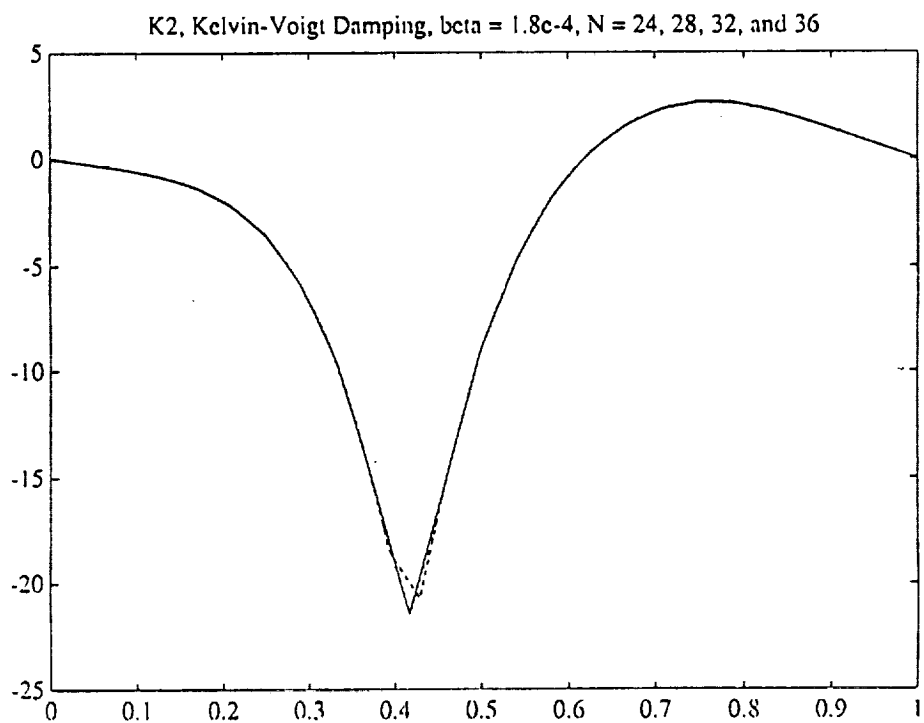

Figure 16

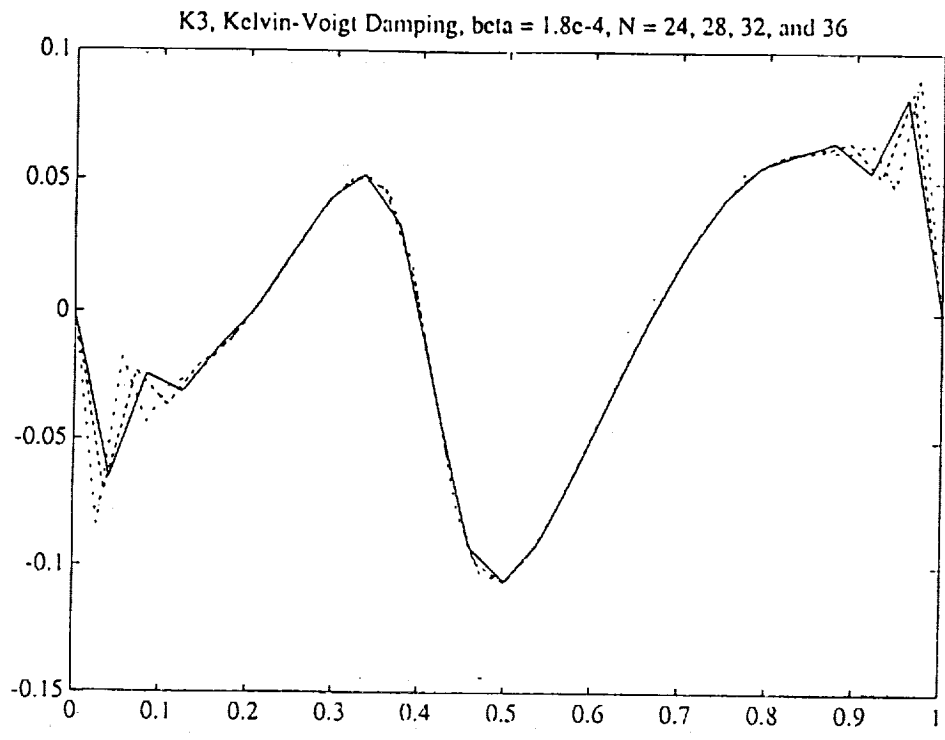

Figure 17

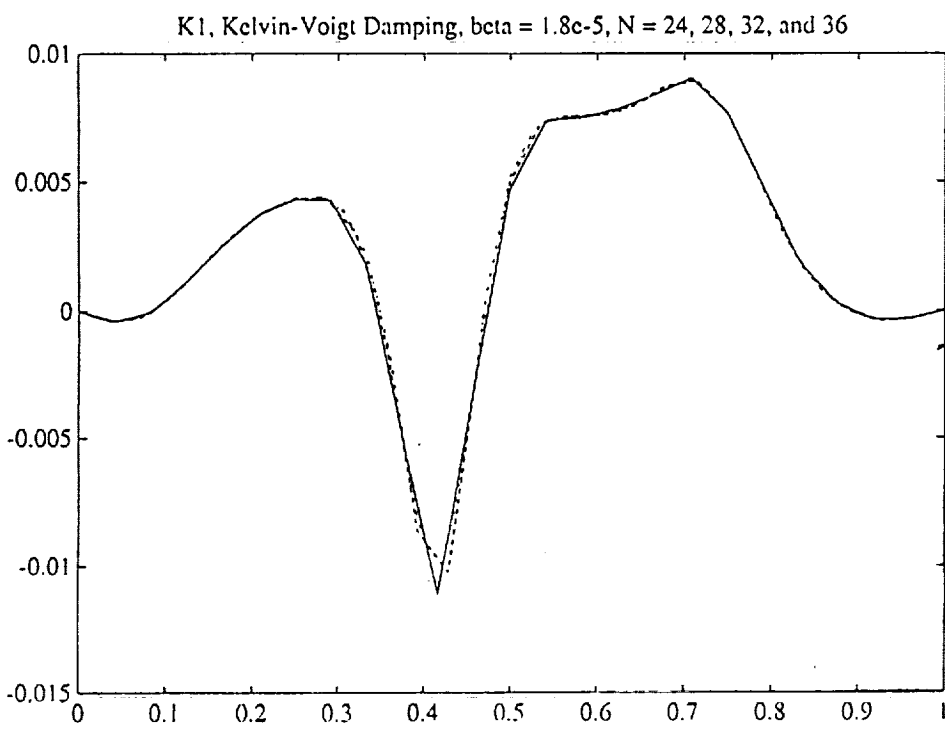

Figure 18

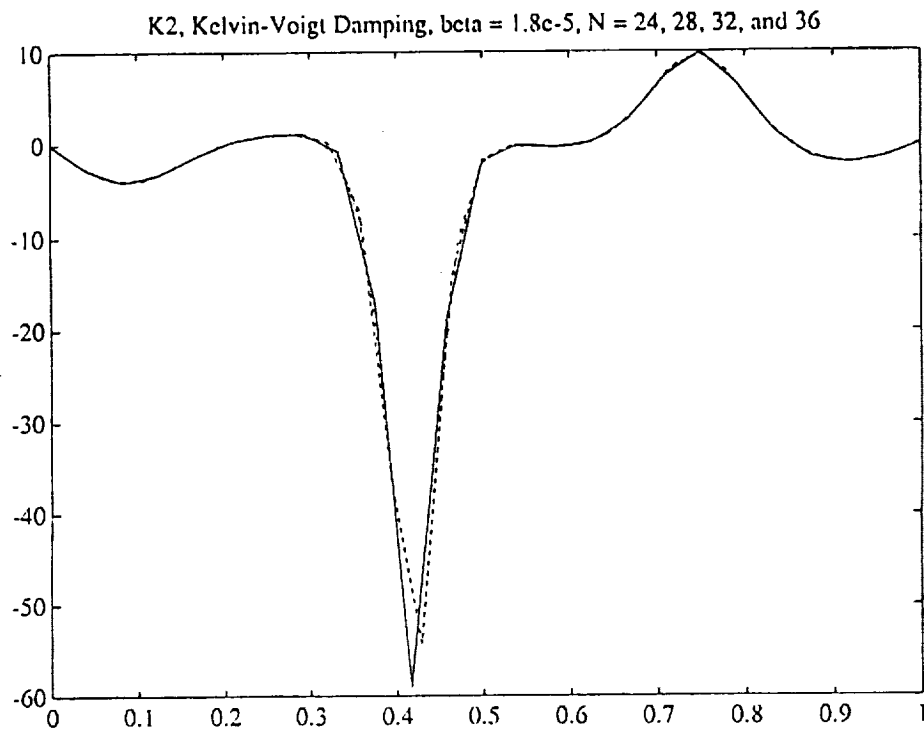

Figure 19

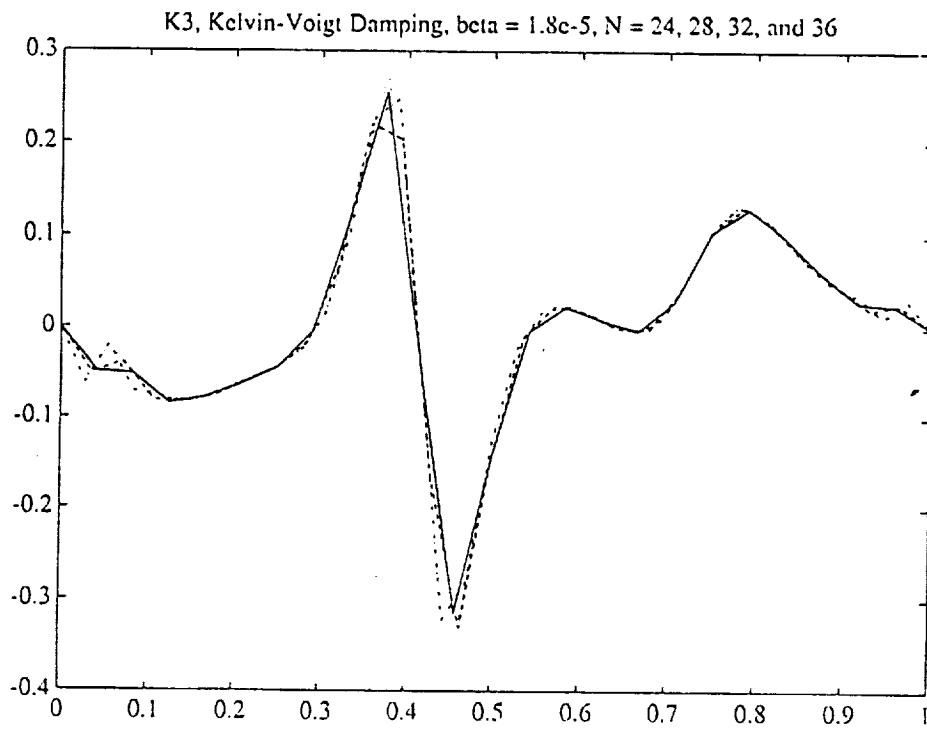

Figure 20

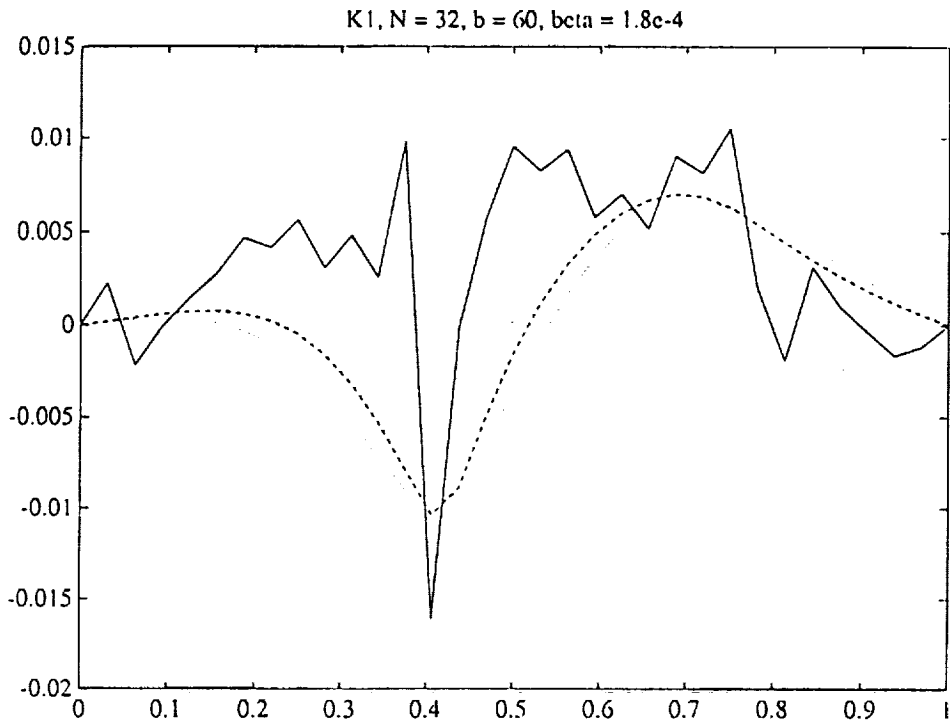

Figure 21

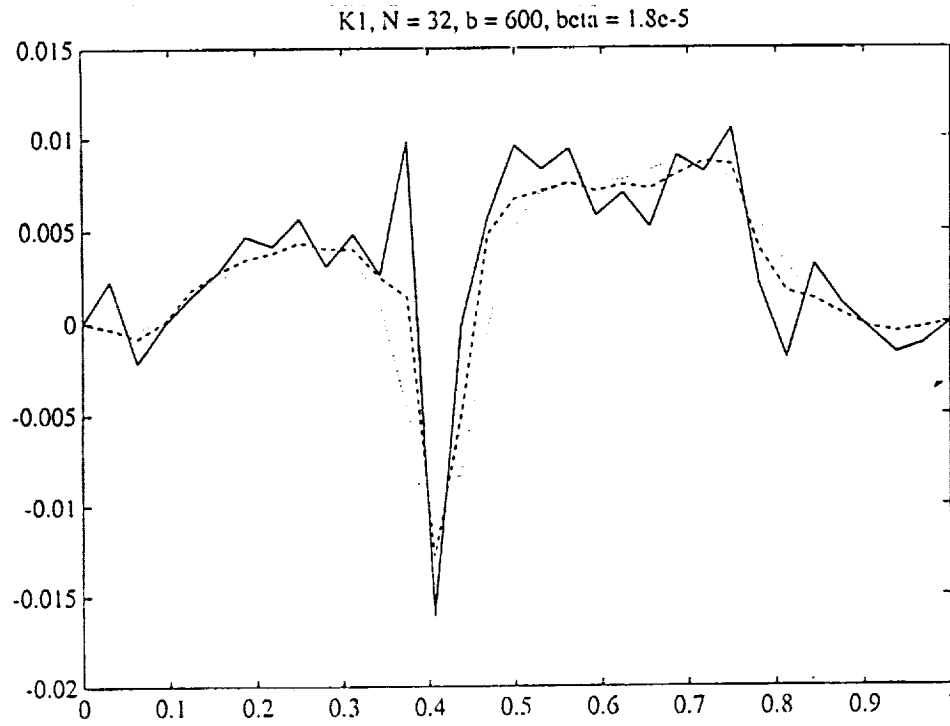

Figure 22

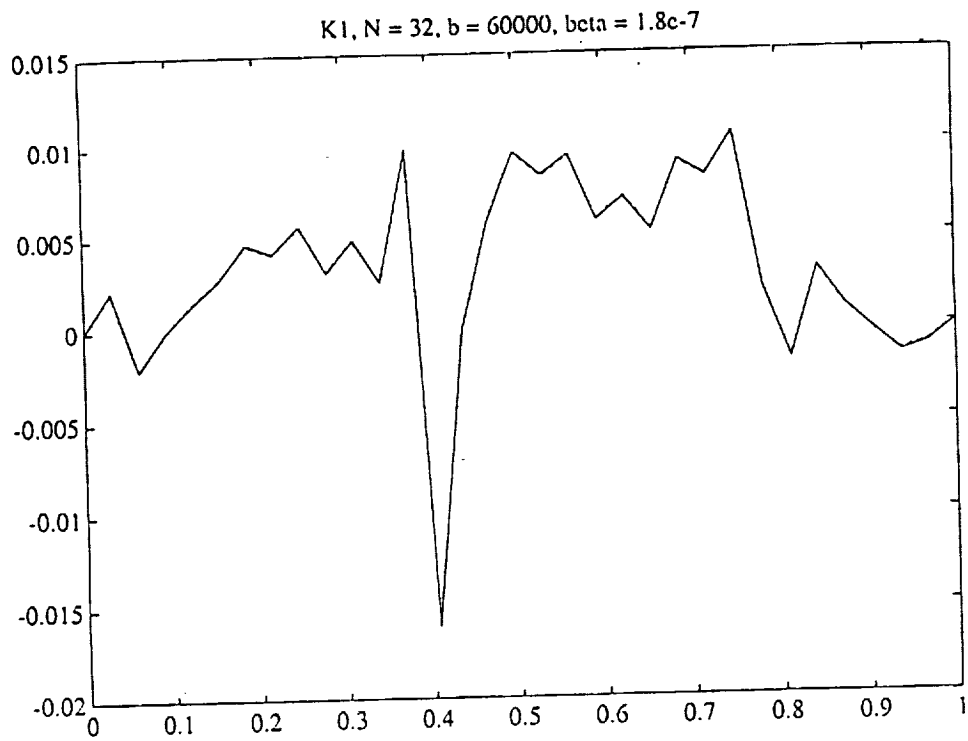

Figure 23

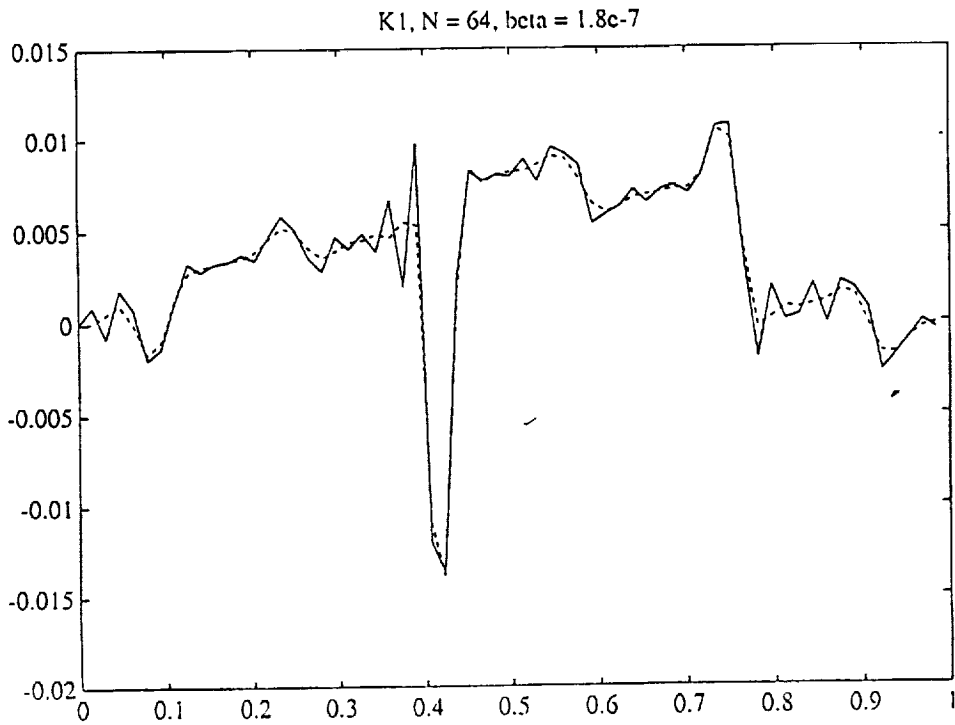

Figure 24

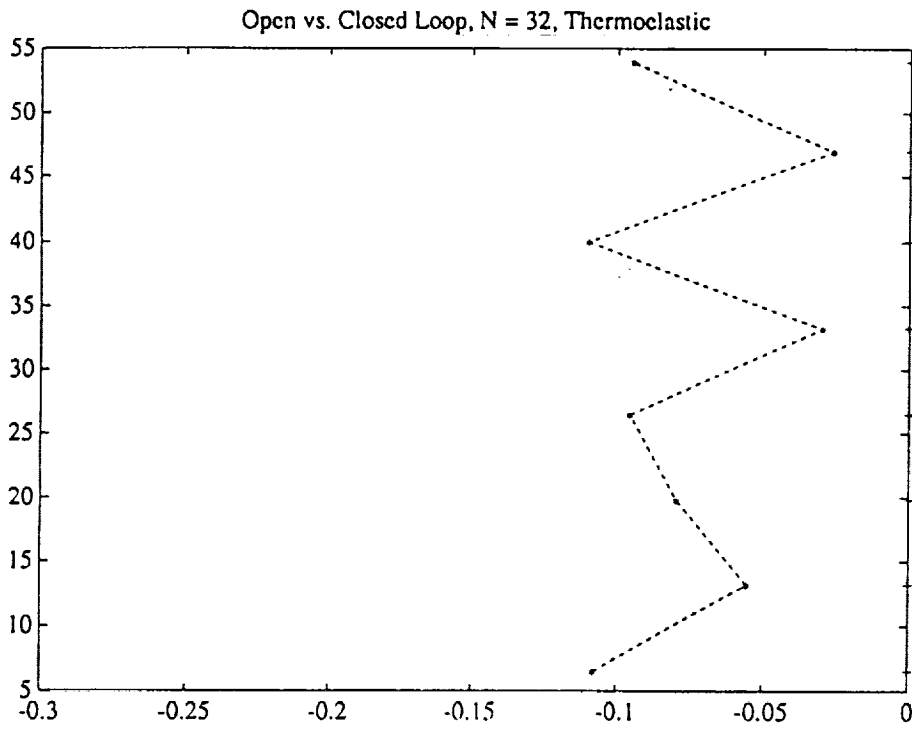

Figure 25

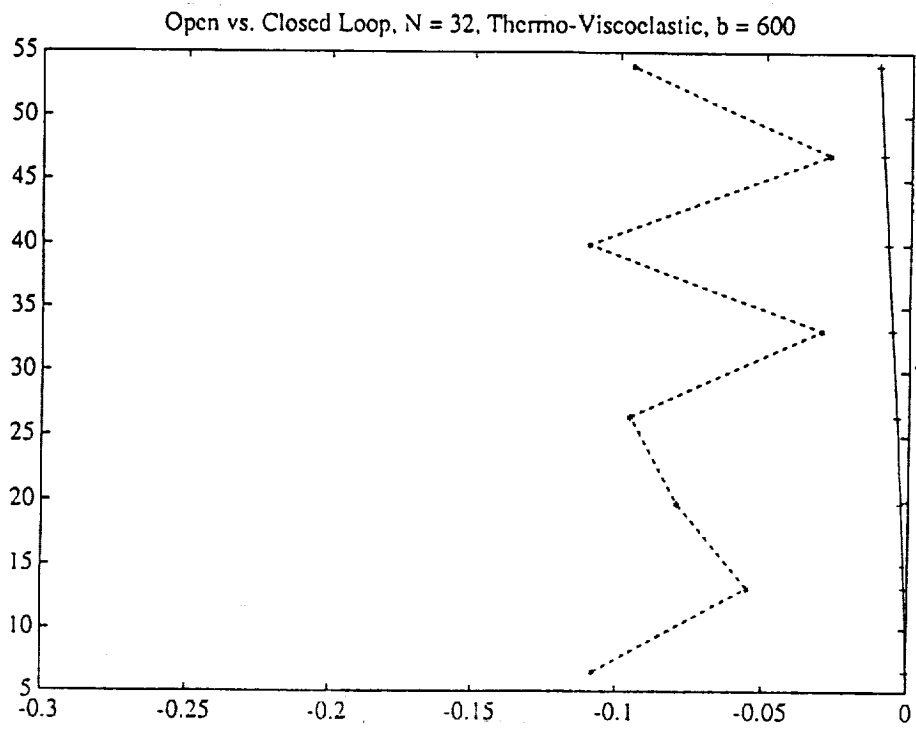

Figure 26

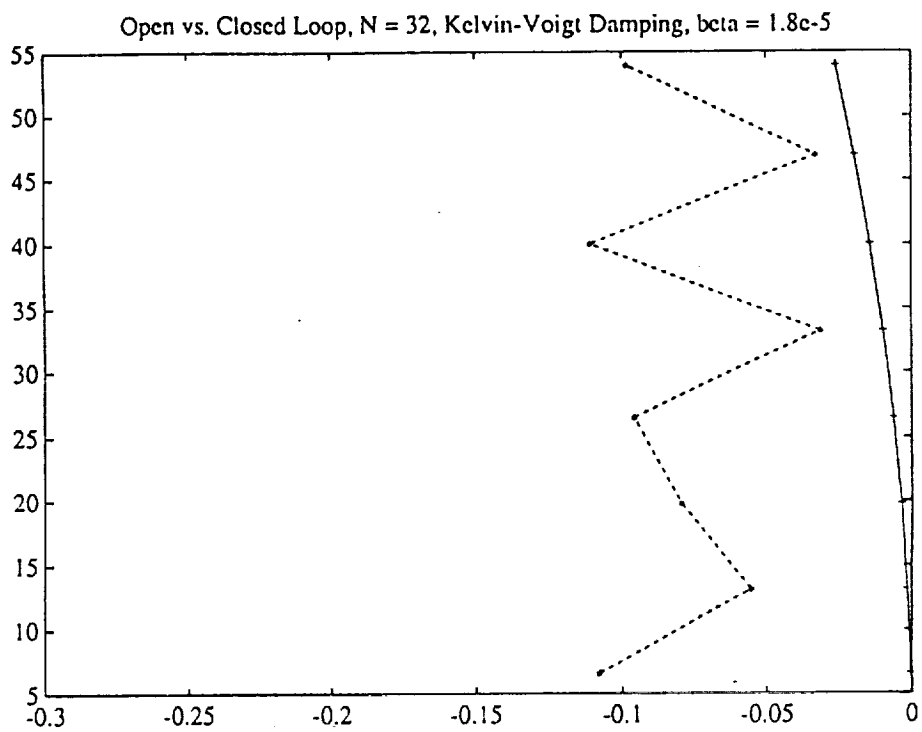

Figure 27

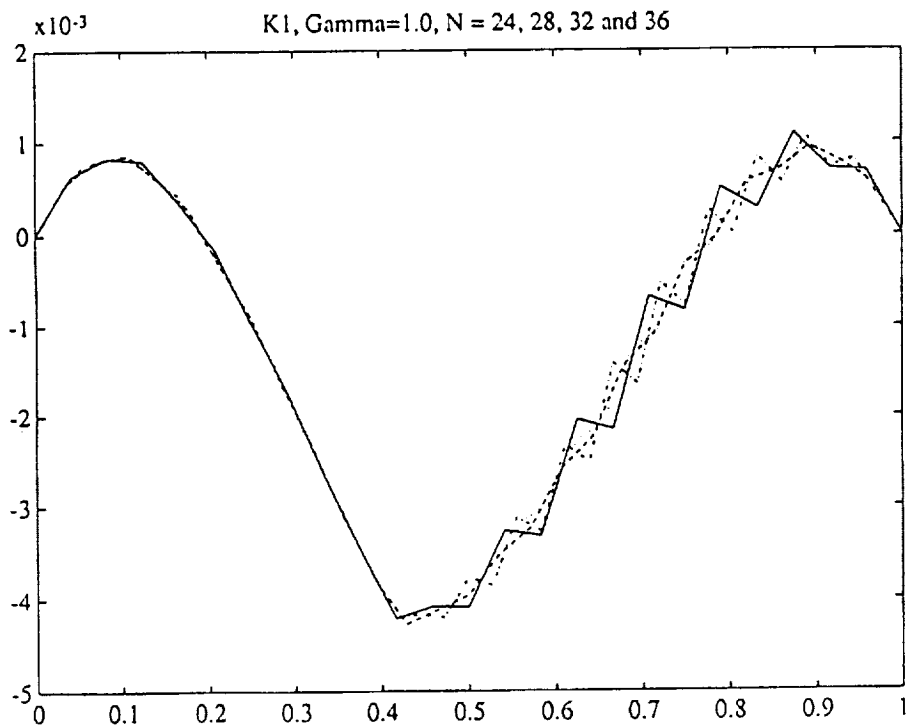

Figure 28

K2, Gamma=1.0, N = 24, 28, 32 and 36

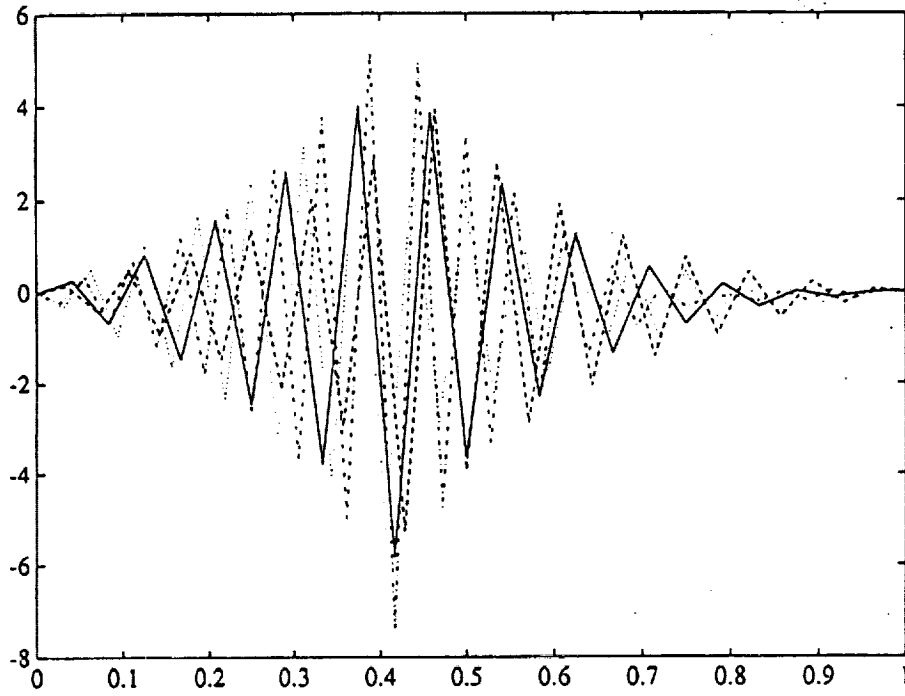

Figure 29

K3, Gamma=1.0, N = 24, 28, 32 and 36

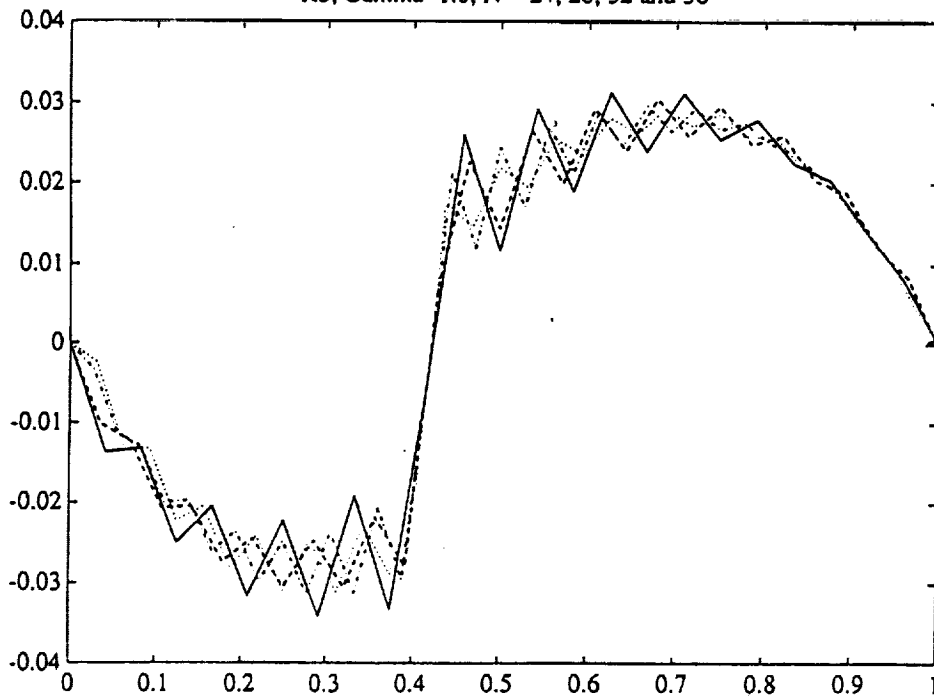
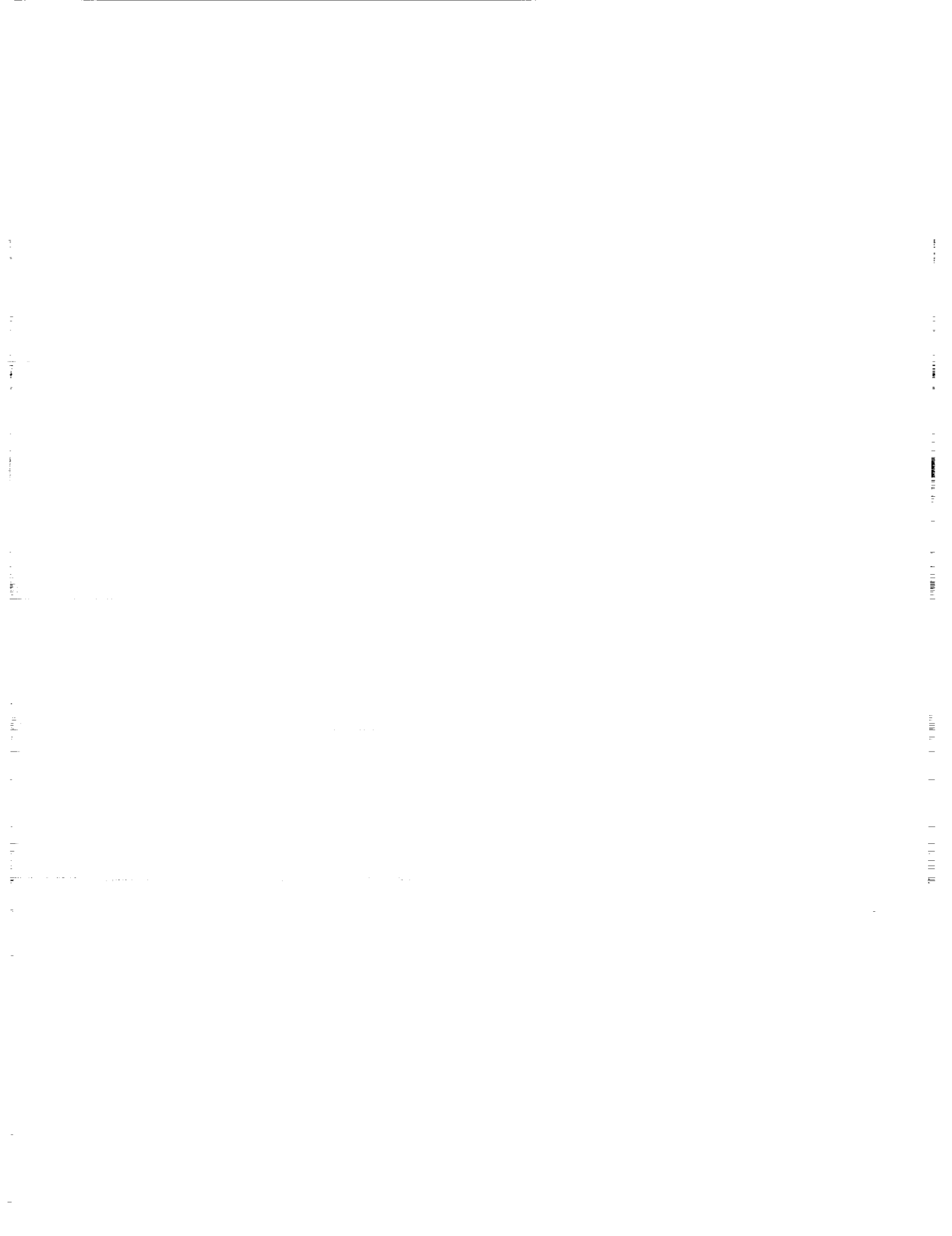

Figure 30





Report Documentation Page

1. Report No. NASA CR-182054 ICASE Report No. 90-43		2. Government Accession No.		3. Recipient's Catalog No.	
4. Title and Subtitle APPROXIMATIONS OF THERMOELASTIC AND VISCOELASTIC CONTROL SYSTEMS				5. Report Date June 1990	
				6. Performing Organization Code	
7. Author(s) J. A. Burns Z. Y. Liu R. E. Miller				8. Performing Organization Report No. 90-43	
				10. Work Unit No. 505-90-21-01	
9. Performing Organization Name and Address Institute for Computer Applications in Science and Engineering Mail Stop 132C, NASA Langley Research Center Hampton, VA 23665-5225				11. Contract or Grant No. NAS1-18605	
				13. Type of Report and Period Covered Contractor Report	
12. Sponsoring Agency Name and Address National Aeronautics and Space Administration Langley Research Center Hampton, VA 23665-5225				14. Sponsoring Agency Code	
15. Supplementary Notes Langley Technical Monitor: Richard W. Barnwell Submitted to J. of Numerical Functional Analysis and Optimization Final Report					
16. Abstract This paper deals with the development and analysis of well-posed models and computational algorithms for control of a class of partial differential equations that describe the motions of thermo-viscoelastic structures. We first present an abstract "state space" framework and a general well-posedness result that can be applied to a large class of thermo-elastic and thermo-viscoelastic models. This state space framework is used in the development of a computational scheme to be used in the solution of an LQR control problem. A detailed convergence proof is provided for the viscoelastic model and several numerical results are presented to illustrate the theory and to analyze problems for which the theory is incomplete.					
17. Key Words (Suggested by Author(s)) thermo-elastic systems, control, approximations			18. Distribution Statement 64 - Numerical Analysis 66 - Systems Analysis Unclassified - Unlimited		
19. Security Classif. (of this report) Unclassified		20. Security Classif. (of this page) Unclassified		21. No. of pages 68	22. Price A04

