

NASA Technical Memorandum 100762

**An Atlas of
ECMWF Analyses (1980-87)
*Part II--Second Moment Quantities***

S. Schubert
*Goddard Space Flight Center
Greenbelt, Maryland*

S. Moorthi
*University Space Research Association
Columbia, Maryland*

W. Higgins
*National Academy of Sciences
National Research Council
Washington, D.C.*

M. Suarez
*Goddard Space Flight Center
Greenbelt, Maryland*

C.-K. Park
*Centel Federal Services Corporation
Reston, Virginia*



National Aeronautics and
Space Administration

Goddard Space Flight Center
Greenbelt, MD

1990

TABLE OF CONTENTS

	PAGE
I. INTRODUCTION.....	vii
II. LIST OF QUANTITIES.....	viii
III. REFERENCES.....	xiii
IV. ACKNOWLEDGMENTS.....	xiii
V. APPENDIX A: DATA PROCESSING.....	xv
VI. APPENDIX B: SOURCES OF DIGITIZED DATA.....	xvii
VII. THE SECOND MOMENT SEASONAL MEAN FIELDS	
A. DECEMBER, JANUARY, FEBRUARY.....	1
i) DEVIATIONS FROM MONTHLY MEANS	
GLOBAL.....	3
ZONAL AVERAGES.....	11
ii) DEVIATIONS FROM SEASONAL CYCLE	
UNFILTERED.....	25
LOW PASS.....	33
BAND PASS.....	41

B. MARCH, APRIL, MAY.....	49
i) DEVIATIONS FROM MONTHLY MEANS	
GLOBAL.....	51
ZONAL AVERAGES.....	59
ii) DEVIATIONS FROM SEASONAL CYCLE	
UNFILTERED.....	73
LOW PASS.....	81
BAND PASS.....	89
C. JUNE, JULY, AUGUST.....	97
i) DEVIATIONS FROM MONTHLY MEANS	
GLOBAL.....	99
ZONAL AVERAGES.....	107
ii) DEVIATIONS FROM SEASONAL CYCLE	
UNFILTERED.....	121
LOW PASS.....	129
BAND PASS.....	137

D. SEPTEMBER, OCTOBER, NOVEMBER.....	145
i) DEVIATIONS FROM MONTHLY MEANS	
GLOBAL.....	147
ZONAL AVERAGES.....	155
ii) DEVIATIONS FROM SEASONAL CYCLE	
UNFILTERED.....	169
LOW PASS.....	177
BAND PASS.....	185
E. ANNUAL.....	193
i) DEVIATIONS FROM MONTHLY MEANS	
GLOBAL.....	195
ZONAL AVERAGES.....	203
ii) DEVIATIONS FROM SEASONAL CYCLE	
UNFILTERED.....	217
LOW PASS.....	225
BAND PASS.....	233
TIME SERIES OF ZONAL MEAN MONTHLY STATISTICS.....	241

I. INTRODUCTION

The Goddard Laboratory for Atmospheres (GLA) has over the past few years acquired a large data base of 00Z and 12Z initialized analyses (1980-87) from the European Center for Medium Range Weather Forecasts (ECMWF). In support of our on-going research activities we have found it convenient to compile these analyses in the form of an atlas.

The original ECMWF/WMO data was obtained on a 2.5° latitude by 2.5° longitude grid in a packed format. This data was unpacked and interpolated to a 4° latitude by 5° longitude grid for the purpose of computing various statistics and plotting. Appendix A describes further details of the data and data processing. In part I of this atlas we present various first moment quantities for monthly, seasonal and annual averages. The present volume (Part II) presents various second moment quantities averaged over a season including both transient and standing eddy components. Since we accumulate the statistics on a monthly basis, the majority of the transient statistics presented in this volume are computed as deviations from monthly means. However, selected fields have been processed differently in order to retain the longer time scales and remove the influence of the seasonal cycle. These statistics are based on deviations from the average seasonal cycle. The deviations are filtered to separate the contributions of the band pass (2.5 - 6 days) and low pass (> 10 days) regions of the spectrum.

The ECMWF analysis system has undergone a number of changes during the period 1980-87. Trenberth and Olson (1988) have done an extensive study of the ECMWF analyses for 1979-86 and examined the impact of analysis system changes on data quality (see their Table I and discussion). The change to diabatic nonlinear normal mode initialization in September of 1982 dramatically increased the strength of the tropical divergence. For quantities sensitive to the divergence we have limited the time averages to 1984-87. For these fields the shorter time-averaging period is clearly indicated. Otherwise the averages include all 8 years. It must be emphasized that many other changes occurred to the analysis system during this time period leading to inhomogeneities in the data. This is particularly true for the moisture fields (see eg. Trenberth and Olson, 1988). No attempt has been made to take this into account when performing the time averages.

We note that other recent compilations of assimilated data that may be useful for comparisons are those of Trenberth and Olson (1988) based on essentially the same data (1979-86), Hoskins et. al. (1989) which emphasizes special diagnostics and year to year

variations in ECMWF analyses for the period 1979-1989 and Lau (1984) which examines the FGGE year based on analyses produced at GFDL.

In accordance with ECMWF conditions any publications making use of the figures and/or data in this atlas must acknowledge ECMWF as the data source.

II. LIST OF QUANTITIES

The bulk of the statistics presented in this volume are accumulated on a monthly basis where daily fluctuations are computed with respect to a monthly mean. This allows the statistics to be easily updated as new data becomes available. For the transients the covariances are defined as

$$\overline{xy} = \bar{x} \bar{y} + \overline{x'y'} \quad (1)$$

where the bar denotes a monthly average and the prime a deviation from the monthly average. For zonal averages

$$[\overline{xy}] = [\bar{x}][\bar{y}] + [\bar{x} * \bar{y} *] + [\overline{x'y'}] \quad (2)$$

where the brackets denote a zonal average and the asterisk (*) denotes a deviation from the zonal average. The monthly mean statistics are then averaged to produce the seasonal and annual means. The global maps consist of various transient eddy covariances (last term in (1)), while the zonally averaged covariances consist of both the standing and transient eddy terms (second to last and last terms of (2)).

For selected statistics of the form $\overline{x'y'}$ the data was processed differently in order to isolate particular regions of the spectrum. This was accomplished by first removing the time mean and annual and semi-annual harmonics computed from the average of all 8 (or in some cases a subset of the 8) years of data. The deviations were then further processed to isolate the synoptic and low frequency fluctuations. This was done by applying a band pass filter which retains time scales between 2.5 and 6 days and a low pass filter which retains time scales of 10 days and greater. The seasonal statistics were then computed from deviations with respect to the appropriate seasonal mean for each year and then averaged

over all years. Note that only the intraseasonal time scales are retained in the deviations. The filters are essentially identical to those described by Blackmon and Lau (1980). The only difference is that the filters used here are of higher order (35 point instead of 10 point). The advantage of the higher order is that it provides a better approximation to the ideal amplitude response function. The disadvantage is that more points are needed so that the seasons are to some extent more "contaminated" by the adjacent seasons. In practice, little difference was found between results from the two filters. See Schubert (1986) for a comparison of the amplitude response functions of the present and Blackmon and Lau (1980) band pass filters.

While the low and band pass filtered fields are the primary focus of the above analysis, for completeness, we also show the unfiltered fields. In general, the statistics based on the deviations from the monthly means and those from the unfiltered deviations from the seasonal cycle were found to be very similar. The latter are composed of the intraseasonal time scales (approximately 1-90 days) while the former include, in addition to time scales less than one month, part of the seasonal signal inherent in the deviations from monthly means.

We also include the extended E-P vector

$$\mathbf{E}_u = \left(\frac{1}{2}(\overline{v'^2} - \overline{u'^2}), -\overline{u'v'} \right) \quad (3)$$

introduced by Hoskins et. al. (1983) for both the unfiltered and filtered deviations from the seasonal cycle . The present analysis uses the slightly modified form (the factor of 1/2) of this quantity which is parallel to the relative group velocity for the barotropic case (Trenberth, 1986).

The following lists the quantities contained in Part II. The units are given as part of the figure captions and contour intervals are easily seen from the plots themselves. Plots are shown for seasonal and annual averages. The global maps are presented at 850 and 200 mb. The cross sections are based on all the levels obtained from ECMWF which are 1000, 850, 700, 500, 300, 200, and 100 mb. The fields are grouped according to season. Within each group the first set of statistics involve deviations from monthly means (averaged over a season) which consist of both global fields and zonal averages. This is followed by selected maps and cross sections of unfiltered and filtered quantities computed from deviations from the seasonal cycle. The final maps are time series of zonally averaged monthly mean statistics. We indicate below the quantities and (for convenience) the relative positions of the plots in the atlas for each data group.

Deviations from Monthly Means

<u>Quantity</u>	<u>Relative Position</u>
$\sqrt{u'u'} (200\text{mb}), \sqrt{v'v'} (200\text{mb})$	1
$\sqrt{T'T'} (850\text{mb}), \sqrt{T'T'} (200\text{mb})$	2
$\sqrt{q'q'} (850\text{mb}), \sqrt{Z'Z'} (500\text{mb})$	3
$\overline{v'T'} (850\text{mb}), \overline{u'T'} (850\text{mb})$	4
$\overline{v'q'} (850\text{mb}), \overline{u'q'} (850\text{mb})$	5
$\overline{u'v'} (200\text{mb})$	6
$\overline{\omega'T'} (850\text{mb}), \overline{\omega'q'} (850\text{mb})$	7
$\overline{v'Z'} (200\text{mb}), \overline{u'Z'} (200\text{mb})$	8
$\sqrt{[u'u']}, \sqrt{[\bar{u}*\bar{u}^*]}$	9
$\sqrt{[v'v']}, \sqrt{[\bar{v}*\bar{v}^*]}$	10
$\sqrt{[T'T']}, \sqrt{[\bar{T}*\bar{T}^*]}$	11
$\sqrt{[Z'Z']}, \sqrt{[\bar{Z}*\bar{Z}^*]}$	12
$\sqrt{[q'q']}, \sqrt{[\bar{q}*\bar{q}^*]}$	13
$[u'v'], [\bar{u}*\bar{v}^*]$	14
$[v'T'], [\bar{v}*\bar{T}^*]$	15
$[v'q'], [\bar{v}*\bar{q}^*]$	16
$[v'Z'], [\bar{v}*\bar{Z}^*]$	17
$[\omega'T'], [\bar{\omega}*\bar{T}^*]$	18
$[\omega'q'], [\bar{\omega}*\bar{q}^*]$	19

Deviations from Seasonal Cycle

<u>Quantity</u>	<u>Relative Position</u>
Unfiltered	
$\overline{v'T'} (850\text{mb}), \overline{v'q'} (850\text{mb})$	20
$\overline{u'v'} (200\text{mb})$	21
$\sqrt{\overline{Z'Z'}} (500\text{mb}), \overline{u'u'+v'v'} (200\text{mb})$	22
$\overline{V'T'} (850\text{mb}), \overline{V'q'} (850\text{mb})$	23
$E_u 200\text{mb}$ (contours of $\overline{v'T'}$ at 850mb)	24
$[\overline{u'v'}], [\overline{v'T'}]^1$	25
Low pass (periods > 10 days)	
$\overline{v'T'} (850\text{mb}), \overline{v'q'} (850\text{mb})$	26
$\overline{u'v'} (200\text{mb})$	27
$\sqrt{\overline{Z'Z'}} (500\text{mb}), \overline{u'u'+v'v'} (200\text{mb})$	28
$\overline{V'T'} (850\text{mb}), \overline{V'q'} (850\text{mb})$	29
$E_u 200\text{mb}$ (contours of $\overline{v'T'}$ at 850mb)	30
$[\overline{u'v'}], [\overline{v'T'}]^{1,2}$	31
Band pass (2.5 < periods < 6 days)	
$\overline{v'T'} (850\text{mb}), \overline{v'q'} (850\text{mb})$	32
$\overline{u'v'} (200\text{mb})$	33
$\sqrt{\overline{Z'Z'}} (500\text{mb}), \overline{u'u'+v'v'} (200\text{mb})$	34
$\overline{V'T'} (850\text{mb}), \overline{V'q'} (850\text{mb})$	35
$E_u 200\text{mb}$ (contours of $\overline{v'T'}$ at 850mb)	36
$[\overline{u'v'}], [\overline{v'T'}]^{1,2}$	37

¹Due to tape problems the heat fluxes (for zonal averages only) are based on the years 1980-85

²The zonally-averaged fluxes were processed using the Blackmon and Lau (1980) versions of the band and low pass filters. All other quantities are computed with the higher order versions of these filters described in section II

Time Series (Deviations from Monthly Means)

<u>Quantity</u>	<u>Relative Position</u>
$\sqrt{[\bar{u}'u']}$ (200mb)	1
$\sqrt{[\bar{u} * \bar{u} *']}$ (200mb)	2
$\sqrt{[\bar{v}'v']}$ (200mb)	3
$\sqrt{[\bar{v} * \bar{v} *']}$ (200mb)	4
$\sqrt{[\bar{T}'T']}$ (200mb)	5
$\sqrt{[\bar{T} * \bar{T} *']}$ (200mb)	6
$\sqrt{[\bar{T}'T']}$ (850mb)	7
$\sqrt{[\bar{T} * \bar{T} *']}$ (850mb)	8
$\sqrt{[\bar{q}'q']}$ (850mb)	9
$\sqrt{[\bar{q} * \bar{q} *']}$ (850mb)	10
$\sqrt{[\bar{Z}'Z']}$ (500mb)	17
$\sqrt{[\bar{Z} * \bar{Z} *']}$ (500mb)	18
$[\bar{u}'v']$ (200mb)	19
$[\bar{u} * \bar{v} *]$ (200mb)	20
$[\bar{v}'T]$ (850mb)	21
$[\bar{v} * \bar{T} *]$ (850mb)	22
$[\bar{v}'q']$ (850mb)	23
$[\bar{v} * \bar{q} *]$ (850mb)	24
$[\bar{v}'Z']$ (200mb)	25
$[\bar{v} * \bar{Z} *]$ (200mb)	26

Appendix B describes how to access these data sets on the IBM 3081.

III. REFERENCES

- Blackmon, M. L. and N.-C. Lau, 1980: Regional characteristics of the Northern Hemisphere wintertime circulation: A comparison of the simulation of a GFDL general circulation model with observations. *J. Atmos. Sci.*, **37**, 497-514.
- Hoskins, B. J., H. H. Hsu, I. N. James, M. Masutani, P. D. Sardeshmukh and G. H. White, 1989: Diagnostics of the global atmospheric circulation based on ECMWF analyses 1979-1989. WMO, WCRP-27, WMO/TD-No. 326.
- Lau, N.-C., 1984: Circulation statistics based on FGGE level III-B analyses produced at GFDL. NOAA Data Report ERL GFDL-5.
- Schubert, S. D., 1986: The structure, energetics and evolution of the dominant frequency-dependent three-dimensional atmospheric modes. *J. Atmos. Sci.*, **43**, 1210-1237.
- Trenberth, K. E., 1986: An assessment of the impact of transient eddies on the zonal flow during a blocking episode using localized Eliassen-Palm flux diagnostics. *J. Atmos. Sci.*, **43**, 2070-2087.
- Trenberth, K. E. and J. G. Olson, 1988: ECMWF Global Analyses 1979-1986: Circulation Statistics and Data Evaluation. NCAR/TN-300+STR, NCAR Technical Note, February, 1988, National Center for Atmospheric Research, Boulder, Colorado.

IV. ACKNOWLEDGMENTS

We wish to thank Ms. Laura Rumburg for helping draft many of the figure titles.

V. APPENDIX A- THE DATA PROCESSING

The ECMWF analyses are the initialized fields provided to GLA (code 611) in an internal bit format. The data processing involves several steps including unpacking and converting to a 2 X 2.5 degree grid. During this step the relative humidity is converted to specific humidity. Then an interpolation is made to a 4 X 5 degree grid. All eddy statistics are computed from the lower resolution fields. Both resolutions of the basic parameters are available on tape. Further details of the data are provided below.

ORIGINAL PACKED DATA AS RECEIVED FROM ECMWF:

2.5° latitude by 2.5° longitude in internal bit format
1000, 850, 700, 500, 300, 200, 100 hPa
separate 00Z and 12Z tapes

DATA (IM,JNP)

IM= 1, .. , 144 starting at 177.5 W and going east to 180 E
JNP = 1, .. , 73 starting at North Pole

- (1) geopotential height (m)
- (2) temperature (°K)
- (3) u (m/s)
- (4) v (m/s)
- (5) relative humidity (%)
- (6) vertical velocity (Pa/s)

UNPACKED ECMWF DATA

2° latitude by 2.5° longitude or 4° latitude by 5° longitude
1000, 850, 700, 500, 300, 200, 100 hPa
00Z and 12Z combined for each tape

DATA(IM,JNP)

IM=1, .. , 144 (72) starting at 180° W and going east to 177.5° E (175° E)
JNP= 1, .. , 91 (46) starting at South Pole

Quantity

- (1) sea level pressure (hPa)
- (2) geopotential height (m)
- (3) temperature (°K)
- (4) u (m/s)
- (5) v (m/s)
- (6) specific humidity (g/g)
- (7) vertical velocity (Pa/s)
- (8) divergence

The specific humidity (q) is computed from the relative humidity

$$q = q_s * RH * 0.01$$

where

$$q_s = 0.622 * e_s / (p - .378 e_s)$$

and e_s is the saturation vapor pressure determined from the empirical formulae

$$\begin{aligned} 6.1078 * \text{EXP} \{ 21.8747 * (T - 273.16) / (T - 7.66) \} & \quad \text{for } T \leq 273.16 \\ 6.1078 * \text{EXP} \{ 17.269 * (T - 273.16) / (T - 35.86) \} & \quad \text{for } T > 273.16 \end{aligned}$$

VI. APPENDIX B- SOURCES OF DIGITIZED DATA

The data fields (for Part II of this Atlas) are currently stored on several MVS data sets and are meant for use by NASA scientists with access to the IBM 3081 mainframe. We also anticipate that these fields will be made available on floppy disks for both IBM compatible and Macintosh personal computers in the near future. For further information concerning the use of this data contact

Siegfried Schubert
NASA/GSFC Code 611
Greenbelt, MD 20771
(301) 286-3441

In the following we present the information necessary to access the data sets for Part II on the IBM 3081.

1. DATA SET NAMES AND READ FORMATS

a) DEVIATIONS FROM MONTHLY MEANS

GLOBAL FIELDS

W3RWH.ECMWF.VARNCE

$$\sqrt{u'u'}, \sqrt{v'v'}, \sqrt{T'T'}, \sqrt{Z'Z'}, \sqrt{q'q'}$$

W3RWH.ECMWF.COVRNCE

$$\overline{v'T'}, \overline{u'T'}, \overline{v'q'}, \overline{u'q'}, \overline{u'v'}$$

W3RWH.ECMWF.COVRNCE2

$$\overline{\omega'T'}, \overline{\omega'q'}, \overline{v'Z'}, \overline{u'Z'} \quad (1980-87)$$

W3RWH.ECMWF.COVRNCE3

$$\overline{\omega'T'}, \overline{\omega'q'}, \overline{v'Z'}, \overline{u'Z'} \quad (1984-87)$$

ZONALLY-AVERAGED FIELDS

W3RWH.ECMWF.ZONMN.VARNCE

$$\sqrt{[u'u']}, \sqrt{[\bar{u} * \bar{u} *]}, \sqrt{[v'v']}, \sqrt{[\bar{v} * \bar{v} *]}, \sqrt{[T'T']}, \sqrt{[\bar{T} * \bar{T} *]}$$

W3RWH.ECMWF.ZONMN.VARNCE2

$$\sqrt{[Z'Z']}, \sqrt{[\bar{Z} * \bar{Z} *]}, \sqrt{[q'q']}, \sqrt{[\bar{q} * \bar{q} *]}$$

W3RWH.ECMWF.ZONMN.COVRNCE

$$[\overline{u'v'}], [\bar{u} * \bar{v} *], [\overline{v'T'}], [\bar{v} * \bar{T} *], [\overline{v'q'}], [\bar{v} * \bar{q} *], [\overline{v'Z'}], [\bar{v} * \bar{Z} *]$$

W3RWH.ECMWF.ZONMN.COVRNCE2

$$[\overline{\omega'T'}], [\bar{\omega} * \bar{T} *], [\overline{\omega'q'}], [\bar{\omega} * \bar{q} *]$$

READ FORMAT

```
C NSEAS IS THE NUMBER OF SEASONS = 4
C IS=1    DJF (AVERAGED FOR 1980-87)
C IS=2    MAM (AVERAGED FOR 1980-87)
C IS=3    JJA (AVERAGED FOR 1980-87)
C IS=4    SON (AVERAGED FOR 1980-87)
C IS=5    ANNUAL (AVERAGED FOR 1980-87)

C NLEV IS THE NUMBER OF LEVELS = 7
C IL=1    1000MB
C IL=2    850MB
C IL=3    700MB
C IL=4    500MB
C IL=5    300MB
C IL=6    200MB
C IL=7    100MB
C NVAR IS THE NUMBER OF VARIABLES IN THE PARTICULAR DATA SET

PARAMETER(IMP1=73,JNP=46,NSEAS=5,NLEV=7,NVAR=5)
DIMENSION VAR(IMP1,JNP,NVAR,NLEV,NSEAS)
DIMENSION VARZ(JNP,NVAR,NLEV,NSEAS)

C J=1 IS THE SOUTH POLE, I=1 IS THE DATELINE
C FIELDS ARE WRAPPED SO THAT X(1,J)=X(IMP1,J)
DO 10 IS=1,NSEAS
DO 10 IL=1,NLEV
DO 10 IV=1,NVAR
    READ(8) ((VAR(LON,LAT,IV,IL,IS), LON=1,IMP1),LAT=1,JNP)
C FOR ZONAL AVERAGES
    READ(8) (VARZ(LAT,IV,IL,IS),LAT=1,JNP)
10 CONTINUE
```

b) DEVIATIONS FROM SEASONAL CYCLE

i. E-P FLUXES

W3RWH.ECMWF.EPFLUX.SNMN.LOW

Low pass $(\overline{v'v'} - \overline{u'u'})/2$ at 200mb, $-\overline{u'v'}$ at 200mb, $\overline{v'T'}$ at 850mb

W3RWH.ECMWF.EPFLUX.SNMN.BAND

Band pass $(\overline{v'v'} - \overline{u'u'})/2$ at 200mb, $-\overline{u'v'}$ at 200mb, $\overline{v'T'}$ at 850mb

W3RWH.ECMWF.EPFLUX.SNMN.UNFILT

Unfiltered $(\overline{v'v'} - \overline{u'u'})/2$ at 200mb, $-\overline{u'v'}$ at 200mb, $\overline{v'T'}$ at 850mb

READ FORMAT

C NSEAS IS THE NUMBER OF SEASONS

C IS=1 DJF (AVERAGED FOR 1980-87)

C IS=2 MAM (AVERAGED FOR 1980-87)

C IS=3 JJA (AVERAGED FOR 1980-87)

C IS=4 SON (AVERAGED FOR 1980-87)

C IS=5 ANNUAL AVERAGE (AVERAGED FOR 1980-87)

C NVAR IS THE NUMBER OF VARIABLES IN THE PARTICULAR DATA SET

PARAMETER(IMP1=73,JNP=46,NSEAS=5,NVAR=3)

DIMENSION VAR(IMP1,JNP,NVAR,NSEAS)

C J=1 IS THE SOUTH POLE, I=1 IS THE DATELINE

C FIELDS ARE WRAPPED SO THAT X(1,J)=X(IMP1,J)

DO 10 IS=1,NSEAS

DO 10 IV=1,NVAR

READ(8) ((VAR(LON,LAT,IV,IS), LON=1,IMP1),LAT=1,JNP)

10 CONTINUE

ii. OTHER GLOBAL FIELDS

W3RWH.ECMWF.VARIANCE.SNMN.LOW

Low pass $\sqrt{\overline{Z'Z'}}$ at 500mb, $(\overline{v'v'} + \overline{u'u'})$ at 200mb

W3RWH.ECMWF.COVARNCE.SNMN.LOW

Low pass $\overline{u'v'}$ at 200mb, $\overline{u'T'}$ at 850mb, $\overline{v'T'}$ at 850mb, $\overline{u'q'}$ at 850mb, $\overline{v'q'}$ at 850mb

W3RWH.ECMWF.VARIANCE.SNMN.BAND

Band pass $\sqrt{\overline{Z'Z'}}$ at 500mb, $(\overline{v'v'} + \overline{u'u'})$ at 200mb

W3RWH.ECMWF.COVARNCE.SNMN.BAND

Band pass $\overline{u'v'}$ at 200mb, $\overline{u'T'}$ at 850mb, $\overline{v'T'}$ at 850mb, $\overline{u'q'}$ at 850mb, $\overline{v'q'}$ at 850mb

W3RWH.ECMWF.VARIANCE.SNMN.UNFILT

Unfiltered $\sqrt{\overline{Z'Z'}}$ at 500mb, $(\overline{v'v'} + \overline{u'u'})$ at 200mb

W3RWH.ECMWF.COVARNCE.SNMN.UNFILT

Unfiltered $\overline{u'v'}$ at 200mb, $\overline{u'T'}$ at 850mb, $\overline{v'T'}$ at 850mb, $\overline{u'q'}$ at 850mb, $\overline{v'q'}$ at 850mb

READ FORMAT

```
C NSEAS IS THE NUMBER OF SEASONS
C IS=1    DJF (AVERAGED FOR 1980-87)
C IS=2    MAM (AVERAGED FOR 1980-87)
C IS=3    JJA (AVERAGED FOR 1980-87)
C IS=4    SON (AVERAGED FOR 1980-87)
C IS=5    ANNUAL AVERAGE (AVERAGED FOR 1980-87)

C NVAR IS THE NUMBER OF VARIABLES IN THE PARTICULAR DATA SET

PARAMETER(IMP1=73,JNP=46,NSEAS=5,NVAR=3)
DIMENSION VAR(IMP1,JNP,NVAR,NSEAS)
C J=1 IS THE SOUTH POLE, I=1 IS THE DATELINE
C FIELDS ARE WRAPPED SO THAT X(1,J)=X(IMP1,J)
DO 10 IS=1,NSEAS
DO 10 IV=1,NVAR
    READ(8) ((VAR(LON,LAT,IV,IS), LON=1,IMP1),LAT=1,JNP)
10 CONTINUE
```

iii. ZONAL AVERAGES

W3RWH.ECMWF.ZONAL.FLUX.SNMN.LOW

Low pass $[\overline{u'v'}], [\overline{v'T'}]$

W3RWH.ECMWF.ZONAL.FLUX.SNMN.BAND

Band pass $[\overline{u'v'}], [\overline{v'T'}]$

W3RWH.ECMWF.ZONAL.FLUX.SNMN.UNFILT

Unfiltered $[\overline{u'v'}], [\overline{v'T'}]$

READ FORMAT

```
C NSEAS IS THE NUMBER OF SEASONS
C MOMENTUM FLUXES ARE AVERAGES FOR 1980-87
C HEAT FLUXES ARE AVERAGES FOR 1980-85
C IS=1    DJF
C IS=2    MAM
C IS=3    JJA
C IS=4    SON
C IS=5    ANNUAL AVERAGE

C NVAR IS THE NUMBER OF VARIABLES IN THE PARTICULAR DATA SET

PARAMETER(JNP=46,NLEV=7,NSEAS=5,NVAR=2)
DIMENSION VAR(JNP,NVAR,NSEAS)
C J=1 IS THE SOUTH POLE

DO 10 IS=1,NSEAS
DO 10 IV=1,NVAR
    READ(8) ((VAR(LAT,ILEV,IV,IS),LAT=1,JNP),ILEV=1,NLEV)
10 CONTINUE
```

C) TIME SERIES OF ZONALLY AVERAGE MONTHLY MEANS

These fields are stored in a partitioned data set

W3CKP.ECMWF.ATLAS (member)

where the members are

TVAR: Transient variance statistics (eg. u'u')

ZVAR: Standing variance statistics (eg. u*u*)

TCOV: Transient covariance statistics (eg. u'v')

ZCOV: Standing covariance statistics (eg. u*v*)

READ FORMAT

```
PARAMETER(NMONS=96,JNP=46,NVAR=4)
```

```
DIMENSION VAR(NMONS,JNP)
```

```
C NVAR IS THE NUMBER OF VARIABLES = 6 (VARIANCE) OR 4  
(COVARIANCE)
```

		<u>VARIANCE</u>	<u>COVARIANCE</u>
C	IV=1	(UU) ^{1/2} AT 200 MB	UV AT 200 MB
C	IV=2	(VV) ^{1/2} AT 200 MB	VT AT 850 MB
C	IV=3	(TT) ^{1/2} AT 850 MB	VQ AT 850 MB
C	IV=4	(TT) ^{1/2} AT 200 MB	VZ AT 200 MB
C	IV=5	(QQ) ^{1/2} AT 850 MB	
C	IV=6	(ZZ) ^{1/2} AT 500 MB	

```
C J=1 IS THE SOUTH POLE, I=1 IS JAN OF 1980, I=96 IS DEC OF 1987
```

```
C
```

```
DO 10 IV=1,NVAR
```

```
    READ(8) IV, VAR
```

```
10 CONTINUE
```



VII. THE SECOND MOMENT FIELDS

DJF

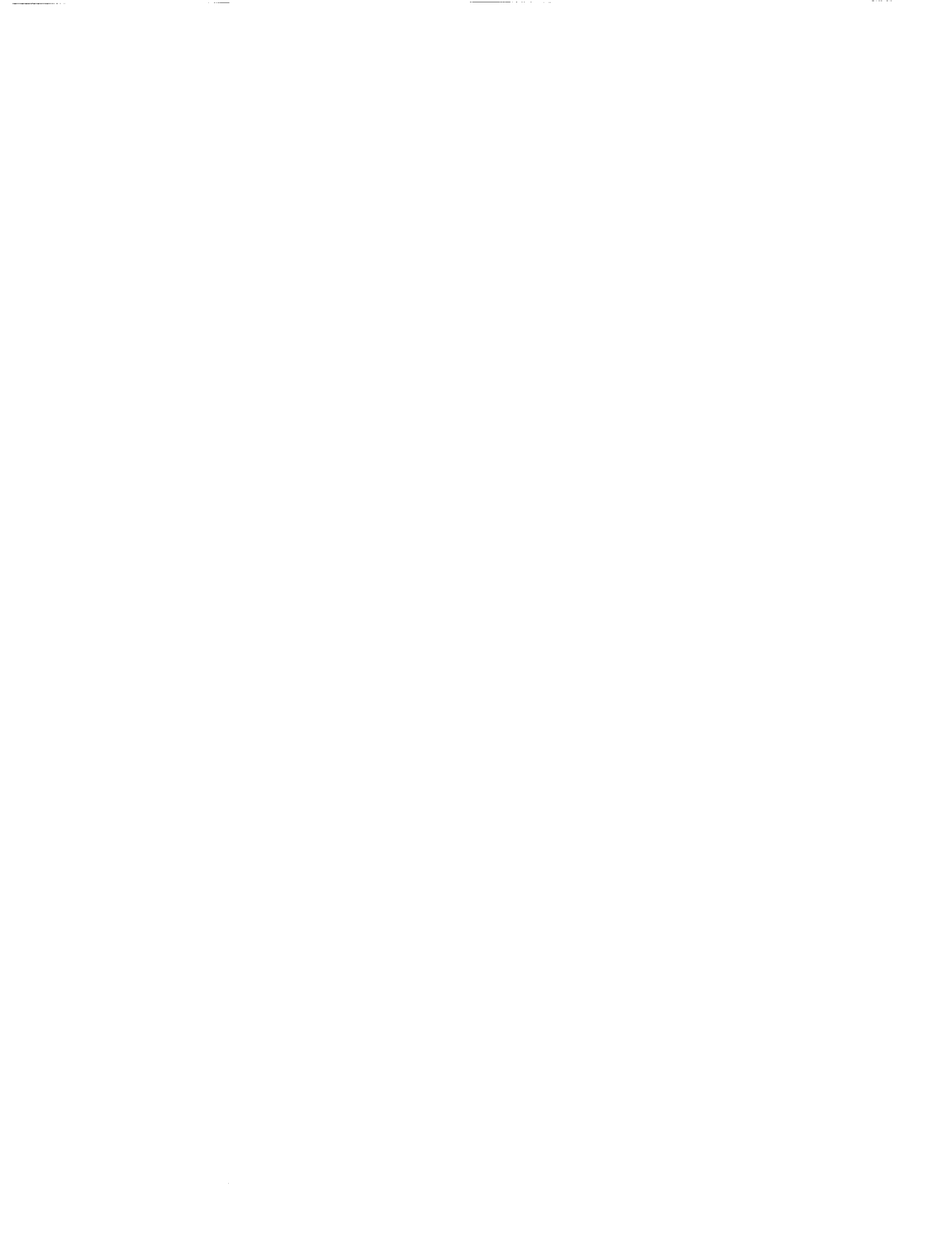
DEVIATIONS FROM MONTHLY MEANS

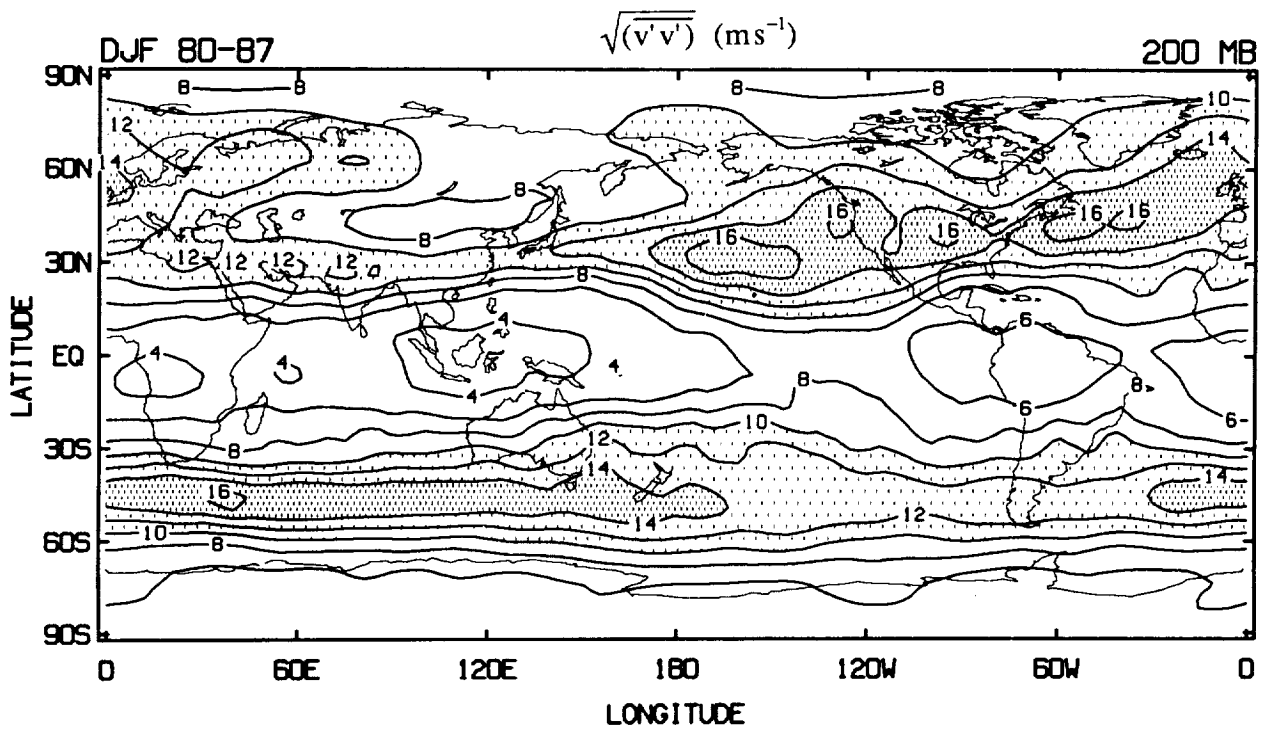
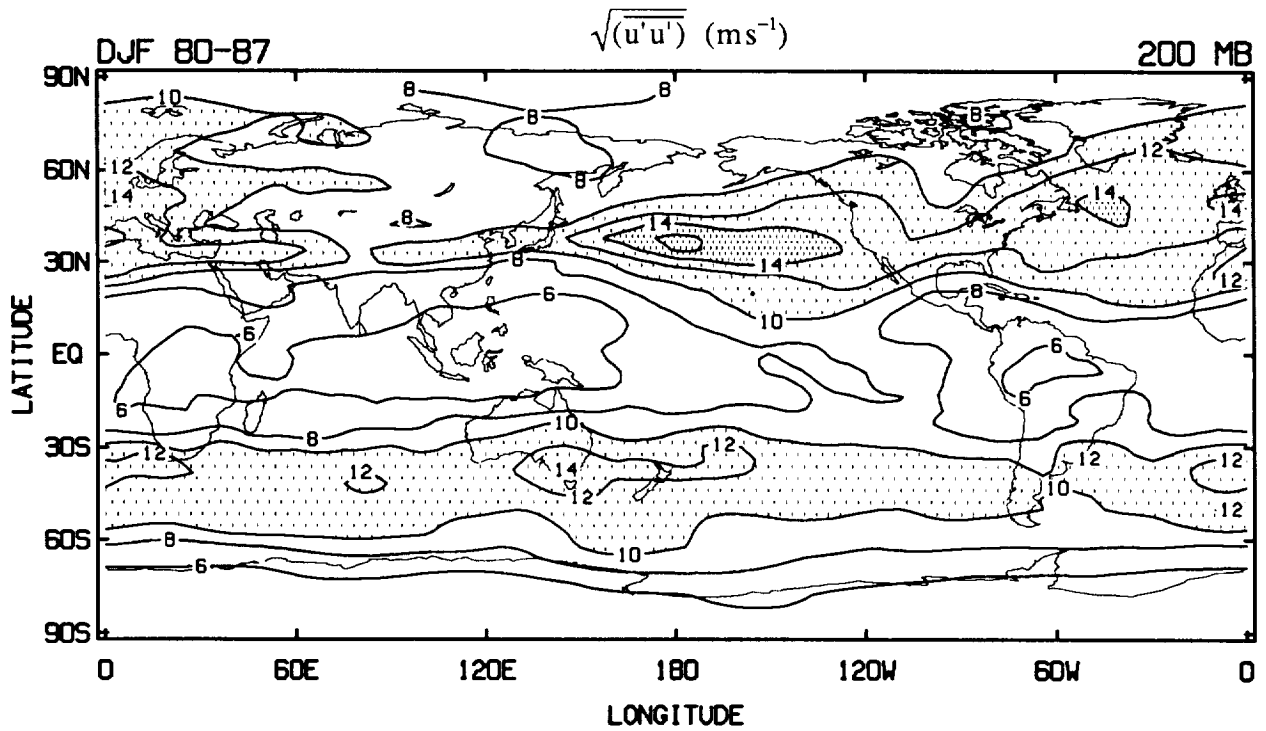

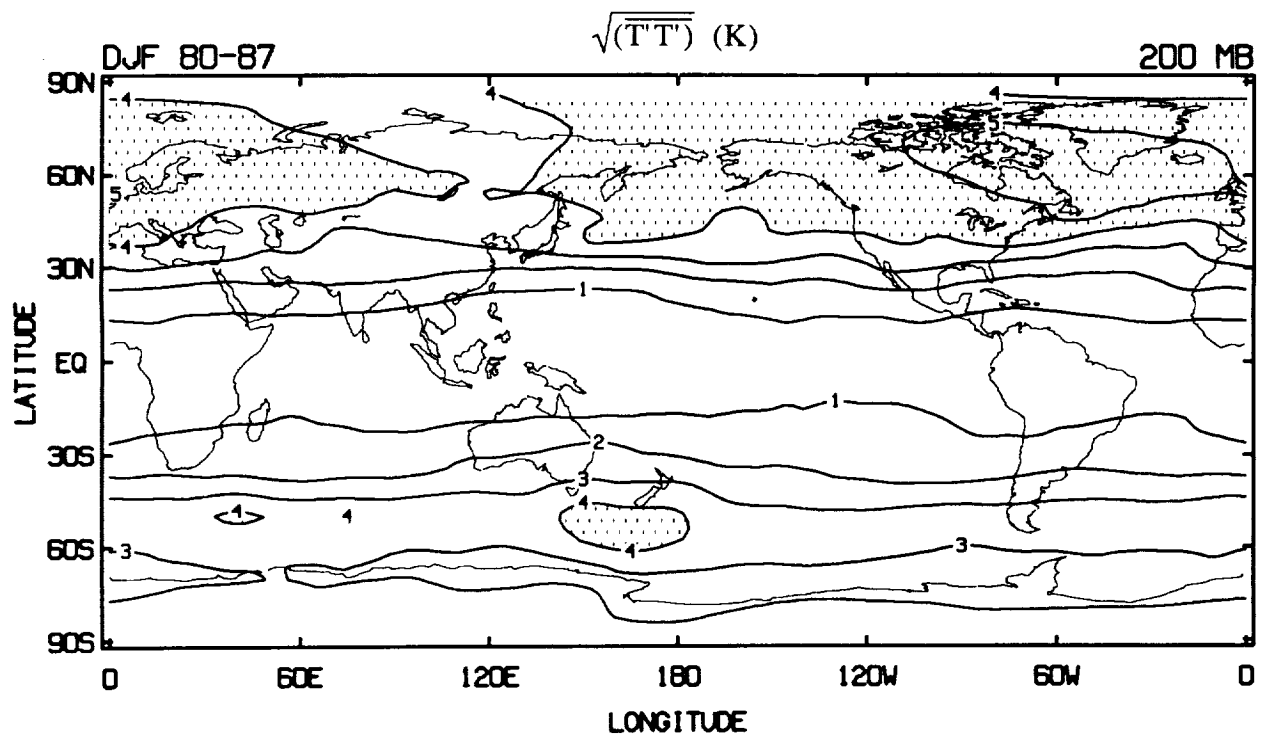
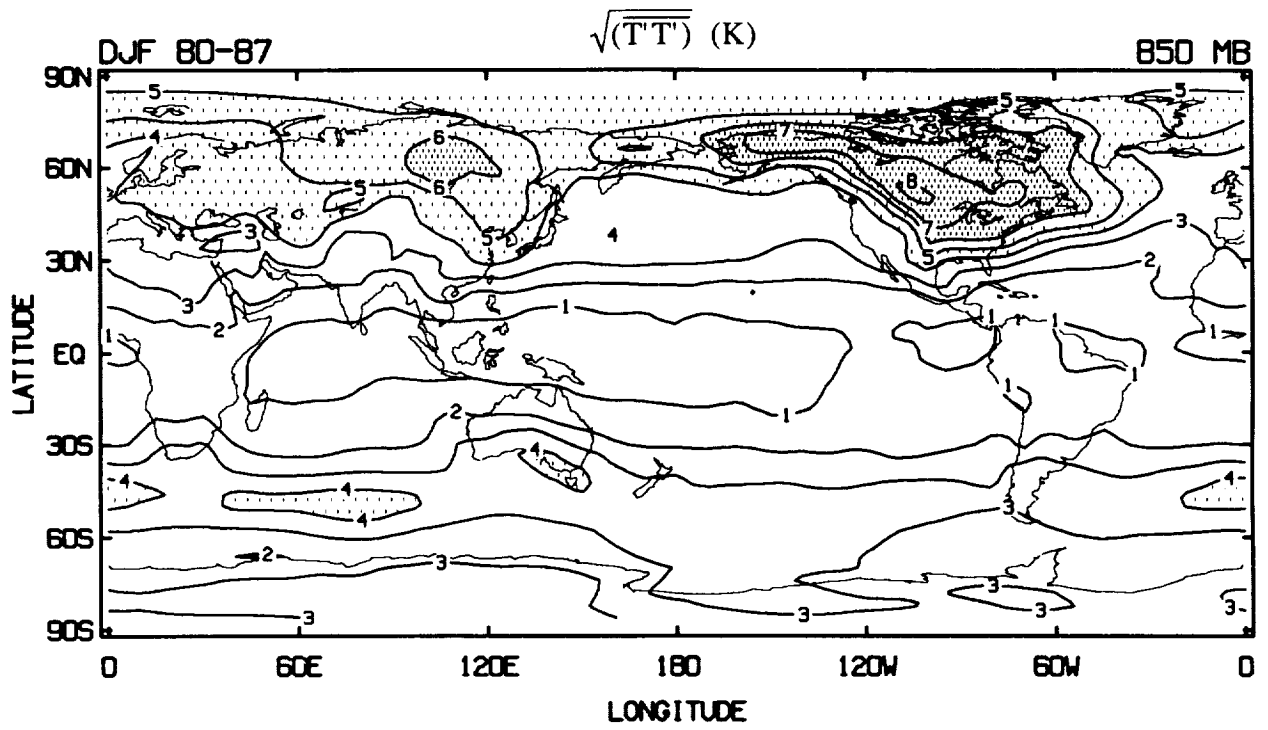



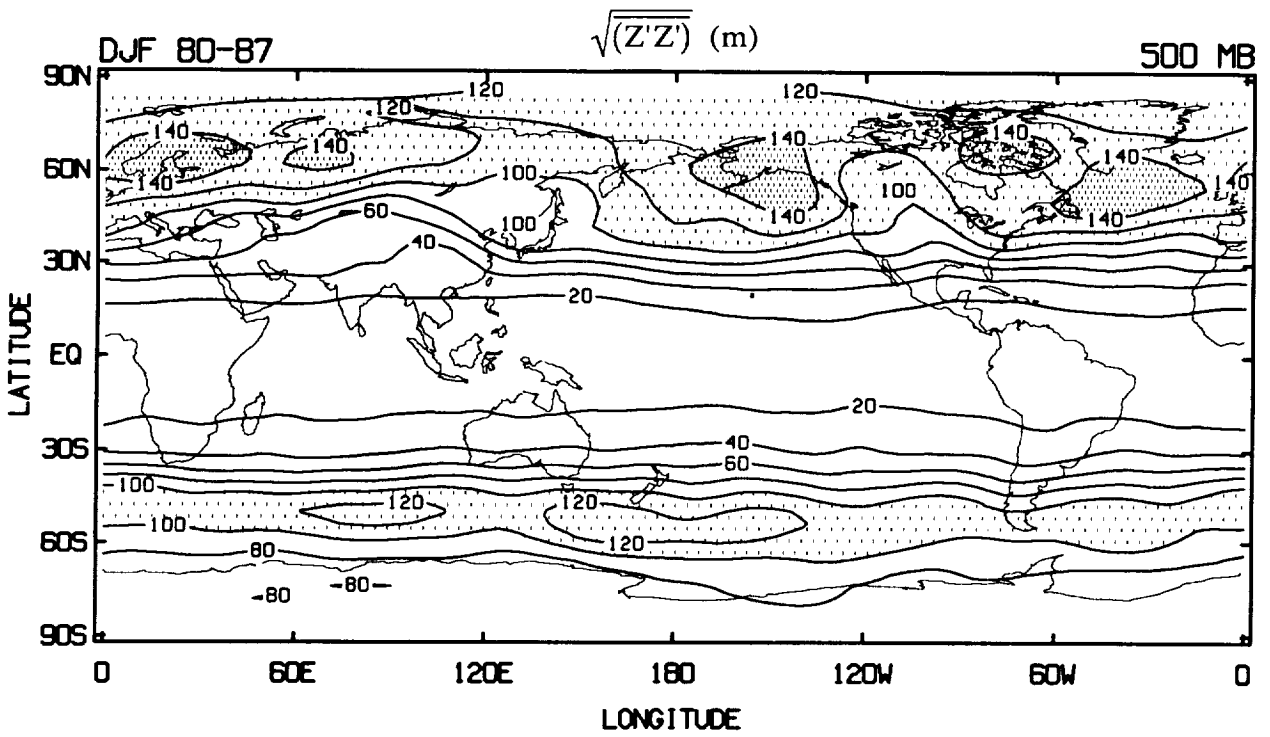
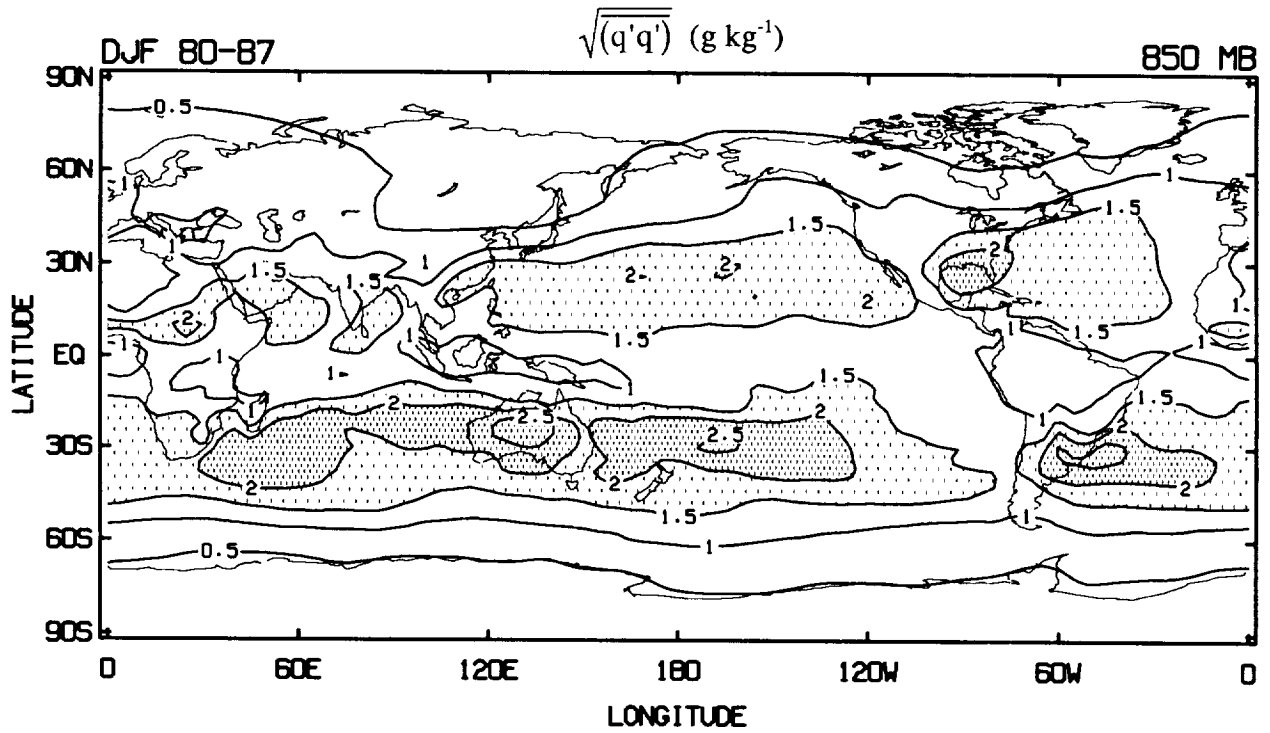

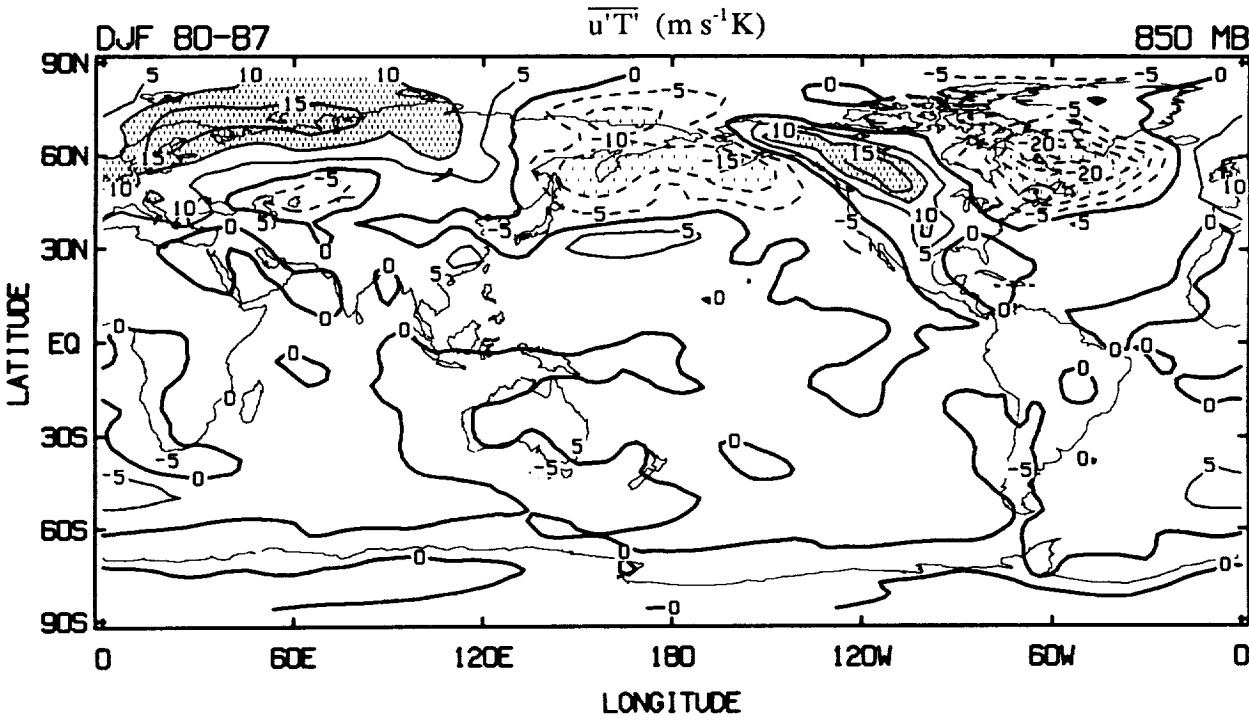
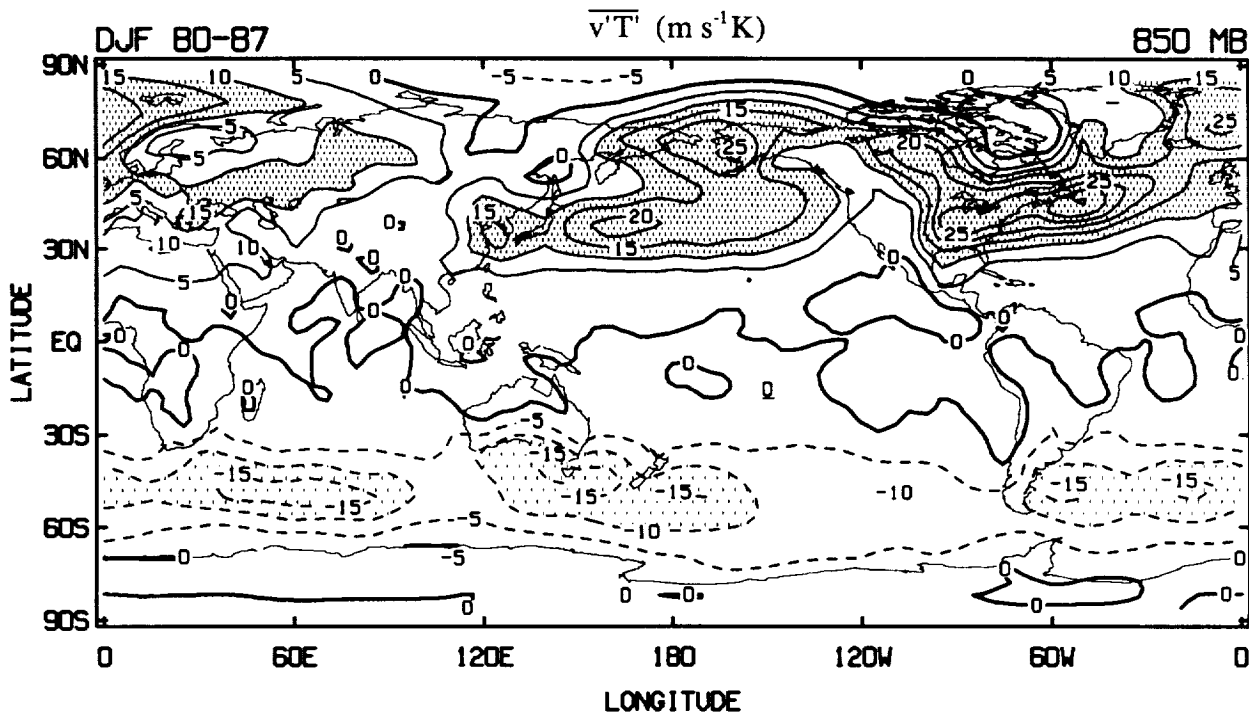

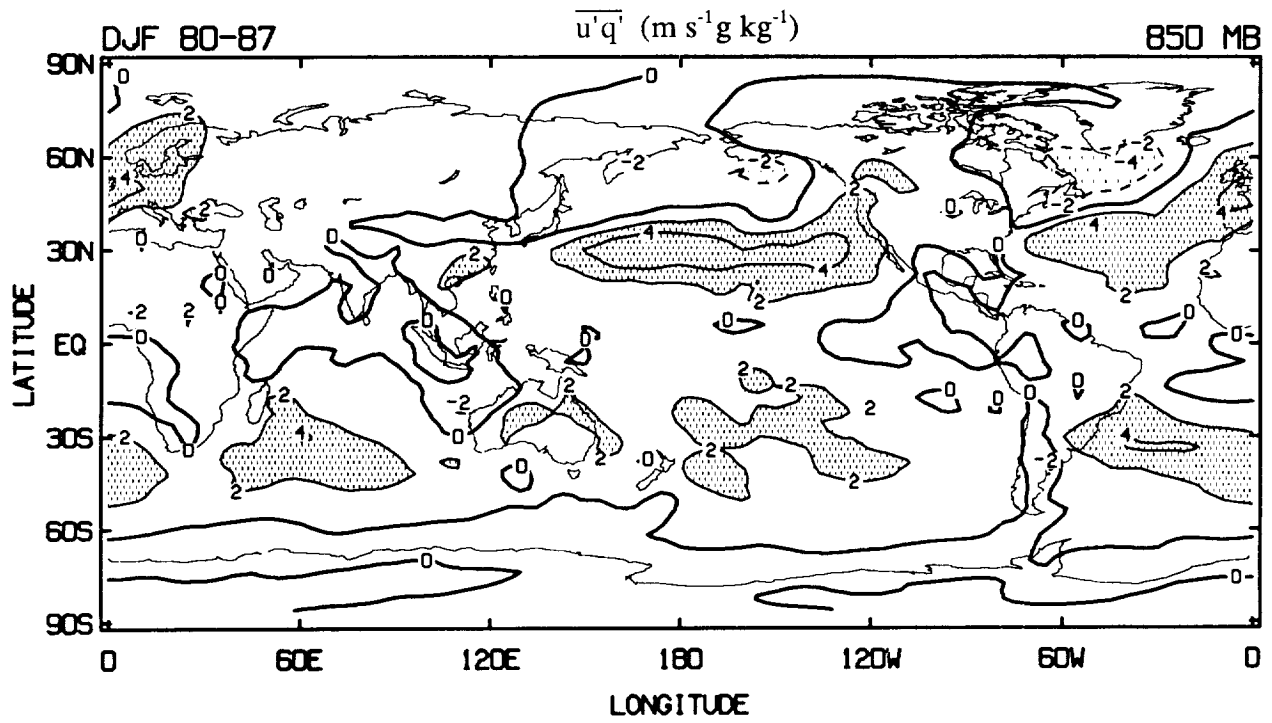
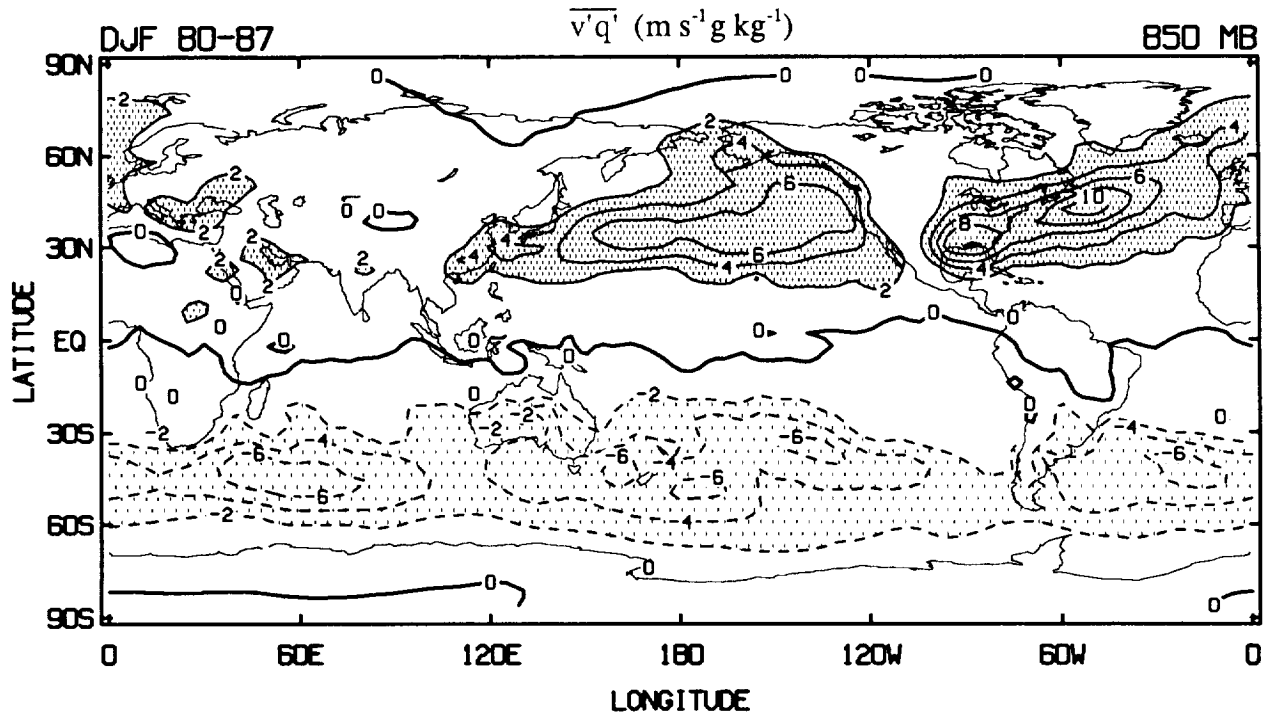

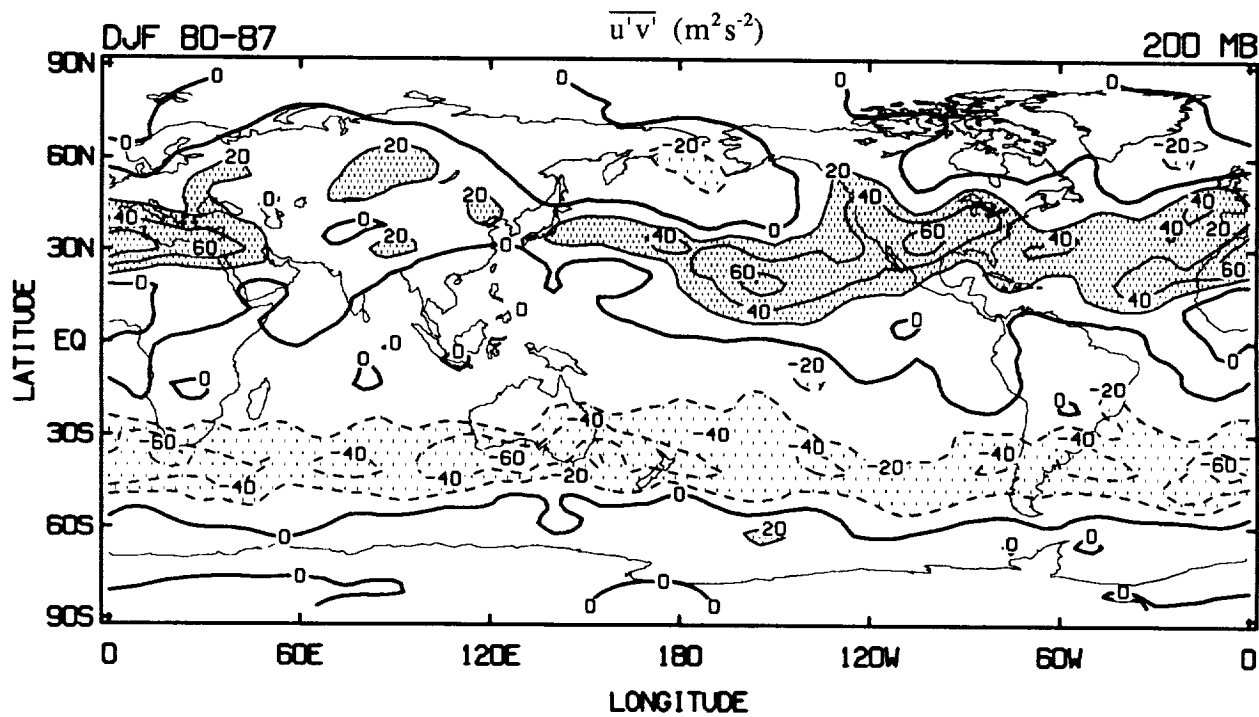

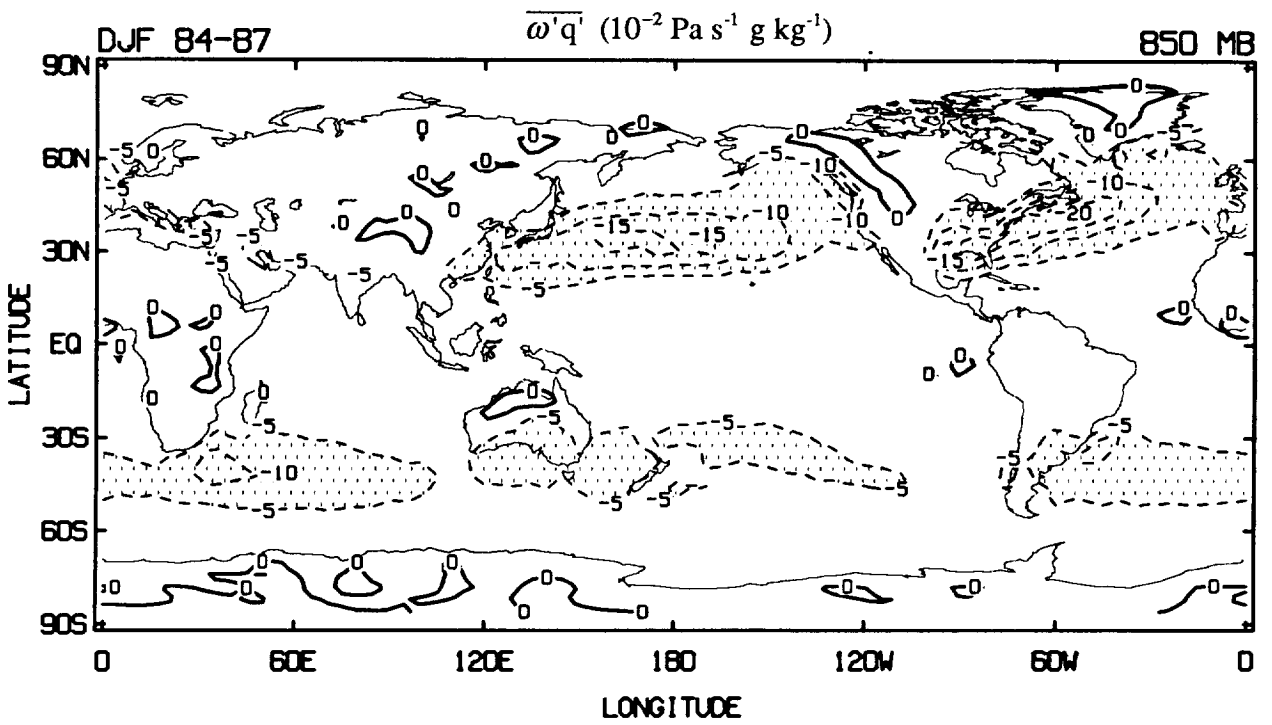
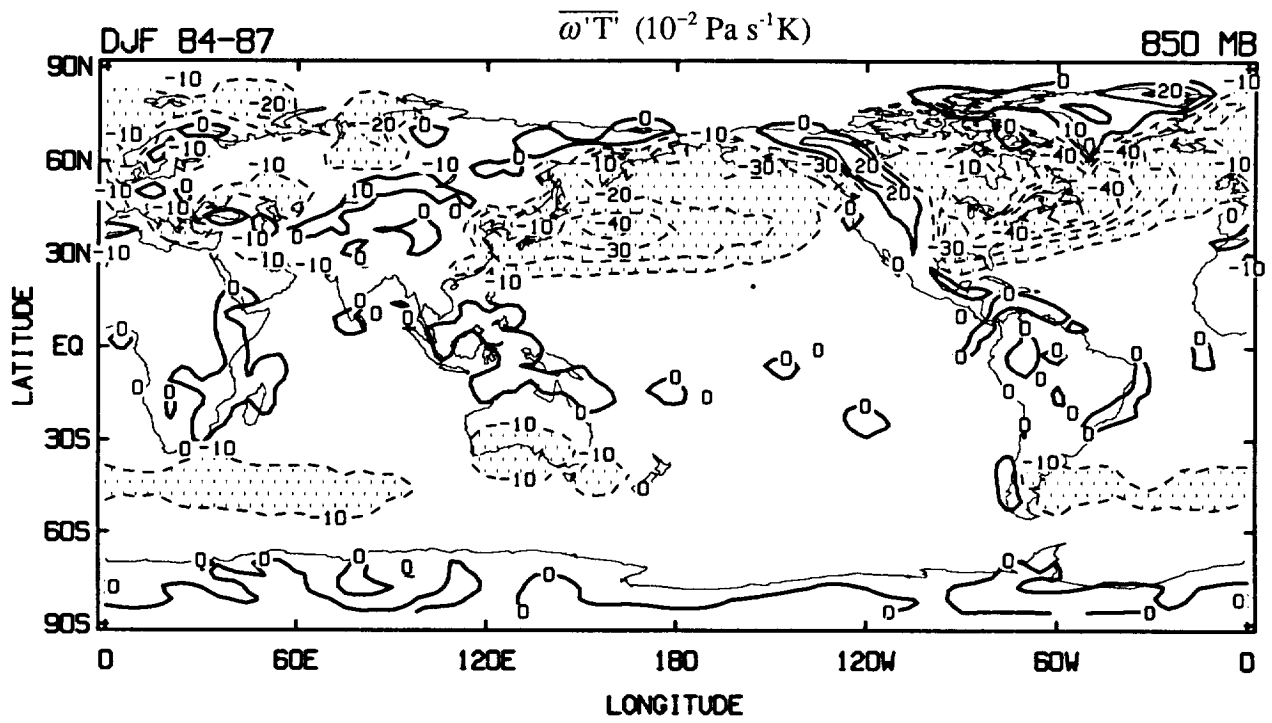

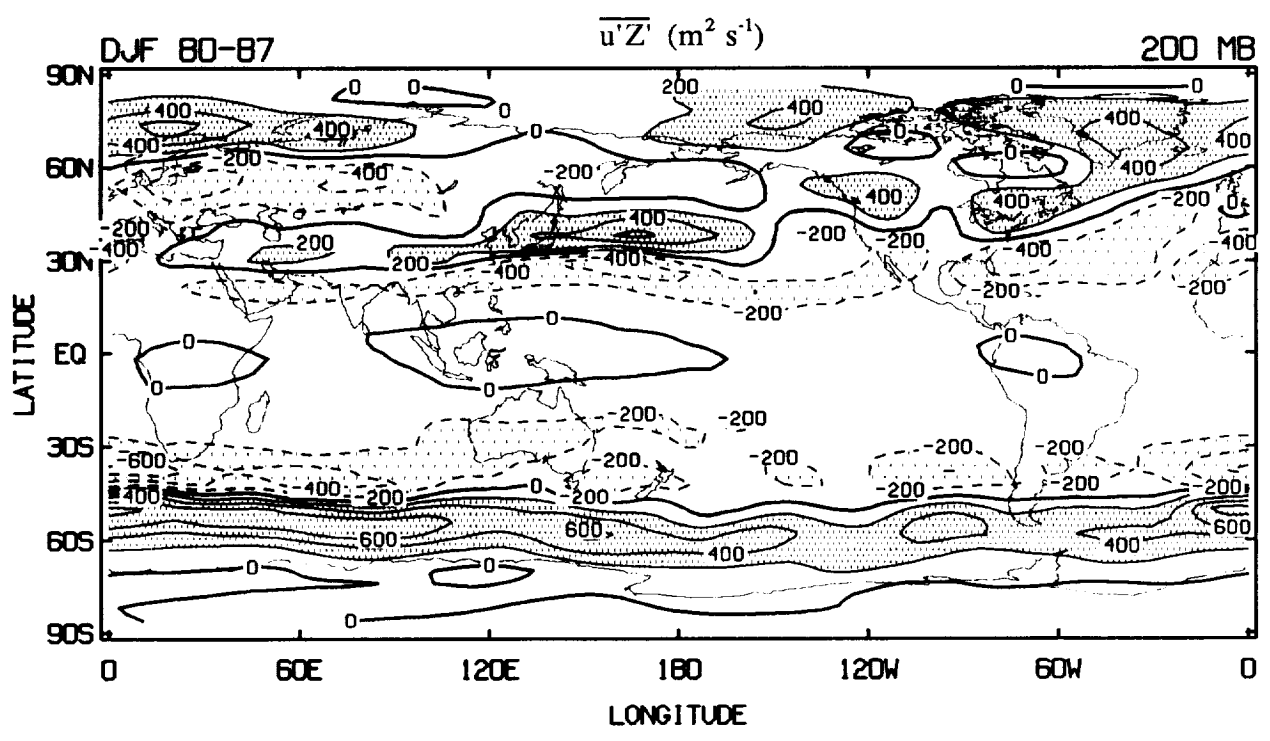
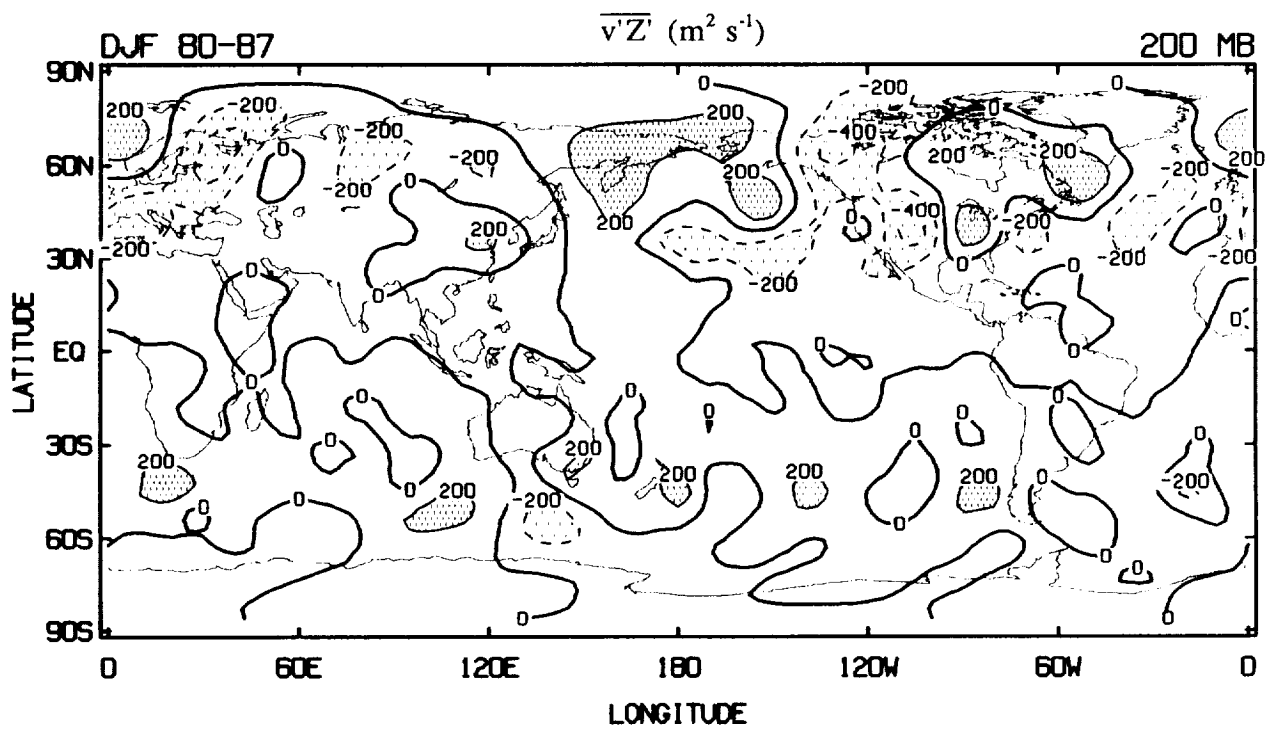

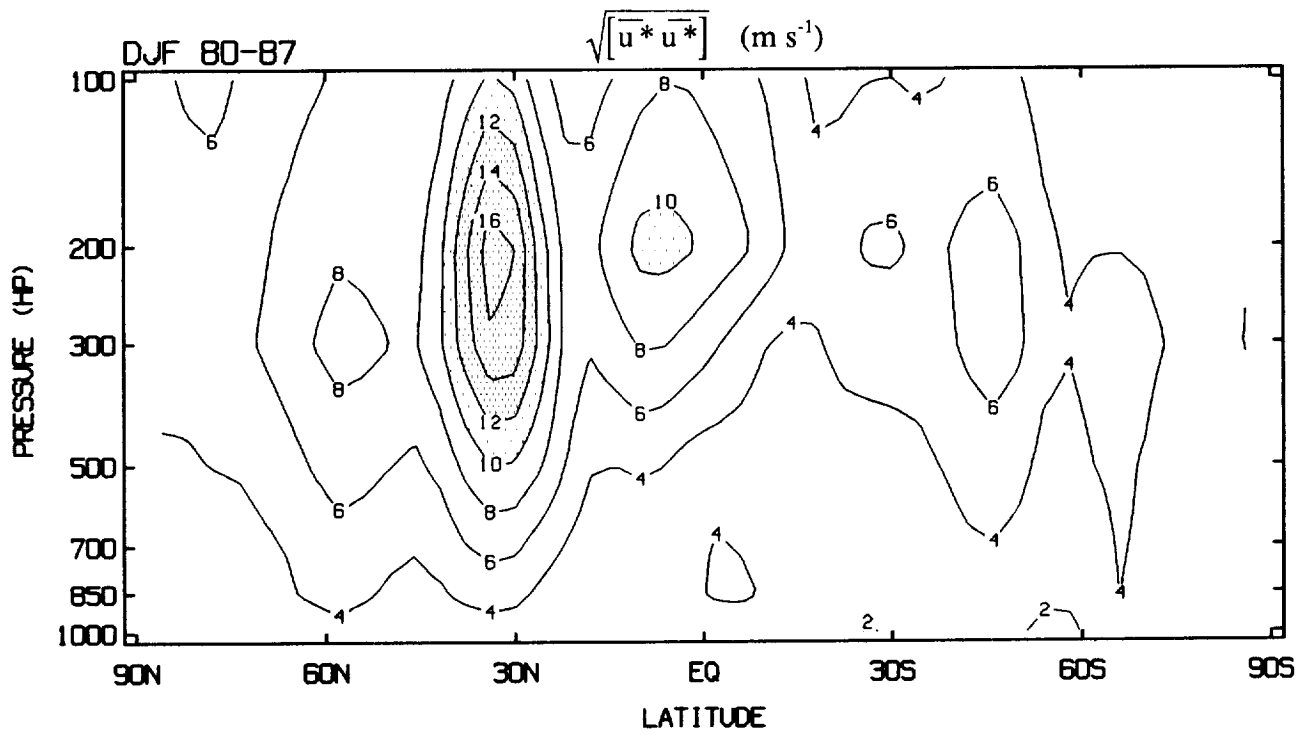
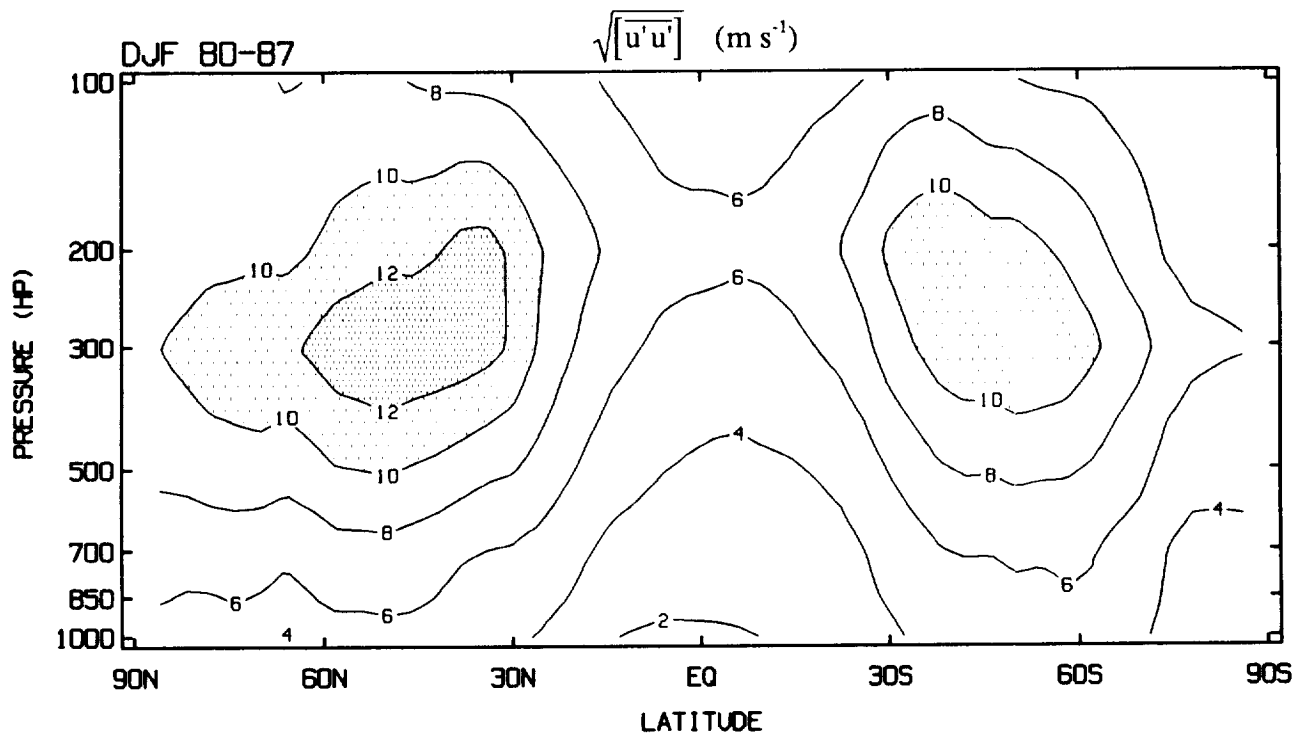

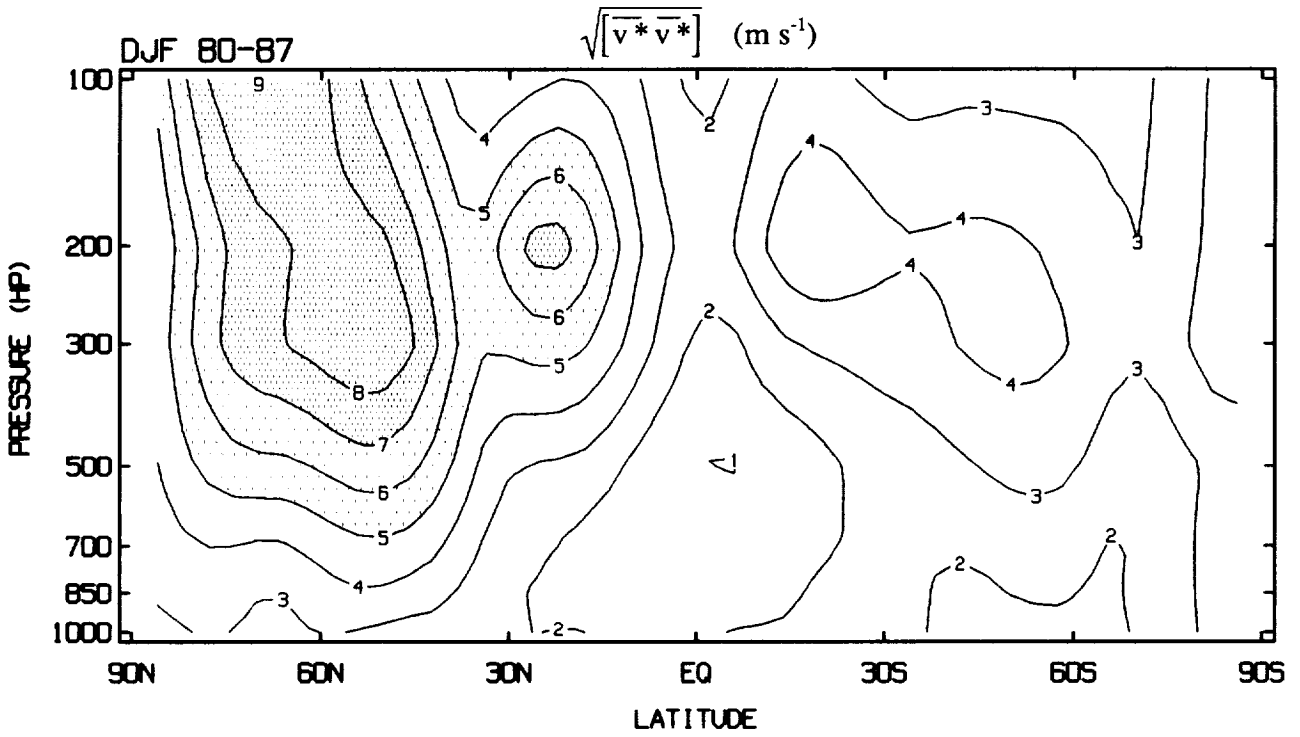
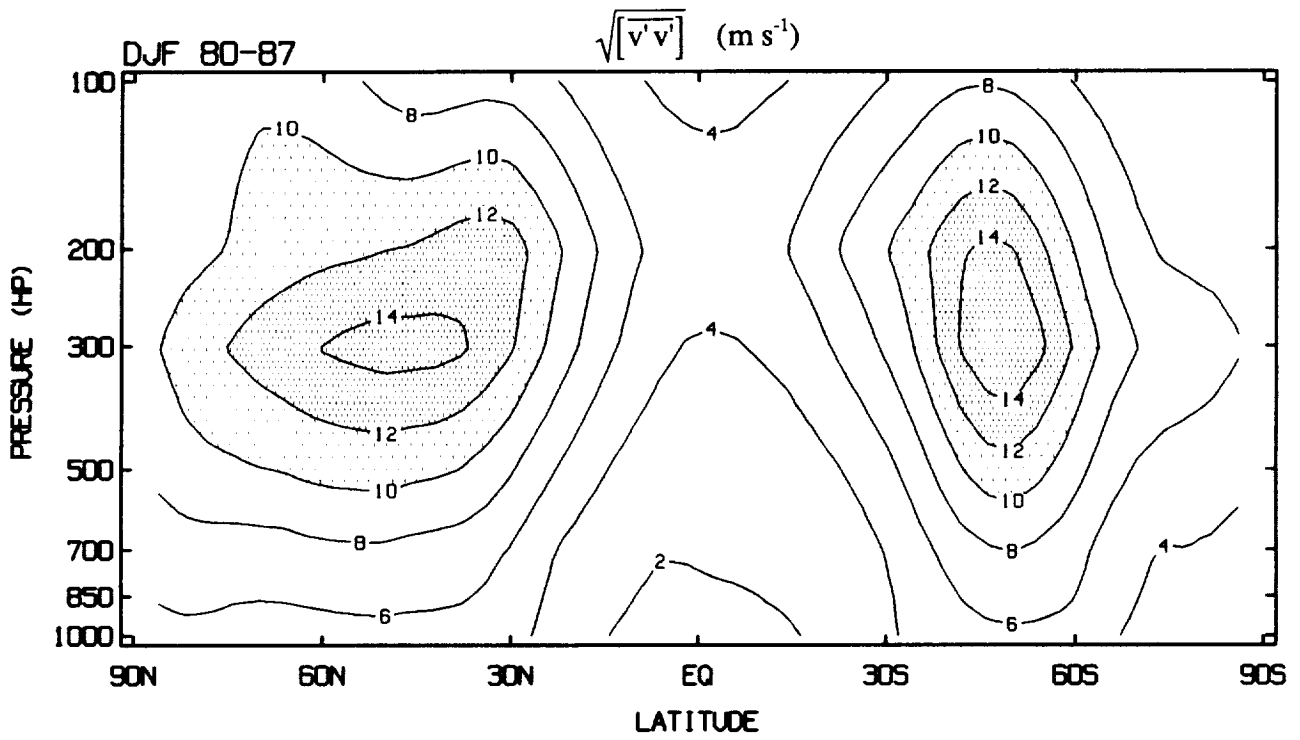

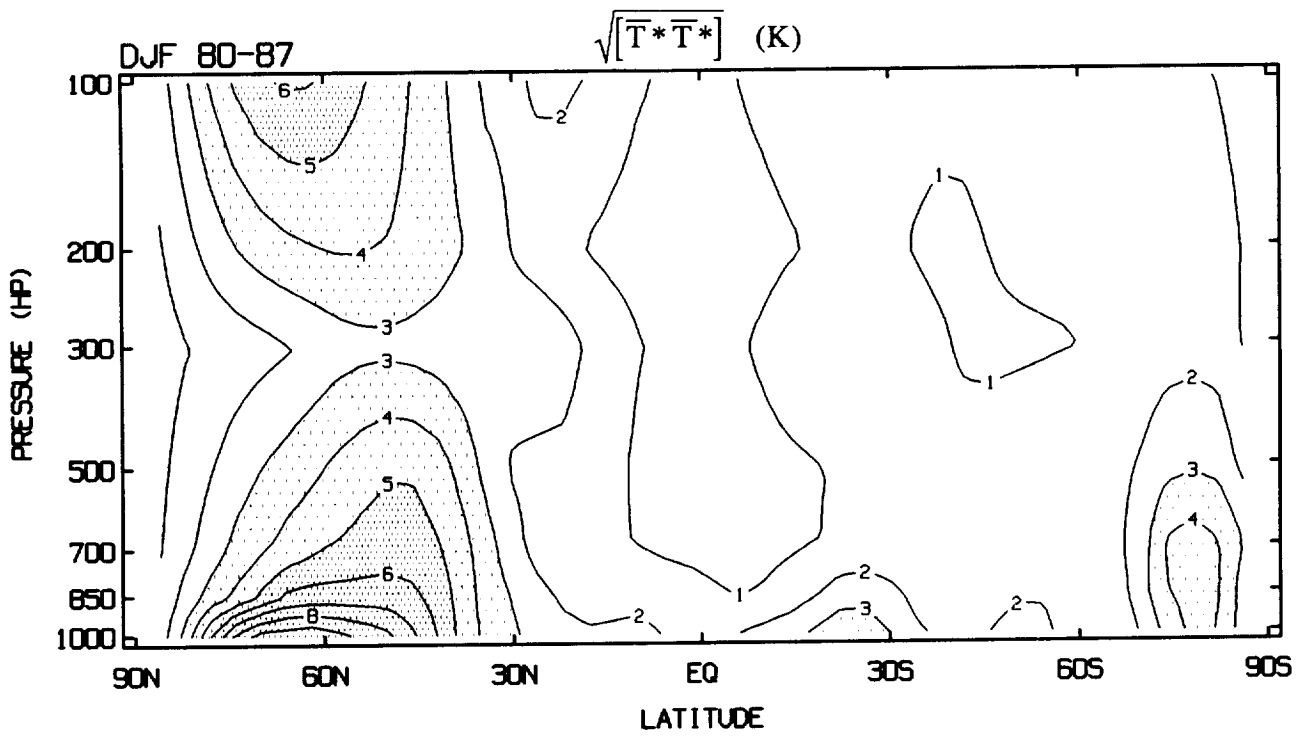
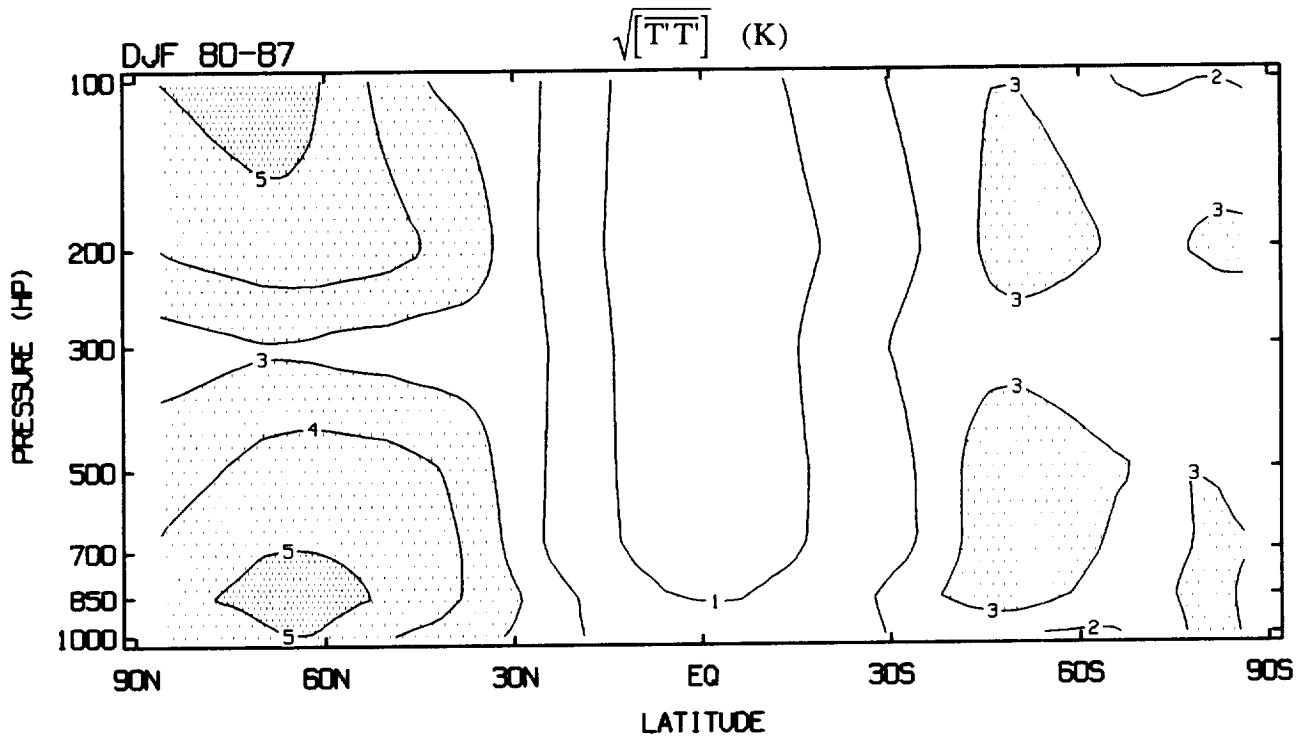

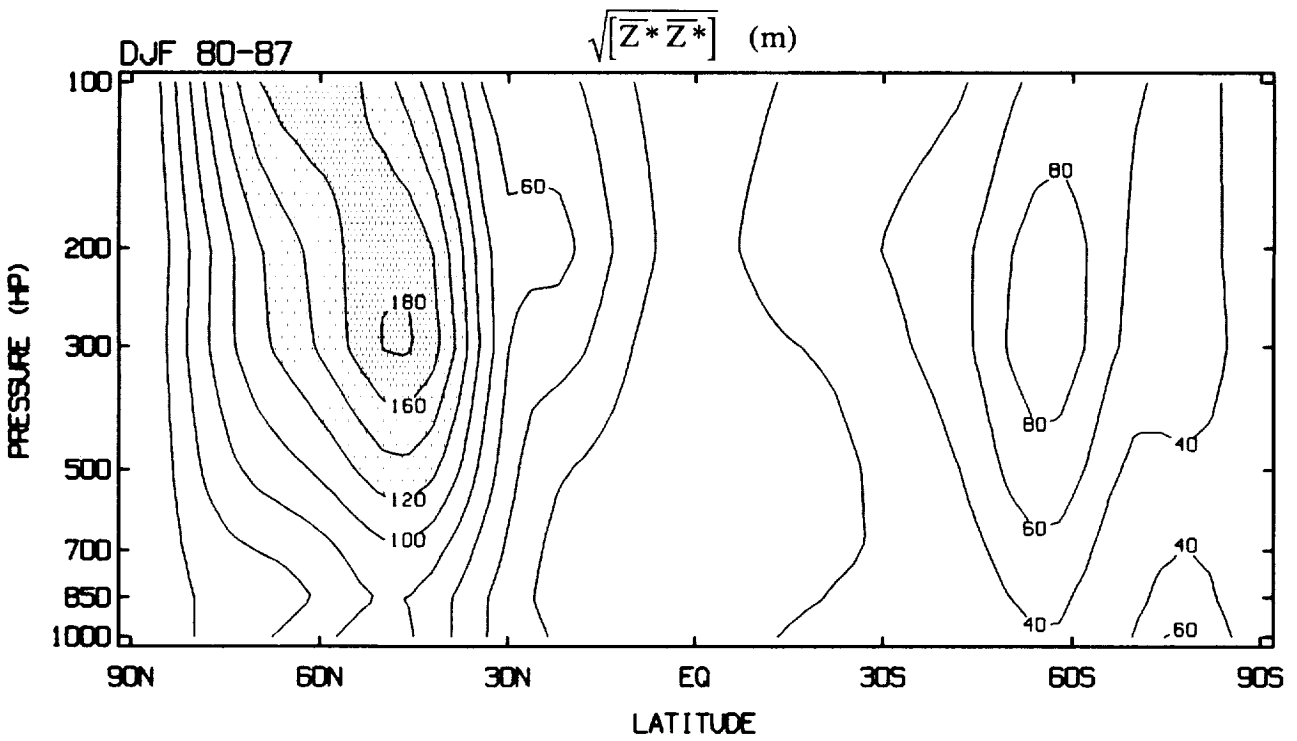
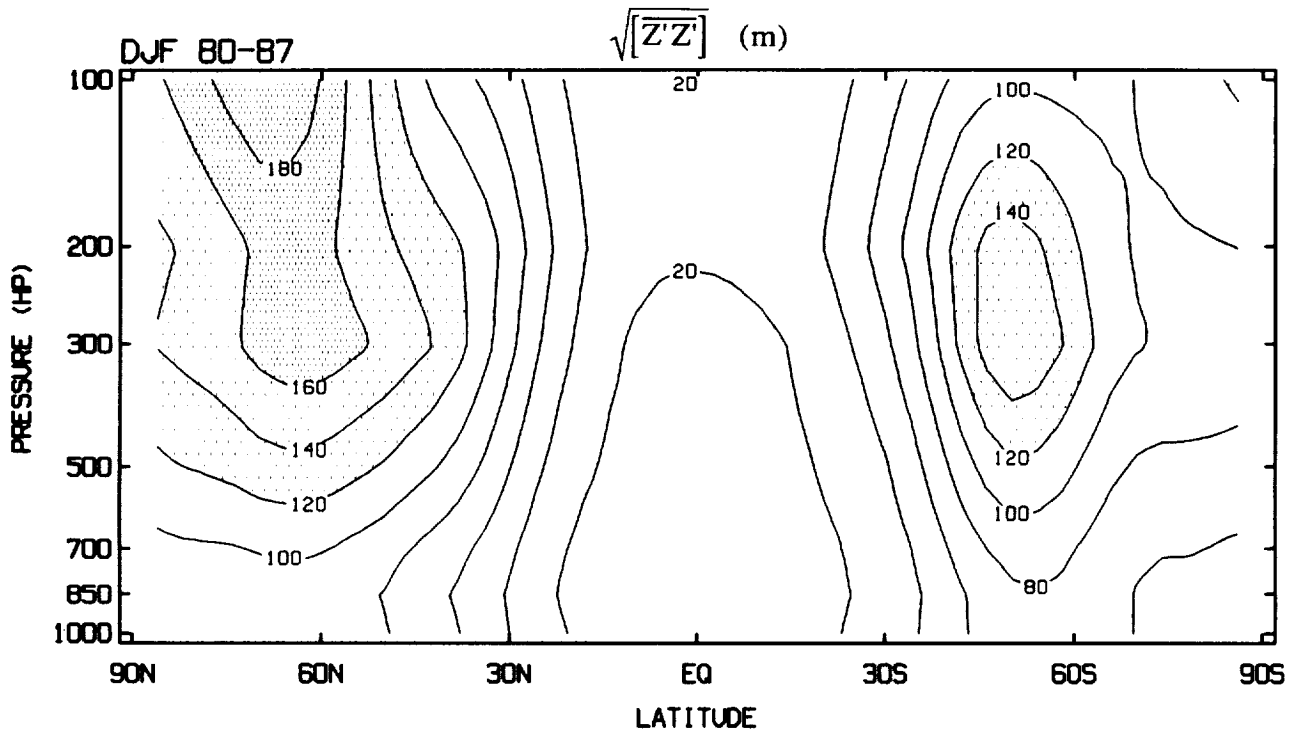

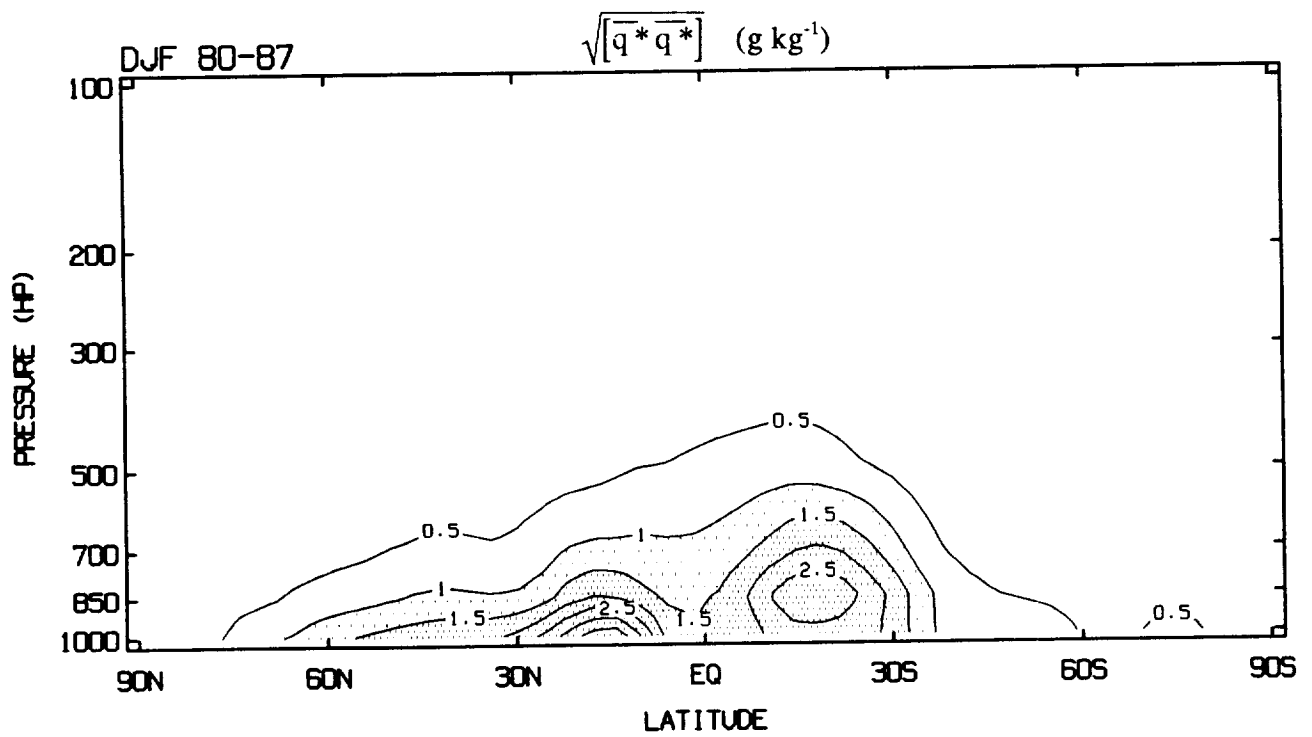
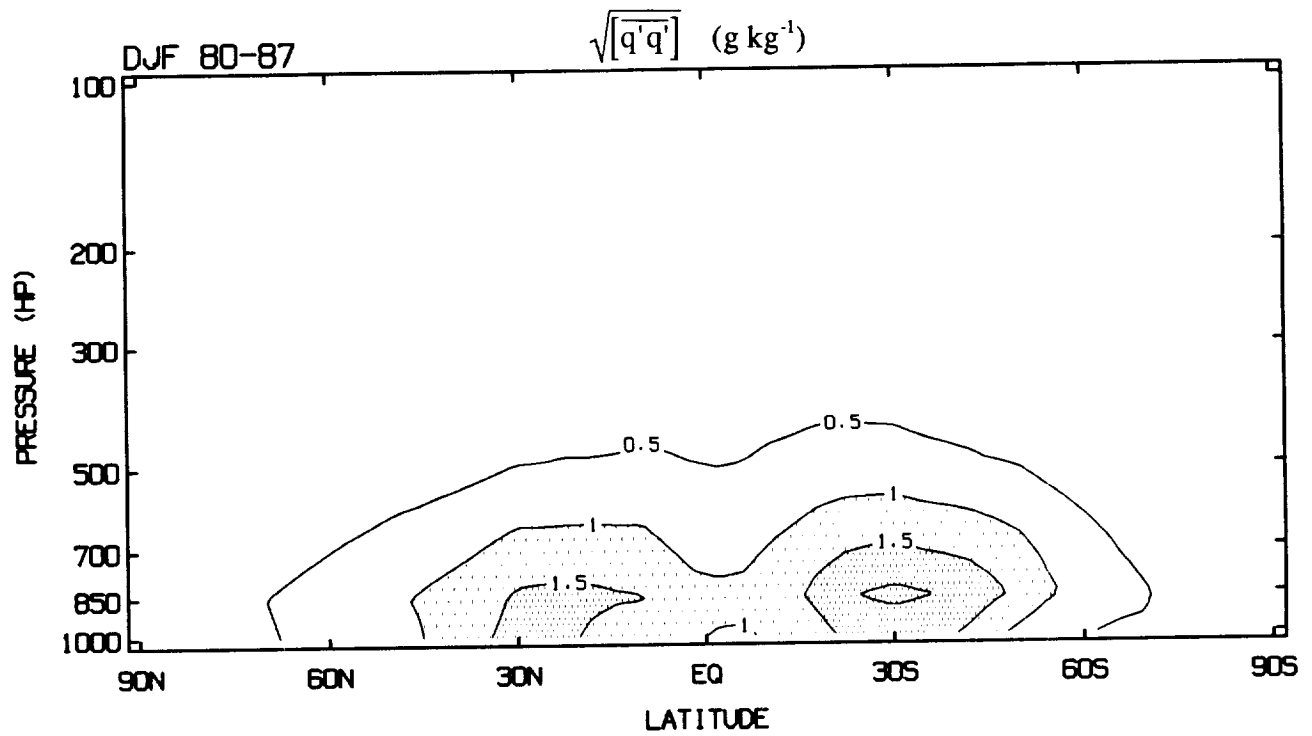

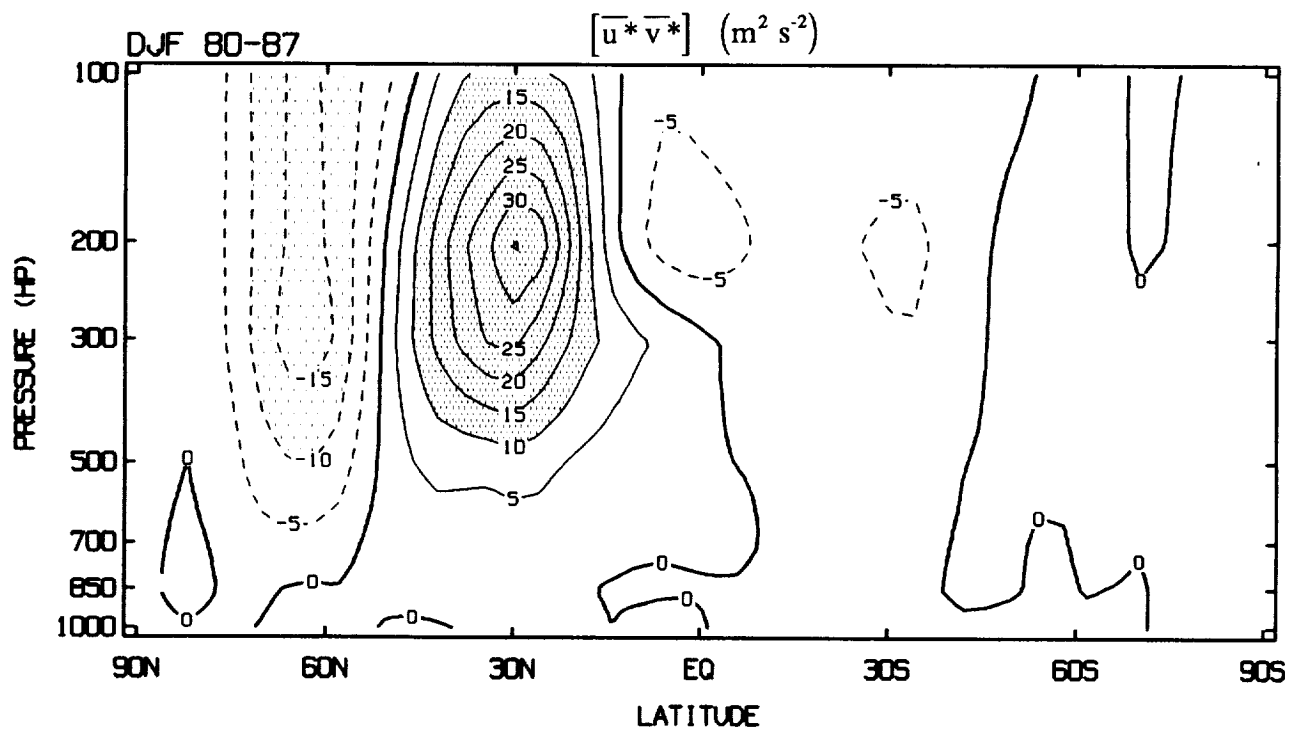
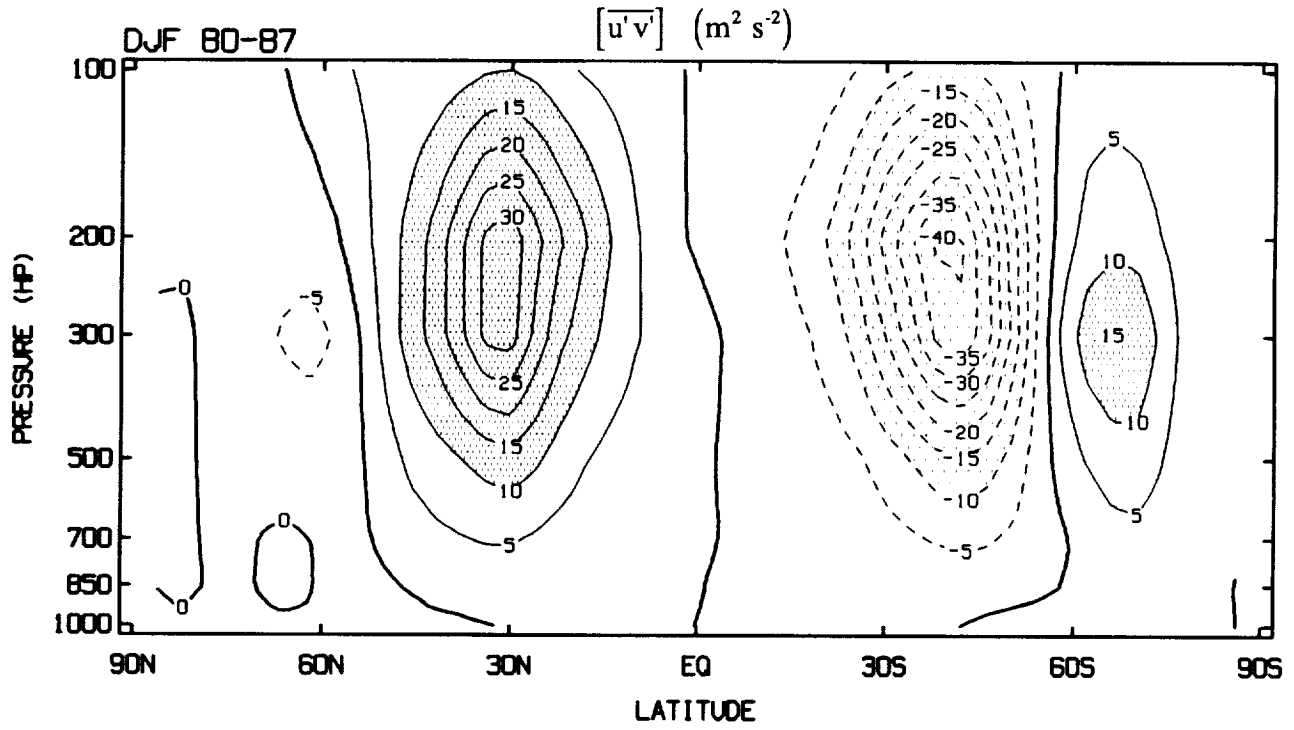

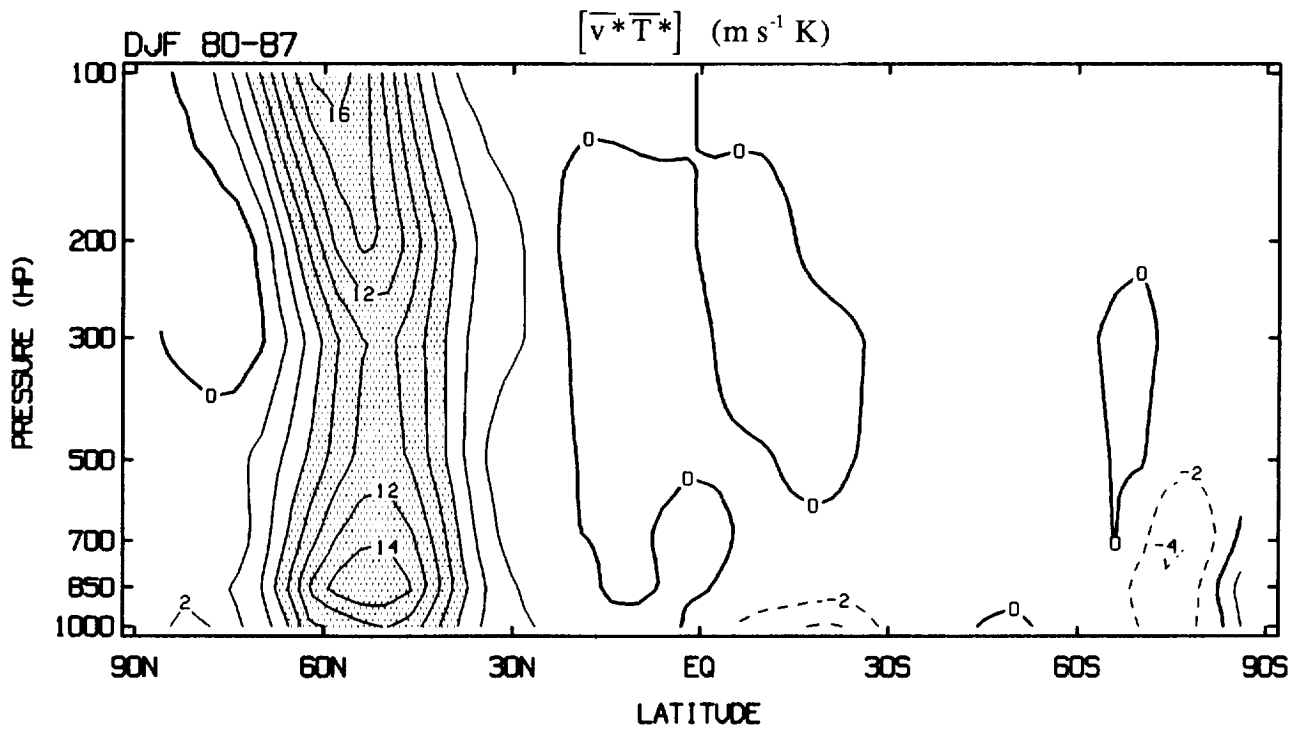
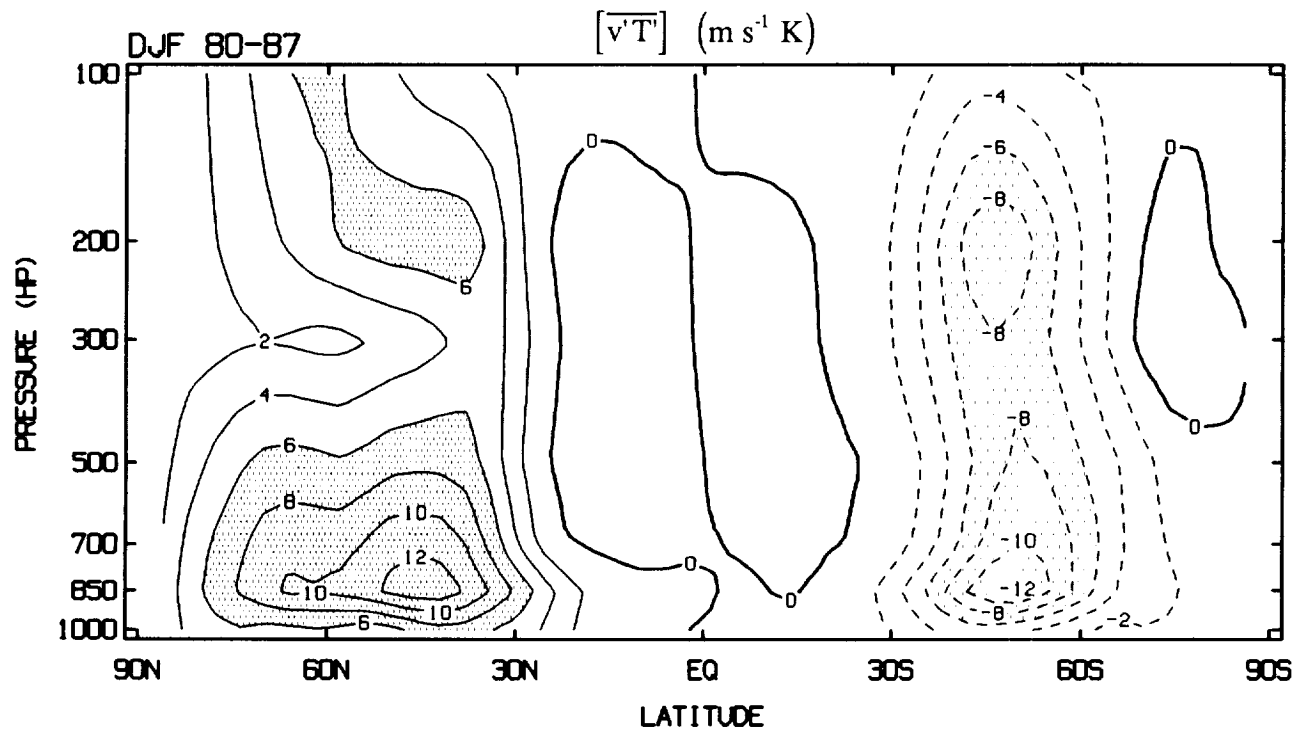

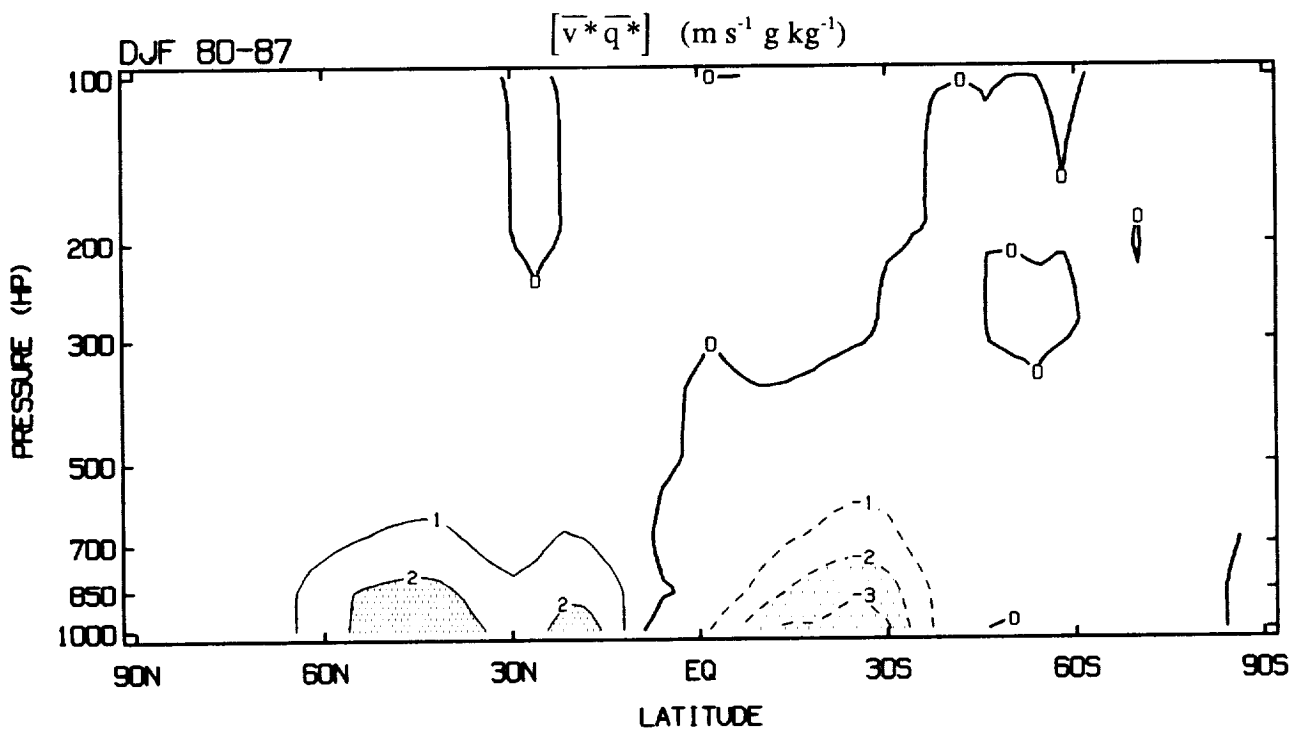
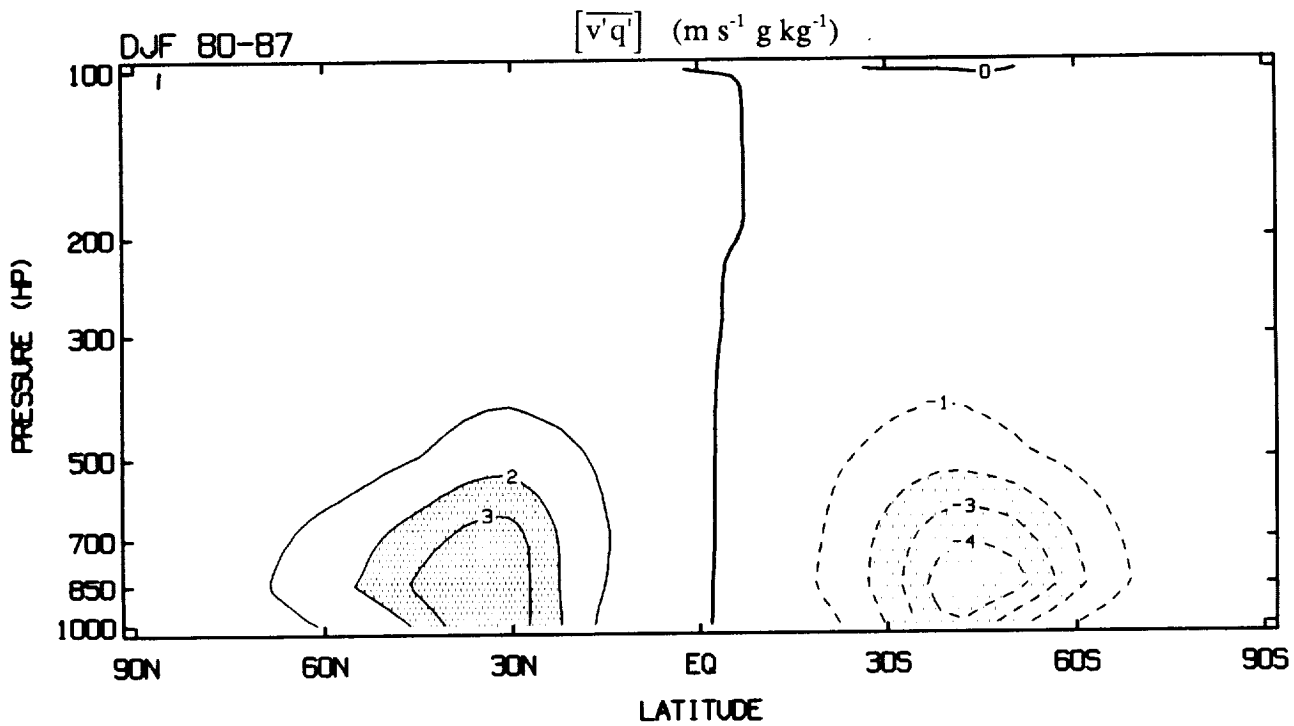

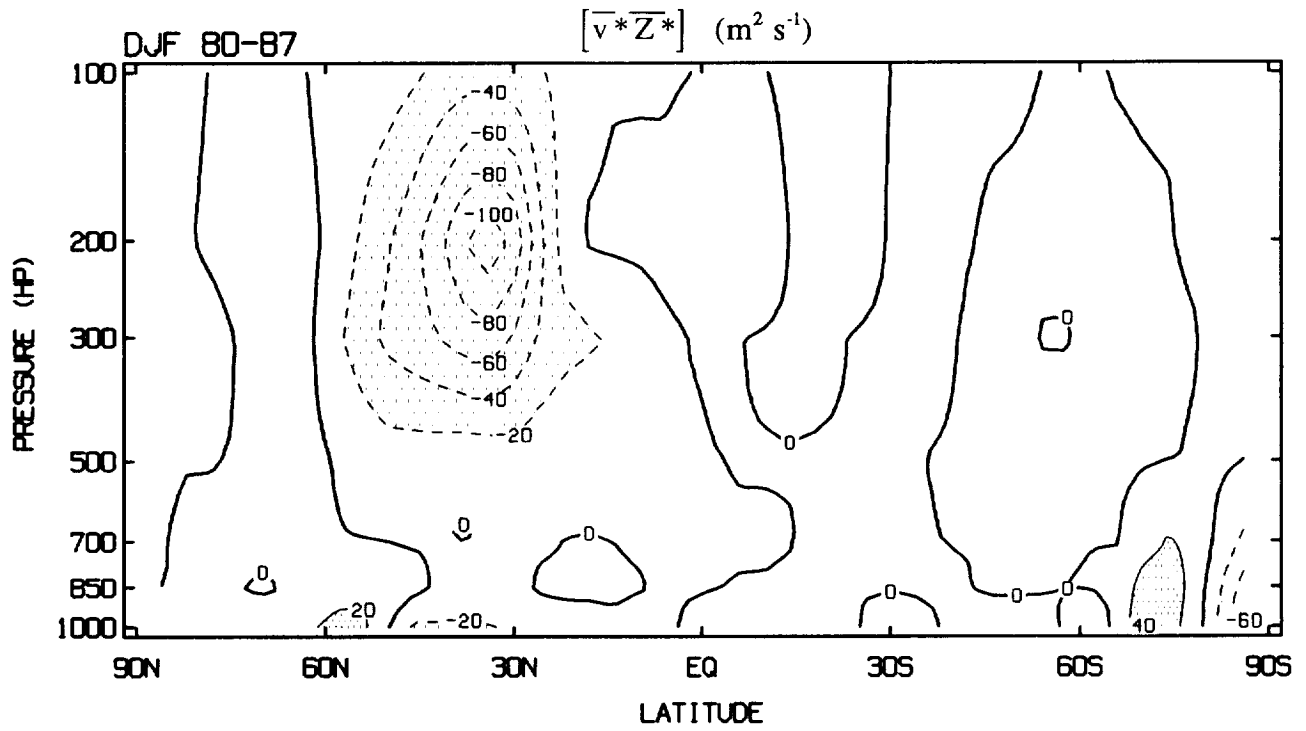
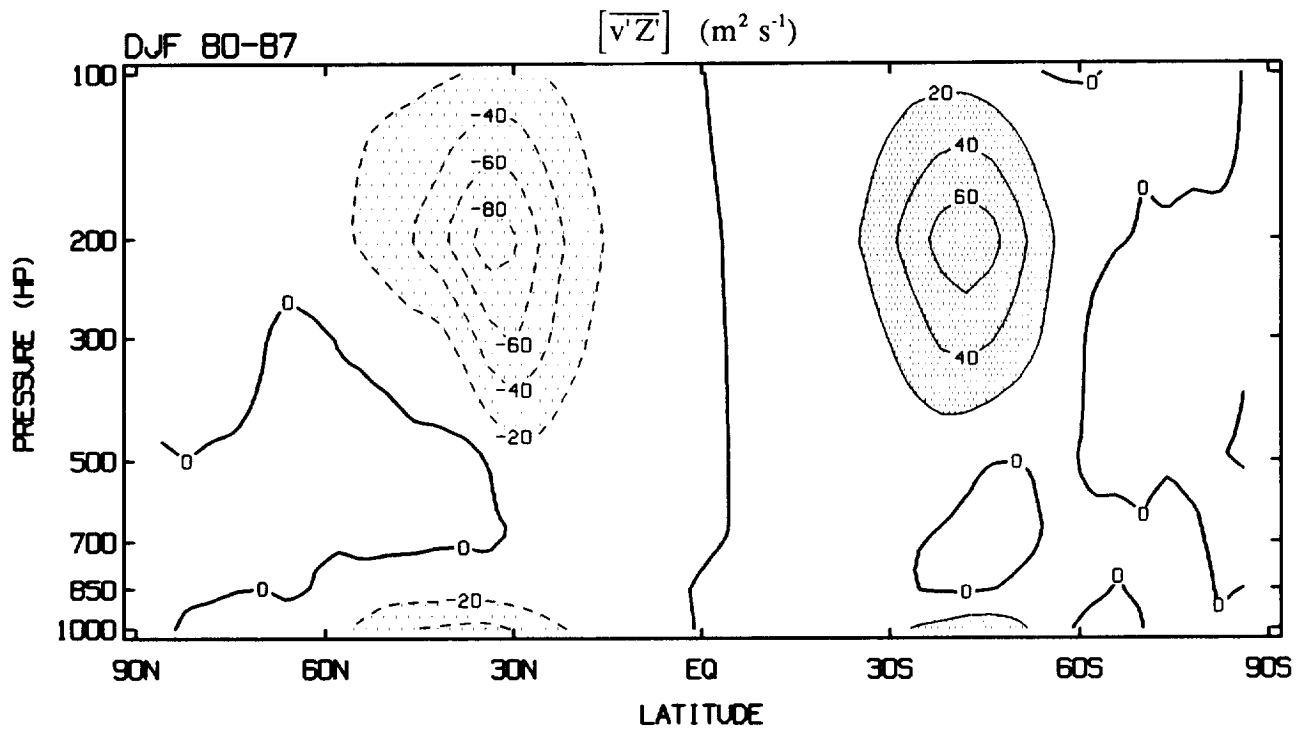

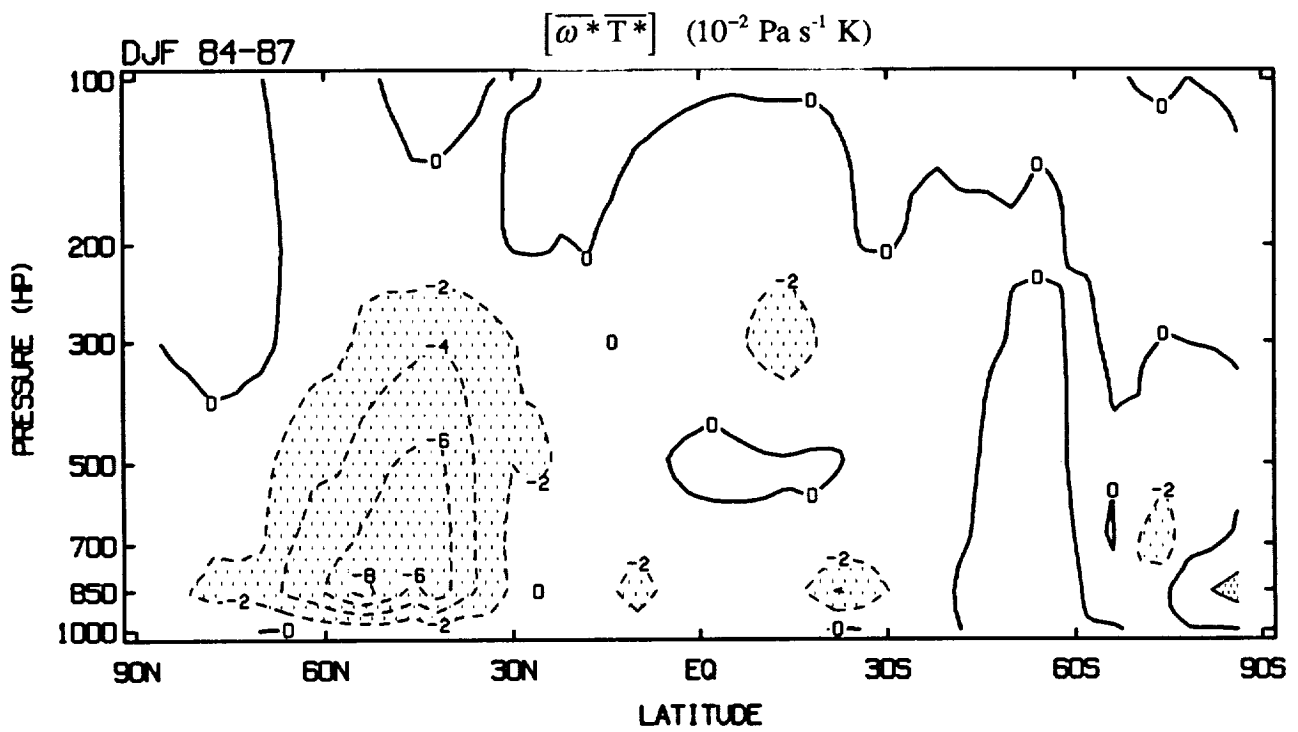
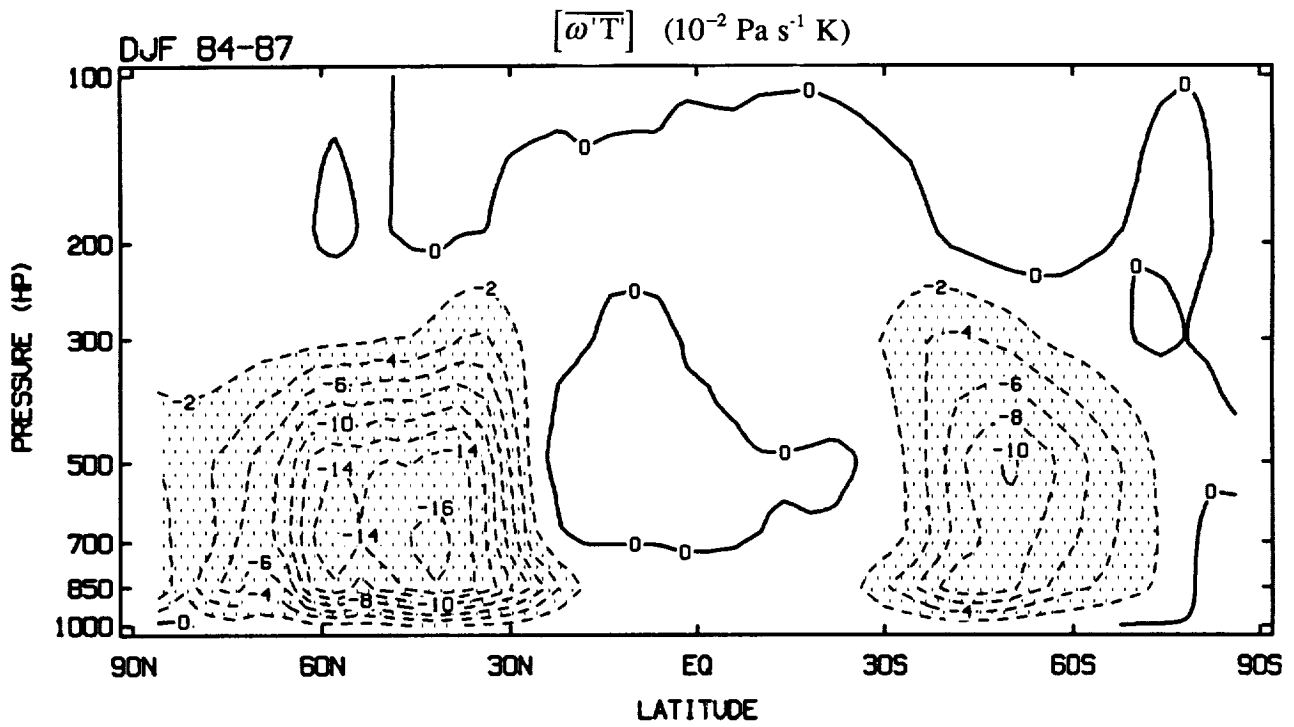

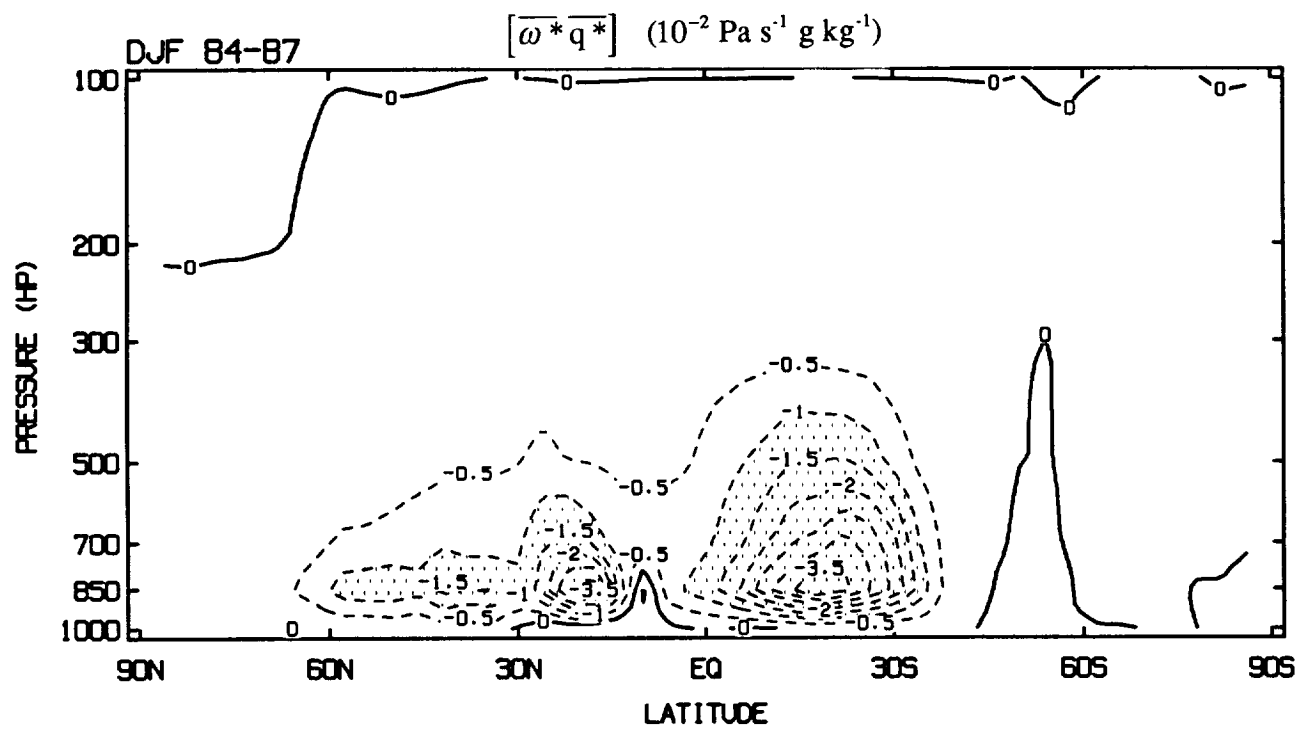
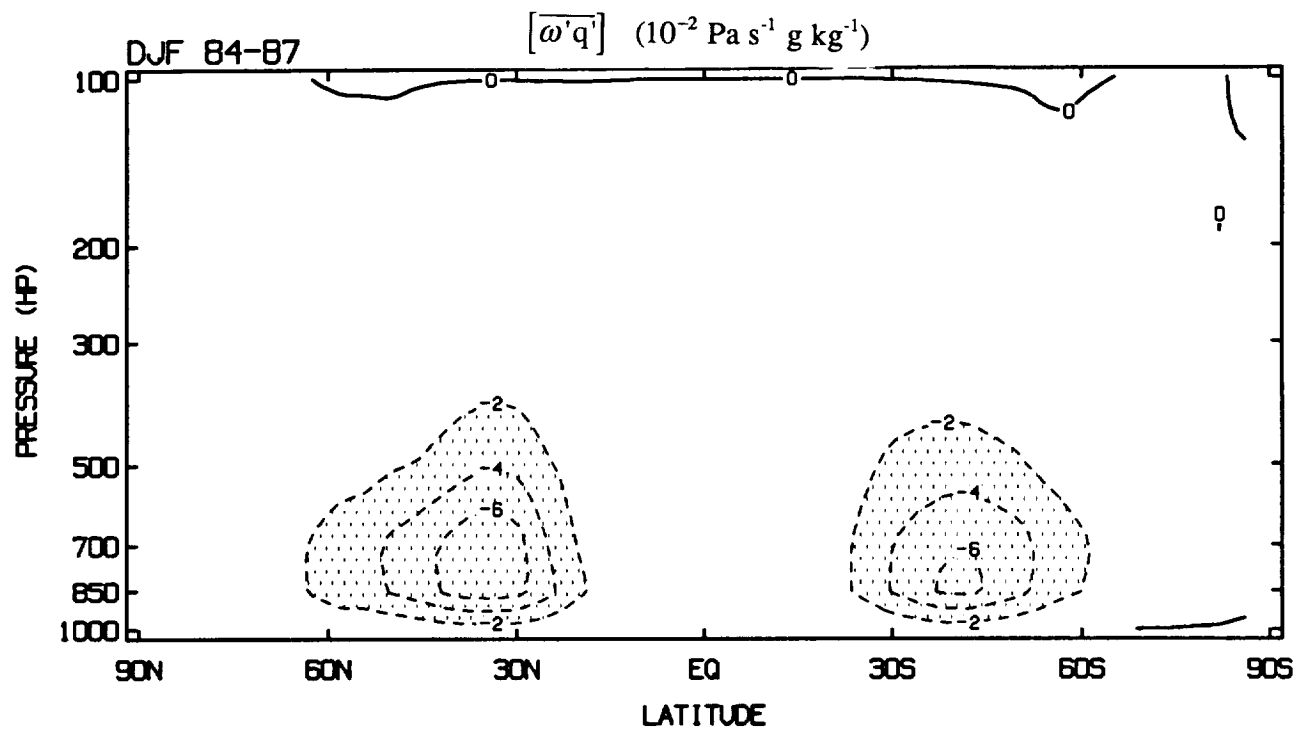

DJF

DEVIATIONS FROM SEASONAL CYCLE

UNFILTERED



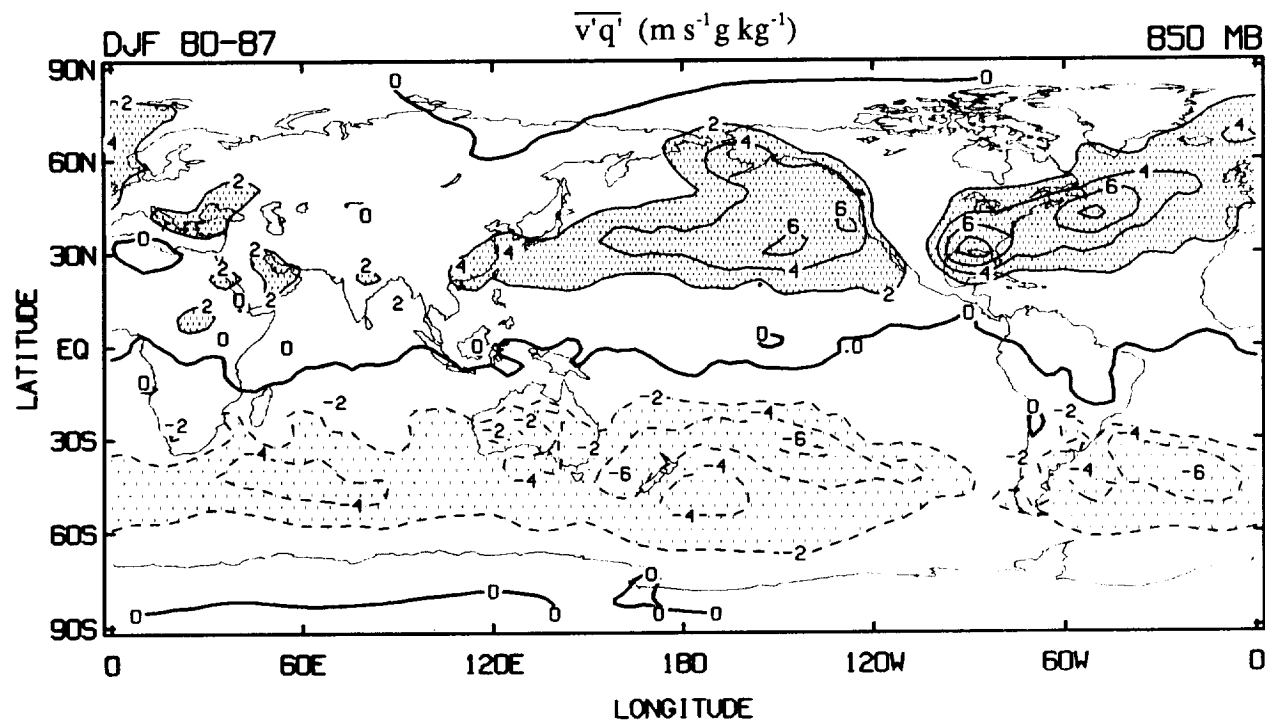
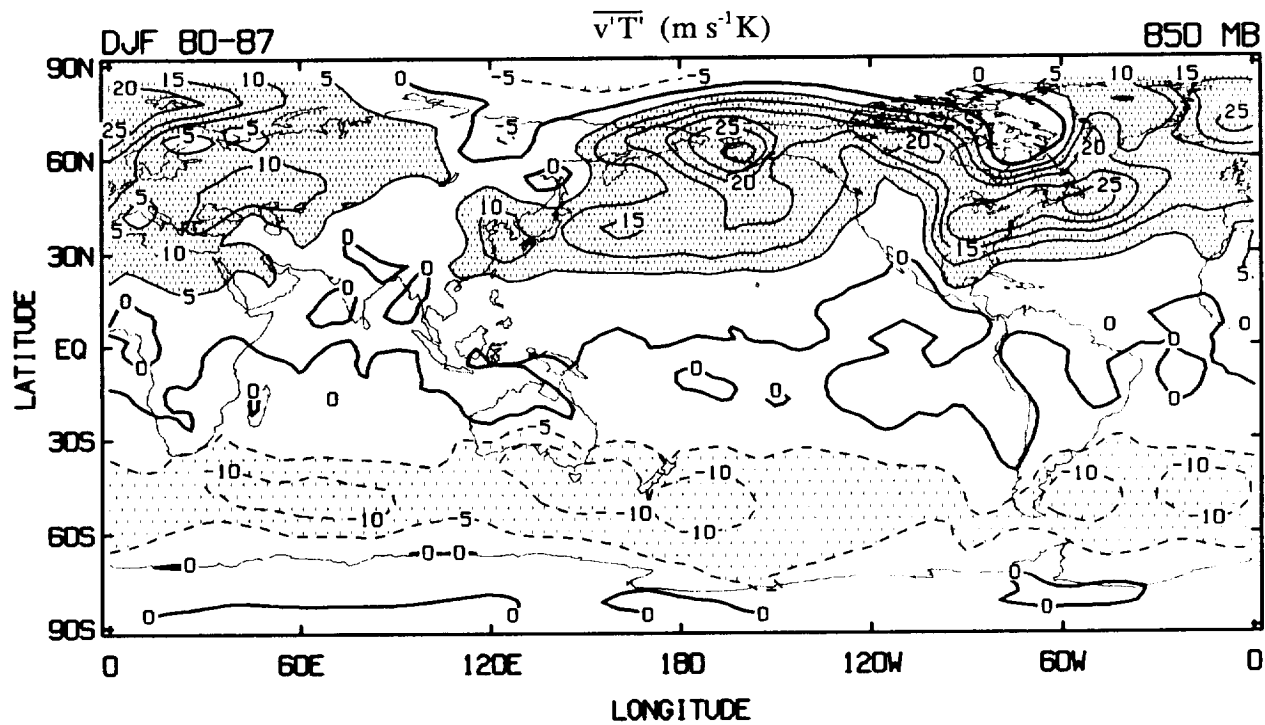

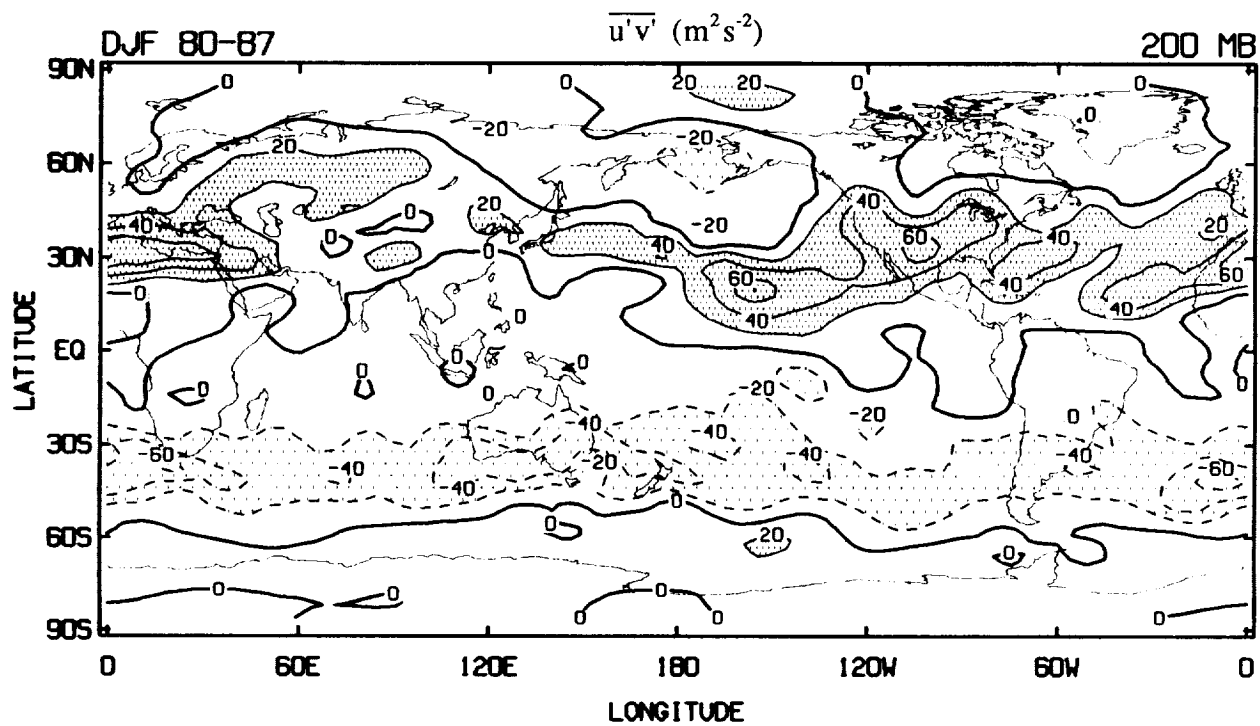

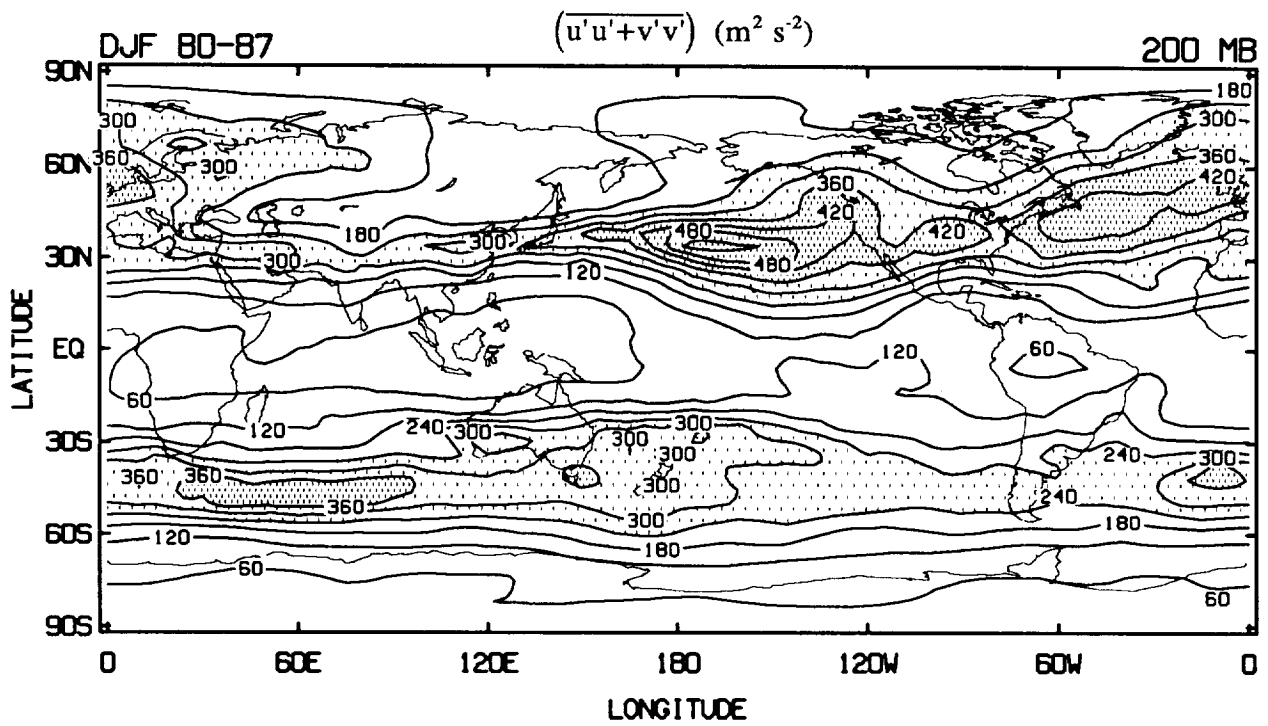
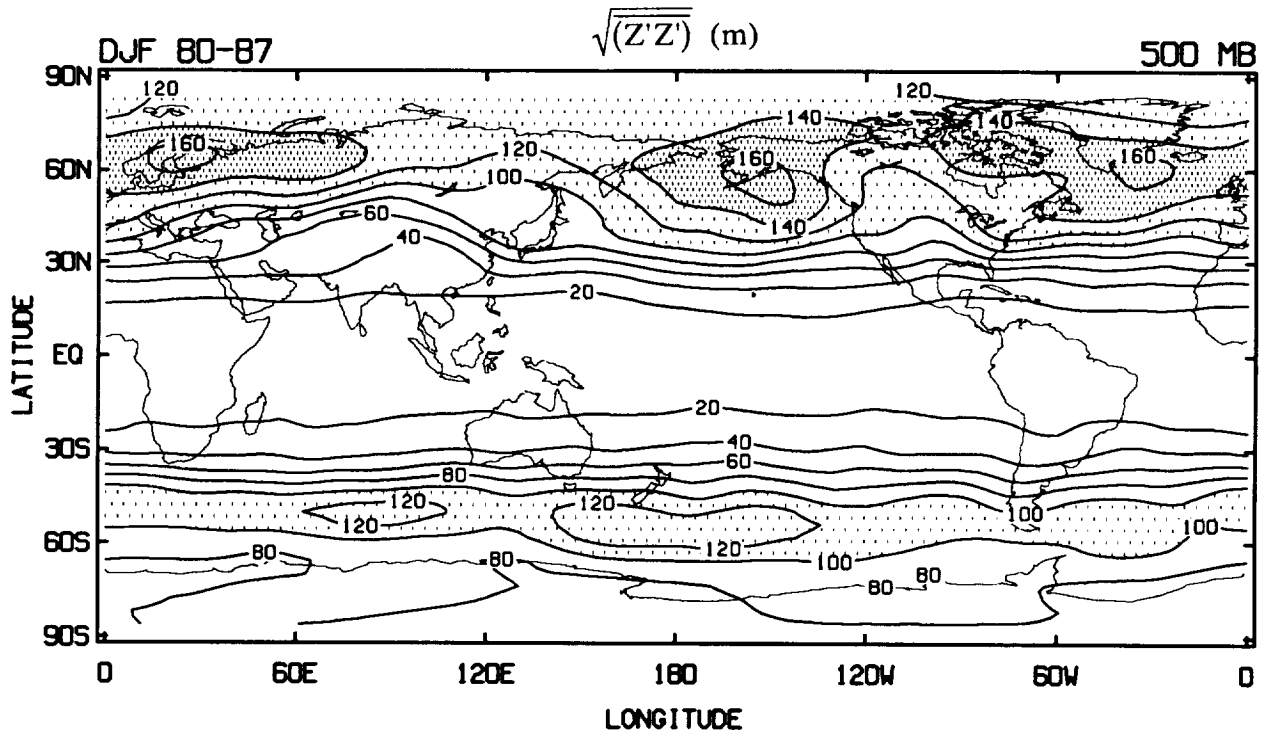

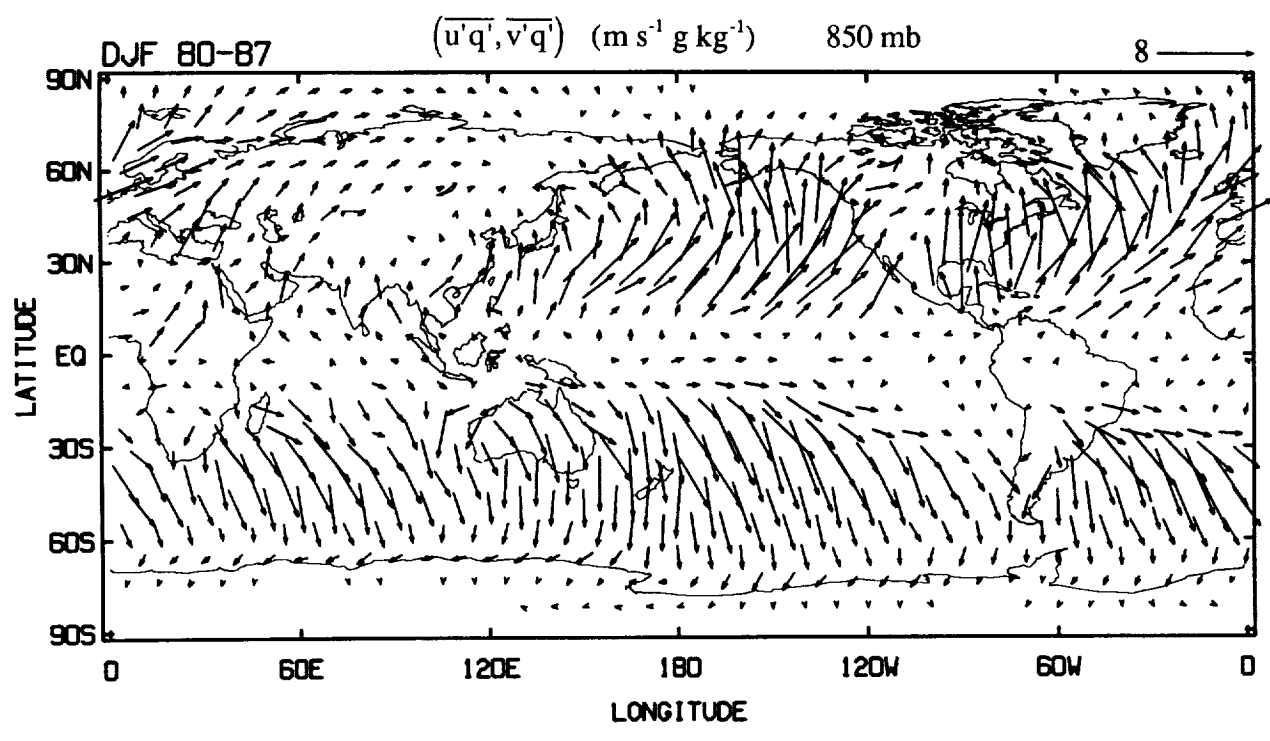
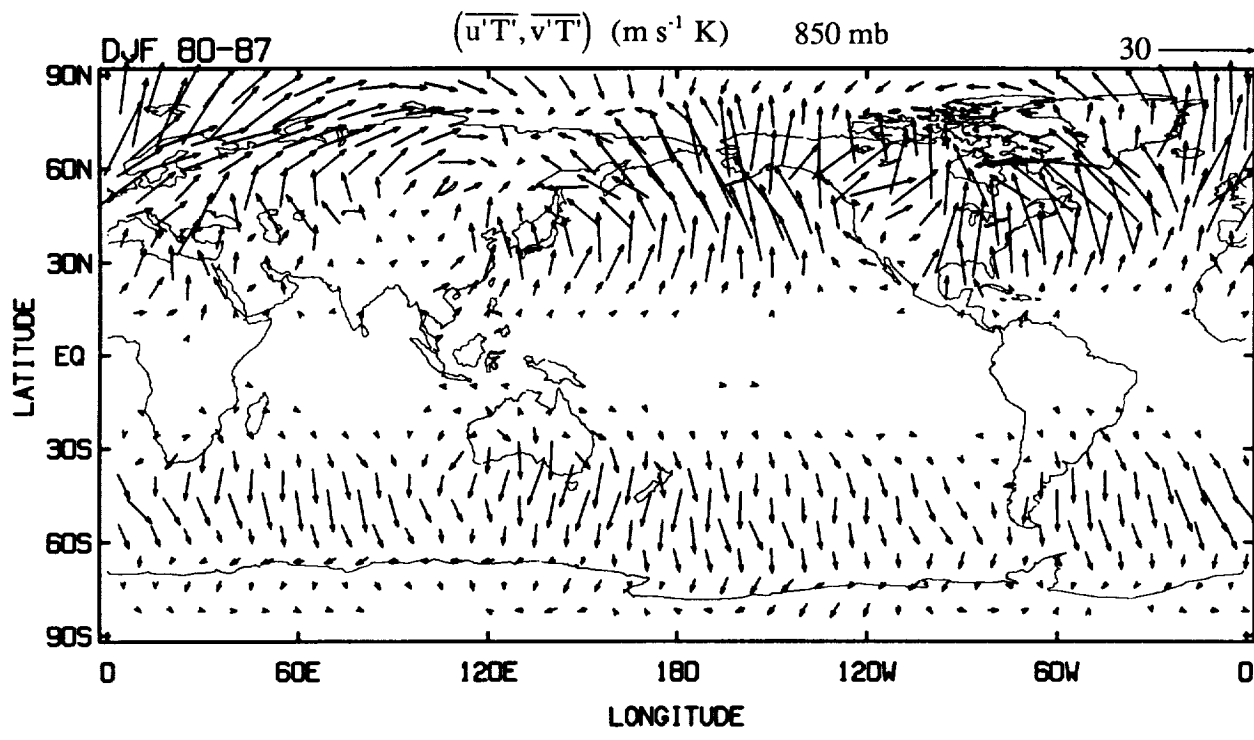

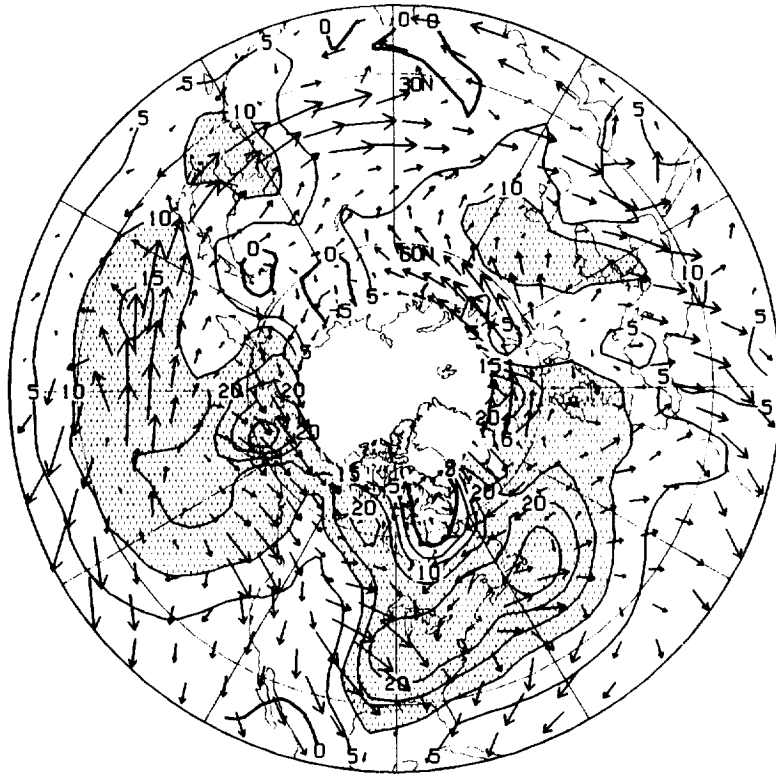

$\overline{v'T'}$ ($\text{m s}^{-1}\text{K}$) 850 mb

E_u ($\text{m}^2 \text{s}^{-2}$) 200 mb

100 →

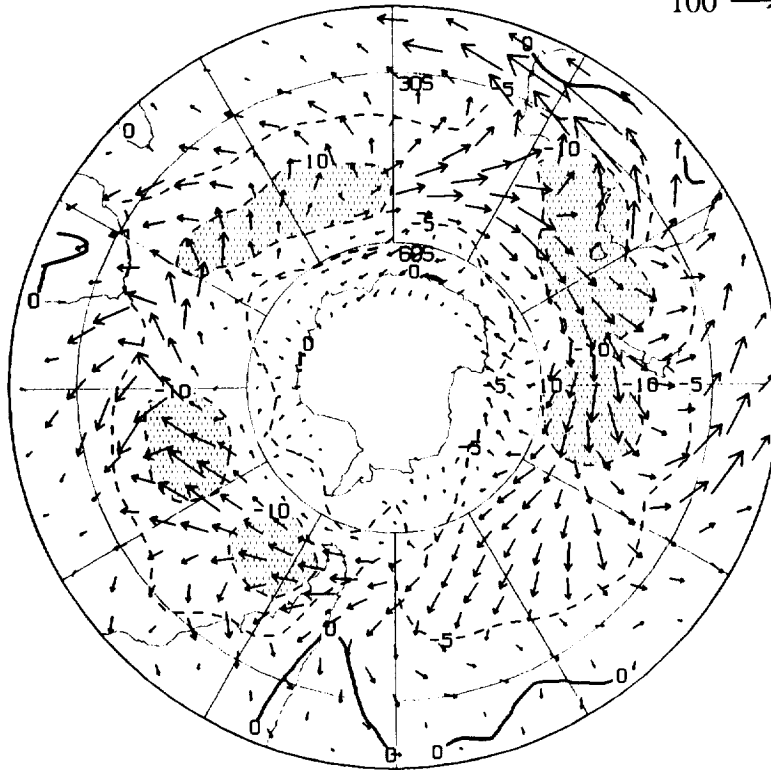

DJF (80-87)

31

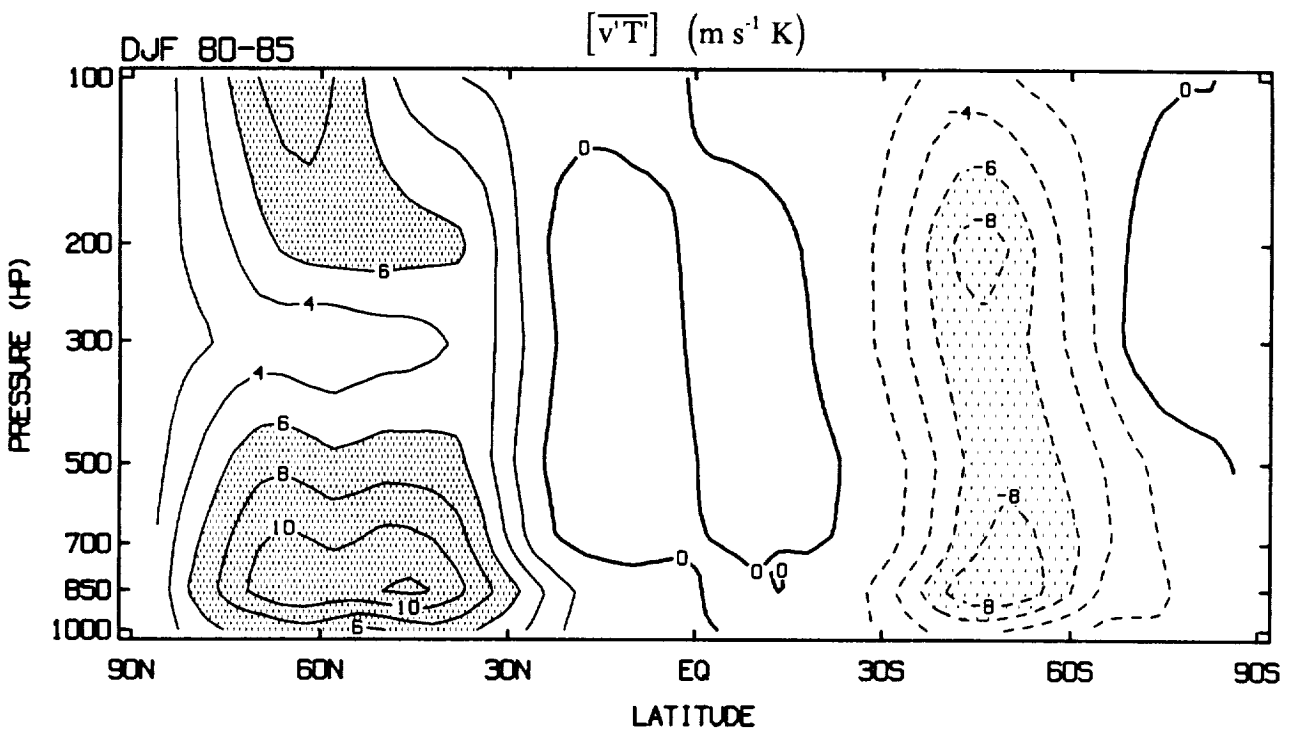
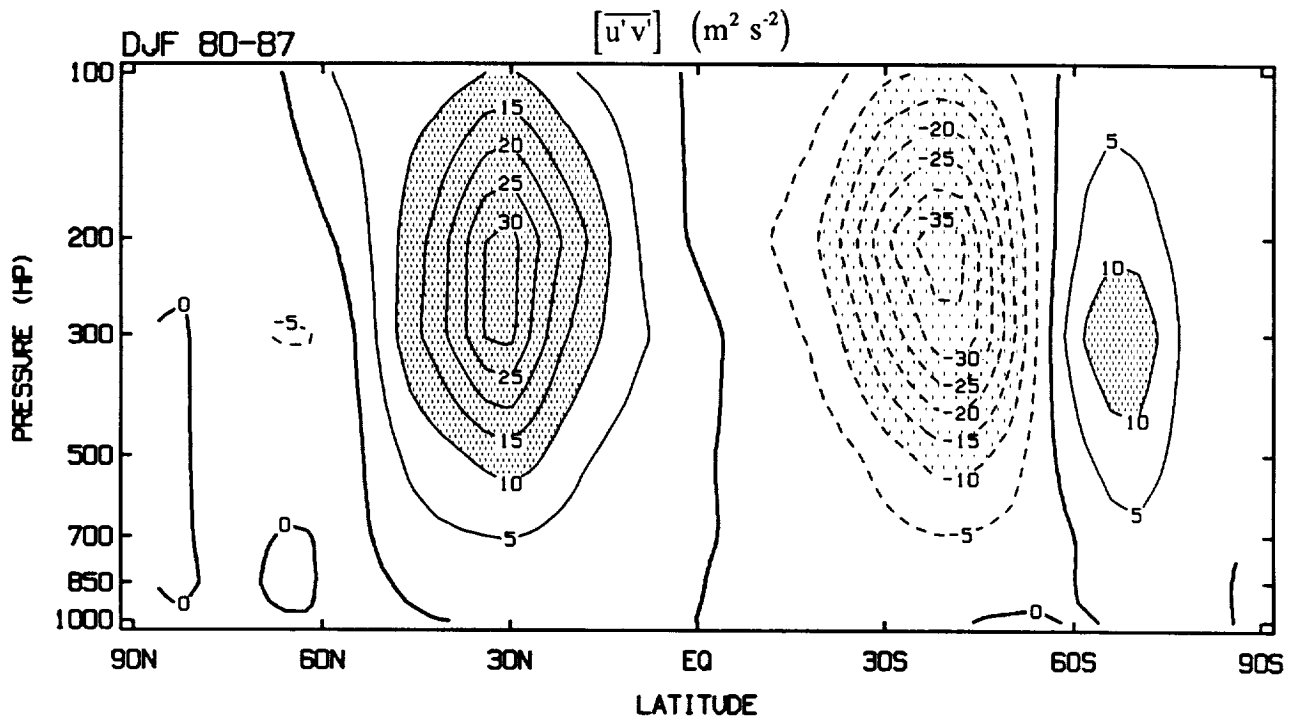

LOW PASS

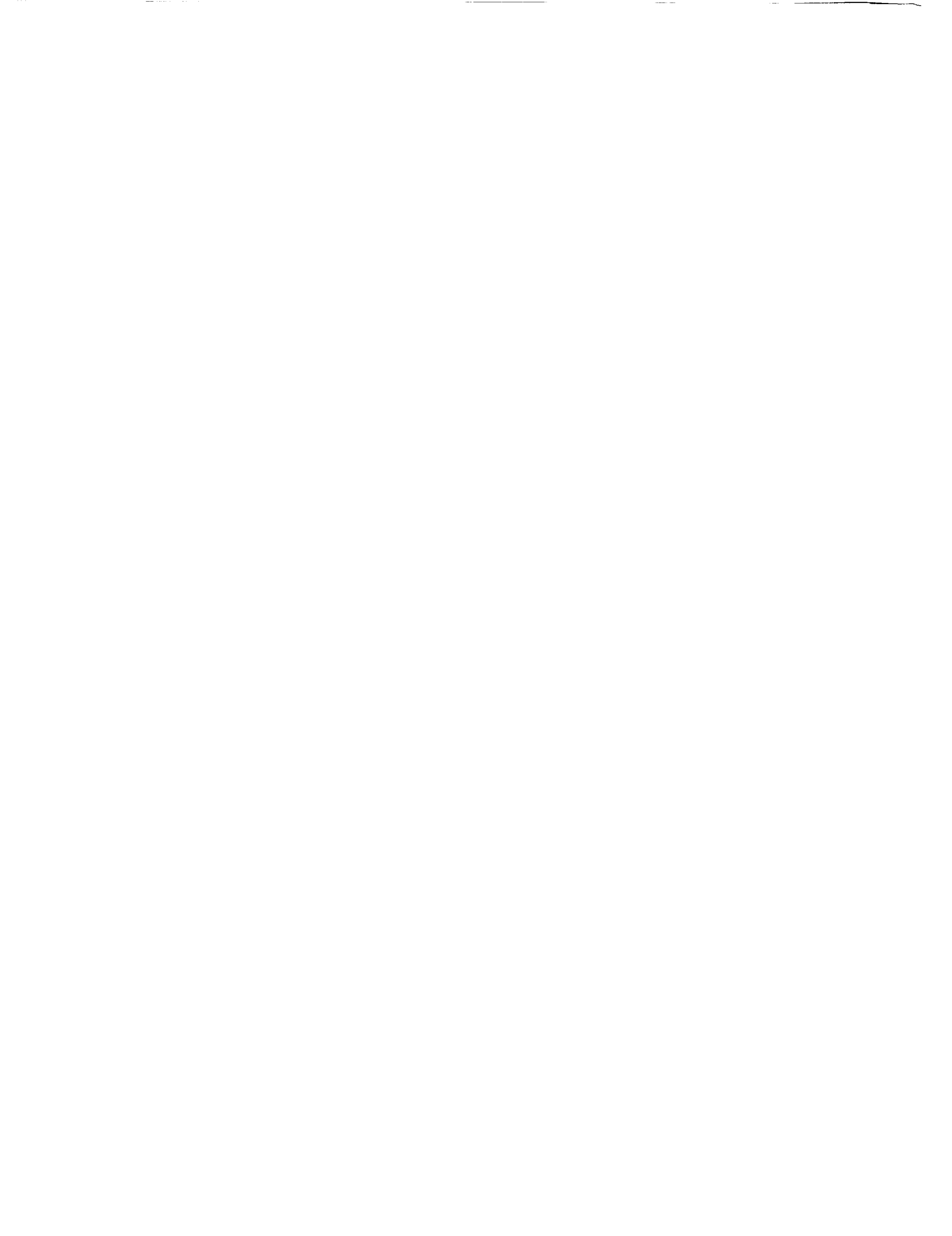

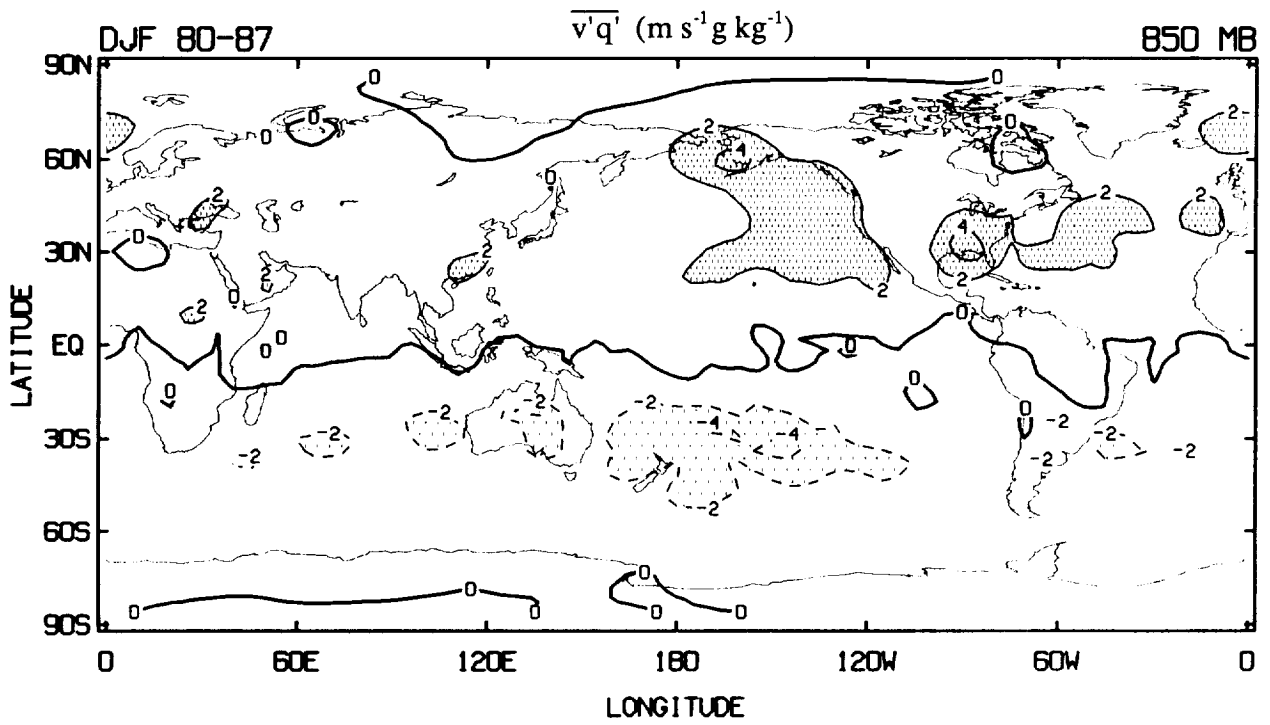
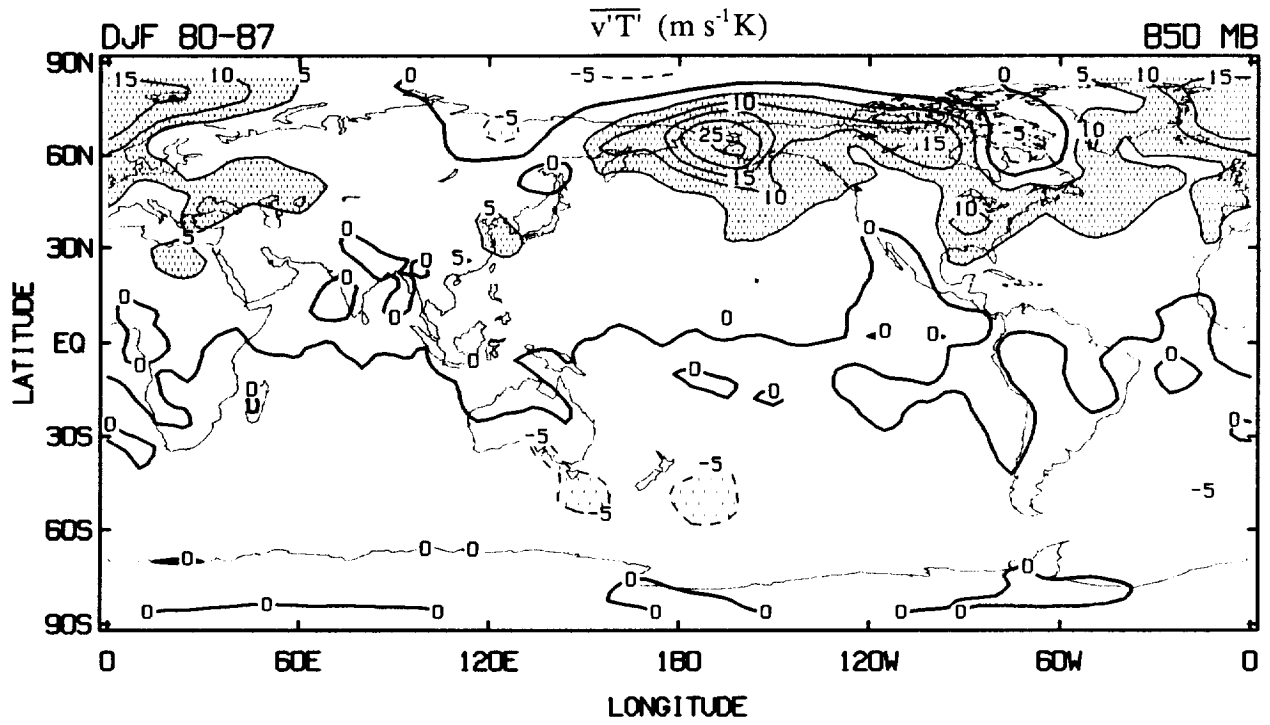

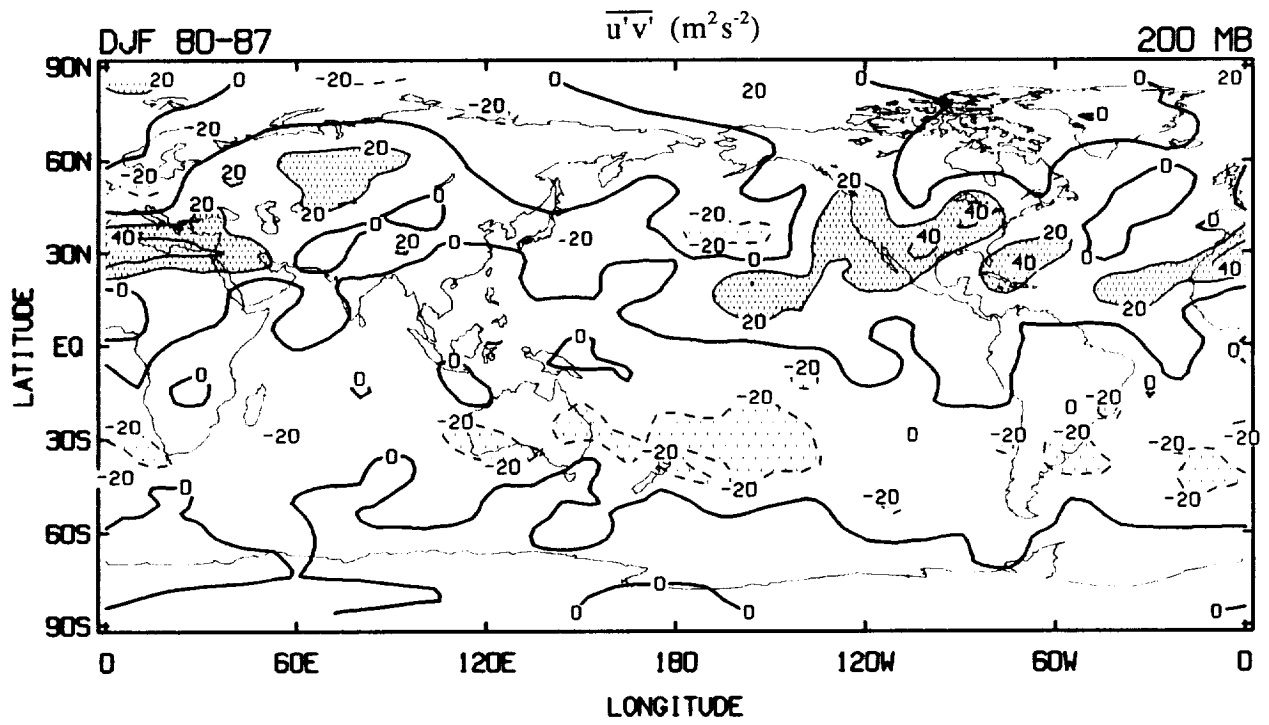

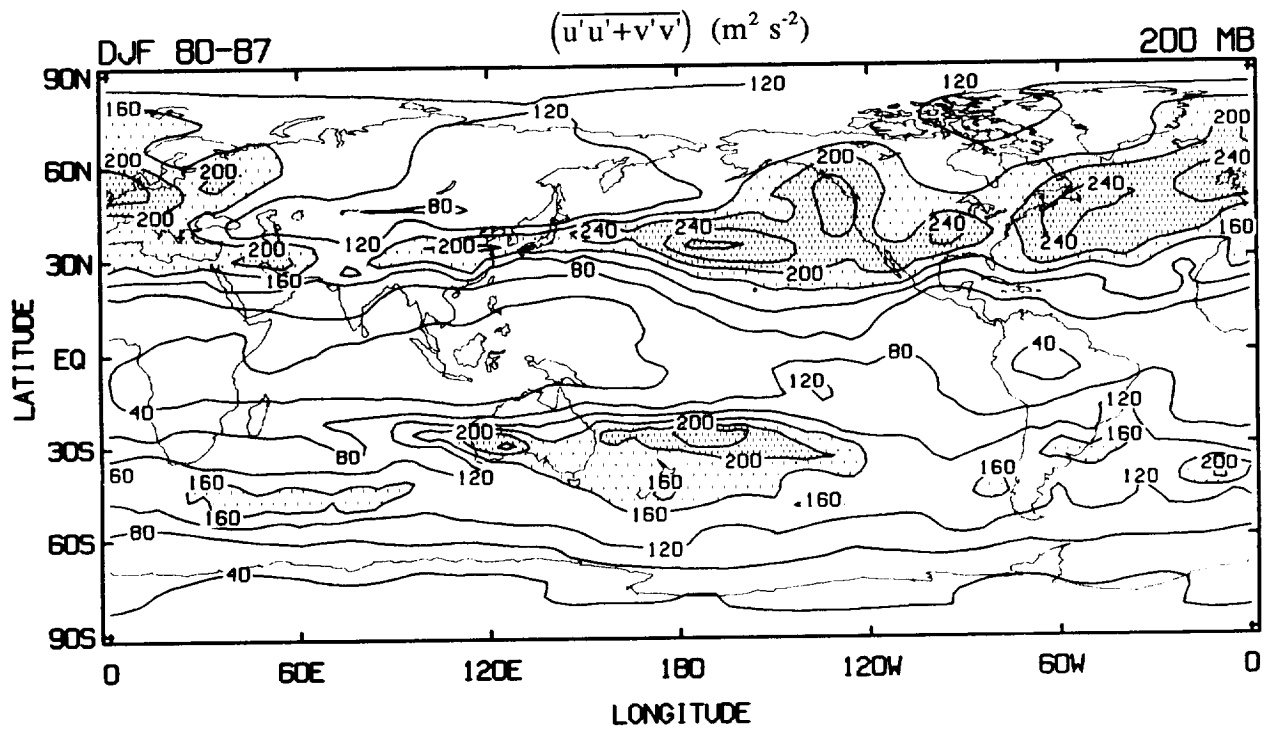
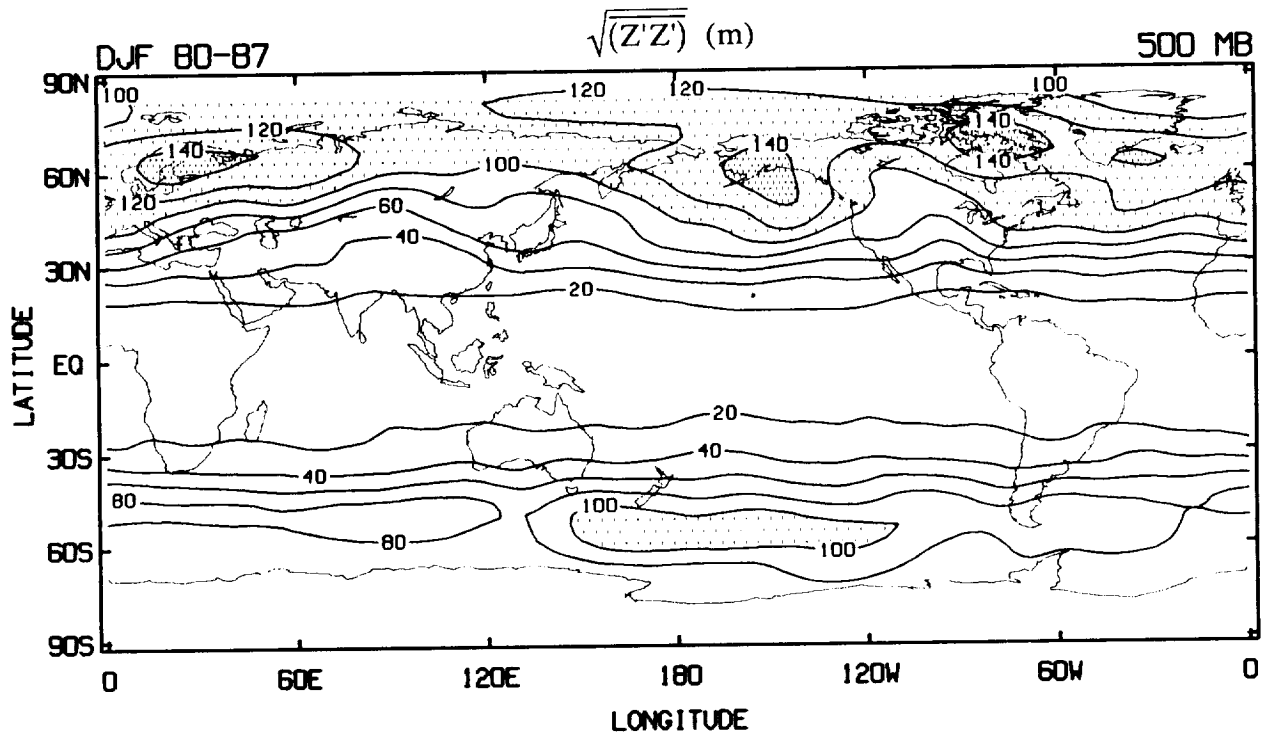

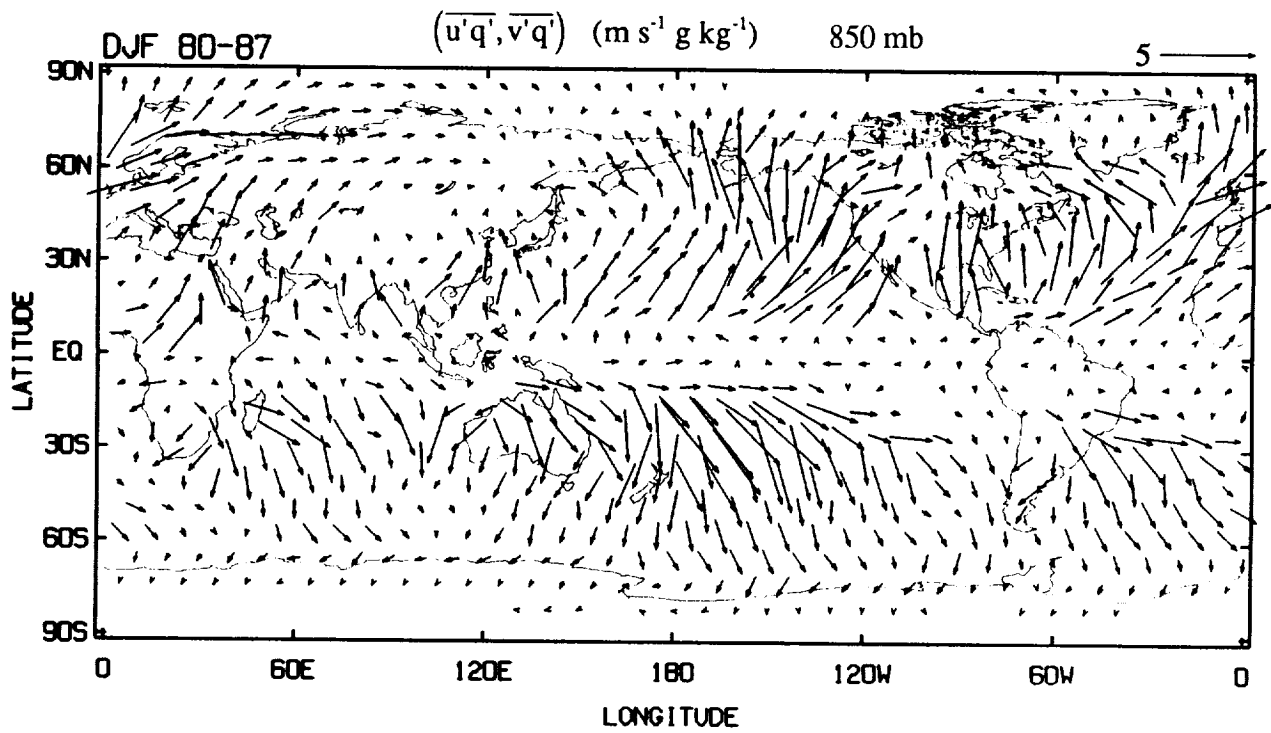
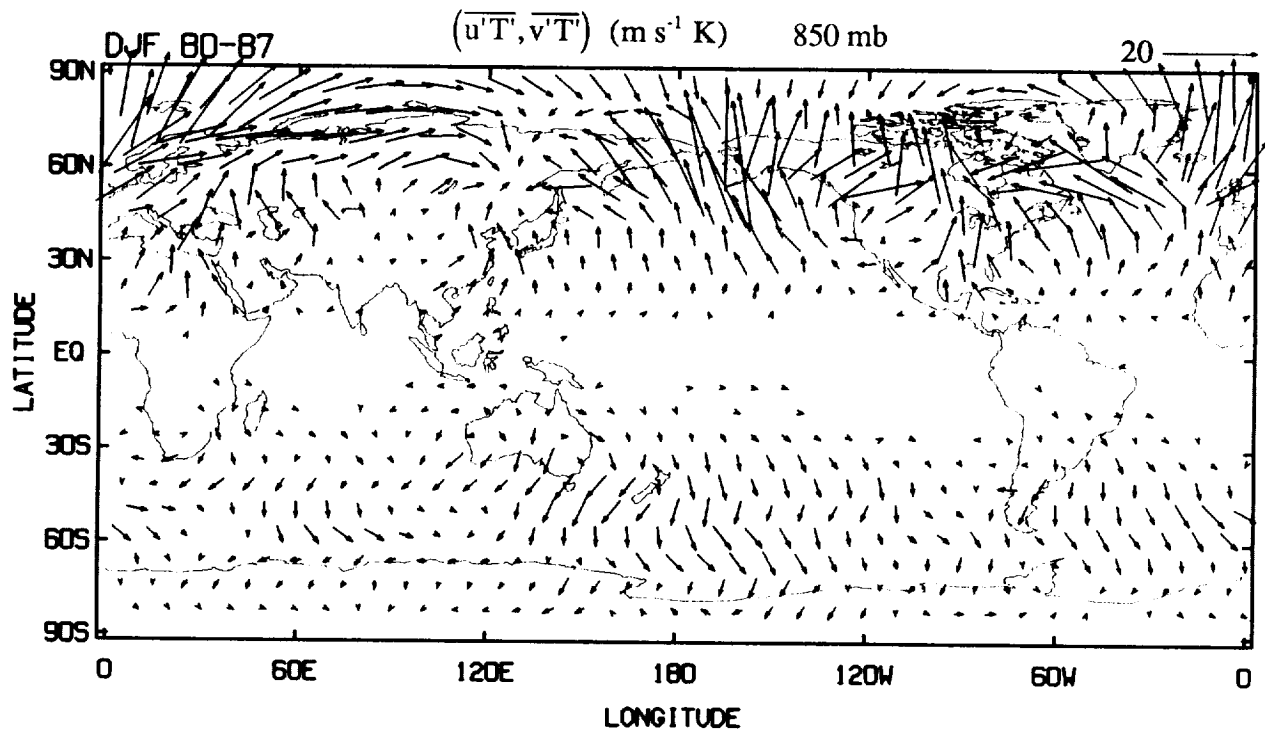

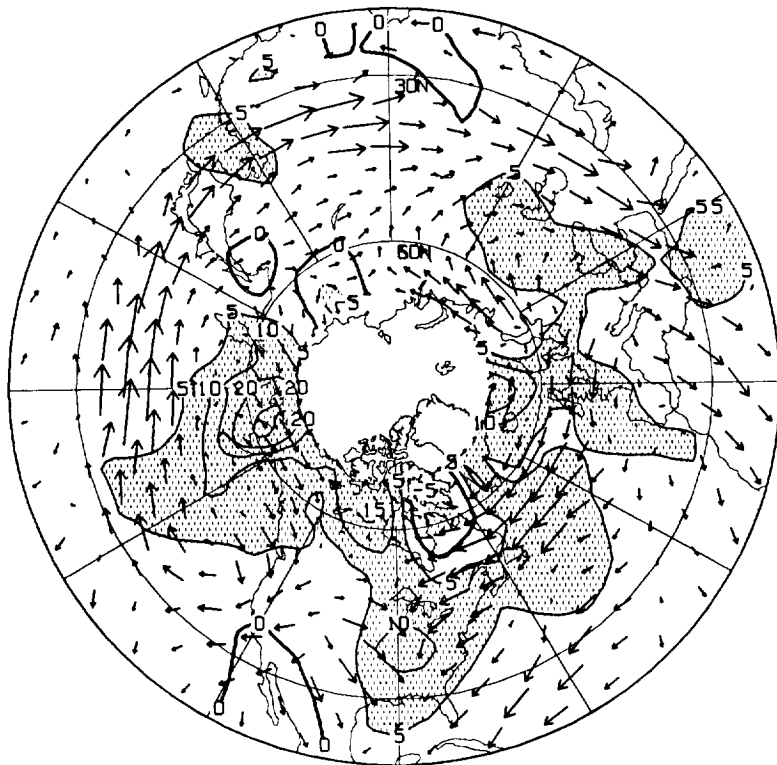

$\overline{v'T'}$ ($\text{m s}^{-1}\text{K}$) 850 mb

E_u ($\text{m}^2 \text{s}^{-2}$) 200 mb

100 \rightarrow

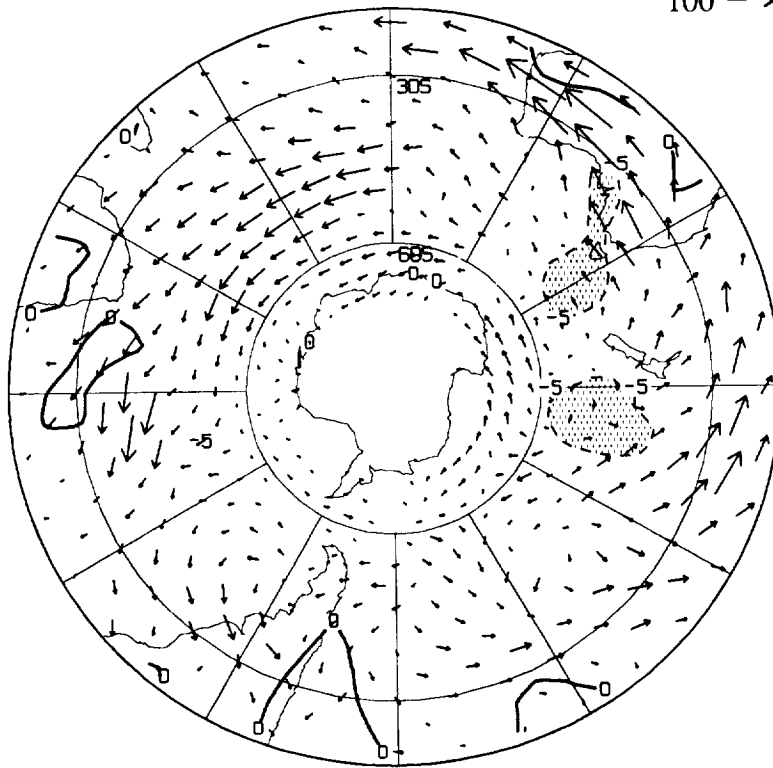

DJF (80-87)

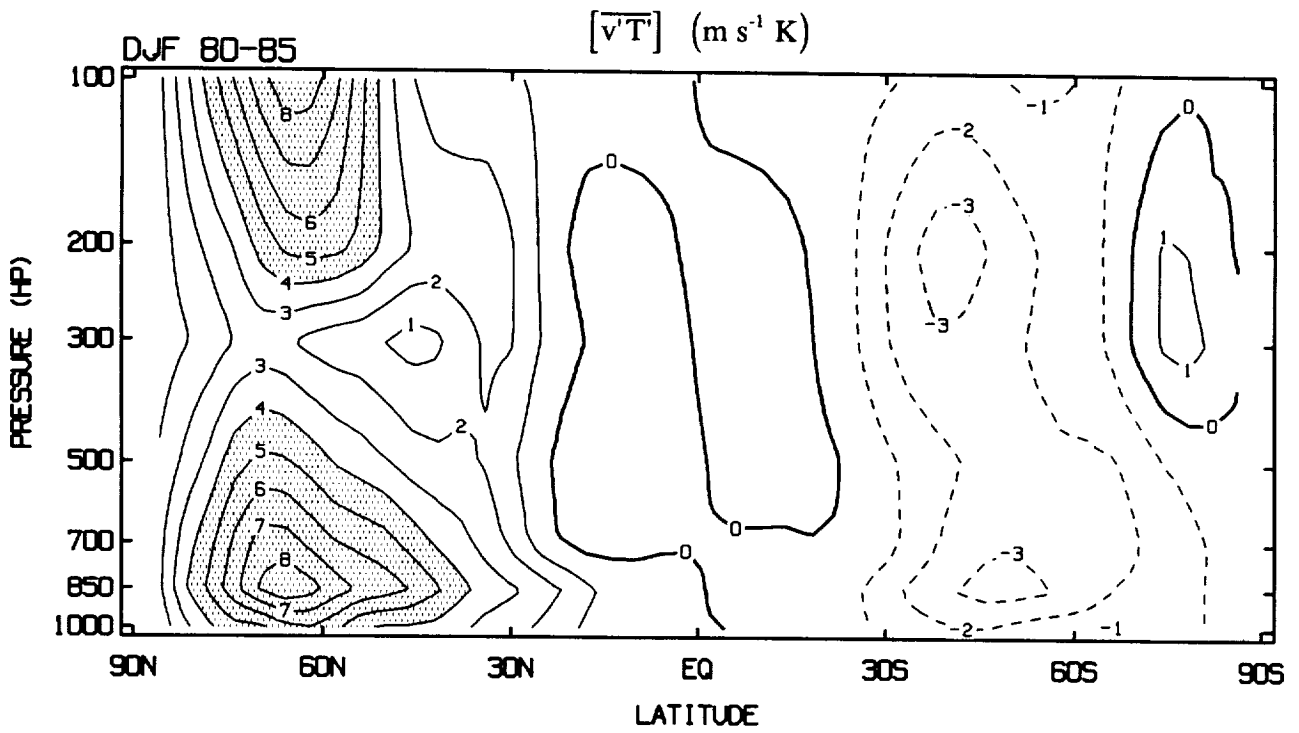
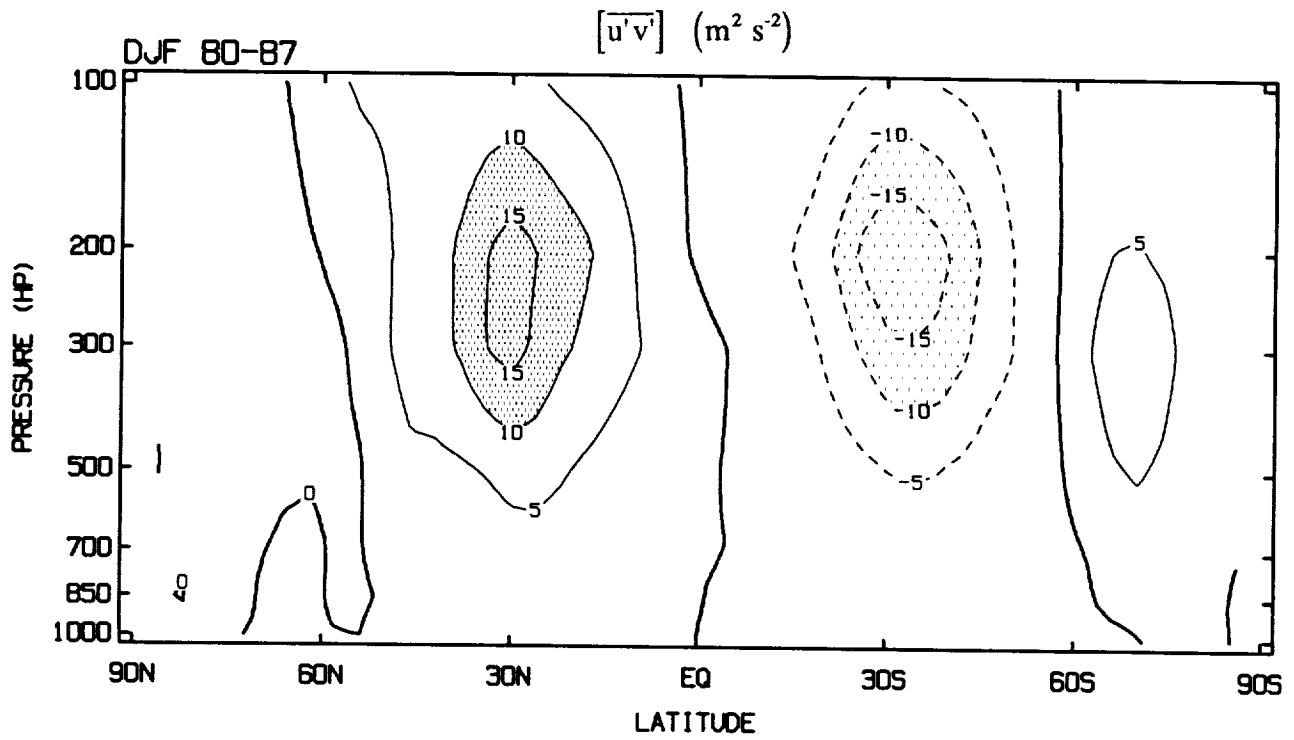

BAND PASS

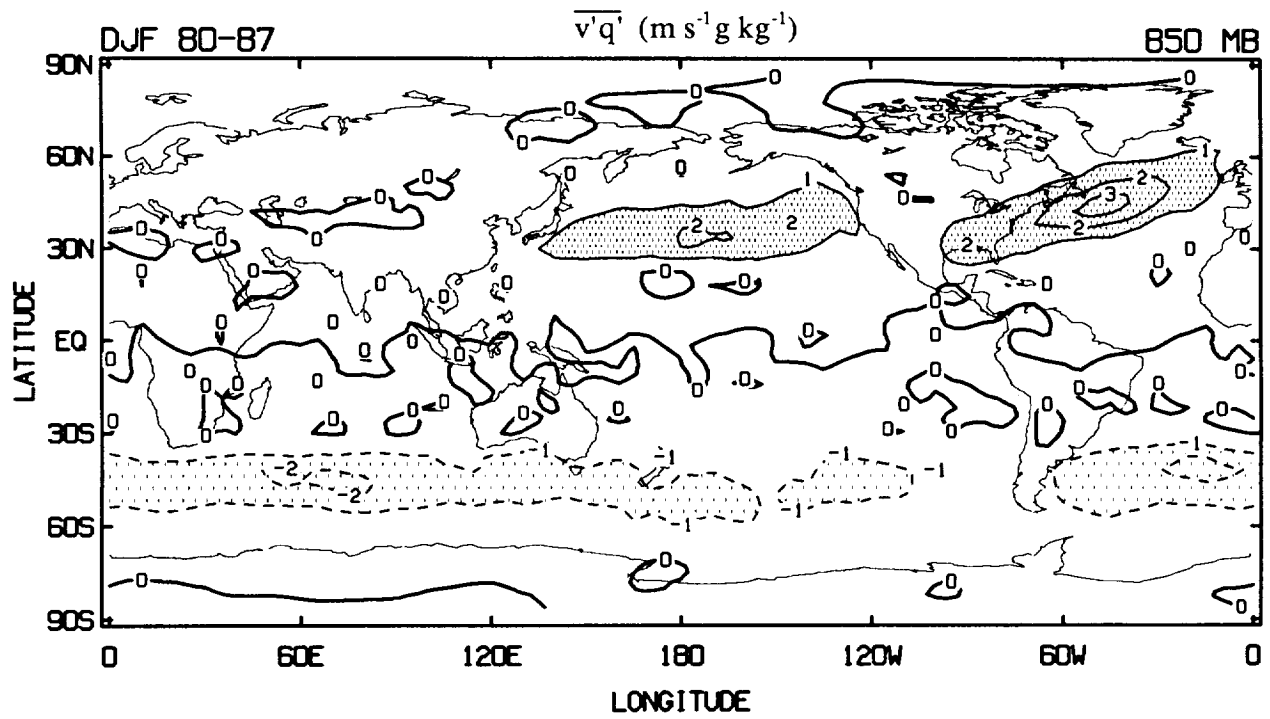
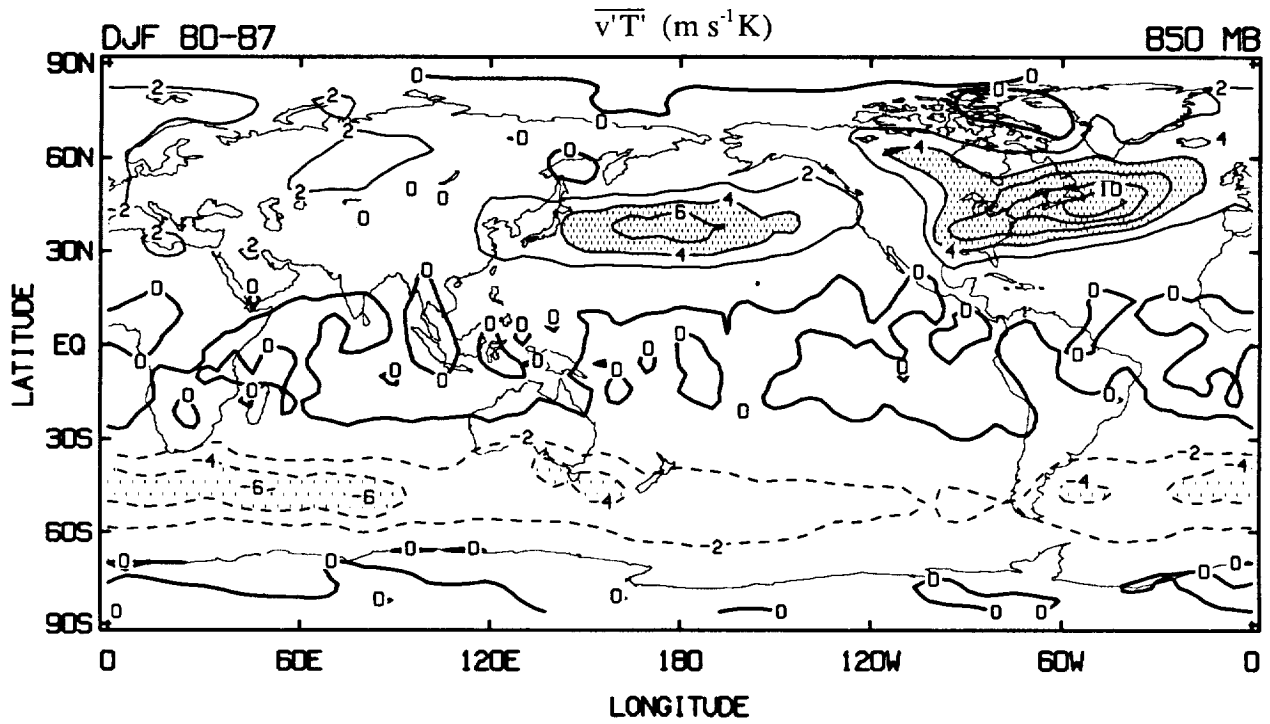

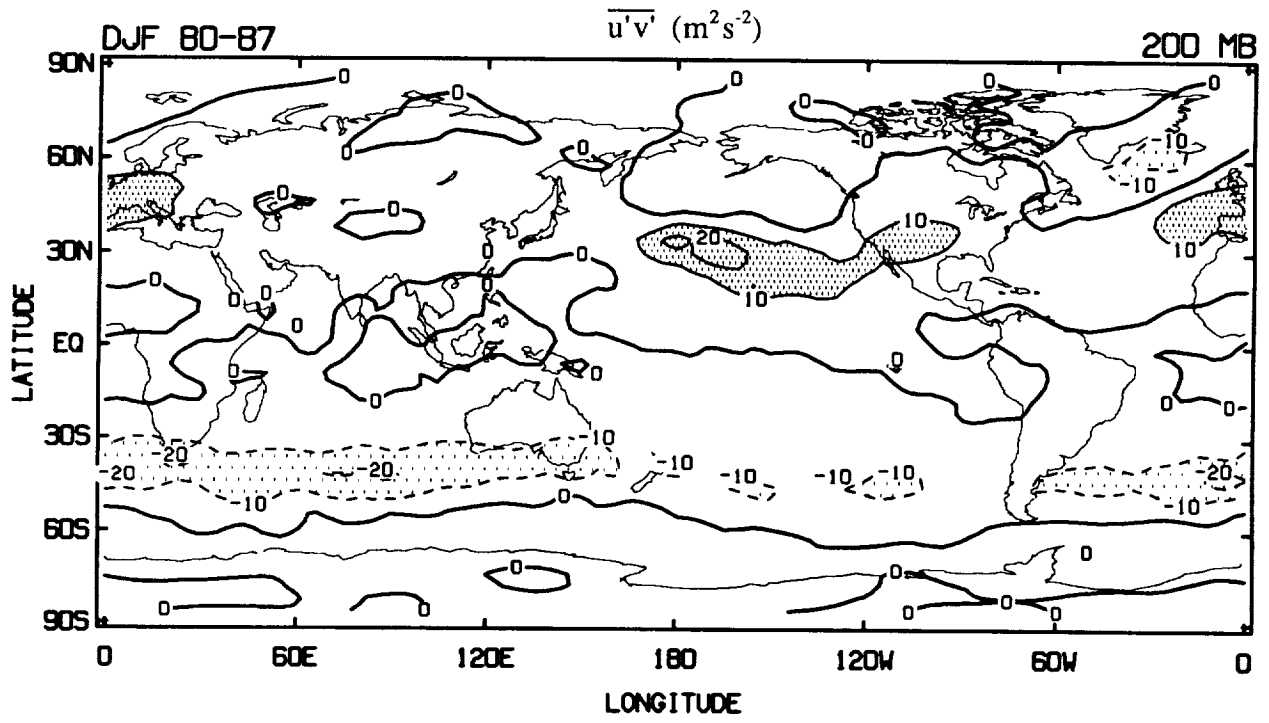

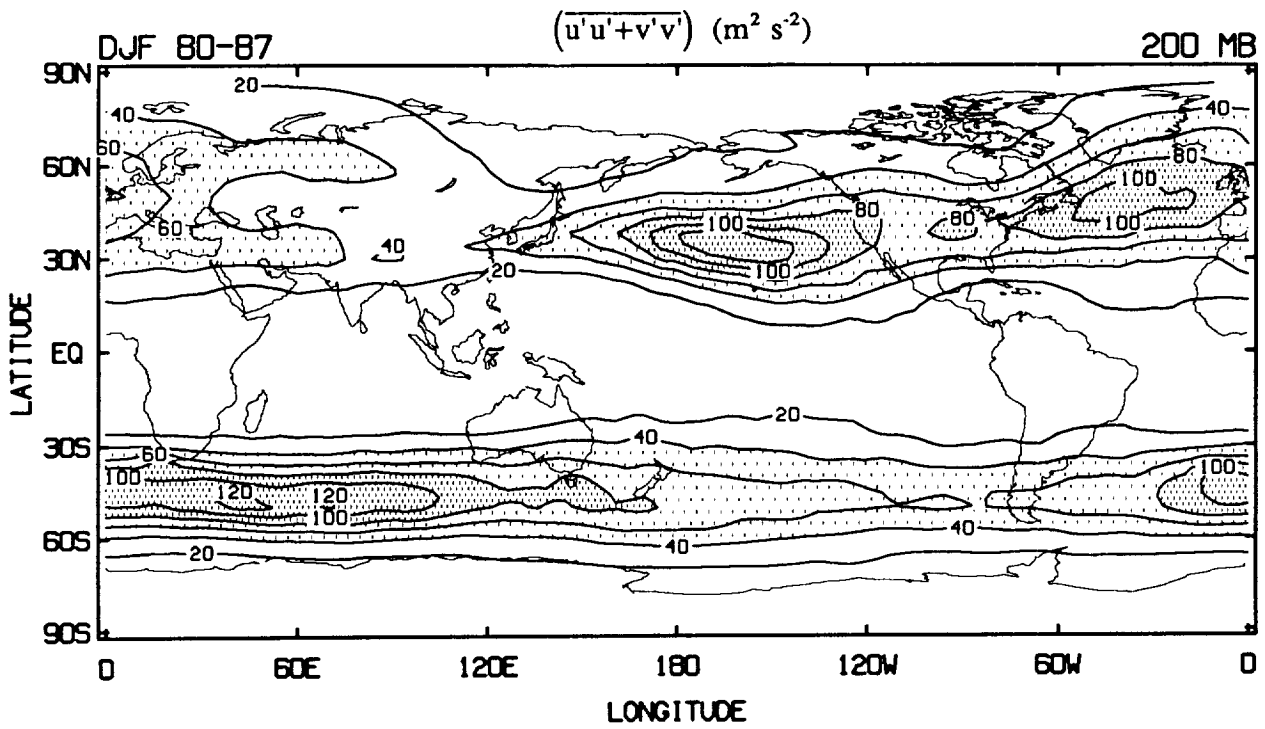
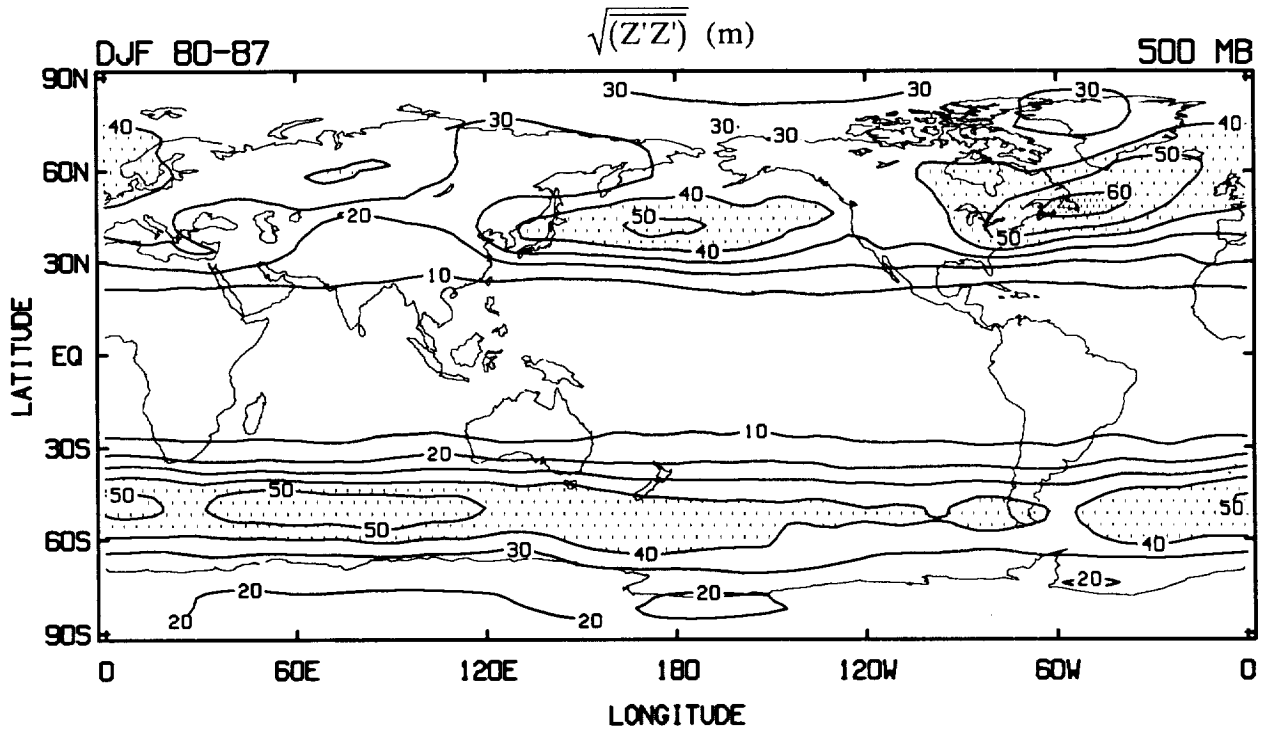

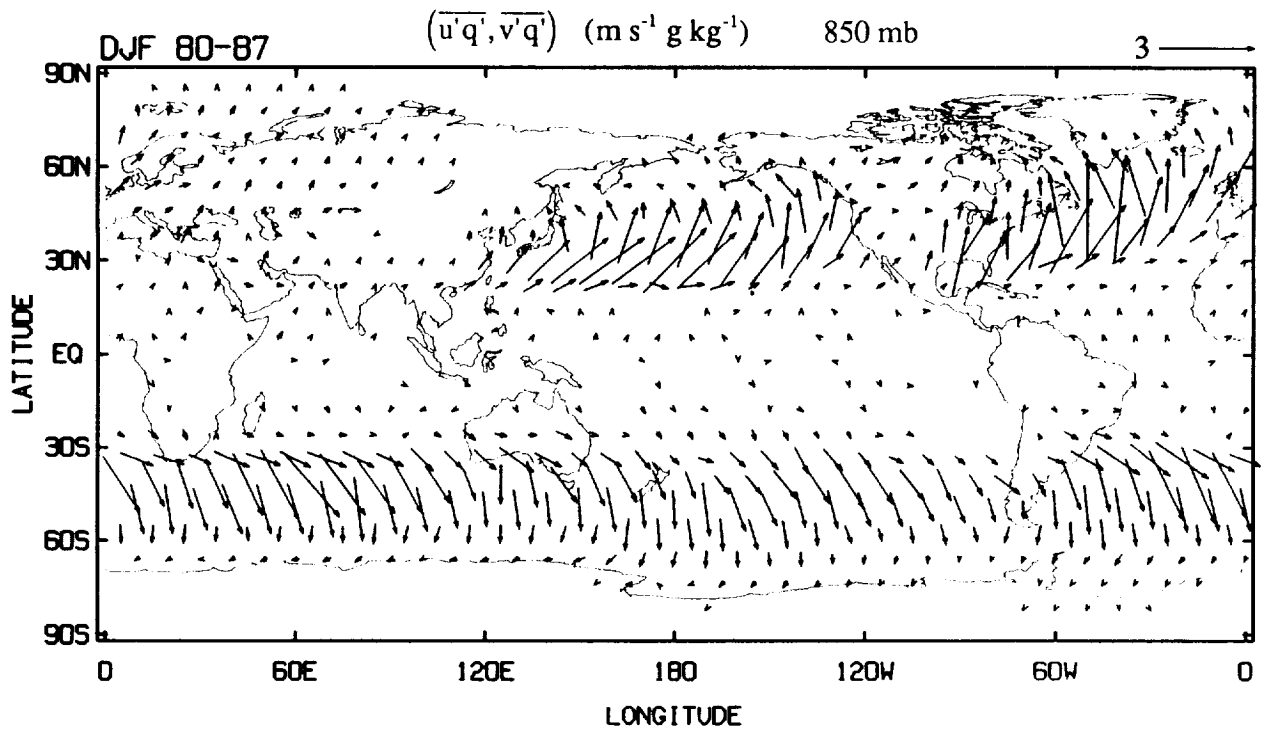
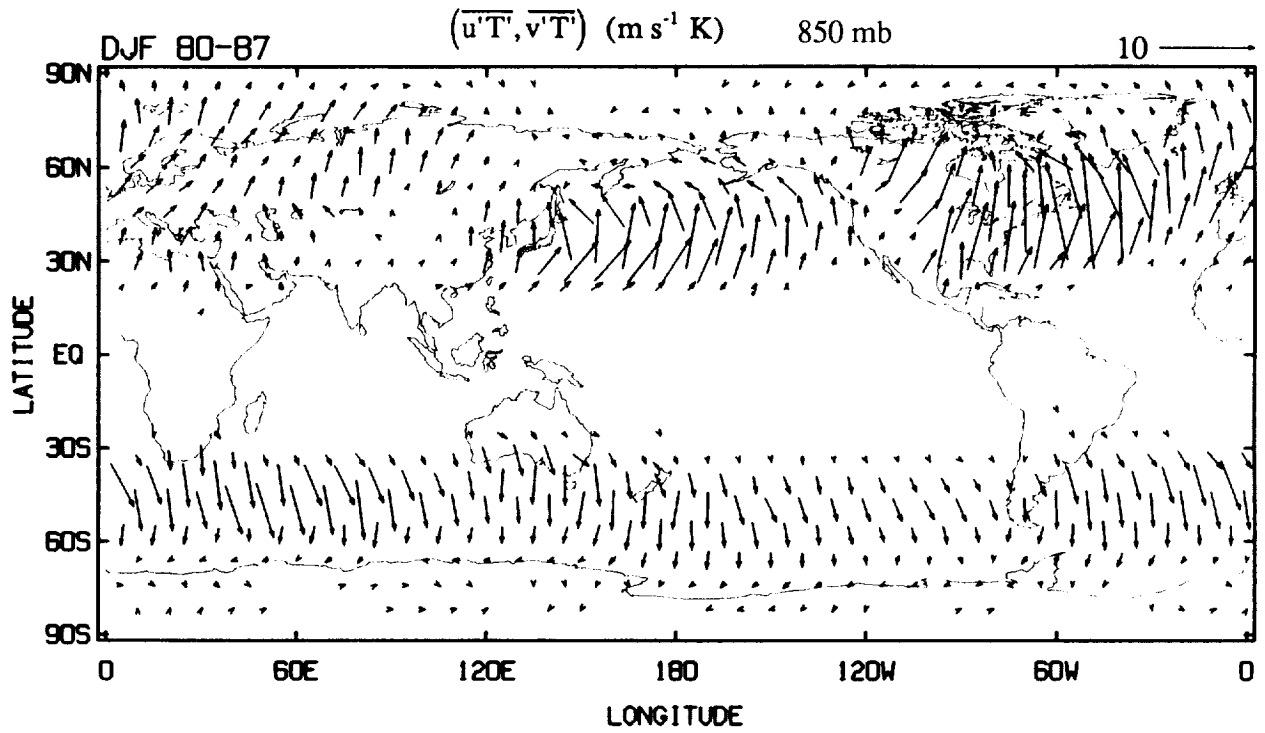

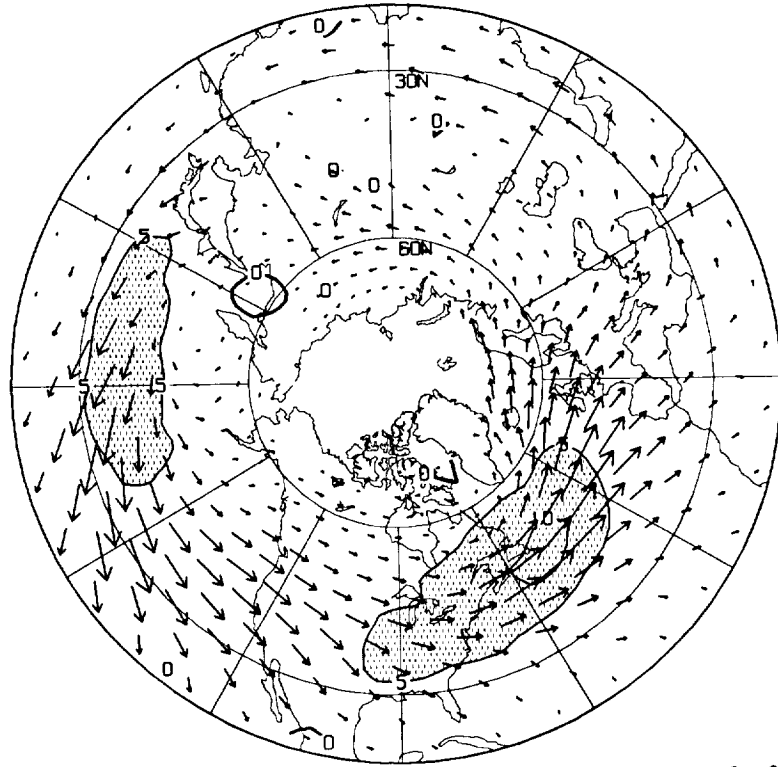

$\overline{v'T'}$ ($\text{m s}^{-1}\text{K}$) 850 mb

E_u ($\text{m}^2 \text{s}^{-2}$) 200 mb

50 \rightarrow

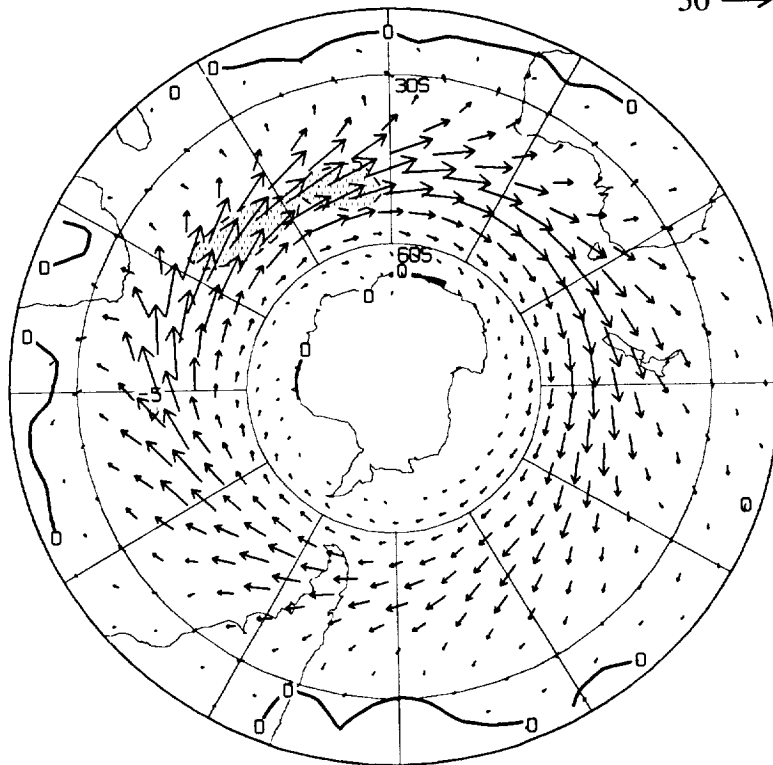

DJF (80-87)

47

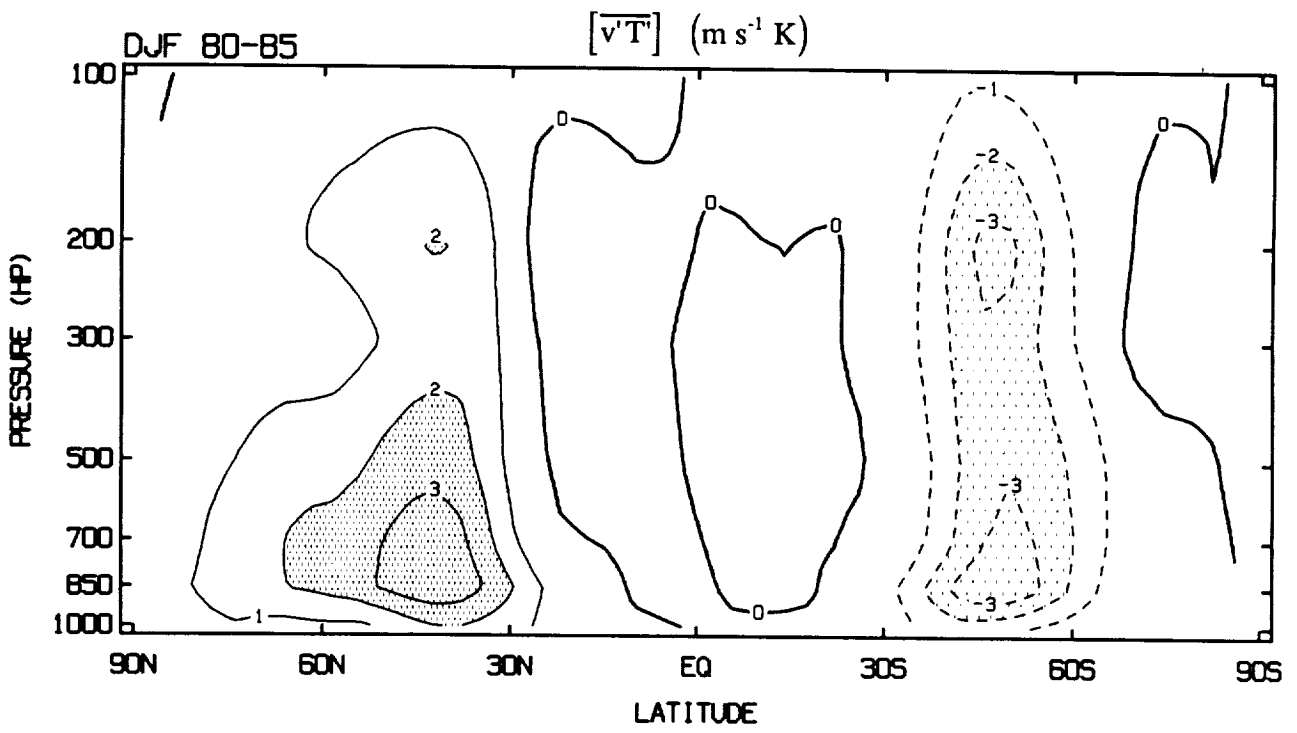
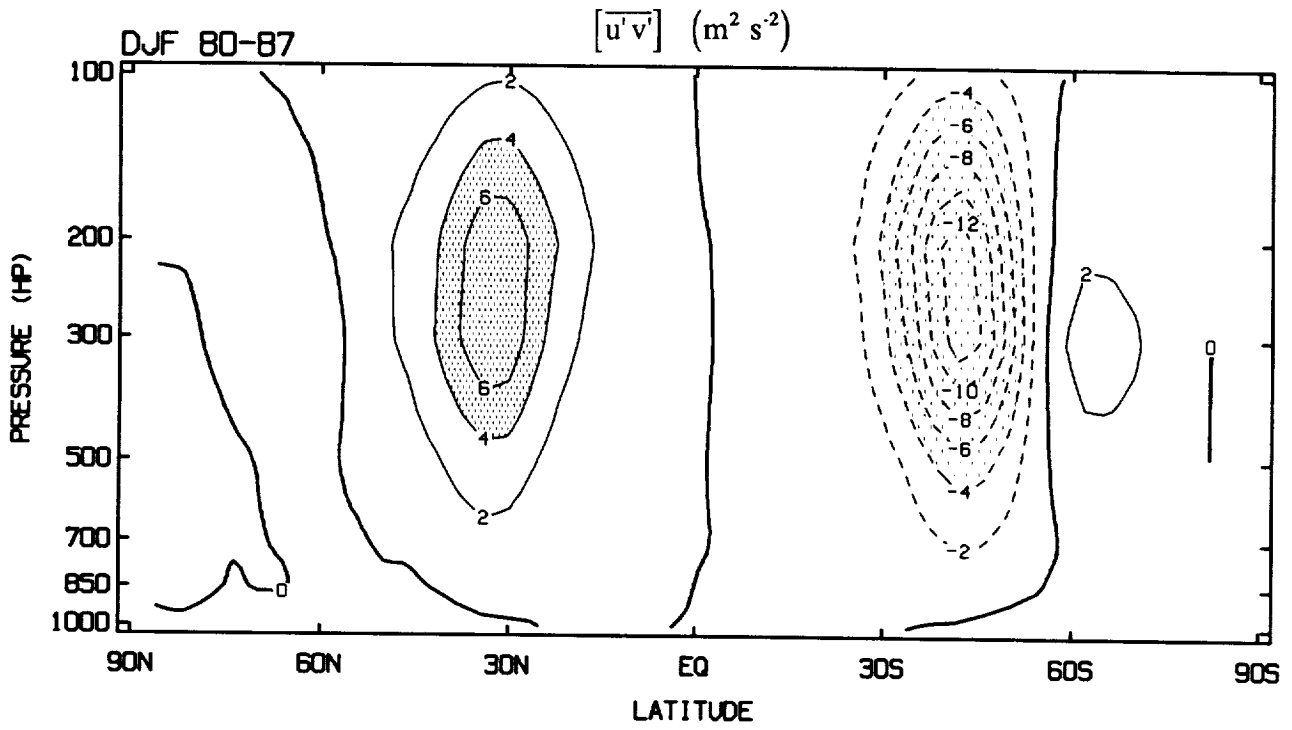

MAM

DEVIATIONS FROM MONTHLY MEANS

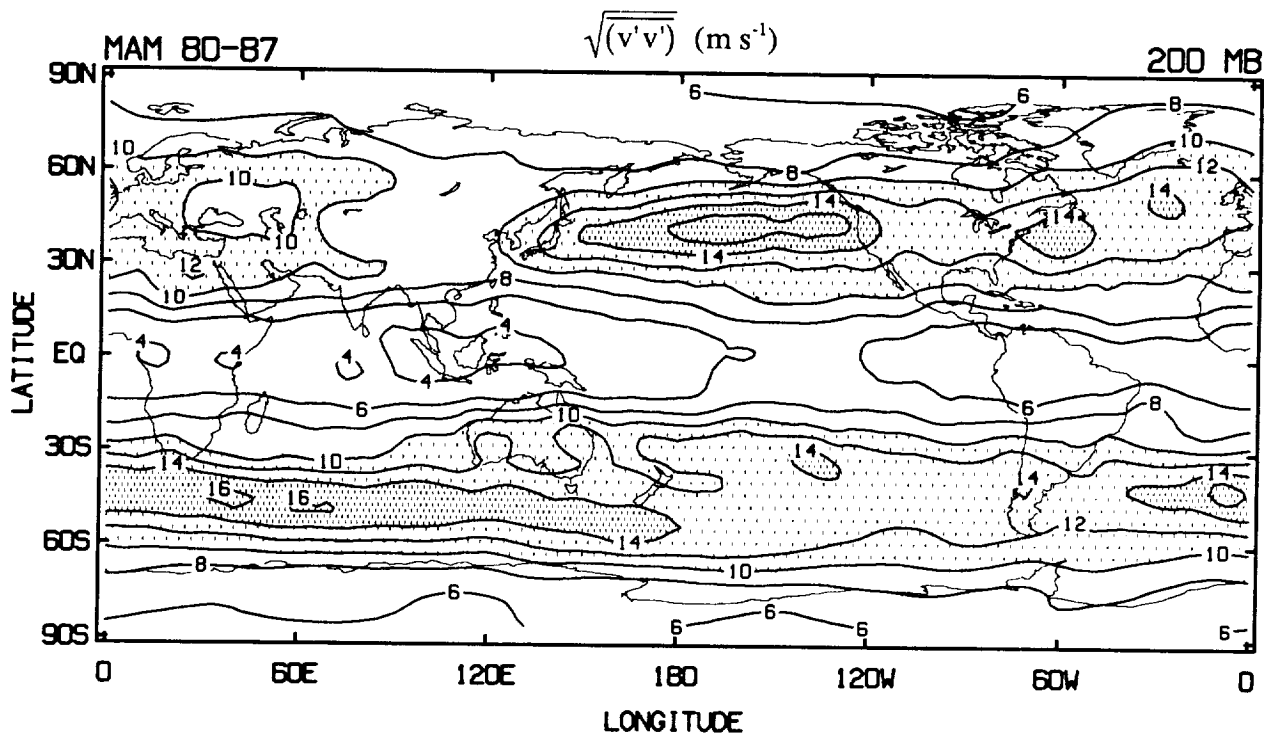
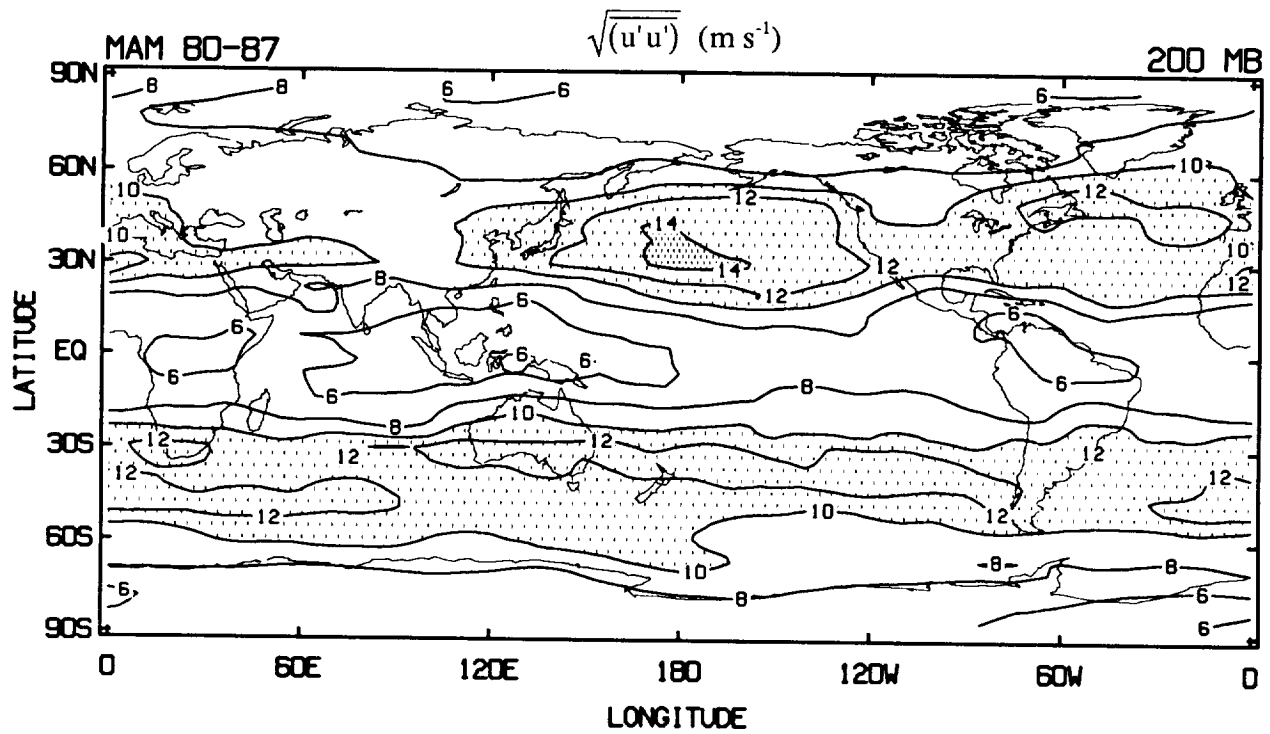

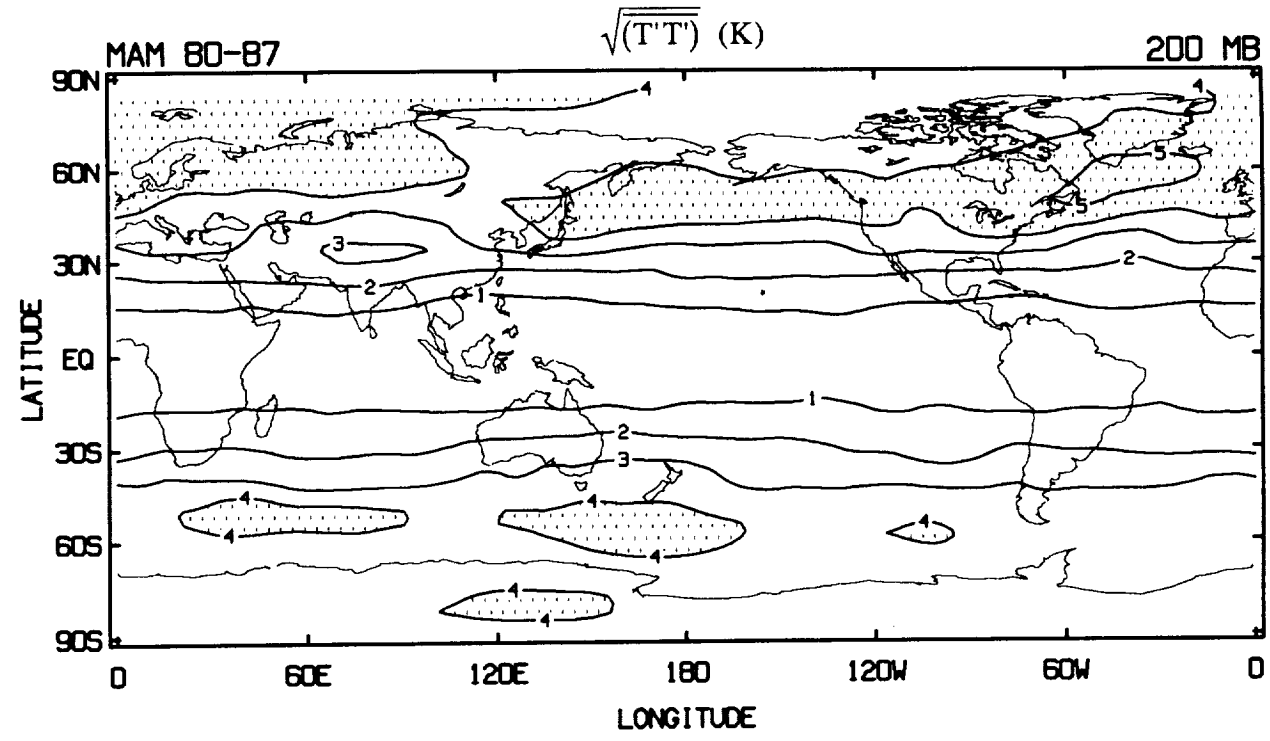
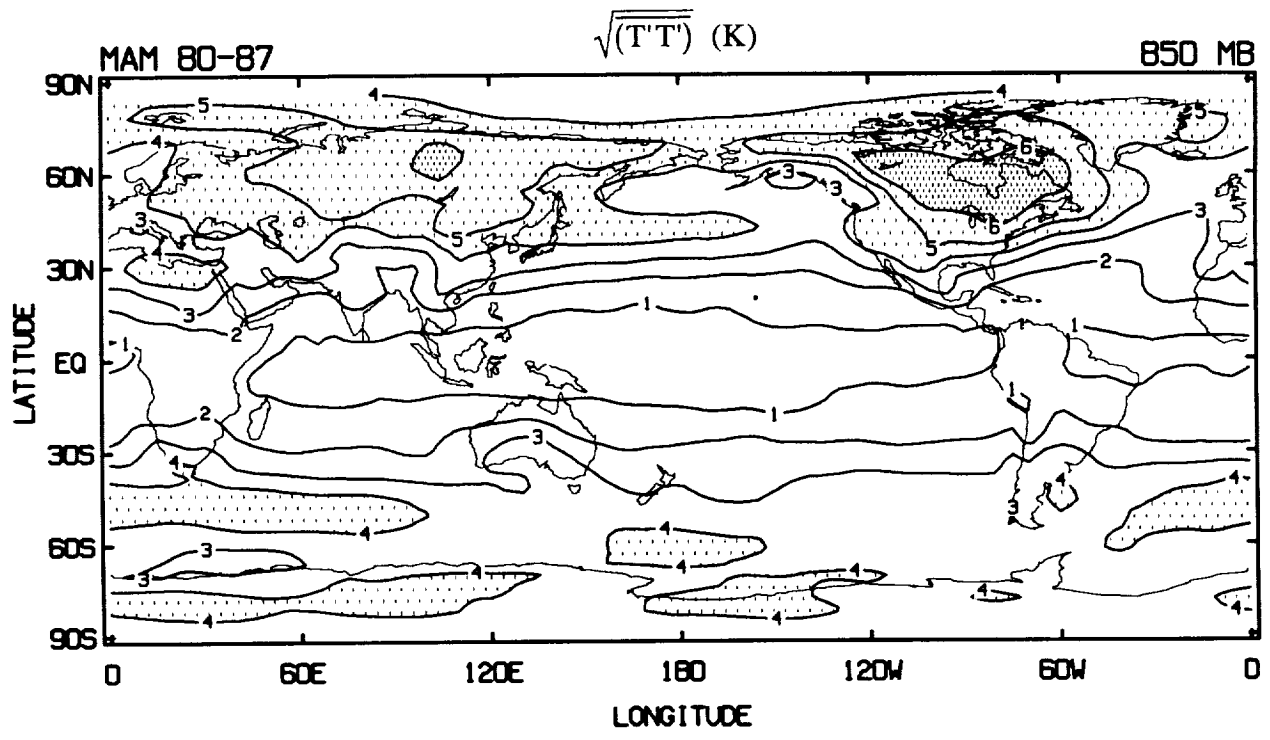

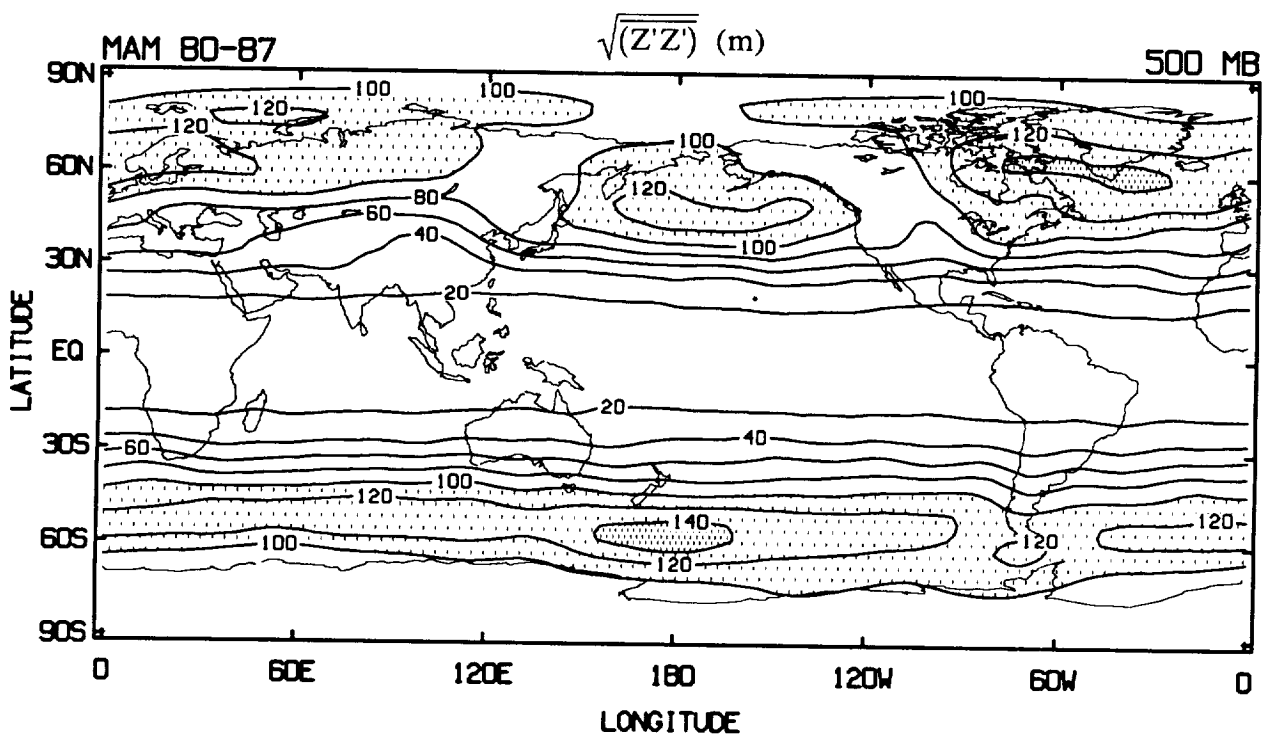
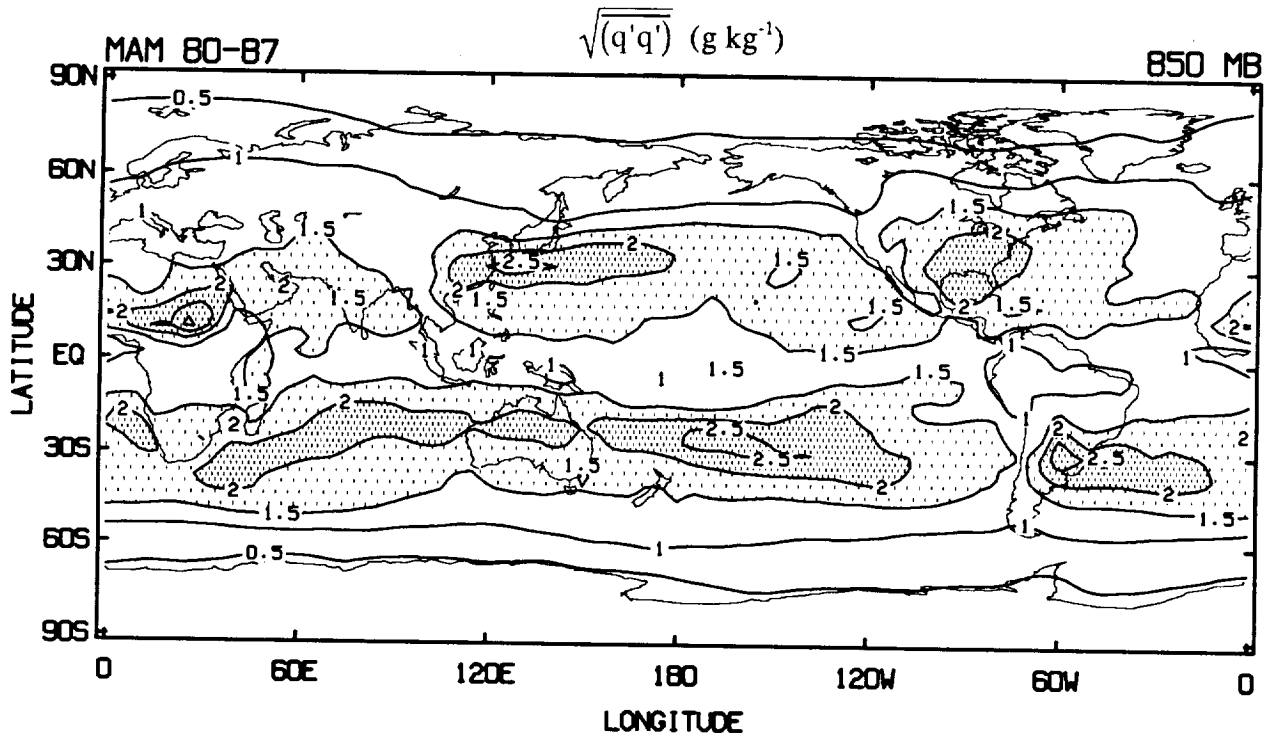

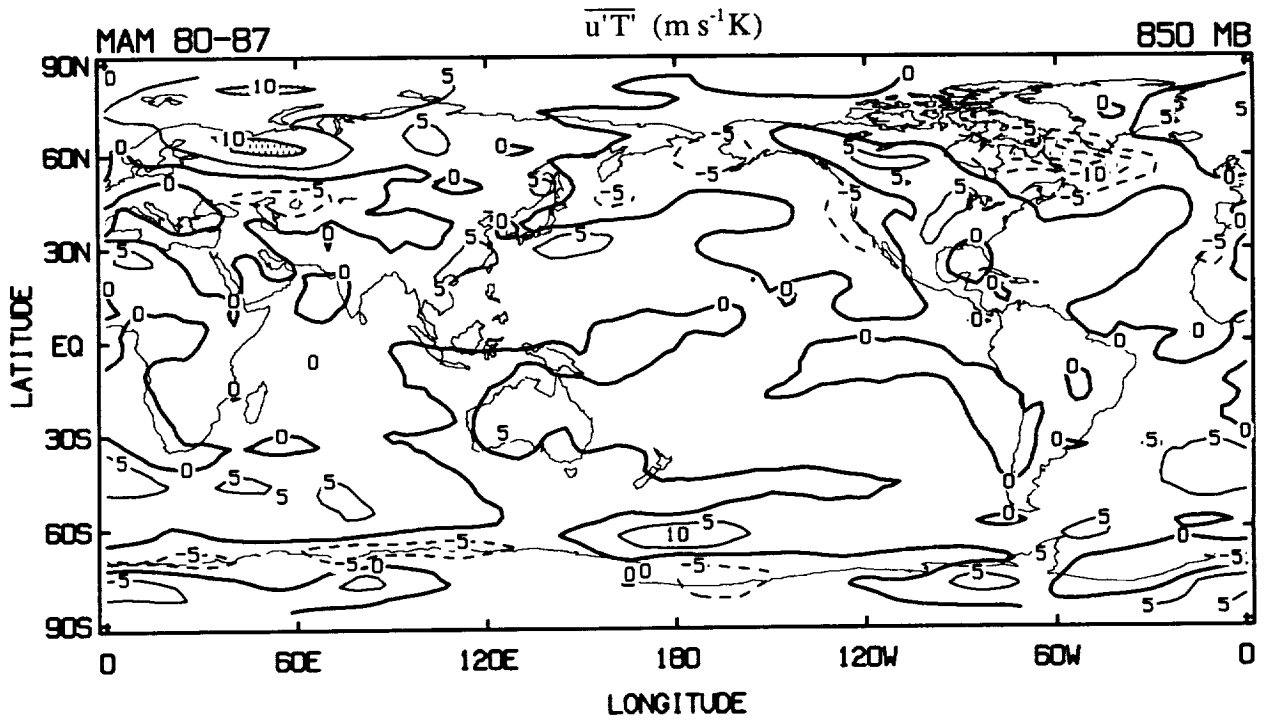
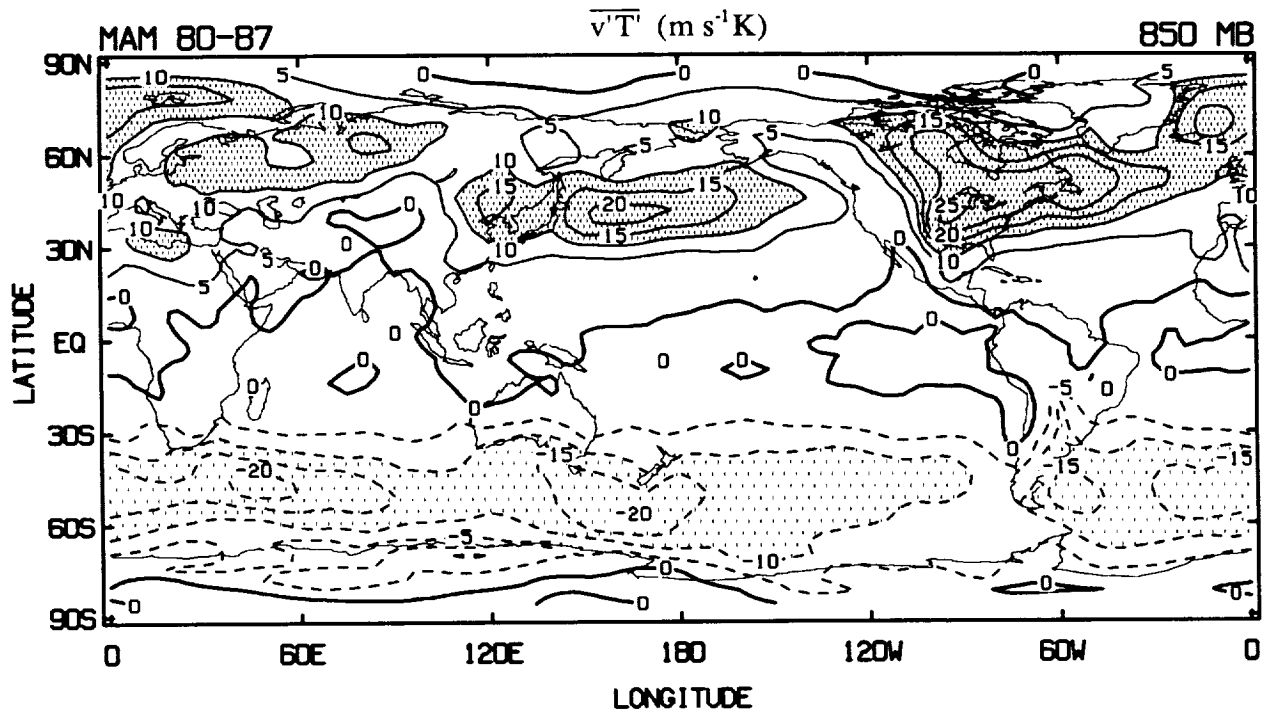

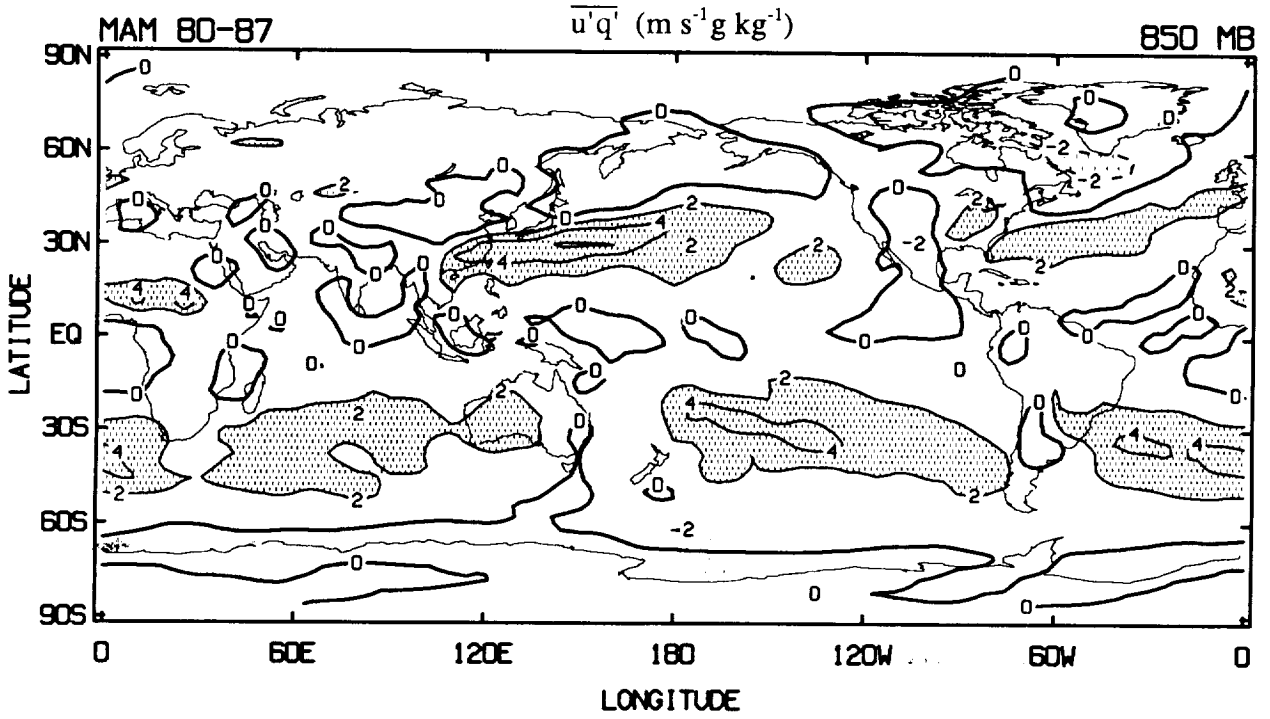
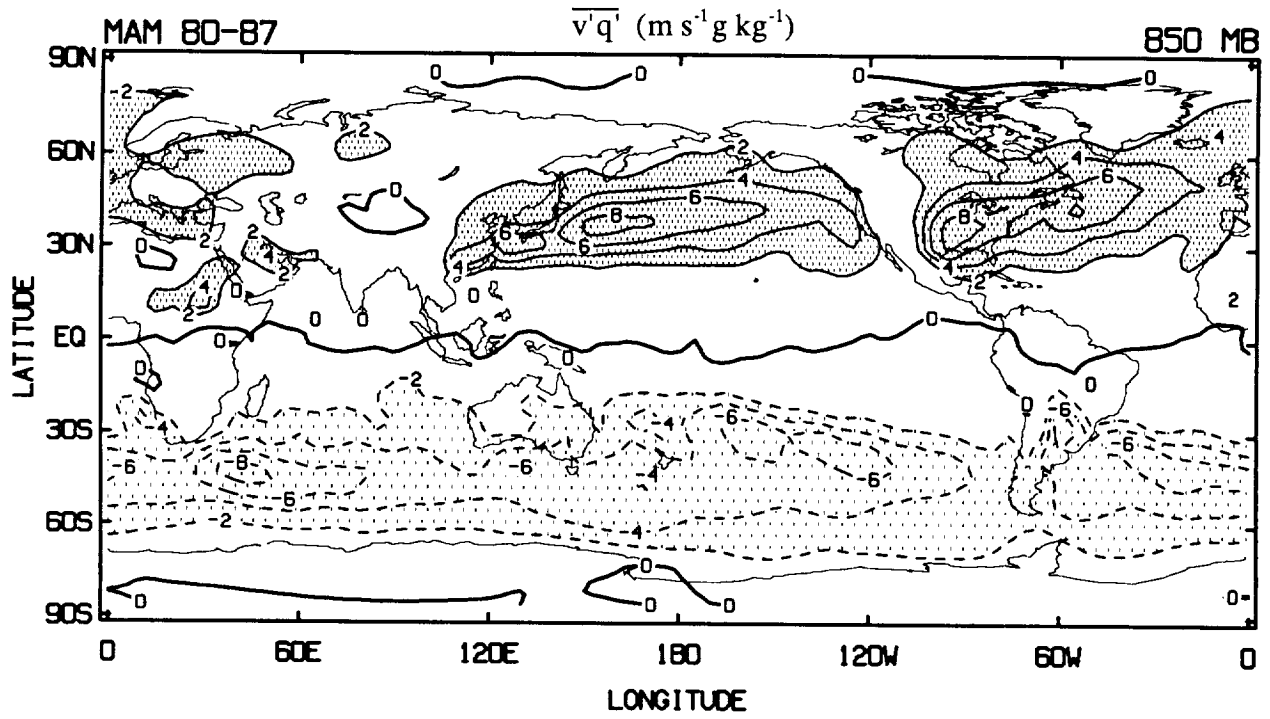

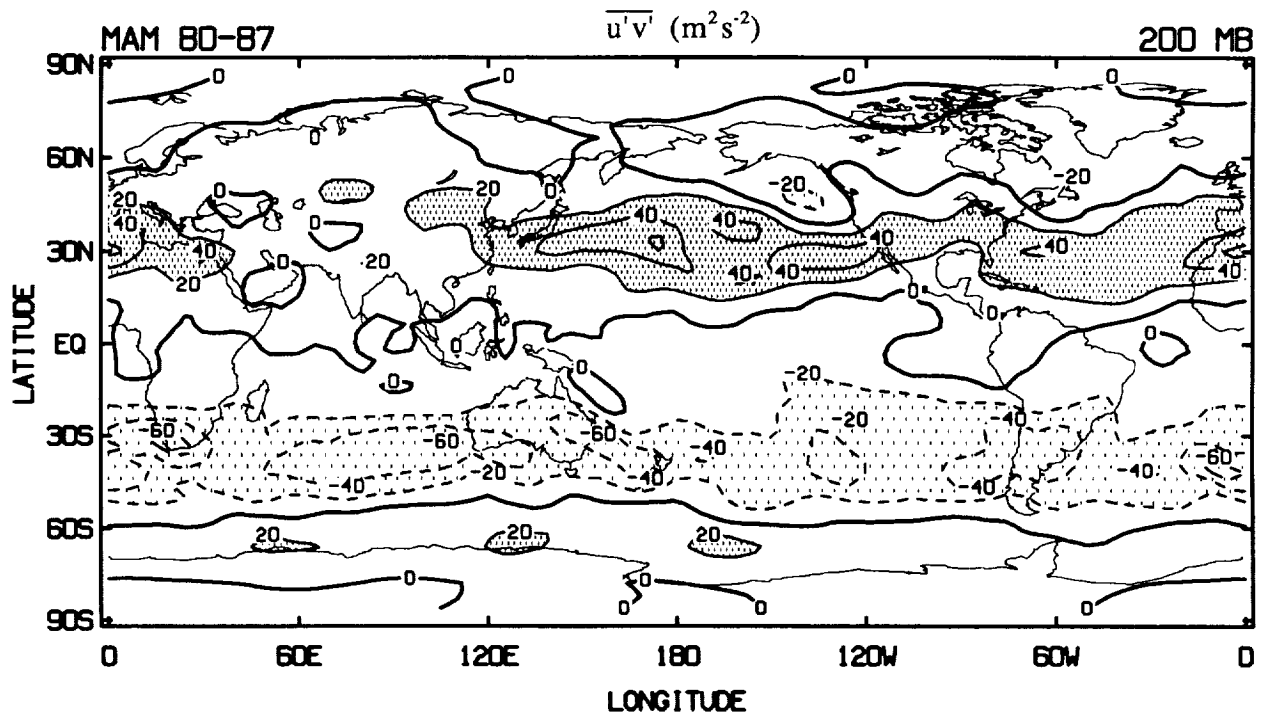

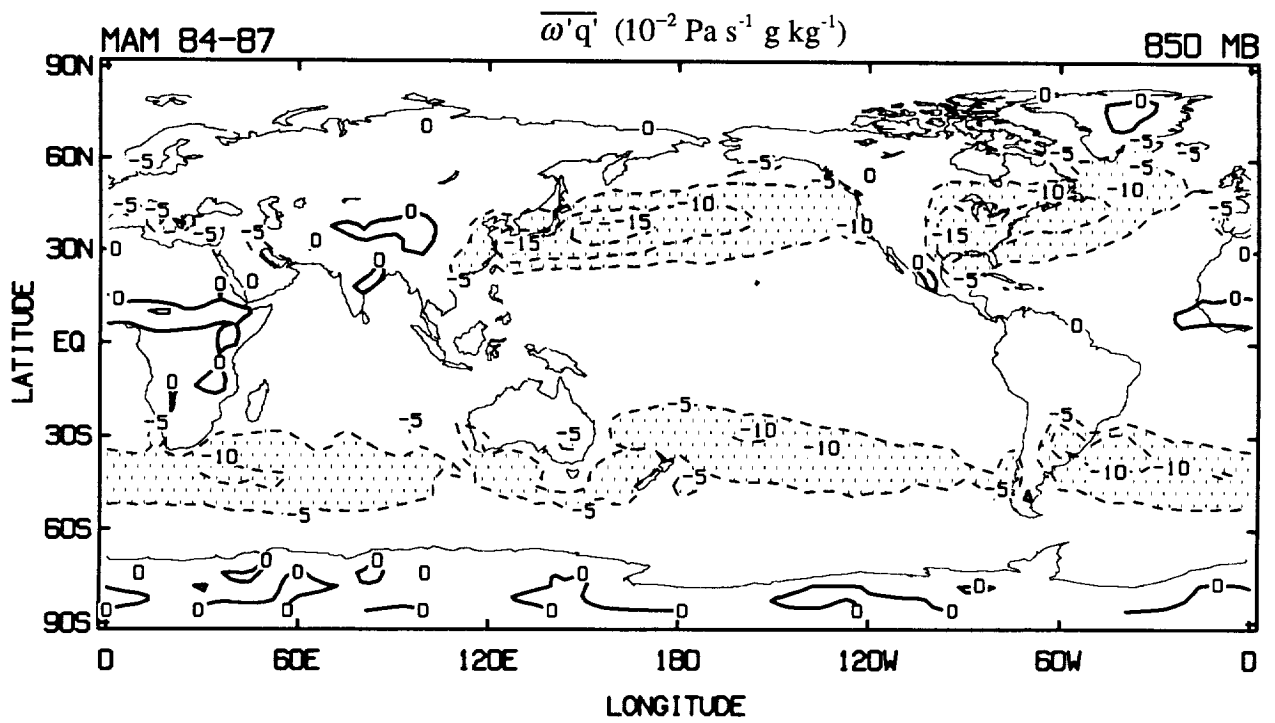
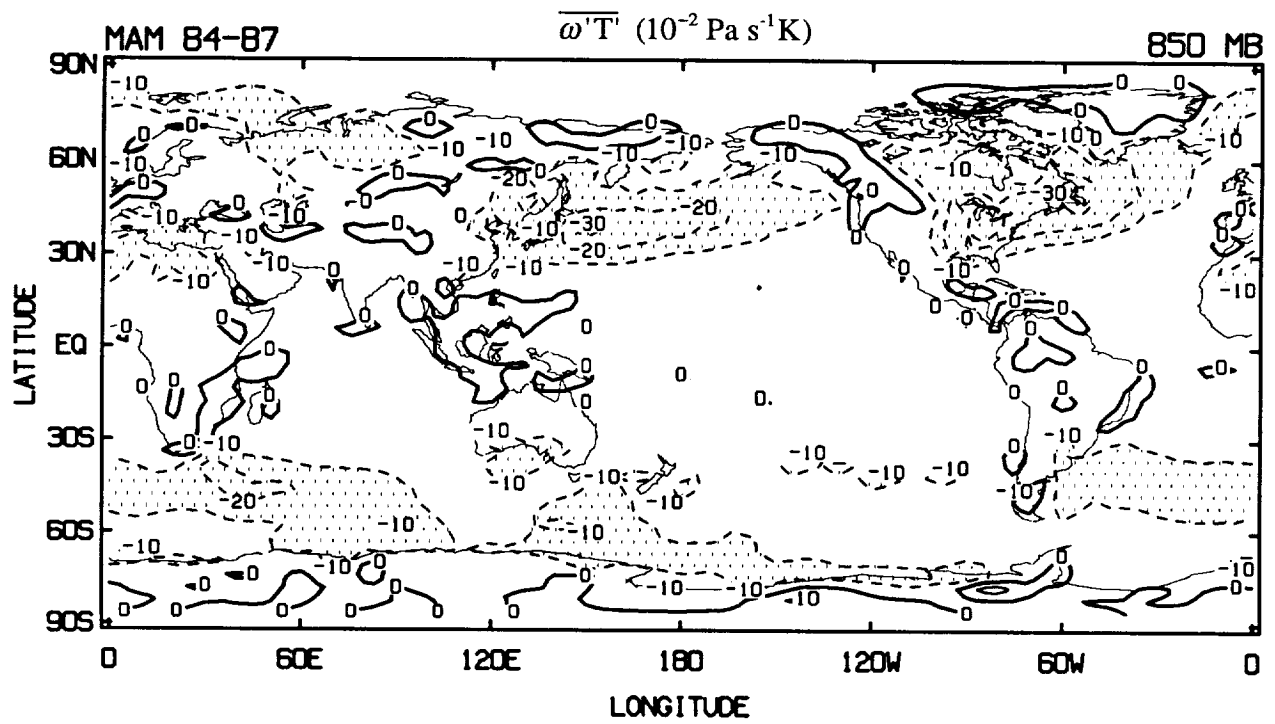

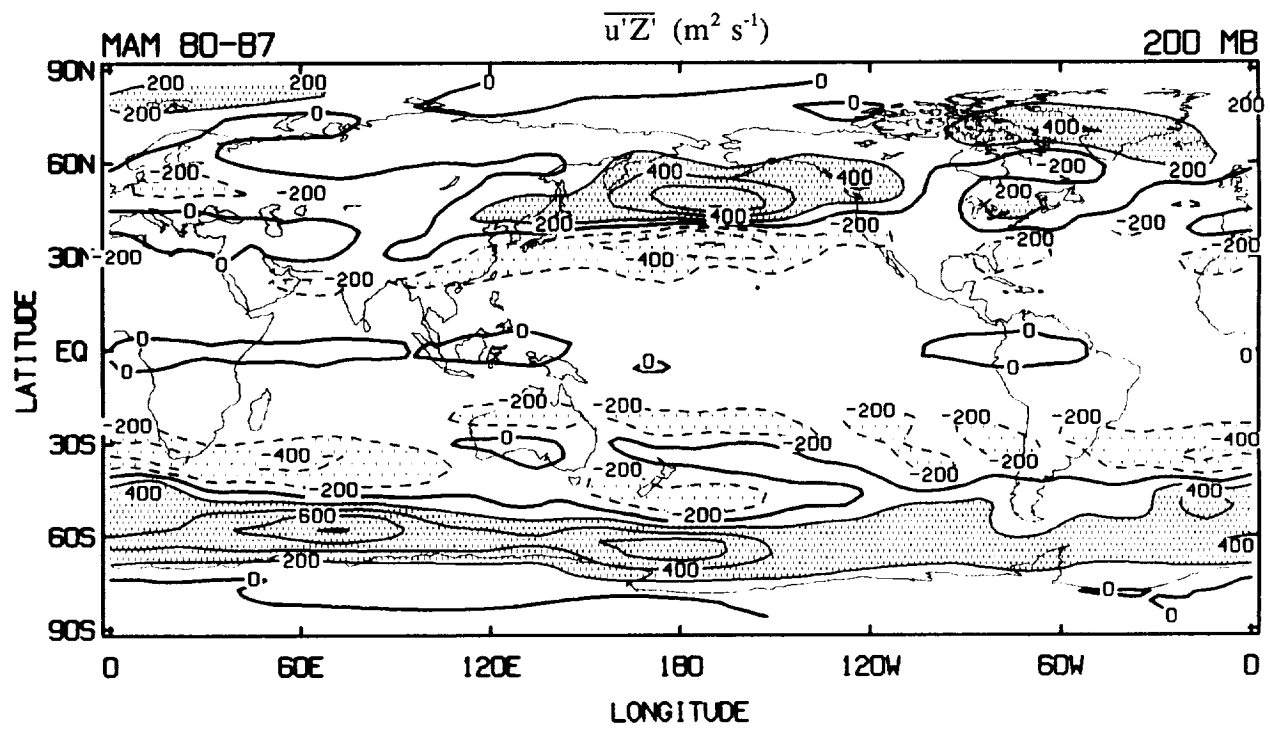
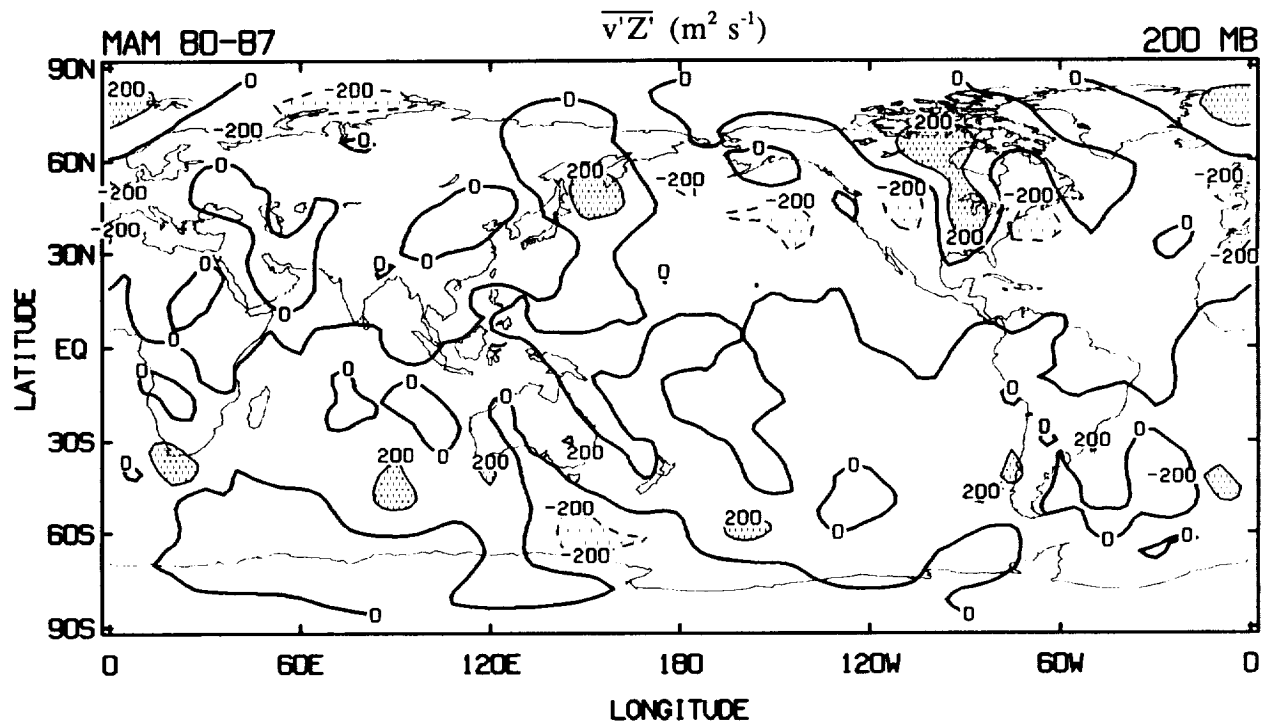

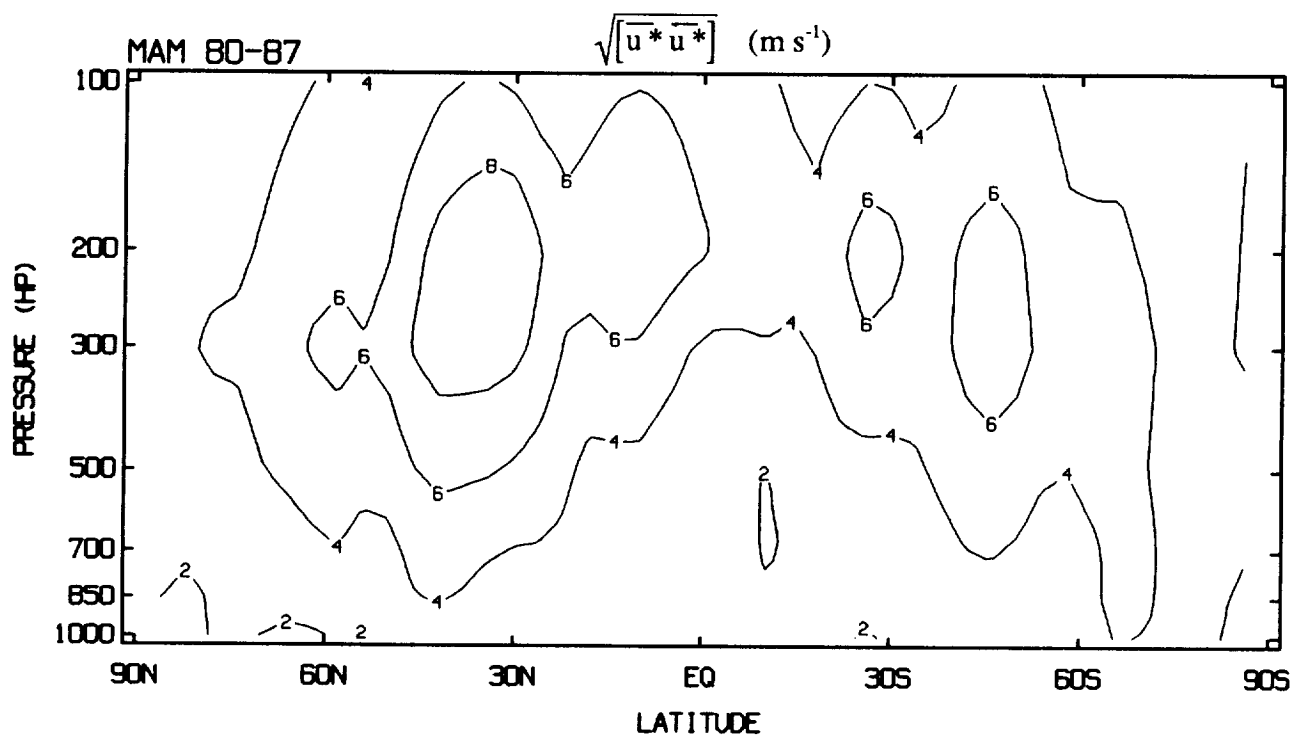
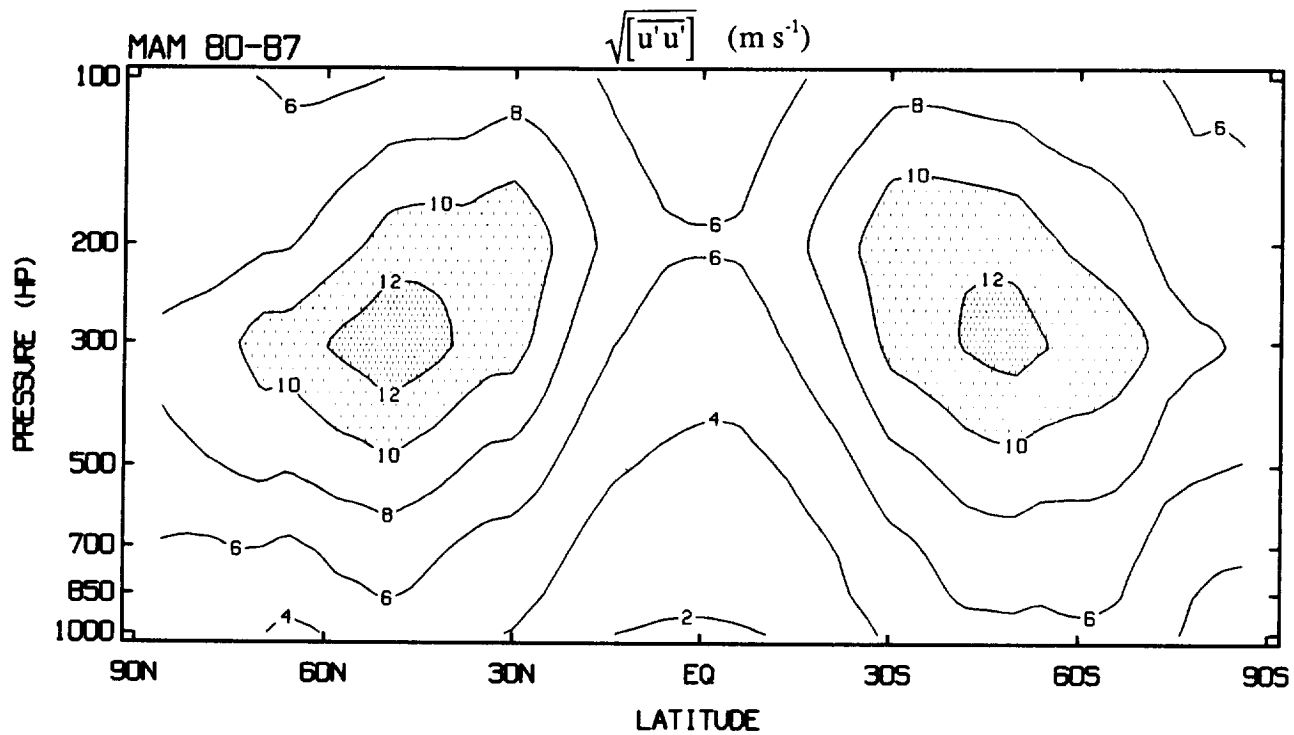

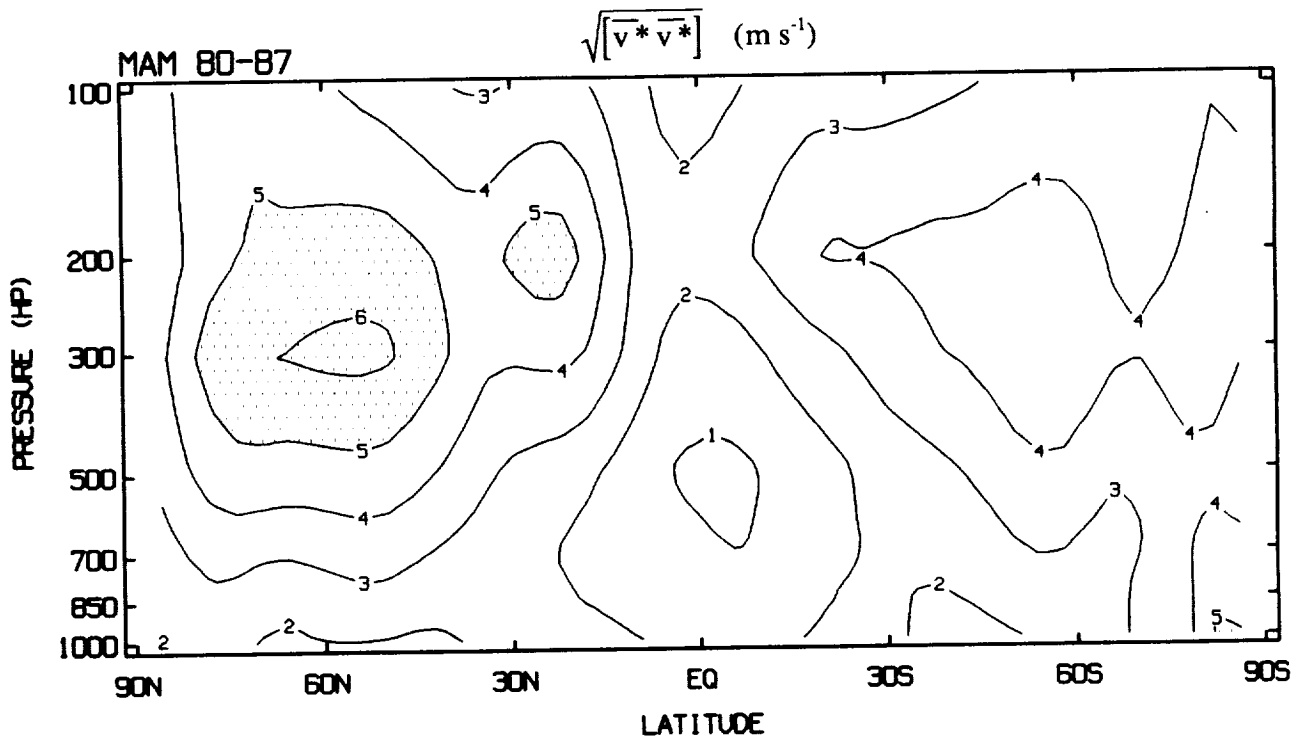
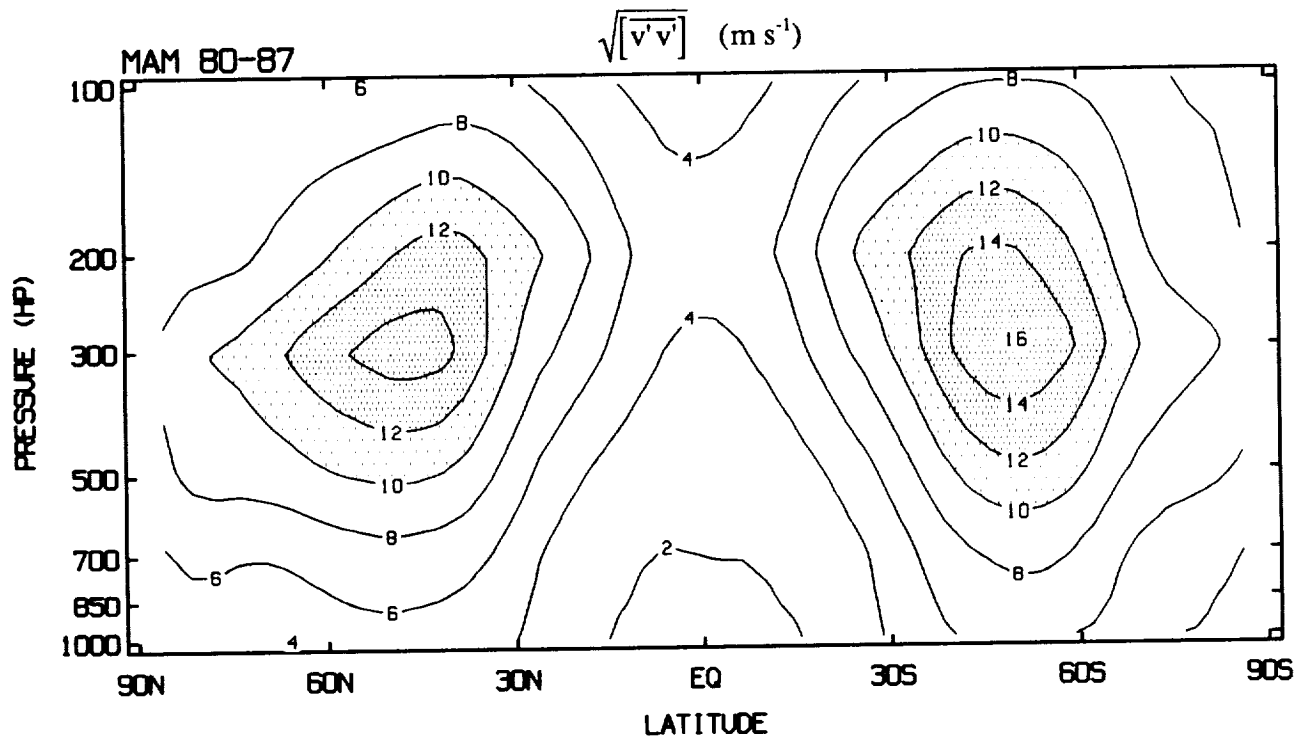

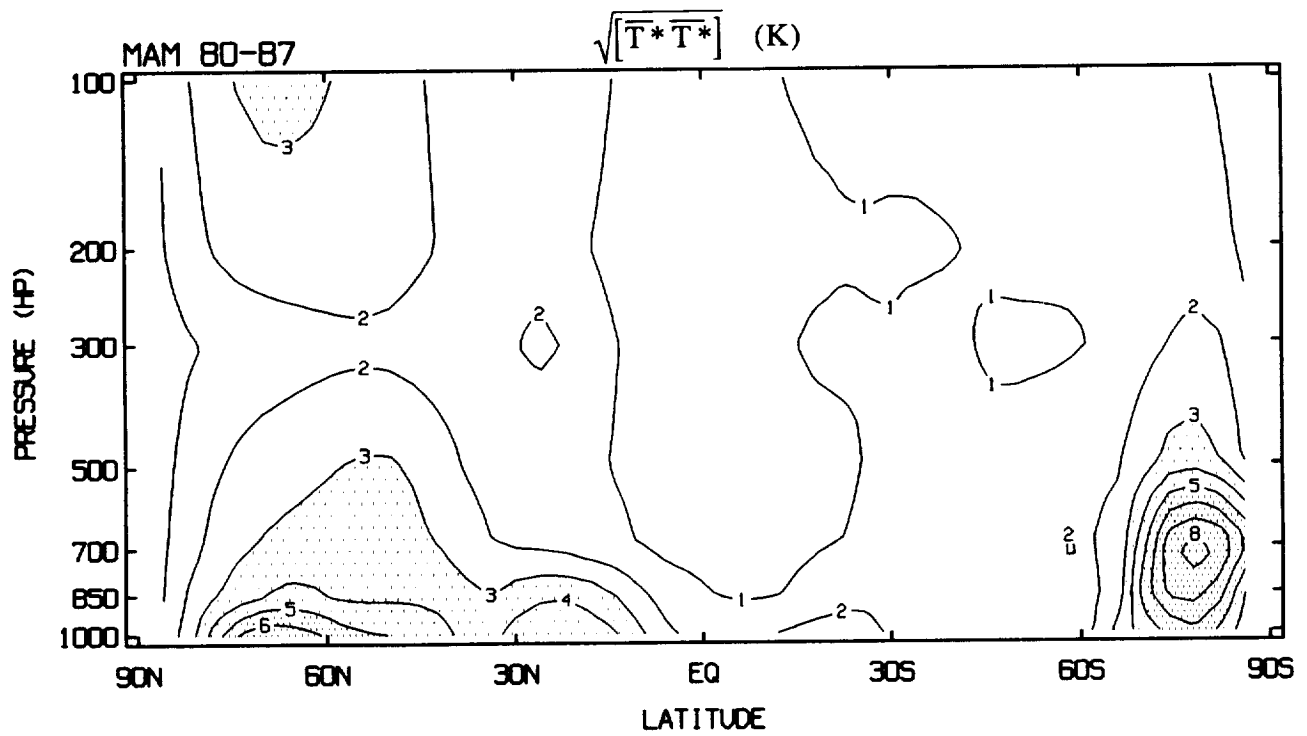
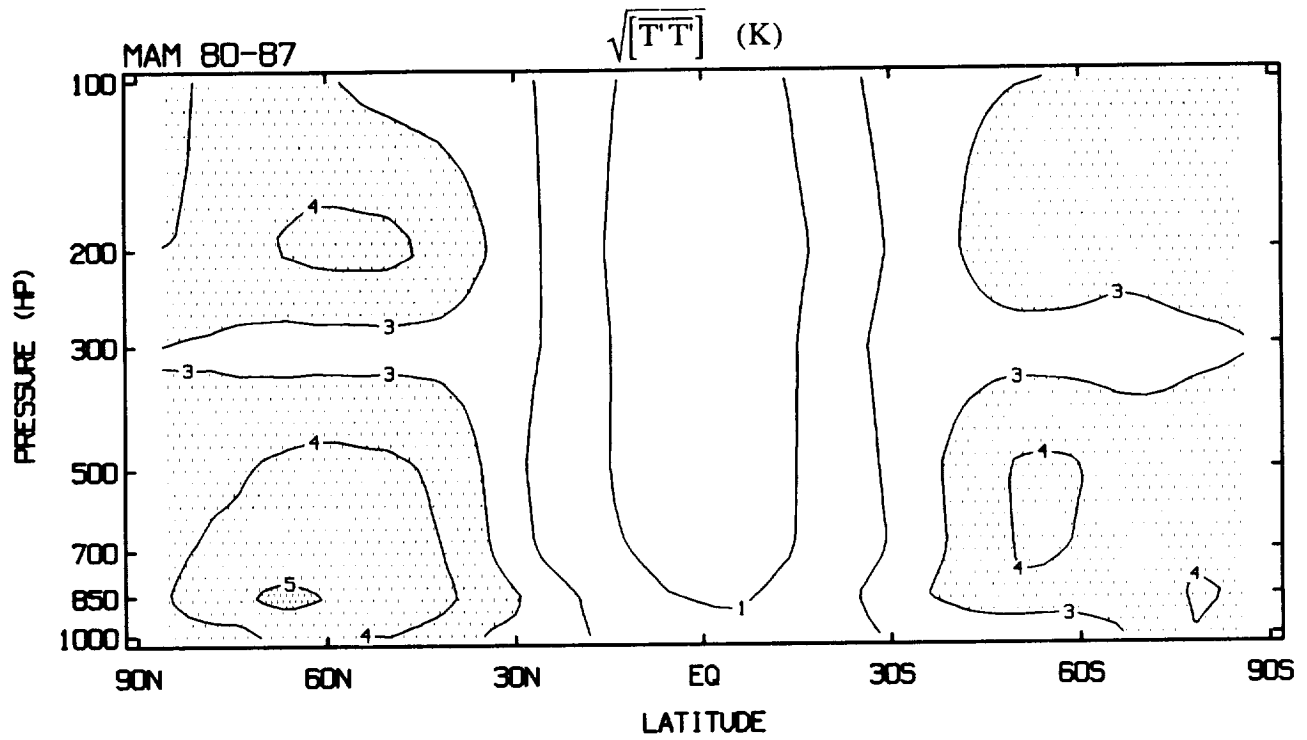

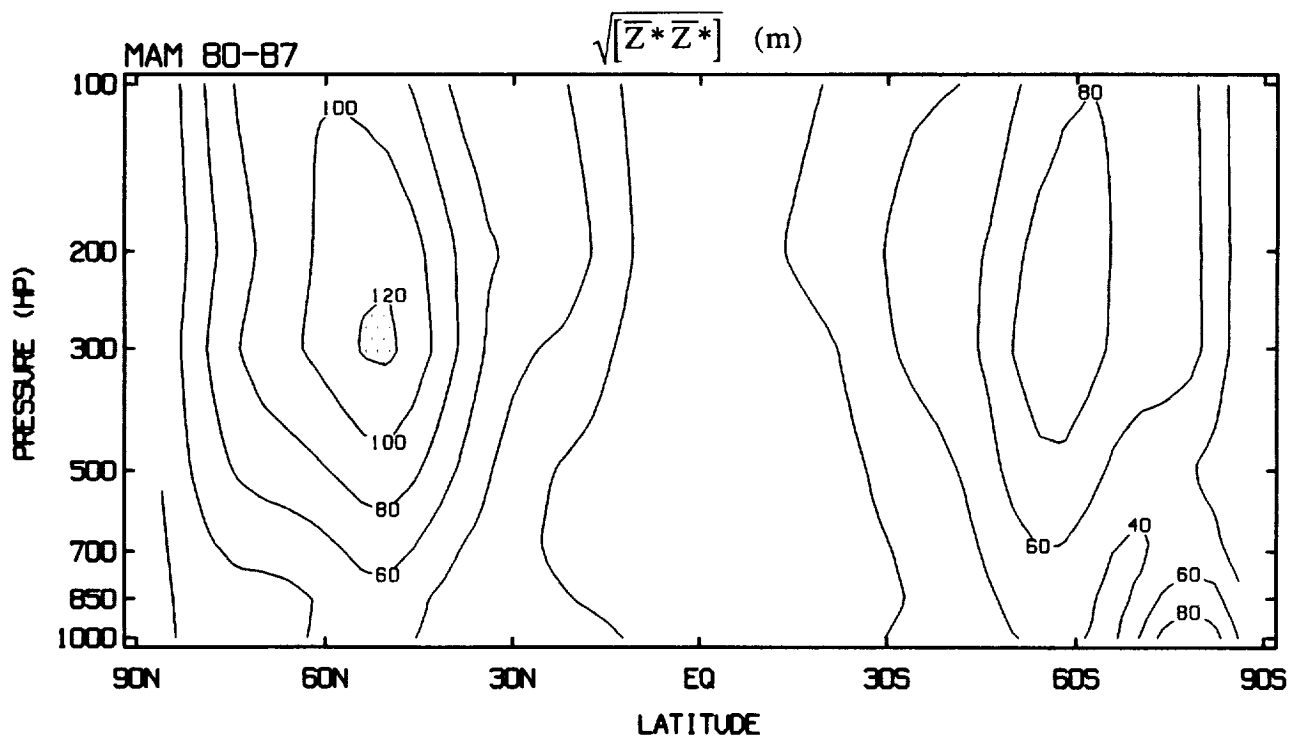
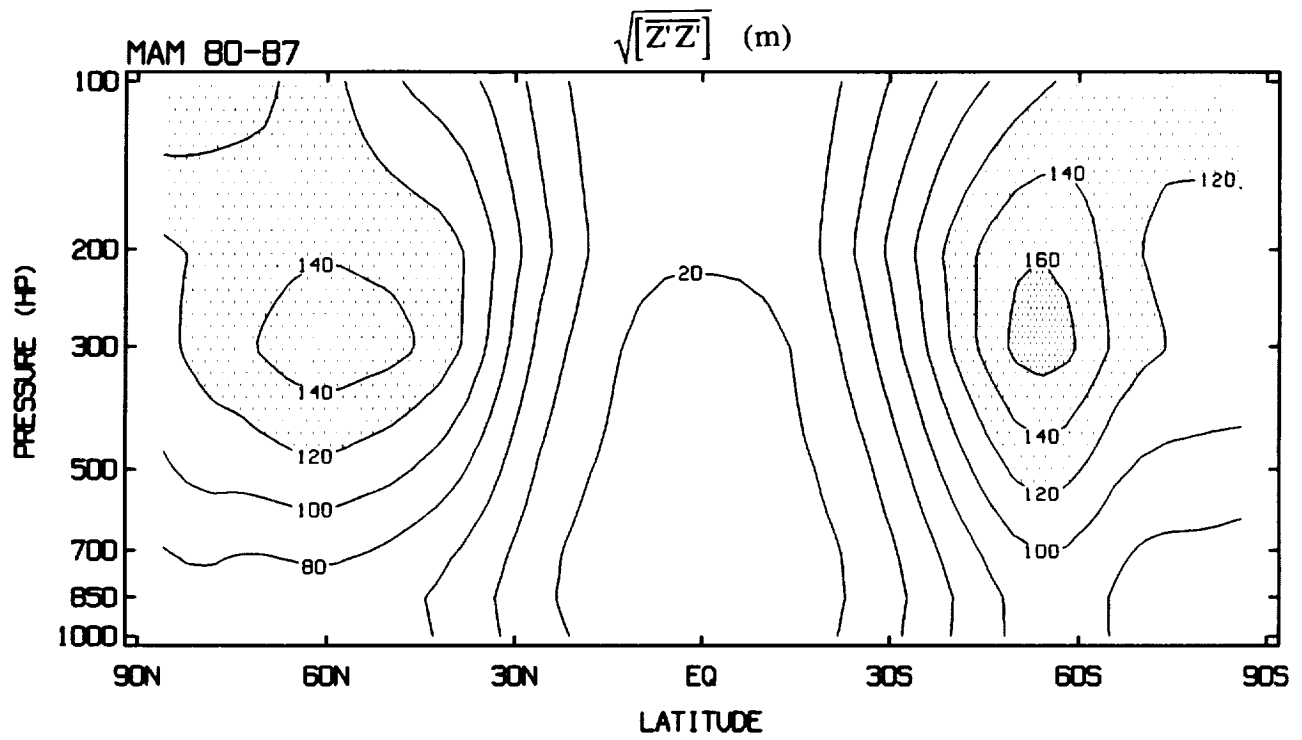

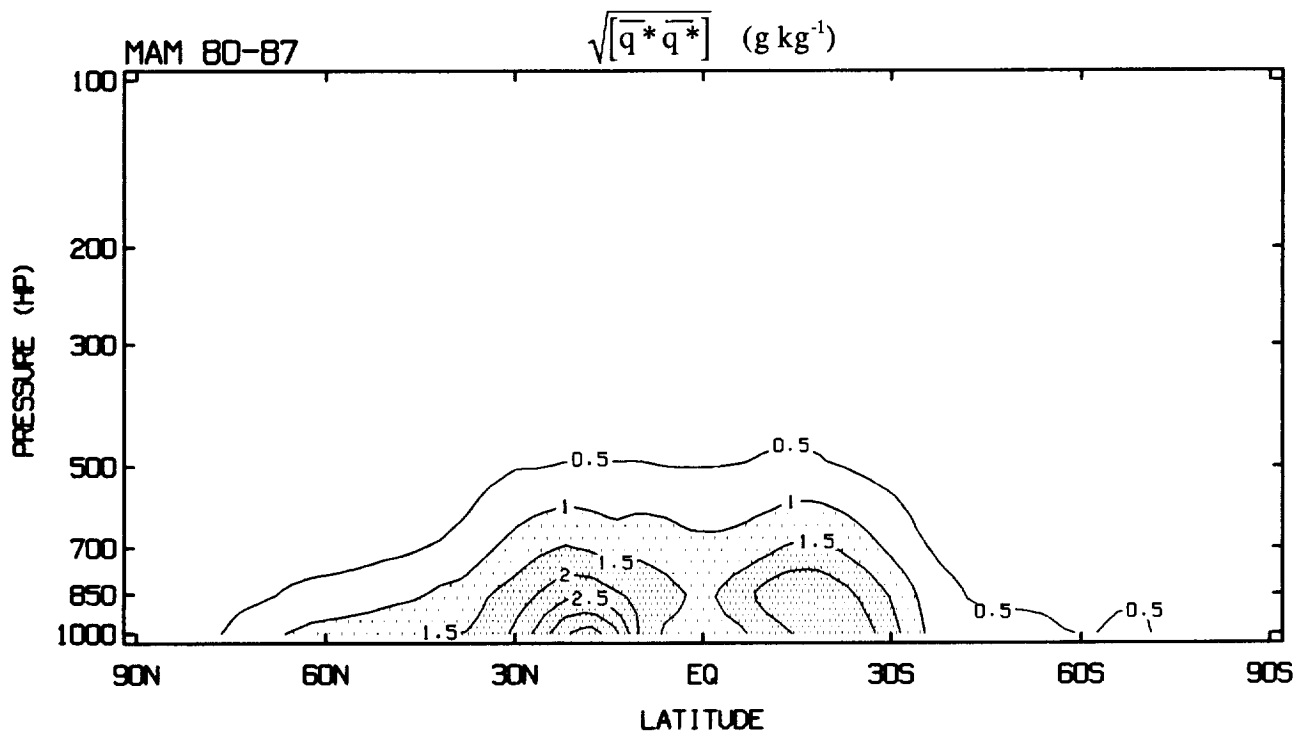
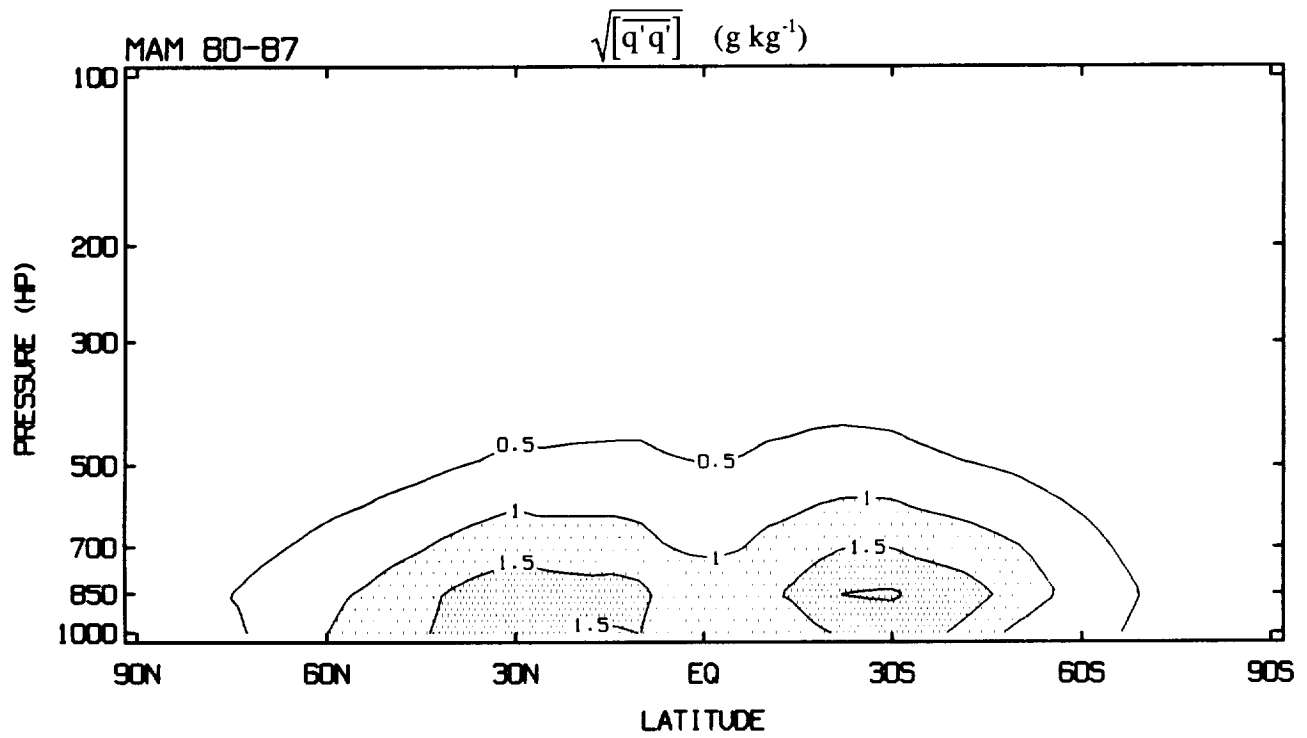

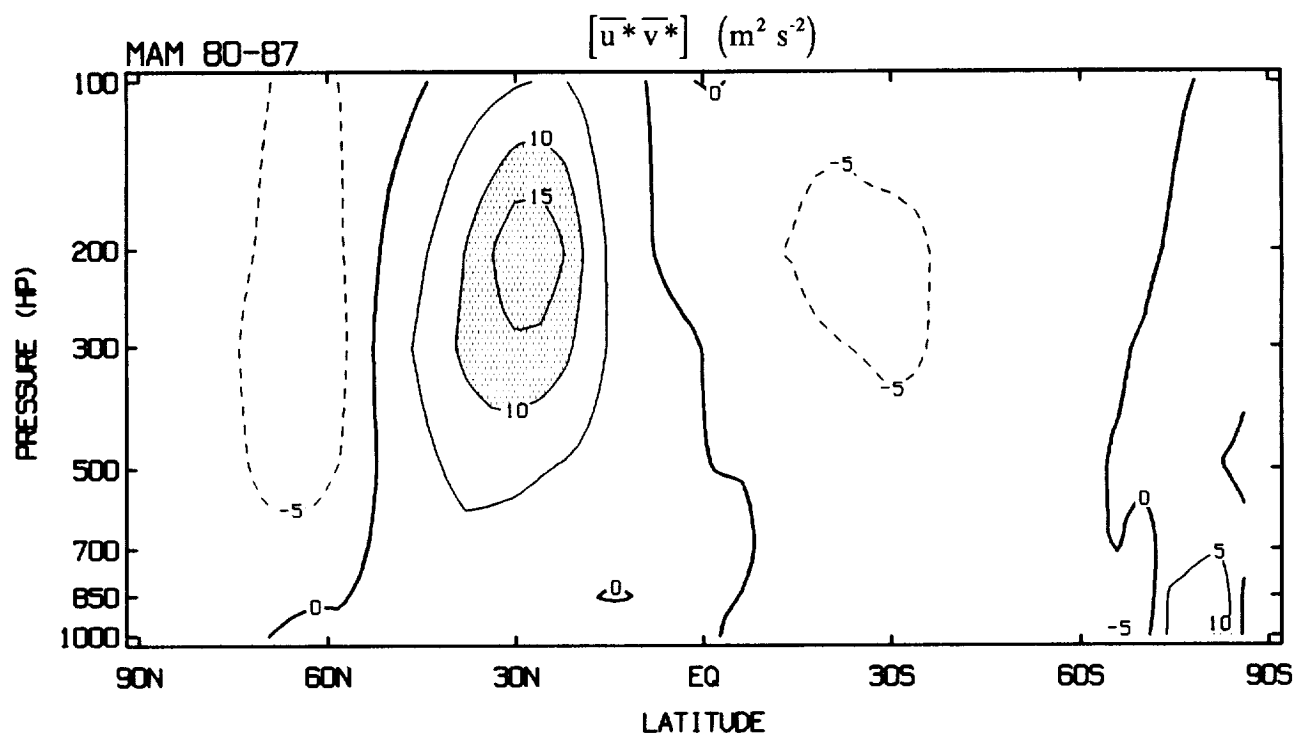
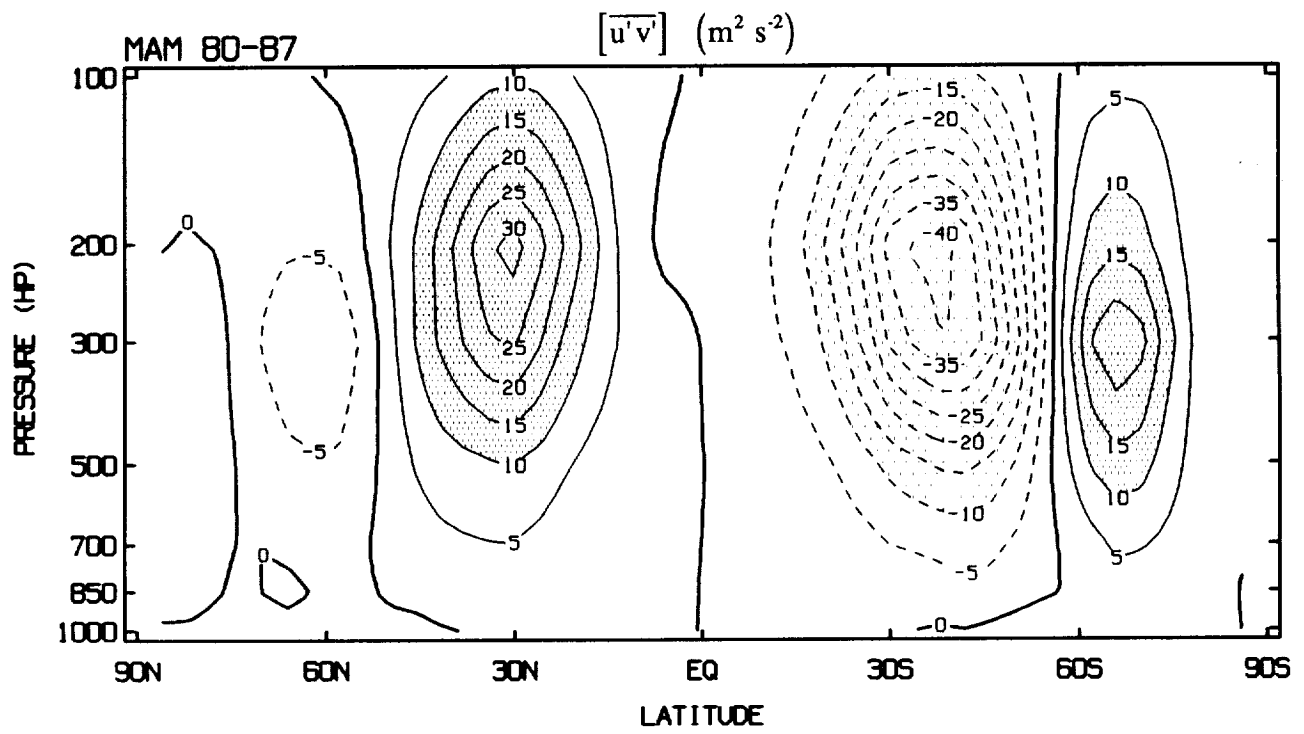

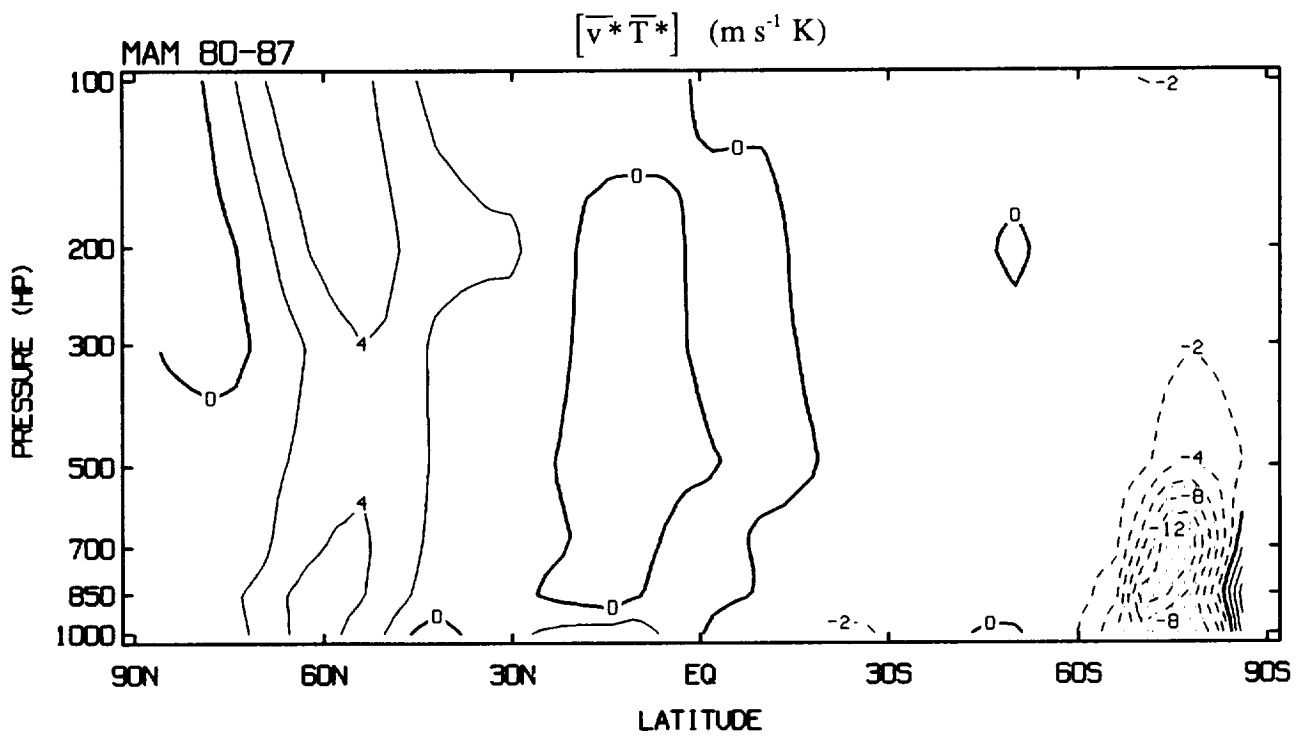
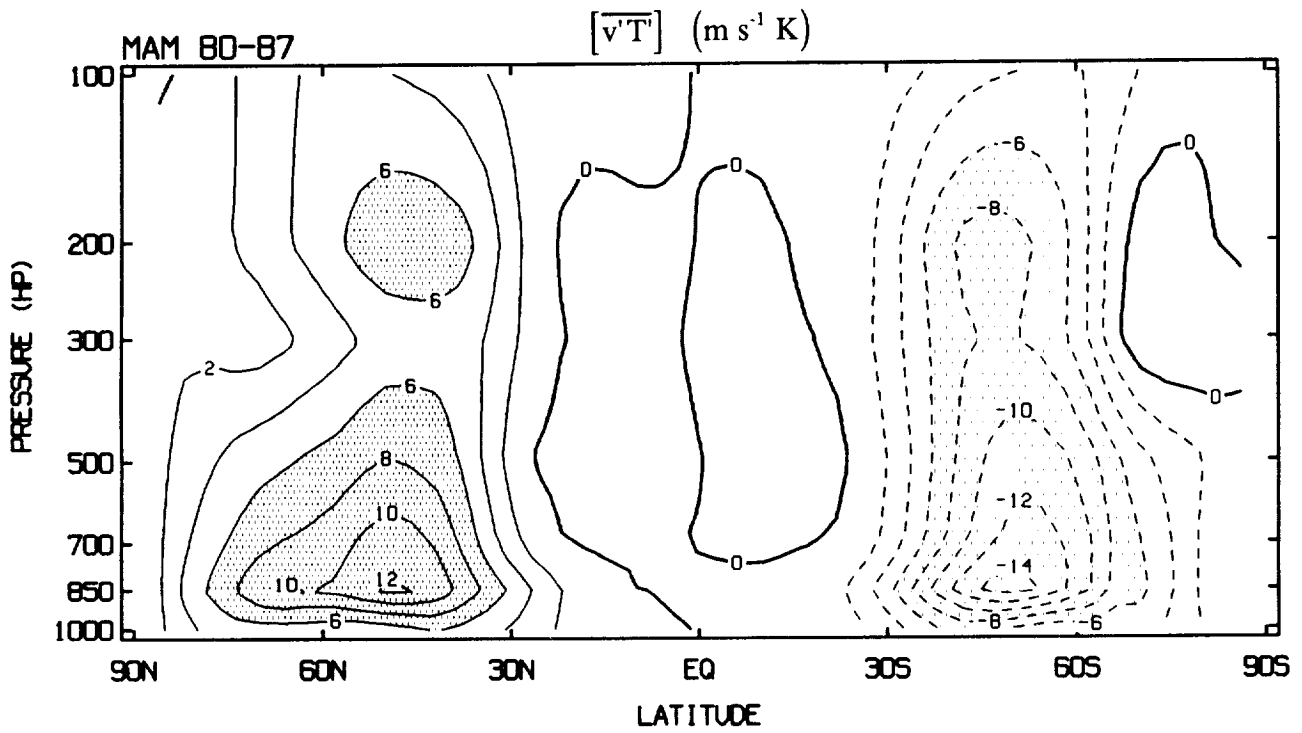

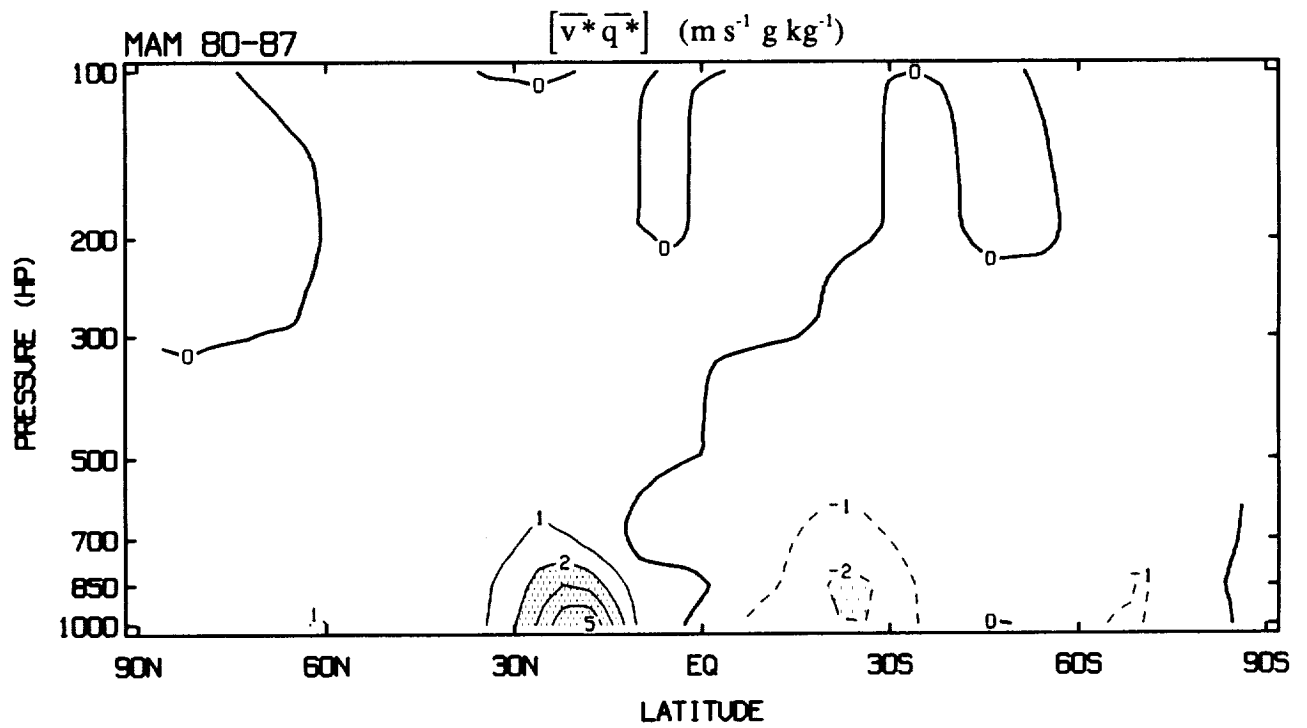
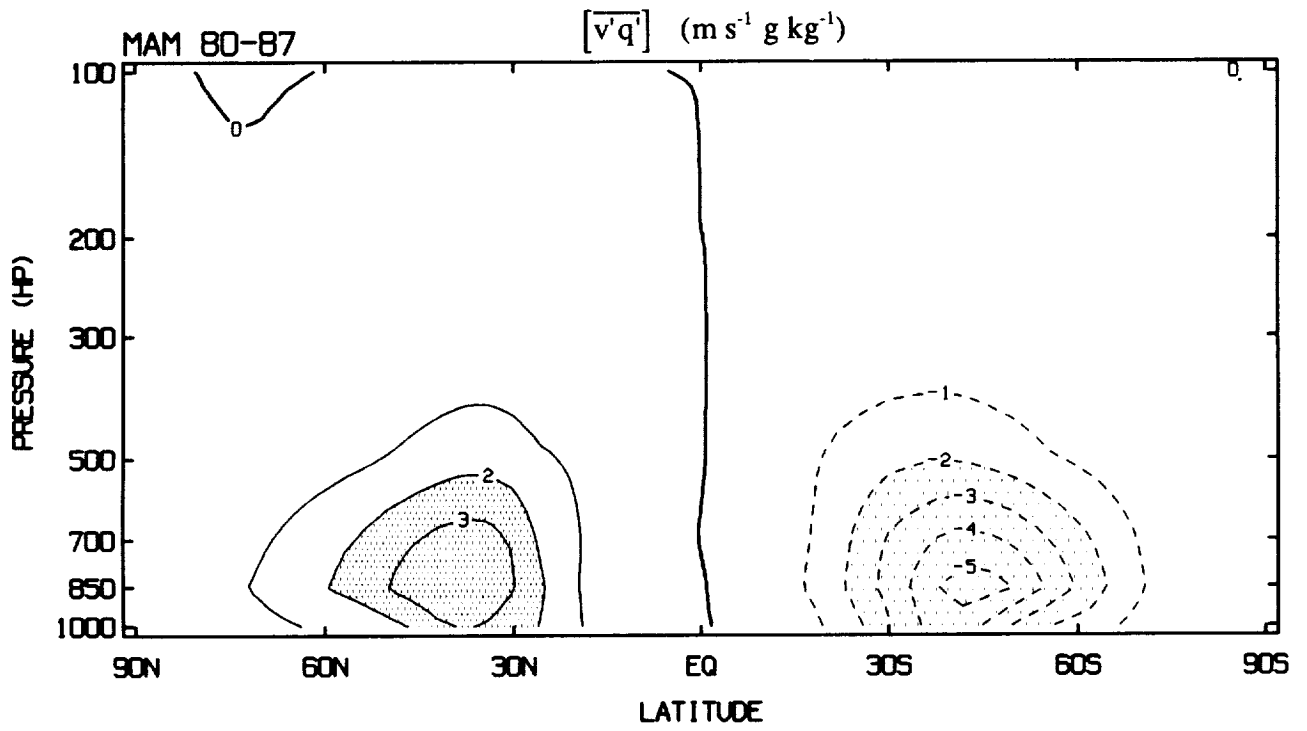

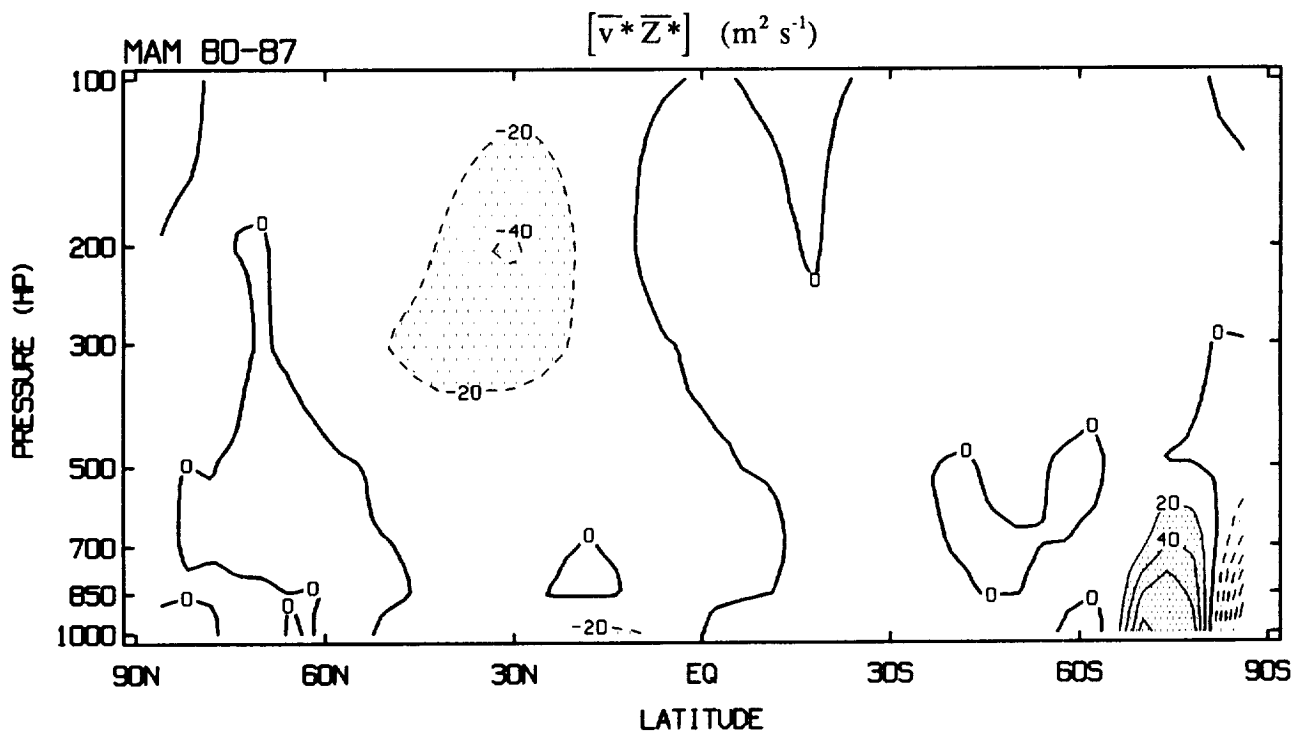
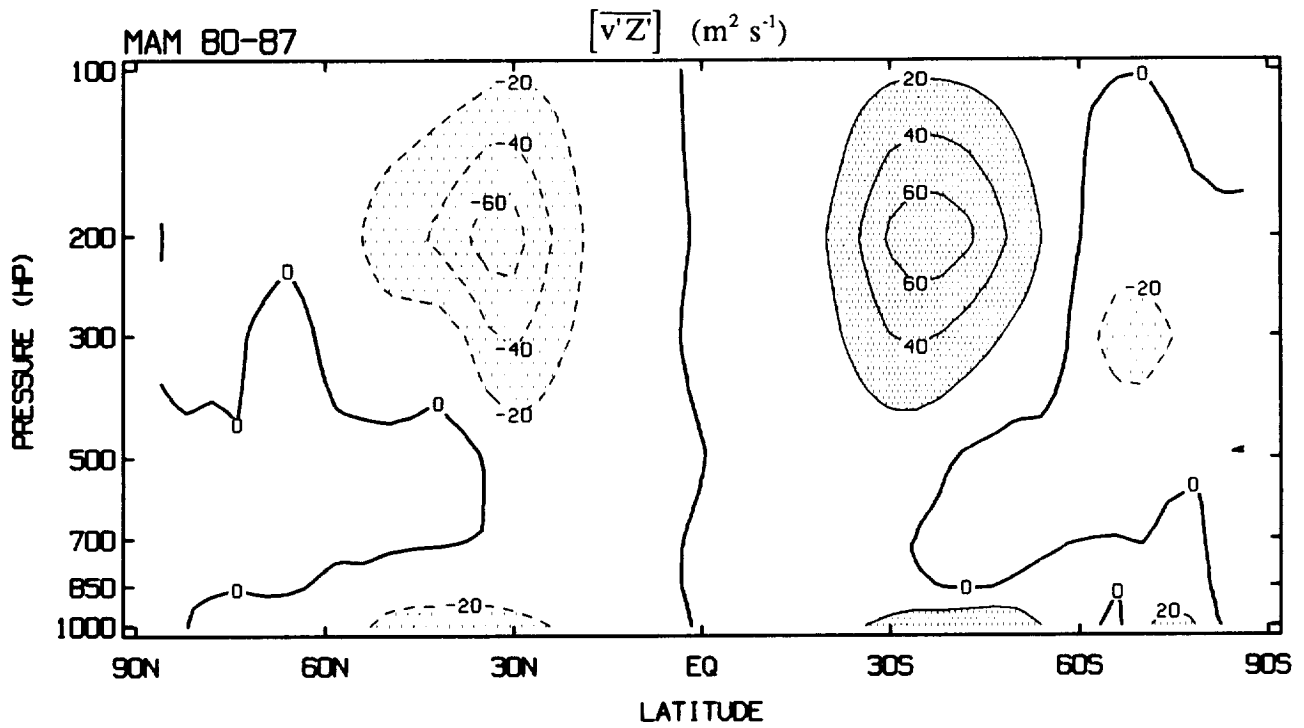

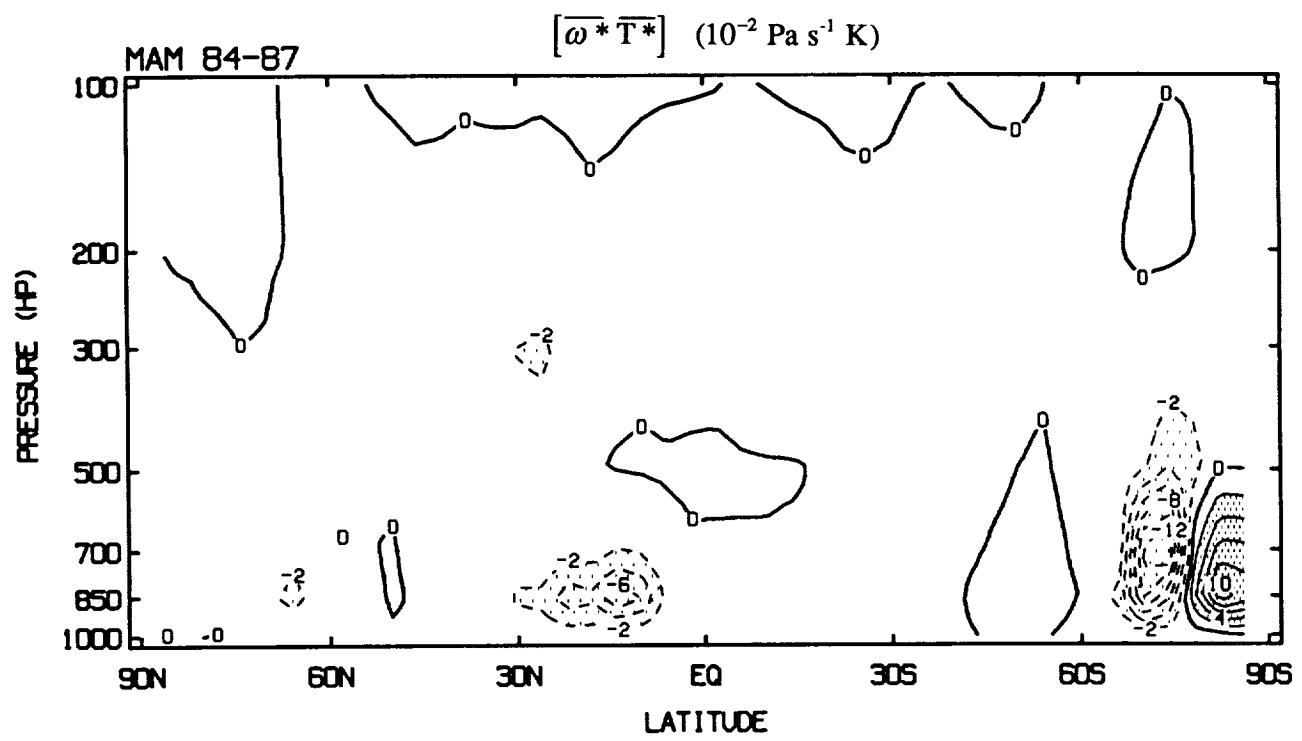
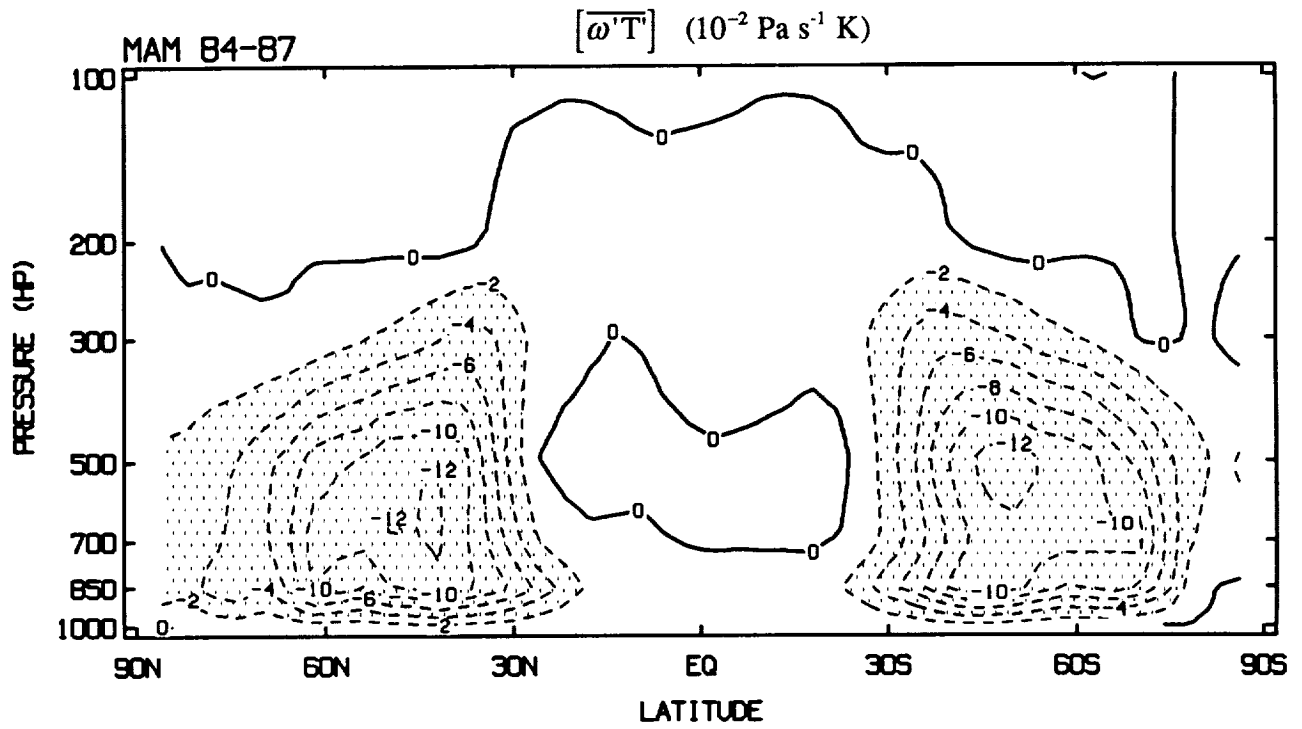

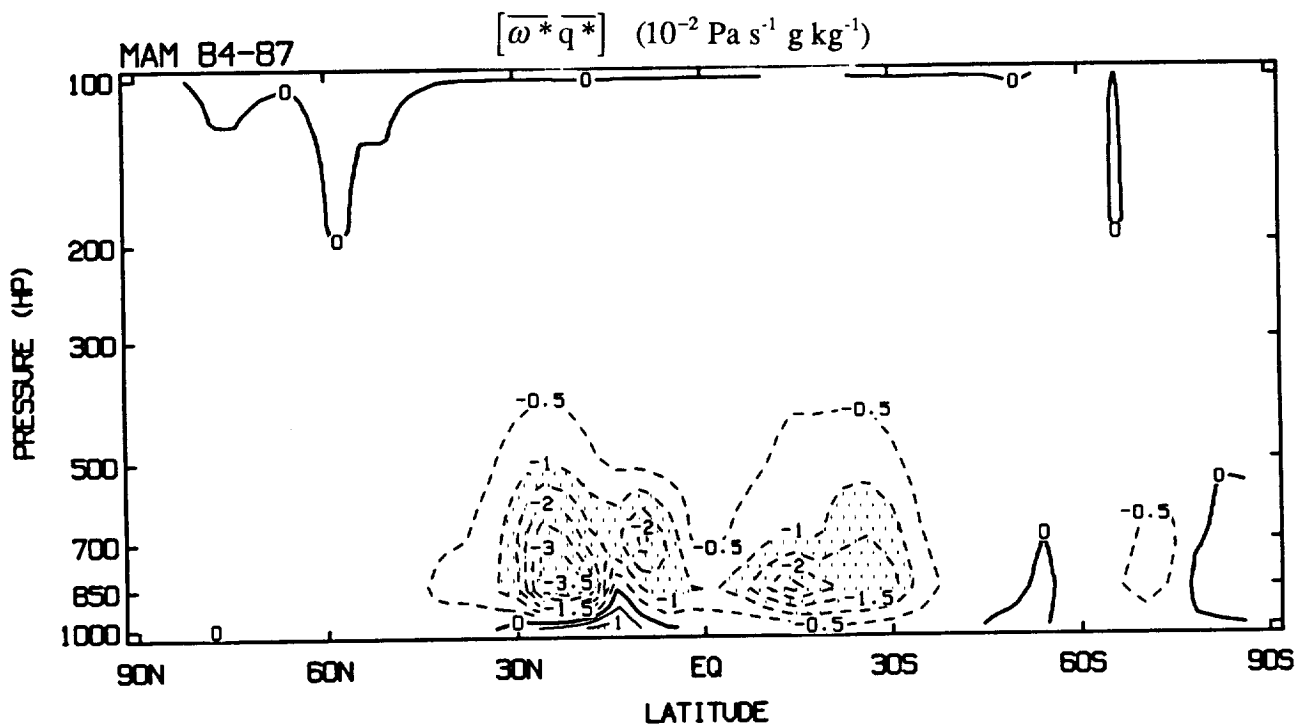
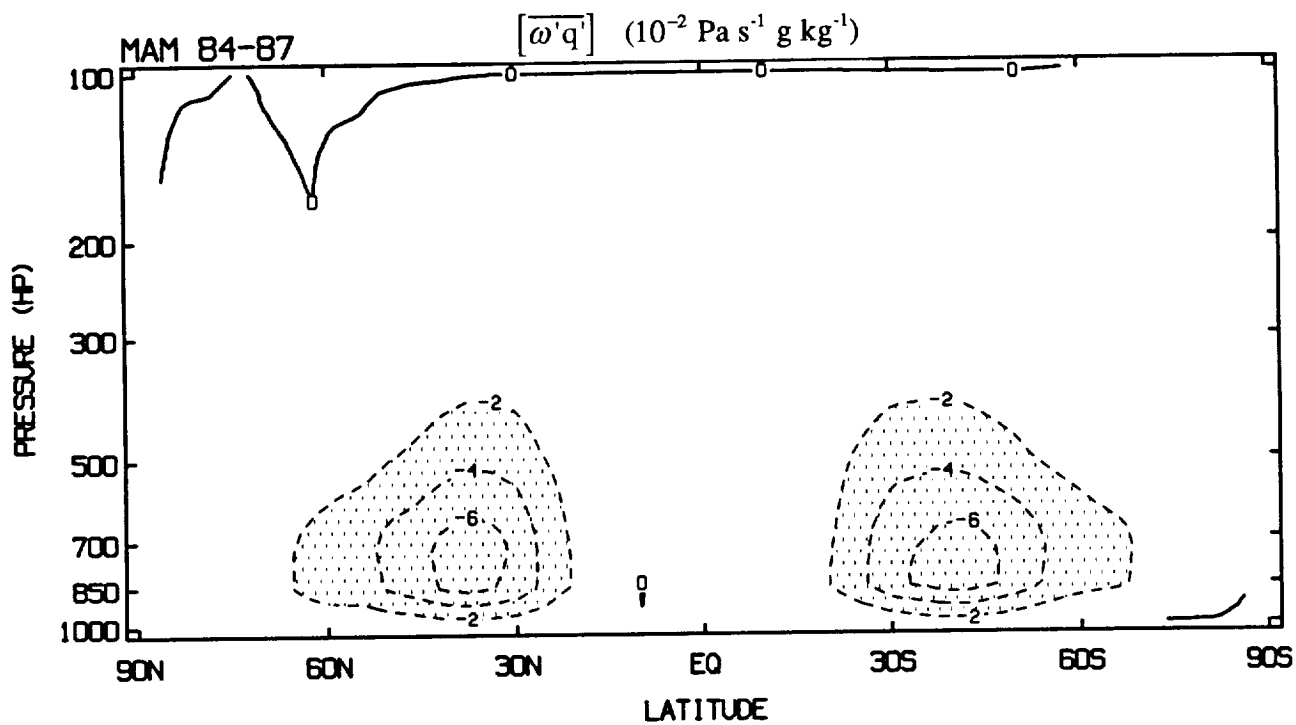

MAM

DEVIATIONS FROM SEASONAL CYCLE

UNFILTERED

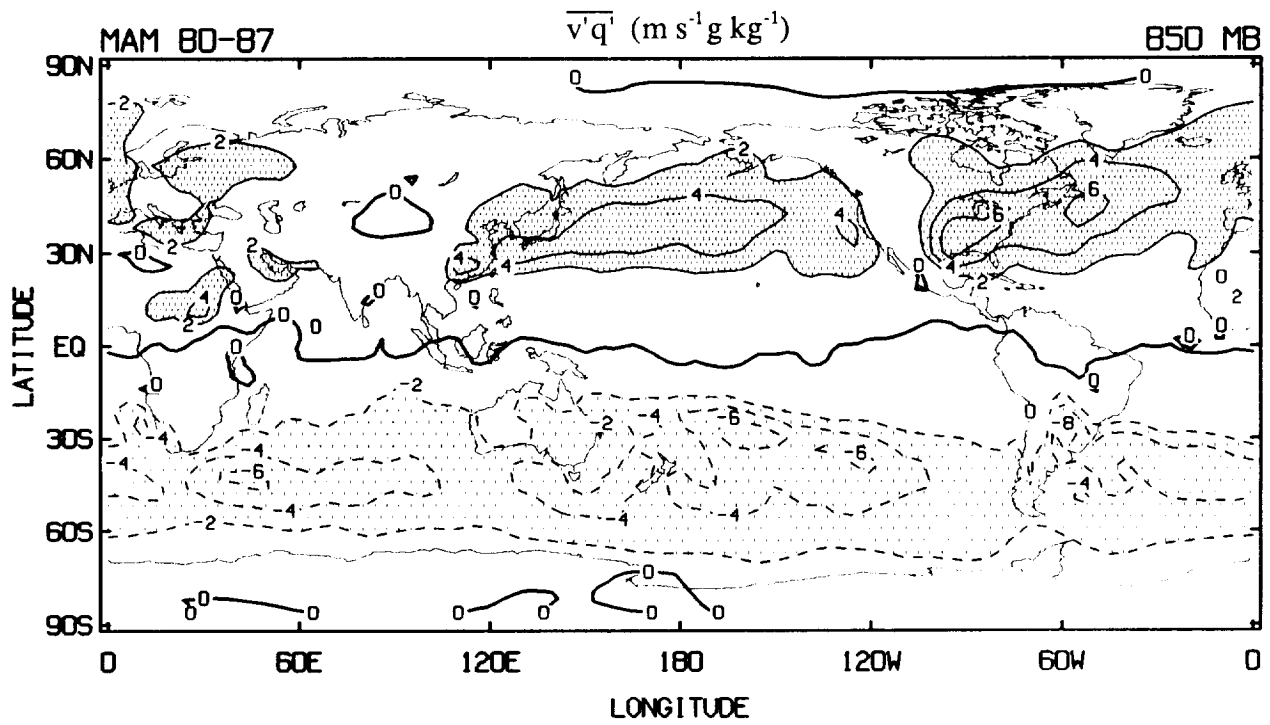
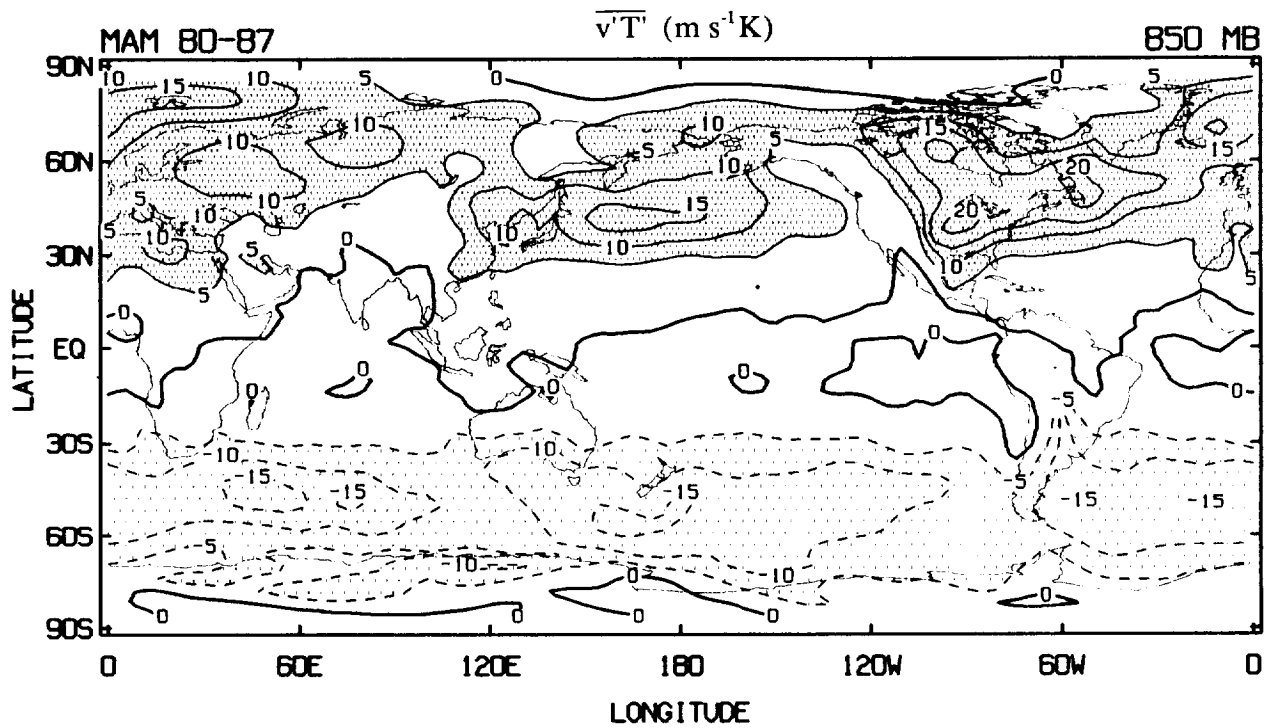

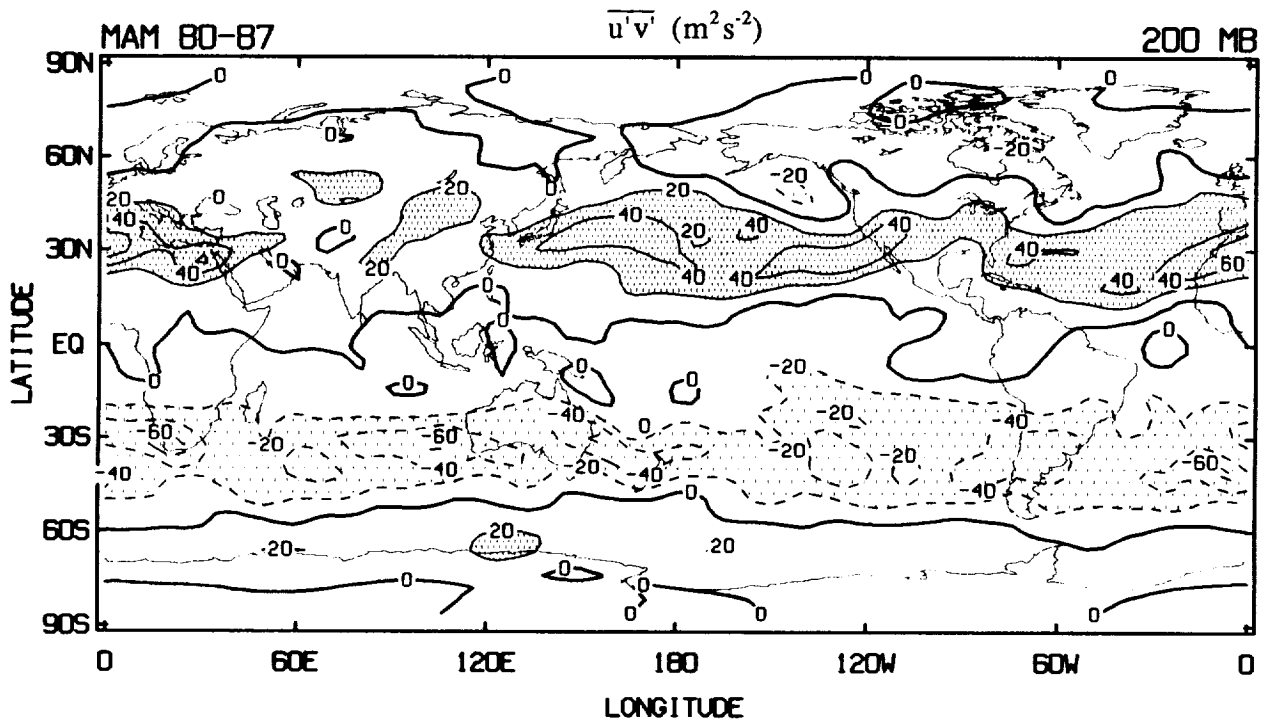

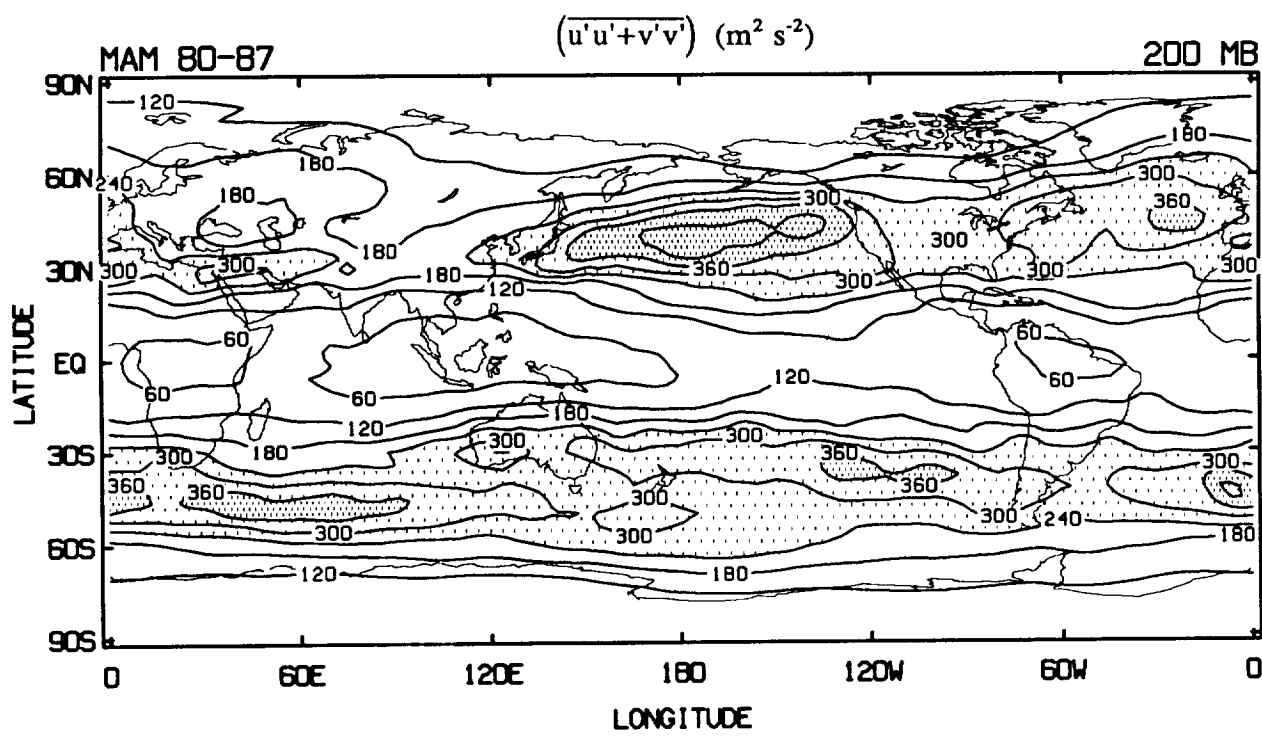
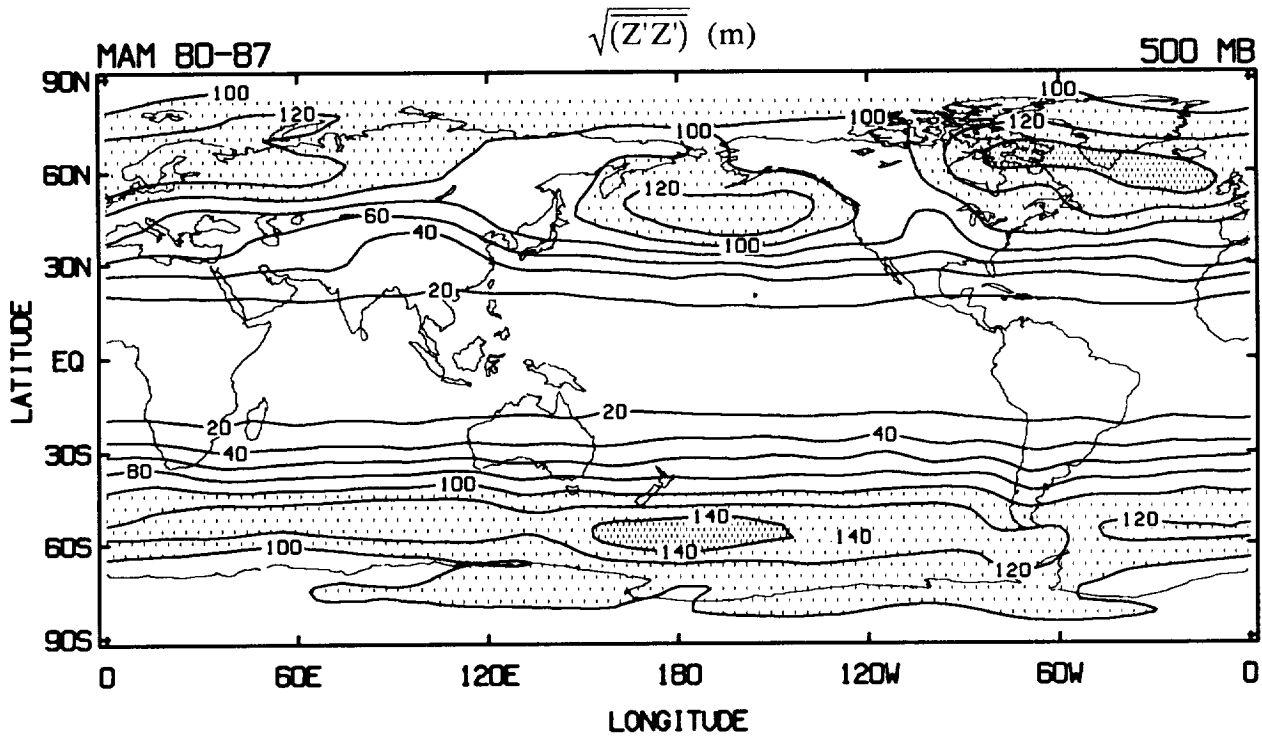

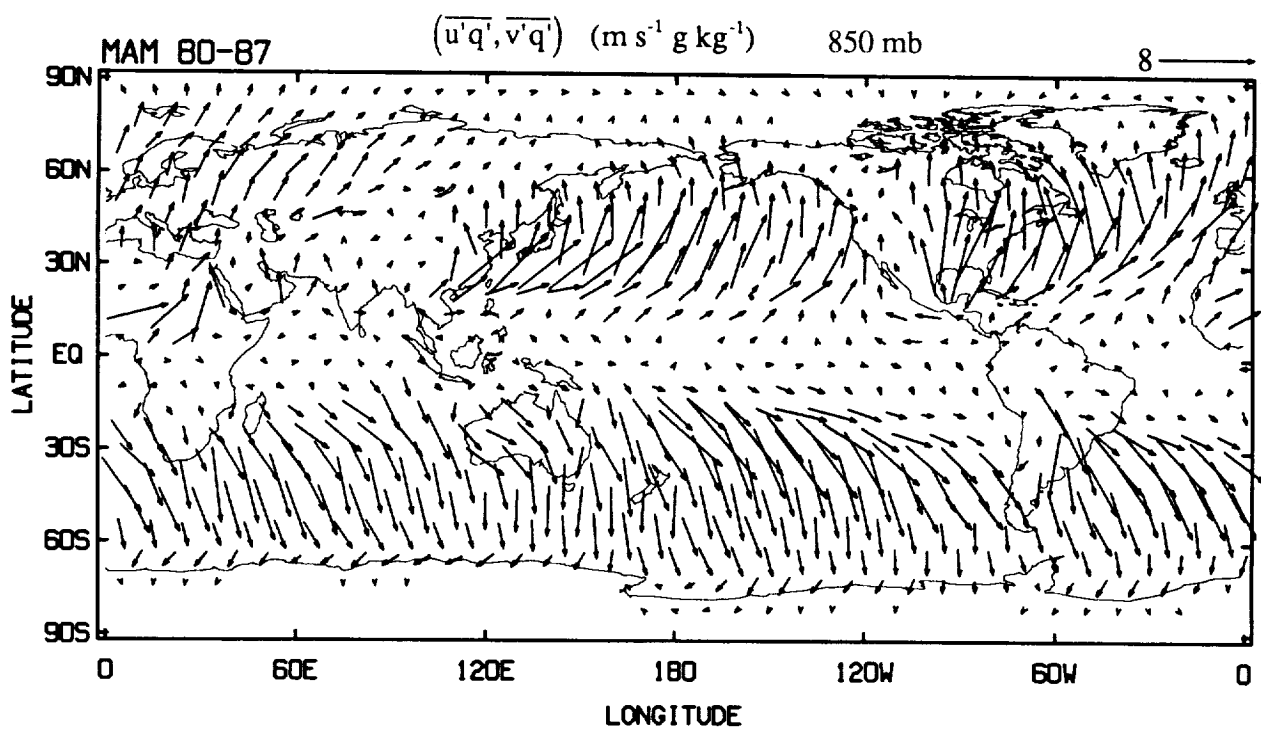
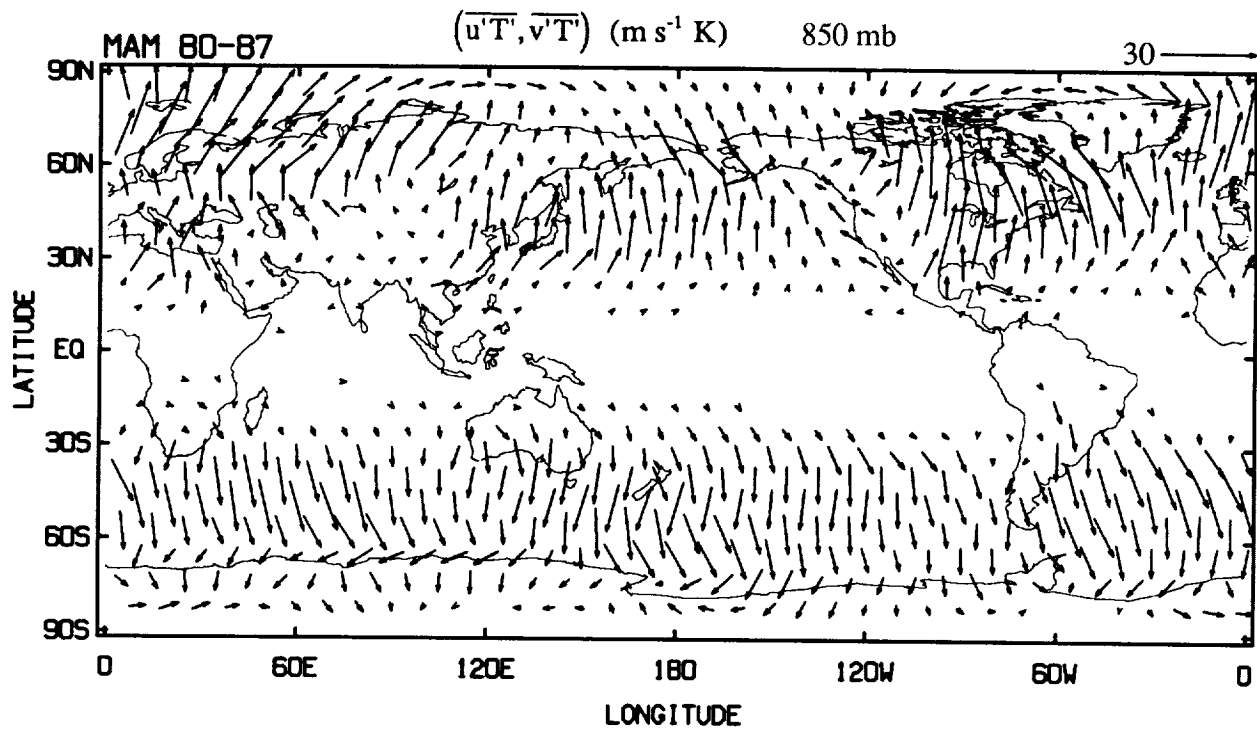

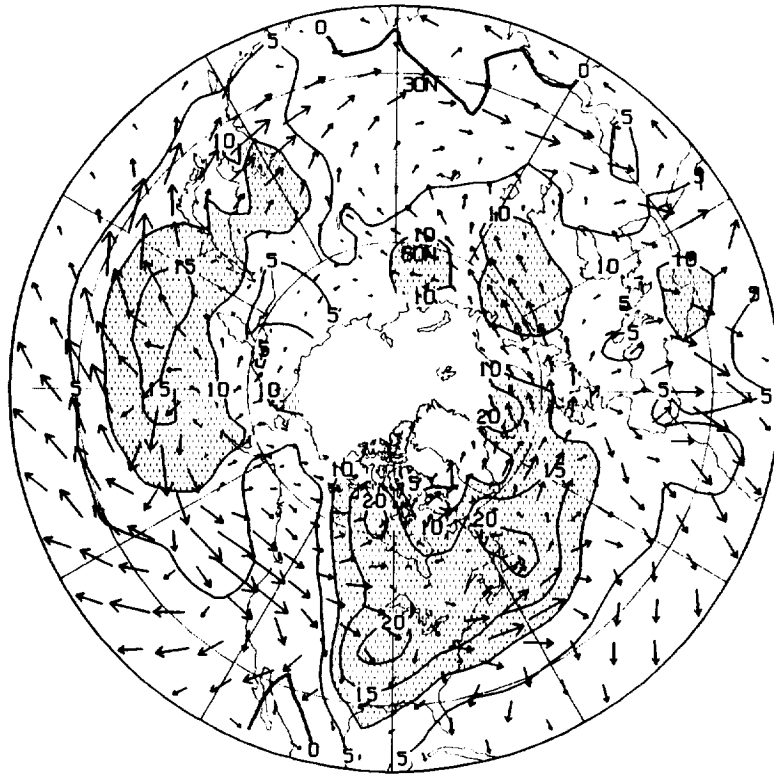

$\overline{v'T'}$ ($m s^{-1}K$) 850 mb

E_u ($m^2 s^{-2}$) 200 mb

100 →

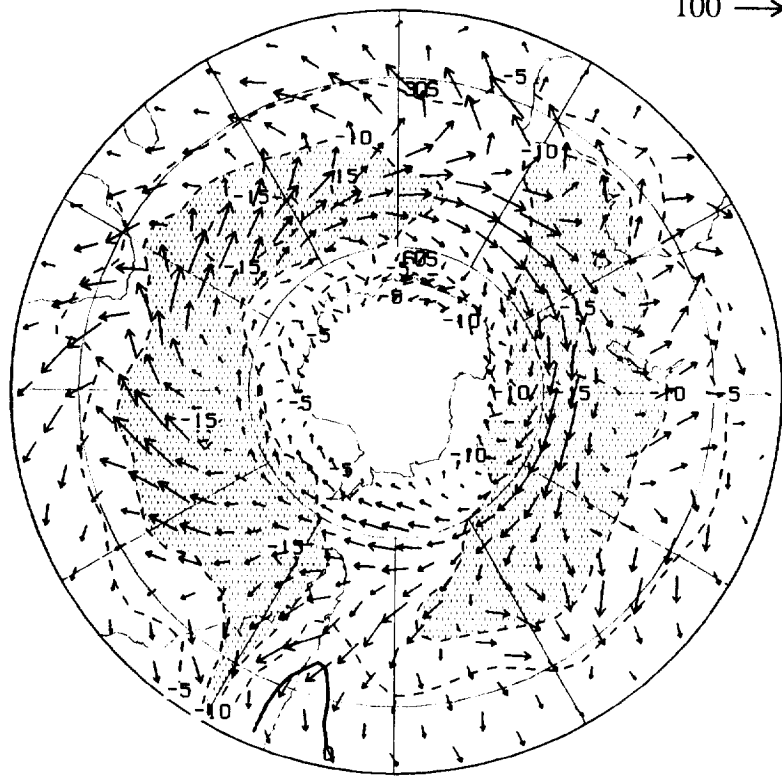

MAM (80 - 87)

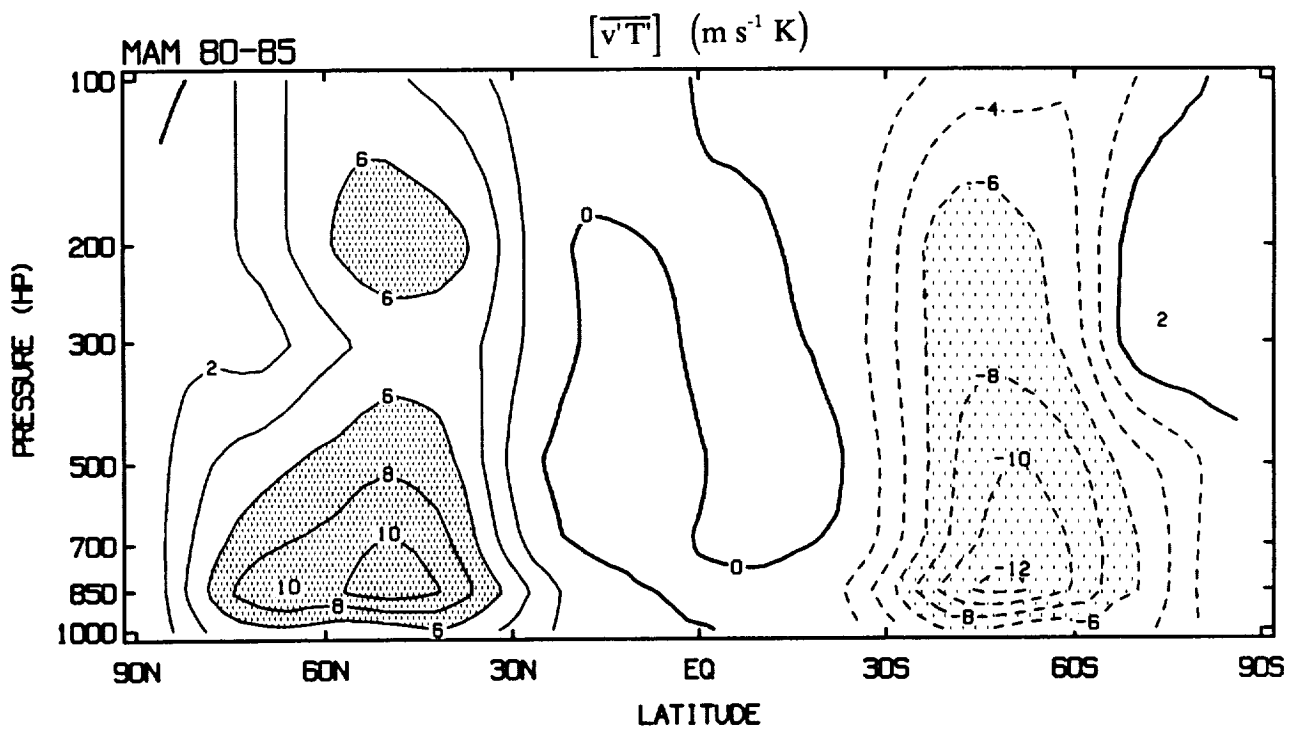
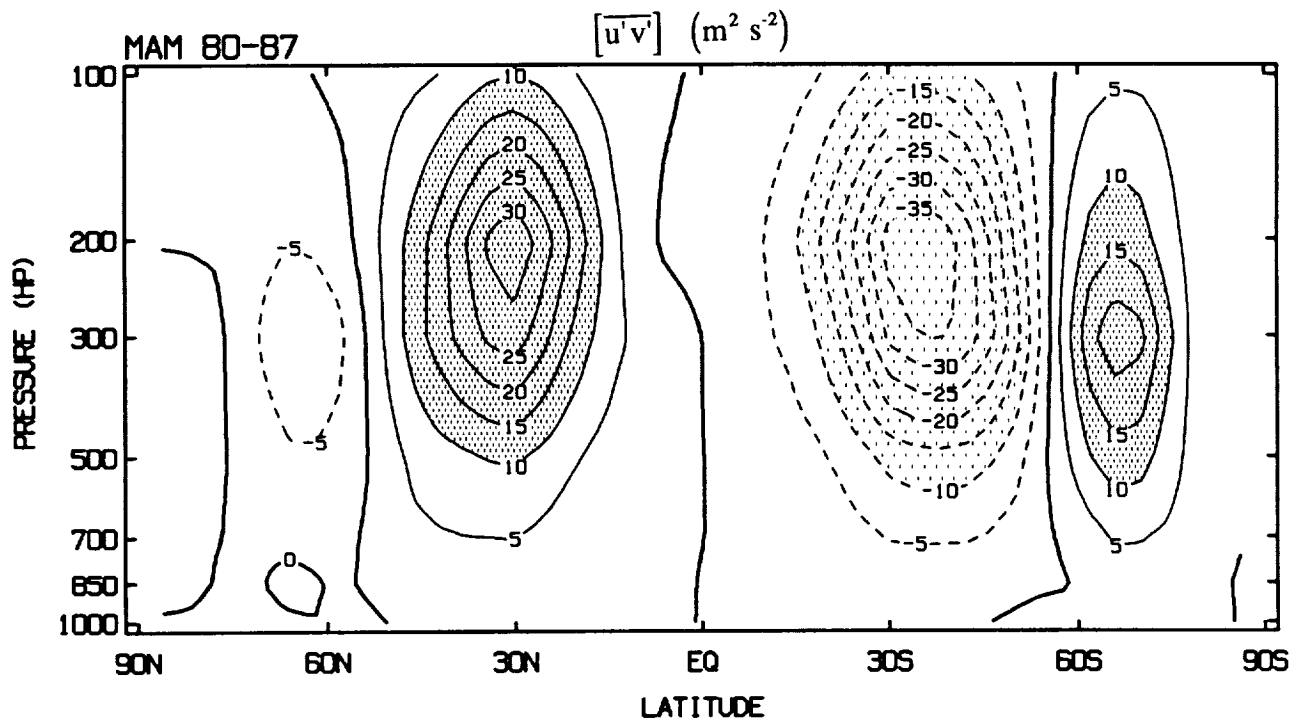

LOW PASS

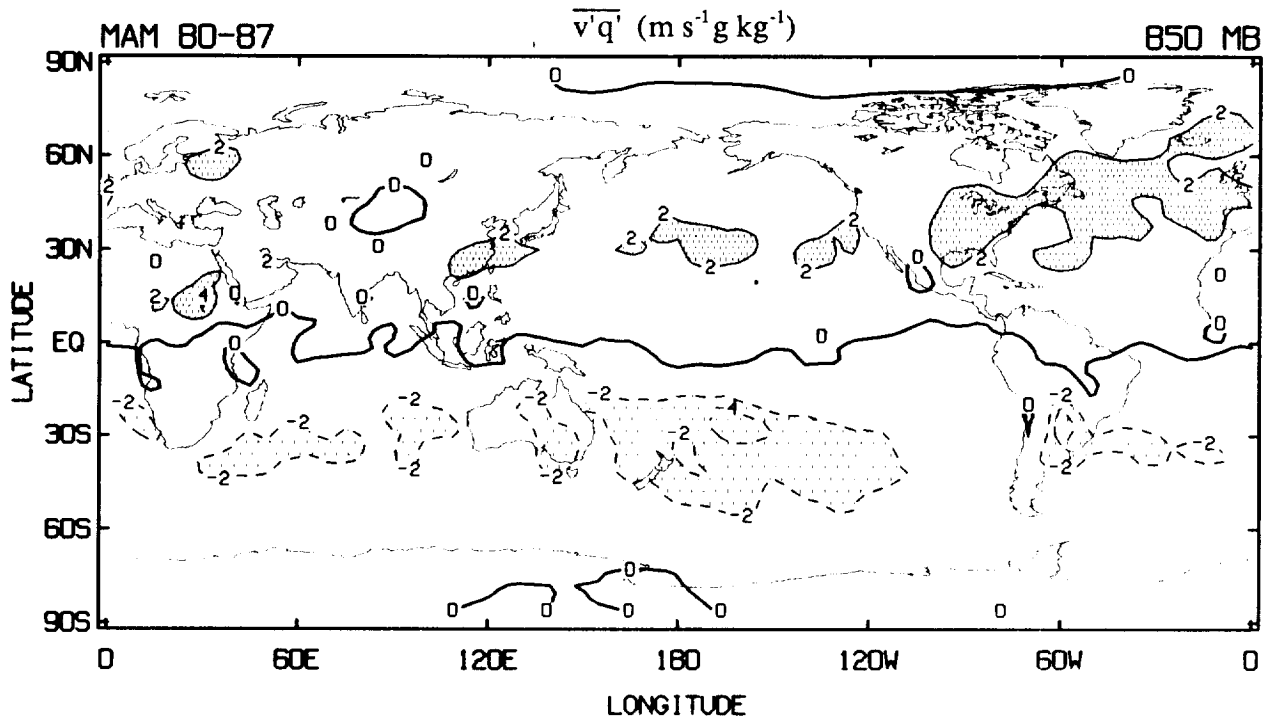
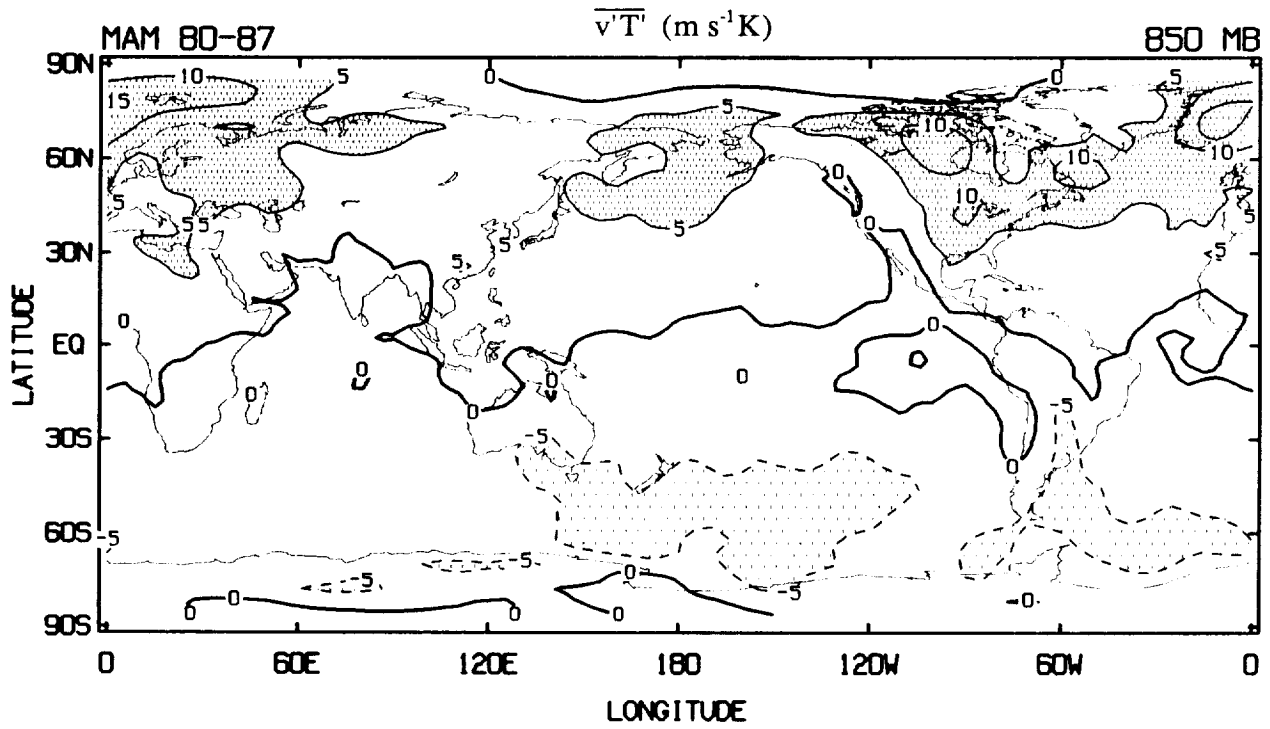

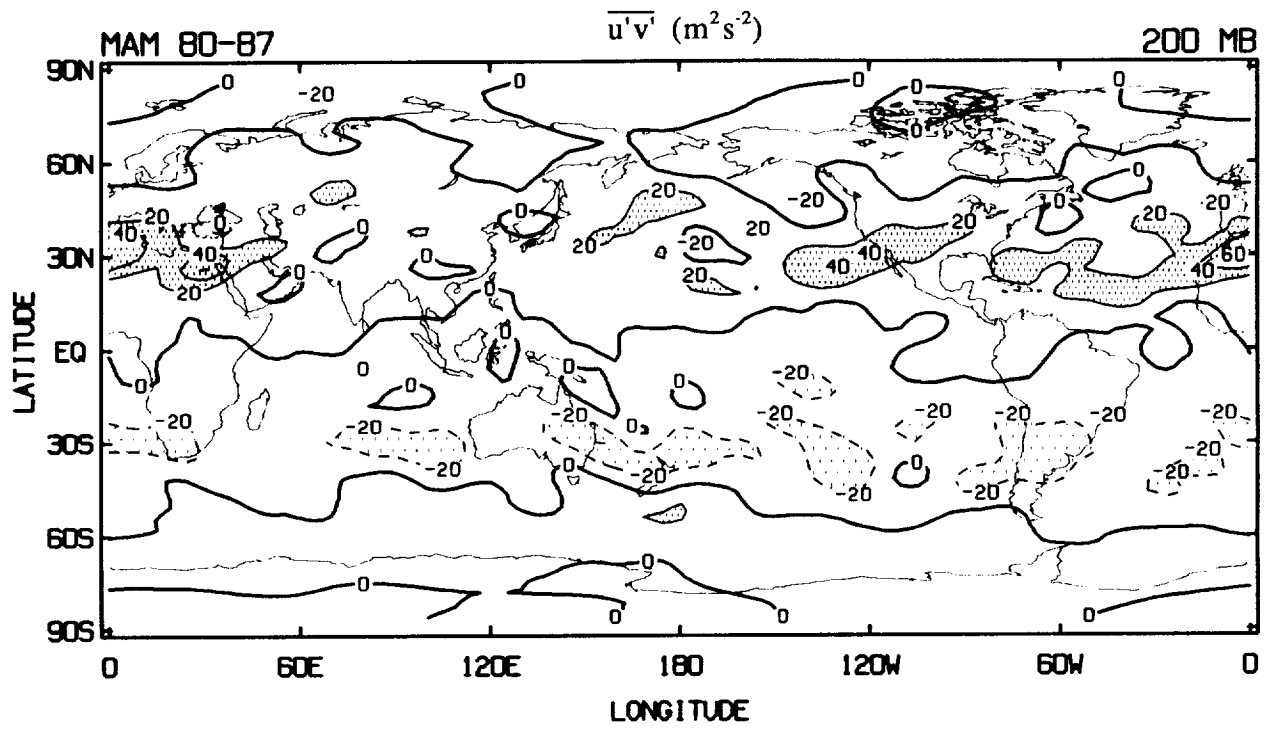

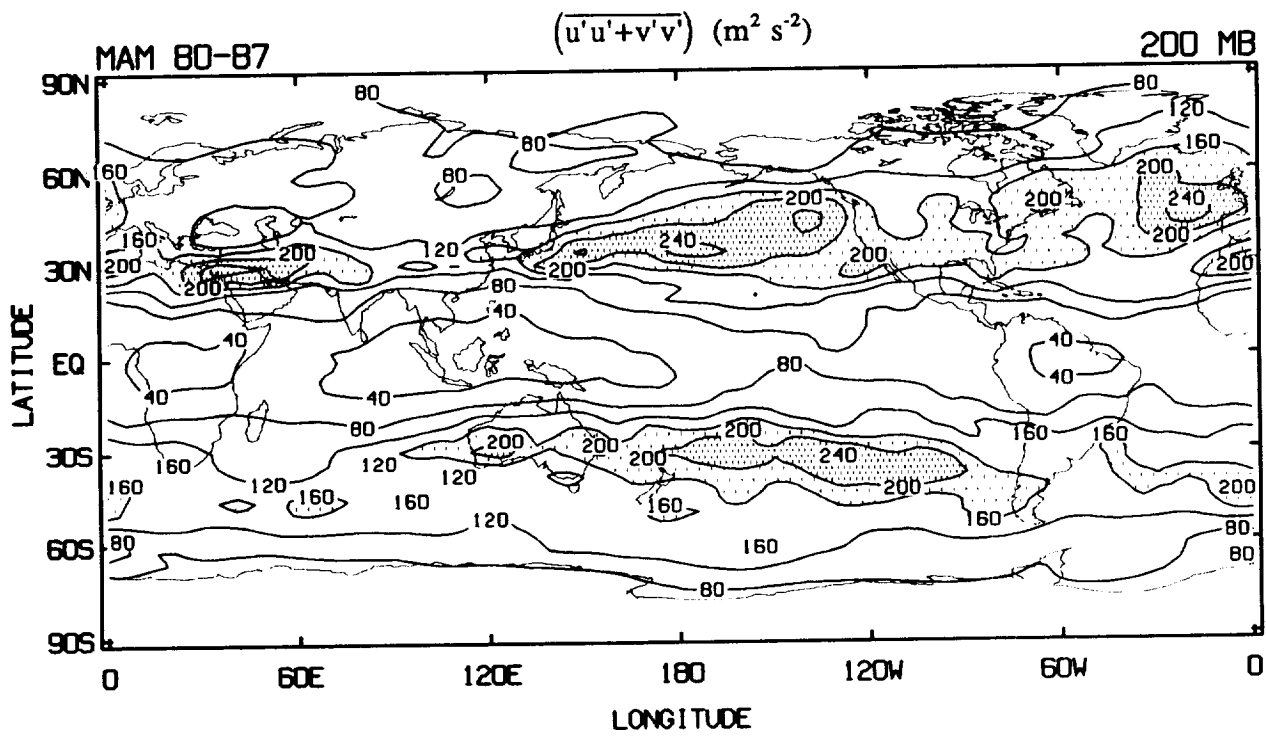
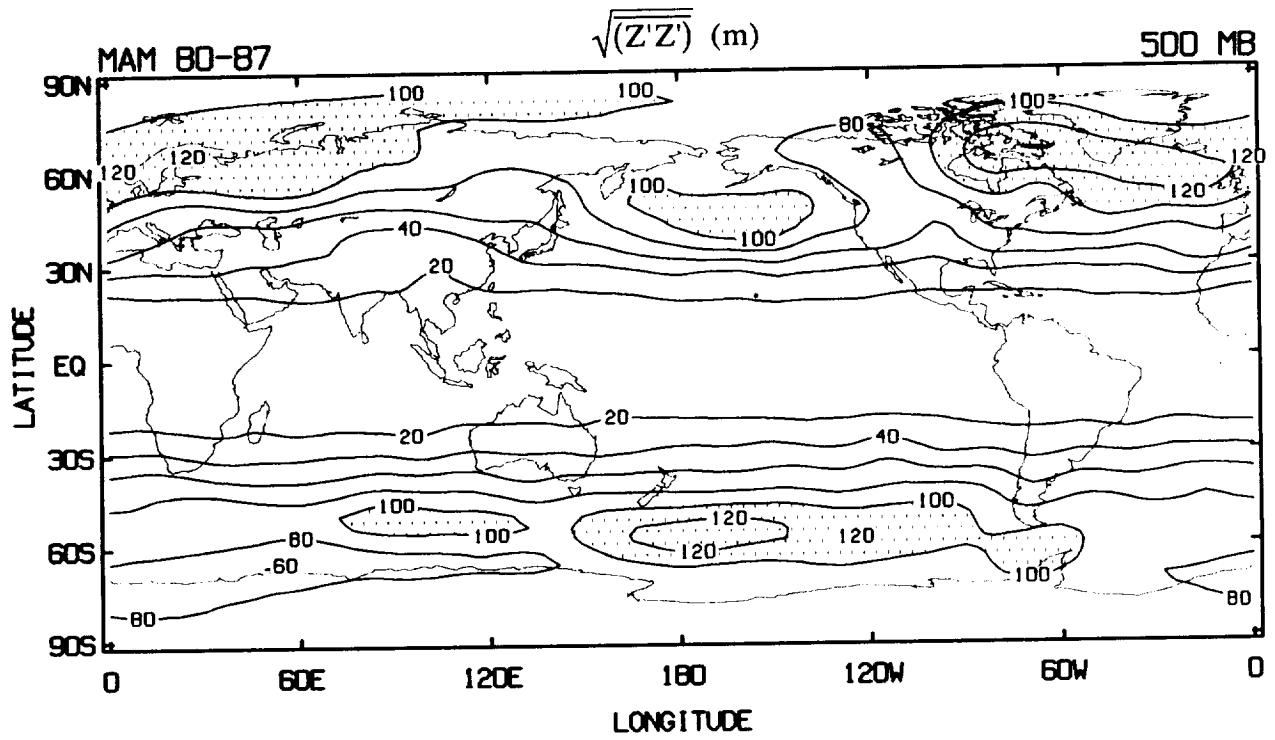

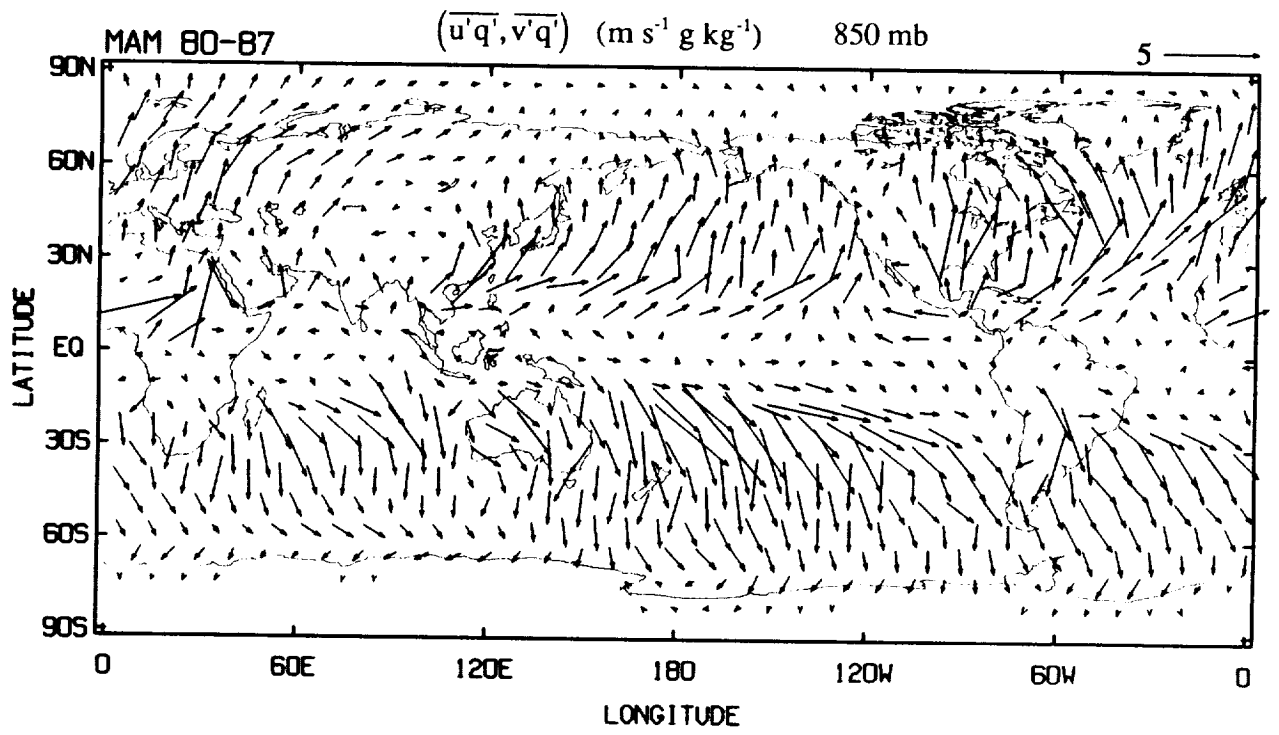
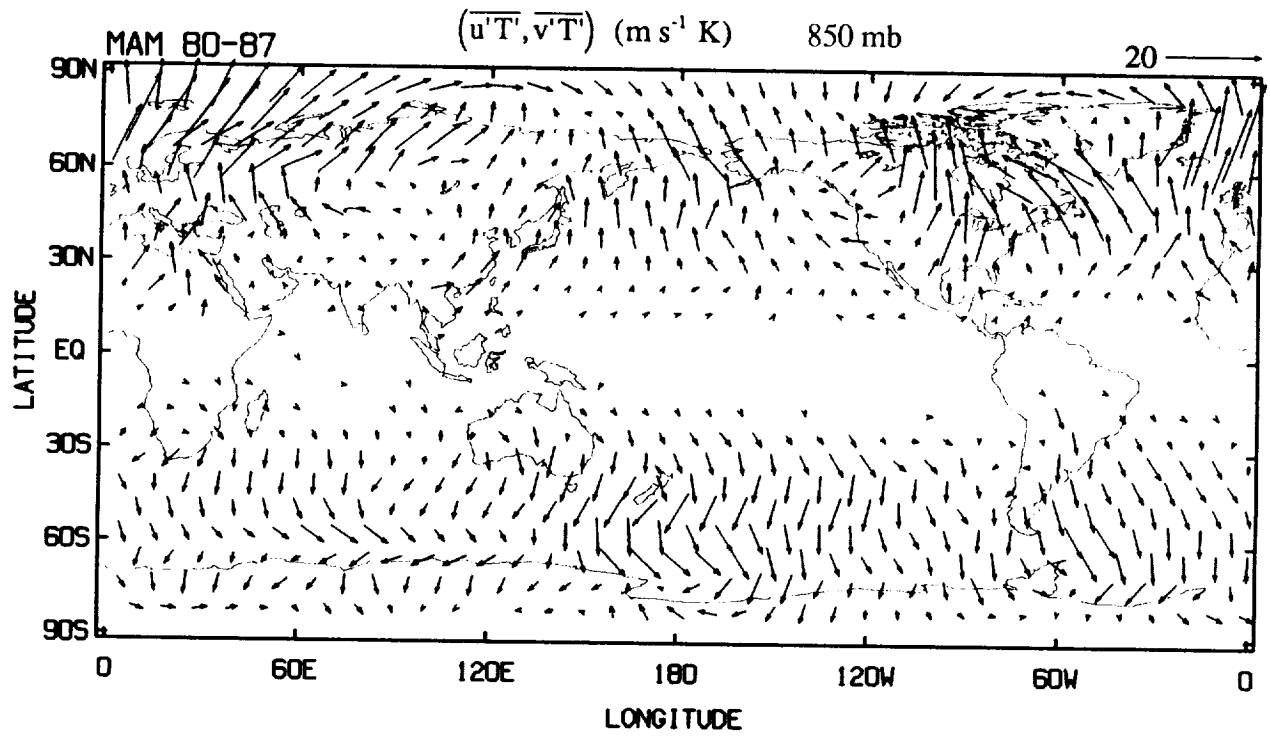

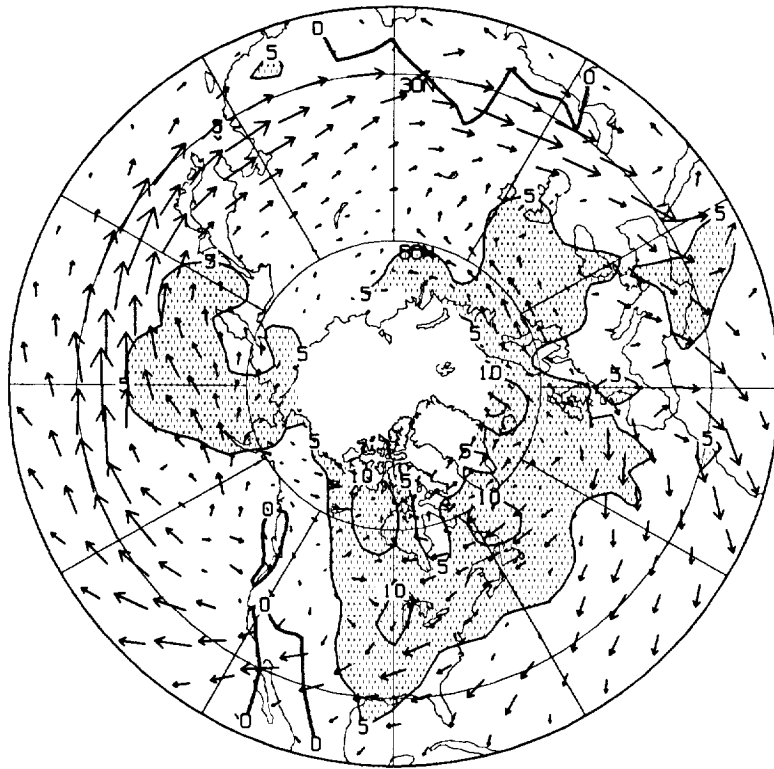

$\overline{v'T'}$ ($\text{m s}^{-1}\text{K}$) 850 mb

E_u ($\text{m}^2 \text{s}^{-2}$) 200 mb

100 \rightarrow

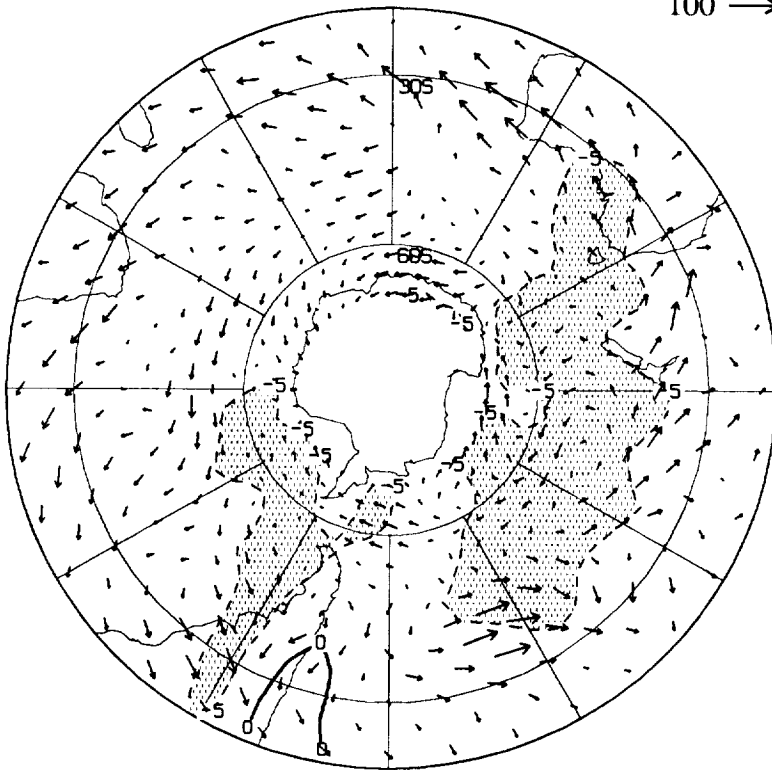

MAM (80 - 87)

87

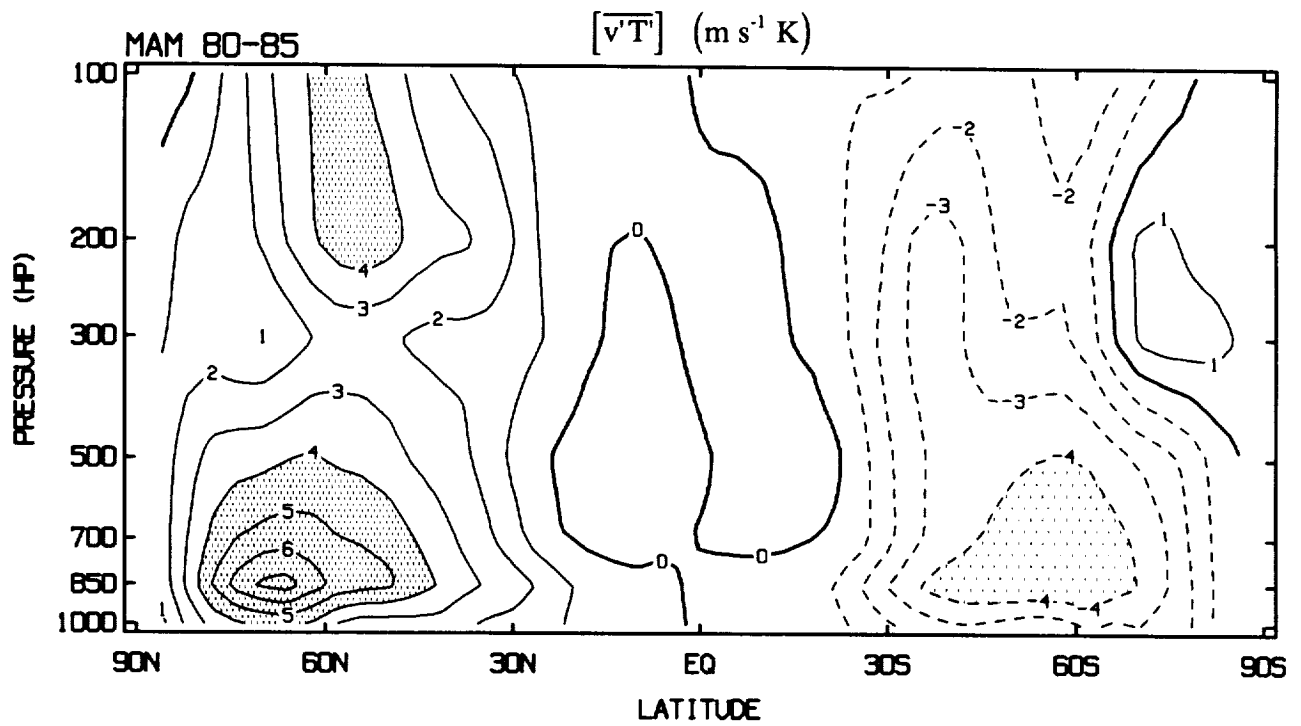
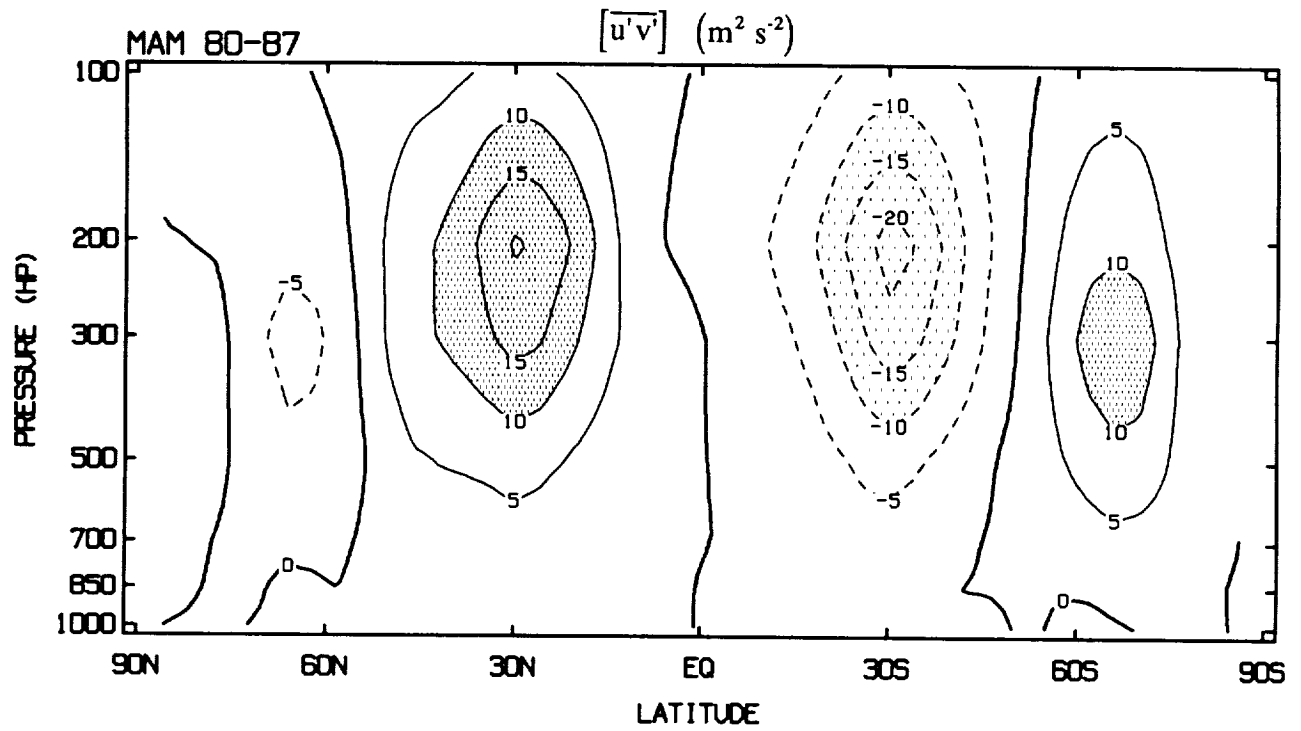

BAND PASS

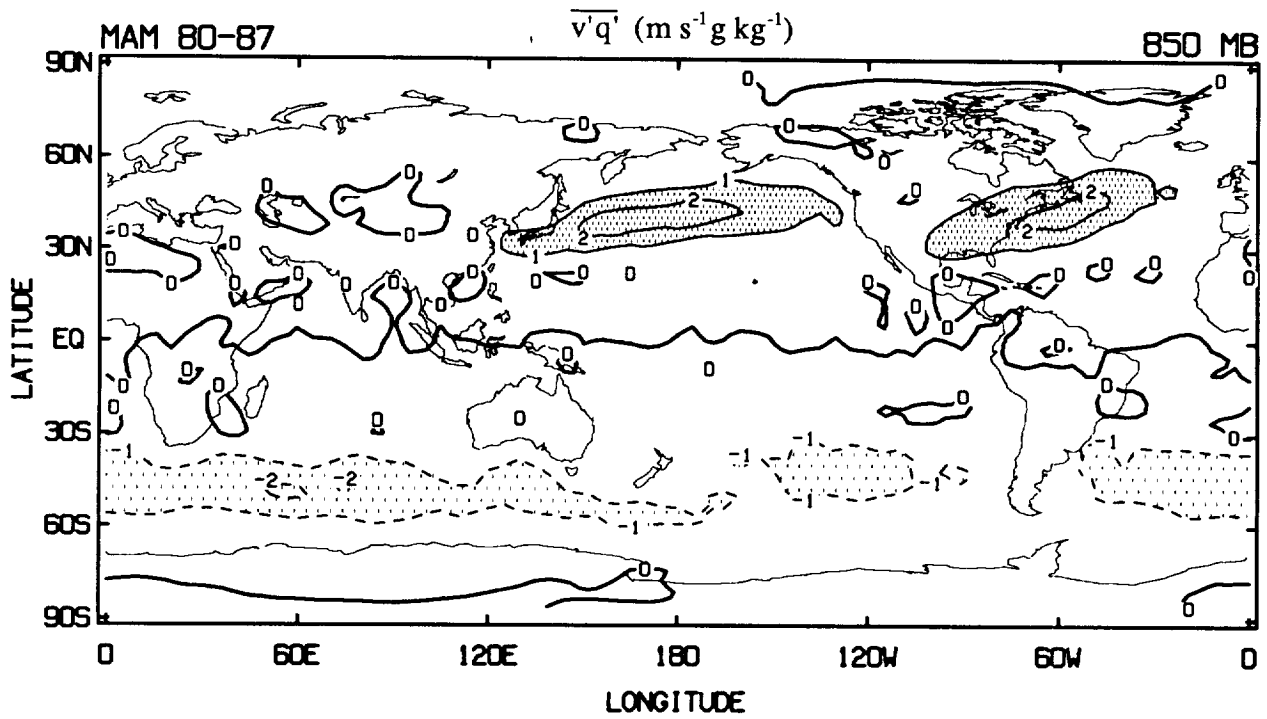
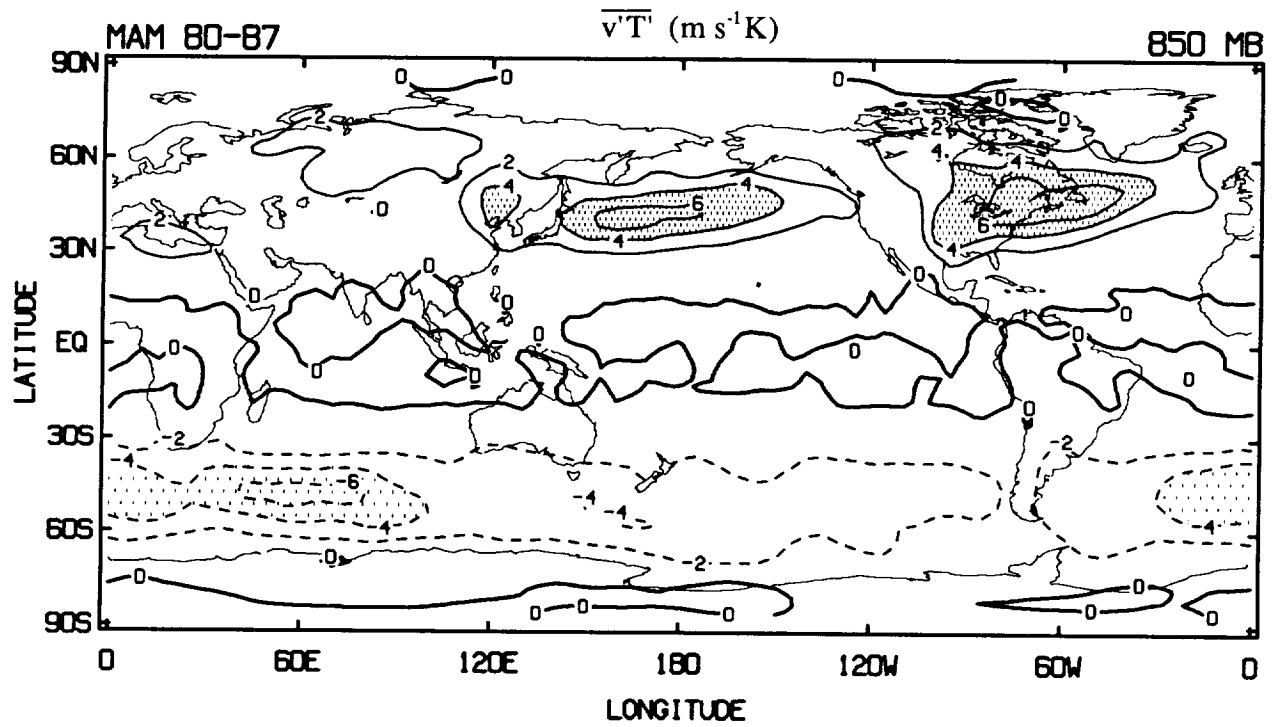

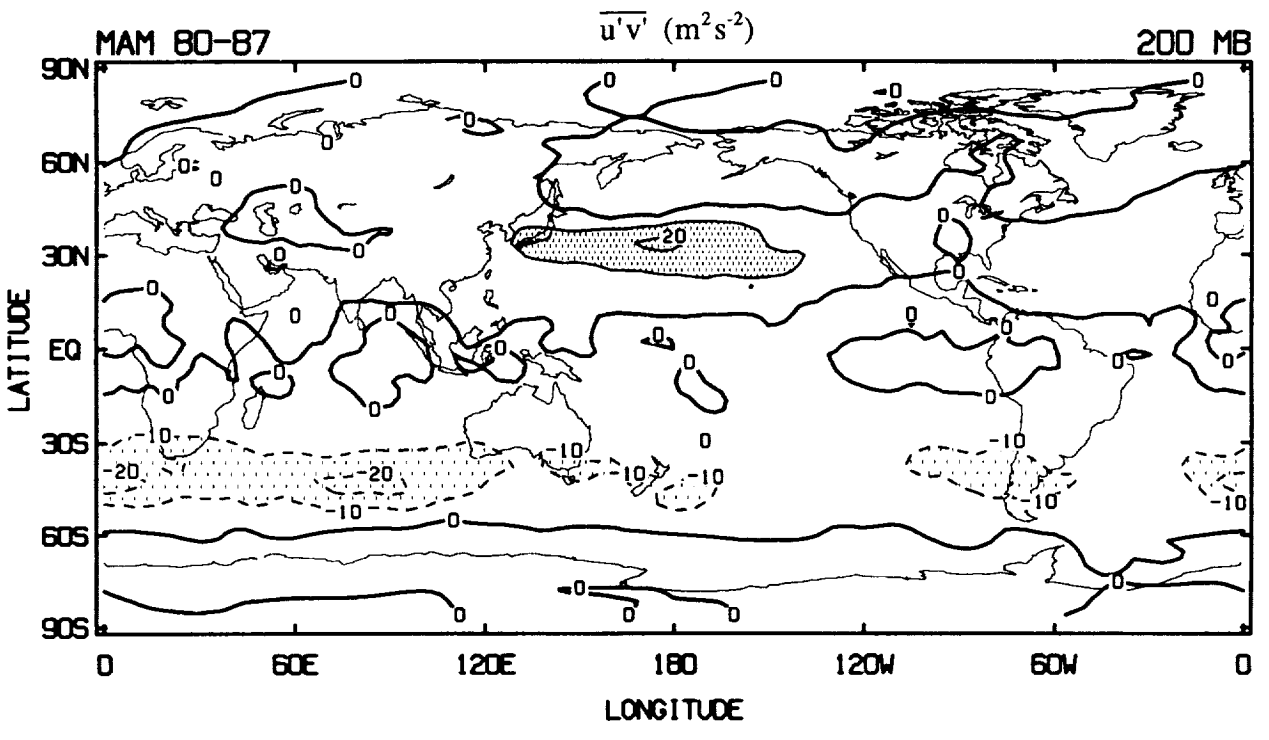

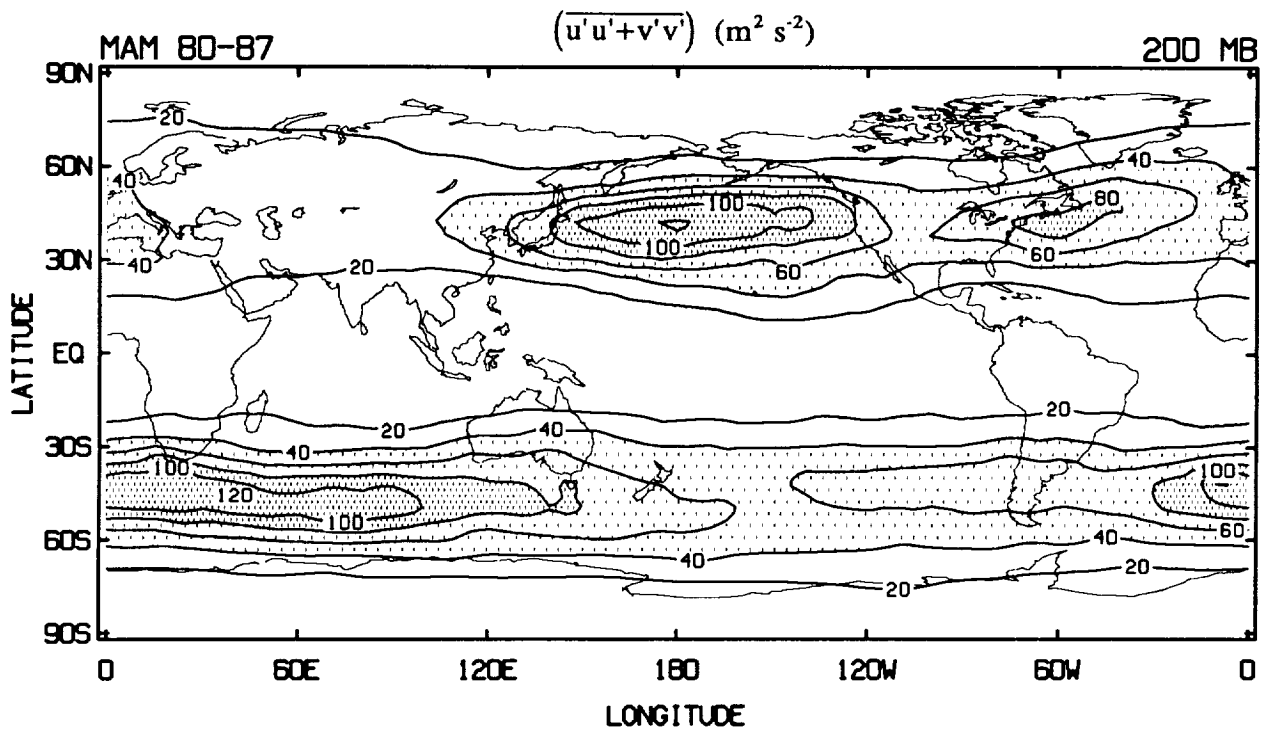
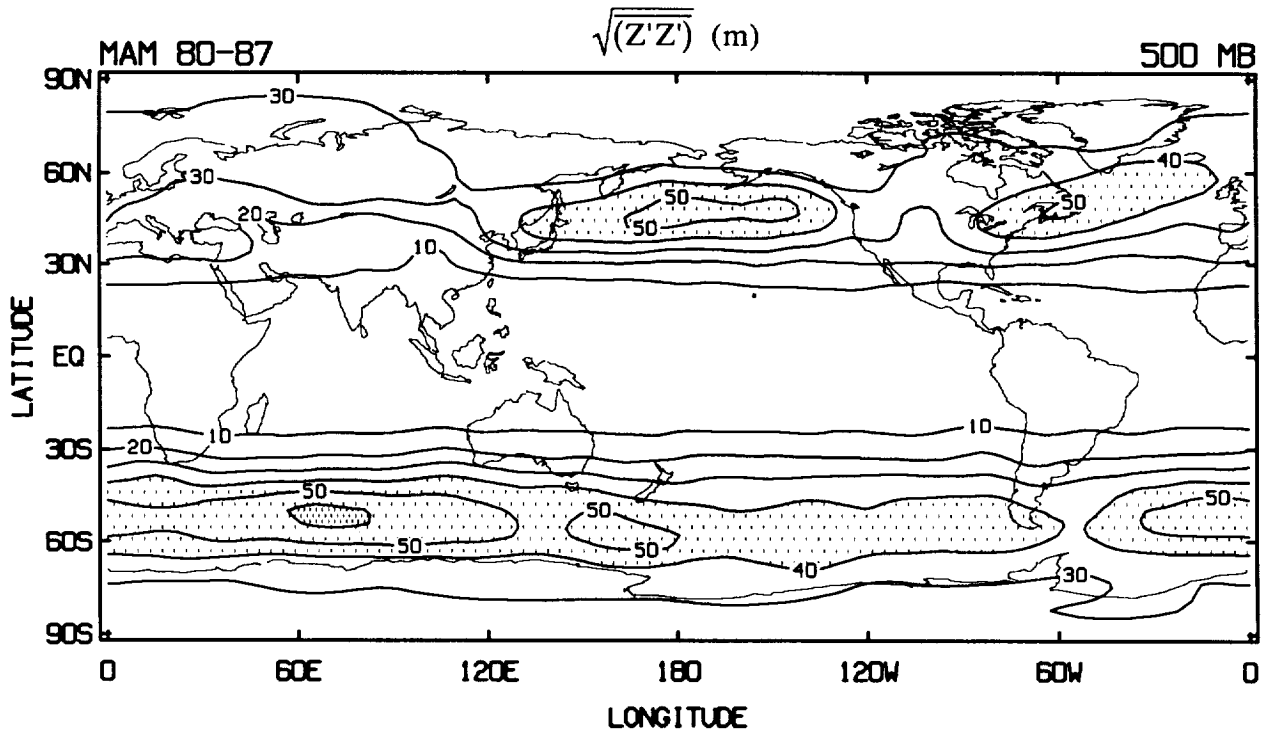

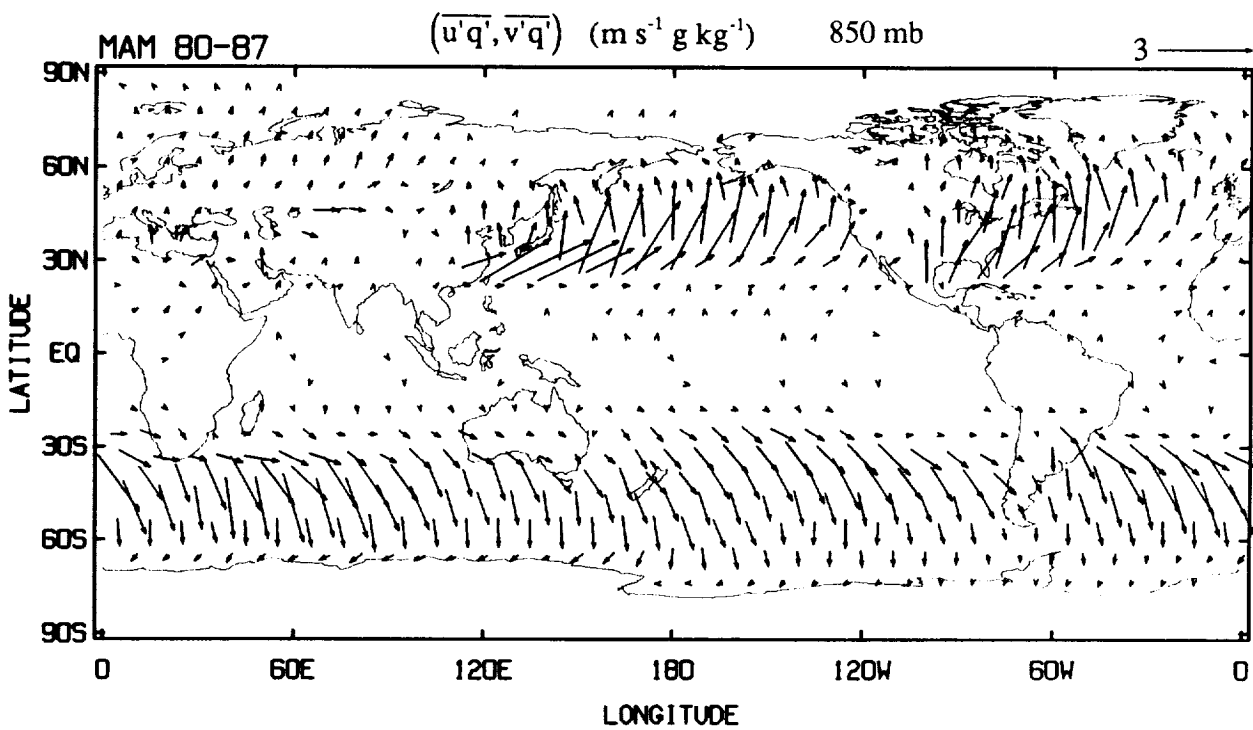
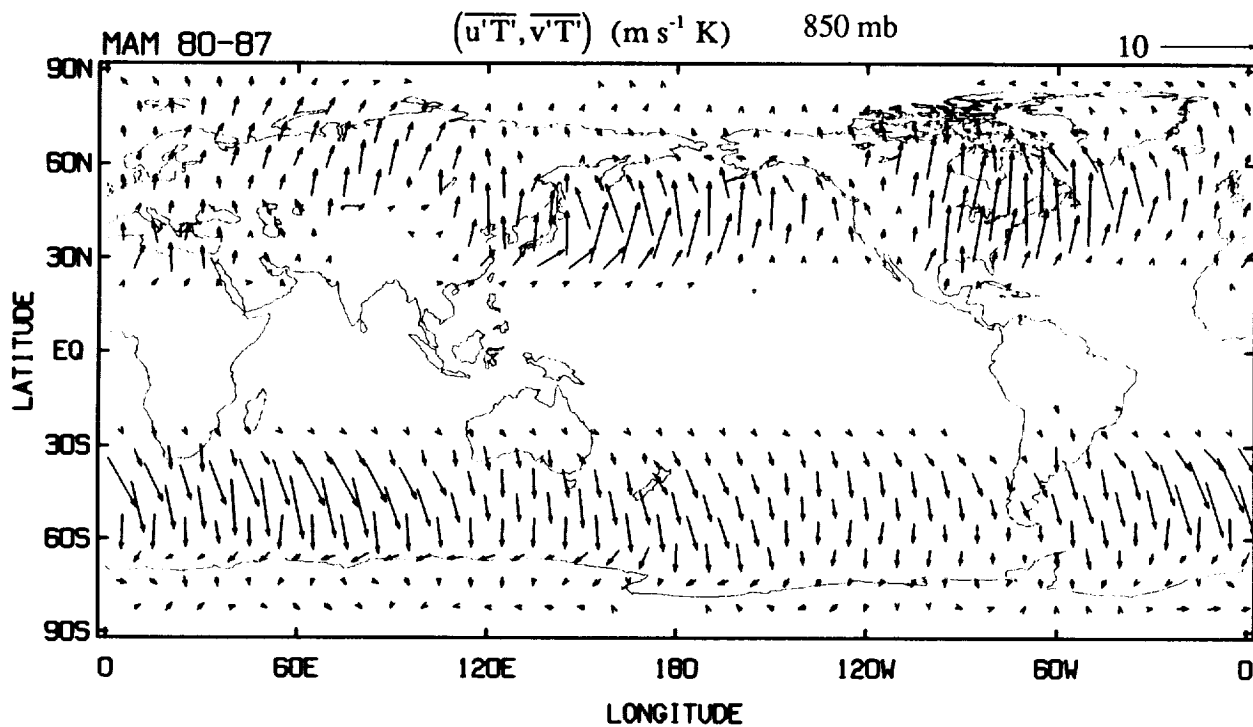

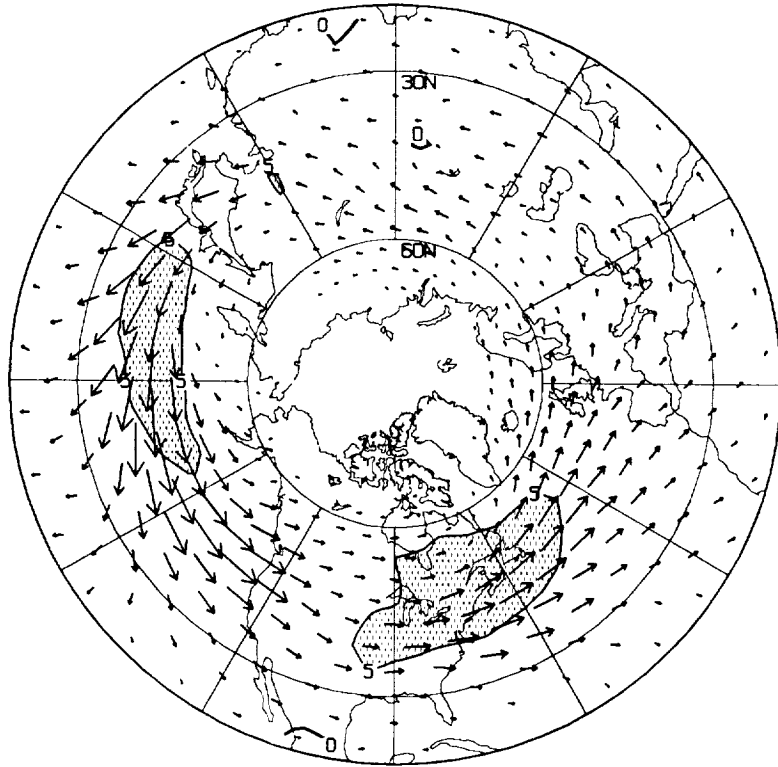

$\overline{v'T'}$ ($\text{m s}^{-1}\text{K}$) 850 mb

E_u ($\text{m}^2 \text{s}^{-2}$) 200 mb

50 \rightarrow

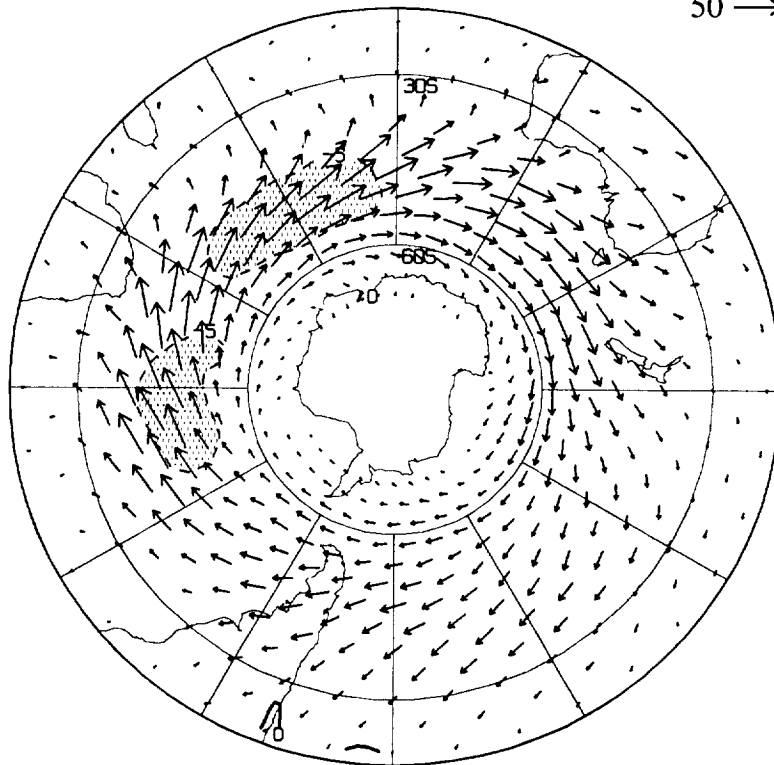

MAM (80 - 87)

95

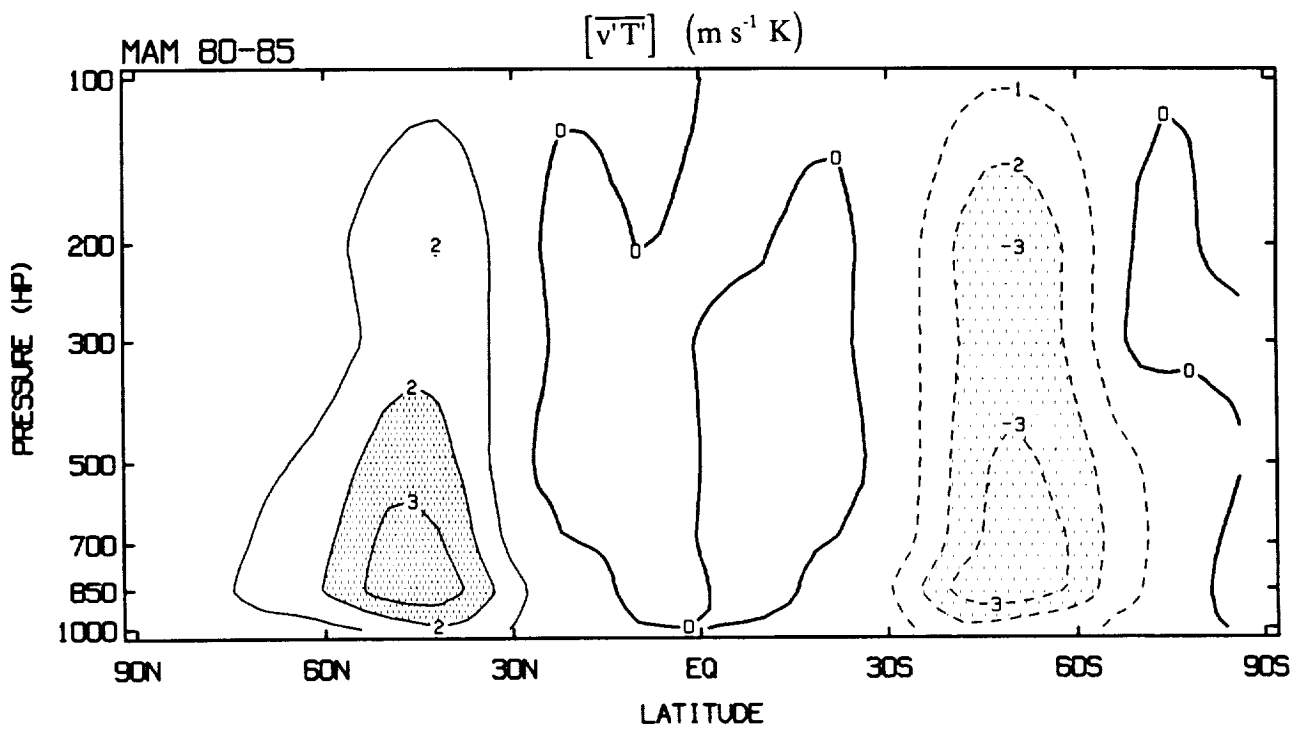
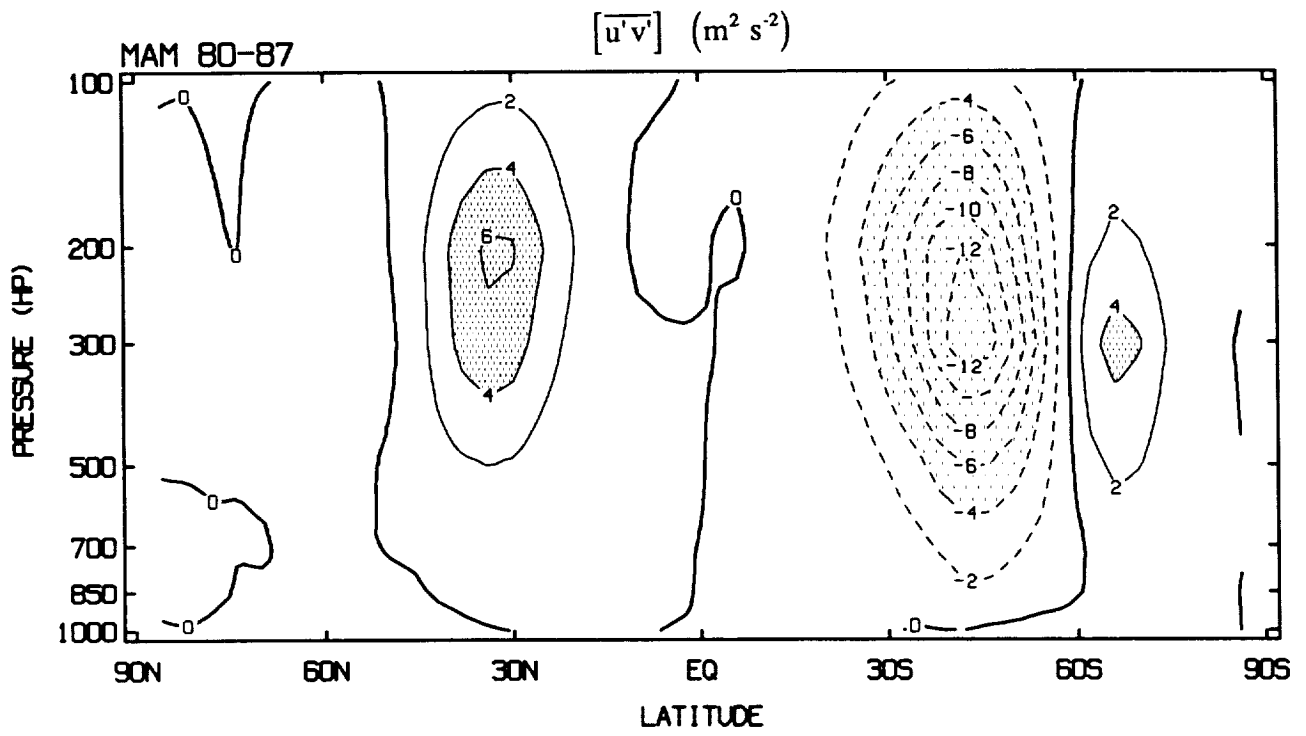

JJA

DEVIATIONS FROM MONTHLY MEANS



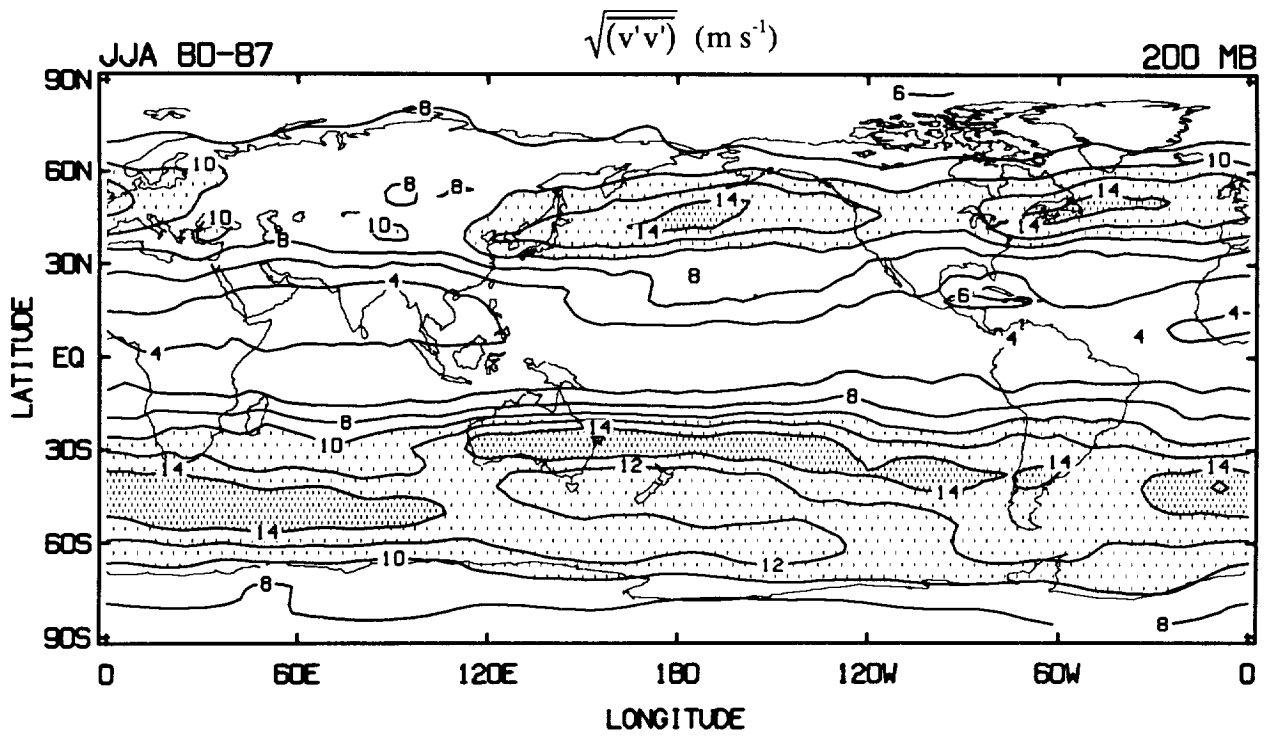
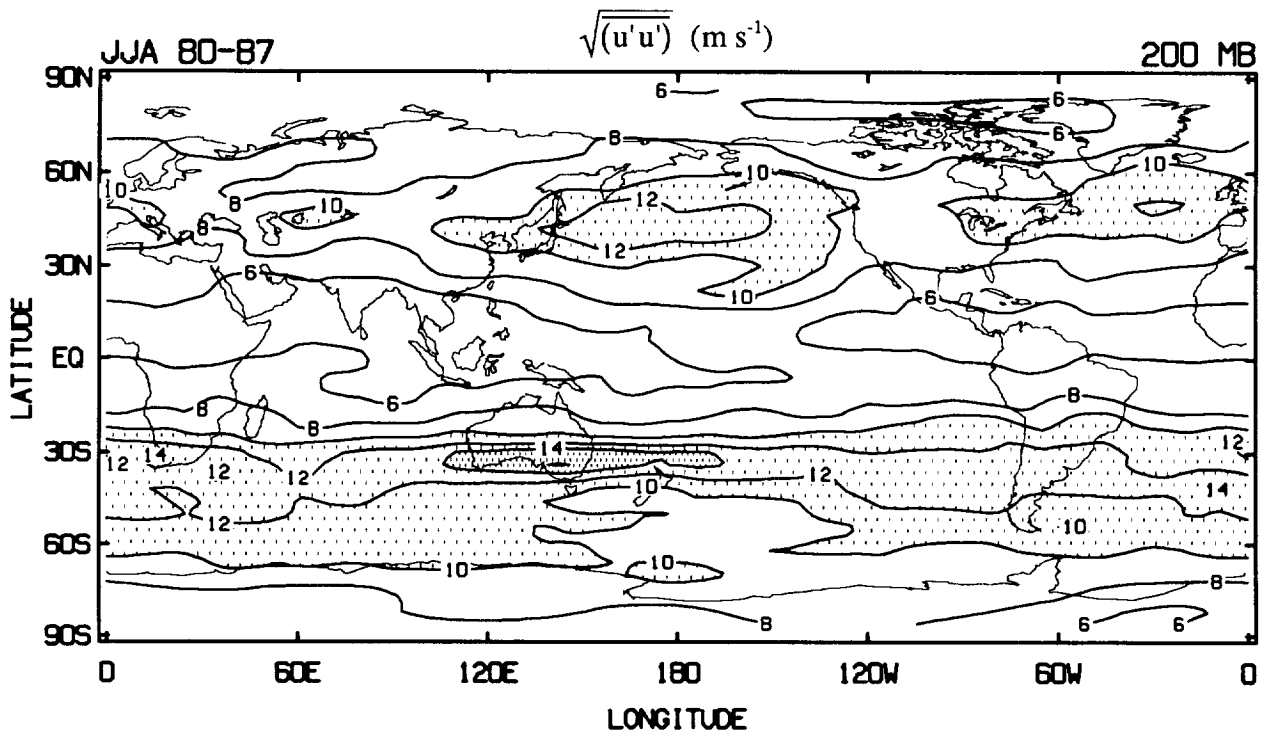

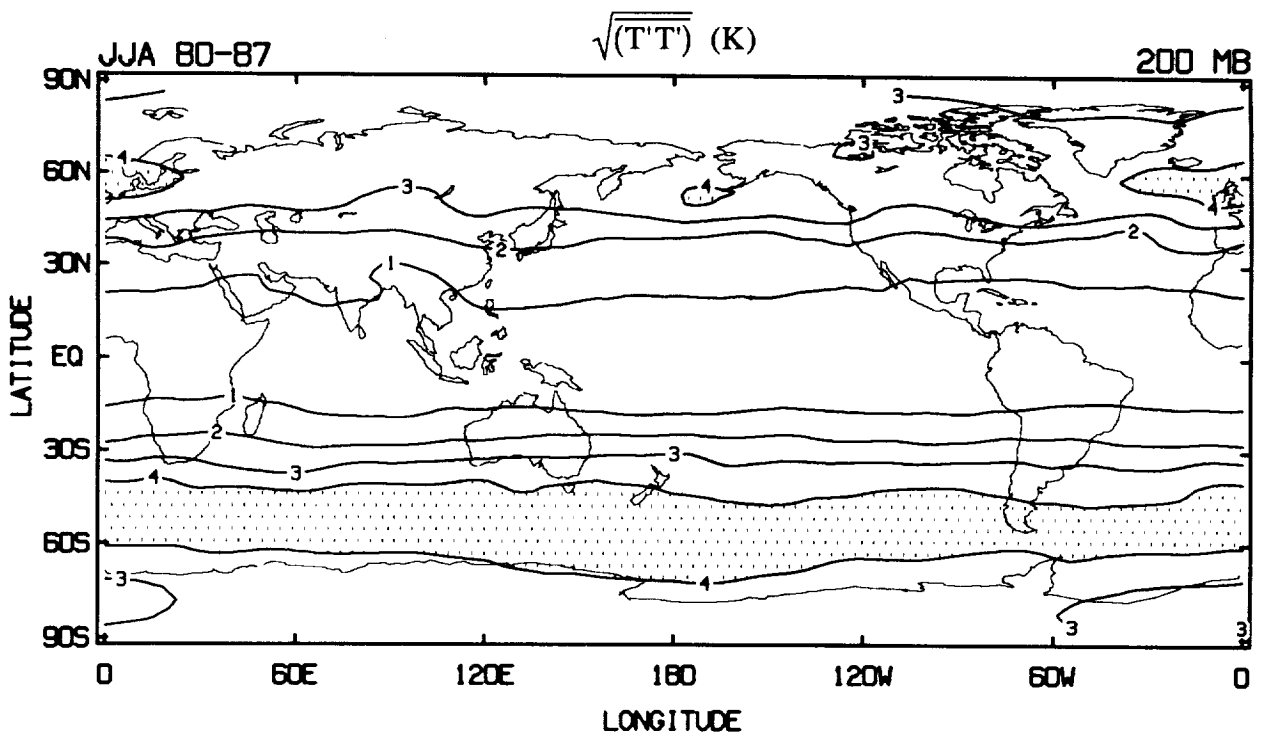
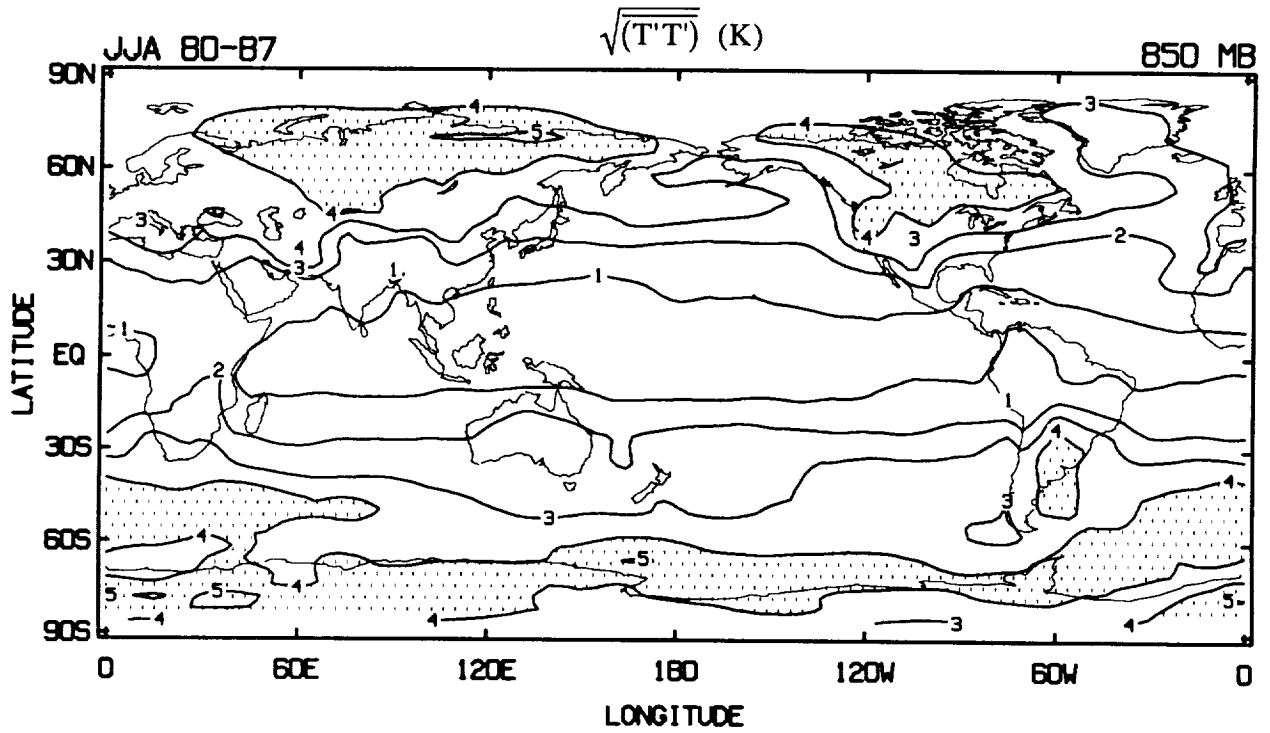

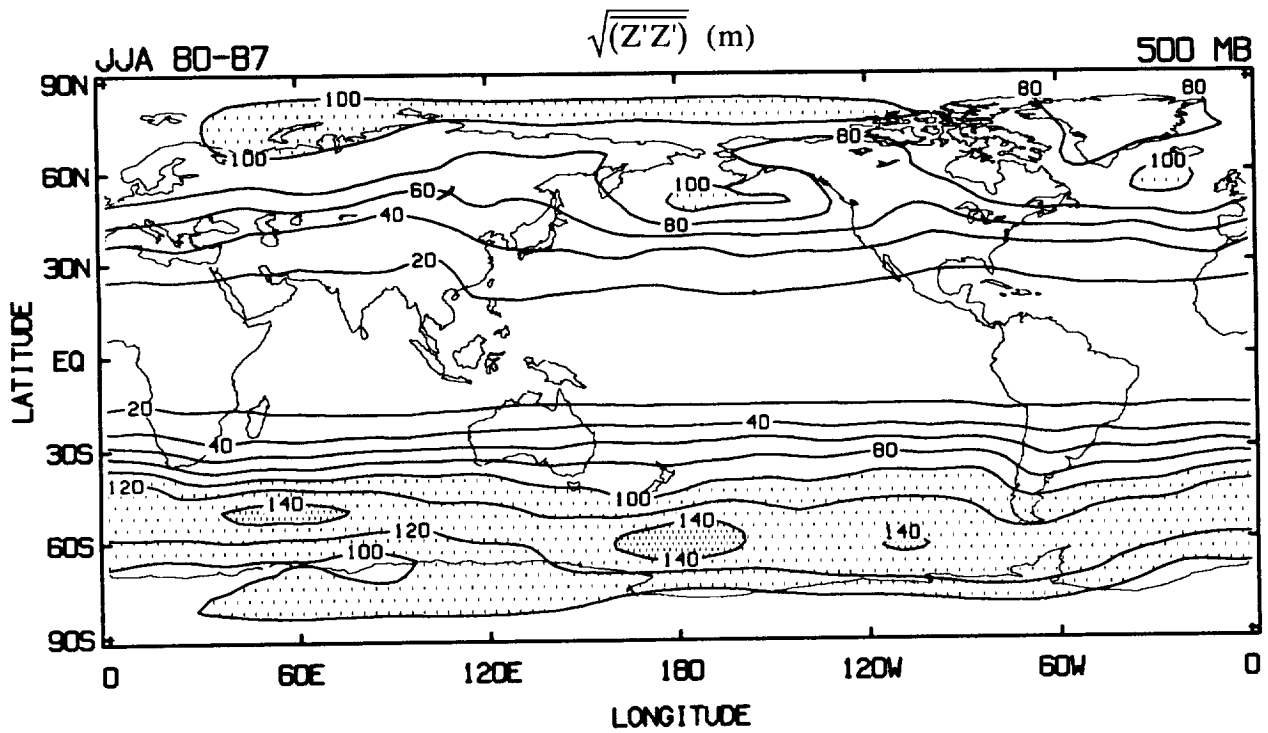
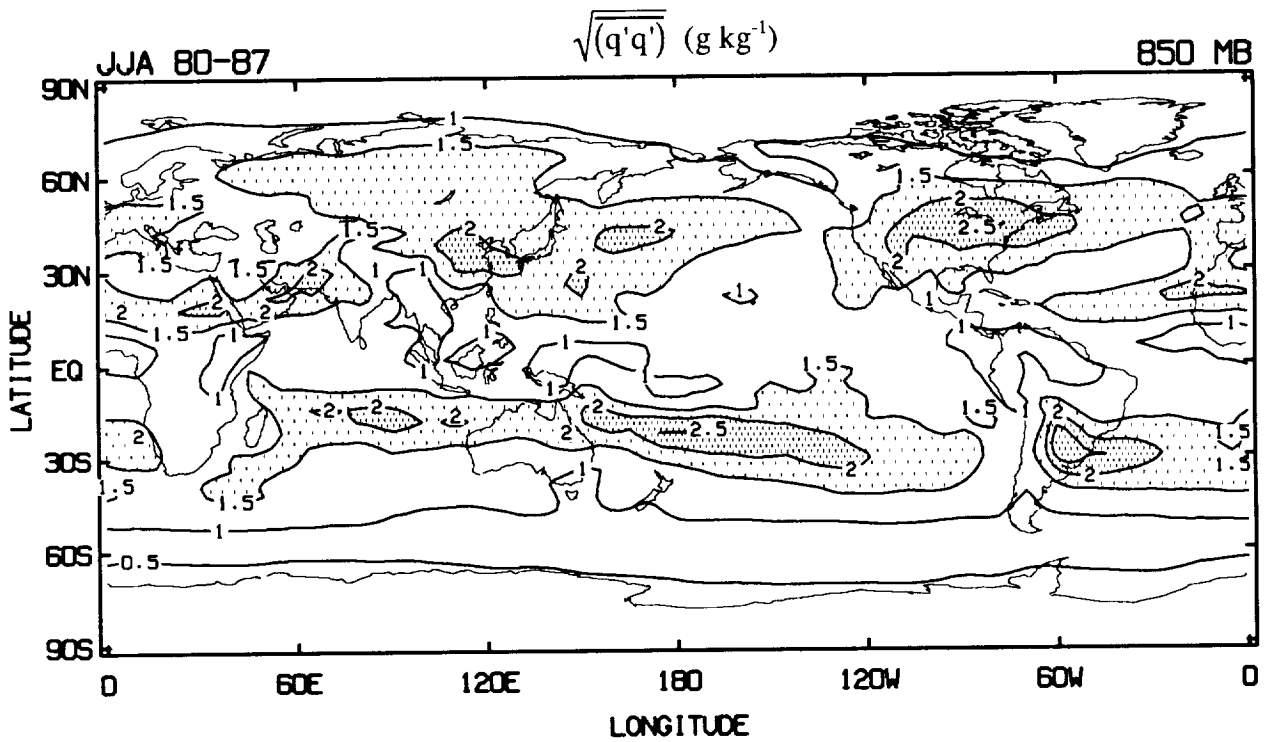

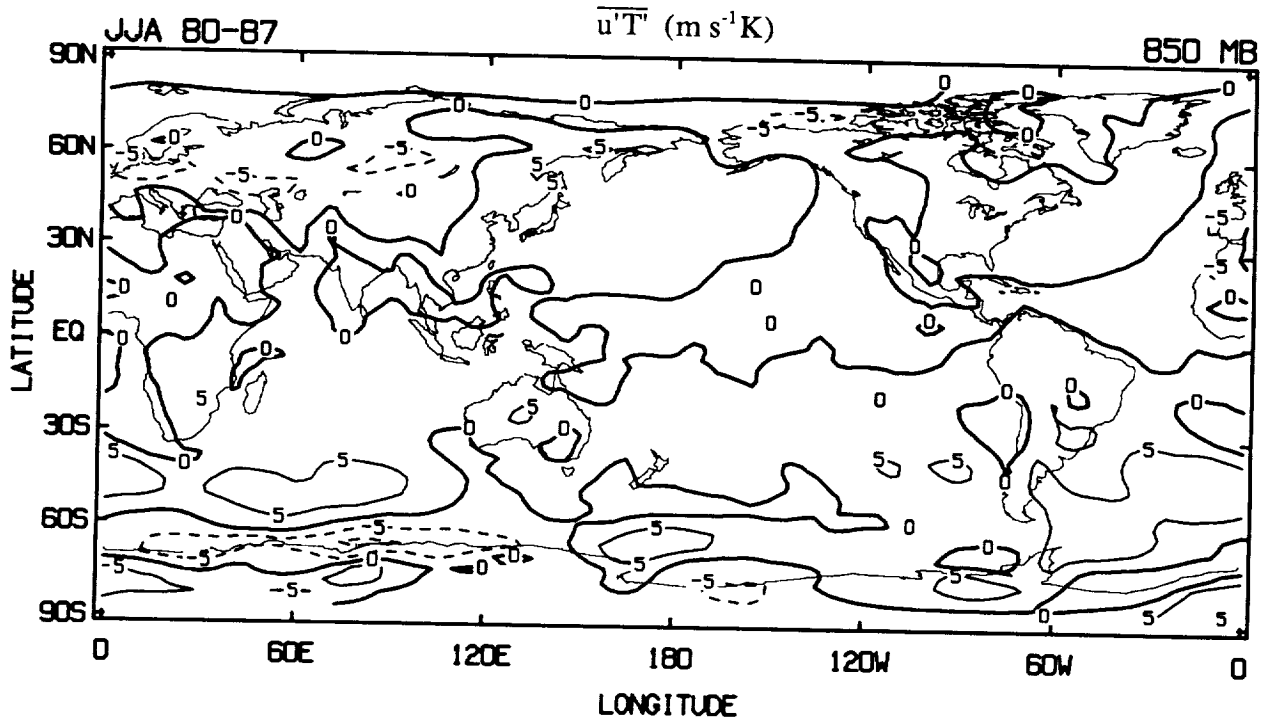
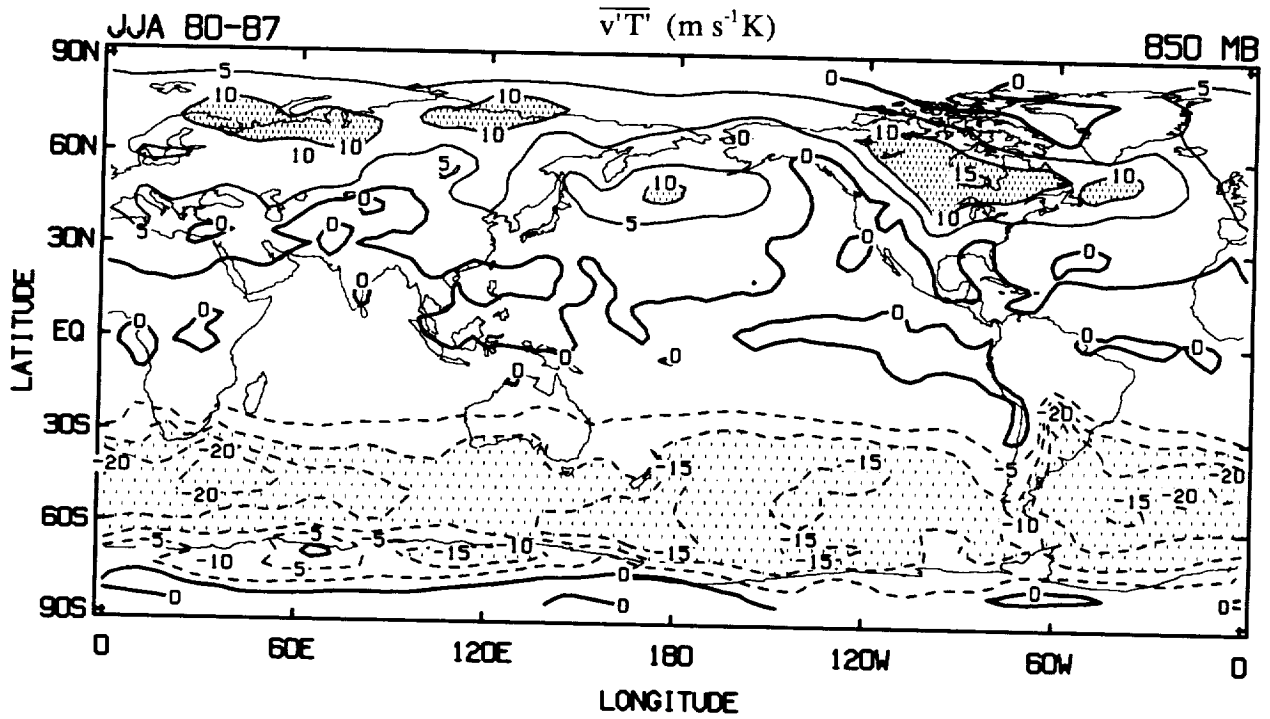

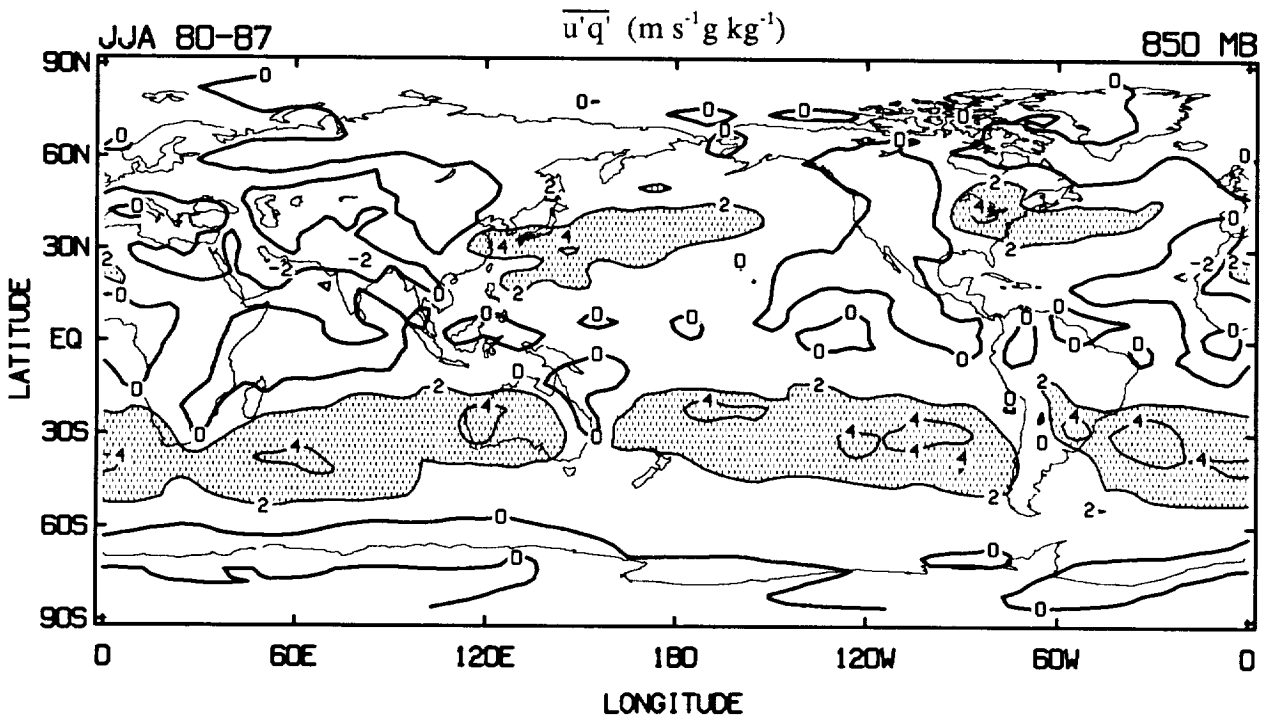
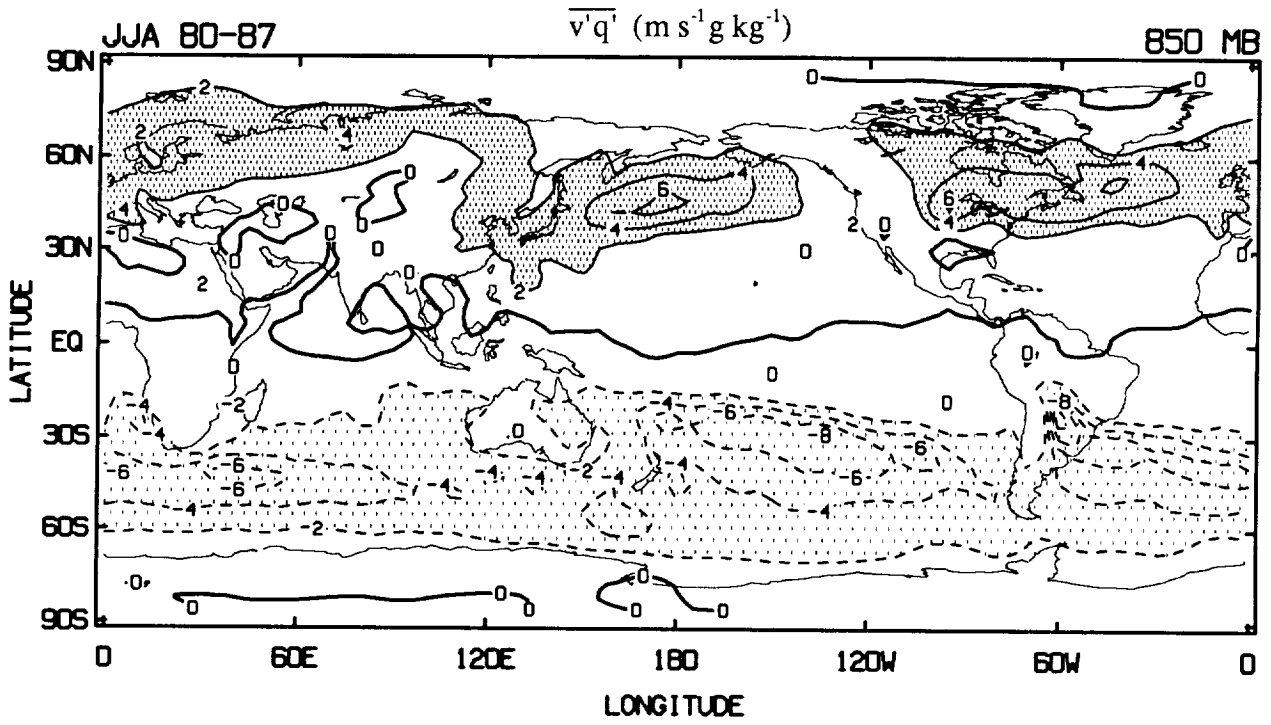

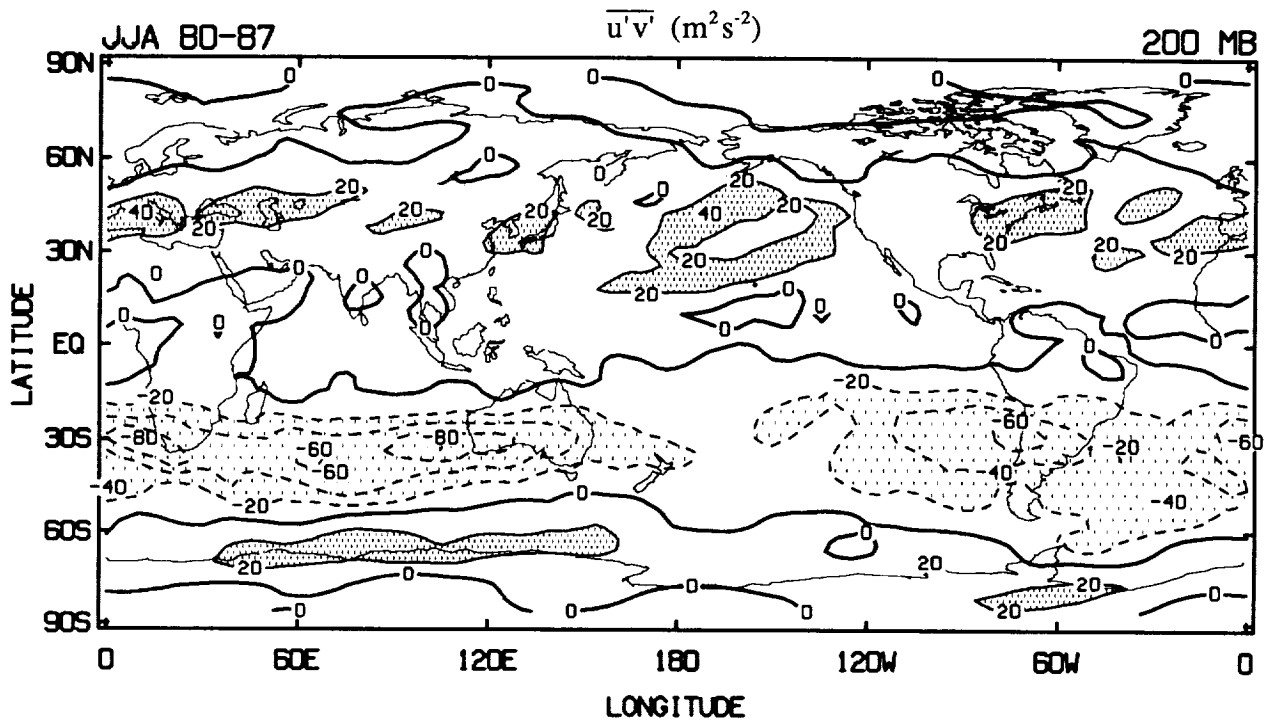

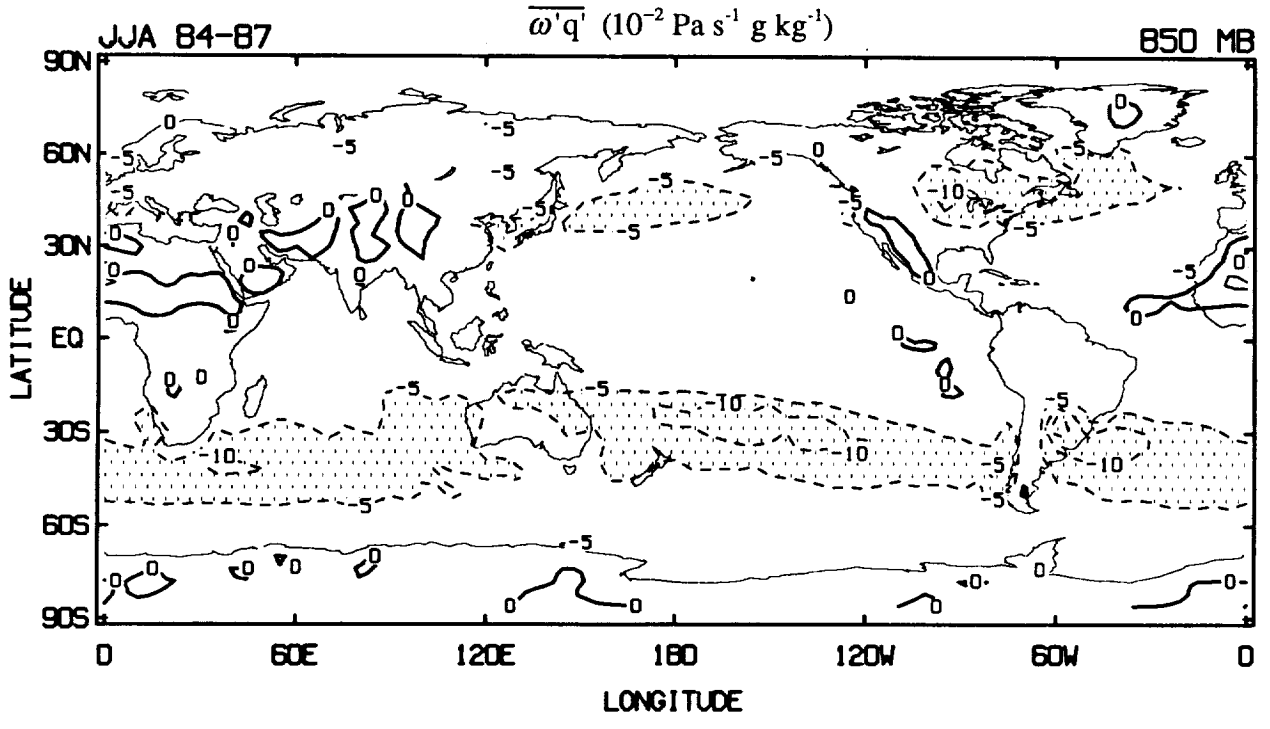
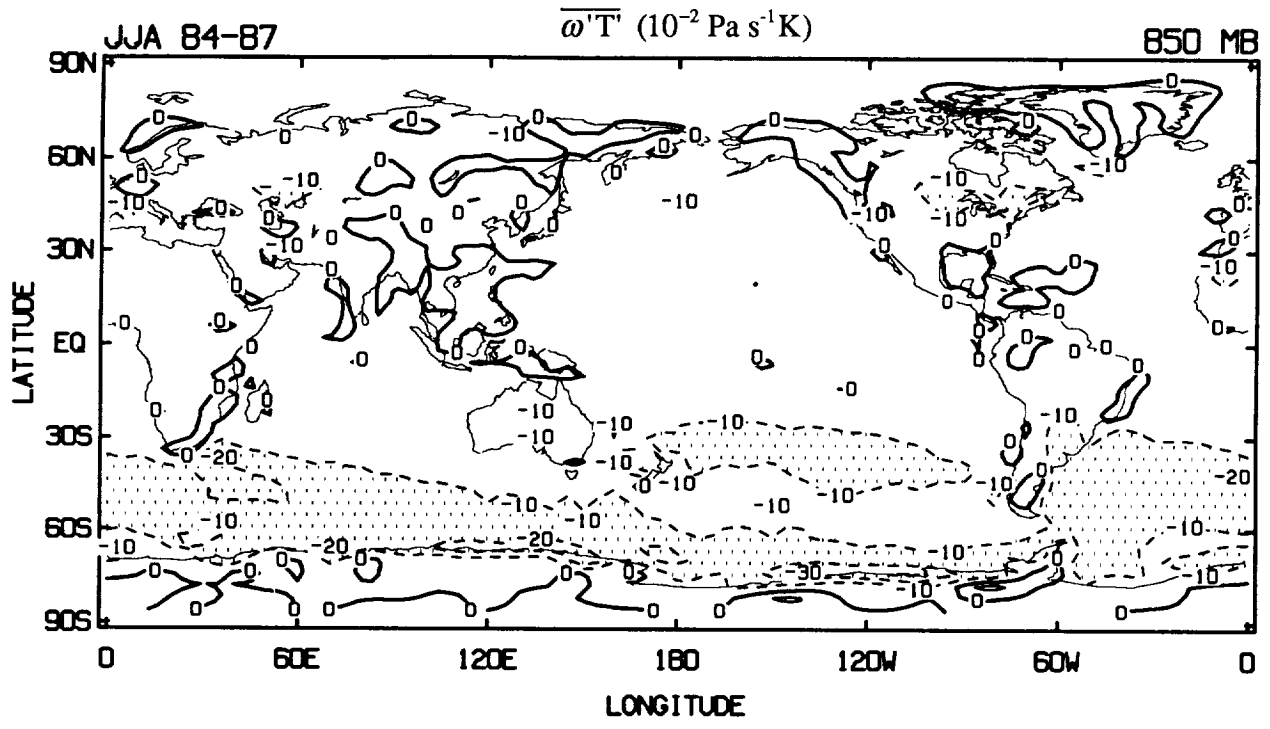

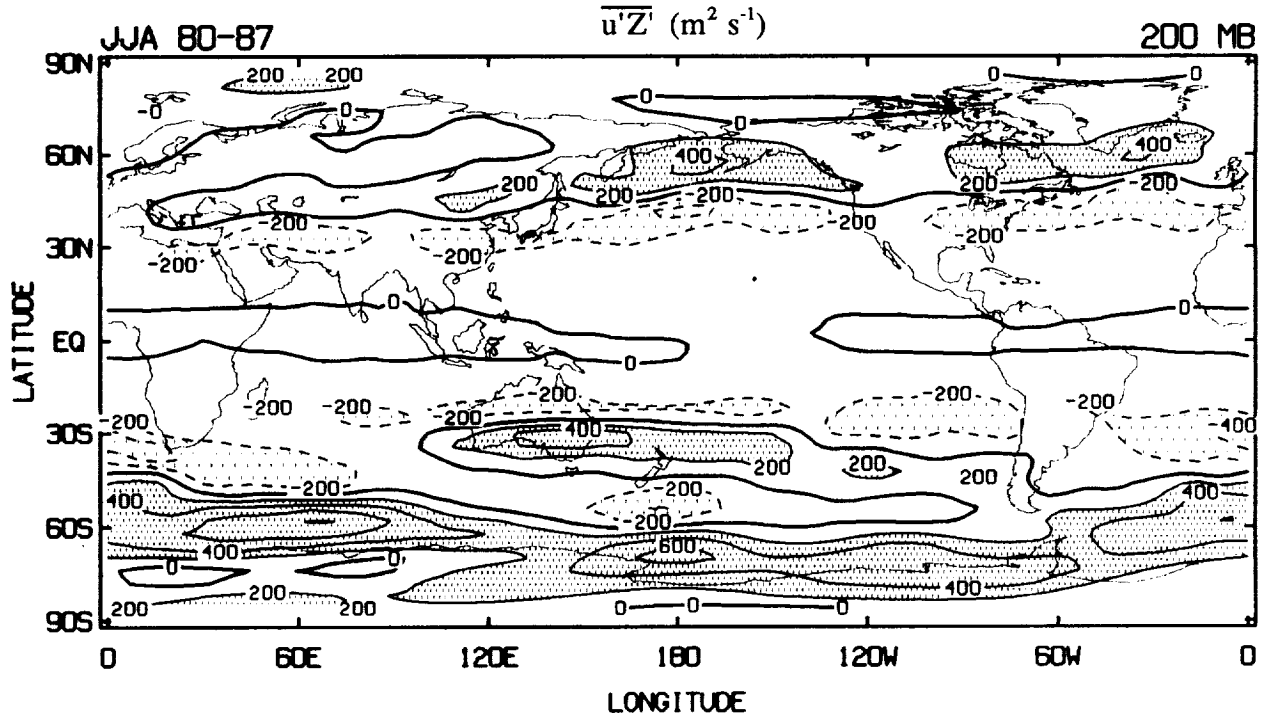
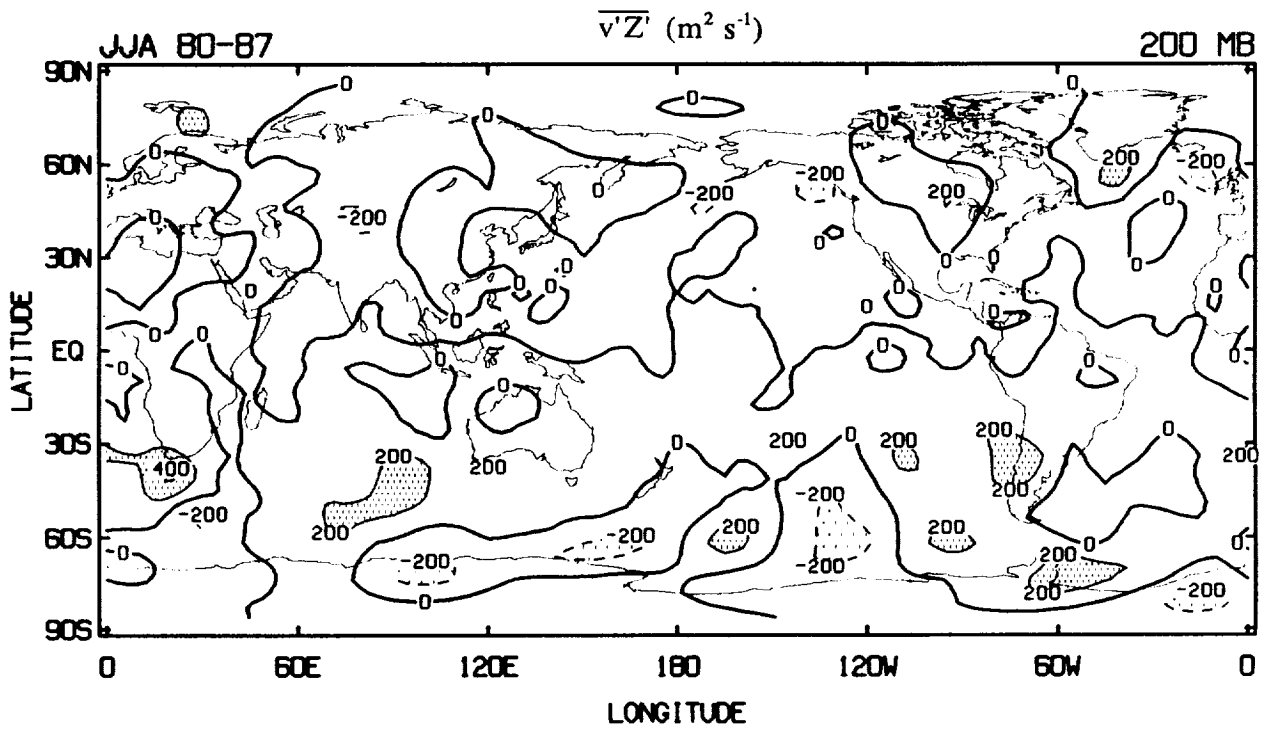

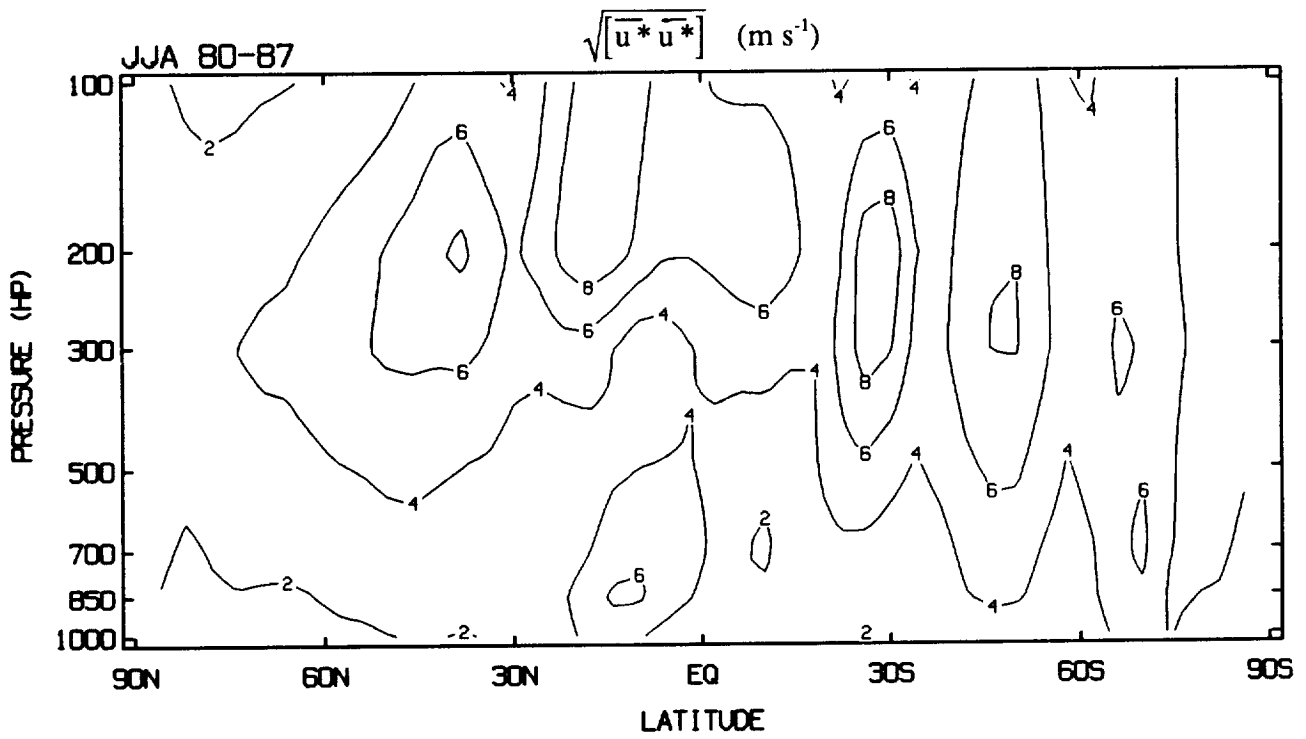
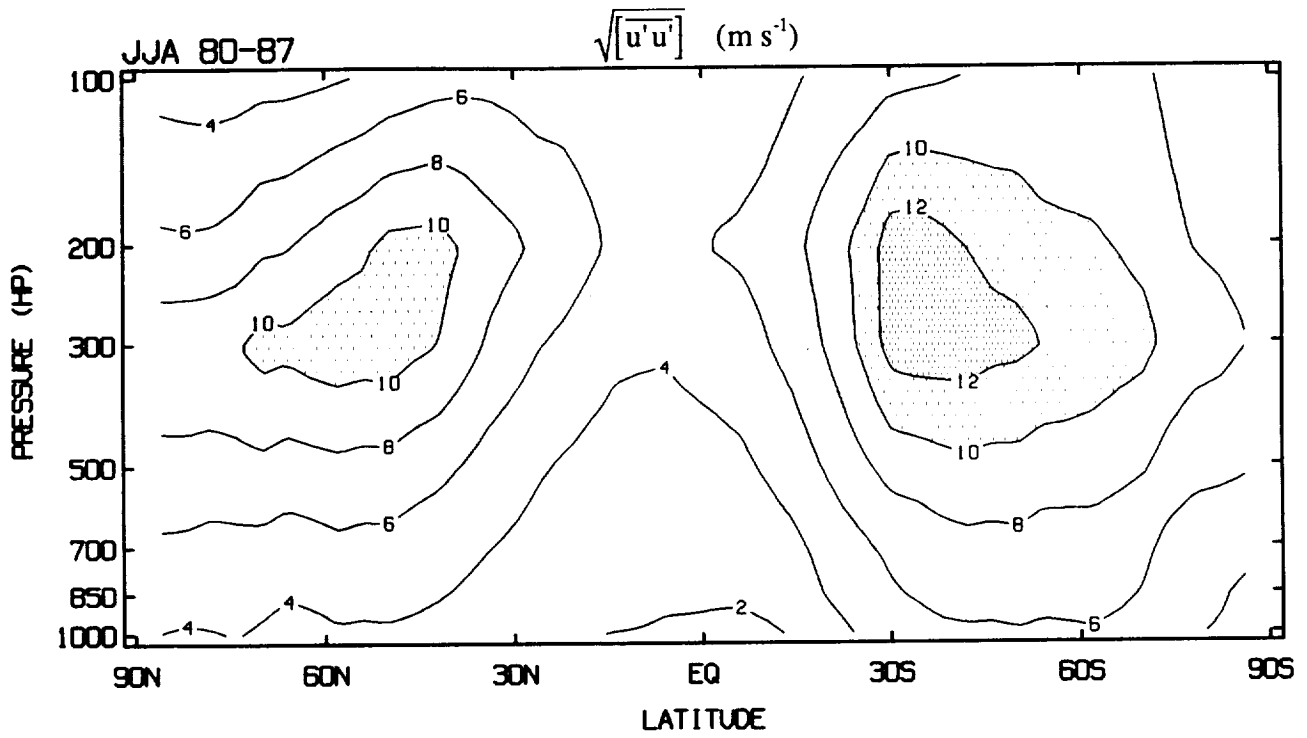

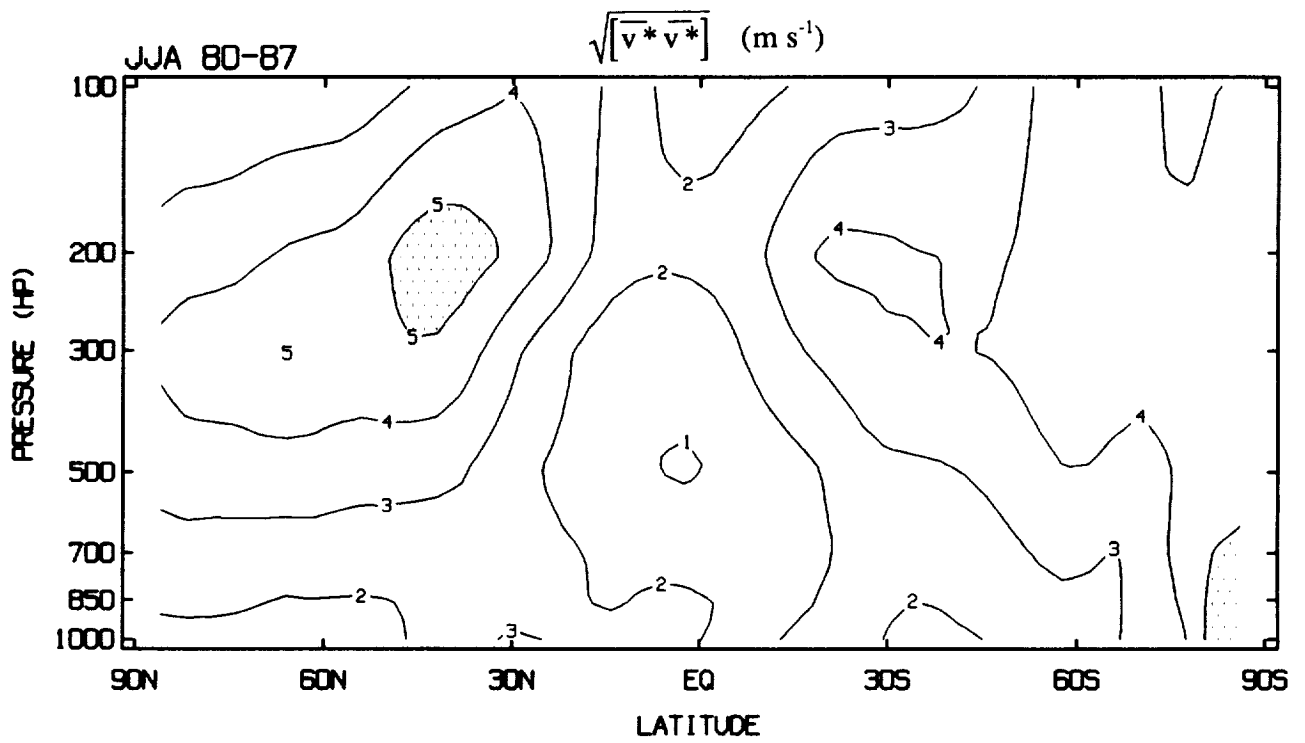
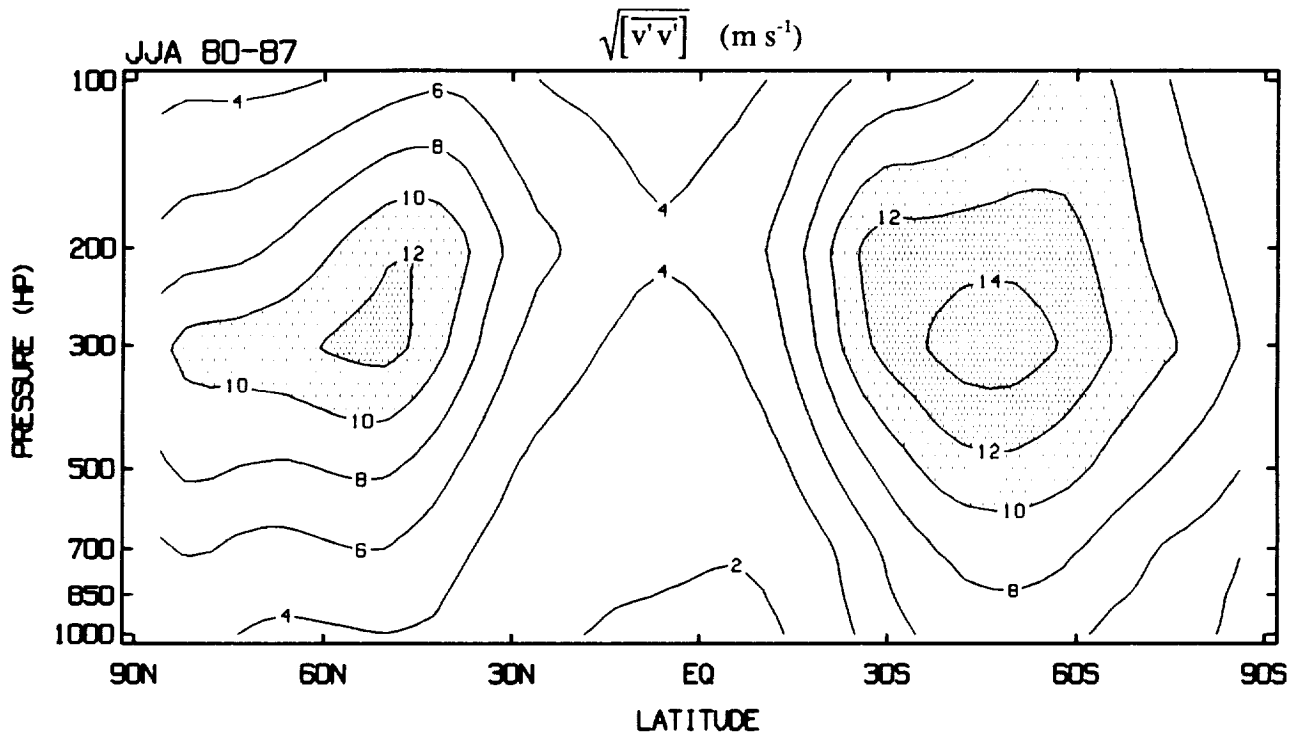

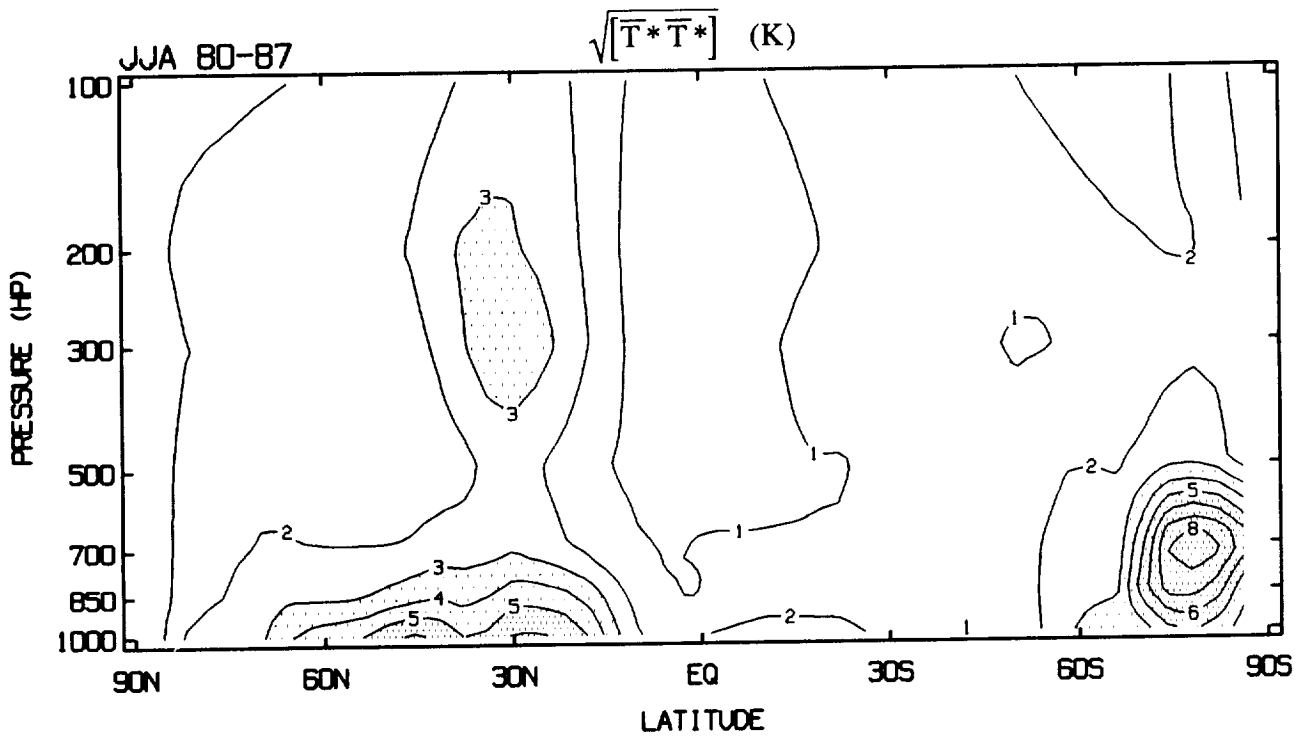
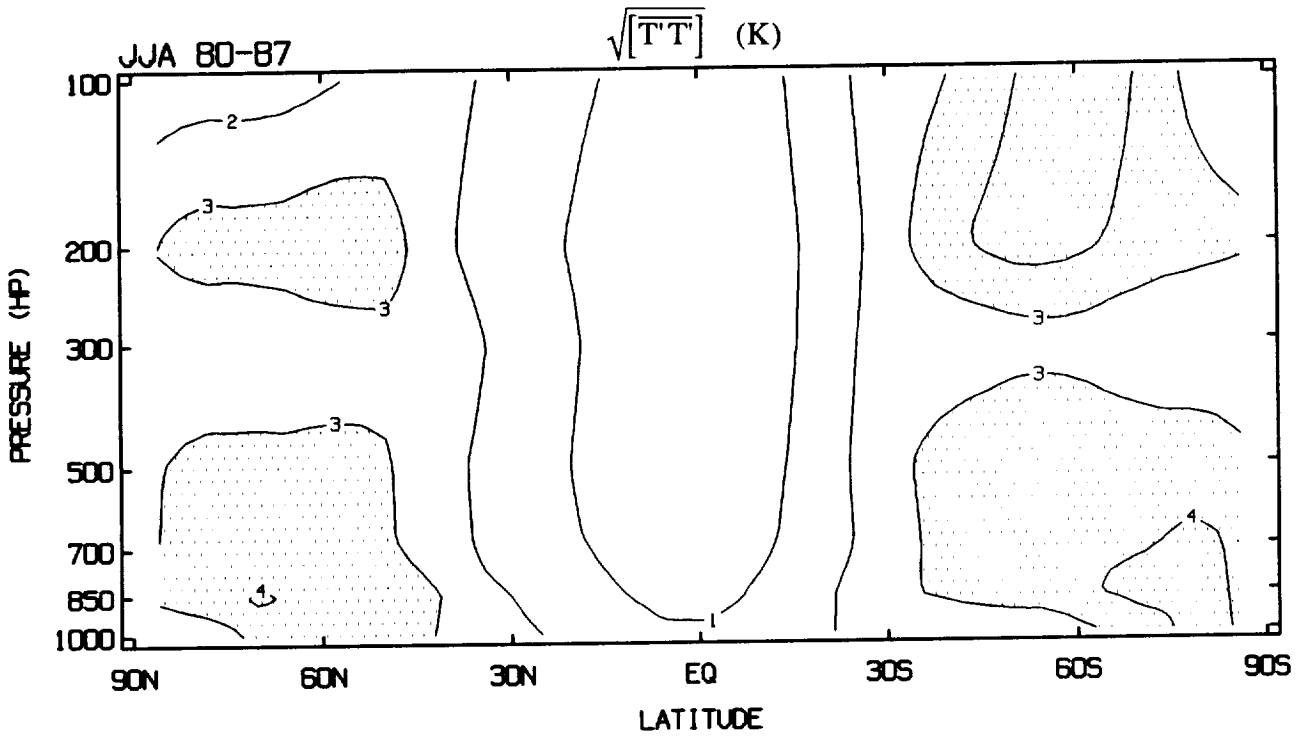

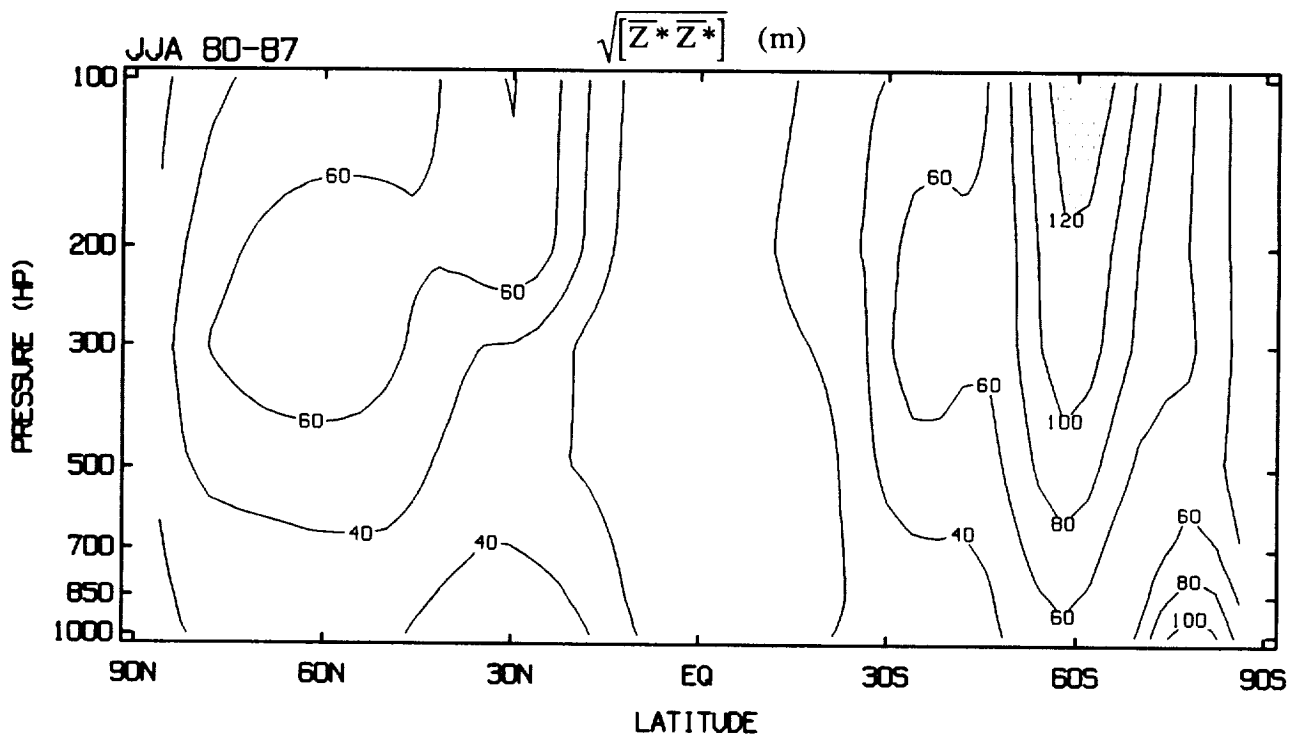
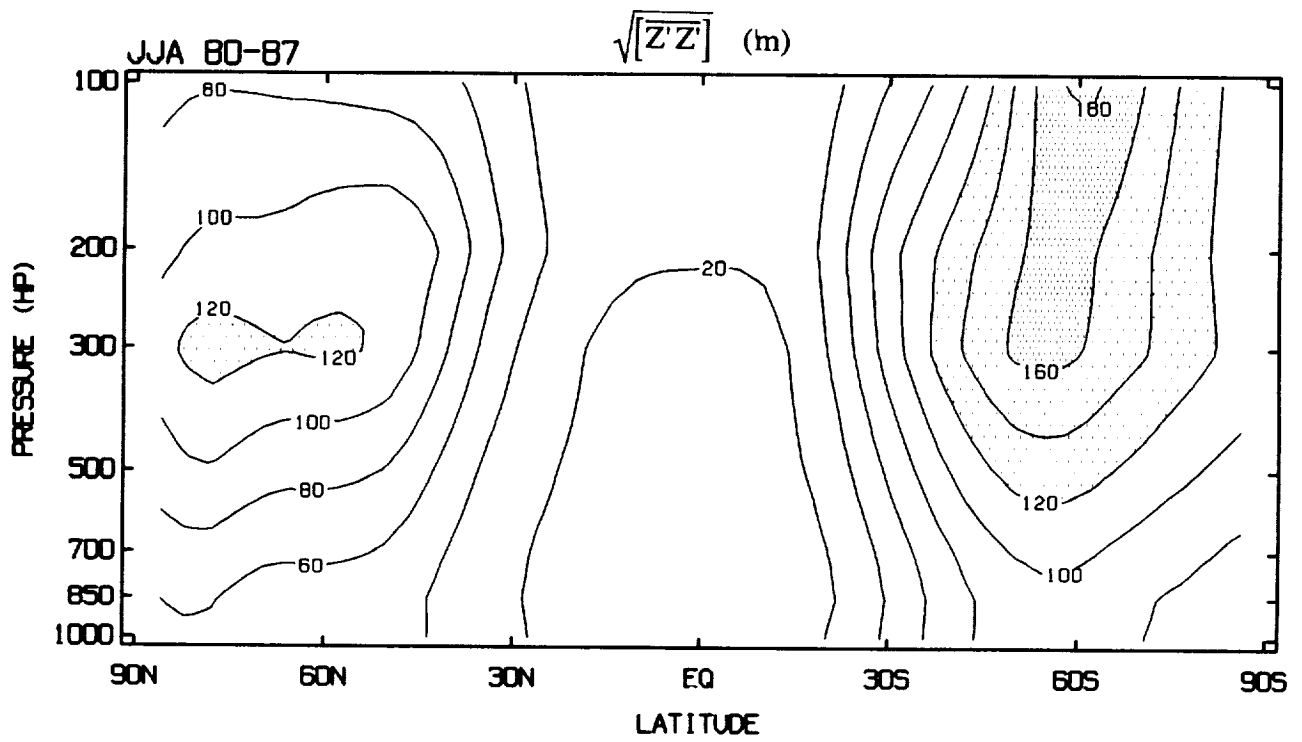

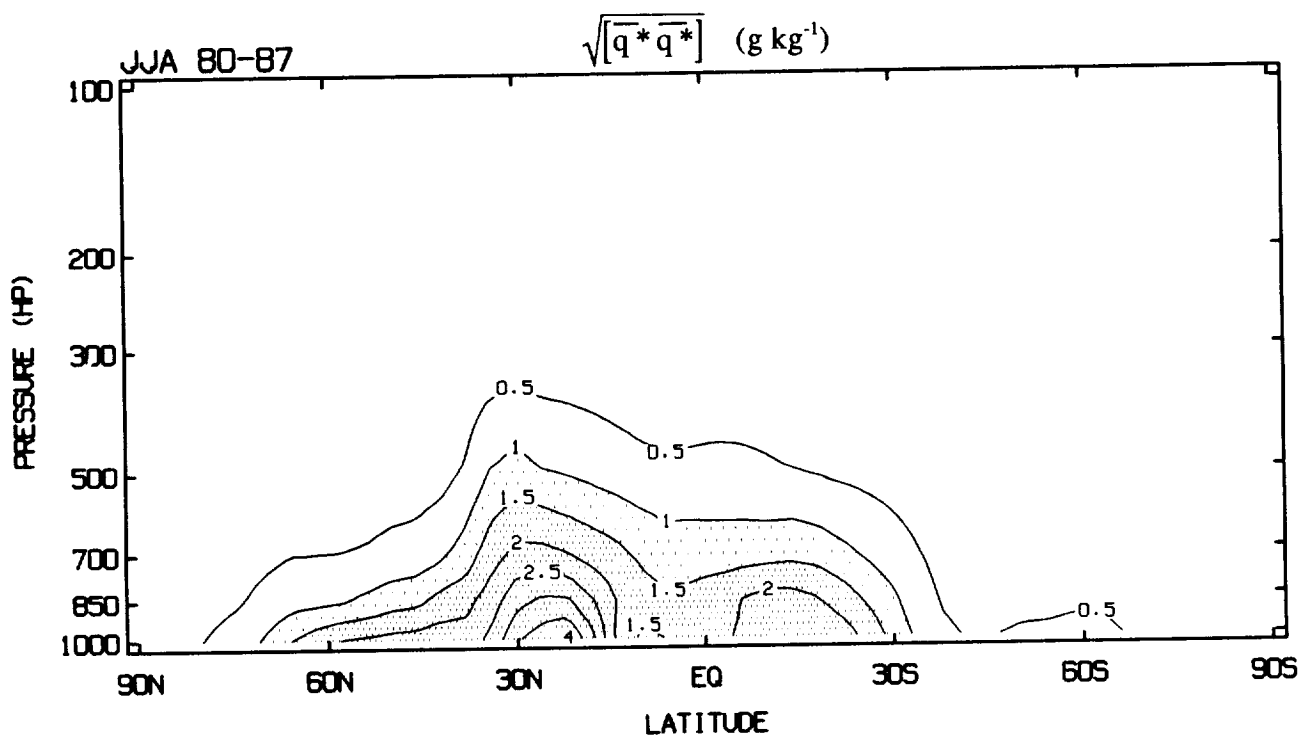
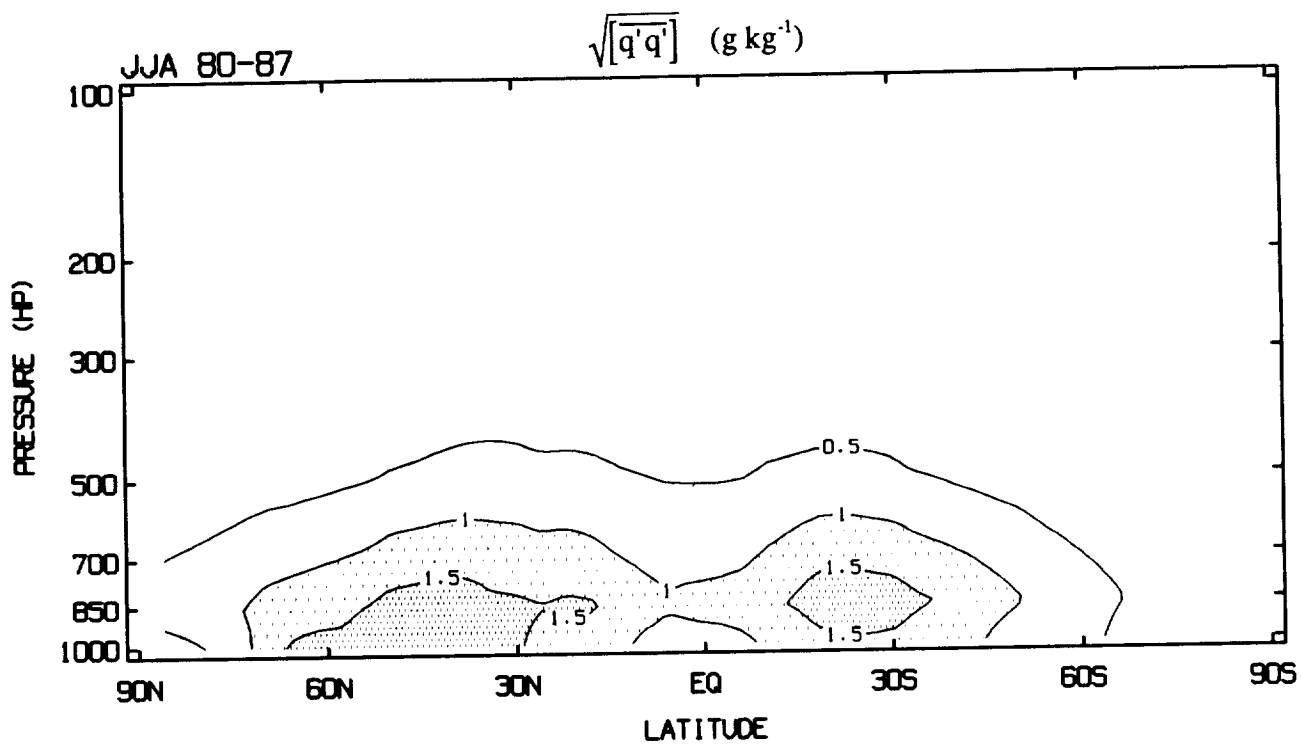

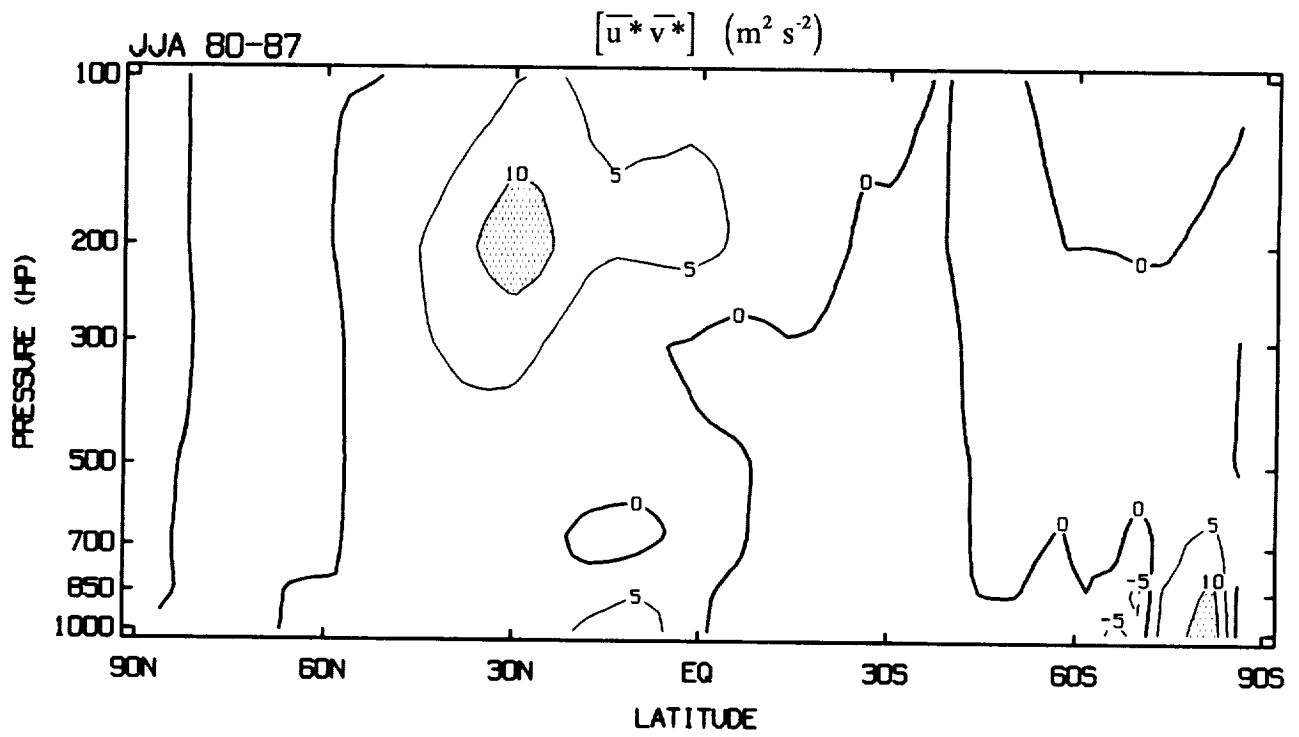
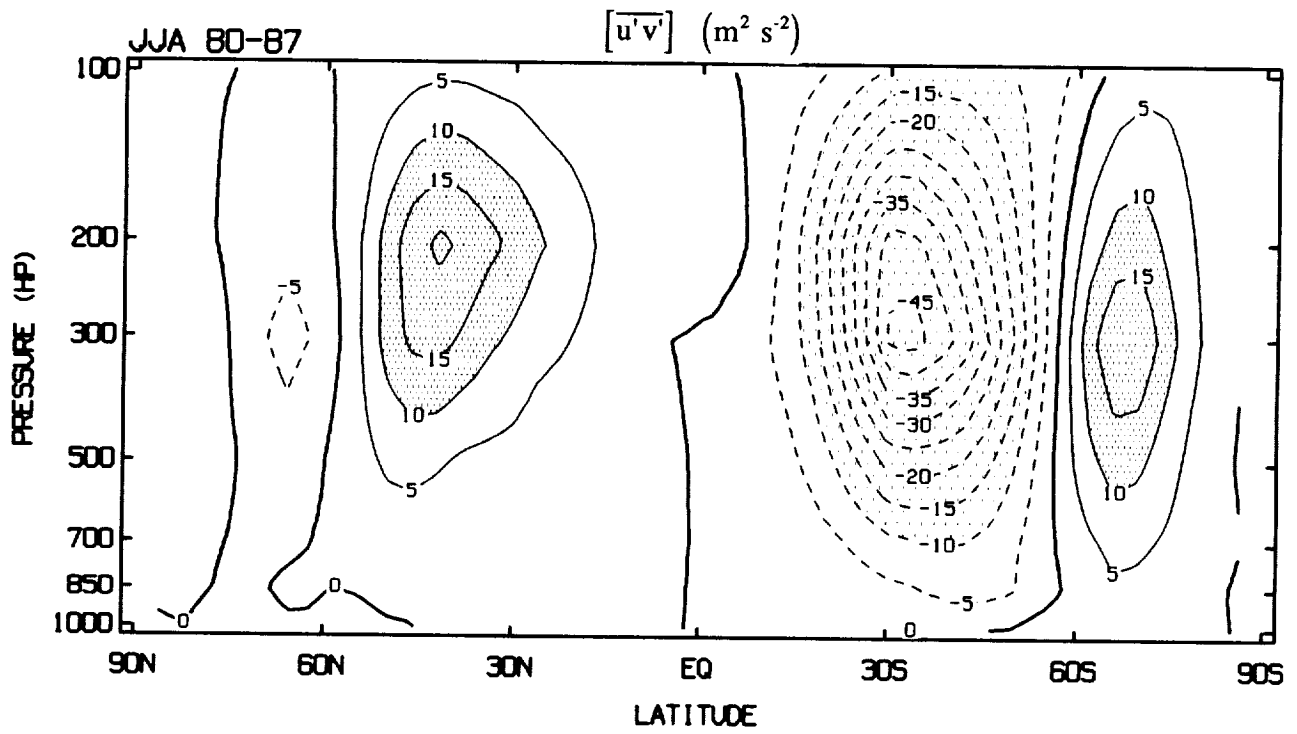

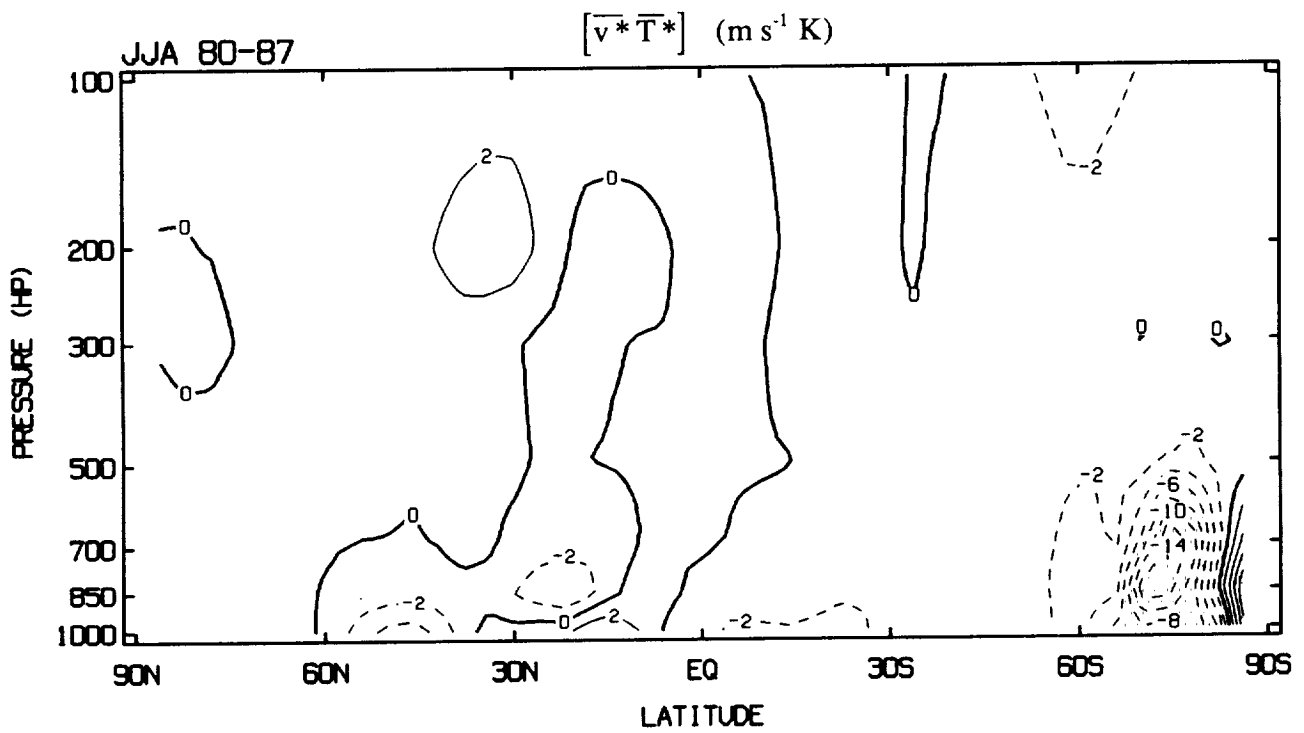
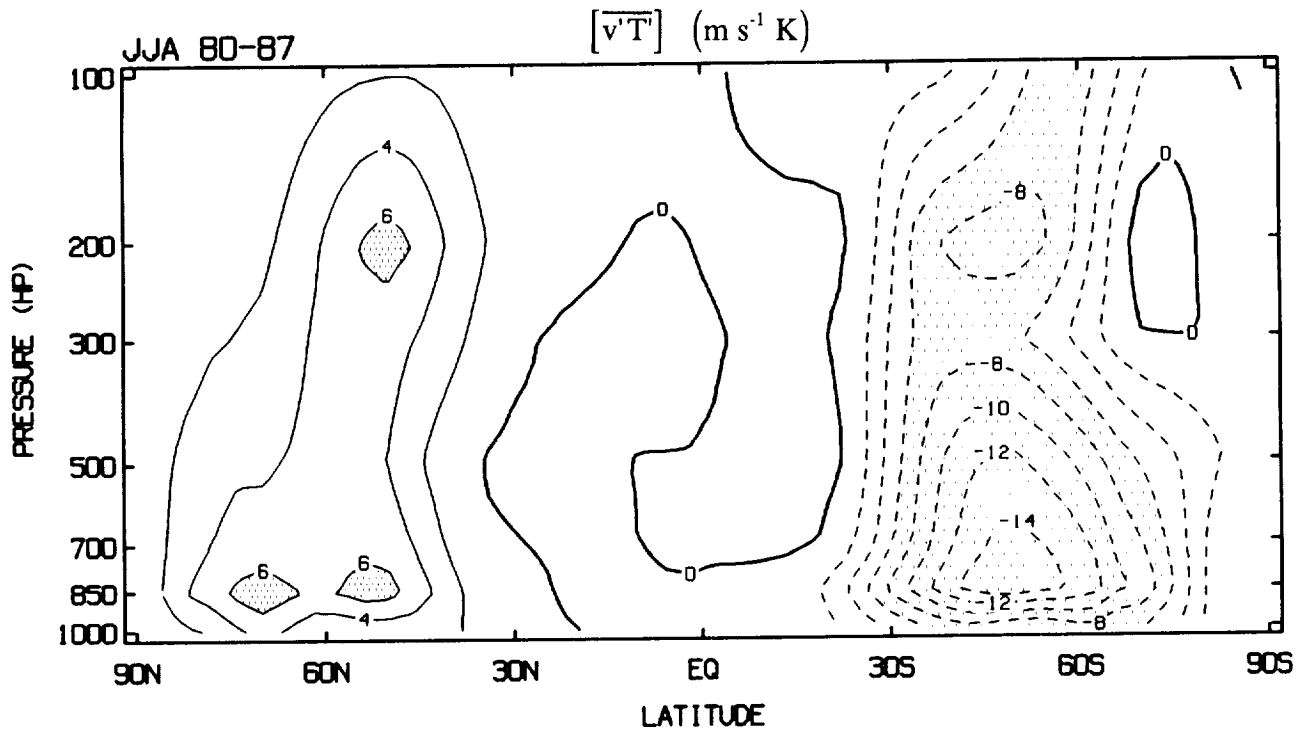

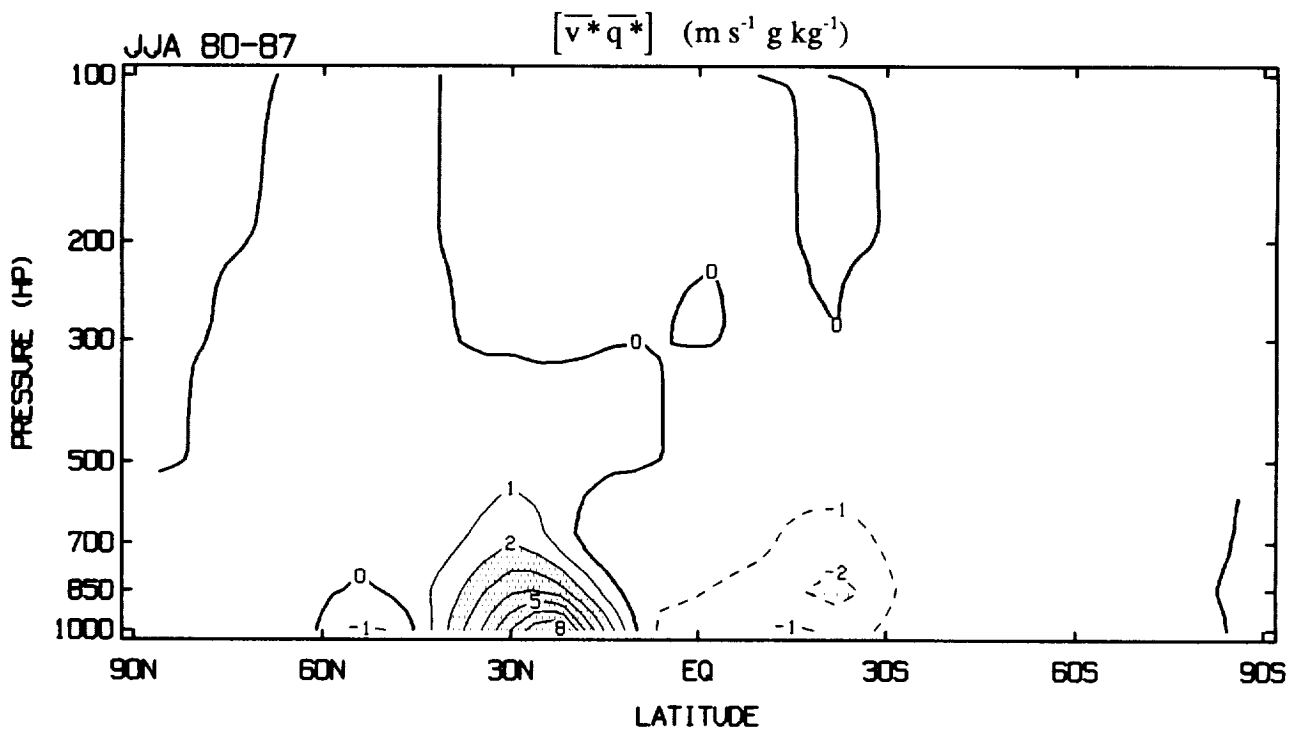
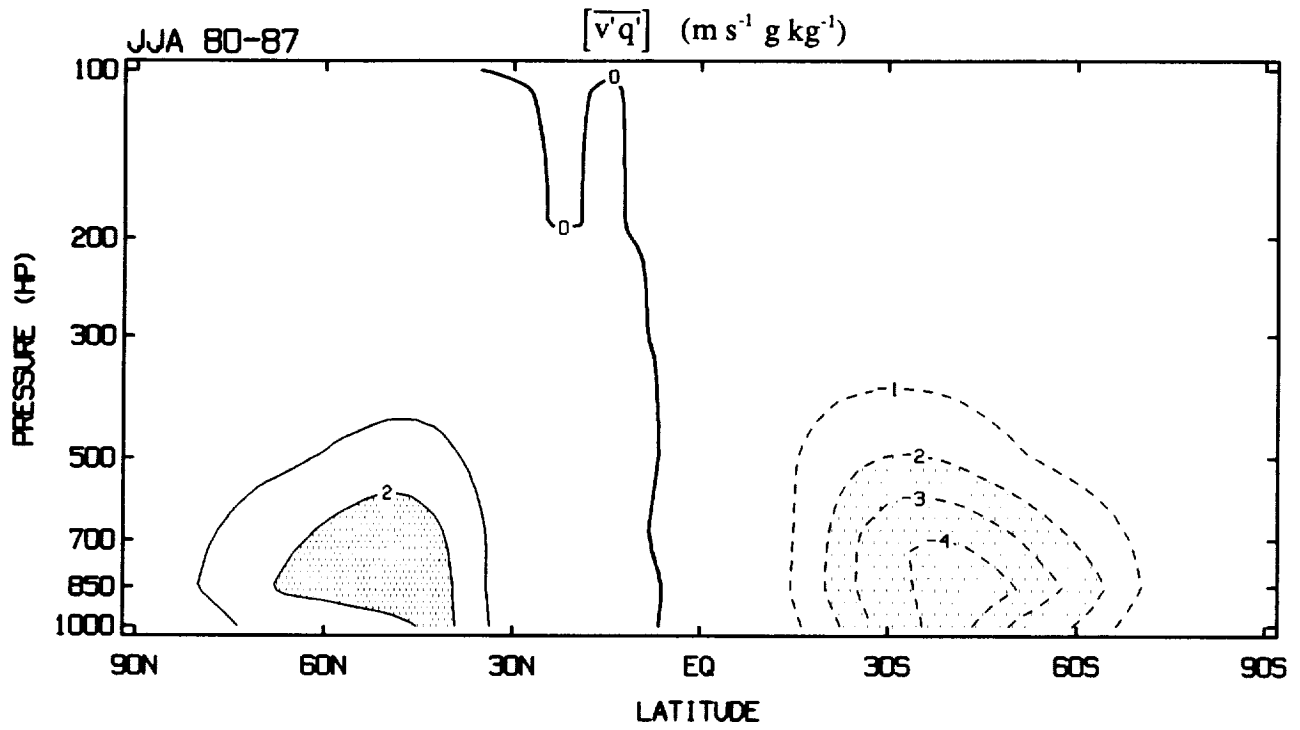

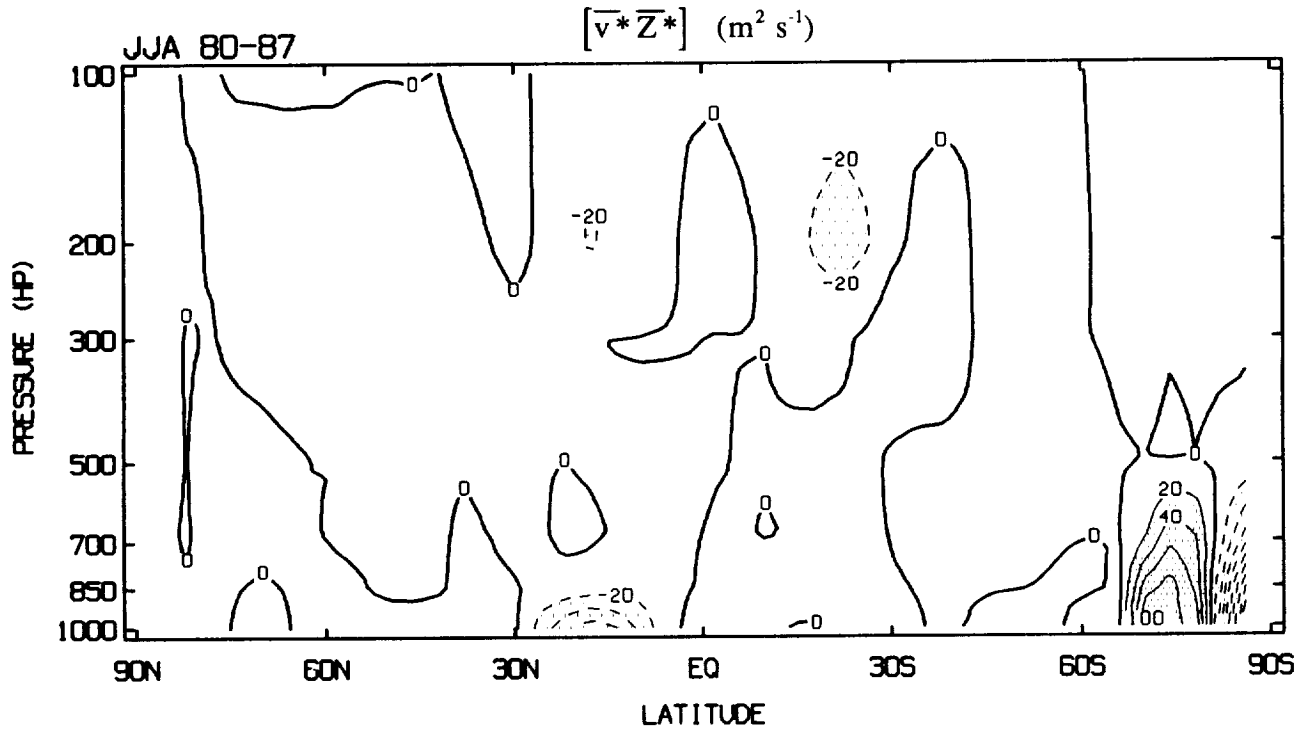
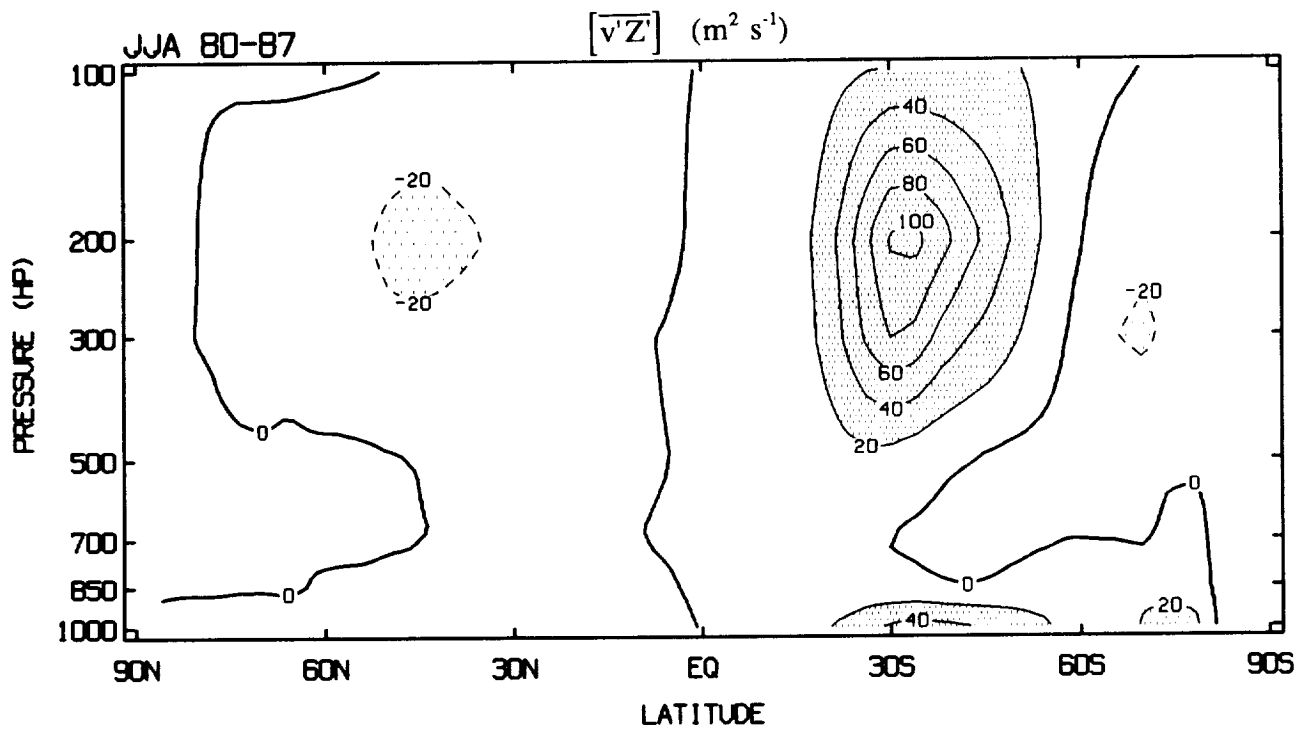

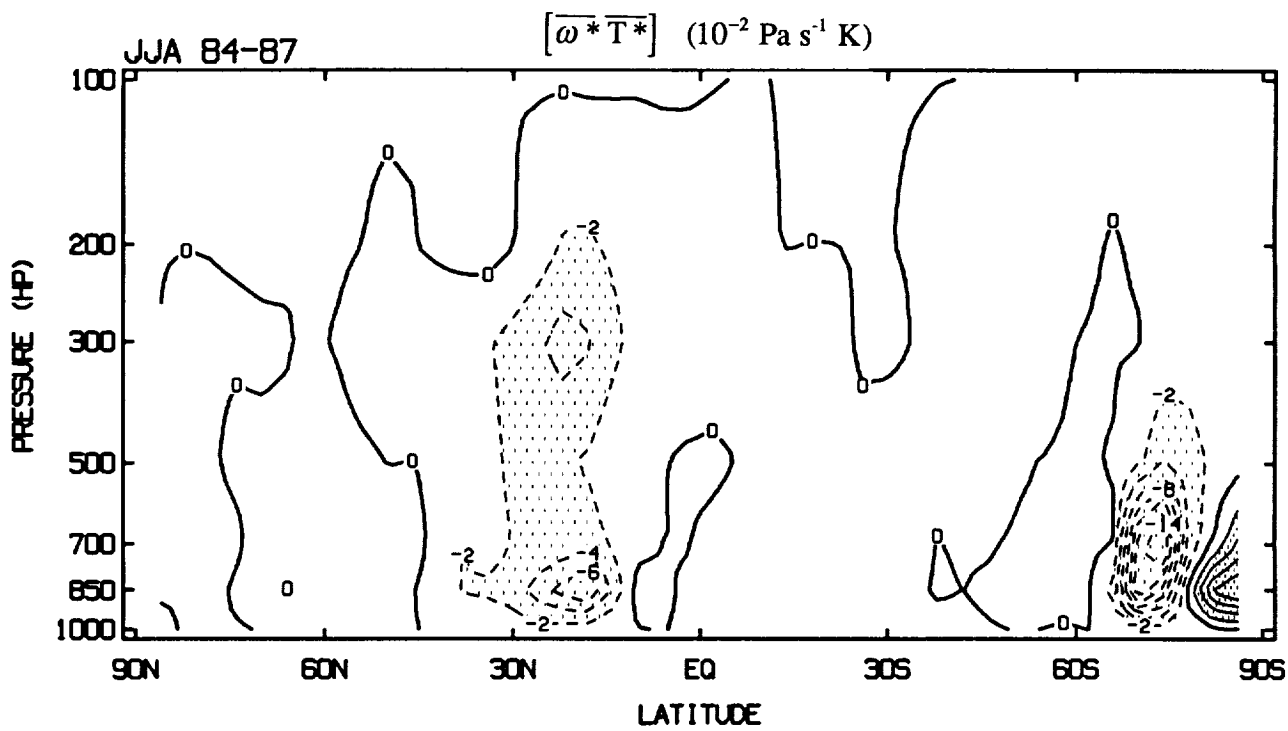
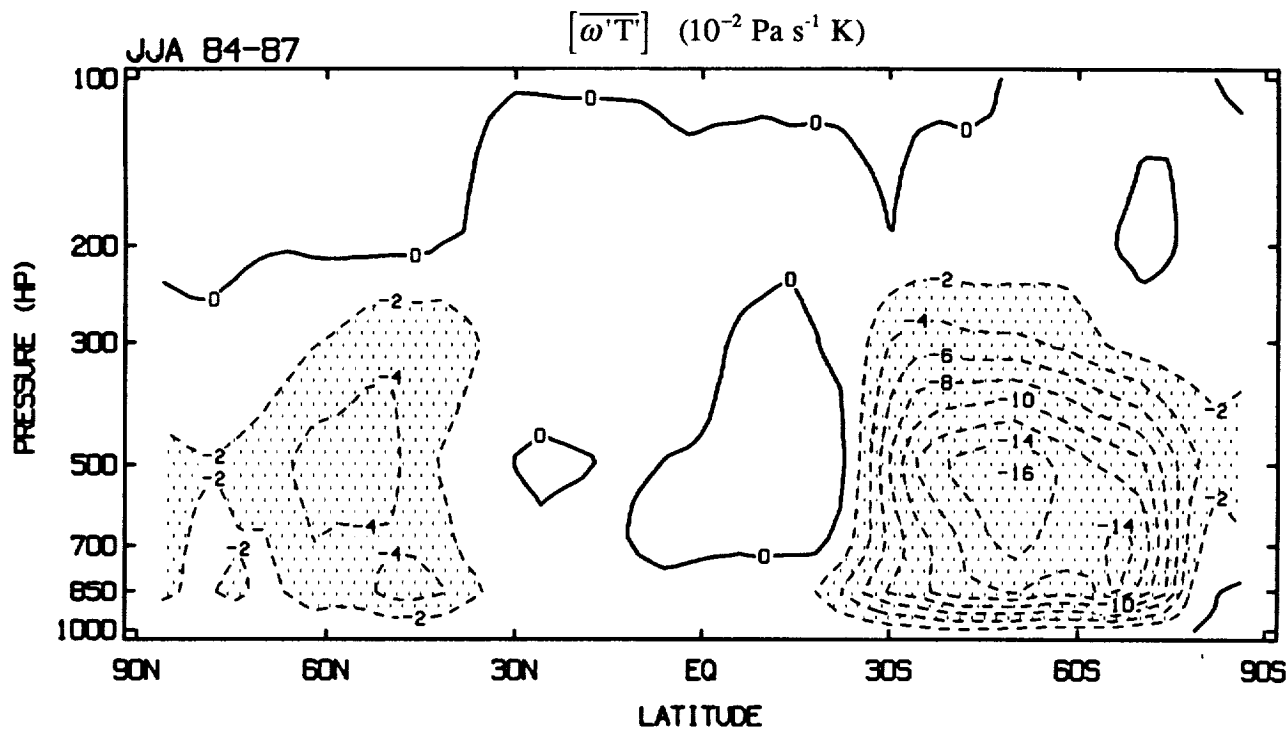

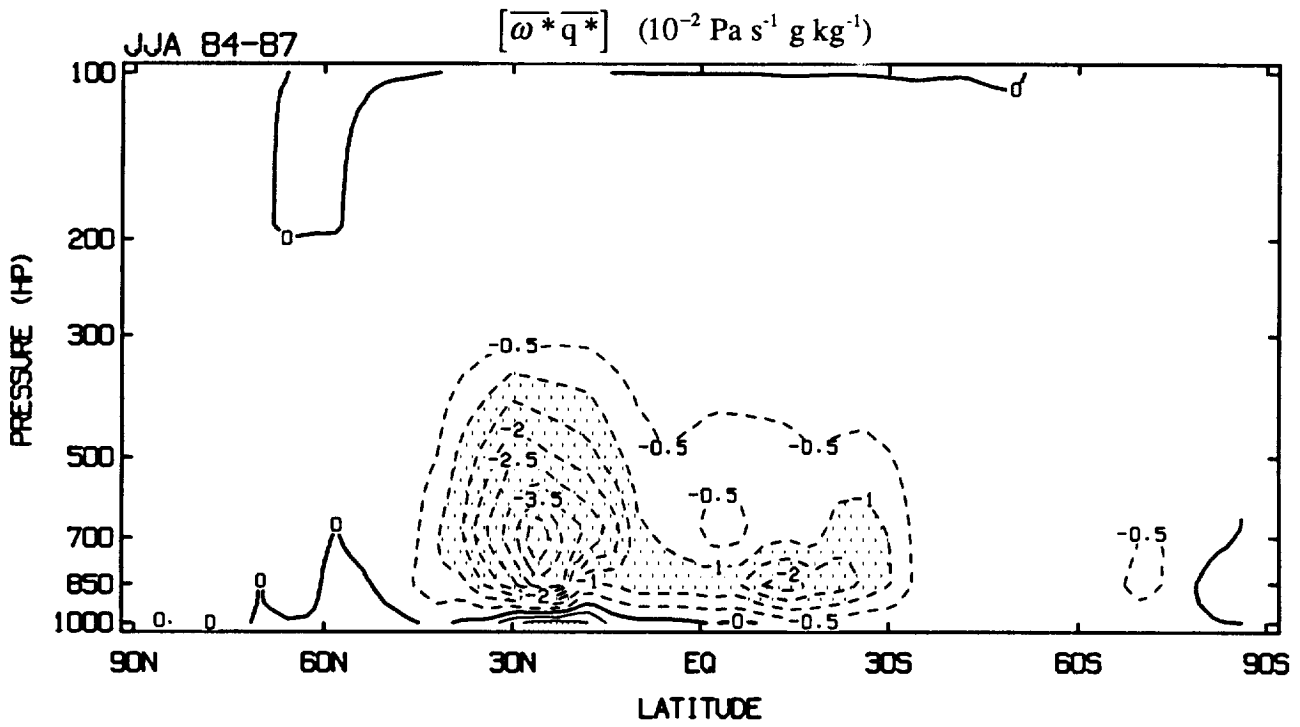
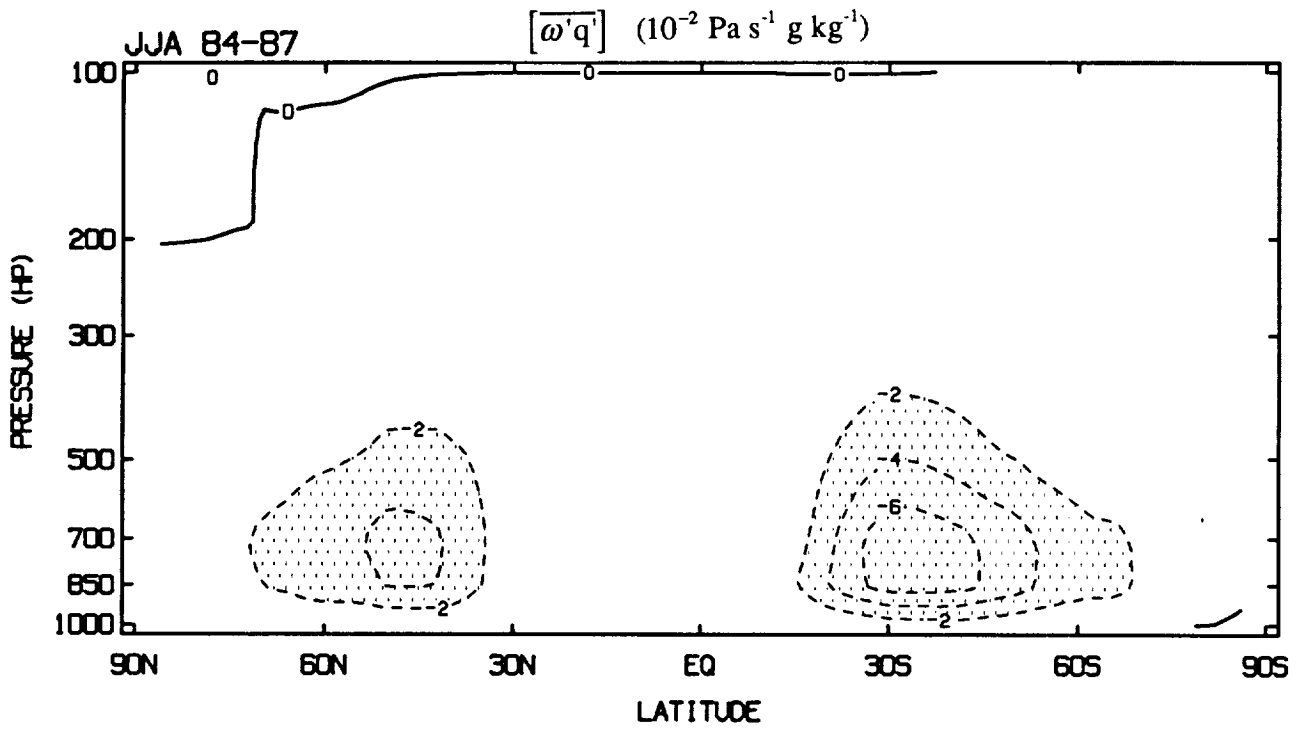

JJA

DEVIATIONS FROM SEASONAL CYCLE

UNFILTERED

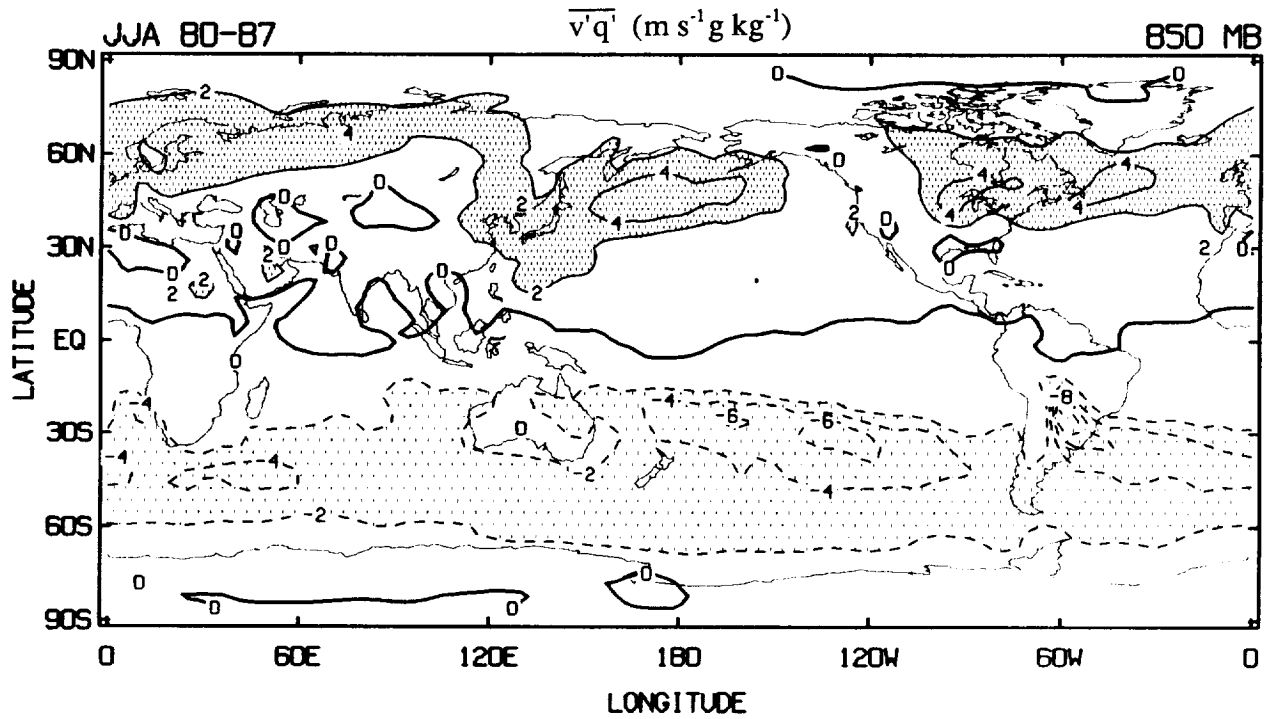
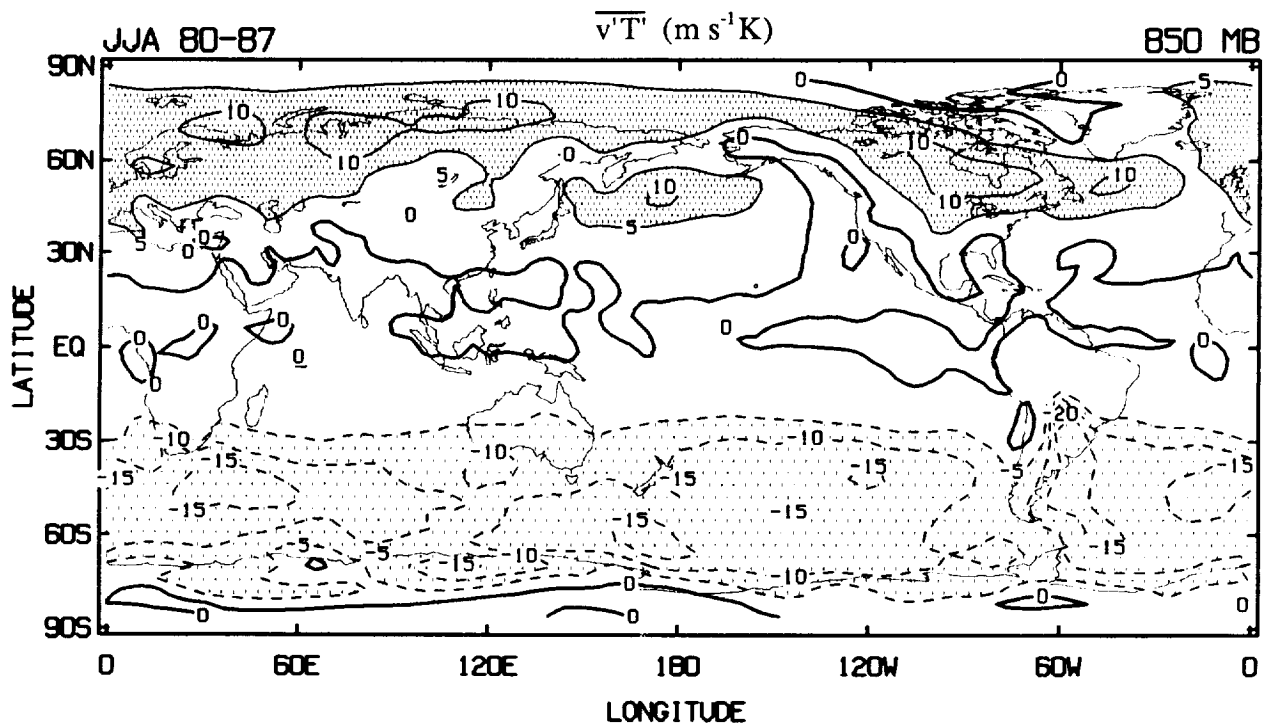

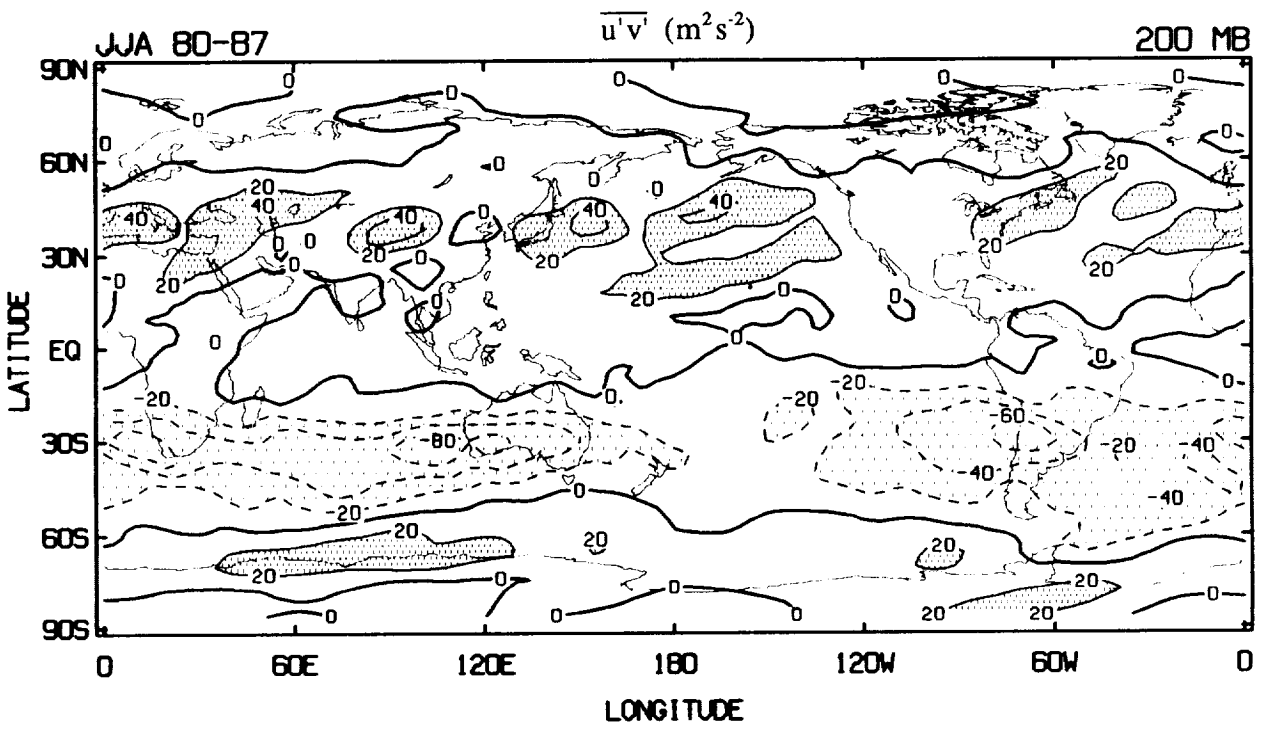

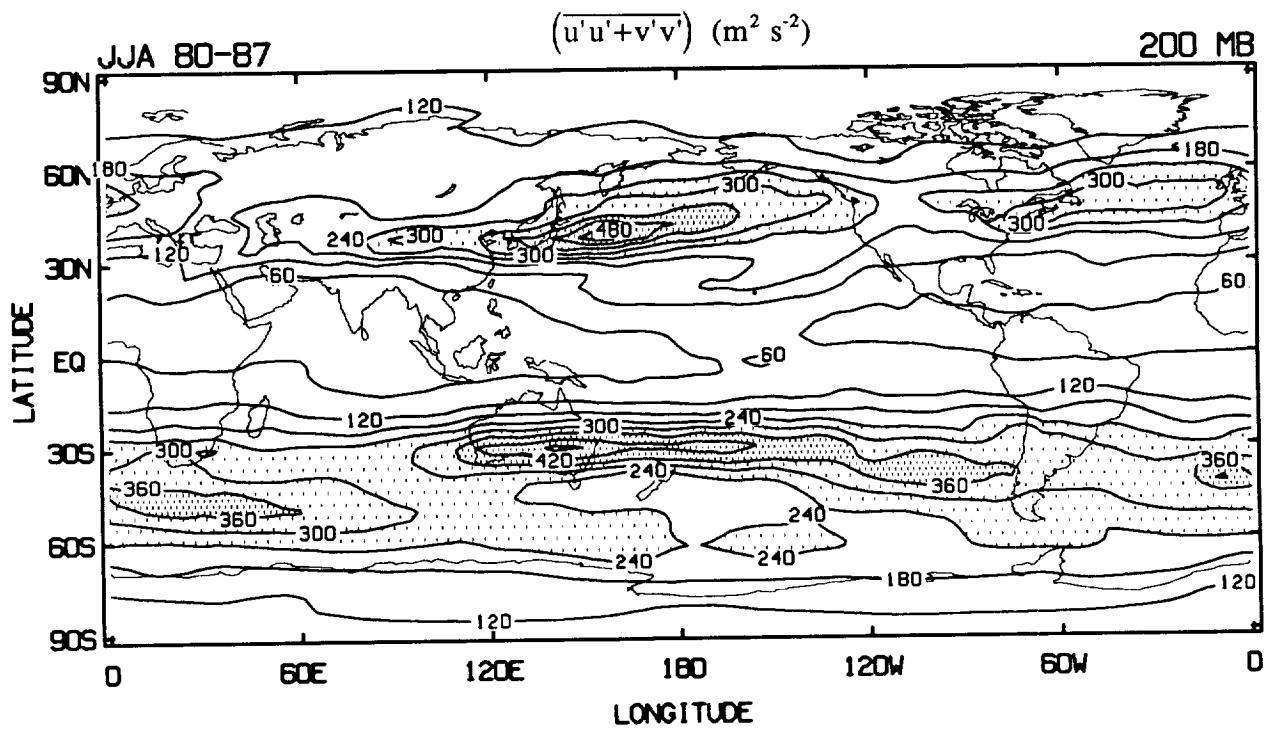
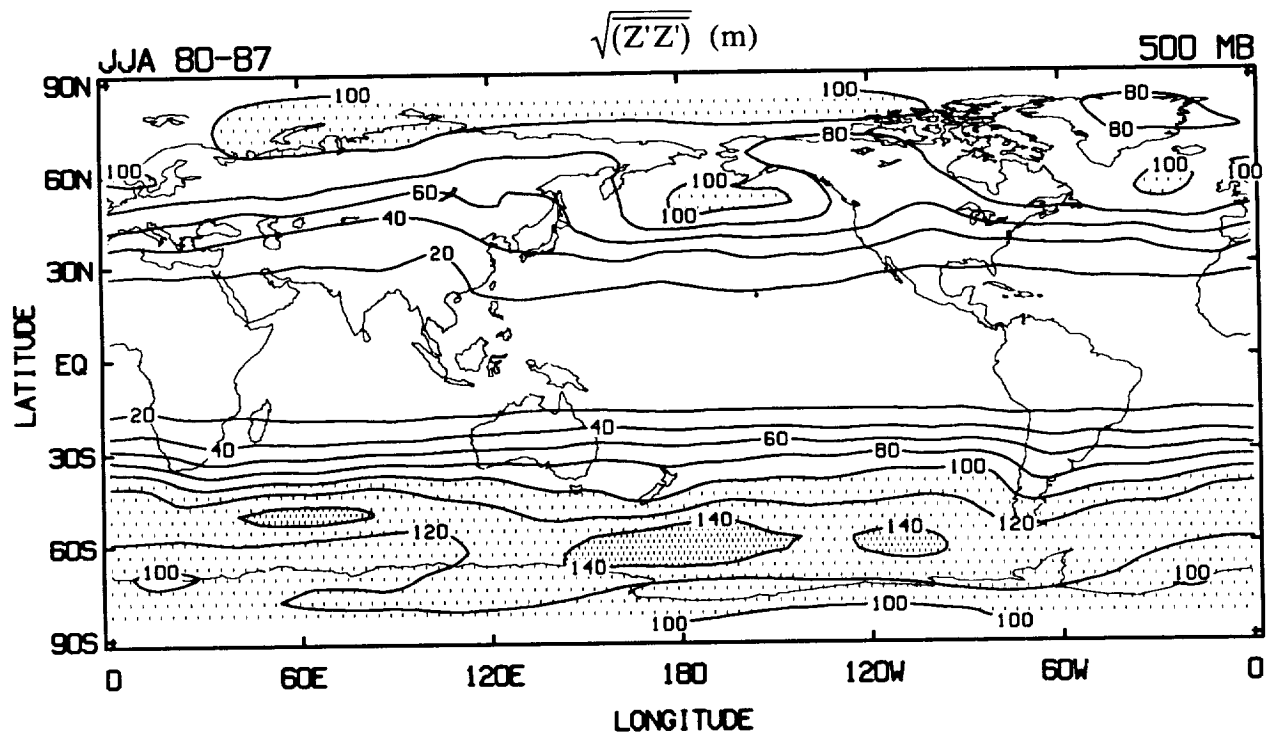

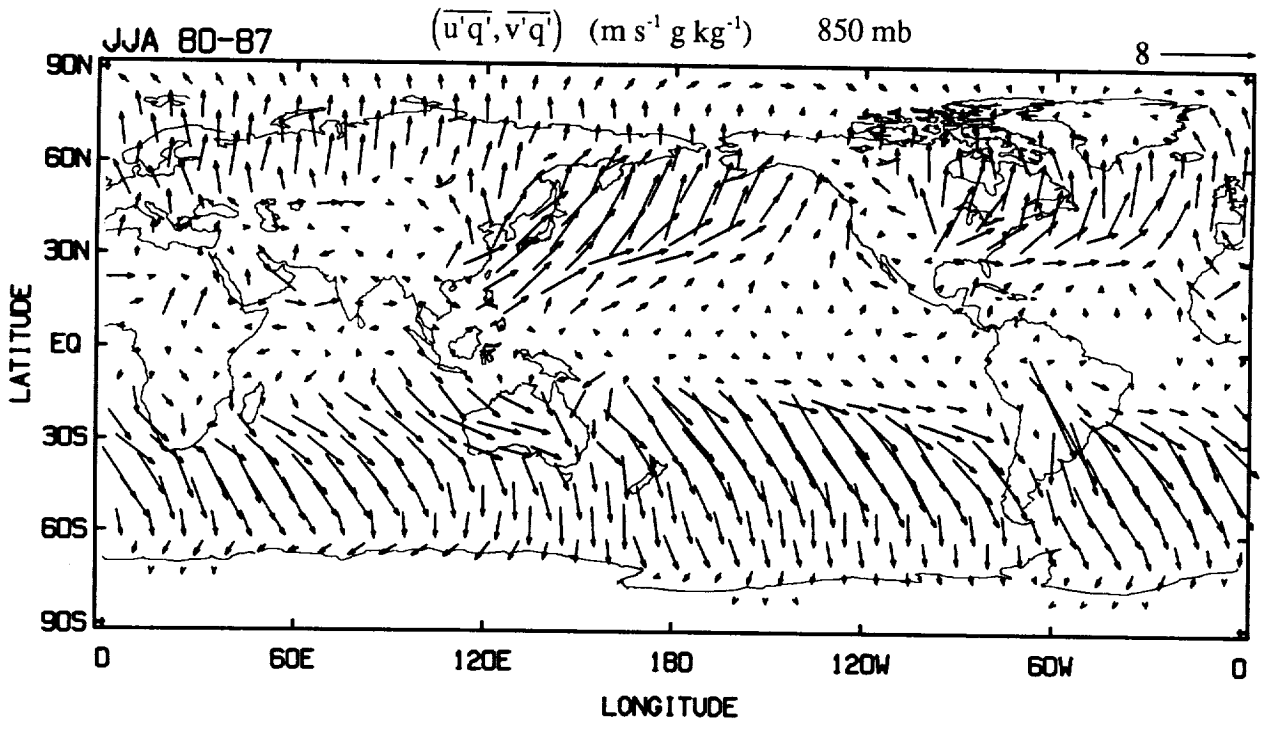
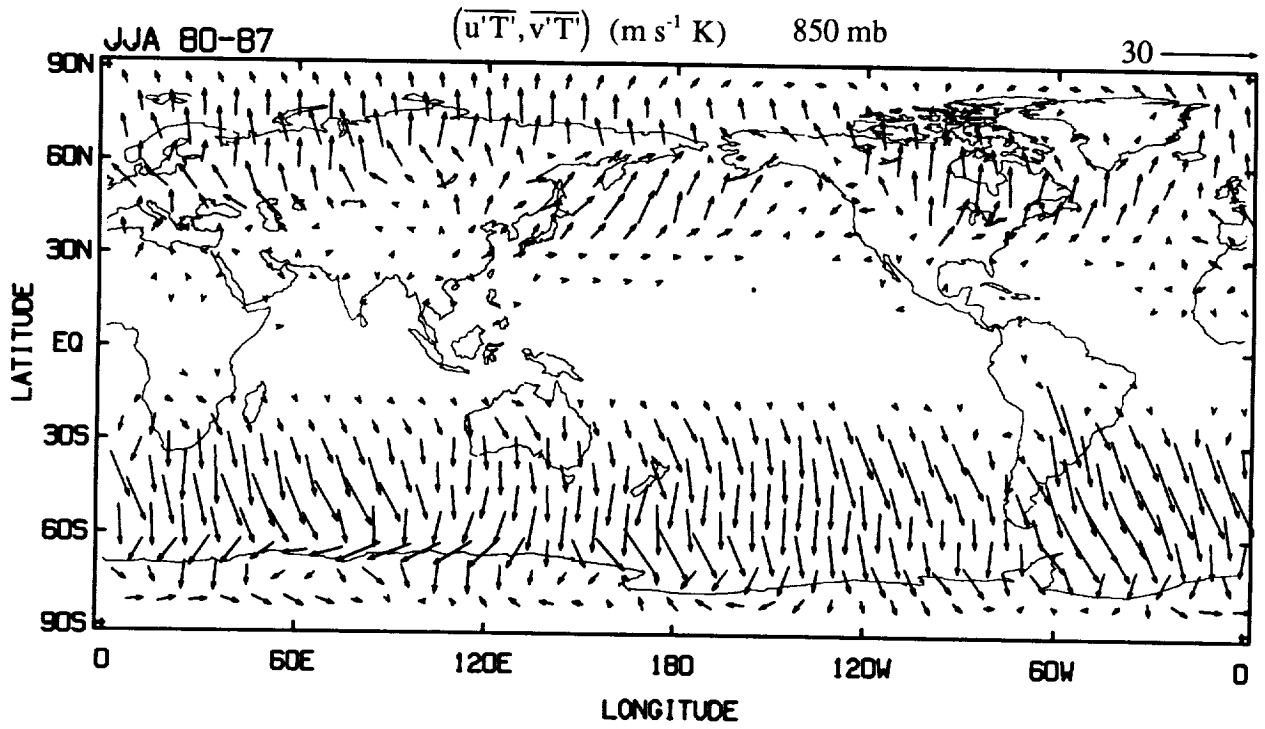

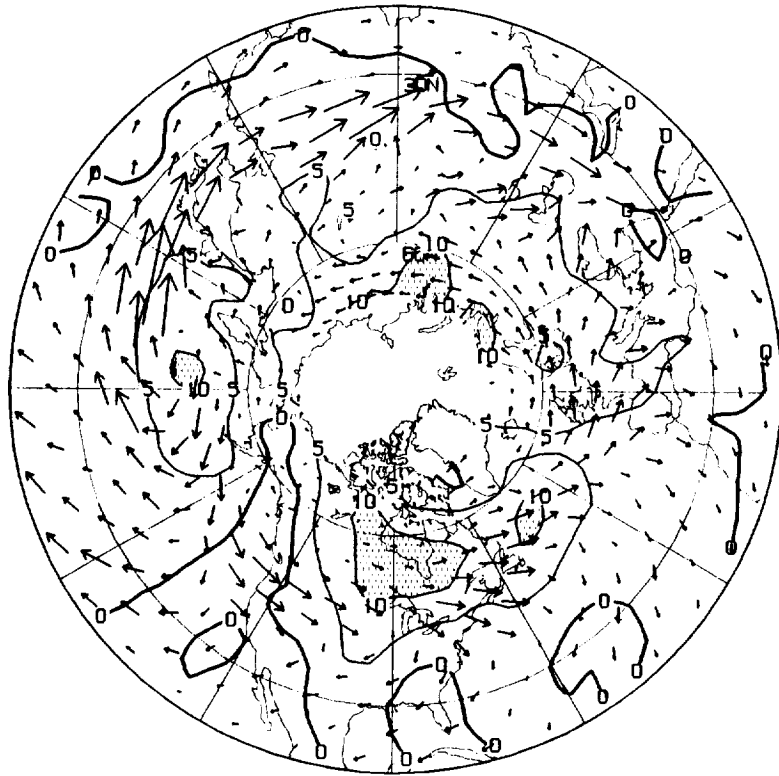

$\overline{v'T'}$ ($\text{m s}^{-1}\text{K}$) 850 mb

E_u ($\text{m}^2 \text{s}^{-2}$) 200 mb

100 \rightarrow

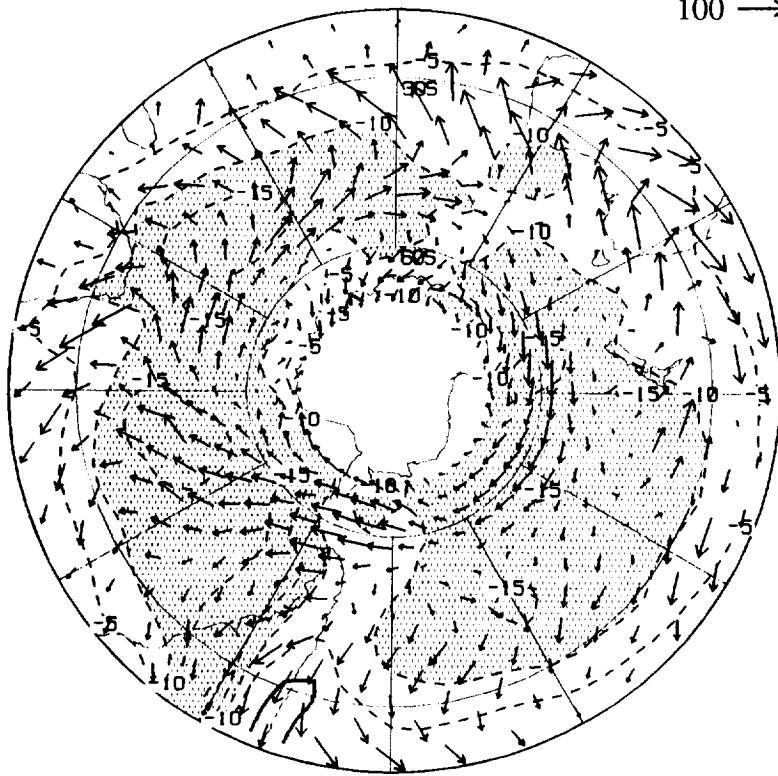

JJA (80 - 87)

127

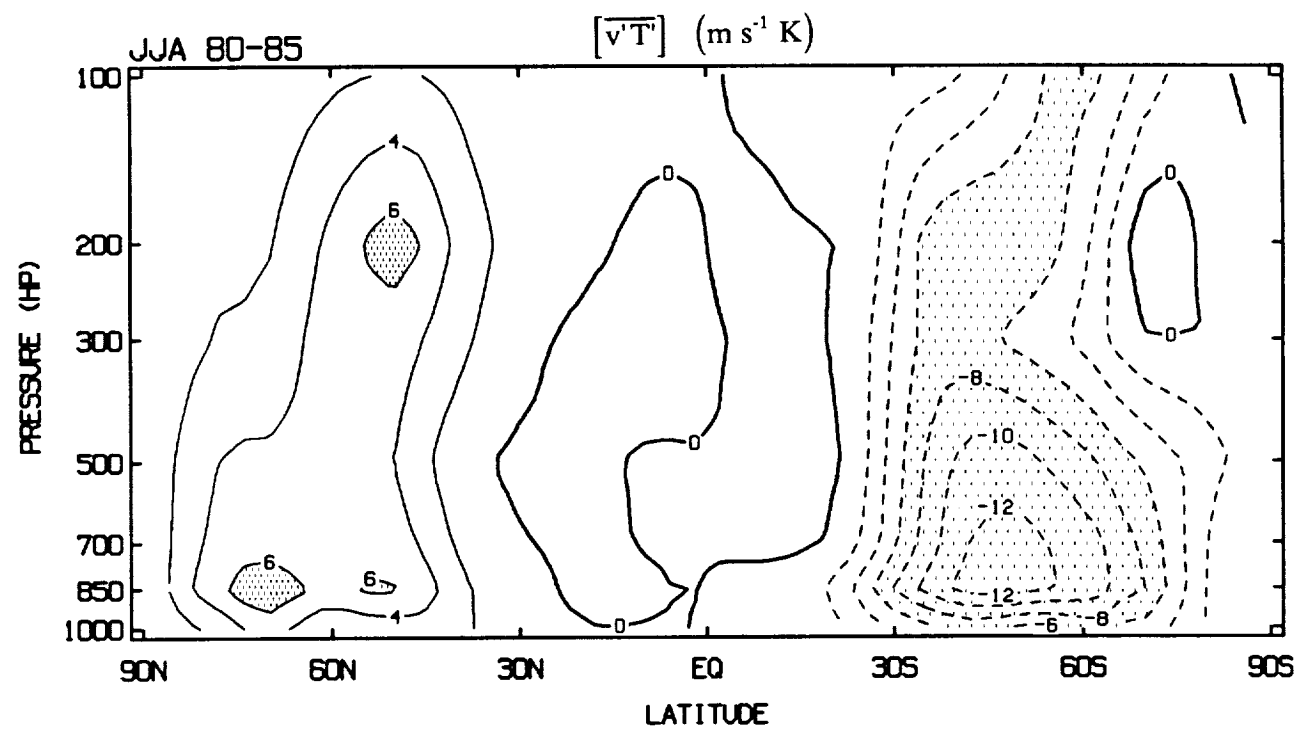
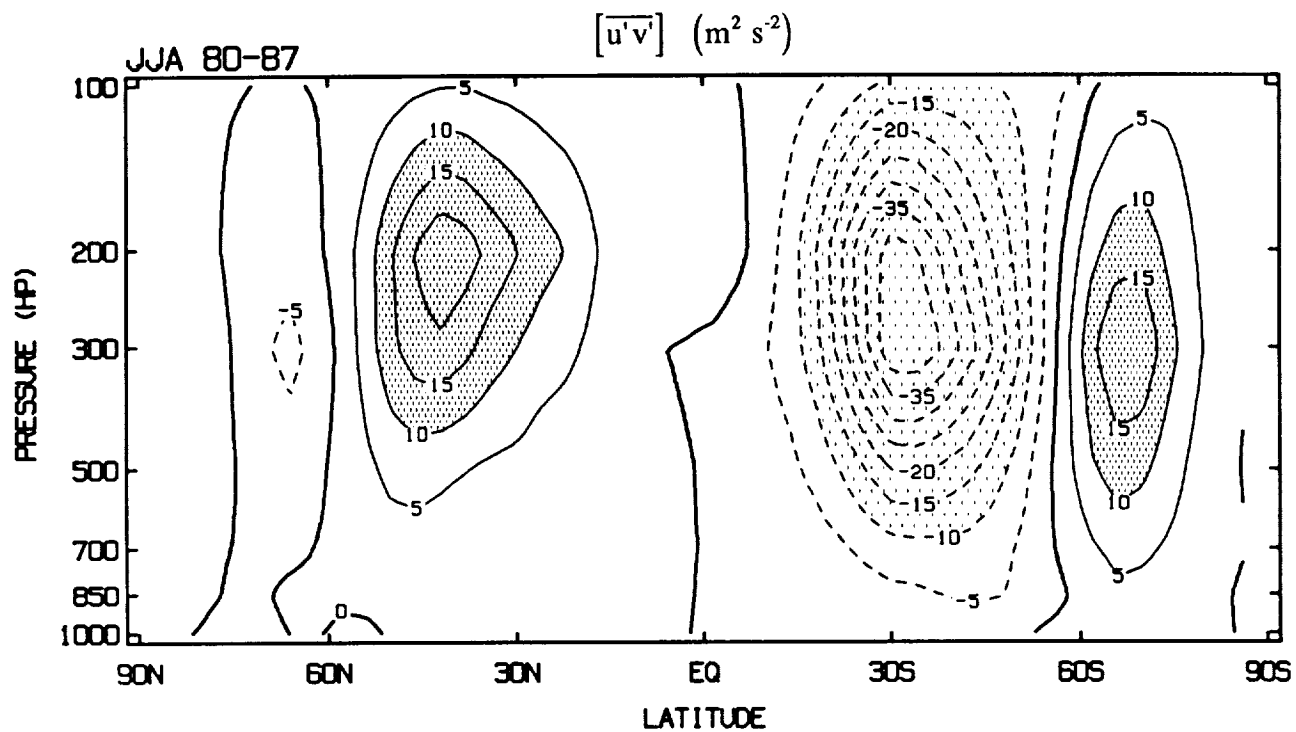

LOW PASS

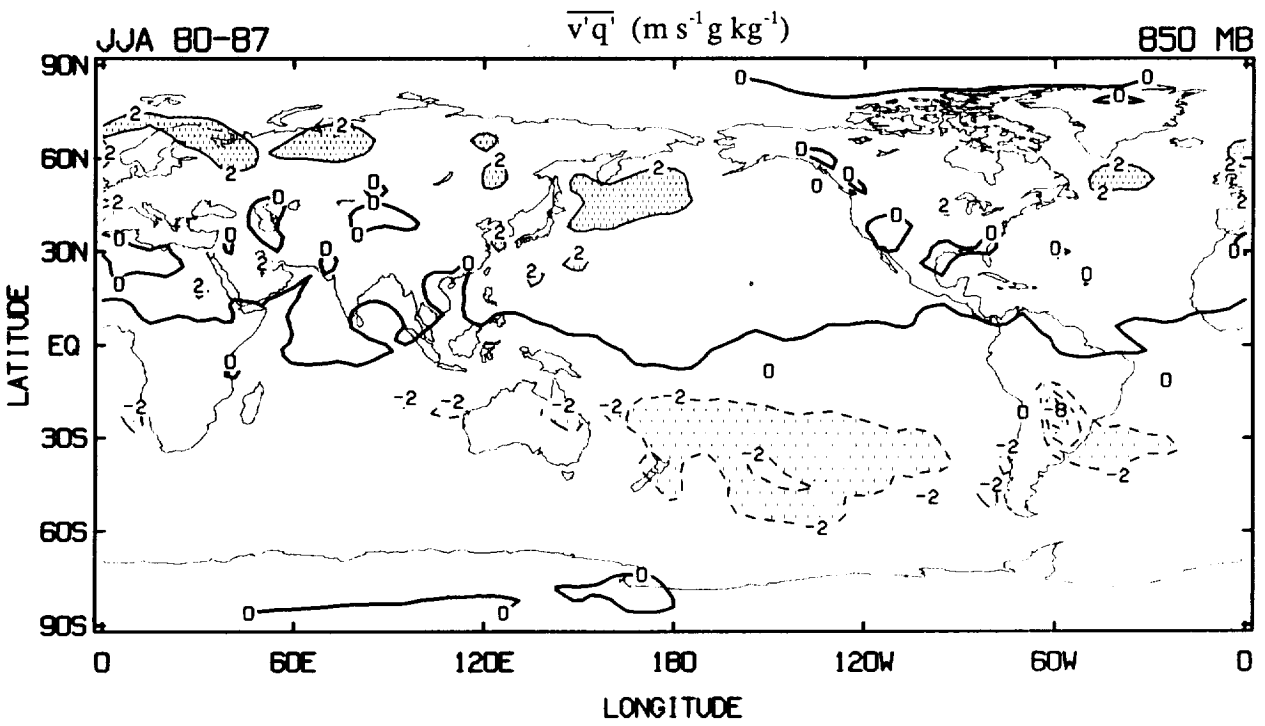
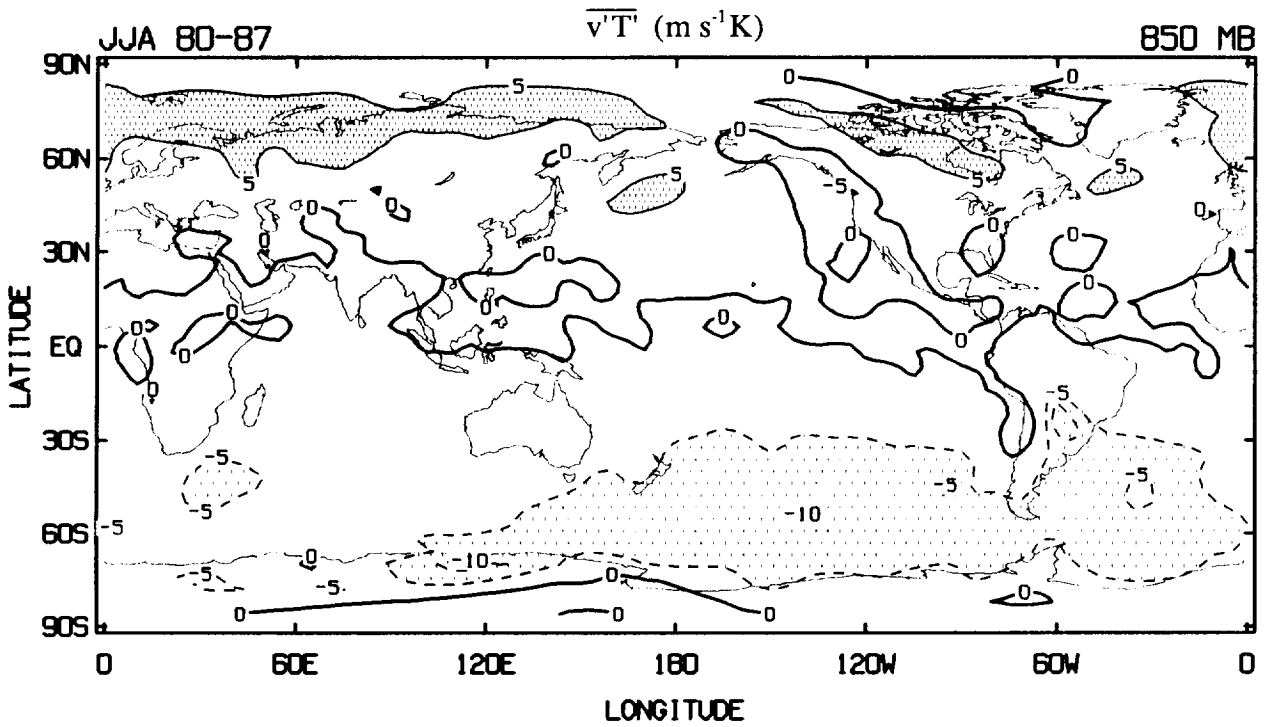

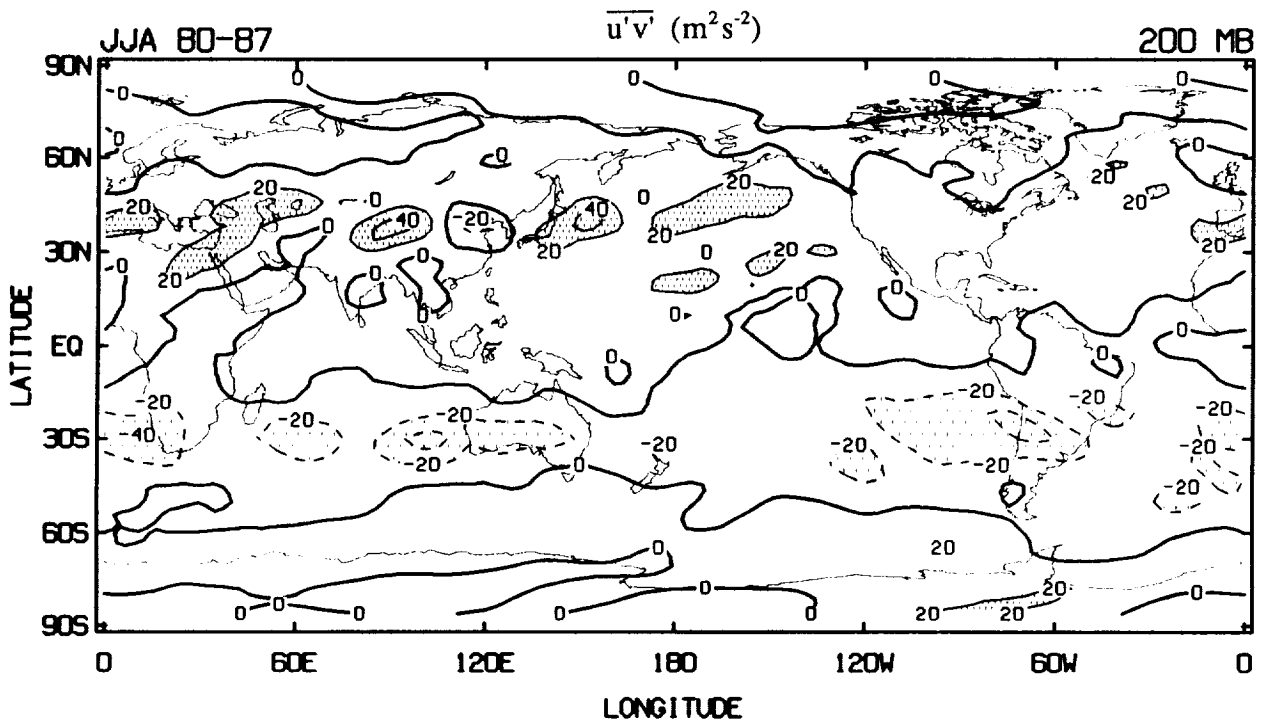

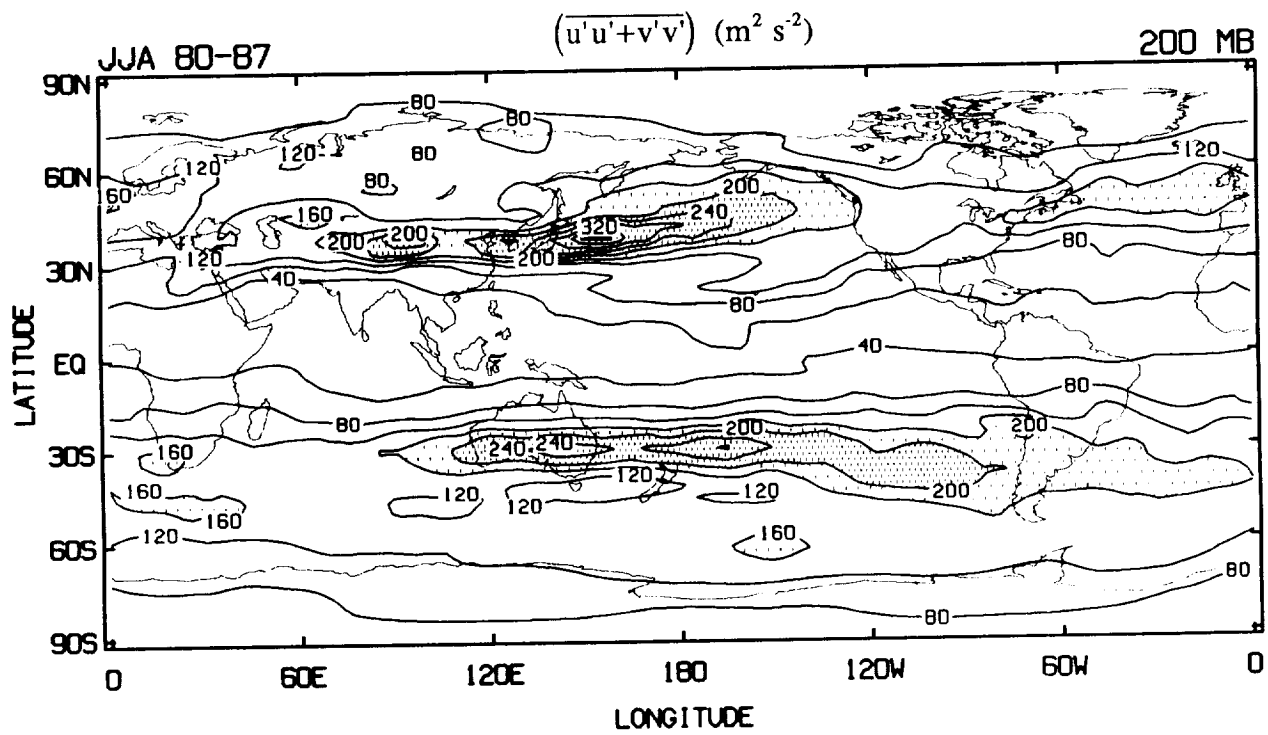
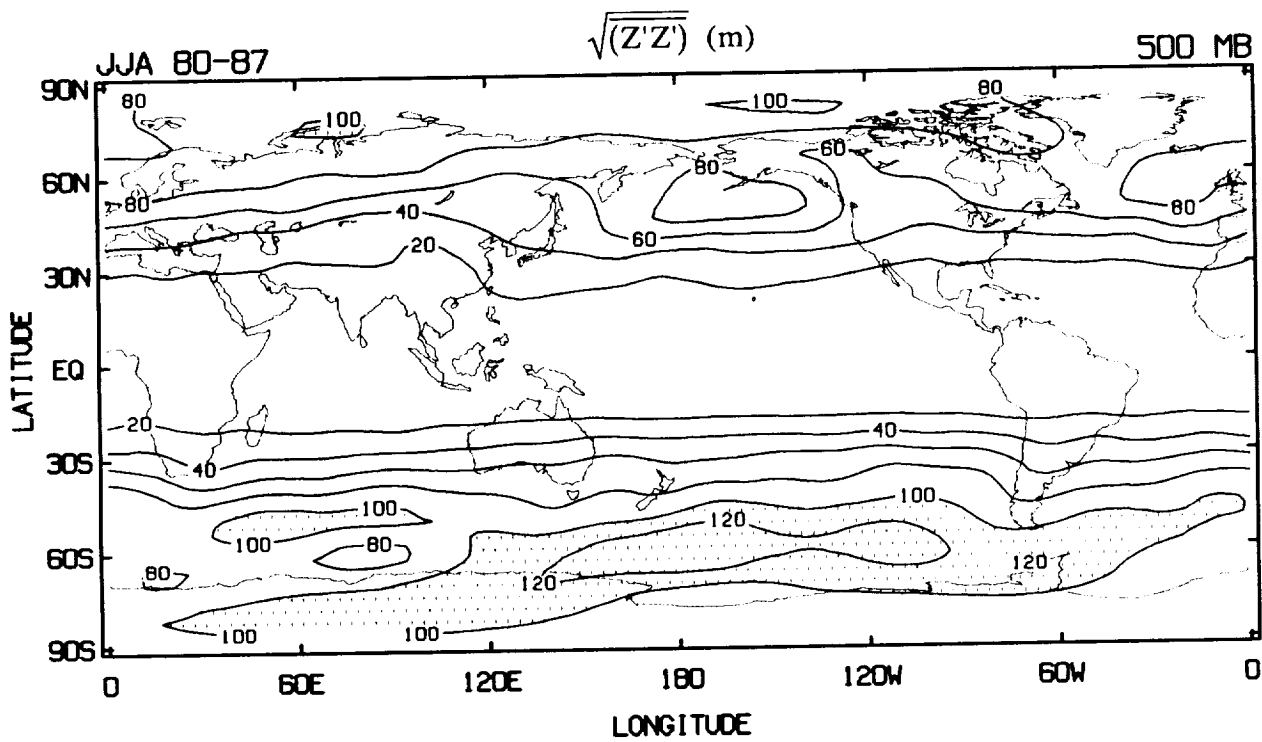

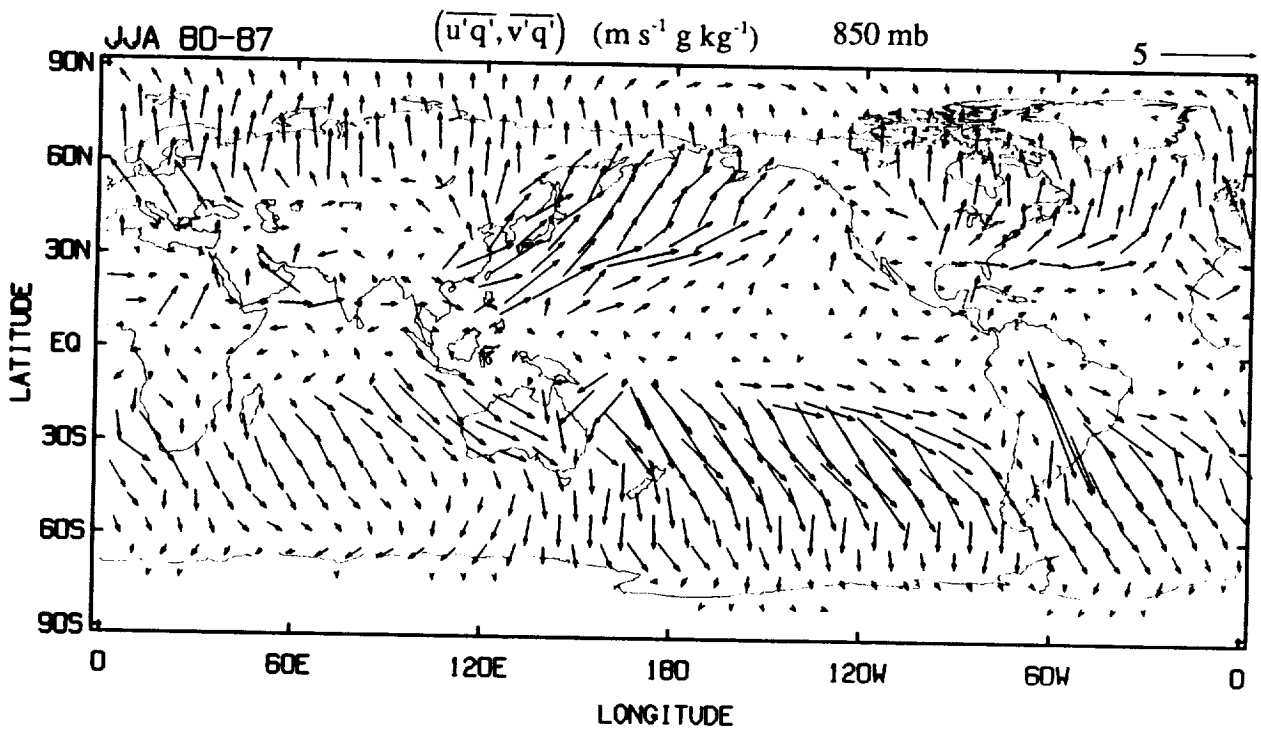
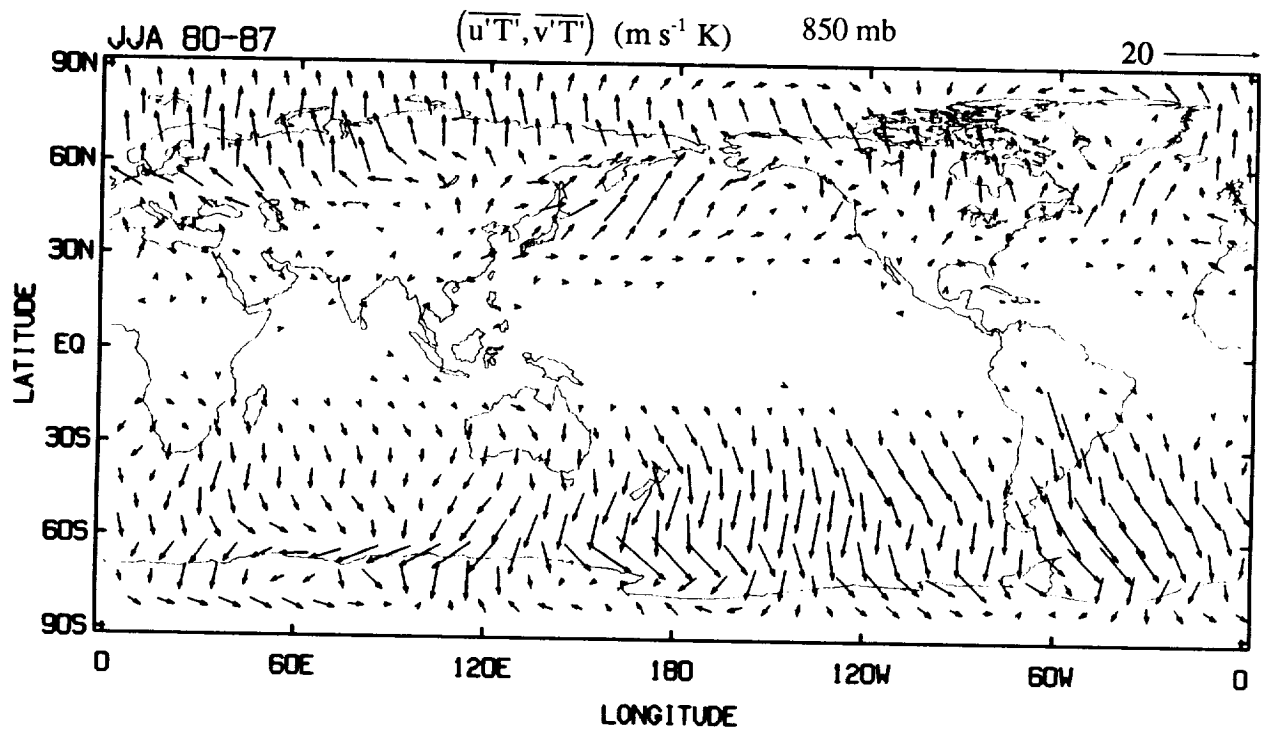

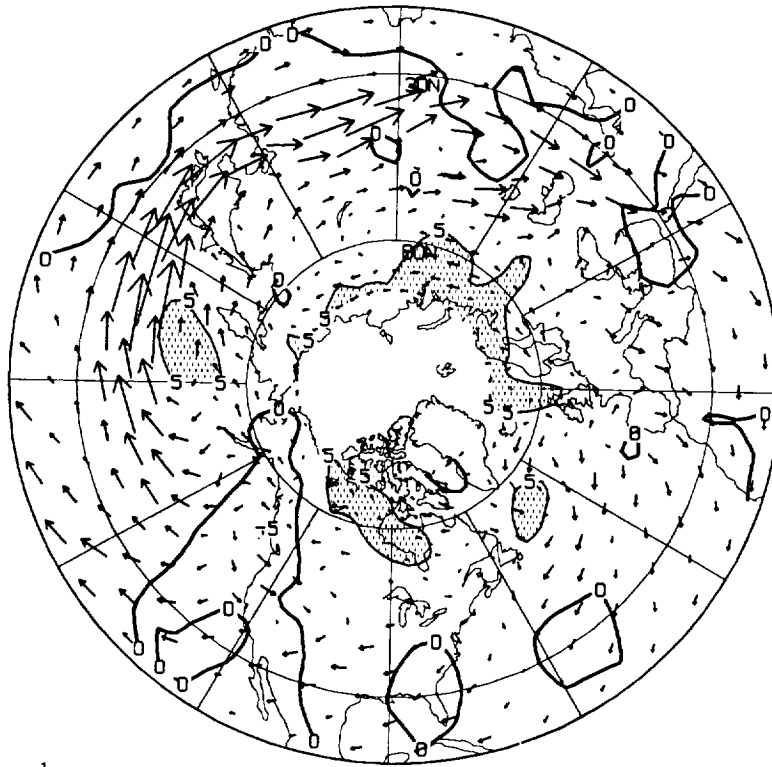

$\overline{v'T'}$ ($\text{m s}^{-1}\text{K}$) 850 mb

E_u ($\text{m}^2 \text{s}^{-2}$) 200 mb

100 \rightarrow

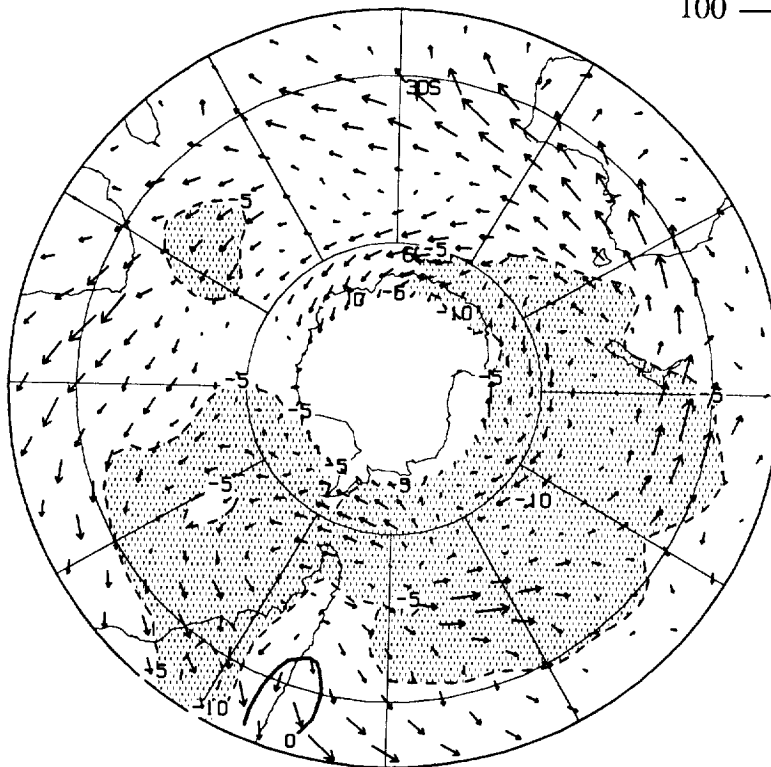

JJA (80-87)

135

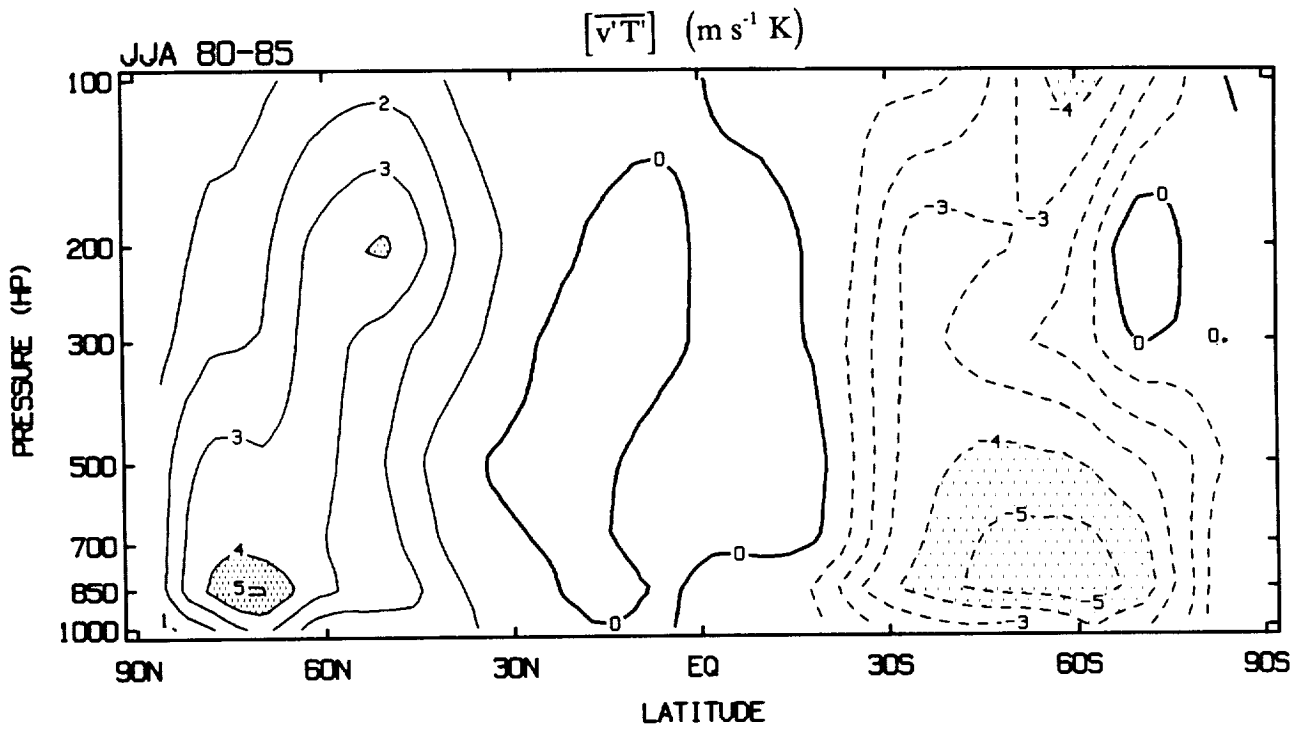
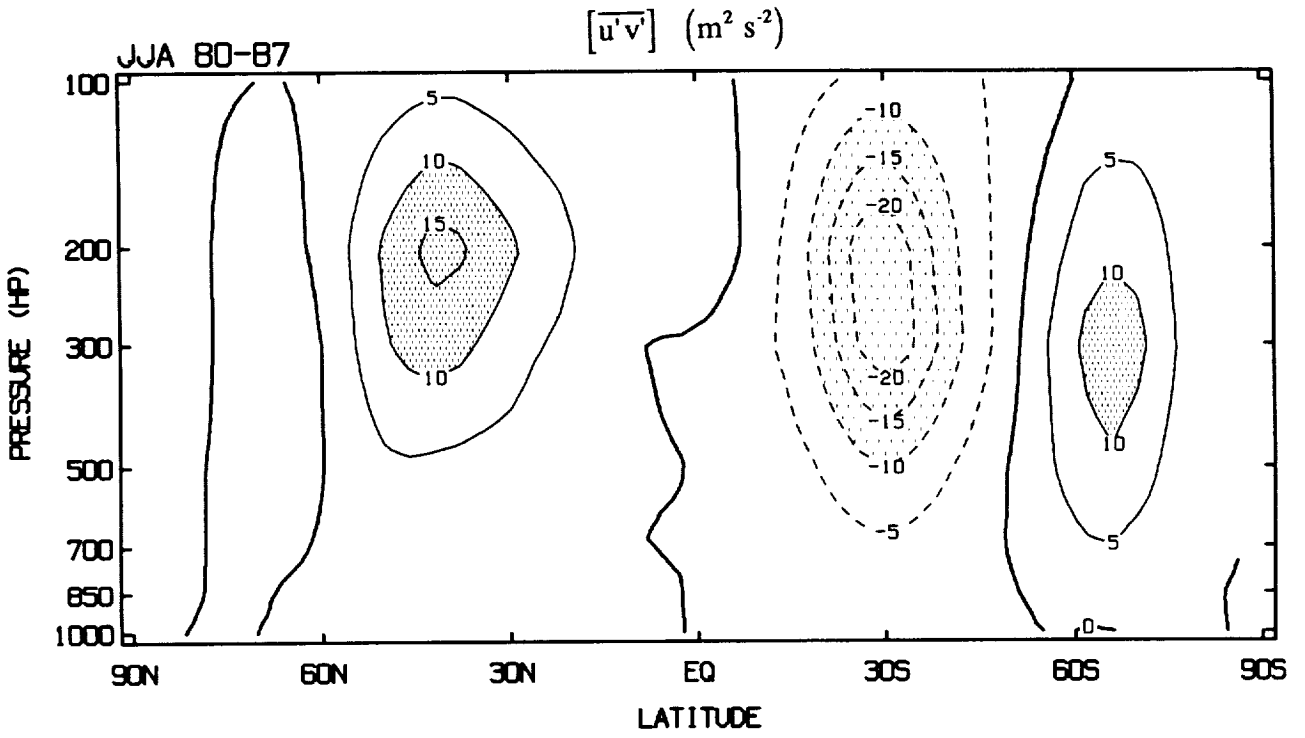

BAND PASS

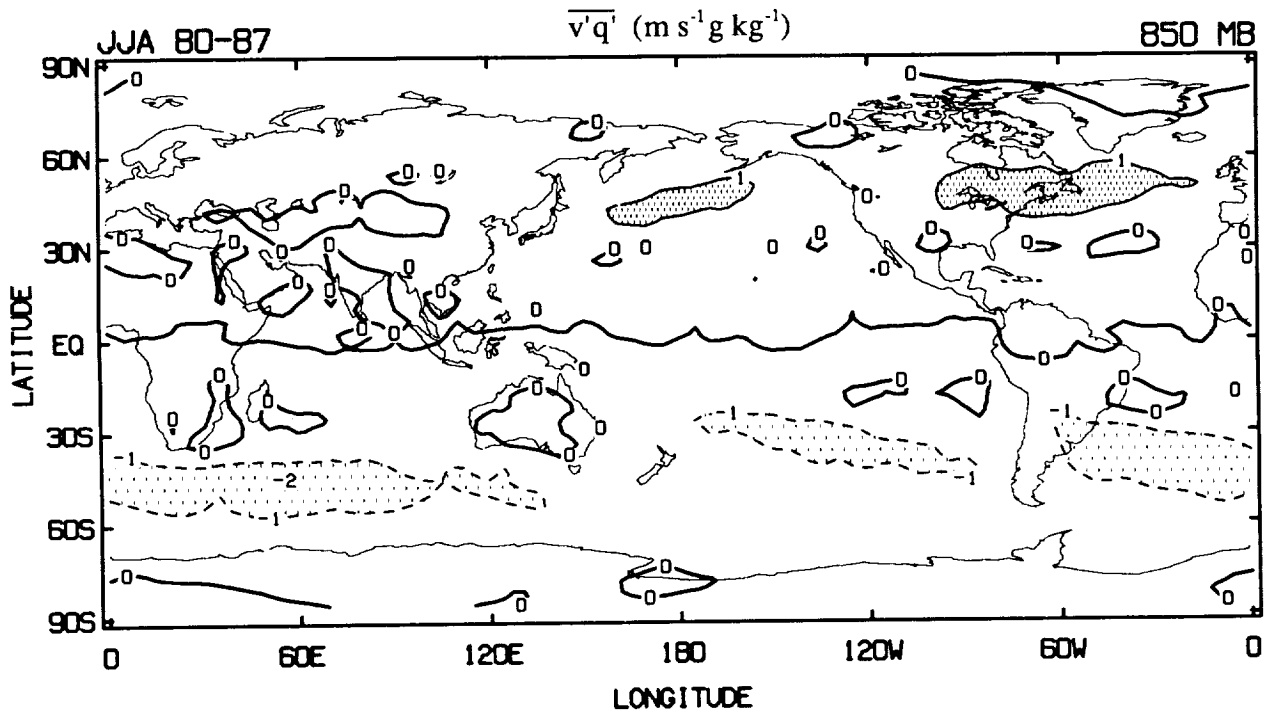
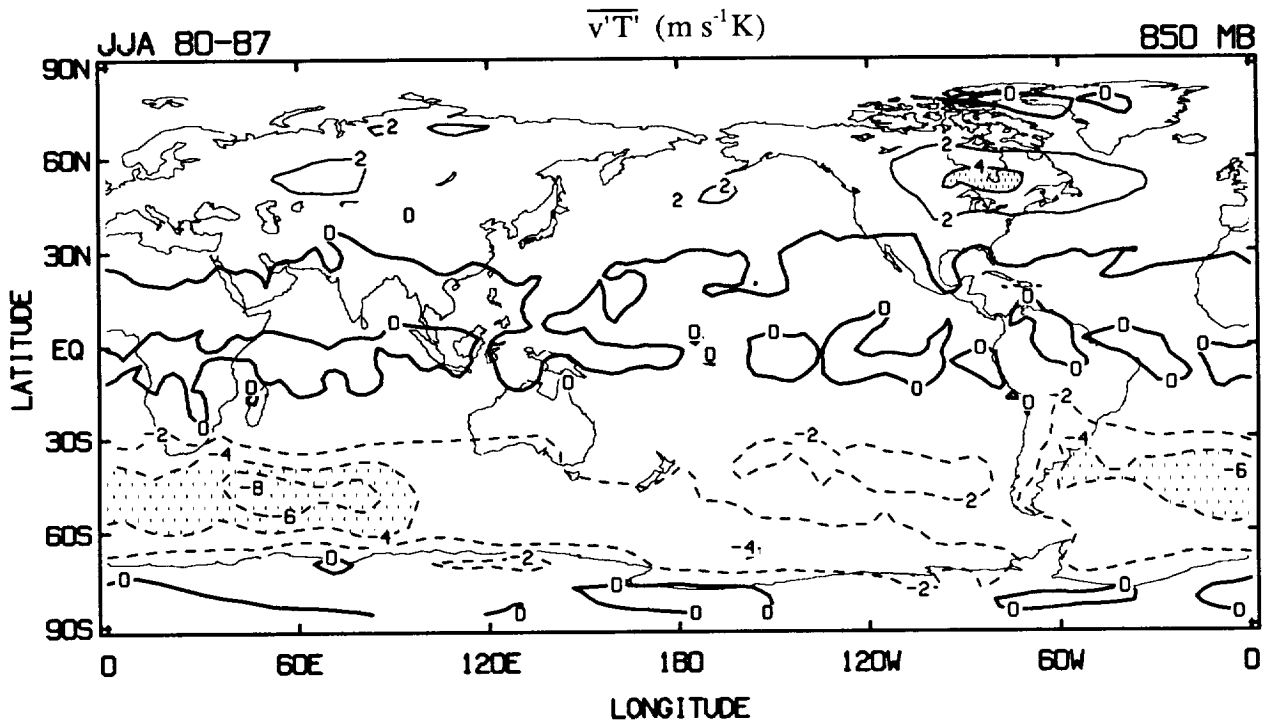

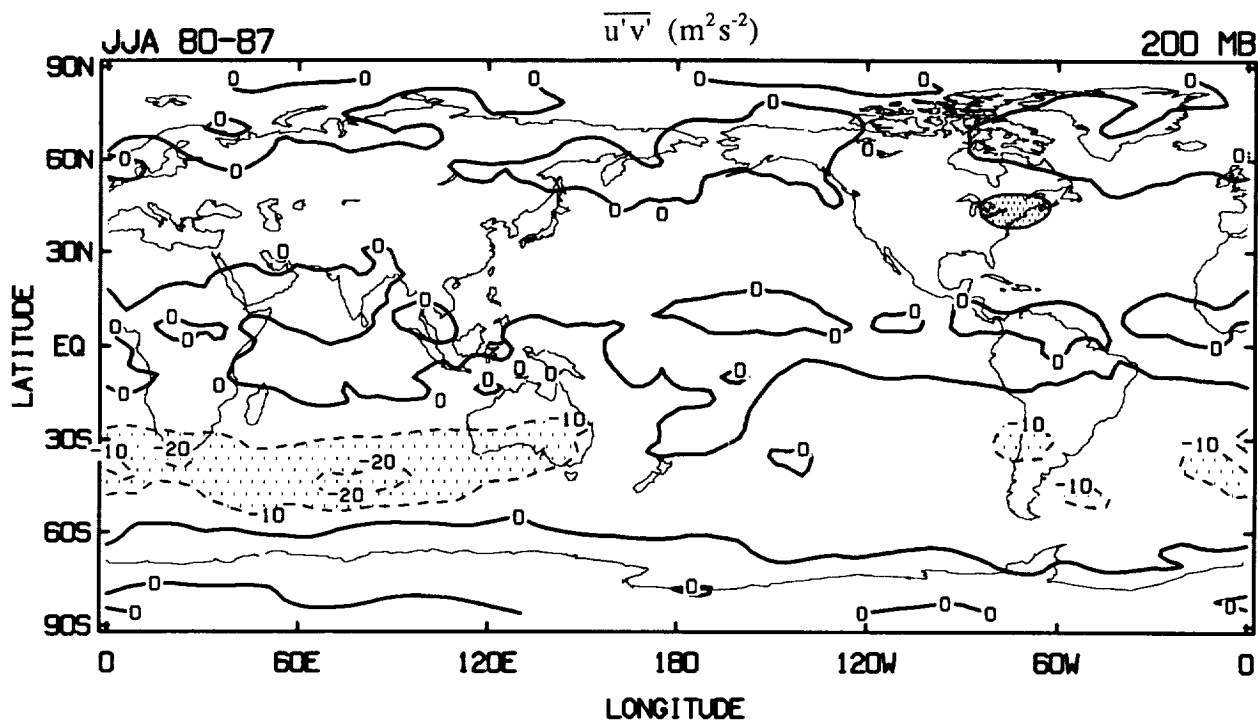

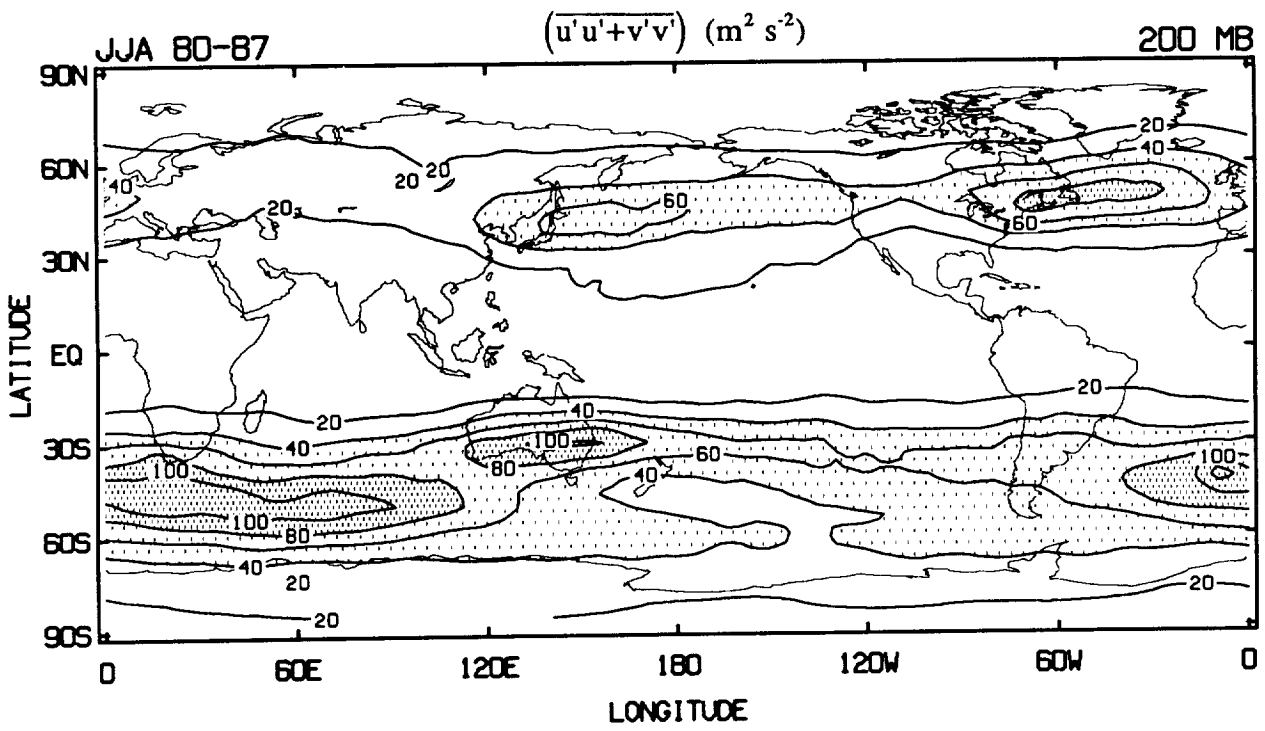
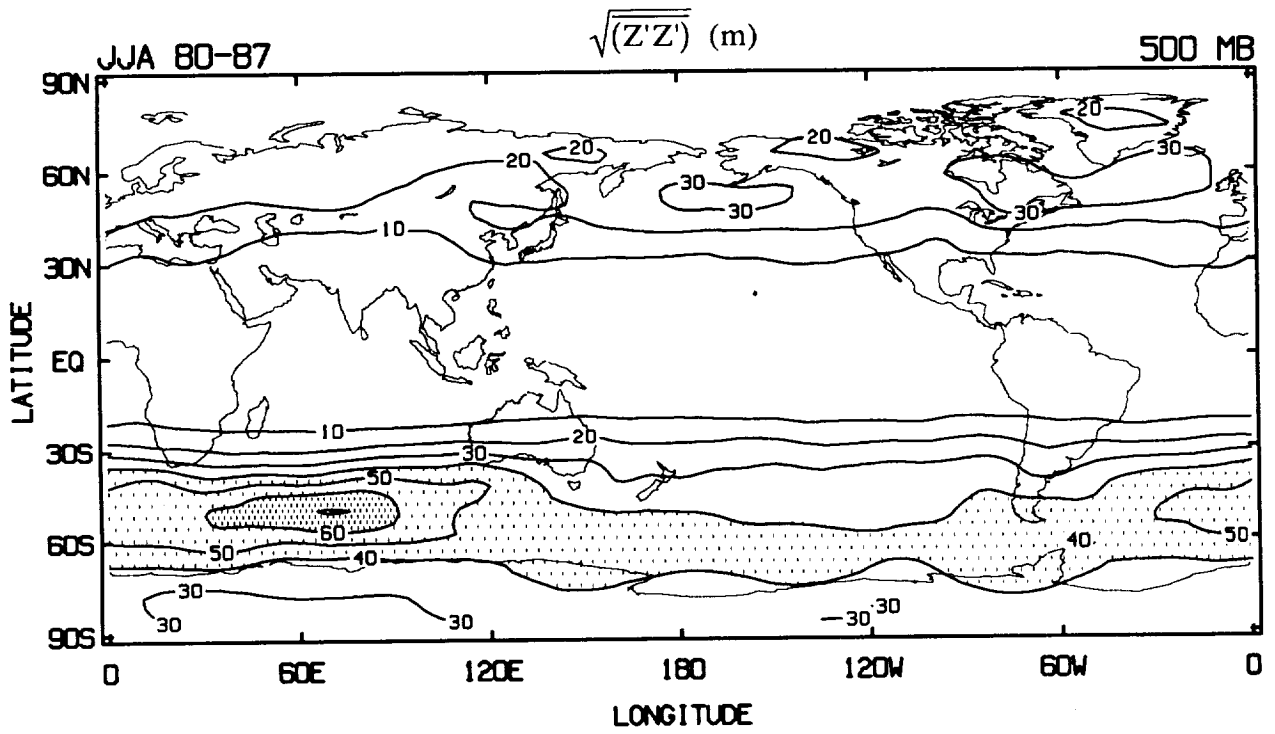

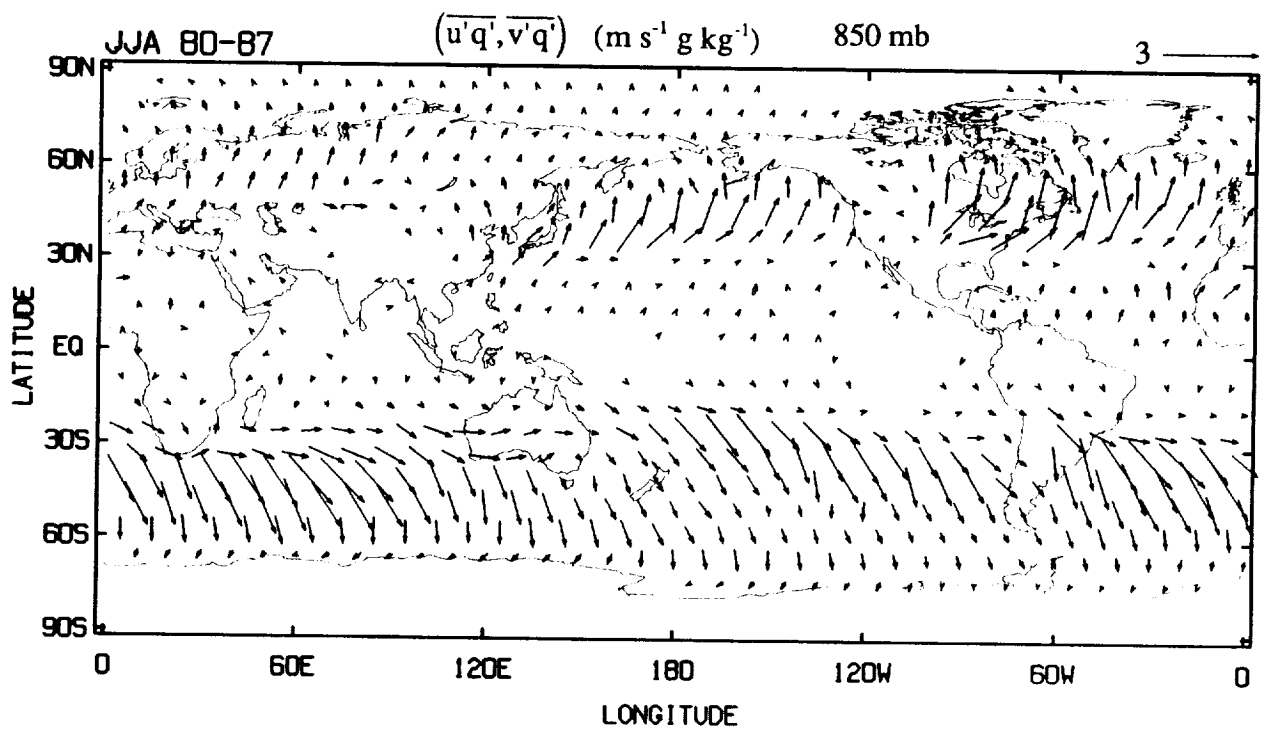
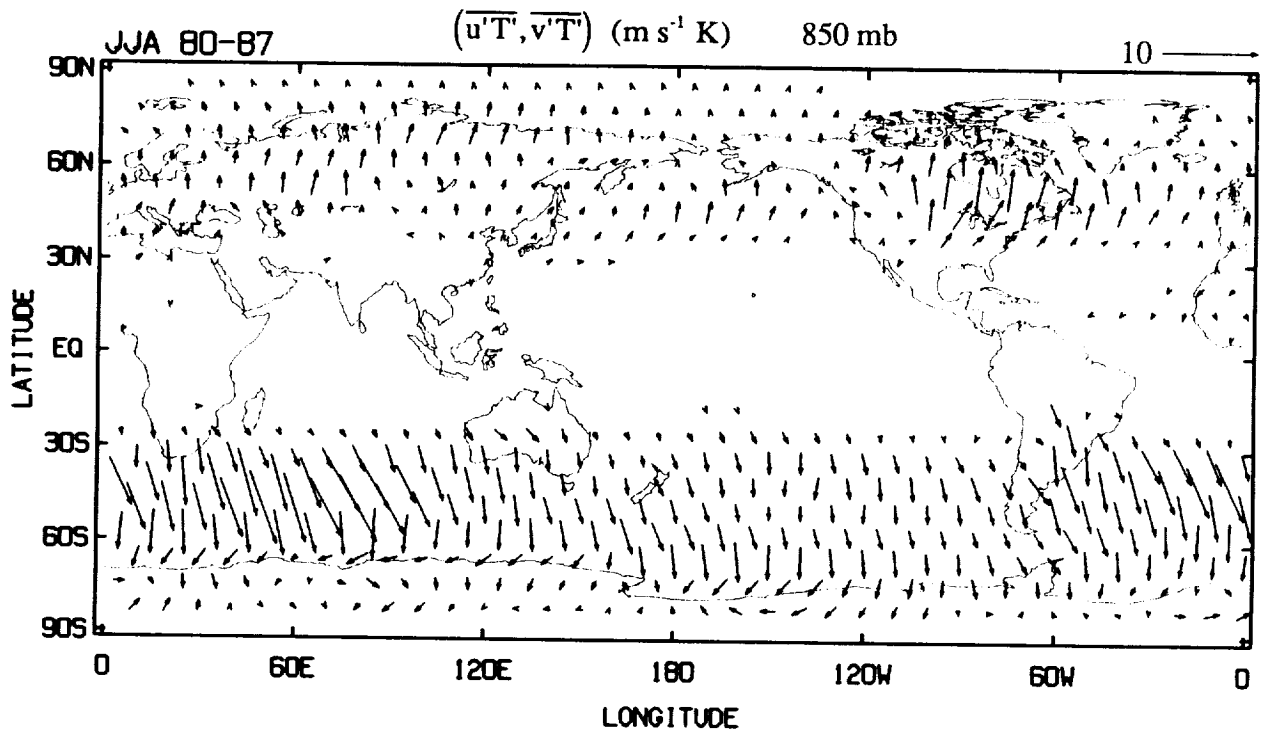

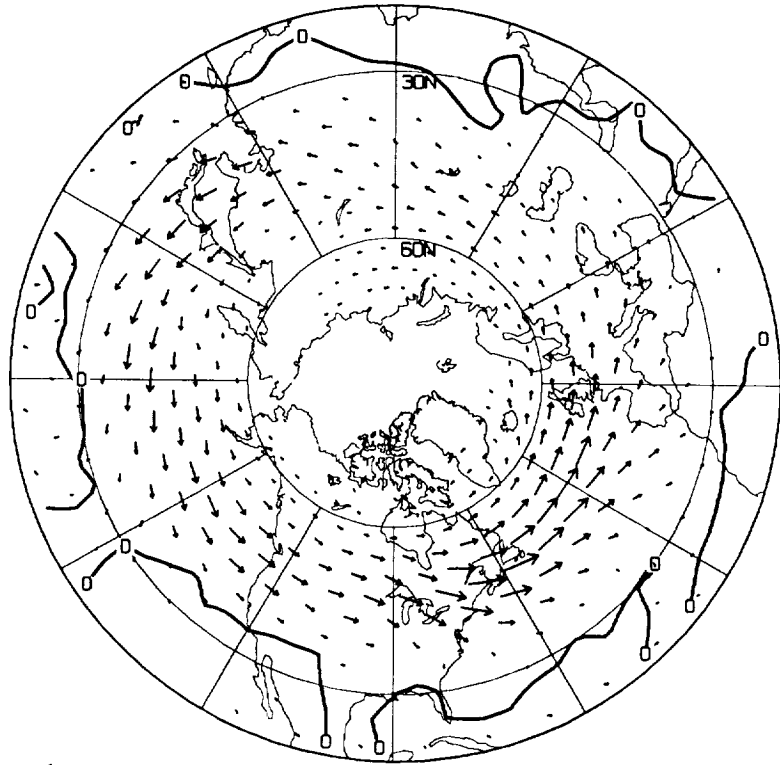

$\overline{v'T'}$ ($\text{m s}^{-1}\text{K}$) 850 mb

E_v ($\text{m}^2 \text{s}^{-2}$) 200 mb

50 \rightarrow

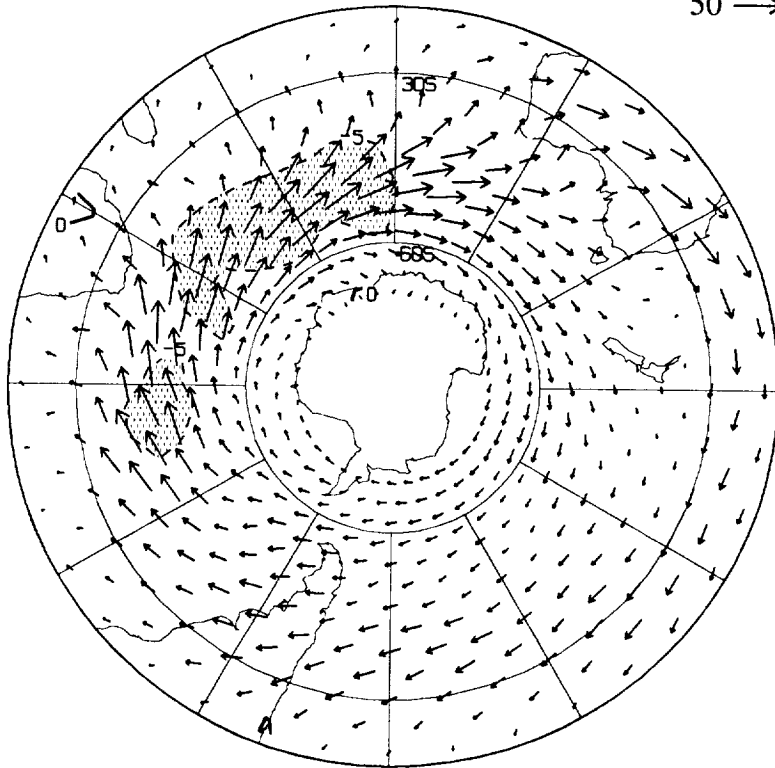

JJA (80-87)

143

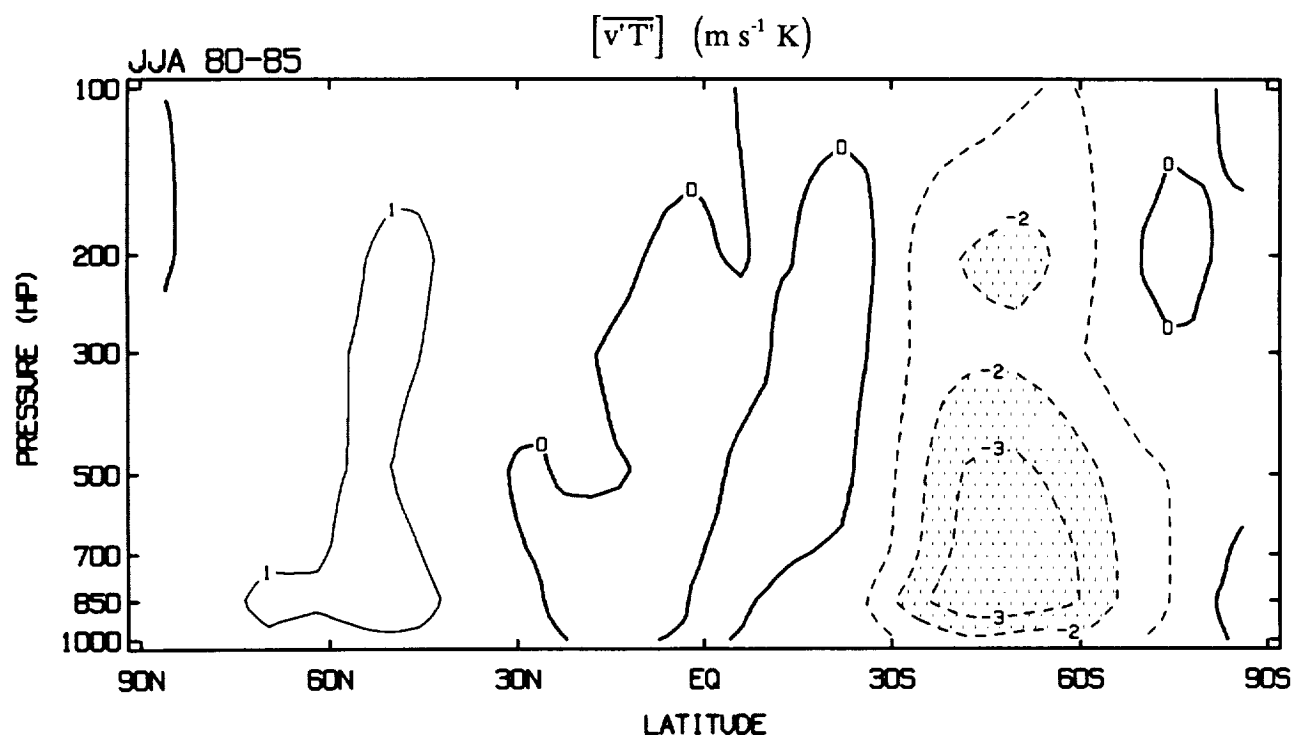
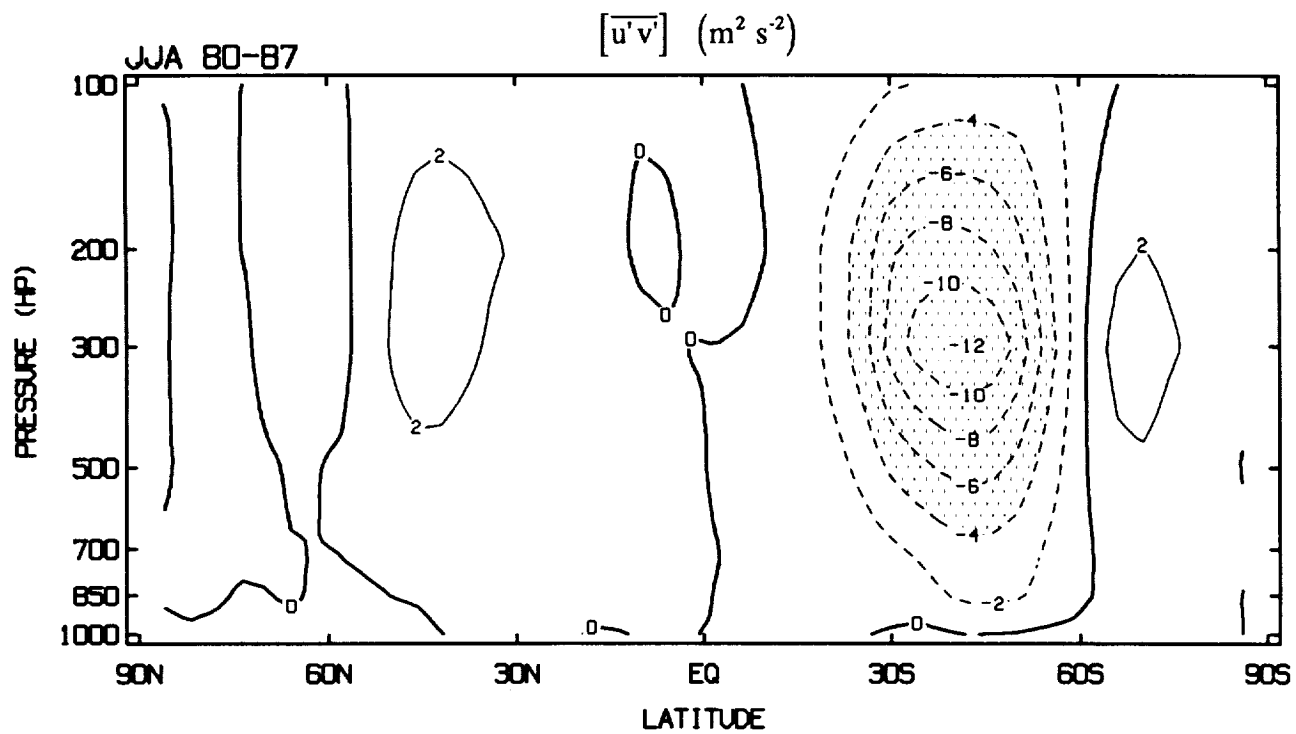

SON

DEVIATIONS FROM MONTHLY MEANS

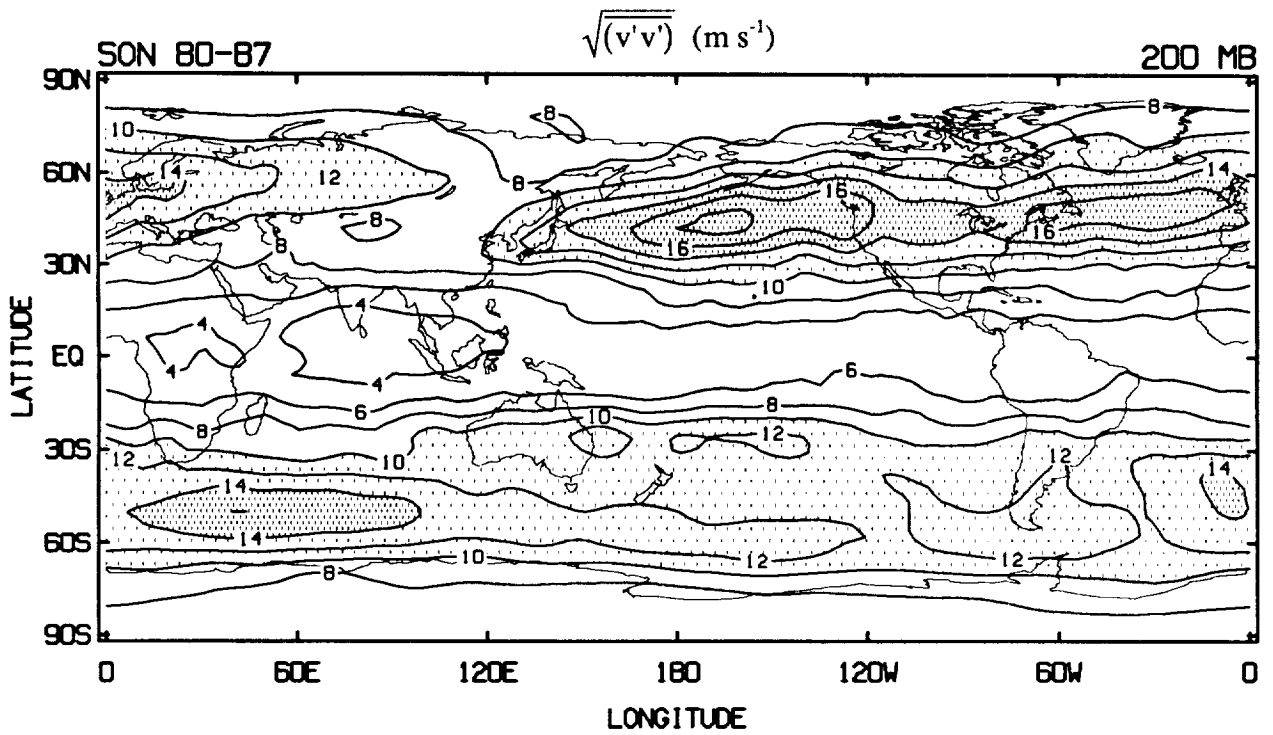
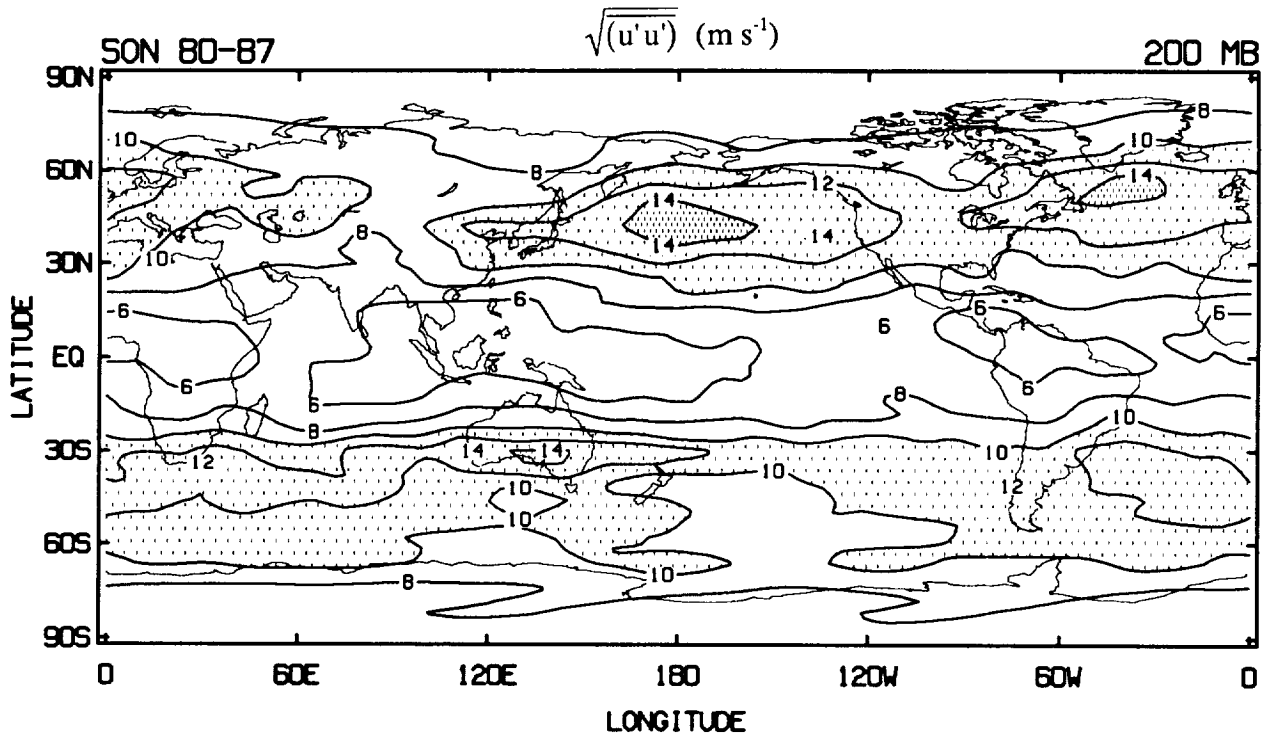

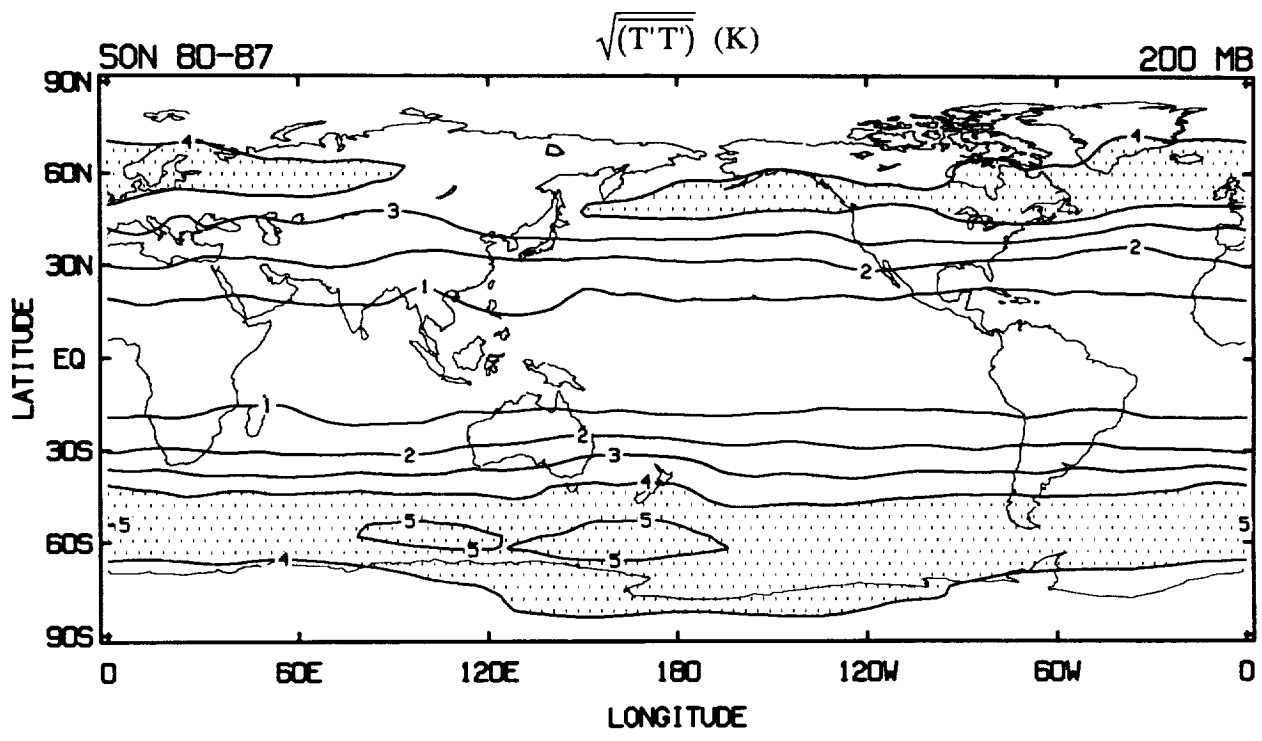
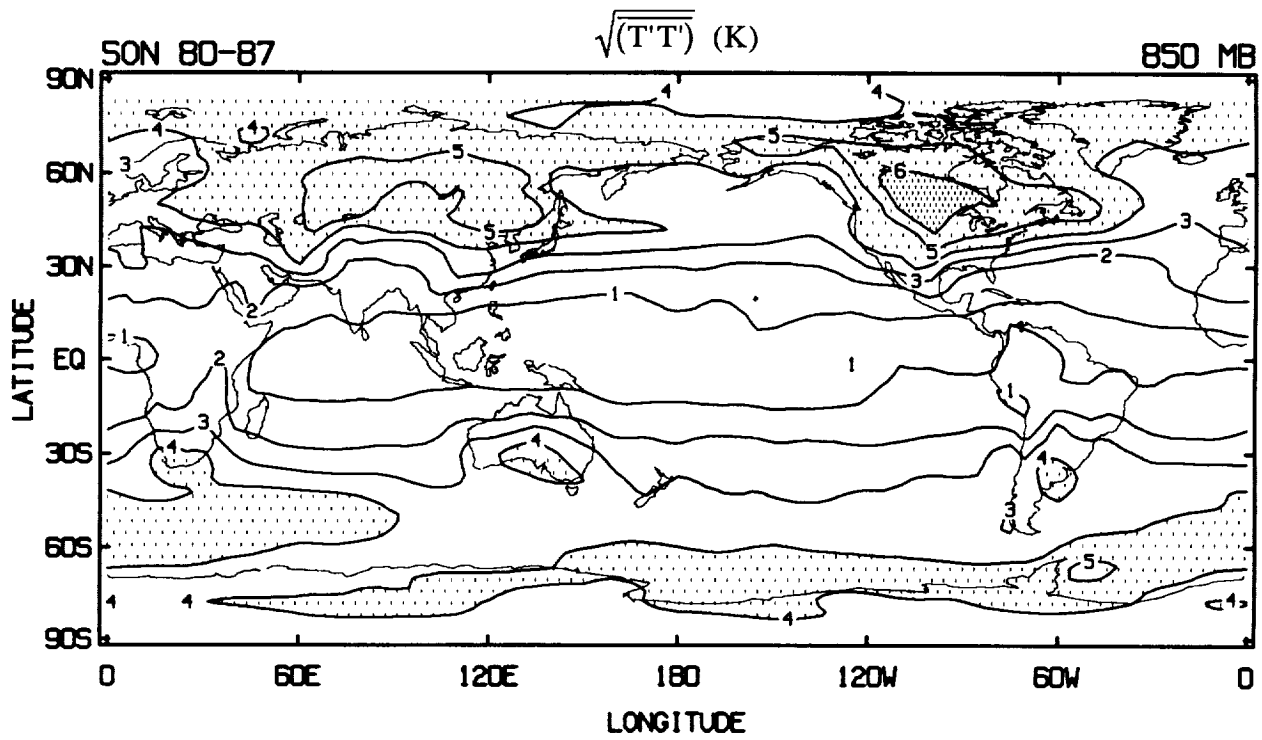

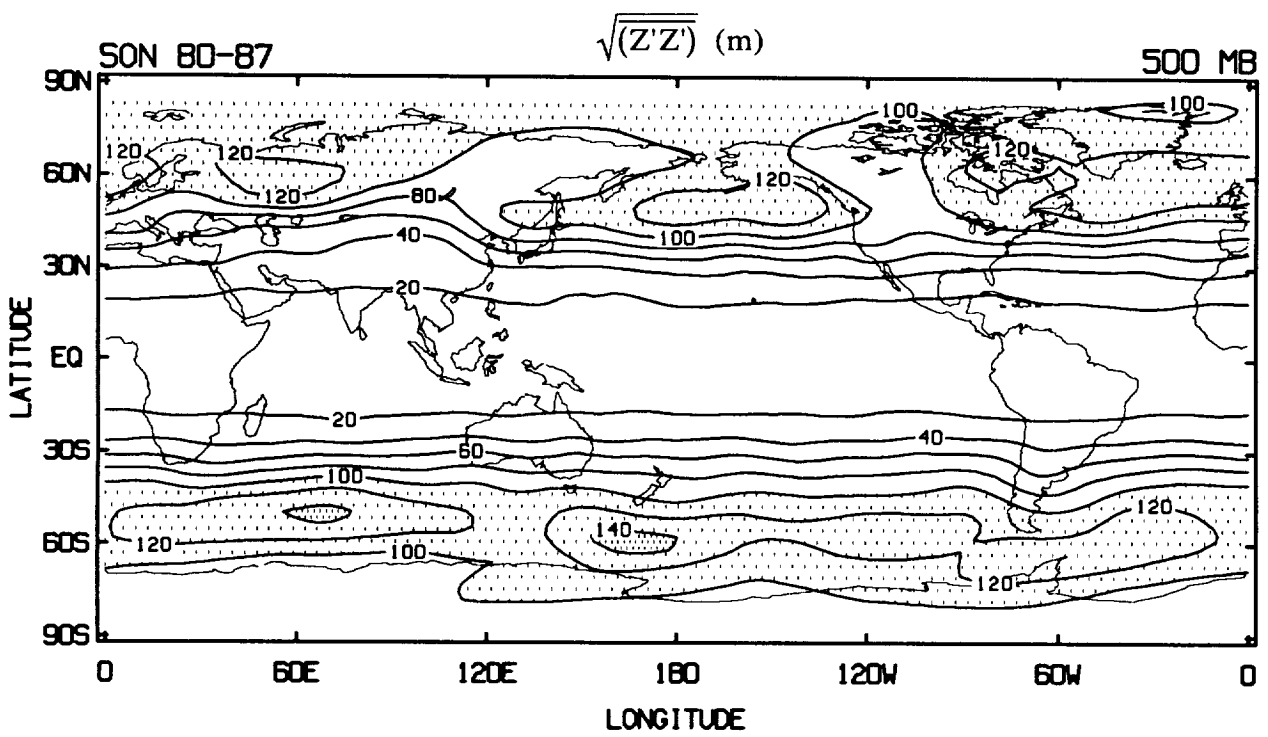
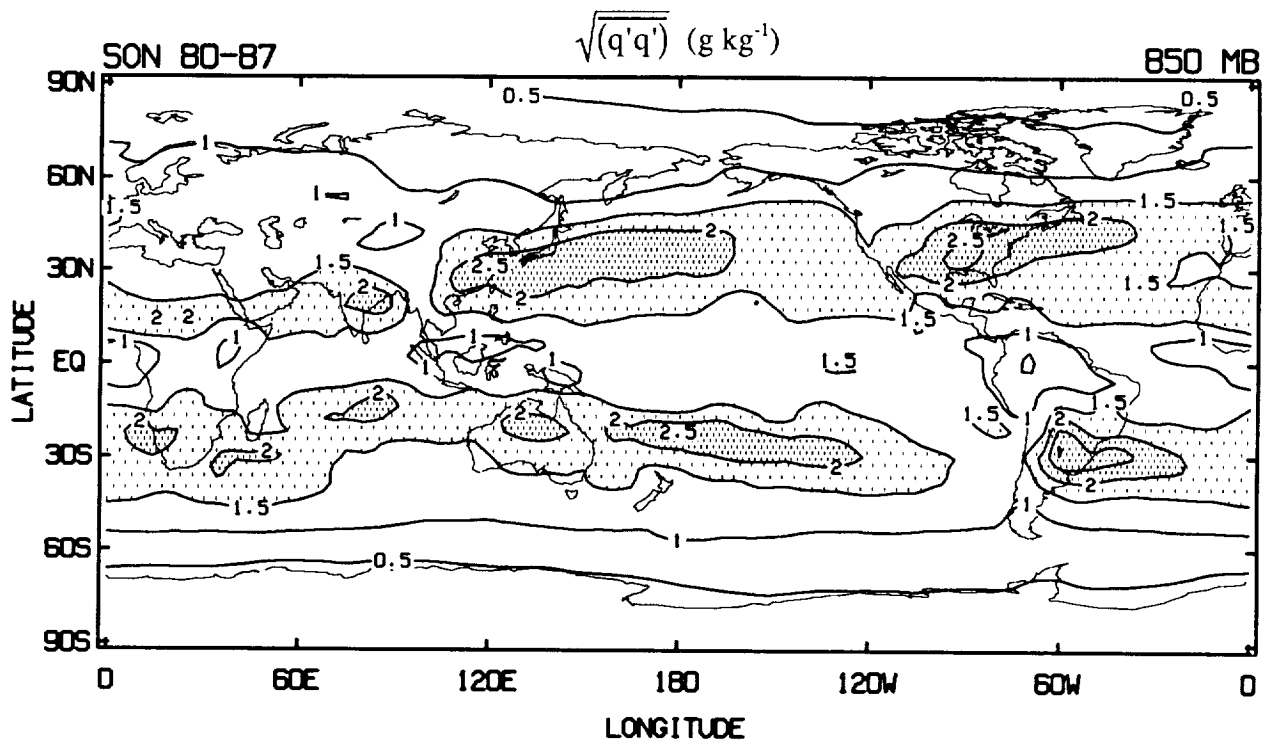

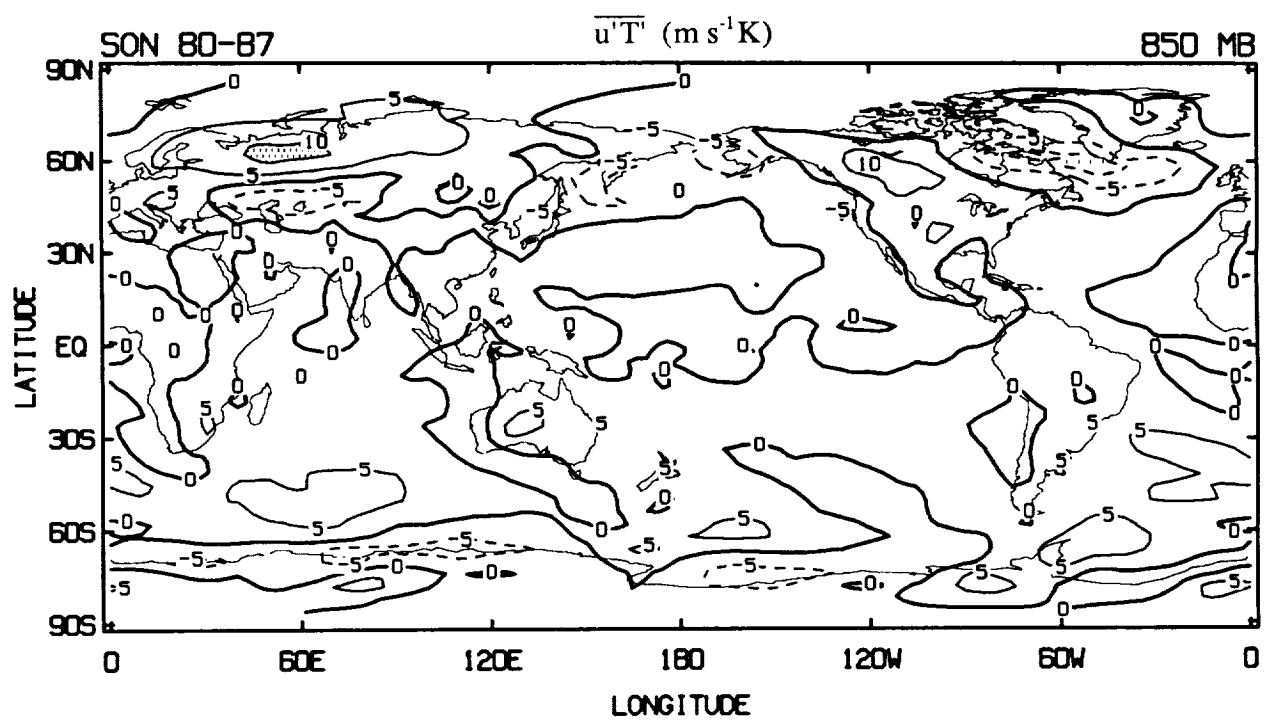
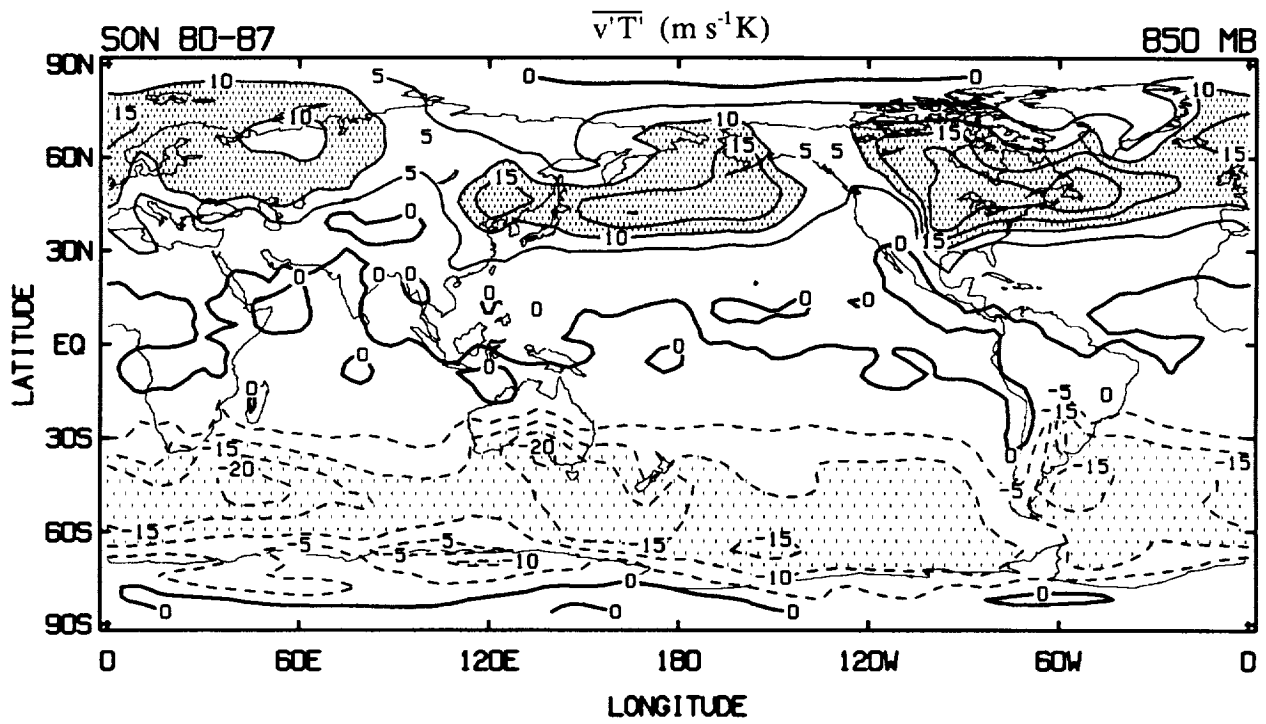

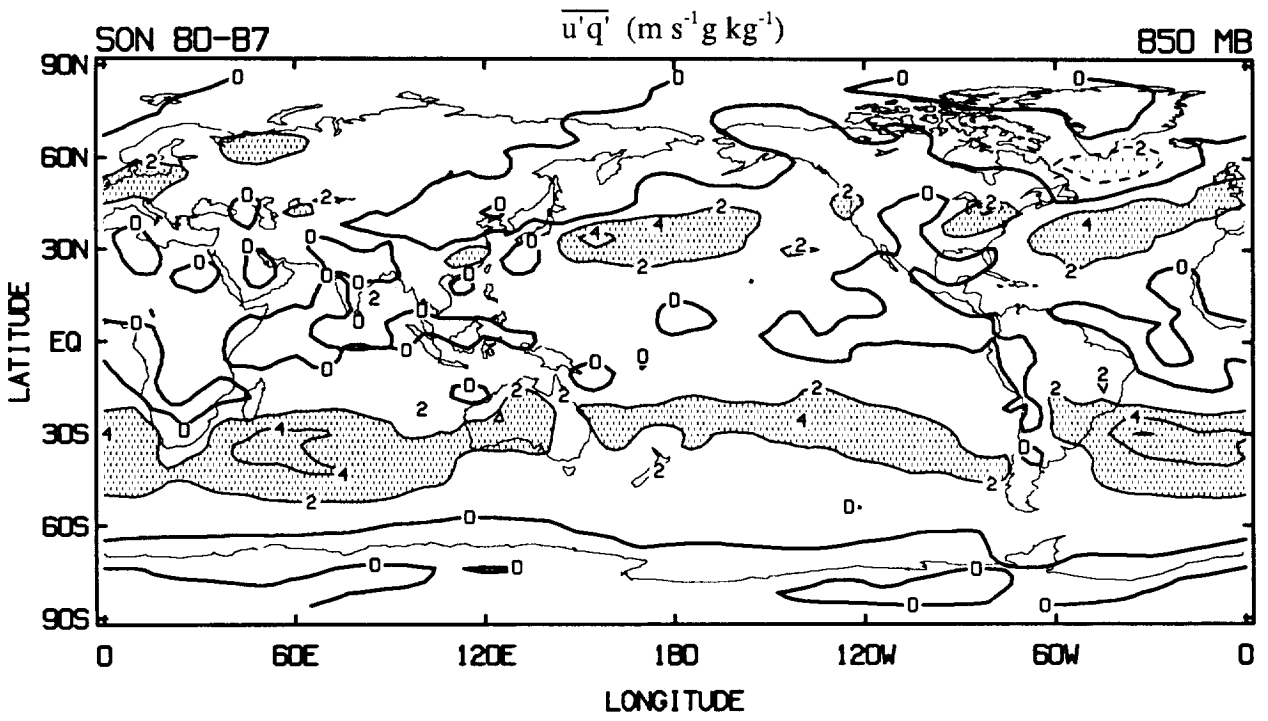
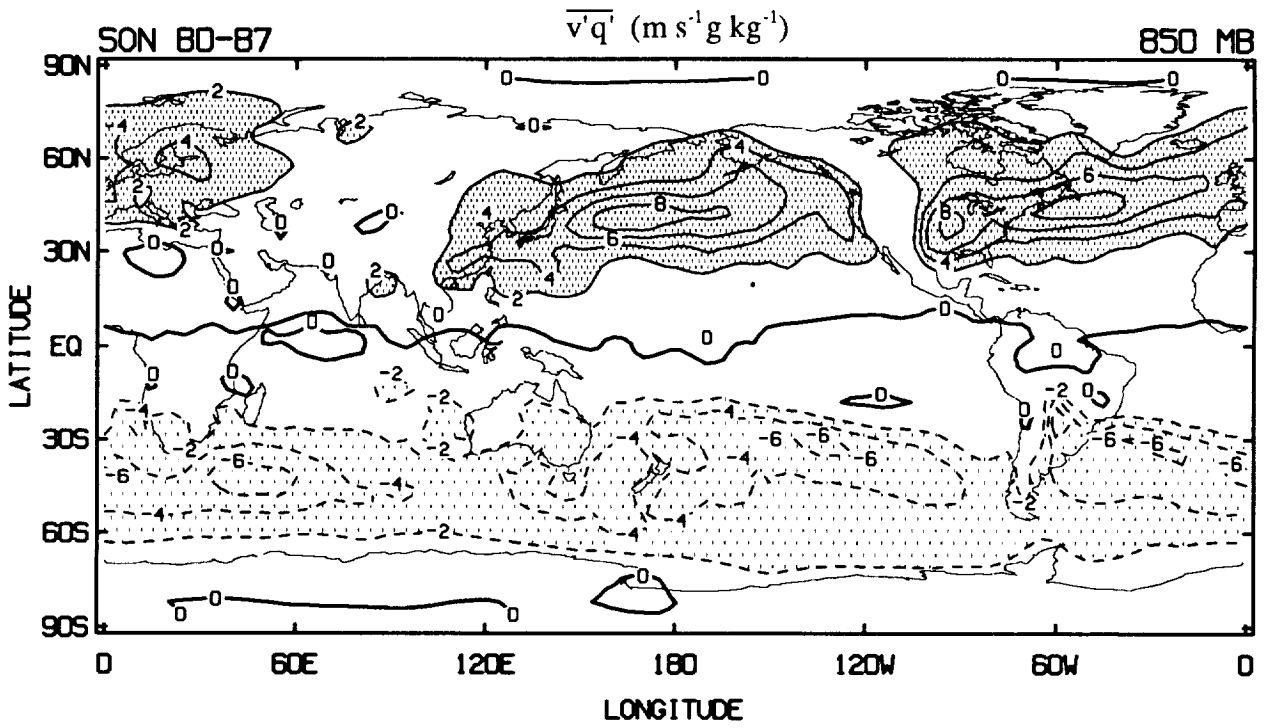

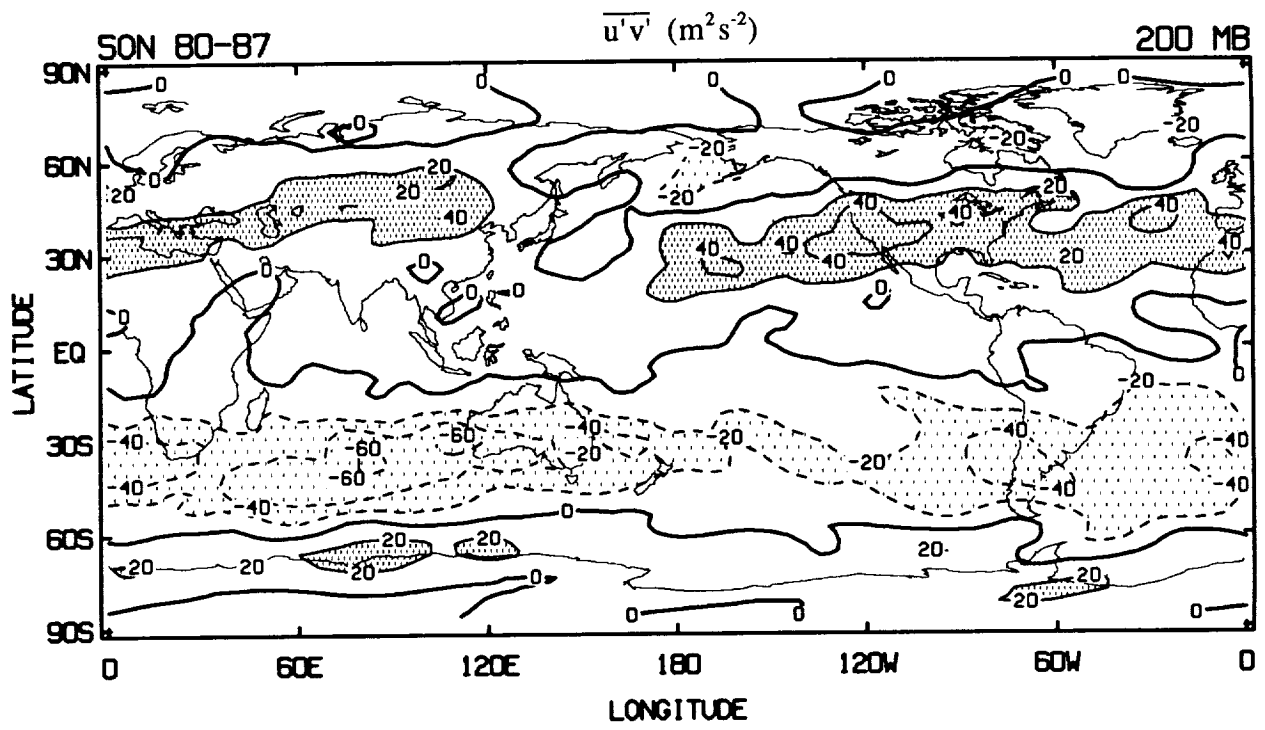

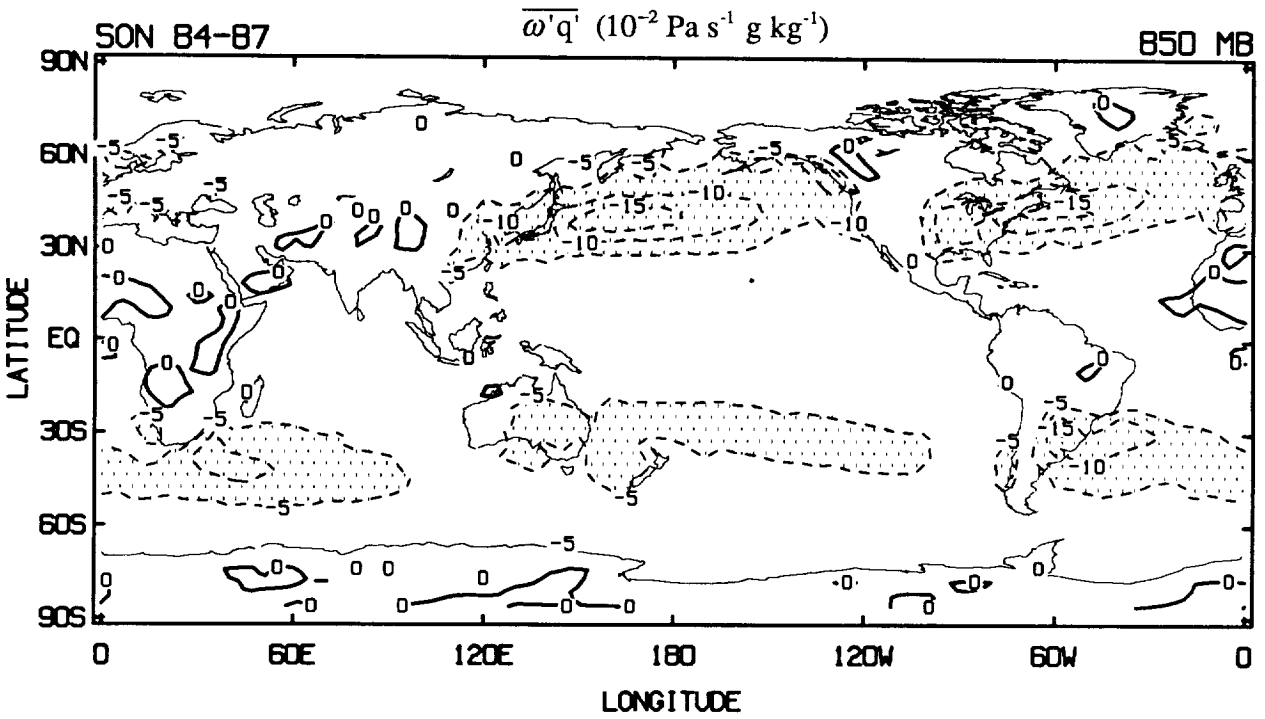
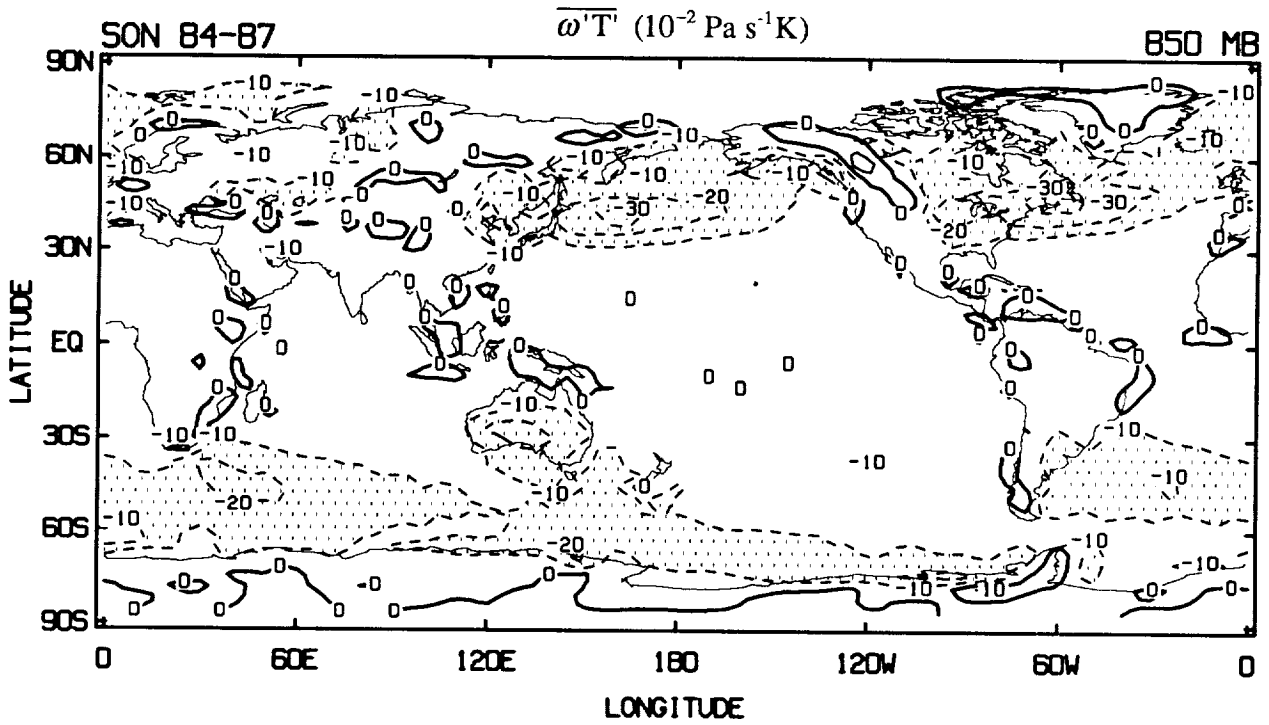

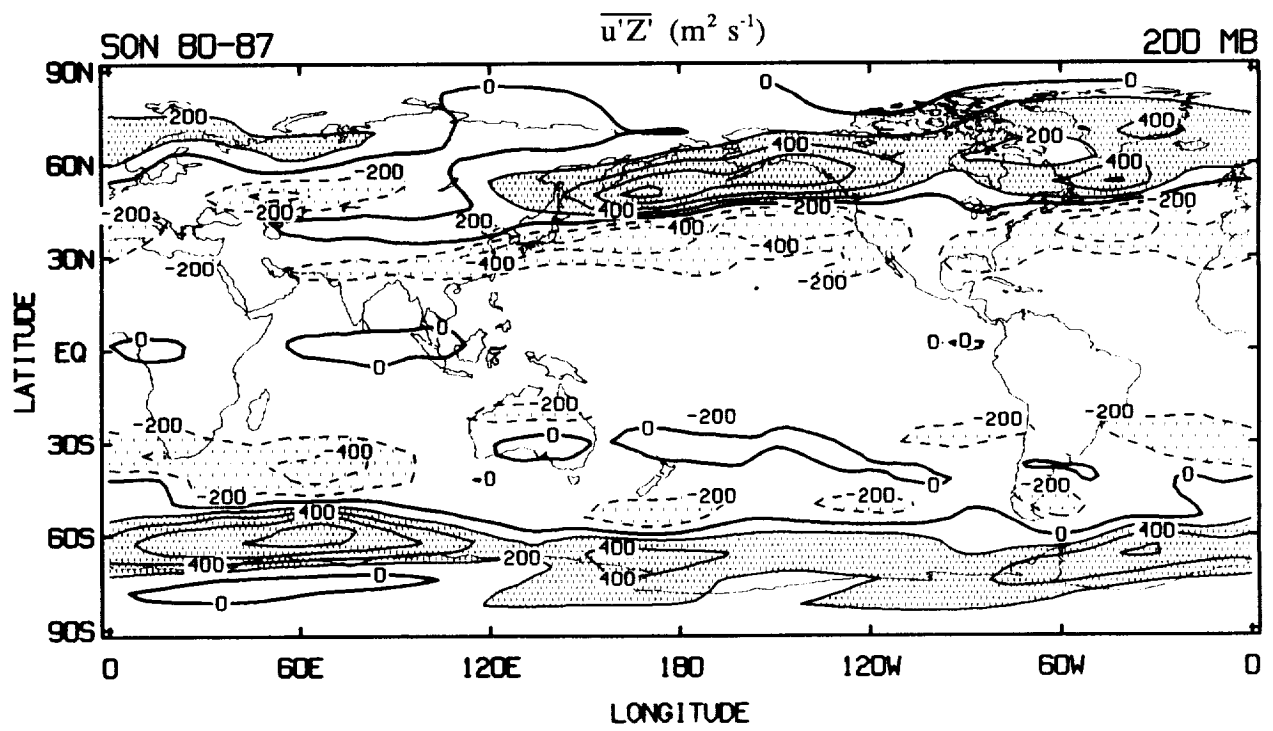
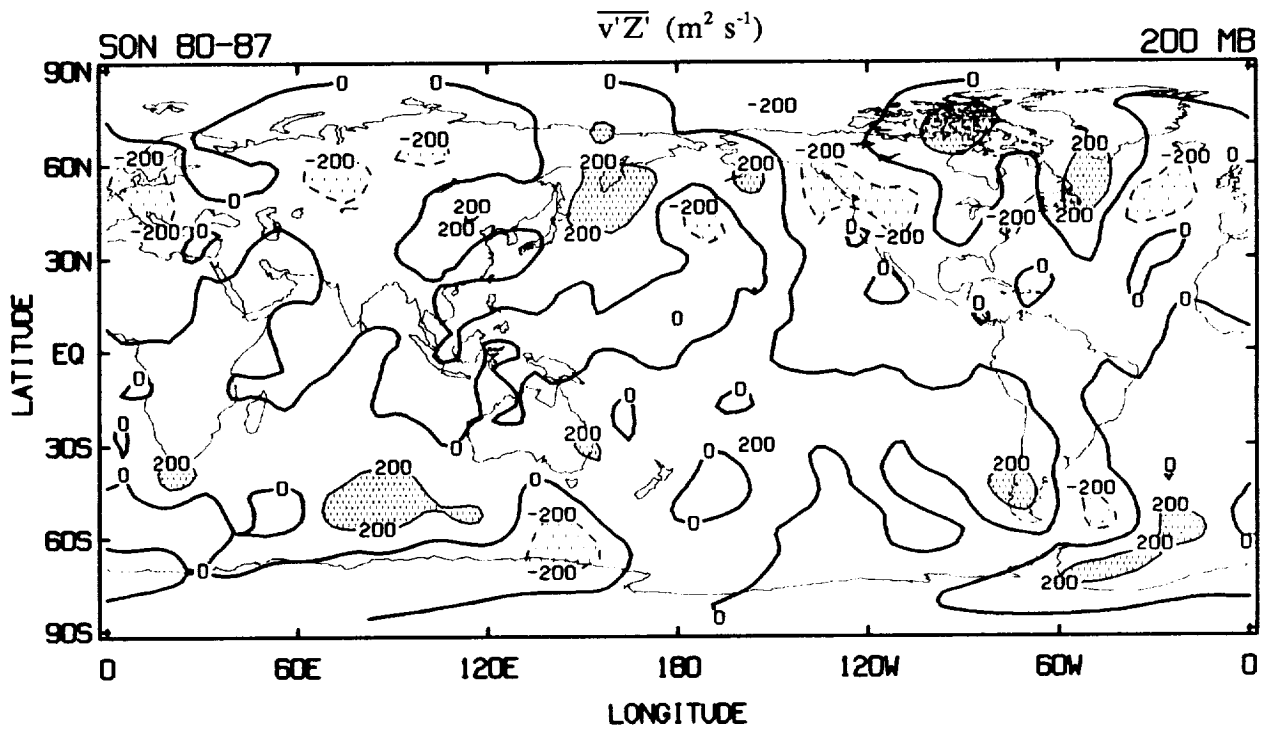

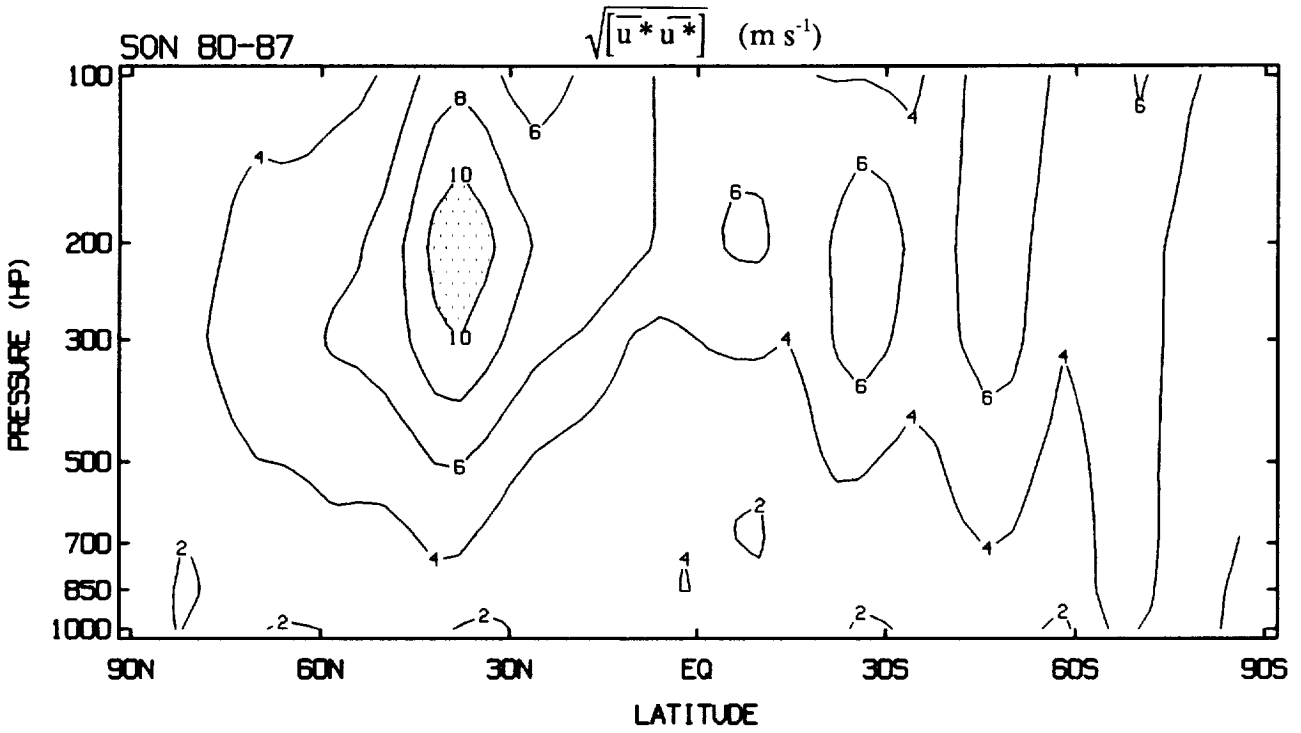
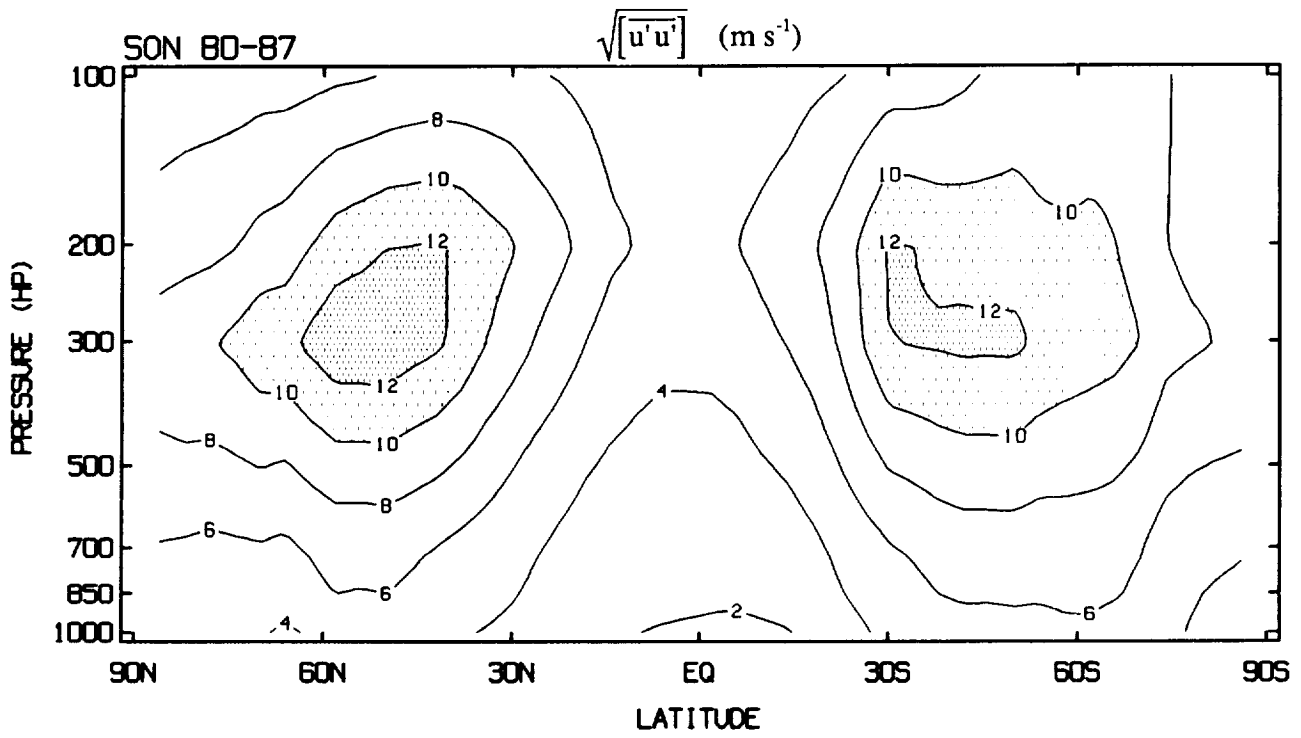

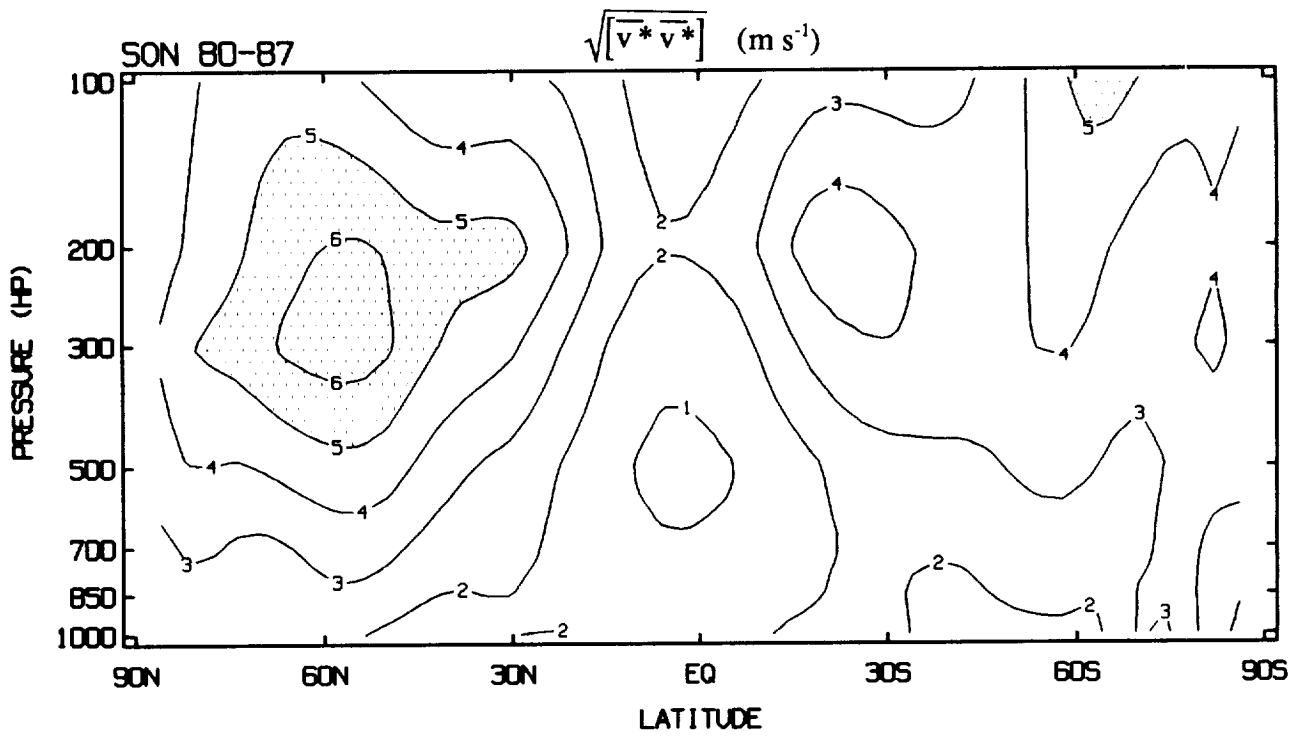
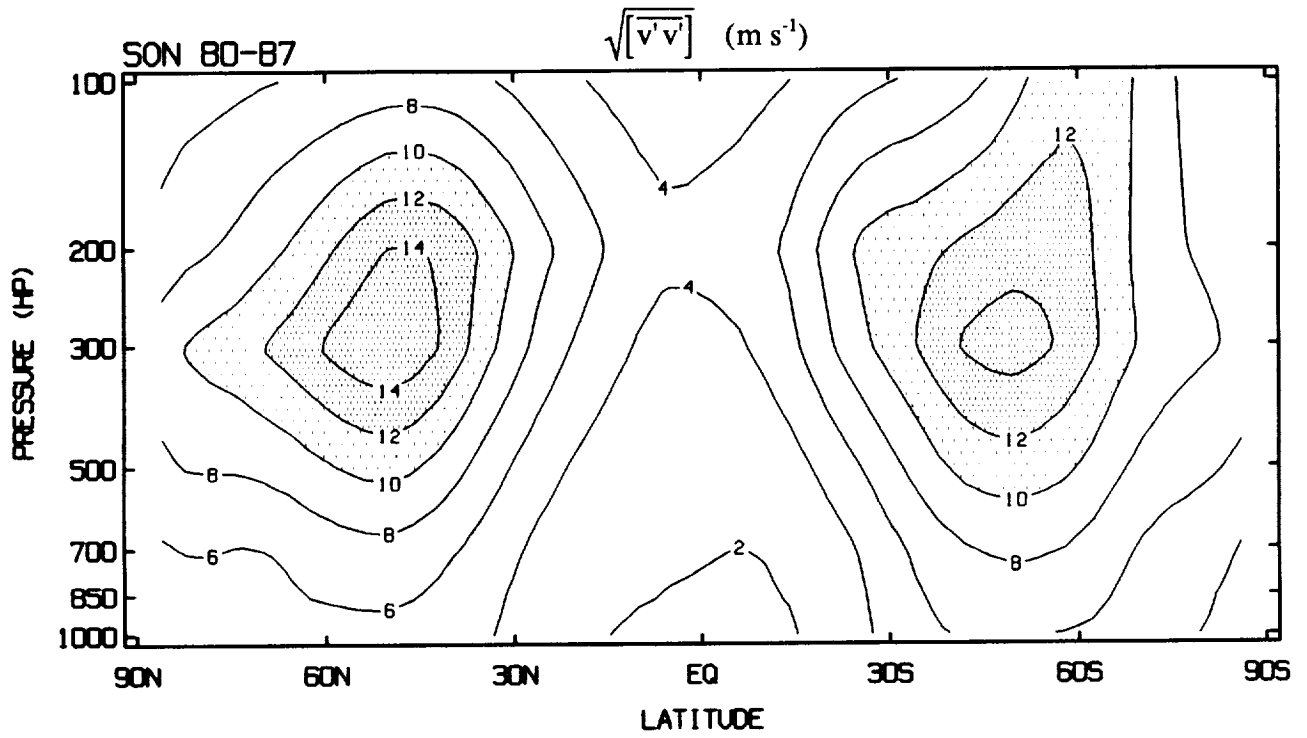

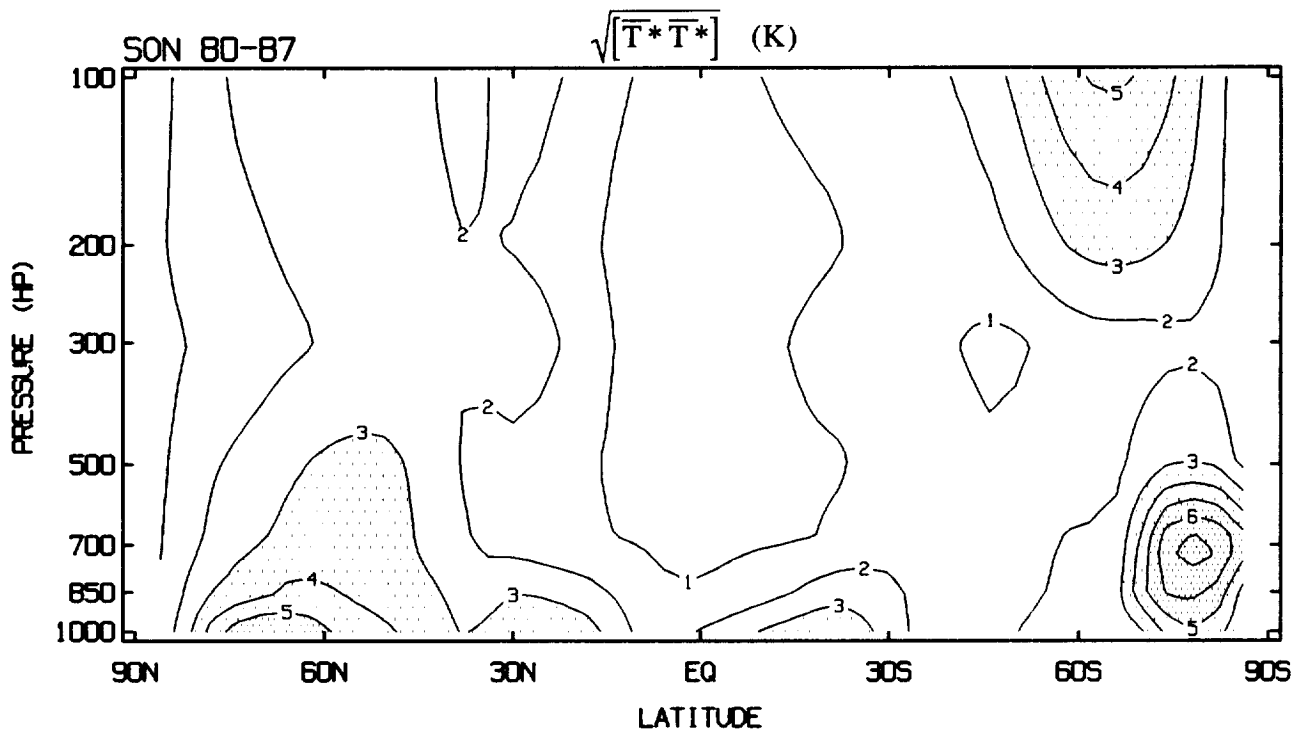
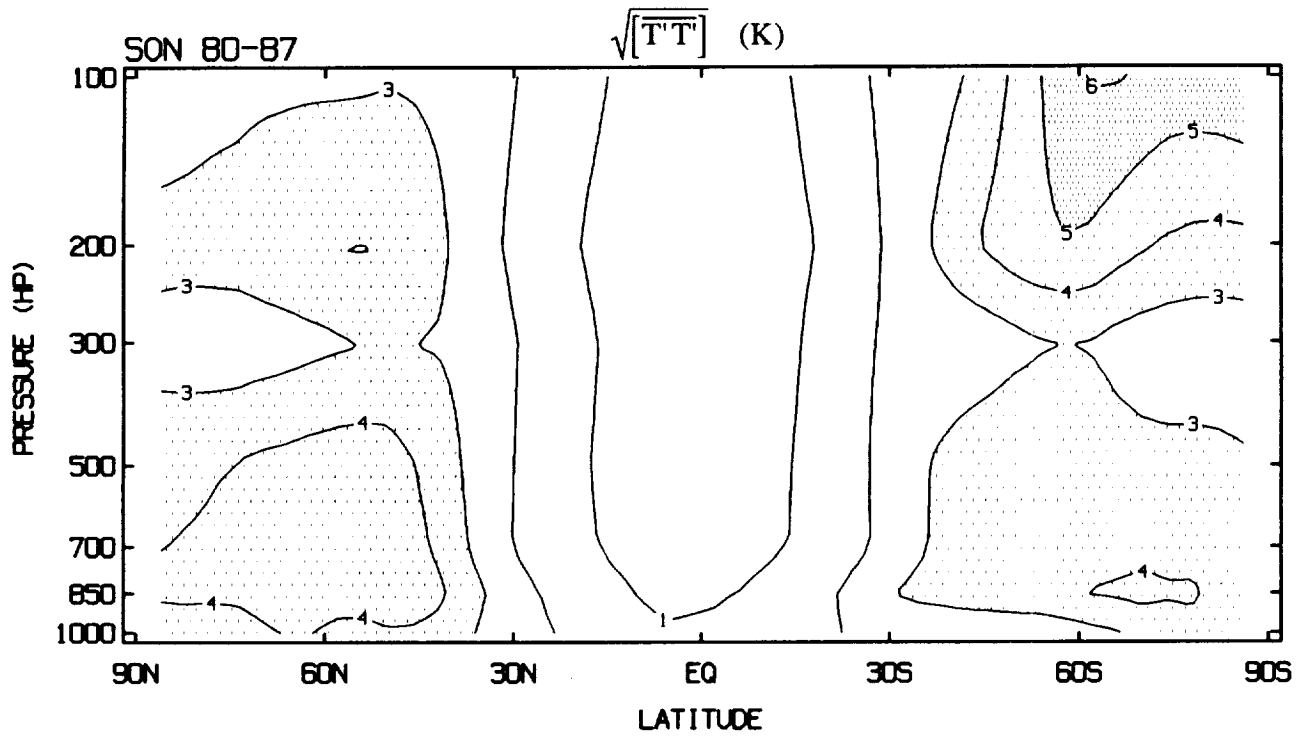

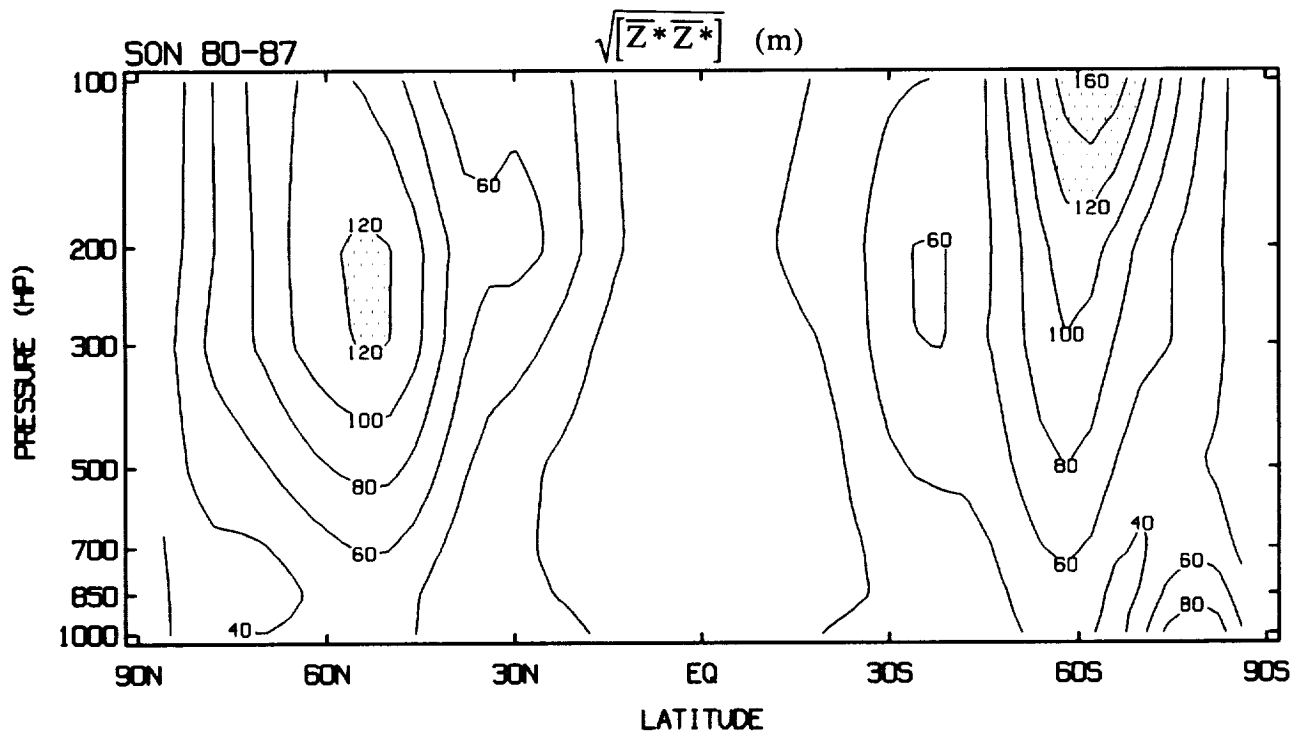
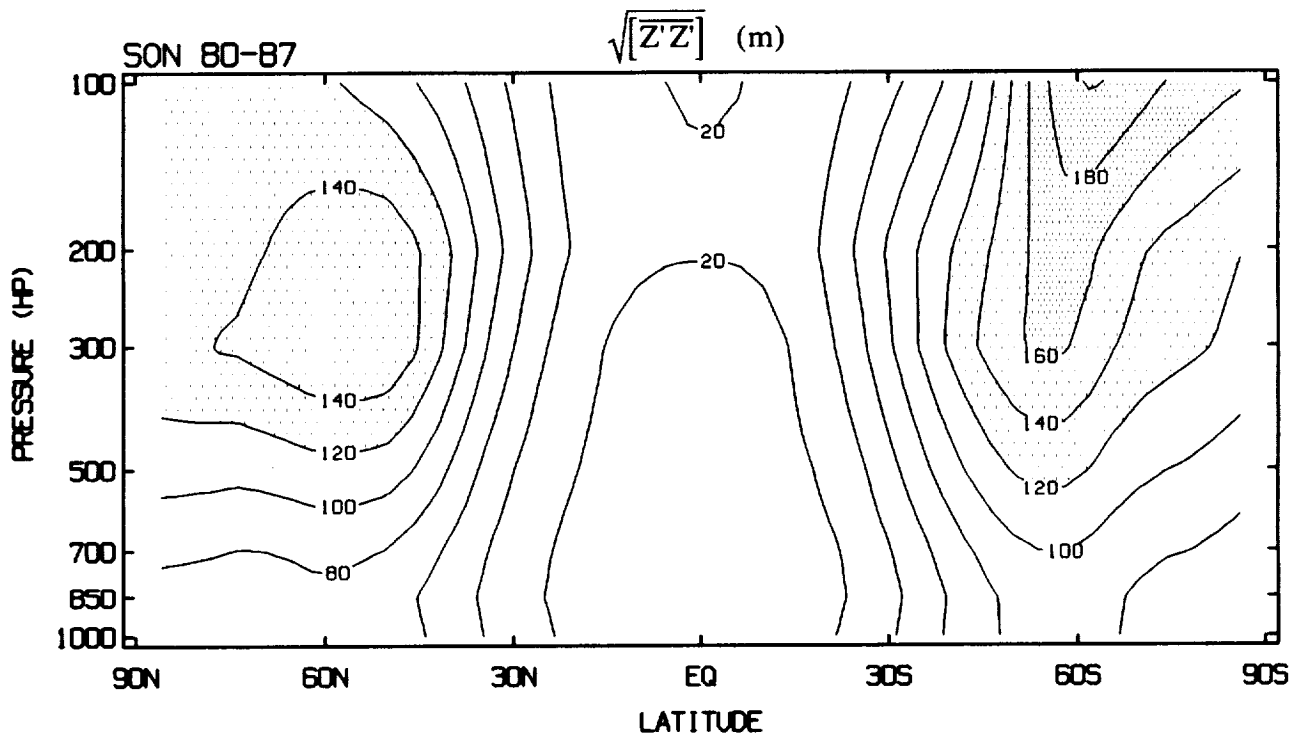

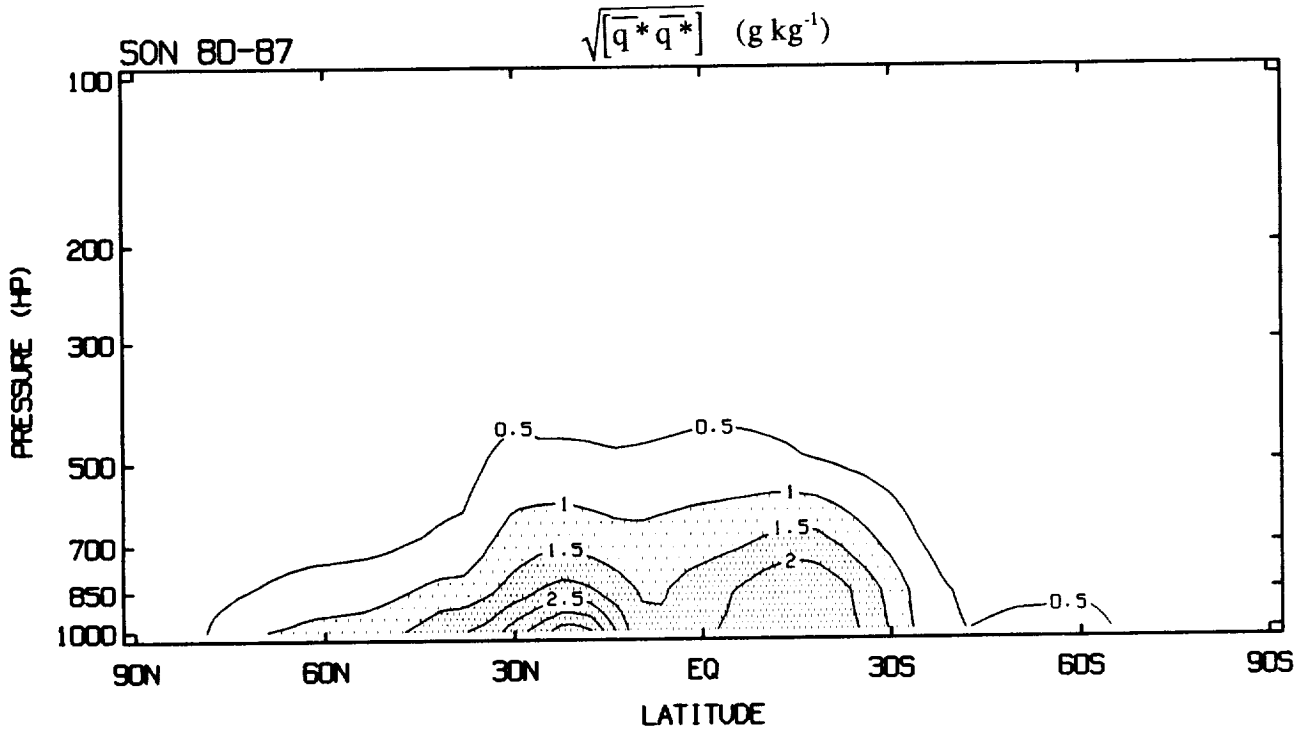
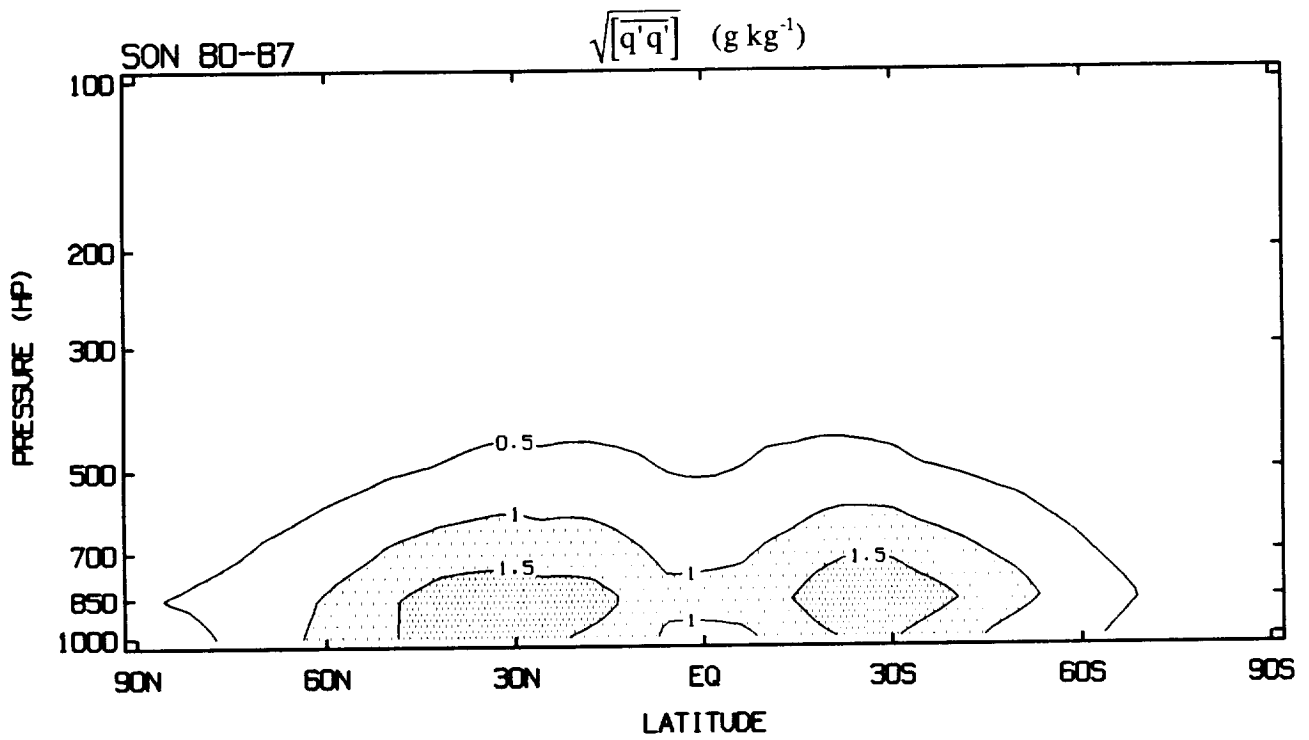

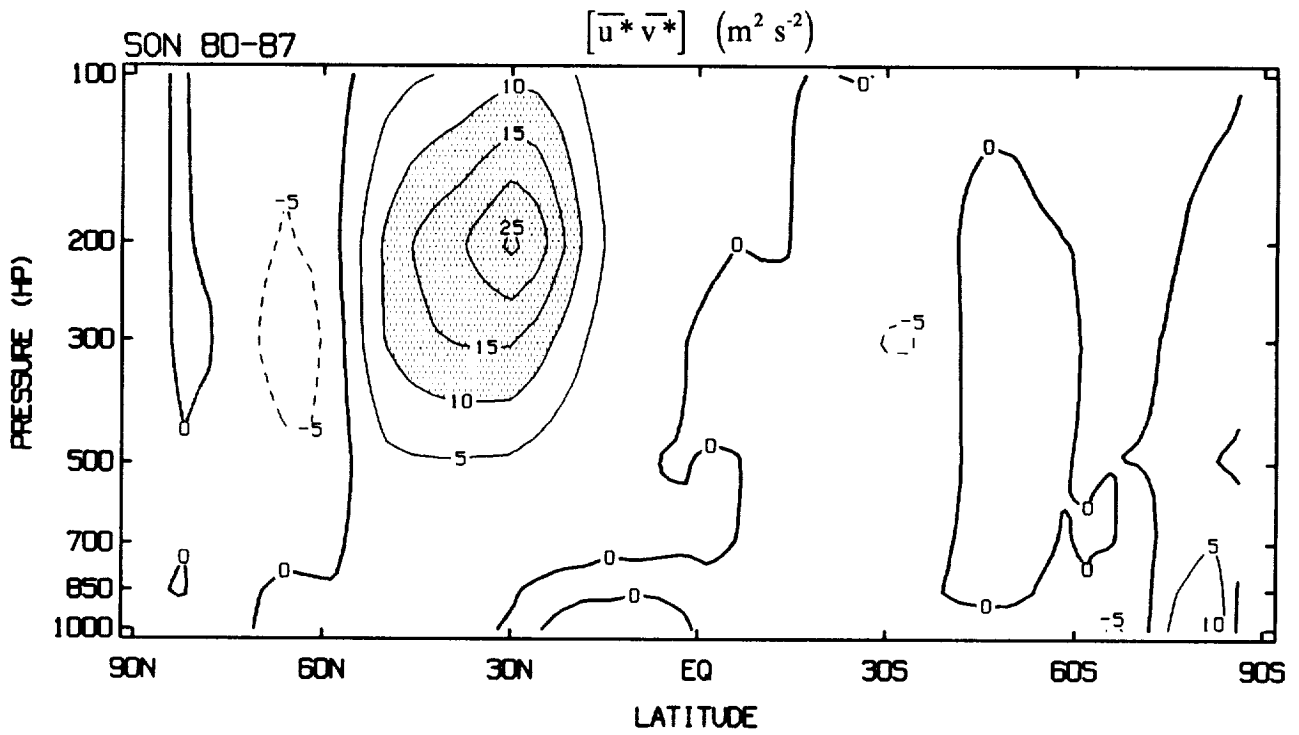
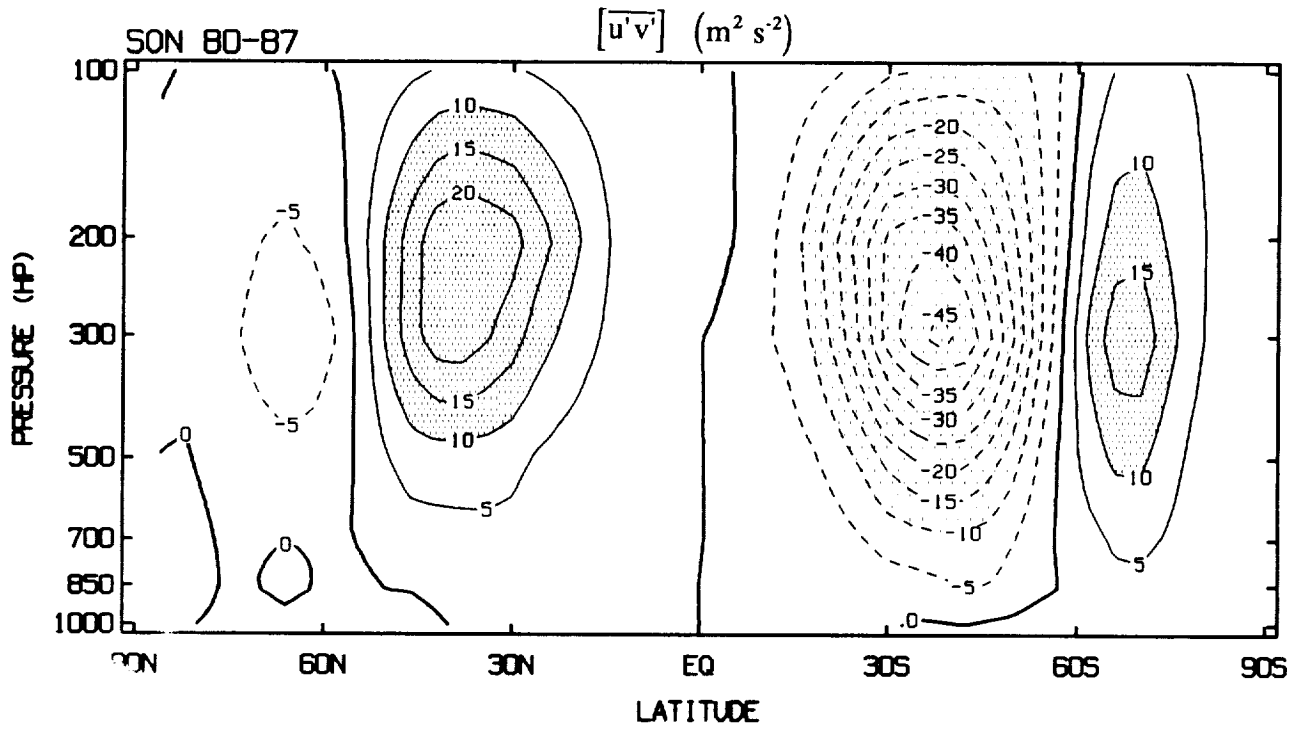

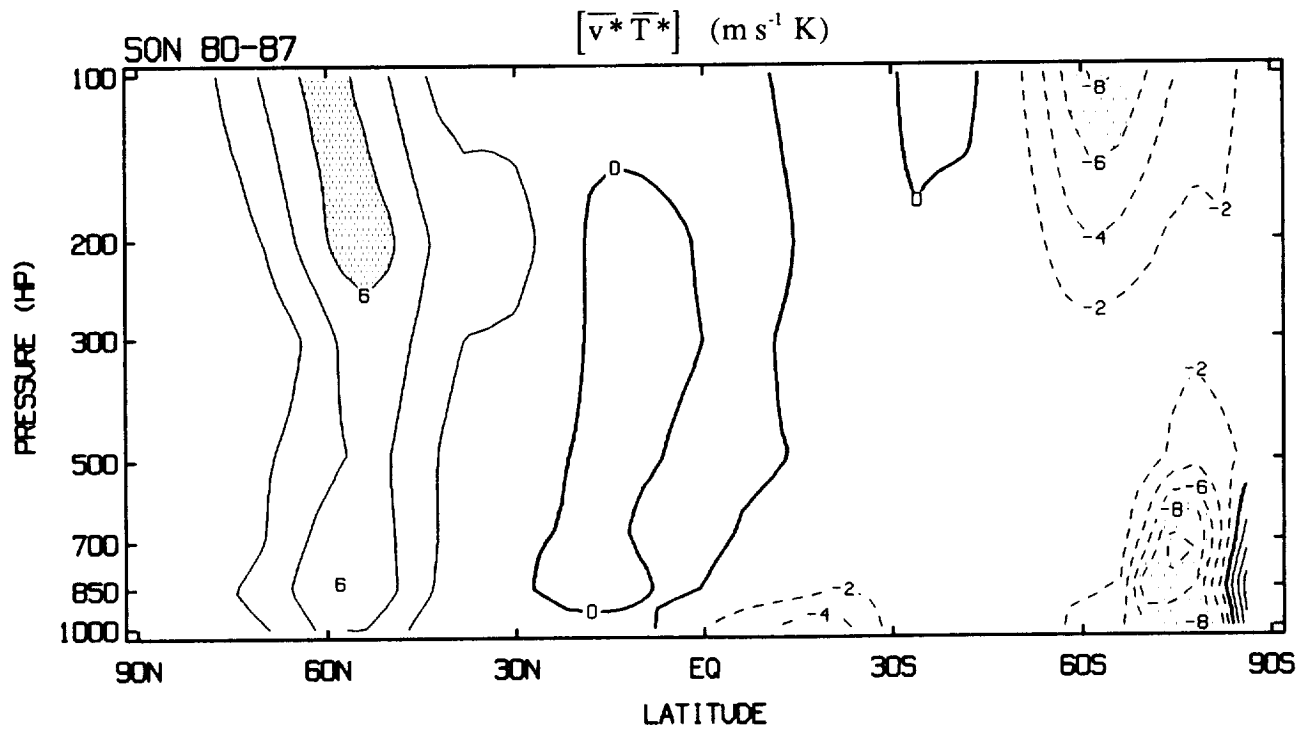
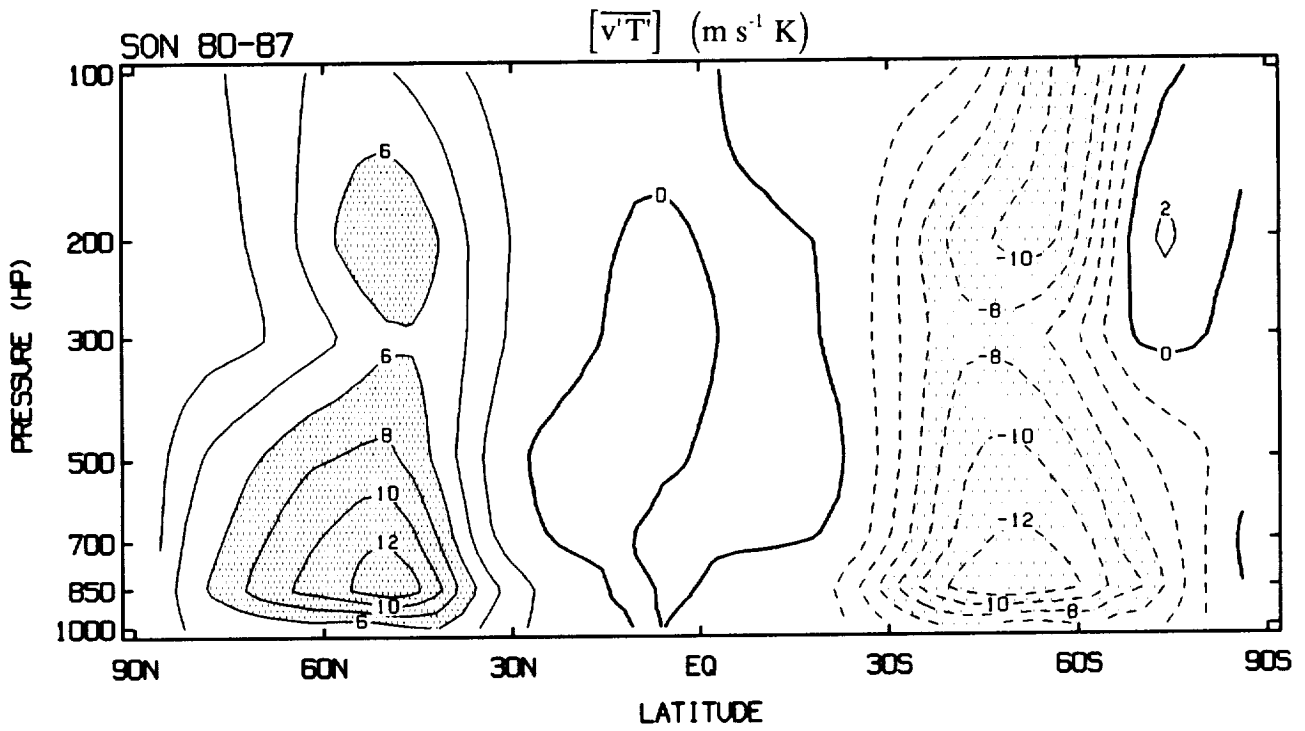

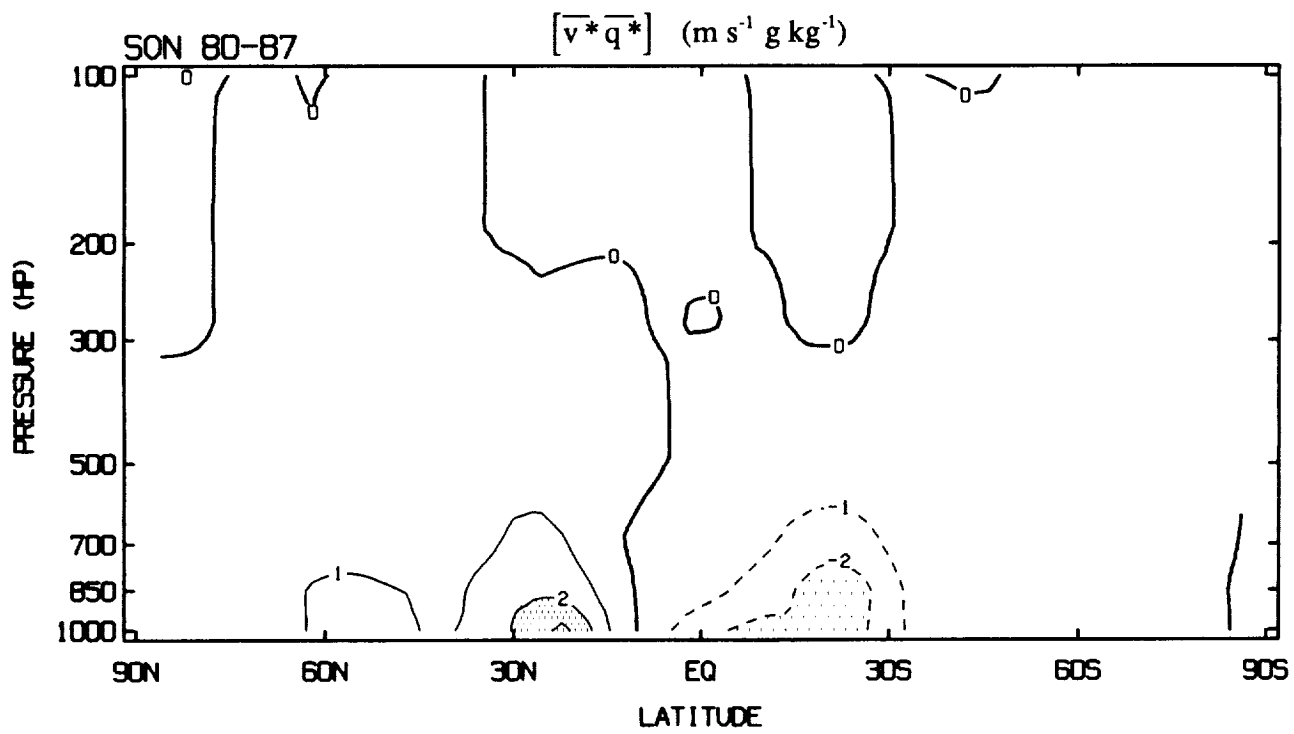
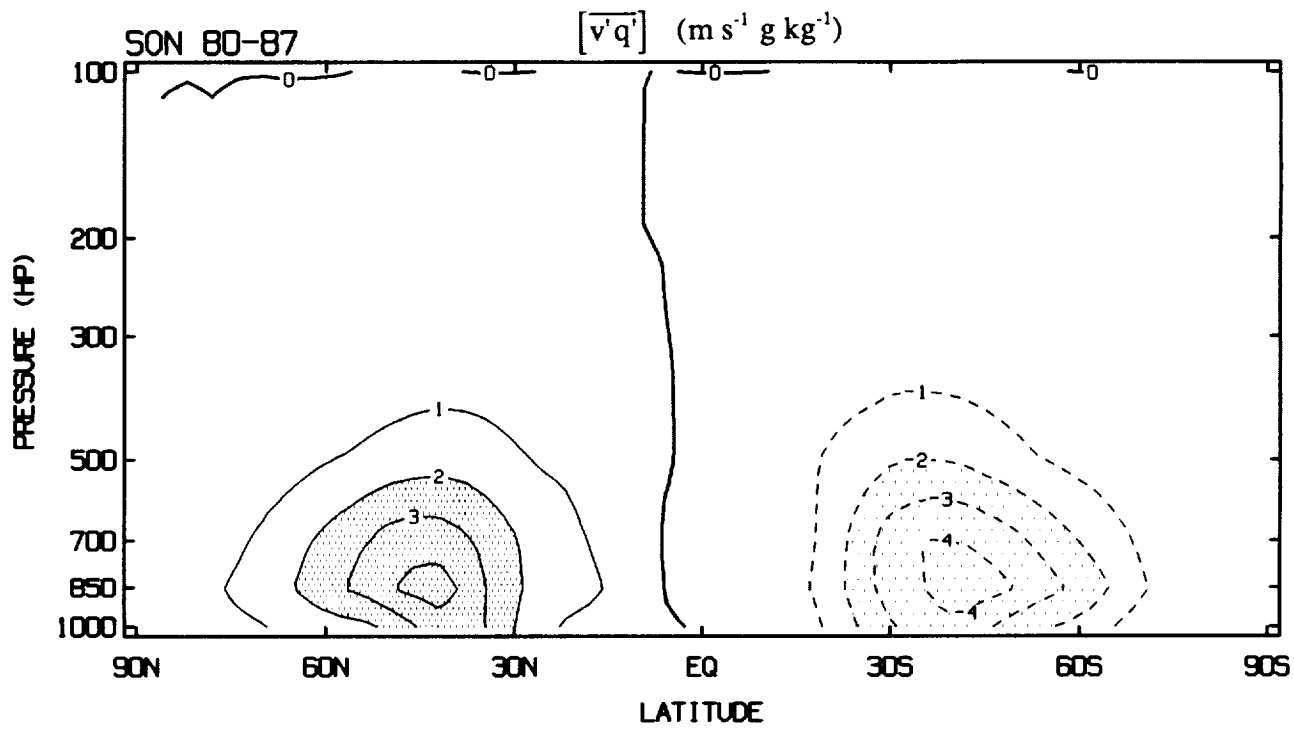

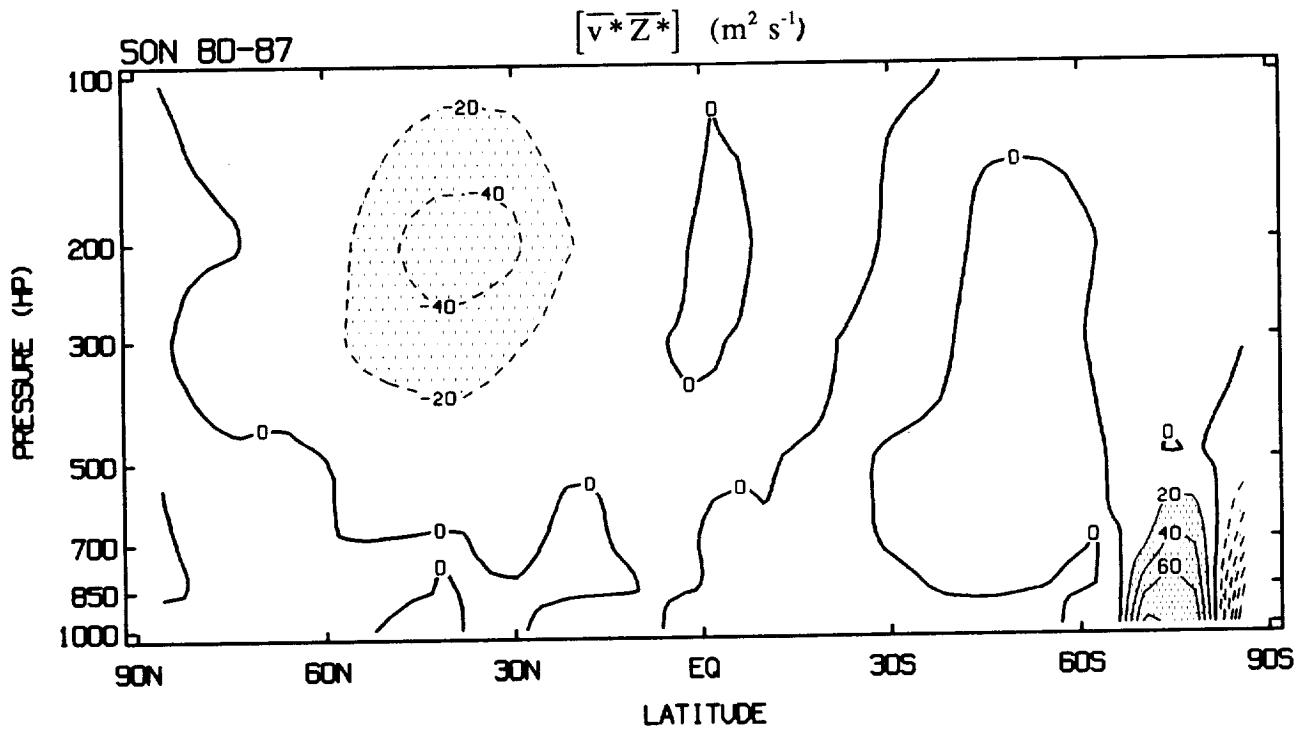
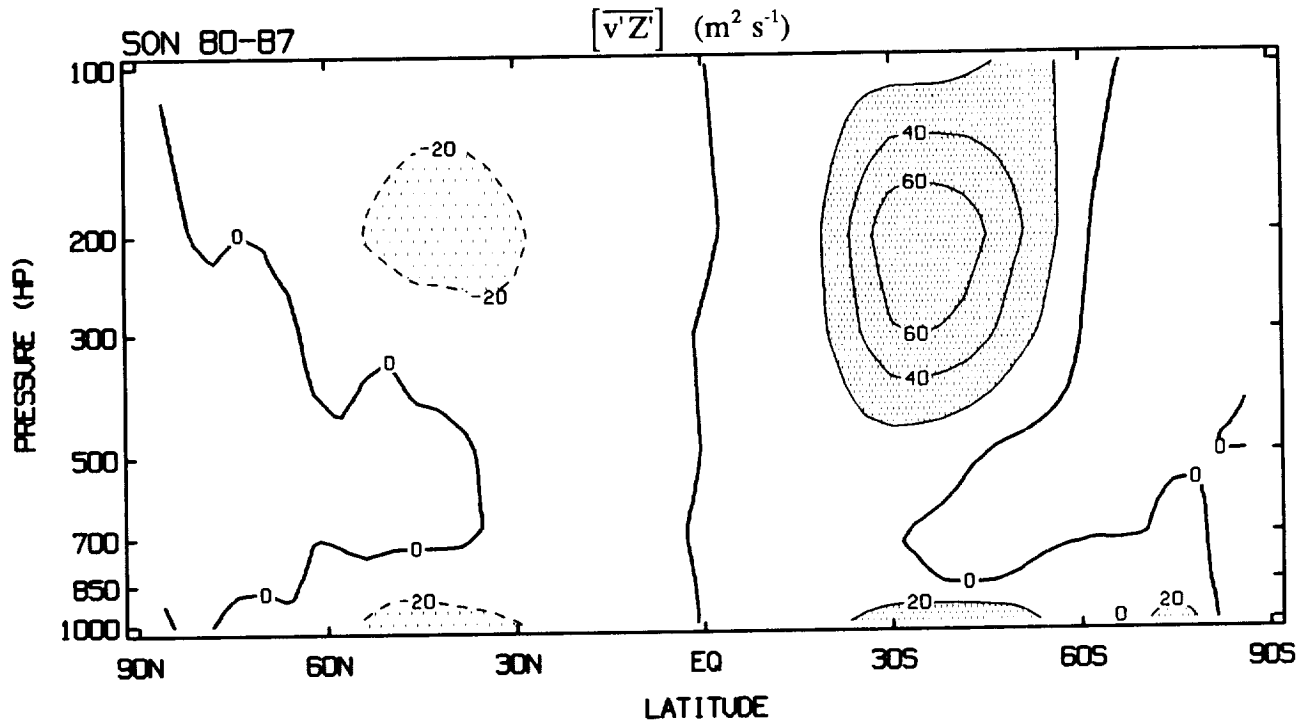

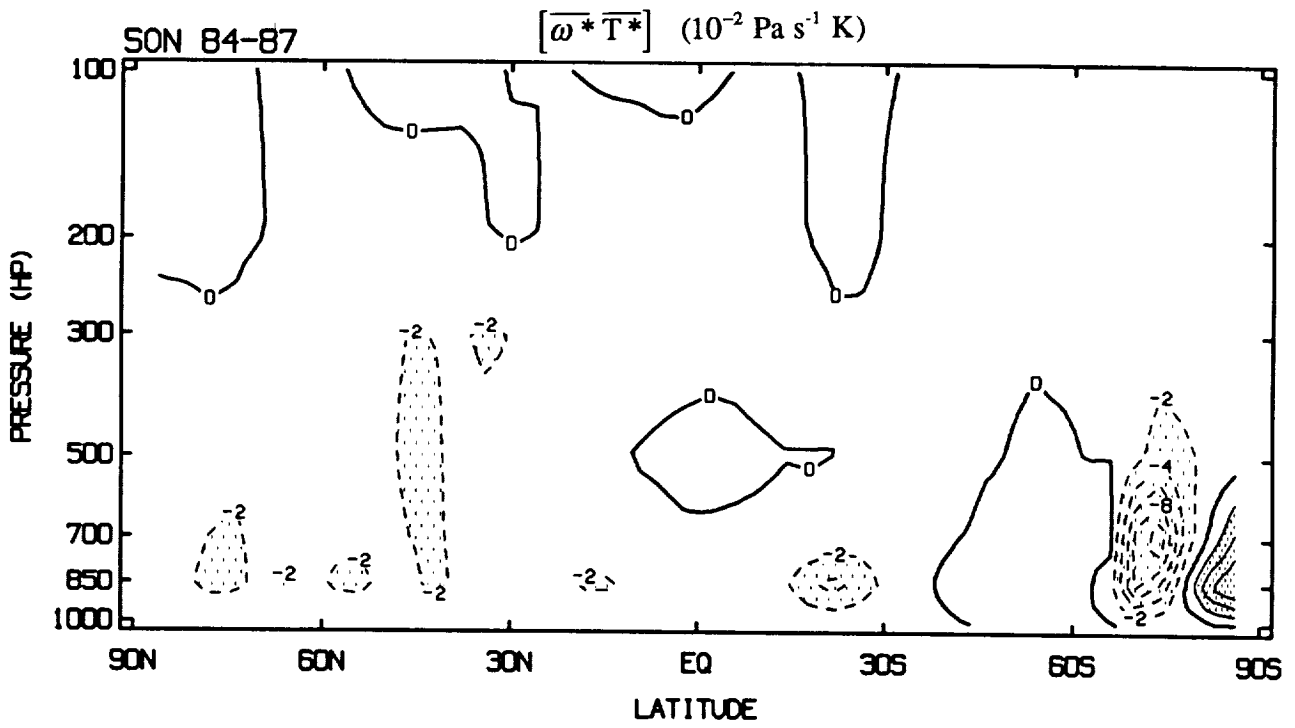
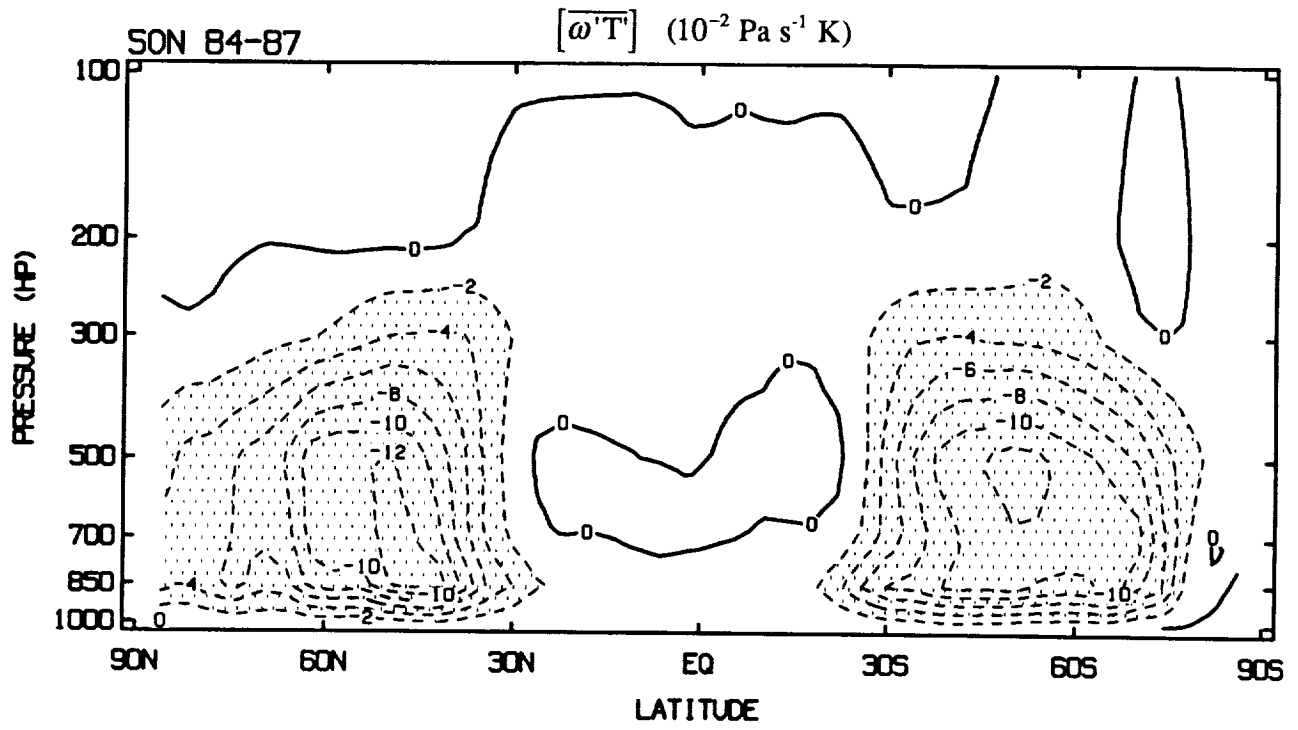

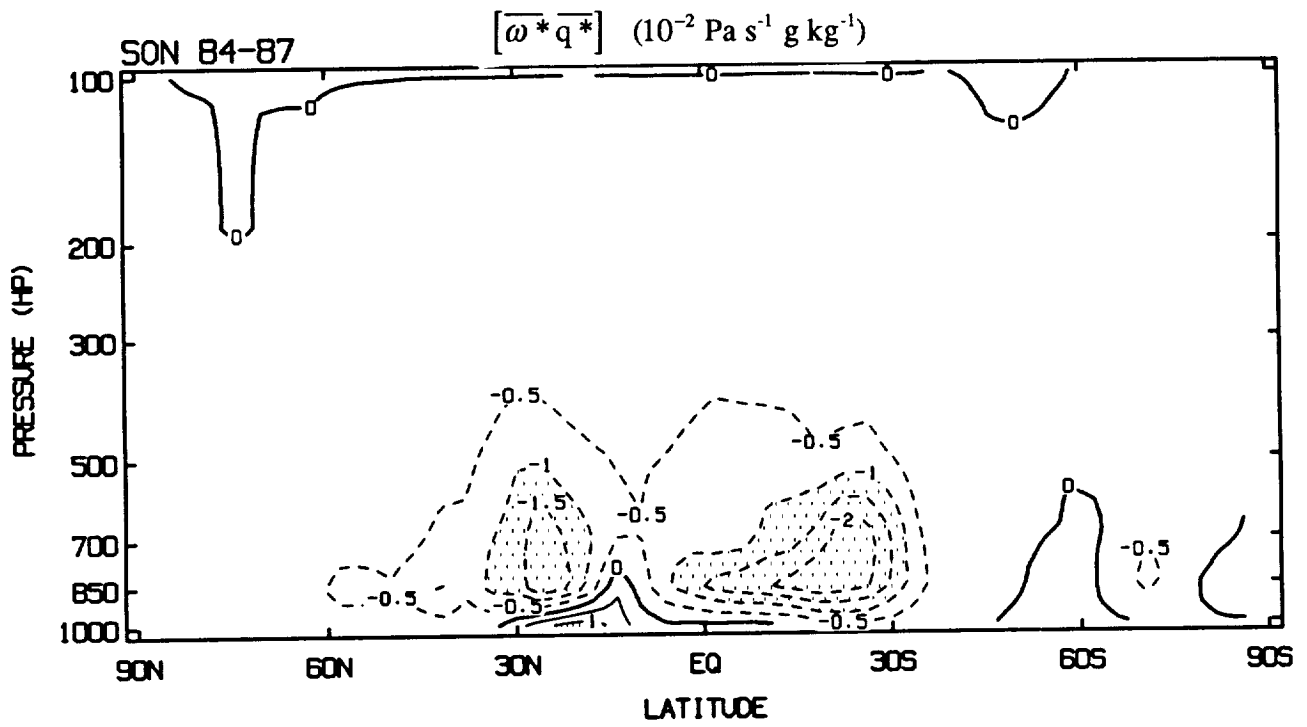
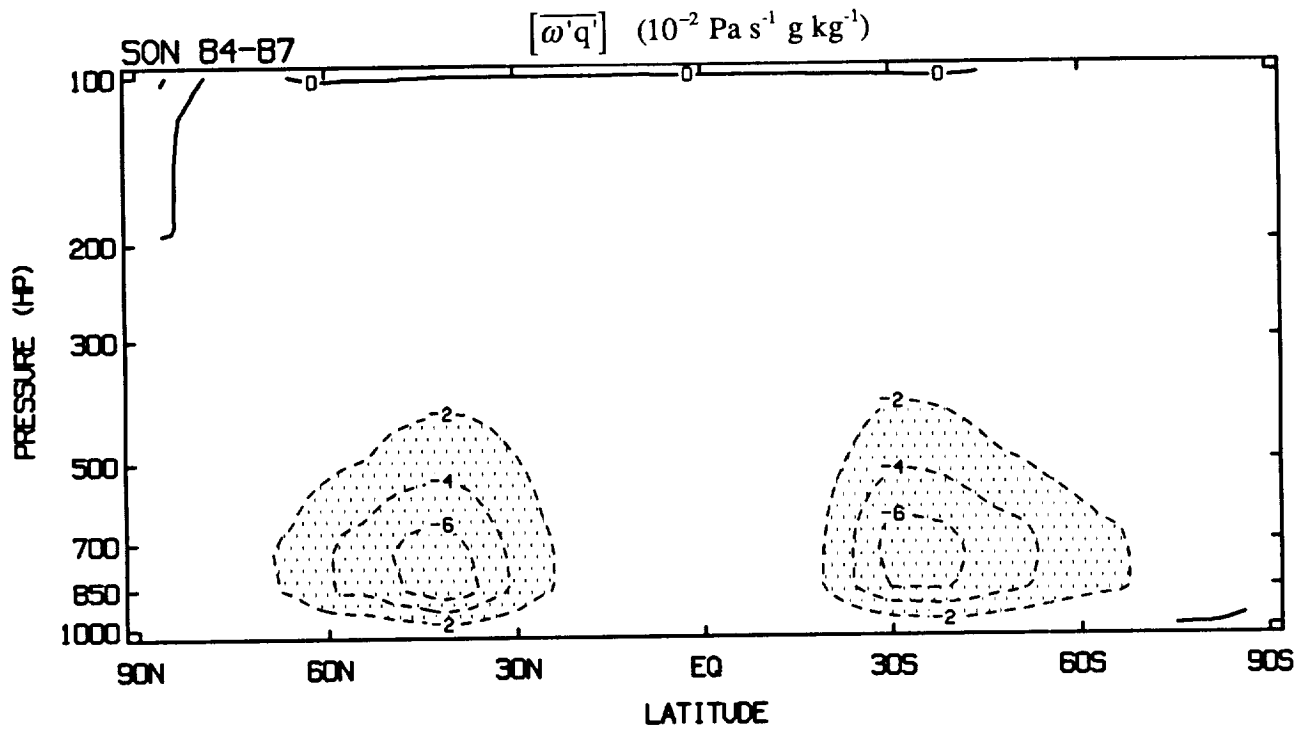

SON

DEVIATIONS FROM SEASONAL CYCLE



UNFILTERED

169

PRECEDING PAGE BLANK NOT FILMED

PAGE 168 INTENTIONALLY BLANK

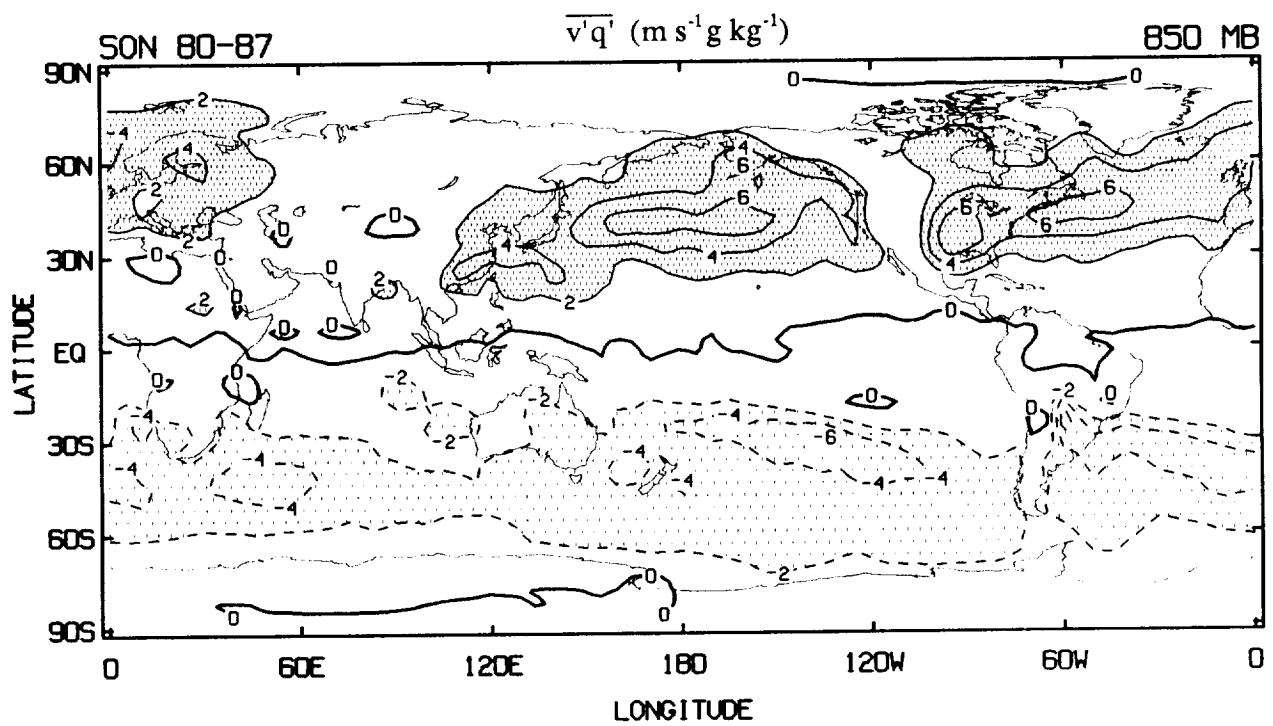
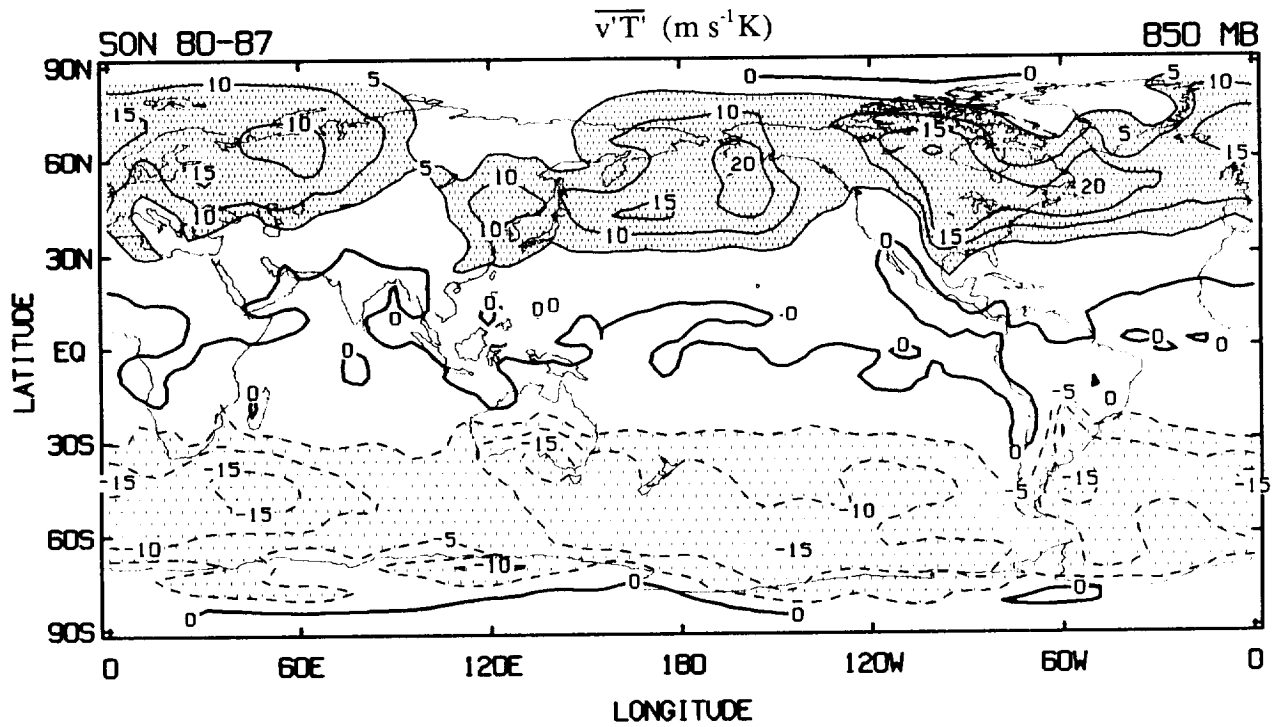

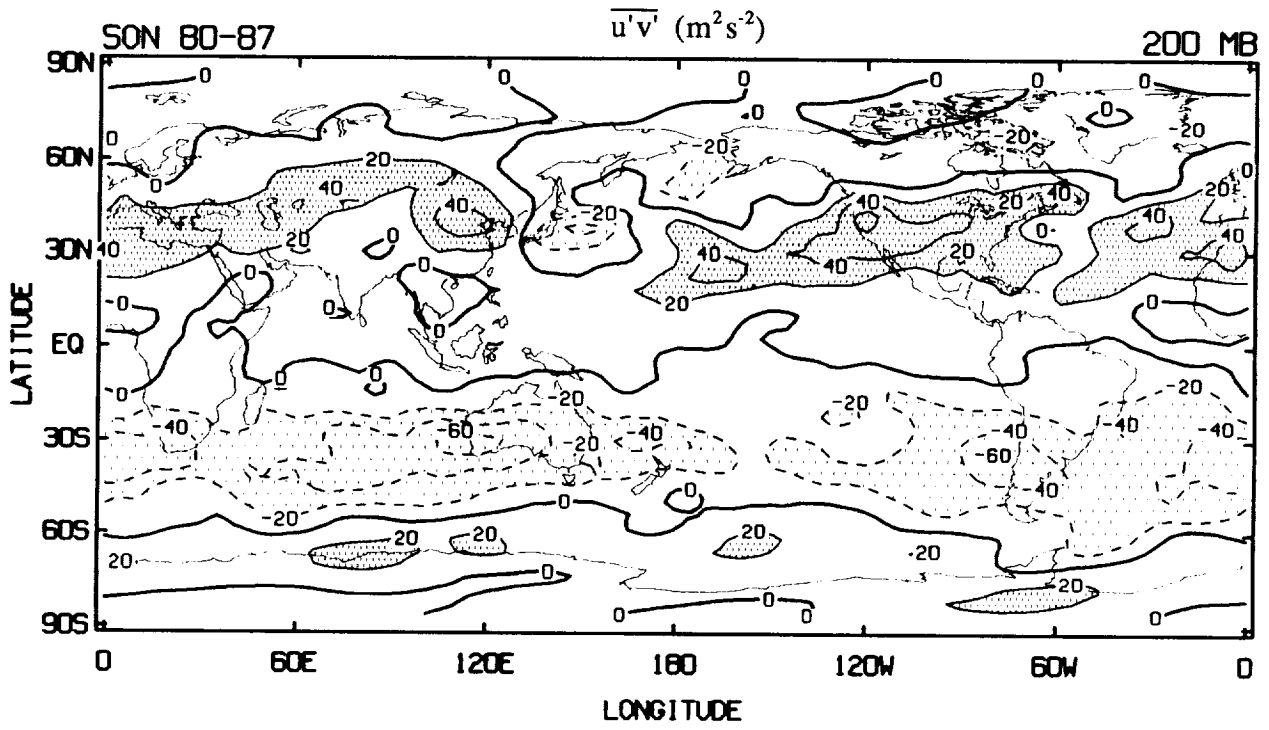

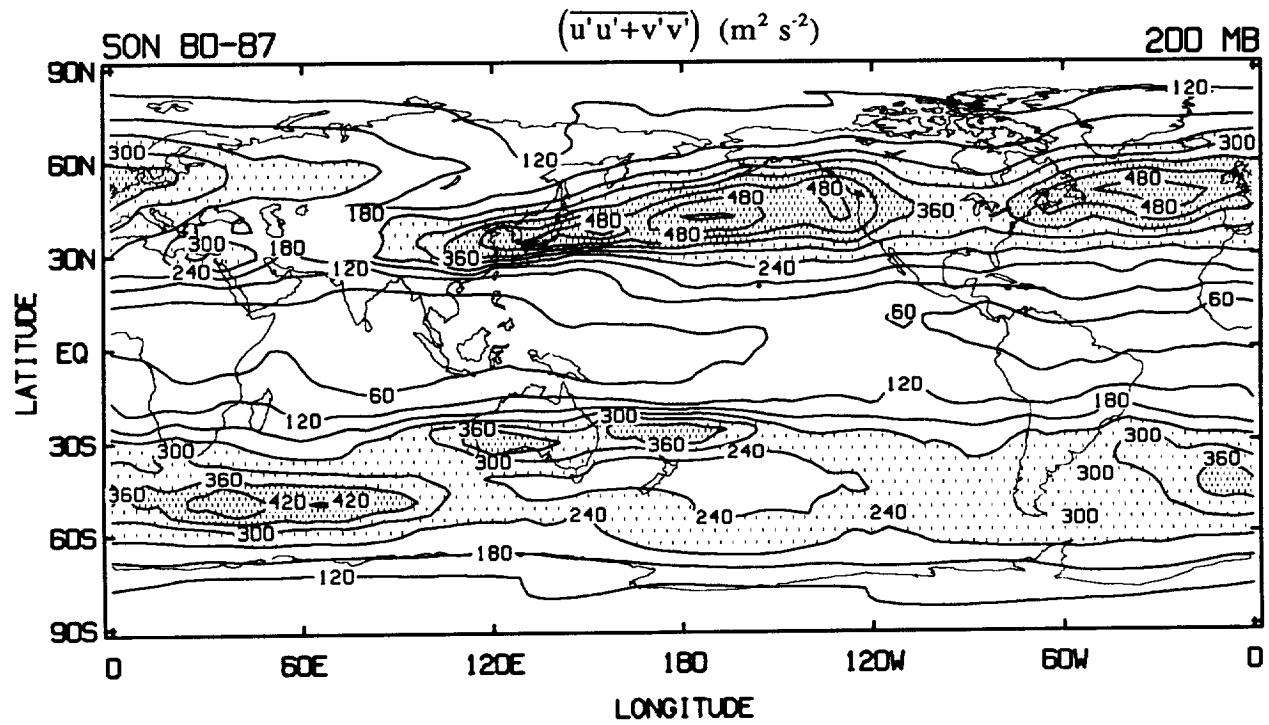
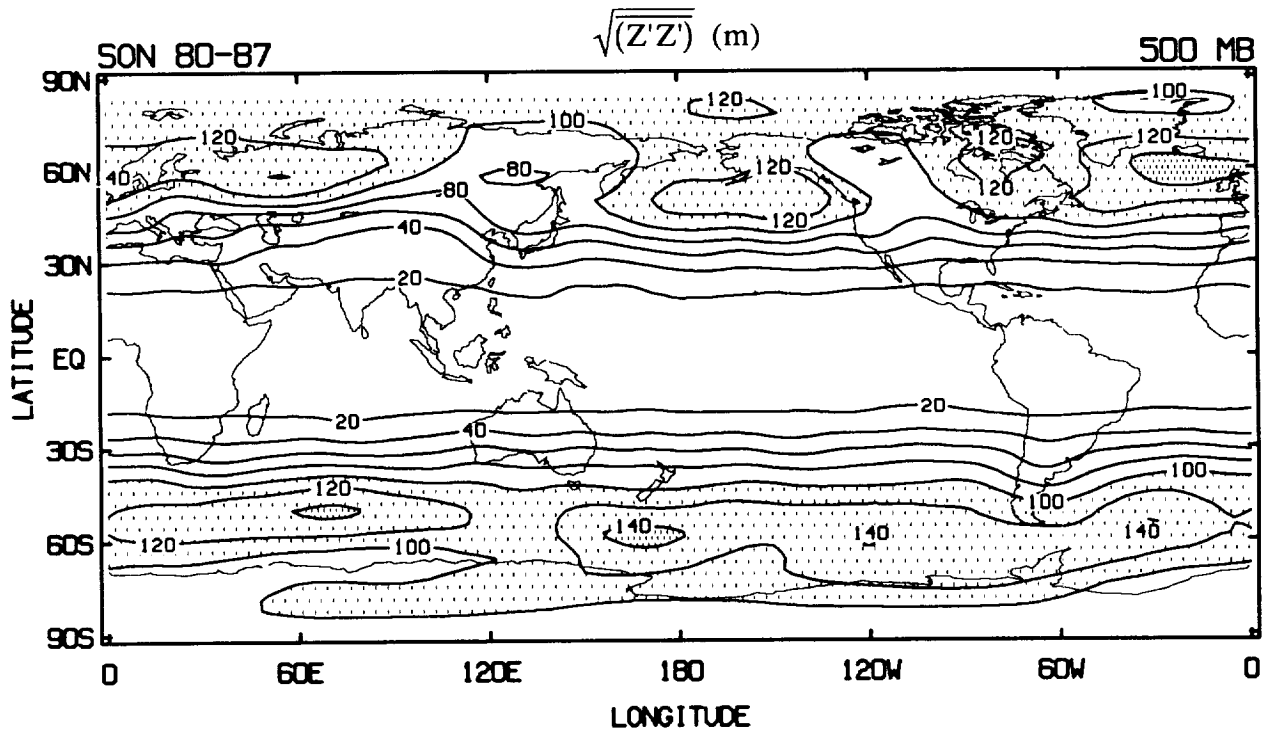

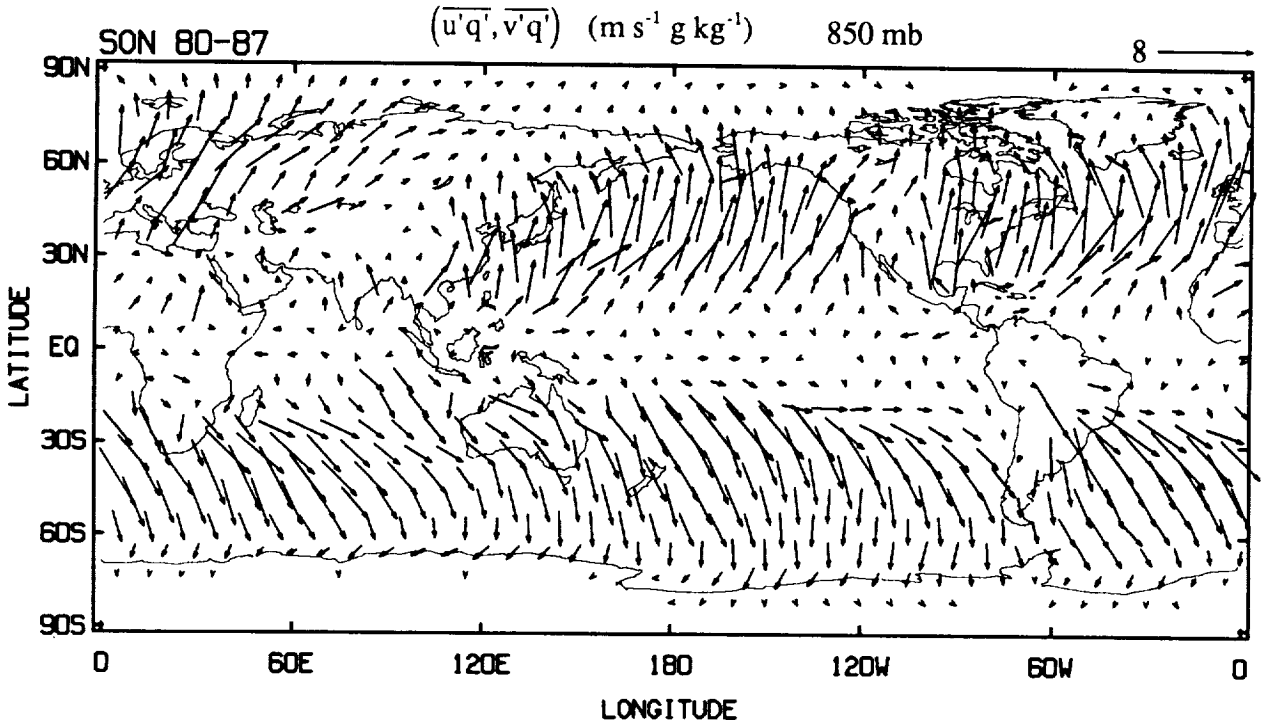
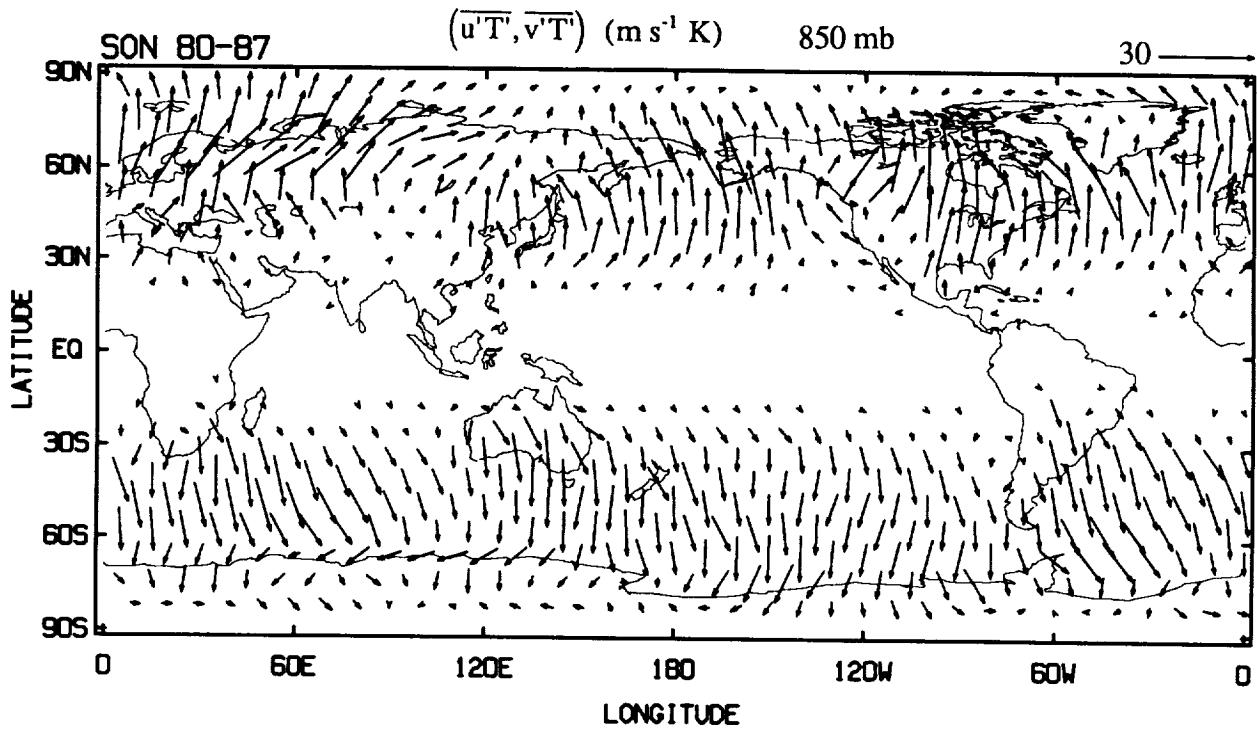

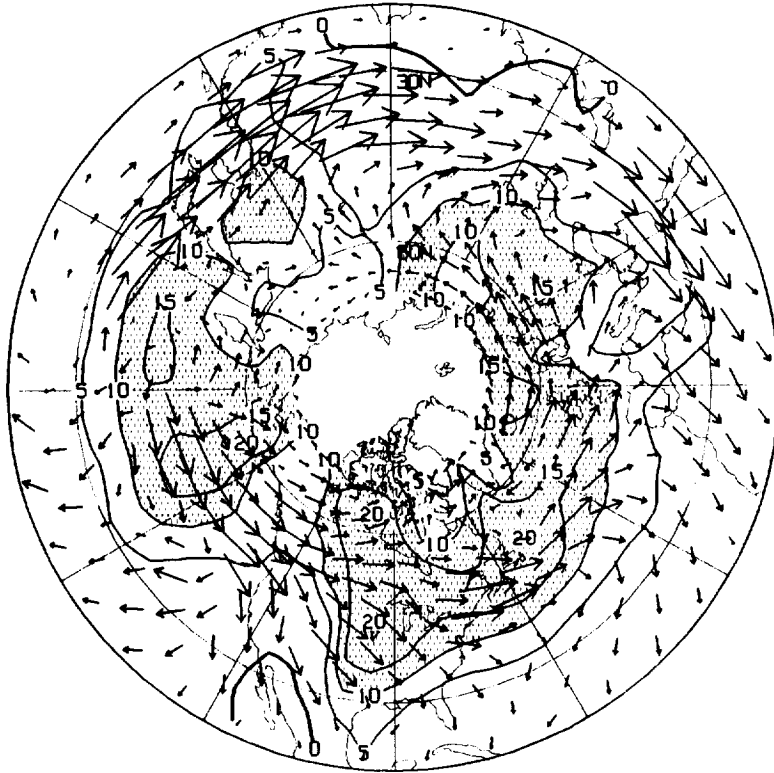

$\overline{v'T'}$ ($\text{m s}^{-1}\text{K}$) 850 mb

E_u ($\text{m}^2 \text{s}^{-2}$) 200 mb

100 \rightarrow

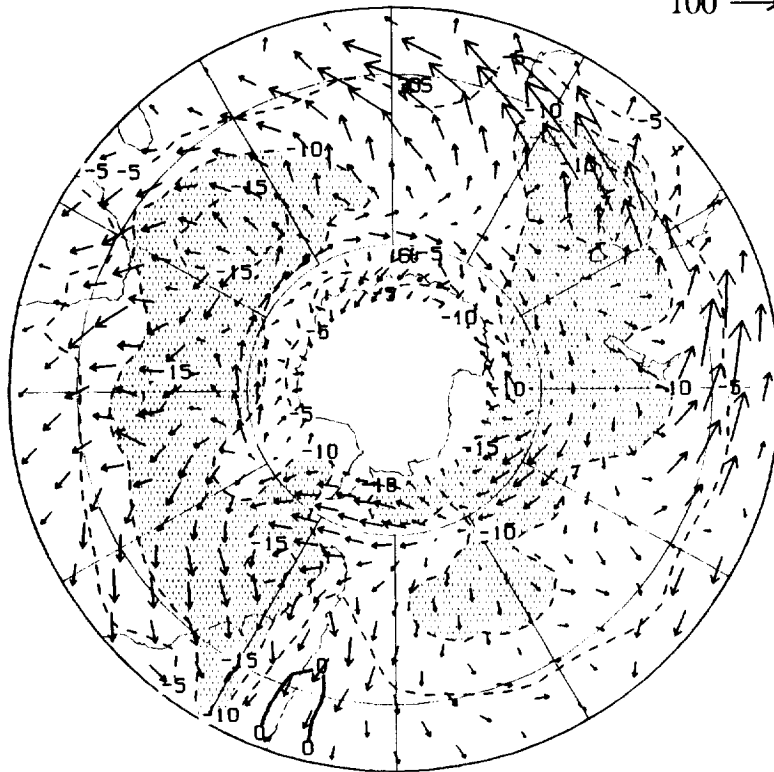

SON (80 - 87)

175

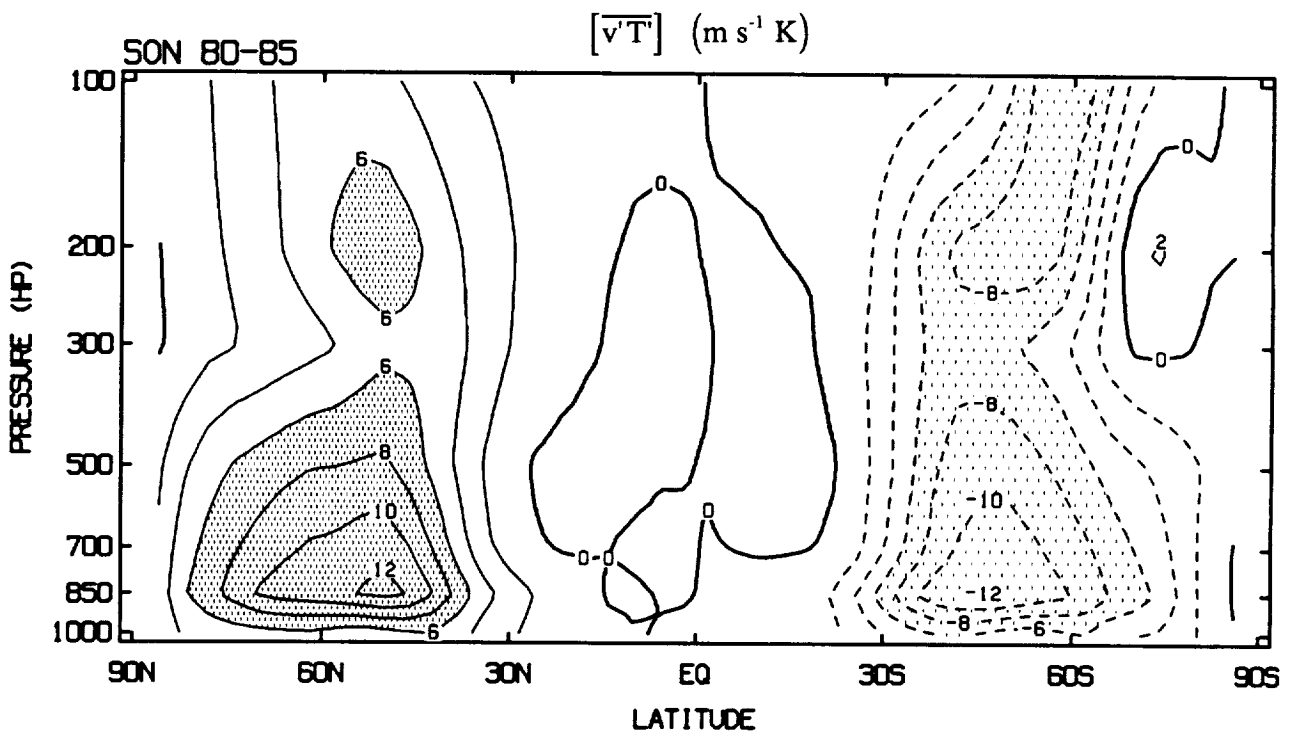
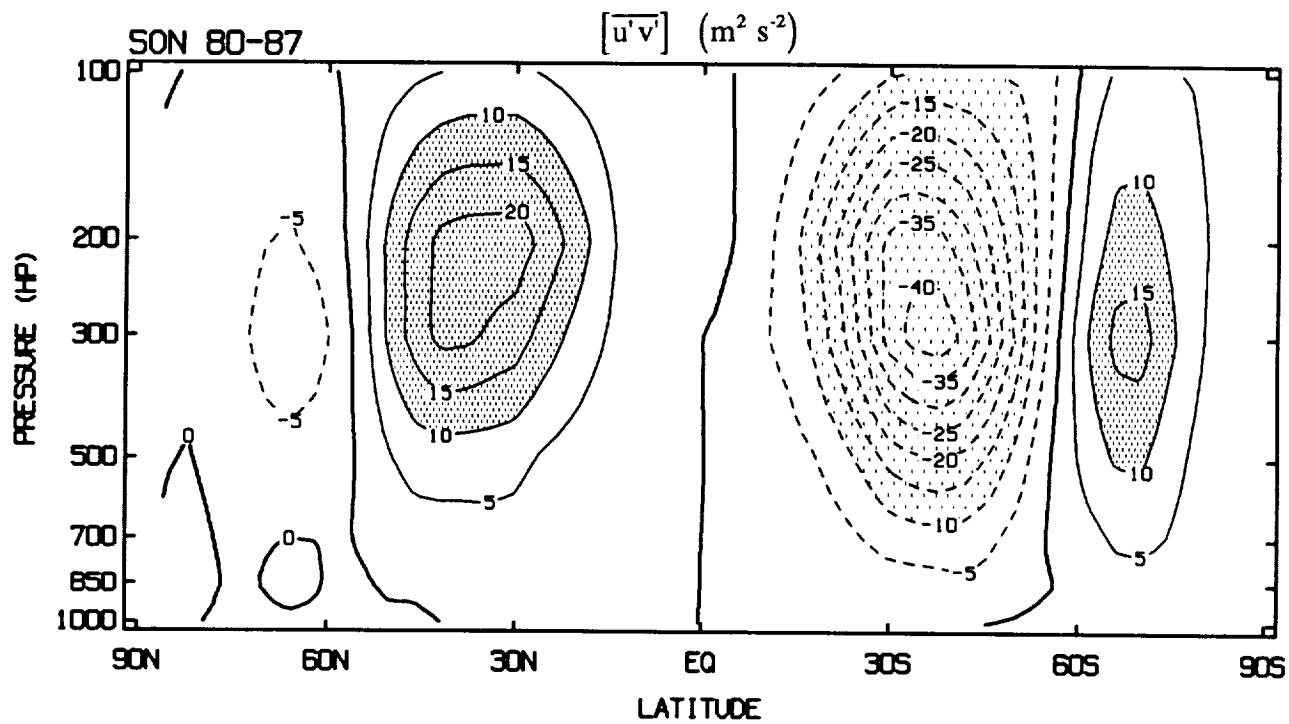

LOW PASS



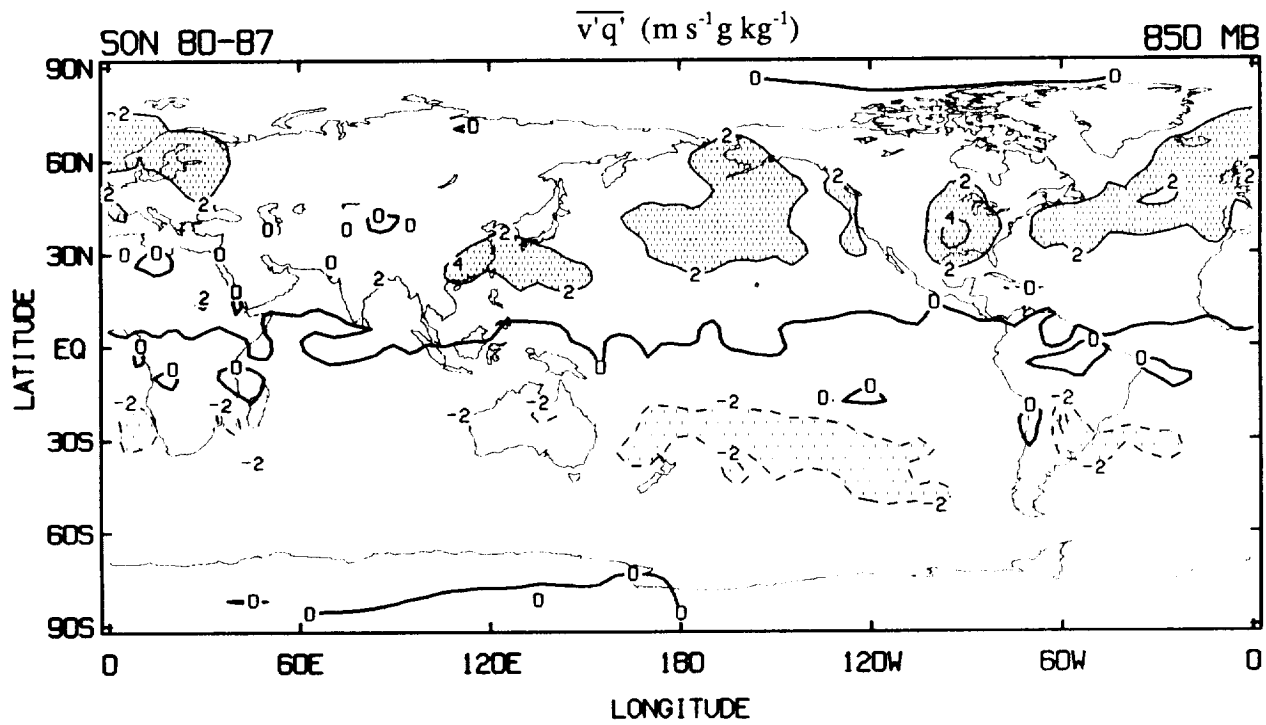
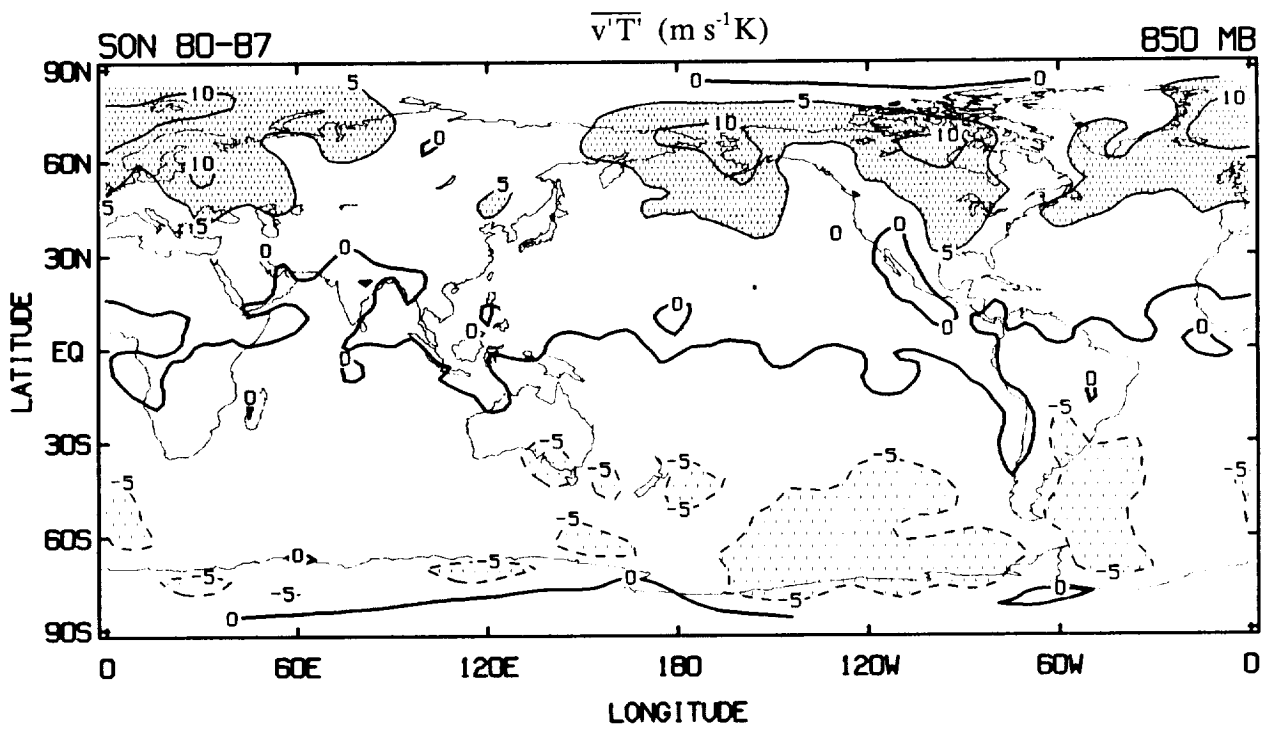

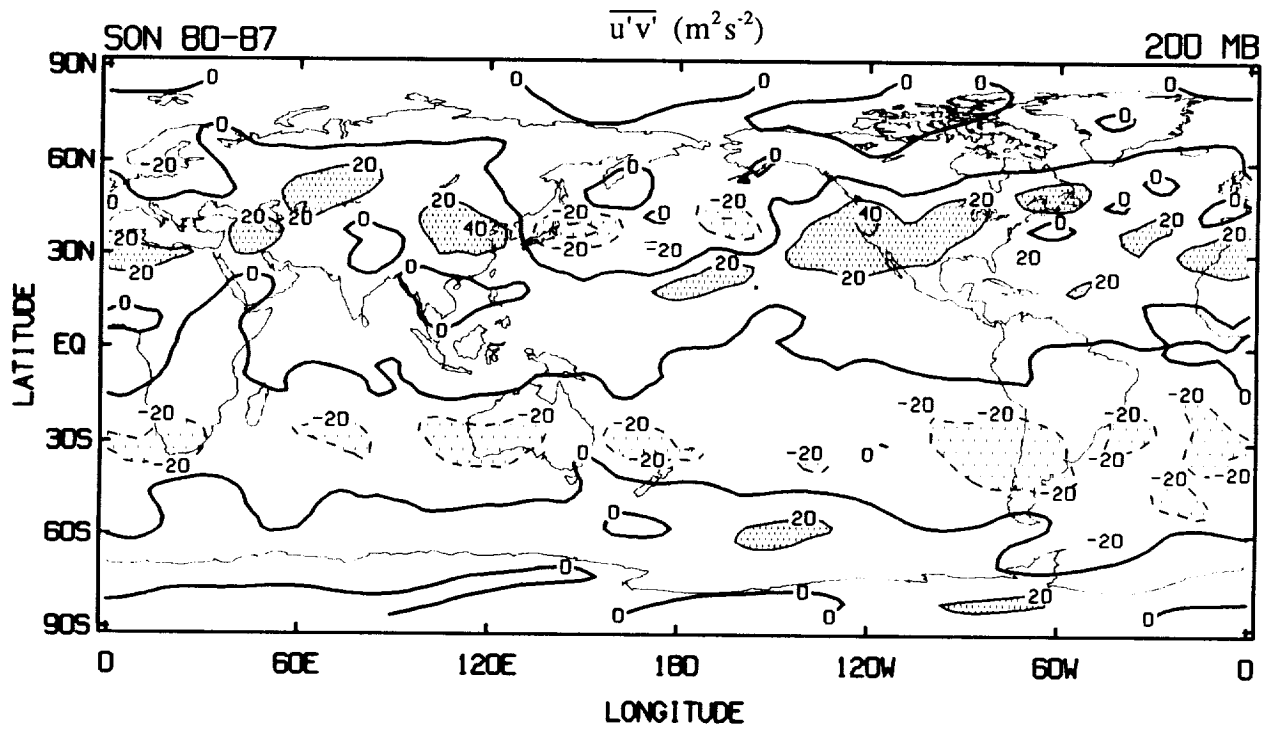

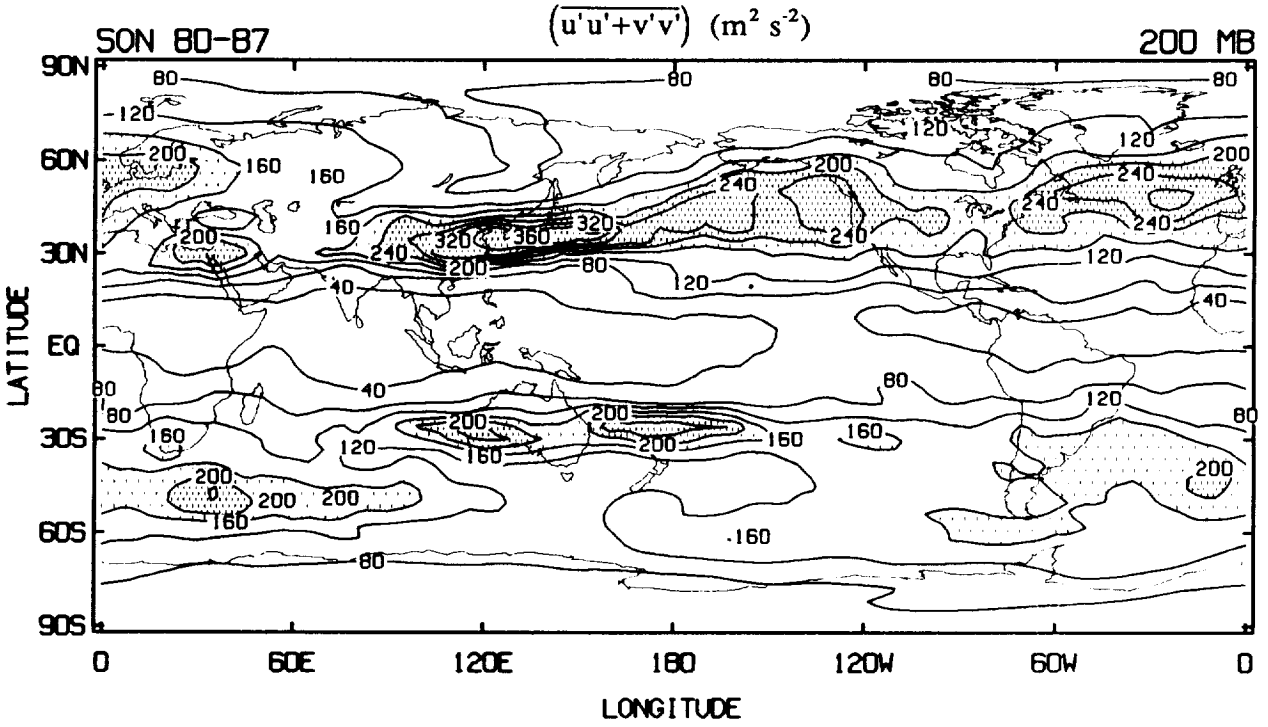
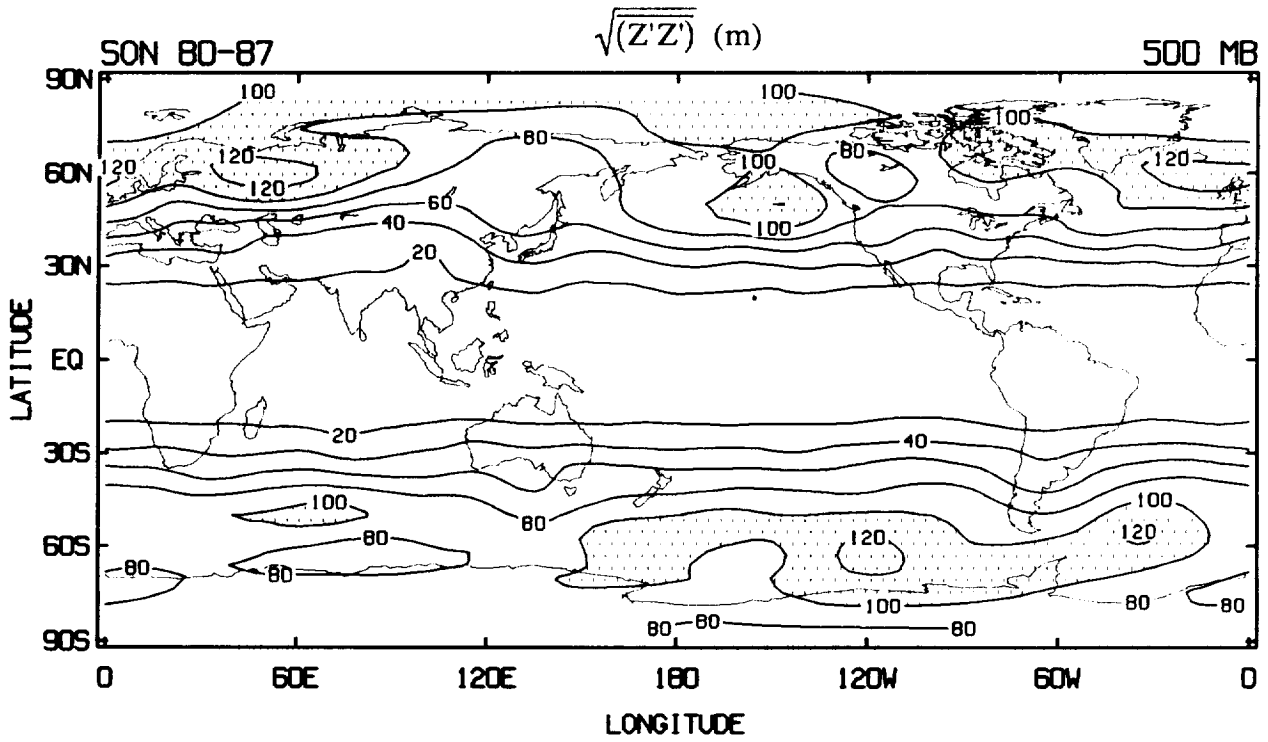

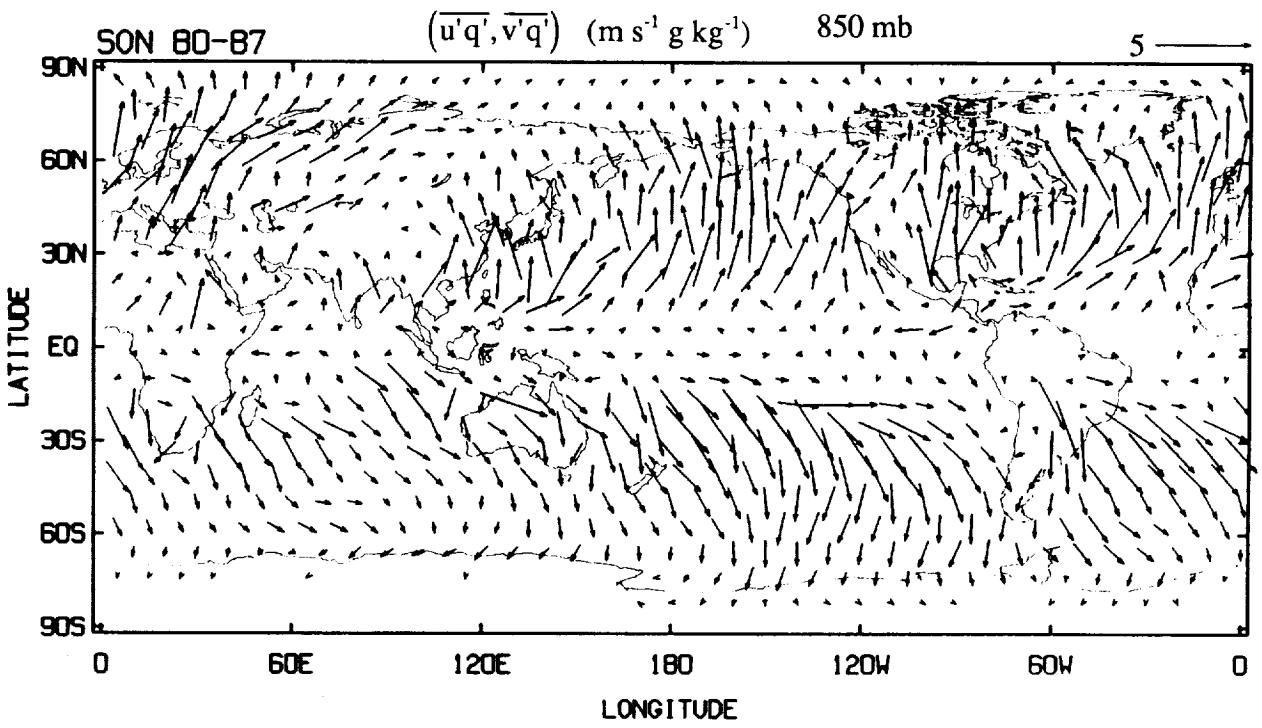
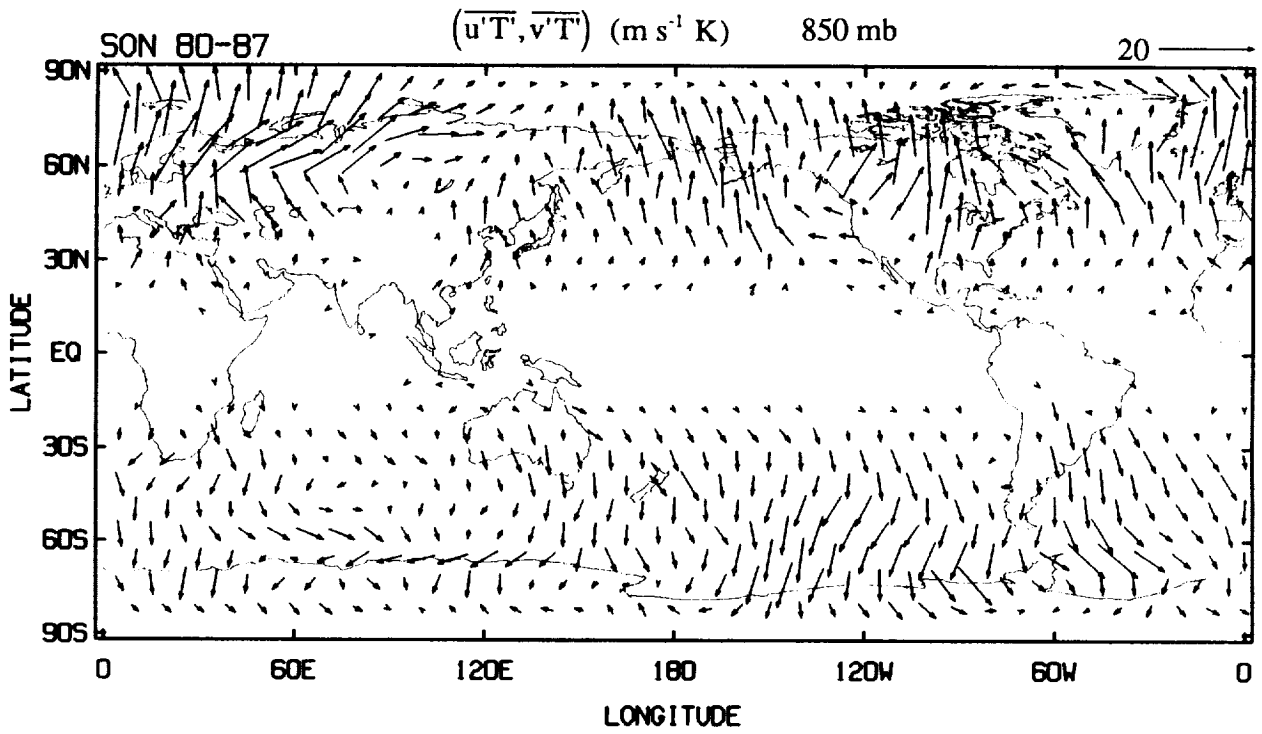

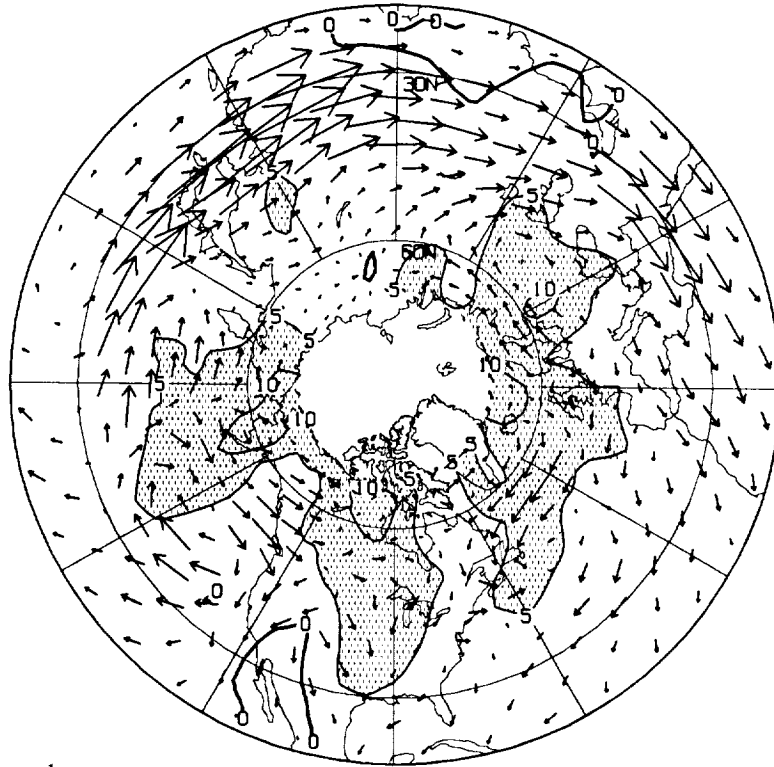

$\overline{v'T'}$ (m s⁻¹K) 850 mb

E_u (m² s⁻²) 200 mb

100 →

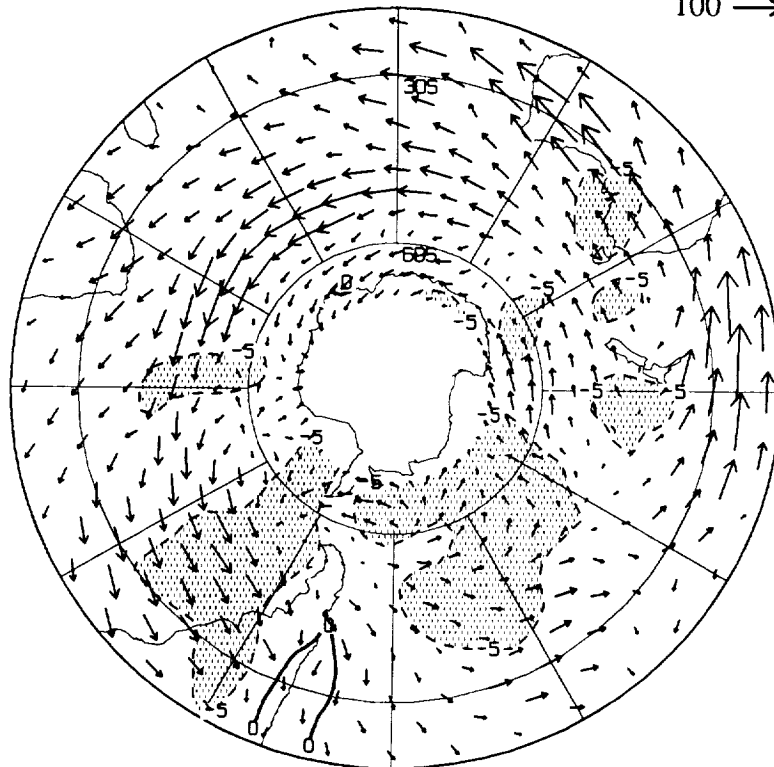

SON (80-87)

183

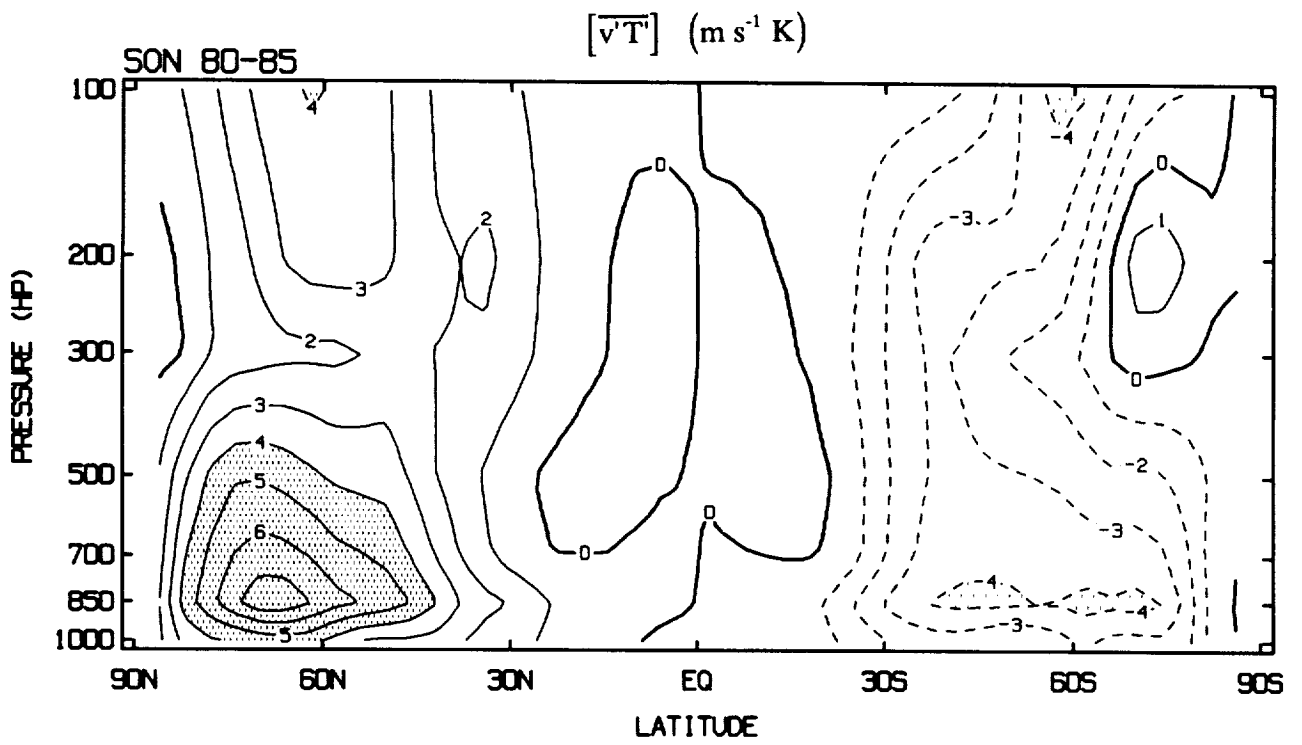
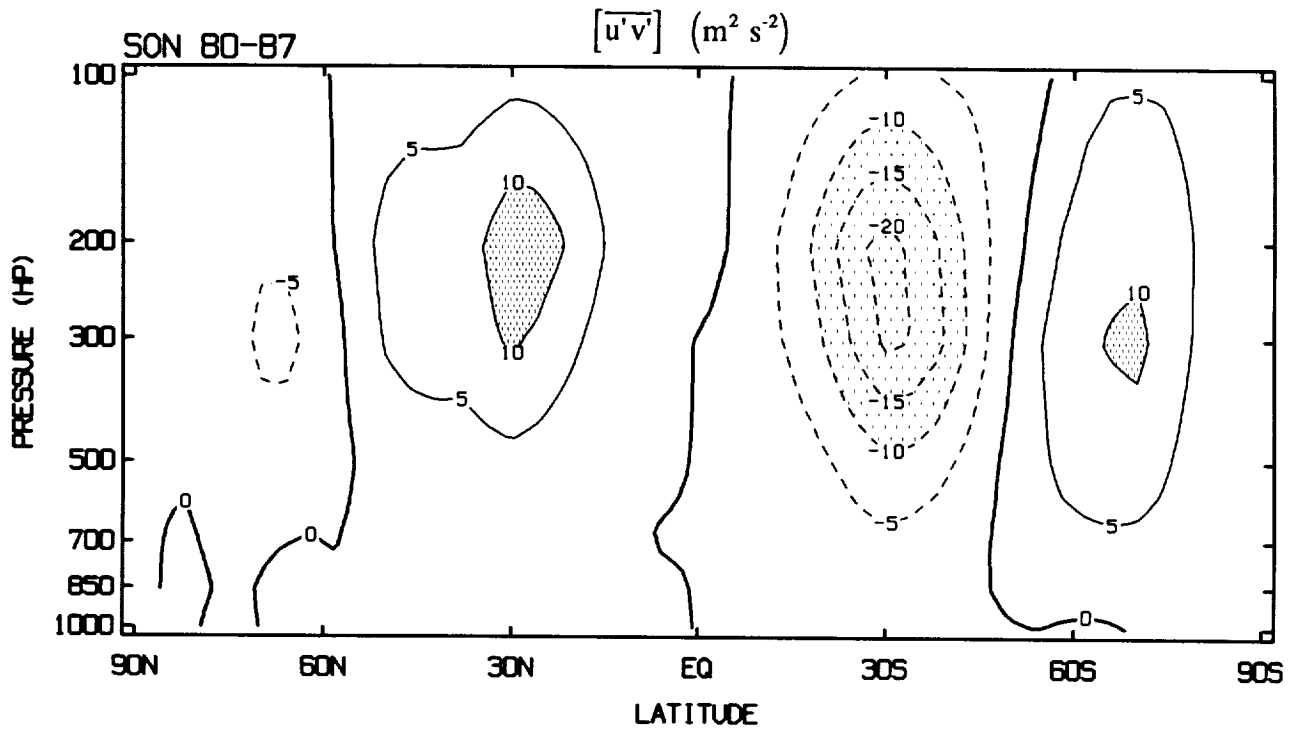

BAND PASS



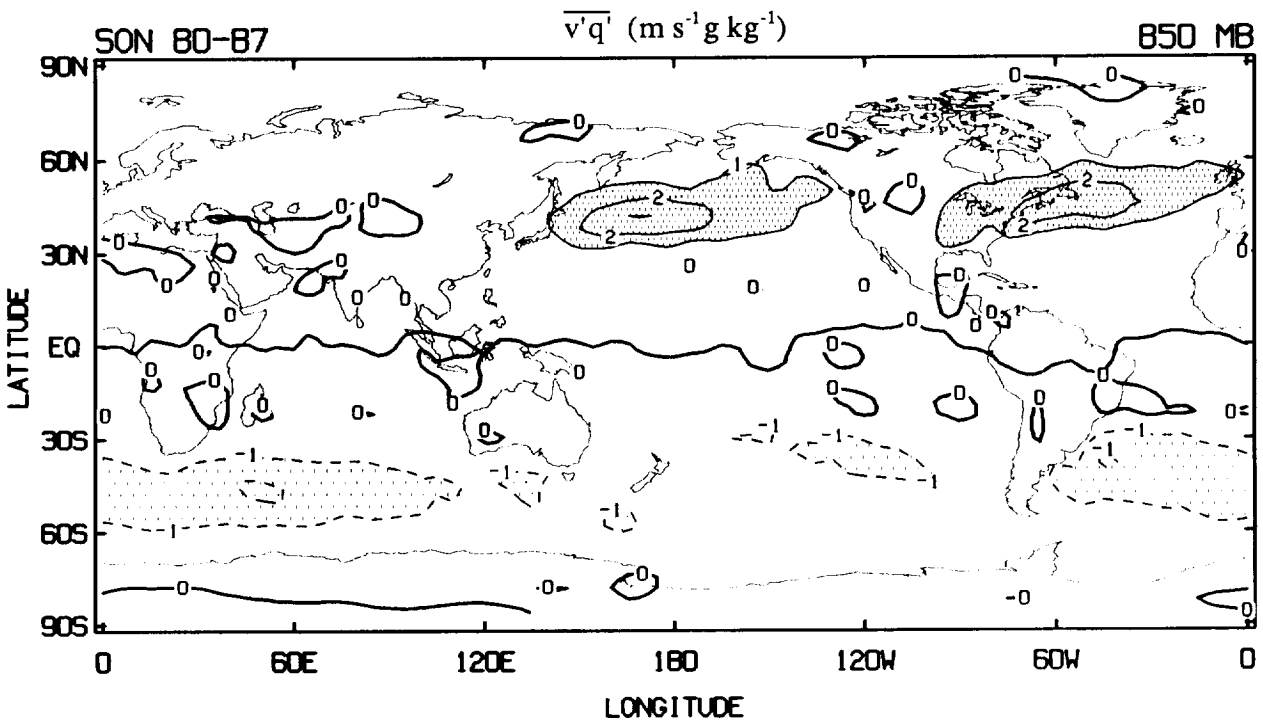
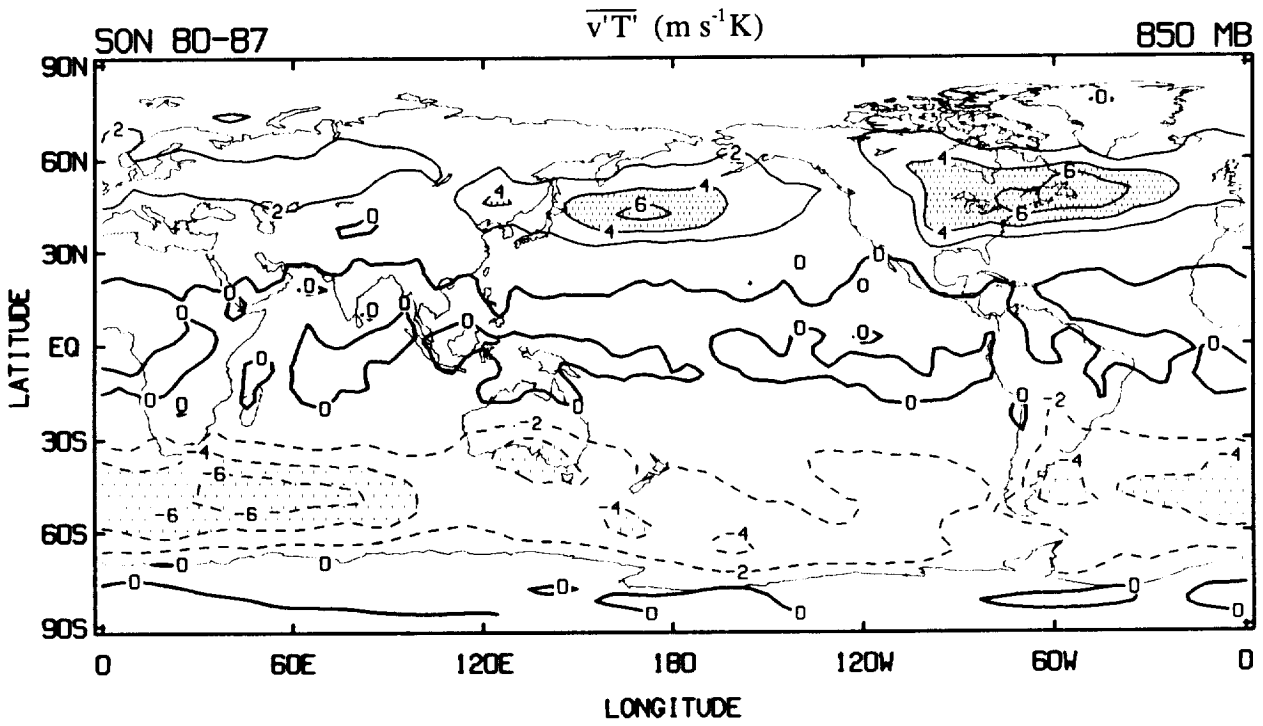

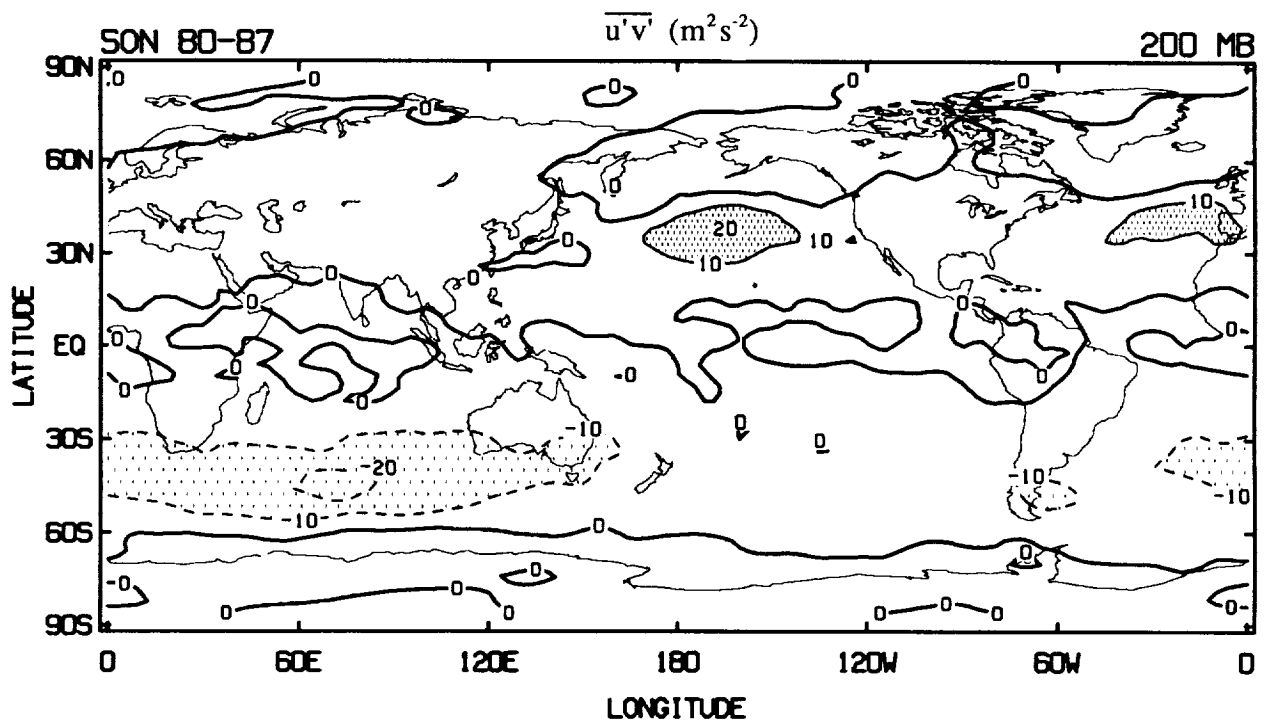

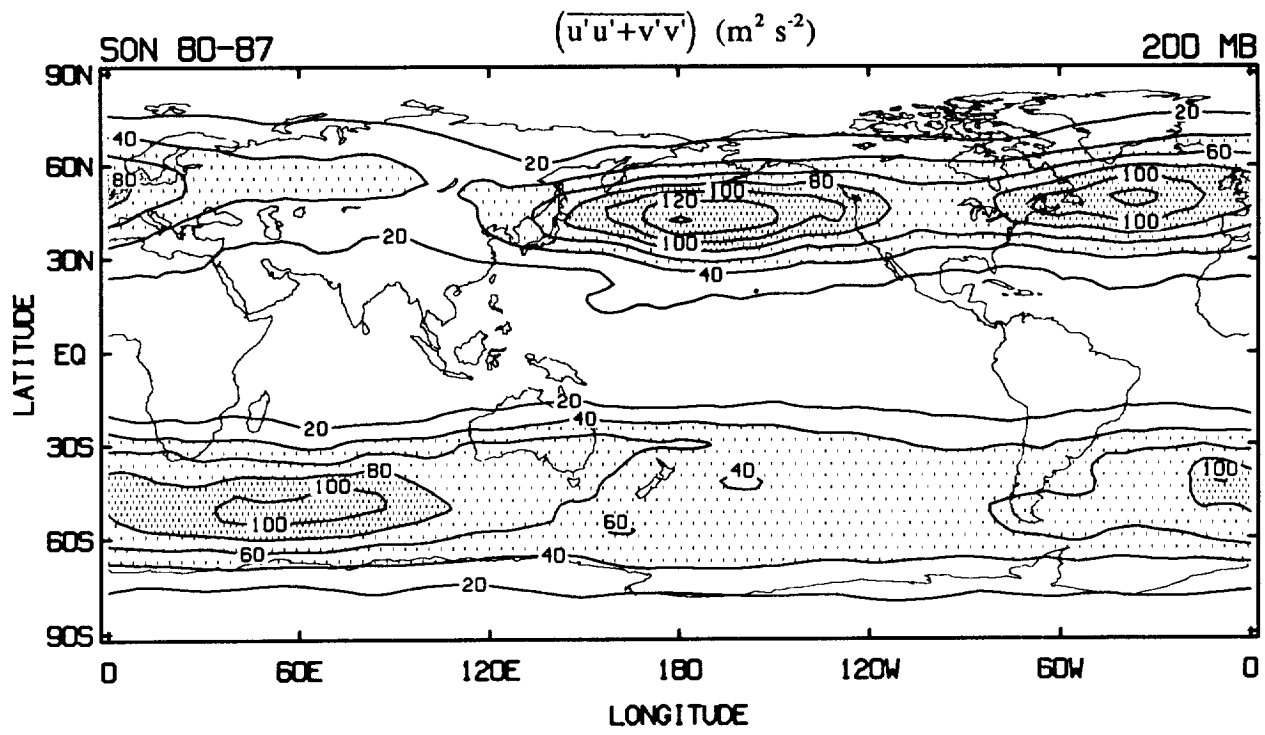
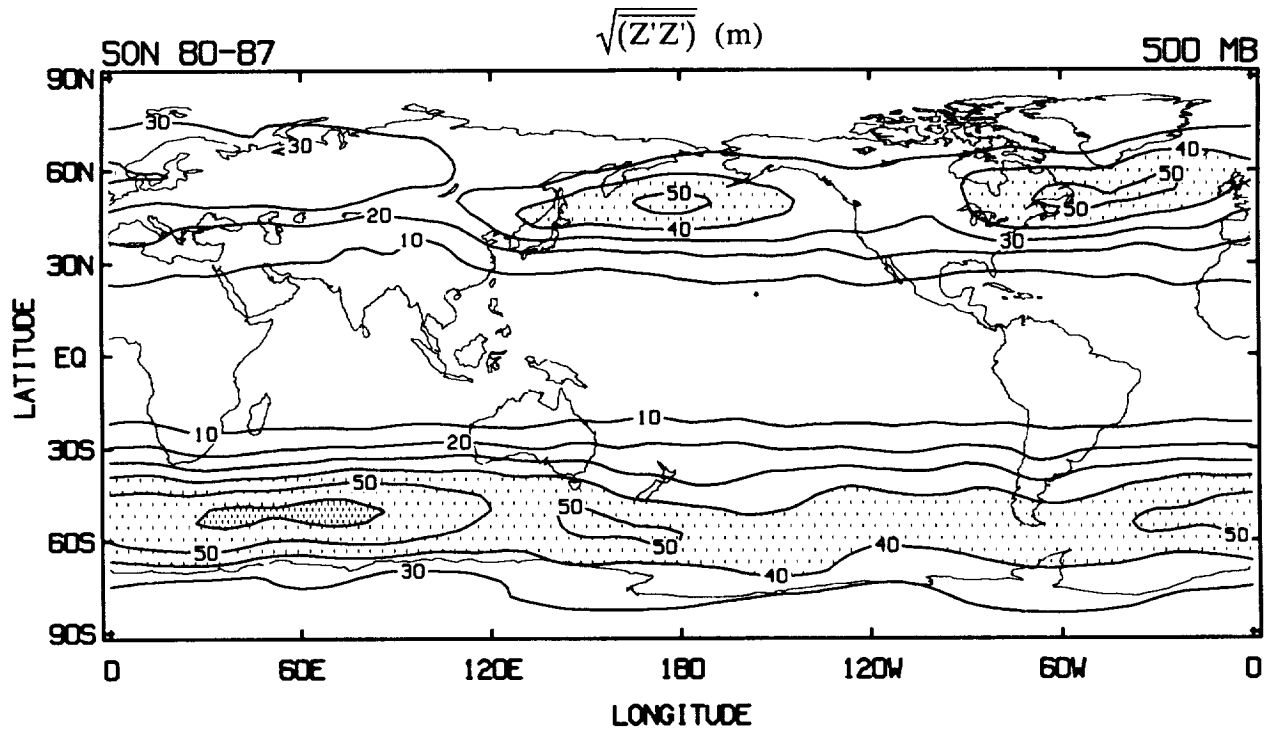

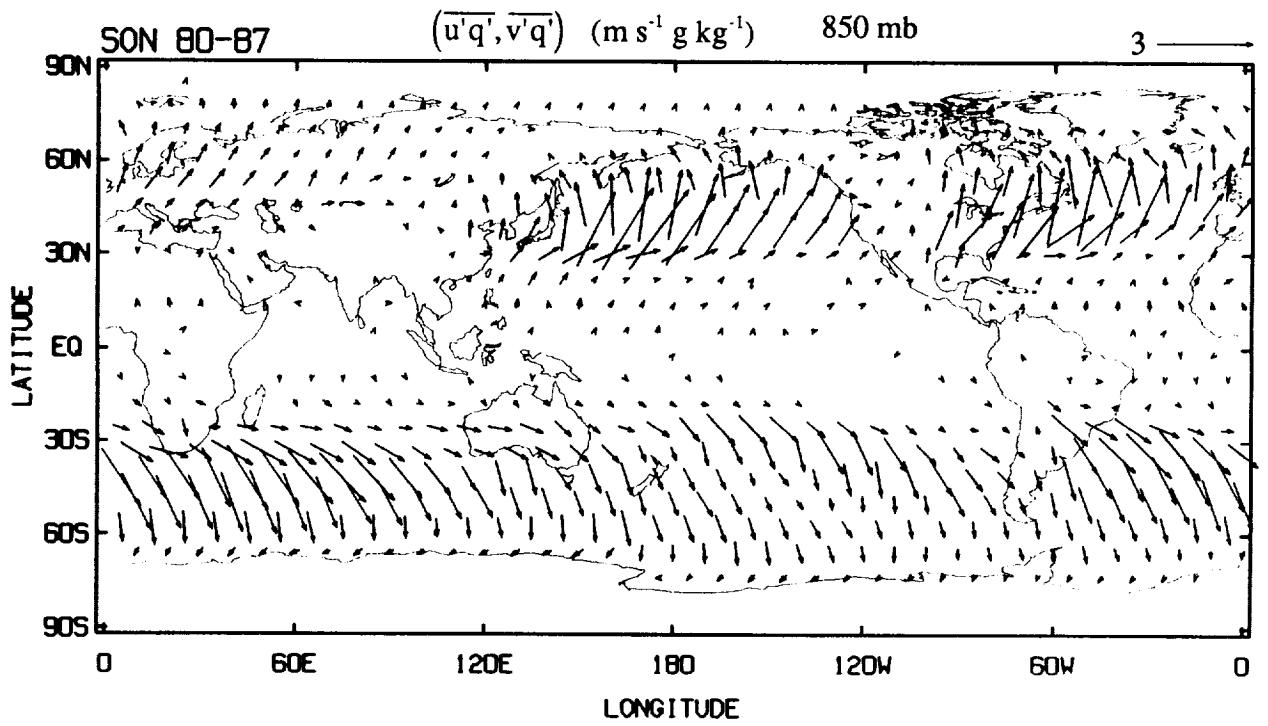
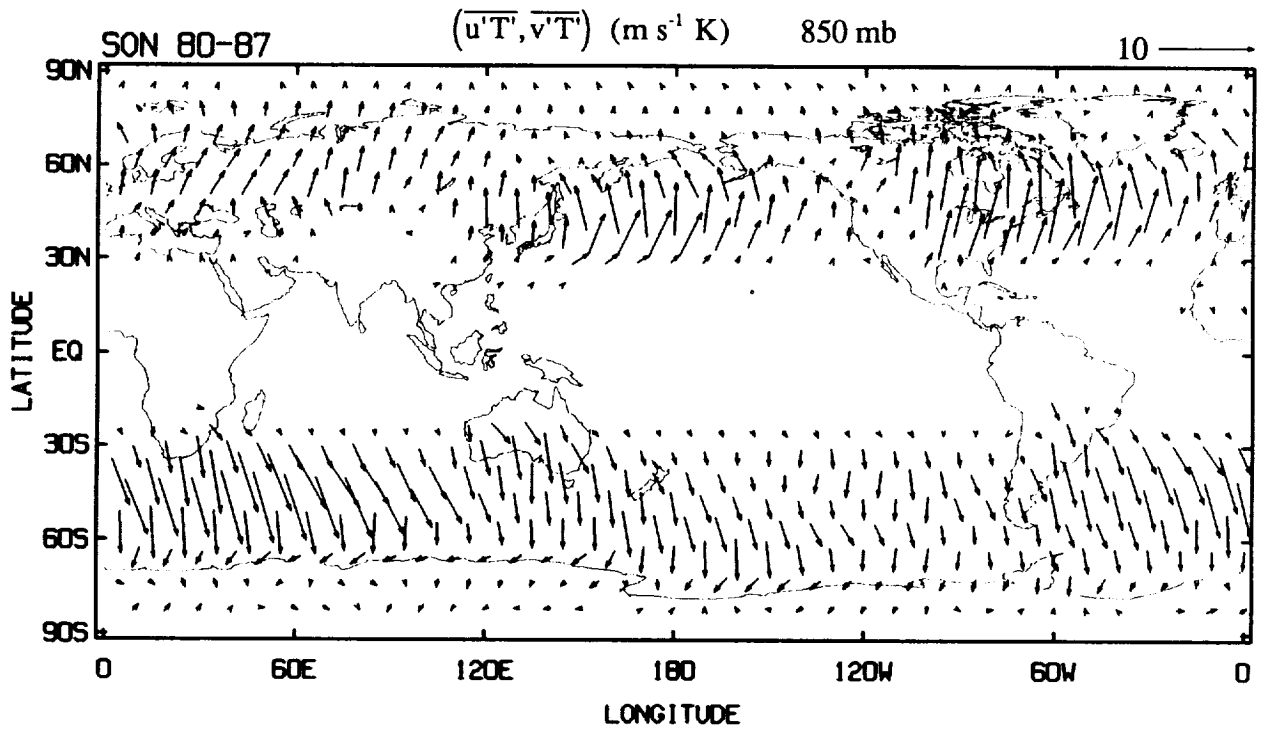

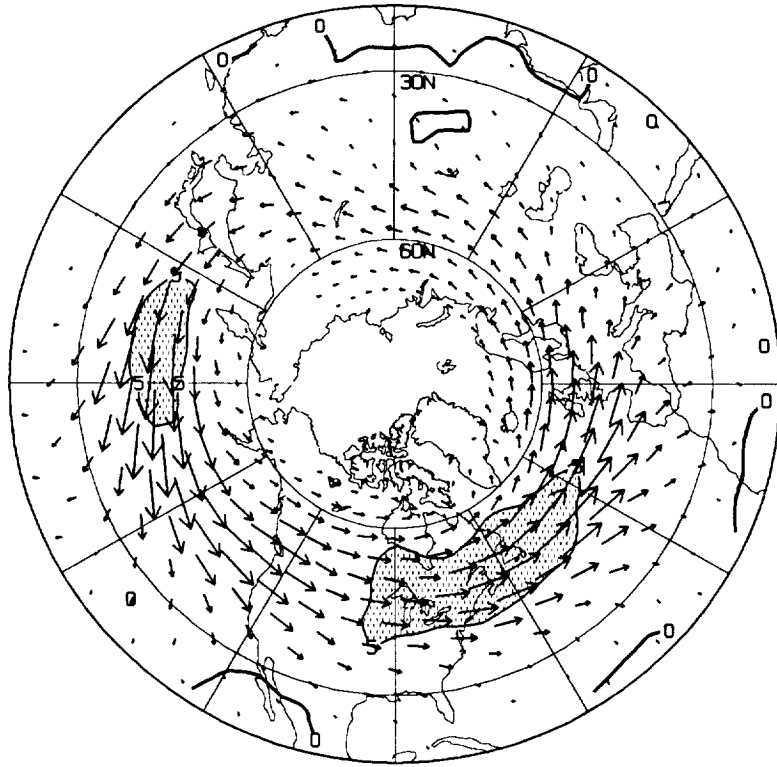

$\overline{v'T'} \text{ (m s}^{-1}\text{K)}$ 850 mb

$E_u \text{ (m}^2\text{ s}^{-2})$ 200 mb

50 →

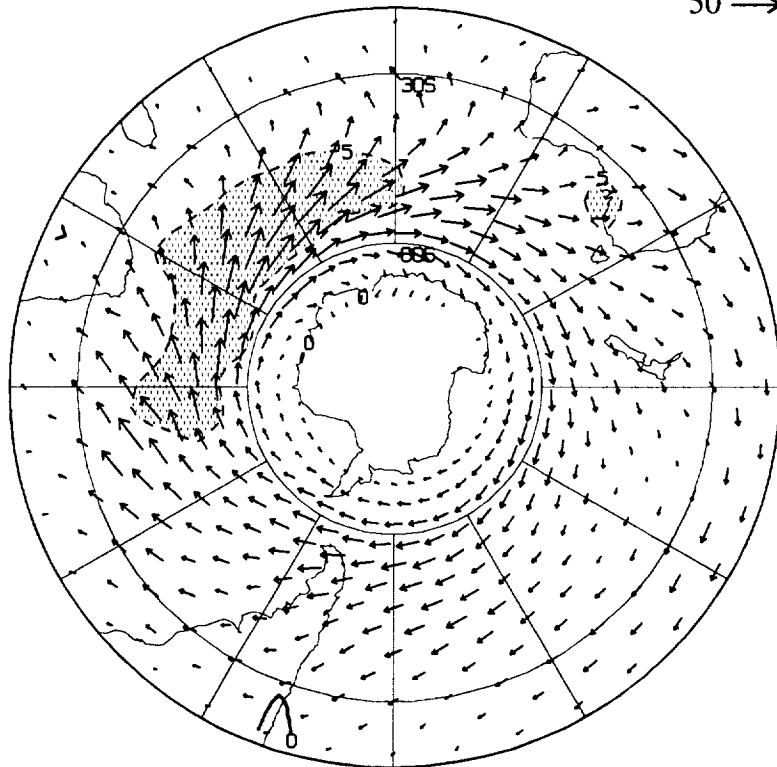

SON (80-87)

191

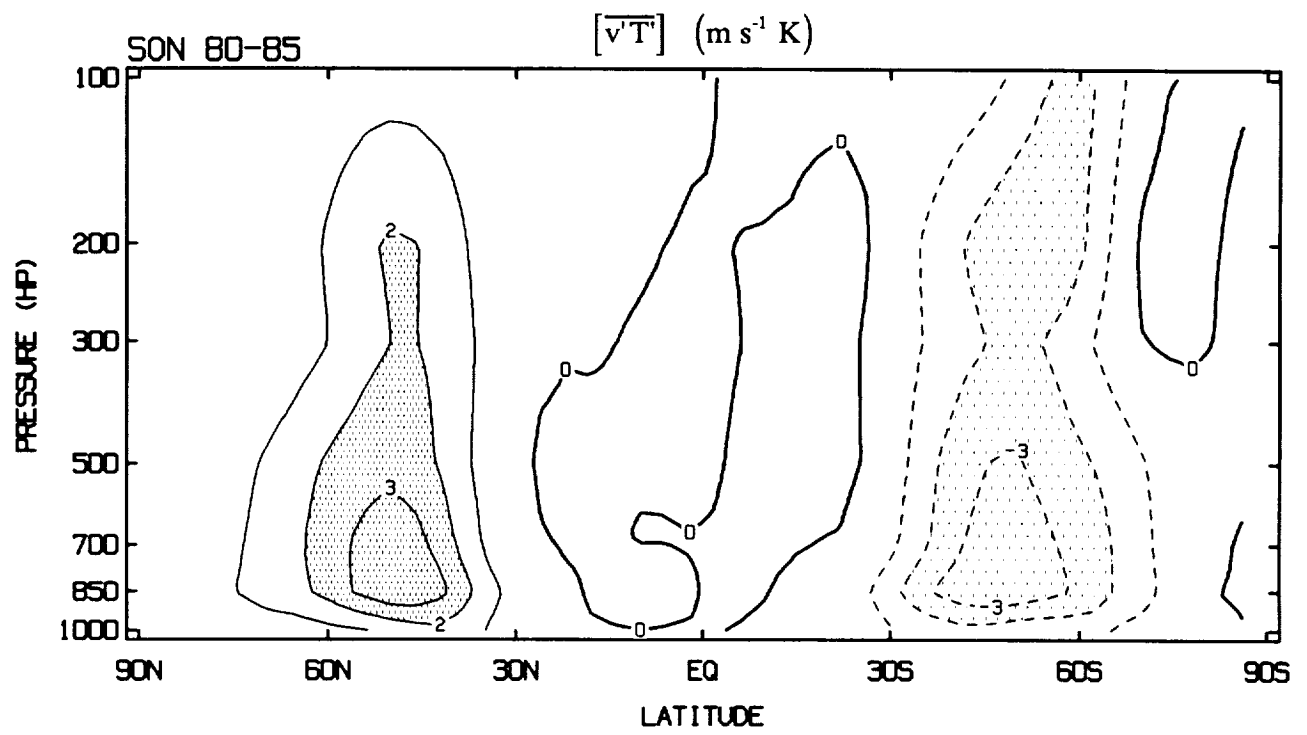
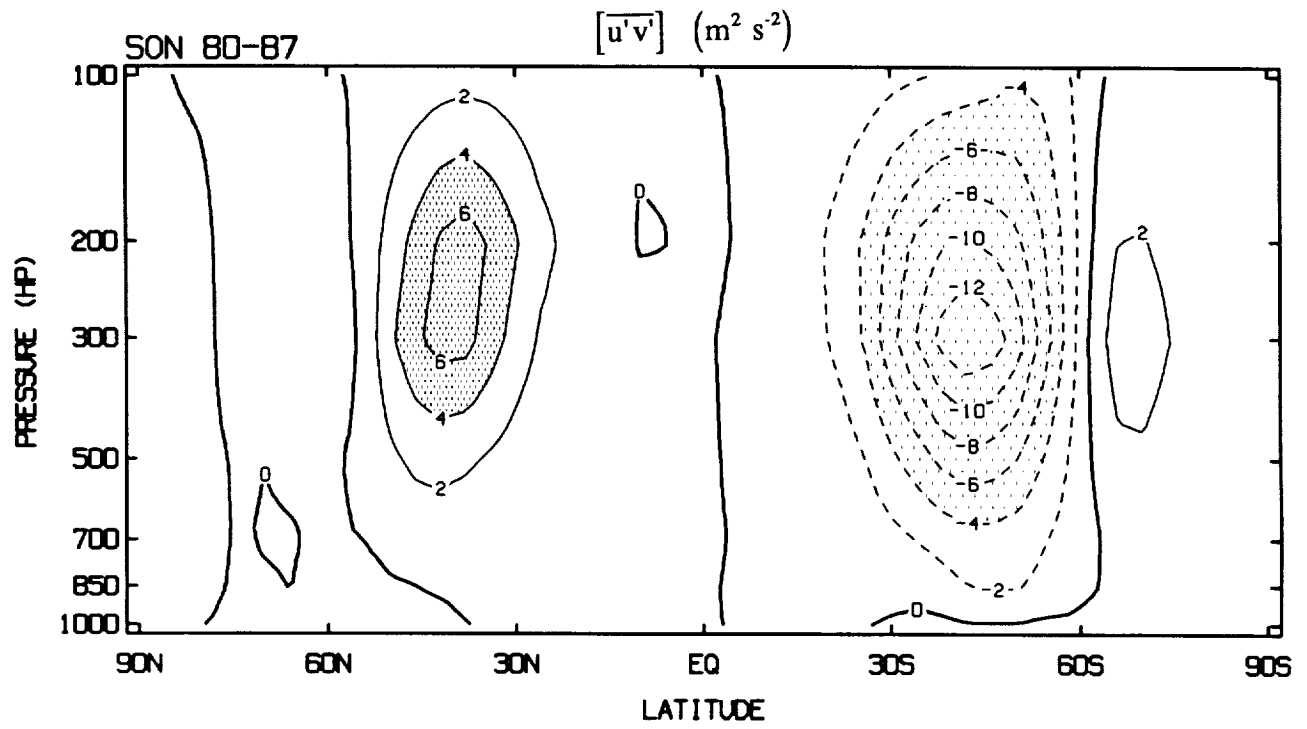

ANNUAL

DEVIATIONS FROM MONTHLY MEANS



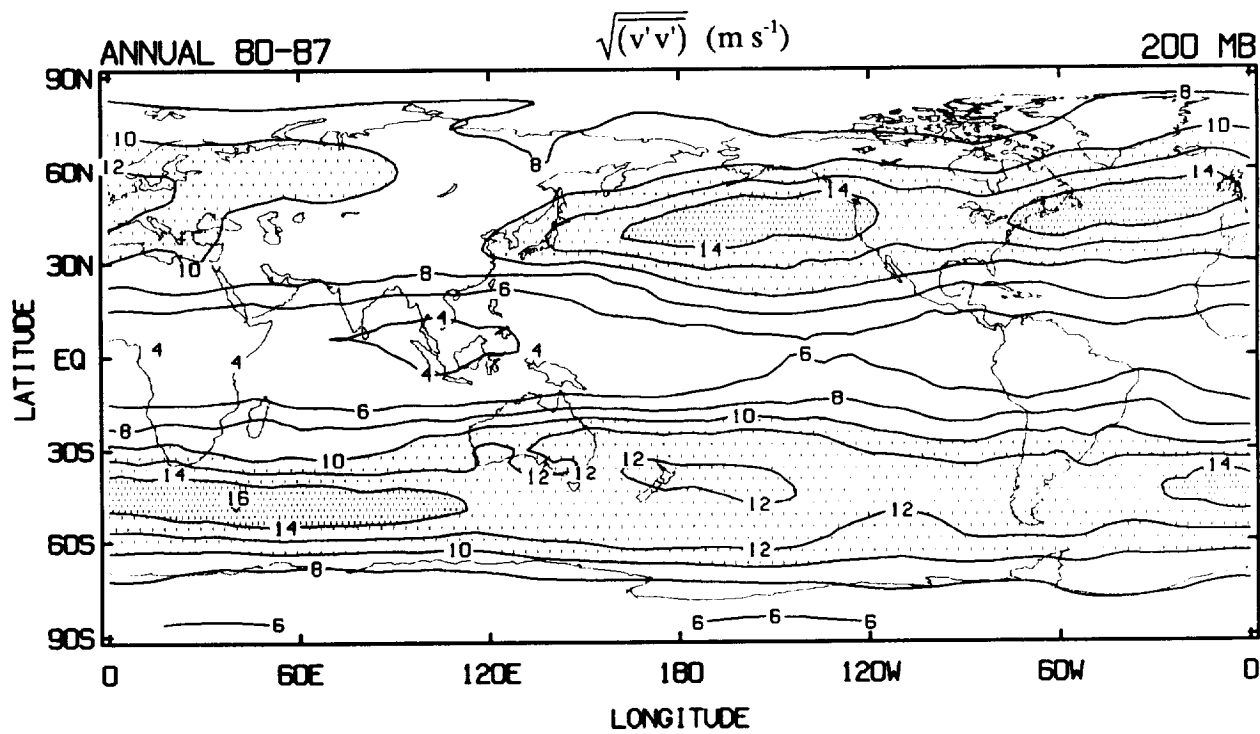
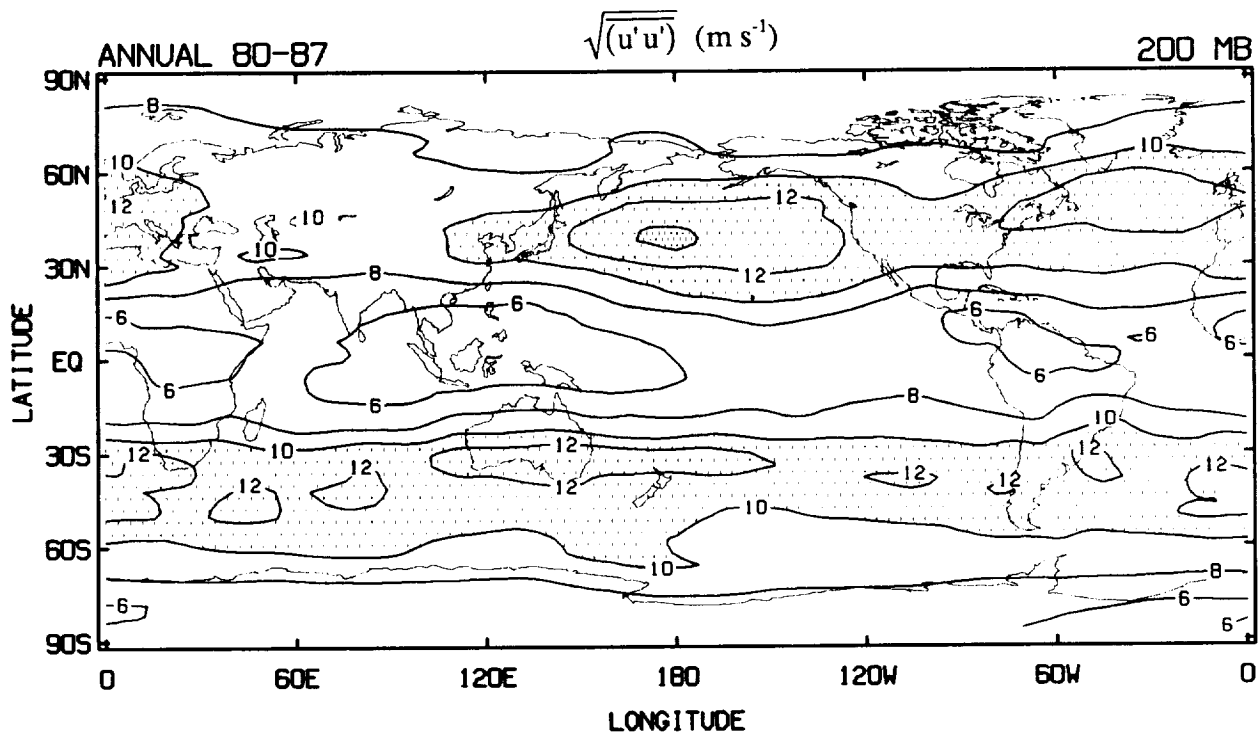

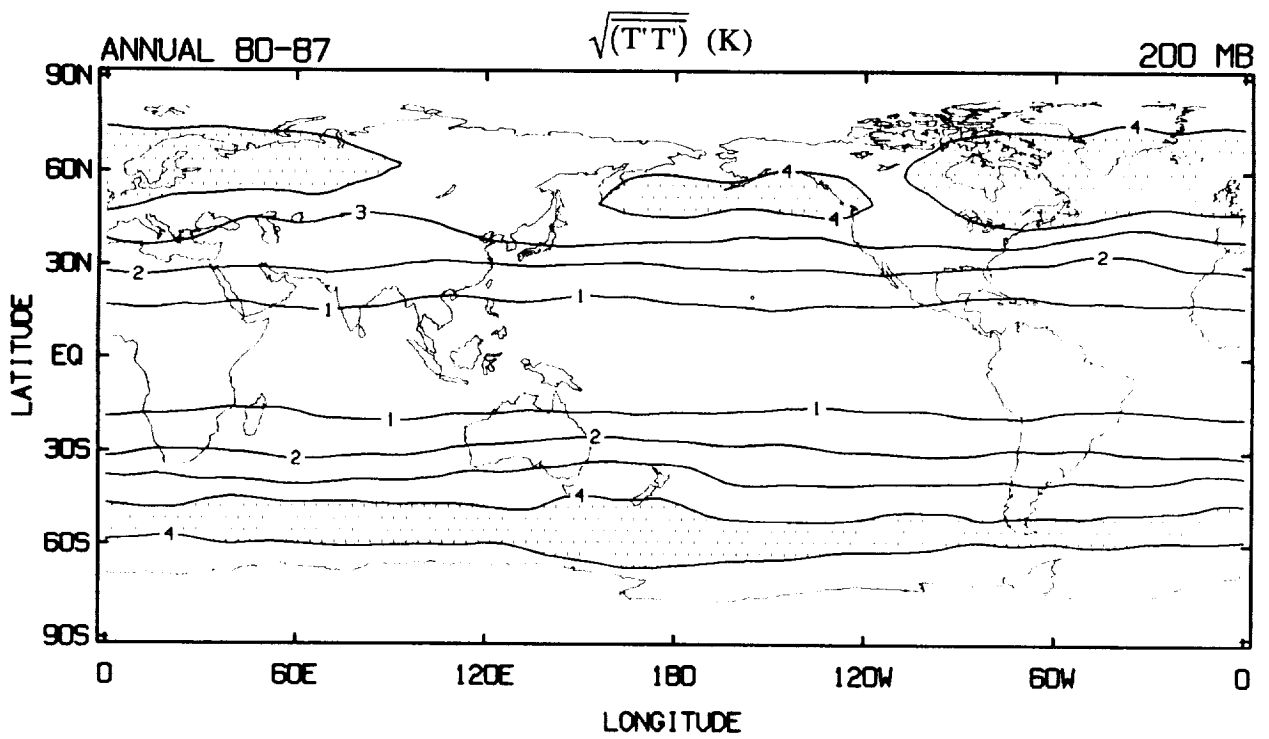
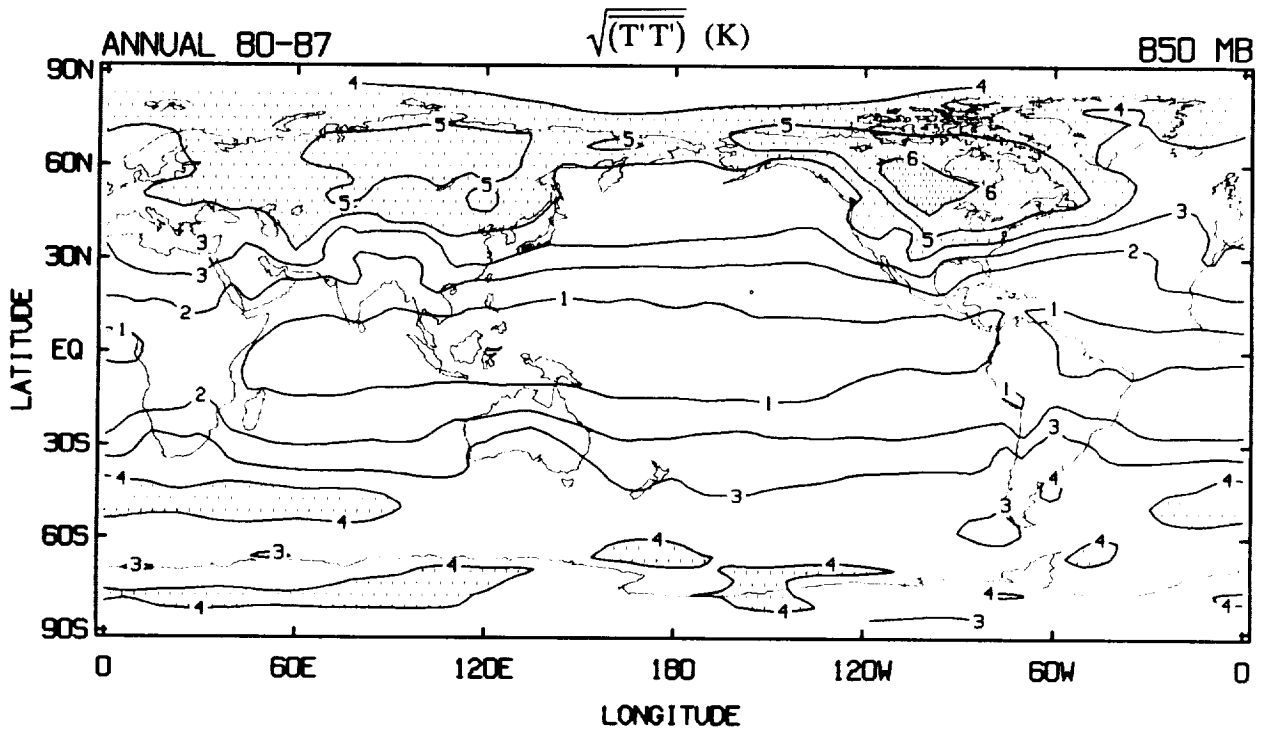

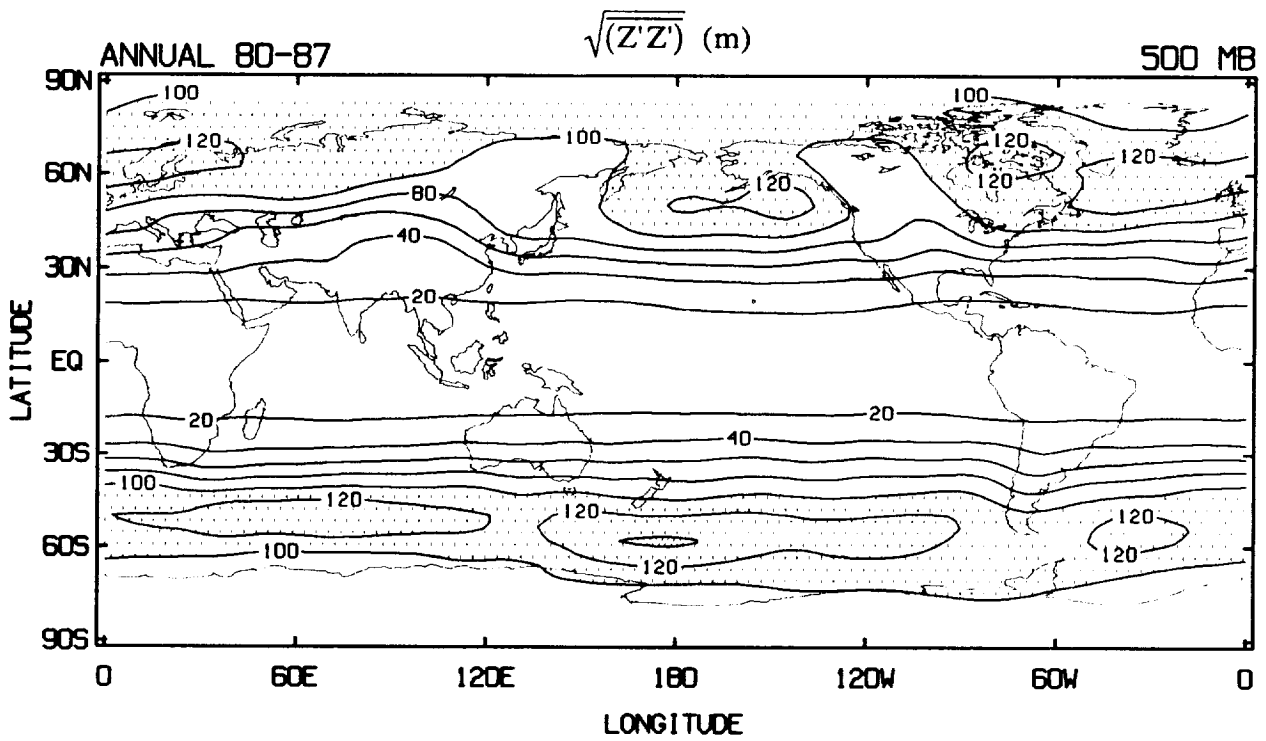
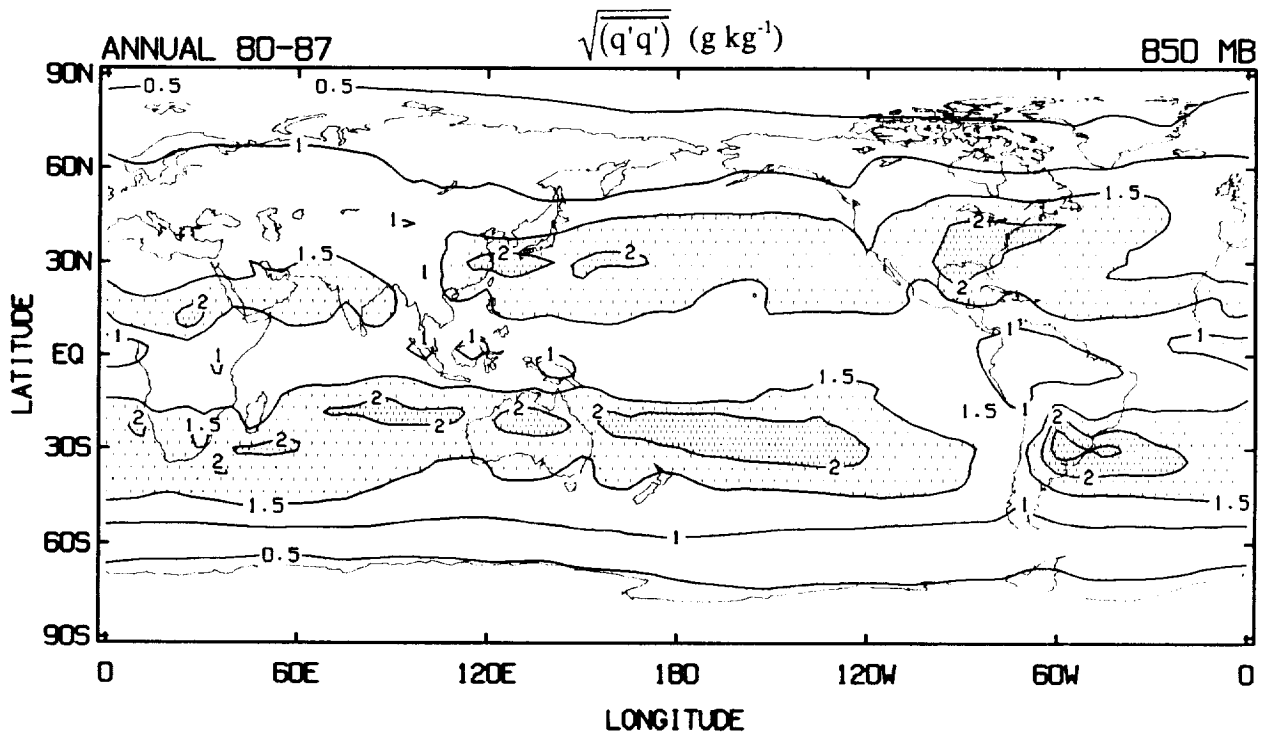

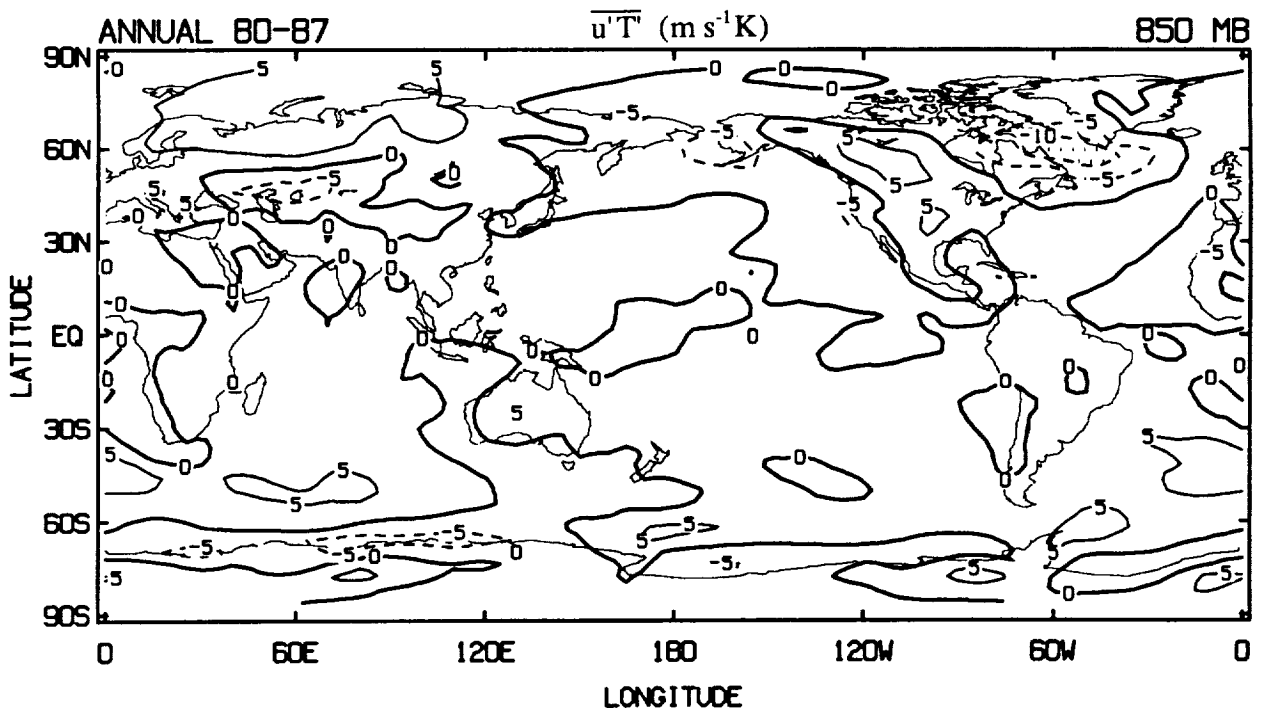
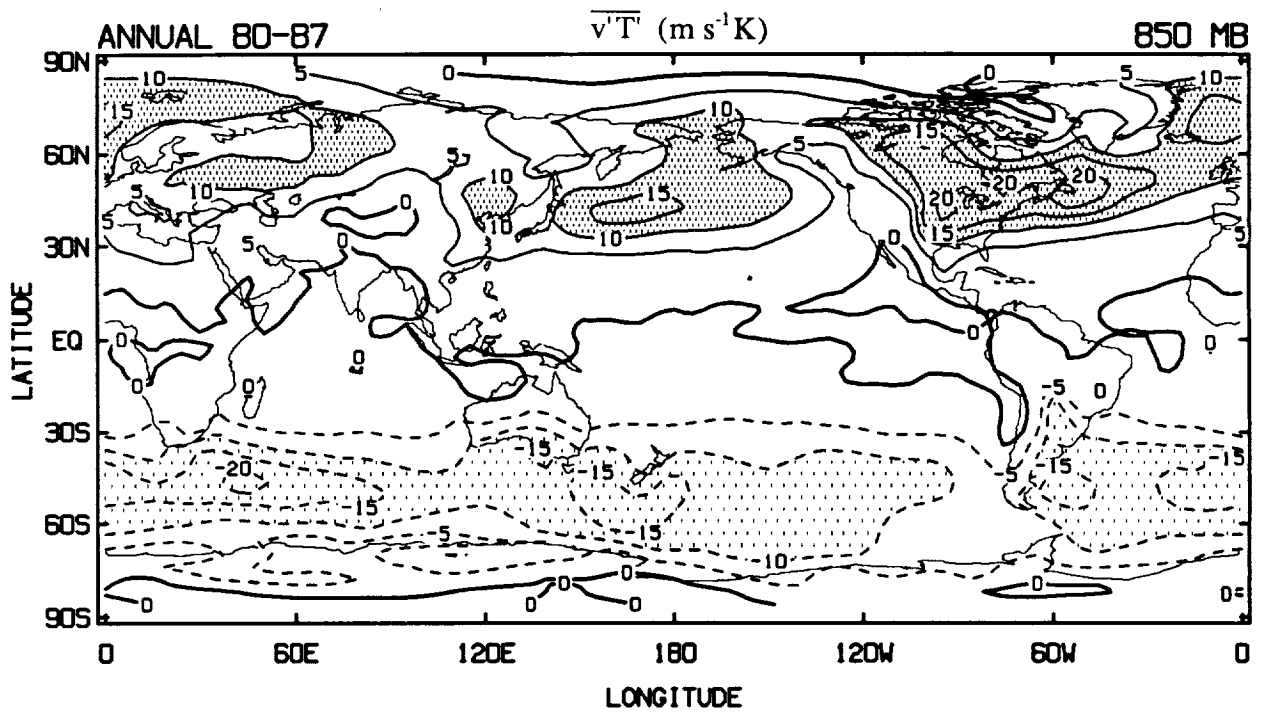

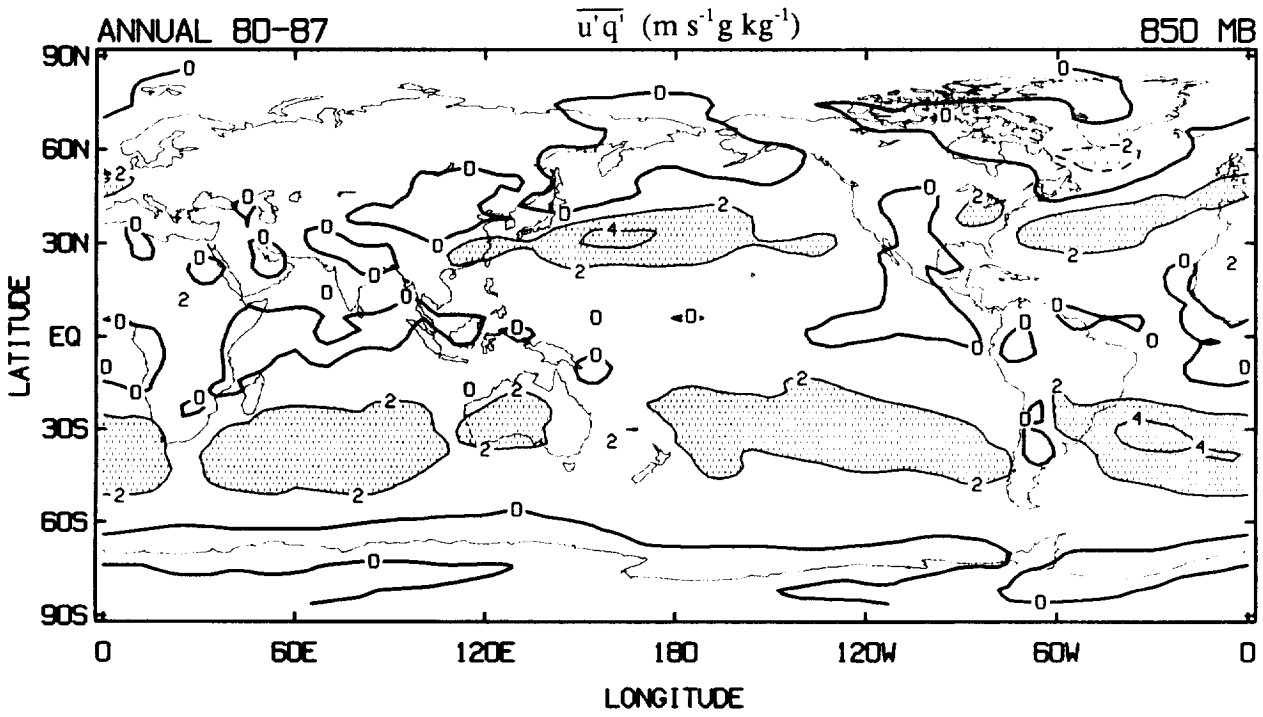
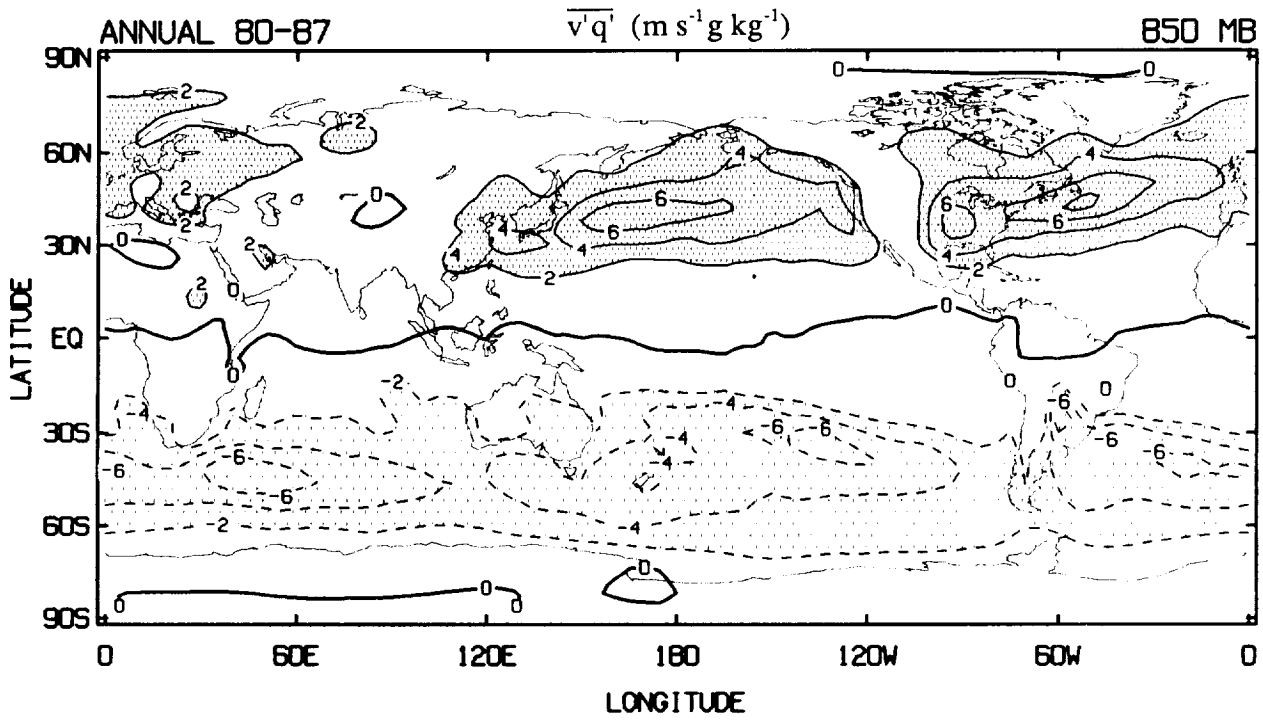

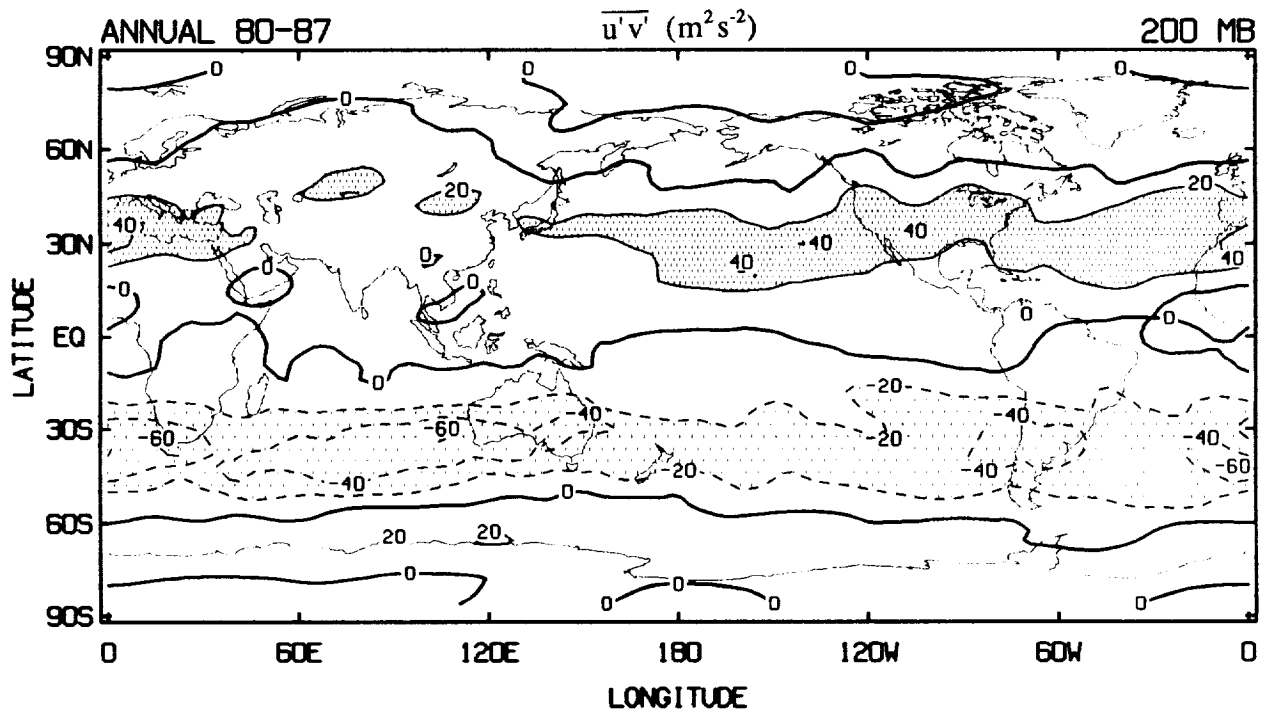

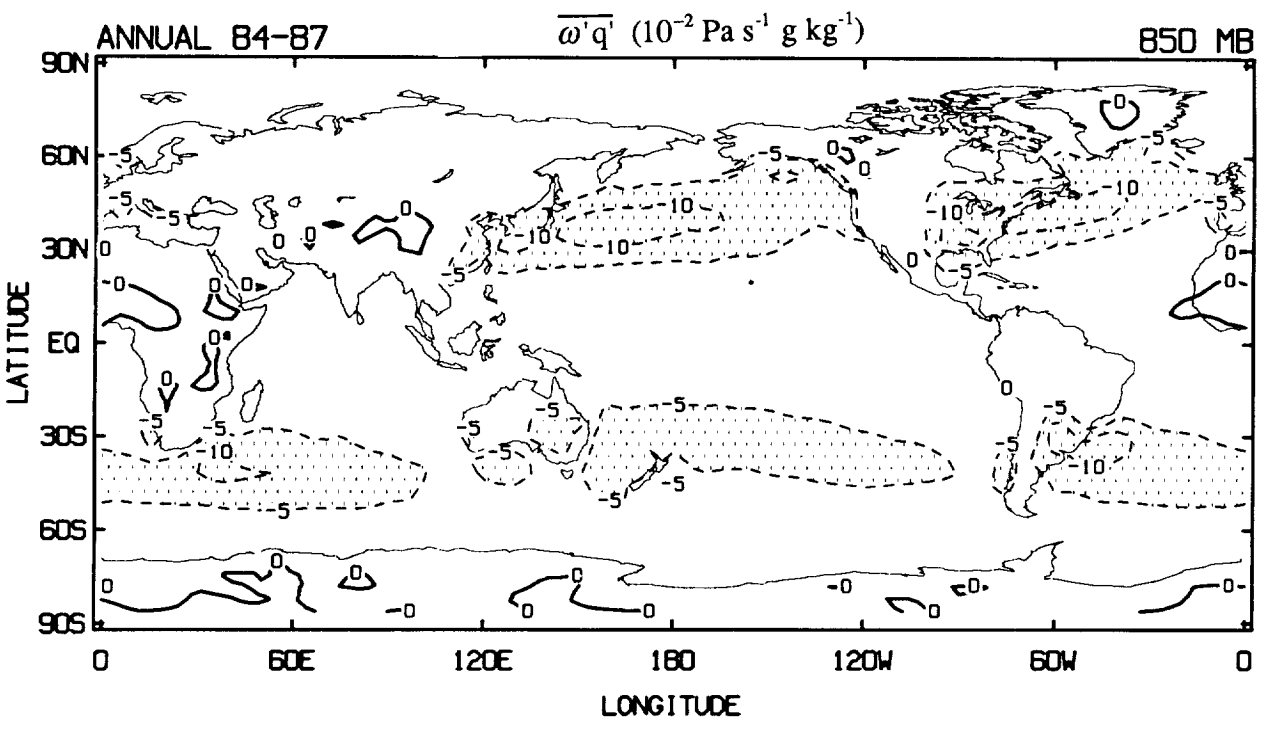
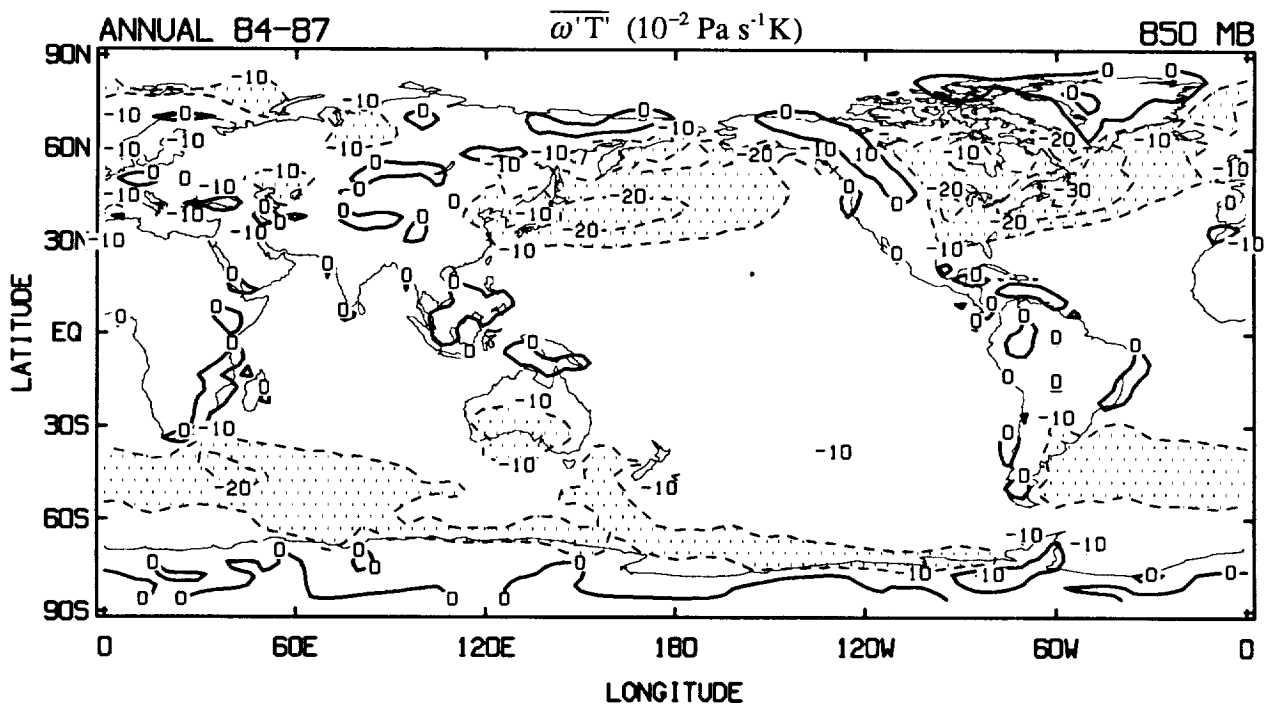

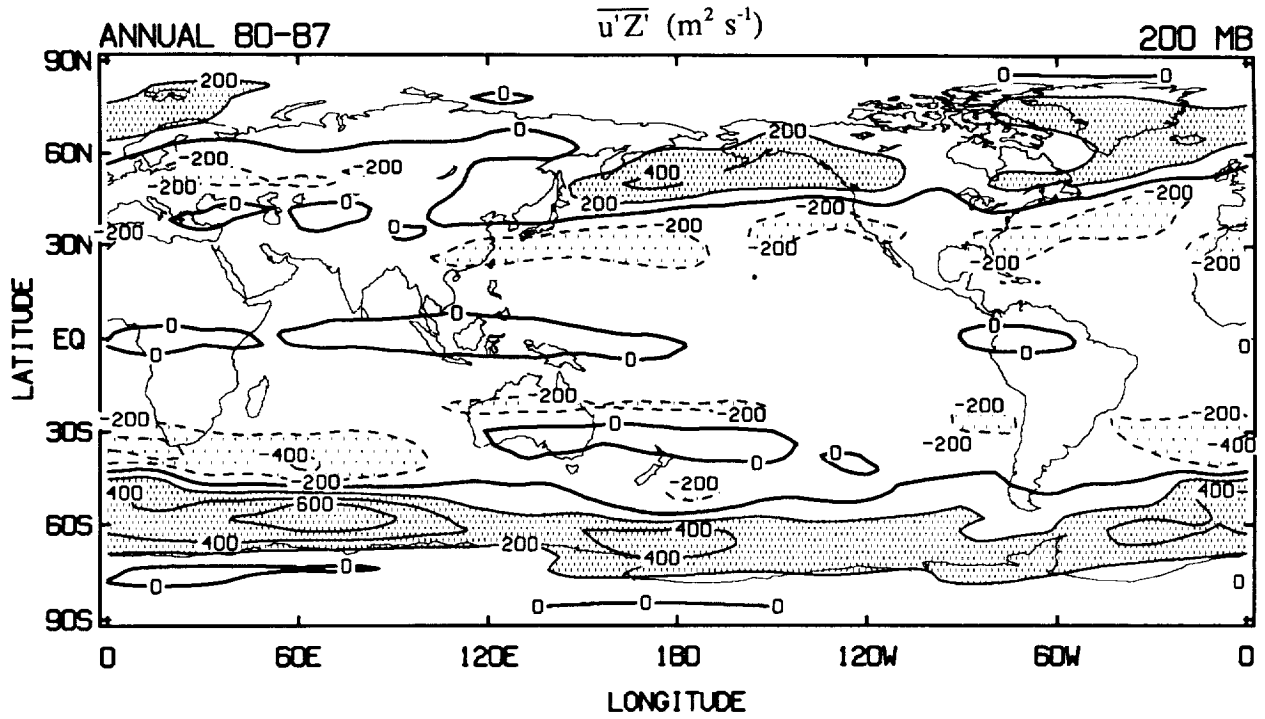
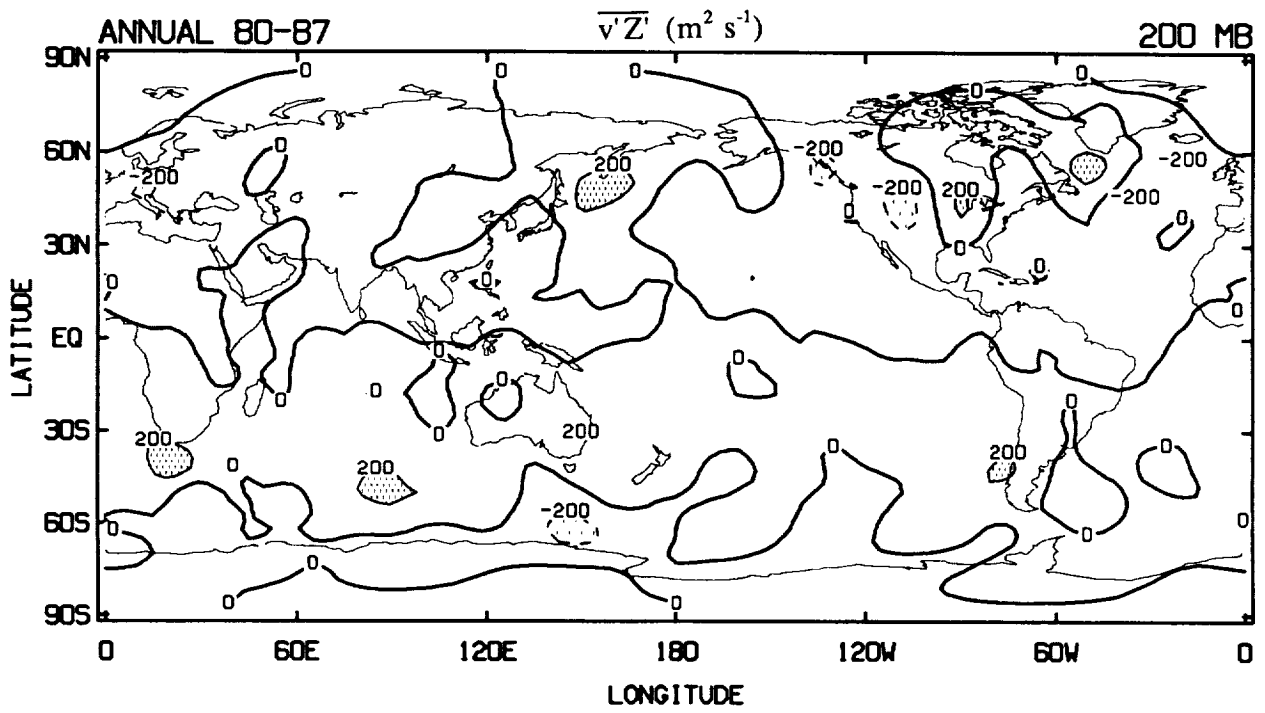

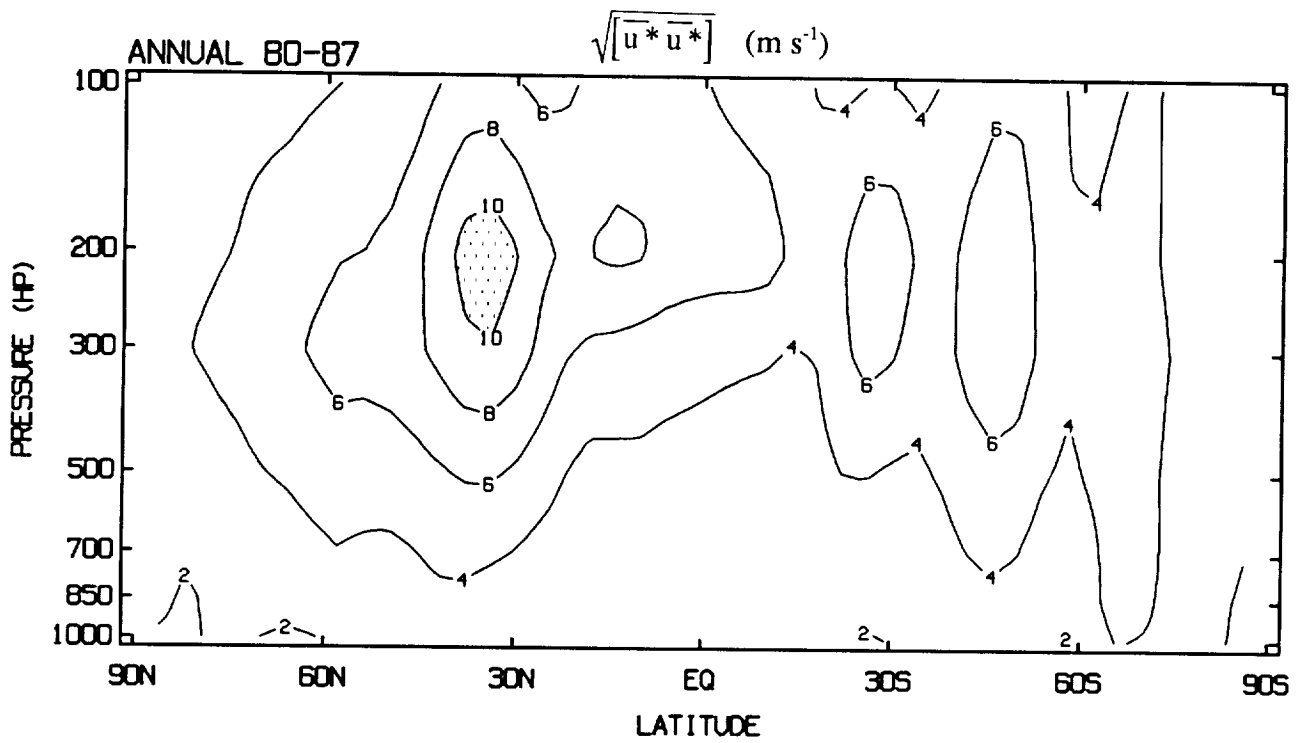
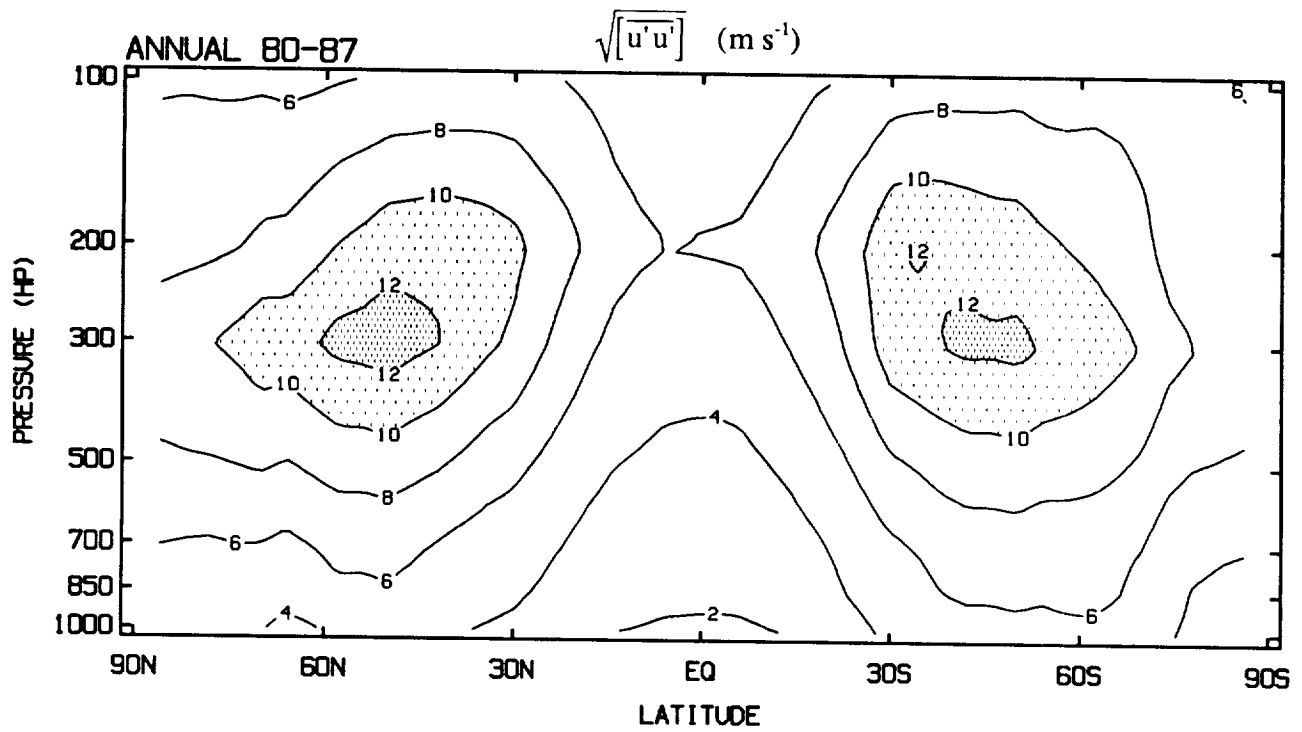

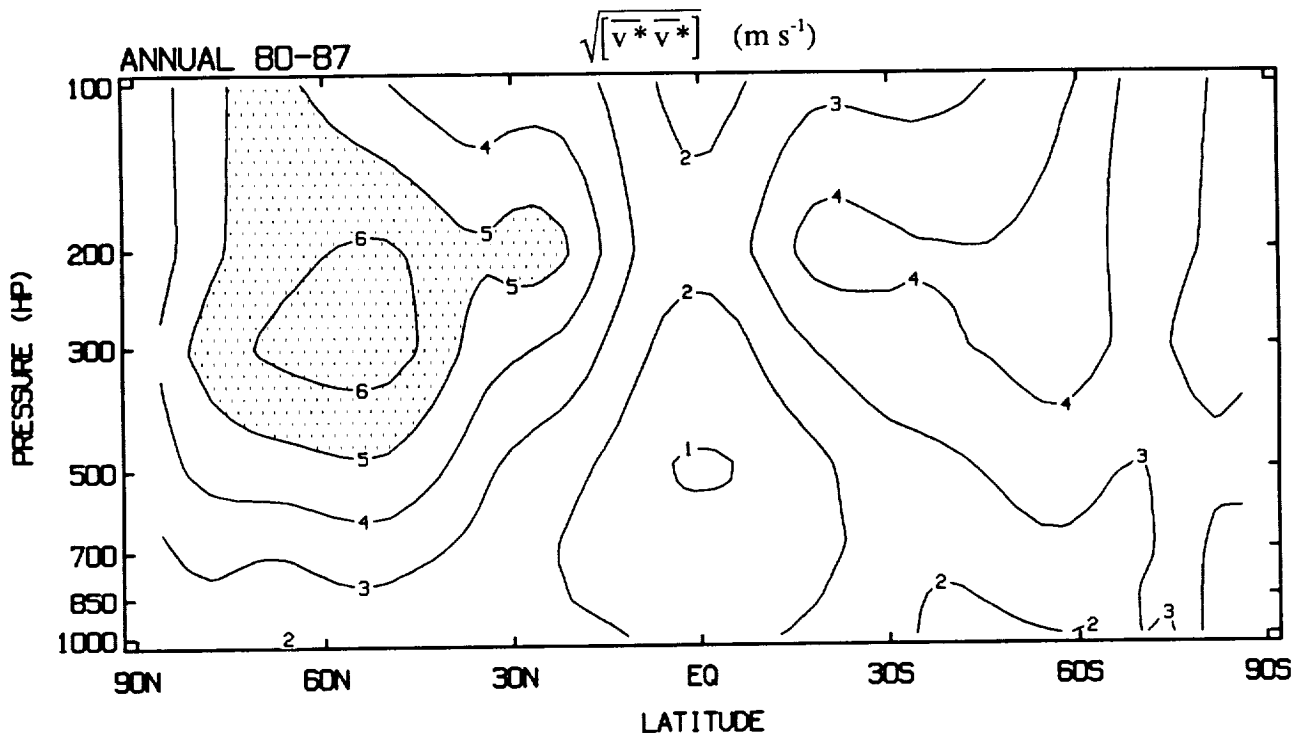
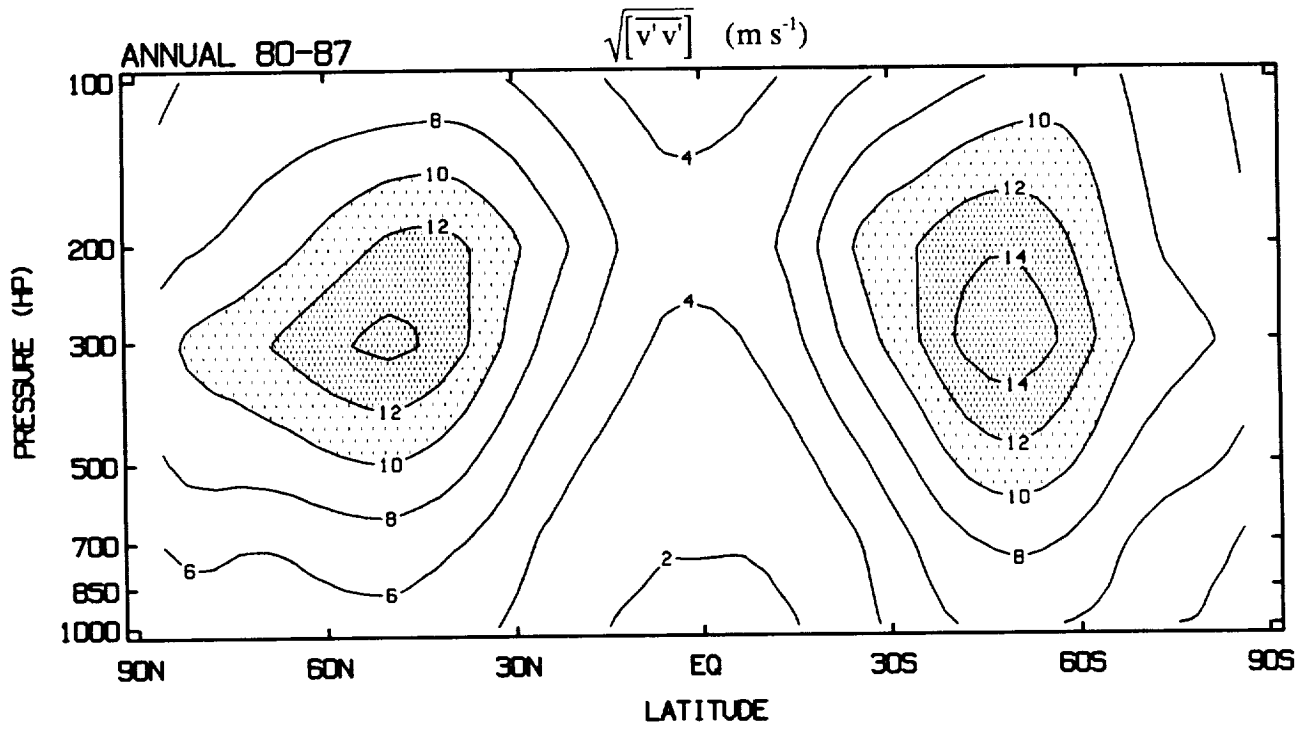

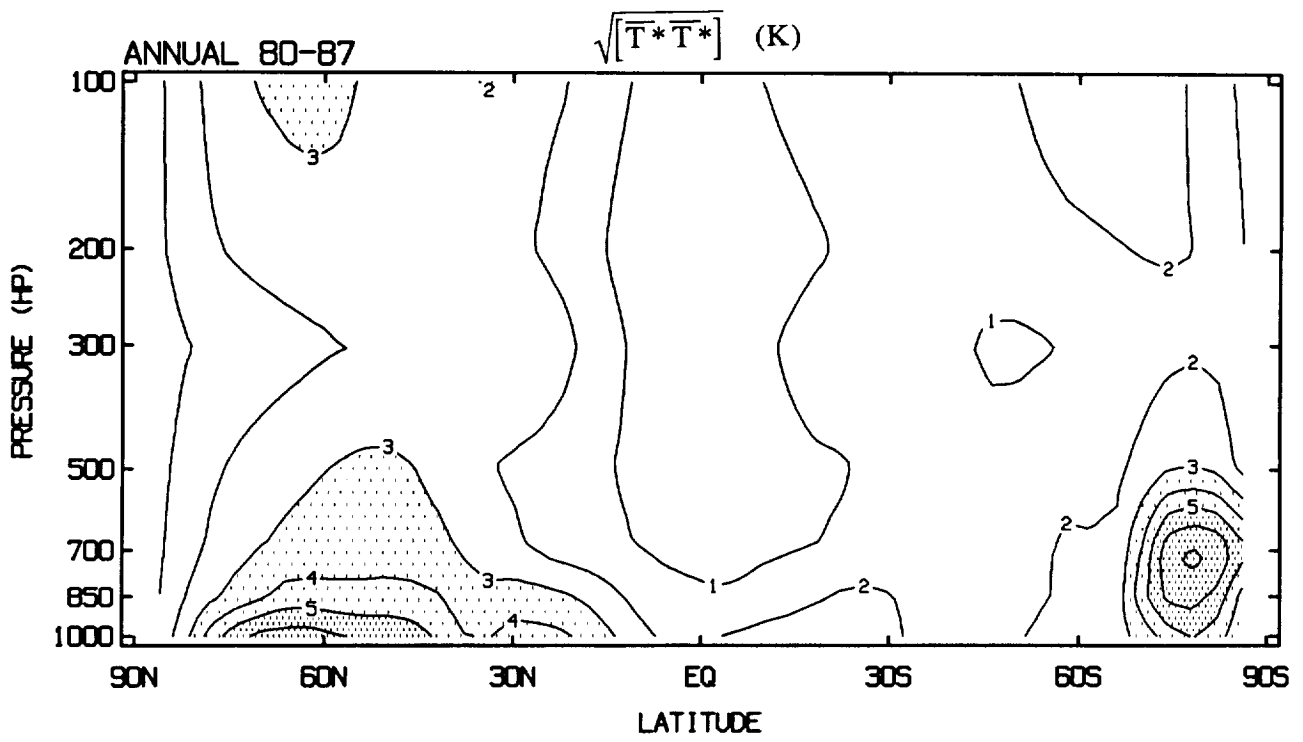
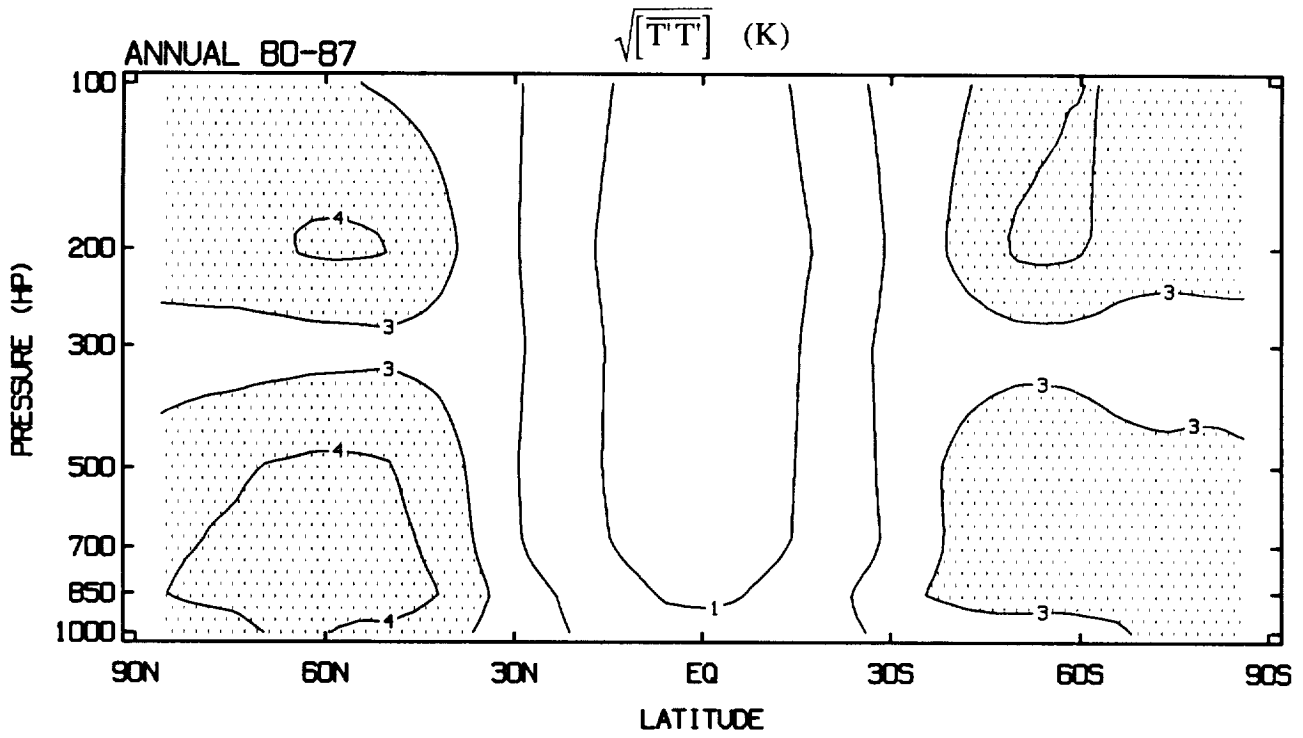

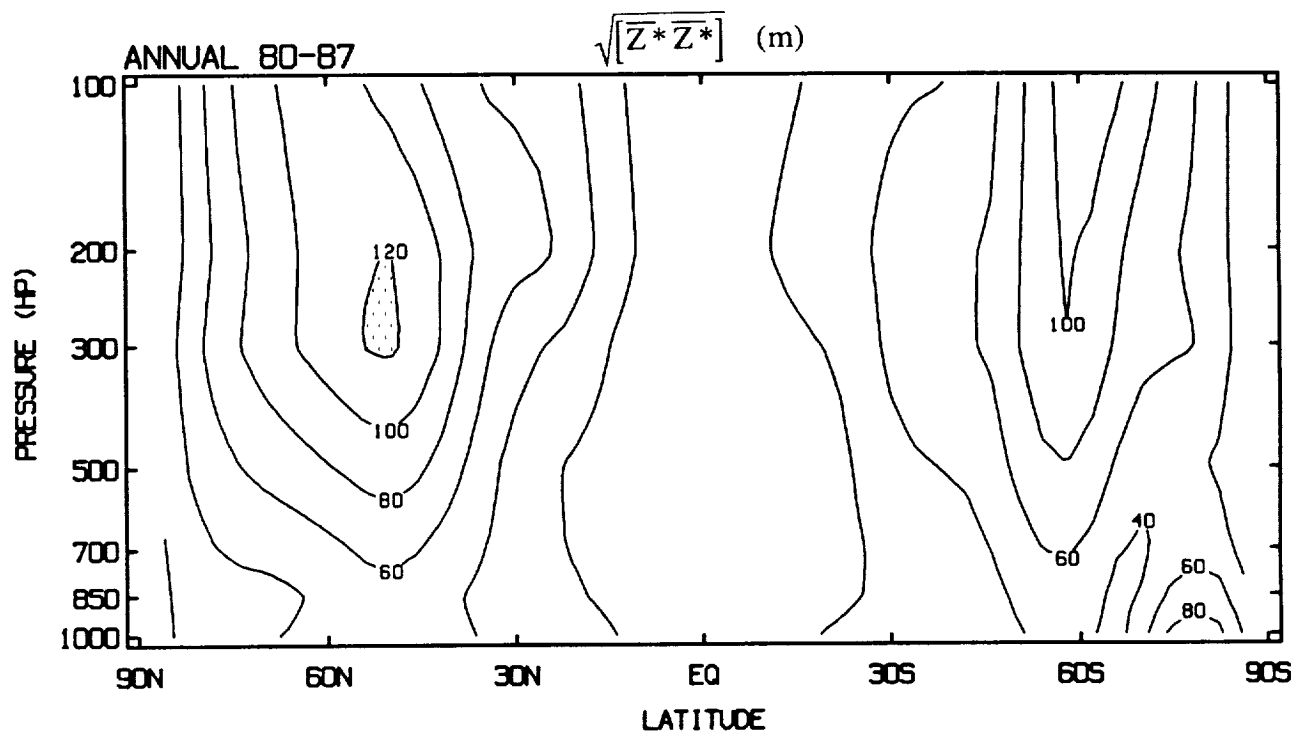
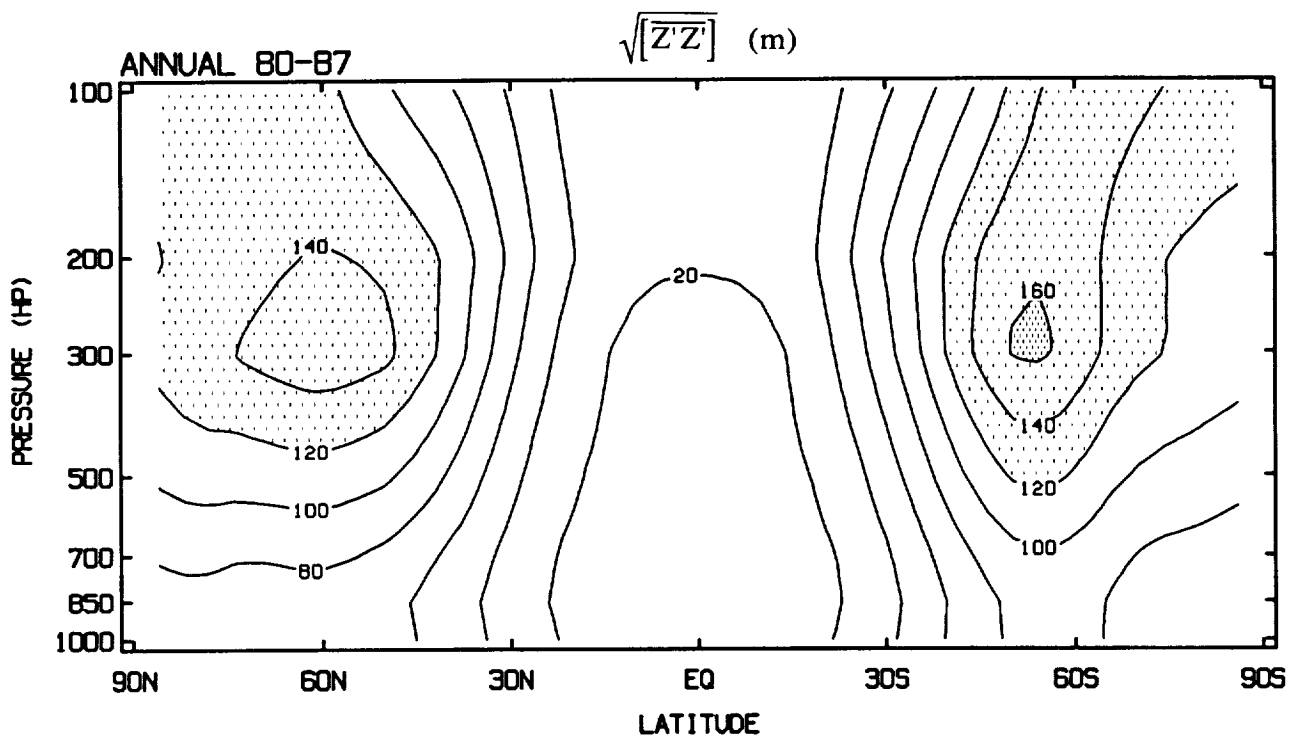

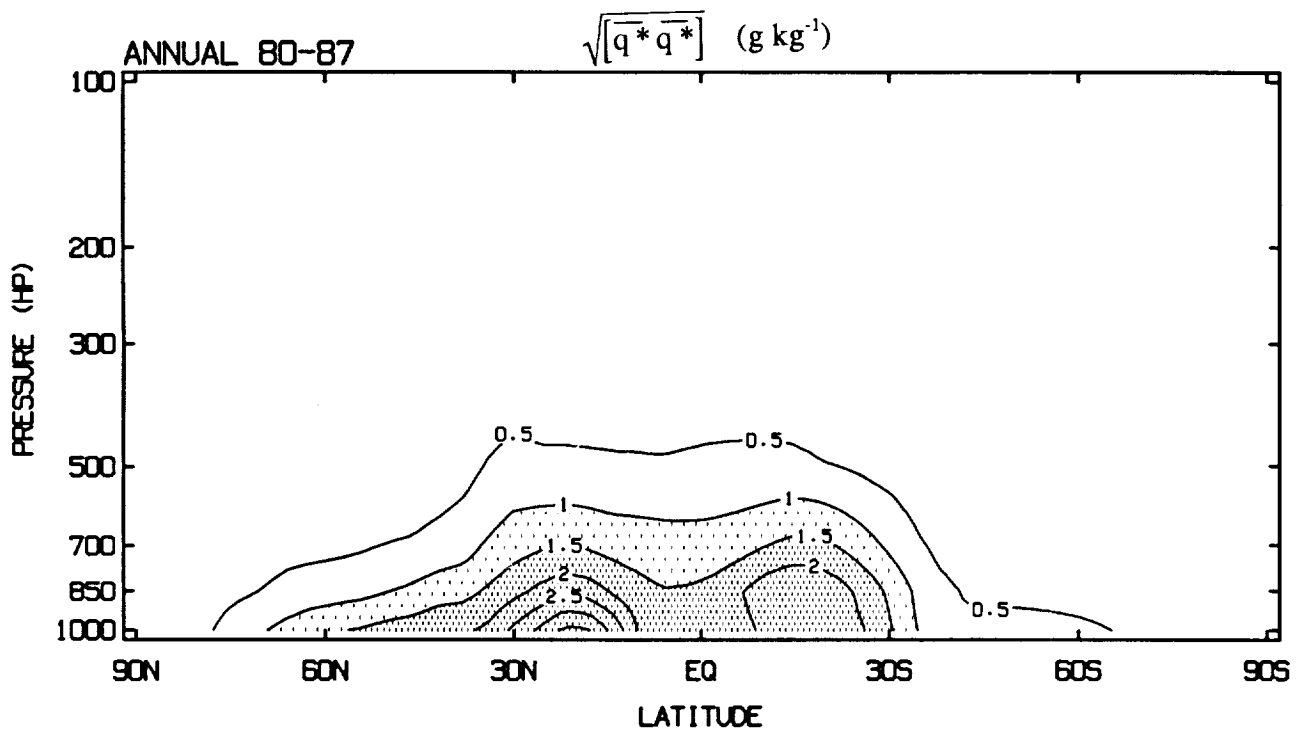
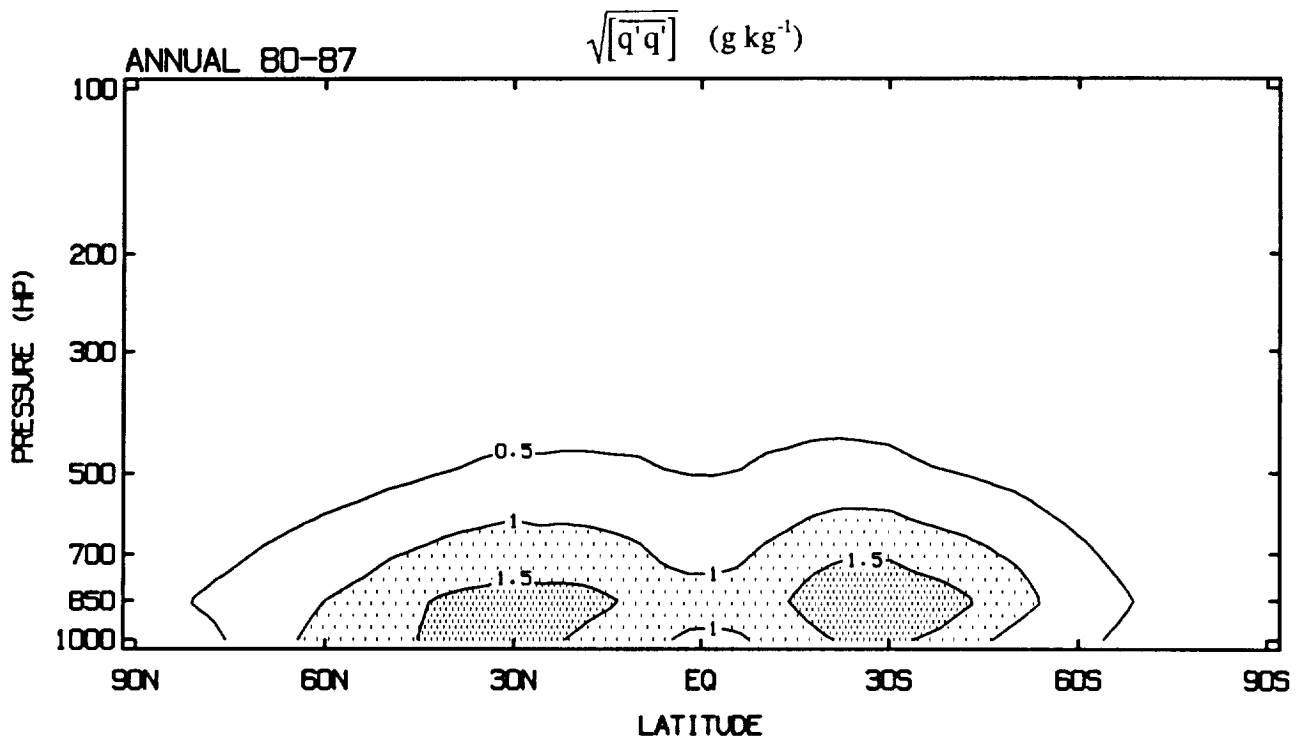

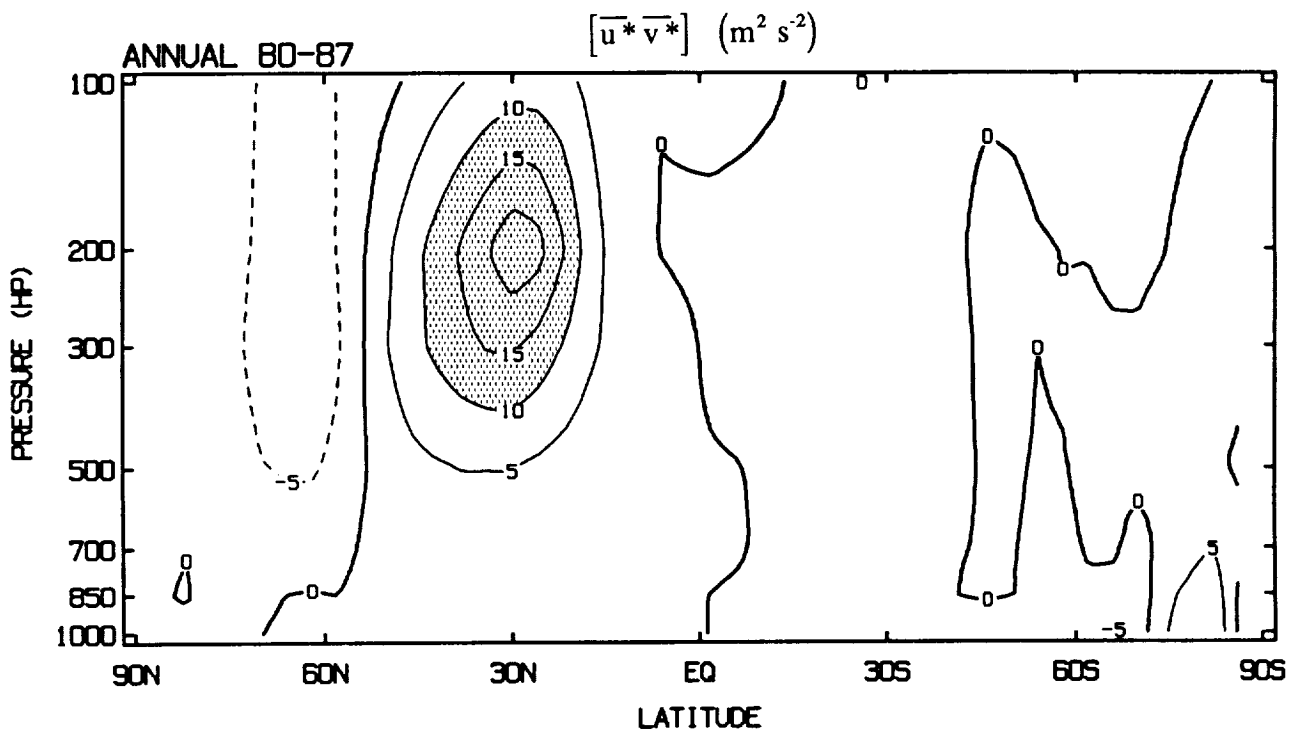
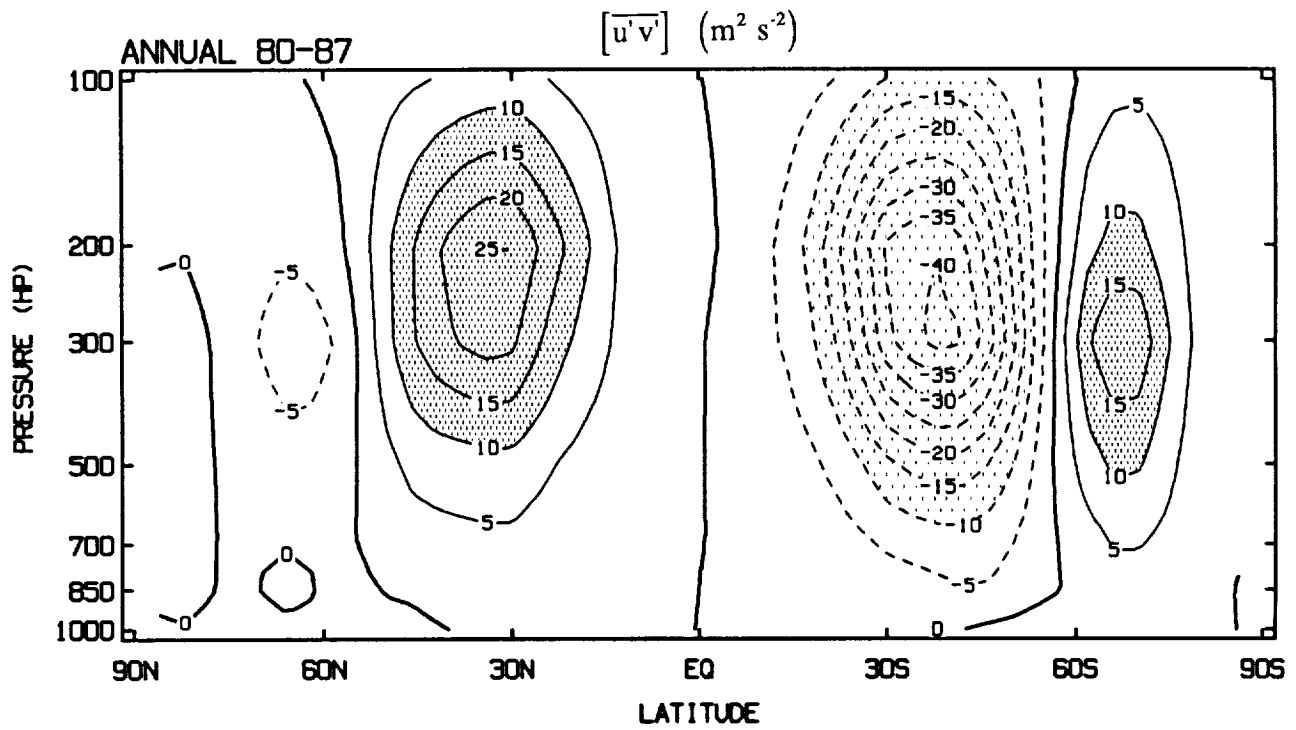

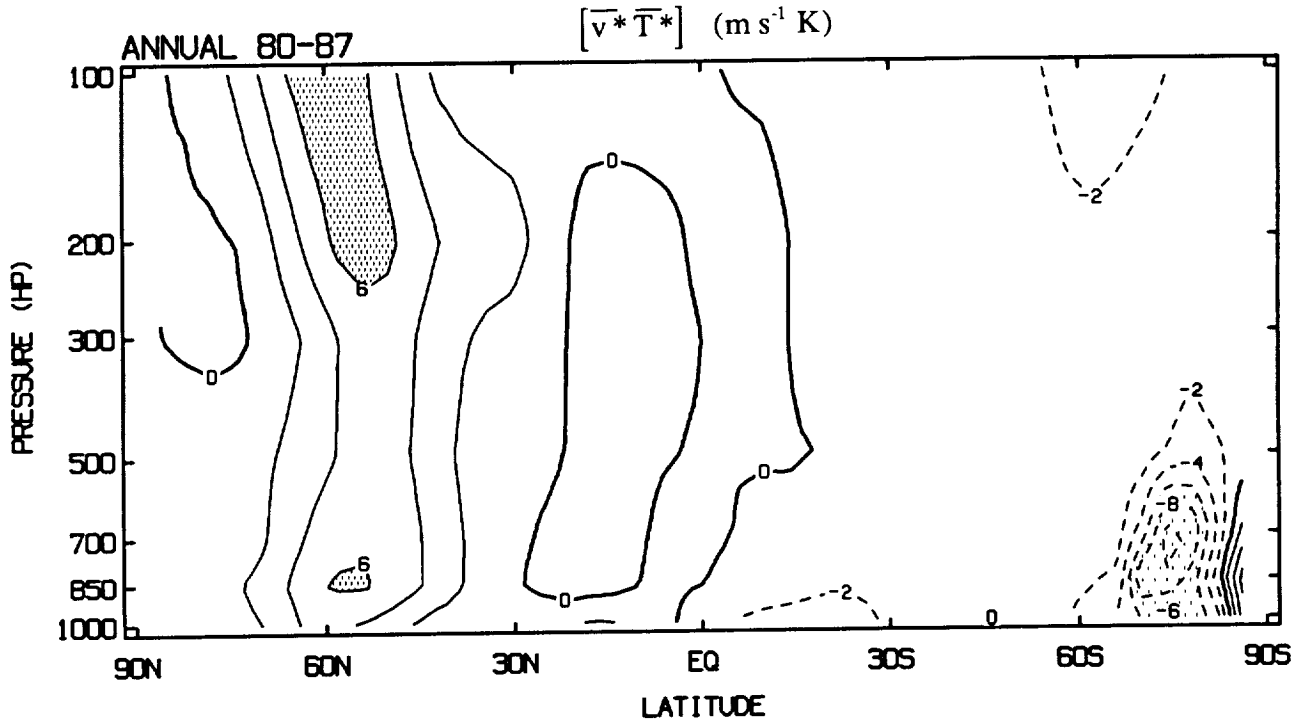
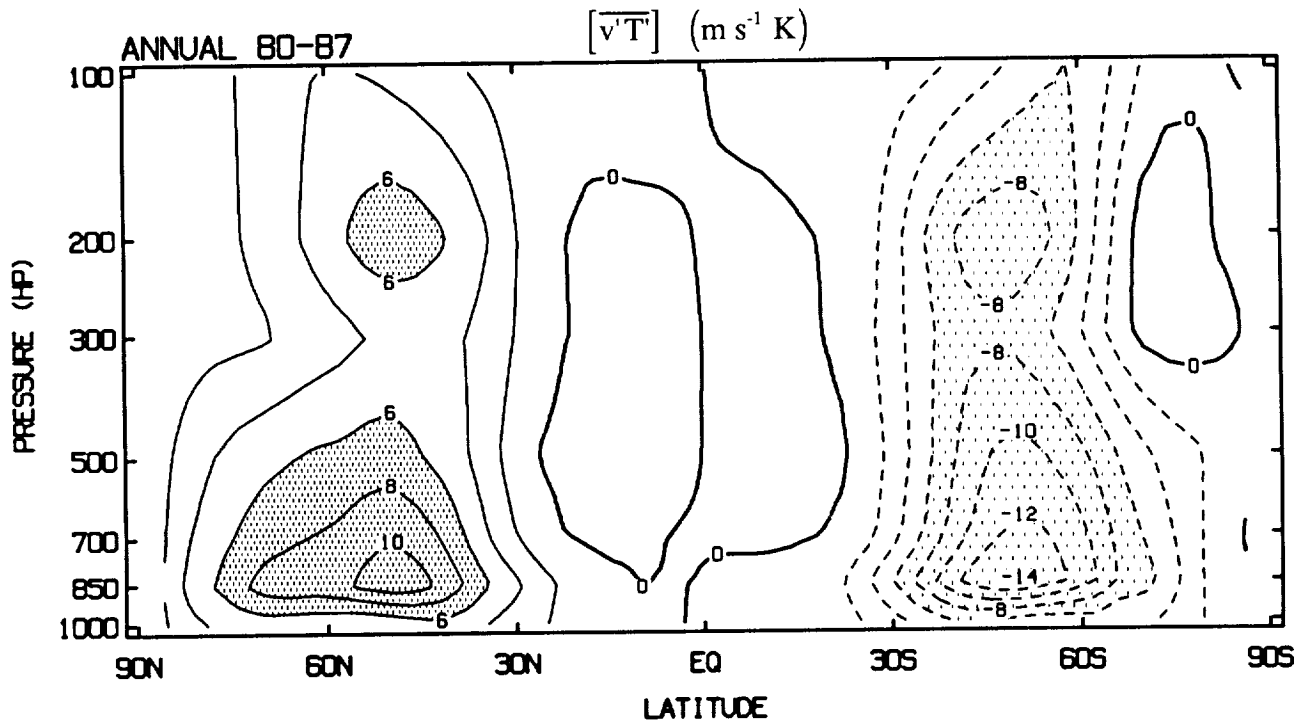

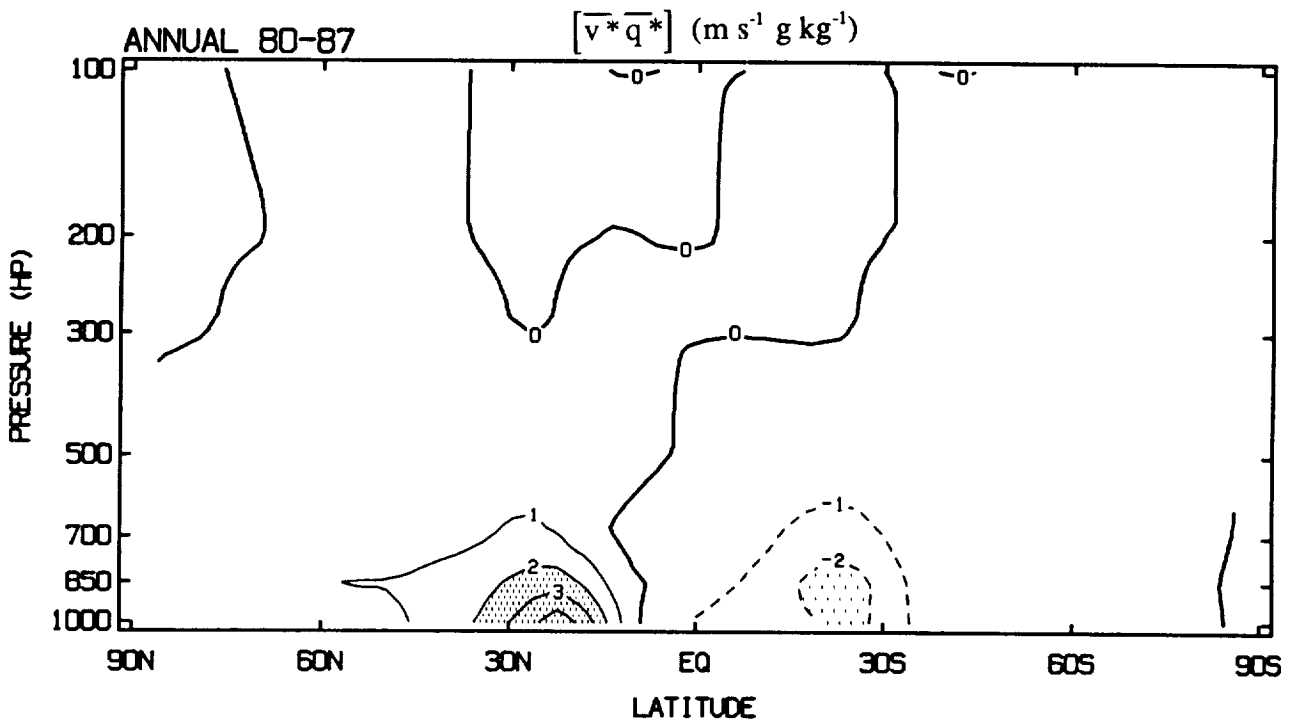
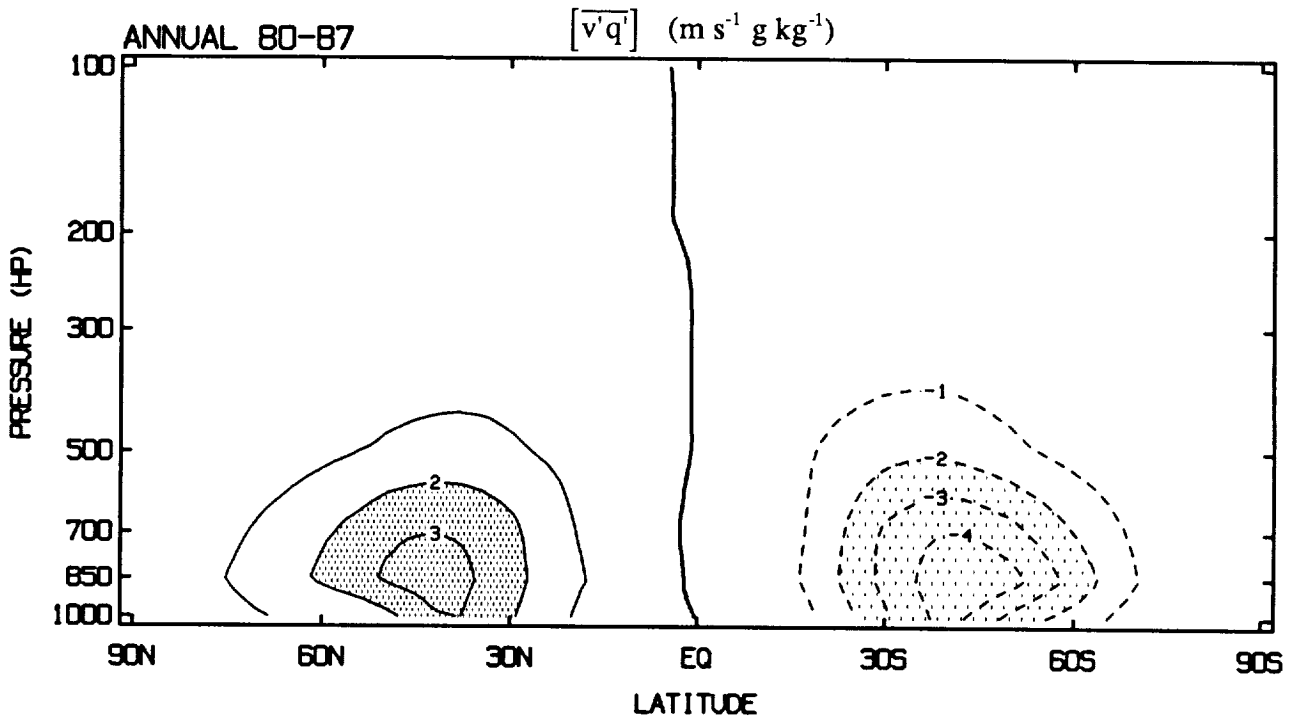

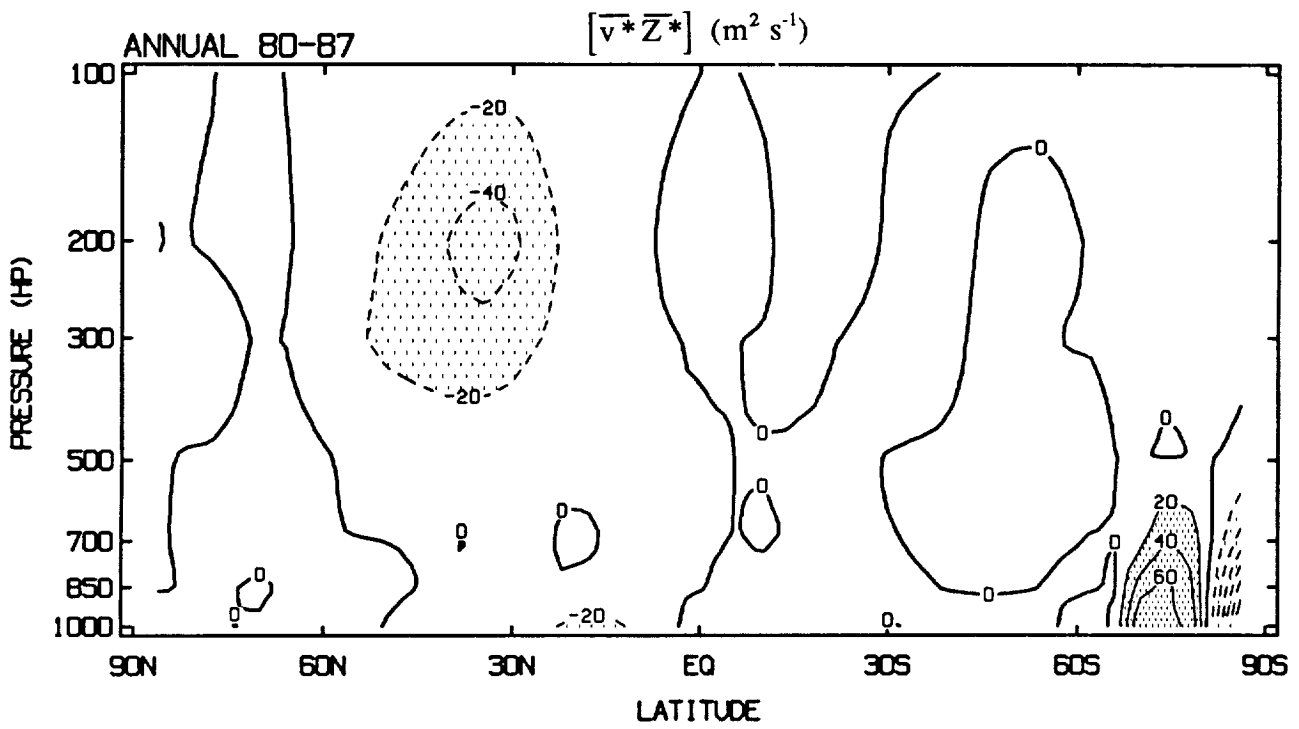
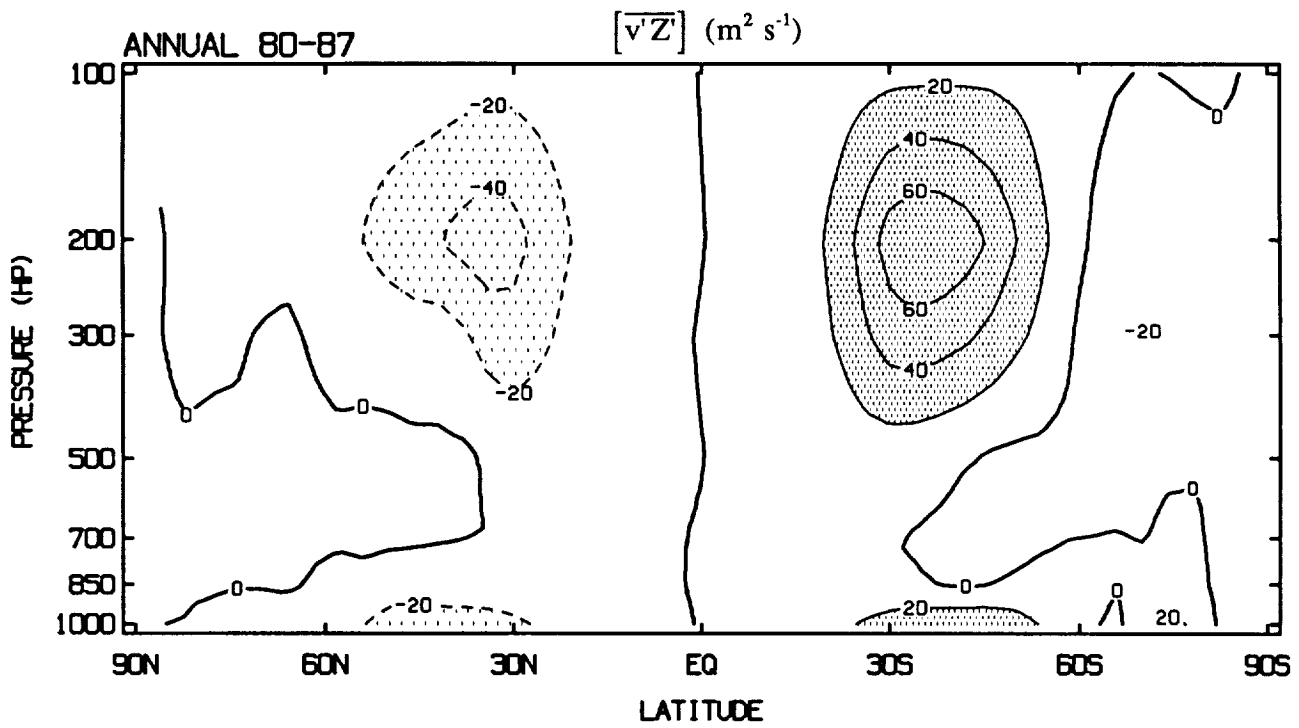

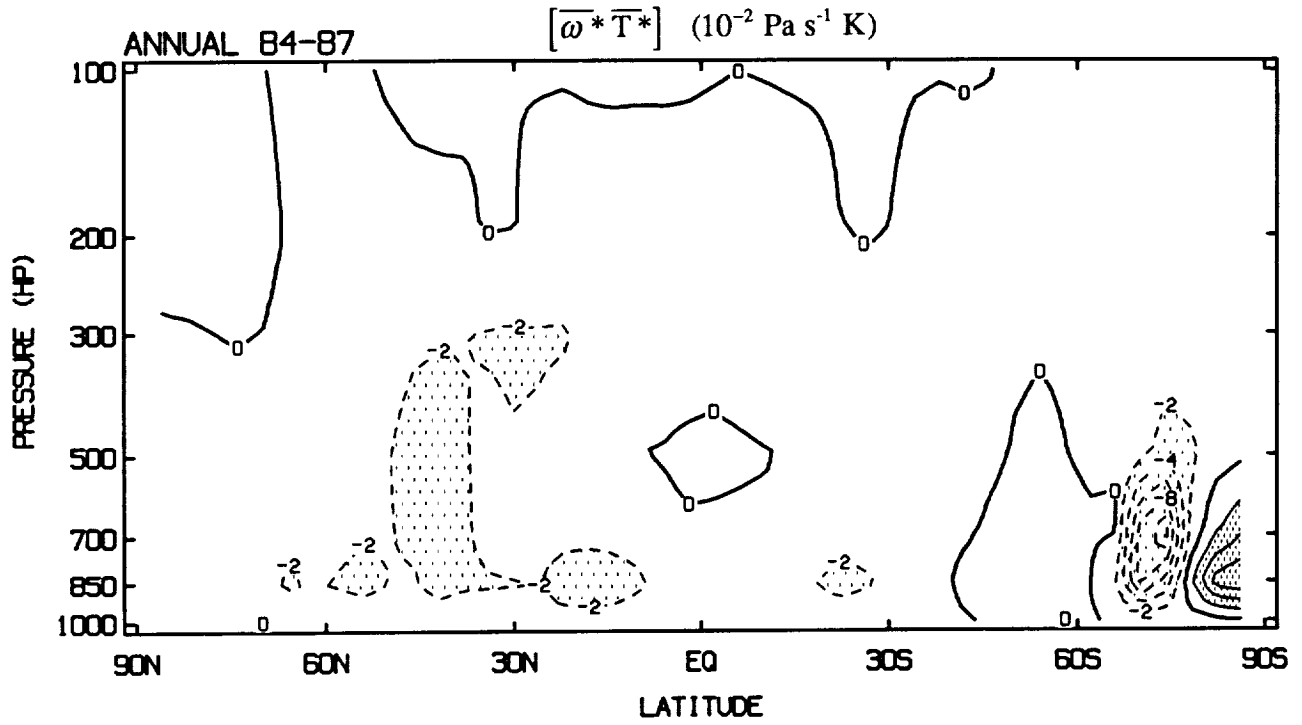
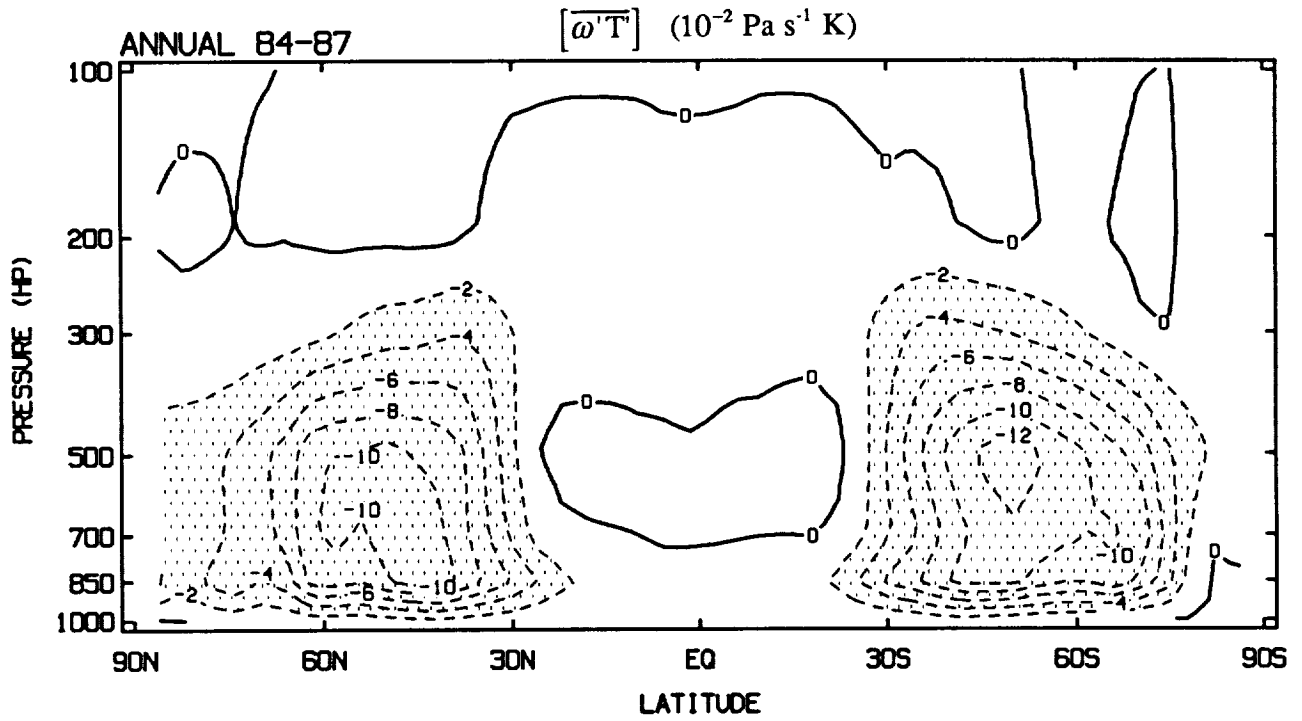

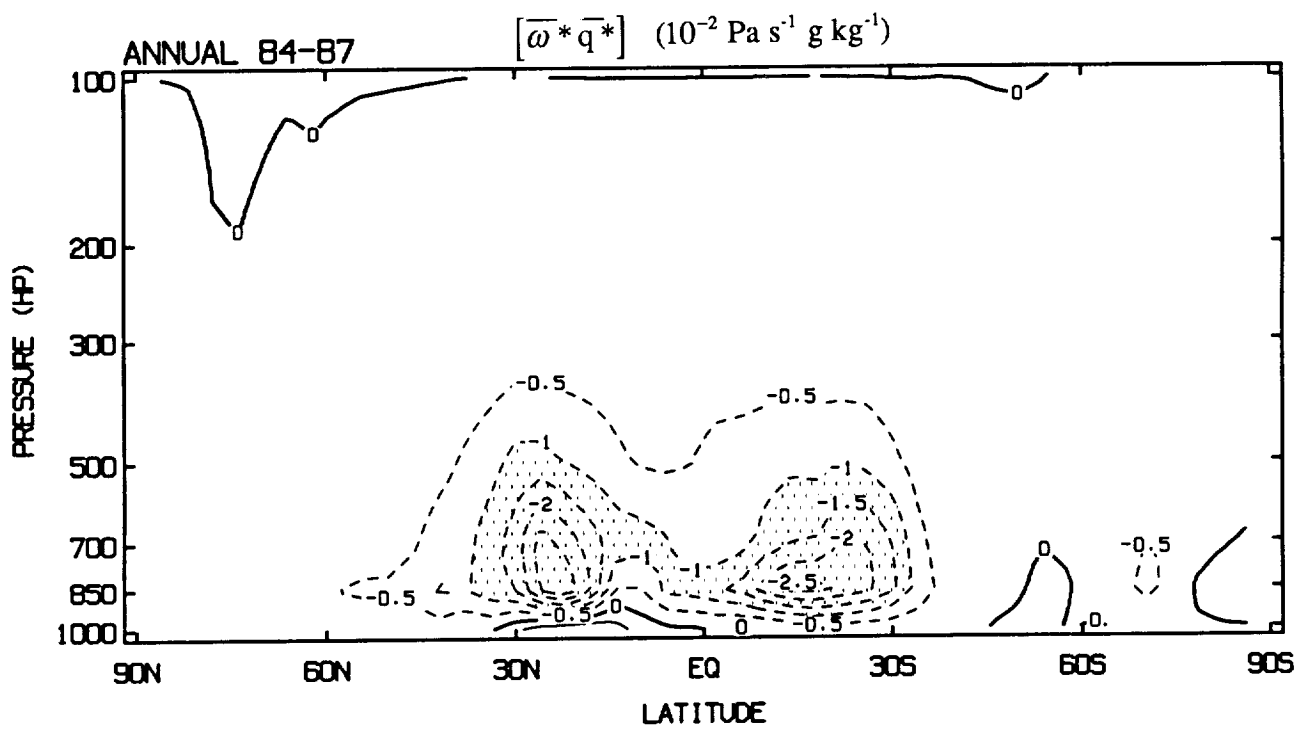
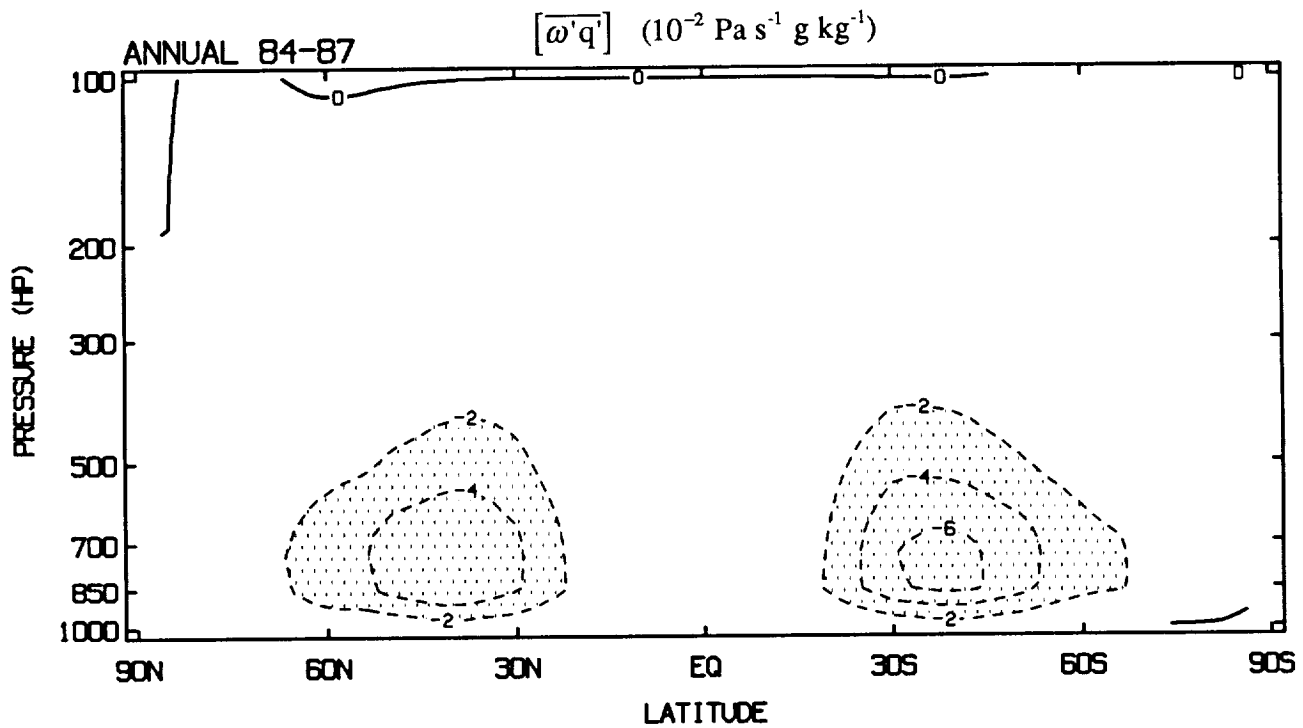

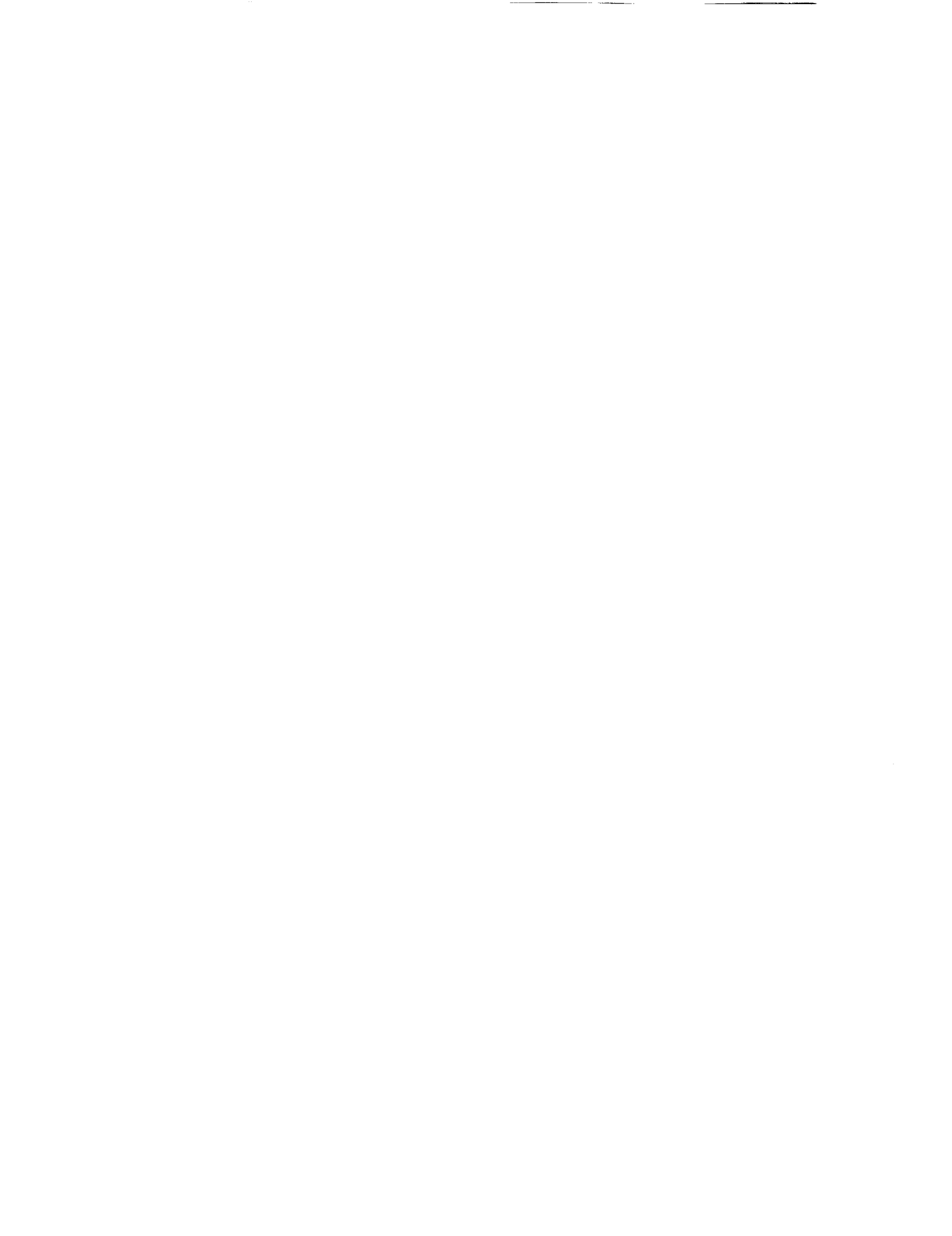

ANNUAL

DEVIATIONS FROM SEASONAL CYCLE



UNFILTERED

217

PRECEDING PAGE BLANK NOT FILMED

PAGE 216 INTENTIONALLY BLANK

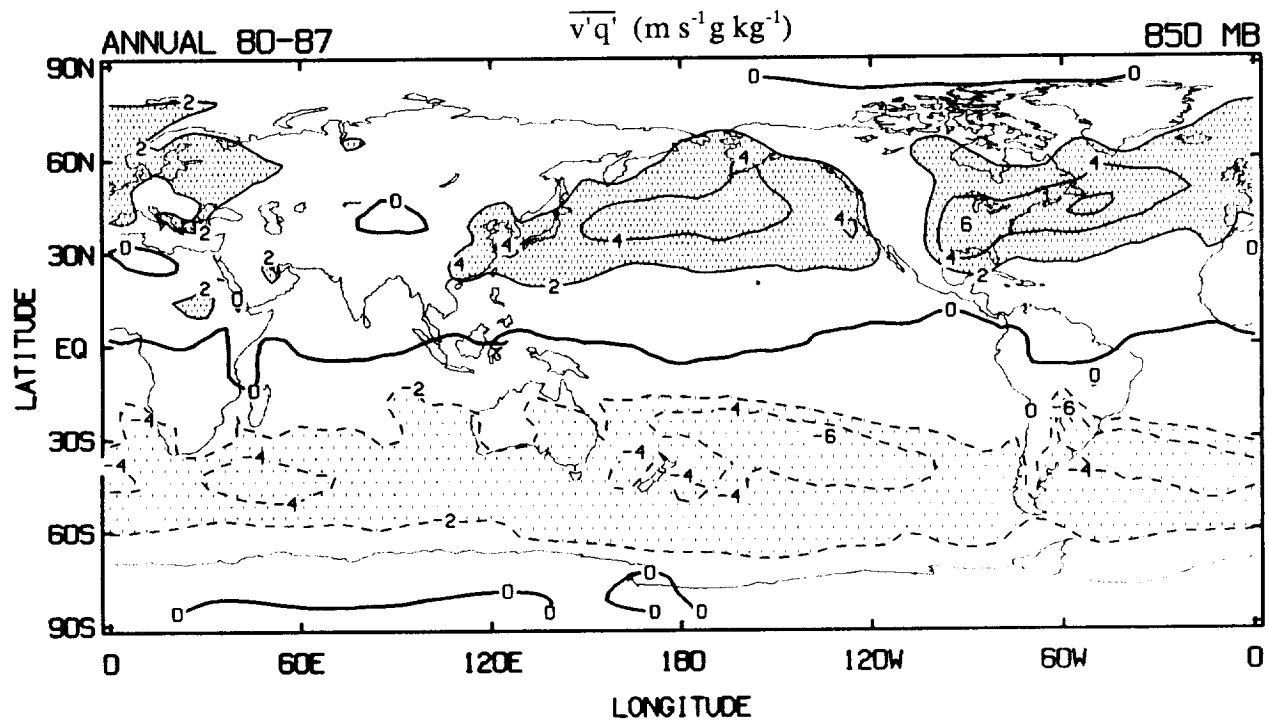
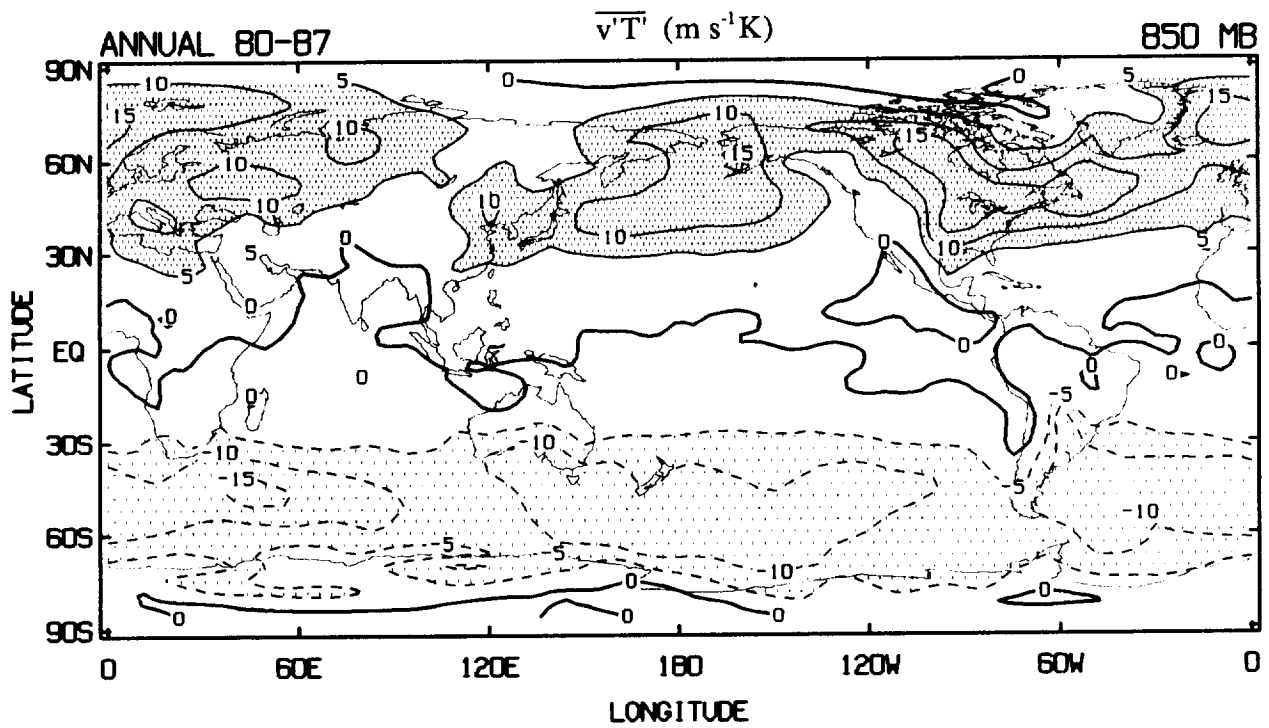

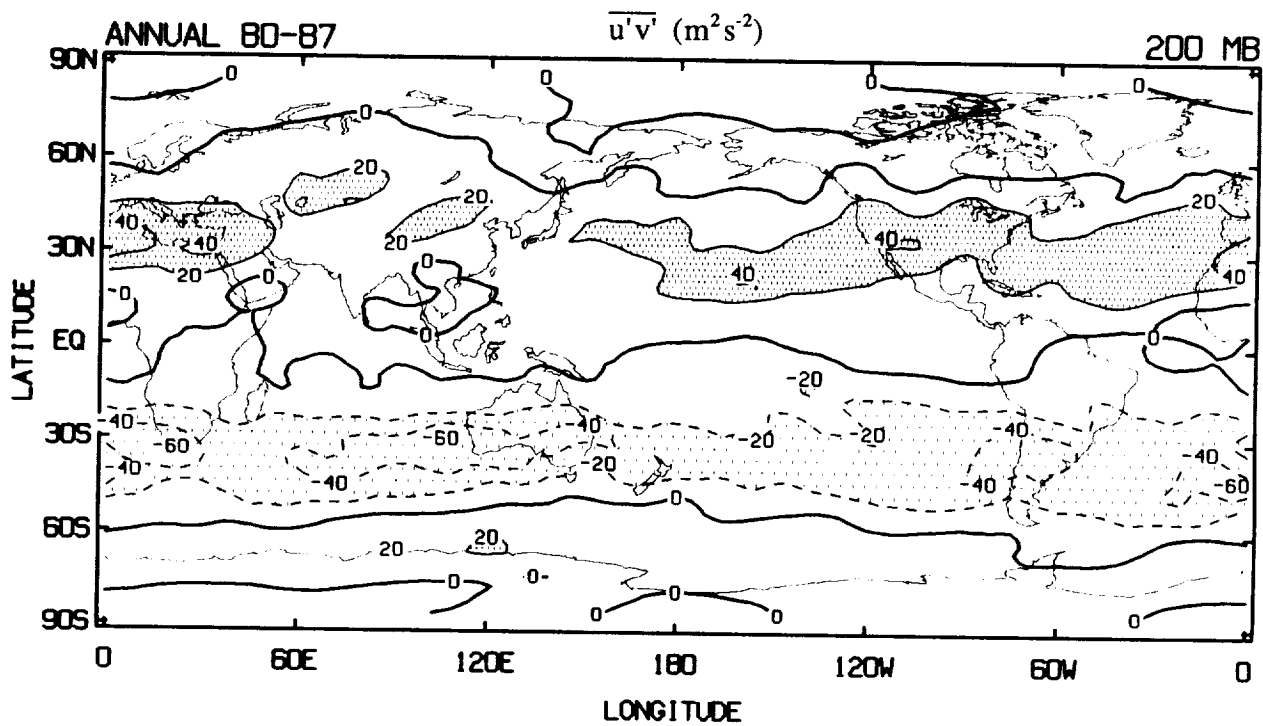

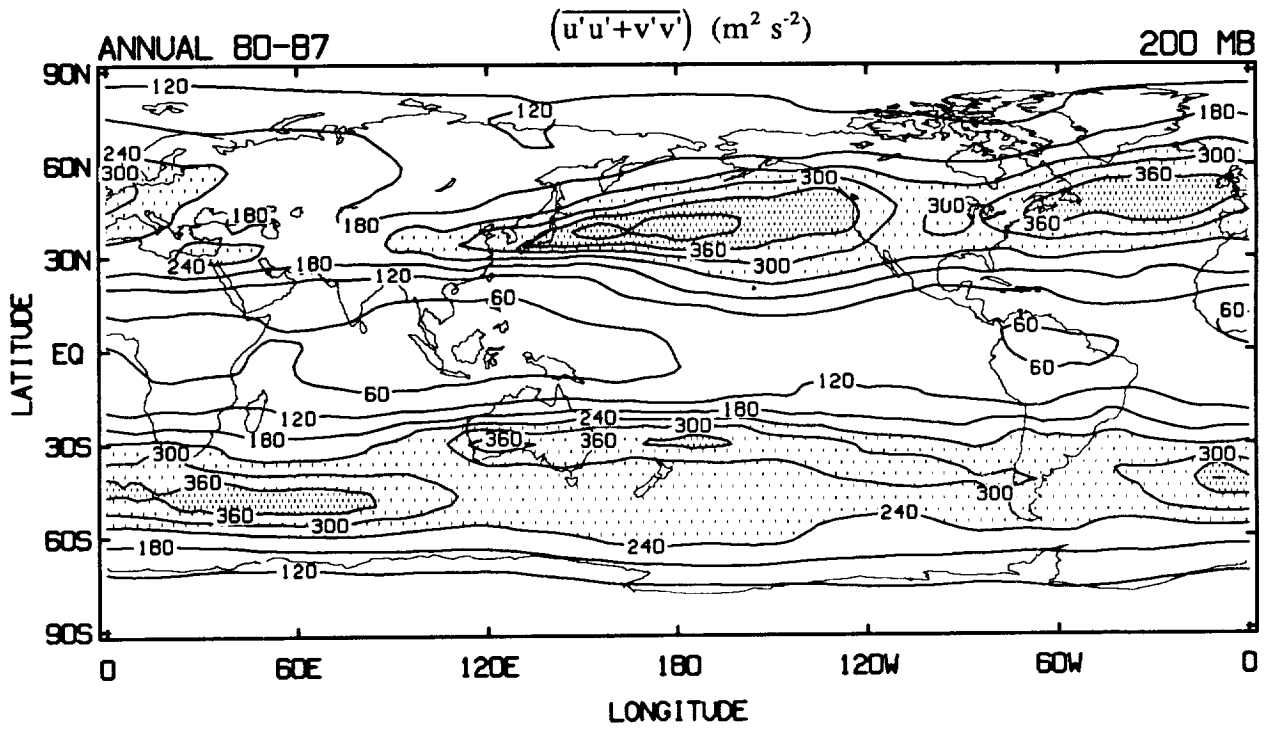
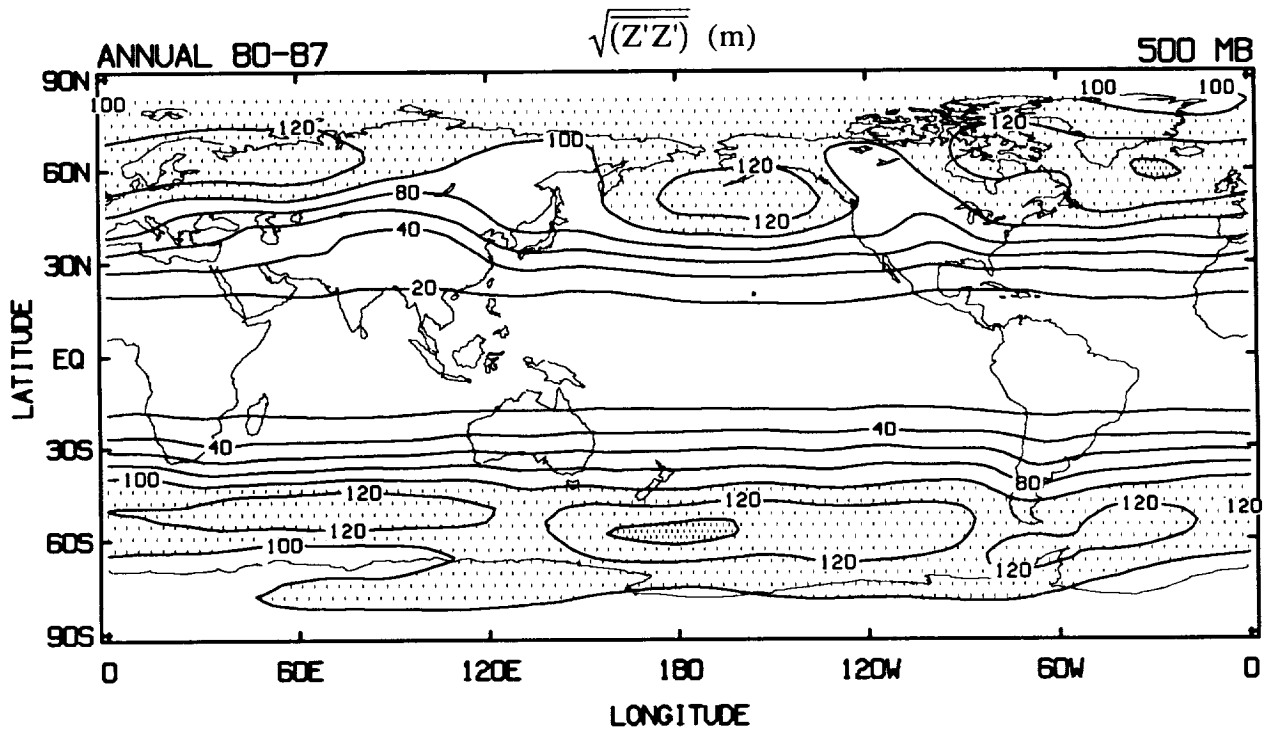

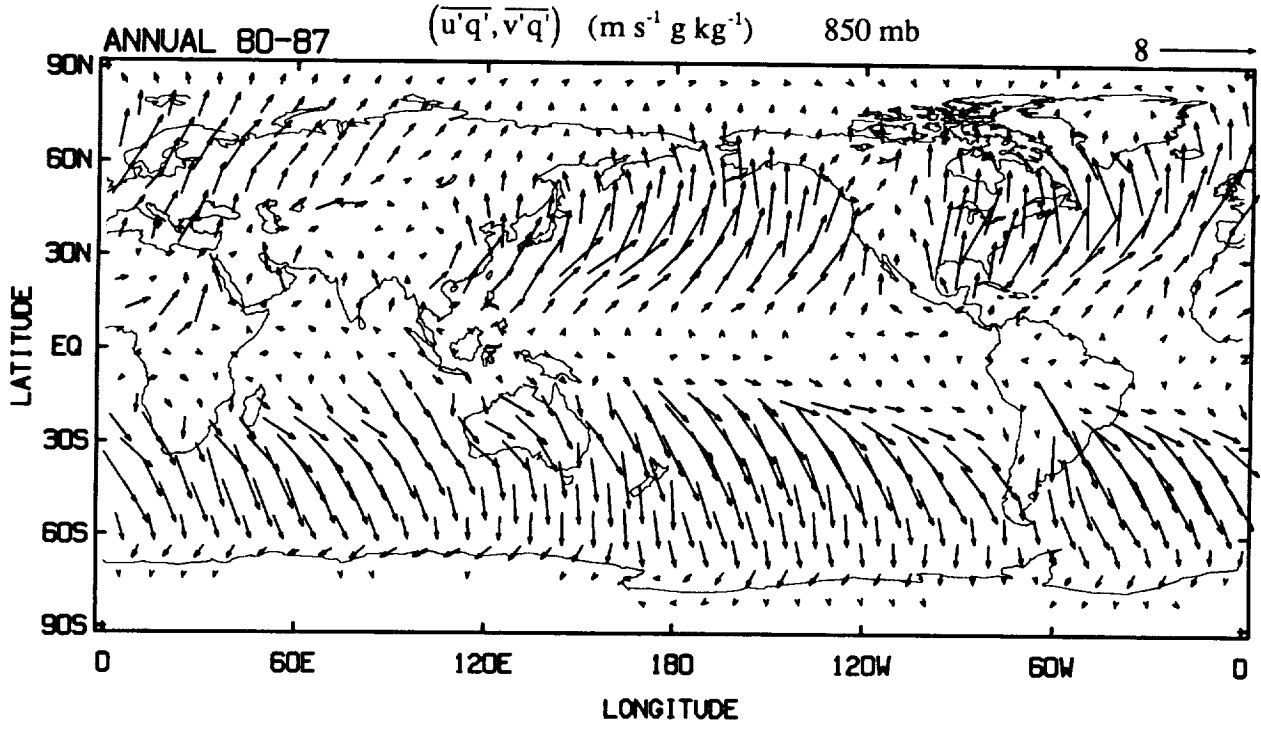
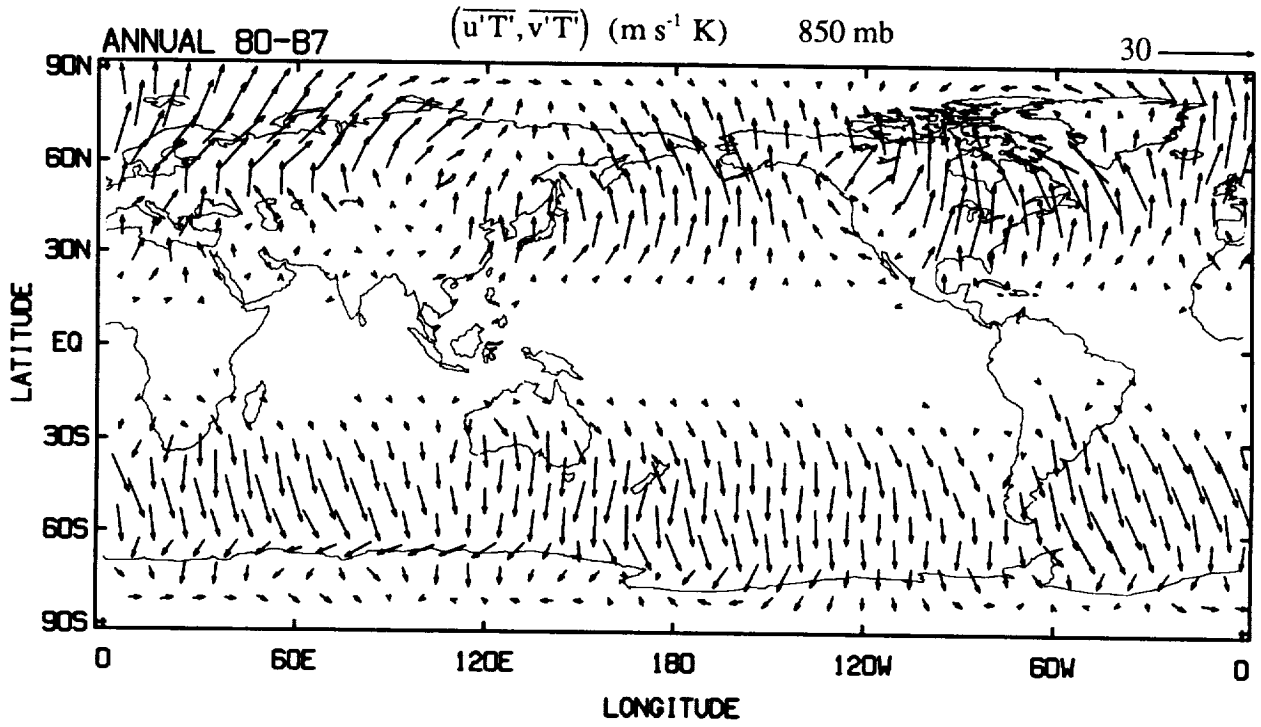

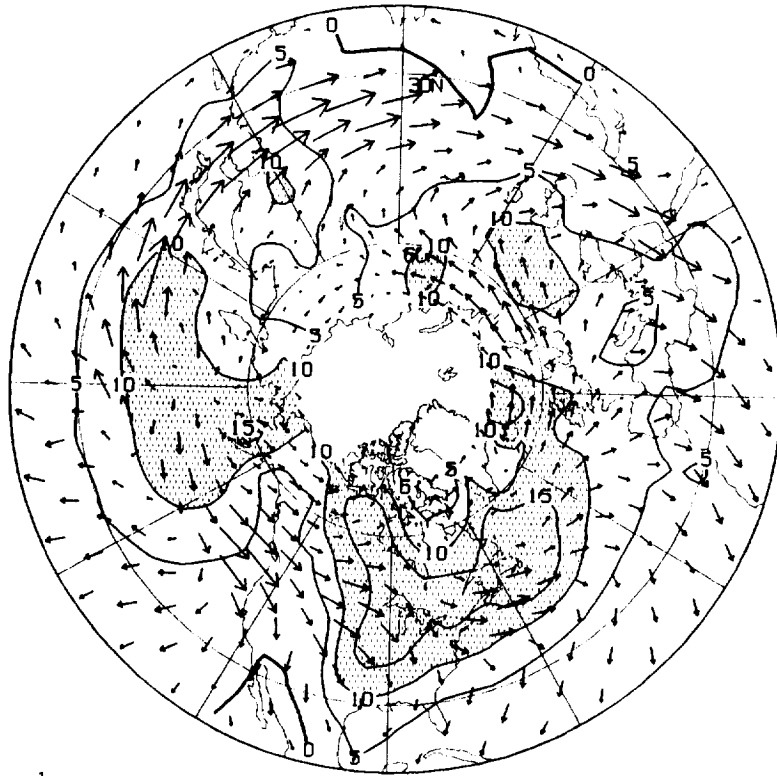

$\overline{v'T'}$ ($\text{m s}^{-1}\text{K}$) 850 mb

E_u ($\text{m}^2 \text{s}^{-2}$) 200 mb

100 →

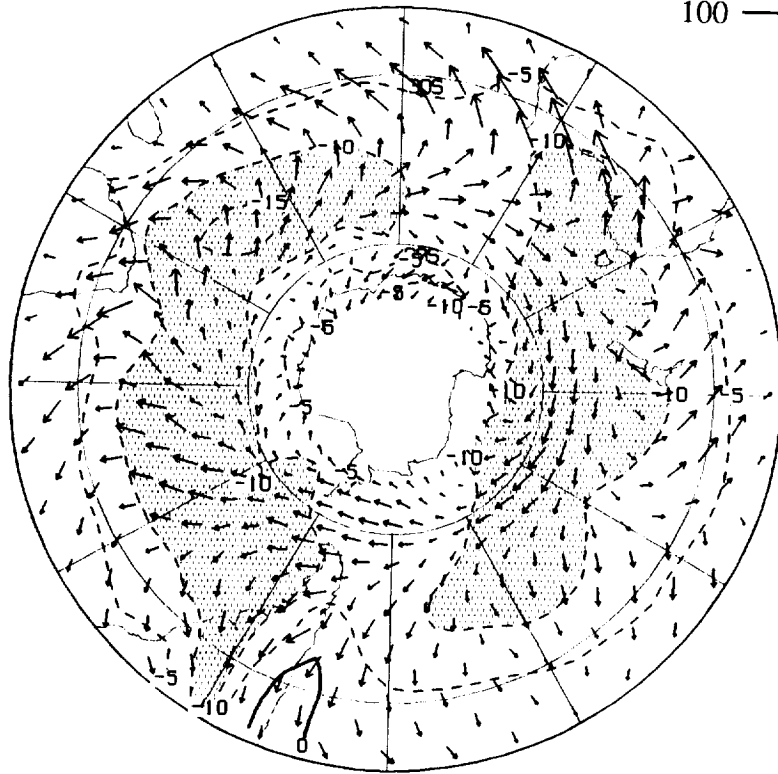

ANNUAL (80-87)

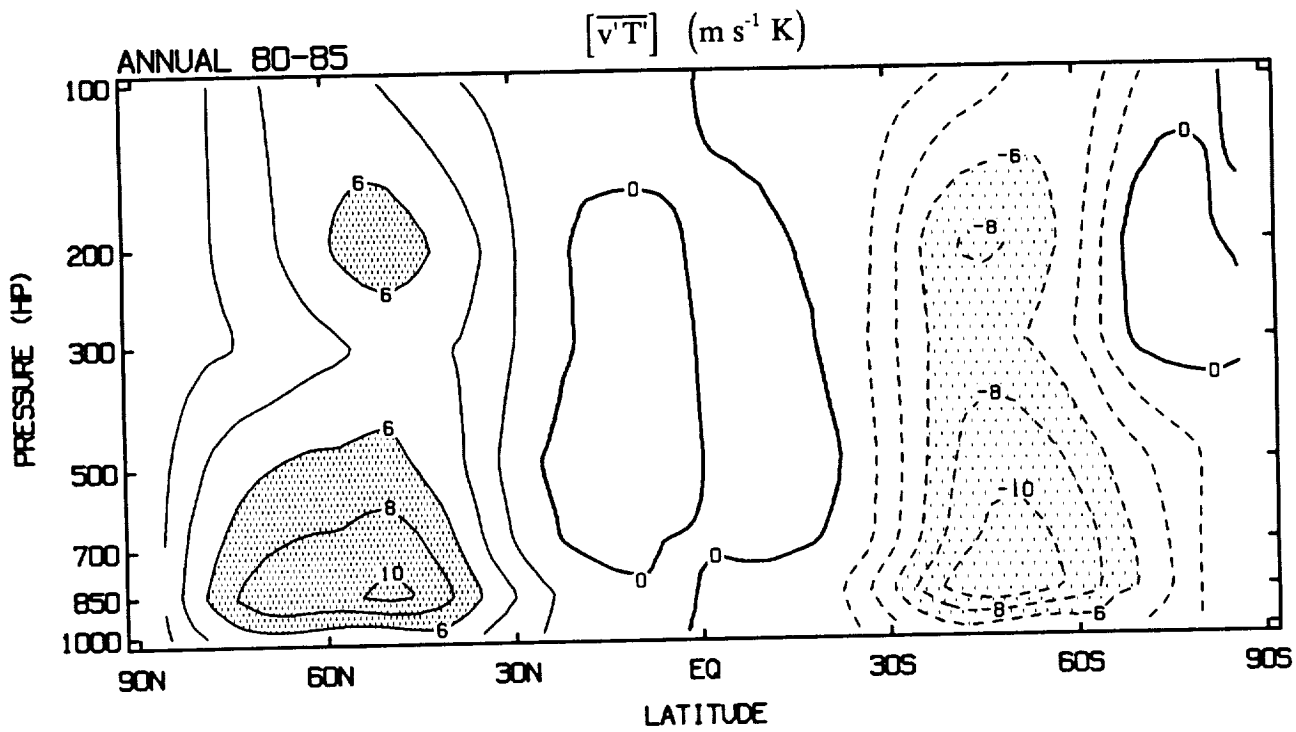
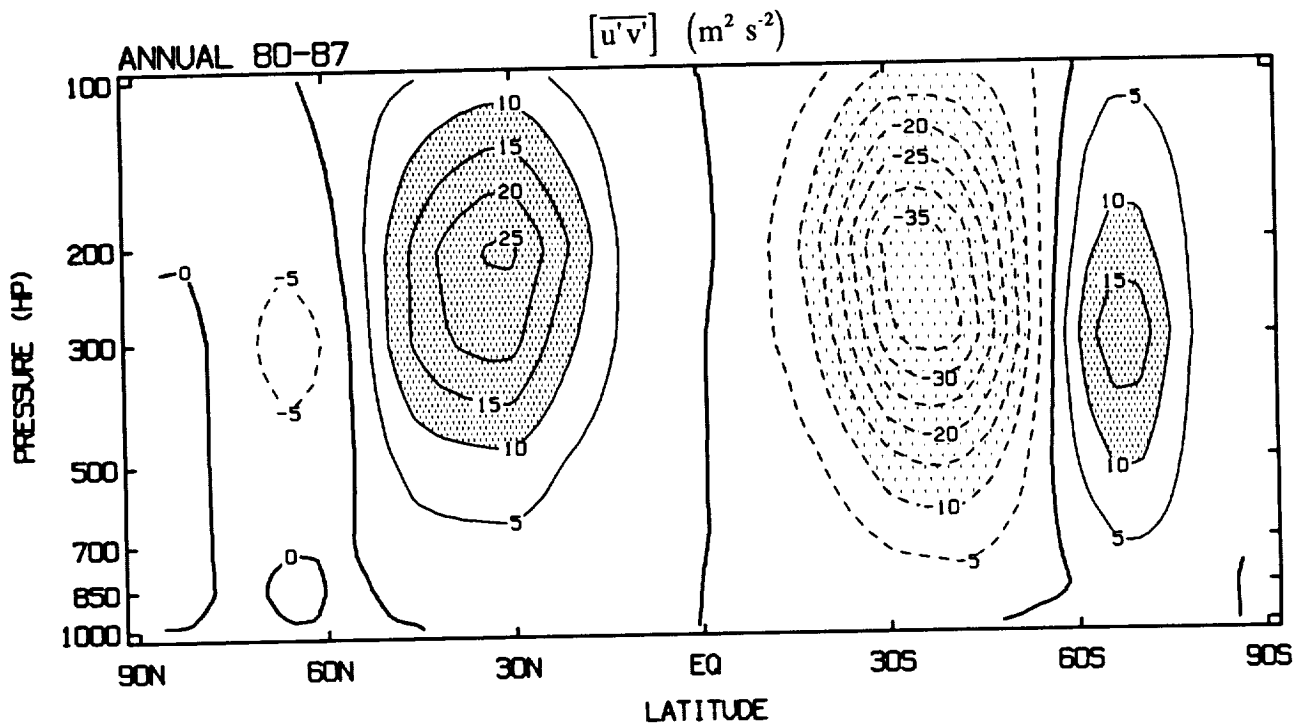

LOW PASS



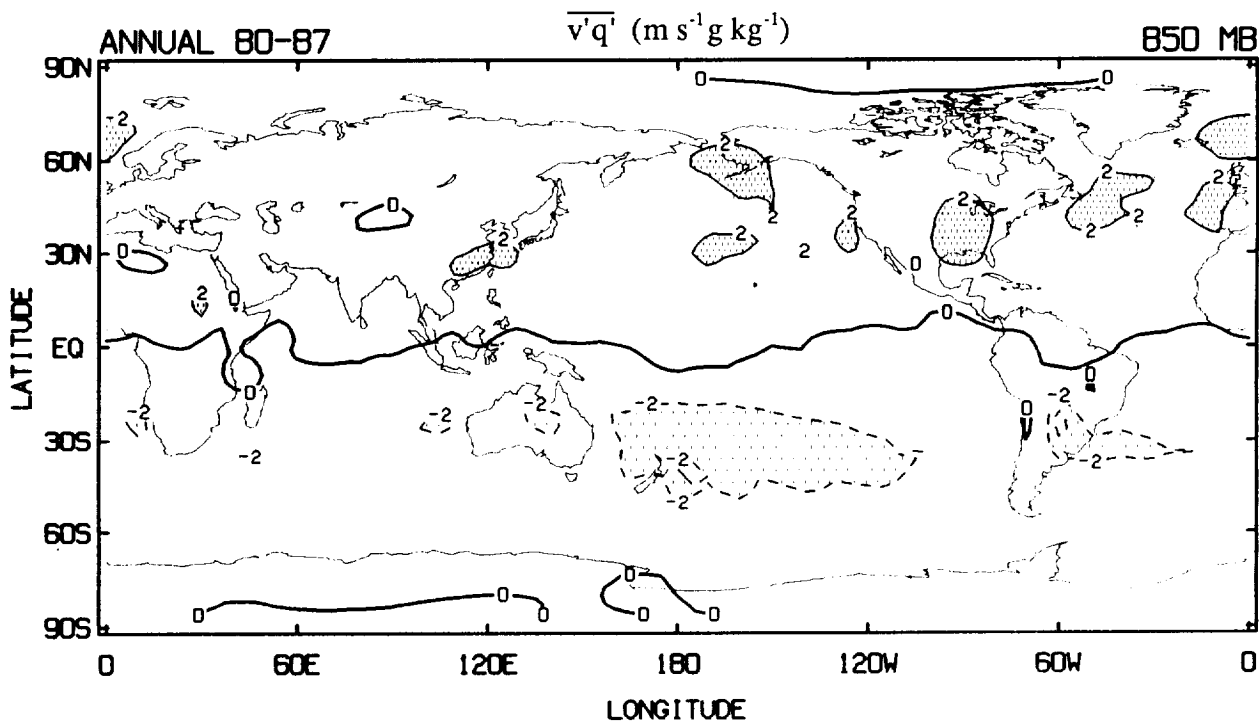
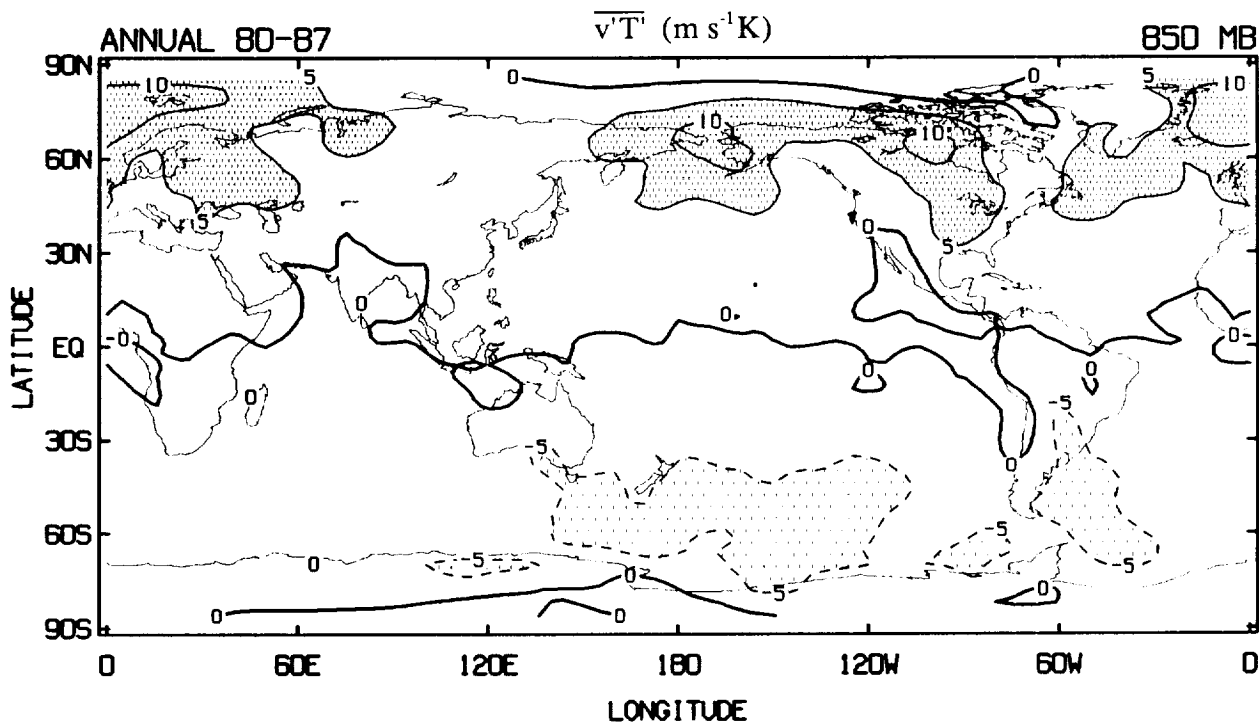

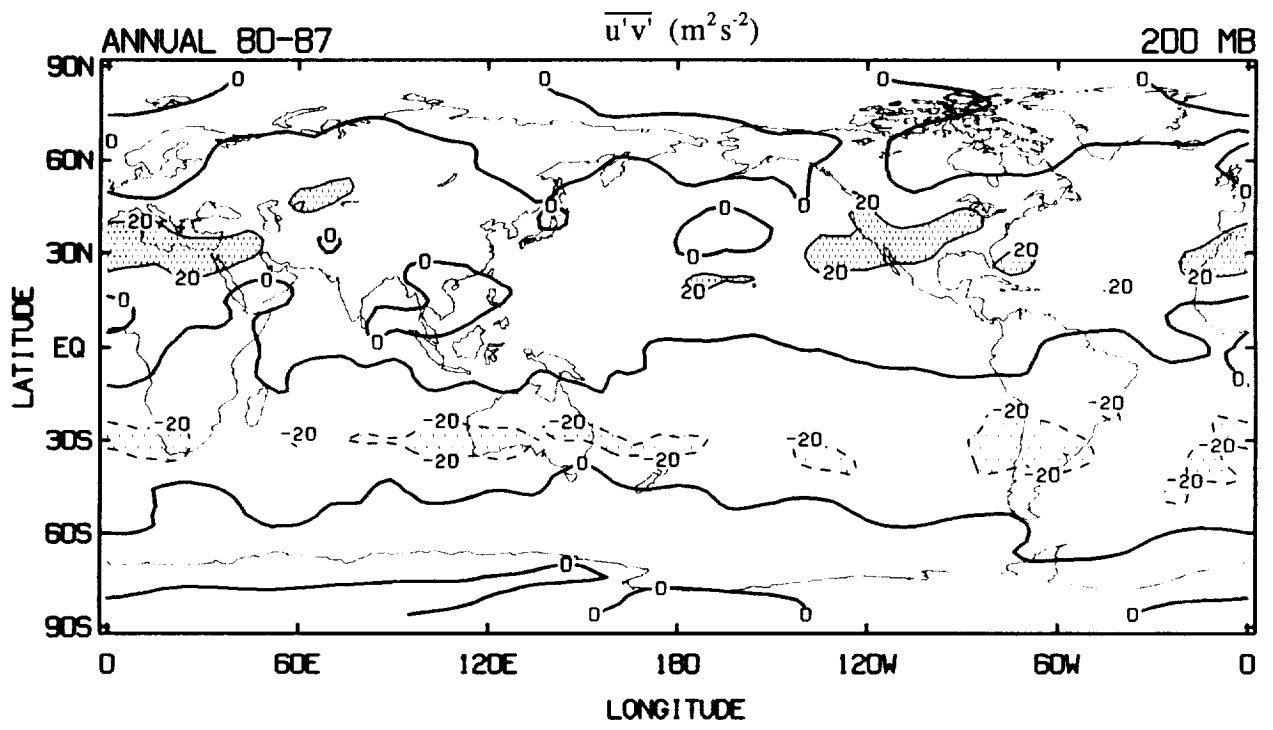

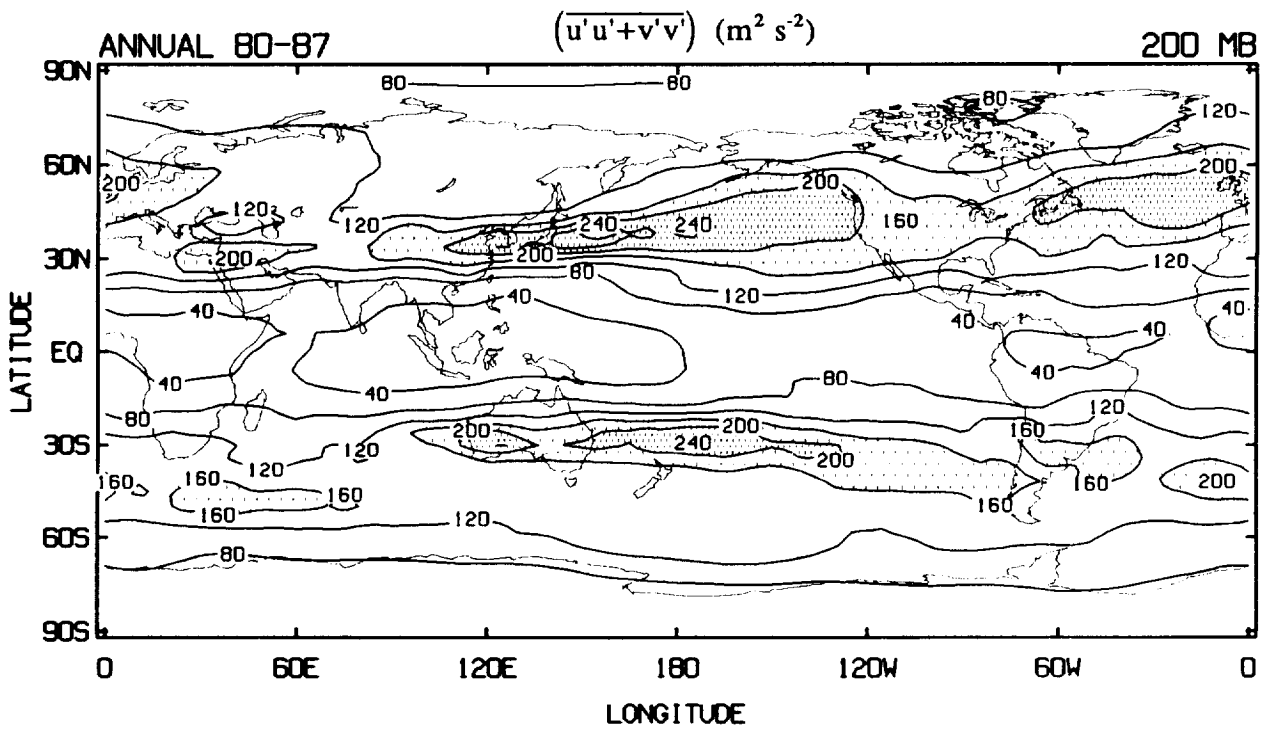
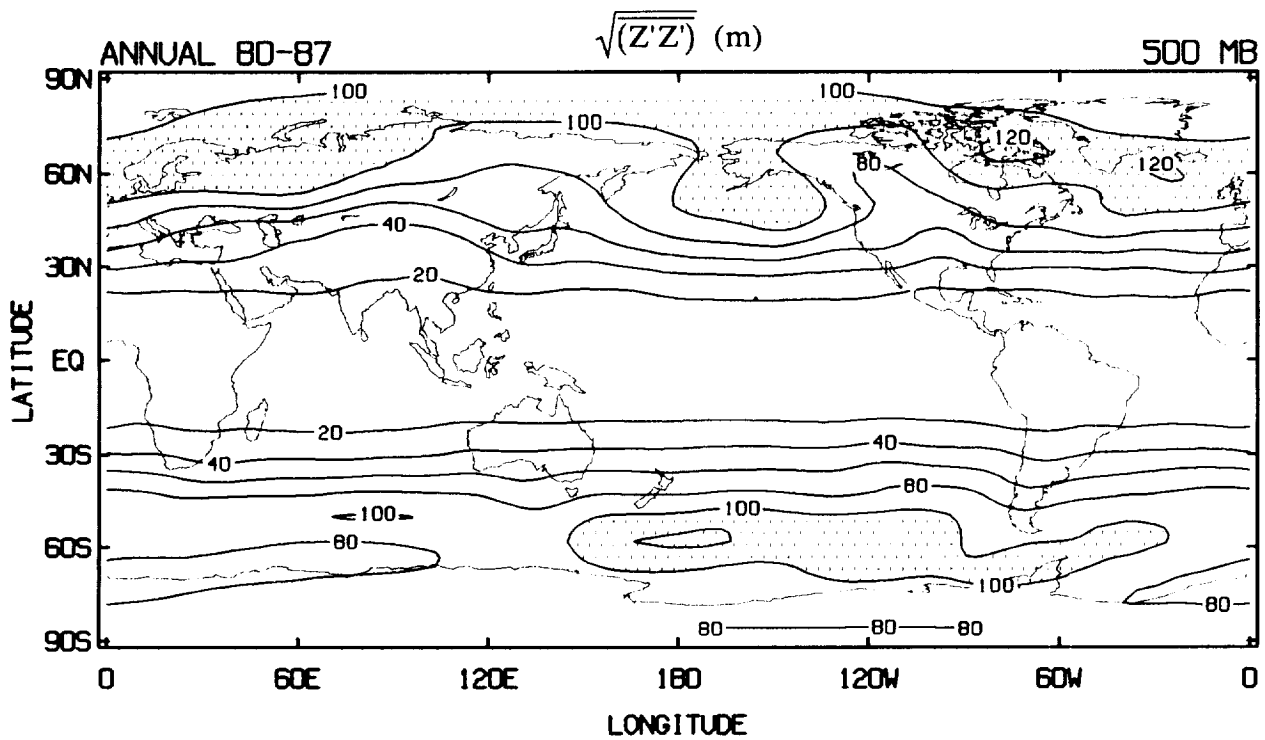

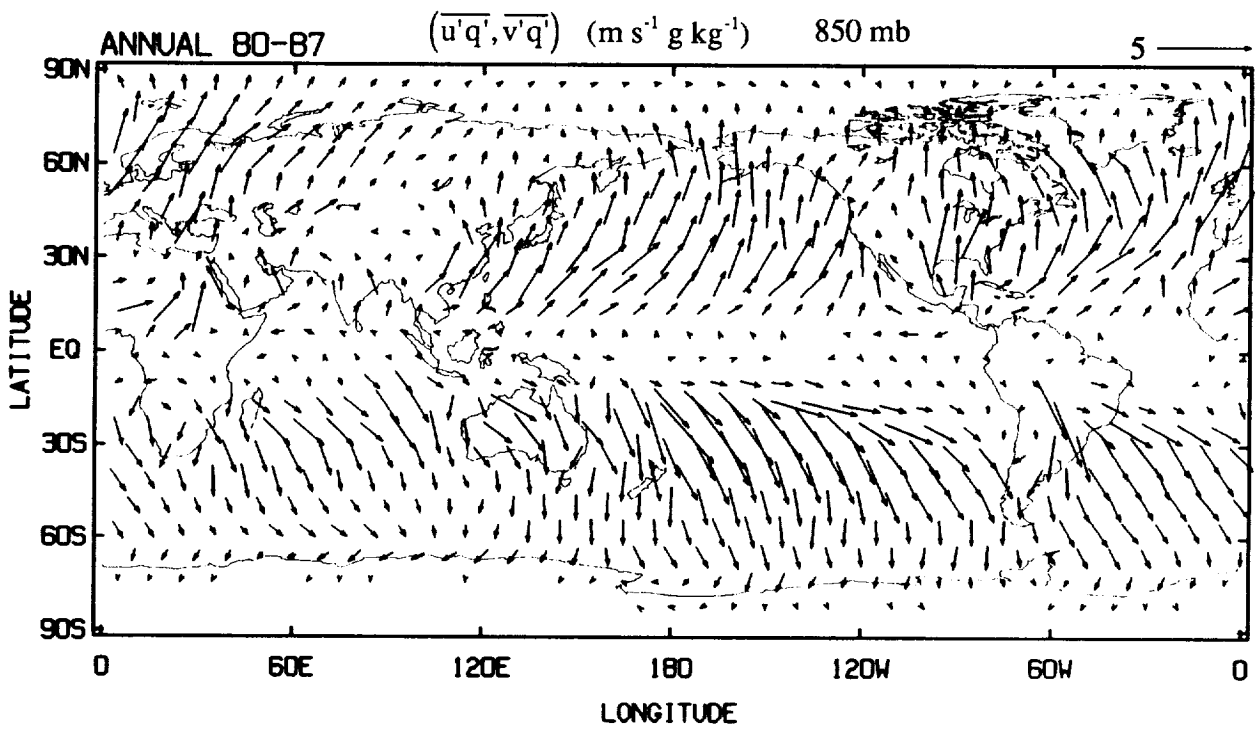
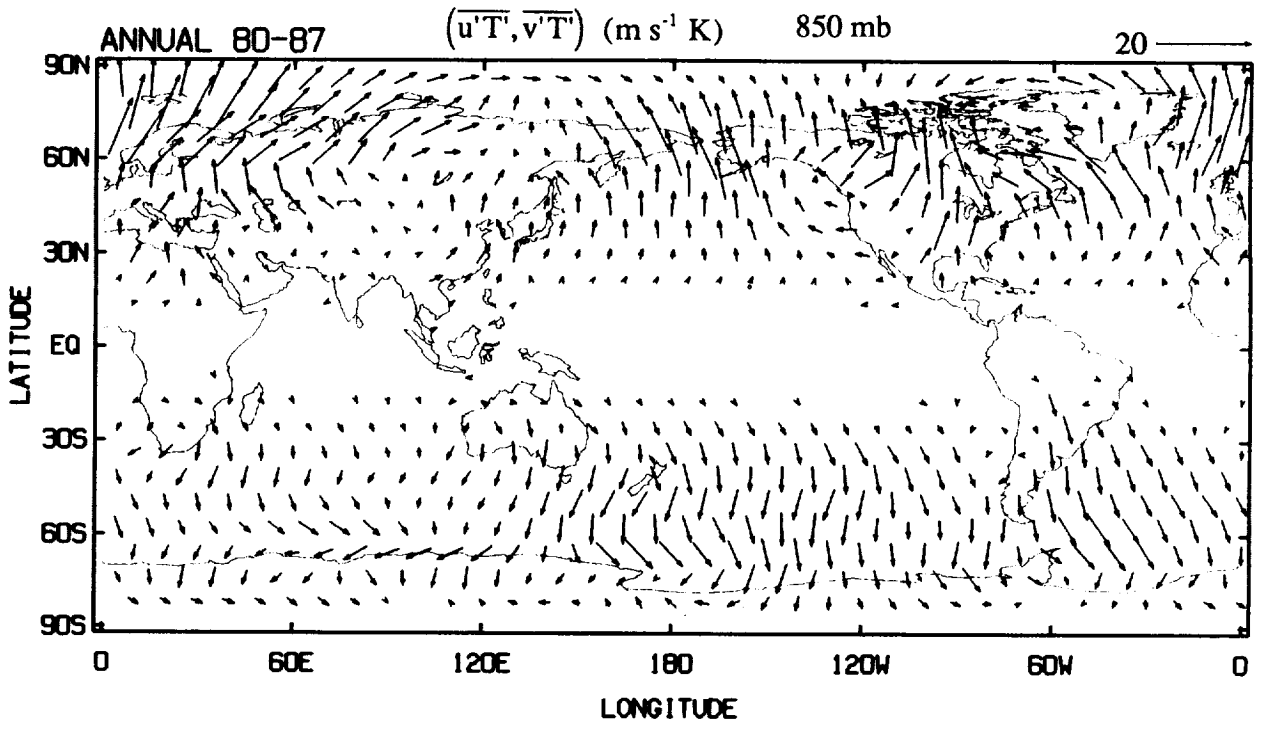

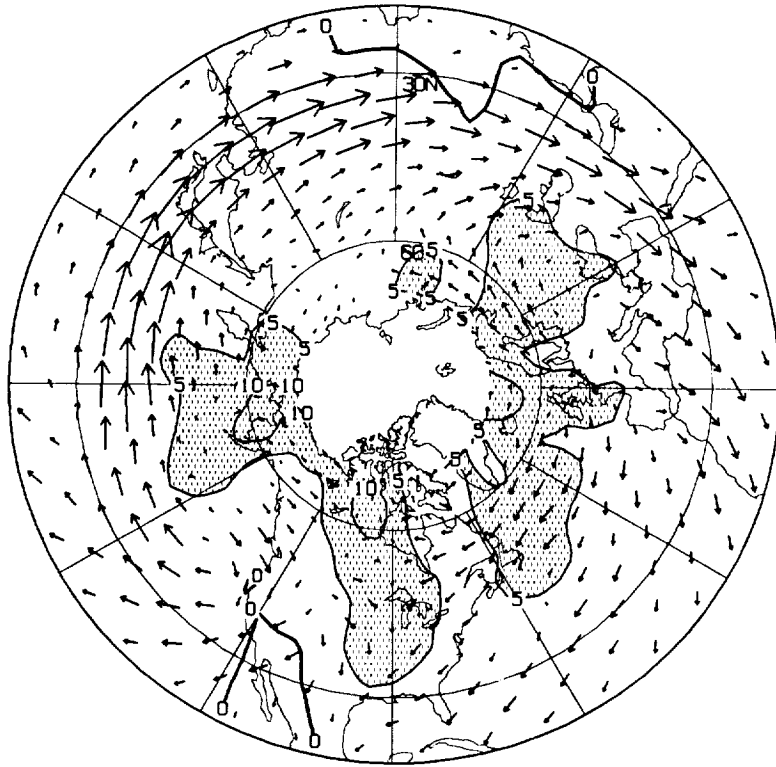

$\overline{v'T}$ (m s⁻¹K) 850 mb

E_u (m² s⁻²) 200 mb

100 →

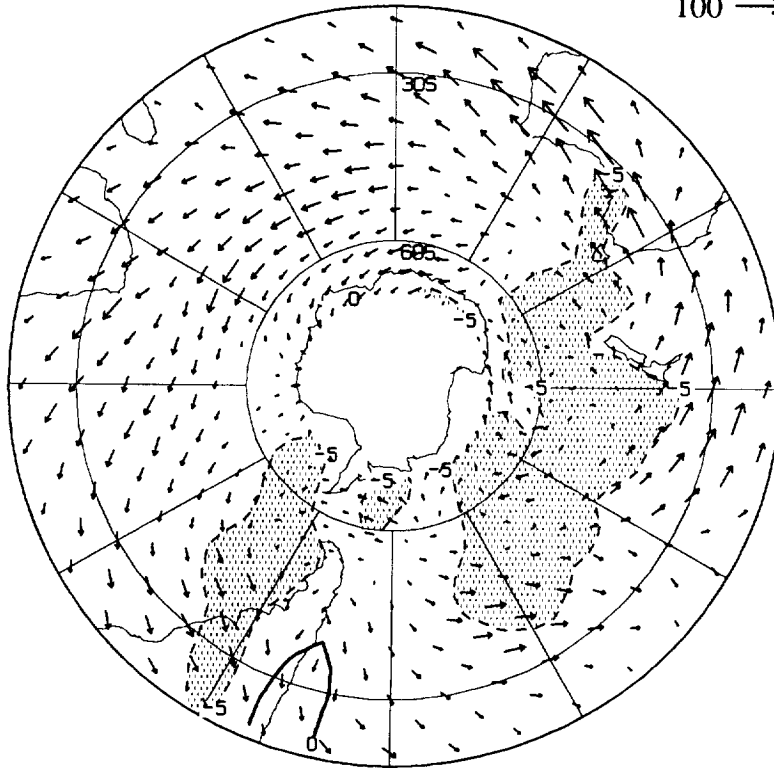

ANNUAL (80 - 87)

231

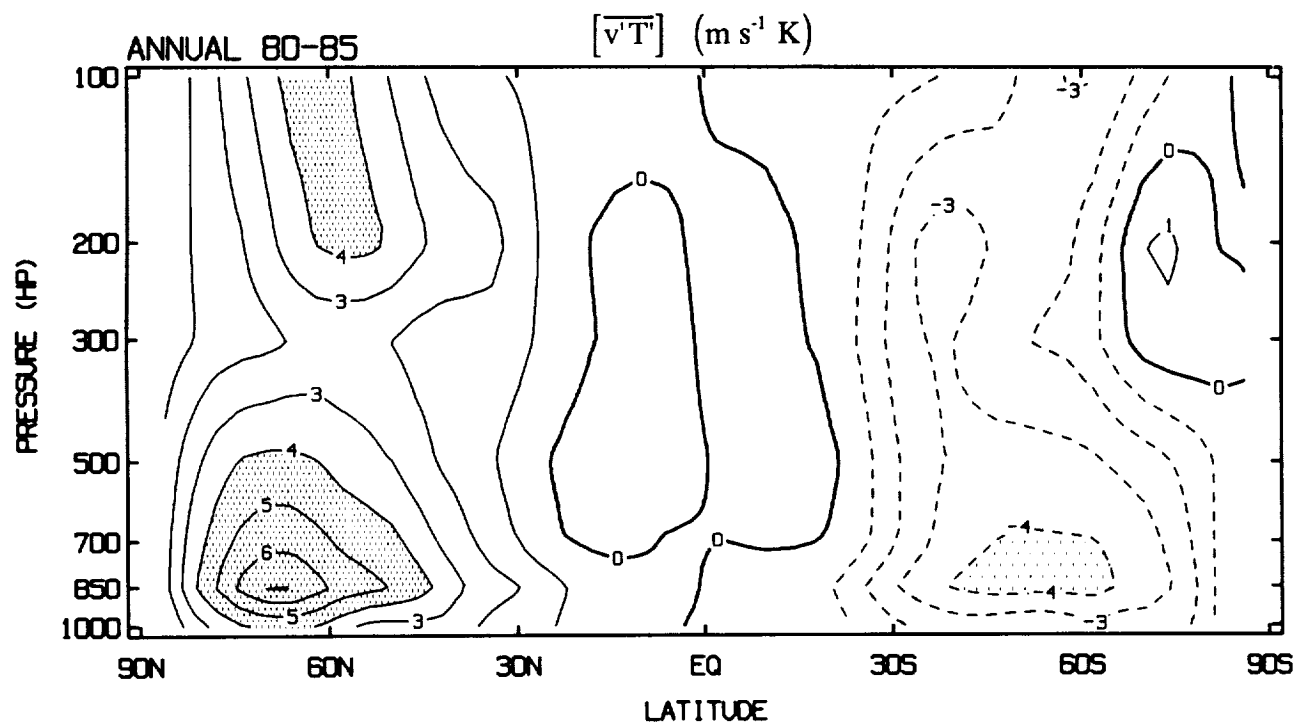
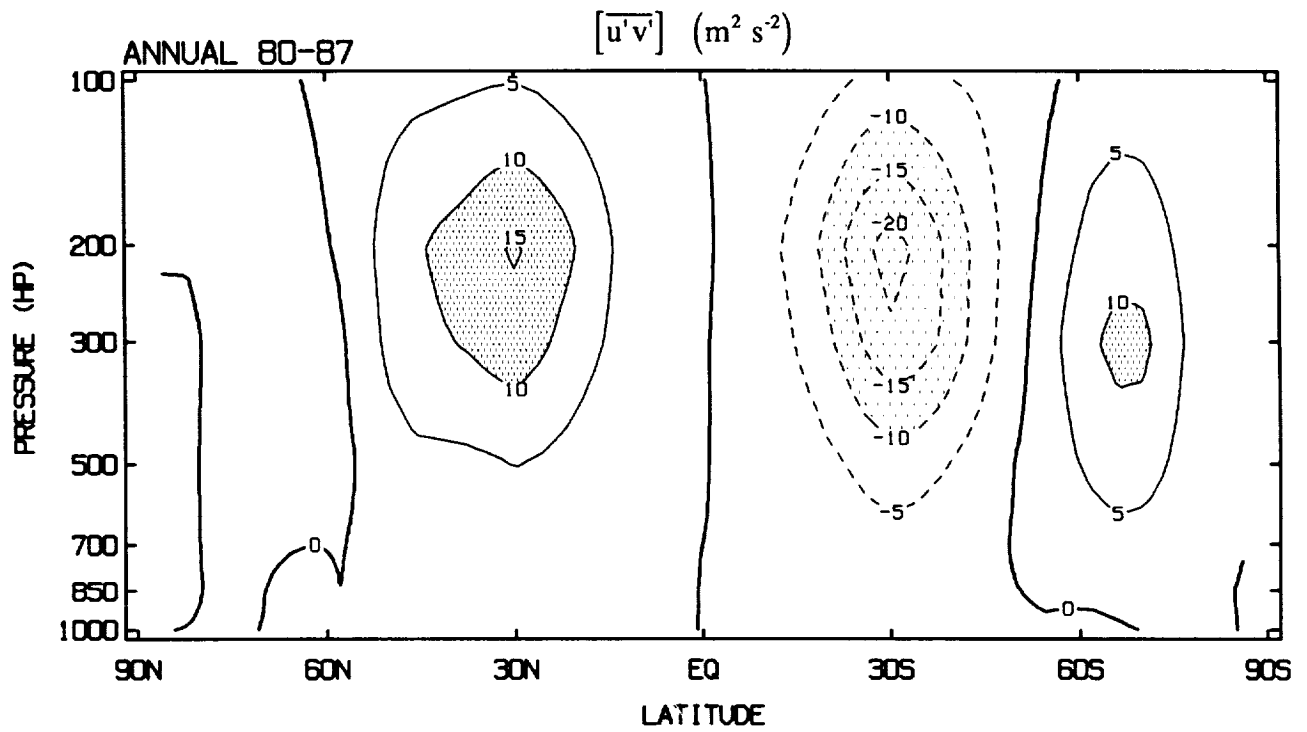

BAND PASS

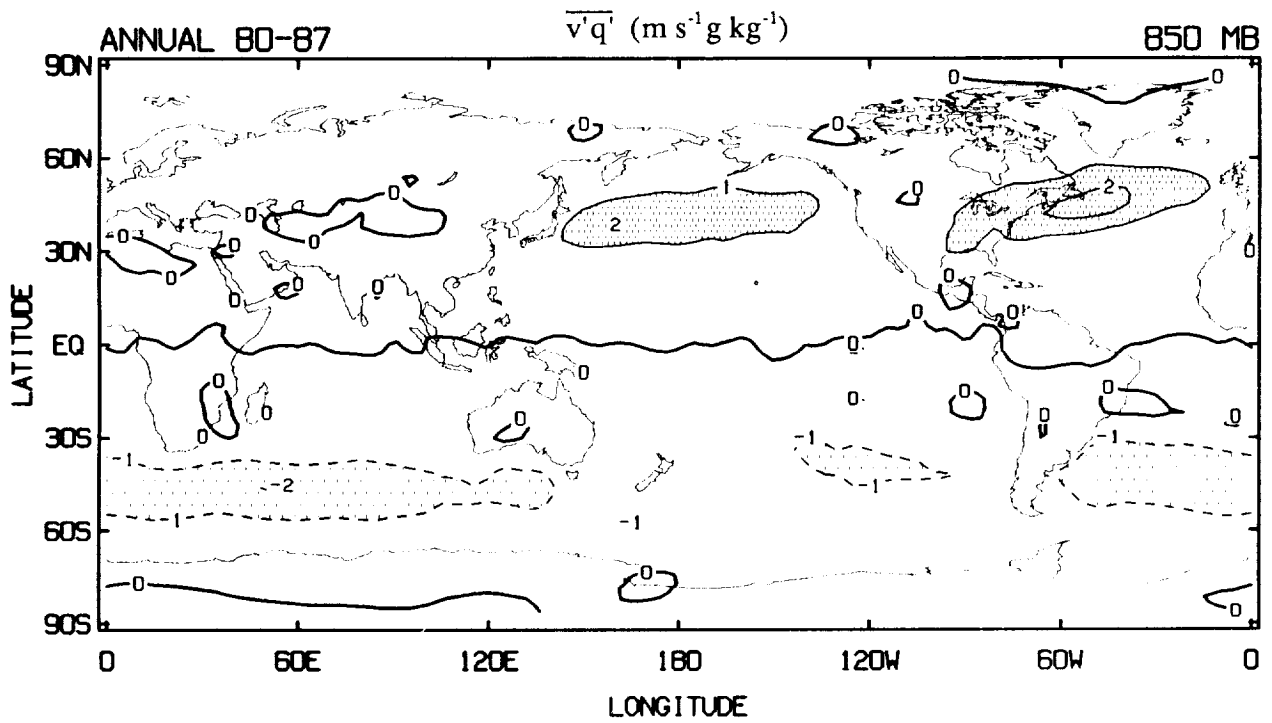
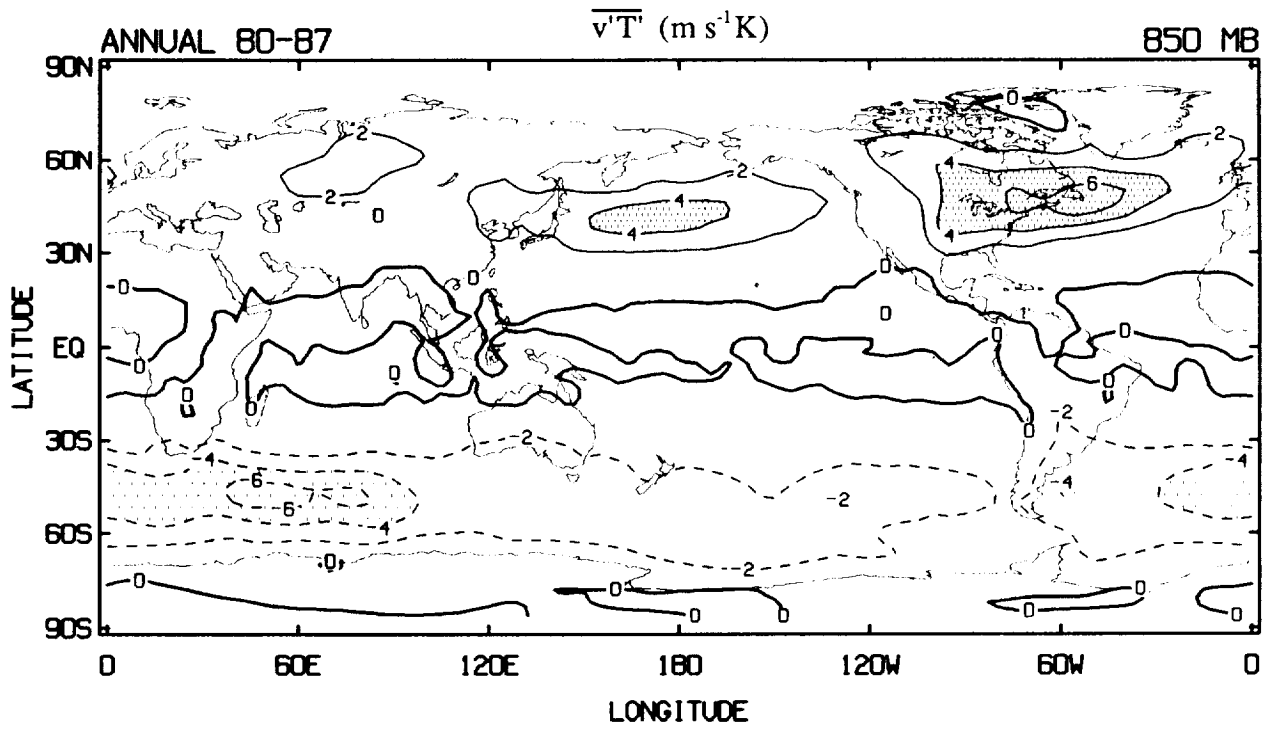

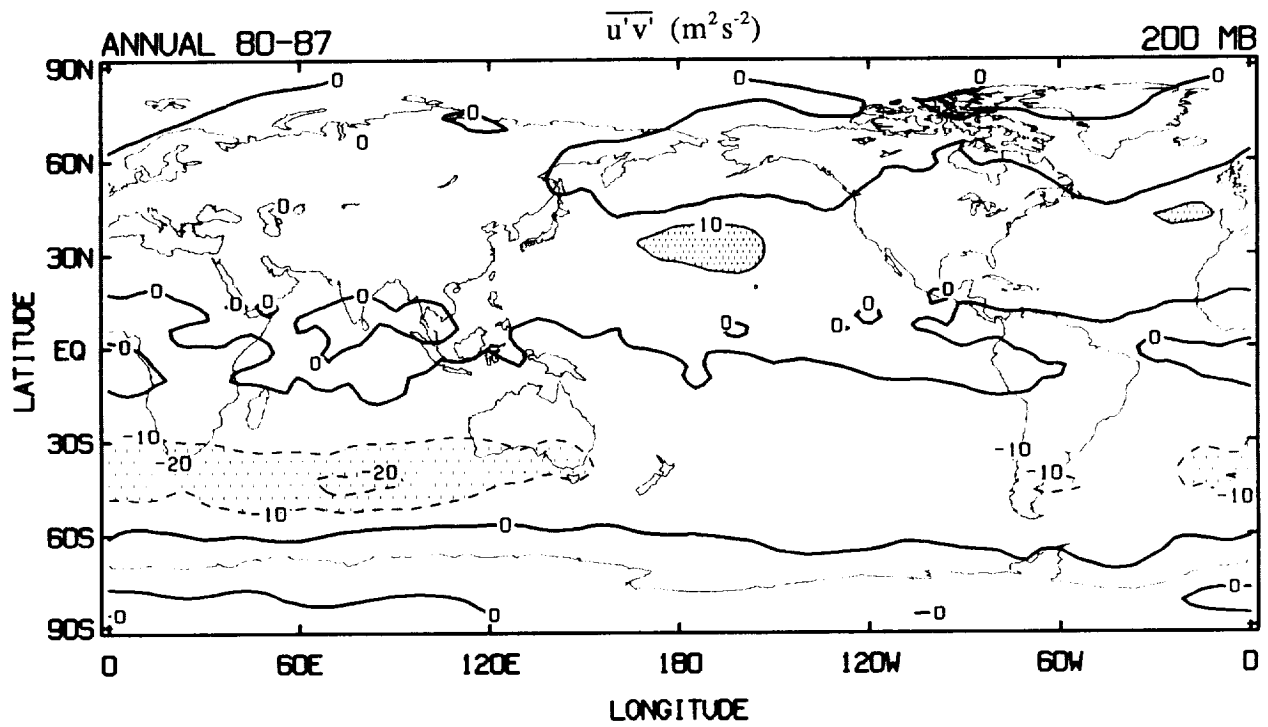

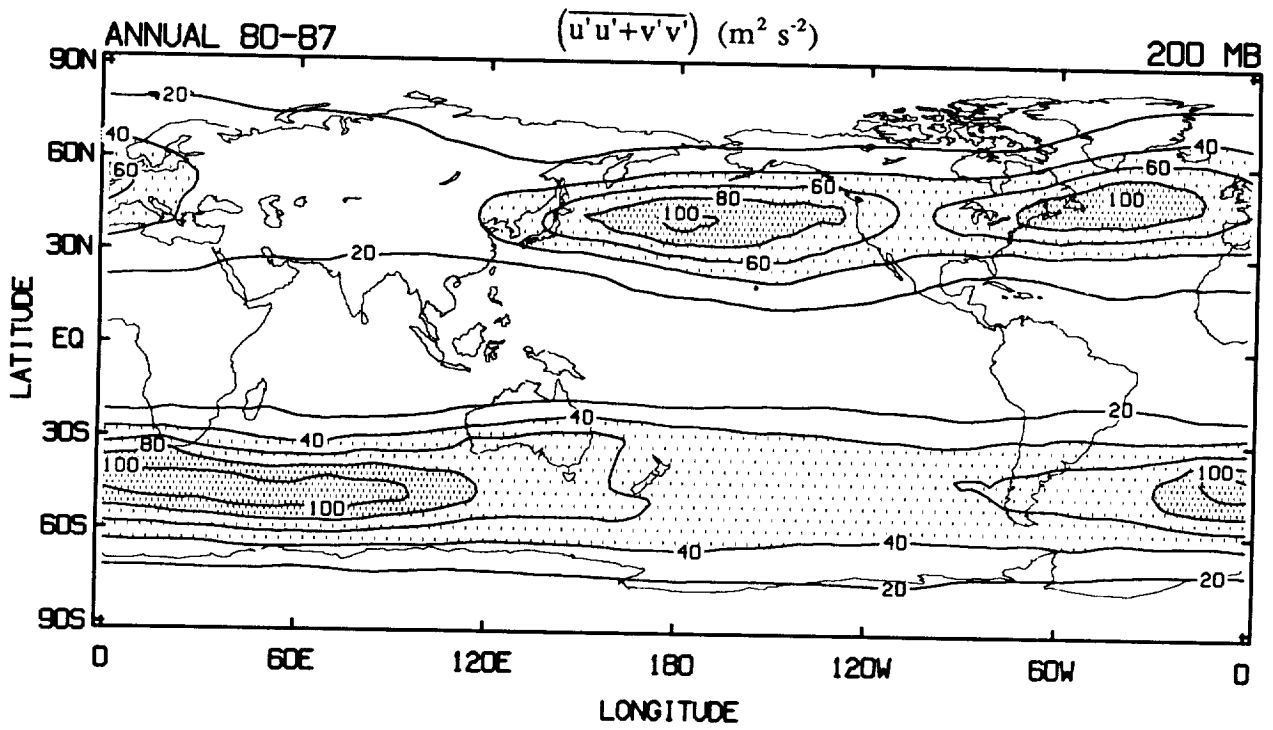
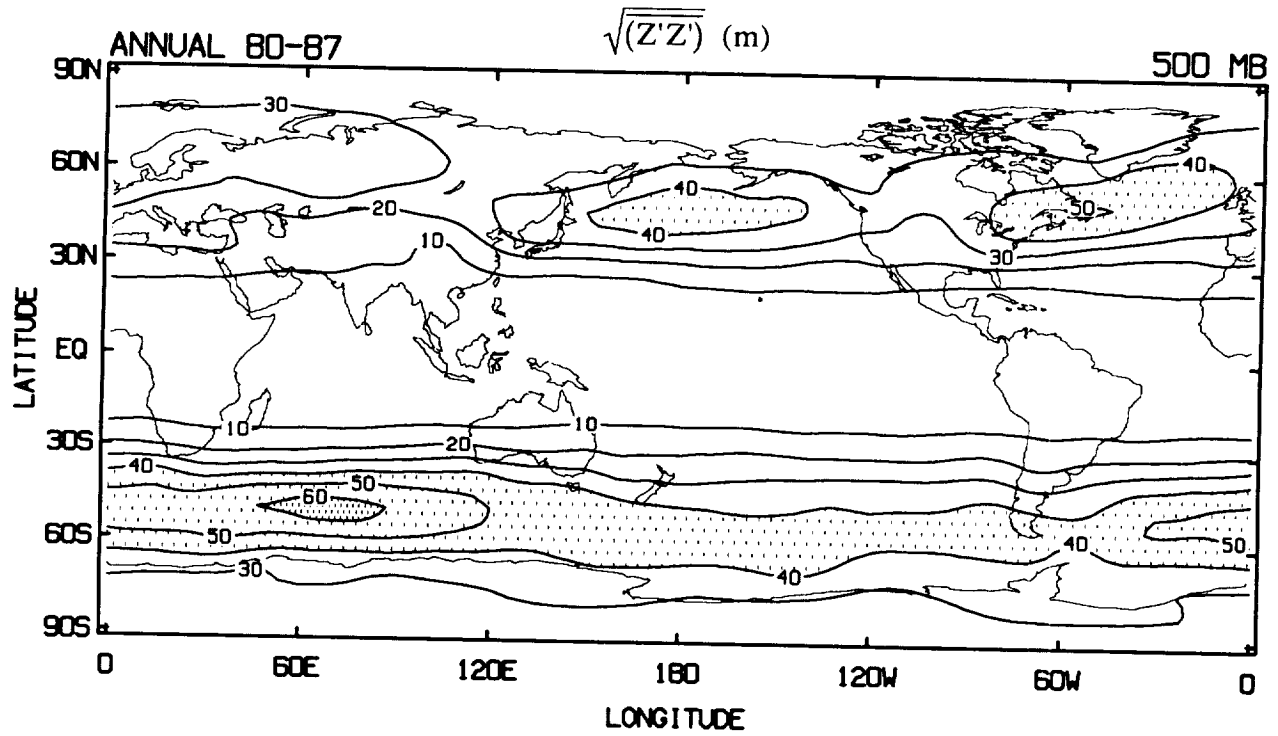

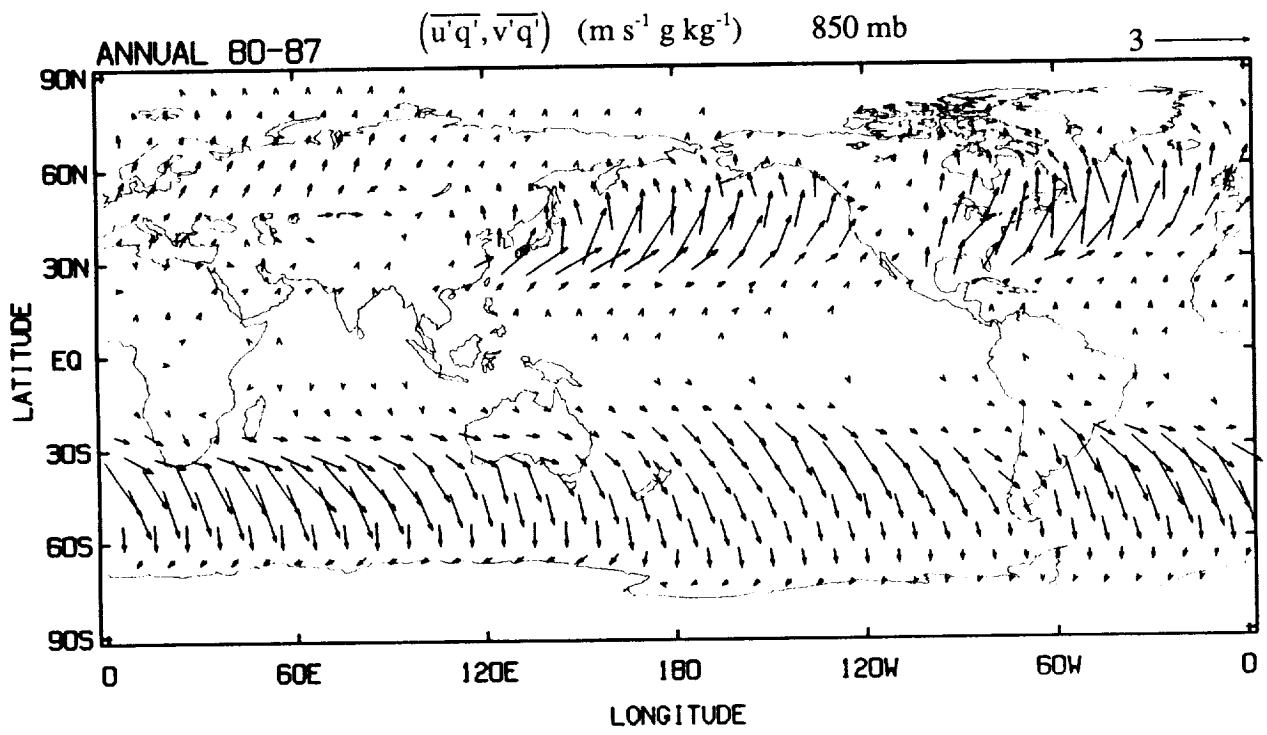
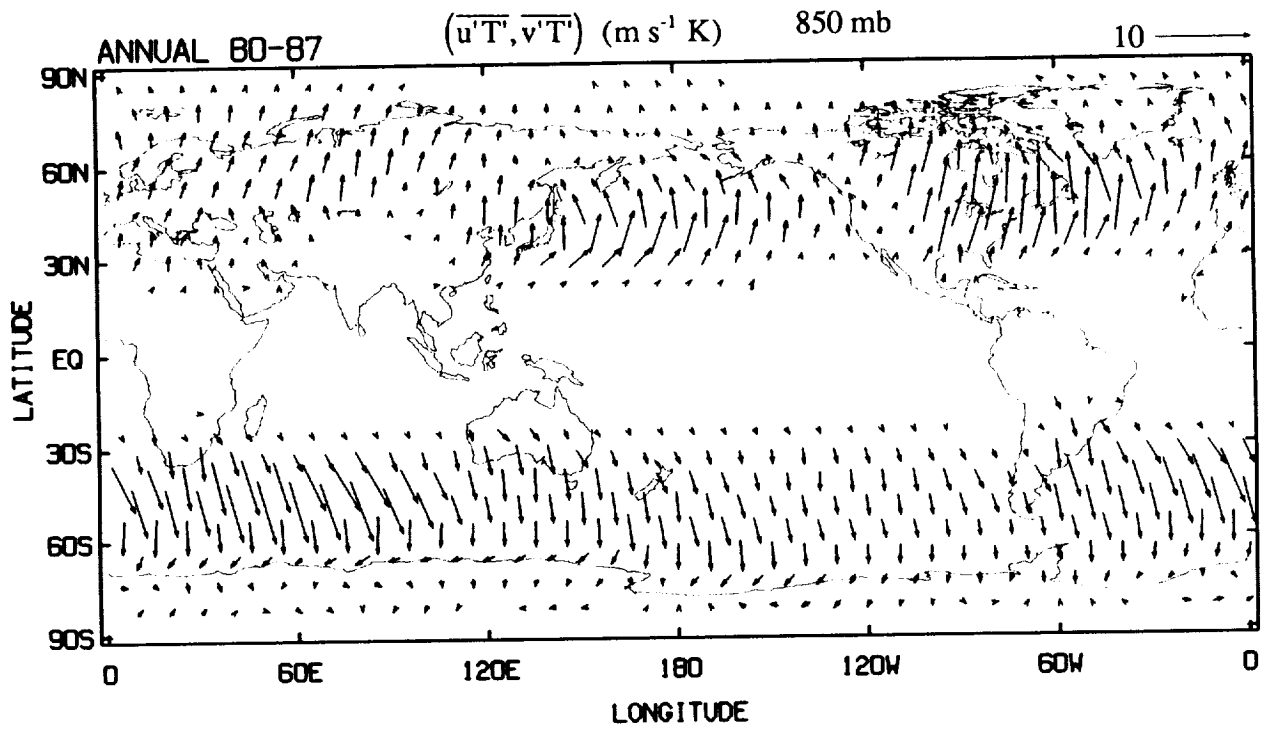

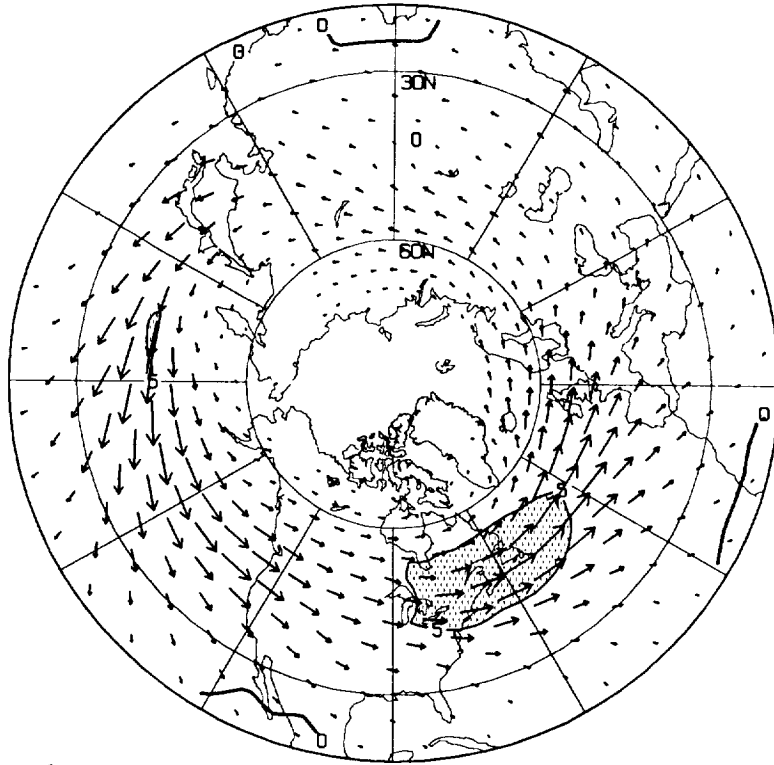

$\overline{v'T'}$ ($\text{m s}^{-1}\text{K}$) 850 mb

E_u ($\text{m}^2 \text{s}^{-2}$) 200 mb

50 →

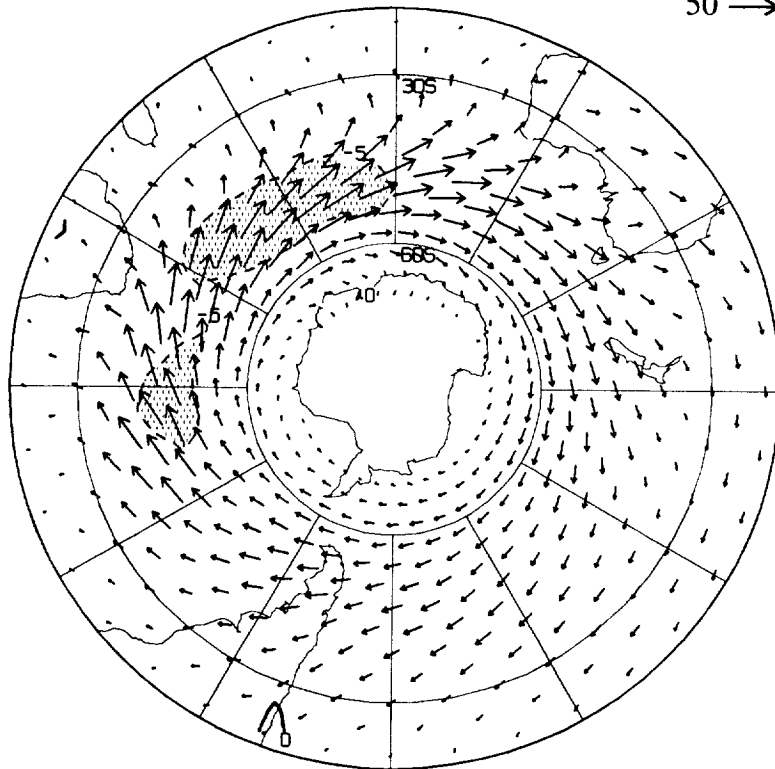

ANNUAL (80 - 87)

239

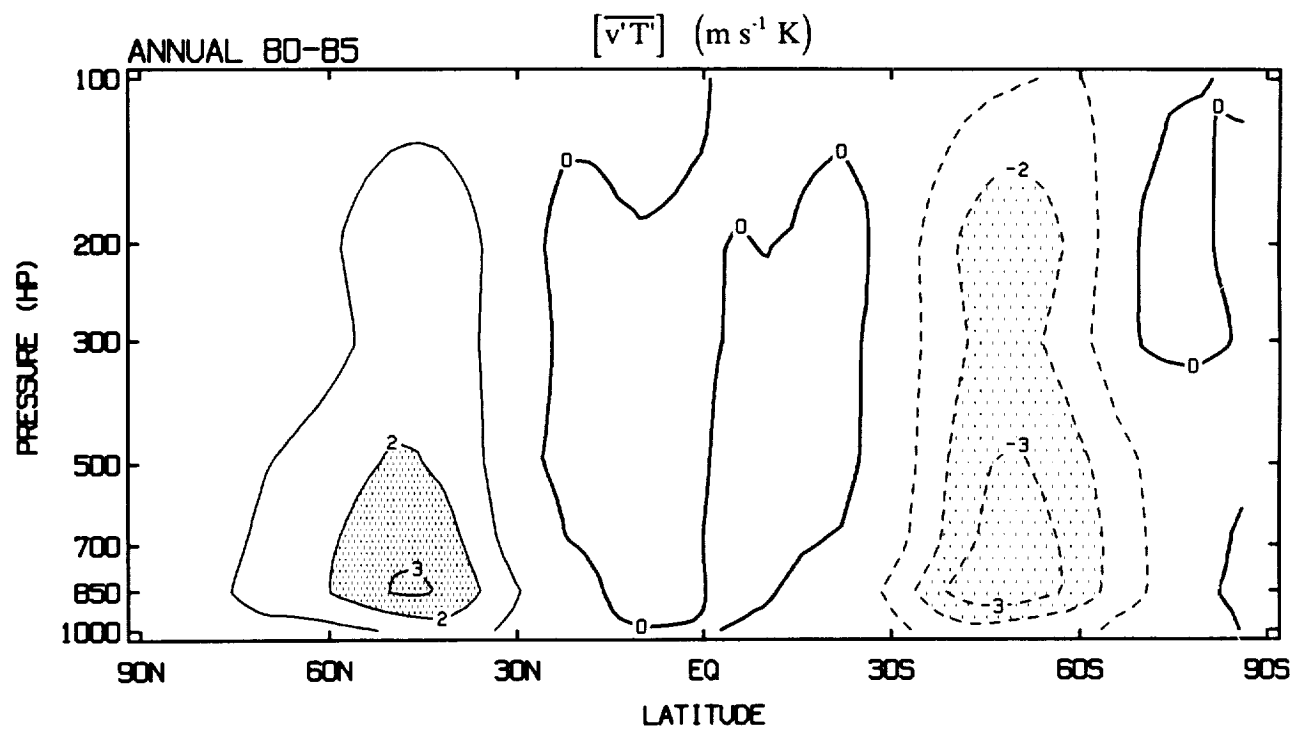
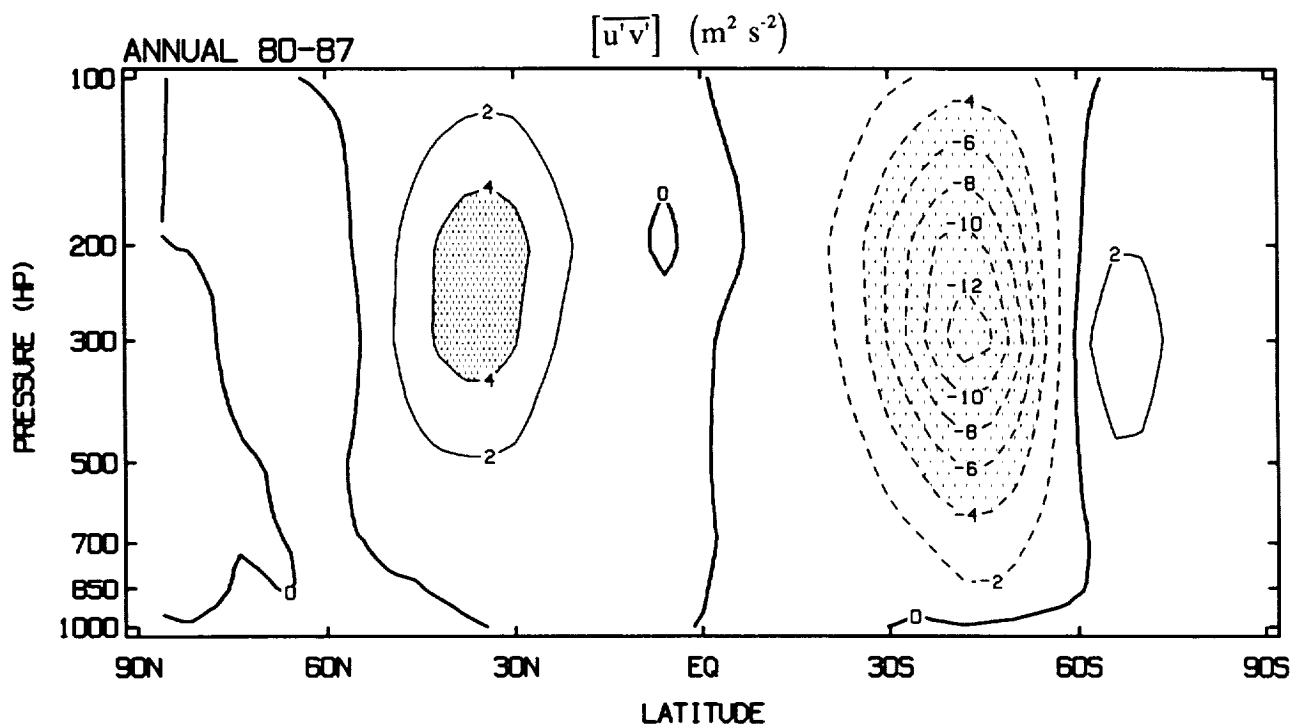

TIME SERIES

MONTHLY MEANS



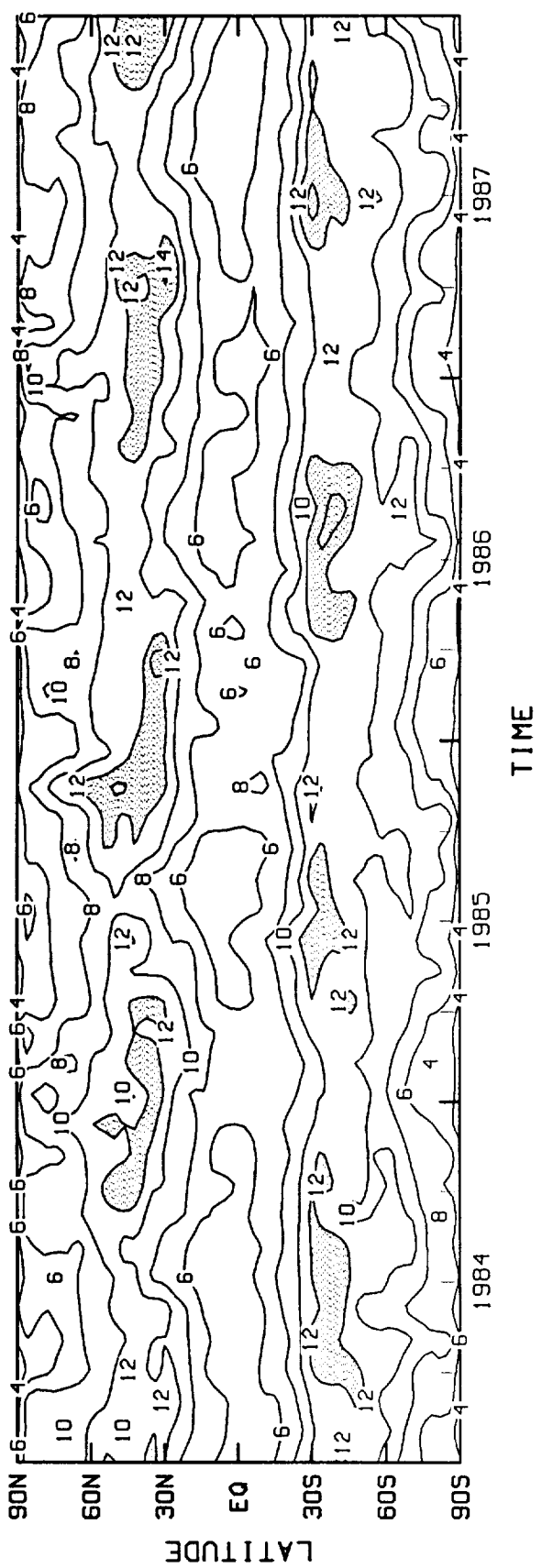
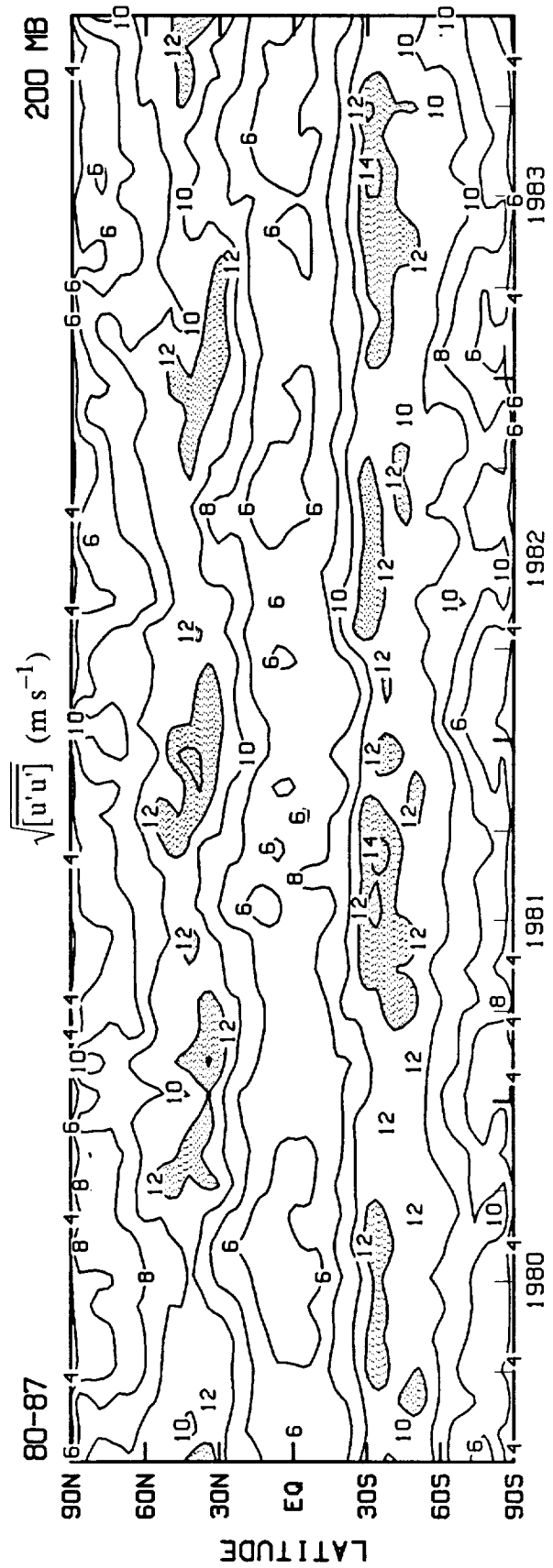

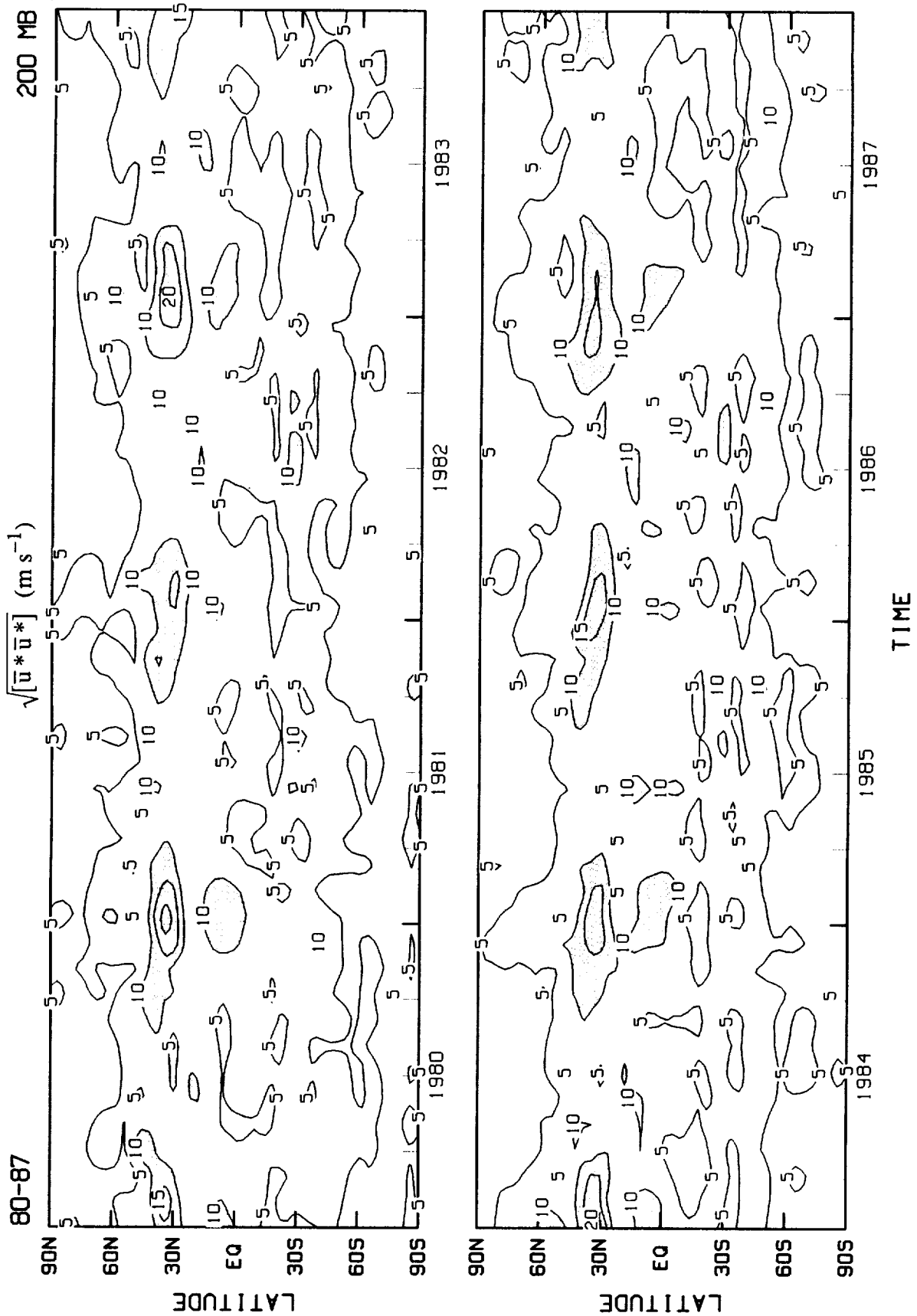

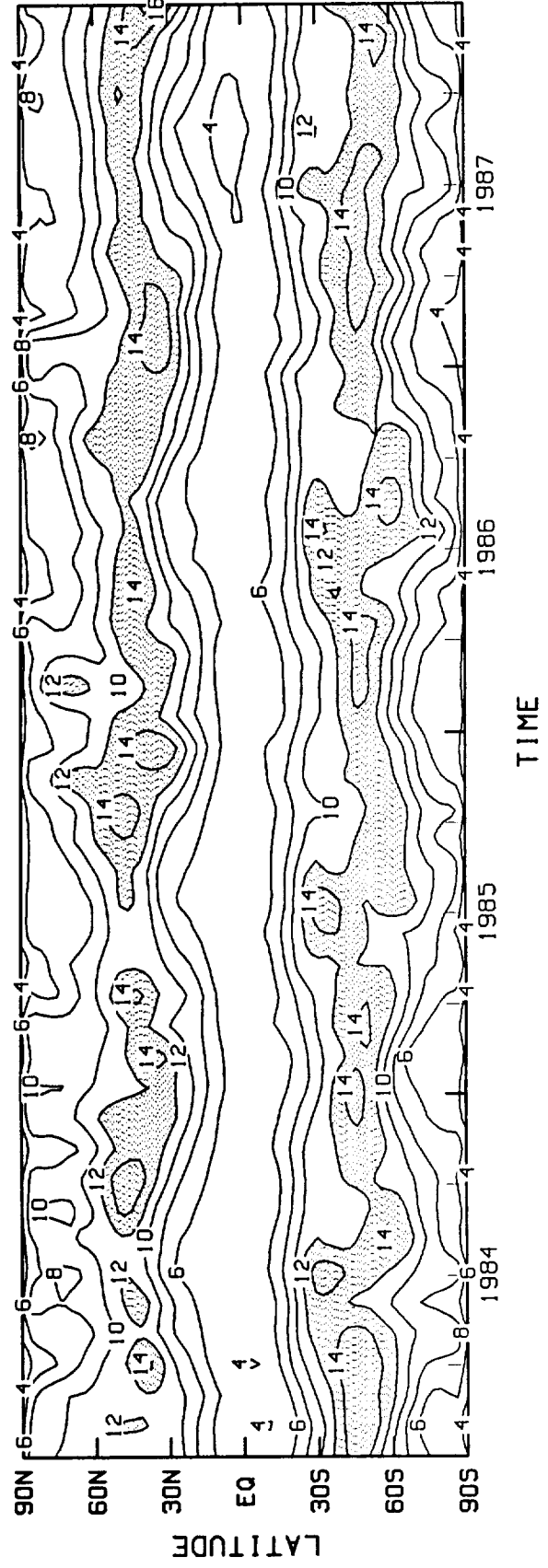
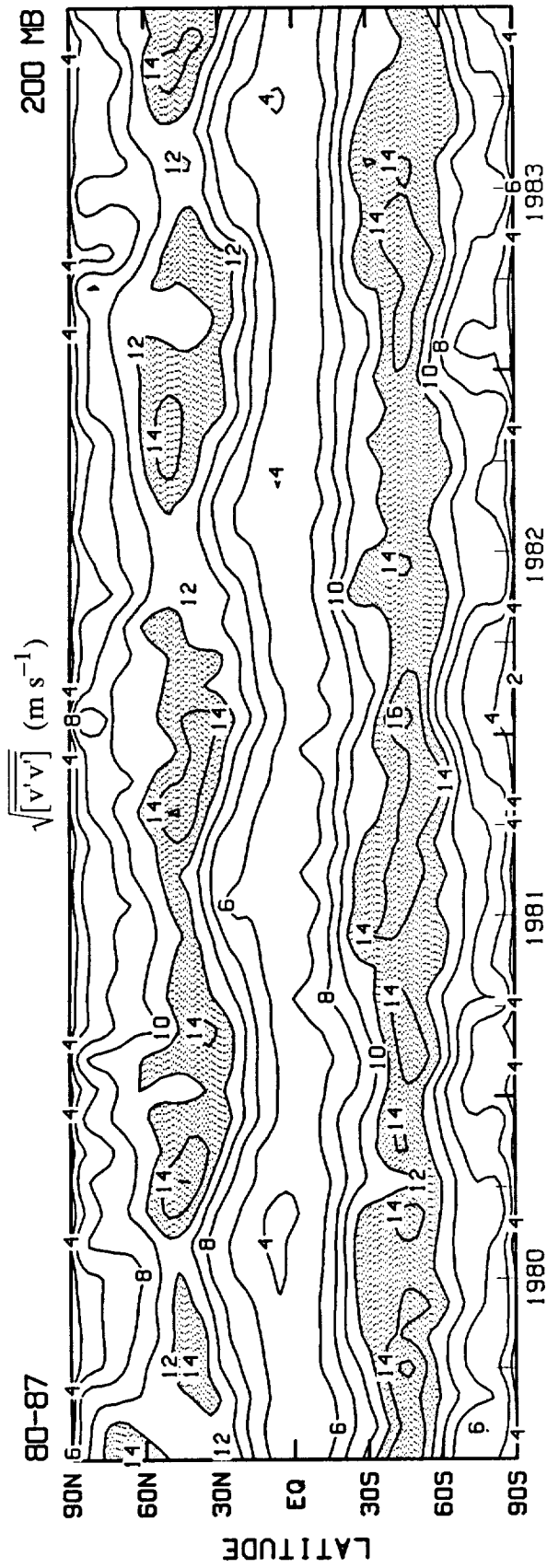

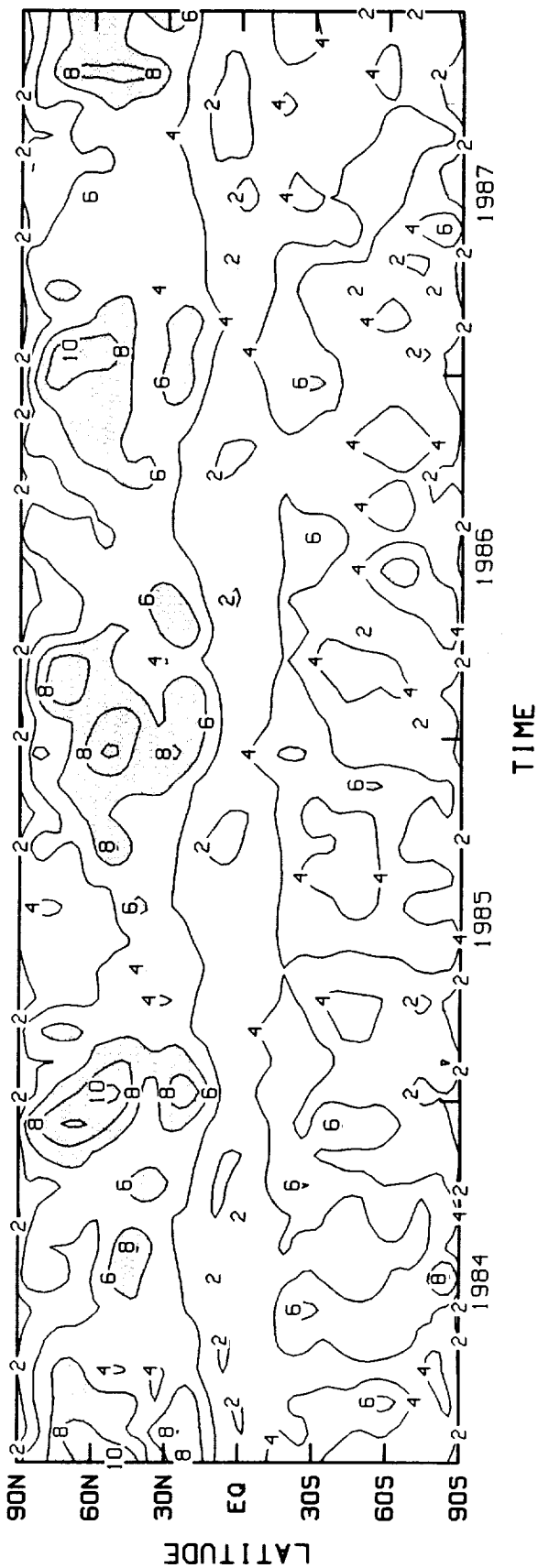
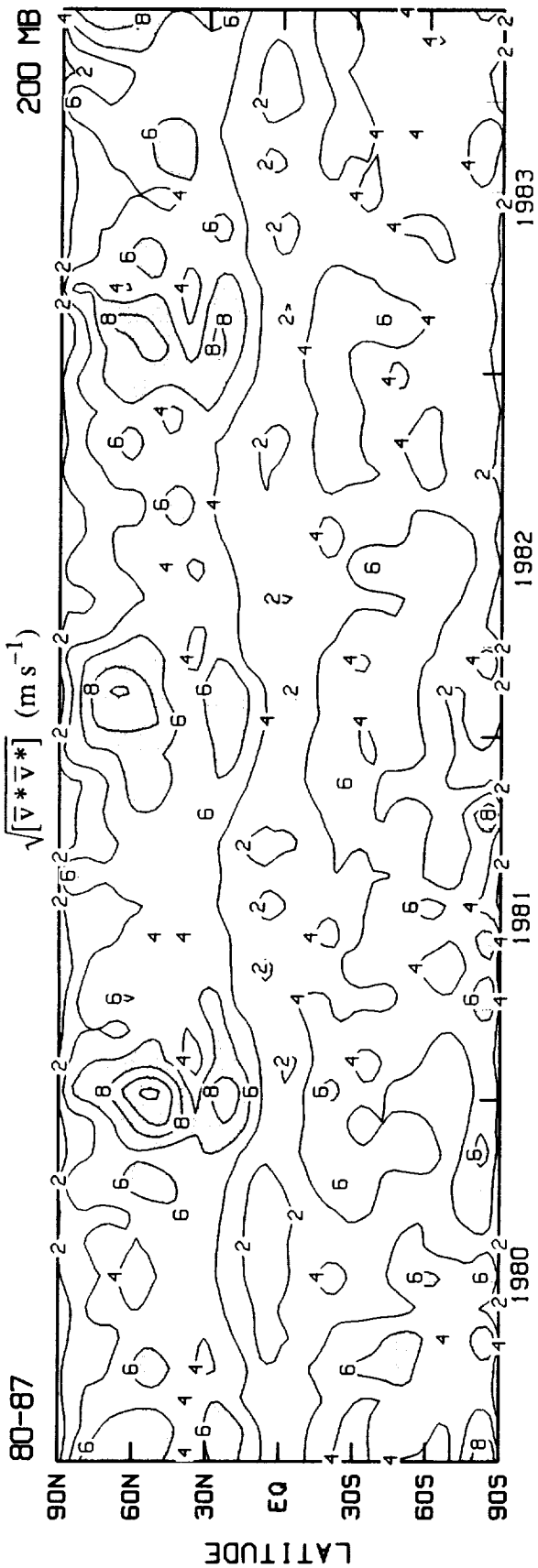

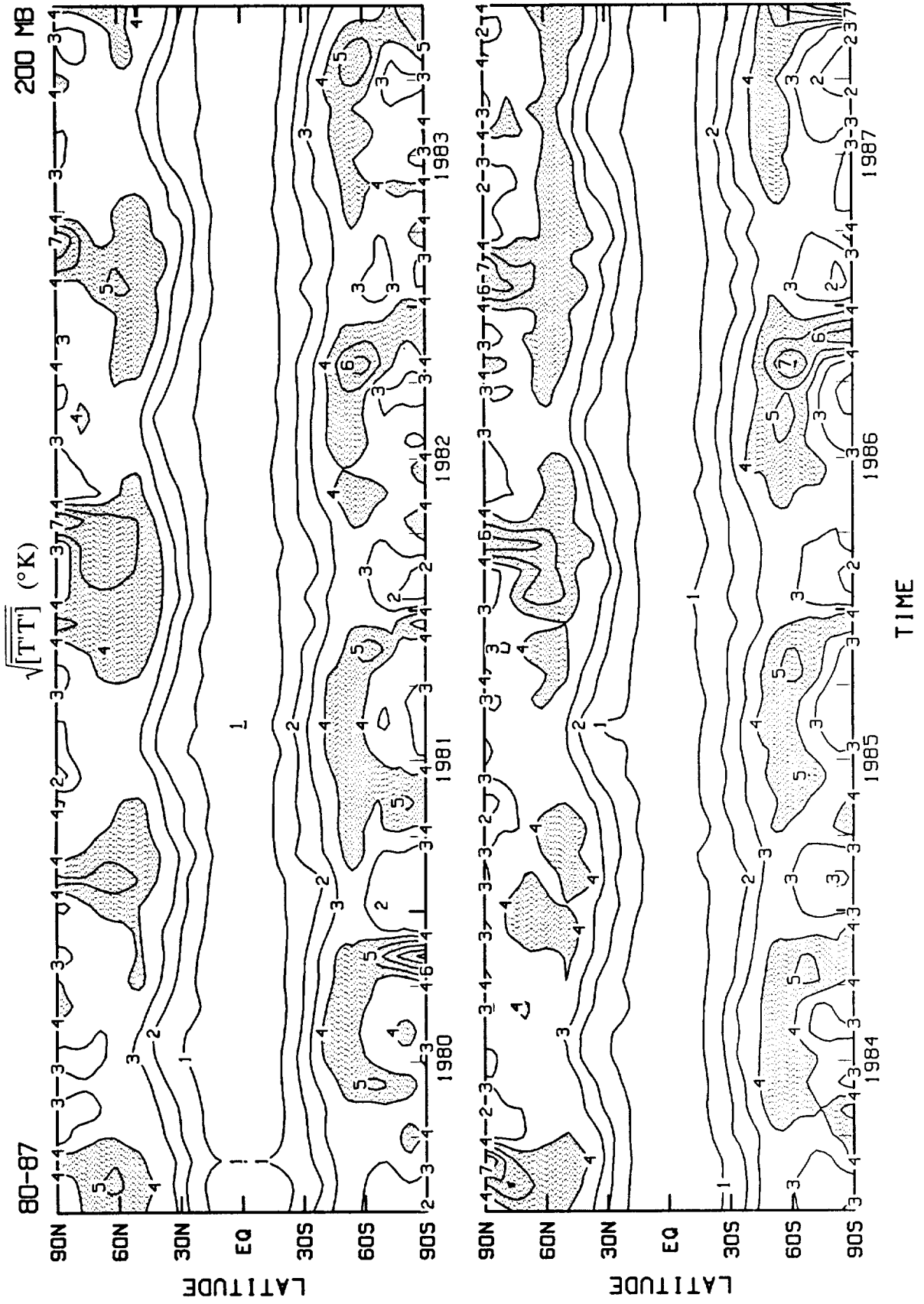

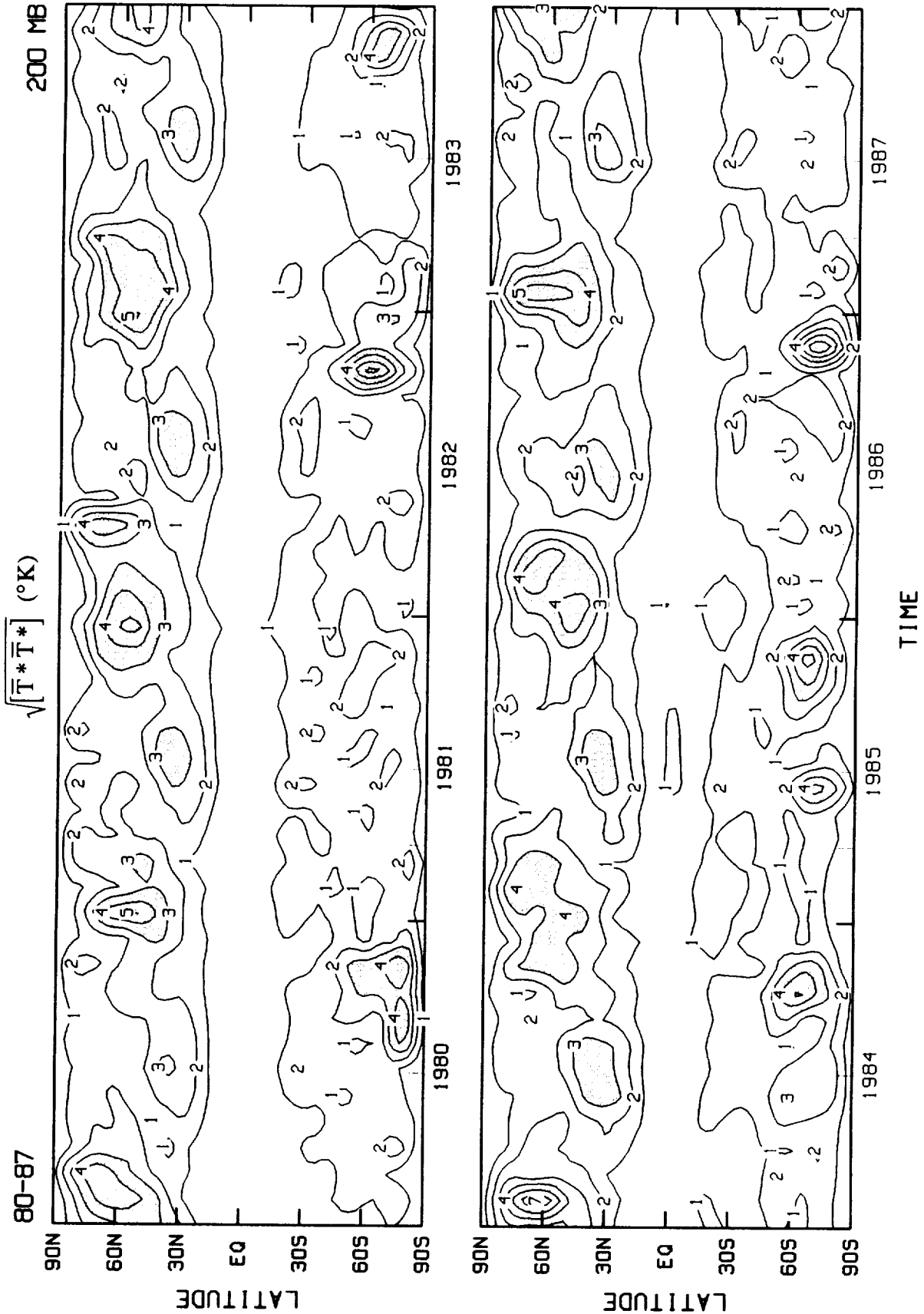

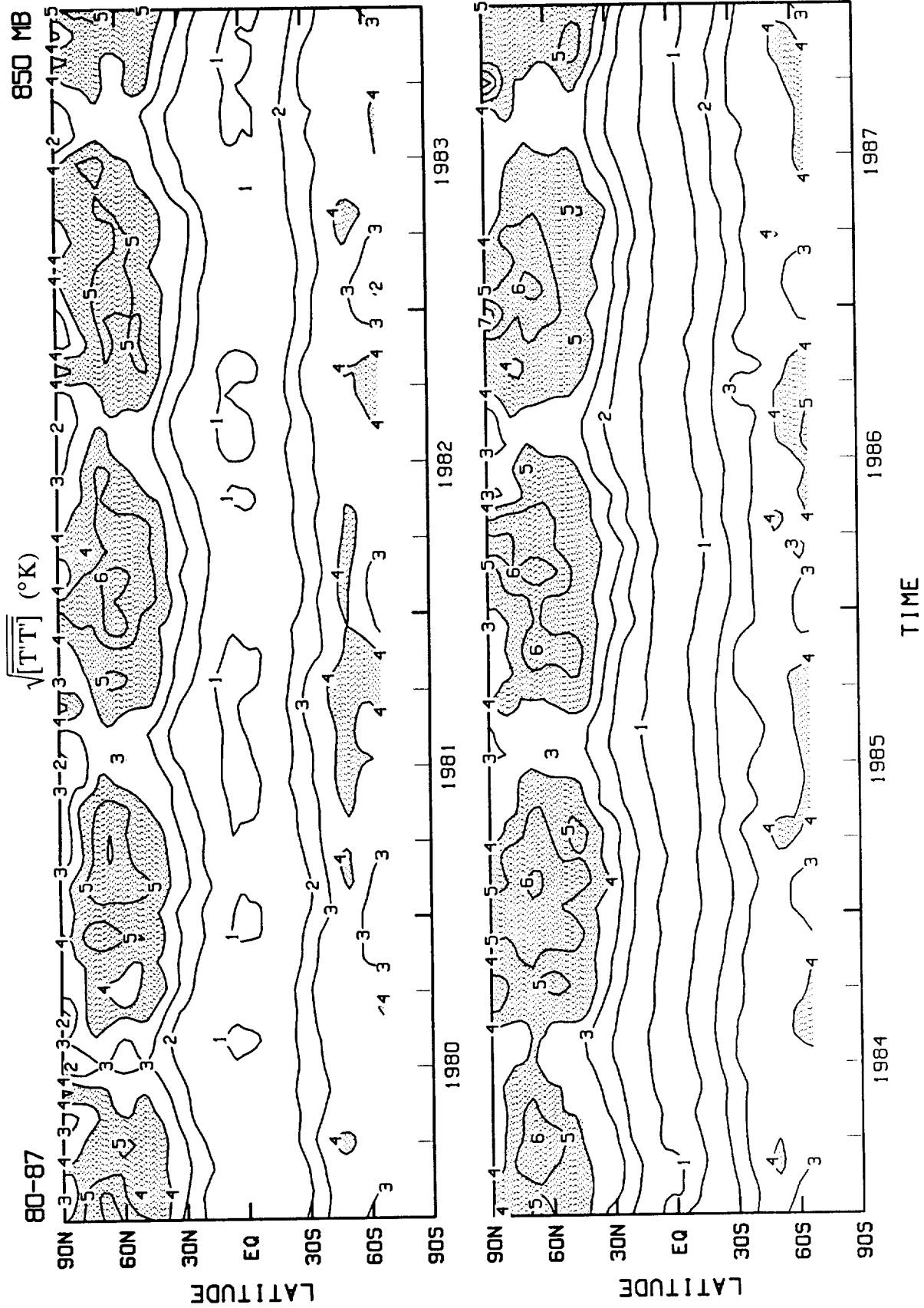

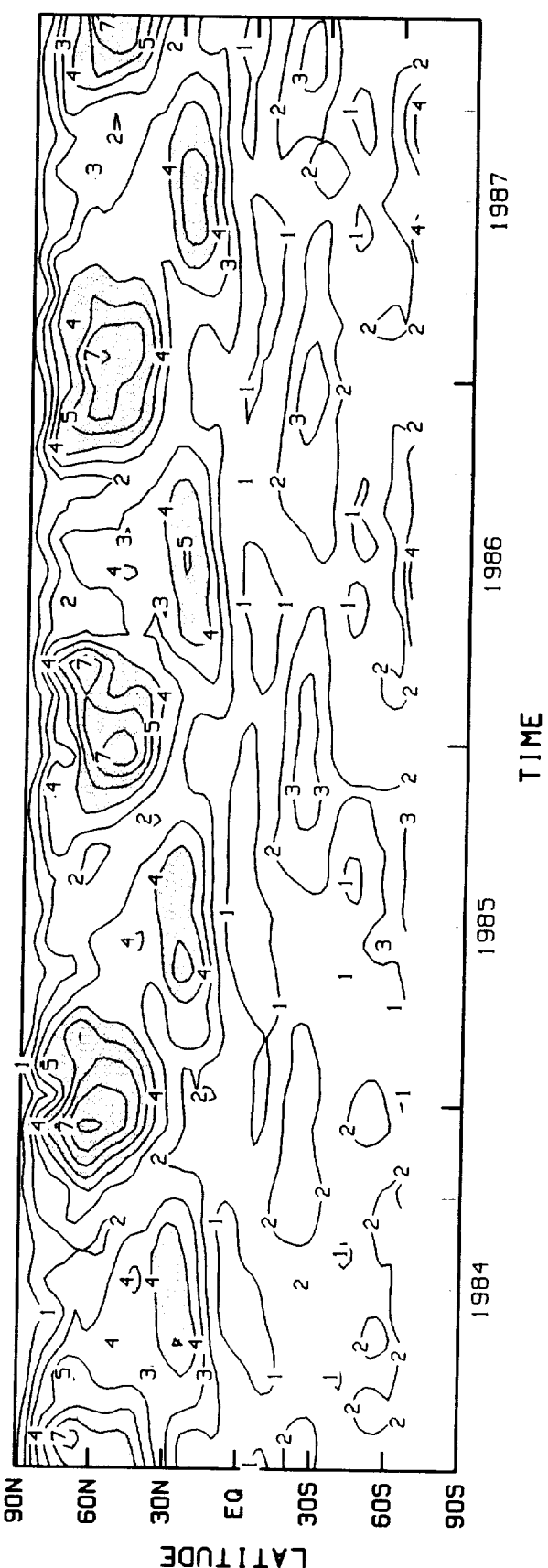
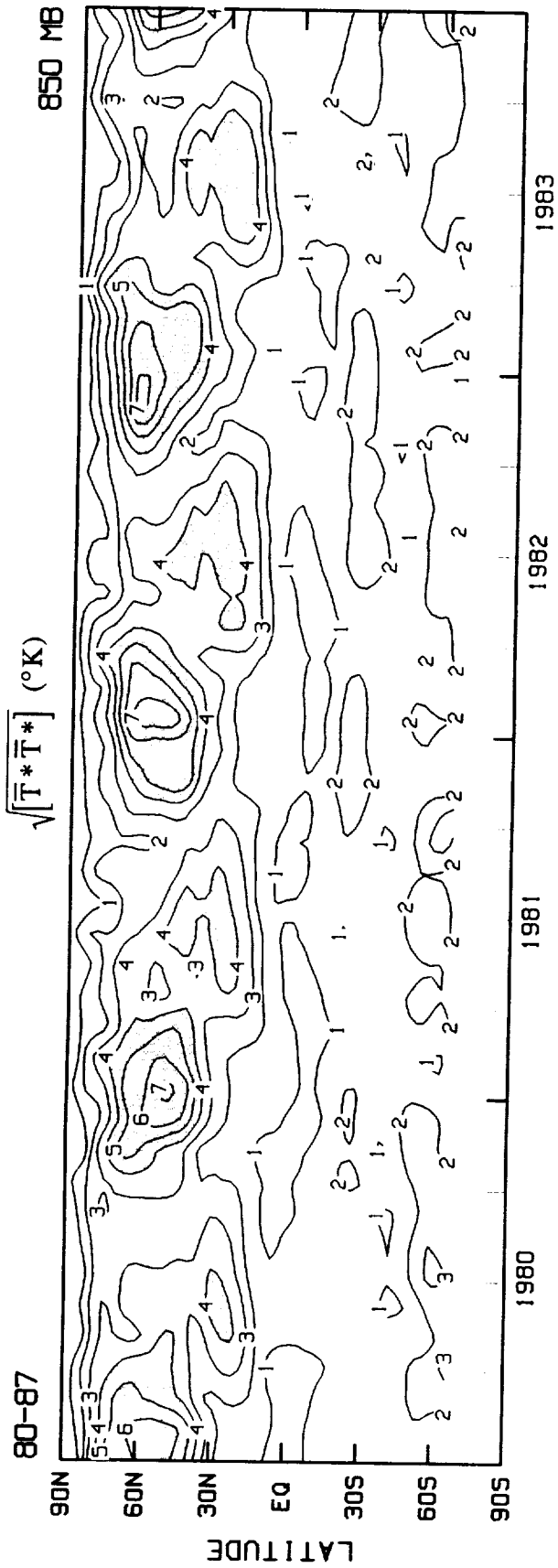

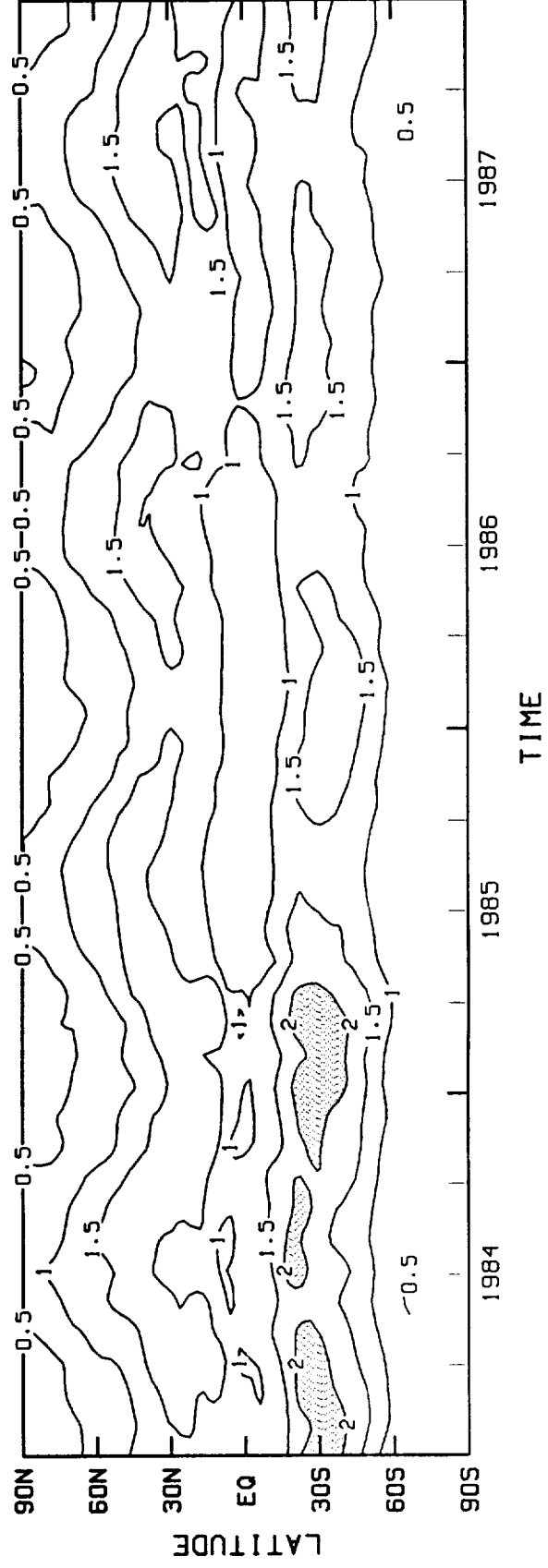
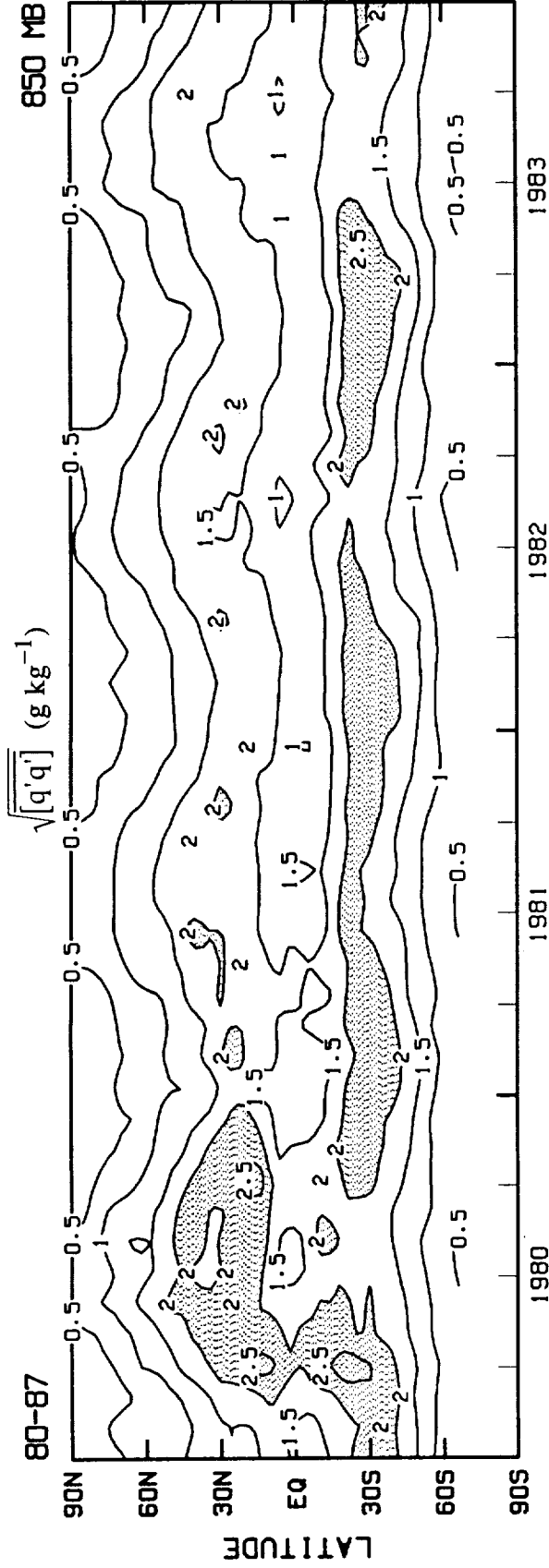

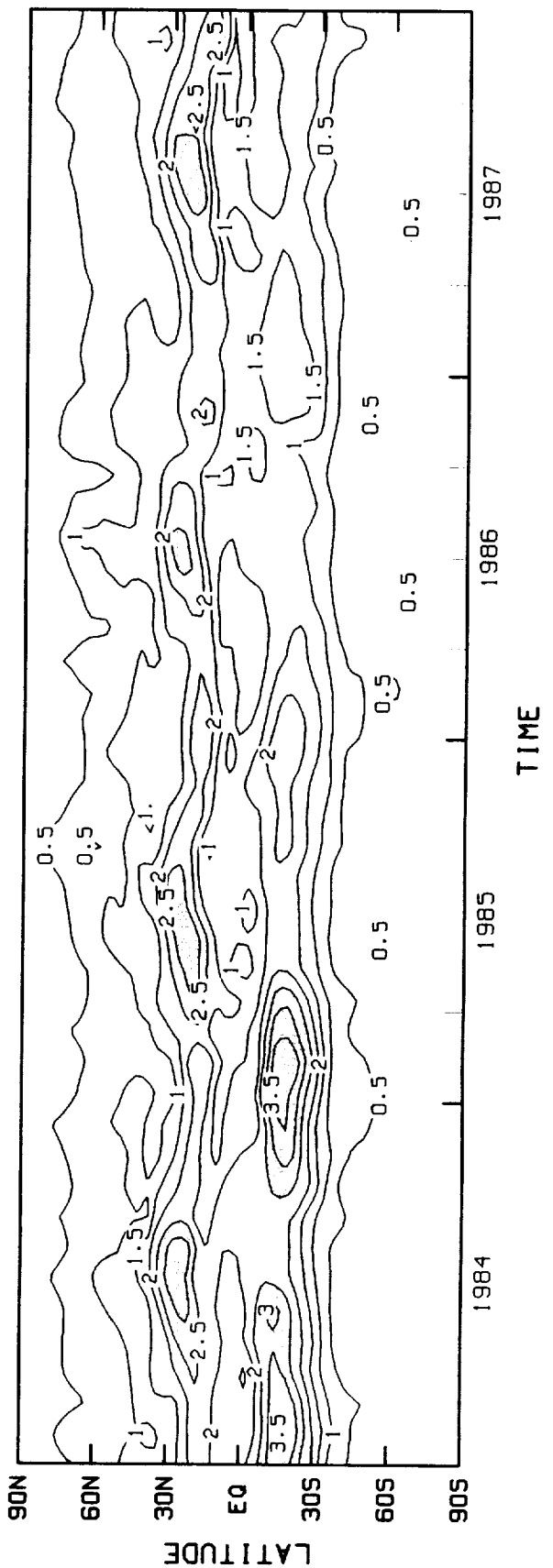
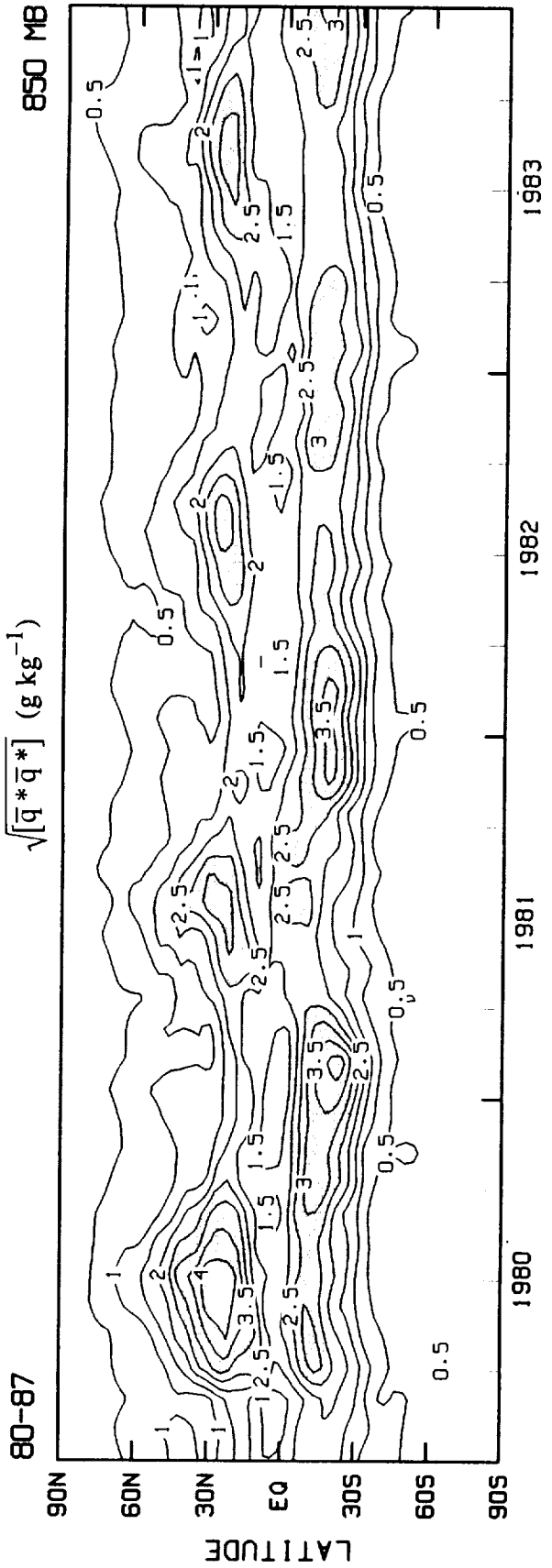



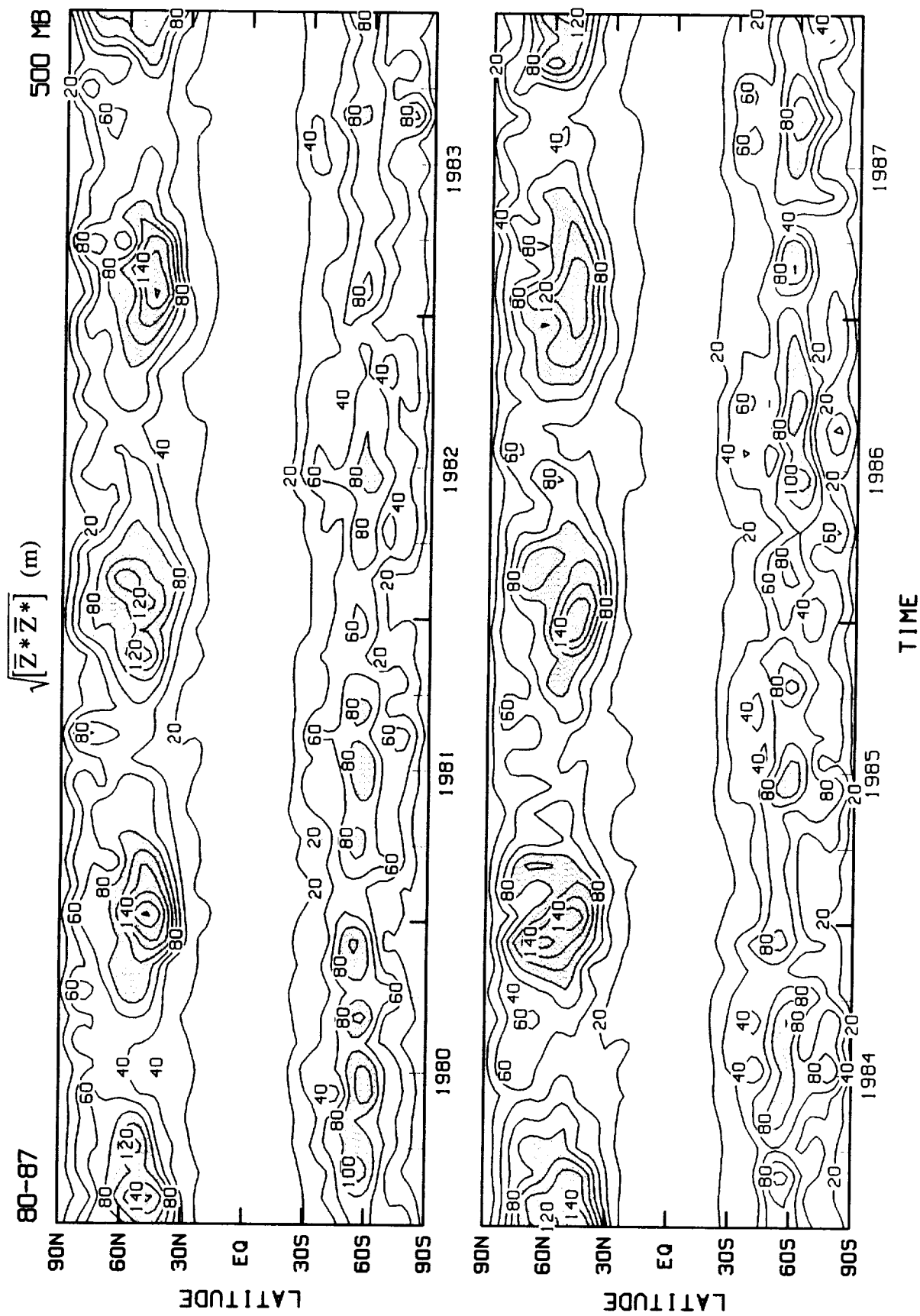

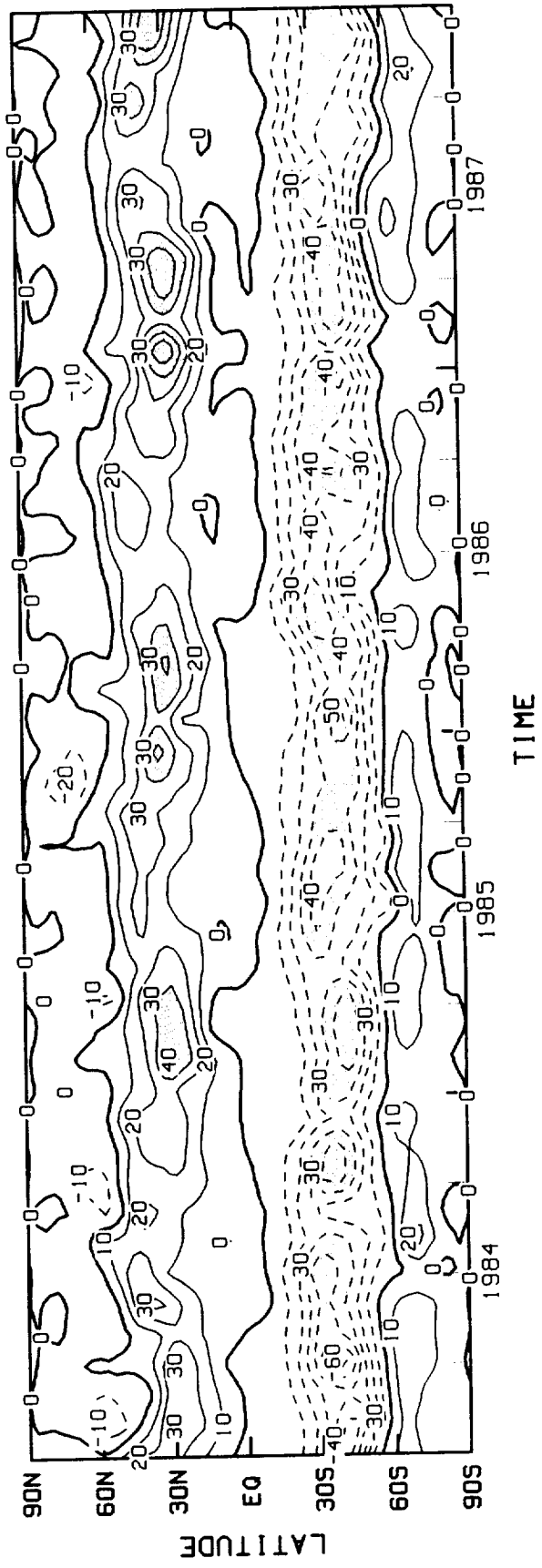
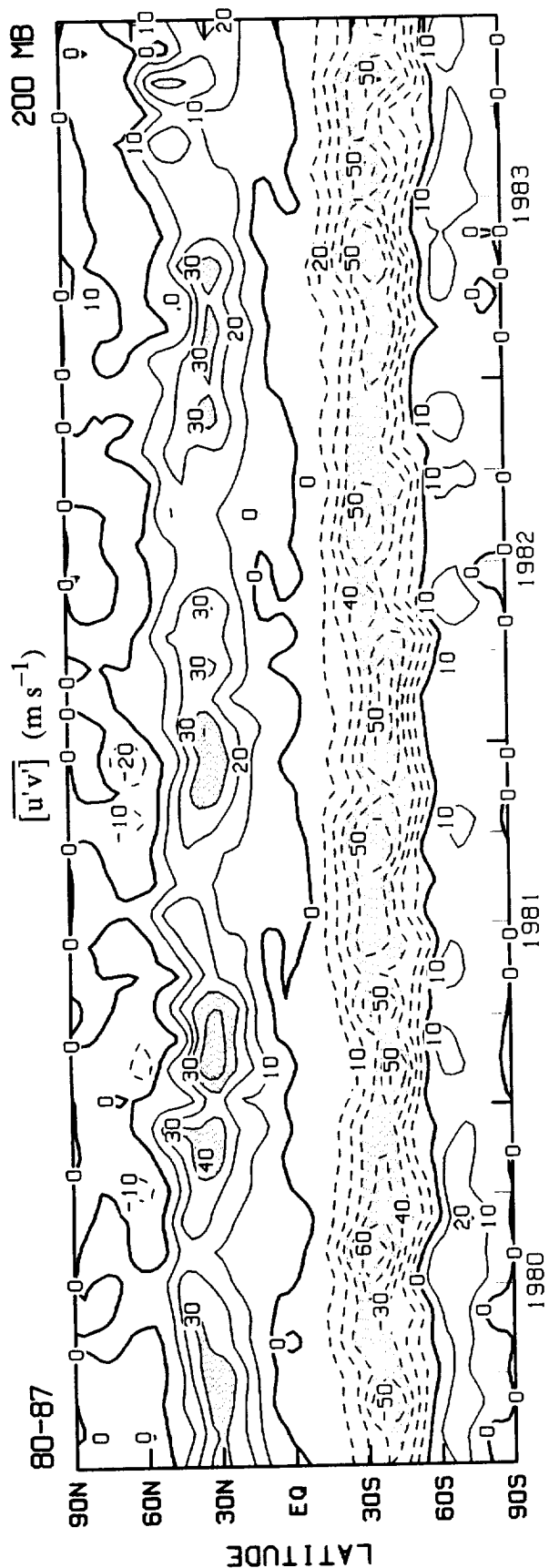

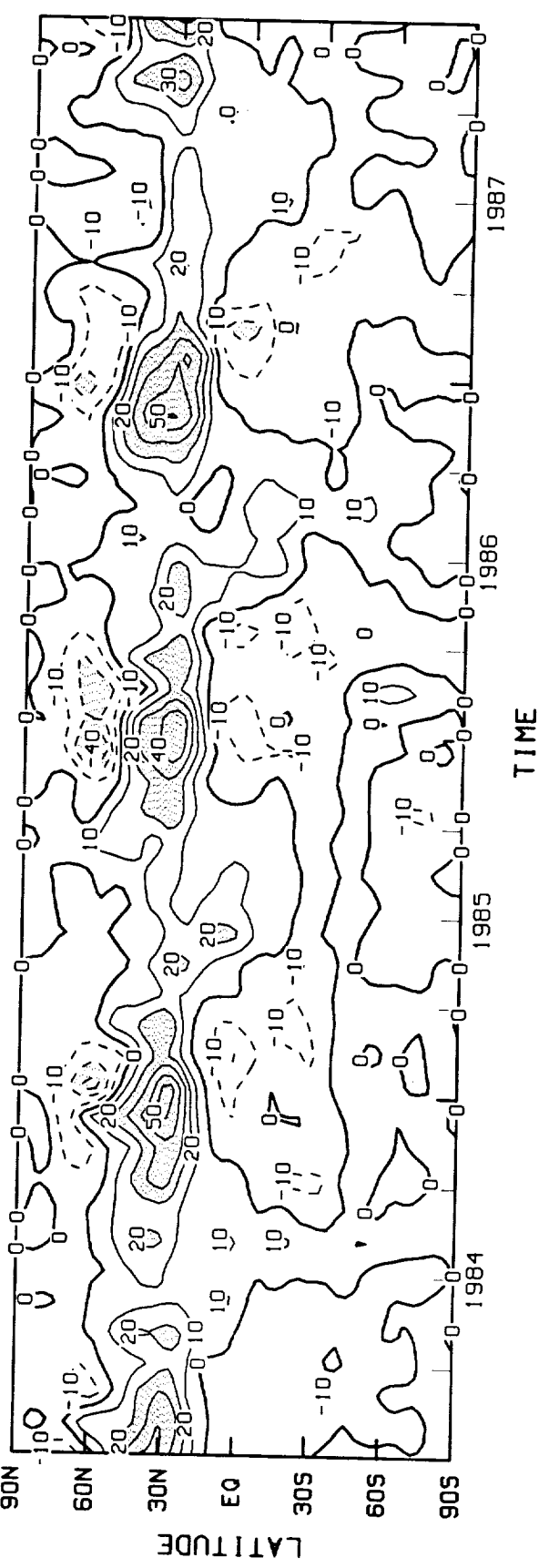
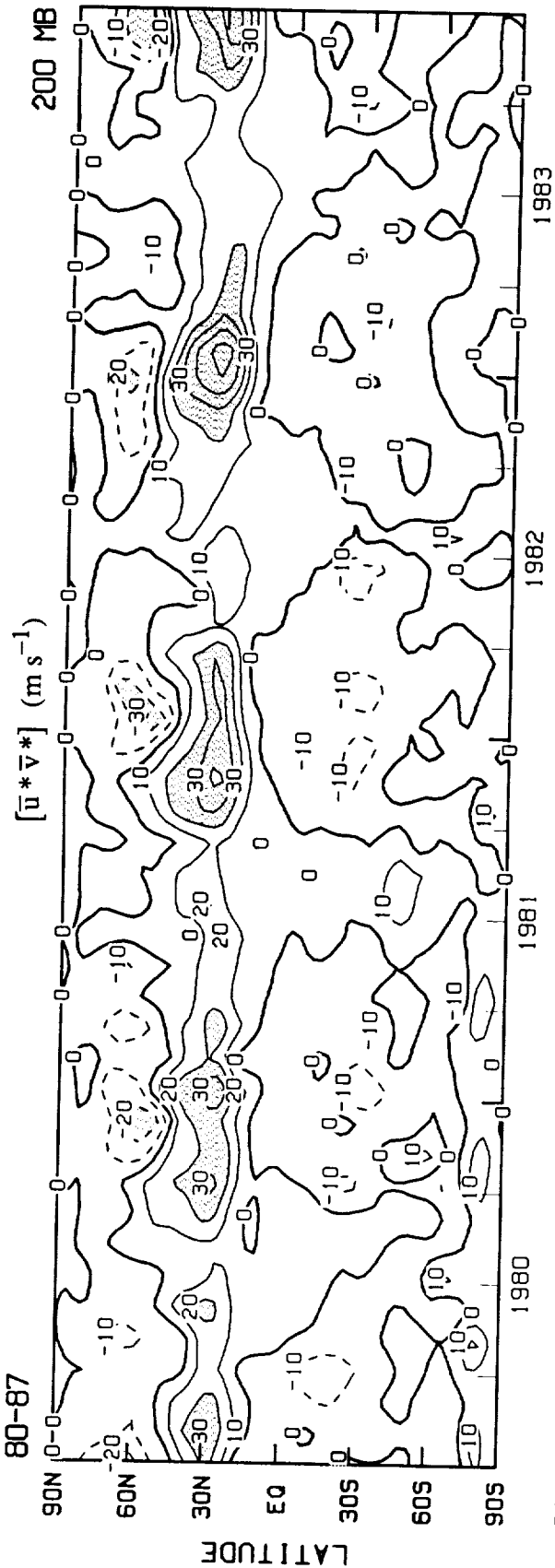

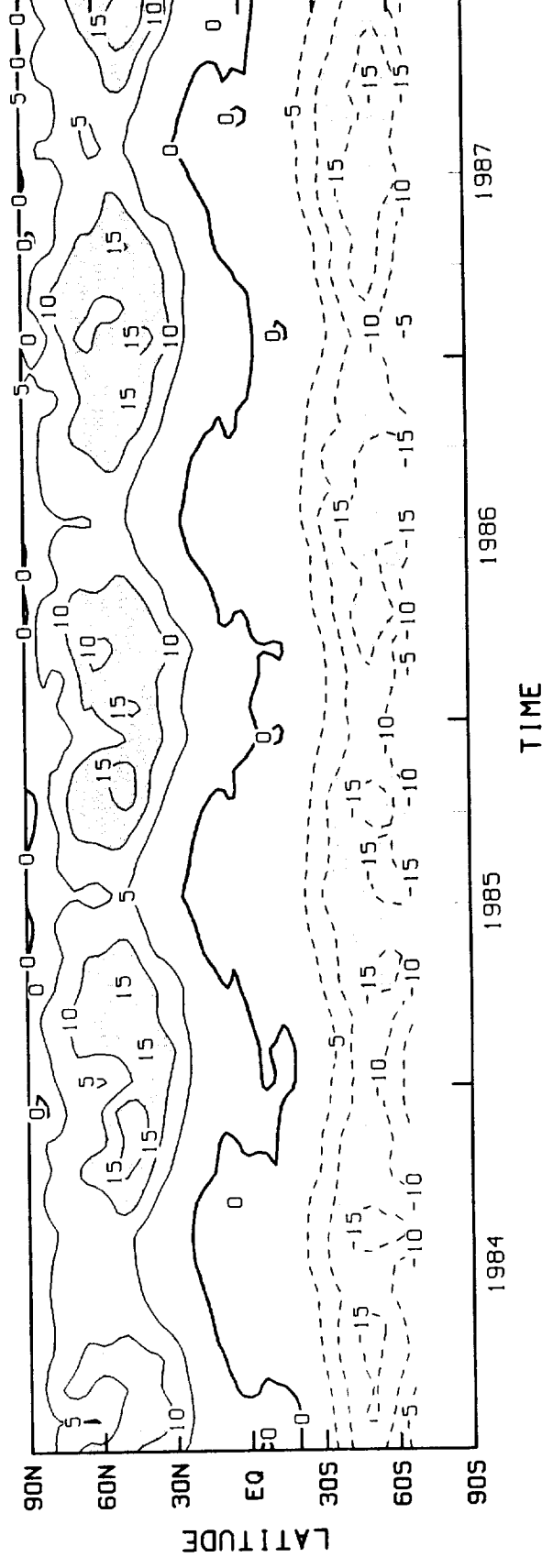
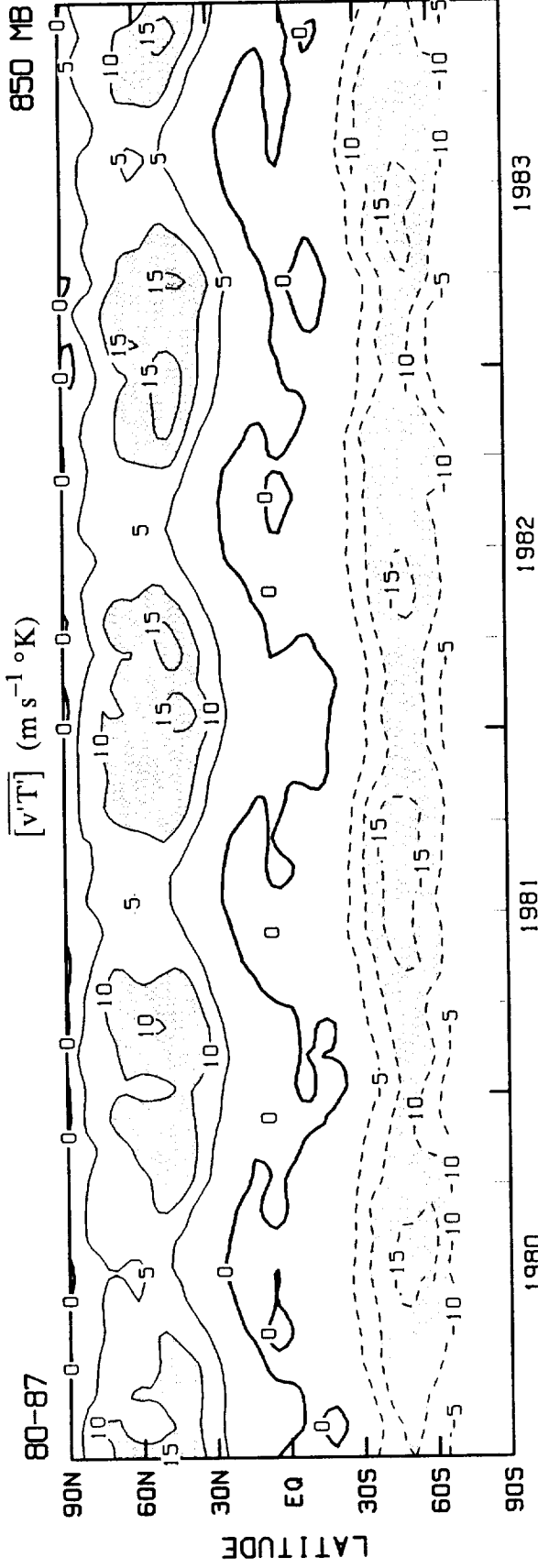

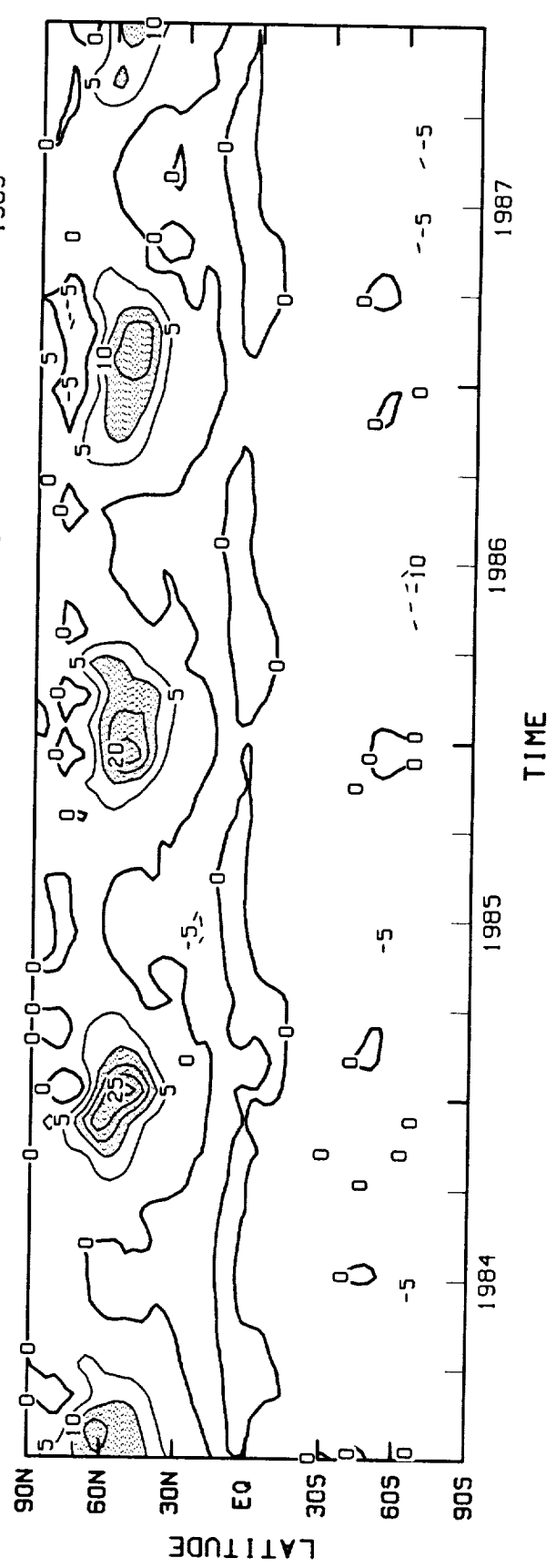
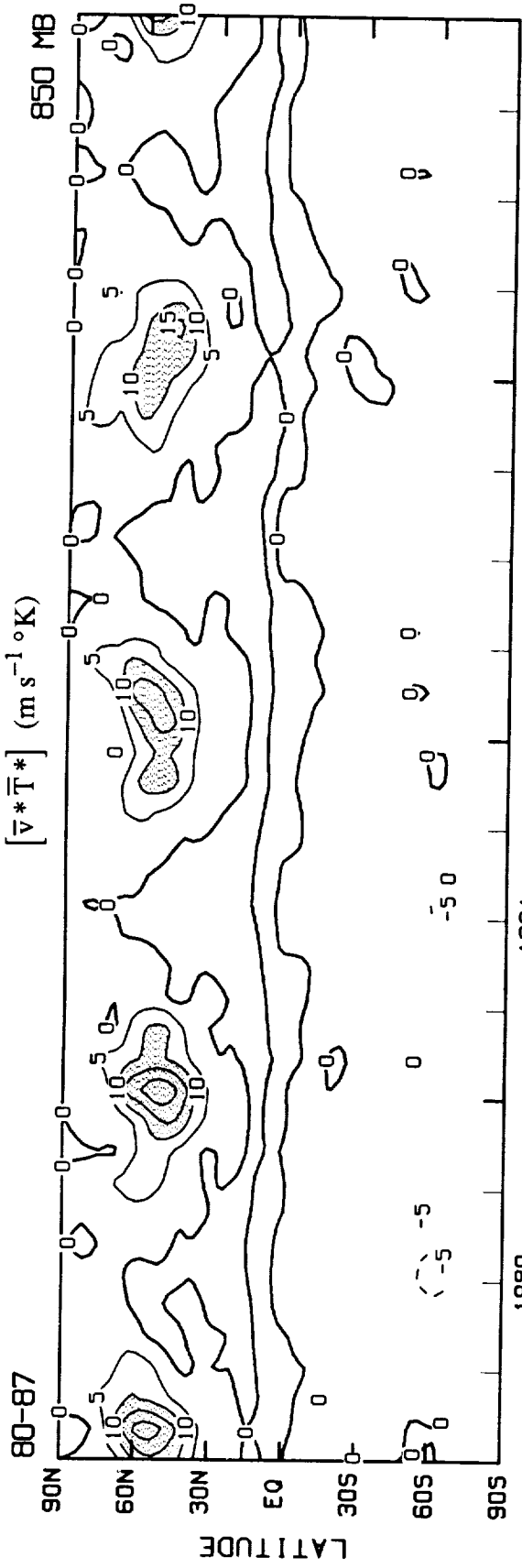

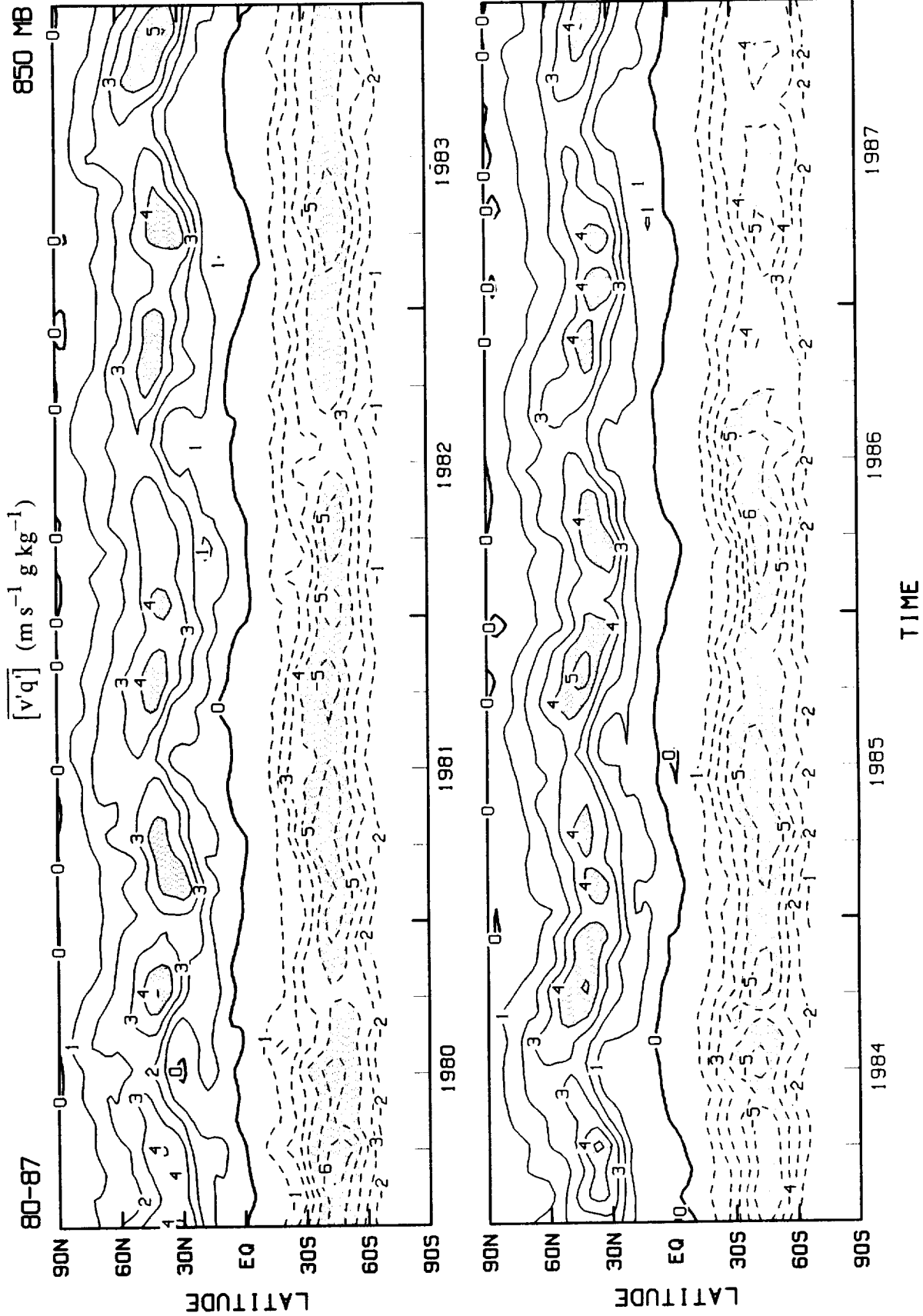

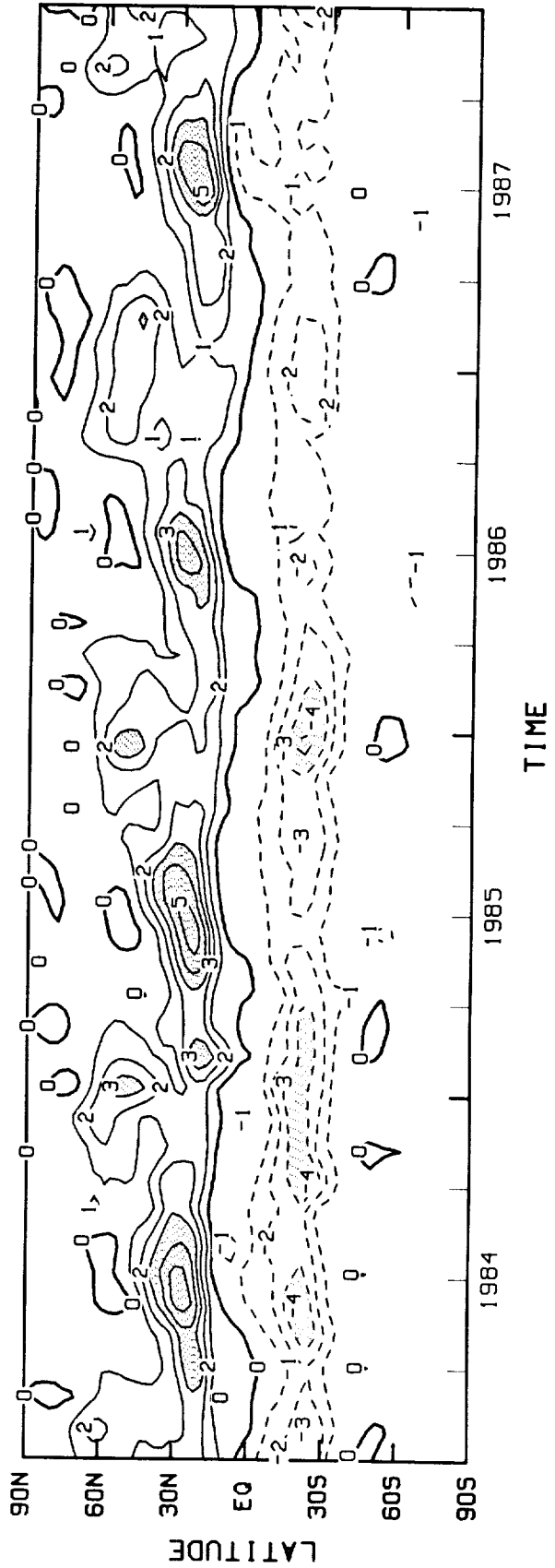
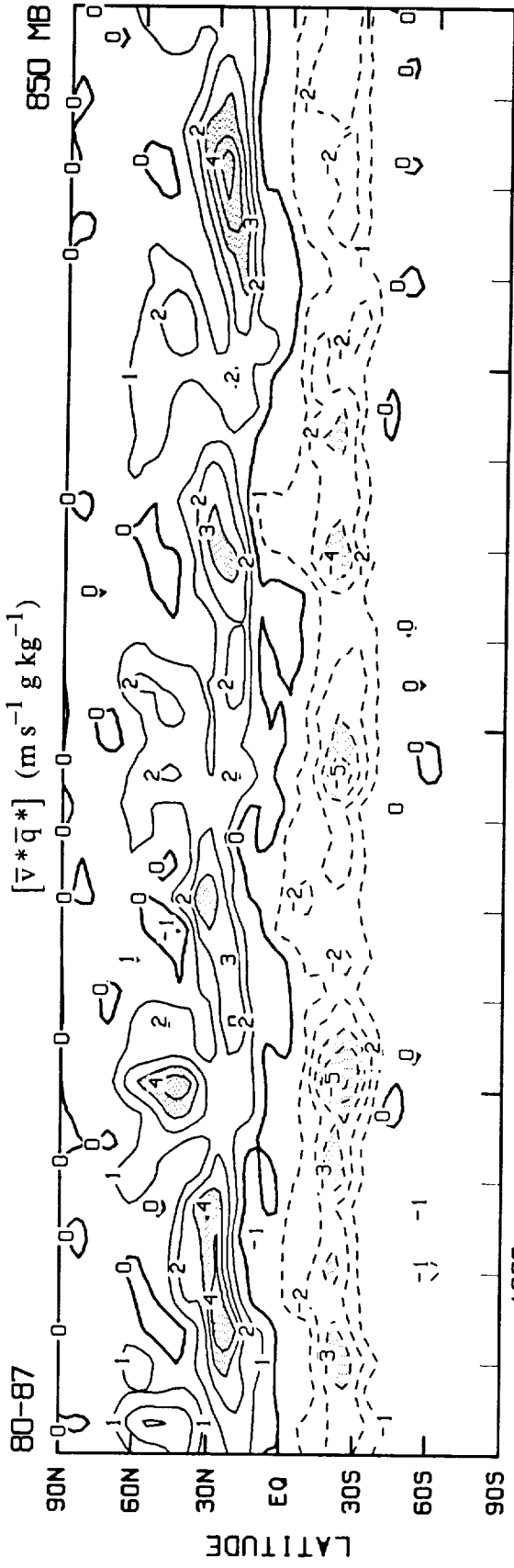

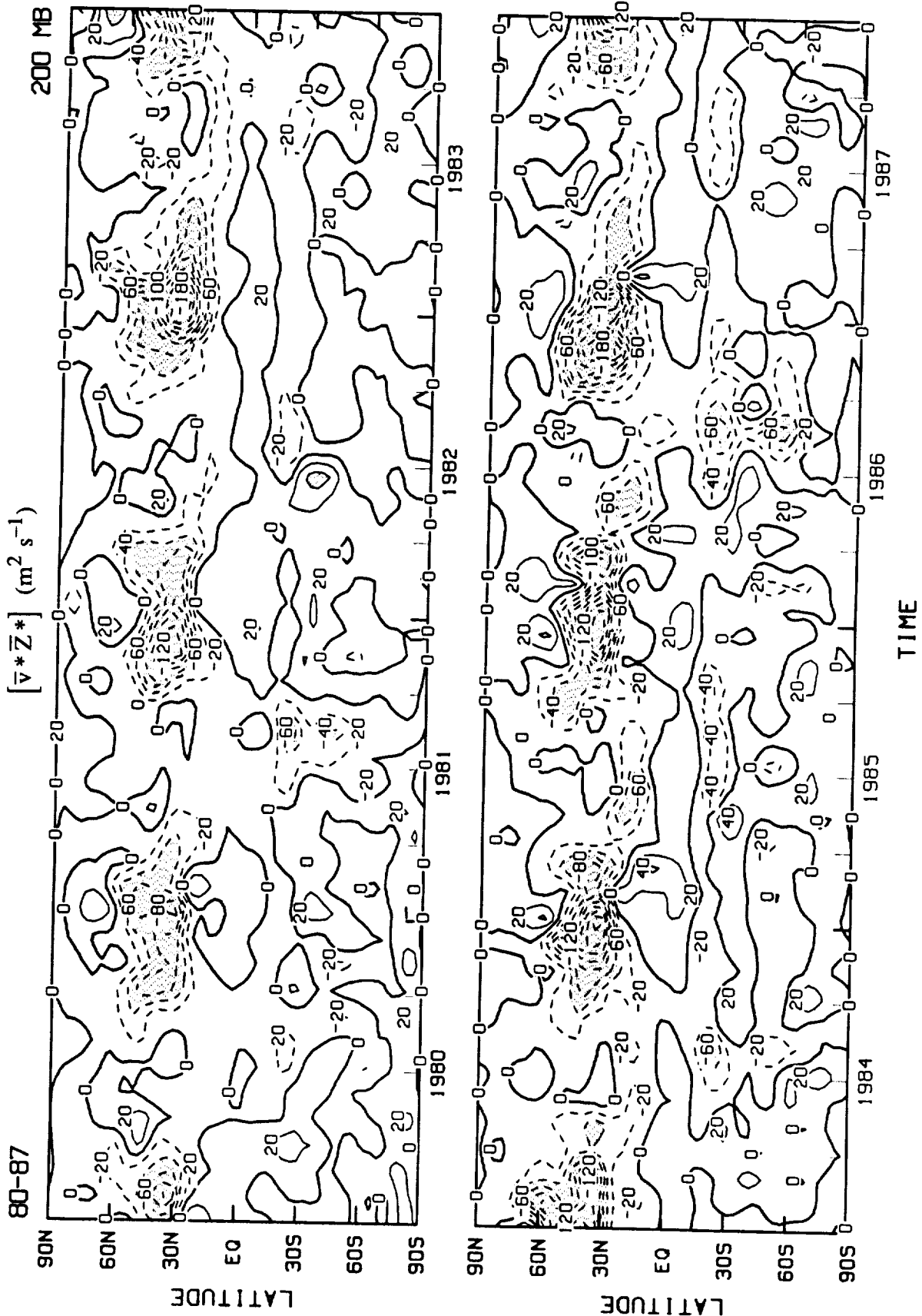



Report Documentation Page

1. Report No. NASA TM 100762		2. Government Accession No.		3. Recipient's Catalog No.	
4. Title and Subtitle An Atlas of ECMWF Analyses (1980-87) Part II--Second Moment Quantities				5. Report Date June 1990	
				6. Performing Organization Code 911.0	
7. Author(s) S. Schubert, W. Higgins, C.-K. Park, S. Moorthi, and M. Suarez				8. Performing Organization Report No. 90E02172	
				10. Work Unit No.	
9. Performing Organization Name and Address Laboratory for Atmospheres Goddard Space Flight Center Greenbelt, Maryland 20771				11. Contract or Grant No.	
				13. Type of Report and Period Covered Technical Memorandum	
12. Sponsoring Agency Name and Address National Aeronautics and Space Administration Washington, D.C. 20546-0001				14. Sponsoring Agency Code	
15. Supplementary Notes W. Higgins: Nat'l. Academy of Sciences, Nat'l. Research Council, Washington, DC. C.-K. Park: Centel Federal Services Corporation, Reston, VA. S. Moorthi: University Space Research Association, Columbia, MD. S. Schubert and M. Suarez: NASA-Goddard Space Flight Center, Greenbelt, MD.					
16. Abstract This document is an atlas based on European Center for Medium Range Weather Forecasts (ECMWF) initialized analyses for 1980-87. Transports and variances are presented globally at 200 mb and 850 mb as well as zonally averaged for seasonal and annual averages. Selected fields are filtered to isolate the synoptic (2.5 days<periods<6 days) and low frequency (10 days<periods<90 days) regions of the spectrum. In addition, time series of the zonally and monthly averaged transports and variances are presented over the entire 8-year period.					
17. Key Words (Suggested by Author(s)) ECMWF, analyses, atlas, variances, transports			18. Distribution Statement Unclassified-Unlimited Subject Category 47		
19. Security Classif. (of this report) Unclassified		20. Security Classif. (of this page) Unclassified		21. No. of pages 286	22. Price

