

PROJECT EXODUS

**ENAE 412: NASA/USRA Project
Dr. Mark Lewis, Advisor**

Period: January 23, 1990 - May 14, 1990

UM-AERO-90-28

This report is the combined efforts of the following students:

Adams, Dilene
Bryant, Rodney
Dillon, Jennifer
Drum, Darrin
Garrison, Brian
Grewe, George
Irapour, Masoud
Kelly, Lynda
Khalsa, Guru Tej
Mathews, David
McMorrow, Jim
Melton, Craig
Mera, Diego
Patel, Kalpesh
Rainey, Gerald
Rinko, John
Singh, David
Wilcox, Tim
Yen, Tzu-Liang

Final report compiled and edited by:

Bryant, Rodney
Dillon, Jennifer
Grewe, George
McMorrow, Jim
Melton, Craig
Rainey, Gerald
Rinko, John
Singh, David
Yen, Tzu-Liang

ABSTRACT

The University of Maryland, Company B, design for a manned Mars mission is called PROJECT EXODUS. PROJECT EXODUS incorporates the design of a hypersonic waverider, cargo ship and NIMF (nuclear rocket using indigenous Martian fuel) shuttle lander to safely carry out a three to five month mission on the surface of Mars.

The cargo ship transports return fuel, return engine, surface life support, NIMF shuttle, and the Mars base to low Mars orbit (LMO). The cargo ship is powered by a nuclear electric propulsion (NEP) system which allows the cargo ship to execute a spiral trajectory to Mars. Once the cargo ship arrives at Mars it parks in LMO and waits for the waverider. The Earth to Mars trip takes 601 days.

The waverider transports ten astronauts to Mars and back. It is launched from the Space Station with propulsion provided by a chemical engine and a delta velocity of 9 km/sec. The waverider performs an aero-gravity assist maneuver through the atmosphere of Venus to obtain a deflection angle and increase in delta velocity. It executes an aero-brake maneuver at Mars and docks with the cargo ship. The Earth to Mars trip for the waverider takes 108 days.

Once the waverider and cargo ship have docked the astronauts will detach the landing cargo capsules and nuclear electric power plant and remotely pilot them to the surface. They will then descend to the surface aboard the NIMF shuttle. The NIMF shuttle is powered by a nuclear solid core engine which uses either H₂ or CO₂ as propellant. It can hop around the surface of Mars and also ascend back to LMO.

A dome base will be quickly constructed on the surface and the astronauts will conduct an exploratory mission for three to five months. They will return to Earth and dock with the Space Station using the waverider. The waverider will be

powered back to earth by a nuclear solid core engine, with a delta velocity of 10 km/sec. An aero-brake maneuver will be executed at Earth in order to slow down for docking with the Space Station. The Mars to Earth trip takes 178 days.

ACKNOWLEDGEMENTS

(James McMorrow, Gerald Rainey)

The members of the University of Maryland ENAE 412--Group B design team would like to take this opportunity to express their appreciation to Dr. James E. Randolph and Dr. Angus McDonald of the Jet Propulsion Laboratory, for suggesting this work, and Ms. Stacy Weinstein, also of the Jet Propulsion Laboratory, for providing trajectory information. We also thank Dr. Jim Phenix and Dr. Stephen Paddock of the NASA Goddard Space Flight Center for their participation with the USRA program.

We would also like to thank Dr. Ajay P. Kothari for his suggestions pertaining to advanced space propulsion, Dr. John D. Anderson for his suggestions pertaining to aerothermodynamics, Dr. Jewel Barlow for his suggestions pertaining to flight mechanics, Dr. Anthony Vizzini for his many suggestions pertaining to advanced composites and structures, Dr. Sung Lee for his suggestions pertaining to structures, Dr. David Van Wie for his suggestions pertaining to high-speed aerodynamics, Dr. Bruce K. Donaldson for his suggestions pertaining to flight structures, Dr. Allen E. Winkelmann for his suggestions pertaining to gyroscopic effects, and Dr. Everett Jones for his suggestions pertaining to aerodynamic heating. These are all faculty of the Aerospace Engineering department of the University of Maryland at College Park. Thanks also go to Suresh Chander, a research assistant of the Aerospace Engineering department of the University of Maryland at College Park.

We also extend our gratitude to Dr. David E. Glass, Dr. Maurice Averner, Dr. Richard Keefe, Dr. Janice Stoklosa, and Dr. Frauke Westphal of the NASA Langley Center for their help in life sciences and life support. We would like to thank Mr. Bernie Dixon of the NASA Goddard Space Flight Center for information on costing

models. Thanks also go to Dr. Malcolm Cohen of the NASA Ames Center for his help in artificial gravity.

Additional thanks go to Dr. Keith Snail and Dr. James Butler of the Naval Research Laboratory. Thanks also to Professor Walter Daniel of the US Naval Academy. All three men provided help in structures.

The design of the waverider was done through the efforts of graduate student Thomas McLaughlin. His computer programs were necessary for the computer-generated design images of the project's waverider.

Of course, we must give special thanks to Dr. Mark J. Lewis. It was he who coordinated the efforts of this project from the beginning. We learned (as well as enjoyed) the material acquired from his lectures as well as from our own individual research. Additionally, it was he who acquired the Macintosh Computers used in the laboratory.

Above all else, we want to express great appreciation to the contributions and efforts of our teaching assistant. Mr. Lind was responsible for maintaining and overseeing the Macintosh Laboratory as well as guide the efforts of the overall project. Thanks, Charles.

Finally, appreciation is expressed to the USRA program, under the direction of John Alred, for supporting this design experience.

TABLE OF CONTENTS

| | |
|--|-----|
| ABSTRACT..... | i |
| ACKNOWLEDGEMENTS..... | iii |
| INTRODUCTION..... | 1 |
| WAVERIDER..... | 3 |
| 1.1 Introduction..... | 4 |
| 1.1.1 Waverider Considerations..... | 5 |
| 1.2 Waverider..... | 5 |
| 1.2.1 Materials..... | 7 |
| 1.2.2 Waverider Heating..... | 11 |
| 1.2.3 Waverider Shell..... | 17 |
| 1.3 Waverider Trajectory..... | 22 |
| 1.3.1 Aero-Gravity Assist..... | 22 |
| 1.3.2 The AGA Maneuver..... | 25 |
| 1.3.3 The Citherean Atmosphere..... | 32 |
| 1.3.4 Hypersonic Aerodynamics..... | 34 |
| 1.4 Waverider Propulsion..... | 35 |
| 1.4.1 Waverider Boosters..... | 35 |
| 1.4.2 Criteria for Engine Choice..... | 35 |
| 1.4.3 Venus Bound Boost Phase..... | 37 |
| 1.4.4 Structure..... | 37 |
| 1.4.5 Earth Bound Boost Phase..... | 39 |
| 1.4.6 Problems Associated With Solid Core Engines..... | 42 |
| 1.4.7 Nuclear Engine Problem Solutions..... | 43 |
| 1.4.8 Core Shutdown..... | 44 |
| 1.4.9 Heat Properties In Core..... | 45 |
| 1.4.10 Concluding Remarks..... | 45 |
| 1.5 Life Support..... | 47 |
| 1.5.1 Supplies and Regeneration Systems..... | 47 |
| 1.5.2 Power Supply--Deployable Solar Array..... | 54 |
| 1.5.3 Thermal Control..... | 56 |
| 1.5.4 Crew Selection..... | 56 |
| 1.5.5 Physiological Effects of Microgravity..... | 58 |
| 1.5.6 On-Board Centrifuge..... | 60 |
| 1.5.7 Microgravity Countermeasures..... | 63 |
| 1.5.8 Extravehicular Activity (EVA) Suits..... | 64 |
| 1.5.9 Medical Bay..... | 65 |
| 1.5.10 Radiation Concerns..... | 69 |
| 1.6 Conclusion..... | 74 |
| APPENDIX..... | 75 |
| Appendix A..... | 76 |
| Appendix B..... | 78 |
| Appendix C..... | 95 |
| Appendix D..... | 100 |

| | |
|---|-----|
| REFERENCES | 103 |
| CARGO SHIP | 106 |
| 2.1 Introduction | 107 |
| 2.2 Structures | 111 |
| 2.2.1 Truss | 111 |
| 2.2.2 Capsules | 113 |
| 2.2.3 Fuel Tanks | 117 |
| 2.2.4 Power Plant | 117 |
| 2.2.5 NIMF | 119 |
| 2.2.6 Research and Development | 120 |
| 2.3 Propulsion | 120 |
| 2.3.1 Chemical Propulsion Option | 120 |
| 2.3.2 Solid-Core Nuclear Rocket Option | 122 |
| 2.3.3 Nuclear-Electric Propulsion Option | 124 |
| 2.3.4 Trajectory | 127 |
| 2.3.5 Nuclear Power Plant | 129 |
| 2.3.6 MPD Thrusters | 134 |
| 2.4 Cargo Ship Vehicle Reentries | 136 |
| 2.4.1 Reentry Description | 136 |
| 2.4.2 Martian Reentry Heating Characteristics | 137 |
| 2.4.3 NIMF Shuttle Reentry | 138 |
| 2.4.4 Cargo Capsule Reentry | 139 |
| 2.4.5 Nuclear Reactor Capsule Reentry | 139 |
| 2.5 Conclusion | 139 |
| APPENDIX | 141 |
| APPENDIX A | 142 |
| APPENDIX B | 144 |
| APPENDIX C | 147 |
| REFERENCES | 148 |
| SURFACE MISSION | 150 |
| 3.1 Introduction | 151 |
| 3.2 Landing Sites For A Manned Mars Mission | 151 |
| 3.3 Communications | 153 |
| 3.4 Surface Base | 153 |
| 3.4.1 Radiation Concerns | 155 |
| 3.4.2 Construction Techniques | 156 |
| 3.4.3 Characteristics of MARS | 158 |
| 3.4.4 Mars Rover--Expected Performance Level | 160 |
| 3.4.5 Mars Main Base Exterior Layout | 161 |
| 3.4.6 Possible Surface Experiments | 163 |
| 3.6 NIMF Shuttle/Lander | 164 |
| 3.6.1 Lander Design | 164 |
| 3.6.2 Outer Shell | 164 |
| 3.6.3 Skeletal System | 167 |

| | |
|-------------------------------------|-----|
| 3.6.4 Fuel Tank..... | 167 |
| 3.6.5 Crew Port | 167 |
| 3.6.6 NIMF Life Support System..... | 167 |
| 3.6.7 NIMF Propulsion..... | 168 |
| 3.6.8 Exploration Missions | 173 |
| 3.6.9 Radiation Concerns..... | 175 |
| 3.7 Conclusion | 175 |
| APPENDIX..... | 176 |
| REFERENCES | 179 |
| | |
| MISSION COST..... | 180 |
| 4.1 Cost Analysis..... | 181 |
| 4.2 Conclusion | 184 |
| REFERENCES | 185 |
| | |
| CONCLUSION..... | 186 |
| ACRONYMS..... | 189 |
| NAME INDEX | 191 |

INTRODUCTION

(Rodney Bryant, James McMorrow)

"In 1492, Columbus knew less about the far Atlantic than we do about the heavens, yet he chose not to sail with a flotilla of less than three ships...so it is with interplanetary exploration: it must be done on the grand scale."

Wernher Von Braun
Das Marsprojekt 1952

In 1952, Von Braun envisioned the first mission to Mars. In turn, he compiled a document entitled Das Marsprojekt. His version of the mission called for passenger and cargo ships as well as a landing craft. His idea was that the first mission would require many ships to reach the red planet.

PROJECT EXODUS is an in-depth study intended to bring out and address the basic problems of such a mission. The most important problems concern propulsion, life support, structure, trajectory, and finance. EXODUS, which means "mass migration" or "mass departure," will employ a passenger ship, cargo ship, and landing craft for the journey to Mars.

PROJECT EXODUS is scheduled for the year 2025. Construction of the vehicles will be performed at the Space Station. First, the cargo ship will be launched and then the passenger ship, known as the waverider, will be launched depending on the arrival of the cargo ship. The waverider, carrying 10 astronauts, will use the Venus atmosphere to perform an aero-gravity assist for deflection angle and delta velocity savings for the trip to Mars. It will dock in Low Mars Orbit (LMO) with the cargo ship and the astronauts will descend to the Martian surface using the landing craft (NIMF shuttle). After 3 to 5 months on the surface of Mars the astronauts will again use the waverider to return to Earth and dock with the Space Station.

The cargo ship will transport the unassembled Martian base, NIMF shuttle, surface life support and return fuel and engine to LMO. The cargo ship is a very long truss which the payload is attached to. It is propelled in a spiral trajectory to Mars using a Nuclear Electric Propulsion (NEP) system.

The NIMF shuttle is used to transport the astronauts to the Martian surface as well as around the planet. It is powered by a solid core nuclear engine which can use CO₂ as a propellant. The NIMF shuttle has a range of 650 miles, and will be used to bring the astronauts back to LMO with the waverider.

While on the surface the astronauts will construct a dome base which will be mostly underground to help shield against solar radiation. They will explore the planet, perform experiments and attempt to extract useful substances from the planet, such as water. The base will be the start for possible colonization.

This report presents the three major components of the design mission separately. Within each component the design characteristics of structures, trajectory, and propulsion are addressed. The design characteristics of life support are mentioned only in those sections requiring it.

WAVERIDER

Brian Garrison
Lynda Kelly
John Rinko
Tim Wilcox
Guru Tej Khalsa
Diego Mera
Jenny Dillon
George Grewe
Jim McMorrow
Darrin Drum

1.1 Introduction

(Jenny Dillon)

A waverider is a generic term for a hypersonic vehicle whose shape is such that the shock wave is attached all along the leading edge. With this design, no pressure "leaks" over the leading edge to the top surface. This allows the vehicle to "ride" the shock wave and maximize its lift vector. By performing a Venus aerogravity assist the waverider can absorb some of the planet's momentum to increase the vehicle's delta-v. This will reduce the propulsion system energy requirements. The waverider will fly upside down through the atmosphere. The high lift will counteract the centrifugal force to keep the vehicle inside the atmosphere.

The waverider will use chemical boosters to leave from the space station. These boosters will be jettisoned before the Citherean maneuver. The energy gained by this maneuver will be enough to get to Mars. There will be no other external power supply.

The waverider will aero-brake at Mars and rendezvous with the cargo ship in a low Martian orbit. The astronauts will descend to the Martian surface in the NIMF shuttle. After 3 to 5 months, they will again use the NIMF to get back to the waverider. A solid core nuclear engine booster will be on the cargo ship. This engine will be attached to the end of the waverider and used as the propulsion system for the return trip to Earth. The nuclear engine will be jettisoned before the waverider aero-brakes at Earth.

A majority of the assembly of the waverider and cargo ship will be done at the space station. The components for these will have been launched to the space station using whatever advanced launch system has been developed by 2012.

A major factor of designing the waverider is that it will be able to operate under the maximum predicted loads for all of these maneuvers. This does not

allow for a very volume efficient vehicle. The waverider requires careful integration of the structures, propulsion, and life support systems.

1.1.1 Waverider Considerations

(Brian Garrison & Lynda Kelly)

Several key factors were considered in the design of the waverider. Integration with propulsion and life support was a primary factor. The airframe was designed to meet the needs and constraints of these systems as much as possible.

In projecting the mission to the year 2012, when construction is expected to begin, it is assumed that the cost and availability of materials, in particular carbon-carbon composites, will improve and that composite performance will be upgraded. This assumption appears sound in view of the ever-increasing demand for composite materials.

1.2 Waverider

The waverider is the hypersonic manned vehicle designed to transport the astronauts to Mars. It will use an aero-assist maneuver at Venus and then return them to Earth via a sprint mission.

The actual design process for the waverider begins by placing a generic shape such as a cone or wedge in a flow field to create a shock wave. The waverider leading edge is then created so that it is everywhere attached to the shock. Subsequently, the lower surface is designed along the streamlines present in the flow field. Finally, the upper surface is constructed along the freestream streamlines so that the pressure acting along the upper surface is simply the freestream pressure. Since each leading edge design corresponds to a unique waverider, an almost infinite number of waveriders are possible for each shock. However, existing software can generate specific, optimized waveriders for a particular condition.

Generally, these conditions are maximum lift to drag ratio, minimum coefficient of drag and volumetric efficiency.

For this mission, the waverider shape was generated using a code written by Mr. Tom McLaughlin [1]. The input data, dimensions, and actual waverider shape appear in Appendix A and Figure 1.1. Several runs were performed using various input data before settling on this shape. The other generated shapes appear in the appendix. The particular shape chosen was optimized for a maximum L/D while also considering volumetric efficiency. As seen from Appendix A, the waverider has a L/D of 8.47, a length of 60 m, a maximum height of 6.01 m and maximum width of 16.43 m.

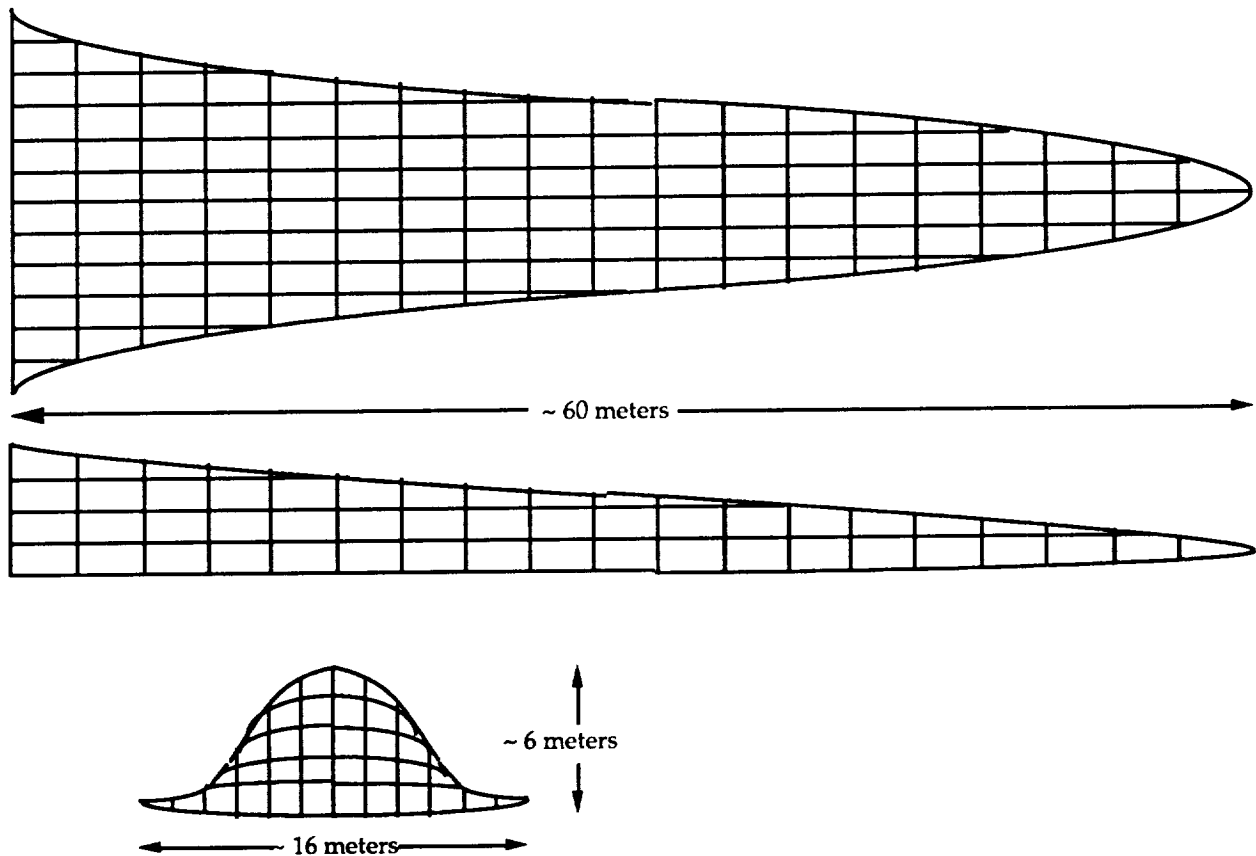

Figure 1.1 Waverider Shape and Dimensions

1.2.1 Materials

In actually constructing the waverider, extensive research was performed to identify the most promising structural material. Materials were assessed on their ability to successfully meet the two most demanding waverider design parameters. These parameters are the material's ability to handle the heat flux and temperature extremes predicted in the Citherean atmosphere and simultaneously provide a significant reduction in structural mass fraction (as compared to conventional materials). In order to meet these criteria, the material chosen had to be lightweight, possess excellent stiffness and strength properties, and demonstrate excellent high temperature performance.

Three-dimensional Advanced Carbon-Carbon (ACC) was chosen as the waverider structural material since this composite best satisfies the aforementioned requirements. An all ACC structure was selected for several reasons. Chief among these was that this design eliminated any need for high temperature, high strength bonds between incompatible materials. In addition, technological projections assumed that by 2012, three-dimensional ACC will possess elevated temperature structural properties equal to or greater than metallic materials. This, in conjunction with ACC's much lower density, makes an all ACC structure a much more viable alternative. Other materials considered included superalloys, titanium-aluminide alloys, metal-matrix composites, and high-temperature polymer-matrix composites. For a detailed property comparison of the materials considered, refer to Figures 1.2 and 1.3. While analyzing this data, one must bear in mind that composite properties vary greatly based on fiber type and volume, matrix type, and production process. The values shown for composites are simply general. Figure 1.4 illustrates a basic carbon-carbon production process while Figure 1.5 depicts the cross section of three dimensional Advanced Carbon-Carbon. In general, the

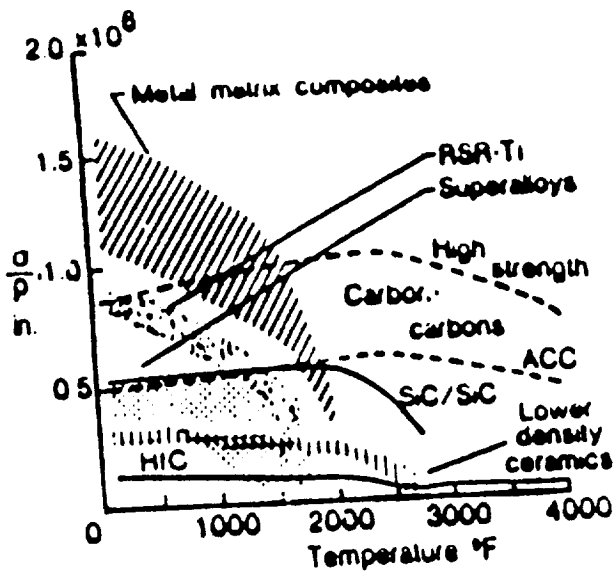

Figure 1.2
HYPERSONIC CANDIDATE MATERIAL COMPARISON

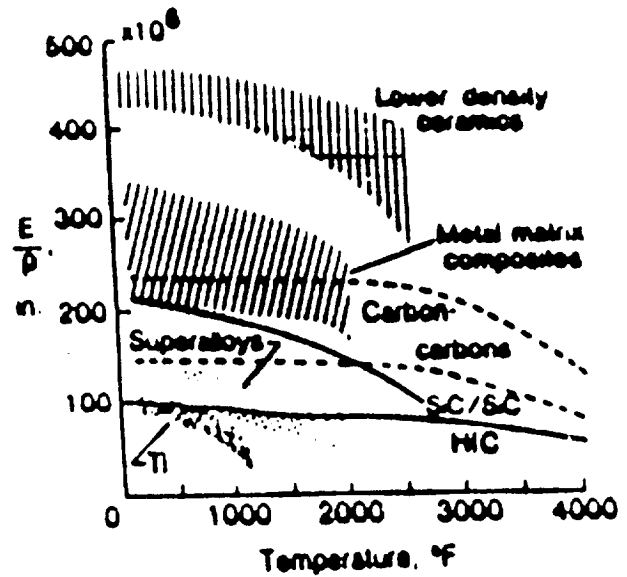
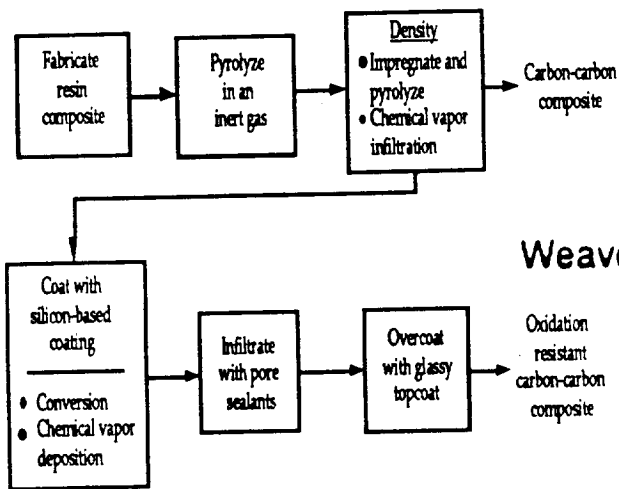
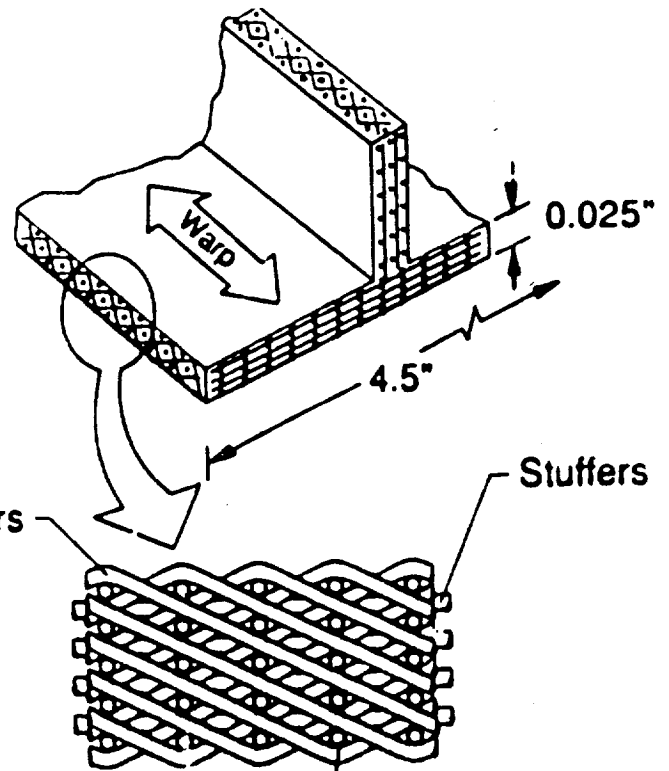

Figure 1.3



ACC PRODUCTION PROCESS
Figure 1.4



INTEGRALLY STIFFENED ACC PANEL
Figure 1.5

metallic materials, although they possess excellent strength and stiffness properties, are considered too heavy for hypersonic vehicle applications. Furthermore, their use is restricted to temperatures below 1250 K. High-temperature polymer-matrix composites have excellent strength to weight and stiffness to weight ratios, but their application is restricted to below 320 K. Future research and development for metallic materials is focusing on metallic matrix composites and rapid solidification rate metals. Some possible advantages of these materials include properties that actually increase with temperature; nevertheless, these materials are still projected to be too dense and not as temperature resistant as ACC. Quite simply therefore, ACC outperforms all other materials above 1250 K, a factor that was earlier identified as a primary material consideration. ACC also has a high emissivity which is a key variable in reducing the surface temperature. Finally, ACC, with a density of about 1.7 g/cm³, is an extremely lightweight yet strong material. This will help ensure a large reduction in structural mass.

Original carbon-carbon composites, known as Reinforced Carbon-Carbon (RCC), were developed for use as the space shuttle's thermal protection system. As such, RCC was created as a heat protection material and not as a structural material. Subsequently, ACC was developed as a possible high temperature structural material and resulted in a 100% in-plane strength increase over RCC. However, this material had significant weaknesses in its out-of-plane properties. Current research indicates that three dimensional ACC offers much improved out-of-plane property performance over conventional two dimensional ACC. The two main techniques for producing 3-D ACC are the orthogonal weave method and angle-interlock weave method. Orthogonal weave ACC has fibers in the thickness, fill, and weave directions while angle interlock ACC has fibers at 45 degrees to the thickness direction. As seen in Figure 1.6 3-D, ACC has up to twice the performance of 2-D ACC in out-of-plane properties. With continued research and development, it can

be reasonably expected that 3-D ACC will be an extremely effective high-temperature structural material by the time actual waverider construction begins (2012). Carbon-carbon composites are, however, extremely susceptible to oxidation at temperatures above 900 K and therefore an external coating must be applied to the composite for

ORIGINAL PAGE IS
OF POOR QUALITY

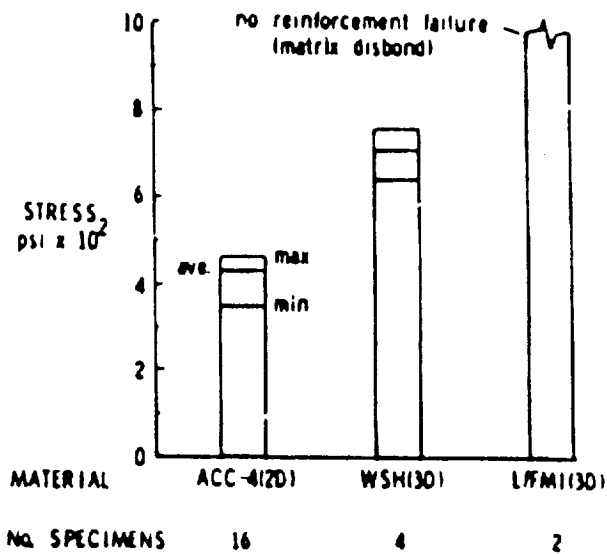

a) Out-of plane tension strength

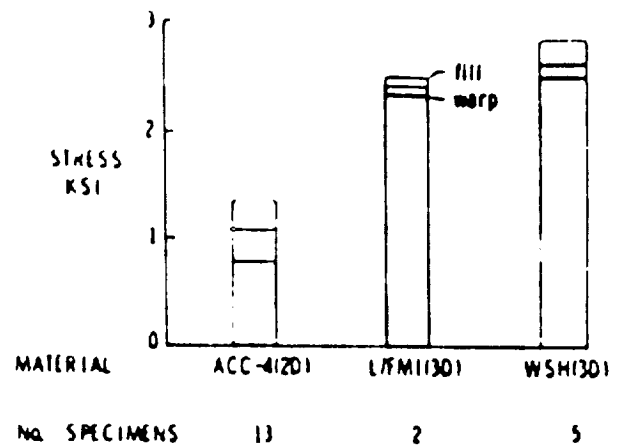

b) Interlaminar Shear Strength

Figure 1.6

successful high-temperature use. External coating requirements include oxidation resistance, low oxygen permeability, and compatibility with the composite substrate. At the present time, external coatings are the weak point of carbon-carbon composites for they restrict the material's use to about 1600 K. Current shuttle technology employs a silicon carbide/borate glass coating (SiC). SiC provides the major protection through the formation of a thin layer of silica glass that results from an initial oxidation phase. The borate glass is used as a sealant to prevent oxidation through cracks which develop in the SiC due to thermal expansion mismatches. These mismatches develop due to the large variance in thermal expansion coefficients between the composite and the coating. While SiC has a

coefficient of 1, carbon-carbon's coefficient is on the order of 1 E-6 . Thus, after several thermal cycles, crack propagation becomes a problem.

Research is presently focusing on two materials, noble metals and highly refractory ceramic coatings for future applications. The noble metal iridium was chosen as the external coating for the waverider leading edge. Besides its extremely high melting point (2700 K), iridium is also non-reactive with carbon and has low oxygen permeability up to 2500 K. Iridium suffers from a lack of adherence to carbon and also has a thermal expansion incompatibility problem similar to SiC. Continued research must focus on these two areas. Refractory ceramic coatings possess good thermal properties but they oxidize rapidly above 2000 K. Thus, they are not applicable for leading edge design. However, these coatings will be used on the aft end of the waverider where the temperatures will not be as high. This will not only reduce the cost of entirely coating the vehicle with iridium but will also help with thermal control since ceramic coatings offer a much higher emissivity. Another possibility for the "cooler" portions of the waverider will be to use an improved version of the SiC coating presently used on the shuttle [2,3].

1.2.2 Waverider Heating

(John Rinko)

The waverider will experience intense aerodynamic heating effects during its passage through the Citherean atmosphere. Designing an integrated structure and thermal protection system capable of withstanding the severe heating conditions represents a major technical hurdle.

Analysis of the heat transfer to the vehicle is very complex. Ideally, the method would involve first calculating the inviscid, three-dimensional flow field over the vehicle followed by three-dimensional boundary layer calculations. This would give the heat transfer rate,

$$q_w = k \left(\frac{\partial T}{\partial y} \right)_w$$

For a design of this scope and magnitude, a complete solution to the Navier-Stokes equation with chemistry effects is in order.

Obviously, these calculations lie beyond the scope of this initial design. However, with some reasonable assumptions and approximations, realistic results for stagnation heating rates, temperatures, and chemistry effects can be calculated. To begin with, the density of atmospheric operation must be calculated. Assuming a force balance for the waverider in which:

Aerodynamic Force (Lift) + Gravity = Centrifugal Force

$$\frac{1}{2} \rho V^2 C_l A + mg = m \frac{V^2}{R}$$

where: m = mass of waverider = 50,000 kg

R = radius of Venus = 6200 km

A = lifting area = 486.6 m²

C_l = coefficient of lift = .02181

V_c = characteristic velocity = $\sqrt{g_{\text{Venus}} R}$ = 7231 m/s

Based on the density, the altitude and freestream temperatures can be calculated as follows:

$$H \text{ (altitude in km)} = 60.286 \times \rho^{-0.057769}$$

$$T \text{ (Kelvin)} = 274 * \rho^{0.07189}$$

These functions are based on power fits of data for latitudes up to thirty degrees from The Venus International Reference Atmosphere, Vol. 5, No. 11 (1985), edited by A. J. Kiliore.

The waverider will approach Venus with a velocity (relative to Venus) of 14,000 m/s. This corresponds to a local Mach number of 71 (based on freestream temperature). This is clearly hypersonic, justifying a number of further

assumptions. First, that the following approximations for the stagnation point holds true:

$$\dot{Q} = \rho_{\infty} \frac{1}{2} V_{\infty}^3 \frac{1.83 \times 10^{-8}}{\sqrt{R}} \left(1 - \frac{h_w}{h_o}\right).$$

where: R = leading edge radius = .1 m
 V_{∞} = freestream velocity in m/s
 ρ_{∞} = freestream density in kg/m³
 h_w = wall enthalpy
 h_o = total enthalpy

From this, it is evident that three factors influence the heating rate: velocity, density, and leading edge radius. The operational density is basically fixed for a given waverider configuration. The velocity is fixed unless reverse thrusting is employed, which increases delta V, defeating the purpose of the aero-gravity maneuver. The only variable is R, which must be finite. The R can be increased only to a point before the vehicle loses the aerodynamic properties which give it the high L/D ratios which characterize waveriders. As a conservative estimate, R = 10 cm is assumed for subsequent calculations. Further, it is assumed that since

$$h_o = h_{\infty} + \frac{V_{\infty}^2}{2} \text{ and } \frac{V_{\infty}^2}{2} \gg h_{\infty}$$

that $h_o \cong \frac{V_{\infty}^2}{2}$ and hence total enthalpy \gg wall enthalpy, reducing the $\left(1 - \frac{h_w}{h_o}\right)$ term to unity [4]. Plugging in gives a maximum stagnation heating rate of 3450 W/cm² for a velocity of 14 km/sec. See Figure 1.7 for a plot heating rate vs. velocity. The above heating rate is the maximum rate the waverider will experience. To keep the aerodynamic integrity of the vehicle, ablation will not be used to control the temperature. Instead a combination of chemistry effects, radiative energy, and conduction (active cooling) will be employed.

The chemistry of the flow will have a significant effect on the temperature and heating rate. The gas flow over the waverider will break down due to the intense heating. Extremely complex chemical reactions will be taking place all along the surface. Dozens of reactions would be occurring simultaneously. These calculations are beyond the scope of this initial design. Instead, assumptions are in order. The chemistry effects are modeled assuming rarefied gas flow and a 100% CO₂ Venus atmosphere. The energy required to break the C-O bonds is calculated based on the equation:

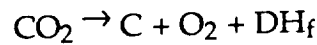

Delta H_f is calculated from ref. [5].

$$\Delta H_{f(298^\circ)} = -393.51 \text{ kJ/mol}$$

$$\Delta H_{f(1500^\circ)} = 8.3144 \text{ J/K mole} \int_{298}^{1500} \{ 3.205 + 3.083 \times 10^{-3} T - 17.13 \times 10^{-7} T^2 \}$$

Integrating yields delta H_f = -346.87 kJ/mol. This corrected value takes into account some of the effects of elevated temperature and is useful as a first approximation. Multiplying this value by the number of mole/second passing over one square centimeter of the waverider and correcting the dimensions gives:

$$Q_{\text{chem}} = \alpha \rho V \times 100 (\text{DH}_f) / \text{MW}$$

Alpha represents the percent of chemical breakdown (10 - 25%). Obviously, not all the CO₂ passing over the waverider will dissociate, but a fair percentage will. Subtracting this value from the stagnation heating rate gives Q_{in}.

In order to calculate a temperature for a given heat rate, the flow is assumed to be in equilibrium with Q_{in} equal to the heat radiating from the craft. Thus, radiation is actually helping to cool the waverider! The radiation effects are taken into account using the Stefan-Boltzmann radiation law.

$$Q = \epsilon \sigma T^4$$

where: σ = the Boltzmann Constant = $5.67 \times 10E-8 \text{ W/m}^2\text{K}^4$

ϵ = emissivity = measure of radiative efficiency.

For black, oxidized metal $.6 < \epsilon < .8$ for $280 \text{ K} < T < 1000 \text{ K}$ and this value increases with temperature. In these calculations the reasonable assumption of $\epsilon = .7$ is used.

Using the Wein Displacement Law:

$$\lambda_m T = 2.8979 \times 10E-3 \text{ mK}$$

the wavelength of maximum emissive power can be calculated.

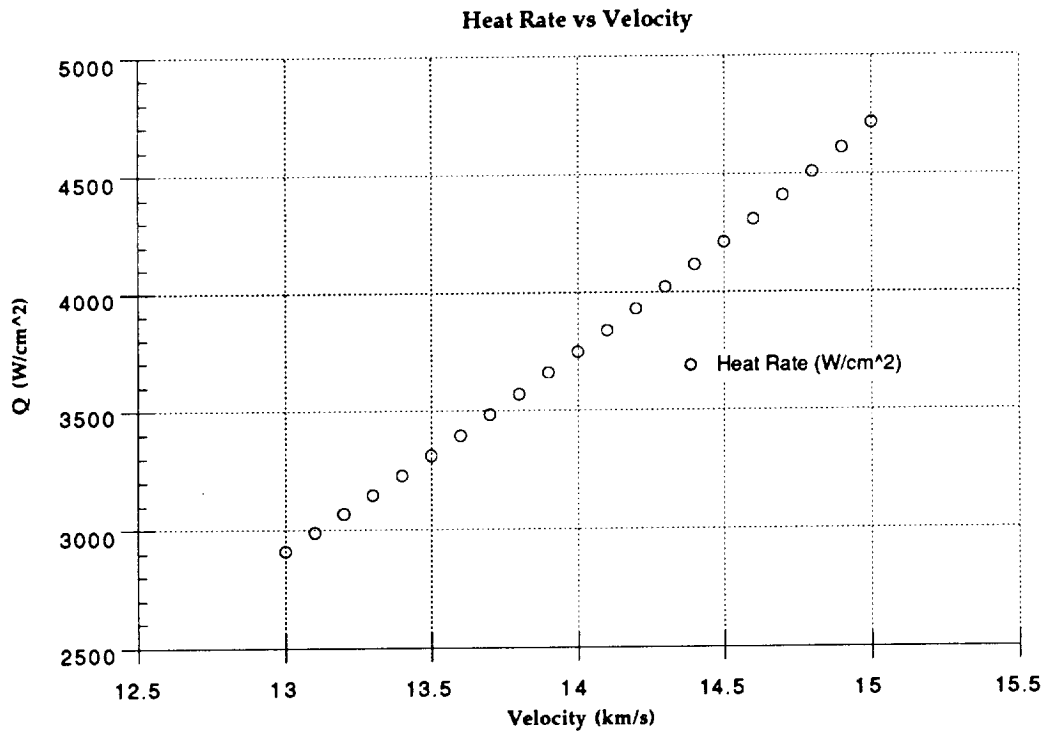

Figure 1.7

Performing the equilibrium calculation with $Q_{in} = Q_{out}$ gives a stagnation temperature of 5550 K. Assuming 10% chemical bond breakage, this temperature drops to 5020 K See Figure 1.8 for temperature with chemical effects as a function of velocity. The Wein displacement law for these temperatures predicts $\lambda_m = 5570$

Angstroms, indicating the waverider will appear yellow-orange along its leading edge during its heating phase in the Citherean atmosphere.

These numbers (which correspond to a velocity of 14 km/s): $Q_{\max} = 3747$ W/cm²; $Q(10\% \text{ chemical breakdown}) = 2500$ W/cm² give a T_{\max} of 5500 K and $T(10\% \text{ chemical breakdown})$ of 5000 K. Based upon these numbers and the capability of our thermal protection system (discussed later), it is evident that the waverider will survive its ten to twelve minute flight through the Citherean atmosphere.

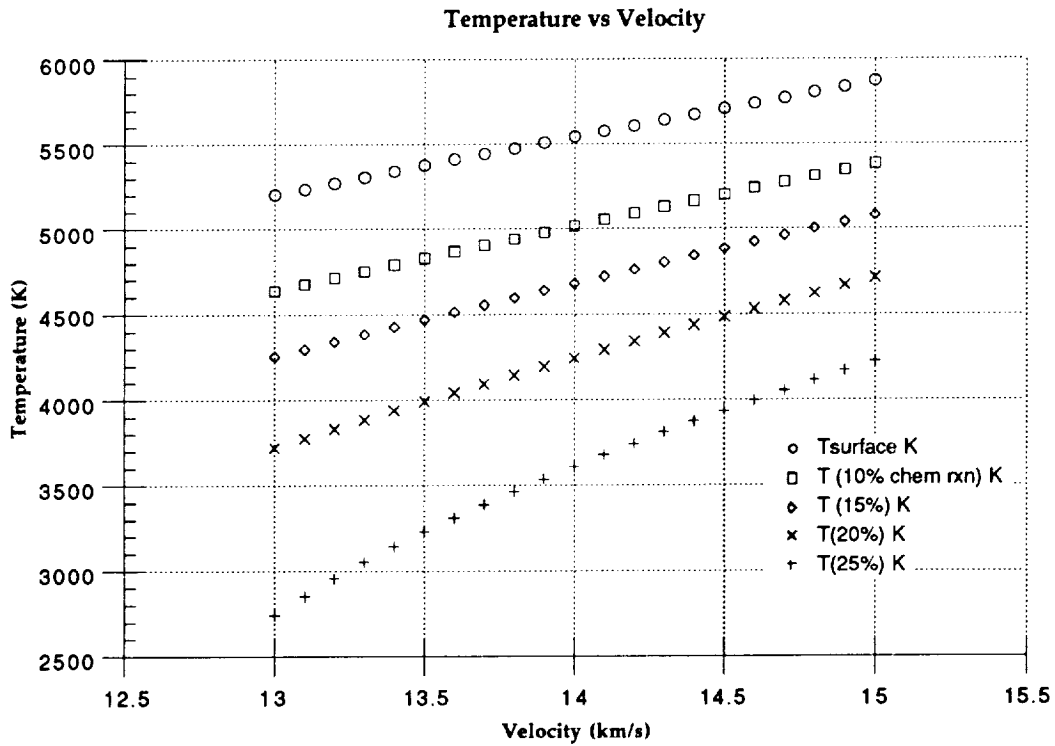

Figure 1.8

1.2.3 Waverider Shell

(Brian Garrison & Lynda Kelly)

The waverider for Project Exodus will be designed as an insulated structure with an actively cooled leading edge. This type of design was chosen over a simple hot structure due to the temperature and heat flux extremes present during the Venus aero-assist. An insulated structure allows the main airframe to be constructed so as to provide maximum structural stability with minimum mass. Heat tiles are then attached to the main airframe so as to present a smooth aerodynamic shell. While also providing durable thermal protection.

Geometrically efficient structural panels were examined for use in the vehicle airframe based on four main factors. These factors are:

- 1) symmetry about the centroid
- 2) high local buckling coefficient
- 3) low core density
- 4) load bearing core

According to ref. [3], the three most promising panels are the tubular panel, beaded web corrugation panel, and the truss-core web corrugation (Figure 1.9). Of these, the truss-core web corrugation is the most promising because it satisfies all of the above factors. The tubular panel has no low core density while the beaded web corrugation has no load bearing core. Thus, the truss-core web corrugation is the subject of current research and development and preliminary reports indicate that it can provide sufficient structural stability along with a significant reduction in structural mass.

TUBULAR

BEADED WEB
CORRUGATION

TRUSS-CORE WEB
CORRUGATION

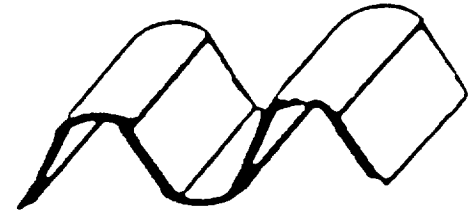
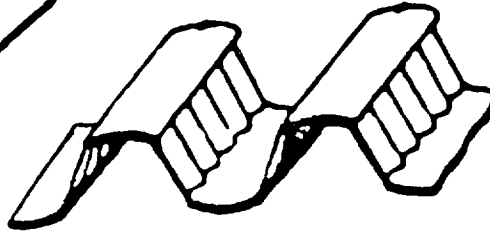
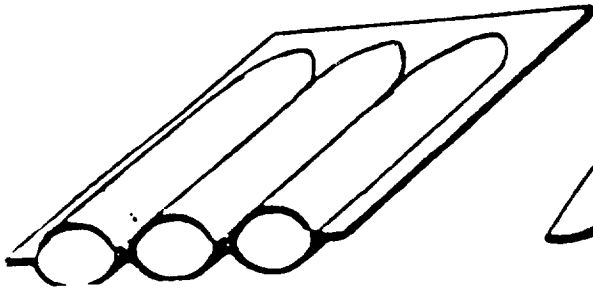

1.0

0.54

0.43

RELATIVE UNIT WEIGHT

Figure 1.9

Finally, once the main airframe is assembled, the heat tiles will then be attached around the existing structure to provide the smooth aerodynamic waverider shape. This will be a key aspect of the construction process for the waverider. Performance is extremely dependent on achieving the exact computer generated shape.

However, heating and temperature extremes will preclude the use of a heat tile system along the leading edge. At this point, a semi-active heat pipe cooling system will be incorporated into the waverider. In brief, a heat pipe is a closed tube with a porous wick lining. The working fluid flows through the wick lining to the heat source where it evaporates and flows in the reverse direction as a vapor through the tube's center. Upon reaching the heat sink, the vapor condenses (giving up heat) into a liquid and starts the process over. Thus the process is self-sustaining once it is started.

The heat pipe design for the waverider is based on work done by Dr. Charles J. Camarda and David E. Glass at NASA Langley [6]. This system is an integrated carbon-carbon/refractory metal heat pipe design. The carbon-carbon is woven around the heat pipes to provide a lightweight, high temperature structural material for the leading edge. In addition, carbon-carbon offers ablative protection in the event of a heat pipe failure. The heat pipes themselves are extremely thin tubes of tungsten. Tungsten is used in this capacity, because it has a low thermal expansion coefficient, high thermal conductivity, and is compatible with liquid metals.

As seen in Figure 1.10, this design actually entails the use of three different piping systems. The chordwise heat pipes provide the primary heat transfer system. The spanwise heat pipes serve to reduce thermal stresses between the chordwise pipes in the stagnation region. Furthermore, they serve to distribute the heat load between other chordwise pipes in the event of a single pipe failure. Finally, the flat plate hydrogen pipes parallel to the leading edge allow internal radiative cooling.

CROSS-SECTIONAL VIEW OF HEAT PIPE DESIGN

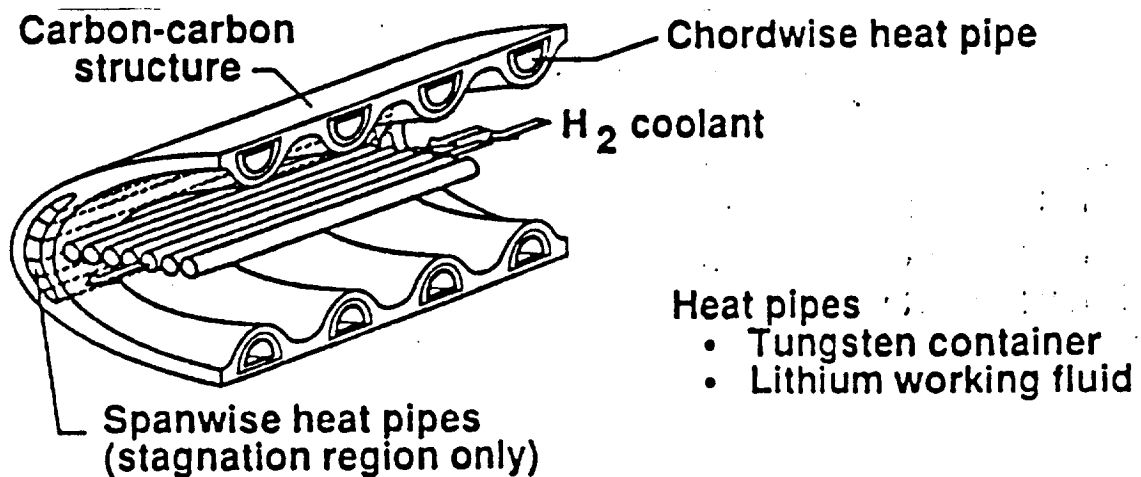

Figure 1.10

This allows the chordwise pipes to maximize their effectiveness by radiating heat both outward to free space and inward to the cryogenic hydrogen pipes. The liquid metal lithium was chosen as the working fluid for the chordwise and spanwise heat pipes. Liquid metals have a higher operating temperature than cryogenic fluids or moderate temperature fluids such as freon. With a melting point of 453 K, lithium is better suited to the conditions encountered during the aero-assist. Finally, lithium has a much higher heat transport capability than other working fluids, on the order of three orders of magnitude greater than cryogenic fluids [7]. Although actual heat pipe sizing and spacing would have to be determined through more extensive research, Dr. Glass was kind enough to perform several waverider runs on the heat pipe analysis code at NASA Langley. In general, one can conclude that the system's effectiveness improves as the heat pipe length is increased while the shell thickness is decreased.

As seen in Figure 1.11, the waverider will actually have a double leading edge design. The original leading edge will conform to the computer-generated waverider shape. This leading edge will comprise the the first twenty-five meters of the waverider and will possess its own heat pipe system. In essence, the waverider's first twenty five meters will simply be a shell to provide the proper waverider configuration. This original leading edge will perform the aero-assist maneuver in Venus and the aero-brake at Mars. While in low Mars orbit, this leading edge will then be pyrotechnically separated from the remainder of the vehicle. This new vehicle will consist of the new leading edge, complete with its own heat pipe system, and the life support module. Several reasons exist for using a double leading edge design. While performing two atmospheric maneuvers, the leading edge could conceivably suffer some damage which would affect its aerodynamic capability. Thus the waverider will have a "new" leading edge for its return trip to Earth which is particularly important for aero-braking. In addition, the new

leading edge will be more blunt than the original leading edge. This will not only reduce the maximum temperature and heating values, but will also increase drag; thus reducing the amount of time needed to slow down in Earth's atmosphere. Finally, by separating the original leading edge, the waverider mass will be greatly reduced. This will reduce the amount of fuel that must be transported by the cargo ship to Mars for the return trip to Earth.

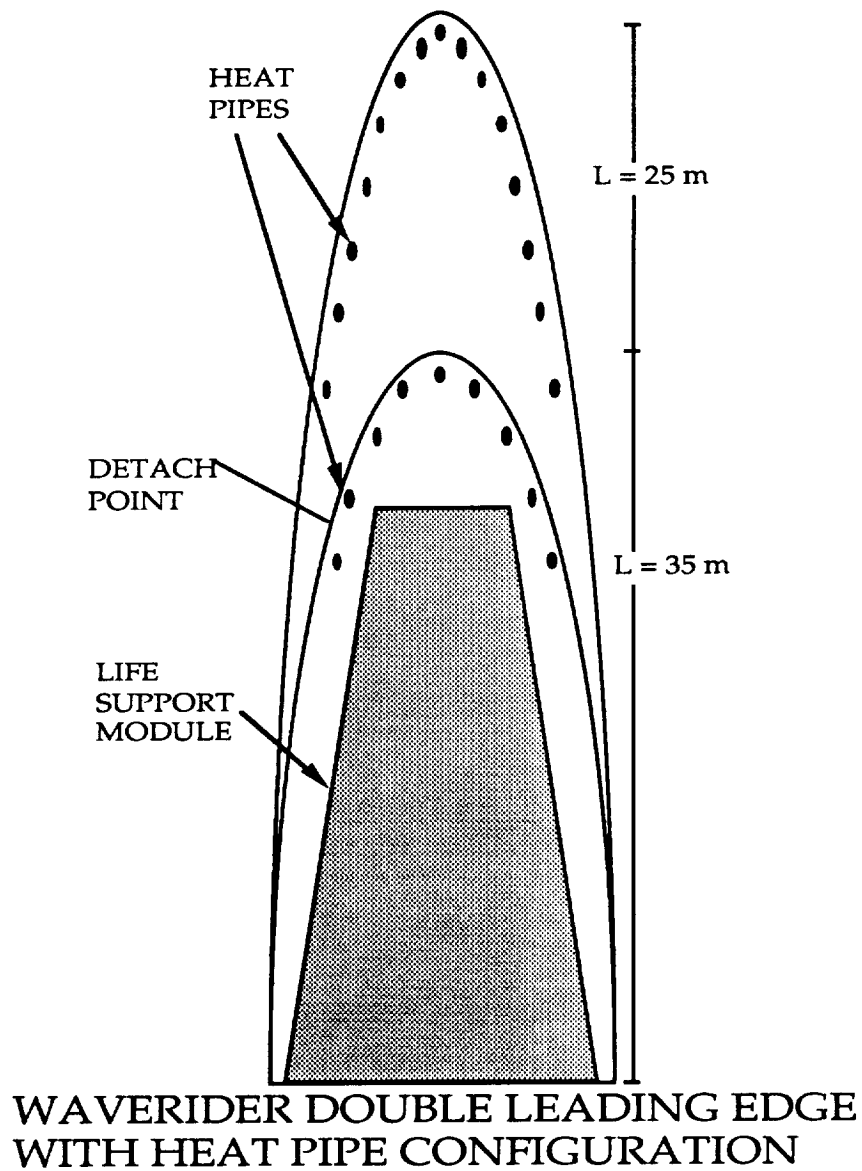

Figure 1.11

1.3 Waverider Trajectory

(Tim Wilcox)

The main objective of the trajectory group is to determine the feasibility of the waverider and whether or not it meets the requirements of the design proposal. The proposal calls for a minimum time of flight for the entire mission. Comparisons are made with other types of possible trajectories such as sprint missions and gravity-only assists. Employing the waverider configuration also satisfies another aspect of the design proposal which calls for the use of state-of-the-art technology. The most important aspects of the waverider design process are the heat transfer analysis and the study of the hypersonic aerodynamics. Essential in this process is a knowledge of the Citherean (or Venusian) environment. In addition to the Venus encounter, the Mars aero-capture must also be analyzed. Finally, the return of the waverider involves aero-braking at Earth. An understanding of the maneuver which the waverider must undertake is required.

1.3.1 Aero-Gravity Assist

Current space exploration missions are using gravity-only assist trajectories in order to optimize propulsion requirements and mission launch opportunities. The Galileo mission to Jupiter is using such a trajectory with not one, but three gravity assists. The probe is to pass Venus once and the Earth twice on its journey to the massive, outer planet. The concept behind the gravity assist is rather simple. The spacecraft departs Earth with an initial heliocentric velocity and receives a boost of energy from the flyby planet, which increases the velocity of the spacecraft, sending it toward the target planet. The most impressive example of such a mission is the pair of Voyager spacecraft which recently completed a grand tour of our solar system's massive outer planets, Jupiter, Saturn, Uranus, and Neptune. Each flyby increased the velocity of the spacecraft considerably. This caused the time of flights

to decrease substantially. Without using the gravity assists, the propulsion requirements would have been enormous in order to maintain the same time of flights. However, the mission was only possible due to the planetary alignment which occurs every 175 years. This constraint is attributed to the fact that the bending angles which the spacecraft receive from the planets are just big enough to send the Voyagers in the correct direction. The angles are directly related to the planets' mass and the velocity of the spacecraft. A massive planet such as Jupiter allows for a greater bending angle than a smaller planet such as Mars. A closer flyby will also result in a larger change of direction. The spacecraft must maintain a velocity higher than the escape velocity of the planet in order to avoid being captured and drawn in toward the planet itself.

With regard to the manned Mars mission project, a new approach must be considered; the aero-gravity assist (AGA). Gravity-only assists rely simply on the celestial mechanics, whereas an AGA also depends on aerodynamics. This maneuver incorporates a vehicle with high aerodynamic lift such that this lifting force augments gravity in balancing the centrifugal force on the vehicle. This equilibrium allows the vehicle to fly through the planetary atmosphere at a constant altitude. With a high lift-to-drag ratio, the amount of time in the atmosphere can be maximized as desired. This aspect of the maneuver is particularly applicable to the waverider configuration. Lift-to-drag ratios of 7-10 have been demonstrated and an L/D of 15 has even been exhibited for the Citherean atmosphere. Consequently, with the capability of remaining in the atmosphere, there are associated drag losses which depend heavily on the time of passage. With a minimized amount of time in the atmosphere, the velocity loss due to drag is also diminished. High drag losses could effectively cancel out the advantages of the AGA maneuver. As seen in figure 1.12, for a L/D of 8.5, a 180-degree turn at a velocity of 10 km/sec would result in a loss of approximately 1.75 km/sec.

VELOCITY LOSS DUE TO DRAG WITH L/D = 8.5

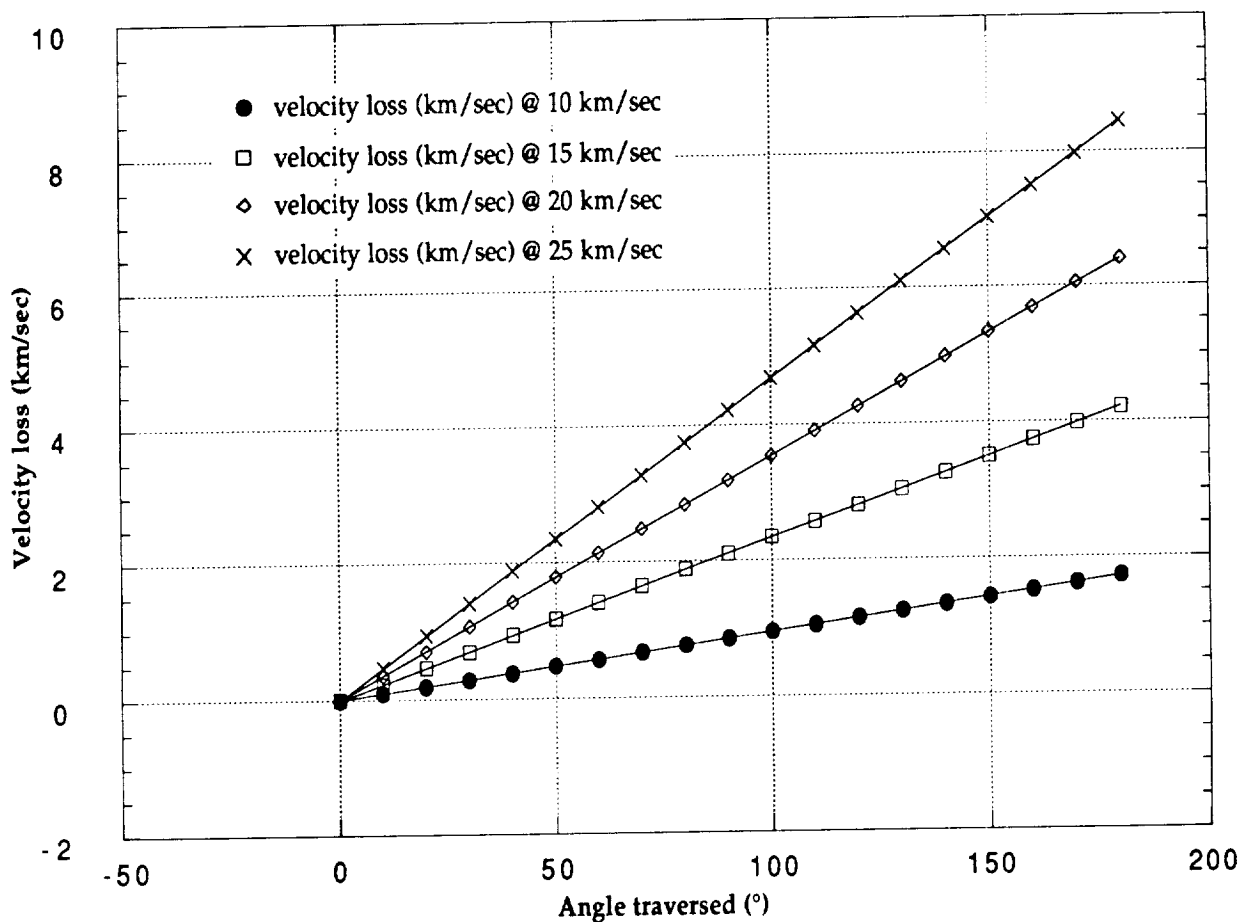

Figure 1.12

Upon departure a propulsive maneuver would be required to compensate for the loss. As the spacecraft's velocity increases, the drag effects become more pronounced. From the same figure it can be seen that a greater percentage of the waverider's velocity is lost with increasing velocity relative to the planet. With a higher L/D ratio, the drag losses are obviously diminished as can be seen in Figure 1.13.

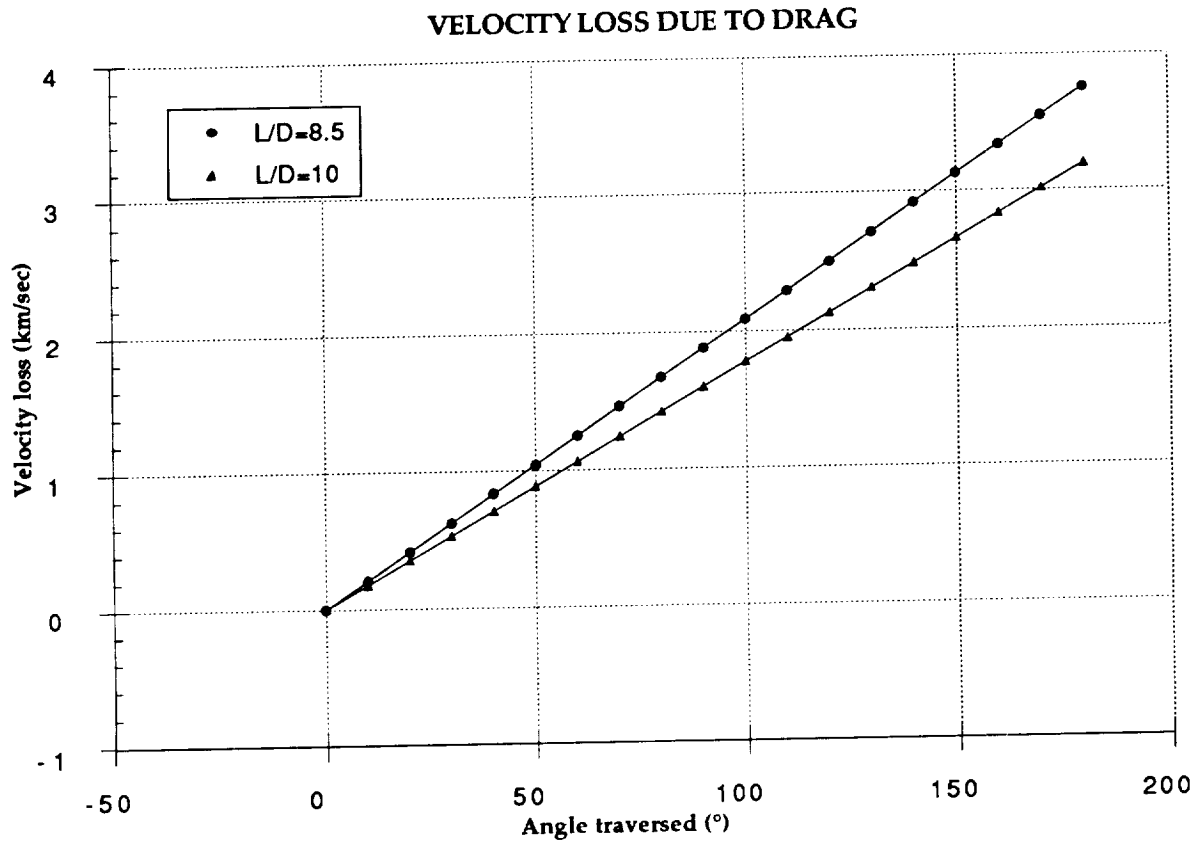

Figure 1.13

1.3.2 The AGA Maneuver

(Guru Tej Khalsa)

The use of a waverider as a spacecraft makes possible the use of an aero-gravity-assist (AGA) maneuver (or maneuvers) in a trajectory. Such a maneuver can reduce the DV required for or the time of flight to a given destination. For a trip to Mars the best candidate for an aero-gravity-assist maneuver is Venus. In order to take full advantage of the waverider spacecraft on a voyage to Mars, trajectories using an AGA at Venus were thoroughly investigated. See Appendix B for programs used to calculate the trajectory.

The trajectory leaving Earth is hyperbolic with perigee at the point of departure, LEO in this case. Since hyperbolas behave asymptotically, hyperbolic trajectories are in the limit basically straight line trajectories away from the central body which is at the focus (see Figure 1.14).

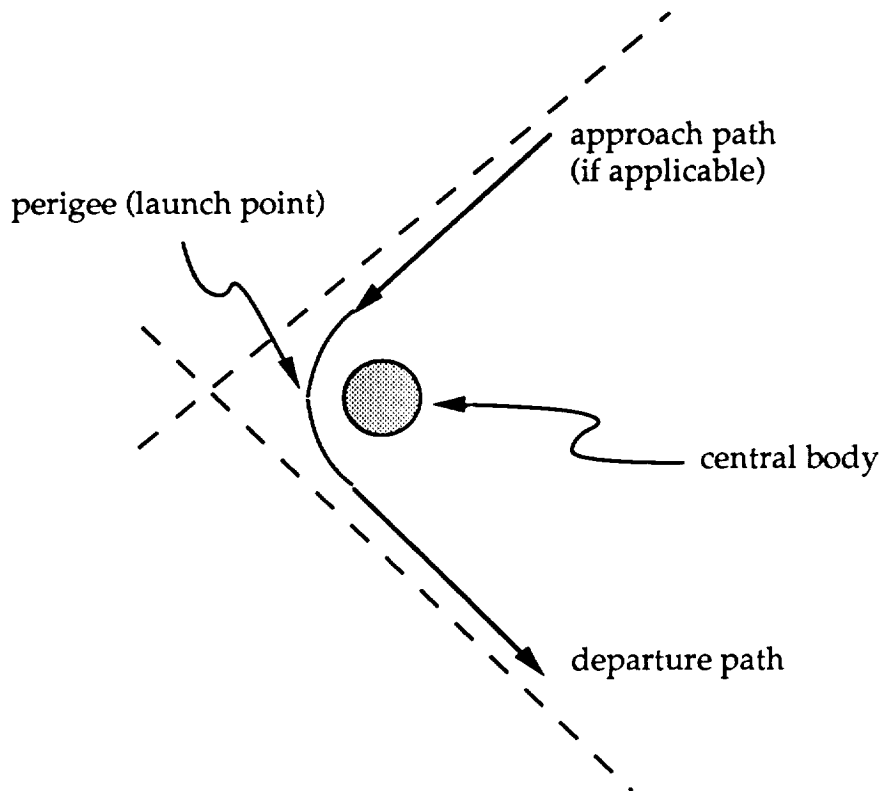

Figure 1.14 Hyperbolic Trajectory

The available propulsion system allows for a DV of 9 km/s from low Earth orbit (LEO). This results in a hyperbolic excess velocity (C3) of 12.66 km/s. This represents the speed of the spacecraft relative to Earth after escaping from Earth's gravitational pull. This allows for a heliocentric speed at departure ranging from 17.13 km/s to 42.45 km/s depending upon the orientation of the spacecraft upon leaving Earth.

By orienting the departure path in the same direction as the Earth's direction of travel the maximum heliocentric velocity can be achieved (see Figures 1.15 and 1.16). Conversely by departing exactly opposite to the Earth's direction of travel the minimum heliocentric velocity is obtained (see Figures 1.17 and 1.18).

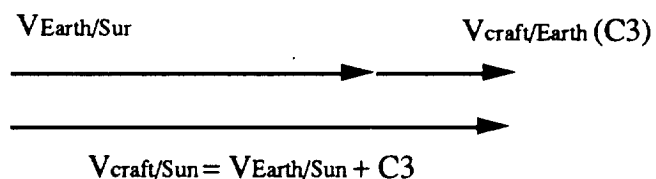

Figure 1.15 Sum of Waverider and Earth Velocities

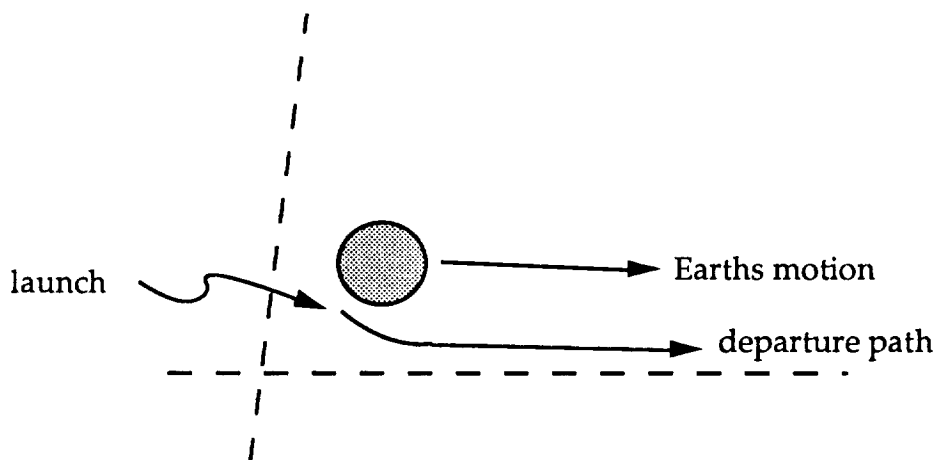

Figure 1.16 Waverider Launch Motion With Earth's Orbital Direction

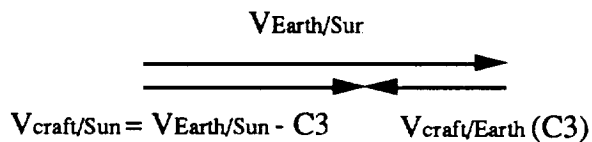

Figure 1.17 Sum of Waverider to Earth and Earth to Sun Velocity

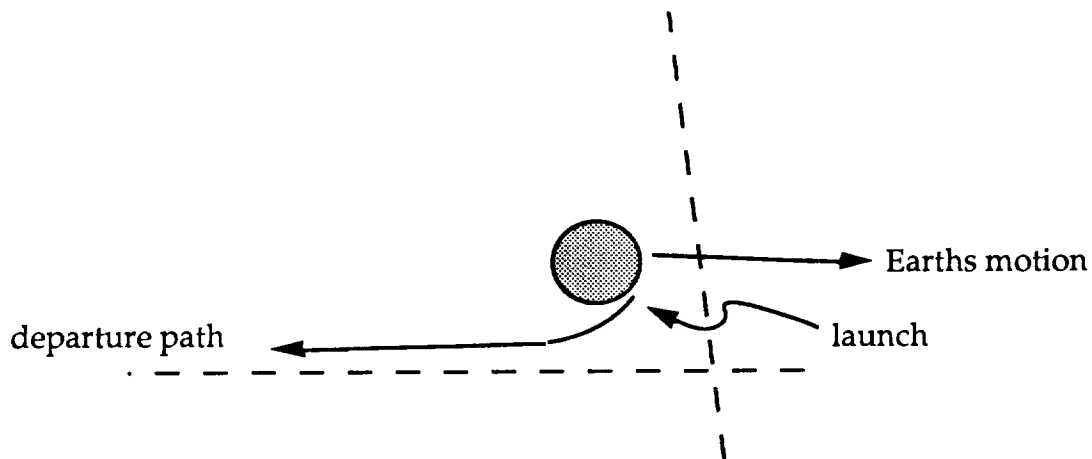

Figure 1.18 Waverider Launch Motion Against Earth's Orbital Direction

In general a low heliocentric velocity departing from Low Earth orbit is desirable for traveling to the inner planets, this dictates a launch in a direction away from the Earth's orbital direction..

Between minimum and maximum heliocentric velocities is a whole range of velocities that have an initial component in the radial direction (see Figures 1.19 and 1.20).

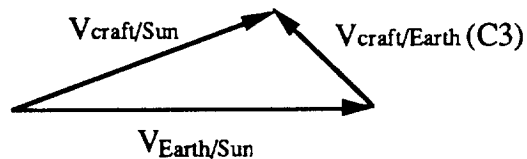

Figure 1.19 Vector Sum of Craft to Sun and Craft to Earth Velocity

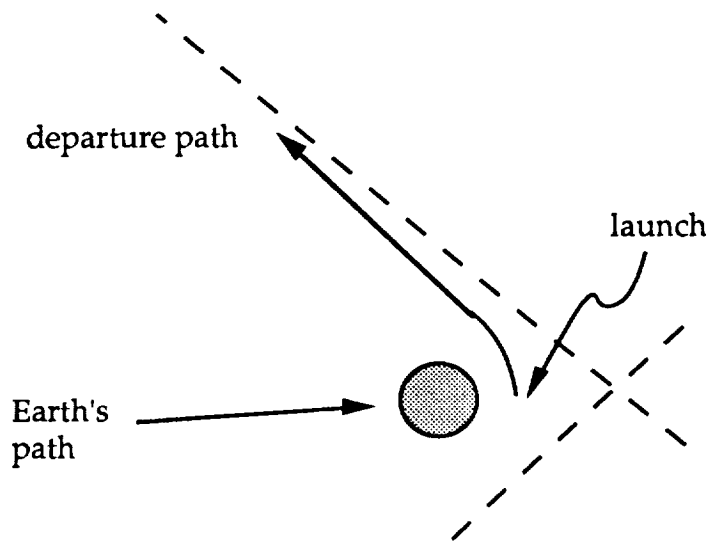

Figure 1.20 Typical Heliocentric Launch Trajectory

The angle between the heliocentric velocity vector and the local horizontal is referred to as phi. For any angle phi and a given maximum value of C3 the extreme values of the heliocentric velocity are given by:

$$V_{\text{extreme}} = V_{\text{earth}} \cos \phi \pm \sqrt{V_{\text{earth}}^2 \cos^2 \phi - V_{\text{earth}}^2 + C3^2}$$

The maximum velocity that the spacecraft can have in the vicinity of the Earth for a given phi and still make it to Venus is given by:

$$V_{\text{max}} = \frac{2 \left(\frac{\mu_{\text{sun}}}{R_{\text{venus}}} - \frac{\mu_{\text{sun}}}{R_{\text{earth}}} \right)}{\left(\frac{R_{\text{earth}}}{R_{\text{venus}}} \right)^2 \cos^2 \phi - 1}$$

This is the velocity that results in a transfer orbit which is tangent to Venus' orbit at exactly one point, any increase in velocity will result in a trajectory whose perigee is greater than Venus' orbital radius. At each angle phi the velocity was

varied from the minimum value to the lesser of the upper limiting values. Knowing the velocity at departure, phi at departure, and heliocentric radius at departure (Earth orbital radius), the complete trajectory can be calculated.

Upon arrival at Venus the relative velocity of the waverider to Venus was calculated and the turn angle about the planet was varied from 0 to 360 degrees. For each turn angle, theta, the new velocity and phi were calculated (see Figure 1.21).

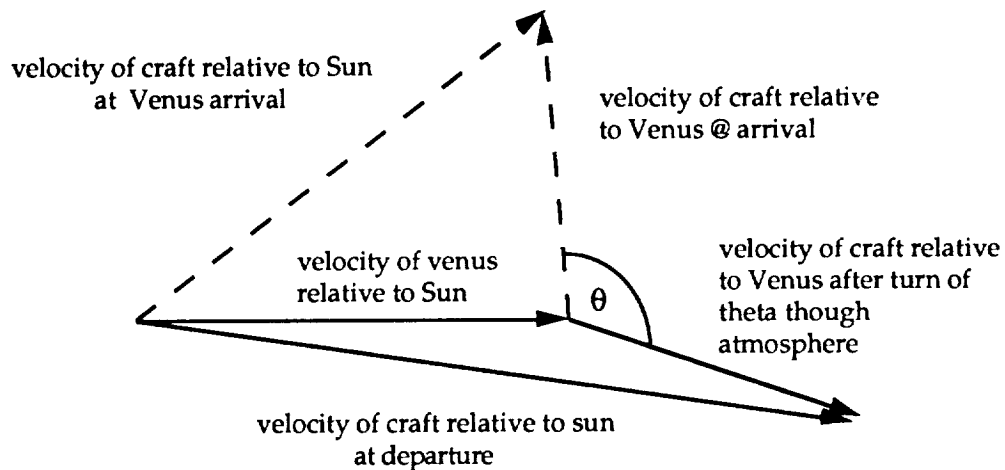

Figure 1.21 Velocity of Craft Relative to Sun

For each of these turn angles the trajectories were checked to see if they would reach Mars. All trajectories that met the time constraints and DV limitations were examined.

This above procedure was repeated for a sprint type mission that went directly from Earth to Mars. Return missions from Mars were all direct sprint types. The possibility of using the Venus AGA on the return trip was also investigated, but proved to make little sense. This is because any trajectory that goes from Mars to Venus must pass by Earth's orbit.

The data collected indicated that in general a sprint mission to Mars is quicker and requires less DV than a Venus AGA maneuver. However the Venus flyby trajectory did have some important characteristics. For flight times exceeding about 4 months the Venus trajectory provides a more favorable positioning of the planets during the mission. This basically means that the Venus trajectory allows for a longer stay time on the Martian surface with a larger return window (13 months for the Venus AGA vs. 8 months for the sprint mission). The Venus flyby in any case provides an alternative positioning of the planets to the sprint mission, and this can be a desirable condition when using a separate cargo mission that is to be launched prior to the manned mission.

Since the shortest time to Mars was desired the fastest trajectories possible were selected as candidates for the flight out. These were subjected to the constraints that a maximum DV of 9 km/s is available for LEO departure and a maximum DV of 14 km/s can be achieved with an aero-brake at Mars (the g-forces for higher speeds become intolerable).

Venus AGA trajectory:

DV = 9 km/s departing Earth

TOF = 108 days (3 1/2 months)

Turn angle at Venus = 170 deg

Velocity at Venus = 21 km/s

Stay time at Mars = 0-220 days (up to about 7 1/2 months-return anytime)

Return time = 178 days (in all cases)

Sprint trajectory:

DV = 8.75 km/s

TOF = 62 days (2 months)

stay time at Mars = 0-230 days (up to about 7 1/2 months-return anytime)

return time = 178 days (in all cases)

1.3.3 The Citherean Atmosphere

(Tim Wilcox)

In order to analyze the hypersonic aerodynamics of the waverider, the flight environment must be known. The density variation with altitude is the primary topic of concern. The flyby altitude is necessary for the remaining analyses. This is determined in the following manner. The AGA maneuver is based on the equilibrium of the lifting and gravitational forces with the associated centrifugal force. From the previous trajectory calculations, it is shown that the waverider velocity relative to the planet is 14 km/sec. With the parameters of the waverider such as lift coefficient and planform area, an appropriate density can be extracted from the equation which correlates to the required altitude. For this project the density calculated is at an altitude of 92 km.

The speed of sound at an altitude of 92 km in the Venus atmosphere is 248 m/sec which yields a Mach number for the waverider of 72. This value certainly qualifies for the hypersonic regime. The aerodynamics is discussed in a later section.

The Citherean atmosphere is divided into 3 major parts; lower, middle, and upper. The lower atmosphere ranges from the surface to 100 km altitude. The density variation is shown in Figure 1.22. Below 50 km the atmosphere is rather dense and would cause major drag losses. The temperature variation is also depicted in Figure 1.23. The temperature decreases with increasing altitude to about 95 km, where it then begins to increase again. Coincidentally, the waverider will fly at this lowest temperature regime. However, the amount of heat transfer to the vehicle makes this ambient condition insignificant.

The atmosphere consists of 96.5% carbon dioxide (CO₂) and 3.5% nitrogen (N₂). There are also many different compounds which are found in trace amounts,

such as: He, Ne, Ar, Kr, Xe, CO, O₂, O₃, H₂, H₂O, SO₂, H₂SO₄, NH₃, Cl₂, and CH₄. The sulfuric acid is predominantly located at 50 km altitude and in trace amounts so it should not be of major concern with regard to corrosion of the waverider or some other type of chemical reaction. The dense clouds top off at an altitude of 65 km, well below the flight regime. A more specific description of this regime is the haze layer (65-100 km). With the above information the aerodynamics can be considered.

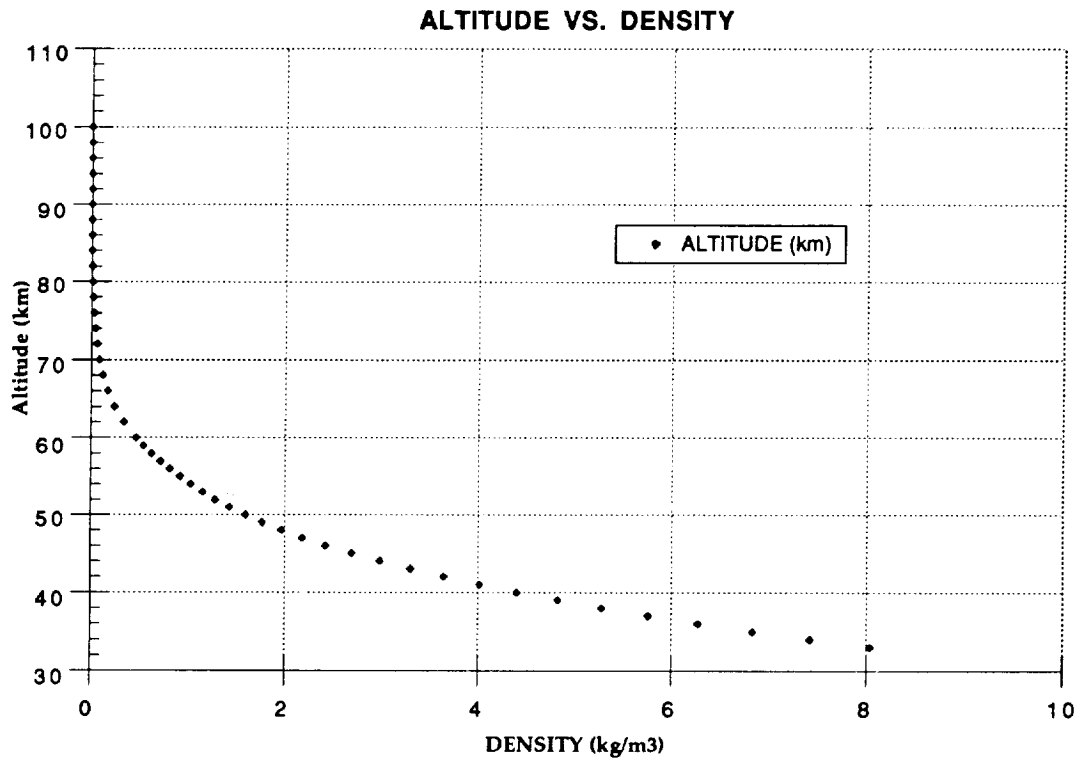

Figure 1.22 Martian Density Variation With Altitude

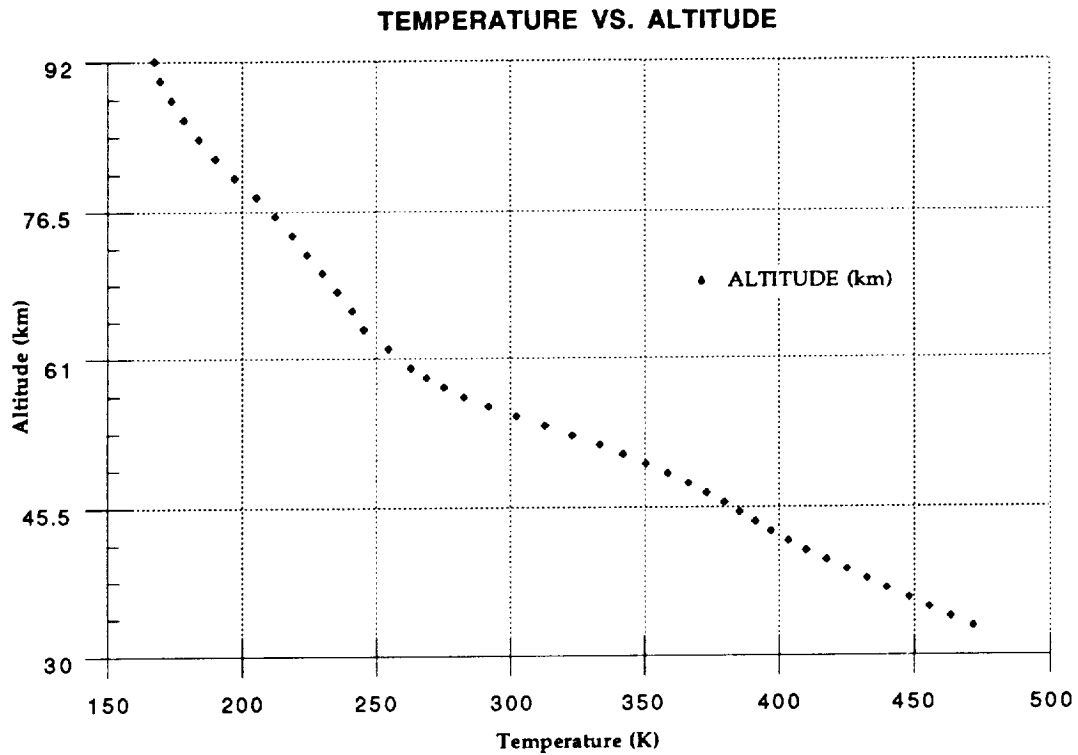

Figure 1.23 Martian Temperature Variation With Altitude

1.3.4 Hypersonic Aerodynamics

It has been determined that the Mach number is 72, well within the hypersonic regime. Associated with this high velocity are specific types of flow conditions. There is an extremely thin and viscous shock layer which causes a major interaction between the inviscid flow behind the shock and the viscous boundary layer on the surface of the waverider. This condition results in a relatively thick boundary layer, the thickness of which is approximately proportional to the square of the Mach number. This boundary-layer thickness is about the same magnitude as the shock-layer thickness. Within the shock layer are extremely high temperatures which cause the gas to be chemically reacting. The carbon dioxide dissociates at a temperature in the range of 2000-4000 K, whereas the

nitrogen will dissociate from 4000-9000 K. This results in the presence of free electrons. These electrons are the main cause for communications blackouts for most Earth re-entry vehicles. The shock equations which normally would determine the flow properties cannot be used since the calorically-perfect gas assumption is no longer valid. The ratio of the specific heats (γ) is no longer constant. Therefore, numerical solution techniques which account for the physics and chemistry of the gas must be incorporated in the analysis.

1.4 Waverider Propulsion (Diego Mera)

1.4.1 Waverider Boosters

A major advance in rocketry has been achieved in the United States program to develop nuclear propulsion. The program to develop nuclear propellant rockets has experimentally demonstrated altitude specific impulse of more than 760 sec assuming a nozzle area ratio of 40:1. An operating time of 30 min has been experimentally achieved at this specific impulse and full design power of 1100 MW. The ability to restart these systems and run them back up to full specific impulse and full power has been demonstrated. Stable operation has been achieved over a wide thrust range at this high specific impulse. The ability to control the system over the entire operating range from start-up to full power and during shutdown has been demonstrated with liquid hydrogen as the propellant. Reactor and total rocket system weight is within a value that can permit large payload gains for many space missions as a result of the high specific impulse achieved. All of the above performance and operating characteristics have been demonstrated in full-scale power reactor and breadboard engine tests. In addition, laboratory scale experiments indicate the potential ability to go to higher specific impulse and longer operating time with high thrust engines and higher power density reactor. The high reliability and our good understanding of these systems is demonstrated by the fact that every one of these tests met or exceeded the test objectives that had been set. ref. [8]

1.4.2 Criteria for Engine Choice

The above statements makes light of the fact that solid core nuclear engines can be considered as off the shelf technology. Reliability and performance can be expected to be met for the mission from these engines. Given the design requirements for the mission, a solid core nuclear engine booster for the return trip back from Mars and a chemical booster for the trip to Mars was chosen. The reason for the decision is explained below using a fuel requirement graph comparing the

use of nuclear vs. chemical engine propulsion (Figure 1.24). Using the rocket equation and solving for fuel mass required, the following graph was developed.

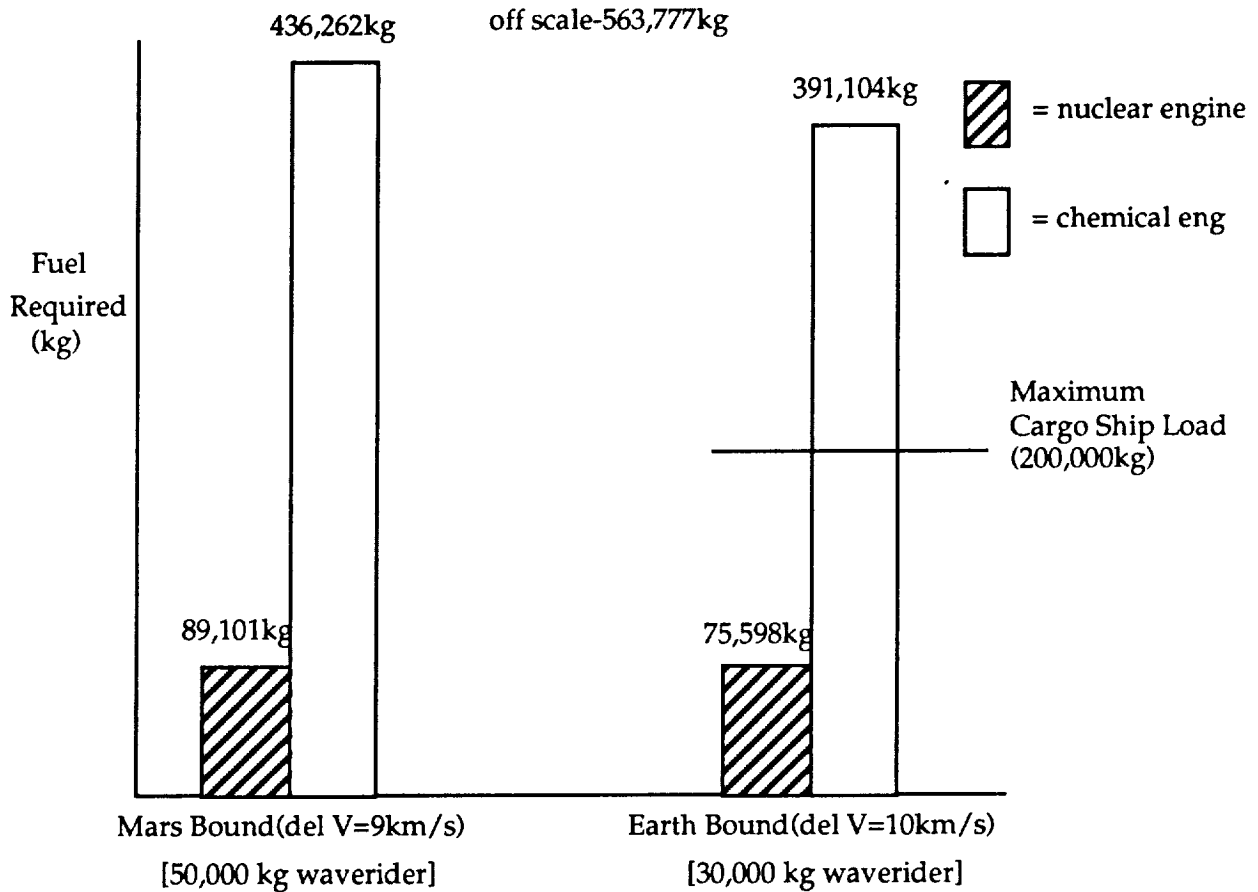

Figure 1.24 Mission Requirements of Nuclear vs. Chemical Engines

| | Nuclear | Chemical |
|----------------|-----------------|--------------------------|
| Isp | 1150 seconds | 450 seconds |
| Mass Flow Rate | 120 kg/s | 23 kg/s |
| Engine Mass | 8000 kg | 300 kg |
| Fuel | Liquid Hydrogen | Liquid Hydrogen & Oxygen |
| Thrust | 1380 KN | 45 KN |
| Burn Time | 719 sec | 5.26 hours |

Fuel tank mass approximately 15,000 kg [9] (Appendix C.1)

As seen above, the nuclear engine outperforms the chemical engine by a wide margin. Due to the fuel limit imposed by the cargo ship, a chemical engine will have been unsuitable for the Earth bound boost. The nuclear engine was decided upon to solve this problem. The question was whether or not to use nuclear on the way there. Since there is less of a restriction on the amount of fuel that can be put into LEO, it was decided to go with the cheaper cost of supplying fuel for a chemical booster as opposed to paying for a more expensive nuclear engine.

1.4.3 Venus Bound Boost Phase

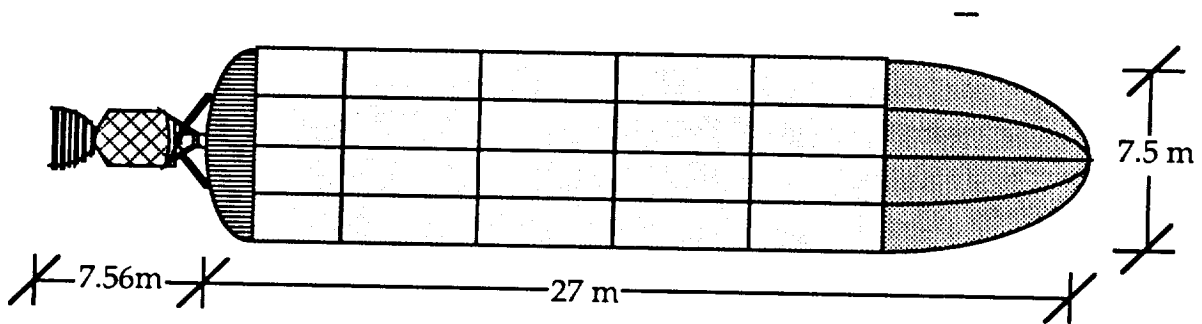

Figure 1.25 Fuel Module Dimensions

Fuel Module Overall Dimensions & Propellant Weights

| | | | |
|--------------|------------|-----------------------|------------|
| Length: | 27 meters | Liquid Oxygen Tank: | 374,312 kg |
| Diameter: | 7.5 meters | Liquid Hydrogen Tank: | 61,949 kg |
| Mass(empty): | 15,000 kg | Total Fuel Mass: | 436,262 kg |

1.4.4 Structure

The fuel module (Figure 1.25) consists of two separated tanks connected by a corrugated inter tank section. Since most of the volume is taken up by the hydrogen, it will be located in the aft part of the module. It will be made of aluminum alloys and a spray on polyurethane foam for insulation from Earth

launch conduction heat transfer with the atmosphere. In orbit, this foam will be removed (no conduction in space vacuum), to reduce tank mass. The above approximations were based on the Space Shuttle external fuel tank. Engine mix ratios will be the same, thus on a percentage basis, the approximate volumes (and thus dimensions) were calculated. (Appendix C.2)

A lightweight chemical engine was chosen instead of a larger, heavier, and higher thrust engine for several reasons. High thrust is not required for the boost phase since it is starting in a near zero gravity environment. Instead of using a large chemical engine that has a large mass flow rate and high thrust, a light engine having a lower mass flow rate but a longer burn time. By using the rocket equation for an engine mass of 3000 kg, computing the fuel required and comparing the calculation for an engine mass of 300 kg. It is found that there is a savings of 18,084 kg of fuel in using the lighter engine. (Appendix C.4)

Chemical Booster Engine (Figure 1.26)

Del V required = 9,000 m/s

| | |
|---|---------------------------------------|
| Exhaust Velocity- 4,414 m/s | Fuel Flow Rate-23 kg/s |
| Chamber Pressure- 3.02e6 N/m ² | Chamber Temp-4,857 K |
| Exit to Throat Area Ratio- 109:1 | Thrust-45 KN |
| Engine Mass- 300 kg | Exit Density-3.0e-3 kg/m ³ |
| Exit Temp- 1,335 K | Exit Pressure-1.8e-3 N/m ² |
| Isp- 450 sec | Exit Area- 1.767 m ² |
| Exit Mach Number- 5.09 | (Appendix C.3) |

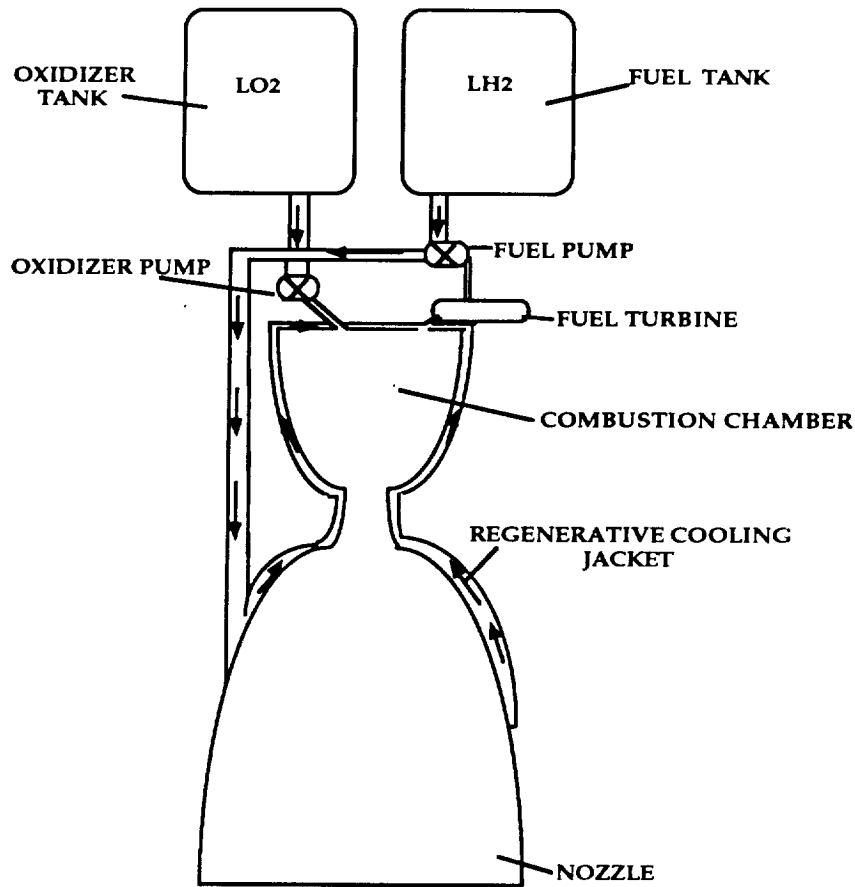

Figure 1.26 Chemical Booster Engine

1.4.5 Earth Bound Boost Phase

The return portion of the trip will involve the transfer of the hydrogen fuel module off the cargo ship, and reconnection to the waverider in the same configuration as the Venus bound boost phase connection. The Earth bound boost engine is based on the design of the Phoebus 2-A engine developed during the US NERVA program. It is important to note that the Phoebus 2-A engine is being used only as a model for the design of the engine. This engine as is could accomplish the mission, but with great inefficiencies. The engine is very heavy and this will be a performance factor which will be reduced. The idea behind using a nuclear engine

is that the technology has advanced along very nicely and engine cost can be kept down to a minimum.

Earth Bound Booster Engine

Mass Estimates

| | |
|----------------------------|-------------------------|
| Del V required = | 10,000 m/s |
| Exhaust Velocity- | 11,281 m/s |
| Chamber Pressure- | 3.83e6 N/m ² |
| Chamber Flow Rate- | 120 kg/s |
| Chamber Temperature- | 3,444 K |
| Thrust- | 1,249 KN |
| Exit Temperature- | 525 K |
| Exit to Throat Area Ratio- | 122:1 |
| Exit Area- | 4.6 m ² |

(Appendix C.5)

| | |
|--------------------------|-----------------|
| Reactor Core & Hardware- | 4,832 kg |
| Reflector & Hardware- | 1,027 kg |
| Shield- | 500 kg |
| Pressure Vessel- | 300 kg |
| Miscellaneous- | 1,341 kg |
| TOTAL | 8,000 kg |

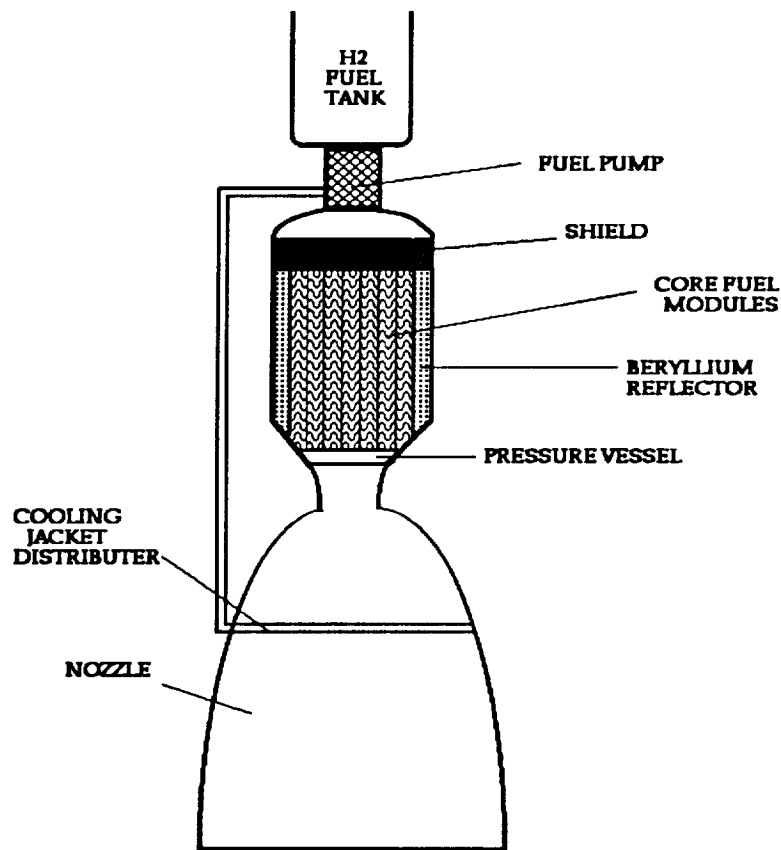

Figure 1.27 Nuclear Engine

DESCRIPTION OF ENGINE FUEL MODULES

FUEL ELEMENT

- Provides heat transfer surface & energy for heating H_2
- U(235) in solid matrix of UC

TIE TUBES

- Contains Zr moderator sleeves & ZrC corrosion protective coating

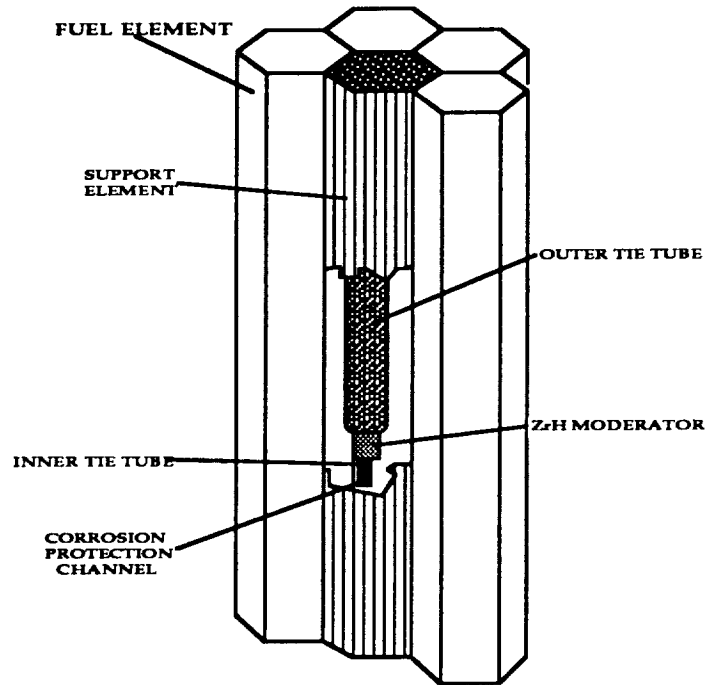

Figure 1.28 Fuel Module

The fuel is pumped from the tank as shown above. The LH_2 is channeled through a regenerative cooling jacket to keep the nozzle and reflector within tolerable heat conditions. Part of the fuel is diverted to a turbine, which runs the fuel pump, and this fuel is then expelled. The rest of the fuel is fed to the fuel distributors which distributes the fuel down through the fuel channel tie tubes, where it is heated to approximately 3444 K. Upon heating, it expands and is ejected through the nozzle.

The reactor chain reaction is controlled by boron control rods which are inserted or retracted to control the fission process. A ZrH moderator will be used as the energy absorption and transfer medium. A beryllium reflector acts to control neutron leakage from the core. ZrC is used to protect the tie tubes from hydrogen corrosion.

1.4.6 Problems Associated With Solid Core Engines

- 1) Corrosion
- 2) Changing Properties Under Radiation Exposure
- 3) Thermally Induced Loads
- 4) Core Shutdown

Fuel elements must withstand steady loads because of pressure differences arising from the flow & heating of gaseous propellant. The fuel element base must carry the fissionable material, hence it should not be composed of materials which compete strongly with the fuel for neutrons. Another set of requirements are posed by the corrosion chemistry of heated propellant gases. All of the interesting propellants are highly hydrogenous, and very hot hydrogen is a highly reactive reducing agent which can embrittle some materials, hydride others, and form volatile hydrogen compounds with others. The choice of materials for use in fuel elements is extremely limited under these conditions [10].

Given the engines developed during the NERVA program the Phoebus 2-A was selected as the working model for several reasons. Its high mass flow rate expelled fuel quickly, thus total burn time is reduced over the other nuclear engines which have a lower mass flow rate but have a longer operational lifetime. In other words, even though the Small Nuclear Engine has an operational lifetime that is double the Phoebus 2-A, its mass flow rate is so small (8.5 kg/s) that the maximum amount of fuel it could consume is about 68,000 kg. This value is well below the

86,000 amount available for use. More importantly this engine also meets the NIMF requirement with respect to thrust. In this manner, only one engine configuration is used to accomplish two parts of the mission and thus reduce the different number of engines used. The Phoebus engine as is, is inefficient. The engine technology will not be advanced greatly. Just enhanced for the mission. This will keep the redesign and modification cost low. It will use U-235 in a composite matrix of UC-ZrC solid solution with Carbon. The ZrC coating will be retained as the coating against H₂ corrosion in the fuel channel tie tube. The use of pure Beryllium as the reflector is a departure from the materials normally used. The engine reflector material, moderator, turbine, cooling jacket, and turbo pumps will be redesigned. The original engine had a gross mass of about 11,000 kg and we hope to reduce this to 8,000 kg with the modifications. An Isp of 1150 is an improvement over the engine's original Isp of 953.

1.4.7 Nuclear Engine Problem Solutions

A burn time of 719 seconds occurs for the Earth bound boost.

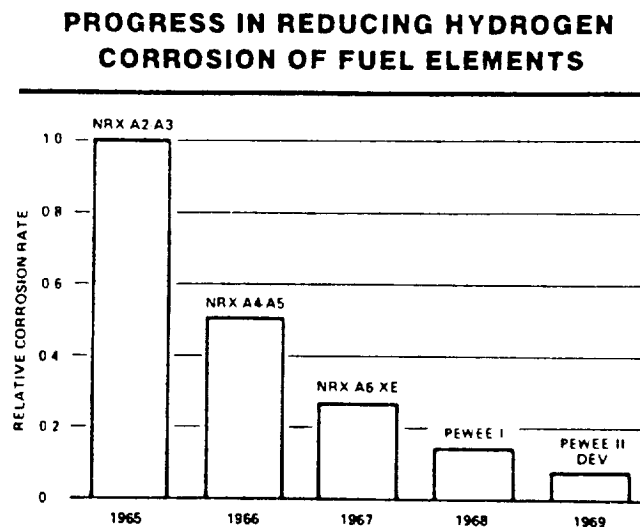

Fig. 10.13 Progress in reducing hydrogen corrosion of fuel elements. Courtesy of Los Alamos National Laboratory and Westinghouse Astronuclear Laboratory.

Figure 1.29 Corrosion of Nuclear Engine

As seen on this Figure 1.29, corrosion was a topic treated effectively during the NERVA program. The operational lifetime of the Phoebus 2-A and engines similar to it was approximately 5,000 seconds-this is well below the Earth bound boost time. Out of all the materials used in treating corrosion, a ZrC coating of the tie tube walls seemed to work best. It was used on the "Small Nuclear Engine". The "SNE" was the culminated efforts of the nuclear engine program. With an operational lifetime of about 9,000 seconds, it gave the highest operational lifetime of any flight configured model. ZrC was used to protect the fuel element from the reducing hazards of superheated hydrogen. Taking into account that CO₂ will be the working fluid for 99% of the flight missions and superheated CO₂ is not as reducing as H₂, the engine should be able to have a longer lifetime. It should also be pointed out that finding a more appropriate material should not be difficult in light of the great strides made in the past. One final note to engine corrosion. Since increased operational lifetimes means increased flight missions, it should be kept in mind that there is a finite number of missions that the astronauts could accomplish in their time allotted. Thus, spending an inordinate amount of effort to produce an engine with say a 10,000 hour operational lifetime is not relevant to this mission.

1.4.8 Core Shutdown

The waverider is a space vehicle without internal engines. This means that the fuel module will have to be jettisoned after the fuel is exhausted, and with it will go the nuclear engine. Since the module will be in a highly elliptical orbit, it will not be possible to recover the engine or fuel tank. This solves the core shutdown problem, since the engine will be released and allowed to destroy itself. The engine will not explode as it might first seem. Studies were made during the NERVA program to cause an explosion. After great effort, they could only manage to get the engine to "burn" itself up [9].

1.4.9 Heat Properties In Core

This is a very tricky area to work in. Most of this deals with the extreme temperatures encountered in the core. The choice of ZrH as the moderator was chosen for its low atomic number so that it will give a high scattering cross section [12]. The hydrogen is the actual moderating material with the Zirconium additive added for properties enhancement and obviously a solid medium for hydrogen to be in. Also, the addition of carbon to Uranium in the core increases the temperature tolerance of Uranium up to 2,348 K [12]. Last but not least is the reflector. The choice of the reflector has a major effect on the fissioning critical mass needed. The reflector reflects radiation back into the core to reduce radiation leakage. Usually a good moderating material will act as a good reflector and vice versa. The choice for a beryllium reflector was based on its extremely low neutron area cross section ($.0009 \text{ barns/cm}^2$) and light weight property [13]. Beryllium [Be] has the highest strength-weight ratio of any metal at ordinary temperature. With its melting point at 1,277 C, Be offers much better high temperature properties than Al or Mg. Thus far, Be has been used mainly unalloyed. Its use is restricted by its scarcity and its high cost [14]. Its worst property is its low melting point, the core temperature of 3,444 K makes it a large temperature discrepancy to have to cool. However, since the reflector occupies the outer portion of the engine, regenerative cooling would be an easy task to accomplish. The main draw back to beryllium is its very high processed cost. At \$250,000/kg [15] this would make the 1,027 kg reflector cost 256 million in 1990 dollars.

1.4.10 Concluding Remarks

The choice of a beryllium reflector was based on the assumption that the high cost of production would decrease. Beryllium is an extremely toxic substance when

inhaled during the manufacturing process. It was felt that this cost would come down due to the use of robots in the process which are not effected by the toxic effects. The use of Carbides at the end of the Nuclear Engine program showed great promise in increasing core temperature tolerance as seen in Figure 1.30.

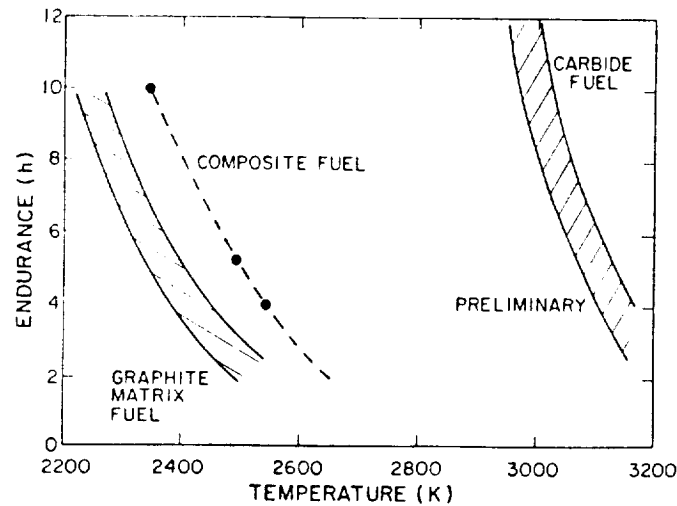

Fig. 10.12 Anticipated lifetimes of various Rover reactor fuels. From David S. Gabriel, Statement to Committee on Aeronautics and Space Sciences, U.S. Senate, 1973.

Figure 1.30 Carbide Fuel Characteristics

It is hoped that regenerative cooling of the engine core (only reflector) would be required and thus minimize core complexity.

The choice of the chemical booster over the nuclear for the Venus bound boost was based solely on budgetary constraints. Its obvious that at today's prices, the cost of a nuclear engine would far out cost the price of the extra fuel required. If the

cost of the nuclear engine were to fall to an acceptable level that would compete with the fuel launch costs, then it will be a wise choice to go with the nuclear engine. Less fuel means more payload for other systems and less fuel to deal with. Finally, throughout the project, the calculation of fuel masses with changing loads was a constant occurrence. A computer code designed to calculate fuel requirement masses for a given load, engine Isp, and engine mass for a given delta V was developed. Prog[2] & a Casio calculator program that does the same thing as Prog[1]. The programs as well as the sample calculations denoted by [C] are given in Appendix C.

1.5 Life Support

(Jenny Dillon)

1.5.1 Supplies and Regeneration Systems

A major concern for any mission in space is providing enough food, water and oxygen for the astronauts to survive the mission. To provide these life support supplies, an integrated regeneration system, also known as a closed loop system, is proposed. An important question is why regenerate, why not just carry all of the needed supplies. The reason is that for long term missions, a regeneration system reduces launch weight and launch volume, and that reduces the transportation to orbit costs [16].

Example:

For a crew of 4 astronauts

| | Stored Water | VAPCAR (water reclamation system) |
|--------------------|-------------------|--------------------------------------|
| Equivalent Weight* | 10,700 kg | 3,400 kg |
| Launch Volume | 38 m ³ | 25 m ³ |

*Equivalent weight = weight of flight unit, spares, and consumables for 90 days at launch [17]

An integrated regeneration system is very complex. It involves carbon dioxide removal and concentration, carbon dioxide reduction, oxygen generation, water reclamation, solid waste removal and processing, nitrogen generation, and the storage for all of these processes. Storage is very important because the output of one subsystem is the input to another. Matching these flow rates would be very difficult. Providing storage for each subsystem helps to eliminate this problem. The same type of regeneration systems will be used on the waverider and on the Martian Base.

Carbon Dioxide Removal and Concentration

To remove carbon dioxide from the crew living area and concentrate it for processing, an Electrochemical Depolarization Carbon Dioxide Concentrator (EDC) will be used. This process removes carbon dioxide continuously from the cabin area by passing the air through a series of electrochemical cells (Figure 1.31). The reaction produces electrical energy in the form of direct current, and heat. The advantages of an EDC are that the direct current produced can be used by other subsystems. The EDC can be operated continuously or cyclically, so it could be operated during the astronauts' night, when power demands are less. Also, the

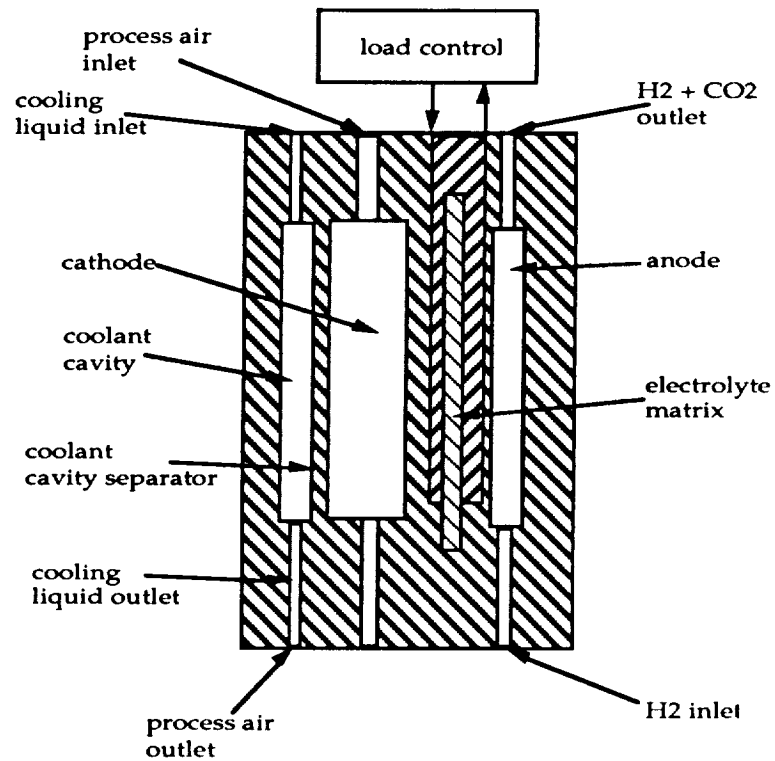
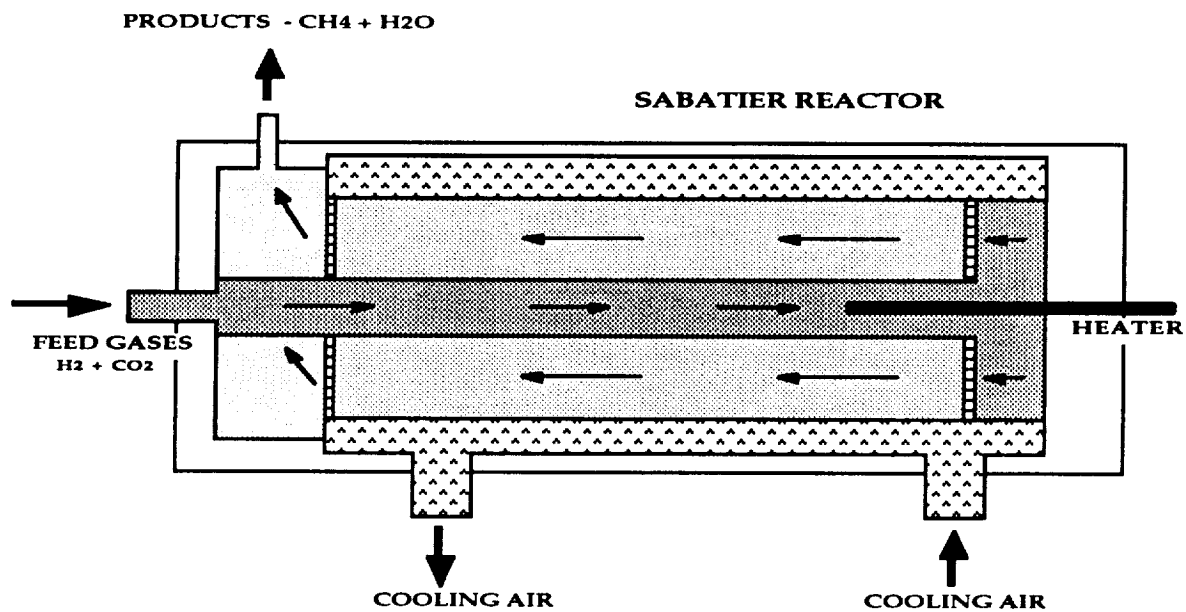

Figure 1.31 Electrochemical Depolarization Carbon Dioxide Concentrator (EDC) [18]

carbon dioxide removal rate can be varied by changing the current level. This is useful since the carbon dioxide production rate will depend on the amount of astronaut activity. The only real disadvantage is that to provide the oxygen for this process, more power must be supplied to the oxygen generator. This power penalty is greatly outweighed by the benefits of an EDC.

Carbon Dioxide Reduction



REACTION: $\text{CO}_2 + 4\text{H}_2 = \text{CH}_4 + 2\text{H}_2\text{O} + \text{heat}$ (in the presence of a catalyst)

Figure 1.32 Sabatier Process

[18]

The Sabatier Process (Figure 1.32) is the best method for carbon dioxide reduction. The carbon dioxide is reacted with hydrogen to produce methane and water. This is combined with a methane cracking process to provide carbon and hydrogen. Another option would be to install a methane engine to provide some of the internal power for the subsystems. More research would have to be done to determine if the power generated was worth the extra weight.

The advantages of this system are that the hydrogen needed for this process is provided by the water and methane it produces. A good catalyst is 20% ruthenium on Alumina, this catalyst allows the reaction to begin at about 450 K, after that no external heat is required, the reaction is self sustaining. If the temperature exceeds 866 K, the reverse, endothermic reaction takes place. This prevents the system from

overheating. Finally, the deposit carbon produced by this process is a hard solid block which is important for ease of maintenance and for safety. In a micro-gravity environment, small particles floating around can be dangerous. Other methods produce a loose powdery form of carbon which would be more difficult to remove.

Oxygen Generation

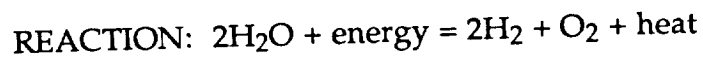
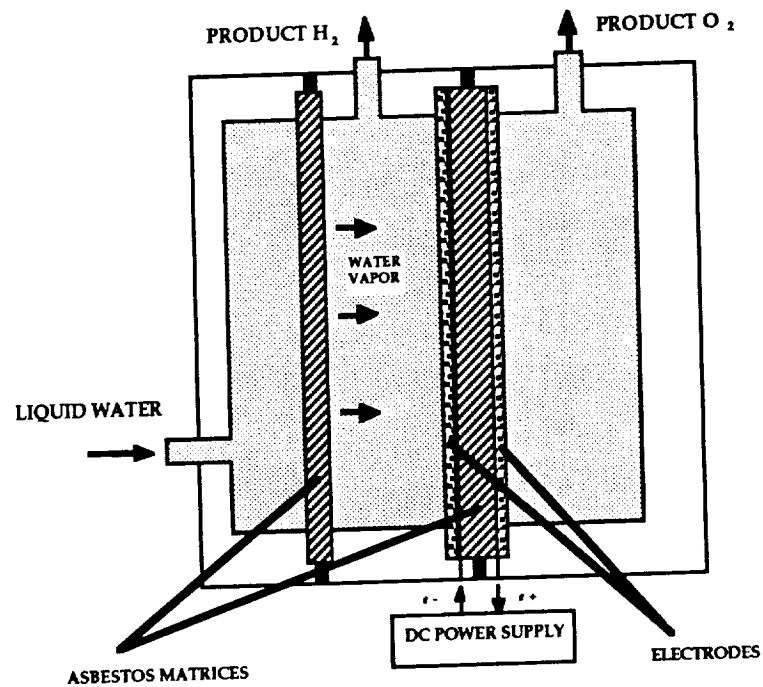

Figure 1.33 Static Feed Water Electrolysis

[18]

Oxygen is generated using Static Feed Water Electrolysis (Figure 1.33). The reaction splits the water into oxygen and hydrogen. The hydrogen is stored for the Sabatier Process and the oxygen is stored for crew consumption. The advantages are that it can be operated continuously or cyclically, and that it uses a DC power supply, at least part of which can be obtained from the EDC subsystem.

Water Reclamation

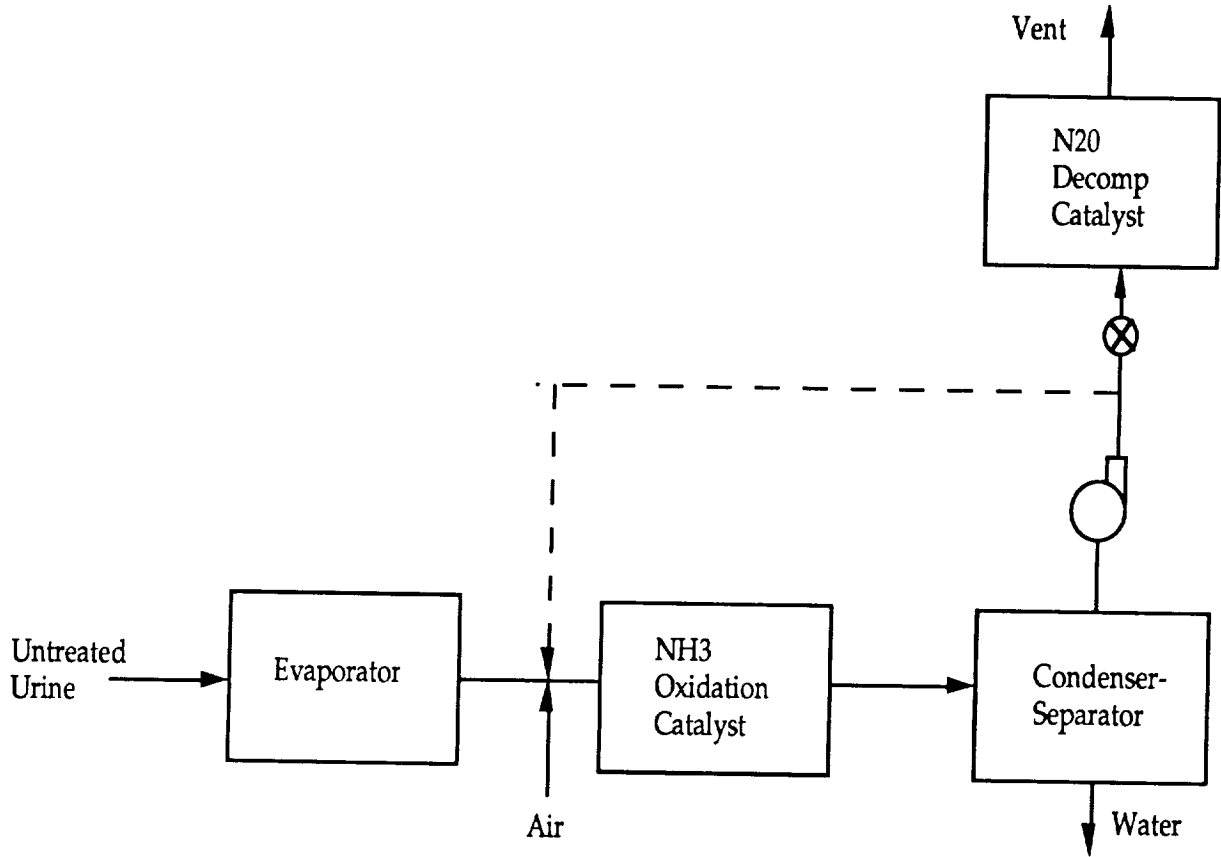

Figure 1.34 Vapor Phase Catalytic Ammonia Removal (VAPCAR)

[18]

For water reclamation, the method chosen is Vapor Phase Catalytic Ammonia Removal, or VAPCAR (Figure 1.34). VAPCAR combines vaporization and the high temperature catalytic oxidation of impurities. The advantages are that VAPCAR eliminates the need for expendable chemicals for pre- or post-treatment. This reduces the launch weight. The high temperature minimizes the growth of microorganisms, this provides a very high quality water. This high quality is one of the main reasons for choosing this system. The disadvantages are that VAPCAR

has not been extensively developed, and requires high maintenance time, but this should decrease with further development.

Table 1.1 Estimated Mass and Volume of the Life Support Supply Systems

| | Mass | Volume |
|--------------------------------|----------|----------------------|
| EDC | 193 kg | 0.65 m ³ |
| Sabatier | 114 | 0.51 |
| Static Feed | 146 | 0.28 |
| VAPCAR | 659 | 6.33 |
| Storage tanks | 55 | 0.31 |
| Stored O ₂ & tank | 142 | 0.15 |
| Stored H ₂ O & tank | 3,000 | 10.0 |
| Food | 4,036 | 6.0 |
| Galley | 150 | 7.2 |
| ----- | | |
| TOTAL | 8,495 kg | 31.43 m ³ |

Solid Waste Processing/Nitrogen Generation

The problems of solid waste processing and nitrogen generation are closely related. Wet oxidation can be used for both. The reason for processing solid waste is fairly obvious, if it is not processed, it either has to be stored as it is or vented into space. Nitrogen generation is necessary because of cabin leakage and because nitrogen can be used to periodically purge the airlock. The process of wet oxidation reduces the solid waste material to a slurry which is oxidized at an elevated pressure and temperature. The advantages of wet oxidation are that it does not require pre-drying, additives, or the introduction of a bacteria or a virus. It reduces to a small, light weight, sterile, nondegradable ash. Wet oxidation produces carbon dioxide

which can be stored and recycled, or used with a plant system. With certain catalysts this process produces gaseous nitrogen. The disadvantages are that incomplete oxidation may require post-treatment. Currently no catalyst has been found to achieve complete oxidation and the production of gaseous nitrogen, but there are some promising combinations using Ruthenium and Rubidium. If wet oxidation does not provide enough nitrogen, another option would be hydrazine (N_2H_4) dissociation to produce nitrogen and hydrogen.

One important feature in all of these systems is that none of them require membranes or filters. Over long periods of time membranes lose their efficiency, filters must be changed, and the replacement and spent filters must be stored. Finally, because the integrity of this regeneration system is important to the success of this mission, a dedicated crew member will be responsible for monitoring, maintaining and repairing the life support systems.

1.5.2 Power Supply--Deployable Solar Array

(George Grewe)

The power supply for the waverider will be a 300 kg solar array. It will work in conjunction with rechargeable fuel cells to power the life support systems, communication systems, and onboard computers. The solar array will be retracted for the thrust and the aero-maneuver portions of the waverider mission (Aero-maneuvers at Venus, Mars, and Earth). During these periods, the rechargeable fuel cells will be the source of power.

| Possible Choices | Power/mass Ratio(W/kg) | 22 kw System Mass(kg)* |
|-------------------------------------|------------------------|------------------------|
| State of the art photovoltaic array | 66.0 w/kg | 366 kg |
| Advanced Photovoltaic array | 300.0 w/kg | 81 kg |

*An Additional 10% added for structural support of the array.
A Deployment Motor Mass is not Included.

The advanced solar array (See Figure 1.35) is expected to improve the power to mass ratio considerably for space solar arrays from the 66 w/kg to potentially 300 w/kg. This improvement includes both the improved cell efficiencies and better fuel cell coupled for down period operations [19]. The expected output at Mars (1.52 AU) will roughly be half of the output at earth(1 AU). This is taken into account in the solar array mass estimates for the waverider [20].

The expected continuous peak power consumption for the life support

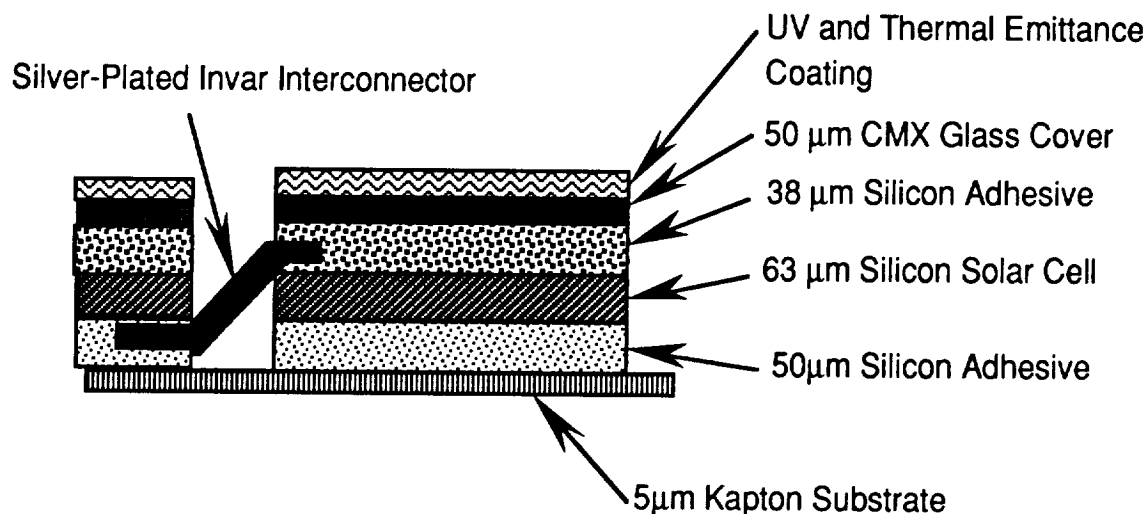

Figure 1.35 Advanced Photovoltaic Solar Array [See Ref. 19]

module is about 10 KW. The breakdown is EDC = 0.35 kw, SAB = 0.075 kw, SF = 1.75 kw, VAPCAR = 4.65 kw, miscellaneous power uses (pumps, lighting, sensors,

computers, etc.) = 4 kw. Using a series of rechargeable fuel cells to complement the power supply for unusual power consumption periods (ie., aero-maneuvers).

The solar array will be retracted for the thrust and aero-maneuver portions of the flight. The solar array would be coupled with a series of rechargeable fuel cells for down periods of operations (Thrust Phases and Aero-maneuvers at Venus, Mars and Earth).

1.5.3 Thermal Control

The expected heat production for the life support module in free space flight is about 10 kw. The expected sources of production are life support recycling about 6.25 kw, metabolic 0.854 kw for the crew, the remaining miscellaneous heat production sources electrical and mechanical equipment should be about 2 to 3 kw. These levels of heat production will vary depending on the type and level of activities preformed by the crew. Thermal control for the life support module will consist of heat acquisition (cold plates), transport (piping) and heat rejection (radiator) systems. A detailed analysis of this is not done in this report [21].

1.5.4 Crew Selection

The process of crew selection will be very complicated. There are specific technical requirements for each astronaut as well as physical and psychological qualifications. Until the scientific community decides exactly what experiments it wants to run on the Martian surface, and until astronaut candidates have been interviewed, very few absolute requirements can be stated. Since the safety of the crew and the success of the mission are the most important concerns, as few limitations as possible will be placed on crew selection, in order to obtain the most capable astronauts.

A manned mission to Mars will require some very advanced technology. Because of the many difficult problems that must be addressed, an international mission is proposed. The countries who have excelled in certain areas of technology will be asked to take part in this mission. They will be asked to contribute to the technological needs and to the candidate astronaut corps. It is believed that an international mission based on ability holds more promise for success than does a solo attempt based on pride and politics.

The primary language to be used on this mission will be English. Ideally, each astronaut will also be able to speak in the language of the listener (as was done on the Apollo-Soyuz mission). However, if the chosen crew is too multinational, this may be prohibitive.

No restrictions will be placed on the gender of the astronauts. Ideally however, there would be at least 2 of each sex (avoiding the situation of 9 women and 1 man or 9 men and 1 woman), primarily for psychological reasons. There should not be any special problems associated with long term space flight for women. Menstruation may be an inconvenience in space, but gravity has very little to do with the process. The uterus contracts and forces the blood and sloughed-off tissue to flow out. The use of tampons should allow a woman to have a normal period in space.

Inevitably, the prospect of a mixed gender crew brings up the question of sex in space. This is something that ultimately must be decided by the astronauts themselves. However, it must be made absolutely clear that pregnancy in space must be avoided at all costs. The radiation levels and the problems associated with fetal development in micro-gravity could not result in the normal birth of a healthy baby. Therefore, a supply of contraceptives will be part of the mission cargo.

1.5.5 Physiological Effects of Microgravity

(James McMorro)

"...it is known that short periods of weightlessness have inconsiderable effects...extended exposure to it may be different."

Wernher Von Braun

Das Marsprojekt 1952

Before space travel began, microgravity was not considered to be a health risk. However, as spaceflight became more and more common, it became evident that near-zero gravity was anything but benign. Without gravity, many physiological problems surface: the heart shrinks, bones thin, and muscles weaken. The body attempts to adapt to the new environment, however, this "adaptation" causes more harm than good.

The first physical change is "space sickness"--nausea, vomiting, disorientation, headaches, and irritability. This has been known to last several days [22]. It is believed that this problem is caused when the inner ear detects motion; but visually, there is no motion. This "conflict" causes confusion, which results in the sickness. However, this problem tends to correct itself once the body adapts to the lack of gravity (although vomiting in a microgravity environment could cause a person to choke).

During the first days of weightlessness, body fluids shift upward, causing the face, neck and upper torso of the astronaut to swell. As a result, the output of diuretic hormones increases which in turn increases urination. This decreases the volume of plasma in the body. Within thirty days, fluid balance is achieved.

Since less blood is in circulation, the heart will shrink slightly. The heart is essentially a large muscle, and with less blood to pump, this muscle will atrophy slightly (shrink). Therefore, heartbeat is occasionally irregular, and may result in an arrhythmia. Also, lung capacity decreases, either because there is now less volume

in the chest cavity (because of fluid buildup) or because the diaphragm tends to rise in microgravity.

Red cell production drops off in microgravity. Though the cause is unknown, this drop in production is considered harmless. But if an astronaut lost blood from an injury, there could be problems. Red blood cells developed in microgravity are unusually shaped--scalloped, mulberry-shaped, squarish, and spherical variants are often observed.

The number of killer and enhancer lymphocytes (white blood cells)--the ones that attack invading organisms--also drop off in production in microgravity. The cause of this reduction is also unclear. The number of neutrophils (also white blood cells)--the ones that digest bacteria and other foreign matter--increase. It is not known how these changes actually affect the immune system.

Without gravity, there is no pressure on the spinal column. The spine will expand and the astronaut will increase in height by about two inches. This has no ill effects on the human body. However, back on Earth, gravity will pull the astronaut back together.

The biggest physiological concern of microgravity is the atrophy of muscles and bone thinning--where the bone is losing its mineral content. Muscles require gravity for resistance, which strengthens them while doing everyday tasks. Bones require gravity to grow properly and maintain density. In microgravity, muscles weaken and atrophy, and bones lose calcium and become porous. It is possible to have a full recovery of muscle strength after a long term spaceflight. However, it may take weeks or even months.

Full recovery from bone thinning, however, may not be possible. Bone demineralization may be a permanent effect. On the Skylab missions, astronauts lost 0.5 percent of their body calcium every month, almost all of it from bone [22]. It is not known if this loss is continual or if it will eventually level off. It would seem

that the demineralization occurs mostly (if not totally) in the bones that bear the most weight. The lost calcium works its way into the urinary system, which increases the risk of kidney stones. Additionally, when about 40 to 60 percent of the calcium is gone, bones break quite easily. This is of particular concern if an astronaut were to break a bone during a flight. In microgravity, the bone could heal in an unnatural position. This makes bone thinning the biggest concern of the physical damage caused by microgravity.

The solutions to these problems (muscle atrophy and bone demineralization) are fairly simple. Muscle integrity can be maintained through exercise. The ship (waverider) will be equipped with a bicycle, treadmill, and nautilus. A standard nautilus includes components to exercise leg, arm, chest, stomach, and shoulder muscles. Since weights are useless in space, high stiffness springs will be substituted. When an astronaut displaces the spring by so much, an opposing force is generated. This resistance will provide the muscles with the needed exercise.

The solution for bone thinning will be a combination of medication and artificial gravity. An on-board centrifuge will simulate gravity. Its centrifugal force, tied in with injections of a calcium based drug, should inhibit bone demineralization (details on the centrifuge and the medical process will appear in subsequent sections).

Once Mars has been reached, it is assumed that the planet's .38 gee gravity field will alone prevent bone thinning, etc. In the unlikelyhood that .38 gee is not enough, then it may be necessary to dismantle the centrifuge and bring it to the planet surface. This is an extreme step, however, it is a possible scenario.

1.5.6 On-Board Centrifuge

If artificial gravity is deemed necessary on a manned Mars mission--as it was in this project--how will it be "administered?" The method here is a centrifugal device within the waverider that allows astronauts to receive a daily "g-dose."

One theory on this topic was proposed by MIT graduate student Peter Diamandis. Bone demineralization may be staved off by applying centrifugal force along the longitudinal axis of the body [22]. The force would “begin” at the head and move towards the feet, much in the same manner as true gravity acts on the human body. This led Diamandis to construct his “rotating bed” centrifuge.

The waverider on-board centrifuge is designed along similar lines. It consists of four “beds” that are rotated simultaneously. Each bed will have a headrest, handholds, and foot pedals. When a human is rotated, movement of the fluid in the inner ear versus what the subject observes can cause disorientation and nausea. Therefore the headrest must support the head and prevent it from moving. Likewise, the subject will be blindfolded to eliminate unnecessary visual “stimuli.” The handholds and foot pedals are meant to keep displaced fluid from building up (a natural side-effect of high speed rotation) [23]. Exercise of both hands and feet will keep fluids in motion. To be certain that the centrifuge is properly balanced, counterweights will be affixed to each of the four beds. This will ensure that each bed has the same mass as the other three (despite the fact that each astronaut will undoubtedly have a different overall body mass than the others). The centrifuge will take 30 to 45 seconds to come up to speed. This will allow the subject sufficient time to adapt to the rotating system. The centrifuge will need to be rotated at either 29 rpm for 1 gee (at the subject’s center of mass) or 20.5 rpm for 1 gee (at the subject’s feet). A healthy body can withstand a gravity gradient of 2 gee or less, and the bed’s “exercise equipment” will deal with the fluid displacement (see Figure 1.36).

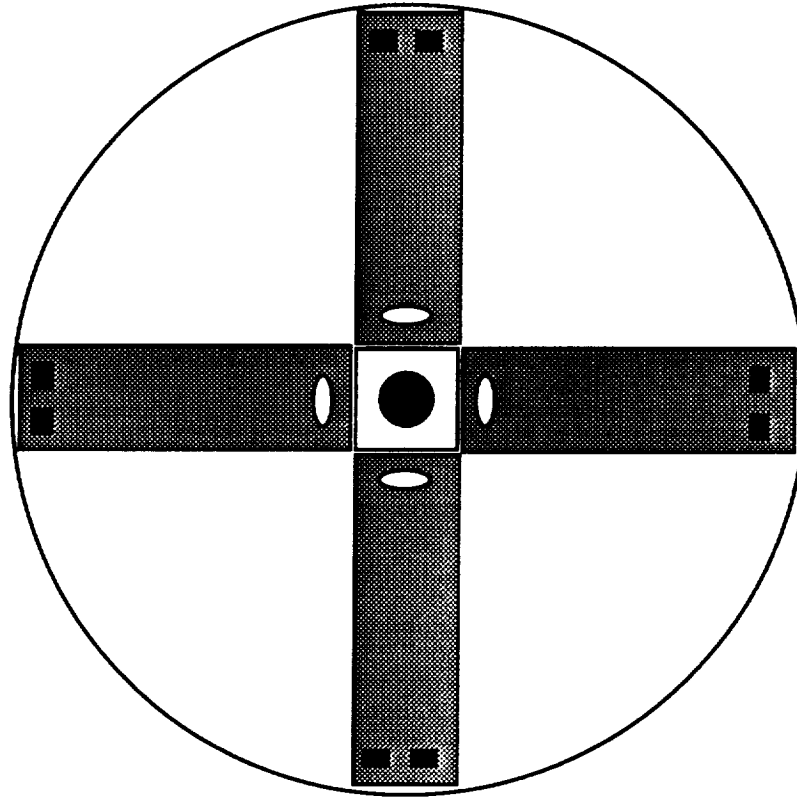

Figure 1.36 Top View of Centrifuge

A rotating body within a moving ship causes gyroscopic motion, therefore a counter-rotation disc will be placed concentrically beneath the centrifuge to offset the motion. Likewise, a rotating body within a moving ship can cause problems if the ship is maneuvering, despite the counter-rotation disc [24]. Therefore, it is recommended that the centrifuge NOT be used while the waverider is undergoing maneuvers (and the entire crew should be on alert during major maneuvers, anyway). Both centrifuge and disc will each be driven by 2 horsepower DC motors. Each motor will use 180 armature volts and will pull about 12 amps. Though a single motor could have driven both devices, a taxed motor can produce power fluctuations. Therefore, two motors are desirable. The structure will be made of graphite-epoxy. Graphite-epoxy is a light weight composite material with a density

of about 1610 kg /m³ [25]. As a result, the entire centrifuge system will be on the order of 2000 kg.

1.5.7 Microgravity Countermeasures

The problem with bone-thinning during long-term space flights has never been totally resolved. There have been a series of solutions: calcium-based medication, exercise, negative pressure suits, and centrifugal force (artificial gravity) [26]. Of all these solutions, only one--centrifugal force--has been "totally" successful in preventing bone damage in a microgravity environment. An experiment conducted by the Soviets used rats in a centrifuge for nearly twenty-four hours a day [27]. When a load of about one gee was produced, bone thinning in the rats apparently came to a halt. However, it was necessary to keep the rats in the centrifuge for nearly twenty-four hours a day. An astronaut would be useless to the mission if it was necessary for him/her to be centrifuged for that amount of time.

Another alternative is to equip the entire ship with artificial gravity. That is the entire ship--or a large portion of it--rotates to provide sufficient centrifugal force to simulate gravity which should forestall bone thinning. However, such a vessel would probably weigh a fair bit more than a conventional one [22]. This would mean greater fuel consumption [26]. Such a vessel could therefore be difficult to build and launch.

There is another theory, one that is untried and perhaps unheard of. This theory suggests that combining calcitonin injections with centrifugal force could forestall bone thinning in astronauts [28]. An astronaut could be injected with a standard daily dose of the drug (about 5 mg) and then immediately enter the centrifuge. If the human body could be "fooled" into thinking that this rotating force is actually gravity, then maybe the calcitonin will take hold and perform its task: inhibit bone demineralization. The time required of the astronaut to spend in

the centrifuge in order for the drug to work is not known. However, it is hoped to be a short length of time.

If the calcitonin does work for a short duration centrifuge "trip," then bone demineralization will be minimized for a long term space flight. This may well be a more acceptable way of preventing bone damage until a vessel can be more suitably equipped with artificial gravity. It would be wise to conduct experiments of this type on Space Station Freedom.

1.5.8 Extravehicular Activity (EVA) Suits

During the course of the voyage, it may be necessary for the astronauts to work outside the ship. Also, of course, they will be performing tasks on the surface of Mars. This will require extravehicular (EVA) suits.

The EVA suits serve three basic functions. First, the suit maintains the health of the astronaut--supplying oxygen, removing carbon dioxide and body heat. Second, it enables the astronaut to perform useful tasks outside of the ship or planet base. Finally, the suit protects the astronaut from extreme temperatures, micrometeorites and space debris, and radiation [29]. The EVA suit is critical to the astronaut as he/she will often be required to leave the environment of the ship or the Mars base.

The EVA suit utilizes a self-contained life-support system. The system consists of two parts: a backpack unit, and a control/display unit on the suit chest. The backpack unit supplies oxygen for breathing, pressurization of the suit, and ventilation. The system also removes body heat and circulates water used in the liner, removes carbon dioxide and odors. The control/display unit automatically provides user instructions, checks suit functions, and acknowledges any suit malfunctions. Finally, a catheter is connected to a plastic bag for collecting urine.

Also, tight fitting plastic pants (basically a diaper) is used to collect solid waste. The suit therefore addresses the bare essentials of human sustenance.

Currently, there are three different types of EVA suits being considered for use on Space Station Freedom. These are the shuttle suit, the hybrid suit, and the hard suit [30]. While the shuttle suit already exists, the remaining suits are still in development. Of these three type suits, a hard suit would probably be the most suitable for a manned Mars mission. This suit has the best protection against the radiation of space, be it Van Allen, galactic cosmic ray, or solar flare radiation. On the surface of Mars, the greatest danger is ultraviolet radiation. Mars has no ozone layer to shield the worst of these rays, as on Earth. However, the hard suit promises full radiation protection [30].

Again, the EVA suit is critical to the astronaut's well-being as well as to the mission requirements. Exterior repairs to the vessel or performing Mars surface activities will not be possible without the suits. Fortunately, it would appear that the EVA development programs of the space station will also produce the EVA suits necessary for the manned Mars mission.

1.5.9 Medical Bay

A manned mission to Mars will not only take many months of travel, it will also carry the crew a great distance from Earth. While several of the American and Soviet missions took several months to complete, they occurred in orbit of Earth. If necessary, a seriously injured crew member could have been transported back to Earth in a relatively short time. This is not the case with a manned Mars mission. Even if a serious injury does occur, it could take a great deal of time to return to Earth. As a result, the medical facilities of the waverider must be as readily equipped for a medical emergency as is possible. This also means that certain risks may have to be accepted by both NASA and the crew of the mission.

Prior to the mission, all crew members must be screened for any physical deficiencies. If the screening is done properly, it seems likely that there will be few, if any, major medical problems during the mission. The primary purpose of the medical bay (referred to as a "Health Maintenance Facility" by NASA) will, be to monitor the crew's health and practice "preventive" medicine, especially in relation to microgravity countermeasures.

Current designs of the space station's medical facilities call for four general requirements: the surgeon and the HMF can reasonably handle most common non-surgical medical problems, the mission surgeon and HMF can reasonably handle minor surgical problems and possibly handle major surgical problems, the mission surgeon and HMF can effectively monitor the long-term effects of microgravity on the astronauts, and the surgeon and HMF can provide a conditioning program in order to maintain the skeletal, cardiovascular, and muscular system of the astronauts during the mission [31].

The medical bay of the waverider will be very similar to the Space Station HMF. The problem with the equipment of the waverider medical bay is that it would have to be modified to function in microgravity. Once Mars has been reached, then the one-third gravity field will simplify the use of the medical equipment. Also, medical procedures that would have been difficult to perform in space would be simplified.

The primary equipment of the medical bay is as follows:

MICROGRAVITY COUNTERMEASURES--treadmill, bicycle, nordic

track, nautilus system (modified with springs), and on-board centrifuge

TOXICOLOGY--mass spectrometer, gas chromatograph

PRESSURE CHAMBER--modification to airlock

HEMATOLOGY/IMMUNOLOGY--qualitative blood count system

MICROBIOLOGY--automated microbial system

IMAGING--digital radiography, miniaturized CAT scan system, ultrasound scanner

PHYSICIAN'S EQUIPMENT--standard physical exam equipment including stethoscope, dialostic/systolic indicator, etc.

INTRAVENOUS--intravenous administration system (modified to function in microgravity)

CARDIOVASCULAR/LIFE SUPPORT--cardiac life support/resuscitator

RESPIRATORY/VENTILATOR--device to measure respiratory pressures, blood gas analyzer, respiratory support equipment

PHARMACY/SUPPLIES--pharmaceuticals, supplies which include bandages, splints, etc.

SURGERY/ANESTHESIA--surgical table incorporating supplies, restraint system, lighting, cauterizing equipment, suction devices, anesthetics, dental kit

This equipment is very similar to that of the HMF of Space Station Freedom [32]. The only significant change is that there is additional equipment for treatment of bone demineralization and calcium loss.

Since major injuries have never occurred in space, there is some question as to how such injuries would be treated. Also, there is still question as to whether or not major surgery can be performed in space. It is highly likely, however, that some experience in this area will be acquired aboard the space station.

There are certain injuries and ailments that behave differently in space than they do on Earth. This is essentially due to the nature of microgravity. Astronauts are already aware of how to treat some of these. For instance, sinuses will not drain without gravity. A head cold is the result. However, this can be easily treated by use of decongestants. There are similar scenarios.

There are, however, injuries--and possibly ailments--that will be difficult to treat in the presence of microgravity. For instance, scientists believe that neck and spinal cord injuries can be treated by restraining the injured astronaut. Even though such an injury has never occurred, scientists are still practicing "preventive" medicine to find ways of dealing with such scenarios.

But what if an astronaut were to break a bone in space? It is theorized that the break would heal in an unnatural position. This leads to two different options. First, the break could be set and allowed to heal. If it did heal in an unnatural position, then the unfortunate astronaut would have to wait until a gravity field were reached; the bone would have to be broken again and then reset again. The other option is to use some chemical/pharmaceutical means to inhibit bone reformation until a gravity field were reached. This, of course, would limit the usefulness of the astronaut for the rest of the voyage. While the use of diphosphonates supposedly inhibits bone reformation, there is some question to the drug's effectiveness. Thus, if no reformation inhibitor exists, then there would be no choice but to rebreak the bone and reset it later.

Finally, there is the question of how to perform major surgery in space. Blood flows in strange patterns in zero gravity. It doesn't pool up or hide anything. The only movement of blood is strictly from the force of the blood against the walls of the vessels--blood pressure--and from circulation. Since this is the case, surgery in space might actually be simpler than on Earth. On Earth, constant suction is generally required for major operations. This will be all too true for operations performed in microgravity. Blood would leave the wound or surgical opening and, since it doesn't pool up, it would in a sense "take off" where it could be easily vacuumed or suctioned away. This would leave the surgeon with a much better view of the injury. However, it may be some time before any experience may be gained in major surgical operations in space.

Again, since a manned Mars mission will occur millions of miles from Earth, it will be necessary for the HMF of the waverider to be able to handle as many medical emergencies as possible. However, medical screening of the astronauts--before the mission--should minimize the number of possible medical emergencies. Some knowledge on how to handle medical emergencies may take place aboard the space station. However, since actual medical events are so rare, the main purpose of the HMF will be in the treatment of minor ailments and the long term medical monitoring of the crew.

1.5.10 Radiation Concerns

(Darrin Drum)

During a manned Mars mission the astronauts will encounter Van Allen Belt radiation, Galactic Cosmic Rays, and Solar Cosmic Rays (also known as Solar Flares). The main source of nuclear radiation is from the NIMF Shuttle engines on the shuttle itself and the return trip. The other source of nuclear radiation is the cargo ship engines. This is an unmanned vehicle so the only problem would be irradiation of the food and other necessary life support equipment. However, radiation shielding is incorporated into the engine design.

Van Allen Belt radiation may not seem to be an important radiation consideration due to the short amount of time spent in the Van Allen Belts. The Van Allen Belts consist of two "clouds" of energized particles. The first of these belts consists of low energy protons which are fairly easy to shield from by using the ships outer structure. The second belt consists of a "cloud" of electrons that can cause many problems with regard to shielding of a spacecraft. These electrons ionize the metal shields, to cause a secondary radiation of x-rays which bombards the astronauts, and can cause injury and nausea if the ship does not clear the Van Allen Belts in a reasonable amount of time. Even so, a round trip passage through the

Van Allen Belts will give the astronauts the equivalent of 1.14 rem of radiation which is 4.5% of the 30 day exposure limit for the bone marrow of the astronauts as defined by NASA (Table 1.2) [33].

Table 1.2 Radiation Exposure Limits

| Length of Time | Bone Marrow Rem at 5 cm | Skin Rem at 0.1 mm | Ocular Lens Rem at 3 mm |
|-----------------------|----------------------------|-----------------------|----------------------------|
| 1 yr. avg. daily dose | 0.2 | 0.5 | 0.3 |
| 30 days maximum | 25 | 75 | 37 |
| Quarterly maximum | 30 | 80 | 40 |
| Yearly maximum | 60 | 170 | 85 |
| Career minimum | 200 | 600 | 300 |

The major concern of any space mission is galactic cosmic rays and solar flares. Galactic cosmic rays are high energy, low density particles that enter the solar systems from other galaxies and solar systems. These particles are the result of supernovas and other calamities that have ejected high energy particles into the cosmos. These particles have energies on the order of MeV to GeV and can penetrate one meter of aluminum with little difficulty [34]. The projected launch date gives an advantage concerning GCR's because it is during a projected solar maximum. During a solar maximum, the high level of solar activity acts to suppress the amount of Galactic Cosmic Rays that enter the solar system.

The sun goes through an approximately 11 year cycle during which the number of sunspots increases and decreases which lead to cyclic increase and

decrease in the number of solar flares. Shielding from the radiation caused by these solar flares is the major concern of the space mission.

The mission has three portions where radiation considerations are of concern. These three portions were the planetary mission, the cargo mission, and the waverider mission. On the planet of Mars, radiation is of some concern due to the less lowered atmospheric protection afforded the astronauts by Mars. In order to overcome this problem, the base will be buried. While on missions with the NIMF Shuttle, the radiation worries are not so high, because the shuttle can return to base quickly so the astronauts can be shielded from large solar flares. In the event of small solar flares, the shuttle's structure will provide a safe haven for the astronauts.

The major concern of the cargo mission is to protect the food from radiation. This can be accomplished by placing the food in the center of the cargo capsule and surround the food by easily non-ionizable scientific experiments and then the heavier equipment on the outer parts of the cargo ship.

The last and most important part of the mission that requires radiation consideration is the manned waverider mission. In August 1972, there was a solar flare that would have caused severe nausea and vomiting -- but not death -- to any astronauts that would have been in space at that time (with 2 g/cm² of aluminum shielding). However, continued exposure to solar flare radiation would have quickly killed the astronauts. It has been determined that the equivalent of 20 g/cm² (7.5 cm) of aluminum [35] would have been enough to bring the level of radiation from that solar flare down to an allowable limit of 14 rem [36].

In order to create a "hot" room where the astronauts could go to in case of a large solar flare, many items are taken into consideration. Among these items are the size of the astronauts and the amount of radiation the astronauts would face around Venus. To address the Venus problem, a known property of radiation is

that it is proportional to one over the distance squared. Knowing that the distance from the sun to Venus is (108×10^6) [37] the proportional amount of Venus radiation is found as follows:

$$X \text{ g/cm}^2 = (150 \times 10^6 \text{ m})^2 = 38.6 \text{ g/cm}^2$$

$$20 \text{ g/cm}^2 (108 \times 10^6 \text{ m})^2$$

The use of this number to provide shielding for the astronauts would have lead to prohibitive weight for radiation shielding (about 50,000 kilograms which is the weight of the ship). The use of 20 g/cm^2 seemed to be a reasonable assumption due to the following reasons:

- (1) Most of the mission time is spent between Earth and Mars where the 20 g/cm^2 is sufficient, and
- (2) the probability of encountering such a large solar flare while on a Venus flyby is low even during solar maximum.

More solar flares occur during the downside of the solar cycle and the waverider will be flying by Venus during the upside of the solar cycle. Knowing that a normal human being needs 1.42 m^3 of space and that this is a 10 person crew, the bunk area then needs to be 14.2 m^3 in size.

The waverider also gives some protection from solar flare radiation. Assuming a total thickness of 2 in (5.08 cm) at the shell, and knowing that advanced carbon-carbon has a density of 1.67 g/cm^3 , an equivalent amount of 8.64 g/cm^2 of shielding is found. $(1.67 \text{ g/cm}^3 \times 5.08 \text{ cm})$, $20 \text{ g/cm}^2 - 8.64 \text{ g/cm}^2 = 11.36 \text{ g/cm}^2$ of shielding still necessary. Standard NASA shielding is 2.0 g/cm^2 . This will give the thickness of the bunk room walls as $2.0 \text{ g/cm}^2 / 2.7 \text{ g/cm}^3 = 0.74 \text{ cm}$. The dimensions of the bunkroom are 1 m x 3.3 m x 4.3 m. This easily fits into the given space aboard the waverider. The weight of the Aluminum walls can be found as follows. First each different wall piece volume is found. The effective volume is 4.3 meters x 1.0 meters x 0.0074 meters = $0.032 \text{ m}^3 \times 2 = 0.064 \text{ m}^3$. Total volume = 0.323

m³. This gives shielding mass of 872 .1 kg. 9.36 g/cm² of shielding need to be accounted for. A water bladder form of shielding will be used, i.e. placing water around the bunkroom walls to use as shielding. This was done as a form of protection from GCR's because of their high ionizing properties. Since water is harder to ionize than aluminum and other metals, it was chosen to use water to provide some form of protection from GCR's. It is known that 20 g/cm² of water protection weight 16,633 kilograms for 10 people for 9.36 g/cm² is equivalent to:

$$(9.36/20) = (x/16633) = 8.894 \text{ kilograms [38].}$$

This gives a total shielding weight of 8,656 kilograms. For a summary of results see Table 1.3.

Table 1.3 Amount of Shielding Required

| | |
|--|-------------------------|
| 1. Amount of space necessary per person | 1.42 m ³ |
| 2. Amount of space necessary for crew | 14.2 m ³ |
| 3. Effective shielding from ship | 8.64 g/cm ² |
| 4. Required shielding | 20.0 g/cm ² |
| 5. "Storm cellar" shielding required | 11.36 g/cm ² |
| 6. Effective shielding from walls | 2.0 g/cm ² |
| 7. Thickness of sleeping quarter walls | 0.74 cm |
| 8. Weight of walls | 872.1 kg |
| 9. Shielding yet required | 9.36 g/cm ² |
| 10. Mass of remaining shielding using H ₂ O | 7,784.0 kg |
| 11. Total shielding mass | 8,656.0 kg |

1.6 Conclusion

(Jenny Dillon)

There have been some questions raised about the feasibility of using a hypersonic waverider as a spacecraft. This report has addressed the problems of materials and heating, as well as some possible solutions; the advantages of the waverider for the required trajectory maneuvers; the different propulsive systems that can be used with this vehicle; and the suitable life support systems that can be placed on the volume constrained waverider. More research is necessary, but at this point, the hypersonic waverider appears more than capable of successfully completing this mission.

APPENDIX

----- FLIGHT CONDITIONS -----

Mach No. = 7.00000E+01
Pressure = 4.47600E+02 N/m2
Density = 1.18600E-02 kg/m3
Temperature = 1.97180E+02 K
Dynamic press = 1.31594E+06 N/m2

----- GENERATING BODY FOR FLOWFIELD -----

Length = 3.53688E+02 m
Cone angle = 6.00000E+00 degrees
Shock angle = 6.34168E+00 degrees

----- AIRCRAFT DIMENSIONS -----

Aircraft length = 6.00000E+01 m
Base height / length = 1.00191E-01
Semi-span / length = 1.36953E-01
Planform area = 4.86883E+02 m2
Base area = 4.84679E+01 m2

Wetted area (upper) = 6.34060E+02 m2
Wetted area (lower) = 4.89950E+02 m2
Total wetted area = 1.12401E+03 m2

Aircraft volume = 1.10493E+03 m3
Volumetric Efficiency = 2.19515E-01

----- INVISCID AERODYNAMICS -----

CLp1 = 2.21699E-02 CDp1 = 2.36663E-03
CLpu = -3.40136E-04 CDpu = 0.00000E+00 CMpl = -1.35471E-02
CLpb = 0.00000E+00 CDpb = -3.38596E-05 CMpd = -1.47142E-04
CLp = 2.18297E-02 CDp = 2.33278E-03 CMP = -1.36942E-02
L/D = 9.35783E+00

----- VISCOUS AERODYNAMICS -----

Local transition Reynolds number = Inf
Upper surface transition dist from LE = Inf m
CLf1 = -1.97635E-05 CDf1 = 2.03192E-04 CMf1 = -4.69441E-07
CLfu = 0.00000E+00 CDfu = 3.77388E-05 CMfu = -1.30628E-06
CLf = -1.97635E-05 CDf = 2.40931E-04 CMf = -1.77572E-06
CL = 2.18100E-02 CD = 2.57371E-03 CM = -1.36960E-02
L/D = 8.47415E+00

----- HEAT TRANSFER DATA -----

Aircraft wall temperature = 7.85000E+02

Appendix B

```
C      EARTH-VENUS-MARS (W/VENUS AEROGRAVITY ASSIST)
C      TRAJECTORY PROGRAM

C THIS PROGRAM CALCULATES ALL POSSIBLE TRAJECTORIES FROM EARTH TO
C VENUS TO MARS (LEO-LMO) GIVEN AN MAX DELTA V AT LEO AND A MAX
C DELTA V AT MARS.
C
LOGICAL BOGUS, VENUS
  REAL MUsun, VPERleo, Vleo, deltaV1, VXdepE, MUsun, Rleo, Vearth, NUmax,
>   Rearth, NUoE, NUfV, Tvenus, Rvenus, Vinf1, THETA1, THETA2, VXarrV,
>   delta, VXdepV, Vvenus, NUoV, NUfM, Tmars, Rmars, Vinf2, MUmars, Vatm,
>   Rlmo, VPERlmo, Vlmo, deltaV2, VXarrM, MUvenus, TRAJ(2000,19),
>   DELmax, Vint, Vfin, Vstep, TAint, TAffin, TAstep, C3theta, C31,
>   PHIarrV, PHIdepV, X, Y, ARG, Vmars, k, PHIdepE, Vmax, C3, deltaNU,
>   PHImax, PHIstep, PHI, delVmax, delVlim, Tlimit
INTEGER NUM

COMMON/CONST/MUsun,BOGUS,VENUS,k

EXTERNAL DEG,RAD

PARAMETER (Rleo=6697.05, Vleo=7.71484, MUsun=3.986E5, Rlmo=3549.0,
>   Vearth=29.79, Rearth=149.5E6, Vvenus=35.04, Vmars=24.14,
>   Rmars=227.8E6, MUmars=4.305E4, Rvenus=108.1E6,
>   Vlmo=3.48284, MUvenus=3.257E5)

C***** INITIALIZE VARIABLES *****

MUsun=1.327E11
NUM = 0

C***** READ IN DATA *****

  WRITE(*,*)'INPUT deltaV1max,PHIstep,Vstep,TAinitial,TAfinal',
>   ',TAstep,Tmax,V2max,(E-NU)m'
  READ (*,*) delVmax,PHIstep,Vstep,TAint,TAfin,TAstep,Tlimit,
>   delVlim,NUmax

C***** CALCULATE MAX PHI (REL. 2 SUN) FOR A GIVEN POSSIBLE DEL V ****

VPERleo = Vleo + delVmax
C3 = SQRT(VPERleo**2 - 2.0*MUsun/Rleo)

PHImax = ASIN(C3/Vearth)

WRITE(6,102)
WRITE(7,108)
```

```

C***** ENTER PHI LOOP - FROM 0 TO MAX PHI *****

      DO 10 PHI = 0.0,-PHImax,-RAD(PHIstep)

C***** DETERMINE MIN AND MAX POSS. VEL (REL. 2 SUN) FOR TRAJ 2 VENUS

      Vint = Vearth*COS(PHI) - SQRT(Vearth**2*COS(PHI)**2 - Vearth**2
>          + C3**2)
      Vfin = Vearth*COS(PHI) + SQRT(Vearth**2*COS(PHI)**2 - Vearth**2
>          + C3**2)
      Vmax = SQRT(2.*(MUsun/Rvenus - MUsun/Rearth)/((Rearth/Rvenus)
>          **2*COS(PHI)**2 - 1.))

      IF(Vmax .LT. Vint) THEN
      GOTO 10
      ELSEIF(Vmax .LT. Vfin) THEN
      Vfin = Vmax
      ENDIF

C***** INCREMENT VELOCITY FOR A GIVEN PHI *****

      DO 11 VXdepE = Vint,Vfin,Vstep
      PHIdepE = PHI

      VENUS = .TRUE.

C***** CALCULATE TRAJ TO VENUS FOR GIVEN PHI & VELOCITY *****

      CALL XFER(Rearth,VXdepE,PHIdepE,NUoE,NUfV,Tvenus,Rvenus,
>          Vinf1,VXarrV,Vvenus,PHIarrV)
      Evenus = Vinf1**2/2.0

C***** VARY TURN ANGLE AT VENUS *****

      DO 12 delta = TAint,TAfin,TAstep
      ARG = (Vinf1**2+Vvenus**2-VXarrV**2)/(2.0*Vinf1*Vvenus)
      THETA1 = ACOS(ARG)-3.1415927

      THETA2 = THETA1 + RAD(delta)
      X = Vinf1*COS(THETA2)
      Y = Vinf1*SIN(THETA2)
      VXdepV = SQRT((X+Vvenus)**2+Y**2)
      PHIdepV = ASIN(Y/VXdepV)
      VENUS = .FALSE.

C***** CALCULATE TRAJ TO MARS FOR A GIVEN T.A. AT VENUS *****

      CALL XFER(Rvenus,VXdepV,PHIdepV,NUoV,NUfM,Tmars,Rmars,
>          Vinf2,VXarrM,Vmars,PHIarrM)
      IF (BOGUS) GOTO 12

C***** CALCULATE DELTA V 2 *****

```

```

VPERlmo = SQRT(Vinf2**2 + 2.0*MUmars/Rlmo)
deltaV2 = VPERlmo - Vlmo

> deltaNU = (Tvenus + Tmars)*.98562628-(DEG(NUfV-NUoE)
+DEG(NUfM-(NUoV-k*6.28319)))

C***** RECORD TRAJ DATA IF CONDITIONS ARE CORRECT *****

> IF (((Tvenus+Tmars) .LE. Tlimit) .AND.
(deltaV2 .LE. delVlim) .AND. (deltaNU .LT. NUmax) ) THEN

Vatm = SQRT(Vinf1**2+2*MUvenus/6247.)
deltaV1 = SQRT(VXdepE**2+Vearth**2-2*VXdepE*Vearth*
> COS(PHIdepE) + 2*MUearth/Rleo) - Vleo

C31 = SQRT((Vleo + deltaV1)**2 - 2.0*MUearth/Rleo)
IF((PHIdepE.LE.0.000000001) .AND.
> (PHIdepE.GT.-.000000001))THEN
C3theta = 0.0
ELSE
C3theta = DEG(ACOS((Vearth**2+C31**2-VXdepE**2)/
> (2.0*C31*Vearth)))
ENDIF

NUM = NUM + 1

TRAJ(NUM,1) = DEG(PHIdepE)
TRAJ(NUM,2) = deltaV1
TRAJ(NUM,3) = deltaV2
TRAJ(NUM,4) = delta
TRAJ(NUM,5) = Tvenus + Tmars
TRAJ(NUM,6) = DEG(NUfV-NUoE)+DEG(NUfM-(NUoV-k*6.28319))
TRAJ(NUM,7) = deltaV1 + deltaV2
TRAJ(NUM,8) = Tvenus
TRAJ(NUM,9) = Tmars
TRAJ(NUM,10) = DEG(NUfV-NUoE)
TRAJ(NUM,11) = DEG(NUfM-(NUoV-k*6.28319))
TRAJ(NUM,12) = 0.0
TRAJ(NUM,13) = TRAJ(NUM,6) - TRAJ(NUM,5)*0.52399058
TRAJ(NUM,14) = DEG(NUfV-NUoE) - Tvenus*1.60264436
TRAJ(NUM,15) = TRAJ(NUM,5)*.98562628
TRAJ(NUM,16) = TRAJ(NUM,6)
TRAJ(NUM,17) = DEG(NUfV-NUoE) + Tmars*1.60264436
TRAJ(NUM,18) = Vatm
TRAJ(NUM,19) = C3theta

> WRITE(6,103) NUM,TRAJ(NUM,1),TRAJ(NUM,4),TRAJ(NUM,2),
> TRAJ(NUM,3),TRAJ(NUM,5),TRAJ(NUM,15)-TRAJ(NUM,6),
> TRAJ(NUM,7),Vatm,TRAJ(NUM,19)

> WRITE(7,107) NUM,TRAJ(NUM,13),TRAJ(NUM,14),TRAJ(NUM,15),
> TRAJ(NUM,16),TRAJ(NUM,17)
ENDIF

```



```
12 CONTINUE
11 CONTINUE
10 CONTINUE
```

```
STOP
```

```
102 FORMAT(' REF#   PHI TA @ VENUS deltaV1  deltaV2  ',
>  ' Ttot E-NU  Vtot Vatm  C3theta')
103 FORMAT(1X,I4,4X,F5.1,5X,F6.2,3X,F7.2,6X,F5.2,4X,
>  F6.2,3X,F6.2,3X,F5.2,3X,F5.2,4X,F6.2)
107 FORMAT(3X,I3,6X,F6.2,3X,F6.2,6X,F6.2,3X,F6.2,3X,F6.2)
108 FORMAT(' REF#   Mo   Vo   Ef   Mf   Vf)
```

```
END
```

```
C***** SUBROUTINE TO CALCULATE INTERPLANETARY TRAJECTORIES *****
```

```
  SUBROUTINE XFER(Rdep,VXdep,PHI1,NUo,NUf,TOF,Rarr,Vinf,VXarr,
>  Vtarg,PHI2)
```

```
  LOGICAL BOGUS, VENUS
  REAL Rdep,VXdep,PHI1,NUo,NUf,TOF,Rarr,Vinf,h,P,Exfer,a,Eo,Ef,
>  VXarr,MUsun,Vtarg,k,PHI2
```

```
  COMMON/CONST/MUsun, BOGUS, VENUS,k
```

```
  h = Rdep*VXdep*COS(PHI1)
  P = h**2/MUsun
  Exfer = VXdep**2/2 - MUsun/Rdep
  e = SQRT(1. + 2*Exfer*h**2/MUsun**2)
  a = P/(1. - e**2)
```

```
  IF (Rarr .GT. P/(1.0 - e)) THEN
    BOGUS = .TRUE.
    RETURN
  ENDIF
  k = 0.0
  BOGUS = .FALSE.
  IF((PHI1 .LE. 0.00000001) .AND. (PHI1 .GT. -.00000001))THEN
    NUo = 3.14159
  ELSE
    NUo = ACOS((P/Rdep - 1.)/e)
  ENDIF
  Eo = ACOS((e + COS(NUo))/(1. + e*COS(NUo)))
  IF (PHI1 .LT. 0.0) THEN
    NUo = 6.2831853 - NUo
    Eo = 6.2831853 - Eo
  k = 1.0
  ENDIF
```

```

NUf = ACOS((P/Rarr - 1.)/e)
Ef = ACOS((e + COS(NUf))/(1. + e*COS(NUf)))
IF (VENUS) THEN
  Ef = 6.2831853-Ef
  NUf = 6.2831853 - NUf
  k = 0.0
ENDIF

TOF = SQRT(a**3/MUsun)*((Ef - e*SIN(Ef)) - (Eo - e*SIN(Eo))
> + 6.2831853*k)/86400.0
VXarr = SQRT(2*(MUsun/Rarr + Exfer))
PHI2 = ACOS(h/(VXarr*Rarr))
Vinf = SQRT(VXarr**2 + Vtarg**2 - 2*VXarr*Vtarg*COS(PHI2))

```

```

RETURN

```

```

END

```

```

REAL FUNCTION RAD(X)
REAL X
RAD = X*3.14159/180.0
RETURN
END

```

```

REAL FUNCTION DEG(Y)
REAL Y
DEG = Y*180.0/3.14159
RETURN
END

```

```

C      EARTH-MARS SPRINT TRAJECTORY PROGRAM
C
C THIS PROGRAM CALCULATES ALL POSSIBLE TRAJECTORIES FROM EARTH TO
C MARS (LEO-LMO) (DIRECT) GIVEN A MAX DELTA V AT LEO AND A MAX
C DELTA V AT MARS.
C
LOGICAL BOGUS, VENUS
  REAL MUsun, VPERleo, Vleo, deltaV1, VXdepE, MUsun, Rleo, Vearth, NUmax,
>   Rearth, NUoE, Vinf1,
>   NUfM, Tmars, Rmars, Vinf2, MUmars, Vatm,
>   Rlmo, VPERlmo, Vlmo, deltaV2, VXarrM, TRAJ(2000,19),
>   Vint, Vfin, Vstep, C3theta, C31,
>   Vmars, PHIdepE, Vmax, C3, deltaNU,
>   PHImax, PHIstep, PHI, delVmax, delVlim, Tlimit
INTEGER NUM

COMMON/CONST/MUsun,BOGUS

EXTERNAL DEG,RAD

PARAMETER (Rleo=6697.05, Vleo=7.71484, MUsun=3.986E5, Rlmo=3549.0,
>   Vearth=29.79, Rearth=149.5E6, Vmars=24.14,
>   Rmars=227.8E6, MUmars=4.305E4,
>   Vlmo=3.48284)

C***** INITIALIZE VARIABLES *****

MUsun=1.327E11
NUM = 0

C***** READ IN DATA *****

WRITE(*,*)'INPUT deltaV1max,PHIstep,Vstep,',
>   'Tmax,V2max,(E-NU)m'
READ (*,*) delVmax,PHIstep,Vstep,Tlimit,
>   delVlim,NUmax

C***** CALCULATE MAX PHI (REL. 2 SUN) FOR A GIVEN POSSIBLE DEL V ****

VPERleo = Vleo + delVmax
C3 = SQRT(VPERleo**2 - 2.0*MUsun/Rleo)

PHImax = ASIN(C3/Vearth)

WRITE(6,102)
WRITE(7,108)

C***** ENTER PHI LOOP - FROM 0 TO MAX PHI *****

DO 10 PHI = 0.0,PHImax,RAD(PHIstep)

C***** DETERMINE MIN AND MAX POSS. VEL (REL. 2 SUN) FOR TRAJ 2 VENUS

```

```

      Vint = Vearth*COS(PHI) - SQRT(Vearth**2*COS(PHI)**2 - Vearth**2
>          + C3**2)
      Vfin = Vearth*COS(PHI) + SQRT(Vearth**2*COS(PHI)**2 - Vearth**2
>          + C3**2)
      Vmin = SQRT(2.*(MUsun/Rearth - MUsun/Rmars)/(1.-(Rearth/Rmars)
>          **2*COS(PHI)**2))

      IF(Vmin .GT. Vfin) THEN
      GOTO 10
      ELSEIF(Vmin .GT. Vint) THEN
      Vint = Vmin
      ENDIF

```

C***** INCREMENT VELOCITY FOR A GIVEN PHI *****

```

      DO 11 VXdepE = Vint,Vfin,Vstep
      PHIdepE = PHI

```

C***** CALCULATE TRAJ TO MARS FOR GIVEN PHI & VELOCITY *****

```

      CALL XFER(Rearth,VXdepE,PHIdepE,NUoE,NUfM,Tmars,Rmars,
>          Vinf1,VXarrM,Vmars,PHIarrM)

```

```

      IF (BOGUS) GOTO 12

```

C***** CALCULATE DELTA V 2 *****

```

      VPERlmo = SQRT(Vinf1**2 + 2.0*MUmars/Rlmo)
      deltaV2 = VPERlmo - Vlmo

      deltaNU = (Tmars)*.98562628-(DEG(NUfM-NUoE))

```

C***** RECORD TRAJ DATA IF CONDITIONS ARE CORRECT *****

```

      IF (((Tmars) .LE. Tlimit) .AND.
>      (deltaV2 .LE. delVlim) .AND. (deltaNU .LT. NUmax) ) THEN

      Vatm = SQRT(Vinf1**2+2*MUmars/3450.)
      deltaV1 = SQRT(VXdepE**2+Vearth**2-2*VXdepE*Vearth*
>          COS(PHIdepE) + 2*MUearth/Rleo) - Vleo

      C31 = SQRT((Vleo + deltaV1)**2 - 2.0*MUearth/Rleo)
      IF((PHIdepE.LE.0.000000001) .AND.
>      (PHIdepE.GT.-.000000001))THEN
      C3theta = 0.0
      ELSE
      C3theta = DEG(ACOS((Vearth**2+C31**2-VXdepE**2)/
>      (2.0*C31*Vearth)))
      ENDIF

```

```

NUM = NUM + 1

TRAJ(NUM,1) = DEG(PHIdepE)
  TRAJ(NUM,2) = deltaV1
  TRAJ(NUM,3) = deltaV2
  TRAJ(NUM,4) = deltaV1 + deltaV2
TRAJ(NUM,5) = Tmars
TRAJ(NUM,6) = DEG(NUfM-NUoE)
TRAJ(NUM,7) = 0.0
TRAJ(NUM,8) = TRAJ(NUM,6) - TRAJ(NUM,5)*0.52399058
TRAJ(NUM,9) = TRAJ(NUM,5)*.98562628
TRAJ(NUM,10) = Vatm
TRAJ(NUM,11) = C3theta

  WRITE(6,103) NUM,TRAJ(NUM,1),TRAJ(NUM,2),
>   TRAJ(NUM,3),TRAJ(NUM,5),TRAJ(NUM,9)-TRAJ(NUM,6),
>   TRAJ(NUM,4),Vatm,TRAJ(NUM,11)

  WRITE(7,107) NUM,TRAJ(NUM,13),TRAJ(NUM,15),
>   TRAJ(NUM,16)
ENDIF

12 CONTINUE
11 CONTINUE
10 CONTINUE

STOP

102 FORMAT(' REF#   PHI deltaV1  deltaV2  ',
>  ' Ttot E-NU  Vtot Vatm  C3theta')
103 FORMAT(1X,I4,4X,F5.1,3X,F7.2,6X,F5.2,4X,
>  F6.2,3X,F6.2,3X,F5.2,3X,F5.2,4X,F6.2)
107 FORMAT(3X,I3,6X,F6.2,6X,F6.2,3X,F6.2)
108 FORMAT(' REF#   Mo   Ef   Mf   ')

END

```

C***** SUBROUTINE TO CALCULATE INTERPLANETARY TRAJECTORIES *****

```

SUBROUTINE XFER(Rdep,VXdep,PHI1,NUo,NUf,TOF,Rarr,Vinf,VXarr,
>  Vtarg,PHI2)

LOGICAL BOGUS
  REAL Rdep,VXdep,PHI1,NUo,NUf,TOF,Rarr,Vinf,h,P,Exfer,a,Eo,Ef,
>  VXarr,MUsun,Vtarg,PHI2

COMMON/CONST/MUsun,BOGUS

```

```

h = Rdep*VXdep*COS(PHI1)

```

```

P = h**2/MUsun
Exfer = VXdep**2/2 - MUsun/Rdep
e = SQRT(1. + 2*Exfer*h**2/MUsun**2)
a = P/(1. - e**2)

IF (Rarr .GT. P/(1.0 - e)) THEN
  BOGUS = .TRUE.
  RETURN
ENDIF

BOGUS = .FALSE.
IF((PHI1 .LE. 0.000000001) .AND. (PHI1 .GT. -.000000001))THEN
  NUo = 0.0
ELSE
  NUo = ACOS((P/Rdep - 1.)/e)
ENDIF
Eo = ACOS((e + COS(NUo))/(1. + e*COS(NUo)))

NUf = ACOS((P/Rarr - 1.)/e)
Ef = ACOS((e + COS(NUf))/(1. + e*COS(NUf)))

TOF = SQRT(a**3/MUsun)*((Ef - e*SIN(Ef)) - (Eo - e*SIN(Eo)))
> /86400.0
VXarr = SQRT(2*(MUsun/Rarr + Exfer))
PHI2 = ACOS(h/(VXarr*Rarr))
Vinf = SQRT(VXarr**2 + Vtarg**2 - 2*VXarr*Vtarg*COS(PHI2))

RETURN

END

REAL FUNCTION RAD(X)
REAL X
RAD = X*3.14159/180.0
RETURN
END

REAL FUNCTION DEG(Y)
REAL Y
DEG = Y*180.0/3.14159
RETURN
END

```

```
C THIS PROGRAM CALCULATES THE ANGULAR DISPLACEMENT IN
C DEGREES OF THE PLANETS EARTH, MARS, AND VENUS OVER A
C GIVEN NUMBER OF DAYS AND DISPLACEMENT EARTH RELATIVE
C TO MARS.
C
```

```
REAL Dbeg, Dend, STAY, MARS, EARTH, VENUS
WRITE(*,*) 'ENTER Dbegin, Dend'
READ(*,*) Dbeg, Dend
```

```
WRITE(6,50)
```

```
DO 10 STAY = Dbeg,Dend,1.0
```

```
MARS = STAY*0.52399058
EARTH = STAY*0.98562628
VENUS = STAY*1.60264436
```

```
WRITE(6,100) STAY, MARS, EARTH, VENUS, EARTH-MARS
```

```
10 CONTINUE
```

```
STOP
```

```
50 FORMAT(' STAY MARS EARTH VENUS E-M')
```

```
100 FORMAT(2X,F4.0,4X,F7.2,4X,F7.2,4X,F7.2,4X,F5.2)
```

```
END
```

C THIS PROGRAM CALCULATES TRAJECTORIES FROM MARS TO EARTH
 C (LMO-LEO) GIVEN AN INTIAL DELTA V AT LMO

C

LOGICAL BOGUS, VENUS

```
REAL MUsun, VPERleo, Vleo, deltaV1, VXdepM, MUsun, Rleo, Vearth,
> Rearth, NUoE, Vinf1, VXarrE, NUoM, NUfE, Tearth1, Rmars, MUmars,
> Rlmo, VPERlmo, Vlmo, deltaV2, Vint, Vfin, Vstep, TAint, T Afin, NUmax,
> T Astep, PHlarrEVmars, k, PHldepM, Vmax, C3, Vatm, PHlmax, PHlstep,
> PHI, delVmax, delVlim, Tlimit, TRAJ(1000,11), Tearth2, deltaNU
```

INTEGER NUM

COMMON/CONST/MUsun, BOGUS, VENUS, k

EXTERNAL DEG, RAD

```
PARAMETER (Rleo=6697.05, Vleo=7.71484, MUsun=3.986E5,
> Vearth=29.79, Rearth=149.5E6, Rmars=227.8E6,
> MUmars=4.305E4, Rlmo=3549.0, Vlmo=3.4828, Vmars=24.14)
```

MUsun=1.327E11

NUM = 0

```
WRITE(*,*) 'INPUT deltaVmax, PHIs, Vs, Tmax, V2max, NUmax'
READ (*,*) delVmax, PHlstep, Vstep, Tlimit, delVlim, NUmax
```

```
VPERlmo = Vlmo + delVmax
C3 = SQRT(VPERlmo**2 - 2.0*MUmars/Rlmo)
PHlmax = ASIN(C3/Vmars)
```

WRITE(6,102)

```
DO 10 PHI = 0.0, -PHlmax, -RAD(PHlstep)
  Vint = Vmars * COS(PHI) - SQRT(Vmars**2 * COS(PHI)**2 - Vmars**2 + C3**2)

  Vfin = Vmars * COS(PHI) + SQRT(Vmars**2 * COS(PHI)**2 - Vmars**2 + C3**2)
```

```
Vmax = SQRT(2. * (MUsun/Rearth - MUsun/Rmars) / ((Rmars/Rearth)
> **2 * COS(PHI)**2 - 1.))
```

```
IF(Vmax .LT. Vint) THEN
  GOTO 10
ELSEIF(Vmax .LT. Vfin) THEN
  Vfin = Vmax
ENDIF
```

```
DO 11 VXdepM = Vint, Vfin, Vstep
  PHldepM = PHI
```

```
CALL XFER(Rmars, VXdepM, PHldepM, NUoM, NUfE, Tearth1, Tearth2,
> Rearth, Vinf1, VXarrE, Vearth, PHlarrE)
```



```

    VPERleo = SQRT(Vinf1**2 + 2.0*MUearth/Rleo)
    deltaV2 = VPERleo - Vleo
    deltaNU = Tearth2*.98562628 - DEG(12.56637062 - NUfe - NUoM)
    IF ((Tearth2 .LE. Tlimit) .AND. (deltaNU .LE. NUmmax) .AND.
    > (deltaV2 .LE. delVlim)) THEN
        Vatm = SQRT(Vinf1**2+2*MUearth/6478.)
        deltaV1 = SQRT(VXdepM**2+Vmars**2-2*VXdepM*Vmars*
    > COS(PHIdepM)+2*MUmars/Rlmo)-Vlmo
    NUM = NUM + 1

    TRAJ(NUM,1) = DEG(PHIdepM)
    TRAJ(NUM,2) = deltaV1
    TRAJ(NUM,3) = deltaV2
    TRAJ(NUM,4) = Tearth1
    TRAJ(NUM,5) = deltaV1 + deltaV2
    TRAJ(NUM,6) = DEG(NUfe-NUoM)
    TRAJ(NUM,7) = TRAJ(NUM,4)*.98562628
    TRAJ(NUM,8) = Vatm
    TRAJ(NUM,9) = Tearth2
    TRAJ(NUM,10) = DEG(12.56637062 - NUfe - NUoM)
    TRAJ(NUM,11) = TRAJ(NUM,9)*.98562628

    WRITE(6,103) TRAJ(NUM,1),TRAJ(NUM,2),TRAJ(NUM,3),
    > TRAJ(NUM,4),TRAJ(NUM,9),TRAJ(NUM,5),TRAJ(NUM,8),
    > TRAJ(NUM,7)-TRAJ(NUM,6),TRAJ(NUM,11)-TRAJ(NUM,10)
    ENDIF

11 CONTINUE
10 CONTINUE

    STOP

102 FORMAT(' PHI deltaV1 deltaV2 ',
    > 'Ttot1 Ttot2 Vtot Vatm Eo-NU1 Eo-NU2')
103 FORMAT(1X,F5.1,5X,F7.2,6X,F5.2,4X,
    > F6.2,3X,F7.2,3X,F5.2,3X,F5.2,3X,F6.2,3X,F6.2)

END

    SUBROUTINE XFER(Rdep,VXdep,PHI1,NUo,NUf,TOF1,TOF2,Rarr,Vinf,
    > VXarr,Vtarg,PHI2)
    LOGICAL BOGUS, VENUS
    REAL Rdep,VXdep,PHI1,NUo,NUf,TOF1,TOF2,Rarr,Vinf,h,P,Exfer,a,
    > Eo,Ef,VXarr,MUsun,Vtarg,k,PHI2

    COMMON/CONST/MUsun, BOGUS, VENUS,k

    h = Rdep*VXdep*COS(PHI1)
    P = h**2/MUsun

```

```

Exfer = VXdep**2/2 - MUsun/Rdep
e = SQRT(1. + 2*Exfer*h**2/MUsun**2)
a = P/(1. - e**2)

IF((PHI1 .LE. 0.000000001) .AND. (PHI1 .GT. -.000000001))THEN
  NUo = 3.14159
ELSE
  NUo = ACOS((P/Rdep - 1.)/e)
ENDIF
Eo = ACOS((e + COS(NUo))/(1. + e*COS(NUo)))

  NUo = 6.2831853 - NUo
  Eo = 6.2831853 - Eo
  k = 1.0

  NUf = ACOS((P/Rarr - 1.)/e)
  Ef = ACOS((e + COS(NUf))/(1. + e*COS(NUf)))
  TOF2 = SQRT(a**3/MUsun)*((Ef - e*SIN(Ef)) - (Eo - e*SIN(Eo))
>   + 6.2831853*k)/86400.0

  Ef = 6.2831853 - Ef
  NUf = 6.2831853 - NUf
  k = 0.0
  TOF1 = SQRT(a**3/MUsun)*((Ef - e*SIN(Ef)) - (Eo - e*SIN(Eo))
>   + 6.2831853*k)/86400.0

VXarr = SQRT(2*(MUsun/Rarr + Exfer))
PHI2 = ACOS(h/(VXarr*Rarr))
  Vinf = SQRT(VXarr**2 + Vtarg**2 - 2*VXarr*Vtarg*COS(PHI2))

RETURN

END

REAL FUNCTION RAD(X)
REAL X
RAD = X*3.14159/180.0
RETURN
END

REAL FUNCTION DEG(Y)
REAL Y
DEG = Y*180.0/3.14159
RETURN
END

```

```

C THIS PROGRAM CALCULATES TRAJECTORIES FROM EARTH TO VENUS TO
C MARS. (LEO-LMO) GIVEN AN INTIAL DELTA V AT LEO AND A TURN
C ANGLE AT VENUS
C

```

```

LOGICAL BOGUS, VENUS

```

```

REAL MUsun, VPERleo, Vleo, deltaV1, VXdepM, MUearth, Rleo, Vearth, NUmax,
> Rearth, NUoM, NUfV, Tvenus, Rvenus, Vinf1, THETA1, THETA2, VXarrV,
> delta, VXdepV, Vvenus, NUoV, NUfE, Tearth, Rmars, Vinf2, MUmars, Vatm,
> Rlmo, VPERlmo, Vlmo, deltaV2, VXarrE, Evenus, VPvenus, MUvenus,
> RPvenus, hv, ev, DELmax, Vint, Vfin, Vstep, TAint, TAffin, TAstep,
> PHIarrV, PHIdepV, X, Y, ARG, Vmars, k, PHIdepM, Vmax, C3, deltaNU,
> PHImax, PHIstep, PHI, delVmax, delVlim, Tlimit, TRAJ(2000,18)
INTEGER NUM

```

```

COMMON/CONST/MUsun,BOGUS,VENUS,k

```

```

EXTERNAL DEG,RAD

```

```

PARAMETER (Rleo=6697.05, Vleo=7.71484,
> MUearth=3.986E5, Vearth=29.79, Rearth=149.5E6,
> Vvenus=35.04, Rmars=227.8E6, MUmars=4.305E4,
> Rvenus=108.1E6, Rlmo=3549.0, Vlmo=3.48284,
> MUvenus=3.257E5, RPvenus=6496.35, Vmars=24.14)

```

```

MUsun=1.327E11

```

```

NUM = 0

```

```

WRITE(*,*)'INPUT deltaVmax,PHIs,Vs,TAi,TAf,TAs,Tmax,V2max,NUM'

```

```

READ (*,*) delVmax,PHIstep,Vstep,TAint,TAfin,TAstep,Tlimit,

```

```

> delVlim,NUmax

```

```

VPERlmo = Vlmo + delVmax

```

```

C3 = SQRT(VPERlmo**2 - 2.0*MUmars/Rlmo)

```

```

PHImax = ASIN(C3/Vmars)

```

```

C WRITE(*,*) C3,DEG(PHImax)

```

```

WRITE(6,102)

```

```

WRITE(7,108)

```

```

DO 10 PHI = 0.0,-PHImax,-RAD(PHIstep)

```

```

Vint = Vmars*COS(PHI) - SQRT(Vmars**2*COS(PHI)**2 - Vmars**2
> + C3**2)

```

```

Vfin = Vmars*COS(PHI) + SQRT(Vmars**2*COS(PHI)**2 - Vmars**2
> + C3**2)

```

```

Vmax = SQRT(2.0*(MUsun/Rvenus - MUsun/Rmars)/((Rmars/Rvenus)

```

```

> **2*COS(PHI)**2 - 1.))

```

```

C WRITE(*,*) Vint,Vfin,Vmax

```

```

IF(Vmax .LT. Vint) THEN

```

```

GOTO 10

```

```

ELSEIF(Vmax .LT. Vfin) THEN

```

```

Vfin = Vmax

```

```

ENDIF

```

```

DO 11 VXdepM = Vint,Vfin,Vstep

```

```

PHIdepM = PHI

```

```

C WRITE(*,*) Vint,Vfin,Vmax,DEG(PHIdepM)

```

```

C   WRITE(*,*) deltaV1

VENUS = .TRUE.

CALL XFER(Rmars,VXdepM,PHIdepM,NUoM,NUfV,Tvenus,Rvenus,
>         Vinf1,VXarrV,Vvenus,PHIarrV)
Evenus = Vinf1**2/2.0

VPvenus = SQRT(Vinf1**2 + 2.0*MUvenus/RPvenus)
hv = VPvenus*RPvenus
ev = SQRT(1.0 + 2.0*Evenus*hv**2/MUvenus**2)
DELmax = DEG(2.0*ASIN(1.0/ev))

C   WRITE(6,100)
C   WRITE(6,101) deltaV1, Tvenus, DEG(NUfV), DELmax

DO 12 delta = TAint,TAfin,TAstep
  ARG = (Vinf1**2+Vvenus**2-VXarrV**2)/(2.0*Vinf1*Vvenus)
  THETA1 = ACOS(ARG)-3.1415927

  THETA2 = THETA1 + RAD(delta)
  X = Vinf1*COS(THETA2)
  Y = Vinf1*SIN(THETA2)
  VXdepV = SQRT((X+Vvenus)**2+Y**2)
  PHIdepV = ASIN(Y/VXdepV)
  VENUS = .FALSE.
C   WRITE (3,*) delta,RAD(delta)
C   WRITE(3,*) DEG(THETA1),DEG(THETA2), X, Y ,VXdepV,ARG
  CALL XFER(Rvenus,VXdepV,PHIdepV,NUoV,NUfE,Tearth,Rearth,
>         Vinf2,VXarrE,Vearth,PHIarrE)
  IF (BOGUS) GOTO 12
  VPERleo = SQRT(Vinf2**2 + 2.0*MUearth/Rleo)
  deltaV2 = VPERleo - Vleo

  deltaNU = (Tvenus + Tearth)*.98562628-(DEG(NUfV-NUoM)
>         +DEG(NUfE-(NUoV-k*6.28319)))
  IF (((Tvenus+Tearth) .LE. Tlimit) .AND.
>     (deltaV2 .LE. delVlim) .AND. (deltaNU .LT. NUmex) ) THEN
C
  Vatm = SQRT(Vinf1**2+2*MUvenus/6247.)
  deltaV1 = SQRT(VXdepM**2+Vmars**2-2*VXdepM*Vmars*COS(PHIdepM)
>         + 2*MUmars/Rlmo) - Vlmo
  NUM = NUM + 1
C   WRITE(*,*) deltaV1
  TRAJ(NUM,1) = DEG(PHIdepM)
  TRAJ(NUM,2) = deltaV1
  TRAJ(NUM,3) = deltaV2
  TRAJ(NUM,4) = delta
  TRAJ(NUM,5) = Tvenus + Tearth
  TRAJ(NUM,6) = DEG(NUfV-NUoM)+DEG(NUfE-(NUoV-k*6.28319))
  TRAJ(NUM,7) = deltaV1 + deltaV2
  TRAJ(NUM,8) = Tvenus

```

```

TRAJ(NUM,9) = Tearth
TRAJ(NUM,10) = DEG(NUfV-NUoM)
TRAJ(NUM,11) = DEG(NUfE-(NUoV-k*6.28319))
TRAJ(NUM,12) = 0.0
TRAJ(NUM,13) = TRAJ(NUM,6) - TRAJ(NUM,5)*0.52399058
TRAJ(NUM,14) = DEG(NUfV-NUoM) - Tvenus*1.60264436
TRAJ(NUM,15) = TRAJ(NUM,5)*.98562628
TRAJ(NUM,16) = TRAJ(NUM,6)
TRAJ(NUM,17) = DEG(NUfV-NUoM) + Tearth*1.60264436
TRAJ(NUM,18) = Vatm

WRITE(6,103) NUM,TRAJ(NUM,1),TRAJ(NUM,4),TRAJ(NUM,2),
> TRAJ(NUM,3),TRAJ(NUM,5),TRAJ(NUM,15)-TRAJ(NUM,6),
> TRAJ(NUM,7),Vatm

C WRITE(6,103) delta,TRAJ(NUM,9),TRAJ(NUM,3), DEG(NUoV),
C > DEG(NUfM),TRAJ(NUM,5),TRAJ(NUM,6)
WRITE(7,107) NUM,TRAJ(NUM,13),TRAJ(NUM,14),TRAJ(NUM,15),
> TRAJ(NUM,16),TRAJ(NUM,17)
ENDIF

12 CONTINUE
11 CONTINUE
10 CONTINUE

STOP
100 FORMAT(' ,//,' deltaV1 TOFvenus NUarr MAX TURN ANGLE')
101 FORMAT(' ',F5.2,5X,F6.2,4X,F6.2,6X,F6.2,/)
102 FORMAT(' REF# PHI TA @ VENUS deltaV1 deltaV2 ',
> 'Ttot E-NU Vtot Vatm')
103 FORMAT(1X,I3,6X,F5.1,5X,F6.2,3X,F7.2,6X,F5.2,4X,
> F6.2,3X,F7.2,3X,F5.2,3X,F5.2)
107 FORMAT(3X,I3,6X,F6.2,3X,F6.2,6X,F6.2,3X,F6.2,3X,F6.2)
108 FORMAT(' REF# Mo Vo Ef Mf Vf)
END

SUBROUTINE XFER(Rdep,VXdep,PHI1,NUo,NUf,TOF,Rarr,Vinf,VXarr,
> Vtarg,PHI2)
LOGICAL BOGUS, VENUS
REAL Rdep,VXdep,PHI1,NUo,NUf,TOF,Rarr,Vinf,h,P,Exfer,a,Eo,Ef,
> VXarr,MUsun,Vtarg,k,PHI2

COMMON/CONST/MUsun, BOGUS, VENUS,k

C WRITE(*,*) Rdep,VXdep,DEG(PHI1),COS(PHI1)

h = Rdep*VXdep*COS(PHI1)
P = h**2/MUsun
Exfer = VXdep**2/2 - MUsun/Rdep
e = SQRT(1. + 2*Exfer*h**2/MUsun**2)
a = P/(1. - e**2)

```

```

C   WRITE(*,*) Rarr, P/(1.0 - e),P,Exfer,e,a,h
   IF (Rarr .GT. P/(1.0 - e)) THEN
     BOGUS = .TRUE.
C   WRITE(6,200)
     RETURN
   ENDIF
   k = 0.0
   BOGUS = .FALSE.
   IF((PHI1 .LE. 0.000000001) .AND. (PHI1 .GT. -.000000001))THEN
     NUo = 3.14159
   ELSE
     NUo = ACOS((P/Rdep - 1.)/e)
   ENDIF
   Eo = ACOS((e + COS(NUo))/(1. + e*COS(NUo)))
   IF (PHI1 .LT. 0.0) THEN
     NUo = 6.2831853 - NUo
     Eo = 6.2831853 - Eo
     k = 1.0
   ENDIF
   NUf = ACOS((P/Rarr - 1.)/e)
   Ef = ACOS((e + COS(NUf))/(1. + e*COS(NUf)))
   IF (VENUS) THEN
     Ef = 6.2831853 - Ef
     NUf = 6.2831853 - NUf
     k = 0.0
   ENDIF

   TOF = SQRT(a**3/MUsun)*((Ef - e*SIN(Ef)) - (Eo - e*SIN(Eo))
>   + 6.2831853*k)/86400.0
   VXarr = SQRT(2*(MUsun/Rarr + Exfer))
   PHI2 = ACOS(h/(VXarr*Rarr))
   Vinf = SQRT(VXarr**2 + Vtarg**2 - 2*VXarr*Vtarg*COS(PHI2))
C   WRITE (7,*) NUo,NUf,Eo,Ef,TOF
C   WRITE (7,*) DEG(PHI2), VXarr,Vinf

   RETURN

200 FORMAT('          *** TURN ANGLE INSUFFICIENT ***')

   END

   REAL FUNCTION RAD(X)
   REAL X
   RAD = X*3.14159/180.0
   RETURN
   END

   REAL FUNCTION DEG(Y)
   REAL Y
   DEG = Y*180.0/3.14159
   RETURN
   END

```

Appendix C

SAMPLE CALCULATIONS

C.1-NUCLEAR EARTH BOUND BOOST WITH 30,000 kg WAVERIDER & 15,000kg

FUEL TANK

$$DV = I_{sp}g \ln(m_o/m_f) = I_{sp}g \ln[(m_f+m_e+m_s)/(m_e+m_s)]$$

where: I_{sp} = specific impulse m_s = ship mass + fuel tank

g = gravitational constant 9.81 m/s^2 DV = delta V

m_f = fuel mass

m_e = engine mass

$$m_f = m_s[e(sV/I_{sp}g) - 1] - m_e[1 - e(sV/I_{sp}g)] \quad (P.1)$$

$$m_f = 45,000 [e(10000/9.81*1150) - 1] - 8000[1 - e(10000/9.81*1150)]$$

$$m_f = 75,598 \text{ kg}$$

C.2-FUEL MODULE CALCULATIONS

LH₂ to LO₂ space shuttle ratio for ET

$$O_2/H_2(\text{mass}) = 616,500/102,000 = 6:1 \text{ ref [39]}$$

Total fuel required for Venus Boost = 436,262 kg for del V=9 km/s

% of LO₂ & LH₂ masses: $102,000/718,500 = 14.2 \%$ therefore 85.8 % of mass is LO₂

Multiplying the fuel mass by the above percentages

$$LH_2=61,949 \text{ kg} \quad LO_2=373,312 \text{ kg}$$

Density of LH₂=68kg/m³ & LO₂=1,201kg/m³ ref [40]

$$LH_2 \text{ volume} = 61,949\text{kg}/68\text{kg}/\text{m}^3 = 911\text{m}^3 \quad LO_2 \text{ volume} = 373,312/1201 = 311\text{m}^3$$

$$\text{TOTAL VOLUME} = 1,222 \text{ m}^3$$

ASSUMING A CYLINDER WITH A DIAMETER OF 7.5 M AND IGNORING CONE SHAPE AT TOP

$$1,222 \text{ m}^3 = \text{hpi}(7.5/2)^2 \quad \text{h} = 27\text{m}$$

C.3 LH₂ & LO₂ ENGINE CALCULATIONS

$$I_{sp} = V_e/g = 450\text{sec} = V_e/9.81 \quad V_e = \text{exhaust velocity}$$

$$V_e = 4,414 \text{ m/s}$$

$$\text{Exit Area} = (.75\text{m})^2\pi$$

$$= 1.767 \text{ m}^2$$

EXIT DENSITY

$$\text{Exit density} = m(\text{dot})/A_e V_e = 120/4414 \times 1.767$$

$$= 2.94\text{e-}3 \text{ kg/m}^3$$

CHAMBER TEMPERATURE

$$\text{gamma} = \gamma = 1.22 \text{ ref. [41]}$$

$$R = (8314/18) = 461 \text{ J/kg-K}$$

$$C_p = R/(\gamma-1) = 461 \times 1.22 / (1.22 - 1) = 2,766$$

$$q = C_p (T_2(\text{total}) - T_1(\text{total})) \quad T_1 \sim 0 \text{ ref [13]}$$

$$q = (-57.802 \text{ kcal/g mole}) = \text{heat of formation of H}_2\text{O ref [40]}$$

$$q = (-57.802)(1 \text{ gmole}/18 \text{ g})(1000 \text{ g}/1 \text{ kg}) = 3,211 \text{ kcal/kg} (1 \text{ joule}/2.39\text{e-}4 \text{ kcal})$$

$$= 13,435 \text{ kJ/kg}$$

$$q = C_p T_{\text{total}} = 2766 T_{\text{total}}$$

$$T_{\text{total}} = 4,857 \text{ K}$$

EXIT TEMPERATURE

$$h_{\text{total}} = C_p T_{\text{total}} = 43,435,000 = C_p T_{\text{exit}} + V_e^2/2 = 2766 T_e + 4414^2/2$$

$$T_e = 1,335 \text{ K}$$

MACH NUMBER AT EXIT

$$M_e = 4414/\text{SQR}\{(1.22)1335 \times 461\} = 5.09$$

EXIT PRESSURE

$$P_e = (\text{Density exit}) \times R \times T_e = 2.94\text{e-}3 \times 461 \times 1335$$

$$P_e = 1.814\text{e}3 \text{ N/m}^2 = .0179 \text{ atms} \quad \gamma = \text{gamma}$$

CHAMBER PRESSURE

$$P_{\text{total}}/P_{\text{exit}} = [1 + (\gamma-1/2)M_e^2]^{\gamma/(\gamma-1)} = [1 + (1.22-1/2)5.09^2]^{1.22/(1.22-1)}$$

$$P_{\text{total}} = 3.20113e6 = 31 \text{ atms}$$

EXIT TO THROAT AREA RATIO

$$(A_e/A_t)^2 = M^{-2} \{ 2/\gamma - 1 (1 + (\gamma - 1)/2 M^2) \}^{(\gamma + 1)/(\gamma - 1)}$$

$$A_e/A_t = \text{SQR} \{ [1/5.092^{2/(1.22+1)}] [1 + 1.22 - 1/2] 5.092^{1.22+1/1.22-1} \}$$

$$A_e/A_t = 109$$

C.4 FUEL SAVINGS WITH LIGHTER ENGINE

$$m_f = 65,000 [e(9,000/9.81 \cdot 450) - 1] - 3000 [1 - e(9,000/9.81 \cdot 450)]$$

$$m_f = 454,300 \text{ kg for 3000 kg engine}$$

$$m_f = 65,000 [e(9,000/9.81 \cdot 450) - 1] - 300 [1 - e(9,000/9.81 \cdot 450)]$$

$$m_f = 436,262 \text{ kg for 300 kg engine}$$

$$m_{\text{savings}} = 454,300 \text{ kg} - 436,262 \text{ kg} = 18,038 \text{ kg}$$

C.5 NUCLEAR ENGINE CALCULATIONS

$$R = r/M = 8314/2 = 4157 \text{ J/kg-K}$$

$$C_p = R/\gamma - 1 = 4157(1.23)/1.13 - 1 = 21,828 \text{ J/kg-K} \quad \gamma = 1.23 \text{ ref [14]}$$

EXHAUST VELOCITY

$$V_e = g I_{sp} = 9.81(1150) = 11,281 \text{ m/s}$$

EXIT TEMPERATURE DETERMINATION

$$h_{\text{total}} = \text{constant} = C_p T_{\text{total}} = (21828)3444$$

$$h_{\text{total}} = 7.617e7 \text{ J/kg}$$

$$= C_p T_e + V_e^2/2 = 21,828 T_e + (11,281)^2/2$$

$$T_e = 528 \text{ K}$$

SPEED OF SOUND AT EXIT

$$a_e = \text{SQR} \{ \gamma R T_e \} = \text{SQR} \{ 1.23(4157)528 \}$$

$$a_e = 1,644 \text{ m/s}$$

EXIT MACH NUMBER

$$M_e = 11,281/1,644 = 6.86$$

EXIT AREA

$$A_e = (1.21\text{m})^2 p = 4.6 \text{ m}^2$$

EXIT DENSITY

At exit mass flow = 120 kg/s = denstiyexit(A_e)V_e=4.6m²(11,281m/s)denstiyexit
denstiyexit = 2.319e-3 kg/m³

EXIT PRESSURE

From the gas law P_e = denstiyexitRT_e = 2.417e-3(4157)528

$$P_e = 5,075 \text{ N/m}^2 = 0.0512 \text{ atms}$$

CHAMBER PRESSURE

$$P_{\text{total}}/P_{\text{exit}} = (1+[\gamma-1/2]M^2)^{\gamma/(\gamma-1)} \quad \text{ref [42]}$$

$$P_{\text{total}} = (5,075) \{1+(1.23-1/2)6.86^2\}^{1.23/1.23-1}$$

$$P_{\text{total}} = 1.049\text{e}7 \text{ N/m}^2 = 37 \text{ atms}$$

PROGRAM 1 For CASIO fx-7500G

Lbl 1:"ME"?~E:"MS"?~S:"V"?~V:"I"?~I:e(V/(Ix9.81)~K:Sx(K-1)-Ex(1-K)~F:Fdel Goto
1

ME = engine mass MS = ship mass V = del V I = I_{sp} F = answer, fuel required

PROGRAM 2 Fortran Program to Calculate Fuel Required

PROGRAM ISPPRG

INTEGER OPT,ME,ISP,MR,MS,TH

REAL D,MF,K

C MAX FUEL CONSUMED FOR GIVEN DELTA V

WRITE(*,*) ' MAX OPERATING TIME'

READ(*,*) OPT

WRITE(*,*) ' ENGINE MASS'

READ(*,*) ME

WRITE(*,*) ' ISP'

READ(*,*) ISP

WRITE(*,*) ' MASS FLOW RATE'

READ(*,*) MR

```
WRITE(*,*) ' VEHICLE MASS'  
READ(*,*) SM  
WRITE(*,*) ' THRUST'  
READ(*,*) TH
```

```
WRITE(*,*) 'SHIP MASS=',SM,'/ ENGINE MASS=',ME,'/ ISP=',ISP,'/  
-MASS FLOW RATE=',MR,'/ THRUST=',TH,'/ MAX OPT TIME=',OPT
```

```
WRITE(3,*) 'SHIP MASS=',SM,'/ ENGINE MASS=',ME,'/ ISP=',ISP,'/  
-MASS FLOW RATE=',MR,'/ THRUST=',TH,'/ MAX OPT TIME=',OPT  
C THIS IS THE BEGINNING OF THE LOOP FOR DELTA VEL
```

```
WRITE(*,*)  
WRITE(*,*) ' DELTA VEL           MIN FUEL REQ'  
WRITE(3,*) ' DELTA VEL           MIN FUEL REQ'  
DO 10 V=7000,10000,100
```

```
      K= 2.718281828**(V/(ISP*9.81))  
      MF = SM*(K-1)-ME*(1-K)  
      WRITE(*,100) V,MF  
      WRITE(3,100) V,MF  
100  FORMAT (1X,F7.1,10X,F9.2)  
10   CONTINUE
```

```
STOP  
END
```

Appendix D

CALCULATIONS FOR ON-BOARD CENTRIFUGE

OPERATIONAL SPEEDS

a = centripetal acceleration
r = radius
v = tangential velocity
w = angular velocity

$$\begin{aligned}a &= v^2/r \\v^2 &= r^2w^2 \\a &= rw^2 \\1 \text{ gee} &= 9.81 \text{ m/s}^2\end{aligned}$$

In order to have 1 gee at the body's center of mass, let $r = 1.065$ meters.

$$a = 9.81 \text{ m/s}^2 = 1.065 \text{ m}(w^2) \qquad w = 3.035 \text{ radians/s} = 29 \text{ rpm}$$

In order to have 1 gee at the feet, let $r = 2.13$ meters.

$$a = 9.81 \text{ m/s}^2 = 2.13 \text{ m}(w^2) \qquad w = 2.15 \text{ radians/s} = 20.5 \text{ rpm}$$

VOLUME AND MASS

m = mass
r = density
v = volume

Each centrifuge bed will have a width of .75 meters and a length of 2 meters. The distance from the hub will be 2.13 meters. The thickness of each bed is .1 meters. The counter-rotation disc will have thickness of .05 meters.

The volume of the centrifuge is

$$v = [2[(4.26 \text{ m})(.75 \text{ m})] - (.75 \text{ m})^2] (.1 \text{ m}) = .58275 \text{ m}^3$$

The volume of the counter-rotation disc is

$$v = p(2.13 \text{ m})^2(.05 \text{ m}) = .713 \text{ m}^3$$

The material is graphite-epoxy which has a density of $r = 1610 \text{ kg/m}^3$, so

$$\text{mass (centrifuge)} = m_c = 938 \text{ kg}$$

$$\text{mass (two beds)} = m_b = 514.4 \text{ kg}$$

$$\text{mass (disc)} = m_d = 1150 \text{ kg}$$

Also, there are 2 motors that weigh 37.5 kg each. Additional mass will come from the counterweights that will be necessary for each use of the centrifuge. Thus, the total mass of the centrifuge system is on the order of 2000 kg.

MASS MOMENT OF INERTIA

w = width

h = height

I = inertia

m = mass

r = radius

$$I = .5mr^2 \quad (\text{for a disc})$$

$$I = .067m(w^2 + h^2) \quad (\text{for a rectangular prism})$$

The centrifuge will be assumed to behave like a cross, so the inertia is

$$I = .067m_p(w^2 + h^2) + .067m_p(w^2 + h^2) =$$

$$I = .067[514.4\text{kg}](4.26^2 + .75^2)\text{m}^2 + .067[514.4\text{kg}](.75^2 + 4.26^2)\text{m}^2 = 1604.1 \text{ kg}\cdot\text{m}^2$$

The inertia of the counter-rotation disc is

$$I = .5m_d r^2 = .5(1150 \text{ kg})(2.13 \text{ m})^2 = 2608.7 \text{ kg}\cdot\text{m}^2$$

MAXIMUM POWER REQUIRED

a = angular acceleration

d = maximum displacement angle

I = inertia

P = maximum power required

t = time to reach operational speed

w = angular velocity

W = work

The maximum power required will occur at $w = 29 \text{ rpm}$

$$a = w/t$$

$$d = .5at^2$$

$$W = Iad$$

$$P = W/t$$

The power required of the centrifuge is

$$a = (3.035 \text{ radians/s})/30 \text{ s} = .101 \text{ radians/s}^2$$

$$d = .5(.101 \text{ radians/s}^2)(30 \text{ s})^2 = 45.45 \text{ radians}$$

$$W = 1604.1 \text{ kg}\cdot\text{m}^2 (.101 \text{ radians/s})(45.45 \text{ radians}) = 7363.5 \text{ J}$$

$$P = 7363.5 \text{ J}/30 \text{ s} = 245.5 \text{ W} = .33 \text{ hp}$$

The power required of the counter-rotation disc is

$$a = (2.15 \text{ radians/s})/30 \text{ s} = .072 \text{ radians/s}^2$$

$$d = .5(.072 \text{ radians/s}^2)(30 \text{ s})^2 = 32.4 \text{ radians}$$

$$W = 2608 \text{ kg} \cdot \text{m}^2 (.072 \text{ radians/s})(32.4 \text{ radians}) = 8534 \text{ J}$$

$$P = 8534 \text{ J}/30 \text{ s} = 284.5 \text{ W} = .38 \text{ hp}$$

Since the maximum operational speed requires less than half a horsepower for either centrifuge or counter-rotation disc, a 2 hp motor will be sufficient to drive either device.

REFERENCES

- [1] McGlaughlin, Thomas: "Waverider Generating Code."
- [2] Dixon, S.C.: "Structures and Materials Technology Issues for Reusable Launch Vehicles". NASA TM 87626, Oct 1985.
- [3] Tenney, Darrel R.: "Materials and Structures for Hypersonic Vehicles" NASA TM 101501, Oct 1988.
- [4] Anderson, John D.: Hypersonics and High Temperature Gas Dynamics. 1989.
- [5] Castellan, Gilbert W.: Physical Chemistry, 3rd Edition.
- [6] Camarda, Charles J. and Glass, David E.: "Results of Preliminary Design Studies of a Carbon-Carbon/Refractory-Metal Heat-Pipe Wing Leading Edge." NASP TM 1071, July 1989.
- [7] Chi, S.W.: Heat Pipe Theory and Practice. McGraw-Hill Inc, New York.
- [8] Propulsion and Reentry, Vol. XVII Congress L.A.F. 1966.
- [9] Space Nuclear Power, Angelo & Buden; Orbit Book Company, 1985.
- [10] International Series of Monographs in Aeronautics & Astronautics, Division IX. Symposia Volume 11, 1962.
- [11] Monographs: Advanced Propulsion Systems For Space Applications. Vol. 1.
- [12] Rocket Propulsion Elements. Sutton; Wiley; 1982.
- [13] Corliss, William R.: Propulsion Systems For Space. McGraw Hill, 1960.
- [14] Pedersen, Erik S.: Nuclear Energy in Space. Prentice-Hall Inc. 1964.
- [15] CRC Handbook of Chemistry & Physics, 70th Edition 1989-1990.
- [16] Personal conversations with Dr. Maurice Averner and Dr. Richard Keefe of NASA Life Sciences. Personal conversation with Dr. Frauke Westphal, a medical doctor practicing family medicine.

- [17] Hall Jr, John B; Pickett, Shelby J.; and Sage, Karen H.: "Manned Space Station Environmental Control and Life Support System Computer-Aided Technology Assessment Program." SAE Technical Paper Series 840957, July, 1984.
- [18] Wydeven, Theodore: "A Survey of Some Regenerative Physico-Chemical Life Support Technology." NASA, November, 1988.
- [19] Brinker, David J. and Flood, Dennis J.: "Advanced photovoltaic Power System Technology For Lunar Base Applications" for NASA Lewis Research Center, Cleveland, Ohio 44135-3191.
- [20] Bents, Dave, Patterson, Michael J., Berkopec, F., Myers, Ira, and Presler, A.: "Power System Technologies For The Manned Mars Mission," NASA Lewis Research Center, Cleveland, Ohio (NASA Report N87-17789).
- [21] Hartley, James G. and Colwell, Gene T.: "Development of An Emulation-Simulation Thermal Control Model For Space Station Application." Final Report NASA Grant NAG-1-551.
- [22] Ziegler, Jan.: "Life Beyond Gravity." *Air & Space*, Dec '89/Jan '90, pp. 80-87.
- [23] Dr. Malcolm Cohen: Artificial Gravity Laboratory, NASA Ames, Mount View, CA, private conversation.
- [24] Dr. Allen E. Winkelmann: Aerospace Engineering, UMCP, private conversation.
- [25] Dr. Anthony Vizzini: Aerospace Engineering, UMCP, private conversation.
- [26] Shipman, Harry L.: Humans In Space. New York, NY Plenum Press, 1989, pp. 105-110.
- [27] Gazenko, et al.: "Principal Results of Physiological Experiments with Mammals Aboard the Cosmos-936 Biosatellite." Space Biology and Aerospace Medicine. 1980, 14(2), pp. 33-37.
- [28] McMorrow, J.: "Microgravity Countermeasures." University of Maryland, College Park (June Birkley--notary public), 1990, p. 3.

- [29] Group Report: "Spacesuit Extravehicular Hazards Protection." (NASA Report N85-100458).
- [30] Group Report: "EVA Research and Development." (NASA Report N85-V1-2426).
- [31] Duke, M.B.: "Manned Mars Mission Overview." (NASA Report N86-29873).
- [32] Degioanni, Joseph C.: "Mars Mission Health Maintenance Facility." Johnson Space Center, Houston, TX, (NASA Report N87-17773).
- [33] Manned Mars Mission, A working Group Report Summary Report. M. B. Duke et. al. NASA, May 1986. pp. 86. Report # N87-17800.
- [34] Ohanian, Hans C.: Physics. W. W. Norton & Company. New York, NY, 1985.
- [35] Journal of Spacecraft & Rockets. Vol. 26 #6. Nov - Dec. 1987. Solar Cycle Effects on Space Systems.
- [36] Solar Particle Event Prediction for Manned Mars Missions. U. S. Dept of Commerce, Boulder Co. N87-17779 ppG74 - G83.
- [37] The Effects of Cosmic Radiation. N85 - 13466. pp. 19 - 22.
- [38] SICSA Outreach. Vol. 2 Number 3. July - September 1989. "Space Radiation Health Hazards Assessing and Mitigating the Risks."
- [39] Joels, Kerry Mark and Kennedy, Gregory P: The Space Shuttle Operator's Manual. Ballantine Books, New York, 1982.
- [40] Holzmann, Richard T.: Chemical Rockets. Marcel Dekker, New York & London, 1969.
- [41] Kit, Boris and Evered, Douglas S.: Rocket Propellant Handbook. New York-The Macmillan Company, 1960.
- [42] Anderson Jr., John D.: Fundamentals of Aerodynamics. McGraw Hill, 1984.

CARGO SHIP

Tzu-Liang Yen
David Singh
Craig Melton
Gerald Rainey

2.1 Introduction

(Tzu-Liang Yen)

The cargo ship, as its name implies, is an unmanned interplanetary vehicle which carries the supplies and equipment needed by the astronauts on the surface of Mars. It will be assembled at Space Station Freedom with several components that will be constructed in the space environment near the space station. With the cargo ship leading the way, the waverider will leave low Earth orbit when the cargo ship successfully arrives at Mars. Upon arriving at Mars, the cargo ship will remain in low Mars orbit until rendezvous with the waverider. At this juncture, the astronauts will disassemble the components of the cargo ship needed on Mars and send them down to the surface.

The cargo ship is made up of several components comprising of the nuclear reactor, radiation shield, heat radiator, Argon fuel for MPD thrusters, Hydrogen fuel for return trip of the waverider with its attached nuclear engine, two cargo capsules, NIMF, six ion attitude control thrusters, and seven MPD main thrusters. There are also various components which are used to channel the power from the reactor to the ion thrusters. For further clarification, see diagrams, Figures 2.1a and 2.1b. In this section, several pertinent designs of the various components will be given in its own subsection. A breakdown of the masses and distance from the center of gravity of the entire vehicle is given in Table 2.1.

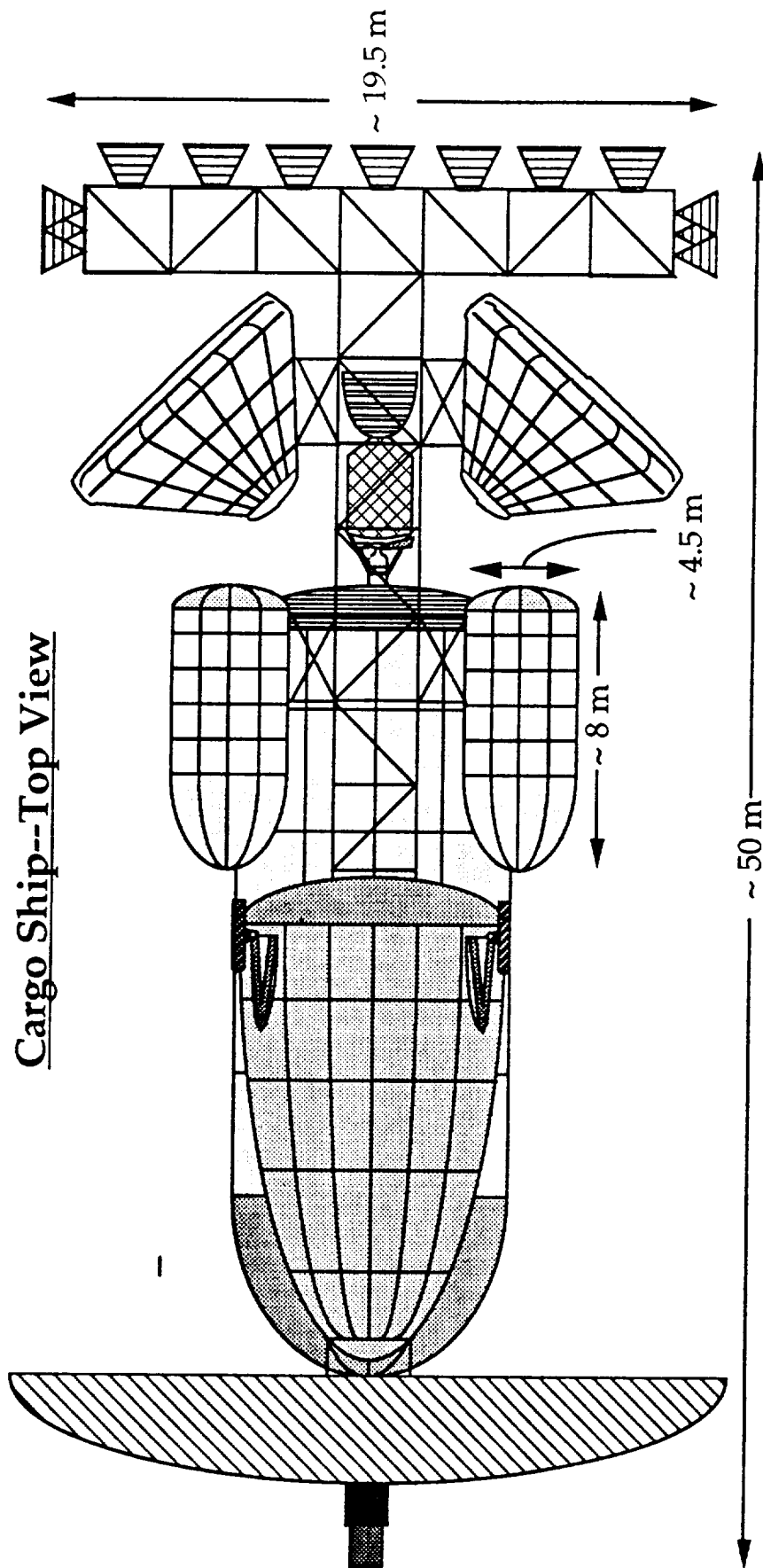

Figure 2.1a Cargo Ship Configuration and Dimensions

Cargo Ship--Side View

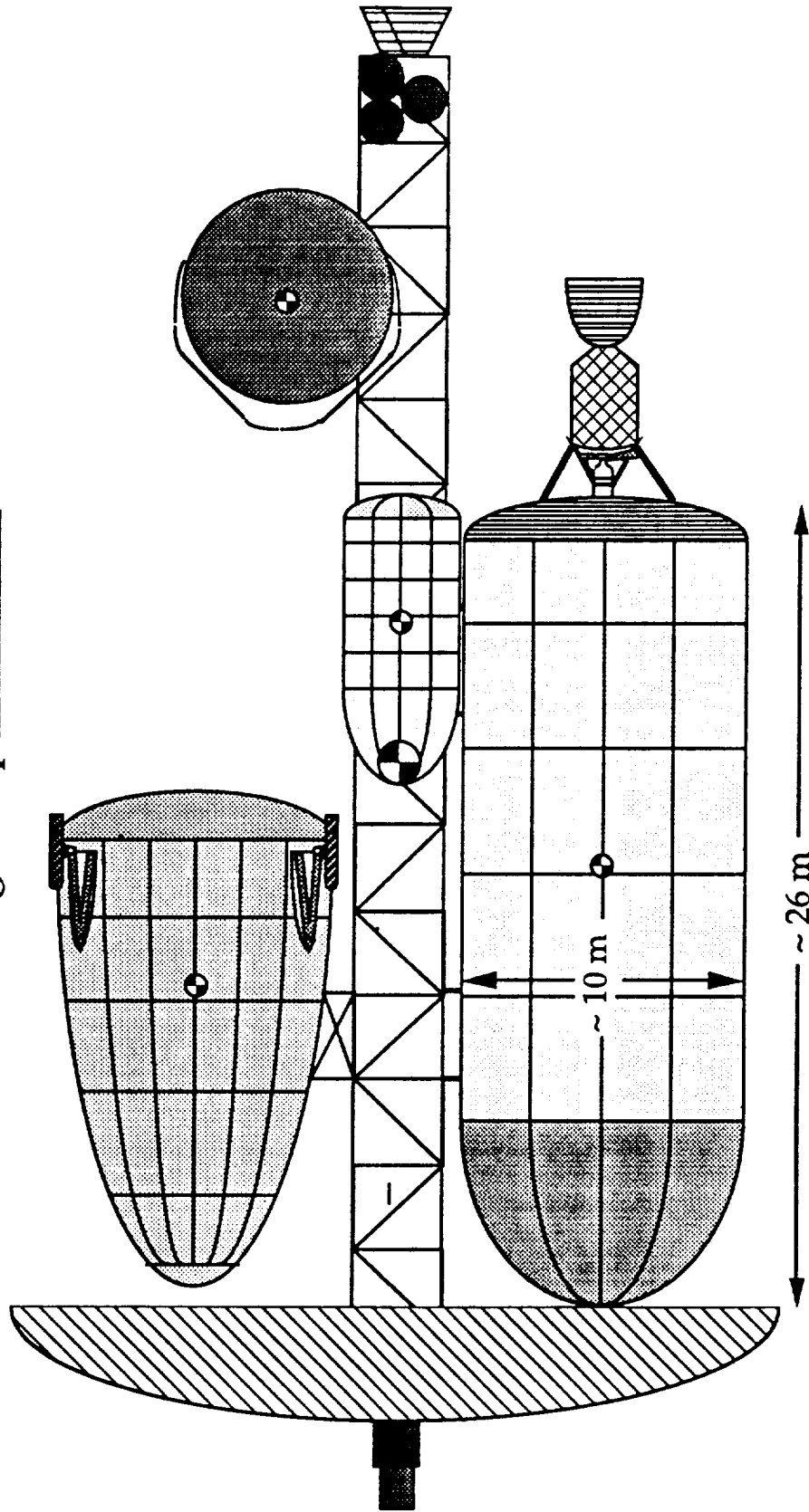

Figure 2.1b Cargo Ship Side Configuration and Center of Gravity Locations

* The center of gravity is denoted by the circles with alternating black and white quarters. The center of gravity of the entire vehicle is located approximately 18 meters from the nose.

Table 2.1 Cargo Ship Mass Breakdown

| <u>Nuclear Power Plant Assembly</u> | <u>Mass</u> | <u>Cg Distance*</u> |
|--------------------------------------|-------------|---------------------|
| Nuclear reactor | 2,310 kg | -- |
| Power plant shielding | 1,300 kg | -- |
| Power plant radiator | 3,105 kg | -- |
| 8 MPD thrusters @ 100 N each | 1,300 kg | -- |
| 6 Ion thrusters @ 100 N each | 1,100 kg | -- |
| Heat pipes and other components | 2,665 kg | -- |
| Fuel(Argon) | 134,000 kg | -- |
| <u>NIMF Assembly</u> | | ~7 m |
| NIMF(shuttle alone) | 30,000 kg | -- |
| NIMF fuel | 18,000 kg | -- |
| <u>Structure and Remaining Parts</u> | | |
| Truss | 2,300 kg | -- |
| 2 Capsules | 50,000 kg | ~6.7 m |
| Return fuel tank for waverider | 87,000 kg | ~7 m |
| Total tank mass | 13,000 kg | |
| Miscellaneous | 5,000 kg | -- |
| | ----- | |
| | 350,806 kg | |

* Applicable to those objects which will be off center.

2.2 Structures

(Tzu-Liang Yen)

2.2.1 Truss

The cargo ship is a vehicle connected by a truss to give flexibility in the arrangement and accessibility of each component. It is a desirable structure due to the type of loads that it sustains. Its main force of action is along its axis which allows for a design to withstand optimal tensile and compressive stresses. Other loads of concern on the members are the buckling loads. The tensile and compressive loads compared to these loads are usually not as significant. Thus, the design is to disallow buckling (and axial stresses). Other concerns are vibratory motion. This will be discussed in the last section on research and development.

The length and cross-sectional area of the truss members have been estimated through a program which was written to generate the buckling and axial loads that the members would feel while varying the dimensions of the members. The dimensions are given in figure 2.2.

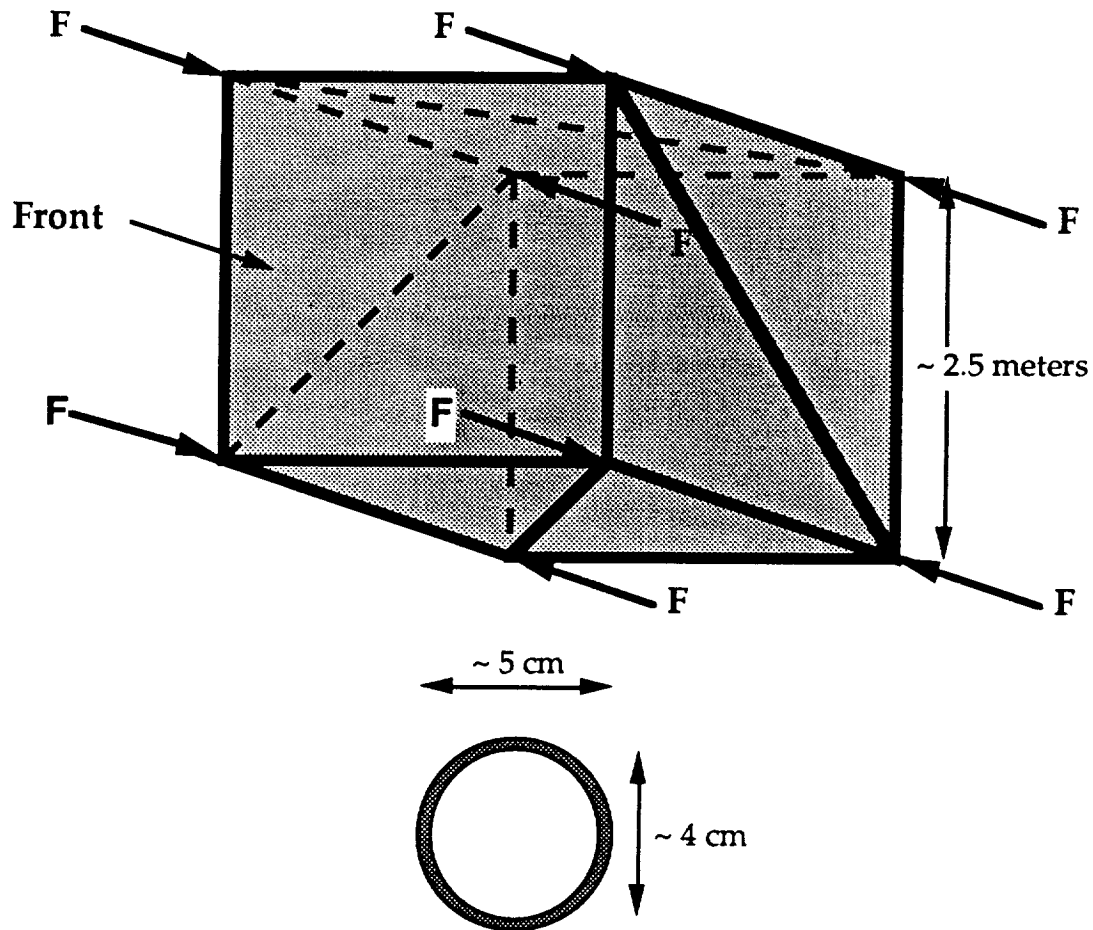

Figure 2.2 Truss Segment and Dimensions

This program was based upon the preliminary calculations using the simple buckling formula, $P_{cr} = (p^2EI)/(L^2)$ which can be converted to $P_{cr} = [p^3E(ro^4 - ri^4)]/(L^2)$ using the moment of inertia equation for the shape of the members, and the Unit Load Method, which is a derivative of the Virtual Load Method. This listing is given in appendix A. The assumptions made were that the forces were point loads and equally applied at the joints between the members. From these calculations, it was determined that for a force, F , acting on the joint of the truss, the orthogonal members had compressive or tensile loads of $F/2$ while the diagonal members had compressive loads of the force divided by the square root of two.

The materials considered for the truss members are titanium and graphite epoxy. The titanium is used for nodes(connection elements) of the truss. In using the composite, graphite epoxy, for the individual truss members, strength increases while density decreases, therefore weight decreases. The members are also clad with aluminum to prevent erosion. The erosion is due to the proximity of the atomic oxygen during construction in low Earth orbit. The construction process begins with bonding the truss member to the titanium end fittings with a cold-hardening adhesive system. These three materials are selected so that the coefficients of thermal expansion is very low [1].

2.2.2 Capsules

The cargo capsules that will be sent down to the surface of Mars will have the configuration of the Apollo capsules. This shape offers several desired characteristics. It has a high drag coefficient which is required for the rapid deceleration in Mars' thin atmosphere. It decreases the heating on the undersurface of the capsule due to the large radius curvature. Increasing the radius of curvature increases the distance between the surface and the shock. Also, if designed correctly, the structure will be stable about one orientation only. This means that during initial reentry, no matter what the attitude of the vehicle is, it will stabilize about the nose forward orientation without an attitude control system. A fourth advantage is that there is already a wealth of knowledge compiled from the Apollo program. The stability of the capsules is dependent on the center of gravity of the capsule. If it is located at approximately $0.175 D$ from the nose of the capsule, the capsule will be stable with the blunt side forward and unstable with the apex forward [2]. The shape and some dimensions of the capsules are given in Figures 2.3a and 2.3b.

Capsules for Entry into Martian Atmosphere

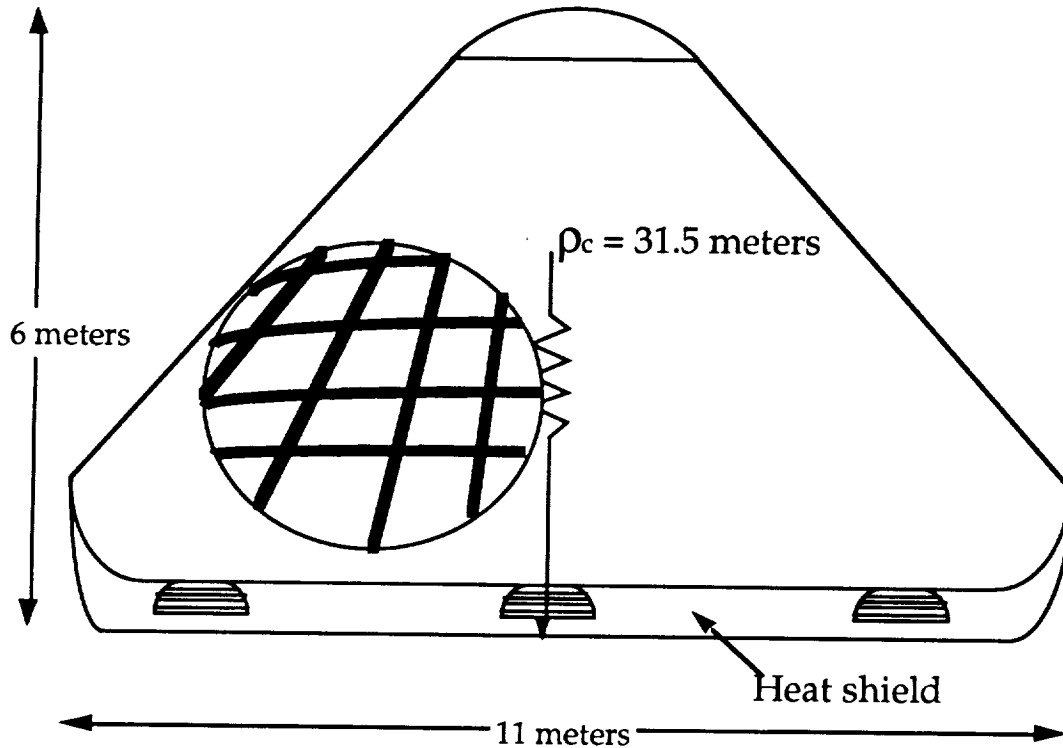

Figure 2.3a Capsule Dimensions

The reentry of the capsules of this mission will utilize the two decelerators: parachutes and retro rockets. The parachutes will be stowed in a small compartment at the tip of the apex of the capsule. After activation and deployment of the chutes, the landing gear will be extended and the heat shield for the retro rockets will be discarded exposing the nozzles, and when the capsules comes close to the surface of Mars the retro rockets will fire to decelerate to a soft landing velocity.

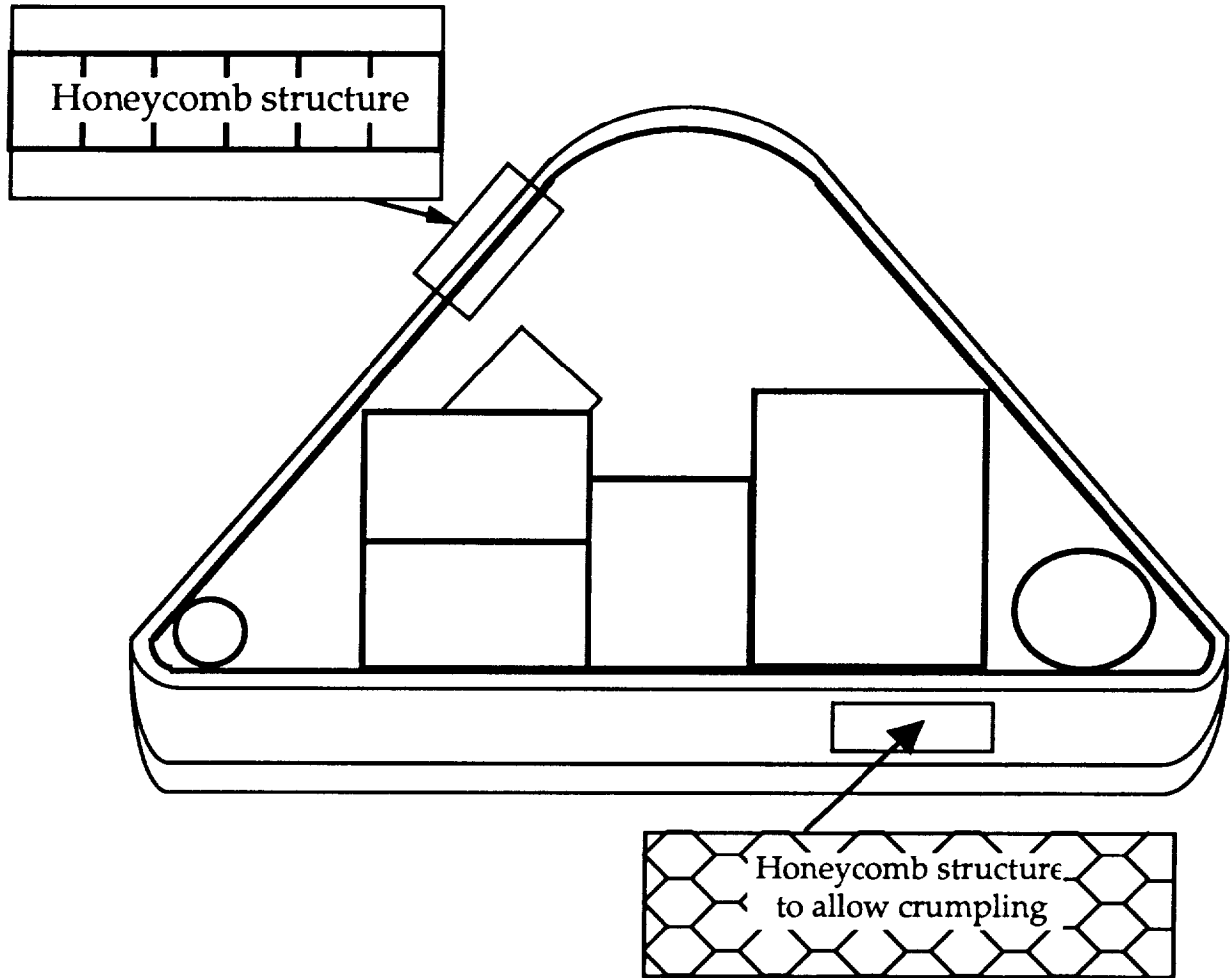

Figure 2.3b Capsule Conceptual Design

The materials considered for the capsules are Carbon-Carbon composites and aluminum alloys. The composites are used for the undersurface of the capsule. This surface comes in contact with the greatest heat. From the calculation made by trajectory, the 1400 Kelvin can be easily withstood by the composite material. The infrastructure of the capsules will probably be made out of materials such as boron-aluminum. Although this material is probable, it will not necessarily be used, because the development of composite technology may advance to a level where the confidence in the reliability of the structure is comparable to those of the metals previously utilized. The chute material will probably be nylon which has a density of approximately one kilogram per square meter. These chutes for the mass of the

capsules can be in the form of three 67 meter diameter chutes, two 81 meter diameter chutes, or one 115 meter diameter chute. These values were generated from a ratio taken from performance requirements needed for the Viking mission [3]. These values would give a mass in the thousands of kilograms. Thus, it is probable that larger retro rockets will be required.

Although the capsule has a crushable floor, it is felt that landing gears are needed. It has been proposed to insert legs in between the outer and inner surface walls. Part of the leg will be braced against the honeycomb structure of the side walls used for structural integrity. This will also allow crumpling of the side wall honeycombs. Figure 2.4 shows this proposal.

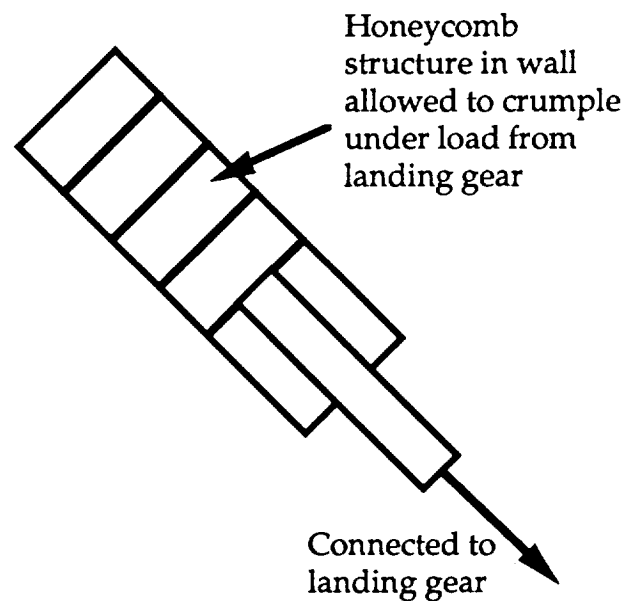

Figure 2.4 Feasible Landing Gear Design

2.2.3 Fuel Tanks

The fuel tanks used on this mission are the two argon fuel tanks and the hydrogen tank. The reason for using two tanks of argon is to maintain the balance of the cargo ship. Although the individual tanks are smaller than the hydrogen tank, the mass of the two argon tanks with fuel outweigh the hydrogen tank by nearly a factor of two. Design of the tanks have not yet been carried out carefully. It is given that both types of tank will require cryogenic containment, which requires the need of a superinsulation. Figure 2.5 gives a general design of the fuel tank based on the volume requirement of the liquid hydrogen. The external shell of these tanks is composed of the superinsulation, honeycomb for structural integrity, and the external skin. In designing it in this manner micro-meteorites will ricochet off the skin when striking an area in the pocket of the comb.

2.2.4 Power Plant

The only structural component of the power plant that is of concern here is the radiator. Currently, the exact dimensions of the structure have not yet been determined. For purposes of calculating the aerodynamic loads and heating descending to the surface of Mars, dimensions based on the area requirement for the dissipation of heat from the reactor are needed. These dimensions are shown in Figure 2.6.

The radiator will be also be used as a heat shield for the reactor and radiation shield of the power plant during descent into the atmosphere. The radiator will take the form of a hexagonal heat shield panels attached to a tetrahedral support truss with connections of the three non adjacent vertices of the hexagon to the three of the equilateral triangle. The radiator pipes which are the principal components of the radiator will be placed behind the shield. This design of the heat shield is such

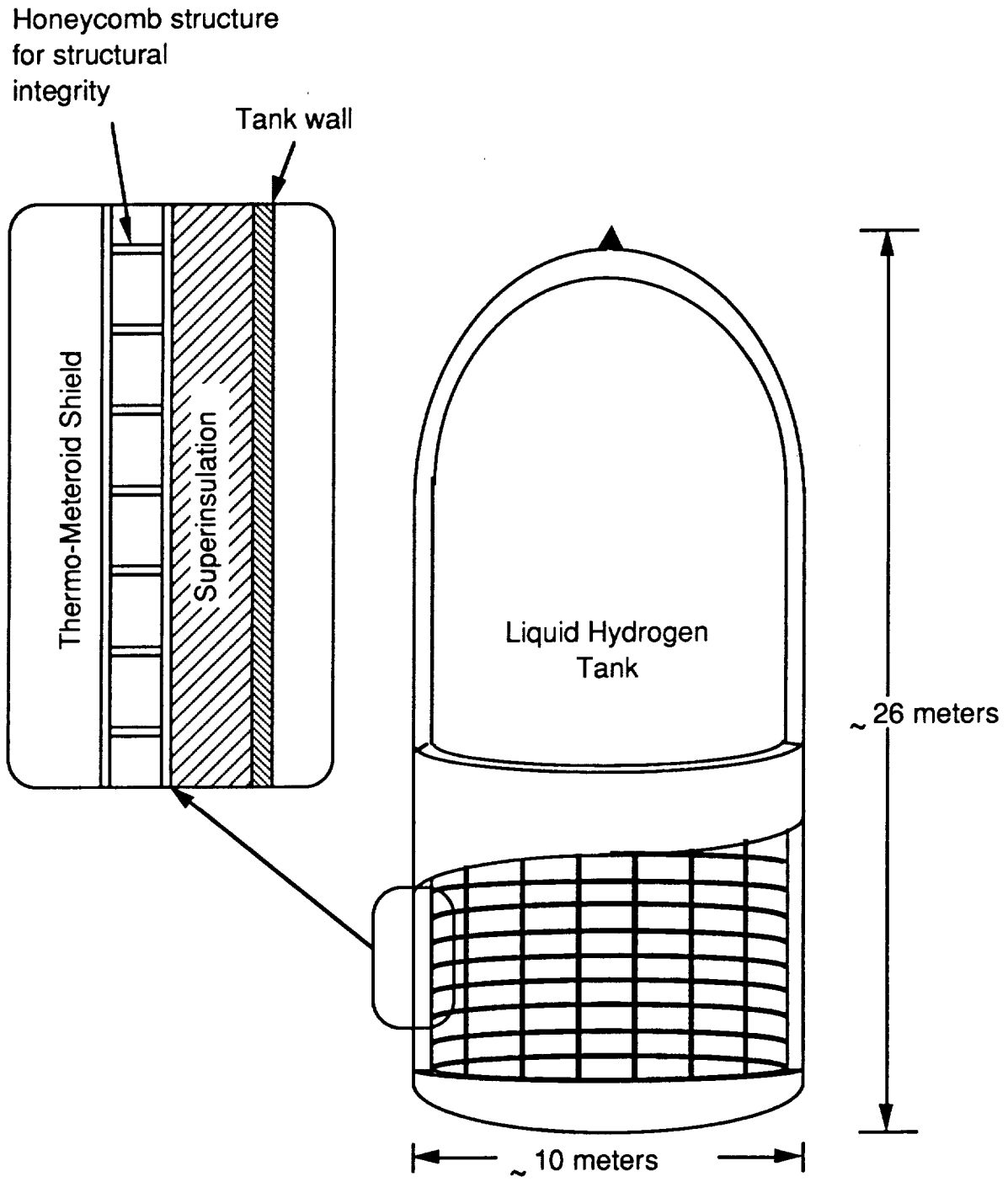

Figure 2.5 Fuel Tank Shape and Dimensions

that no viscously heated gases will penetrate the graphite epoxy face plates of the shield. The face plates themselves are sandwiches of the G/E plates with a aluminum honeycomb core [4].

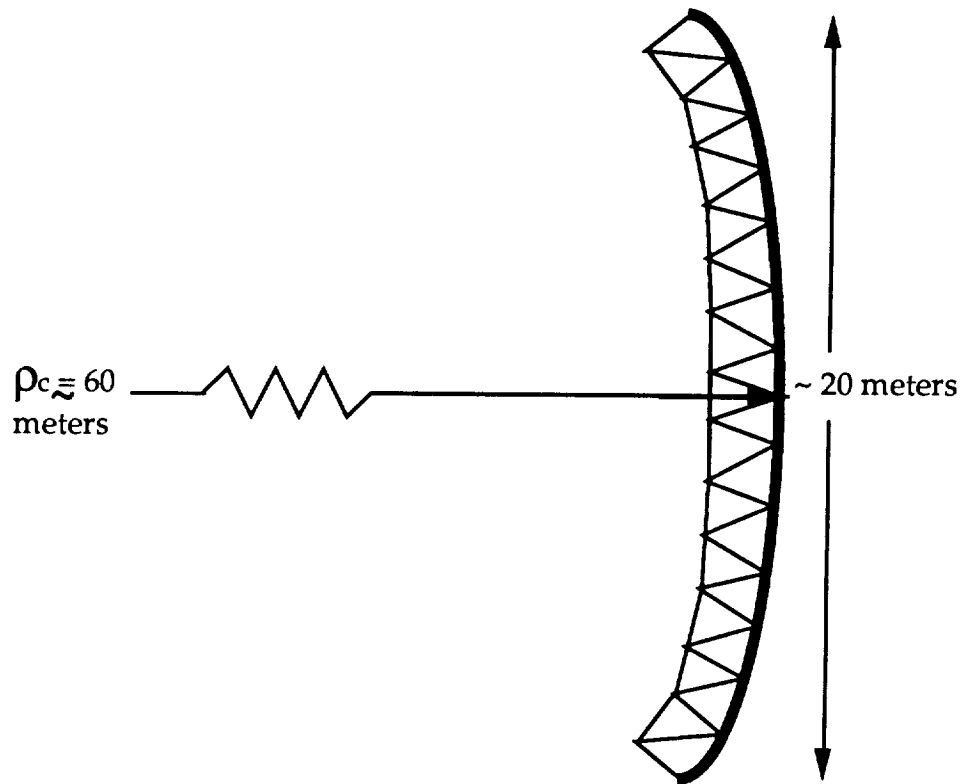

Figure 2.6 Dimensions of Radiator

The process of sending down the power plant is to first remove the reactor and radiation shield and place them behind the radiator/heat shield. Since this arrangement will place the center of gravity of the combination close to the convex surface of the shield, it will make the structure stable about one orientation like in the case of the Apollo-shaped capsules.

2.2.5 NIMF

The NIMF shuttle will be discussed in detail in the surface mission volume.

2.2.6 Research and Development

Further research will be conducted on the possibility of using composite materials for the majority of the structures. If this is proven feasible, it will result in greater fuel, cost, and weight savings. Investigation into the use of actuators to straighten out truss structure due to deformation of members will also be carried out [5]. Analysis of vibrations of entire vehicle through techniques such as "matrix iteration" and "rotation method" will be performed.

2.3 Propulsion

(David Singh)

For this mission, a large payload consisting of the Martian base equipment, the NIMF shuttle/lander, and the return fuel and engine for the waverider, is required to be delivered from Low Earth Orbit (LEO) to Martian parking orbit. Since the volumetric capacity of the waverider craft is too small to transport this massive load, a cargo ship has been designed to perform this mission.

The main purpose of the cargo ship is to deliver a maximum payload both efficiently and inexpensively to Mars. Since mission time is not of great importance, a low thrust orbital maneuver can be considered for this cargo vehicle. A nuclear-electric propulsion system was compared to both advanced chemical boosters and a nuclear-thermal rocket as possible options for this specific mission.

2.3.1 Chemical Propulsion Option

A chemical propulsion system would have been very easy to incorporate into the cargo vehicle design because of the level of development of present and near-future chemical boosters. Advanced chemical thrusters using cryogenic liquid hydrogen/liquid oxygen fuel provide very high thrust to weight values during the extremely short burn times. Utilizing a standard high energy Opposition Class

trajectory, the total flight time to Mars would be 254 days [6]. This is a fairly short time compared to various other trajectories.

The major drawback of a chemical propulsion system is the low specific impulse (Isp). The maximum available Isp is approximately 460 seconds, because the kinetic energy of the combustion process is limited by the energy released by the chemical reaction between the fuel and oxidizer. Since a hydrogen/oxygen mixture is the most efficient and practical chemical propellant, the maximum available Isp will not increase significantly with any other type of fuel.

Since the specific impulse is limited to 460 seconds, the exhaust velocity will remain less than 4500 m/sec. Therefore, a large fuel mass will be required to achieve the necessary delta V for this mission. As can be seen from Table 2.2, 855,770 kg of fuel would be needed to deliver a 215,000 kg spacecraft from Earth to Mars. Not only will this amount of fuel be costly to produce and store on Earth, but it will also be very expensive to launch into LEO. Seven separate launches of the Advanced Launch System (ALS) would be required to get this mass into orbit. Using an orbiting fueling station would also be expensive due to the large volume necessary to store this fuel in orbit.

| | CHEMICAL | NUCLEAR-THERMAL | NUCLEAR-ELECTRIC |
|-------------------------------|---------------------|------------------------|-------------------------|
| SPECIFIC IMPULSE (SEC) | 460 | 950 | 4000 |
| THRUST (N) | 2.1*10 ⁶ | 1.1*10 ⁶ | 115 |
| TRAJECTORY TYPE | HOHMANN | HOHMANN | SPIRAL |
| DELTA V (KM/SEC) | 7.5 | 7.5 | 18.1 |
| TOTAL TRAVEL TIME | ~6 MONTHS | ~6 MONTHS | 601 DAYS |
| FUEL MASS (KG) | 855,770 | 235,406 | 134,000 |

Table 2.2 Mission Characteristics Comparison

There are many additional problems and risks in using chemical fuel. If liquid propellants are used, there is the possibility of spontaneous combustion due to the presence of hydrogen and oxygen. The choice of solid propellants has a greater risk due to the extreme instability and flammability of the fuel. Also, large cryogenic fuel tanks will be needed in order to store the fuel during the trip.

Although chemical boosters appear to be a likely propulsion choice for the cargo ship due to its high thrust to weight ratio and relatively short trip time, it is not ideal for this specific mission because the low specific impulse and the resulting large fuel mass pose a major design problem.

2.3.2 Solid-Core Nuclear Rocket Option

Solid-core nuclear thermal rockets are another possibility for propelling the cargo ship. This system operates by passing hydrogen fuel through the core of a nuclear reactor and heating it to a high temperature. The propellant is then expanded out a nozzle to produce thrust. Since a nuclear reaction is the energy source for this system, virtually any fuel can be used with the reactor, and there is no requirement for the additional mass of an oxidizing fuel.

Since exhaust velocity is inversely proportional to the square root of the molecular weight of the fuel, the lightest possible propellant, hydrogen (H_2), will be used. This provides vastly superior specific impulse values over conventional chemical boosters. An Isp of 950 seconds can easily be achieved while providing similar thrust values as chemical boosters. Exhaust velocity is also proportional to the square root of total temperature, T_0 , so the maximum possible core temperature is desired.

However, the limiting constraint of solid core nuclear rockets is that the core temperature cannot exceed the melting temperature of the core materials. With the

current material technology of carbon-based materials and tungsten alloys, the maximum T_0 must be less than 2700 K. Also, at high temperatures, hydrogen has a tendency to corrode the core materials. These factors need to be taken into consideration during the design of the solid-core engine.

More advanced gas-core nuclear thermal rockets avoid the material limitations of solid-core rockets by passing the fuel through a high temperature uranium plasma. Theoretically, Isp values can reach upwards of 6000 sec. with core temperatures as high as 20,000 K. A sample round-trip cargo mission using gas-core rockets has been estimated to take 280 days [7]. However, these advanced rockets are still in the developmental stages and will not be available before the mid-21st century.

The availability of solid-core nuclear engines for the cargo vehicle will not be a problem. Several engines were successfully tested during the NERVA project, and modernized versions can easily be developed in a fairly short time. Since solid-core engines are being built for both the waverider vehicle and the NIMF lander, a variant of the engine can be produced for use on the cargo ship. Although the cost of developing a nuclear engine will be very high, the savings in launching less fuel into LEO can amount to \$1 billion [7]. The necessary fuel for a minimum-energy Hohmann transfer trajectory is 235,406 kg, significantly less than is required by the chemical boosters. Also, since volatile oxidizers will not be necessary for a nuclear rocket, handling and storage of the propellants is much easier. These make the solid-core nuclear rocket more attractive than chemical boosters.

However, the possible safety concerns and general public hysteria about nuclear-thermal rockets may pose a problem in incorporating these engines into the cargo vehicle. Accidental re-entry of the nuclear core into the atmosphere can be disastrous. The risks resulting from using nuclear-thermal rockets on the cargo ship

should be avoided if possible. Therefore, a more efficient and safer propulsion system would be more ideal.

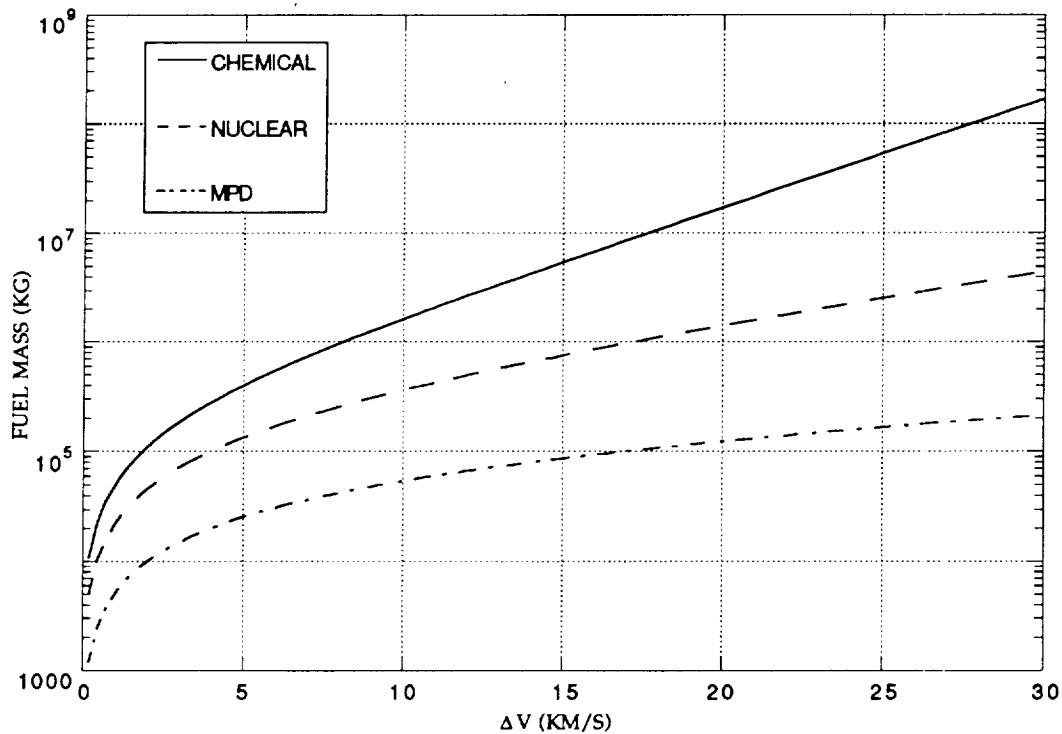

Figure 2.7 Fuel Mass Comparison

2.3.3 Nuclear-Electric Propulsion Option

A nuclear-electric propulsion (NEP) system was determined to be the most attractive propulsion option for this mission. This system consists of a multi-megawatt nuclear power plant which generates electricity necessary to operate the Magnetoplasmadynamic (MPD) thrusters. The MPD thrusters generate an electrical arc between an anode and a cathode which then ionizes the propellant. The resulting plasma is then electromagnetically accelerated through the MPD nozzle to

create thrust. The resulting exhaust velocity is extremely high, and specific impulse values ranging from 3000 to 9000 seconds can be attained.

Since fuel mass is related exponentially to the inverse of the specific impulse, large fuel savings can be achieved by using an NEP system. In order to transport a 200,000 kg payload from LEO to Martian parking orbit, only 134,000 kg of fuel would be required. This is significantly less than the corresponding required fuel for the chemical and nuclear-thermal propulsion systems. As can be seen from Table 2.2, the fuel savings achieved by using an NEP system is extremely large.

Although the NEP system provides extremely low acceleration levels, the performance is continuous over very long periods of time. Therefore, mission time is not greatly effected. Although the specific cargo mission is to deliver a large payload of cargo to Martian orbit, the outstanding performance of an NEP system can be observed in a manned mission scenario. In a sample manned Martian exploratory mission, three mission types were studied: Conjunction class, Opposition class, and Spiral class transfer trajectories.

A Conjunction mission is a low-energy ballistic transfer in which the trajectory spans 180 degrees. It has a relatively short transfer time, but Earth and Mars will be out of phase for the return trajectory, so an extremely long stay time of 1.45 years will be required. The total mission time for such a mission will be 1009 days [8].

Another type of trajectory is the high-energy Opposition transfer. This provides a very short transfer time, but a stay time of only 20 days would be possible on the Martian surface due to the alignment of the planets. A total mission time of 519 days will be possible, but a large-scale exploratory mission will not be possible [8].

If a low-thrust spiral trajectory is used for the same mission, it can cut down the total mission time of a Conjunction mission and increase the total stay time of a Opposition mission. Although the spacecraft will take over 600 days to reach Mars,

the stay time can be increased to 100 or 200 days. The total mission time will last 2.5 years, much less than low-energy ballistic case [8].

Although the resulting fuel savings are significant, NEP systems have not been seriously considered for such a mission largely from the lack of a suitable power source. Instead of being energy-limited like chemical rockets, NEP systems are essentially power-limited; i.e. performance is limited by the amount of electricity that is produced by the system [9]. The generation of multi-megawatt power levels is limited by the design of the nuclear reactor, which must be lightweight and compact. In the past, an NEP system was not considered for a long-term space mission due to the insufficient level of development of space nuclear power plants. However, with the results of the SP-100 program, in which a 100 kW reactor was successfully developed for space applications, the practicality of a multi-megawatt power plant proved feasible [10]. A power system capable of generating 1 MW of electricity is projected to be available during the 1990's, and a multi-megawatt power plant can be developed by the early years of the next century [11].

Another major concern of the NEP system is the availability of high performance MPD thrusters. Relatively high specific impulse values and thruster efficiencies have been achieved; however, thruster lifetimes have been unsatisfactory in laboratory testing. Also present are problems in electrode erosion, dissociation, and plasma instability. However, it has been projected that these problems can be corrected in the near future [12].

The NEP system was chosen over the chemical and nuclear-thermal boosters due to the increased fuel mass savings and large deliverable payload. Although the NEP system is a very technologically ambitious project for the unmanned cargo vehicle mission, its increased performance and efficiency far outweigh the necessary development costs.

2.3.4 Trajectory

Since the NEP system provides thrust values of only 115 N, a high-energy trajectory cannot be utilized for this mission. Therefore, a low-thrust spiral trajectory must be incorporated into the mission design. The NEP system provides continuous low thrust over a large portion of the transfer trajectory.

The spiral trajectory consists of three separate legs: Earth escape spiral, outbound coast, and Martian capture spiral. The transfer begins with the 52 day Earth escape spiral over which the cargo vehicle slowly escapes the Earth's gravitational well by making many spiraling orbits. The spacecraft then coasts for several months until it refires its engines to straighten its orbit. When the cargo vehicle approaches Mars, it begins to spiral over a period of 39 days until it reaches Martian parking orbit [8].

Since the spiral trajectory is a low-thrust maneuver, the total mission time lasts a period of 601 days, or 1.65 years. This is significantly longer than if a high-energy Hohmann transfer was utilized. However, due to the nature of the mission, a shortened trip is not required. Since the payload is only cargo, it is only necessary for the cargo ship to reach Martian parking orbit before the waverider vehicle.

A problem associated with a low-thrust spiral trajectory is that a significant period of time is spent in the Earth's radiation belts. However, the cargo vehicle is unmanned, so only the payload needs to be shielded. If a NEP system was to be used for a manned mission, the crew would probably board the vehicle at geosynchronous orbit, so as to avoid exposure to the radiation belts.

| <u>MISSION TIME (DAYS)</u> | |
|----------------------------|-----------|
| EARTH SPIRAL | 52 |
| OUTBOUND COAST | 510 |
| <u>MARS SPIRAL</u> | <u>39</u> |
| TOTAL | 601 |

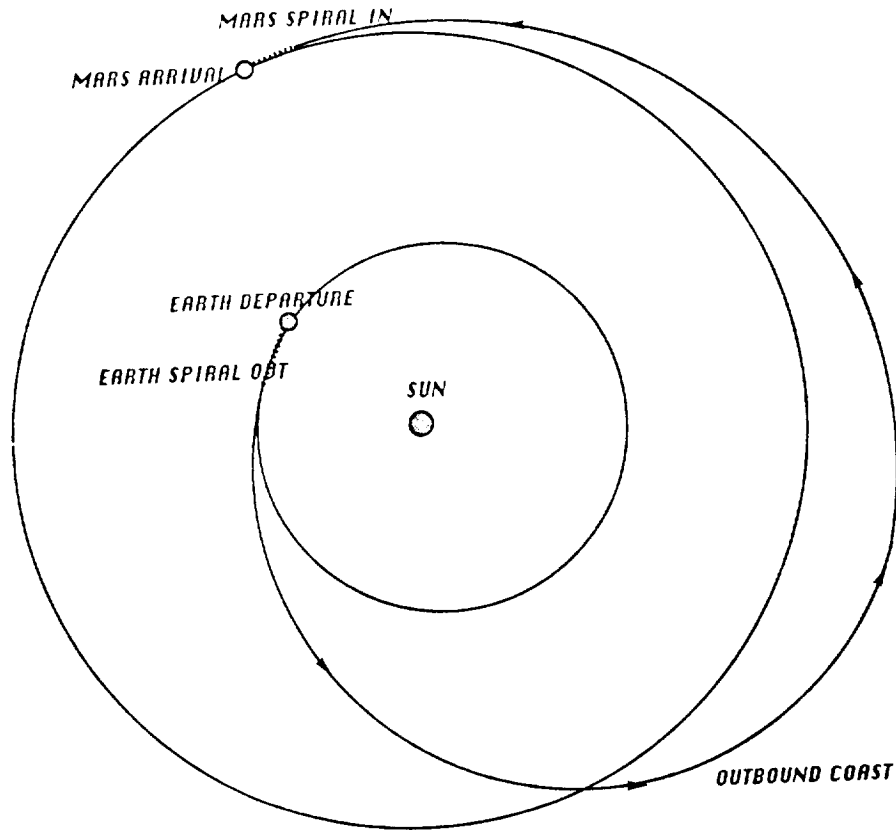

Figure 2.8 Low Thrust Spiral Trajectory To Mars

A possibility to avoid the long time spent in the radiation belts is to have a high-energy chemical or nuclear-thermal booster to escape the Earth's magnetic field. However, the resulting mission time is only slightly improved, but the fuel mass is almost doubled due to the additional booster. Therefore, a pure low-thrust transfer is desired.

2.3.5 Nuclear Power Plant

The main component of the nuclear-electric propulsion system is the space nuclear power plant. This generates all of the power necessary for the MPD thrusters and the onboard power systems. The space nuclear power plant consists of four main sub-systems:

1. Nuclear Reactor
2. Neutron Reflectors
3. Radiation Shield
4. Heat Transportation and Rejection System

The nuclear reactor is a $5 \text{ MW}_e / 20 \text{ MW}_t$ distributed heat transport design. This type of reactor is favored over conventional solid-core reactors mainly because of safety reasons. The absence of a core pressure vessel increases the chances of core burn-up in case of an accidental atmospheric re-entry. Also, in case of land impact, the core reactor will be in a subcritical configuration. The curved structure of the reflector prevents core compression in the case of impact [13].

Another reason for using a distributed heat transport reactor is due to the inherent redundancy in the design. This significantly decreases the mass and dimensions of the system as compared to a solid-core reactor. The total mass of a 5 MWe distributed heat reactor is only 2310 kg. The reactor is a cylindrical shape 67.6 cm high and 67.6 cm in diameter [13].

The reactor uses uranium dioxide (UO_2) as fuel in wafer form. The average fuel temperature is approximately 1500 K. However, the maximum attainable temperatures are around 1700 K. Fuel swelling is accommodated by the porosity of the UO_2 . An alternative form of fuel is coated particles. In this case, fuel swelling is absorbed in a porous graphite coating [14].

The core is surrounded by a thin containment can and layers of insulation that can significantly reduce the heat leakage of the reactor. However, during

nuclear fission, neutrons tend to scatter away from the reactor and leak out of the core. Therefore, a neutron reflector surrounds the core to improve the neutron efficiency of the system. The reflector is constructed of a material that has low neutron absorption characteristics and a high scattering cross-section, such as beryllium or graphite.

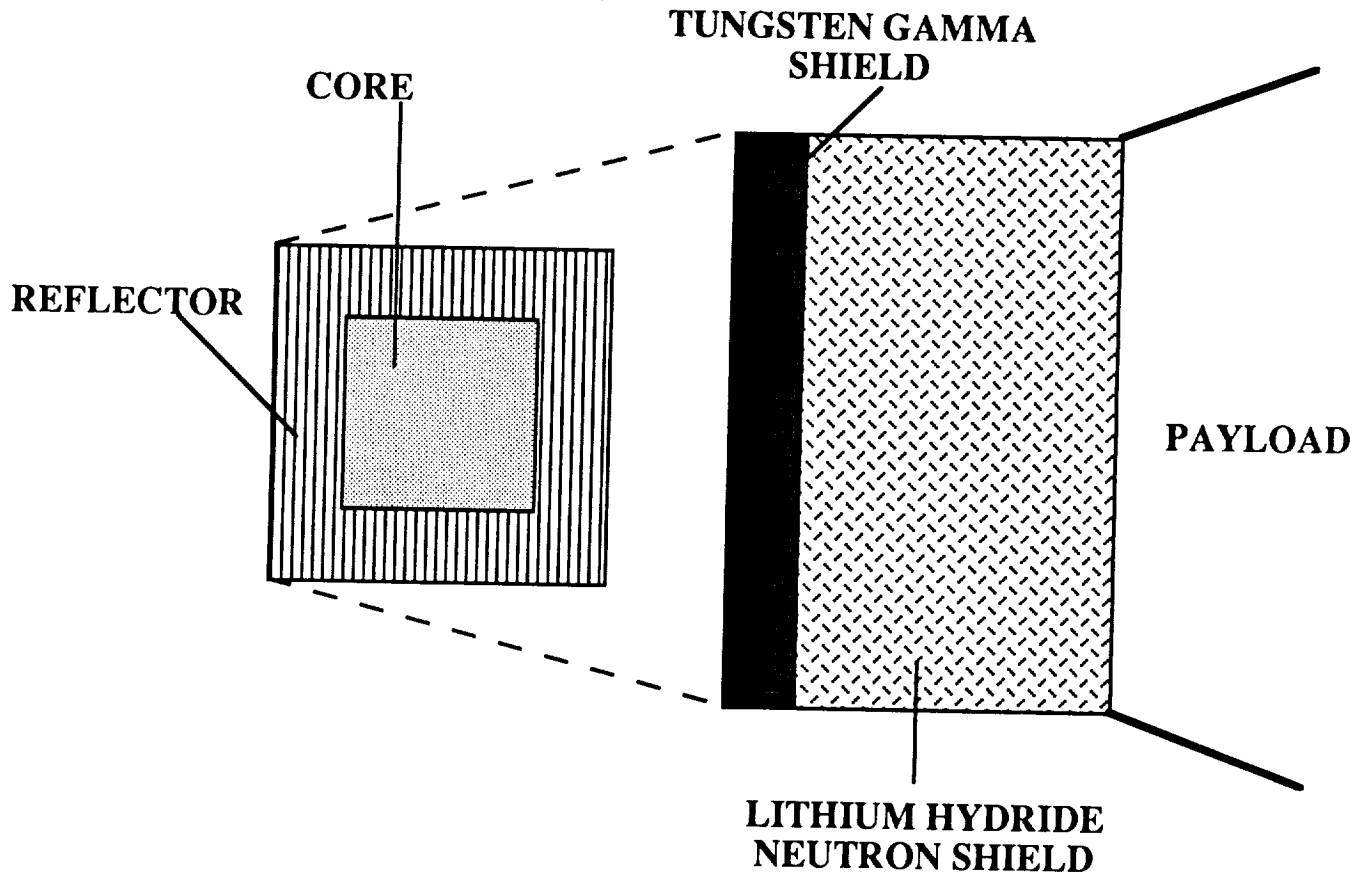

Figure 2.9 Shielding & Reflector Configuration

The neutrons that leak out of the core scatter into the reflector material and some are reflected back into the core. The use of a reflector reduces the critical mass of the nuclear power plant and supports flux flattening in the core [13]. The resulting uniform power generation increases the efficiency of the system.

The radiation shield is necessary to protect the cargo vehicle from the radiation emitted from the nuclear reactor. The shielding design depends upon the size and nature of the reactor, the configuration of the spacecraft, the length of the mission, the type of mission, and the total dosages permitted.

For this mission, a preferential four-pi contoured shield will be designed. This type of shield is a shadow shield that provides protection in all directions around the radiation source, but emphasizes protection in one preferred direction, the position of the ship. The shield is constructed of lithium hydride neutron absorber and tungsten gamma radiation shielding [13]. The lithium hydride shield prevents neutrons created from the nuclear processes from penetrating through and bombarding the vehicle. The tungsten shield absorbs gamma radiation emitted from the reactor, and prevents contamination of the payload (Figure 2.9).

Since the cargo ship is an unmanned vehicle, the mass of the shielding is not as large as if it was a manned vehicle. That is because the allowed radiation dosage for manufactured structures is larger than that for humans. Manufactured structures can withstand a neutron dose of 10^{11} to 10^{14} n/cm² and a gamma dose of 106 to 109 rad. This compares to respective maximum human dosages of 108 n/cm² and 500 rad [13]. Therefore, a man-rated shield might weigh 4 to 6 times the weight of an unmanned vehicle shield.

Since the core temperature of the reactor can reach upwards of 1500 K, coolant paths are needed to remove waste heat from the core. Therefore a heat transportation and rejection system is needed to be incorporated into the design. This consists of two components that are necessary to prevent the nuclear reactor from overheating -- heat pipes and the waste heat radiator. This system must be designed such that it will have the capability to minimize mass and minimize thermal losses, remove all excess heat from the system, start up after shut-down,

prevent cooling fluid leakage, and accommodate all thermally induced dimension changes.

Heat pipes are devices that are responsible for removing waste heat from the nuclear power plant by transporting a working fluid between the reactor and the radiator [14]. They are self-contained components that do not require pumps or compressors for heat transport. They attain very high thermal conductances by means of two-phase flow with capillary circulation.

The ability of a heat pipe to transfer thermal energy is proportional to the latent heat of vaporization of the working fluid (See Figure 2.10). Therefore, a fluid such as lithium, with a latent heat of vaporization of 20,525 kJ/kg is ideal for heat pipe use [13]. The working fluid operates between the heated and cooled regions and circulates in two phases, liquid and gas. The waste heat from the reactor vaporizes the cooling fluid which then travels to the condenser region in the radiator. The fluid is then cooled by releasing heat into the surrounding space and condenses back into a liquid. The liquid then flows back to the reactor and repeats the process.

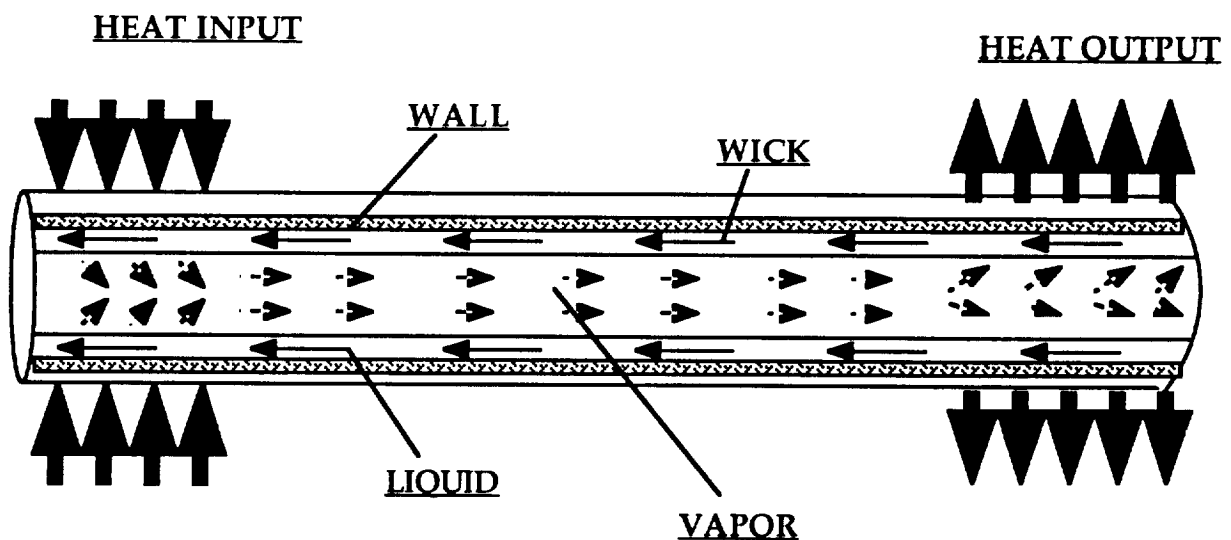

Figure 2.10 Heat Pipe Structure

The heat pipe structure must be constructed such that it allows two phase flow to be present. A wick structure provides capillary action which permits the return of the cooling fluid liquid back to the reactor. Also, the wall should be constructed of thin material since thermal energy is transferred through conduction heat transfer. The design of a distributed heat transport reactor allows for several heat pipes to fail without endangering the entire system (Figure 2.10).

The waste heat radiator is a structure designed according to the power level and the operating temperature of the nuclear reactor. The amount of radiated waste heat is determined by the Stefan-Boltzmann law to be proportional to the fourth power of the radiating surface temperature. For this design, 290 heat pipes are constructed into a radiator with a surface area of 310 m² [13]. This type of heat transport system is preferential over more advanced concepts, because the loss of a single heat pipe will not affect the system output due to the elimination of single failure points. Also, the heat pipes are 98% reliable over a period of 7 years [13]. However, conventional heat pipe radiator technology is satisfactory up to only 5 MW. At higher power levels, an advanced heat rejection system would be necessary due to the enormous amounts of excess heat. However, for our design, heat pipe radiator technology is sufficient.

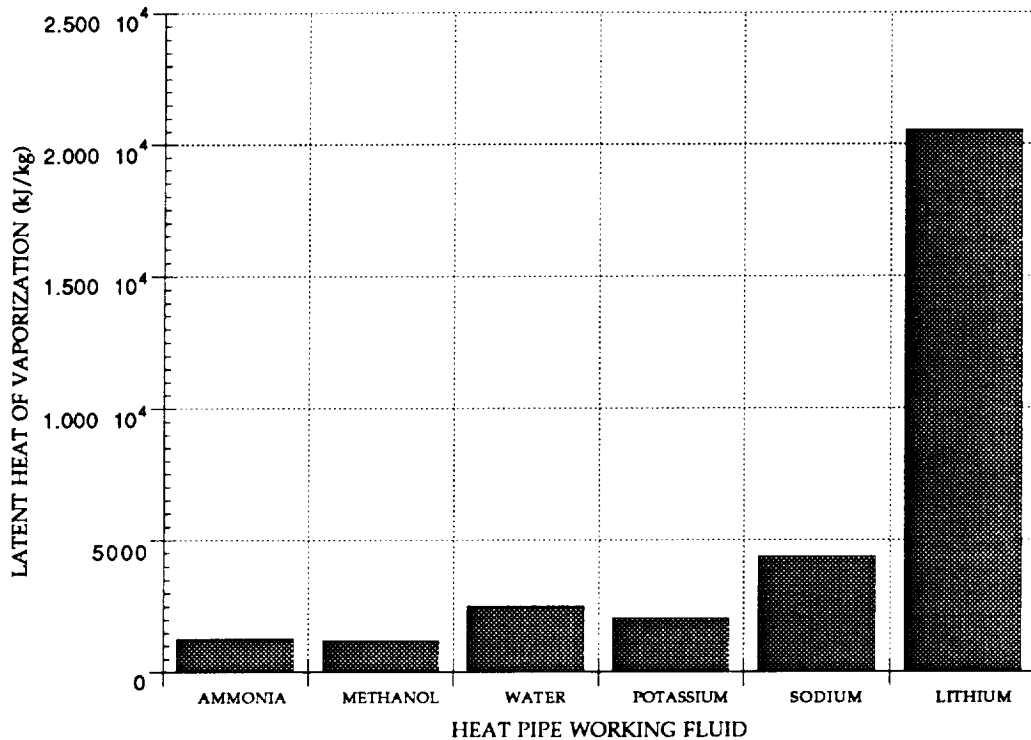

Figure 2.11 Latent Heat of Vaporization of Heat Pipe Working Fluid

2.3.6 MPD Thrusters

The main engines for the cargo ship will be Magnetoplasmadynamic (MPD) thrusters. These engines ionize propellant and electromagnetically accelerate the resulting plasma to very high speeds. The plasma is then expanded out through a nozzle to produce thrust. Although MPD thrusters are still in the development stages, the prospect of using them in cargo-type low thrust missions is extremely attractive.

Exhaust velocities have been measured ranging from 15,000 to 80,000 m/s in laboratory conditions. These can provide extremely high specific impulse values on the order of 1500 to 8000 seconds. Thus the resulting fuel mass is significantly less than comparable chemical or nuclear-thermal systems. (See Figure 2.7)

For this mission, seven MPD thrusters will be fired individually in succession. This will provide the necessary delta-V for the cargo ship to achieve a constant low acceleration necessary to complete the spiral trajectory. A thrust of 115 N will be assumed for an Isp of 4000 seconds, thus giving a thruster efficiency of 50%. This is a reasonable value since efficiencies ranging from 10% to 30% with specific impulses of 1000 to 4500 seconds have already been achieved in laboratory testing [12].

A number of possible fuels were studied for the cargo mission. Hydrogen and lithium have provided very high thruster efficiencies at higher specific impulse values, but they both are not attractive for use on this mission. Hydrogen fuel will need to be cryogenically stored for the long mission, and this will require large amounts of power and advanced storage systems. Lithium does not have a storage problem, but the resulting exhaust from the MPD thrusters can possibly plate the cargo vehicle surface.

Potassium propellant is extremely attractive, because its low ionization potential provides a very high thrust efficiency. Also, potassium can be stored in a solid form and then liquefied at 62 degrees Celsius before use. However, again there is the possibility of the exhaust coating the spacecraft surface. Xenon and mercury were also considered as propellant possibilities. However, the amount of xenon required for the mission will be difficult to produce due to the low quantities of it naturally occurring on Earth. Mercury has been studied as a possible propellant for several decades since it can provide outstanding performance values, but its toxic characteristics eliminate it as a viable option.

Overall, argon was proven to be the most attractive propellant, because it presents no storage problems or performance constraints. Argon propellant can easily be stored in a liquid form in cryogenic tanks. A 16,301 kg cryogenic argon storage tank has already been designed with a mass of only 721 kg [11]. Also, the

resulting specific impulse and thruster efficiency is sufficient for this specific mission.

Since MPD thrusters are still in the research and development stages, there are several technological problems that will need to be solved before an effective thruster can be developed. Among these are electrode erosion, plasma instability, and dissociation losses [14]. Anode erosion is especially prevalent when using argon propellant. The MPD system might suffer losses of 15 to 40% due to anode and dissociation losses. Over the last several decades, electrode erosion has been significantly reduced due to the amount of research directed into this field [12]. Also, plasma instability contributes toward efficiency losses and poses another major problem in MPD thruster development. All of these design problems must be answered before a high performance argon-fueled MPD thruster can be developed for this mission.

2.4 Cargo Ship Vehicle Reentries

(Craig Melton)

2.4.1 Reentry Description

The cargo ship reentry vehicles include the NIMF shuttle, two cargo capsules of similar geometry, and the reactor with its heat shield. All of the above enter as non-lifting ballistic bodies. The model atmosphere and calculation methods for Martian reentry can be found in Appendix B. The major advantage of ballistic reentry is a relatively short "critical" heating period. The reentry vehicle reaches the lower, denser altitudes quickly giving a high heating rate per unit time, but the total heat transferred is not that high due to the quick deceleration period. This justifies the use of blunt nosed heat sink type reentry configurations.

The major disadvantage to a ballistic reentry path is a limited landing range. Unlike lifting vehicles which may have a landing range of hundreds of kilometers a ballistic body has little directional control and therefore little control over its landing site. To keep the NIMF within reasonable range of the cargo capsules upon landing the timing for release of the capsule and shuttle are critical. Differences in geometry give the capsules and shuttle different decelerations at different times leading to different reentry flight times and downrange distances as shown in Figure 2.12. The cargo ship, traveling at an orbital speed of 3.34 km/sec, will first release the NIMF shuttle 1195 km. from the landing site. The cargo ship will be released 3.5 seconds later and the reactor 91 seconds later for close landing proximity.

2.4.2 Martian Reentry Heating Characteristics

All Martian reentry heating problems were analyzed using an Allen and Egger's model. (See "A Comparative Analysis of the Performance of Long Range Hypervelocity Vehicles" by Egger's, Allen and Neice, NACA TN 4046, Oct. 1957.)

For a description of heating analysis see Appendix C

Table 2.3 lists the time rate of average heat input per unit area (dH_{av}/dt) and the time rate of local stagnation region heat input per unit area (dH_s/dt) for each reentry body. These heating rates and maximum temperatures are very reasonable and well below the melting points of the reentry materials.

| | NIMF | Cargo Capsule | Reactor Capsule |
|----------------|-----------------------|-----------------------|------------------------|
| dH_{av}/dt | .84 W/cm ² | .65 W/cm ² | .044 W/cm ² |
| dH_s/dt | 24 W/cm ² | 21 W/cm ² | 2 W/cm ² |
| Stag. Temp. | 1400 K | 1400 K | 1100 K |
| Max. Temp. Alt | 9.8 km | 14 km | 34 km |

Table 2.3 Reentry Heating Characteristics

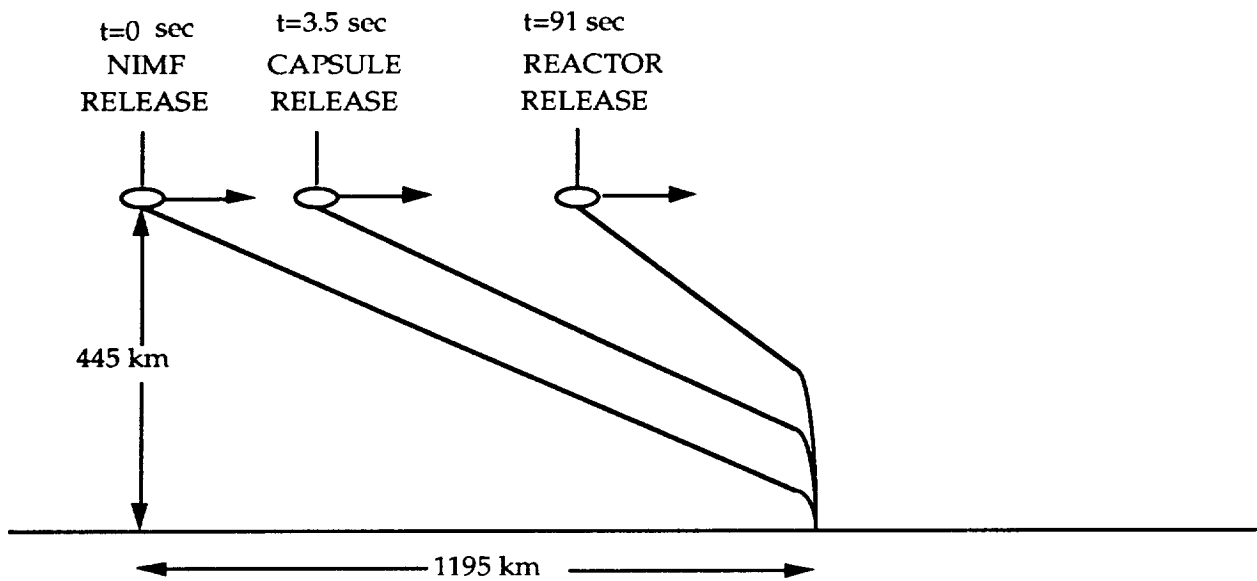

Figure 2.12 - Cargo Ship Re-entry Body Release Diagram

| | <u>NIMF SHUTTLE</u> | <u>CARGO CAPSULE</u> | <u>REACTOR CAPSULE</u> |
|------------------|-----------------------|-----------------------|------------------------|
| MASS | 30000 kg | 25000 kg | 10000 kg |
| ENTRY ANGLE | 20 deg. | 20 deg. | 25 deg. |
| DRAG COEFF. | 2.0 | 2.0 | 2.0 |
| FRONTAL AREA | 80 m ² | 95 m ² | 310 m ² |
| BALLISTIC PARAM. | 707 Pa. | 487 Pa. | 60 Pa. |
| MAXIMUM DECEL. | 18 m/sec ² | 18 m/sec ² | 22 m/sec ² |
| MAX. DECEL. ALT. | 9.8 km. | 14 km. | 34 km. |
| TIME OF FLIGHT | 482 sec. | 487 sec. | 390 sec. |
| RANGE | 1195 km. | 1184 km. | 885 km. |

TABLE 2.4 Reentry Body Characteristics

2.4.3 NIMF Shuttle Reentry

The NIMF shuttle will be injected into the Martian atmosphere by a short firing of its main engine. It will then rotate to proper reentry attitude employing directional thrusters and then maintain a constant entry angle of 20 degrees. The vehicle will approach its maximum deceleration of 18 m/sec² at an altitude of 9.8 km. traveling at a speed of 2 km/sec. The large parachute will then be deployed with simultaneous firing of the main engine to rapidly decelerate the vehicle for

landing. Deploying landing gear will also help to decelerate the vehicle, though landing gear drag will not be necessary to slow the vehicle. In case of landing gear failure, the vehicles structure will survive though the main engine nozzle will be destroyed. For this reason a spare nozzle is included in a cargo capsule for quick replacement.

2.4.4 Cargo Capsule Reentry

The two cargo capsules will be injected into the Martian atmosphere by thrusters at an entry angle of twenty degrees. Each capsule will approach its maximum deceleration of 18 m/sec^2 at an altitude of 14 km at a speed of 2 km/sec. Parachutes will then be deployed along with firing of thrusters to slow the capsules to landing speeds. Landing gear drag is not necessary for minimum deceleration. Landing gear failure does not constitute cargo loss due to the shock absorbency of the capsule floors honeycomb structure.

2.4.5 Nuclear Reactor Capsule Reentry

The nuclear reactor capsule will be injected into the Martian atmosphere at an angle of 25 degrees. It will reach its maximum deceleration of 22 m/sec^2 at an altitude of 34 km at which time it will deploy a large parachute for landing.

2.5 Conclusion

(Gerald Rainey)

Due to the volume restrictions of the waverider a cargo ship had to be designed. The design of an extra interplanetary vehicle can be justified by the fact that one ship would be extremely massive and require an extremely powerful propulsion system along with an incredible amount of fuel. No humans are aboard the cargo ship, therefore the low thrust trajectory can be used which requires low

thrust propulsion which in turn has the lesser fuel mass requirement. Also the use of a cargo ship is justified by the size and mass of the payload that is required for the surface mission and the return trip. New technology has been introduced in the cargo ship design with the use of MPD thrusters. More research will be required to perfect their performance and reliability. Further calculations and research will also have to be devoted to determining launch dates in order to ensure a LMO arrival of the cargo ship and launch of the waverider that will minimize the total storage time of the cargo ship payload. An important design advantage of the cargo ship and the entire mission is that the nuclear power plant for the cargo ship will also be used as the power plant for the Martian base. The overall importance of the cargo ship is that it allows the use of a manned waverider mission which performs a Venus aerogravity assist. Without it, the waverider would not be feasible.

APPENDIX

APPENDIX A
DETERMINATION OF FUEL TANK DIMENSIONS

```
10   CLS
20   COUNT = 0
30   FINAL = 1911!
40   VFMIN = 1E+10
50   PU = 200
60   PI = 3.14159
70   E = 7.5E+10
80   LT = 100
90   FOR L = .5 TO 5 STEP .5
100  FOR RI = 0 TO .1 STEP .005
110  COUNT = COUNT + 1
120  PRINT INT(10000*COUNT/FINAL)/100; "% CALCULATED"
130  RO = ((4*L*L*PU/1.41414)/(E*PI^3)+ RI^4)^.25
140  V=PI*(RO^2-RI^2)*L
150  ROD = ((8*L*L*PU)/(E*PI^3)+RI^4)^.25
160  VD = PI*ROD^2-RI^2)*1.414#*L
170  VT = 8*V + 4*VD
180  N = INT(LT/L+1)
190  VF=N*VT + 4*V
200  IF VF < VFMIN THEN GOSUB 290
210  NEXT RI
220  NEXT L
230  PRINT "VMIN = "; VFMIN
240  PRINT "RO = ";RODES
250  PRINT "RO, DIAG = ";RODDES
260  PRINT"RI = "; RIDES
270  PRINT "L = "; L
280  END
290  VFMIN = VF
300  LDES = L
310  RODES = RO
320  RODDES = ROD
```

330 RIDES = RI

340 RETURN

APPENDIX B
MARTIAN ATMOSPHERE MODEL AND
CALCULATION METHODS

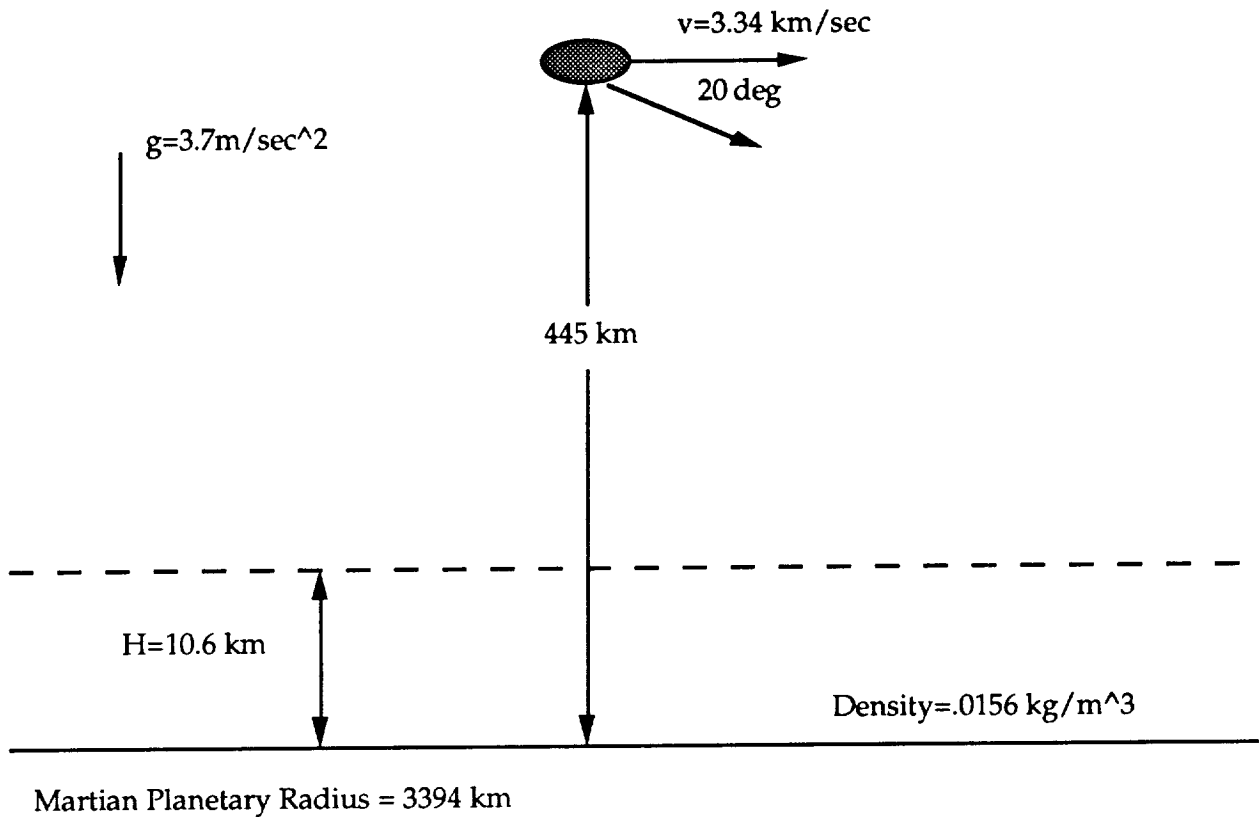

MARTIAN ATMOSPHERIC MODEL

The Martian atmosphere will be assumed to be a non-rotating sphere with an exponential atmosphere of the form $\rho = \rho_0 e^{-by}$ where beta is the inverse of the scale height H which equals 10.6 km. for Mars. (see Hypersonic and Planetary Entry Flight Mechanics by Vinh, Busemann, and Culp, p.4) A parking orbit of 445 km. gives an orbital speed of 3.34 km/sec.

The ballistic re-entry with no lift calculations were based on Loh's equations. Several assumptions were made to break the equations into a workable form.

Loh's basic equations are:

$$dV/dt = -(\rho g V^2 / 2b) + \sin \gamma$$

$$V(d\gamma/dt + dq/dt) = g \cos \gamma - (\rho g V^2 / 2b)(Cl/Cd)$$

$$(R + h)dq/dt = V \cos \gamma$$

$$dh/dt = -V \sin \gamma$$

Where:

| | |
|--|---|
| γ = entry angle (degrees) | b = ballistic parameter (Pa) = mg/CdS |
| V = velocity (m/sec) | q = inertial reference frame (deg.) |
| R = planetary radius (m) | h = altitude (m) |
| g = gravitational accel. (m/sec ²) | ρ = density (kg/m ³) |
| Cl = lift coefficient | Cd = drag coefficient |

By assuming constant angle and disregarding lift, gravitational, and centrifugal forces these equations can be rewritten in more convenient forms. The final forms used for calculations were:

$$Z = H \ln [\rho_0 g h / b \sin \gamma]$$

$$na = V_e^2 \sin \gamma / 2 g e h$$

$$V = .6065 V_e$$

Where :

| |
|---|
| Z = Maximum decel. altitude (m) |
| na = maximum axial deceleration (m/sec ²) |
| V_e = entry velocity (m/sec) |

See Re-entry and Planetary Physics and Technology Dynamics, Physics, Radiation, Heat Transfer and Ablation, Springer-Verlag New York, Inc., 1968 by Loh for more detailed derivation.

From the simplified forms of the equations a computer code was written to survey a variety of entry angles and velocities. Final entry angles were chosen on the basis of where maximum deceleration took place (preferably somewhere above

the surface of the planet) in order to minimize the decelerative thrust needed to slow the particular vehicle in consideration.

APPENDIX C REENTRY HEATING

A complete analysis of the Allen and Egger's heating analysis method can be found in Dynamics and Thermodynamics of Planetary Entry by Loh, Prentice-Hall, Inc., Englewood Cliffs, N.J., 1963. The formulas of concern are:

$$(dH_{av}/dt) = 1/4Cf r_0 V_f^3 e^{-by} \exp[(-3Cdr_0A/2bmsin\theta_f)e^{-by}]$$

$$(dH_{av}/dt)_{max} = b/6e(Cf/CdA)mV_f^3 \sin\theta_f$$

$$(dH_s/dt) = k/(s).5(r_0 V_f^3)e^{-.5by} \exp[(-3Cdr_0A/2bsin\theta_f)e^{-by}]$$

$$(dH_s/dt)_{max} = k(bmsin\theta_f/3eCdsA).5(V_f^3)$$

Where: dH_{av}/dt = average heat input per unit area (W/m²)

dH_s/dt = local stagnation region heat input per unit area (W/m²)

C_f = skin friction coefficient

b = atmospheric parameter

V_f = entry velocity (m/sec)

θ_f = entry angle

s = re-entry body nose radius (m)

A = frontal area (m²)

m = re-entry body mass (kg)

C_d = drag coefficient

y = altitude (m)

For the Martian atmosphere the maximum heat input per unit area and maximum local stagnation region heat input per unit area would occur at some negative altitude (within the planet) for our vehicles. Therefore our maximums simply occur when we apply our decelerative thrust at the maximum deceleration altitude.

REFERENCES

- [1] Levin, G. M.: Advanced Solar-Propelled Cargo Spacecraft For Mars Missions. June, 1989.
- [2] Department of Aeronautics and Astronautics, University of Washington, Seattle, Washington. "Advanced Solar Propelled Cargo Spacecraft for Mars Missions," June, 1989.
- [3] Illinois University, Urbana-Champaign: Aerospace Vehicle Design, Spacecraft Section. N89-20123/0/HDM, May 1988.
- [4] Burdisso R. A. and Haftka R. T. "Optimal Location of Actuators for Correcting Distortions in Large Truss Structures," *AIAA Journal* Vol. 27 p. 1406-11, October 1989.
- [5] Bendura, Richard and Whitlock, Charles: Flight Test Performance of Supersonic Parachutes in Low Density Environment. NASA-TN-D-5296, 1969.
- [6] Timnat, Y.M. Advanced Chemical Rocket Propulsion. Academic Press, Orlando. FL., 1987.
- [7] Borowski, S.K. et.al. "Nuclear-Thermal Rockets: Next Step to Space," *Aerospace America*, June 1989.
- [8] The NASA Mars Conference. ed. Duke Reiber. vol 71 American Astronautical Society, San Diego, 1988.
- [9] Hill, P. and Peterson, C. Mechanics and Thermodynamics of Propulsion. Addison-Wesley Publishing Co., Reading, MA, 1965.
- [10] Electric Propulsion and Its Applications to Space Missions. ed. R. Finke. AIAA, New York, 1979.
- [11] Coomes, E.P. and King, "Pegasus: A Multi-Megawatt Nuclear-Electric Propulsion System," PNL-SA Paper No. 13510, 1987.

- [12] Sovey, J.S. and Manteniaks, M.A. "Performance and Lifetime Assessment of MPD Arc Thruster Technology," NASA Paper, 1987.
- [13] Angelo, J. and Buden D. Space Nuclear Power. Orbit Book Co., Malabar, FL, 1985.
- [14] Aerospace Century XXI: Space Flight Technologies. ed. G. Morgenthaler. American Astronautical Society, San Diego, 1987.

SURFACE MISSION

James McMorrow
Guru Tej Khalsa
Masoud Irampour
George Grewe
Dilene Adams
Kalpesh Patel

3.1 Introduction

(George Grewe)

The major components of the surface mission are the NIMF shuttle, the 5-MW nuclear reactor power supply, the main dome, the two landing capsules, the life support and recycling equipment, the scientific payload, the rover, the extraction equipment, and miscellaneous piping, wiring, and tankages. The surface mission will last about three months. It will entail a large number of short-range, two to five kilometers missions around the main base and multiple long-range missions to several sites of interest. During these missions, experiments will be set up and samples will be collected at the various sites.

3.2 Landing Sites For A Manned Mars Mission

(James McMorro)

The site selection for a manned landing will depend upon many factors, but there are two issues that are very important: safety and geological interest. For the purpose of a safe touchdown, a site must be evaluated for relatively flat terrain, surface area that it covers, harshness of climate, and low tectonics activity (in the event of a Marsquake or volcanic eruption). The site selection will also need to be studied from a geological standpoint. The goal of the mission is a scientific evaluation of the planet, and therefore the landing site must be in an area of geological significance.

| | SITE | COMMENTS |
|----|---------------|--------------------------------|
| 1) | Mount Olympus | may be too high for aero-brake |
| 2) | Aureole | young lava flows |
| 3) | Argyr Basin | wide diversity of features |
| 4) | Isidia Basis | wide diversity of features |

- | | | |
|-----|------------------|-----------------------------|
| 5) | Chasma Boreale | climate may be too harsh |
| 6) | Canyonlands | complex site, many features |
| 7) | Outwash Channels | open and spacious |
| 8) | Fretted Terrain | open and spacious |
| 9) | Highland Patera | limited geological features |
| 10) | Mangala Vallis | fair number of features |

[1]

Of the sites listed, the Outwash Channels and the Fretted Terrain show great promise as landing sites. They are open and spacious, which would make a landing less difficult and much safer. The Argyr Basin and Canyonlands, on the other hand, also show promise as landing sites as they offer a wide variety of geological features to investigate (basins, lava flows, stratified walls, etc.). However, the base of Olympus and Chasma Boreale, may prove unworthy as landing sites. While they offer many geological features for study, these sites may be hazardous. The climate of Chasma Boreale may be too harsh for a successful mission. Mount Olympus is very high in elevation, standing at 37,000 feet, so there may be neither time nor room for a landing craft to maneuver. The craft would then impact into the side of the mountain. Therefore, it is necessary for a hazard-free landing site to be chosen.

Scientific desirability will be another factor considered in site selection. Other factors include safety, energy requirements, resource availability, and communications needs. During the first few missions it will be necessary to traverse and sample terrains that offer the best geologic diversity. Future missions may focus on more specific problems.

3.3 Communications

(James McMorro)

The requirements for the communications systems for a manned Mars mission will essentially depend on the mission objective, how long the mission takes, and the number of vessels in transit. Issues concerning the system will include data rates, transmission frequencies, and communications coverage.

Depending on the coverage requirements, a link between Mars and Earth may either be direct or relayed. While a direct link is very simple, it only provides about fifty percent coverage [2]. An option may be to put a string of satellites in orbit of Mars to act as relays for more coverage.

The communication system technology necessary for a manned Mars mission already exists. However, computer software and electronics are constantly being improved upon. Newer, more efficient, and less expensive communication system options, such as laser communications, may become available as time goes on.

3.4 Surface Base

(Guru Tej Khalsa, Masoud Irampour)

A geodesic dome was chosen for the Martian base. The most volume-efficient structure was desired so that the interior living space could be maximized while minimizing the total surface area. Therefore, the material mass required to be transported to the Martian surface will be minimal. The sphere is the most volume efficient shape and this can be conveniently represented by a geodesic.

A constant factor in space travel is cramped living and working spaces due to the high cost of launching materials from the Earth's surface. One of the driving costs for this is that as the density of a payload becomes relatively low, the cost to orbit a given mass increases. In the case of the Martian base, there is the additional consideration of transporting cargo through the Martian atmosphere to the surface.

Construction of facilities at Space Station Freedom can assist in lowering launch costs (e.g. waverider, cargo ship). However, in the case of the Martian base the structure would have to be built far more durable to survive atmospheric reentry than will be necessary for surface requirements. The obvious solution is to construct the base on the Martian surface. To make this feasible, several conditions had to be met:

- 1) consistent reliability
- 2) consistent durability
- 3) short construction time
- 4) ease of construction for astronauts clad in spacesuits
- 5) construction with limited resources

Meeting all these requirements, a geodesic dome was considered to be the best choice. To achieve the volume necessary to house ten astronauts, the required life support, and miscellaneous equipment, a 5/8 dome of 7.62 meters (25 feet) radius was selected (5/8 refers to a dome larger than a hemisphere).

The geodesic dome consists entirely of triangular pieces which fit together to form the dome (Figure 3.1). Each triangular piece is a plate of Advanced Carbon-Carbon (ACC) composites reinforced on each of the edges with an ACC beam of high stiffness. Mounted on the panel between the beams is a lightweight, insulating material (Figure 3.2) to protect the base against the low temperatures experienced on the Martian surface (180 K).

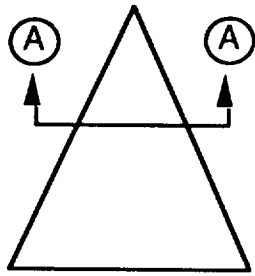

Figure 3.1

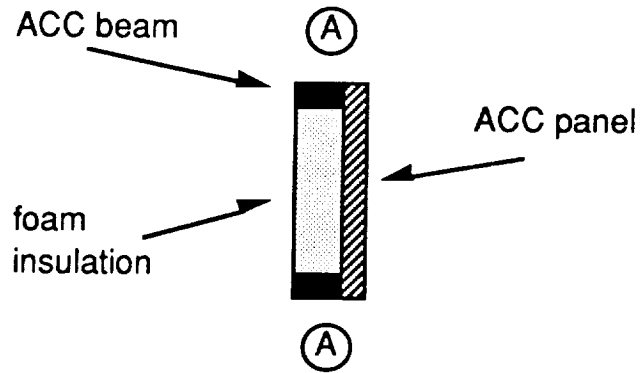

Figure 3.2

To ensure that the final facility is airtight, an internal bladder, or lining, will be inflated inside the dome thus sealing it from the outside atmosphere. This will be much easier than sealing the shell to make it airtight.

3.4.1 Radiation Concerns

The dome material alone will of course be sufficient shelter from the UV radiation incident on the Martian surface. It will not however be sufficient to protect against high energy solar particles generated during solar storms. Three options were considered to protect the crew from this radiation:

- 1) bury the base completely in the Martian soil
- 2) partially bury the base and sandbag the rest
- 3) create a separate radiation storm shelter or bunker

All three are viable options but it would be ideal to have the entire base completely sheltered. With this option, there will never be any work disruption due to radiation concerns, and potential damage to delicate scientific equipment and computers will be minimized. However, due to construction techniques and physical limitations, the base will be partially buried and sandbags will be used to cover the upper portion (Figure 3.3).

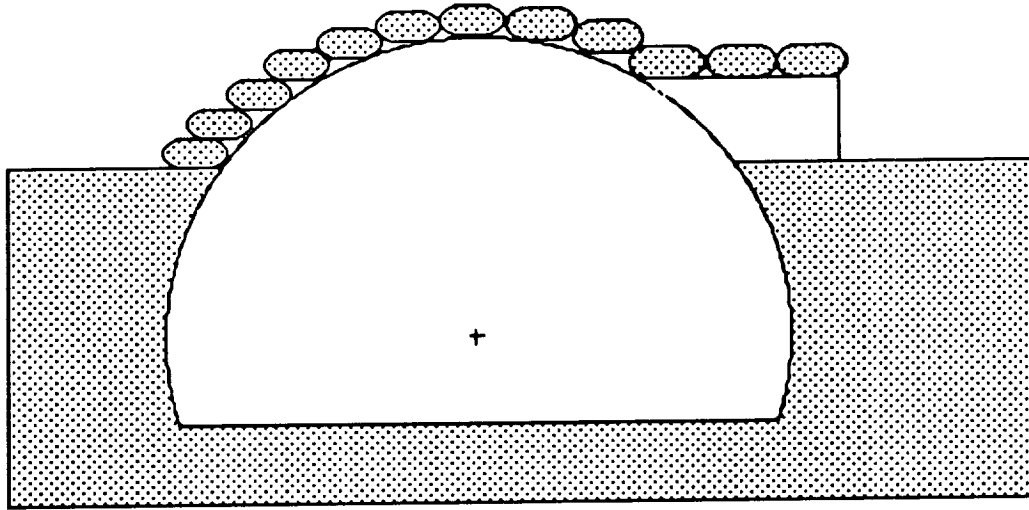

Figure 3.3

3.4.2 Construction Techniques

In order to bury the dome, the first construction task will be to create a crater by using explosives. The explosives will be strategically placed using drilling equipment and remotely ignited from a safe distance. It is possible that this work will be done by robotic explorers already on the surface. The resulting crater(s) will be cleared by the astronauts with the aid of the rover. The floor of the dome will then be constructed in the bottom of the cleared crater(s).

After the floor is assembled the lining will be placed on it and all large equipment will be placed inside. An arrangement of rotating trusses and supports will then be erected on the floor and the dome shell will be constructed on these members. As the shell is constructed, it will be gradually rotated about the trusses until the complete dome is built and connected to the floor. [3]

After the shell is completed, the internal lining will be inflated using a pressure bottle. The astronauts will then enter the dome and secure the lining to

the shell with plastic rivets. This will be done in such a way the the lining is not punctured.

When the shell is completed, the rover will be used to push soil back into the crater to cover the structure. Sandbags will then be used to cover the top. At this point, the dome is a safe shelter for the crew. They can then work from inside the dome to complete the interior construction and set up their equipment and facilities.

Shell construction can be completed by ten people within 1-3 days, depending upon site selection, blasting techniques and available mechanical/robotic assistance. During construction, the crew will use the NIMF shuttle and/or the landing pods for shelter. Once completed, the dome will be a safe and permanent shelter for human habitation on the Martian surface.

The construction time given above is an estimate made by considering several factors. Ten hours is required for five people to construct the geodesic dome structure on Earth. It is assumed that all ten astronauts will have had extensive training in the construction of this facility and will all be available for construction activities on the surface. Since space suits will hamper astronaut activities, the components of the dome will be prefabricated in such a way that minimum dexterity will be required for construction. In addition, sixteen hours have been included for site preparation (blasting/clearing), some of which may be completed before the astronauts arrive at Mars. In addition, due to the reduced gravity on the Martian surface, all components will weigh approximately 1/3 of what they weigh on Earth. Finally, it is considered that after 2.5 months travel time, the astronauts will be able to carry out this task without undue stress.

3.4.3 Characteristics of MARS

(George Grewe)

| | <u>Mars</u> | <u>Earth</u> |
|----------------------|-----------------------|-----------------------|
| Surface Gravity | 3.68 m/s ² | 9.81 m/s ² |
| Planetary Diameter | ~6788 km | ~12683 km |
| Length of Day | ~24.5 hrs | ~24 hrs |
| Year Length | ~686.6 days | ~365 days |
| Atmospheric Pressure | ~8 millibars | ~760 millibars |
| Temperature Range | ~-140 F to +70 F | ~-70 F to +120 F |

Table 3.1 Comparison of Martian and Earth Atmosphere

The surface conditions such as dust storms, low nighttime temperatures, low surface pressures, high ultraviolet fluxes during the daytime, and a non-breathable atmosphere are expected to create certain problems. The solutions to most of these problems are provided by the base life support and individual environmental suits.

The possible effects of dust storms on the surface structures are lowered by partially burying the base. The burying of the main dome also reduces the expected radiation exposure to the crew. The composition of the atmosphere will be used to the advantage of the mission. This will be done by running an extraction operation

where compression, liquification, and separation are used to obtain the desired gases for the NIMF shuttle and life support systems.

Atmospheric Composition Major Components

| | Mars | | Earth |
|-----------------|--------|----------------|-------|
| CO ₂ | 95.32% | N ₂ | 77% |
| N ₂ | 2.7% | O ₂ | 21% |
| Ar | 1.6% | Ar | 1% |

The gas extraction operation will entail the separation, liquification, and storage of CO₂ for the NIMF shuttle, and the separation and storage of the neutral gases Ar and N₂ for the base life support systems. The compressor used for these operations will be powered by the 5 MW nuclear reactor. The liquefied CO₂ will then be piped to the NIMF fuel tanks or storage tanks. (Figure 3.4) The neutral gases will be piped to storage tanks for future uses. The main reason behind using extraction operations on Mars is the large weight savings for the mission. The technology that will be developed for this operation can potentially be used in other missions or on Earth for non-related activities.

EXTRACTION OPERATION

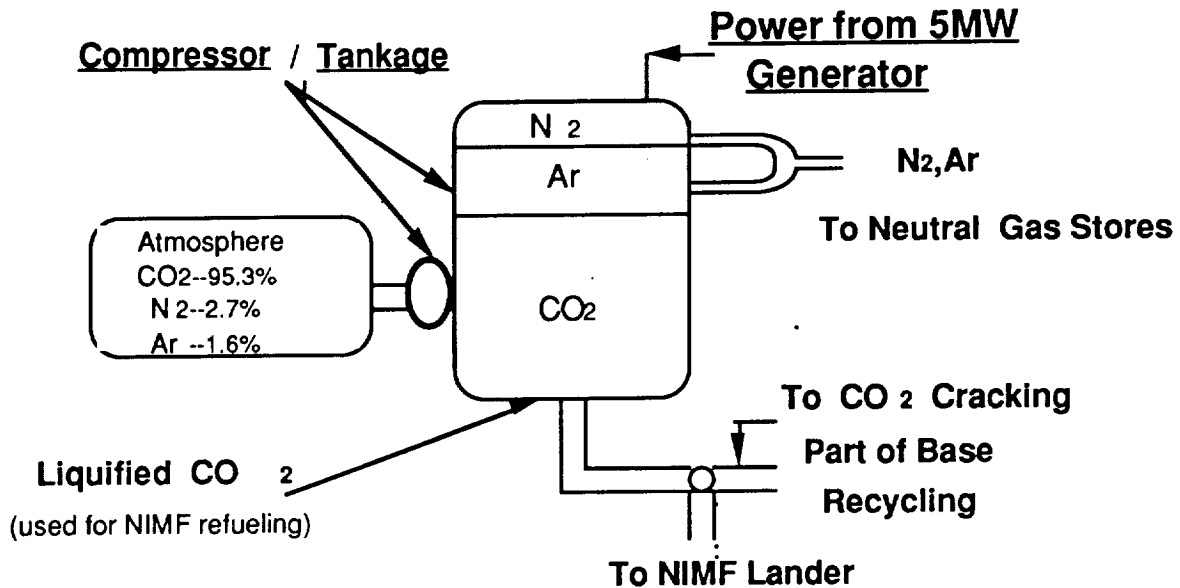

Figure 3.4 Extraction Operation

3.4.4 Mars Rover--Expected Performance Level

The ability to climb 45 degree slopes on soft soil will be critical during the base construction operations. Ground clearance of about 40-50cm will improve performance by increasing the operation speed and stability of the rover on rough terrain. A load capacity of 750kg to 1000kg is expected during the construction of the base. Stability on 45 to 50 degree slopes is expected in the construction phases of the mission.

A legged vehicle will suit the requirements for rough terrain. The short range and large load carrying capability of the legged vehicles makes it more ideal than the 6*6 wheel, hoop wheel, or tracked vehicles. Presently, legged vehicles are slower than the more conventional vehicles mentioned above. However, this is changing rapidly with the improvement of electronic control systems for legged

vehicles. DARPA is working to develop the AVS (Adaptive Suspension Vehicle). Its performance-level, speed, and power requirements are in the desired range, and improved performance will be possible if the AVS is optimized for Martian surface conditions [4].

The major uses for the rover will be the construction of the Martian base, laying the power cables between the surface structures, moving people and equipment to and from the NIMF landing site, and the transportation of surface experiments to sites within 2 to 5 km of the base. The limited range of expected rover operations allow the power requirements to be satisfied by rechargeable fuel cells.

3.4.5 Mars Main Base Exterior Layout

The major points of the main base layout are:

- 1) The locations of the 5MW reactor and the NIMF shuttle landing site will be at a safe distance from the main dome. The reason for the reactor location is the reduction of radiation risk to the crew. The location of the landing site will reduce the takeoff and landing risks to the main dome structure. (Figure 3.5)

- 2) The power supply and distribution start at the 5MW reactor which will be hooked up directly to the main dome high capacity lines. The power will then be shunted to the surrounding operations, such as the compressor/extraction operation for fueling and resupplying of neutral gas stores, power hookups for the NIMF shuttle to recharge on-board fuel cells, the main dome life support, experiments, and a variety of other power uses inside the main dome. (Figure 3.5)

- 3) The base storage of neutral gases: Ar and N₂, water, food supplies, spares, experiments, and the rover support equipment will be done with several pressure tanks, the two landing capsules and the main dome. The neutral gas stores will be a small bottle field of high pressure tanks hooked up to the compressor/extraction

operation. The landing capsules can not only be used for storage of some equipment--such as high explosives and other hazardous substances--they can also hold maintenance operations equipment. The main dome will act as a central store for food, spares, and certain experiments. (Figure 3.5)

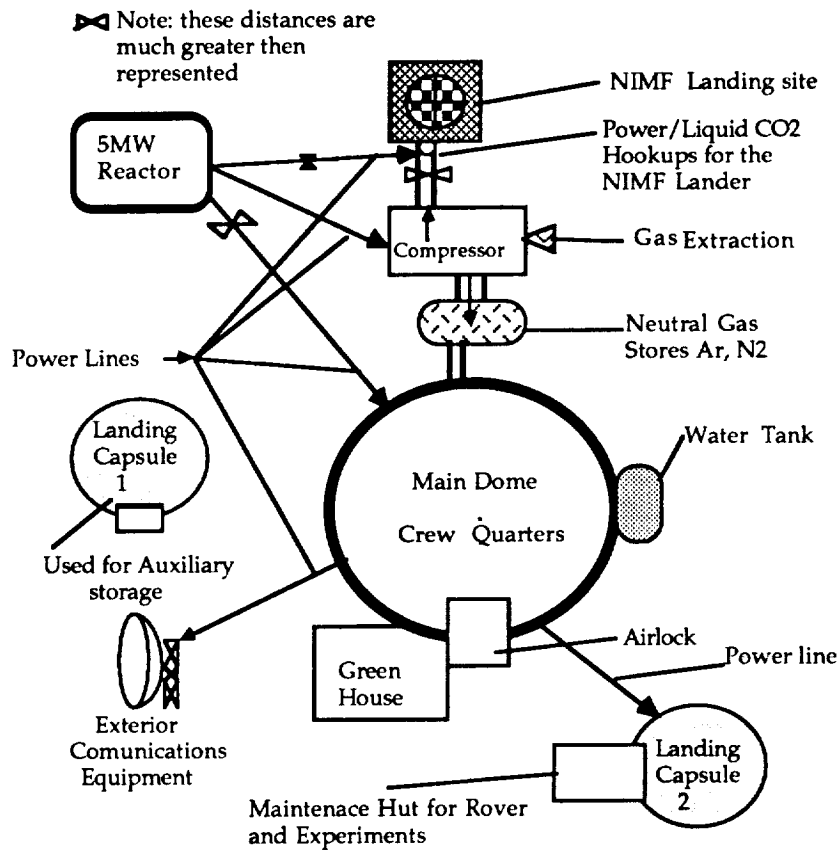

Figure 3.5 Mars Main Base Exterior Layout

3.4.6 Possible Surface Experiments

Various possible Martian surface experiments will be considered for this mission. Among these will be the following:

- Biology Experiments* - Look for life
- Grow food (run Green House Experiments)
- Geology Experiments* - Do surface and subsurface mineral surveys at various sites
- Study Martian volcanism
- Study Martian surface cratering
- Paleontology Experiments* - Look for signs of ancient life at various sites
- Hydrology Experiments
- Study erosion at sites/site
- Look for concentrations of water
- Meteorology Experiments* - Study the Martian weather (weather balloons, direct surface condition measurements over time at several sites)

There will be an open invitation for proposals for scientific experiments to fill the remaining space on the mission. The minimum space available for experimental payloads will be 20 cubic meters and minimum mass will be 5000kg. A detailed analysis of the geology of Mars will provide a considerable windfall to the studies of erosion, tectonics, and hydrology. This will also be the same for most of the areas of research mentioned above.

The base will be pressurized for shirt-sleeve work. This will make it much easier to assemble experiments requiring fragile equipment. The relative ease of sample collection close to the base will also be a factor in equipment selection.

3.6 NIMF Shuttle/Lander

(Dilene Adams)

The NIMF Shuttle/Lander will be used to transport the ten astronauts from the waverider in Low Martian Orbit (LMO) down to the Martian surface. On the surface, the NIMF will transport the astronauts around the planet to various exploration sites.

3.6.1 Lander Design

The NIMF Lander (Figure 3.6) will have a length of about 25 meters with a leg length of about 4 meters. The top portion of the lander houses a parachute that will aid the engine during the descent of the NIMF lander after entering the Martian atmosphere. The space directly between the parachute housing and the crewport will be about 1 meter thick, and each floor of the NIMF lander about 0.152 meters thick.

3.6.2 Outer Shell

The outer shell (Figure 3.7) will be constructed of a composite material for the inner and outer skins around an aluminum honeycomb structure. Such materials are Kevlar 29 (that can be used for ballistic protection of entry vehicles), Graphite-Epoxy, or Boron-Epoxy, which has a composition that can be stronger than Carbon composites and have the rigidity of steel [5].

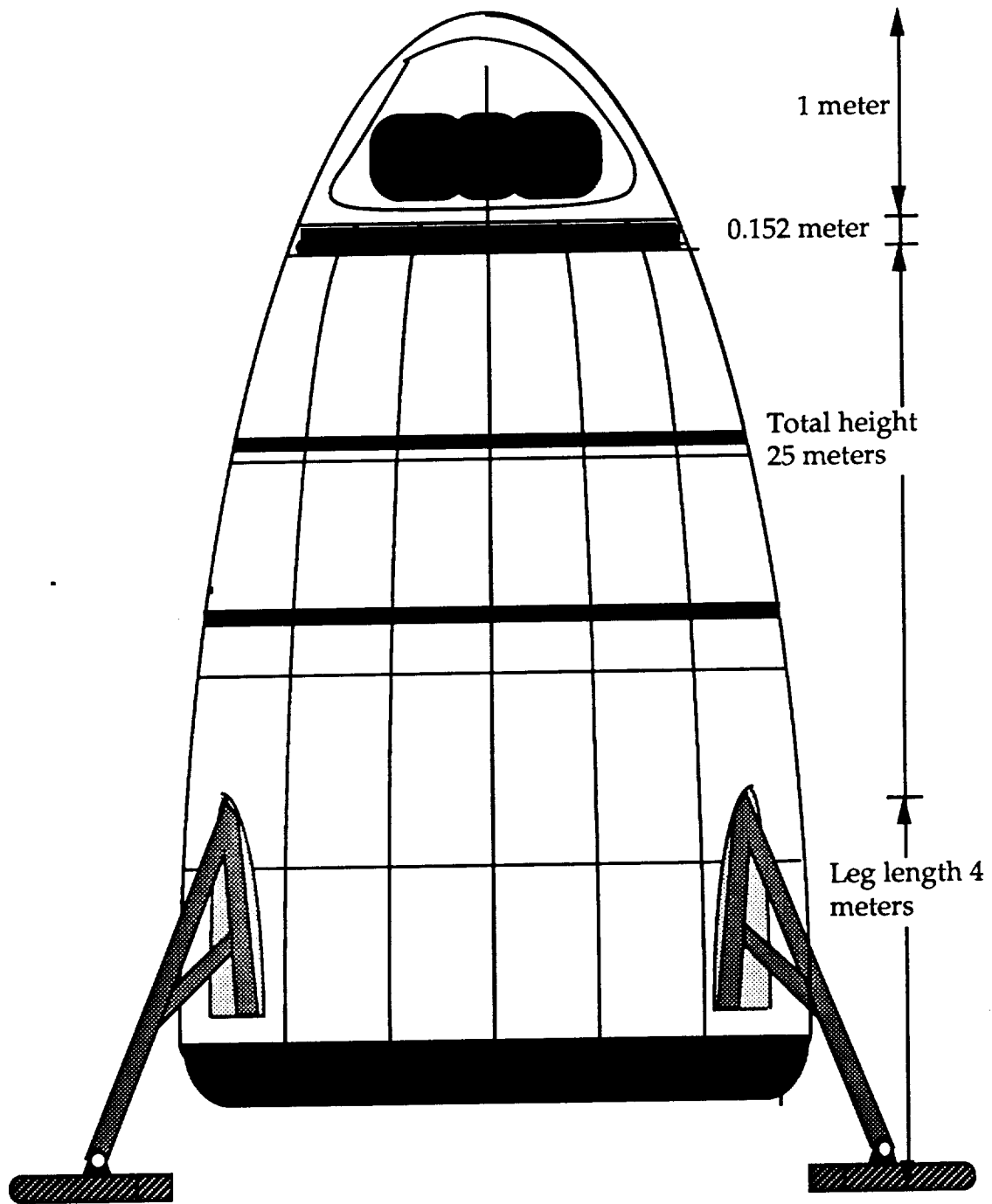

Figure 3.6 NIMF Shuttle Dimensions

Nimf Lander--Internal Structure

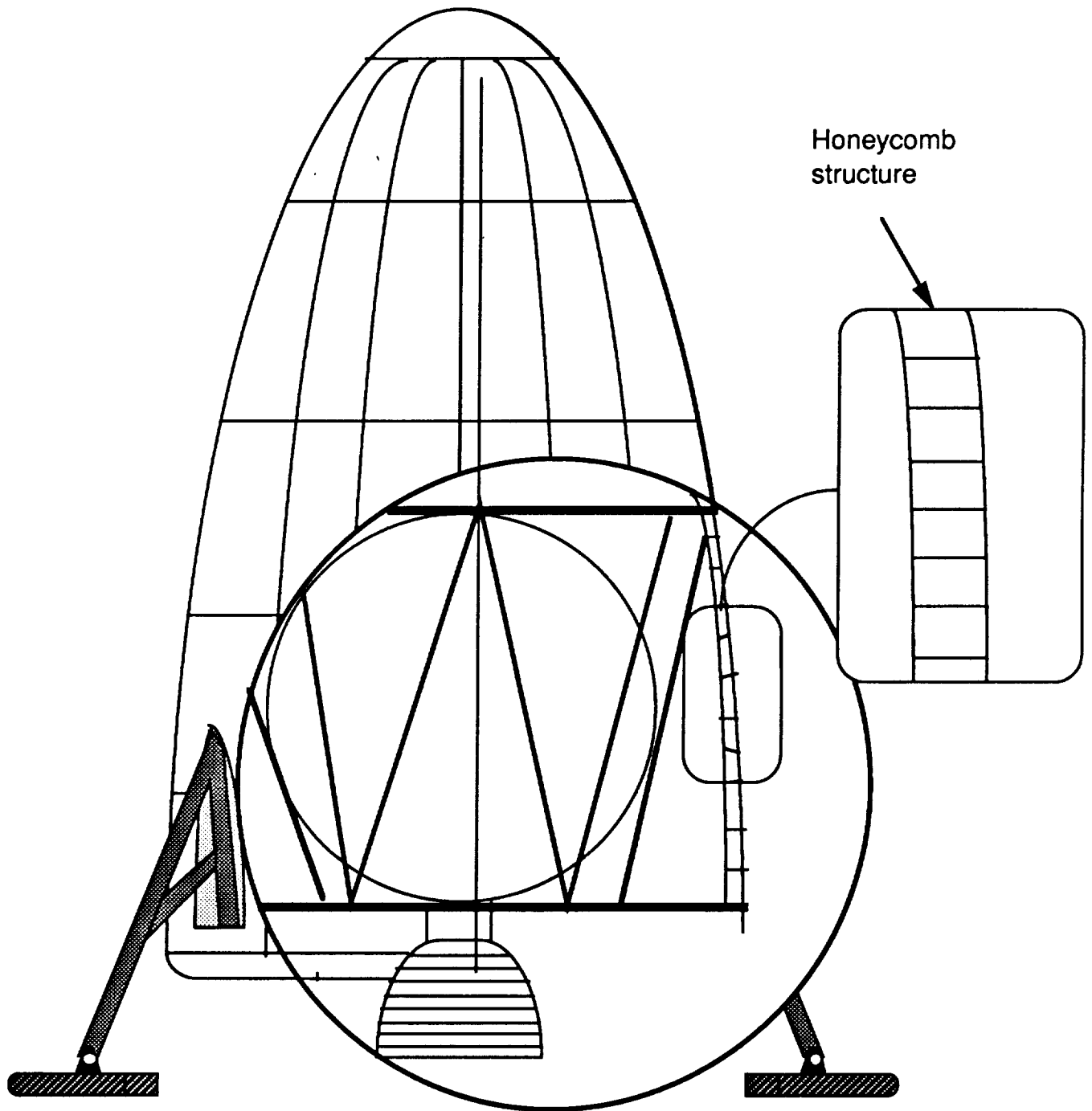

Figure 3.7 NIMF Structural Composition

3.6.3 Skeletal System

The internal structure will be constructed of a composite material such as Boron-Aluminum I-Beams (I-Beams arbitrarily chosen) for the upper structure, and Boron-Aluminum circular struts for the lower internal structure [6].

3.6.4 Fuel Tank

The fuel tank will be made of a Titanium alloy lined with an aluminum interior for insulation. The tank will have a diameter of about 8.44 meters and will weigh about 7,000 kilograms.

3.6.5 Crew Port

The living quarters for the NIMF (Shuttle) Lander will have two floors. Located on the first floor will be the cockpit where controls for all the NIMF systems will be housed. Located on the second floor will be storage for supplies and experiment samples.

3.6.6 NIMF Life Support System

The life support supplies on the NIMF shuttle will be stored onboard. H₂ and O₂ fuel cells will be used as a power source. The pressurized cryogenic tanks storing the O₂, N₂, and Ar will be made of Kevlar-Epoxy with aluminum insulation. The system will use simple valve controls with a manual override valve for emergencies, and have direct exhaust of waste gas to the outside.

The gas mixer/heater will be controlled by a monitor in the crew area. The stress in the pressurized tanks can be computed using [7]:

$$s = P_c * r / 2t$$

where the yield stress for Kevlar-Epoxy is 2675 MPa, and t is arbitrarily chosen to be 0.0025 meters for all of the above mentioned pressurized tanks. This results in a radius of 0.116 meters.

3.6.7 NIMF Propulsion

(Kalpesh Patel)

Propellant Options:

Using propellant manufactured from indigenous Martian materials (instead of transporting propellant from Earth) would make interplanetary travel and space colonization much easier. Possible candidates for indigenous Martian propellant are liquid carbon dioxide, liquid oxygen/liquid monoxide, liquid oxygen/liquid methane, and liquid oxygen/liquid hydrogen. [12]

Liquid Carbon Dioxide (CO₂): The performance aspect of CO₂ is not particularly good compared to other available propellants. However, it is the most readily available propellant on Mars. Indeed, availability of CO₂ on Mars is a great advantage. The propellant will be produced entirely from the Martian atmosphere. Ninety-five percent of the Martian atmosphere is CO₂. To produce liquid CO₂, the Martian air will be pumped into a tank and compressed. At a typical Martian temperature of 233 K, carbon dioxide liquefies under 10 bars of pressure.

Liquid Oxygen/Liquid Monoxide: The performance aspect of the LO₂/LCO combination is not particularly good when used on Earth. However, it will work reasonably well on Mars since the gravity is 1/3 of Earth's. To produce oxygen and carbon monoxide simply compress a quantity of atmospheric CO₂. The process is more involved compared to just producing liquid CO₂, since CO₂ has to be broken down into O₂ and CO.

Liquid Oxygen/Liquid Methane: The most critical component of LCH₄ is hydrogen. The process to make H₂ requires vast amounts of water, and water will be hard to find--much less produce--in large efficient quantities on Mars.

Liquid oxygen/Liquid Hydrogen: The propellant LO₂/LH₂ has been used extensively in past space missions. While it is clearly a high performance option, LO₂/LH₂ requires large quantities of water to produce H₂. The process involved to produce H₂ is complex. Liquid hydrogen is also extremely difficult to store.

Engine Options:

The propulsion systems available for the landing craft are chemical and nuclear engines. The only indigenous propellants available for the chemical engine are LO₂/LH₂ and LO₂/LCH₄, (since they are the only 2 oxidizer and propellant combinations). However, both of these indigenous propellants require large quantities of water for processing.

Nuclear thermal engines use a fission reactor to heat gaseous propellants. They are promising because, in principle, any gas can act as a propellant to some level of efficiency. Therefore all indigenous propellants can be used.

Proposed System:

Since any propellant can be used with a nuclear thermal engine, the system chosen for the landing craft is a solid core nuclear engine. The indigenous propellant that will be used for the lander is liquid carbon dioxide (LCO₂) since it can be processed quickly and easily. Also, its performance satisfies the requirements of the landing craft.

A vehicle using indigenous fuel as a propellant in a nuclear thermal engine is a Nuclear rocket using Indigenous Martian Fuel (NIMF). The NIMF shuttle will have 3 primary functions. First, it will be used to transport the 10 astronauts from Low Mars Orbit (LMO) to the Martian surface. Once the waverider gets to LMO it will dock with the cargo ship (which holds the NIMF shuttle). The 10 astronauts

will then descend to the Martian surface. The NIMF will be used for exploratory missions. That is, it will travel about the Martian surface refueling itself with LCO_2 . When the surface mission is over the NIMF will transport the 10 astronauts back to LMO where it will rendezvous with the waverider.

During the descent phase (from LMO to the Martian surface), hydrogen fuel will be used as the propellant for the nuclear engine. During the surface hops and ascent phase (to LMO), liquid carbon dioxide (LCO_2) will be used as the propellant for the nuclear engine of the NIMF shuttle.

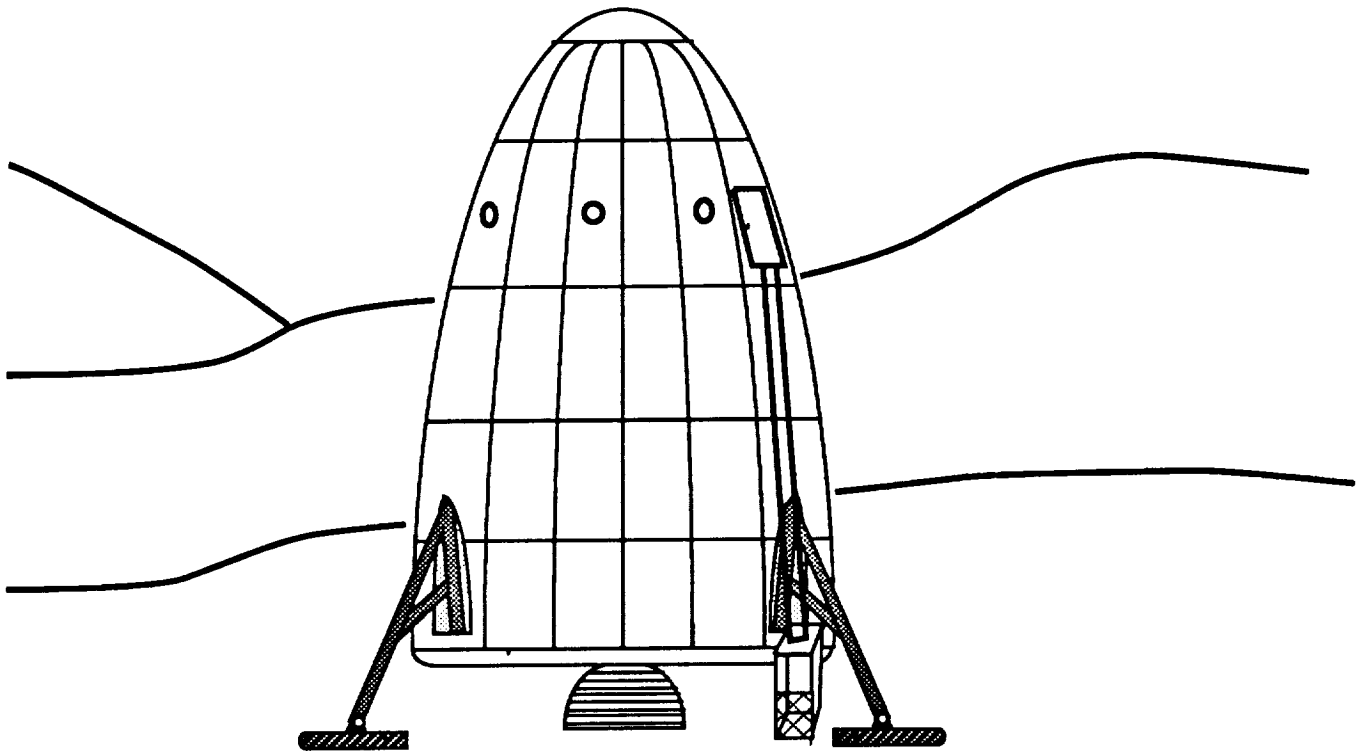

Figure 3.8 The NIMF

Nuclear Engine Performance:

The solid core nuclear engine that is used for the NIMF will be based on the same design as the waverider's return propulsion system.

Engine performance using hydrogen propellant:

| | |
|-------------------------------------|------------|
| THRUST OF ENGINE | 1249 KN |
| LIFETIME OF ENGINE | 4800 sec |
| SPECIFIC IMPULSE (I _{sp}) | 1055 sec |
| MASS FLOW RATE (m) | 120 kg/sec |

Engine performance using carbon dioxide propellant:

Determining the I_{sp} and mass flow rate needed for an engine using CO₂ and the relating mass flow of H₂ to CO₂ inside the engine chamber (see appendix C for detail of calculations). [9]

$$m(\text{H}_2) = \rho_{\text{H}_2} A_{\text{H}_2} V_{\text{H}_2} \quad V \propto (T_0/M)^{1/2}$$

$$m(\text{CO}_2) = \rho_{\text{CO}_2} A_{\text{CO}_2} V_{\text{CO}_2}$$

$$M(\text{H}_2) = 2$$

$$M(\text{CO}_2) = 44$$

$$m(\text{CO}_2) = \{m_{\text{H}_2}^2 * M_{\text{H}_2} * A * \rho_{\text{H}_2}^2 / \rho_{\text{H}_2}^2 * A\} / M_{\text{CO}_2}$$

$$m(\text{CO}_2) = 405 \text{ kg/sec}$$

$$I_{\text{sp}} (\text{CO}_2) = \text{thrust/mass flow}$$

$$I_{\text{sp}} (\text{CO}_2) = 315 \text{ sec}$$

Calculation of thermodynamic properties of CO₂:

$$R = R_e / M \quad R_e = 8314 \text{ J/K}$$

$$C_p = \gamma R / (\gamma - 1) \quad M = 44$$

$$\gamma = 1.3 \quad C_p = 809 \text{ J/kg-K}$$

Calculation of engine performance using CO₂:

Equations used: (assuming isentropic flow thru engine) [8]

$$I_{sp} = V_e / g$$

$$V_e^2 / 2 = C_p (T_o - T_e)$$

$$T^* / T_o = (2 / (\gamma - 1))$$

$$a_e = (\gamma R T_e)^{1/2}$$

$$M_e = V_e / a_e$$

$$P_o = \rho_o R T_o$$

$$P_o / P_e = (1 + (\gamma - 1) / \gamma * M_e^2)^{\gamma / \gamma - 1}$$

$$\rho_e = P_e / R T_e$$

$$m = A_e \rho_e V_e$$

$$\rho^* / \rho_o = (2 / (\gamma + 1))^{1 / \gamma - 1}$$

| | |
|--|---------------------|
| Chamber Temperature (T _o): | 3700 K |
| Throat Temperature (T*): | 3217K |
| Exit Temperature (T _e): | 2197K |
| Chamber Pressure (P _o): | 8 atm |
| Exit Pressure (P _e): | .294 atm |
| Throat Area (A*): | .62 m ² |
| Exit Area (A _e): | 18.3 m ² |
| Velocity Exit (V _e): | 3068 m/sec |
| Mach Number Exit (M _e): | 4.2 |

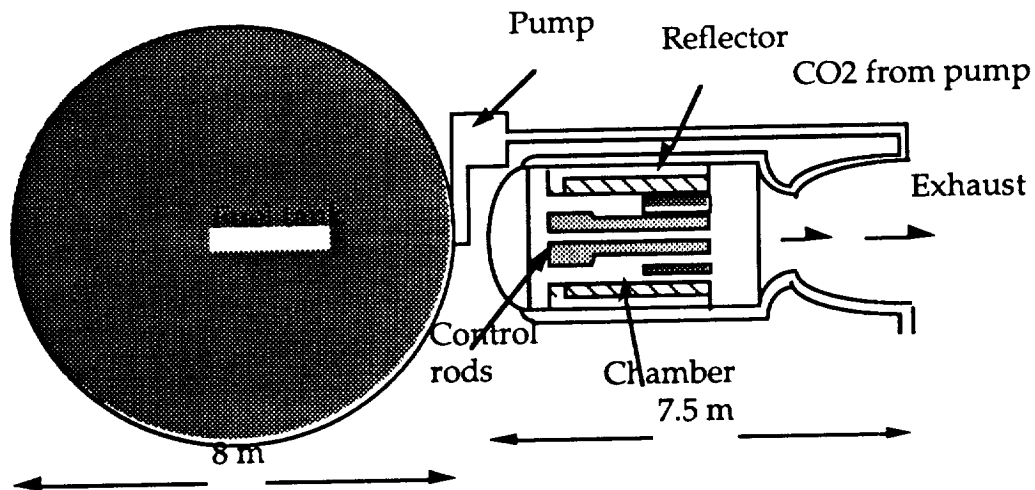

Figure 3.9: Solid Core Nuclear Engine

Calculation of propellant mass:

During the ascent phase (back to LMO) CO₂ will be used.

Using rocket equation to determine propellant mass [10]

$$V_e = g I_{sp} \ln\{M_o/M_f\} + gt$$

$$V_e = 5030 \text{ m/sec}$$

$$M_f = 30,000 \text{ kg}$$

$$M_o = 151,500 \text{ kg}$$

$$M_{CO_2} = 121,500 \text{ kg}$$

$$\text{Volume of tank} = 107 \text{ m}^3$$

| | Fuel H ₂ (descend) | Fuel CO ₂ (ascend) |
|-----------------|-------------------------------|-------------------------------|
| I _{sp} | 1055 sec | 315 sec |
| Mass Flow | 120 kg/sec | 405 kg/sec |
| Mass Fuel | 18,000 kg | 122,500 kg |
| Burn Time | 157 sec | 300 sec |
| Density Fuel | 73.0 kg/m ³ | 1160 kg/m ³ |
| Volume Fuel | 255 m ³ | 105 m ³ |

3.6.8 Exploration Missions

During the exploration missions the NIMF will act like a projectile. It will be fired up vertically. Once the velocity for a given range is obtained the NIMF will make a 45° turn (for maximum range) using its gimbal nozzle and thrusters. At this point, the NIMF will act like a projectile. It will follow a parabolic path. Once the range has been reached it will fire its engine again to turn and slow down vertically. Once the mission is finished at that location, it will be used to go back to the base where it will refuel again. Figure 3.10

$$R = V_0/g *(\sin^2 \alpha)$$

$$V = I_{sp} g \ln \{M_0/M_f\} + gt$$

M_0 = mass of ship and propellant

M_f = mass of ship

M_p = mass propellant

The maximum distance the NIMF can travel is 650 miles. This is because the NIMF fuel tank can only hold 295,800 kg of CO₂. For each maximum round trip the engine will burn for 806 sec. Due to the life time restriction of the nuclear engine, which is 4800 sec, the maximum number of missions the NIMF can make is 5. If the life time of the engine can be improved, the NIMF can be used for more exploration missions.

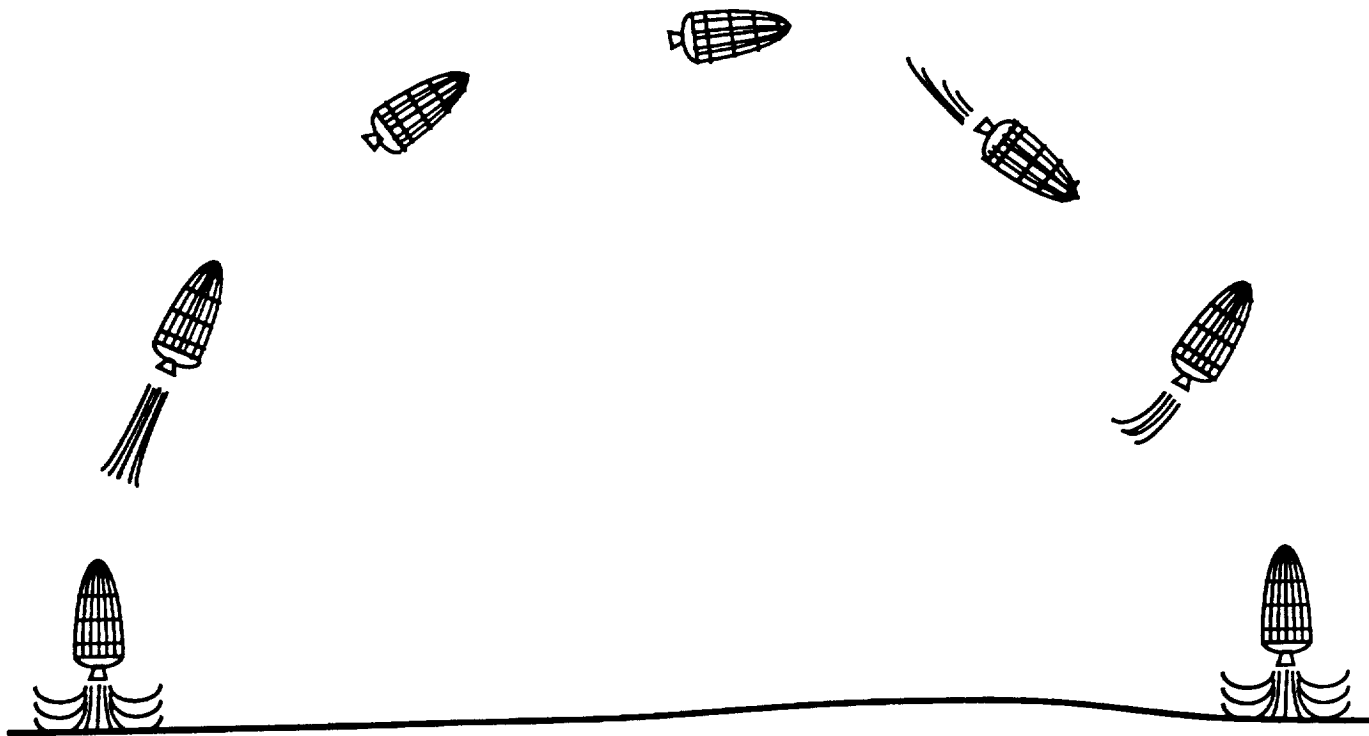

Figure 3.10: NIMF Projection Path

3.6.9 Radiation Concerns

One of the main concerns in using the nuclear engine is the possibility of radioactive contamination from the Martian atmosphere and from the exhaust coming out of the nozzle. Also, there is possible contamination from the lander body due to back flow of the exhaust during landing and takeoff. As the CO₂ is introduced into the reactor core, the CO₂ will become radioactive, with carbon forming C₁₆ & oxygen forming O₁₉, both radioactive isotopes. C₁₆ has a half life of 7 sec and O₁₉ has a half life of 27 sec. These are very short half lives and at a mass flow rate of 405 sec (CO₂), very little radiation will be expelled--provided that no fissionable uranium is expelled from the reactor. In addition to low radiation levels, the gases will diffuse very rapidly, because the gases are very hot when they get expelled from the engine. This means that very little shielding, if any, will be required for the crew.

3.7 Conclusion

(Rodney Bryant)

The design of the surface mission makes the assumption that Mars will be inhabited by robotic rovers and communication satellites will orbit the planet. Construction of the base will be easier with the help of the robotic rovers. Burying the base underground for radiation protection gives the advantage of using a very lightweight but strong material, such as ACC. The NIMF shuttle will greatly increase the scientific exploration possibilities with its wide range capabilities. Extraction of materials such as CO₂, O₂, and possibly H₂O from the planet will tremendously expand the surface mission capabilities. It is important to note that the base is designed to be permanent and therefore reusable for future manned missions.

APPENDIX

APPENDIX

Detailed calculations for NIMF using indigenous CO₂:

Mass flow calculation:

$$\frac{(1202 \text{ kg/m}^3 * 2.016 * 1160^2 \text{ kg}\backslash\text{m}^3) / .0736 \text{ kg/m}^3}{44.0} = 405 \text{ kg/m}^3$$

Isp Calculation:

$$Isp = \frac{1249 \text{ KN}}{(405 \text{ kg/m}^3 * 9.8 \text{ m}^3)} = 313 \text{ sec}$$

Engine Properties:

Exit Velocity:

$$Ve = Isp * g = 313 \text{ sec} * 9.8 \text{ m/sec}^2 = 3087 \text{ m/sec}$$

Temperature at throat exit:

$$T^* = To(2/\gamma - 1) = 3700 \text{ K}(2/1.3 - 1)$$

$$Te = (-Ve^2/2Cp) + 3700 \text{ K} = 2197$$

Exit Velocity and Exit Mach number:

$$ae = (\gamma RT)^{1/2} = (1.3 * 189 * 2197) = 735 \text{ m/sec}$$

$$Me = 3087 \text{ m/sec} / 735 \text{ m/sec}$$

Pressure calculation at chamber throat and exit:

$$Po = po * R * To = 1.16 \text{ kg/m}^3 * 189 * 3700 \text{ K} = 8 \text{ atm}$$

$$Pe = (1 + (\gamma - 1)/2 * Me^2)^{\gamma/\gamma - 1} / Po = .0294 \text{ atm}$$

Throat velocity:

$$(3217 \text{ K}) = 889 \text{ m/sec}$$

Density exit and throat:

$$pe = Pe/RTe = (.0294 * 1.01^5) / (189 * 2197) = 7.15 \cdot 10^{-3} \text{ kg/m}^3$$

$$\rho^*/\rho = (2/g-1)^{1/(g-1)} = .63$$

$$\rho^* = (1.16 \text{ kg/m}^3 * .63) = .73 \text{ kg/m}^3$$

Area throat and exit:

$$A_e = m/\rho^* a^* = 405 \text{ kg} \cdot \text{m}^3 / (7.15 \cdot 10^{-3}) * 3087 \text{ m/sec} = 18.34 \text{ m}^2$$

$$A^* = 405 \text{ kg/m}^3 / .73 \text{ kg/m}^3 * 889 \text{ m/sec} = .63 \text{ m}^2$$

Exploration Mission calculations:

Maximum Distance calculation:

$$\text{From A to B: } V_A = g \text{ Isp} \ln (M_o / M_o - M_{fA})$$

$$\text{From C to D: } V_C = g \text{ Isp} \ln (M_o - M_{fA} / M_o - M_{fD} - M_{fA})$$

$$\text{From D to C: } V_D = g \text{ Isp} \ln (M_o - M_{fA} - M_{fD} / M_o - M_{fC} - M_{fD} - M_{fA})$$

$$\text{From C to A: } V_c = g \text{ Isp} \ln (M_o - M_{fc} - M_{fD} - M_{fA} / 30,000 \text{ kg})$$

To determine maximum range, pick range, solve for velocity ,then solve above equation for fuel used thru each engine firing phase.

| | |
|-----------------------------|-------------------|
| Maximum range: | 650 miles |
| Velocity Needed: | 1824 m/sec |
| Maximum fuel NIMF can hold: | 297,000 kg of CO2 |
| Fuel used from A to B: | 136,179 kg of CO2 |
| Fuel used from C to D: | 76,070 kg of CO2 |
| Fuel used from D to C: | 44,050 kg of CO2 |
| Fuel used from B to A: | 24,371 kg of CO2 |

Total number of maximum range missions = 5

REFERENCES

- [1] Spudis, Paul D., "Site Selection for Manned Mars Landings - A Geological Perspective", U.S. Geological Survey, Flagstaff, Az. N87-17769.
- [2] Duke, M. B., "Manned Mars Mission Overview", N86-29873.
- [3] Popko, Edward, Geodesics, University of Detroit Press, Detroit, MI., (1968).
- [4] Klein, Gail, "Rover Technology for Manned Mars Mission", Jet Propulsion Laboratory, Pasadena, Ca.
- [5] Schwartz, M. M., Composite Materials Handbook, McGraw-Hill Book Company, New York, N.Y. pp. 2.66-2.69, 3.33-3.37, 7.1-7.5. (1989).
- [6] University of Virginia, "Lunar Lander Conceptual Design", May 17, 1989.
- [7] Beer, Ferdinand P., Johnston, Jr., E. Russell, Mechanics of Materials, McGraw-Hill Book Company, New York, N.Y., pp. 528-534. (1981).
- [8] Anderson John, D., Jr., Modern Compressible Flow, McGraw-Hill Publishing Company, (1990).
- [9] Hill and Peterson, Mechanics and Thermodynamics of Propulsion, Addison-Wesley Publishing Co., Inc. (1970).
- [10] Greenwood, Donald, T., Principles of Dynamics, Prentice-Hall Inc., Englewood Cliff, N.J., (1988)
- [11] Thermodynamic Function of Gases, Volume 1, Ammonia, Carbon Dioxide.
- [12] "Indigenous Martian Propellant.", *Aerospace America*, August 1989.

MISSION COST

Rodney Bryant

4.1 Cost Analysis

(Rodney Bryant)

There are many different methods of analyzing costs and all are usually based on a statistical scheme which uses historical data as comparisons and baselines. Project costs are usually estimated for a total mission cost and then components costs are broken down. However they are sometimes computed in reverse by pricing components first and summing up to a total project cost. A cost analysis for a mission of this size is never exact and usually has an uncertainties in the billions of dollars.

The costing model for this mission was broken up into two parts: waverider and cargo mission. This model generates a bottom line cost based on the mass of the two interplanetary vehicles. Personnel costs are derived from the bottom line cost. The original model was designed for space vehicles launched from earth. Since the vehicles for this mission will be constructed and launched from the Space Station, cost estimates had to be calculated for Earth to Space Station launches, construction at the Space Station and fuel storage costs.

Development of the bottom line cost involves costing space vehicle and instruments, mission systems integration, mission operations, data processing and data analysis. Space vehicle and instruments include all components aboard the vehicle, such as propulsion systems, fuel, life support, structures, onboard computers, etc. Mission systems integration includes integration as well as all other wrap around costs like systems test and evaluation, installation and checkout, trainers and simulation, development, production, operations, etc. Mission operations, data processing and data analysis involves mainly ground support. [1]

From the bottom line cost the number of personnel required can be calculated. This mission will require about 130,000 personnel members, with a cost of \$120,000 for each manager and \$100,000 for each engineer and subordinate personnel member. [1]

Launch cost to the Space Station is based on estimates for the use of an Aero-assisted Orbital Transfer Vehicle (AOTV). Costs range from \$13,000/lb to \$2000/lb depending on how much of the total payload capacity is made useful. The model for this mission uses an average cost of about \$7000/lb. [2] Operations cost involving assembly at the Space Station are estimated to be about \$33,000 per hour for activities involving direct human involvement. [3] Fuel storage costs for Low Earth Orbit (LEO) will run around \$1000/lb. [2]

All cost estimates are added to the bottom line cost and values are inflated to the year 2012 values. Production is scheduled to begin in the year 2012. The waverider will cost \$92.56 billion and the cargo ship will cost \$101.243 billion. Total cost of the mission is estimated at \$193.803 billion for the year 2012.

Cost Estimates

Waverider

Weight $50,000 + 15,000 + 256,000 = 301,000 \text{ kg} \Rightarrow 662,200 \text{ lbs}$

| | |
|--------------------------|------------------------|
| Bottom Line | \$11.490 billion |
| Managers Cost | \$.910 billion |
| Personnel Cost | \$ 6.070 billion |
| Launch Cost | \$ 6.313 billion |
| SS Ops Cost | \$.830 billion |
| <u>Fuel Storage Cost</u> | <u>\$.256 billion</u> |

Total (1990\$) \$25.869 billion

Total (2012\$) \$92.560 billion

Cargo Ship

Weight $10,000 + 2,000 + 600 + 150,000 + 200,000 = 362,600 \text{ kg} \Rightarrow 797,720 \text{ lbs}$

| | |
|--------------------------|------------------------|
| Bottom Line | \$12.540 billion |
| Managers Cost | \$.981 billion |
| Personnel Cost | \$ 6.544 billion |
| Launch Cost | \$ 7.131 billion |
| SS Ops Cost | \$.830 billion |
| <u>Fuel Storage Cost</u> | <u>\$.270 billion</u> |

Total (1990\$) \$28.296 billion

Total (2012\$) \$101.243 billion

Total Mission Cost $(\$92.560 + \$101.243) \text{ billion} = \$193.803 \text{ billion (2012\$)}$

4.2 Conclusion

Projecting technology will often increase cost. This mission utilizes three different propulsion designs: off the shelf chemical, nuclear and nuclear electric. Use of the two nuclear propulsion systems provides fuel savings and increases performance which is enough to justify their use. Employing very lightweight materials such as ACC also presents cost savings. ACC's performance characteristics and production cost are projected to improve greatly by 2012. The most important aspect of keeping the cost of the mission at a minimum is to keep weight at a minimum. This allows launch to Space Station cost and fuel cost to be reduced. Even though development of new technology can bring about higher cost, the knowledge and results gained will eventually allow it to pay for itself.

REFERENCES

- [1] Personal interview with Bernie Dixon, Controllers Office., NASA, Goddard Space Flight Center.
- [2] General Electric, System Technology Analysis of Aero-assisted Orbital Transfer Vehicles., August 1985, NASA TM 26064, 1987.
- [3] McDonnell Douglas, Human Role in Space., NASA TM 13473, 1985.

CONCLUSION

(Rodney Bryant)

The request for proposal called for the use of a hypersonic waverider to transport ten astronauts to Mars for a 3 to 5 month exploratory mission by the year 2025. It also called for using the waverider for an aero-gravity assist through the atmosphere of Venus. Other criteria for the request for proposal were minimum time of flight, minimum cost, minimum launch mass from earth, maximum payload delivery to Mars, safe human environment and practicality of accomplishment with projected technology in the desired time frame.

The waverider will be constructed entirely of advanced carbon-carbon (ACC) which is lightweight but very durable. The waverider will experience extreme temperatures in the atmospheres of Venus, Mars, and Earth due to very high relative velocities. ACC was chosen as the best material to handle all loads encountered by the vehicle and keep the vehicle mass at a minimum. By performing the aero-gravity assist through the atmosphere of Venus, the waverider achieves a deflection angle and delta velocity increase for the trip to Mars, as well as a launch window for a return trip which is open for 7.5 months. The Venus gravity assist also allows for sequential launches of the cargo ship and waverider which will not require the cargo ship to stay in orbit for a couple of years before the waverider can dock with it. The waverider will be constructed with a double leading edge so that the outer portion can be removed after the Mars aero-brake maneuver. Removal of the outer leading edge reduces the vehicle mass and therefore reduces the return trip fuel mass requirements. The return propulsion system will be a nuclear solid core engine which uses H_2 as a propellant. The engine performance characteristics far outweigh those of a chemical engine and the fuel mass requirements are considerably less. The aero-brake maneuvers at Mars and Earth

eliminate the need for a propulsion system for deceleration. Life support aboard the waverider will incorporate an integrated regeneration system instead of all stored supplies. Life support also includes the design of an artificial gravity centrifuge to help counteract the effects of microgravity.

The cargo ship, which is a long truss with all the payload attached to it, travels to Mars on a spiral trajectory using a nuclear electric propulsion system. The NEP system consists of a nuclear electric power plant, MPD thrusters and ion attitude control engines. The MPD thrusters and ion engines both use argon for a propellant. The NEP system requires a longer mission time than any of the other propulsion systems considered, however it also requires the least fuel mass. The nuclear electric engine which powers the cargo ship has an operating lifetime of seven years. This engine will also be the powerplant for the Mars base.

The Mars base will be constructed mostly underground to help shield from solar radiation. It is also constructed from ACC. The base is a 3/8 dome which can be constructed in 1 to 2 days. It will provide a shirt sleeve environment for the astronauts to live and work as well as become a permanent structure for future missions. The NIMF shuttle, which is propelled by essentially the same engine used to return the waverider to earth, will be used to transport the astronauts to and from LMO as well as around the planet. The shuttle uses CO₂ as a propellant which will be extracted from the Martian atmosphere and compressed into liquid form. The NIMF shuttle makes it possible to study a wide range of locations on the planet. This in turn, allows for more extensive research of the planet and the possibilities of discovering useful extractable materials which could lead to possible colonization of Mars.

The effort to reduce cost began by keeping mass at a minimum. With production scheduled to begin by the year 2012, financing a mission of this size will have to be done on an international scale. Much of the new technology such as the

waverider, nuclear solid core engine, MPD thrusters and total regenerative life support systems will require more research. Pushing technology is the key to reaching the point that the first stone can be laid for a mission like this. Without a tremendous push for more research and development, man may never set foot on Mars.

ACRONYMS

| | |
|--------------------|--|
| ACC = | Advanced Carbon-Carbon |
| AGA = | Aero-Gravity Assist |
| ALS = | Advanced Launch System |
| AOTV = | Aero-assisted Orbital Transfer Vehicle |
| AU = | Astronomical Unit |
| AVS = | Adaptive Suspension Vehicle |
| DARPA = | Defense Advanced Research Project Agency |
| EDC = | Electrochemical Depolarization Carbon Dioxide Concentrator |
| EVA = | Extravehicular Activity |
| GCR = | Galactic Cosmic Rays |
| HMF = | Health Maintenance Facility |
| Isp = | Specific Impulse |
| L/D = | Lift - to - Drag Ratio |
| LCH ₄ = | Liquid Methane |
| LCO = | Liquid Carbon Monoxide |
| LCO ₂ = | Liquid Carbon Dioxide |
| LEO = | Low Earth Orbit |
| LH ₂ = | Liquid Hydrogen |
| LMO = | Low Mars Orbit |
| LO ₂ = | Liquid Oxygen |
| MMM = | Manned Mars Mission |
| MPD = | Magnetoplasmadynamic Thrusters |
| NEP = | Nuclear Electric Propulsion |
| NERVA = | Nuclear Engines for Rocket Vehicle Application |
| NIMF = | Nuclear Indigenous Martian Fuel |

RCC = Reinforced Carbon-Carbon
SAB = Sabatier Process
SF = Static Feed Water Electrolysis
SNE = Small Nuclear Engine
TOF = Time of Flight
UV = Ultra Violet
VAPCAR = Vapor Phase Catalytic Ammonia Removal

NAME INDEX

Adams 151, 164
Bryant 4, 176, 182, 186
Dillon 6, 7, 51
Drum 6, 72
Garrison 6, 20
Grewe 6, 57, 151, 152, 159
Irampour 151, 154
Kelly 6, 20
Khalsa 6, 29, 151, 154
McMorrow 2, 4, 6, 61, 151, 152, 154
Melton 109, 139
Mera 6, 39
Patel 151, 169
Rainey 2, 109, 142
Rinko 6, 14
Singh 109, 123
Wilcox 6, 26, 36
Yen 109, 110, 114