

P119

# GENESIS LUNAR OUTPOST

CRITERIA AND DESIGN



Space Architecture Design Group  
Edited by Timothy Hansmann and Gary T. Moore



UNIVERSITY OF WISCONSIN MILWAUKEE

(NASA-CP-185074) GENESIS LUNAR OUTPOST  
CRITERIA AND DESIGN (WISCONSIN UNIV.)  
119 P CSCL 054 N90-26403

UNCLAS  
03/54 0295003

---

## **GENESIS LUNAR OUTPOST CRITERIA AND DESIGN**

designs and illustrations by

Dino J. Baschiera  
Joe Paul Fieber  
Patrick Groff  
Michele Gruenberger  
Susan E. Moss  
Janis Huebner Moths  
Kerry Lynn Paruleski  
Scott A. Schleicher  
Curtis W. Schroeder

text written by

Dino J. Baschiera  
Joe Paul Fieber  
Timothy Hansmann  
Janis Huebner Moths  
Gary T. Moore

report compiled and edited by

Timothy Hansmann, NASA/USRA Teaching Assistant  
Gary T. Moore, Professor of Architecture

June 11, 1990

---

## **GENESIS LUNAR OUTPOST: CRITERIA AND DESIGN**

Dino J. Baschiera, Joe Paul Fieber, Patrick Groff, Michele Gruenberger, Susan E. Moss, Janis Huebner Moths, Kerry Lynn Paruleski, Scott A. Schleicher, and Curtis W. Schroeder; edited by Timothy Hansmann and Gary T. Moore

### **ABSTRACT**

This design study -- the third in the space architecture series -- focused on the requirements of an early stage lunar outpost. The driving assumptions of the scenario was that the base would serve as a research facility and technology testbed for future Mars missions, a habitat supporting 12 persons for durations of up to 20 months, and would sustain the following five experimental facilities: Lunar surface mining and production analysis facility, construction technology and materials testbed, closed environmental life support system (CELSS) test facility, lunar farside observatory, and human factors and environment-behavior research facility.

Based upon the criteria set forth in a previous programming document, three preliminary lunar base designs were developed. Each of the three schemes studied a different construction method and configuration. The designs were then evaluated in terms of environmental response, human habitability, transportability, constructibility, construction dependability and resilience, and their suitability in carrying out the desired scientific research. The positive points of each scheme were then further developed by the entire project team, resulting in one integrated lunar outpost design.

This project and report were produced under a grant to the Regents of the University of Wisconsin System, University of Wisconsin-Milwaukee Center for Architecture and Urban Planning Research. Universities Space Research Association/Universities Advanced Design Program operates under Grant NASW-4435 from the National Aeronautics and Space Administration.

## **PUBLICATIONS IN ARCHITECTURE AND URBAN PLANNING**

Center for Architecture and Urban Planning Research  
University of Wisconsin-Milwaukee  
P.O. Box 413  
Milwaukee, WI 53201-0413

Report No. R90-1  
ISBN-0-938744-69-0

Additional copies of this report are available for \$10.00 prepaid by writing to the above address.

## 1. EXECUTIVE SUMMARY

Students at the University of Wisconsin-Milwaukee Department of Architecture (UWM/DAR) undertook a study of lunar habitats during the 1989-90 academic year. These studies involved an informational seminar in the fall semester, followed by a design studio in the spring. Students from architecture and mechanical and structural engineering were involved, some bringing previous backgrounds in interior design, biology, and construction technology. These studies resulted in three alternative scenarios for lunar habitation, and an integrated design for a early stage Lunar Outpost.

On the 20th anniversary of "One giant leap for mankind," President Bush this year announced a goal to land people on the moon by 2005, and this time to stay. Project Genesis is proposed as the first early stage, permanently occupied habitat on the moon.

Called Genesis, this early, evolutionary outpost is proposed both as a long-term testbed for all materials, processes, and development strategies to be employed in a mature lunar colony to be undertaken over the next 20 years, and as a testbed for all processes to be employed in the exploration and eventual settlement of Mars.

Following guidelines provided by consulting engineers and scientists at NASA's Johnson Space Center (NASA/JSC) and its prime contractors, the UWM design team designed Genesis for a full-time crew of eight to twelve persons on rotations of six to nine months with a maximum duration of 20 months. Crew gender, nationality, and ethnicity are expected to vary as the consortium of world aerospace partners all become involved in free-flowing scientific,

architectural, and engineering communication.

There are five mission objectives for Project Genesis: (1) lunar surface mining and production analysis for lunar oxygen (Lunox), helium 3 (H3), and other minerals; (2) lunar construction technology and materials testbed for testing high technology construction with inflatable, the use of lunar regolith for radiation shielding, lunar glass, lunar concrete, and sintering techniques using advanced telerobotic systems; (3) closed system ecological life support system (CELSS) test facility; (4) lunar far side observatory; and (5) human factors and environment-behavior research facility.

The first manned mission to establish the outpost, which is expected to land on the moon in 2005, could last as little as 14 days. The astronauts, architects, and engineers will live inside their lunar landing vehicle (LLV) and spend much of each day performing extra-vehicular activities (EVA) involved in the initial base construction. A pressurized construction module will be the first order of business, followed by the evolutionary development of phased construction of the rest of the Genesis. Once all systems, subsystems, and backups have been verified, and the initial operation configuration (IOC) has been put in place, crew change outs will occur every nine months to a year as the astronauts and their partners perform research and manufacturing operations at the Lunar Outpost.

Research, design, and development of Project Genesis was initiated in mid-1989 by the UWM Center for Architecture and Urban Planning Research and Department of Architecture in cooperation with the College of Engineering and Applied Science under the first year of a three-year grant from NASA/Universities Space Research

## Genesis Lunar Outpost

Association (NASA/USRA) University Advanced Design Program. UWM/Architecture is one of only three architecture schools in the 44-university NASA/USRA University Advanced Design Program. The program stresses the systems approach to design in which the class works together on a major "real world" space design project.

The project was performed over the course of two academic semesters. In the fall of 1989, an information seminar was conducted (Architecture 392/792, 3 credits) in which interested students received lectures, read extensively, and conducted simple sketch designs to come up to speed on information needed to design a lunar habitat. In the spring of 1990, a space architecture design studio was conducted (Architecture 690, 3 or 6 credits) in which the actual designs were developed. Three students served as team leaders for the various design and analysis teams.

Initially three different design scenarios were explored based on differing sets of engineering and architectural assumptions: (1) use of Space Station Freedom-type hard modules and other earth based construction technology; (2) use of the lunar surface craters and lava tubes; and (3) use of inflatable structures. Results of these scenarios were presented to and reviewed by NASA, USRA, industry, and university personnel. The best of each scenario was then combined into a final integrative design featuring design responses to human habitation requirements, the lunar environment, and advanced construction technology.

We recall the words of former Chancellor Clifford V. Smith, Jr. of the University of Wisconsin-Milwaukee, as quoted in the Milwaukee Journal and elsewhere, "With this sizable grant and the unique challenges it brings, the University of Wisconsin-Milwaukee and its

students, faculty, and administrators have taken a giant stride toward the future."

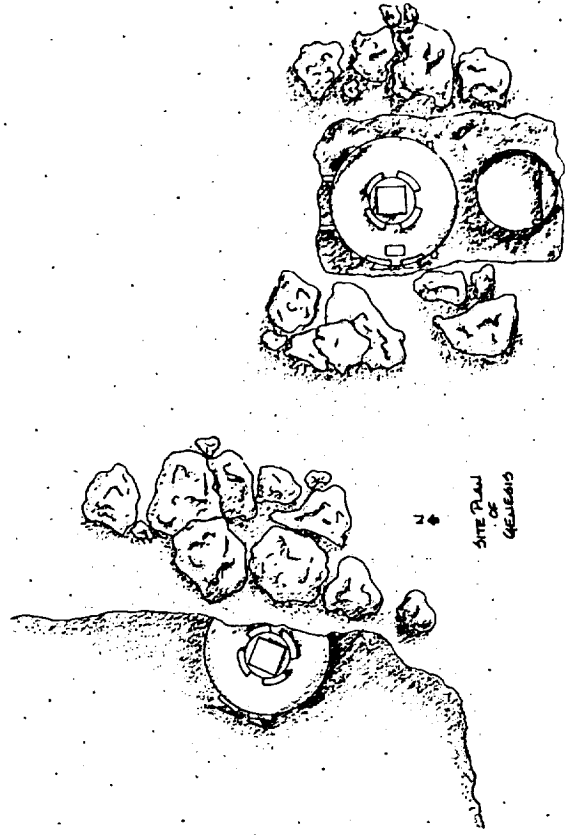

## 2. PREFACE

This report presents the architectural design for a lunar base habitat and research facility to be constructed for eight to twelve people at the proposed Apollo 18 site, Marius Hills, located 56 degrees 45 minutes West by 13 degrees 10 minutes North. Construction would begin in 2005, and full operating configuration would be achieved by 2015.

Following President Bush's goal to land people on the moon by 2005, and this time to stay, the base was planned for a construction start date of 2005. Design and construction will be led by a team of astronauts, scientists, architects, and engineers working together to build a permanently occupied habitat on the moon.

Called "Genesis," this evolutionary outpost is planned both as a long-term testbed for all materials, processes, and development strategies to be employed in a mature lunar colony to be undertaken in the next 20 years, and as a testbed for all processes necessary for exploration and eventual research and habitation of Mars.

### Background

Faculty and students of the University of Wisconsin - Milwaukee School of Architecture and Urban Planning (UWM/SARUP) have been actively involved in the research, analysis, and design of extraterrestrial environments since the spring of 1987.

In early 1987, the School began working with the Astronautics

Corporation of America's Technology Development Center, a world-wide aeronautics and aerospace company headquartered in Milwaukee, to define space design issues and criteria. In the fall of 1987, the Department of Architecture offered its first studio in "Space Architecture: Lunar Base Scenarios," resulting in the first in our Space Architecture Report Series (Schnarsky, Cordes, Crabb, & Jacobs, 1988). Simultaneously, the School and its Center for Architecture and Urban Planning Research hosted a series of workshops by leading members of the aerospace industry and visiting lectures by nationally recognized experts, made slide and video presentations at national meetings including the 3rd, 4th, and 5th Annual Summer Conferences of NASA/USRA (e.g., Cordes, Moore, & Hansmann, 1989), and wrote a series of articles for architects and academics about space research and design opportunities (e.g., Schnarsky, 1988).

### NASA/USRA Lunar Outpost Project

Design and development of this lunar facility was initiated in 1989 by the University of Wisconsin-Milwaukee's Center for Architecture and Urban Planning Research (UWM/CAUPR) and Department of Architecture (UWM/DAR) in cooperation with the College of Engineering and Applied Science (UWM/CEAS). It was supported by the first year of a three-year grant from NASA/Universities Space Research Association (NASA/USRA) University Advanced Design Program. UWM/Architecture is one of 44 universities in the NASA/USRA University Advanced Design Program, and one of only three architecture schools in the program. The program stresses the systems approach to design in which the class works together on a major "real world" project.

The project was completed over the course of two academic semesters. In the fall of 1989, an information seminar was conducted (Architecture 392/792, 3 credits) in which interested students received lectures, read extensively, and conducted simple sketch designs to "come up to speed" on information needed to design a lunar habitat. The product was a program requirements document available in the Space Architecture Series (Baschiera, et al., 1989).

In the spring of 1990, a space architecture design studio was conducted (Architecture 690, 3 or 6 credits) in which the actual designs were developed. The results are reported in this document.

The seminar was run by Mr. Edwin Cordes, a recent graduate of our Master of Architecture program and now a design engineer for Space Station Freedom at the McDonnell Douglas Space Systems Company, and myself. I ran the studio with significant input from a cast of visiting faculty and national critics from NASA Johnson Space Center and elsewhere. Our chief consultant through the year was Mr. Thomas Crabb, an astronautical engineer and Vice President of Orbital Technologies Corporation in Madison, Wisconsin. The NASA/USRA teaching assistant was Mr. Timothy Hansmann, who had been a summer intern in the Advanced Programs Department of the Engineering Directorate at NASA/JSC. Three extra-credit students - Messrs. Dino Baschiera and Joseph Fieber and Ms. Janis Huebner Moths - served as team leaders for the various analysis and design teams; together with Ms. Kerry Paruleski, all are now employed in the aerospace industry.

During the design phase of the project, three different design scenarios were explored based on differing sets of engineering and architectural assumptions: (1) use of prefabricated Space Station Free-

dom-type hard modules and other earth-based construction technology; (2) use of the lunar surface craters and lava tubes; and (3) use of inflatable structures. Results of these scenarios were presented to and reviewed by NASA, USRA, industry, and university personnel. The best of each scenario was then combined into a final integrative design.

This report summarizes the main performance requirements for a lunar outpost (cf. Baschiera et al., 1989 for greater detail), discusses the advantages and limitations of the three preliminary scenarios explored, and presents the final integrated design solution.

Since drafting this report, and as a direct outgrowth of the first year of our NASA/USRA grant, we were invited to be the lead unit on what evolved into a \$3.4 million grant proposal to the University of California Lawrence Livermore National Laboratory to research, design, fabricate, and test a new concept for a second US space station. The proposal involves a consortium of academic departments (architecture, chemistry, engineering, and materials science) at two major universities together with four industrial partners. The Proposal is under review and pending.

Gary T. Moore, Ph.D.  
Professor of Architecture  
Project Director and Faculty Advisor

### 3. ACKNOWLEDGEMENTS

The team members would like to thank the National Aeronautics and Space Administration (NASA) and the Universities Space Research Association (USRA) for sponsoring the project, and Celeste Sychter-Wilson from the Lyndon B. Johnson Space Center who was our NASA/JSC liason. Special thanks to Dr. Gary T. Moore, our faculty advisor, and Mr. Tom Crabb of Astronautics Corporation of America for their support and assistance with human factors and technical information, and for their confidence in the team's capabilities throughout the academic year.

Thanks also to Kriss Kennedy, Mike Roberts, and John Connolly of the Johnson Space Center for technical and program assistance, and in helping define the requirements of the project.

The team is also grateful to Dr. John Alred, Program Manager at USRA, Deborah Neubek of the University of Houston's Sasakawa International Design Program in Space Architecture, and Professor Aurio Andino of the University of Puerto Rico's Space Architecture Program for taking the time to visit and add their valuable input during the course of the project.

Thanks to Mr. Ed Cordes, now at McDonnell-Douglas Corporation, Houston, without whom the program would not exist at the University of Wisconsin-Milwaukee.

We also owe our thanks to the following: to our Visiting Faculty, Profs. Ryoichi S. Amano, Department of Mechanical Engineering; Al Ghorbanpoor, Department of Civil Engineering; Robert Greenstreet and Anthony J. Schnarsky, Department of Architecture; Umesh

Saxena, Department of Industrial and Systems Engineering; and to our Visiting Critics, Michael Kalil, Architect, Kalil Studios, New York; Jason Lorandos, Sasakawa International Design Program in Space Architecture, University of Houston; Ronald R. Teeter, Orbital Technologies Corp., Madison; and Claudio Veliz, Architect, New York.

Timothy Hansmann  
NASA/USRA Teaching Assistant





**TABLE OF CONTENTS**

<b>1. EXECUTIVE SUMMARY</b>	iii		
<b>2. PREFACE</b>	v		
<b>3. ACKNOWLEDGEMENTS</b>	vii		
<b>4. LIST OF FIGURES</b>	xi	<b>6.7 Crew Support/Habitat</b>	27
<b>5. INTRODUCTION</b>	1	<b>6.4 Construction Operations</b>	15
5.1 General	1	<b>6.5 Partial Gravity Considerations</b>	16
5.2 Project Goals	2	<b>6.6 Site and Master Planning</b>	17
5.3 Lunar Base Objectives	2	6.6.1 Site Considerations	17
5.4 Design Methodology	4	6.6.2 Master Plan Components	17
<b>6. DESIGN ISSUES/REQUIREMENTS</b>	11	6.6.3 Base Layout Strategies	23
6.1 Introduction	11	6.6.4 Image	26
6.2 Lunar Environmental and Surface Properties	11		
6.2.1 Lunar Atmosphere	11		
6.2.2 Lunar Regolith	11		
6.3 Lunar Structural Design	12		
6.3.1 Structural Design Criteria	12		
6.3.2 Systems Options/Earth-based Materials	13		
6.3.3 Systems Options/In Situ Resource Utilization	14		
		<b>6.7.1 General Design Requirements</b>	27
		<b>6.7.2 Personal Quarters</b>	28
		<b>6.7.3 Personal Hygiene Facilities</b>	29
		<b>6.7.4 Laundry Facilities</b>	30
		<b>6.7.5 Exercise Facility</b>	30
		<b>6.7.6 Medical Facility</b>	31
		<b>6.7.7 Group Recreation Areas</b>	33
		<b>6.7.8 Meals/Meal Preparation Area</b>	34
		<b>6.7.9 Zoning, Proximities, Volumes, and Phasing</b>	34
		<b>6.8 Base Operations</b>	35
		6.8.1 Command Center	35
		6.8.2 Intra-Base Communications: Teleconferencing and Meeting Facilities	37
		6.8.3 Logistics/Storage Systems	37
		6.8.4 Safehavens/Emergency Systems	37
		6.8.5 EVA Chamber	38
		6.8.6 Power Systems	39
		6.8.7 ECLSS/HVAC Systems	41

6.8.8 Lighting Systems	42	<b>9. APPENDICES</b>	
6.8.9 Thermal Control Systems	42		
6.9 Mission Operations: Research Facilities	43	A. Publications, Talks, and Interviews on Space Architecture	103
6.9.1 General Laboratory Considerations	43		
6.9.2 Lunar Surface Mining and Production Facility	44		
6.9.3 Construction Technology Testbed	44		
6.9.4 CELSS Research Facility	45		
6.9.5 Lunar Farside Observatory	45		
6.9.6 Human Factors and Environmental Behavior Research Facility	45		
<b>7. GENESIS: LUNAR BASE DESIGN</b>	<b>47</b>		
7.1 Three Alternative Scenarios	47		
7.1.1 Prefab Module Construction	48		
7.1.2 Lunar Craters and Lava Tubes	54		
7.1.3 Inflatable Structures with Modules	59		
7.2 Final Design Solution: Integrative Design	66		
7.2.1 Design Approach	66		
7.2.2 Site and Master Planning	67		
7.2.3 Interior Configuration	77		
7.2.4 Construction Technology	90		
<b>8. REFERENCES</b>	<b>101</b>		

## 4. LIST OF FIGURES

Figure 5.4-1.	Fall seminar objectives and milestones	5	Figure 7.1.1-4.	Section through the domed teleconference/workstations area	52
Figure 5.4-2.	Spring studio objectives and milestones	5	Figure 7.1.1-5.	Longitudinal sections	53
Figure 5.4-3.	Module design	6	Figure 7.1.2-1.	Entrance to lava tube scenario from crater	55
Figure 5.4-4.	Teleconference area	7	Figure 7.1.2-2.	Other entrance/exit to lava tube scenario	56
Figure 5.4-5.	Hygiene facility	7	Figure 7.1.2-3.	Lower level floor plan and section of lava tube scenario	57
Figure 5.4-6.	Water subsystem	7	Figure 7.1.2-4.	Upper level floor plan	58
Figure 5.4-7.	Programming matrix	8	Figure 7.1.2-5.	Site plan	59
Figure 6.6.1-1.	Lunar outpost site	18	Figure 7.1.2-6.	View into the lava tube	59
Figure 6.6.1-2.	Specific site location	19	Figure 7.1.3-1.	Site configuration of the inflatable lunar outpost scenario	60
Figure 6.6.2-1.	Landing pads and components	20	Figure 7.1.3-2.	North end of site	61
Figure 6.6.2-2.	Genesis master plan	21	Figure 7.1.3-3.	South end of site	62
Figure 6.6.3-1.	Comparison of base layout configurations (SICSA, 1989)	25	Figure 7.1.3-4.	Phased development of the inflatable scheme	63
Figure 6.7.5-1.	Diagrams of possible layouts of exercise facilities	32	Figure 7.1.3-5.	Deployment of the inflatable structures in 8 primary stages (a-h)	64-65
Figure 6.7.6-1.	Diagrams of possible layouts of medical facilities	33	Figure 7.1.3-6.	Section through inflatable dome	66
Figure 6.7.7-1.	Diagram of a possible layout of a group recreation area	34	Figure 7.2.2-1.	Genesis overall base layout	69
Figure 6.7.9-1.	Zoning diagram	35	Figure 7.2.2-2.	Phasing of Project Genesis: Phase 1	71
Figure 6.7.9-2.	Proximity diagram	35	Figure 7.2.2-3.	Phasing of Project Genesis: Phases 2 through 4	72-74
Figure 6.7.9-3.	Volumetric phasing chart for the habitat/crew quarters area	36	Figure 7.2.2-4.	Site and master plan evolution: Phases 1 through 4	75
Figure 7.1.1-1.	Initial three phases for the hard module scenario	49	Figure 7.2.2-5.	Master plan evolution into a mature or Advanced Lunar Outpost	76
Figure 7.1.1-2.	Phases 2 and 3 for the hard module scenario	50	Figure 7.2.3-1.	Genesis Lunar Outpost: Phase 1 plans and section	80
Figure 7.1.1-3.	Base floor plan	51	Figure 7.2.3-2.	Phase 2 plan and sections	82

**4. LIST OF FIGURES ( Cont. )**

Figure 7.2.3-3.	Phase 3 floor plan	85
Figure 7.2.3-4.	Phase 4 floor plan	87
Figure 7.2.3-5.	Section through base habitat	88
Figure 7.2.3-6.	Axometric of the habitation dome	89
Figure 7.2.4-1.	Concept drawing for a regolith collecting and bagging machine	91
Figure 7.2.4-2.	Technical concept designs for habitat structure	92
Figure 7.2.4-3.	Recommended inflatable laminated membrane	93
Figure 7.2.4-4.	Expanding floor truss	94
Figure 7.2.4-5.	Planned collapse of structure for transport	94
Figure 7.2.4-6.	Floor panels in deployment	95
Figure 7.2.4-7.	Hard connectors, interlocking connectors, and structural plans	97
Figure 7.2.4-8.	Regolith bagging and stacking - early phase	98
Figure 7.2.4-9.	Regolith bagging and stacking near completion	99

## 5. INTRODUCTION

### 5.1 NEWS RELEASE

June 13, 2005

Please join us for a historical review of Genesis, the first outpost on the moon.

The year is 2005. Today the United States in conjunction with its space partners Canada, Japan, the European Space Agency, and the Soviet Union has landed its first team of astronauts, scientists, architects, and engineers to build a permanently occupied habitat on the moon.

Called Genesis, this early, evolutionary Outpost will function as a long-term testbed for all materials, processes, and development strategies to be employed in a mature lunar colony to be undertaken in the next 20 years, and as a testbed for developmental technologies to be employed in the exploration and settlement of Mars.

Design and development of this lunar test facility was initiated in the year 1989 by NASA/USRA and its prime contractors in conjunction with the University of Wisconsin-Milwaukee's Center for Architecture and Urban Planning Research and Department of Architecture in cooperation with the College of Engineering and Applied Science. A dedicated, insightful, and resourceful group of eleven students — architects, interior designers, and engineers — developed three experimental scenarios for Genesis.

These three scenarios, each based on different assumptions, provided the basis for the Lunar Outpost, and for the further development of one of Earth's last frontiers.

The best of each of the three scenarios was subsequently combined into one integrated design solution for the Outpost, since known as NASA Project Genesis.

Following guidelines provided by NASA and its prime contractors, the UWM design team designed Genesis for a full-time crew of eight to twelve persons on rotations of six to nine months. Crew gender, nationality, and ethnicity varied as the consortium of world aerospace partners all became involved after the fall of the Iron Curtain and the subsequent fall of the Great Wall, opening the entire world to free flowing scientific, architectural, and engineering communication.

There were five purposes for Project Genesis: (1) lunar surface mining and production analysis for lunar oxygen (Lunox), helium 3 (H3), and other minerals; (2) lunar construction technology and materials testbed for testing high technology construction with inflatable, the use of lunar regolith for radiation shielding, lunar glass, lunar concrete, and sintering techniques using advanced telerobotic systems; (3) closed system ecological life support system (CELSS) test facility; (4) lunar far side observatory; and (5) human factors and environment-behavior research facility.

The first manned mission, which landed earlier today, June 13, 2005, will last only 14 days. The astronauts, architects, and engineers, will live inside their lunar landing vehicle (LLV) and spend much of each day performing extra vehicular activities (EVA) involved in the initial base construction. A pressurized construction module will be the first order of business, followed by the evolutionary development of phased construction of the rest of the Genesis. Once all systems, subsystems, and backups have been verified, and the initial operation configuration (IOC) has been put in place, crew change outs will occur every 9 months to a year as the astronauts and their partners perform research and manufacturing operations at the Lunar Outpost.

We recall the words of former Chancellor Clifford V. Smith, Jr. of the University of Wisconsin-Milwaukee, as quoted in the Milwaukee Journal and elsewhere, "With this sizable grant and the unique challenges it brings, the University of Wisconsin-Milwaukee and its students, faculty, and administrators have taken a giant stride toward the future." The world owes much to the brave beginnings of this hearty group of students, now successful architects and engineers at NASA and its prime contractors.

But let us step back, and look at the beginnings of Genesis. Let us take a historical look at the three scenarios as they were first presented in a design studio at UWM back in February, 1990, and at the final integrative design as it was presented at the 6th Annual NASA/USRA Summer Conference held at NASA/Lewis Research Center exactly 15 years ago to the day.

## 5.2 PROJECT GOALS

This project was part of a three-year effort to investigate, research, analyze, and design outposts on the moon, human settlements on Mars, and the habitation requirements of long-duration manned transportation systems such as will be used between the Earth, the moon, and Mars.

The overriding objective of the project is to enhance architectural and architectural/engineering education in space design through establishing an advanced space architecture program that integrates architecture, engineering, planning, human factors, environment-behavior studies, natural resource utilization, and advanced construction technology.

The project had three specific project goals:

1. **Design solutions.** To develop major, creative yet realistic architectural and architectural/engineering design solutions to space design issues involved in the "bridge between worlds," in particular, in response to lunar outpost evolution, human factors and environment-behavior issues, safety, energy, construction technology, and the utilization of natural resources.

2. **Curriculum development and pedagogy.** To enhance, further develop, and maintain courses and studios in the area of space architecture in the School of Architecture and Urban Planning in conjunction with the College of Engineering and Applied Science at the University of Wisconsin-Milwaukee, and also to offer the design student the opportunity to become well versed in space and high technology.

3. **Useful information.** To produce information and design solutions useful to the aerospace community, NASA, its prime contractors and subcontractors, and NASA/USRA schools in the area of long-duration habitation design, and to publish this information and disseminate it in a manner that makes it accessible and timely to these communities.

## 5.3 LUNAR BASE OBJECTIVES

A lunar outpost had eight major objectives or performance requirements to satisfy:

1. Able to be constructed at an Earth-facing equatorial location.
2. Able to be constructed of light-weight, durable materials that require a minimum of EVA time.
3. Contained within the next generation of sophisticated Earth-lunar transport systems, expected to be comprised of four primary components:

- a. the US Space Transport Shuttle system;
  - b. heavy-lift launch vehicle such as the Space Transport System unmanned Shuttle C with its cargo capacity of 69,000 K (150,000 lbs) and cargo bay accommodating payloads up to 25 m long by 4.5 m wide (82 x 15 ft) to low-Earth, space-station-inclination orbit (LEO);
  - c. the low-Earth orbit Space Station Freedom (SSF) and associated platforms, perhaps to include the more recently proposed Lawrence Livermore National Laboratory Earth Station; and
  - d. the planned Cis-lunar transport system, a dual-use system comprised of an orbital transfer vehicle (OTV) and a separated reusable lunar lander that transports construction components to the lunar surface along with crews and logistics.
4. Capable of housing 8-12 astronauts of different nationalities, genders, and specialties for periods of time up to 20 months though with a normal change-out time of 6-9 months.
  5. Provision for all necessary life-support systems and quality of life systems necessary for a safe and humane existence, including but not limited to:
    - a. anthropometrics and human factors;
- b. health and safety issues;
  - c. environment-behavior issues including people, activities, isolation and interaction, privacy, personal space, and territoriality;
  - d. habitability and architectural issues;
  - e. environment-behavior issues in crew areas, crew support, operations of base, and design for productivity; and
  - f. space biospheres, Controlled Ecological Life-Support Systems (CELSS), and Environmentally Controlled Life-Support Systems (ECLSS).
6. Integration of advanced technologies, including but not limited to the following:
    - a. space construction technology;
    - b. advanced systems of energy use and energy conservation; and
    - c. advanced mechanical systems including power, thermal, air movement, and hydraulic systems;
  7. Understanding and response to the natural environment of the moon, the physics, geology, and natural environmental qualities of the moon, lunar resource utilization, and

appropriate "urban" design so as to retain the natural qualities of the moon: "Take only pictures, leave only footprints."

8. Support for five main mission operations, all research functions:
  - a. lunar surface mining and production analysis for lunar oxygen (Lunox), helium 3 (H3), and other minerals;
  - b. lunar construction technology and materials tested for testing high technology construction with inflatable, the use of lunar regolith for radiation shielding, lunar glass, lunar concrete, and sintering techniques using advanced telerobotic systems;
  - c. closed ecological life support system (CELSS) test facility;
  - d. lunar far side observatory; and
  - e. human factors and environment-behavior research facility including post-occupancy evaluations (POEs) of Genesis itself.

Each of these mission objectives and their associated performance requirements are examined in detail in the next major section, Section 6.

## 5.4 DESIGN METHODOLOGY

To achieve these goals and mission objectives, the project team proceeded in three main phases:

1. **Fall semester seminar.** The project began with a fall semester seminar of 12 students from architecture, interior design, mechanical and structural engineering, and liberal arts/pre-architecture. The seminar was under the leadership of Edwin Cordes, a recent graduate of the UWM M.Arch. program and of the International Space University in Strasbourg, France, and Dr. Gary Moore, a research architect and environmental psychologist who was the overall project director. The NASA/USRA teaching assistant was Mr. Timothy Hansmann, who had been a NASA/USRA intern at the Johnson Space Center. The product was a programming/requirements document (Baschiera et al., 1989).

A brief study of the current habitation/laboratory modules for Space Station Freedom was conducted to acquaint the students with certain design constraints. Highlighted results appear in Figures 5.4-3, 5.4-4, 5.4-5, and 5.4-6. Additionally, the base was organized into four program categories, and a programming matrix addressing the base elements and their design issues was formulated.

2. **Spring design studio — three alternative design scenarios — preliminary design.** A design studio in the spring semester developed a lunar outpost initiated from that document. A group of 11 students, more than half of whom had been in the fall seminar, were drawn from architecture, interior design, and mechanical and structural engineering. Issues considered included anthropomet



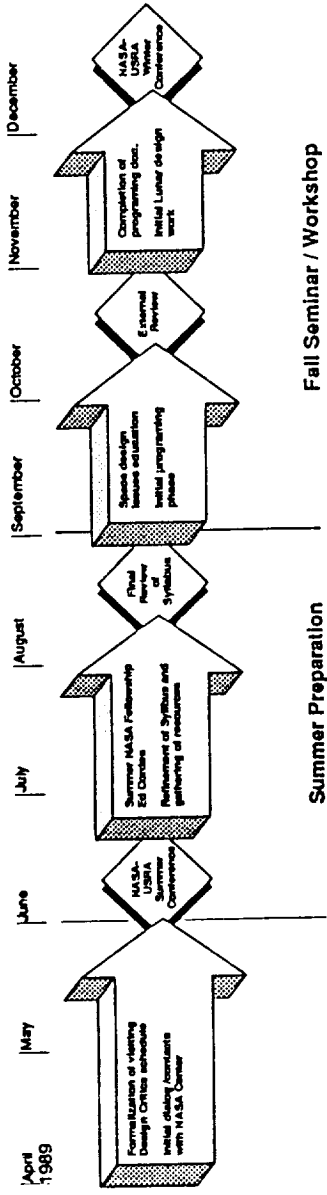

Figure 5.4-1. Fall semester objectives and milestones.

rics, human factors, health and safety, psychological and social issues, habitability, energy systems, construction technology, internal and external base operations, and base master planning and phasing.

For a short time, teams explored different sub-systems of the base (research module, manufacturing module, habitat module, transportation system, overall base planning and layout). Three alternative design scenarios were explored in detail, and preliminary design

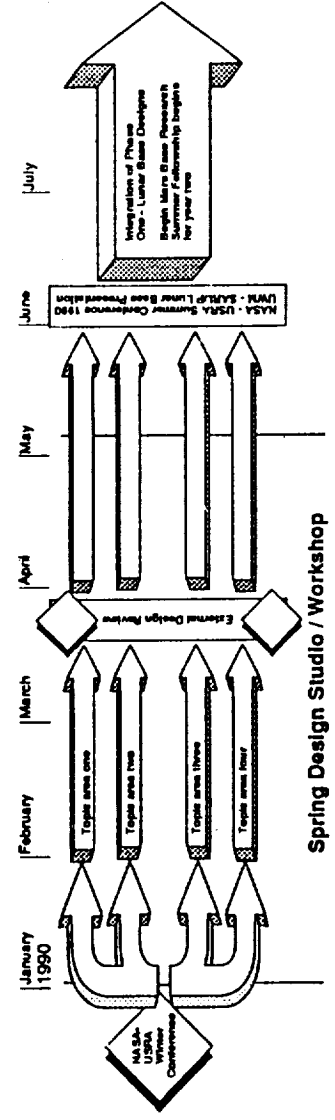

Figure 5.4-2. Spring studio objectives and milestones.

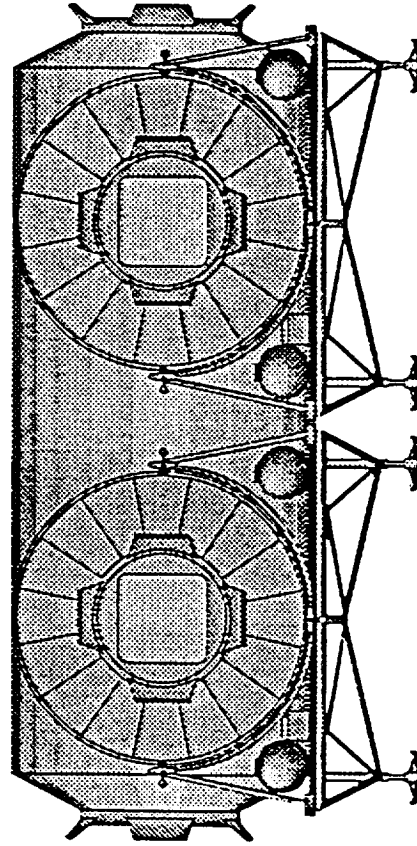
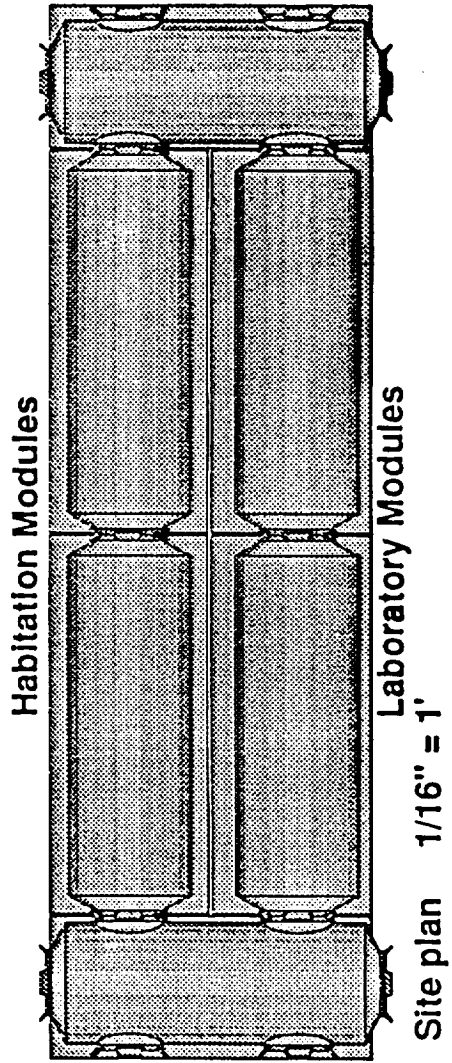

Figure 5.4-3. Module design.

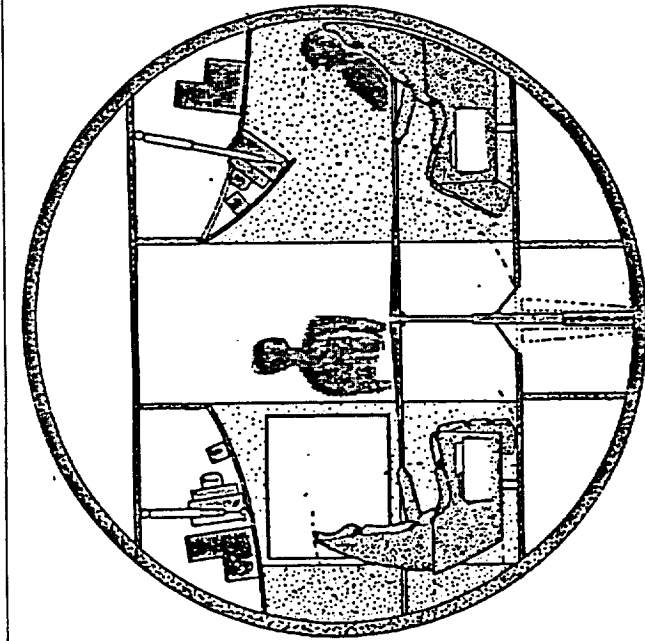

Figure 5.4-4. Example: teleconference area.

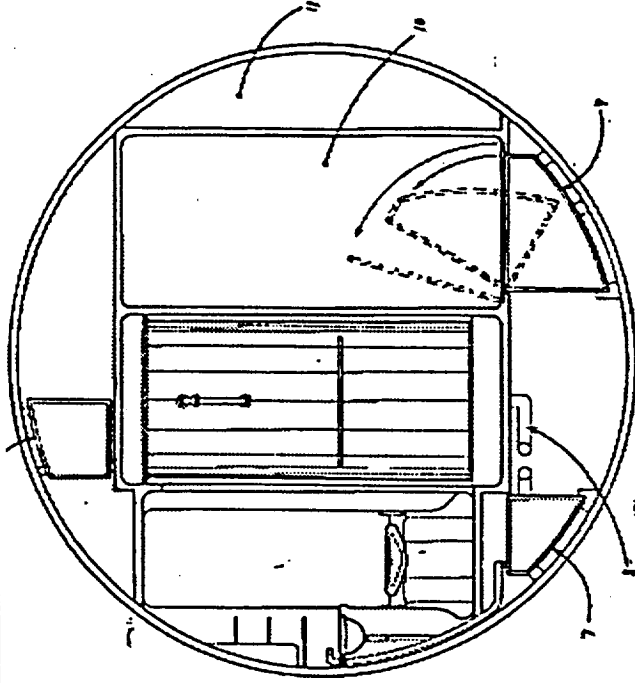

Figure 5.4-5. Example: hygiene facility.

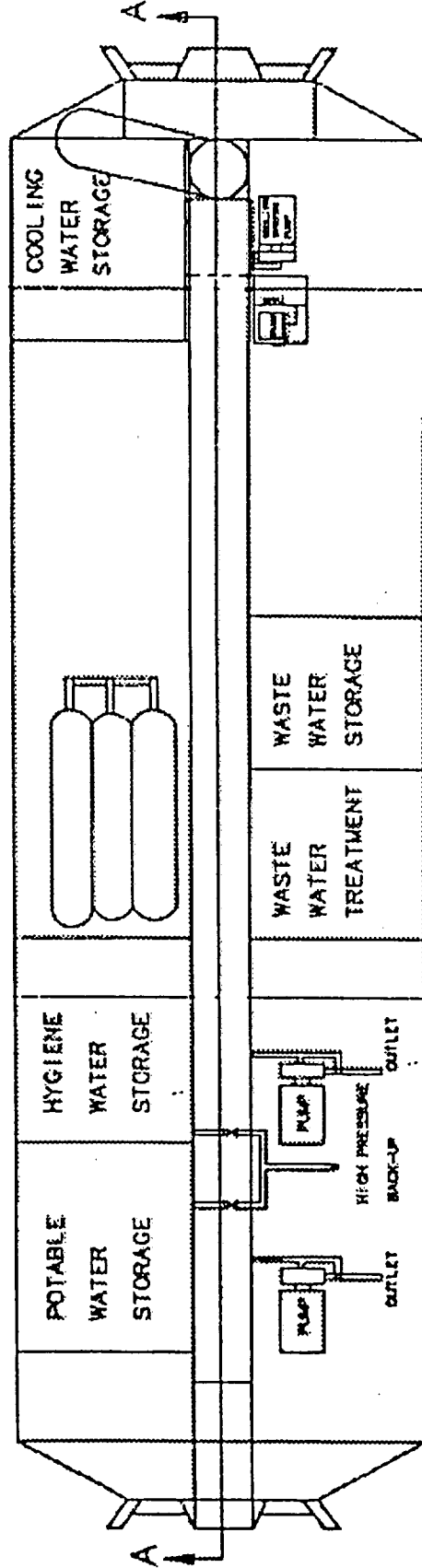

Figure 5.4-6. Preliminary water subsystem.

Design Issues

Base Elements	Design Issues																				
	+ Very Important	- Somewhat Important	0 Not Important	Privacy	Anthropometrics	Coding	Color / Decor	Gender Issues	Materials	Thermal / Light Req.	Health / Safety	Social Interaction	Sound Transmission	Personalization	Wayfinding	Productivity	Atmosphere Control	Redundancy	Ergonomics	Proximity	
Personal Quarters	+	+	+	+	+	+	+	+	+	+	+	+	+	+	+	+	+	+	+	+	+
Meal / Meal Prep.	0	+	+	+	+	+	+	+	+	+	+	+	+	+	+	+	+	+	+	+	+
Sleeping	+	+	+	+	+	+	+	+	+	+	+	+	+	+	+	+	+	+	+	+	+
Hygiene	+	+	+	+	+	+	+	+	+	+	+	+	+	+	+	+	+	+	+	+	+
Exercise	+	+	+	+	+	+	+	+	+	+	+	+	+	+	+	+	+	+	+	+	+
Group Recreation	0	+	+	+	+	+	+	+	+	+	+	+	+	+	+	+	+	+	+	+	+
Materials Storage	0	+	+	+	+	+	+	+	+	+	+	+	+	+	+	+	+	+	+	+	+
Workstations / Lab	0	+	+	+	+	+	+	+	+	+	+	+	+	+	+	+	+	+	+	+	+
Biosphere	0	+	+	+	+	+	+	+	+	+	+	+	+	+	+	+	+	+	+	+	+
Medical Facility	+	+	+	+	+	+	+	+	+	+	+	+	+	+	+	+	+	+	+	+	+
Safehaven / Emergency	+	+	+	+	+	+	+	+	+	+	+	+	+	+	+	+	+	+	+	+	+
Communications	0	+	+	+	+	+	+	+	+	+	+	+	+	+	+	+	+	+	+	+	+
Teleconl. / Meetings	0	+	+	+	+	+	+	+	+	+	+	+	+	+	+	+	+	+	+	+	+
Command Center	0	+	+	+	+	+	+	+	+	+	+	+	+	+	+	+	+	+	+	+	+
EVA / IVA & Monitor	0	+	+	+	+	+	+	+	+	+	+	+	+	+	+	+	+	+	+	+	+
Power	0	+	+	+	+	+	+	+	+	+	+	+	+	+	+	+	+	+	+	+	+
Transportation	0	+	+	+	+	+	+	+	+	+	+	+	+	+	+	+	+	+	+	+	+
Remote Operations	0	+	+	+	+	+	+	+	+	+	+	+	+	+	+	+	+	+	+	+	+
ECLSS	0	+	+	+	+	+	+	+	+	+	+	+	+	+	+	+	+	+	+	+	+
Waste Storage	0	+	+	+	+	+	+	+	+	+	+	+	+	+	+	+	+	+	+	+	+
Base Layout	0	+	+	+	+	+	+	+	+	+	+	+	+	+	+	+	+	+	+	+	+
Circulation / Translation	0	+	+	+	+	+	+	+	+	+	+	+	+	+	+	+	+	+	+	+	+
Lighting	0	+	+	+	+	+	+	+	+	+	+	+	+	+	+	+	+	+	+	+	+
Image	+	+	+	+	+	+	+	+	+	+	+	+	+	+	+	+	+	+	+	+	+
Storage Systems	0	+	+	+	+	+	+	+	+	+	+	+	+	+	+	+	+	+	+	+	+

Figure 5.4-7. Programming matrix.

solutions were presented at a Preliminary Design Review (PDR) on February 17, 1990. The three scenarios, each pursued by a different team, were as follows:

- a. prefabricated rigid space structures using clusters of space station-sized pressure vessels, aluminum alloy domes, and interconnect nodes;
- b. underground architecture using the natural lunar craters and lava tubes; and
- c. inflatables using a laminated Kevlar bladder with a space frame structure.

Separate modules were designed for laboratory and habitation functions. The entire facility was designed to be buried under a sufficient amount of lunar regolith (approximately 1.5 m) for proper radiation protection and thermal control.

Each team was comprised of architects and engineers with different specialties: environment-behavior systems, human factors, interior design, structural or mechanical engineering, and construction technology. This division — vertically by sub-system and horizontally by specialty — insured that each sub-system responded to all design factors and that all sub-systems would later contribute to an integrated solution.

The most promising design concepts and ideas were selected at a mid-semester PDR led by guest critics from NASA/JSC and McDonnell Douglas Space Systems Company and visiting faculty from the UWM Departments of Architecture, Mechanical Engineering, and

### Civil Engineering.

The product was a set of design drawings and presentation boards, together with an associate slide presentation, that was presented at several regional and national meetings and received a special student design commendation award from the Environmental Design Research Association at its 21st annual conference held at the University of Illinois, Urbana-Champaign, Illinois.

3. **Spring design studio - final integrated design solution - design development.** The design concepts and ideas selected from the PDR were further developed by the entire project team.

First, a number of critical technical issues needed further research, analysis, and design exploration — materials, joining systems, hatches and gaskets, structural system, deployment and erection systems, and regolith containment systems. Each was explored in depth by one or two members of the team with critical input from our NASA/JSC consultants and industry representatives.

Second, the project team was subdivided into teams for the further exploration and design development of parts of the overall Genesis Lunar Outpost. The three critical teams were:

- a. site and master planning (see Sections 6.6 and 7.2.2 below);
- b. interior configuration (see Sections 6.7 and 7.2.3 below); and
- c. construction technology (see Sections 6.4 and 7.2.4 below).

## Genesis Lunar Outpost

Each team was again comprised, as best we could, of architects and engineers and of team members with backgrounds and expertise in design, environment-behavior issues, and technology.

The product was a final set of design development drawings, together with a comprehensive slide presentation, that was presented at the NASA/USRA 6th Annual Summer Advanced Design Program Conference, NASA/Lewis Research Center, and elsewhere in this country and overseas. The details of this design are given below in Section 7.

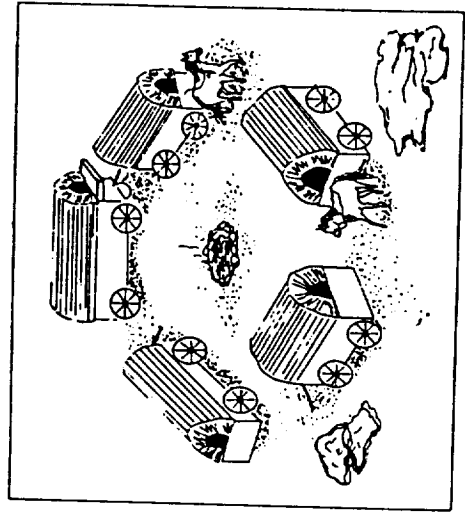

## 6. DESIGN ISSUES/REQUIREMENTS

### 6.1 INTRODUCTION

The design of facilities for lunar habitation presents much more than a technological challenge. The technology will be crucial, but it must be developed with a sensitivity and understanding of the inhabitant's needs. The design must take into account how our physiology interacts with the built environment, and our role in the ecosystem, and come to realize those factors directing our lives which are so closely linked to this planet that we do not even realize they exist.

Being more than just a shelter, the lunar habitat must be capable of recreating, in microcosm, many of the aspects of life we experience on Earth but which are absent on the moon.

### 6.2 LUNAR ENVIRONMENTAL AND SURFACE PROPERTIES

#### 6.2.1 Lunar Atmosphere

One of the foremost concerns is the absence of a habitable atmosphere on the moon. Since life support requires the presence of a pressurized atmosphere contained within most of the structures, these structures must be able to support the differential pressures resulting from a high internal pressure and a low external pressure. Geometric shapes which most economically resist these tension forces, such as spheres, would prove to be most economical in

providing pressurized habitable volumes.

The requirements of a closed-system architecture also stipulate total control and conservation of all resources necessary for human life. Designs must permit minimal leakage and the ability to recycle air, water, wastes, and materials.

The lack of a lunar environment also results in the presence of intense solar and cosmic radiation. A lunar structure must therefore be capable of either absorbing the harmful radiation, or be able to support some type of shielding.

The presence of solar radiation without an insulative atmosphere also produces extreme temperature variations. At the lunar equator, for example, the temperatures range from 111 C (231 F) during the lunar day to -171 C (275 F) at the end of the 14 day lunar night cycle. This provides a lunar day-night or sun-shade temperature variance of 280 C (500 F), with a thermal shock which can range from 150 to 200 C/hr (Podnieks, 1988). This leads to thermal erosion caused by continual expansion and contraction of materials.

#### 6.2.2 Lunar Regolith

From a geotechnical point of view, it is believed that the moon will be a relatively simple and stable place to build. The lunar regolith, the generic term applied to all lunar surface soil types, is similar to very fine grained sand and extends to a depth of at least two meters, and possibly twenty meters or more, fairly consistently over the lunar surface. The three main properties which are responsible for prob-

lem soils on Earth are absent on the moon: there is no water, no clay minerals, and no organics. In addition, the mineralogy and particle size distribution is limited to a fairly narrow range. Therefore the single most important factor is the relative density of the soil.

The top few centimeters of the lunar surface are very loose. However, eons of meteoroid impacts have produced a very dense subsurface, so much so that it should be possible to excavate vertical walls to a depth of at least two meters (NASA TM 82478, 1982).

The lunar soil itself can provide a number of elements which can be used to fabricate structural materials. Studies have been conducted which propose lunar concrete, basalt, glass, and metal structures (e.g. Lin, 1988), all of which can be totally or partially derived from the lunar regolith. The properties of these lunar materials will generally have higher bearing strengths than their Earth-based counterparts, mostly due to the anhydrous atmosphere of the moon.

The lunar regolith would also serve as a natural radiation shield. Recent studies have shown that as little as 50 centimeters of regolith covering would provide acceptable levels of radiation protection (Nealy, 1988).

## 6.3 LUNAR STRUCTURAL DESIGN

### 6.3.1 Structural Design Criteria

Problems mentioned previously have immediate impact on the nature of a structure to be built in the environment of the moon. In all buildings it is necessary to resist and transmit loads through a

structural system. The design and development of the structural system in relation to a building concept is one of the major formal decisions made by the designer. In space it will be recognized that environmental and economical concerns will be dominantly expressed in the shape and form of the structures we build there.

In general, it may be useful to consider the following general design criteria when choosing a structural system (Roberts, 1989):

- **Reliability:** Is the structural system likely to fail?
- **Resilience:** If a failure occurs, will the failure be catastrophic or will the structural system offer some redundancy?
- **Habitability:** How conducive is the system to providing a livable environment?
- **Transportability:** How economical will the system be in terms of delivery and packaging?
- **Constructibility:** Is the structure economical and safe in terms of its assembly requirements?
- **Expandability:** How well does the structure lend itself to future growth?

#### 6.3.1.1 Pressure Vessel Design/Load Carrying Strategies

The preliminary design of a tensile membrane can be approached



### 6.3.2 Systems Options/Earth-Based Materials

#### 6.3.2.1 Prefabricated Modules

Prefabricated modules are self-contained, pressurized vessels which can be fully outfitted prior to launch. The fact that all equipment can be integrated and checked out prior to its use, and also the fact that it is the most proven method of providing a pressurized volume, has made this method of construction very attractive for early phase space habitats under 1000 cubic meters. The major limitations in the use of prefabricated modules are that the largest base module size is constrained to the maximum size of launch and landing vehicles, and also the need for equipment that will be capable of lifting and moving 4MT. Using the Space Station Common Module (6 meters in diameter and 22 meters long), it would take 150 modules to provide a volume of 30,000 cubic meters and 5,000 modules to provide a volume of 1,000,000 cubic meters.

#### 6.3.2.2 Pneumatic Structures

Pneumatic structures are structures which are supported by a pressure differential. They offer clear advantages in creating large, easily deployable volumes which are highly compactible for launch. Pneumatic structures can be broken down into two major categories of air inflated structures and air supported structures. When air is contained within a member to form inflated structural elements (columns, arches, beams, walls, ribs, etc.), it is classified as air inflated construction. An air supported structure consists of a structural membrane which is supported by a pressure differential. The membrane not only contains the internal pressure but also becomes the main structural element. Unlike thin shell aluminum

from basic geometric and mechanics methods. The required thickness,  $t$ , of a structural material may be determined for a sphere of radius  $R$ , internal pressure  $p$ , and material working stress  $O_w$  by the relationship:

$$t = pR/O_w$$

As stated before, the sphere offers the most stable pressure differential geometry. Toruses, cylinders, and cones offer the next best solutions. Shapes which use sharp corners should be avoided, as structural failures are very likely to occur at these transition points.

The use of fabrics or structural metals which are very strong in withstanding tensile forces are the most common load carrying materials. Materials such as lunar concrete or basalt would be used mostly in applications where their high compressive strength is utilized and their low tolerance to tensile stresses will not expose the material to possible structural failure.

In addition, materials must be selected which resist heat deterioration and mechanical fatigue, or provisions must be made to insulate them against these loads.

Current construction methods are limited to prefabricated systems which are, at most, assembled in space. Establishing a permanent presence in space will depend on our ability to "give off the land" just as explorers have done in the past. The use of extraterrestrial resources will be an important step in reducing costs in the long run as well as decrease dependence on the Earth.

structures, inflatables must either be of a least resistant geometry such as a sphere or torus, or utilize a restraining device such as a net to help them retain their desired shape. Inflatables must also be redundant in construction so that a small puncture or separation will not result in a catastrophic depressurization

Connections to other inflatables, modules or specialized nodes such as an EVA chamber provide additional difficulties for the designer. Possible solutions include the use of multi-layer shells as well as an interior structural system for redundancy. Flooring and wall systems inserted into the inflated structure would prevent having to attach to the sides of the membrane, causing additional stress points.

#### 6.3.2.3 Prefabricated Frame Structures

Prefabricated frame structures are formed from the joining of individual structural members. Deployable frame members are usually fabricated as metal tubular shapes with node connectors that allow a variety of connection points, such as that envisioned for Space Station Freedom. Past examples include space frames and geodesic domes.

The advantage of prefabricated frames lies in their ability to expand to a large volume from a compact delivery volume. The disadvantages include the need for intensive EVA operations to erect the frame and the difficulty of sealing the structure for pressurization. Therefore, this type of structure will most likely be used for unpressurized volumes such as hangars.

#### 6.3.2.4 Tent Structures

Tent structures consist of stressed fabrics supported by compression masts, arches or ribs. Many tent structures use cables to carry the tensile forces resulting from the stretched fabric. As on Earth, tents can provide large, unpressurized protected volumes.

### 6.3.3 Systems Options/In-Situ Resource Utilization

#### 6.3.3.1 Lunar Concrete (Cement Based Material) Structures

Concrete is a mixture of three elements: cement or a bonding agent, aggregate and water. The lunar regolith can provide the aggregate for this process, which is usually 75-80% of the mixture. The offsetting disadvantage is the need for water in the mixing process, a resource which will be quite precious at the lunar base. However, concrete structures offer a number of structural advantages: they have a long lifetime, require little maintenance, and have good compressive strength for external loadings. Disadvantages include the need for water, a pressurized environment in which to cure, and a low tolerance to tensile forces.

#### 6.3.3.2 Sintered/Cast Basalt Structures

Basalt, a hard dense volcanic rock abundantly present in lunar regolith, can be utilized as a structural material through sintering or casting. Sintering creates an increased adhesion between particles through moderate heating. Casting is a process in which melted fluid is poured into a mold and after cooling produces a solid. Casting can produce tiles, blocks, bricks, pipes and other building components

## 6.4 CONSTRUCTION OPERATIONS

which can be used in construction. It is expected that the mechanical and physical properties of cast basalt will be superior to earth metals (Blacic, 1985). The physical properties of lunar cast basalt are shown in table # as compared to terrestrial concrete.

### 6.3.3.3 Glass Structures

On Earth, glass materials are weakened by the presence of water in the atmosphere. The anhydrous environment of the moon would allow the use of solid glass components in structural applications that would not be possible on Earth. Glass is a readily available resource in the lunar regolith, and might be cast to form solid beams and plates, extruded into cords or stranded into cables for internal reinforcement of other elements low in tensile strength.

### 6.3.3.4 Structural Metals Structures

Metals such as aluminum, titanium, iron and magnesium may also be fabricated from the lunar soil. Metal components such as plates, columns and beams could be produced from these metals and applied structurally in much the same way as they are used on Earth. However, the production of metal would require an advanced stage of lunar development.

Until recently, little attention has been directed to the phase of lunar activity that begins once equipment has landed and ends when the initial habitat becomes usable. Many of the early excavation and construction equipment designs were modifications of terrestrial machinery such as the bulldozer and the back-hoe. Since that time the impracticality of such equipment has been determined. Equipment to be used for space applications must be uniquely designed for that environment. In particular, traditional terrestrial construction equipment depends upon its own weight for counter-balance and for reaction to heavy loads. The constraints of transportation will necessitate that construction machinery will have to weigh as little as possible and still be able to perform their functions.

There are, at the most basic, three categories of equipment which need to be present during the construction phase:

- Lifter: Disconnect, position, connect, lift, place
- Transporter: Transport of crew and/or cargo
- Soil Mover: Excavate, grade, compact, trench

Cargo handling systems must be able to accommodate the maximum cargo size and weight that must be moved, transportation distance to be traversed, and maximum lift and reach that these systems must have to unload and position the cargo (Eagle Engineering, 1988). Size and weight of cargo is in turn constrained by the capabilities of the transportation system. The required lift and reach will also be determined by the configuration of the lander.

Soil handling requirements will be determined by the structural method chosen as well as the conditions of the local terrain. For example, a partially buried inflatable sphere will require a great deal of excavation, as well as a large amount of regolith for radiation protection.

A study conducted by Eagle Engineering developed a number of design goals for lunar construction equipment in response to the severity of the lunar environment (Eagle Engineering, 1988):

- **Versatility:** The systems can be made capable of performing multiple tasks by attaching different implements.
- **Commonality:** A modular design and common subsystem approach should be pursued where practical to reduce spares and maintenance requirements.
- **Reliability:** Dust-control, lubrication, and maintenance will be important design considerations.
- **Low weight:** Although the equipment must be rugged for reliability, lunar materials (soil or rocks) could be used as counterweights and/or ballast to improve the stability and/or traction of the equipment and to reduce the machine's Earth launch weight.
- **Telerobotics:** The systems should be capable of both manual and teleoperated operation to potentially reduce EVA requirements.

Whenever possible, construction operations should be automated to reduce the risk of human exposure to the extraterrestrial environment.

## 6.5 PARTIAL GRAVITY CONSIDERATIONS

The proper design of lunar habitation with respect to the reduced gravity level of the moon is imperative to the success of a lunar base. The main difference from Earthly experience will be in terms of 1/6 gravity locomotion, although partial gravity will affect most of the senses, as well as eating and sleeping. The designer must be sensitive to the volumetric and environmental changes required to function efficiently in a reduced gravity situation.

In partial gravity walking, less muscular energy is expended, resulting in less potential energy to be converted into kinetic energy for forward acceleration. Less acceleration in the forward direction makes walking velocities lower; therefore, the point at which walking shifts to running is lowered. In a lunar gravity situation, walking is impractical, slow, and virtually impossible (Margaria and Cavagna, 1964).

Because inhabitants will be accustomed to expending earth gravity forces to walk, they will bounce higher. Extended stay in 1/6g will reduce this bouncing because of muscle and bone atrophy as well as their acclimation to the new environment. In addition, the increased forward body inclination will also lessen the height of the bounce to be designed for. However, the interior architecture must still respond to this situation.

According to 1/6g simulations, loping is the most comfortable walking gait. One aspect to be considered here is that the speed of partial gravity loping, 3 m/sec, is over twice as fast as the most comfortable walking gait on Earth of about 1.2m/sec (Hewes, Spady and Harris, 1966). This potential design problem is compounded by the fact that there is reduced traction in partial gravity environments because of less friction between the subject and the surface of the ground.

The impacts of reduced gravity will manifest themselves especially in the design of:

- Corridors: corridors should be clear of obstructions and provide hand mobility aids to control direction and speed
- Floor surfaces: materials for floor surfaces should provide a coarse surface to increase traction
- Ceiling heights: ceiling heights of 2.44m for circulation areas and 2.13m for smaller enclosed spaces have been recommended in response to the increased bouncing of partial gravity locomotion
- Staircases: stair risers will be increased to account for the ease of vertical bounding in 1/6 gravity to some-where in between 41cm and 1.25m. The higher figure will be the most comfortable initially, while the lower figure takes into account the muscular deterioration which will occur during an extended stay

- Chairs: due to body posture changes in microgravity, normal sitting positions will most likely not be comfortable. The design of chairs should take into account a body posture somewhere in between normal gravity sitting and the neutral body posture experienced in microgravity (Capps and Moore, 1990)

## 6.6 SITE AND MASTER PLANNING

### 6.6.1 Site Considerations

A lunar base site must offer the widest range of research opportunities while still remaining easily accessible. It should be at an Earth-facing location for ease of communications. At the present time, based upon Apollo explorations, most is known about about lunar equatorial sites. It is therefore recommended that until more is known about the composition of other sites, such as lunar polar sites, that the site chosen should be at an Earth-facing equatorial site.

### 6.6.2 Master Plan Components

Facilities for the support of crew members and their activities will form the main focus of the base. This area will consist of the living quarters as well as accommodations for scientific experimentation and crew recreation. In addition, a number of other facilities will comprise the overall architecture of the base.

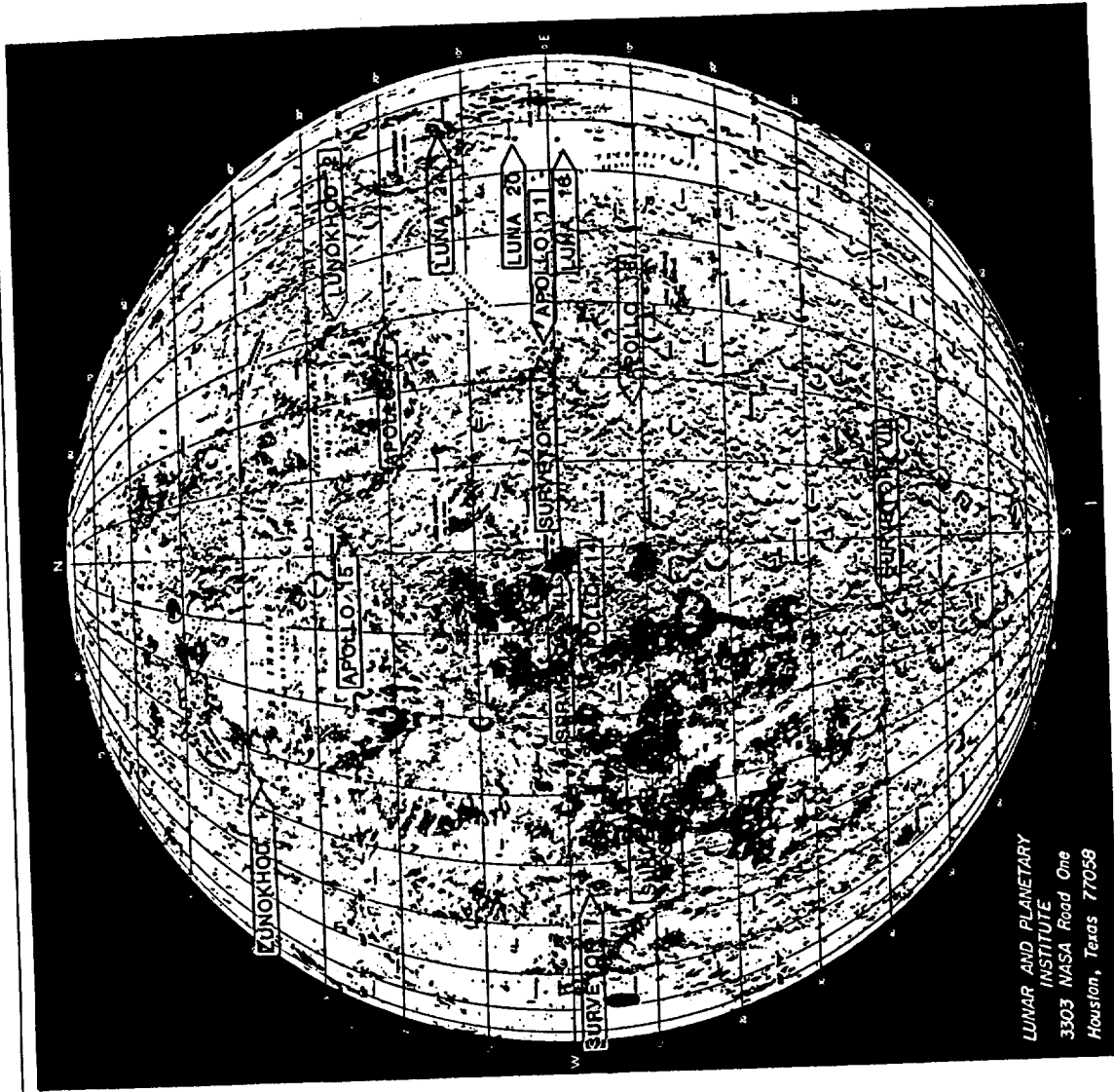

Figure 6.6.1-1. Lunar outpost site.

**Planet Surface Systems**

**LUNAR OUTPOST  
SITE CHARACTERISTICS**

**Site Location:**

Marius Hills

56 degrees 45 minutes W  
13 degrees 10 minutes N

Figure 6.6.1-2. Specific site location

**NORTH**

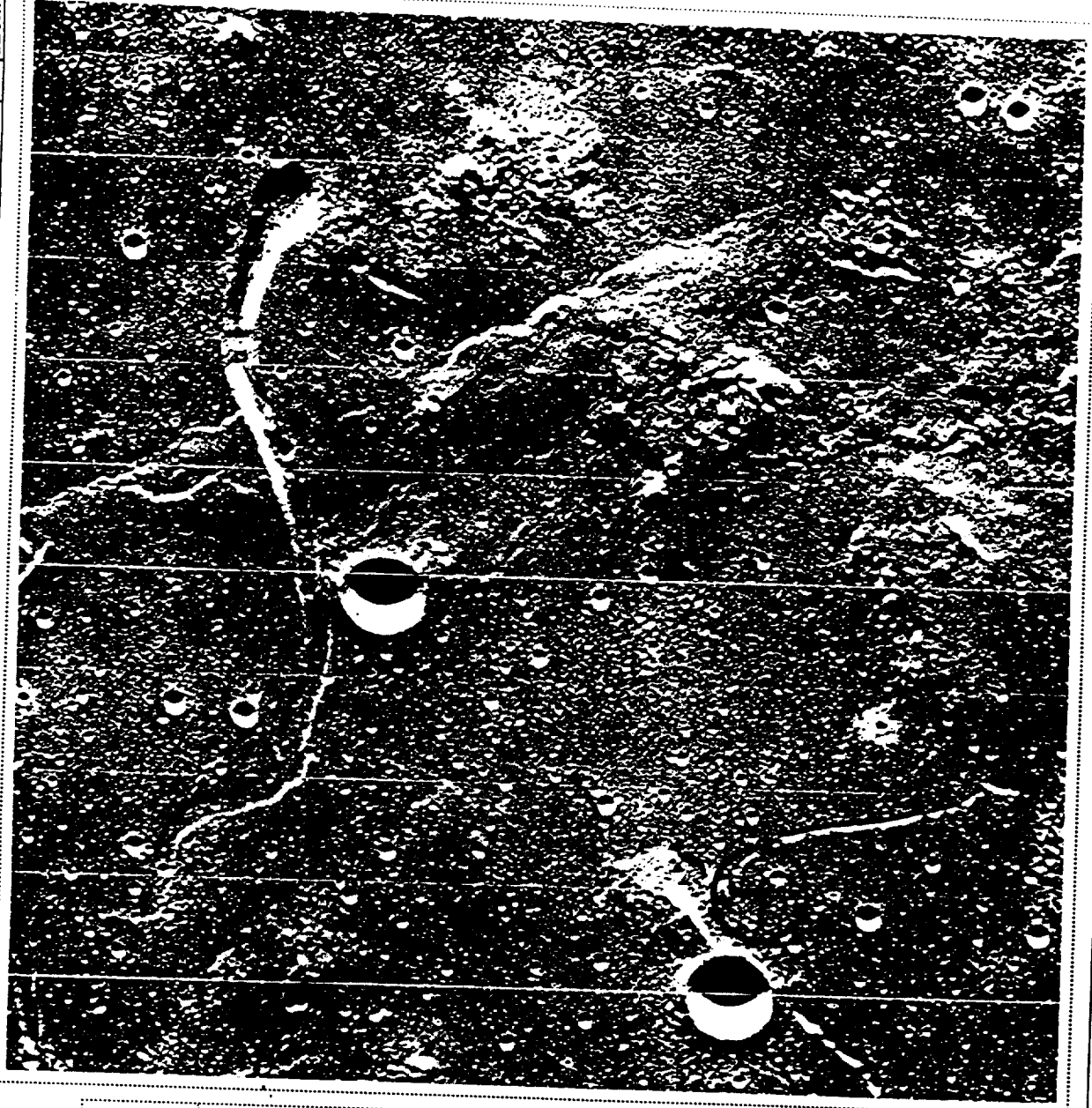
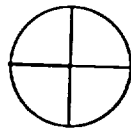

### 6.6.2.1 Habitat and Research Center

The central element of the base master plan and layout will be the crew habitat and research center. As detailed below, it should be developed in a series of phases, perhaps over a 10 year period. The first element will be an "assembly facility," to be followed by a phased growth of the habitat and research center. Details of the habitat, and of the various mission operations and their research requirements, are given in later sections.

### 6.6.2.2 Launch and Landing Facilities

Launch and landing facilities will consist of several remote landing areas that have lander servicing equipment and crew/payload transfer systems.

This facility should be located in proximity to the areas of the base that it would most frequently serve, such as the habitat area and industrial area. This proximity should be subservient to any safety requirements, which dictate that a distance of 2-5 km should be maintained to protect the base from blast effects (Eagle Engineering, 1988).

Lunar landers will be descending from lunar orbit in an east-west direction and should not have to cross over any base elements. By orientating the facility on a north-south axis in respect to the rest of the base, no component of the base would be endangered by an approaching lander or a lander which overshoots its objective.

The individual landing pads should be separated from other equipment by 250-400m to prevent blast damage, and the surface of the

pad should be free of objects for about 100-200m around the target area. The actual target area should be about 50m in diameter and the surface should have a slope no greater than 6 degrees, ideally less than 2 degrees. Surface stabilization may be considered to minimize dust. Markings and navigational aids will increase the accuracy of manned landings and allow for the possibility of automated landings. Until highly accurate unmanned landings are possible, it may be necessary to have two separate facilities in the event of an accident, with the unmanned facilities locate farther out along the north-south axis (Eagle Engineering, 1988).

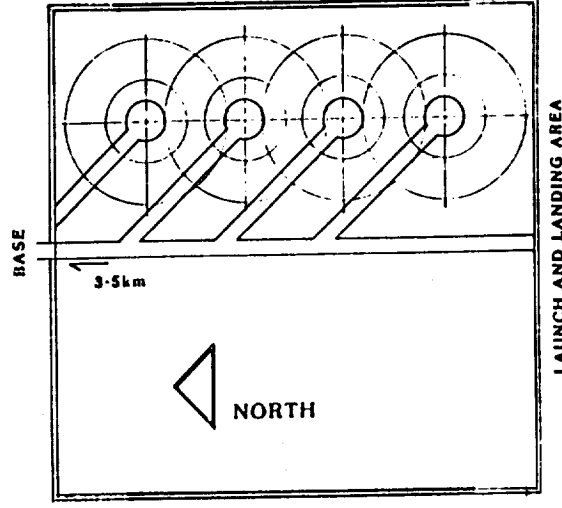

Figure 6.6.2-1. Landing pads and components.

### 6.6.2.3 Base Garage and Maintenance Facilities

This area is used to store and maintain vehicles when they are not in use as well as repairing damaged equipment. It may consist of a large





non-pressurized hangar, but may also include a pressurized area for more delicate repairs which could not be carried out within the habitat's laboratory facilities.

#### 6.6.2.4 Transportation Systems

Surface transportation is needed to travel between some of the more distant base elements, for collecting of lunar samples, and for the transfer of crew and payloads from one area of the base to the other. The transportation should be compatible with all possible payloads and should be adaptable to many tasks. There may be pressurized rovers for longer term traverses as well as equipment for the transfer of non-pressurized cargo.

Organized Roadways between all segments of the base would allow for efficient transportation of materials and crew while also acting as a possible organizing device for the base.

#### 6.6.2.5 Power Plant

There must be a dependable source of adequate power on hand at all times and it is likely that several redundant systems will serve the lunar base. Some of the possible power sources include nuclear power (SP-100), solar power, and fuel cells. Alternative sources will be studied for effective use in future developments.

This power system should be located far from habitation areas and away from dust producing activities.

#### 6.6.2.6 Lunar Surface and Production Analysis Operations

The use of lunar resources will help provide economic incentive for the development of a lunar base. The mining and refinement of metals, isotopes (Helium-3) and other materials (lunar oxygen, etc.) are a few of the resource utilization processes envisioned to occur. This area will have special power needs and will have other location requirements in relation to the remainder of the base.

#### 6.6.2.7 Construction Technology and Materials Test-bed/Tele-robotic Research Laboratories

Initial phases of base construction will involve high technology tele/autonomous robotic techniques. Later phases of base construction will involve the use of exotic materials and high technology construction methods as well as in-situ materials for economical lunar development. Construction research will study these new materials and construction methods for future lunar and Mars development, as well as develop more advanced tele-robotic systems, lunar transport vehicles, and EVA systems.

#### 6.6.2.8 Closed Ecological Life -Support System (CELSS) Research Facility

The Closed Ecological Life-Support System (CELSS) will be a study of an entirely closed cycle of food and waste management. It will serve as a prototype for a mature lunar base as well as space stations and a Mars outpost. An efficient environmental support system will reduce reliance on outside sources of materials and thereby lower the cost of running a manned extraterrestrial facility as well as offer a psychological independence for the crew. By

including the crew within the ecosystem, this facility may encompass many of the factors which humans require for social and psychological comfort on Earth.

#### 6.6.2.9 Lunar Farside Observatory

Astronomical research will have an important role in the lunar base, as the absence of atmosphere and protection from Earth's magnetosphere make the farside of the moon an excellent stable platform for cosmic observation. Operation and monitoring of the equipment will be controlled from the base even if most information is relayed directly to Earth. Periodic servicing and repair will require visits by lunar base crew members.

#### 6.6.2.10 Human Factors and Environmental-Behavior Research Facility

The study of the psychological and sociological effects of living in a remote closed environment will help refine base systems and components for a second generation lunar base as well as other extraterrestrial outposts. The evaluation of the needs and activities of the crew and their environment will take place primarily through daily interaction with equipment and post-occupancy evaluations (POE's) of base elements.

#### 6.6.2.11 Safe Haven

Areas designated as a safehaven is required for the base in case of a solar flare emergency or failure of the main habitat. It should either be appropriately isolated or physically separated from the rest of the base and contain everything the crew may require until a rescue

attempt can be made or flare activity ceases. This would include back-up supplies of food, water, communications, limited hygiene, EVA, ECLSS, extra shielding, etc.

#### 6.6.2.12 Logistics and Materials Storage

Many elements of the lunar base need some form of storage to organize and protect materials and equipment. Both incoming supplies and outgoing materials as well as spare components and waste materials need to have an area designated to house them. This area should be easily expandable and adaptable, and should provide for easy access by crew members. For possible hazardous materials, extra precaution should be allowed to reduce the risk of contamination. At least one of these storage areas should be near the launch and landing facilities.

#### 6.6.2.13 Communications Equipment

Provisions will need to be made for omni-directional antennae, radar dishes, etc. among the base elements.

### 6.6.3 Base Layout Strategies

The overall layout of the lunar base should reflect an organizational idea or geometry that allows the base to be understood functionally as well as used efficiently. In terms of wayfinding, especially during the 14-day lunar night, a regular pattern to the lunar base will be important psychologically. A grid or axis that is easily understood at large distances will allow for easy orientation. Several ordering principles are inherent in the functions that make up the base and the

type of structures used to form the base.

The early stages of lunar development will be very dependent on earth-launched supplies, including habitable structures. These modules (or inflatables, etc.) and their corresponding connecting nodes will limit the configuration to one which is economical and transportable. The primary issues for the configuration are separate, isolatable volumes, dual egress, phased growth, and modularity. Another factor to consider is keeping the early stage simple to allow for the limited construction capabilities of an early lunar outpost.

Dual egress among the separate, isolatable volumes allow for crew members to exit a structure in an emergency, and also allows complete circulation throughout the habitat in case one area is damaged or unusable.

The base elements will arrive from earth at different times, so any one phase should not require additional units for complete usage. They should also function as an entire base when all of the elements are in place. Phasing the growth of the lunar base will require careful planning to arrive at a configuration which provides for these needs as well as possible future expansion.

Limiting the number of module types lowers the cost of the base through standardization and length of on-site construction time. Unique elements require special systems and increase time and money spent on development.

Lunar construction using standardized modules at this early stage may restrict structures to the two dimensional lunar surface. "Second floors" and "basements" require additional equipment which

may not be justifiable until a later period of development. Generally, simple designs and layouts are more cost effective and easier to employ. Alternatively, there is a possibility of limited use of lunar lava tubes, sub-surface construction, etc.

Some possible geometric configurations that involve the use of a single module design are triangular, raft, linear, and grid (figure 6.6.3-1).

The triangular configuration allows for dual egress and uniform growth, but the nodes become complex and exits are far from some points of the base. The raft arrangement allows dual egress but requires a higher ratio of nodes to modules.

The linear configuration has a low number of nodes, but allows for limited circulation and a "tunnel" effect.

The grid or orthogonal configuration appears to offer a good combination of dual egress, uniform growth, and easy implementation and standardization.

A composite configuration would combine some of the positive aspects of several geometries ( SICSA, 1989).

Different construction methods are likely to suggest different configurations. Tunneling, for example, would not be dependent on modularity but the pathway and efficient use of tunneling machinery. The use of craters, lava tubes, or other physical features of the moon would result in a configuration dictated by the lunar geography, giving a natural ordering system.

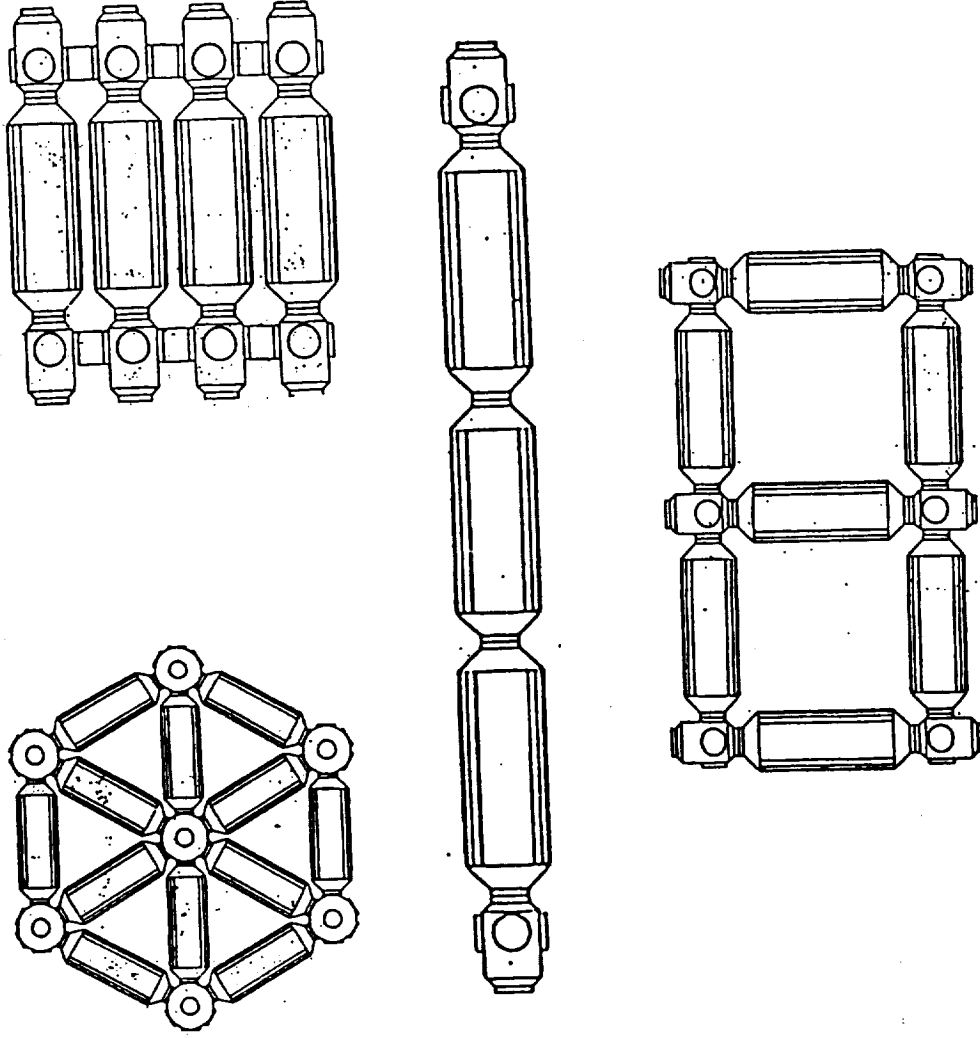

Figure 6.6.3-1. Comparison of triangular, raft, linear, and grid base layout configurations (SICSA, 1989).

The psychological health of the crew should also be considered in the overall configuration of the habitat. Modules may quickly tire the mind by the lack of a "visual landscape." A larger length and width habitat is required for long-term psychological health. There should be public and private areas outside of those areas designated for meetings and private quarters. One centralized area would provide a physical focal point for the base which could correspond to some key activities of the base. A large public area with semi-public and private spaces nearby would lower the feeling of living in a collection of identical modules. It might also be helpful to have a rest area that would have reminders of earth. Such an area could simply be a biosphere with special additions such as benches or a trellis to remove the feeling of confinement in a human-made environment.

#### 6.6.4 Image

Considerations should be made as to the visual effect of a lunar base from the earth. Actual physical features will not be a problem of the early moon base, but it is possible that base lighting will be visible from earth during the lunar night. It is also possible that orbiting debris or dust will alter the familiar view of the moon. This visible evidence of lunar occupancy would not be viewed by all with equal enthusiasm, and a proper approach at the outset of exploration will lesson conflicts in the future.

##### 6.6.4.1 Symbolic Messages

The lunar base will, however, still be symbolic of a number of things to people not directly involved with the space program. It will hold a special place in the solar system as the first outpost on another world and should therefore reflect positive qualities of the nations

involved as images are transmitted back to earth. A configuration that is well organized and pleasing will suggest intelligence and forethought as well as goodwill and a sense of unity.

Part of the lunar base's image will be the ability of people to recognize it as a human place. Visual cues can help identify the base as an organized habitat and not simply a collection of space hardware. A simple gateway on the path between the landing area and the rest of the base or a symbolic entry way in front of the EVA/base entrance are some examples of small details that could have an effect on the image of the base. These types of visual cues relating the base to other known structures may be important for the crew by giving them a feeling of security.

Since the entire habitation area of the base will be covered in some form of radiation shielding, another cue will be needed to mark the presence of the lunar base. A series of lights along pathways would be a simple method of defining the base and creating a sense of unity among the elements, as well as being functional.

The lunar base should be consistent in its imagery on the interior and exterior. The overall base ordering should suggest a single organized structure that functions efficiently as a work place and is comfortable as a temporary home. Careful and creative use of space can increase the pleasure of working in the lunar environment and thereby increasing the efficiency of the crew members.

##### 6.6.4.2 Care for the Lunar Environment

A roadway system on the moon, even if not necessary for vehicular use, would help restrict or at least contain the amount of footprints

and tracks left behind by crew members. A "paved" or sintered roadway or stabilized surface would lower the amount of dust kicked up by movement throughout the base.

A litter clean-up program would eliminate unsightly waste in the base surroundings and perhaps help encourage finding new uses for "useless" items. A careful treatment of the lunar environment will make the lunar base a more pleasant place to work and live in. It will also demonstrate to the earthbound that the nations involved in the lunar base are being thoughtful about future generations of visitors. Selection of materials (food containers, etc.) which could be reformed for alternate uses will be important.

## 6.7 CREW SUPPORT/HABITAT

### 6.7.1 General Design Requirements

Critical to the physical, social, and psychological needs of the crew members will be the design of the crew support habitat. It will be an environment responsive to group interaction, and simultaneously responsive to privacy. Considered a "home away from home," it will employ earth-like amenities as well as basic necessities in the form of: personal quarters, hygiene facilities, a laundry facility, recreation area, medical and exercise areas, and meal preparation areas.

In addition to the partial gravity implications touched on previously, the designer should take into account information concerning human dimensioning in relation to the environment. The NASA Man-Systems Integration Standards (NASA-STD-3000, 1989) provides a great amount of information concerning anthropometrics, sizing,

reach envelopes, etc. The data provided is broken down into the 95% American male and the 5% Oriental female. These parameters take into account the diversity of the human race and anthropometric design for in space. Where reach is an issue, the shortest measurement should be used (5% female), whereas if clearance is an issue, the larger measurement should be used (95% male). Provided in the companion Program/Requirements document (Baschiera et al., 1989) are standing and sitting data found in the NASA Standards and other sources.

For safety reasons, in case of emergency depressurization, interior circulation paths must be wide enough for two astronauts to pass each other with their space suits donned. This translates into a width of about 140cm for pathways.

Racks should be sized according to anthropometric data as well the factor of partial gravity. For the movement of racks into or within the habitat, standard *Space Station Freedom* racks may be too bulky to move about. Therefore it has been suggested that racks be reduced to half the size of the Space Station rack width (Kennedy, 1989). The standard lunar rack for non-outfitted structures would therefore be 1m (40") deep by 53cm (21") wide by 2.13m (84") high.

Ceiling heights are based upon psychological feelings of space as well as usable height. Usable height for the average human is about 2.15m (7'-0"), although the standard ceiling height is 2.45m (8'-0"). Because of partial gravity and the isolation of a lunar base, it has been suggested that ceiling heights be raised to 3.0m (10'-0"). However, this increase does not seem necessary because of the stooped posture the body assumes in reduced gravity and expected adaptation of walking skills over time.

Wayfinding and coding should be used as both normal operational and emergency aids in crew functioning. The use of lighting cues, labeling, and colors can be used to denote various zones or controls. Emergency lighting should respond automatically and indicate the pathway to the nearest safehaven.

### 6.7.2 Personal Quarters

Personal quarters will comprise of the individual's sleeping quarters, dressing area, personal storage, and area for private recreation and leisure, usually also the sleeping quarters. Depending on the final configuration of the initial base, these components may or may not all be located in one room or area. Due to space limitations within the initial lunar outpost phase, it may be necessary to split some of these components apart, such as the dressing area being shared by everyone and a group storage area.

As mission durations lengthen and the base grows larger, the need for more personal space will grow. Privacy and personalization will become very important and these associated areas will need to be grouped into one area to become more like our bedrooms on earth.

Privacy will play an important part in the lunar base. The crew will need a place to go to escape from the rest of the crew and be alone. Privacy will be more important in space than it typically is on earth due to the confinements of being limited to a small area that you know you cannot leave. Some of the problems are obvious. For example, sleep is a personal activity requiring a quiet surrounding. Physical seclusion is therefore required. Many of the problems associated with privacy are related to the perceptions of the environ-

ment. It is possible to make the spaces *seem* more private than they actually are. In this way we may be able to effectively create the feeling of privacy without going to drastic, costly means to do it. Because of the need for visual and audio privacy, a physically separated area will be needed to provide complete isolation from the surrounding area. Methods of altering perception may be used within these and other areas.

Personalization plays a large part in privacy. If a person has a space they can personalize, it will reflect their personality and help emphasize their individuality. Personalizing a space can make it seem larger, or at least make the lack of space less apparent. To aid in this process a crew member should easily be able to hang pictures and otherwise add personal items to their surroundings. These personal items will need to meet certain safety requirements. An example of this would be a concern for flammability and outgassing of the materials.

One way to help in the personalization process is to allow for use of color. The use of color is important to add variation to the environment, especially when you are confined to a smaller area. What will help even more is if the crew member can select the color of their personal quarter. This will help in making them comfortable in their surroundings and in emphasizing their individuality.

Another way to personalize a space is in the choice of thermal and lighting levels. If someone sleeps better in a cool room they should have the ability to keep their quarters at a lower temperature. In the same way, lighting should be adjustable too. A range of 0 to 100 foot candles (fc) will be needed to meet the needs of the different tasks occurring in the personal quarters. Sufficient light should be avail-



able for tasks requiring higher light levels. This can be aided by the use of task lighting.

#### 6.7.2.1 Sleeping Quarters

The sleeping area will be the main area of the personal quarters. With partial gravity present, sleeping will need to be in the horizontal position. An area of 7.1 cubic meters (250 cubic feet) should be sufficient for sleep, reading, and other activities that may require use of the sleeping area. (SICSA, 1989).

For ease of entry and exit, the top of the bed should be located at a level approximately 18" off the floor. At this level an average person can sit and have their feet touch the ground. A bed will need to be provided with a surrounding open area of 2.15m (7') long, .9m (3') wide, and 1.2m (4') high (Packard, 1981).

The materials involved in the sleeping area will need some consideration. The area should be free of sharp corners and padding may be desired to avoid injury in use of this area. Sleeping materials such as blankets, sheets, pillows, etc. should be easily removed for cleaning. The mattress should be removable for cleaning or replacement should that be desired.

A main electronics console should be located within easy reach of the sleeping area. On this console should be controls to all lighting in the room, a communications link with the rest of the base, and an alarm system to warn of fire or pressure loss.

#### 6.7.2.2 Dressing Area

This area will more than likely not be a separate space on its own, but will utilize transition space in the personal quarters, and will require a volume measuring about .9m (3') by 1.9m (6') by 2.2m (7') tall (SICSA, 1989). The dressing area should be located close to the clothing storage area. A place to sit while dressing will also be required, such as the bed.

#### 6.7.2.3 Personal Storage

Provisions should be made for the storage of the person's clothing, accessories, some toiletry items, memorabilia, and other personal belongings. This should encompass a volume of approximately .6 cubic meters (20 cubic feet) (NASA, 1988).

The crew members should be able to generally locate what they need just by looking at the storage area. The majority of the clothing can be through different sizes and locations of the different storage drawers and closets. The visible surfaces should be largely flat and not contain areas that will allow accumulation of dust, dirt, etc.

#### 6.7.3 Personal Hygiene Facilities

Good grooming can enhance self image, improve morale, and increase productivity of the crew member. Adequate and comfortable bathing and body waste management facilities have been high on the list of priorities of participants in various space missions. Some modification of personal hygiene practices and procedures may be necessary due to equipment design limitations and water

supply restrictions. Too great a modification, however, could impact negatively on crew self image and productivity. It would be unwise to expect optimum performance unless optimum conditions are provided.

Objectionable body odors can quickly build without adequate personal hygiene facilities. This is a predictable source of interpersonal conflict (NASA-STD-3000, 1989). Use experiences with Skylab shower design has shown that personal hygiene facilities will be less frequently used if they are awkward, uncomfortable, not adequately private, or take an inordinate time to use (NASA-STD-3000, 1989).

Waste management system design should follow the following design considerations (NASA-STD-3000, 1989):

- reliability
- ease of use
- acceptance
- number of facilities
- privacy

The body waste management facility must be both psychologically and physiologically acceptable to crew members. NASA recommends that one facility be provided for every four crew members. It is also important that defecation and urination facilities provide both visual and auditory privacy for the user (NASA-STD-3000, 1989).

#### 6.7.4 Laundry Facilities

Facilities for the washing and drying of clothes will be required for

long duration space settlement because of the inefficiency of disposing of and resupplying clothing. A clothes washer/dryer has been estimated for the Space Station Freedom at 1.2m (4') x 0.3m (1') x 1.2m (4') or 0.45m (16 cu. ft.) (Lewis, 1983).

It is expected that one laundry facility will be required for every eight crew members (SICSA, 1989).

#### 6.7.5 Exercise Facility

The size of the exercise facility will be necessarily small and compact. The space must be able to support a broad range of exercise related functions. While "aerobic" classes will not be held in this area, there will be a need for room to stretch the entire body and have clearance for movements associated with exercise along with the required exercise machines themselves. There is a need for the individual machines to provide at least two specialized exercises, either by adding or taking away parts and pieces, or by changing speeds of the machines providing variation in the exercise. In this way, the amount of machines can be reduced by 2 and the layout or spacing will be reduced as well. Also important is the way the facility will evolve over time during subsequent missions or longer missions, as more people use it, or at times when it may be necessary for several people to use the facility at the same time. While being flexible at first, machines could specialize later as more machines are added, or the adaptability of the machines could remain while providing more open space for different stretching or exercise programs. As more people use the facility it will be necessary to keep their movements and actions in mind as their exercise programs evolve.

There are a few exercise machines that are very flexible in their usage and allow for a broad range of users (sizes, strengths, etc.), and exercises (motions, resistance, forces, etc.).

- stationary bicycle
- treadmill
- bench press machine
- attachable weights
- rowing machine

Since the early facility will be small and probably may not be a dedicated space but rather along a corridor or in conjunction with another space, the exercise machines should be as collapsible as possible. The easiest way to stow the machines is to have them hinge off of the wall and come out of a compartment. Storage of other items could be to disassemble the mechanism and place in a cabinet. This is the most time consuming and clumsy method. Another way is to have the mechanisms come up from the floor, although they might interfere with systems or storage.

Along with the necessary exercise machines there should be open space for stretching or full body movement exercises or tumbling or yoga. This space could be used for persons to warm up before exercising on machines, to warm down after a session, or while waiting to use a machine.

Perhaps the most intriguing possibility for interior architecture is for the special items that can be provided in other facilities. Astronauts have previously voiced concern over the lack of windows in a facility (Stuster, 1986), but there are endless possibilities for effects in the lunar base. Incorporated into the stationary bike could be a manual trash compacting machine, or a generator to supply power to the base. There could be a large screen TV to provide sights and sounds (through headphones) of famous bike trails or highways, it could be computer operated to adjust tension on the bike when the screen shows a hill. The treadmill and rowing machine could have much the same effects, moving through famous sites (shopping malls, lakes, etc.), varieties of sights and sounds conforming to the rate of exercising. Audio and visual stimulation can be applied to anywhere in the exercise facility, as well as computer monitoring or control of

the exercising session. Even with all these possibilities, a simple window to the outside may be as soothing during a workout as anything else, and if its one of the only ones on the base, then the people have to work out to see outside.

For the initial phase the required volume dedicated to exercise will be about 19 cubic meters (672 cu.ft) (SICSA, 1989). As mission duration lengthens, the need for a greater variety of stimuli or sufficient variation in the exercise programs to keep the users interested in their respective exercise requirements is necessary. Open space for stretching and perhaps group exercise will be necessary at this point. The machines should retain their flexibility for different exercises and more emphasis placed on obtaining open space. Special effects and computer programs could be installed now. Overall the amount of machines will stay about the same, perhaps one or two added, while the amount of free movement space will increase. The volume needed at this time would be about 40 cubic meters (1568cu.ft) (SICSA, 1989).

### 6.7.6 Medical Facility

It is imperative that any kind of medical facility will be able to be separated from everyday movements, traffic, and personnel of the base. The separating device must be a physical barrier and should be a visual barrier as well. The need for a partition is for creating a sanitary environment on demand. During everyday operation of the base, the facility could be accessible to most people as the needs arise. But when an injury occurs or during tests the facility may need to be subdivided or closed off altogether. Inside the facility could be a sink for the medical person(s) to wash before, during, or after any actions within the closed off environment.

The medical facility should be centrally located for convenience for all who use the base and everything clearly labeled.

The amount of calamities on the lunar surface equals or exceeds that

is more extensive? A method for shielding for a larger area might be necessary. Incorporating it into the partitioning system of the facility is a good idea, or the patient may be placed into a self-contained chamber of some sort.

With the necessity of possible operations or body inspections comes the obvious need for a visual separation between the facility and the rest of the base and possibly in the facility also. It would also be wise for the computer station to be isolated from damage from physical abuse, X-ray or magnetic damage, thermal or chemical damage, or anything else that might occur in the facility.

Due to the delicate nature of experiments or operations in the Medical Facility, there should be some way to adjust the thermal and environmental controls. This can be done by specific controls to the storage systems or a way to control the environment as a whole. It may also be possible for a tent or bag apparatus to cover the bed itself. By maintaining a lower pressure in the Medical Facility, airborne contaminants will not be carried into the rest of the habitat.

Along with the general base lighting in the facility, the table and work space should be lit with adjustable-intensity, movable task lighting. The lighting should be ventilated or shielded such that it doesn't contribute to the heat in the room. The lighting should be adjustable from controls located in an easy to reach place and be clearly defined. It is also possible to light the storage areas or cabinets on an as-needed basis.

Large items to be stored would be body splints, crutches, portable carrying stretchers or boards, the X-ray equipment, the examination bed in the facility, and other bodily sized items. It would seem that the stretchers and such would be used rarely and so should not be the foremost thing in the storage plan. Many of the big items are clumsy and should be placed in a cabinet with a swinging, folding, or rolling door.

Medium-sized items would include the oxygen tanks, the generator

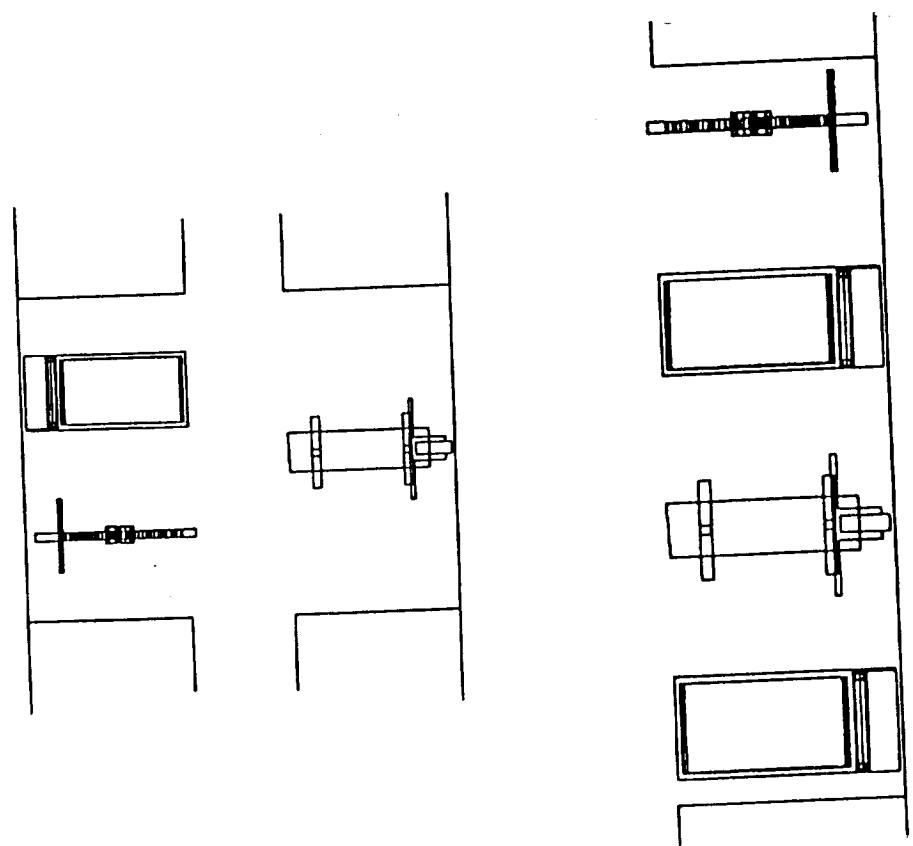

Figure 6.7.5-1. Diagrams of possible layouts of medium-size exercise facilities.

on Earth. There will be a need for an X-raying machine in the facility and the shielding that goes with it. It is possible to have a bib-type shield like at the dentist, but what if the amount of damage to the body

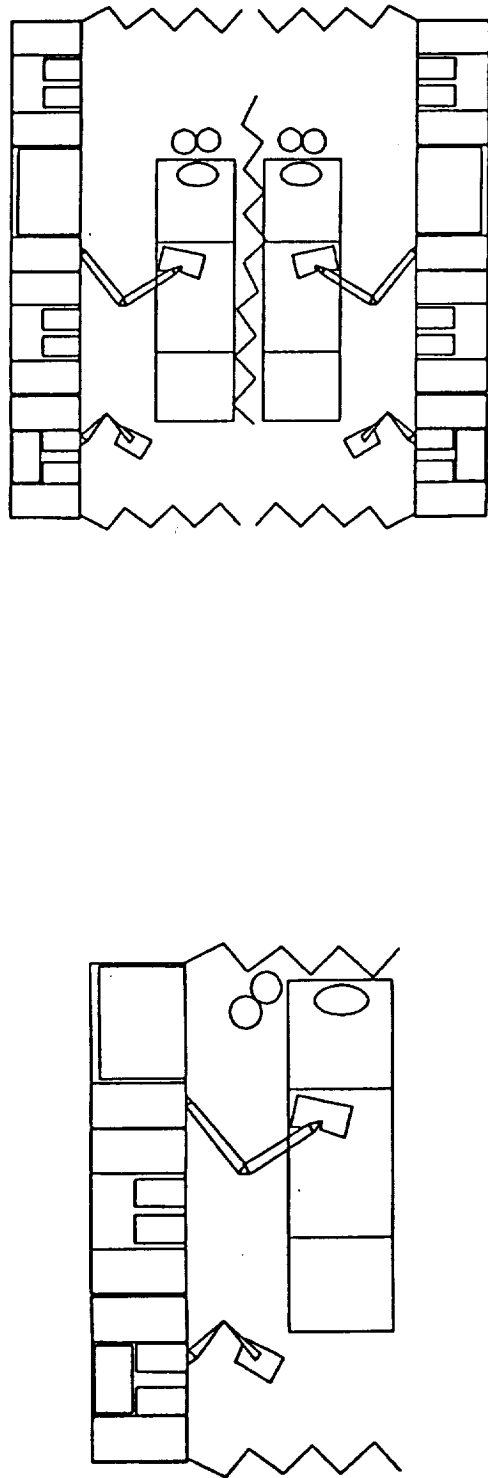

Figure 6.7.6-1. Diagram of the possible layout of a small first phase and larger third phase medical facility.

for X-rays or emergencies, the refrigerator, electronic analyzation systems, and the portable medical equipment and kits. The portable medical kits must be easily findable and accessible. The other items probably won't leave the facility; therefore, proper labeling to find them during normal use of the facility is necessary, not for everybody on the base to find them. The medium sized items can easily be contained in average sized cabinets or some of the stationary equipment could slide out on a drawer and used from there.

The initial base's medical facility will not be a dedicated facility in the sense that it will have to be partitioned off when in use. The layout will hinge on organizing the large amount of storage requirements. The examination table can be collapsible or movable, and the equipment can swing out on arms over or as part of the table. Every user should be familiar to the facility to find material when necessary.

For the initial phase, space requirements will be about 19 cubic meters (768 cu.ft.). As the base develops, the volume will be raised to about 42 cubic meters (1550 cu. ft.) (SICSA, 1989).

### 6.7.7 Group Recreation Areas

The recreation area size and configuration should be adaptable to the type of recreation scheduled. Privacy, anthropometrics, personalization, and atmosphere are the main considerations when planning for the private area. Anthropometrics, coding, atmosphere, materials, and social interaction are the main topics for the group area. It should be kept in mind that although both areas may occupy the same portion of the base, each should be considered independently.

Seating in the area should be adjustable, according to the crew

member's desire, and storage for the crew member's personal items should be available in compartments above the seating or in pockets located in the seat itself. Personal stereo headphones should also be stored in close proximity to the seating, while small personal computers or terminals could be used for T. V. transmissions, conversations with family, or games.

The atmosphere should allow some personal adjustment, and individual lighting should be provided for each chair in the private area and the equipment surrounding it.

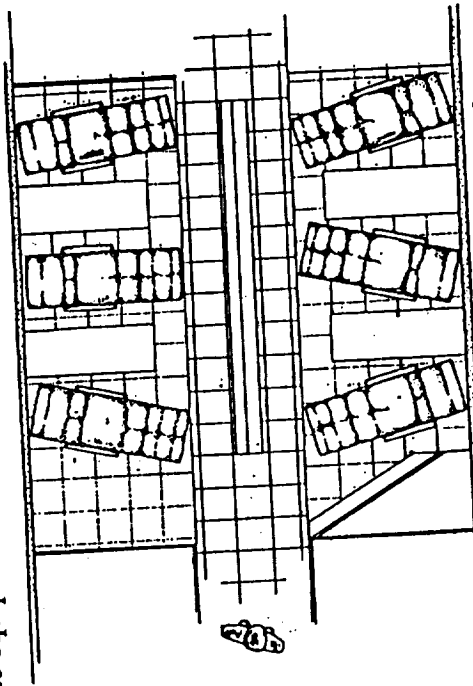

Figure 6.7.7-1. Diagram of the possible layout of a group recreation area.

### 6.7.8 Meals/Meal Preparation Area

A galley area should provide for the preservation, storage, dispensing, and disposal of food and wastes (NASA-STD-3000, 1989). The galley elements should include (NASA, 1988):

- Ambient storage
- Refrigerator/freezer storage

- Bulk food and beverage storage/dispensing
- Automation and food inventory control
- Microwave/convection oven
- Deployable counter (food preparation)
- Trash compactor and storage
- Dishwasher/dryer
- Handwasher/dryer
- Water dispenser

The design of the galley will probably incorporate the above items into a "rack" system. Galley volumes and layout diagrams are given in SICSA (1989) and NASA/JSC Crew Systems Review (1988).

The dining area should provide adequate seating for the entire crew, and may double as part of the group recreation area. The following figure shows standard dimensions required to give adequate seating space.

### 6.7.9 Zoning, Proximities, Volumes, and Phasing

Throughout the above sections, we have referred to three principle phases of the development of the crew habitat - an initial operating configuration, a medium sized facility, and a fully operational base. At each step, it is necessary to consider zoning of activities from noisy (e.g., exercise facility or group recreation) to quiet (personal quarters), and from relatively dirty (e.g., exercise facility) to needing absolute cleanliness (medical facility). It is also possible to create a proximity diagram, as shown, that suggests which activities are best close to each other and which separated by distance or barriers. Finally, each activity area needs to be sized (volumetrically) and the relative sizes need to be adjusted as crew duration increases, all as shown in the accompanying diagrams.

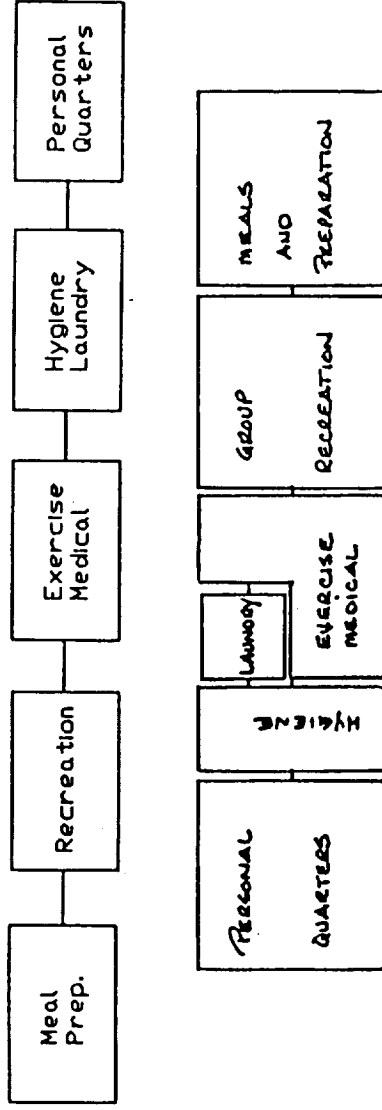

Figure 6.7.9-1 Zoning diagram - noisy to quiet, with associated square meterage layout.

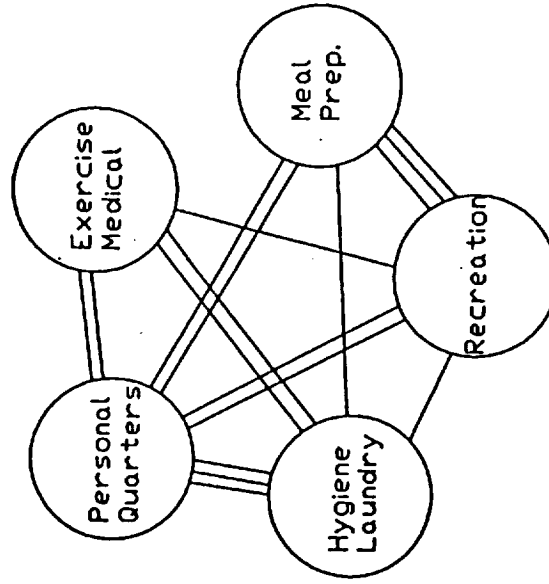

Figure 6.7.9-2 Proximity diagram for five major classes of habitat activities (heavy lines mean close proximity, lighter lines mean more separation).

## 6.8 BASE OPERATIONS

### 6.8.1 Command Center

The role of the Command Center is similar to that of the human nervous system. It is responsible for the monitoring and control of both primary and secondary base systems and activities. General base monitoring systems design issues include:

- Life support systems
- Water systems
- Waste systems
- Communication systems
- EVA systems
- Robotic systems
- Emergency backup systems

Simplicity in the design of this system would reduce crew training time, lighten workloads, and minimize the potential for error. Aspects such as psychological implications and effects must be considered.

Coding is an important issue for all operations, systems, and equip-

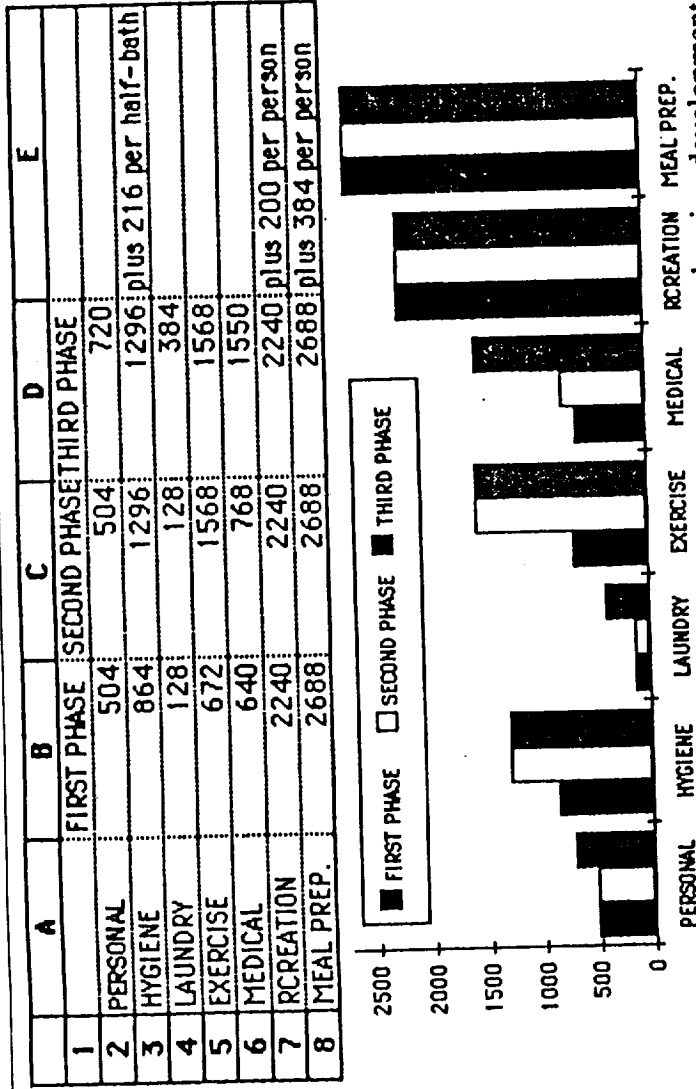

Figure 6.7.9-3. Volumetric phasing chart for the human habitat/crew quarters area showing development of the habitat over three principle phases.

ment. By the nature of its purpose, the command center will be tremendously dependent upon coding. The locations and status of activity or emergency conditions demands that a clear, universal system of coding be used to properly address base functions.

Taking into consideration the selection of color, texture, material finishes, and decorative accessories, the command center should be designed to enhance and support the comfort, performance, and health of the crew.

The proximity of controls and displays and their orientation combine to support the productivity of crew personnel. Controls should be arranged and grouped in a specific, logical manner. Besides normal

operational mode controls, emergency system controls require easy operation by gloved fingers and be easily accessible in the event of depressurization.

Accessibility to components should be of sufficient size to allow for quick repair or replacement. In addition, all systems should have backup capabilities to allow for independent and uninterrupted operation.

The illumination of the command center should provide for a flexible range of operations. Supplemental light sources should be designed to be flexible, and adjustable in order to accommodate a variety of tasks. Reflection and glare should be minimized by the placement of



light sources, the texture of work surfaces, and the orientation of visual displays.

**6.8.2 Intra-Base Communications: Teleconferencing and Meeting Facilities**

This area may utilize another such group interaction-designed area, such as the group recreation area to dining area. The space must be large enough to accommodate the entire crew. It is also suggested that the space be centrally located within the base, and that a personal hygiene facility is near. It is advisable to situated away from high-noise facilities.

The temperature and ventilation system must be adjustable enough to accommodate the presence of different sized groups.

The facility should also provide equipment storage necessary for the conduct of meetings. The following are some requirements and consideration:

- Screen or central display area
- Two-way communication for the participation of persons outside of the facility
- Projection system
- Audio-visual equipment for recordings and playbacks

**6.8.3 Logistics Modules/Storage Systems**

In order to conserve on EVA time, consideration must be given to design aspects of logistic module interfacing equipment with regard to mobility and transport/transfer systems, module integration, and docking systems. The logistics modules must be transferred from landing vehicles to transport vehicles, carried over lunar terrain, and docked to the base. These systems must easily integrate with the typical module configurations: the pressurized logistic supply

module, fluid tankage shipping module, and the unpressurized container pallet module.

An unpressurized warehouse surrounding the base logistic module interface (docking systems) should provide protection from solar activity, micro-meteoroids, and ground blast from the landing site. This area should be large enough to accommodate two to four docked supply and tankage modules as well as storage for pallet modules and queuing areas for incoming and outgoing modules. This area could also store, for long term purposes, modules used as collection containers for trash and wastes until final disposition.

Location of the logistic module interface must be convenient to the landing site to minimize EVA time during retrieval or disposition activities. The logistic module interface must also be efficiently located in the lunar complex to provide easy distribution of supplies, ease of access to modules containing experiments or work activities, safe transfer of returning experiments, and possible trash and waste collection in empty modules. This suggests two possible locations for the interface: first stage or "front door" of the base complex, and centrally located within the base complex.

Temperature and pressure within waste storage systems must be capable of being monitored, to avoid the escape of toxic fumes or unpleasant odors back into habitat areas.

**6.8.4 Safehavens/Emergency Systems**

The safehaven is an area of the base specially equipped or situated to protect the crew from high levels of radiation caused by solar flares or other such emergency conditions where the main habitat is deemed unsafe. The safehaven should be sized to accommodate the entire crew and equipped with all necessities for survival for a period of a few hours to a few days.

Sufficient volume for the crew can be based upon a study conducted

by Breeze (1961) who found that humans need at least 260 cubic feet, from a psychological standpoint, for periods of isolation of less than two months. Multiplying this figure by the crew size, and then adding in equipment and storage needs, will give you an approximate safehaven volume (SICSA, 1989).

### 6.8.5 EVA Chamber

The EVA chamber includes the main storage area which is the interface between the habitation modules and the EVA exit space. The main concern for the EVA chamber is the containment and removal of lunar regolith which accompanies the crew members into the lunar base from the lunar surface. The EVA exit/entrance space is designed to be an airlock and dust lock space. For the initial base layout the exit space and the dust off space will be the same area. As the base expands the two areas will be separate spaces.

The size of spaces, size of hatches and system control locations/positions will be designed to accommodate the upper 95 percentile male and lower 5 percentile female body dimensions. The requirements for size of the exit chamber will allow 2 crewmembers to comfortably move about in their EVA suits with equipment and tools. The size is also designed by the requirement to minimize the exit/dust off space. This minimizes the the air removal requirement. This minimizes the time required to evacuate the air from the space, the air evacuation equipment running time, evacuated air storage requirements and the corresponding air make up requirement upon re-pressurizing the space. The expected air loss is 5% of the initial volume due to evacuation equipment limitations. The main EVA space will be sized to accommodate EVA suit storage, suit donning and doffing. The size of the space will accommodate suit cleaning, suit maintenance and suit resupply needs. The suit expected to be used is the "Hard Suit."

The hatches will be sized to allow ease of exit and entry into the EVA spaces by crew members in the EVA suits. Because of the expected

clumsiness and balance control by crewmen while in the EVA suits, exits and entrances are sized to allow one crewman at a time to pass through easily. Special needs will be encountered and designed for when the emergency scenario concerning passing an injured crewman through the passages.

All hatches and controls for EVA use will be marked according to NASA standards. The marking of hatches and controls will remove confusion of system operation or control. Hatches will be designed with simple positive closing hatches. The hatch control handles will be operable by suited crew members. The handles will be large and the required motion for operation will correspond to the capabilities of the EVA personnel.

The color and decor requirements are minimal. System fittings will be covered or hidden to prevent damage to the systems from exposure to lunar regolith. The color of the EVA spaces will be white. This will assist crewmen in locating areas contaminated by abrasive lunar regolith. The sterile image for these spaces should be maintained to stress the need for maintaining containment of regolith. Since the EVA system will be designed for team use, the psychological effects of the stark white color will be minimized by the continual social interaction.

The materials considered here are the surface materials. The structural materials, design and ability to provide support for pressure changes are assumed to exist. The surface materials will be durable. The material should survive the abrasive effects of the crew traffic and the lunar regolith contact. The surfaces where crew member traffic is expected must be rough to provide adequate footing. All other surfaces should be smooth. The smooth surface will facilitate clean-up of the lunar regolith contamination.

The exit chamber lighting will be designed to provide for crewmembers to have adequate adjustment to lighting conditions on the lunar surface at the time of EVA. During lunar night EVA operations, the EVA exit space lighting will be a minimized red lighting during the

de-pressurizing period. This will provide adequate night vision preparation for the EVA exit. During entry from the lunar night, the lighting will initially be red. As the re-pressurizing process continues, the lighting readjusts to normal lighting levels at small incremental changes in light intensity and color.

In the event of an EVA accident where a crewmember has been exposed to a low pressure atmosphere but not a complete vacuum, special needs for repressurizing are required. The requirements needed concerning the repressurization rates will be provided for by the EVA repressurizing capabilities.

The removal of an injured crewman presents a variety of requirements, which are discussed in detail in the accompanying Program/Requirements Document (Baschiera et al., 1989).

The lunar base is designed for operation and use by different base teams. As a necessity to remove confusion for specific operation of systems and for quick location of components, a method of way-finding is needed. By proper location markers for the EVA system, possible hazardous situations for new, semi-oriented crew members can be eliminated.

Lighting the external lunar base pathways to the EVA exit/entrance space will be required. The lighting of the pathway will allow recognition from 100 m. Proper design of the lighted pathways will be conducted. This design will take into consideration the visual aberrations caused by the lunar lighting and the absence of a lunar atmosphere.

#### 6.8.6 Power Systems

The aspects covered in the design of the power supply include architectural and engineering concerns involved with the deployment and operations of the lunar base power system. The main concerns with the power system are the reliability of power and the safety of the power system.

Three power system types are considered for use in the lunar base design. These systems are: solar power plant, fuel cells, and nuclear power plants. Based on the information available and the design criteria, the power system selected is the nuclear power plant system. The nuclear power plant has increased reliability, has the ability for expansion, has the ability to be delivered to the lunar surface assembled, can be located in existing landscape and can be made safe from human activities.

The power required by the base during its stages of development has been defined initially as requiring 25 Kw of electric power. As the base is completed the power requirements reach 300-500 Kw of electric power (Mendell, 1985).

The initial power is supplied from an Radio-isotope Thermoelectric Generator (RTG) nuclear system. The power system is then designed with SP100 Nuclear reactors.

The power system must have the potential to expand with the growth of the lunar base. This expansion starts from the initial construction into the fully operation phase.

The system may either be sized initially to meet the expected full operation requirements or may be designed such that as the power needs increase, the system will then be expanded.

The power plant will require back up systems for control, power conversion energy storage or back up power. The selected power system must have a minimal amount of required back up systems. This increases the reliability and efficiency and decreases the plant assembly time. The minimal back up systems also limits the required maintenance of the power plant.

The plant should have a minimum construction effort required. Because the power system is needed as soon as base construction begins, it must be constructed quickly and easily.

The power plant must be designed to limit the base crews direct exposure to high temperatures, high voltages, radiation and physical hazards cause by machinery. The power system will be designed to provide for crew safety during periods of maintenance and repair. Adequate design for emergency systems dealing with the power system will be present.

#### 6.8.6.1 Solar cells

This system requires a large field array, a precise efficiency monitoring system which auxiliary systems will be constructed from materials brought from earth.

The efficiency of the solar power plant is dependant upon maintaining the proper angle of the cells to the incident sunlight. With a lunar equator base location the angle of the sun varies. The power needed to drive the tracking system decreases the overall plant efficiency.

The type of photo cell selected is a gallium arsenide cell. This type of photo cell has the lowest loss due to radiation and thermal effects. In an array, the photo cell may reach an optimum efficiency of 20.5%.

The efficiency of the back up fuel cell power plant and the associated heat engine are limited by the temperature of the heat sink for the engine.

The solar power plant requires a back up system during the lunar night and during periods where the photo cells cannot provide the base power requirements. The back up system best suited for this is a fuel cell which drives a Stirling cycle heat engine. The heat engine drives a generator to produce electric power.

A battery storage system will be required to store electrical power to be used to allow completion of required maintenance or repair during the lunar night.

The construction of the solar array field is accomplished by constructing a platform to mount and position the photo cells. The solar array field may also be constructed by attaching the photo cells to a flexible matting that can be rolled onto the lunar surface. Prior to the placing of photo cells the lunar surface will require some initial conditioning.

The construction required for the backup systems include excavation for the storage of the fuel cell storage tanks, the storage for the battery system and the fuel cell power plant.

The solar power system is inherently safe. The energy storage systems must be designed to protect the crew members from high voltage and high temperatures during the power systems operation. The fuel cell fuel requires storage in buried gas storage tanks. Storing the fuels below the lunar regolith protects against micrometeorite and thermal damage. The fuel cell fuel is very explosive, for that reason the fuel cell power system must be located safely away from the lunar base.

#### 6.8.6.2 Fuel cells

Fuel cell power plants are expandable by adding more fuel cells to the power system. The fuel cells must be sized for the expected power requirements. The expansion of the system is made in very large power increments. Due to the delivery of the fuel cell plants and fuels from earth, the launch requirement for expansion is a prime factor for sizing the fuel cells to meet the base power requirements.

The efficiency of the fuel cell power plant is controlled by the temperatures of the heat engine heat sink. The efficiency is controlled by the deep space radiator.

The back up systems required for the fuel cell power plant are a battery storage system and a thermal energy storage system. The battery storage system is required for periods of maintenance or repair. The thermal energy storage system is required for continued

the radiation and allow for the reactor to be located closer to the lunar base, reducing the losses due to the transmission lines.

The RTG technology is past proven in earlier space programs. The initial RTG power plant involves no moving parts and therefore has a high reliability.

The location of the power plant in proximity to the lunar base will be based on the site location of the base. The availability of natural craters will dictate the need for excavation and location of the reactor plant. The distance the plant is located from the lunar base will also be based on the availability of shielding material and the expected radiation levels.

### 6.8.7 ECLSS/HVAC Systems

This section deals with the architectural aspects and design requirements of the Environmental Control Life Support System (ECLSS). The ECLSS will provide an open loop system which will require make up quantities of potable water and atmospheric control gases to be delivered from earth.

The design of the ECLSS is based on the need for an entirely closed loop design. The design of the ECLSS will allow direct incorporation into the closed loop life support system.

The life support system will be designed to recycle much of the water and atmosphere. This minimizes the required quantities to be delivered from the earth. The life support system will provide an internal base pressure of 10 psi. The ECLSS will provide a regulated temperature and humidity level for a shirt sleeve working environment.

The color of the systems that are exposed to crew observation will blend in with the decor of the particular spaces. Only the marking of special system control components will stand out in regards to the

operation of the heat engine during the same periods of maintenance and repair of the fuel cells.

Due to launch considerations for the delivery of the thermal storage system medium from earth, the thermal energy storage system is impractical.

### 6.8.6.3 Nuclear reactor

The SP100 nuclear power plant system will use an RTG plant to generate electric power directly for the lunar base. As the base expands, the increased power needs will be provided from a 100 Kw SP100 nuclear reactor system. The reactor provides electric power from the conversion of thermal energy through a heat engine and electric generator.

The reactor will generate excess energy which will be expelled through the deep space radiator. As the power needs increase the excess heat will be used to drive Stirling cycle heat engines. This reduces the heat load on the deep space radiator and increases the electric power generated.

The distance required between the power plant and the lunar base reduces the efficiency of the plant due to transmission losses in the power lines. This should be minimized by possibly cooling the transmission lines to reduce the electric resistance of the lines.

With the nuclear power plant system the only back up systems are those for the safe operation of the plant. No storage systems are required but may be desired.

The construction for the SP100 power plant deal with shielding the radiation. To limit the safety problem with the high radiation from the reactor plant, it will be located in either a man-made or natural crater. The man-made crater involves extension excavation of the lunar surface. The lunar soil is a poor shielding material. There may be shielding material brought from earth to more effectively shield

spaces decor.

In the systems where vibrations are present during operation, the material selected will either dampen the vibrations or other material which will reduce the vibrations will be added to the system components.

In the water and ventilation system, material will be selected which do not contribute any odor to the space or any taste to the potable water. This will be important in the humidity reclamation system connected to the ventilation system. The water treatment system will require chemical treatment for bacteria control, the chemicals used will be selected to limit the taste imparted to the potable water.

The ECLSS will be designed so that the air in the individual modules is free from noxious fumes, dangerous levels of deadly gases. Irritating and damaging particulate matter will be filtered from the ventilation system.

The system will have to detect rapid pressure loss and be able to monitor the module pressure to give the crew indication of a slow pressure loss. The limits to indicate a rapid or slow pressure loss would be at a reduction of module pressure of 0.5 psi. This value will prevent spurious alarms from system variations during normal operations.

The detection of fire will be of prime importance, not only for the fact that crucial equipment damage will be life threatening, but also the elimination of oxygen in the base will force demands on the atmospheric control system. The other safety considerations for the fire emergency would be the smoke in habitation spaces.

The water storage system for the ECLSS is designed to provide each module with a supply of potable and hygiene water so that isolation of a module does not restrict the operation of the lunar base water system.

The size of the potable water tanks must meet the requirement of having enough volume to meet the two day water use initial water treatment system start up. Depending upon launch logistics, the size of the potable water storage will be sufficient to provide a four day supply of potable water.

### 6.8.8 Lighting Systems

When designing lighting for a specific space, it should be known what the atmosphere of the space is to be like: will it be cozy, restful, business orientated, viewing monitors, etc.? Once the purpose of the space has been decided, the required levels of intensity must then be ascertained. To obtain the correct levels, the illumination levels must be proper for vision and balanced against energy and initial cost.

Lighting has an effect on many variables which influence the way a person views others, space, and themselves. It should be designed not only for task and safety issues in mind, but as an aid in wayfinding and orientation as well as personalizing space. Lighting which causes discoloration of the human complexion should be avoided.

The interior ambient light of the habitats should be indirect diffuse light, placed at either ceiling or floor levels, and be easily accessible for maintenance.

Red light should be used where a person must remain dark adapted. These areas might include the command center or the EVA chamber.

### 6.8.9 Thermal Control Systems

The temperature for general use areas should be 23 to 24 C, with a relative humidity between 30 to 50% (NASA-STD-3000, 1989). To maintain this range, a finned-tube type heat exchanger is envisioned for the venting of heat into space.

## 6.9 MISSION OPERATIONS: RESEARCH FACILITIES

A lunar science and technology facility is needed to create a scientific, space transportation, and industrial infrastructure to support exploration of space and the other planets. Research on the moon can also provide new information about human behavior, the formation of the solar system, and evaluation of potential use of lunar resources for supplying a lunar base, space station, or spaceships destined for Mars and beyond, as well as a source of energy (helium-3). Scientific and technological benefits of a habited lunar base include:

- Surveys of lunar resources and extraction/processing methods: Lunar surface mining and production analysis
- Construction technology testbed
- Plant growth and closed system ecological life support system experiments
- Planetological studies of the solar system's origin and features, and physics/astrophysics/astronomical research in a high vacuum environment: lunar-far side observatory.
- Human factors and environment-behavior systems monitoring and research facility

These science missions would take advantage of the moon's unique environment: (a) high vacuum, (b) low gravity (1/6 of Earth), (c) regolith composition, (d) isolation, (e) low seismic activity (when compared to Earth), and (f) low magnetic field, would constantly monitor lunar and deep space activity, and would develop and test new technologies for later lunar and Martian use.

### 6.9.1 General Design Considerations

There have been basically two approaches to laboratory design for space missions: the dedicated facility approach and the open plan approach. In the dedicated facility approach, a specialized facility is provided for each general field. This approach provides a number of advantages (Batelle, 1987): (a) dedicated space to allow a series of focused experiments, (b) availability of dedicated facilities and equipment which are tailored to the discipline of interest, and (c) physical separation from other science experiments and base operations (Batelle, 1987).

The open plan approach has been most commonly used in space ventures, since space and manpower is limited. However, the dedicated facility approach would seem the most suited to lunar applications, not only for the advantages listed above, but also for the reason of controlling dust from geochemistry and petrology experiments and construction technology research.

Geometrical arrangement of spaces within the habitat may influence its legibility and the ease or difficulty one experiences finding one's way within it; health and safety concerns dictate the need for clear orientation, especially in areas where possible dangers exist. Logical location of elements with respect to historical or hierarchical arrangements should be preserved.

Color and decor should not be overly complex nor should it be overly simple; decor which can be modified would be an added amenity, and wherever possible the decor should also serve as a location coding, noise reduction (texture), or glare reduction function

Material selection is especially important in laboratory facilities, where they must resist the wear and tear associated with experimentation. Materials should be durable enough to withstand abrasion, scratching, and corrosive contaminants, and be easily cleaned and maintained; they should also provide for added traction, noise reduction, and glare reduction where possible.

Certain experiments may require special atmospheric conditions, as well as provisions for dust control or a seal-off ability. Each facility should have its own atmosphere control capability, to insure experimental response and crew safety. Thermal and lighting provisions should be responsive to the needs of scientific experimentation.

Experimental apparatus such as a thin section maker and polisher may produce noise which could be subversive to other experiments or irritating to humans, therefore materials which dampen noise should be used, and apparatus which produce high noise levels should be given special provisions to control sound transmission.

Experiments may take place, or materials used, which may cause harm to crewmembers should an accident occur. Since any harm to crewmembers could be potentially catastrophic, every precaution should be taken with experimental equipment. Facilities should have a seal-off ability, back-up lighting systems should be provided, and first aid capability present to treat cuts, contamination, or possible eye injuries.

Mission operations refers to the experimentation and development aspects of the habitat, therefore productivity is a major issue, especially at an early lunar base where manpower, time, and resources are limited.

### 6.9.2 Lunar Surface Mining and Production Analysis: Geochemistry/Petrology Laboratory

This laboratory would provide facilities for the study and experimentation of lunar resources and extraction/processing methods (mining and resource utilization), as well as for the study of the origins of the moon and the solar system.

The facility should be large enough to house a flow bench, a scanning electron microscope, storage sample racks, and counter space sufficient for experimental apparatus and note taking.

Two smaller rooms, an acoustically isolated sample preparation room large enough to house a thin section maker and a "clean" room which can provide a pristine environment for the study of lunar samples, should also be provided within the facility.

A small pilot plant for the extraction of oxygen from the lunar soil will most likely be operational, necessitating storage space for raw lunar material.

Processing experimentation will be varied, and may include fluidized bed reduction, sintering using microwave plasma, and solar melting. Apparatus will likewise range from superconducting magnets and microwave generators down to particle size sorters. Therefore the size and overall configuration of this facility must meet storage requirements for equipment, as well as be flexible enough to allow for efficient and safe set-up and tear-down of experiments.

Dust control will be extremely important within this area, since not only will sizable amounts of lunar material be present, but experimental apparatus and sample preparation may produce dust in their operations, contaminating not only the atmosphere but also other experiments. Therefore, each piece of equipment should provide some means of dust filtering, and the larger dust producing activities placed within an environmentally isolated room.

To minimize the transport of regolith samples through the habitat, this facility should be located near an airlock, or perhaps have an interface to an airlock.

### 6.9.3 Space Construction Technology Testbed

This facility would test materials, both lunar and earth-based, and methods for advanced space construction. The testbed may actually be comprised of a number of facilities, ranging from a material development laboratory, coordinated with the Lunar Surface Mining and Production Analysis Facility, to an exterior material testing and



### 6.9.5 Far-side Lunar Observatory and Astrophysics Station

deployment area.

Provisions should be made to monitor the possible outgassing of processed materials within a controlled environment before they are exposed to the atmosphere of the habitat.

The testing facility would most efficiently be placed near the Lunar Surface Mining and Production Analysis Facility, to minimize traverse distance between development and testing areas, as well as near the Maintenance Facility, for the sharing of tools and related equipment.

Workstations may be required to monitor the performance and collect data from a Lunar Far-side Observatory. A solar observer, which would monitor solar flare activity, should be given high priority as a safety measure protecting the lunar base inhabitants from extreme radiation.

Since information from a far-side observatory would most likely be relayed directly to earth, a single workstation would most likely be adequate. This workstation would most likely be located within the base operations area, since the most pertinent information would be regarding solar flare activity, a base concern.

### 6.9.4 CELSS Research Facility

Experiments would take place focusing on plant growth and closed-loop ecological system development. Capabilities in biochemistry, analytical chemistry, cell biology, plant physiology and microbiology would be needed.

In the initial phases of the Biosphere, the scale of the facility should remain small until plant productivity, contamination safe-guards, and human safety are proven. This will also be a time to prove whether hydroponics or aeroponics is better suited to the lunar environment.

Once the facility has reached full scale, it should be large enough to supply the entire crew with their daily dietary requirements, as well as an emergency supply of food, and offer sufficient compartmentalization and variety of plant life to ensure against widespread contamination.

The atmosphere for the biosphere may be toxic or non-toxic, in which case temperature, carbon dioxide, and humidity levels are changed to maximize plant productivity. In either case, the facility must be sealed off from the habitat and other areas to preserve its atmosphere and protect the plants from contamination.

### 6.9.6 Human Factors and Environment-Behavior Systems Research Facility

Experiments focusing on the adaptation of humans to isolation and reduced gravity would be an early part of mission operations activities, and is derived from the essential mission of this lunar habitat as a testbed for later Martian exploration. In addition, this facility would monitor cardiovascular deconditioning, bone calcium loss, and muscle atrophy in crew members, as well as monitoring habitat environmental factors such as radiation, water quality, microbiology, toxicology, and barothermal physiology.

The HF/EBS Research Facility should be near both the habitat, the other research areas, the command module, and EVA don/doff areas. It thus should be relatively centralized within the total base structure. As it will primarily be a telecommunications research facility, it could be adjacent to or a part of other research and/or the command center.

Five primary research methods will be involved, and will dictate the size and configuration of the facility:

## Genesis Lunar Outpost

- Telecommunication Monitoring
- Systematic Observation
- Surveys
- Open-ended Interviews
- Focus Groups of the Base Crew

Most of the research will be conducted in situ, where the actual environment-behavior transactions are taking place.

The primary needs for the research "facility," therefore, will be one telecommunications workstation with sufficient monitoring devices to record all of the research being conducted, a hook-up to the central computer for real-time analysis, and storage for any materials which might be administered as questionnaires.

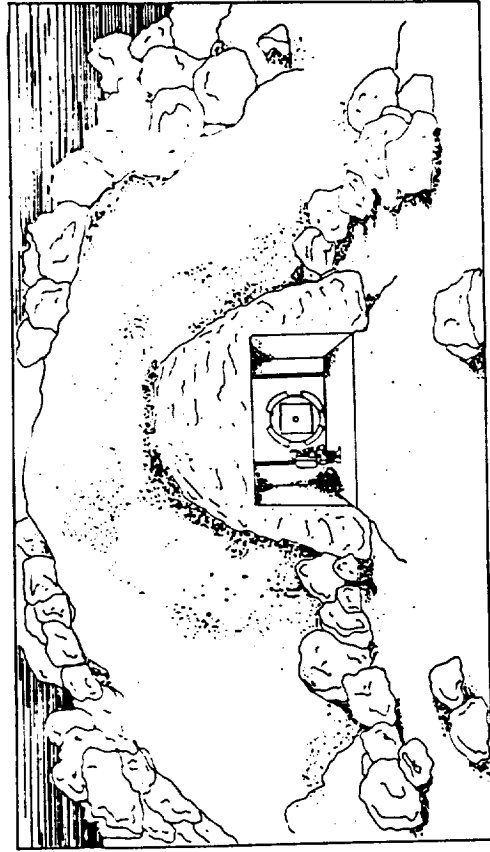

## 7. PROJECT GENESIS LUNAR BASE DESIGN

Based on the above programmatic requirements and performance specifications, this student design project is an application of environment-behavior and engineering design research concepts to the design of a lunar outpost for the year 2005.

The design shows a permanently inhabited lunar base at an Earth-facing equatorial site. The facility is designed to accommodate 8 to 12 astronauts, scientists, architects, and engineers for periods lasting up to 20 months with average crew change-outs of 9 months.

### 7.1 THREE ALTERNATIVE SCENARIOS

Three design scenarios were explored in detail:

- Rigid space structures using clusters of space station sized pressure vessels, aluminum alloy domes, and interconnect nodes;
- Underground architecture using the natural lunar craters and lava tubes; and
- Inflatables using a laminated Kevlar bladder with a space frame structure.

In each scenario, separate modules were designed for laboratory and habitation functions. The entire facility will be buried under a

sufficient amount of lunar regolith (0.5 to 1.5 m) for proper radiation protection and thermal control.

Concerns of the design included provision of public and private spaces for all necessary functions, design for 1/6th gravity of the moon and its effects on design and the use of an environment, systems for multiple uses to conserve space and weight, accessibility to all areas and components, graphic coding of systems to allow ease of identification by crewmembers, and interior configuration which includes provisions for life support and power supply systems. The laboratory area includes workstations for eight crewmembers, an exercise facility, a limited hygiene facility, a system for holding a variety of experiments, command and control center, and a storage system for consumables, excess equipment, and personal items. The habitation area includes sleeping and personal areas for the eight crewmembers, hygiene facilities including both full body and hand cleansing, a meal preparation area, a dining area with facilities for teleconferences and meetings, a crew health care and emergency medical facility, and a storage system for food, medical supplies, and personal items.

These preliminary design scenarios were based on the Programming/Requirements Document completed during the fall semester 1989. The student-produced programming document was based on a seminar on space architecture combined with a loose-leaf reader and Primer written by the faculty advisors. The programming and design work, however, was done entirely by students. The faculty and TA involvement was limited to being advisors, coordinators, and critics of the work.

### 7.1.1 Prefabricated Hard Module Construction

The first scenario focused on the use of Space Station Freedom-type hard modules with connectors and EVA chambers as shown in Figures 7.1.1-1 through 7.1.1-5. Each of the larger modules was designed to fit in a standard Space Shuttle cargo bay, and would be fully outfitted prior to lift-off.

Figure 7.1.1-1 and 7.1.1-2 show the phased development for this scenario and the number of flight with crew and with logistics payloads to construct each phase. Phases A, B, and C are the three preliminary phases of Phase 1 IOC. The IOC also involves a dome habitat center, also constructed from prefabricated Earth-based construction technology (aluminum sheets, self-rigidizing foam, etc.). Note the dual means of egress from all points of the grid layout.

Figure 7.1.1-3 shows the base floor plan with the central command center module flanked by science and medical facilities, domestic management facility, central large domed research and teleconferencing workstations, and crew quarters removed to the upper end of the base. The section D-D through the dome shows the large-two floor workspace of the central work area.

The last illustration shows the layout of these various work and crew areas via a series of longitudinal sections through the various modules.

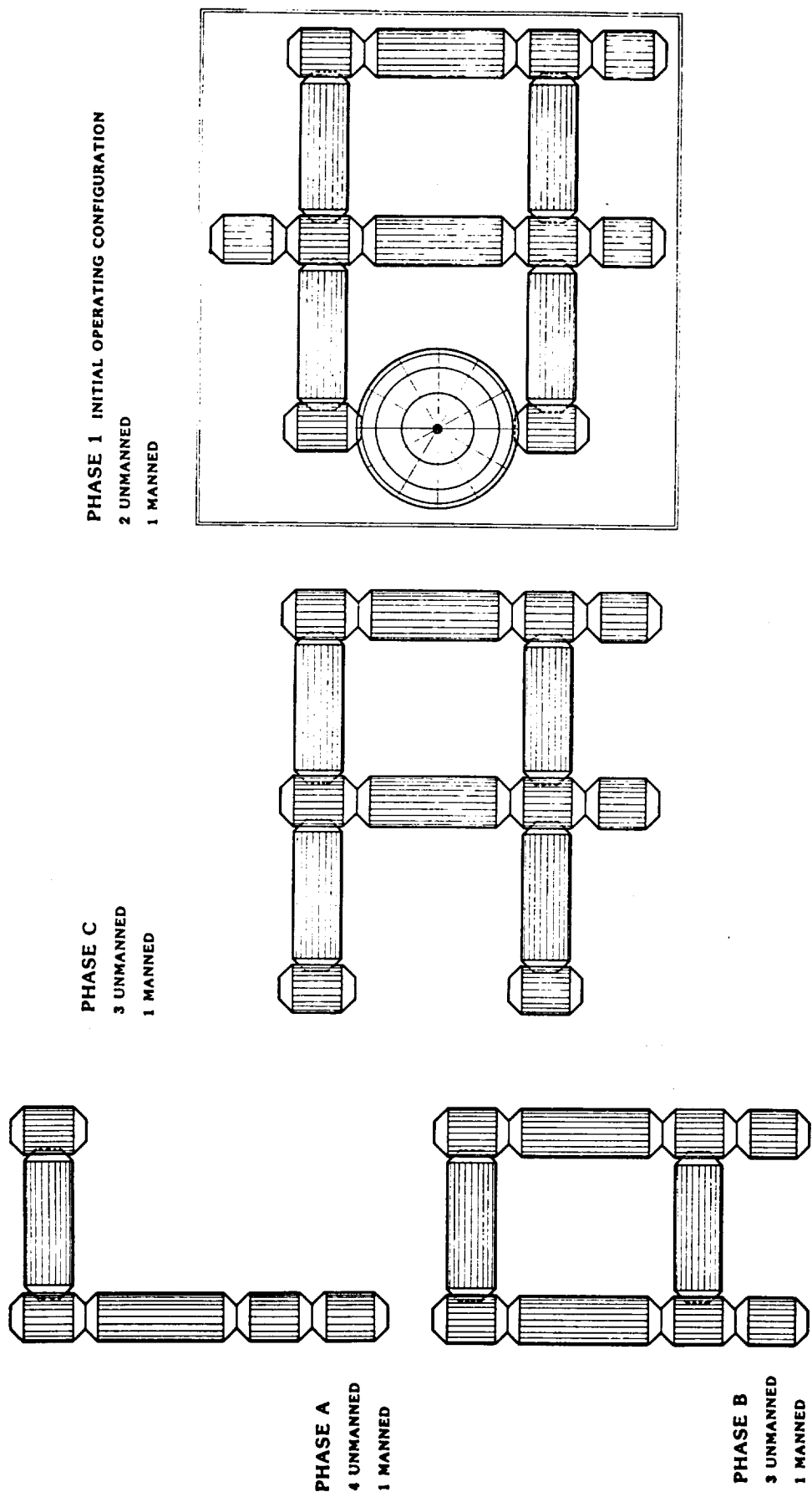

Figure 7.1.1-1. Initial three phases for the hard module scenario of a Lunar Outpost leading up to IOC.

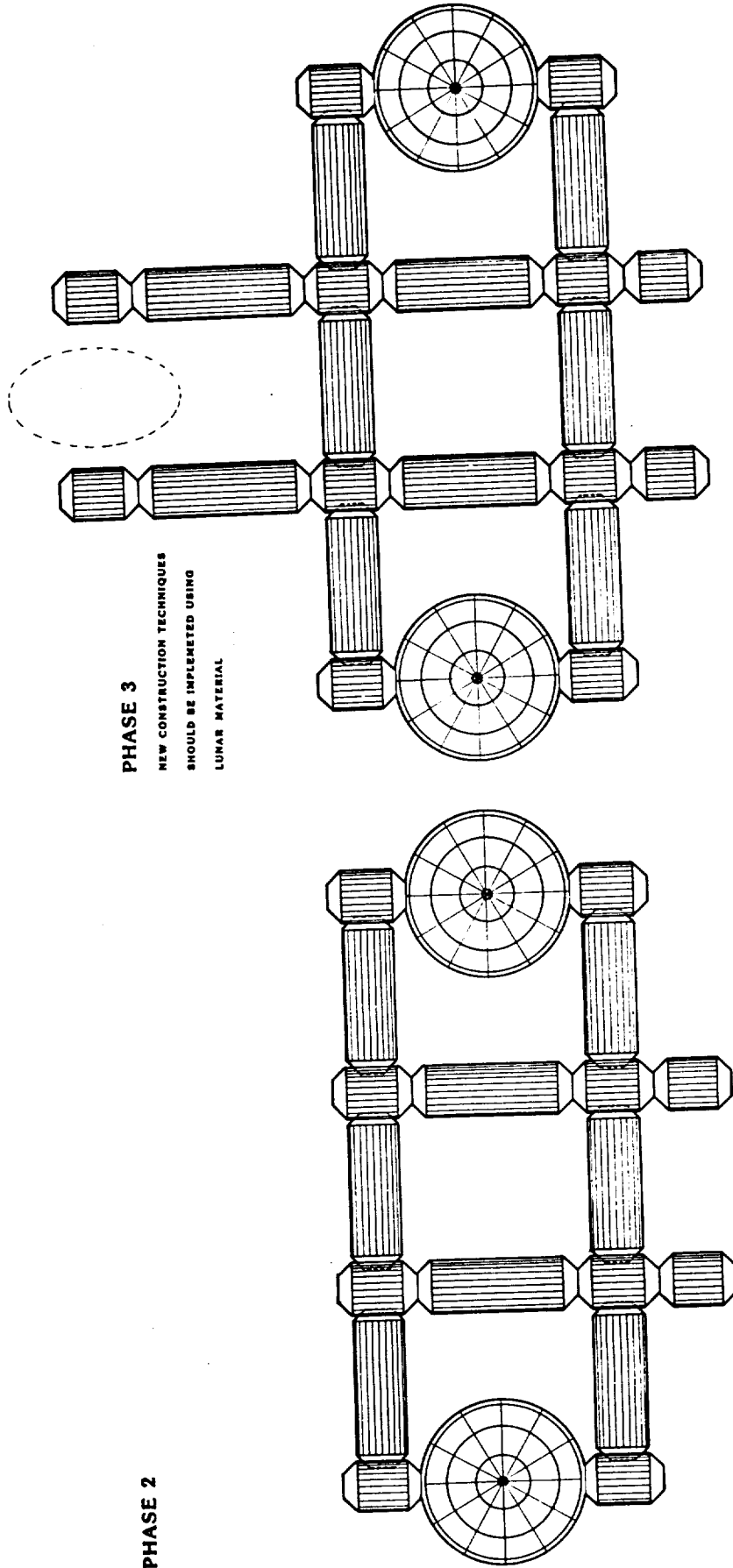

Figure 7.1.1-2. Phases 2 and 3 showing development to an Advanced Lunar Base with two domes, 10 modules for research and mission operations, and associated connectors and EVA chambers.

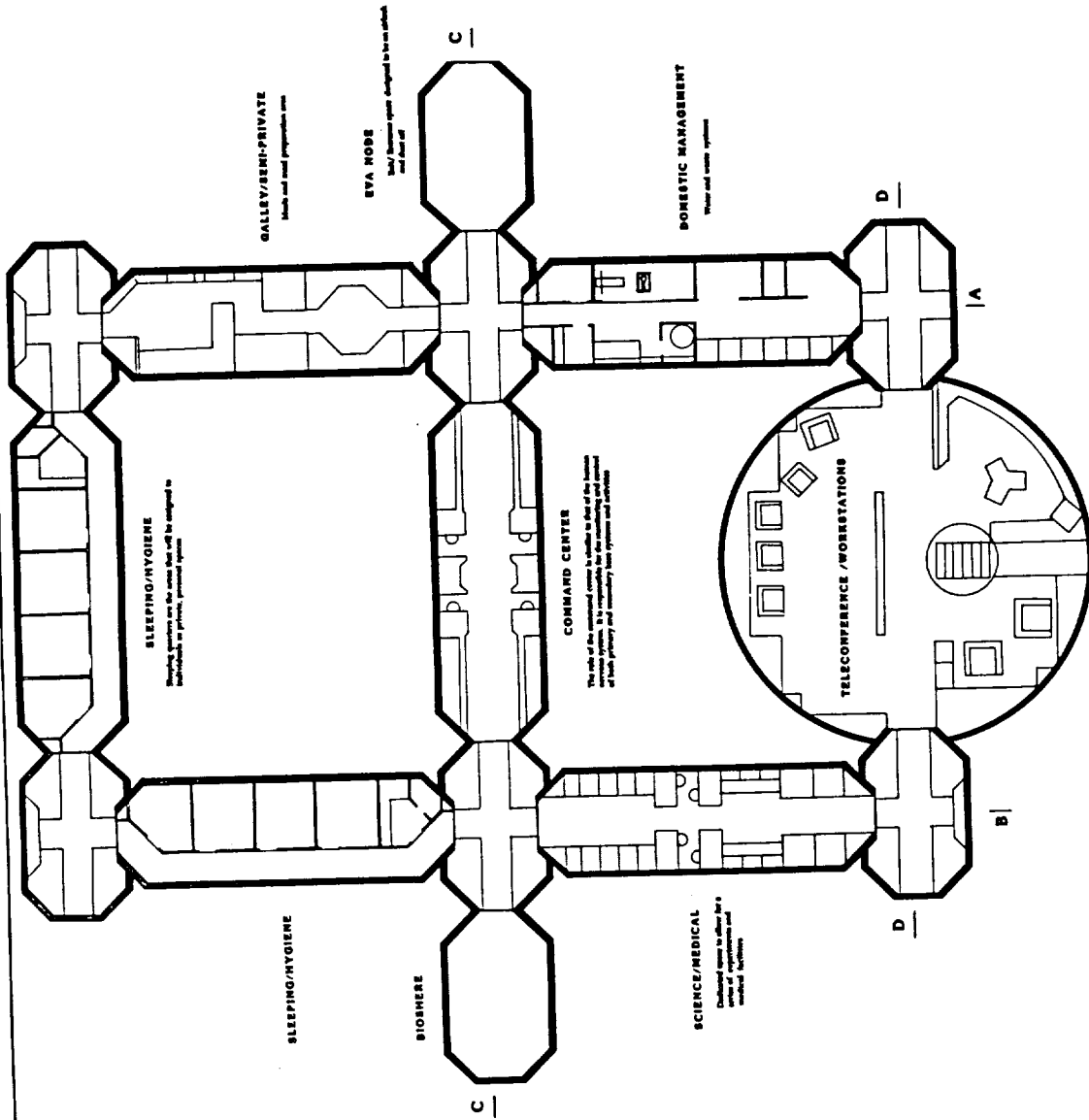
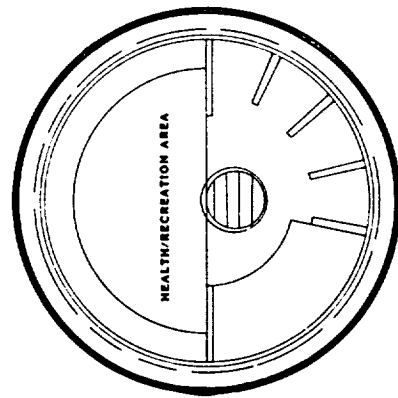
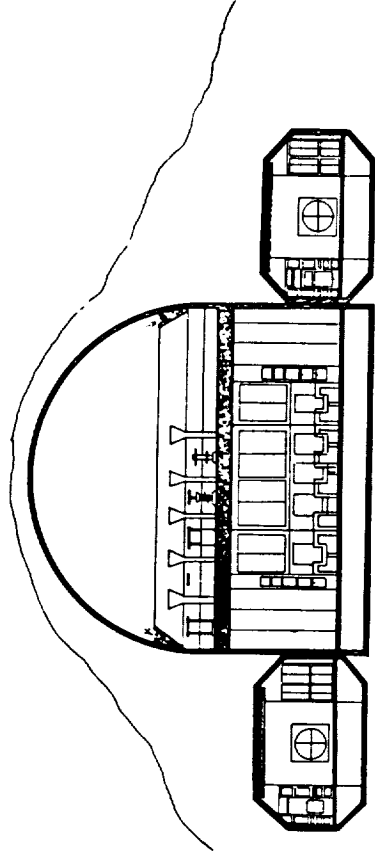

Figure 7.1.1-3. Base floor plan.



DOME SECOND FLOOR PLAN



SECTION D-D

Figure 7.1.1-4. Section D-D through the domed teleconference/workstations area.

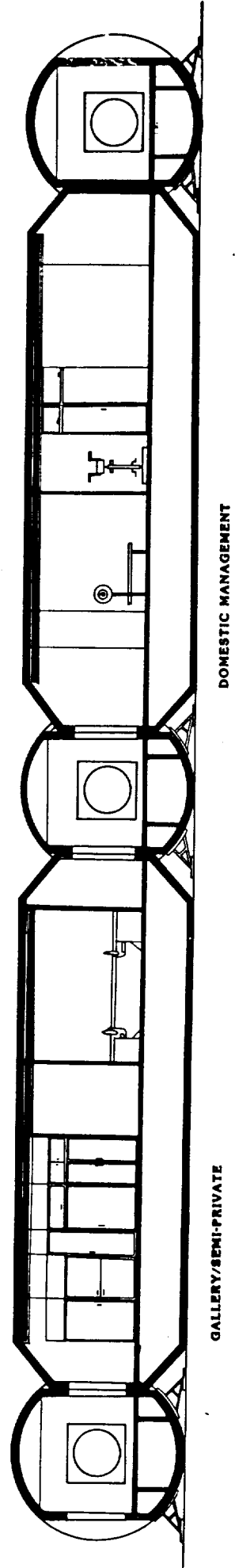

GALLERY/SEMI-PRIVATE

DOMESTIC MANAGEMENT



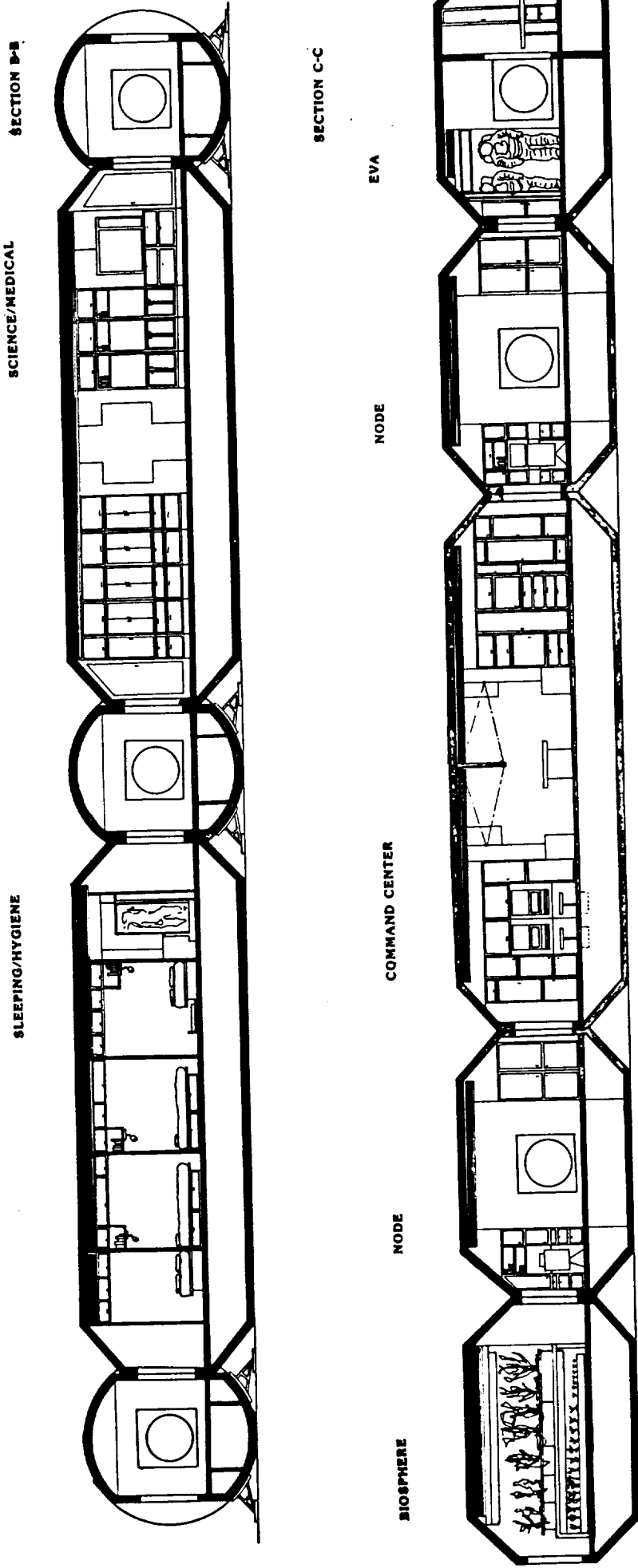

Figure 7.1.1-5. Longitudinal sections.

### 7.1.2 Lunar Craters and Lunar Lava Tubes

The second scenario explored the possibilities of using the abundant craters and associated lava tube systems. The design utilized the descending lava tube opening, as shown in Figure 7.1.2-1 and 7.1.2-2, with a command center just inside the upper entrance of the lava tube formed using a rigidizing foam wall system. As the lava tube continued its steep downward descent, an electromagnetic elevator system was installed.

Using the natural configuration of the lava tube, the large open area was converted into a two-story habitation area, complete with quarters for the crew, laundry, meal preparation area, biosphere, conference and library area, laboratory, exercise area, and ball court. This part of the design scenario is shown in the two floor plans and a section in Figures 7.1.2-3 and 7.1.2-4.

Both entrances to the habitation area had access to the surface via the elevator system. While one opening of the crater and tube provided a laboratory and command center, the opposite end housed a storage facility for equipment and lunar rovers.

A view of the entrance to the lava tube and an overall site plan are shown in Figures 7.1.2-5 and 7.1.2-6.

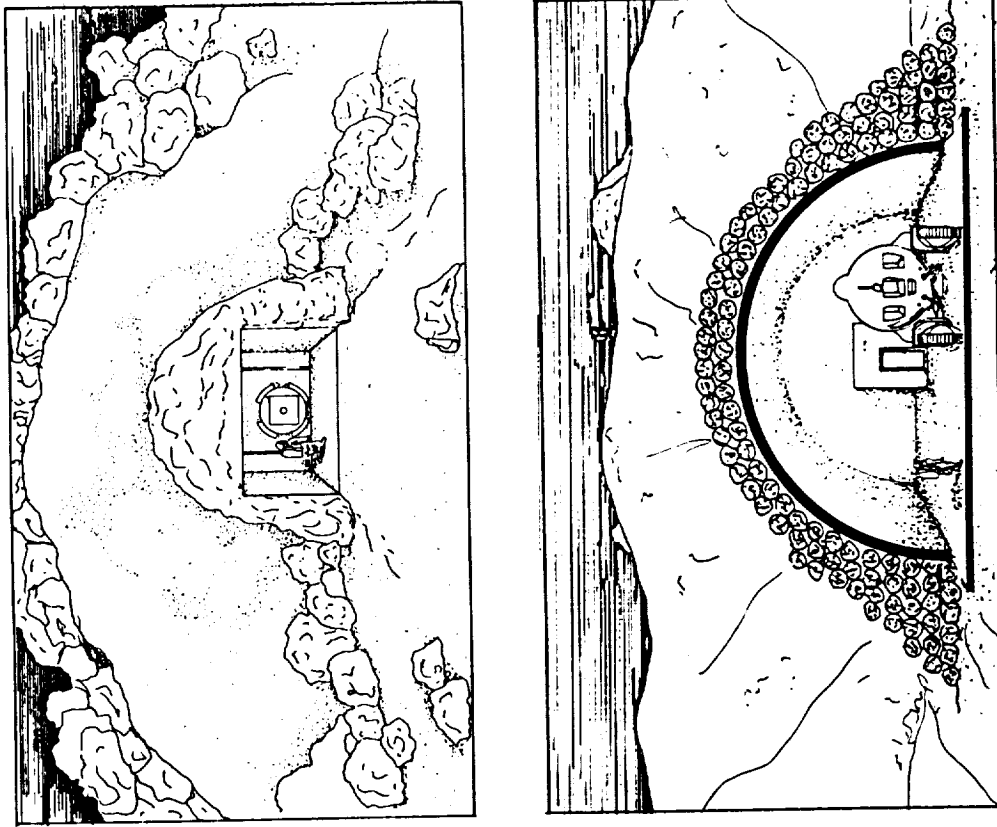

Figure 7.1.2-1. Entrance to the lava tube from a lunar crater, showing the command center on the surface level and the electromagnetic elevator to the deeper recesses of the tube.

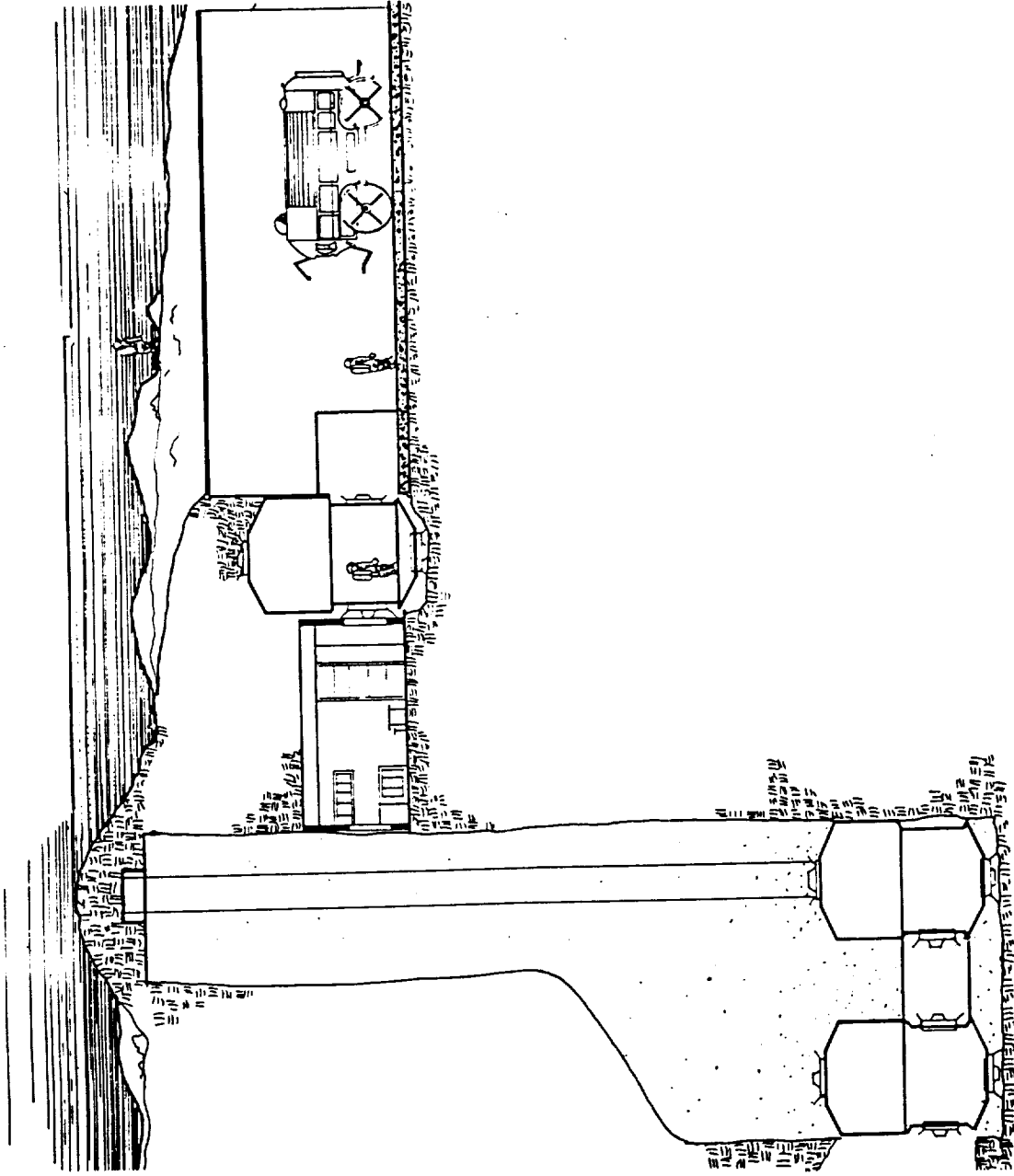

Figure 7.1.2-2. The other entrance/exit to the lava tube showing the logistics/storage area.

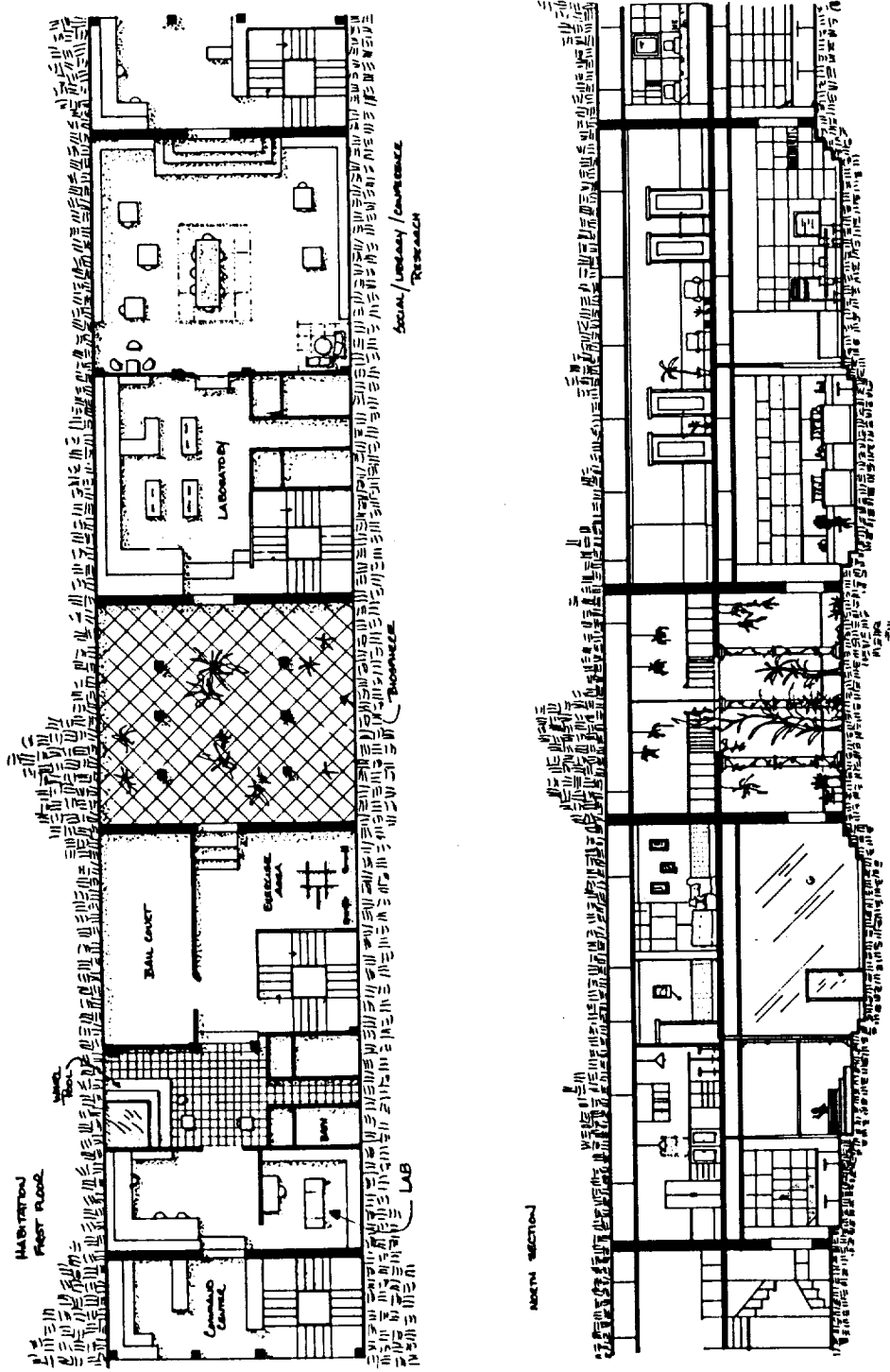

Figure 7.1.2-3. Lower level floor plan and section of the interior configuration of the lava tube scenario. The two ends of this plan and sections connect with the two lower ends of

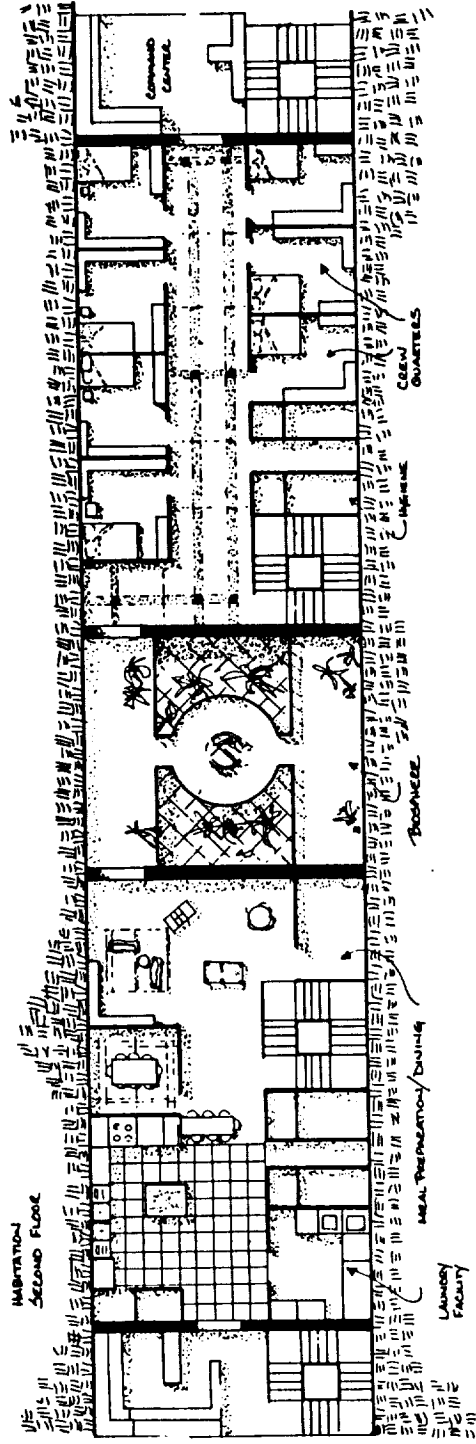

Figure 7.1.2-4. Upper level floor plan.

### 7.1.3 Inflatable Structures

The third scenario expanded on the possible use of inflatables as the primary means of developing the lunar habitat. This scheme also explored site layout and the qualities of "urban design" most fully as well as phasing and deployment of the inflatables. The drawings shown in Figures 7.1.3-1 through 7.1.3-5 (a-h) and 7.1.3-6 are well annotated and self-explanatory.

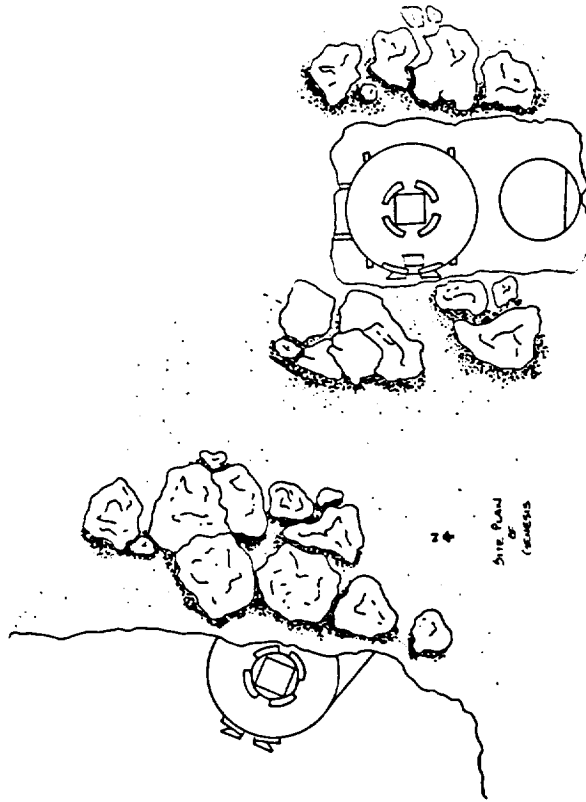

Figure 7.1.2-5. Site plan.

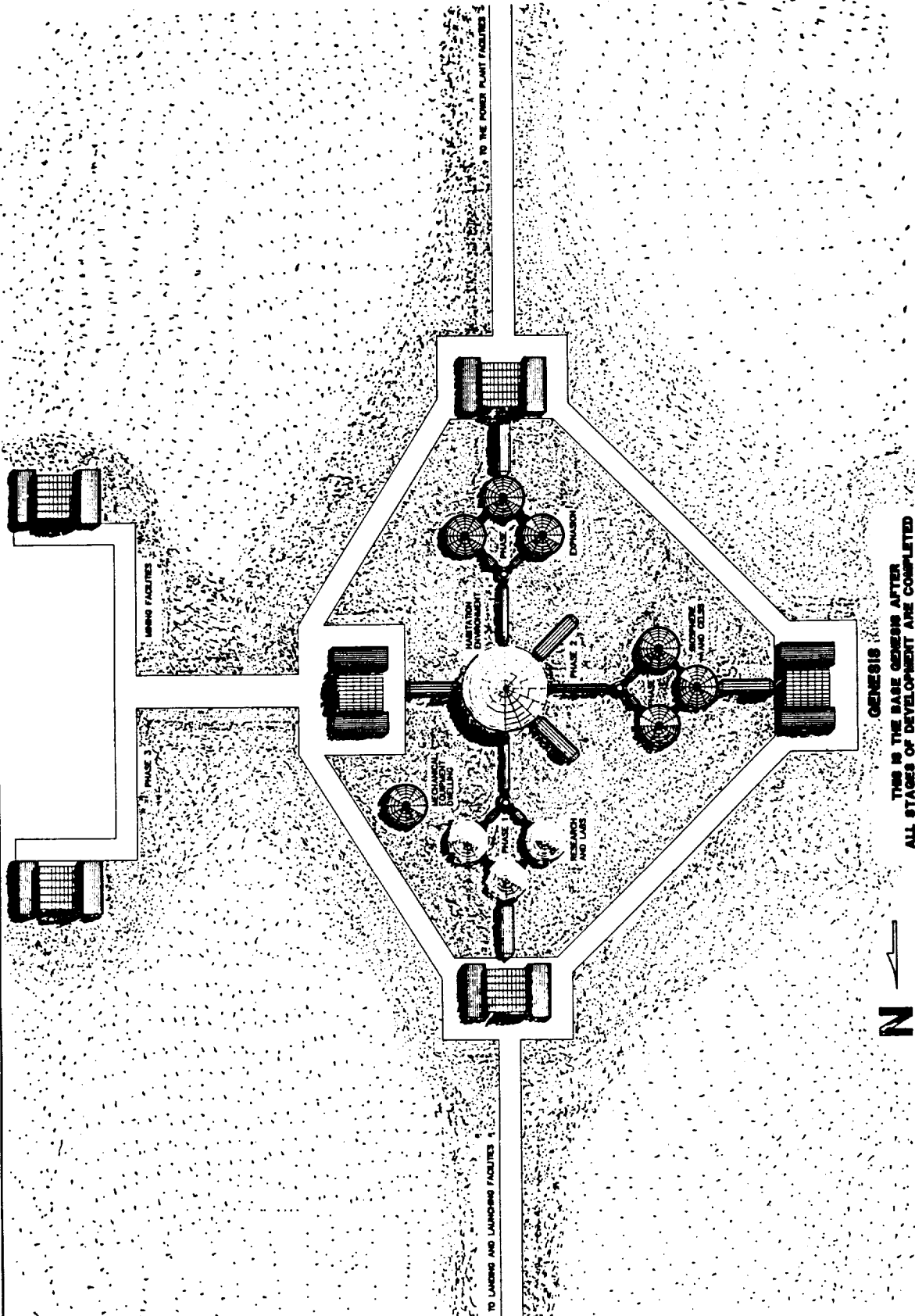

Figure 7.1.3-1. Site configuration of the inflatable lunar outpost. Note that North is to the left.



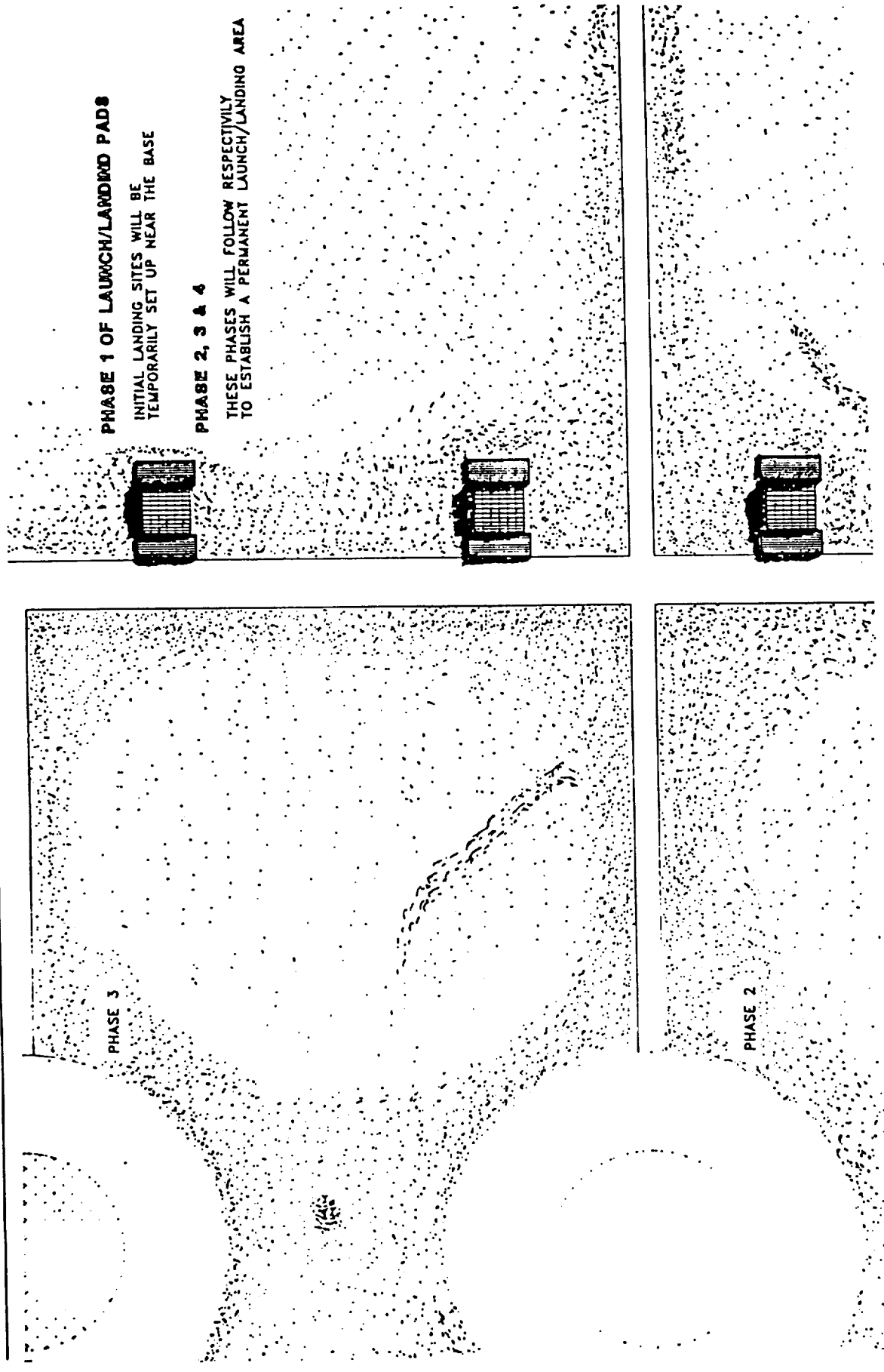

Figure 7.1.3-2. North end (left) of the site showing a portion of the launch/landing pads and growth through Phases 2, 3, and 4.

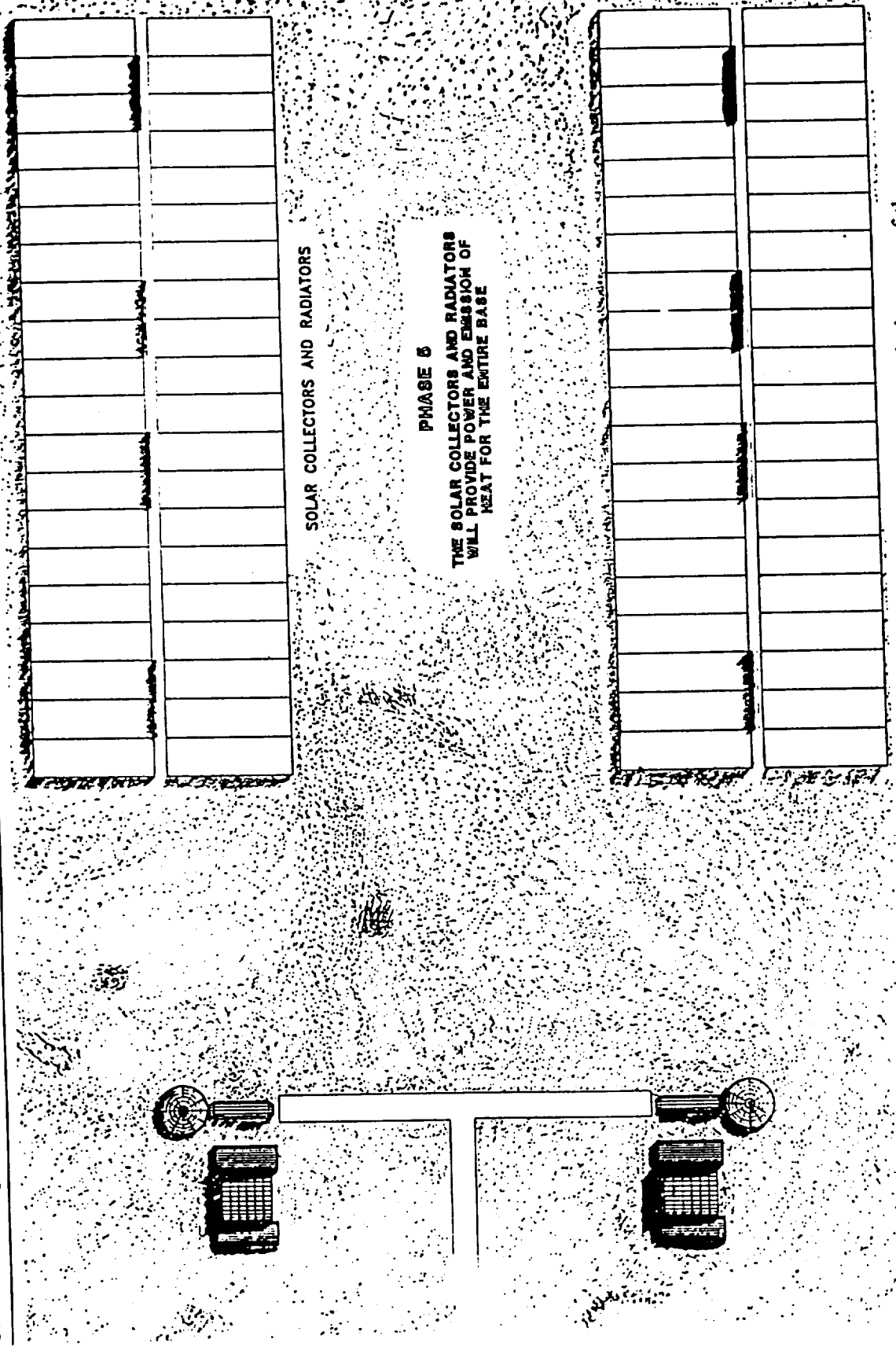
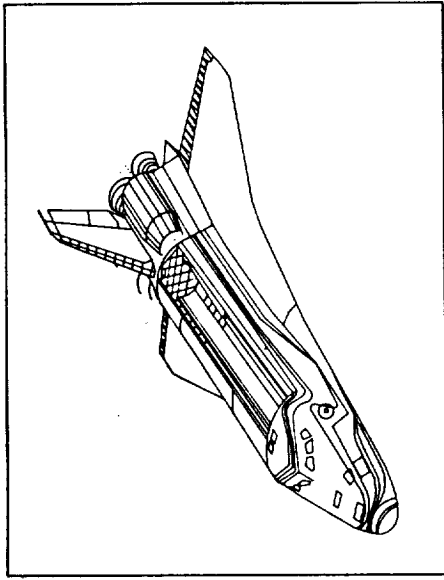
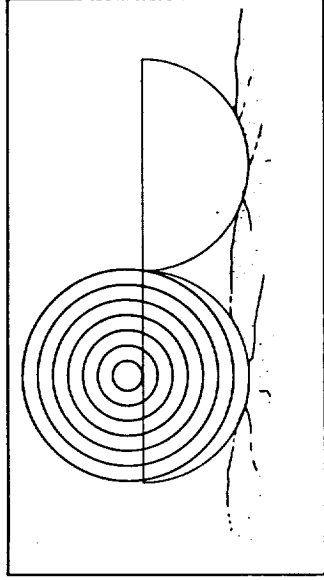

Figure 7.1.3-3. South end (right) of the site showing the power and emission part of the base featuring solar collectors and radiators.





(a) All cargo will be transported by the Space Shuttle, Shuttle C, and other transports.



(c) Inflatable structures will be folded and rolled for easy packaging on-board the shuttle.

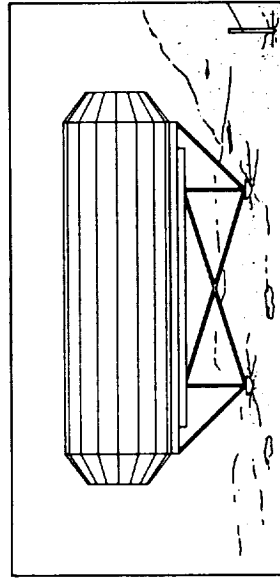

(b) Cargo will be brought down by landers and prepared for construction.

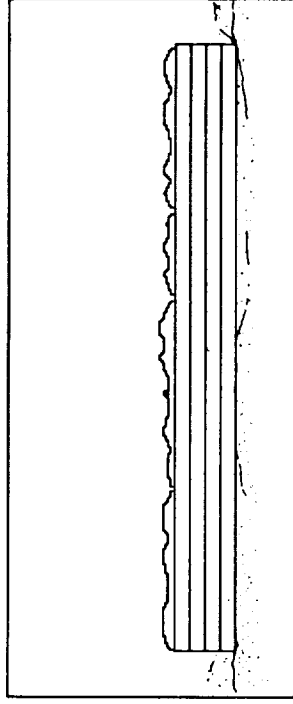

(d) Structure will be unpacked and unfolded on the lunar surface.

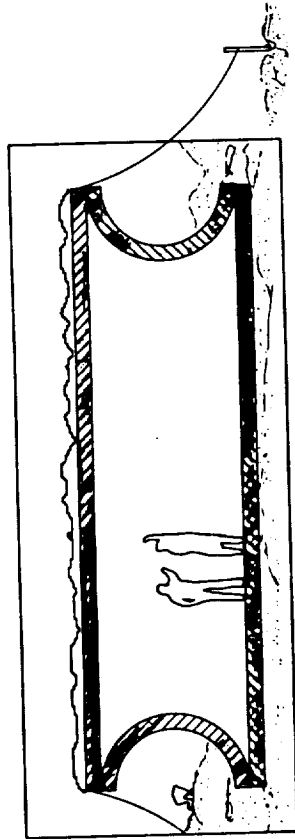

(c) The first and second floors will be inflated and then filled with rigidizing foam.

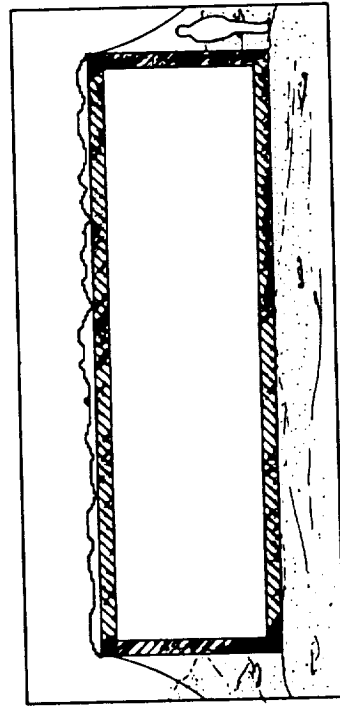

(f) The die walls will then be inflated and also filled with rigidizing foam.

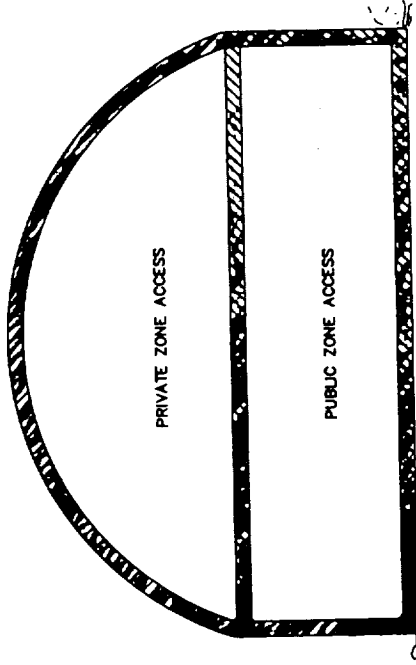

(g) The dome structure will then be inflated and filled with foam.

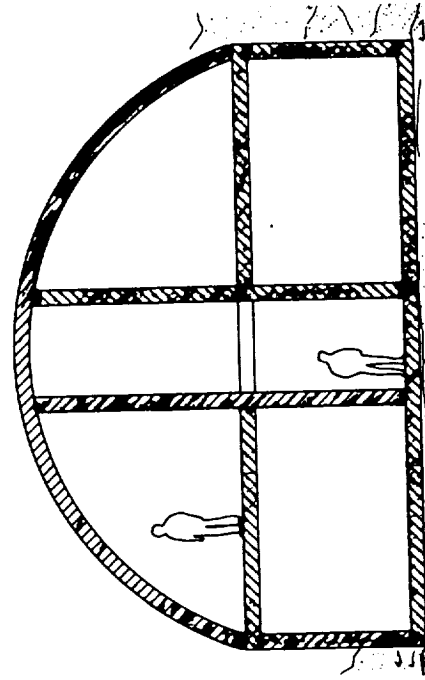

(h) The interior circulation core will finally be constructed, giving additional structural support.

## 7.2 FINAL DESIGN SOLUTION: INTEGRATIVE DESIGN

### 7.2.1 Design Approach

The early stages of lunar development will be very dependent on earth launched supplies including most of the habitable structures. The configuration should be economical and transportable. The primary issues for the configuration are habitability, safety through dual egress and safe havens, phased growth, reduced EVA, modularity, and the limited construction capabilities of an early lunar outpost.

The overall layout of the proposed lunar base reflects an organizational idea or geometry that allows the base to be understood functionally as well as used efficiently. Several ordering principles are inherent in the functions that make the base. The functions of the base include living, research, storage, utilities, mining, and industrial aspects, as well as command and other operations.

The movement of crew, payloads, and equipment in the proposed design should tie-up as few man-hours as possible. Easily used transportation systems eliminate the need for large groups of people working on a single task and will help lower mistakes under stress. A pressurized transportation system would eliminate the time it would take to prepare for EVA. A study of the psychological and sociological effects of living in a remote closed environment will help reshape base systems and components for a second generation lunar outpost, as well as other potential outposts on the moon and Mars. The evaluation of the crew's dependencies will occur primarily through daily interaction with equipment and a post-occupancy evaluation (POE) of the initial operating configuration (IOC).

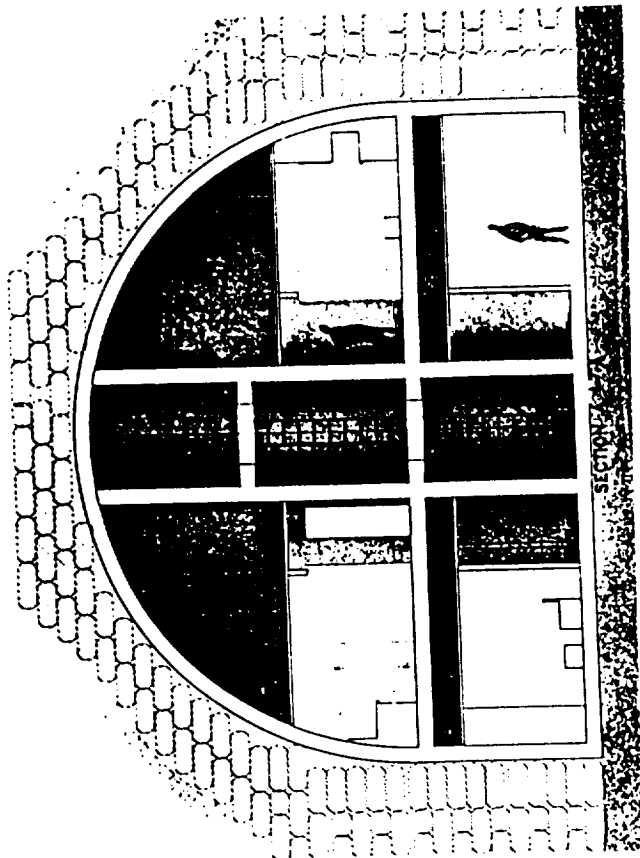

Figure 7.1.3-6. Section through the dome after inflation, insertion of rigidizing foam, and covering with bagged lunar regolith.

From the three design scenarios developed an elaborate but efficient lunar outpost. This base consists of standard space station modules, nodes, inflatables, and a location near lava tubes.

## 7.2.2 Site and Master Planning

### 7.2.2.1 Master Plan Components

The following is a list of the principle 17 components that constitute the master base for the Genesis Lunar Outpost:

**Inflatable Dome Structure #1:** This structure will house the crew support and any related activities. It will be named the habitation dome.

**Inflatable Dome Structure #2:** This structure will house mission operations, the major research workstations (including human factors and environment-behavior monitoring) and supporting functions.

**Inflatable Dome Structure #3:** This third dome will have multiple functions. The first will be a storage area to maintain construction equipment and supplies pertinent to the base. Both incoming supplies and outgoing materials as well as spare components and waste materials need to have a designated. The area will be easily expandable, adaptable and accessible by crew members. The second will be a biosphere facility; this facility will allow the crew to maintain some type of natural vegetation. The third activity of the dome will serve as a gathering area and entry to the outpost.

**Standard Module #1:** This module will contain additional crew support and hygiene facilities.

**Standard Module #2:** This module will house all exercise and health maintenance equipment for the entire base.

**Standard Modules #3 & 4:** These two modules will contain additional mission operations and supportive functions.

**HLLV (Heavy Lift Launch Vehicle) Module:** This module will encase base operations and its supportive functions.

**Three EVA (Extra Vehicular Activity) Modules:** These modules will house activities pertaining to safety, EVA, and observations.

**Logistics Module:** This module supports any supply and resupply functions for the support of the crew and base.

**3 Cupolas:** These special spaces will be used to provide crew members with a view to the environment which exists around them. From these cupola's they will make observations as well as receive visual stimulation.

**Launch and Landing Facilities:** Launch and landing facilities consist of a number of remote landing areas that have lander servicing equipment and crew/payload transfer systems.

**Base Garage and Maintenance Facilities:** These areas are used to store and maintain vehicles when they are not in use as well as repairing damaged equipment. They may consist of large non-pressurized hangers but may also have pressurized areas for more

delicate repairs. These facilities will be expandable and flexible. Individual zones each require hangers, servicing areas, and materials storage areas, but that may prove impractical at early stages of development. The base garage and maintenance facility serves as a focus for repairs and storage of transportation equipment and is located so it is accessible to all zones of the base until each zone has its own limited facility.

**Transportation Systems:** Surface transportation is needed to travel between some of the more distant base elements as well as transferring payloads or crew from one area of the base to another. The transportation system is compatible with all possible payloads and is adaptable to many other configurations. The transportation systems are capable of transferring the crew from either the launch and landing facilities or the safehaven. Rapid evacuation will require the use of a large pressurized vehicle to eliminate EVA preparation time. The pressurized and unpressurized vehicles serve as surface transports.

**Mining Surface and Production Analysis Operations:** The mining of lunar resources provides an economical justification for the lunar base. The mining and refinement of metals, isotopes (Helium-3), lunar oxygen, and other materials are some of the processes that will occur. In addition, experimental systems to test methods of collecting and processing lunar raw materials will be an important component of a more mature lunar base.

**Construction Technology Test-bed and Tele-robotic Research Facility:** Later phases of base construction will involve the use of exotic materials and high technology construction methods as well as in situ materials for economical lunar development, including con-

struction robotic systems, lunar transport vehicles and advanced EVA systems.

**Power Plant:** The power sources must be dependable at all times. They are of extreme importance to the existence of the base. A number of redundant systems serve the base throughout its construction. These power systems consist of solar array fields, a SP-100 and 550 nuclear power facility, and fuel cells. These systems provide adequate power to the base. Alternative power sources will be researched for future developments.

**Lunar Far-side Observatory:** Astronomical research is an important role of the lunar base. An observatory on the farside of the moon will be free of radio interference and greatly increase the abilities of the present earth-locked programs. Operation and monitoring is controlled from the base while service and repair will necessitate a visit from an astronaut or tele-robotic rover.

#### 7.2.2.2 Base Layout

The following configuration is the result of combining the best qualities of the three design scenarios developed earlier, under considerations and analysis of the advantages and limitations of the triangular, raft, linear, and grid configurations discussed earlier. This design is our proposal Genesis Lunar Outpost beginning in the year 2005.

This lunar out post consists of four major areas. The first is the habita/research area, which is centrally located. The second is the permanent power facility located to the north. The third is the mining



no base component will be endangered if a lander overshoots its objective.

The landing pads are separated from any other exposed equipment by 250-400 m to prevent blast damage. The surface of the pads will be free of objects for 100-200 m around the target area. The target area will have a 50 m radius and the actual target will be 30 m in diameter. The surface of the pads will be level with a slope no greater than 6 degrees. Surface stabilization may be considered to minimize dust. Markings and navigational aids are provided to increase the accuracy of manned landings and will allow for the possibility of unmanned landings. There will be a number of facilities provided in the event of an accident.

A roadway system will be developed for each phase of the bases's growth. Organized roadways between all segments of the base will allow for efficient transportation of materials and crew while also giving the base some structure.

and production facility located to the west. The fourth area is dedicated to the launch and landing facility positioned to the south.

The power plant facility is approximately 1 km to the north of the base. It consists of a small nuclear power generator (SP-100) which will be employed in the middle phases of the base development, and a more permanent nuclear facility (550) which will be set into place at the completion of the base. These facilities are either placed in a crater or surrounded by a lunar berm. The purpose for placing these facilities in such configurations allows the base to have protection from any possible leakage of radiation.

The mining and production plant is also located approximately 1 km from the base. This distance is used to provide a safe environment for the base from any dust or objects that may be ejected into the atmosphere. An area of 92 m x 92 m x 2 m is what has been projected for an annual mining expedition. (NASA 90 Day Study, 1990) In this area, the production of lunar oxygen and other chemicals will be produced to provide the base with the means of becoming self-sufficient.

There will be two types of launch and landing facilities. The first facilities will be temporary sites to provide for ease of construction. These sites will be no less than 250-400 m away from the base location. The second type of facilities will be the permanent launch and landing pads. These sites will be located no less than 3 and perhaps 5 km from the base. The orientation of the base on the lunar surface was determined by the link it has with earth. The lunar landers will descend on an east-west path from lunar orbit and must have a clear path to the pads. By having the major axis north-south (perpendicular to the lander orbit) and placing the pads to the south,

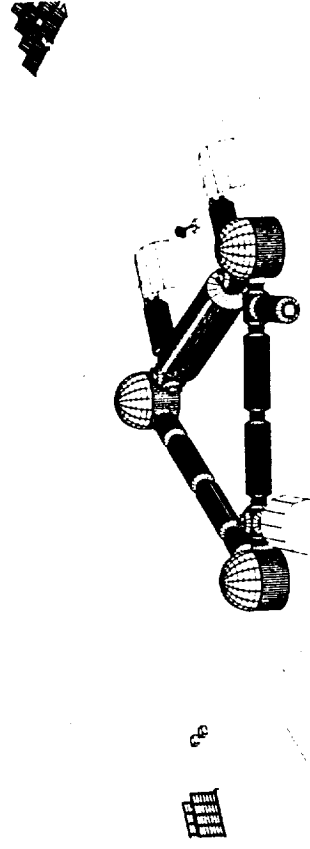

Figure 7.2.2-1. Overall base layout.

Safehavens will be accessible from all points of the base. The EVA modules will serve as the safehavens for the entire base.

Since the base will be covered in regolith radiation shielding, other cues are provided to mark the dignified presence of the lunar base. A series of lights around structures and along roadways provide the base with a sense of unity among base elements.

#### 7.2.2.3 Image

In the public eye, the outpost will have an acceptable appearance from the earth's surface. Considerations have been made as to the visual effect a lunar base will have on the moon. Actual physical features will not be a problem of the early lunar base, but it is possible that the lighting scheme for the base will be visible from earth during the lunar nights. It is also possible for debris or dust orbiting the moon to alter the view from earth. This visible evidence of lunar occupancy is not likely to be viewed by all; a proper approach at the outset of exploration will lessen conflicts in the future.

#### 7.2.2.4 Phasing

The following is a time line through the development and growth of the lunar outpost. The phasing of the base begins in 2005 and will continue to 2015, making it approximately a ten-year venture.

The lunar outpost is a symbol for what the future will hold not only for those directly involved, but for all. It holds a special place in the solar system as the first outpost in another world and will therefore reflect positive qualities of the nations involved. A configuration that expresses a thorough thought process of organization will suggest intelligence and as well as goodwill and a sense of unity.

The main issue of acceptability of the lunar base will be the ability of people to recognize it as a human place. Visual cues will help identify the lunar base as a village, outpost, or home and not a place of imprisonment or a collection of space hardware. A gateway between the landing pads and the rest of the base, or a symbolic entryway into the configuration, are just a few examples that will have a large impact on the image of the lunar base.

# DATE MISSION LIFT VEHICLE CREW EQUIPMENT

EMPLACEMENT 2006	DATE	MISSION	LIFT	VEHICLE	CREW	EQUIPMENT	
SURVEYING	UNMANNED	SHUTTLE C / HLLV	ROVER (SURFACE SURVEYOR) PAYLOADER / UNLOADER TNIM (COMMUNICATION SETUP) EXCAVATION EQUIPMENT GARAGE FACILITY EXPENDABLE LUNAR LANDER	SOIL MOVING EQUIPMENT	REGOLITH BAGGER	STORAGE FACILITY	
				TELESCOPING EQUIPMENT	SOLAR ARRAY FIELD - 1	RADIATORS	EXPENDABLE LUNAR LANDER
				CREW OF FOUR	CREW LOGISTICS FOR FOUR (21 DAYS)	EVA SIZE MODULE	EXPENDABLE LUNAR LANDER
				CONSTRUCTION EQUIPMENT	ROVER (TRANSFER VEHICLE)	ONE INTERCONNECT NODE	LUNAR OXYGEN
EXCAVATION	UNMANNED	SHUTTLE C / HLLV	PROPPELLANT	EXPENDABLE LUNAR LANDER	CREW OF SIX	CREW LOGISTICS FOR SIX	
				CREW LOGISTICS FOR TWELVE	LIFE SCIENCE & GEOLOGICAL EXPERIMENTS	EXPENDABLE LUNAR LANDER	EXPENDABLE LUNAR ASCENT VEHICLE
				HLLV (HEAVY LIFT LAUNCH VEHICLE)	SOLAR ARRAY FIELD - 2	EXPENDABLE LUNAR ASCENT VEHICLE	EXPENDABLE LUNAR ASCENT VEHICLE
				EXPENDABLE LUNAR ASCENT VEHICLE	EXPENDABLE LUNAR ASCENT VEHICLE	EXPENDABLE LUNAR ASCENT VEHICLE	
ASSEMBLY FACILITY	MANNED	STANDARD SPACE SHUTTLE	CREW LOGISTICS FOR TWELVE	CREW LOGISTICS FOR TWELVE	LIFE SCIENCE & GEOLOGICAL EXPERIMENTS	EXPENDABLE LUNAR LANDER	
				EXPENDABLE LUNAR LANDER	EXPENDABLE LUNAR ASCENT VEHICLE	EXPENDABLE LUNAR ASCENT VEHICLE	
				ONE INTERCONNECT NODE	LUNAR OXYGEN	PROPPELLANT	
				EXPENDABLE LUNAR LANDER	EXPENDABLE LUNAR ASCENT VEHICLE	EXPENDABLE LUNAR ASCENT VEHICLE	
SUPPORT EQUIPMENT	UNMANNED	SHUTTLE C / HLLV	RADIATOR FIELD	EXPENDABLE LUNAR LANDER	EXPENDABLE LUNAR ASCENT VEHICLE	EXPENDABLE LUNAR ASCENT VEHICLE	
				EXPENDABLE LUNAR ASCENT VEHICLE	EXPENDABLE LUNAR ASCENT VEHICLE	EXPENDABLE LUNAR ASCENT VEHICLE	
				EXPENDABLE LUNAR ASCENT VEHICLE	EXPENDABLE LUNAR ASCENT VEHICLE	EXPENDABLE LUNAR ASCENT VEHICLE	
				EXPENDABLE LUNAR ASCENT VEHICLE	EXPENDABLE LUNAR ASCENT VEHICLE	EXPENDABLE LUNAR ASCENT VEHICLE	
CREW SUPPORT	MANNED	STANDARD SPACE SHUTTLE	CREW LOGISTICS FOR TWELVE	CREW LOGISTICS FOR TWELVE	LIFE SCIENCE & GEOLOGICAL EXPERIMENTS	EXPENDABLE LUNAR LANDER	
				EXPENDABLE LUNAR LANDER	EXPENDABLE LUNAR ASCENT VEHICLE	EXPENDABLE LUNAR ASCENT VEHICLE	
				EXPENDABLE LUNAR ASCENT VEHICLE	EXPENDABLE LUNAR ASCENT VEHICLE	EXPENDABLE LUNAR ASCENT VEHICLE	
				EXPENDABLE LUNAR ASCENT VEHICLE	EXPENDABLE LUNAR ASCENT VEHICLE	EXPENDABLE LUNAR ASCENT VEHICLE	
SUPPORT EQUIPMENT	UNMANNED	SHUTTLE C / HLLV	PRESSURIZED TUBE (TUNNEL)	EXPENDABLE LUNAR LANDER	EXPENDABLE LUNAR ASCENT VEHICLE	EXPENDABLE LUNAR ASCENT VEHICLE	
				EXPENDABLE LUNAR ASCENT VEHICLE	EXPENDABLE LUNAR ASCENT VEHICLE	EXPENDABLE LUNAR ASCENT VEHICLE	
				EXPENDABLE LUNAR ASCENT VEHICLE	EXPENDABLE LUNAR ASCENT VEHICLE	EXPENDABLE LUNAR ASCENT VEHICLE	
				EXPENDABLE LUNAR ASCENT VEHICLE	EXPENDABLE LUNAR ASCENT VEHICLE	EXPENDABLE LUNAR ASCENT VEHICLE	
CREW SUPPORT	MANNED	STANDARD SPACE SHUTTLE	CREW LOGISTICS FOR TWELVE	CREW LOGISTICS FOR TWELVE	LIFE SCIENCE & GEOLOGICAL EXPERIMENTS	EXPENDABLE LUNAR LANDER	
				EXPENDABLE LUNAR LANDER	EXPENDABLE LUNAR ASCENT VEHICLE	EXPENDABLE LUNAR ASCENT VEHICLE	
				EXPENDABLE LUNAR ASCENT VEHICLE	EXPENDABLE LUNAR ASCENT VEHICLE	EXPENDABLE LUNAR ASCENT VEHICLE	
				EXPENDABLE LUNAR ASCENT VEHICLE	EXPENDABLE LUNAR ASCENT VEHICLE	EXPENDABLE LUNAR ASCENT VEHICLE	
SUPPORT EQUIPMENT	UNMANNED	SHUTTLE C / HLLV	ONE INTERCONNECT NODE	EXPENDABLE LUNAR LANDER	EXPENDABLE LUNAR ASCENT VEHICLE	EXPENDABLE LUNAR ASCENT VEHICLE	
				EXPENDABLE LUNAR ASCENT VEHICLE	EXPENDABLE LUNAR ASCENT VEHICLE	EXPENDABLE LUNAR ASCENT VEHICLE	
				EXPENDABLE LUNAR ASCENT VEHICLE	EXPENDABLE LUNAR ASCENT VEHICLE	EXPENDABLE LUNAR ASCENT VEHICLE	
				EXPENDABLE LUNAR ASCENT VEHICLE	EXPENDABLE LUNAR ASCENT VEHICLE	EXPENDABLE LUNAR ASCENT VEHICLE	
CREW SUPPORT	MANNED	STANDARD SPACE SHUTTLE	CREW LOGISTICS FOR TWELVE	CREW LOGISTICS FOR TWELVE	LIFE SCIENCE & GEOLOGICAL EXPERIMENTS	EXPENDABLE LUNAR LANDER	
				EXPENDABLE LUNAR LANDER	EXPENDABLE LUNAR ASCENT VEHICLE	EXPENDABLE LUNAR ASCENT VEHICLE	
				EXPENDABLE LUNAR ASCENT VEHICLE	EXPENDABLE LUNAR ASCENT VEHICLE	EXPENDABLE LUNAR ASCENT VEHICLE	
				EXPENDABLE LUNAR ASCENT VEHICLE	EXPENDABLE LUNAR ASCENT VEHICLE	EXPENDABLE LUNAR ASCENT VEHICLE	
SUPPORT EQUIPMENT	UNMANNED	SHUTTLE C / HLLV	LUNAR OXYGEN	EXPENDABLE LUNAR LANDER	EXPENDABLE LUNAR ASCENT VEHICLE	EXPENDABLE LUNAR ASCENT VEHICLE	
				EXPENDABLE LUNAR ASCENT VEHICLE	EXPENDABLE LUNAR ASCENT VEHICLE	EXPENDABLE LUNAR ASCENT VEHICLE	
				EXPENDABLE LUNAR ASCENT VEHICLE	EXPENDABLE LUNAR ASCENT VEHICLE	EXPENDABLE LUNAR ASCENT VEHICLE	
				EXPENDABLE LUNAR ASCENT VEHICLE	EXPENDABLE LUNAR ASCENT VEHICLE	EXPENDABLE LUNAR ASCENT VEHICLE	
CREW SUPPORT	MANNED	STANDARD SPACE SHUTTLE	CREW LOGISTICS FOR TWELVE	CREW LOGISTICS FOR TWELVE	LIFE SCIENCE & GEOLOGICAL EXPERIMENTS	EXPENDABLE LUNAR LANDER	
				EXPENDABLE LUNAR LANDER	EXPENDABLE LUNAR ASCENT VEHICLE	EXPENDABLE LUNAR ASCENT VEHICLE	
				EXPENDABLE LUNAR ASCENT VEHICLE	EXPENDABLE LUNAR ASCENT VEHICLE	EXPENDABLE LUNAR ASCENT VEHICLE	
				EXPENDABLE LUNAR ASCENT VEHICLE	EXPENDABLE LUNAR ASCENT VEHICLE	EXPENDABLE LUNAR ASCENT VEHICLE	

## COMPLETION OF PHASE 1

Figure 7.2.2-2. Phasing of Project Genesis: Emplacement Phase 1.

# DATE MISSION LIFT VEHICLE CREW EQUIPMENT

## INTERGRATION PHASE

INTERGRATION PHASE	CREW SUPPORT - HABITATION	SHUTTLE C / HLLV	UNMANNED	CONSTRUCTION EQUIPMENT FOR DOME-1 GARAGE FACILITY-2 EXPENDABLE LUNAR LANDER
2008	CREW SUPPORT	STANDARD SPACE SHUTTLE	MANNED	CREW OF TWELVE CREW LOGISTICS FOR TWELVE LIFE SCIENCE & GEOLOGICAL EXPERIMENTS EXPENDABLE LUNAR LANDER EXPENDABLE LUNAR ASCENT VEHICLE
	EVA FACILITY	SHUTTLE C / HLLV	UNMANNED	EVA FACILITY-2 LUNAR OXYGEN PROPELLANT EXPENDABLE LUNAR LANDER
	CREW SUPPORT	STANDARD SPACE SHUTTLE	MANNED	CREW OF TWELVE CREW LOGISTICS FOR TWELVE LIFE SCIENCE & GEOLOGICAL EXPERIMENTS EXPENDABLE LUNAR LANDER EXPENDABLE LUNAR ASCENT VEHICLE
	MISSION OPERATIONS	SHUTTLE C / HLLV	UNMANNED	CONSTRUCTION EQUIPMENT FOR DOME-2 EXPENDABLE LUNAR LANDER
2009	CREW SUPPORT	STANDARD SPACE SHUTTLE	MANNED	CREW OF TWELVE CREW LOGISTICS FOR TWELVE LIFE SCIENCE & GEOLOGICAL EXPERIMENTS EXPENDABLE LUNAR LANDER EXPENDABLE LUNAR ASCENT VEHICLE
	LANDING EQUIPMENT	SHUTTLE C / HLLV	UNMANNED	LEV SERVER-1 GARAGE FACILITY-3 LUNAR OXYGEN PROPELLANT COMMUNICATION RELAY SATELLITE DISH EXPENDABLE LUNAR LANDER
	CREW SUPPORT	STANDARD SPACE SHUTTLE	MANNED	CREW OF TWELVE CREW LOGISTICS FOR TWELVE LIFE SCIENCE & GEOLOGICAL EXPERIMENTS EXPENDABLE LUNAR LANDER EXPENDABLE LUNAR ASCENT VEHICLE
	POWER FACILITY EQUIPMENT	SHUTTLE C / HLLV	UNMANNED	TELESCOPE DISH SP-100 kw POWER GENERATOR PRESURRIZED ROVER-2 EXPENDABLE LUNAR LANDER
2010	CREW SUPPORT	STANDARD SPACE SHUTTLE	MANNED	CREW OF TWELVE CREW LOGISTICS FOR TWELVE LIFE SCIENCE & GEOLOGICAL EXPERIMENTS EXPENDABLE LUNAR LANDER EXPENDABLE LUNAR ASCENT VEHICLE
	SUPPORT EQUIPMENT	SHUTTLE C / HLLV	UNMANNED	STANDARD MODULE-1 SUPPORT EQUIPMENT EXPENDABLE LUNAR LANDER EXPENDABLE LUNAR ASCENT VEHICLE
	CREW SUPPORT	STANDARD SPACE SHUTTLE	MANNED	CREW OF TWELVE CREW LOGISTICS FOR TWELVE LIFE SCIENCE & GEOLOGICAL EXPERIMENTS EXPENDABLE LUNAR LANDER EXPENDABLE LUNAR ASCENT VEHICLE
	EVA FACILITY	SHUTTLE C / HLLV	UNMANNED	EVA FACILITY-2 LUNAR OXYGEN PROPELLANT EXPENDABLE LUNAR LANDER

## COMPLETION OF PHASE 2

# DATE MISSION LIFT VEHICLE CREW EQUIPMENT

2011	CREW SUPPORT	MANNED	CREW OF TWELVE CREW LOGISTICS FOR TWELVE LIFE SCIENCE & GEOLOGICAL EXPERIMENTS EXPENDABLE LUNAR LANDER EXPENDABLE LUNAR ASCENT VEHICLE STANDARD MODULE-2 SUPPORT EQUIPMENT COPULA-1 EXPENDABLE LUNAR LANDER EXPENDABLE LUNAR ASCENT VEHICLE
	EXERCISE & MEDICAL FACILITY	UNMANNED	CREW OF TWELVE LIFE SCIENCE & GEOLOGICAL EXPERIMENTS EXPENDABLE LUNAR LANDER EXPENDABLE LUNAR ASCENT VEHICLE
	CREW SUPPORT	MANNED	CREW OF TWELVE LIFE SCIENCE & GEOLOGICAL EXPERIMENTS EXPENDABLE LUNAR LANDER EXPENDABLE LUNAR ASCENT VEHICLE
	MISSION OPERATIONS	UNMANNED	STANDARD MODULE-3 SUPPORT EQUIPMENT INTERCONNECTING NODE LUNAR LIQUID OXYGEN PILOT PLANT EXPENDABLE LUNAR LANDER
2012	CREW SUPPORT	MANNED	CREW OF TWELVE CREW LOGISTICS FOR TWELVE LIFE SCIENCE & GEOLOGICAL EXPERIMENTS EXPENDABLE LUNAR LANDER EXPENDABLE LUNAR ASCENT VEHICLE
	LANDING EQUIPMENT	UNMANNED	LEV SERVIER-2 GARAGE FACILITY-4 LUNAR OXYGEN PROPELLANT LUNAR FAR SIDE UV TELESCOPE EXPENDABLE LUNAR LANDER
	CREW SUPPORT	MANNED	CREW OF TWELVE CREW LOGISTICS FOR TWELVE LIFE SCIENCE & GEOLOGICAL EXPERIMENTS EXPENDABLE LUNAR LANDER EXPENDABLE LUNAR ASCENT VEHICLE
	MISSION OPERATIONS	UNMANNED	STANDARD MODULE-4 SUPPORT EQUIPMENT COPULA-2 EXPENDABLE LUNAR LANDER
2013	CREW SUPPORT	MANNED	CREW OF TWELVE CREW LOGISTICS FOR TWELVE LIFE SCIENCE & GEOLOGICAL EXPERIMENTS EXPENDABLE LUNAR LANDER EXPENDABLE LUNAR ASCENT VEHICLE
	SUPPORT EQUIPMENT	UNMANNED	INTERCONNECT NODE-4 INTERCONNECT NODE-5 REFUELING ROVER EXPENDABLE LUNAR LANDER
<b>COMPLETION OF PHASE 3</b>			CREW OF TWELVE CREW LOGISTICS FOR TWELVE LIFE SCIENCE & GEOLOGICAL EXPERIMENTS EXPENDABLE LUNAR LANDER EXPENDABLE LUNAR ASCENT VEHICLE
	ENTRY DOME	UNMANNED	INFLATABLE DOME-3 SUPPORT EQUIPMENT FOR DOME-3 EXPENDABLE LUNAR LANDER EXPENDABLE LUNAR ASCENT VEHICLE

Figure 7-2-3 Phasing of Project Genesis (cont.): Completion of Phase 3.

# DATE MISSION LIFT VEHICLE CREW EQUIPMENT

2016	EVA MODULE-3 COPULA-3 PROPPELLANT EXPENDABLE LUNAR LANDER	SHUTTLE C / HLLV	UNMANNED	EVA MODULE-3 COPULA-3 PROPPELLANT EXPENDABLE LUNAR LANDER
	OXYGEN PLANT SET-UP	SHUTTLE C / HLLV	UNMANNED	GARAGE FACILITY-5 LUNAR OXYGEN MINING EQUIPMENT SUPPORT EQUIPMENT EXPENDABLE LUNAR LANDER EXPENDABLE LUNAR ASCENT VEHICLE
	CREW SUPPORT	STANDARD SPACE SHUTTLE	MANNED	CREW OF TWELVE CREW LOGISTICS FOR TWELVE LIFE SCIENCE & GEOLOGICAL EXPERIMENTS EXPENDABLE LUNAR LANDER EXPENDABLE LUNAR ASCENT VEHICLE
<b>COMPLETION OF PHASE 4</b>				
	OXYGEN PRODUCTION PLANT	SHUTTLE C / HLLV	UNMANNED	ADVANCED POWER FACILITY 550 kw LUNAR OXYGEN PRODUCTION FACILITY PROPPELLANT STORAGE EXPENDABLE LUNAR ASCENT VEHICLE EXPENDABLE LUNAR LANDER
2016	SATALLITE SUPPORT	SHUTTLE C / HLLV	UNMANNED	GARAGE FACILITY-6 DEEP DRILLING EQUIPMENT PROPPELLANT DEPOT PROPPELLANT EXPENDABLE LUNAR LANDER
	LANDING FACILITY SUPPORT	SHUTTLE C / HLLV	UNMANNED	LEV SERVICER-3 GARAGE FACILITY-7 COMMUNICATION RELAY STATIONS EXPENDABLE LUNAR LANDER EXPENDABLE LUNAR ASCENT VEHICLE
	CREW SUPPORT	STANDARD SPACE SHUTTLE	MANNED	CREW OF TWELVE CREW LOGISTICS FOR TWELVE LIFE SCIENCE & GEOLOGICAL EXPERIMENTS EXPENDABLE LUNAR LANDER EXPENDABLE LUNAR ASCENT VEHICLE

## COMPLETION OF BASE - I.O.C. - INITIAL OPERATING CONFIGURATION

Figure 7.2.2-3. Phasing of Project Genesis (cont.): Completion of Phase 4 - IOC.

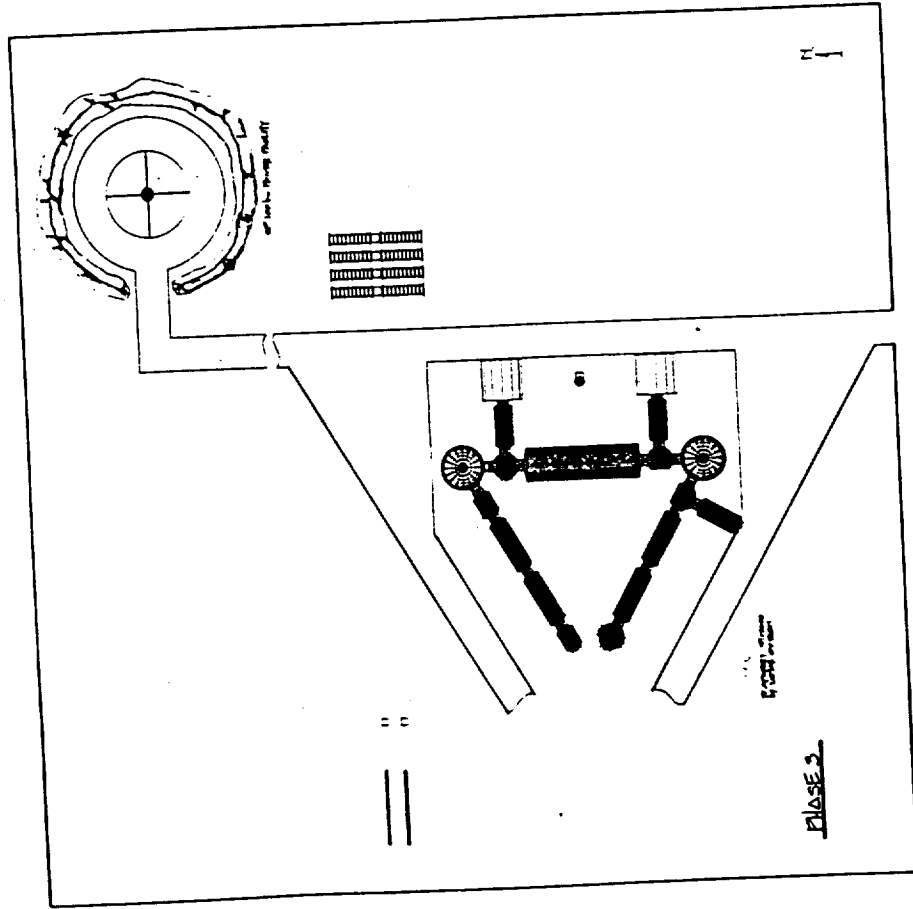

Figure 7.2.2-4. Site and master plan evolution.

Genesis Lunar Outpost

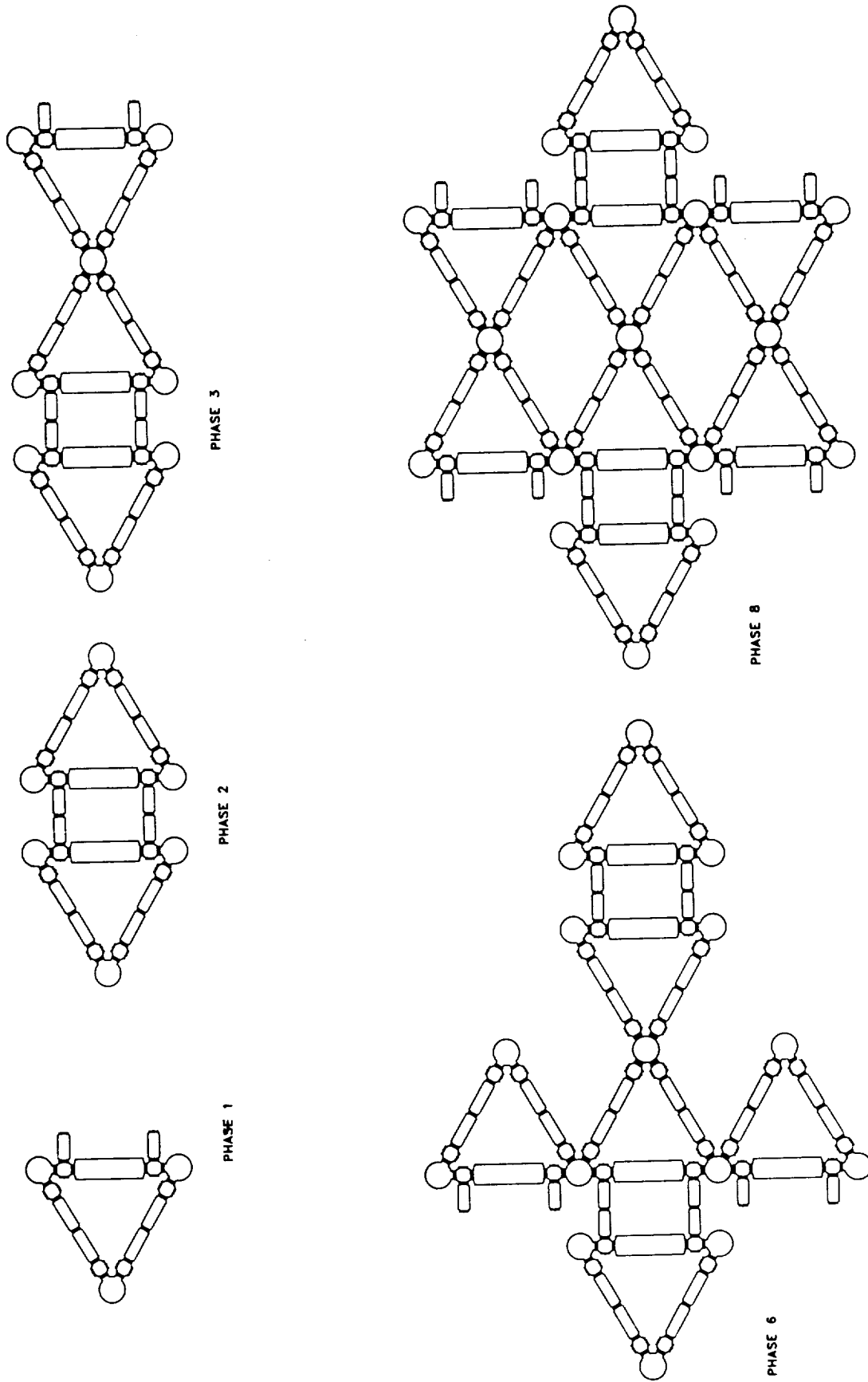

Figure 7.2.2-5. Master plan evolution into a mature or Advanced Lunar Outpost.



## 7.2.3 Interior Configuration

### 7.2.3.1 Architectural Parti

"Our heritage looks to our forefathers and their unending quest to conquer the unknown. Genesis looks back to the pioneer spirit, learning to live off the land, carrying only that which the wagon could hold. In the evening, circling the wagons provided safety from hostile forces. Genesis is created from a safety perspective and a genuine concern for mankind."

### 7.2.3.2 Key Design Issues

Several key design issues were addressed regarding habitability which resulted in the interior configuration for Genesis. Kept in mind as well was the the experimental nature of this base. Variety in the living and working environment was planned to reduce the realities of confinement. The creation of "special places" for group interaction and solitude was designed for stress reduction. The key design issues were:

- anthropometrics
- health and safety
- psychological and social needs
- crew support systems
- construction technology
- internal and external operations
- environment/behavior systems

In conjunction with these issues, the general program criteria were followed in design development:

- reliability
- resilience
- transportability
- efficiency
- constructability
- expandability
- safety
- habitability

Habitability included the following sub-categories:

- provisions for health care facilities
- hygiene
- personal quarters
- work stations
- EVA systems
- crew integration and training
- housekeeping and trash management
- stowage and emergency provisions

### 7.2.3.3 Adjacencies and Zoning

Proximity diagramming was essential to determine physical placement of base components. Highly interactive to solitary proximities were also studied addressing noisy to quiet environments. The final base configuration was determined by not only the volumes of space necessary for the operative and support functions, but also as a result of the above considerations.

Mission Operations	Base Operations	Group Recreation	Bluth, 1987).
Mission Operations	Base Operations	Meal Preparation	
Mission Operations	Mission Operations	Personal Quarters	
<b>DOME 2</b>	<b>HLLV</b>	<b>DOME 1</b>	The human body is affected by:
Mission Operations		Crew Quarters	<ul style="list-style-type: none"> <li>• prolonged isolation in an enclosed space of limited volume</li> <li>• hypodynamia</li> <li>• specific regime of work and rest</li> <li>• elevated level of monotonous noises</li> <li>• risk</li> <li>• novelty and unusual circumstances</li> <li>• possible psychological incompatibility in the group</li> </ul>
<b>MODULE 3</b>		<b>MODULE 1</b>	
Mission Operations		Exercise/Medical	Applicable to life on the lunar surface was the effects the Russians anticipated on the Mir Space Station (Bluth, 1987):
<b>MODULE 4</b>		<b>MODULE 2</b>	<ul style="list-style-type: none"> <li>• fatigue</li> <li>• poor mood</li> <li>• sleep disturbances</li> <li>• sensory deprivation</li> <li>• reduction in motivation</li> </ul>
	Biosphere		
	Social Interaction		
	Storage		
	<b>DOME 3</b>		
<b>7.2.3.4 Response to Social/Psychological Factors</b>			
Key to the design of Genesis was the concern for the inhabitant and his/her mental, emotional and physical status. In studying various analogous living situations, most notable the Soviet Space Station, Mir, and an American base in the Antarctic, factors dealing with the above concerns were addressed and used in the final designs (e.g.			
			<ul style="list-style-type: none"> <li>• illumination changes</li> <li>• music</li> </ul>
Ecopsychological factors characterized the environment (confinement, isolation, and monotony) and facilitated the development of sensory emotional deficiency and impoverishment of subjectivity. Upon investigation into the Mir living conditions, the following environmental experiments and changes were used to provide relief from the stressful living situation (Bluth, 1987):			

The following environmental factors were found to affect crew members' emotions (Bluth, 1987):

- temperature
- humidity
- noise
- vibration
- illumination
- ventilation
- diet
- volume

From the studies done in the Antarctic (Evans, 1987), the following information and conclusions were formulated. "Physical sources of stress can include crowding, irregular or unnatural light cycles; changes in pressure; fluctuating and or extreme temperatures; noise; poor air ventilation; sterile and monotonous surroundings; and the physical threat to the life from the exterior environment...loud noise levels typically occur in ICE's (Isolated and Confined Environments) with engines responsible for propulsion and or life support systems (e.g. ships, submarines, space vehicles, the SEALAB, and Antarctic stations). There is extensive literature linking noise with increased levels of physiological and psychological stress (Cohen & Weinstein, 1982), lack of fresh air is a problem with any ICE that is dependent on recycled air. This can lead to feelings of claustrophobia and a loss of control over the environment. Often these settings have a sterile quality due to the lack of personalization or lack of aesthetically pleasing materials." (Evans, 1987)

The personalization of public and private spaces became a key issue for the inhabitants to feel they had some measure of control over their

environment. Personalization can be accomplished through the modification of the environment (e.g. murals, framed photographs, wall paneling) or through the introduction of items brought from home (e.g. photographs of family, music, family momentos). Altman (1975) has suggested that the display of personal items is a form of human territorial behavior modification of the environment may indicate that an individual is making a commitment to a particular setting. The crew's quarters was the focal point for personalization, but it was easily expanded to the group interactive areas. Arrangeable furniture allowed for individual expression. Additional and specific design considerations based on this line of reasoning are addressed in the following sections on base and mission operations and the crew habitat.

### 7.2.3.5 Base Operations

As the command center for all communications, the area dedicated to base operations is a phased program. A major portion of the Heavy Lift Launch Vehicle (HLLV) module, specifically the upper level in Phase 1, as shown in Figure 7.2.3-1, is for monitoring and control of both primary and secondary base systems and activities. The systems design issues included:

- life support
- water
- waste management
- EVA
- communications
- robotics
- emergency backup

Genesis Lunar Outpost

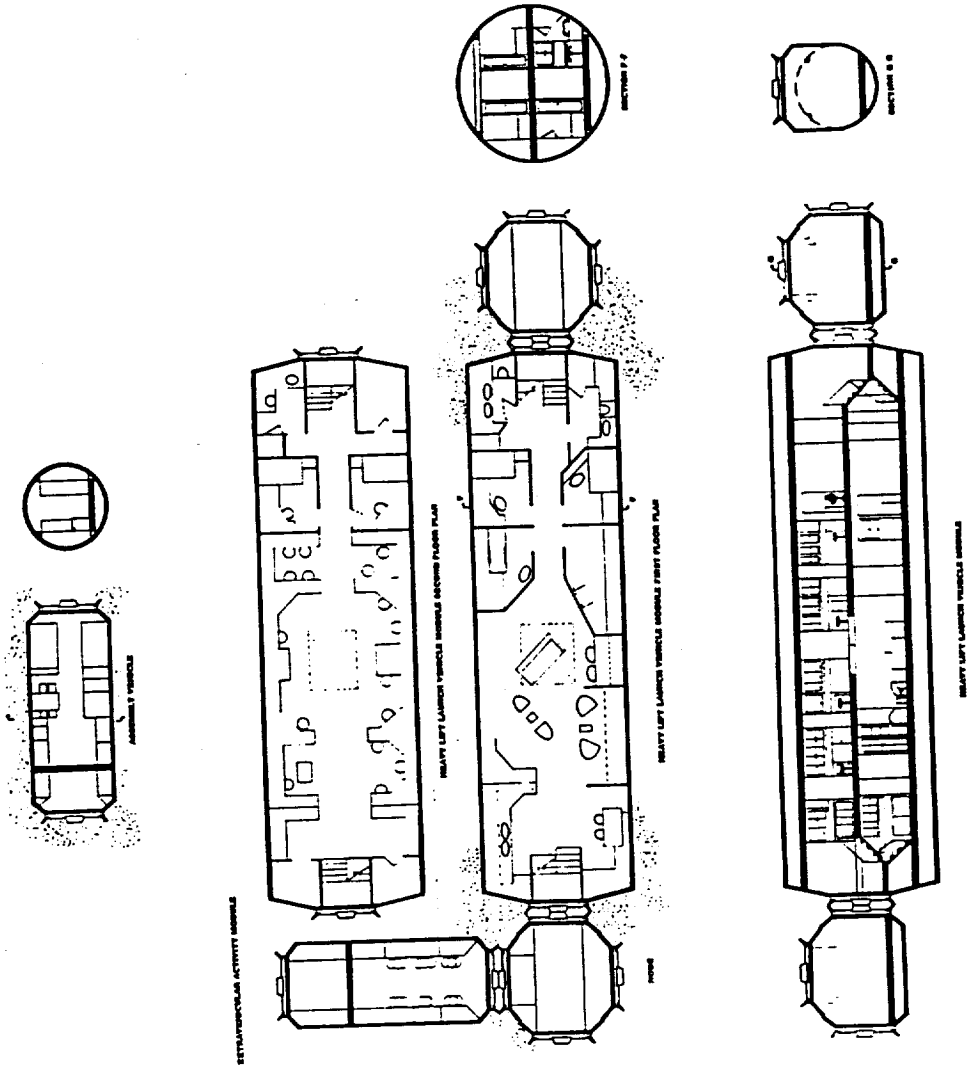

Figure 7.2.3-1. Genesis Lunar Outpost: Phase 1 plans and section.

The Heavy Life Launch Vehicle (HLLV) module's shape is cylindrical. It is composed of two floors with stairs on both ends allowing ingress and egress from the connect nodes. The lower level layout consists of storage compartments, galley, dining area, group recreation and lounging, medical and exercise areas, crew quarters, and double hygiene facilities.

The upper level consists of storage areas on either side of the staircase, a central translation path with a series of workstations on either side, crew quarters, and a hygiene facility. Additional storage is provided.

Phase 2 provides for the expansion of the base operations. The upper level remains as originally constructed except for the crew quarters. They will be shifted into Dome 2 when it is finished. Replacing the quarters will be logistics and storage areas. The lower level will be refitted with operations workstations necessary for the base expansion. These workstations will be both centrally and laterally located within the cylinder, providing larger group work spaces. The central floor hatch doors will be removed and a railing installed, allowing the crew communication both visually and audibly between the two levels.

### 7.2.3.6 Mission Operations

The very nature of the lunar base is experimental with two approaches for laboratory design being either a dedicated facility plan or an open plan approach. Inflatable Dome 1 and two standard modules had been assigned to house the laboratory functions of Genesis. Included in the volumes are (1) lunar surface mining and

Additionally, intra-base communications, teleconferencing and meeting facilities are provided. As this area is one which the inhabitants will work in daily, it was critical to design spaces the crew would readily enjoy being in. Phase 1, upper level, was designed to achieve:

- varied work and monitoring stations for 1, 2, and multiple combinations of crew
- central translation pathway allowing good visual contact with others
- centrally located floor hatch for easy transfer of equipment from level to level
- temporary personal quarters for 2 crewmembers
- hygiene facility

The lower level of the HLLV module provides full crew support for 4 people and consists of a galley (meal preparation area), dining area, group recreation, medical and exercise facilities, personal quarters for 2 crewmembers, hygiene facility and laundry. The galley and dining areas are temporarily secured in place. The group recreational area is open, based on furnishings easily arrangeable by personal preference. Included as well are open shelving, a library table, and a video screening area. The medical area remains secluded, but the exercise area's only partition is a half wall, allowing open visual communication with others. Finishing crew support are two full hygiene facilities.

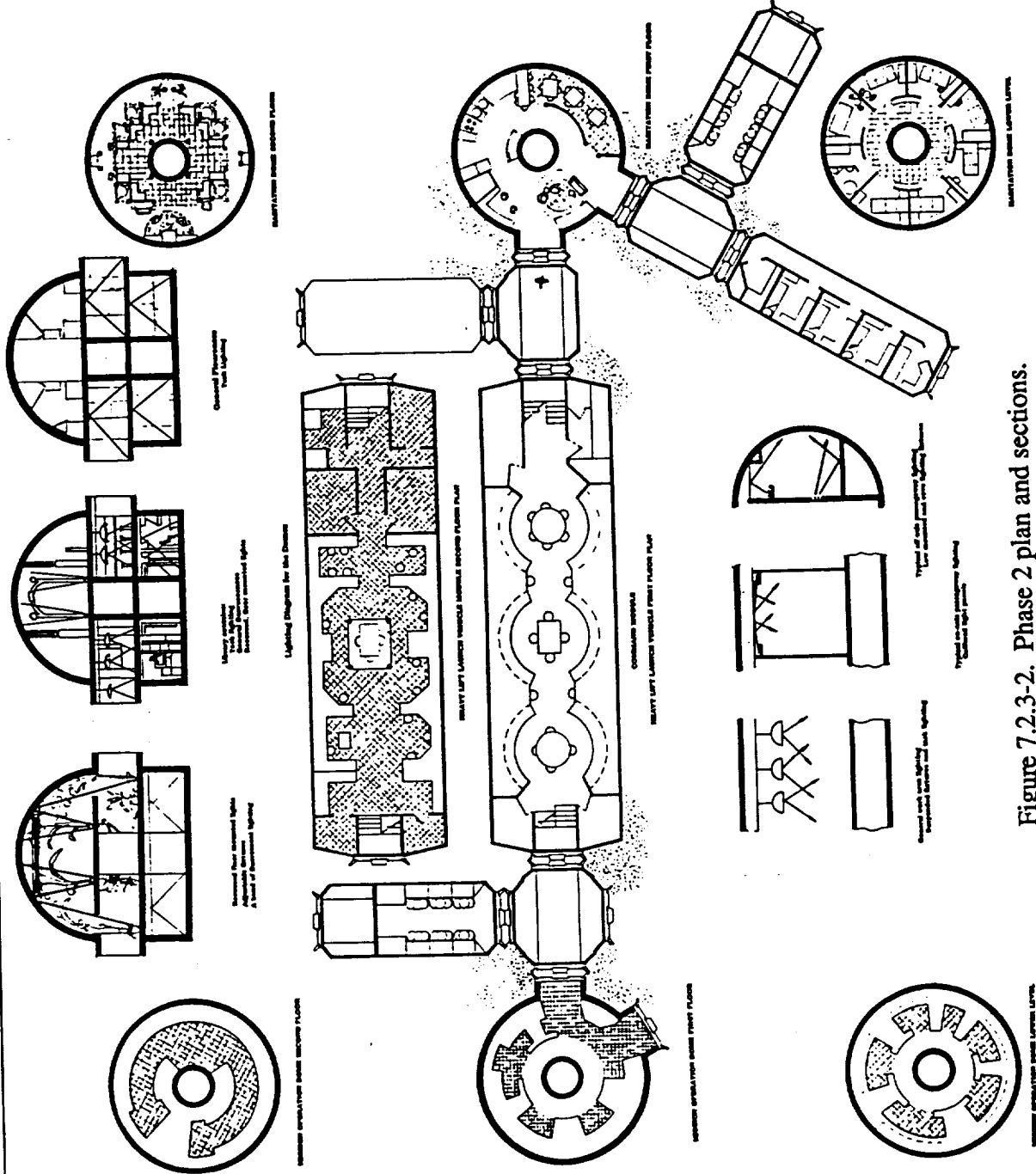

Figure 7.2.3-2. Phase 2 plan and sections.

production analysis - geochemistry and petrology lab, (2) space construction technology testbed, (3) plant growth and horticultural capabilities development, (4) farside lunar observatory and astrophysics station, and (5) human factors and environment/behavior systems monitoring research facility. The scope of each experimental monitoring and workstation area was anticipated to change over the life of the base. Designing for such changes had to include flexibility and compartmentalization. Key design considerations for the mission operations spaces were:

- space necessary for testing of samples, materials, analysis of tests, recording results, sample preparations, and equipment set up and break down
- circulation pathways with ample space for suited or unsuited crewmembers, equipment mobility, sample mobility
- facility arrangement, grouping and layout to promote safe, efficient operation
- minimal transit time between related functions
- necessary volume of space for expected activity levels with ability to isolate areas when necessary for crew health, safety, performance, and privacy
- any experimentation requiring special atmospheric conditions designed with provisions for temperature, humidity, filtering and seal-off

Dome 1, its entire three floors, is designed for workstation variety. With the circular shape of the dome and the lower and first floors utilizing a full-ceiling height, a combination of cabinet and workstation systems are used. Each experiment area provides all equipment necessary for its operation to be within efficient reach. A central translation core allows inhabitants and equipment to be moved. The upper floor has a reduced area due to the curvature of the dome. Space is maximized by placing work surfaces around the perimeter and the central core. Additionally, upper storage and experiment bays are installed around the center core.

In the two standard modules, the linear quality of the structures provides for central translation paths. Workstations in one module are located in the central portion. The second module separates the stations, but still allows good visual contact amongst the crew. Mission operations requirements for space were numerous. Given the experimental nature of the base, a variety of working environments are provided.

#### 7.2.3.7 Crew Habitat

Critical to the physical, social, and psychological needs of the crewmembers, is the crew support habitat. It is an environment responsive to group interaction, and simultaneously responsive to privacy. Considered a "home away from home," it employs "Earth-like" amenities as well as basic necessities in the form of personal quarters, hygiene, and laundry facilities, recreation and relaxation areas, spaces dedicated to medicine and exercise, dining, and the galley or meal preparation area.

As discussed in Base Operations, the initial personal quarters will be for a crew of 4. Mature base operations will house 12 people. Dome 2 has been dedicated to support the crew. The lower level has quarters for 7. They consist of a combination of free-standing and secured furnishings allowing the crewmember flexibility in arranging his/her space. The quarters are placed on the perimeter of the dome structure, leaving a circular translation pathway around the central core connecting the three dome levels.

The first level provides a full galley for preparing meals. An open plan arrangement maximizes the floor area, permitted liberal interaction between the crew, and visually expands the space. Several dining arrangements are possible with small separate tables (capable of being grouped), a counter/stool combination, or more casual dining in a "conversation grouping" near video monitoring equipment. A small, more secluded seating area was designed as well. Noise from the dining area is controlled by using a transparent Plexiglass wall between an archway. The visual communication and open character is kept intact by using the transparent material.

The second floor was designed for a group interactive area centered around an arch accenting the dome ceiling height. The central translation core does not continue to the ceiling. Flexible seating arrangements are possible to enhance personalization of the spaces.

A standard module is additionally dedicated to housing the crew. Provisions are made for four single quarters and one double unit. The cylinder had an off-axis translation pathway which allows a larger living space. A hygiene facility was also designed. All the hygiene areas within the base are designed with adequate facilities to elimi-

nate the possibility of a pattern of substandard hygiene. Also alleviated in this design approach are the ramifications of reduced productivity and interpersonal conflict.

In Phase 3, a second standard module was designed for exercise and medical attention. The space has to support a broad range of exercise-related functions. Adequate body and equipment space is necessary as well as an aesthetically pleasing space. Exercise will be a priority for health maintenance; every effort was made to provide a design to encourage the activity. To further promote exercise, audiovisual presentations will be made via headphones and video screens projecting images of bike trails, jogging tracks, walking areas through parks - the list of available subjects could be endless. The exercise facility in Genesis provides for separate stationary cycling areas, and a larger "workout" room for weight training and progressive resistance equipment. A small hygiene area is utilized as well. The translation pathway through the module is off-axis, thus allowing a greater volume of space for movement and equipment.

The medical facility is separated from daily movement, traffic, and base personnel. The partitioning creates the necessary sanitary environment. They are accessible as needed, but can be subdivided or closed off altogether. Smaller "first-aid" areas are incorporated into base and mission operations, the crew support dome, and EVA chambers.

In Phase 4, dome 3 functions as a large open storage and logistics space on its lower level. Minimal partitioning is created to accommodate variable sizing of supplies and equipment. The first and second floor are dedicated solely as spaces to retreat which will incorporate



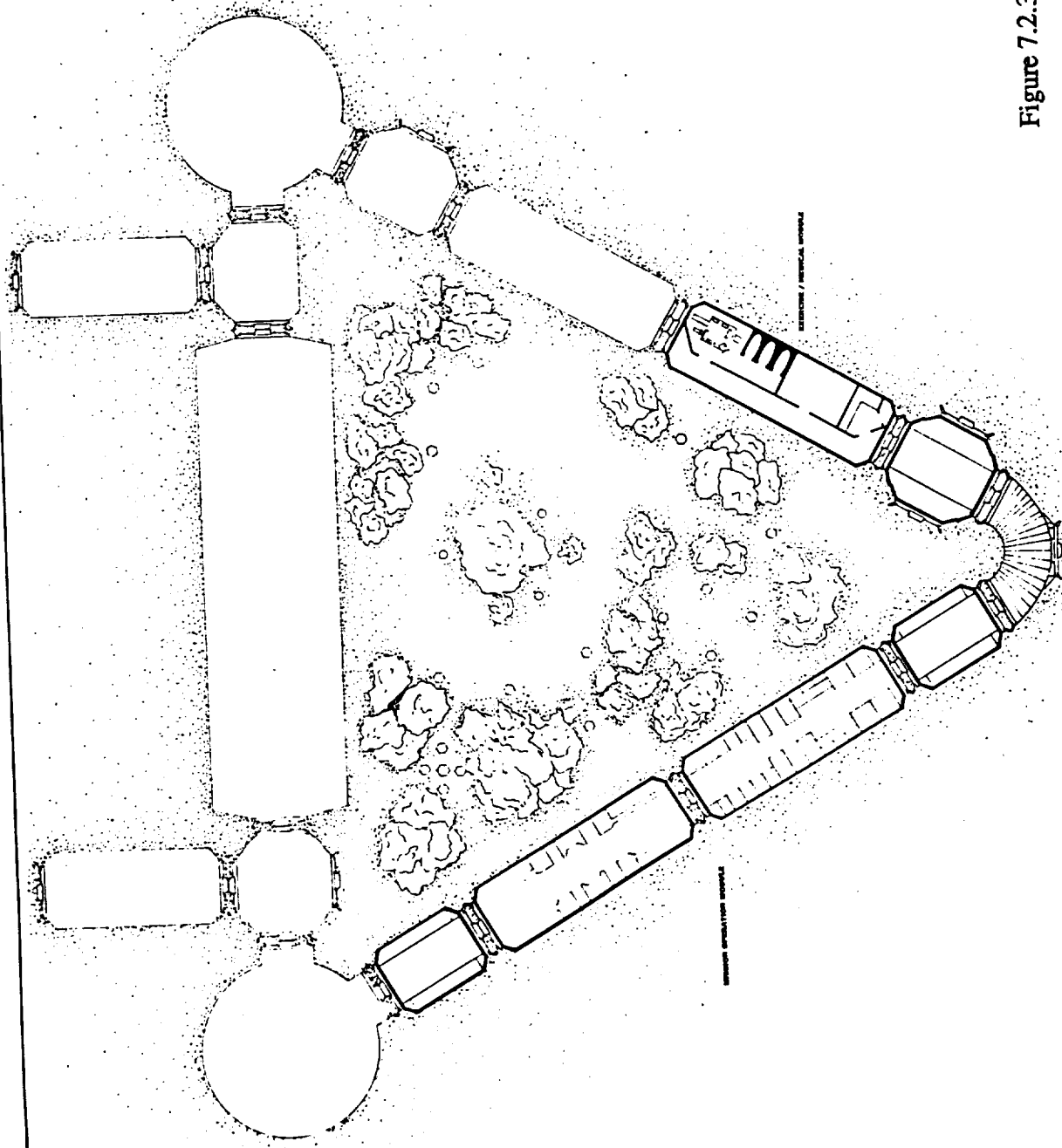

Figure 7.2.3-3. Phase 3 floor plan.

a large amount of plant life. The growth and progress of the plants will be experimental, but has a greater value than purely scientific. Dome 3 is designated a psychological space: plantings being a home-like reminder and reference for base inhabitants. Areas for quiet contemplation and strolling are established. The minimal, but effective, use of water in a small pond has been used to reduce stress and isolation. The upper level, accessible from the central core, utilizes a transparent floor which is smaller and leaves a perimeter space between floor one and two. The visual effects of these components helps create a vast, expansive interior environment, although completely unable to interact with the external environment.

#### 7.2.3.8 Lighting

General work area lighting will include the use of suspended fixtures as well as the use of task lighting. For the on-axis passageways, lighting is provided in coffered light panels. Typical off-axis passageway lighting used is low mounted and cove lighting fixtures. The design of lighting for a specific space takes into consideration the atmosphere required: cozy, restful, business-oriented, monitor viewing - every area generally as well as specifically addressed. Once the purpose for the lighting is ascertained, the levels of intensity are determined. To obtain the correct levels, the illumination must be studied for proper vision and balanced against energy and cost. Efficiency is a major factor when determining a lighting source. These general approaches were addressed:

- lighting should complement decor and color of the space
- lighting should be used as a means of personalizing the

space

- lighting should be sufficiently dispersed through all circulation routes
- lighting should be designed for safety
- lighting not only aids in wayfinding and orientation, but it should illuminate areas to allow for differentiating between different textures
- lighting should be designed to increase and encourage productivity.

General placement of lighting sources are crucial to the design:

- interior ambient light of the module would diffuse light
- all lighting fixtures would be accessible at all times
- ambient lighting fixtures would be placed at ceiling and floor levels
- lighting fixtures would have the ability to be erected and disassembled with common knowledge
- lighting sources would be incorporated into the ceiling and floor or into the individual racks allowing for easy maintenance

Psychological implications of lighting generally found that color has a strong impact on human moods and emotion. Lighting not only affects an individual's mood, but also the interaction with the perception of the spatial environment. Warm lighting creates a sense of warmth and coziness; cool lighting represents a feeling of reserve, formality, and a sensation of coolness.

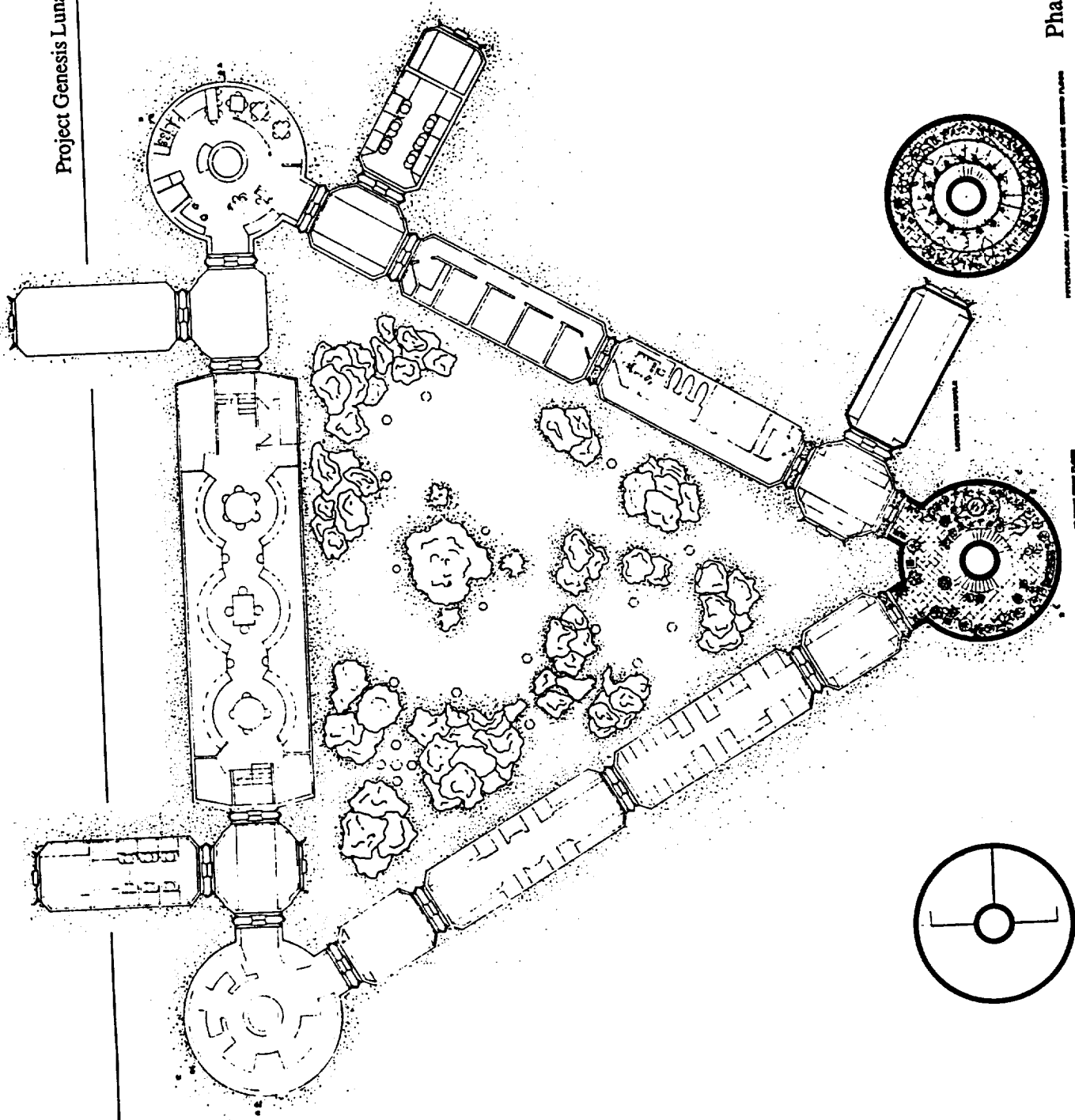

Figure 7.2.3-4.

Phase 4 floor plans.

PROCESSED BY / TRANSMITTED / RECEIVED BY

PROCESSED BY / TRANSMITTED / RECEIVED BY

PROCESSED BY / TRANSMITTED / RECEIVED BY

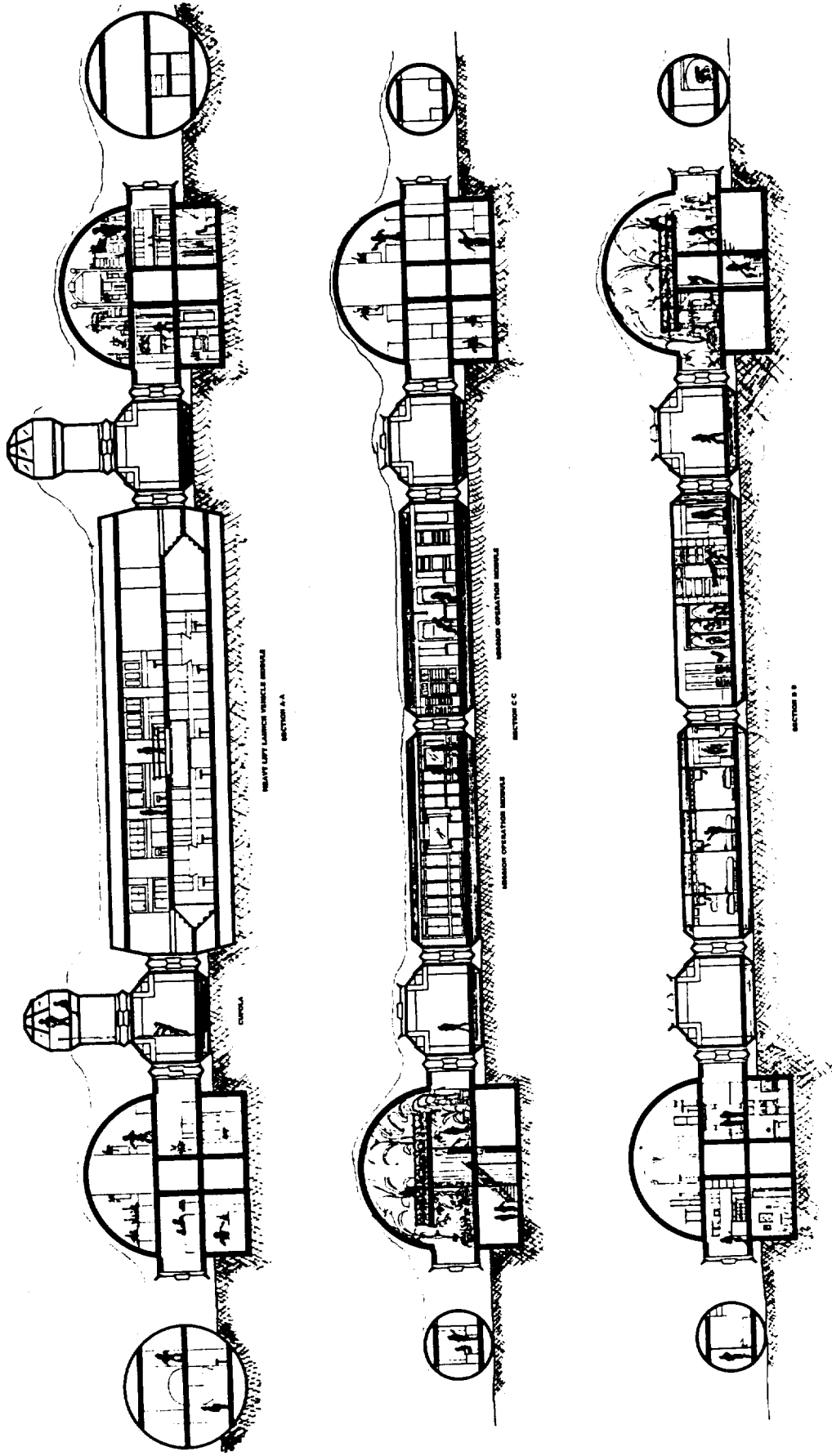

Figure 7.2.3-5. Section through all three arms of the base habitat.

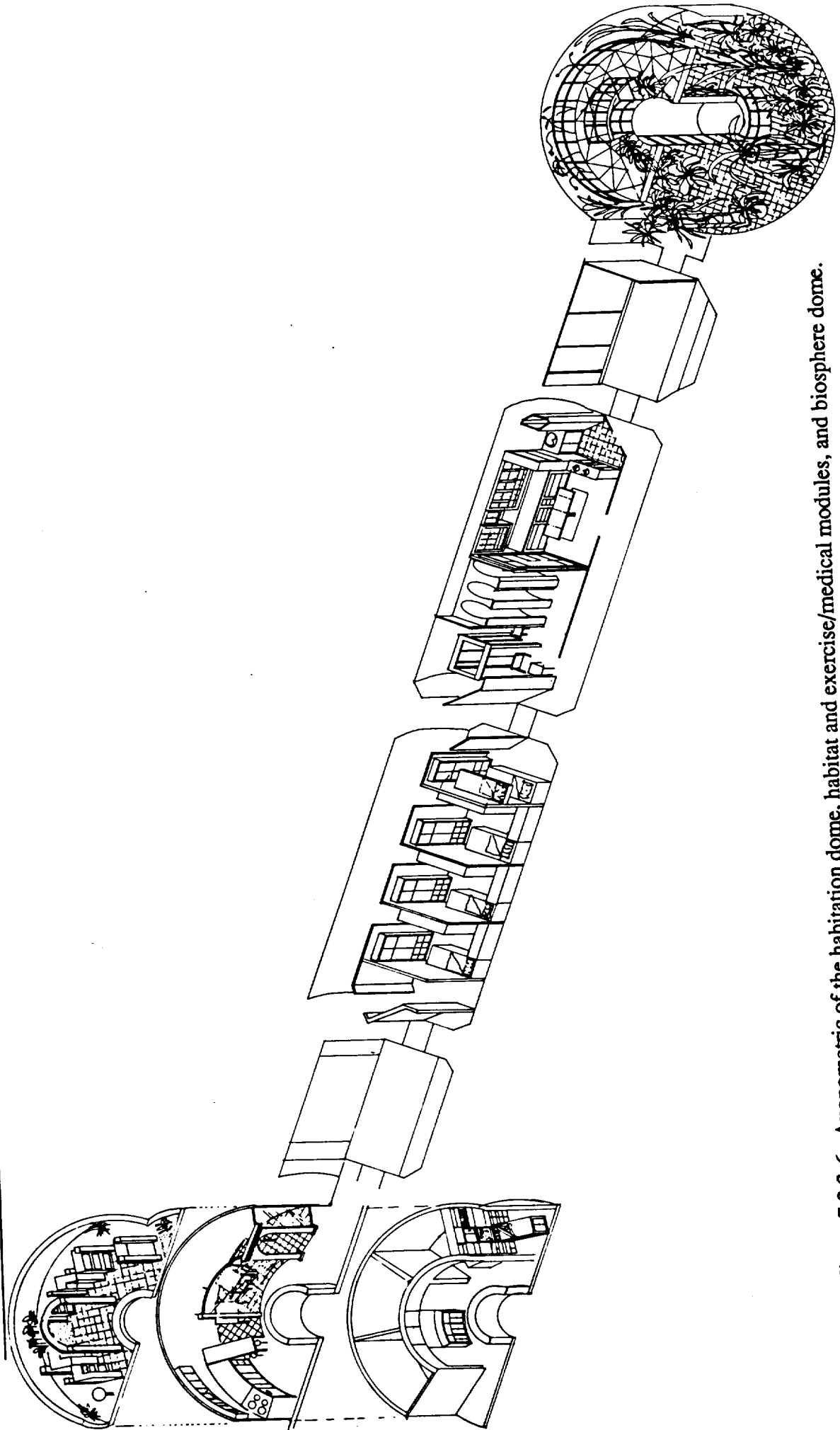

Figure 7.2.3-6. Axonometric of the habitation dome, habitat and exercise/medical modules, and biosphere dome.

As a guideline for the selection of lighting, the following hues were considered:

**Reds** - Reds are warm, exciting and stimulating. The are associated with tension and danger. By carefully augmenting reds with other colors in a scheme, it is possible to achieve life and cheer.

**Orange** - Oranges share the same qualities as reds with some slight modification.

**Yellow** - Yellow is the mildest of warm colors, it represents cheerfulness and humor. Yellows provide strong brightness with less tension than that of reds or oranges. Some yellow tints suggest safety with no negative implications.

**Green** - Greens help balance spaces seeking to be calm and restful, peaceful and constructive. Green remains a good color to promote serenity, and helps to counter any sense of drabness.

**Blue** - Blues are the coolest of all hues, suggest repose rest, calm, and dignity. Blues do have the tendency to create gloominess and depression when used too often in a space.

**Neutral Colors** - Neutrals, especially the grays, make good backgrounds that are easy to live with for long periods of time. Grays can be monotonous, but when

used with other colors, can be successful.

**White** - Whites and near whites represent brightness, openness and clarity. White is a safe hue and can be used in large denominations. It also suggests cleanliness and sanitary views.

Lastly, the control of lighting was considered. Light switches are located generally within the space, easily located by the crewmembers. Given the number of switching options available, a range of styles will be utilized. Remote locations, central panels, multiple switches, and switches controlled by timers, clocks, or light sensors are suggested.

#### 7.2.4 Construction Technology

##### 7.2.4.1 Equipment

The equipment needed to construct the Genesis Lunar Outpost will all need to be brought up before the structure. First off, we will need a lifting crane. This can be the same device used to lift modules off of lunar landers. A vehicle which can move large materials across the lunar surface will be needed. A regolith moving machine will also be required for digging in the sunken parts of the base. A machine for bagging regolith and putting it on the structures is also required. All of these functions could be met by a vehicle which we have conceptualized (Figure 7.2.4-1). The vehicle will be used to gather regolith much like a mining machine works, and then bag the regolith. It can also be used to pull modules into place. After the

expanded and the structure will raise into its approximate shape. With the attachment of the connecting collar, the assembly facility can be attached and the dome can be pressurized. The next step will be the installation of the central column. With this in place, the internal floor pieces will be brought in and put in place. Once the floors are completed, the mechanical systems can be installed and the main components of the structure will be completed.

#### 7.2.4.3 Assembly Facility

The assembly facility is simply a construction shack. It will contain many of the tools needed to construct the elements of the base, a large airlock, and many of the functions needed to support life should a person need to live in it in emergency situation.

#### 7.2.4.4 Space Station Common Module

One of the modules that will be used as a base component will be much the same as the module used in the Space Station Freedom; 2.4 meters in diameter and 13.4 meters long, the module is made of two layers of aluminum enclosing a layer of insulation, making a wall thickness of approximately 11 cm. The major difference between the space station module and the module that we will be using is that the airlock opening in the end of the module must accommodate a full sized (1.3 m x 2.1 m) opening which will allow uninhibited walk-through. The modules will be almost entirely outfitted on Earth, and will employ a rack system which will allow components to be easily interchanged or replaced at any time.

construction work on the base is completed, the machine can be used for lunar mining or in surface exploration.

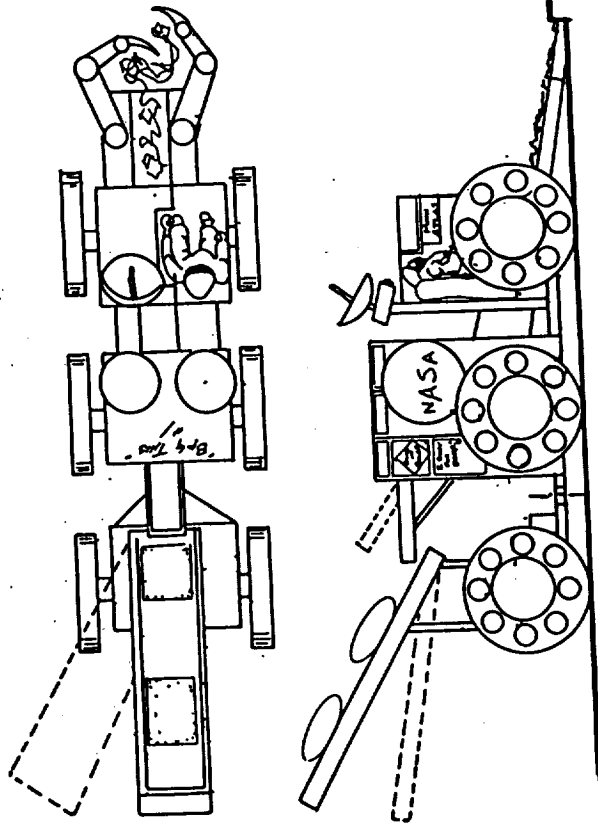

Figure 7.2.4-1. Concept drawing for a multiply-functioning regolith collecting and bagging machine.

#### 7.2.4.2 Construction Methodology

Construction will begin with the foundation augers (Figure 7.2.4-2) being leveled in the surface and the rigid base truss work being installed on the augers. The aluminum panels will then be secured to the truss work. The inflatable (also Figure 7.2.4-2) can then be brought in and secured down to the base. The foam ribs will be

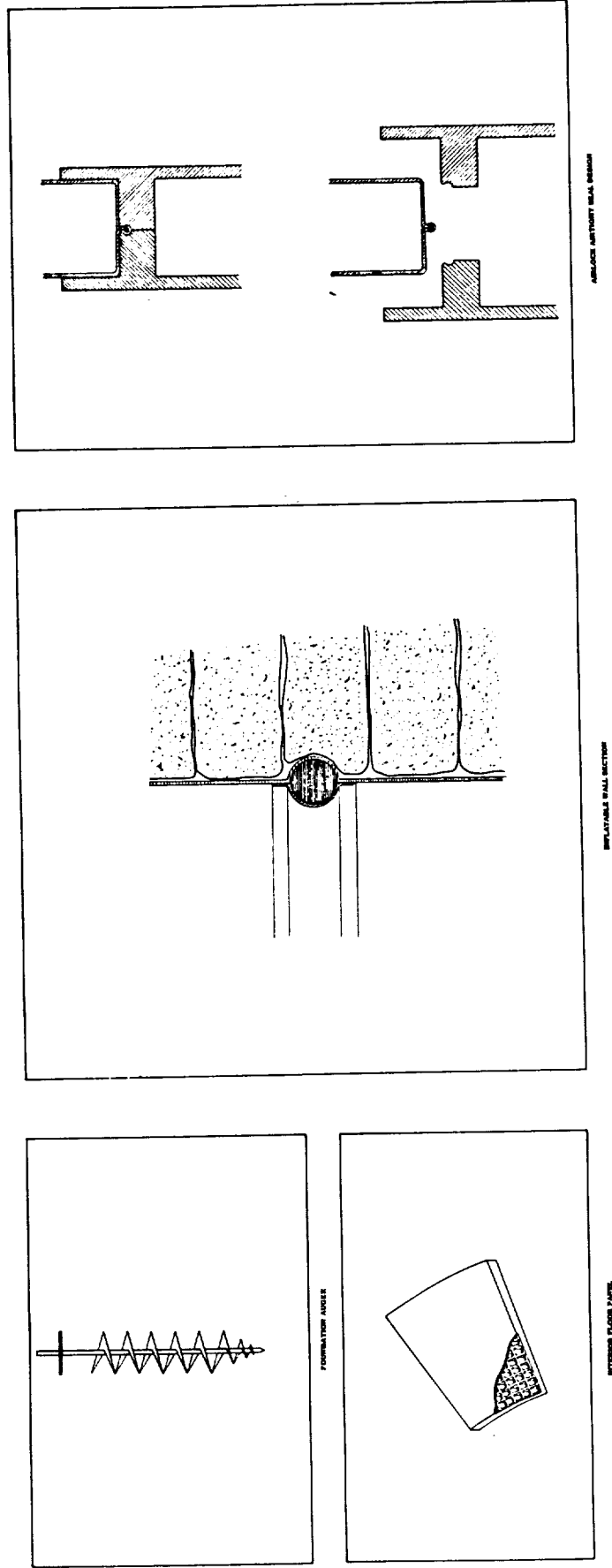

Figure 7.2.4-2. Technical concept designs for foundation augers, airlock airtight seal design, inflatable wall section, and other technologies.



### 7.2.4.5 HLLV Module

The HLLV (Heavy Lift Launch Vehicle) Module will be a major component in our base; 7.6 meters in diameter and 27.4 meters in length, it is much the same as the standard space station module, only much larger. The module will accommodate two floor levels, which will need to be accessed by stairs from the airlock opening centered in the end module.

### 7.2.4.6 Inflatable Structure

The large dome structure will be a foam filled, rib rigidized, air-supported, single membrane inflatable approximately 10 m in diameter, and 10 m tall at its central point. The main component of this inflatable is a laminated membrane comprised of the following materials: Beta Cloth, for the outermost layer, a durability material; Kevlar, the main strength material; Spectra, woven with the Kevlar to aid in flexibility; Mylar, provides an air-tight barrier, and Nomex, the innermost material, protects against fire hazards (Figure 7.2.4-3).

The membrane will be continuous around the entire structure, except for two openings left for airlocks. These openings will be sealed so the entire structure becomes a pressure vessel in which air will be placed at 10855 millibars. The inside of the membrane will be lined with "ribs" formed by chemically welding the same material to the membrane so a grid-work is formed. The inside of these ribs will be lined with the two components of the foam, and separated by a form of resin-gel. When the inflatable is ready for deployment, the ribs will be opened to a vacuum, the gel will evacuate, and the components will interact to form a rigid foam. The expanding of these ribs

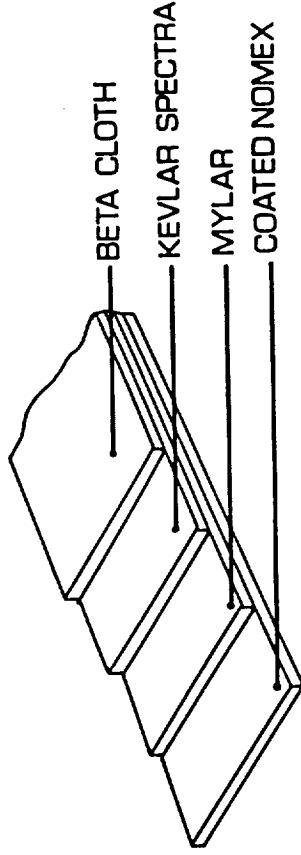

Figure 7.2.4-3. Recommended inflatable laminated membrane. will lift the membrane into its approximate form (Figure 7.2.4-2).

The ribs in the structure serve three purposes. First, they help to keep the membrane in the desired shape by preventing "oil-canning" in the vertical side walls. Second, they provide a solid member to attach floors and other required items. Finally, they support the weight of the regolith and the membrane should the structure loose part or all of its internal pressure. This support is also needed under full pressure on the lower part of the curvature of the dome, where the downward force of the regolith cannot be entirely counteracted by the radial force of the air-pressure. Horizontal and vertical ribs continue in the dome up to 22 degrees from the center, sufficient to support the dome down to 5427 millibars internal pressure. Two perpendicular ribs continue across the top of the dome to aid in

erection of the dome by lifting the membrane up into position.

The inflatable will be held into position by using a number of straps attached to the bottom corner of the structure. These straps will be clamped down to the truss' of the base framework.

#### 7.2.4.7 Rigid Platform with Foundation

A foundation will be needed to spread the weight of the structure over the regolith and to stabilize and level the structure. The purpose for a rigid structural platform is to provide a level, solid base to which the inflatable can be attached. The platform needs to be rigid to prevent the floor of the inflatable from "oil-canning". The platform also serves as a means of connecting the inflatable to the ground.

The foundation is comprised of auger type bits, shown in Figure 7.2.4-2, which will be tele-robotically threaded into the regolith. Using laser guidance, the bits will be set so their tops are all at the same level. A flat plate, which is attached to the upper part of the bit, will be lowered to rest upon the regolith, and then locked into place. This plate will help in the stabilization of the base should the bit lose its stability in the regolith.

The framework for the base of the inflatable structure is composed of lightweight space-frame type truss. The truss radiates outward from a central ring on which they are attached with a form of structural hinge, as shown in Figure 7.2.4-4. The truss' will then fold together much like a revolving door folds for an emergency exit. The end connectors, which form the outer ring of support, and intermediate connectors, between the inner and outer ring, are hinged and

fold inward between the radial members when the structure is collapsed for transport (refer to Figure 7.2.4-5).

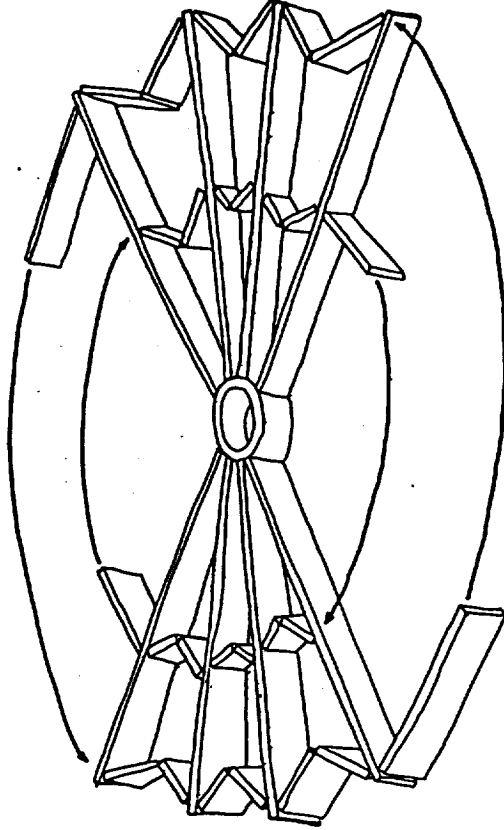

Figure 7.2.4-4. Expanding floor truss.

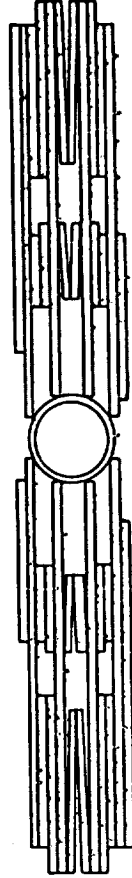

Figure 7.2.4-5. Planned collapse of structure for transport.

### 7.2.4.8 Attachment Ring

The space-frame type truss' will be made of aluminum plates and channels welded together on earth to form a lightweight yet strong truss member. The main radial members will be approximately 5 m long. The central ring will be approximately 1 m in diameter. The octagon formed by these members will be slightly larger than the 10 m inflatable which will be placed on it. This is so the outer edge of the inflatable will lie directly over as many structural members as possible.

The flat surface which covers the truss framework is made of pie shaped aluminum panels (Figure 7.2.4-6). Four sets of two hinged panels will be brought down, unfolded on the truss frame, and bolted down. Finally, a round shaped aluminum panel will be put in the remaining hole in the center and bolted down to complete the plate rigid base.

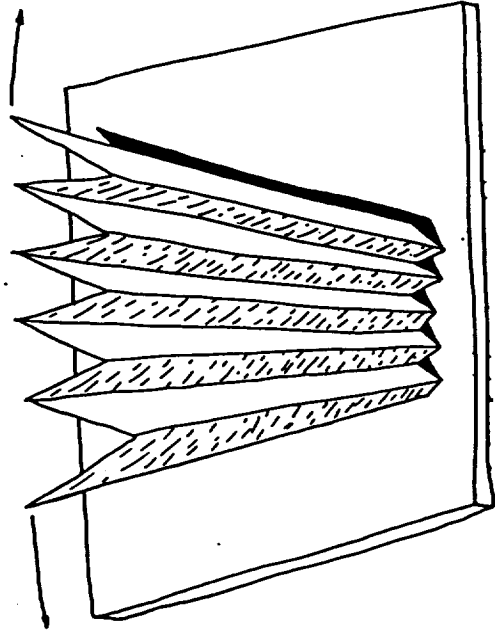

Figure 7.2.4-6. Floor panels in deployment.

The proposed method for attaching a hard module to an inflatable is by using a sandwiched metal ring, which will be attached to the inflatable on the Earth. The inflatable will be constructed with the necessary opening left in the membrane, so the openings edges will be formed by heavier than usual ribs that will fill to create a rigid framework to support the ring. The membrane will have a bead formed at the point where the rib fits into the ring. This bead will be sandwiched in-between the two metal pieces when they are joined together to form an air-tight seal (see figure 7.2.4-7).

The ring is comprised of two cast aluminum pieces which are three meters in diameter. A door opening is left in the middle of each piece, and holes for utilities are provided. These are framed by a perpendicular ridge of metal that will form the sides of the opening. The pieces each contain holes around the perimeter of the entry hole, the outer piece has standard holes, the inner piece has threaded holes. These permit the two pieces to be bolted together. A groove is machined into each piece near the edge of the ridge to allow a space to secure the bead in the membrane. A gasket of an appropriate material will be mounted to the surface of one of the pieces to form an airtight seal when they are assembled (Figure 7.2.4-7).

With this ring in place the inflatable will then have a rigid, flat plate to which a collar can be attached which will contain a standard docking port. This collar will allow for connection of utilities and mechanical lines between a module and an inflatable (see Figure 7.2.4-7).

#### 7.2.4.9 Regolith Containment

Regolith shielding will be needed for protection against radiation, micrometeoroid impacts, and thermal regulation. The thickness required to give us this protection has been calculated to be approximately 50 cm. The regolith shielding will be in the form of Beta Cloth bags filled with regolith, which will be stacked upon the structures. The machine shown in Figure 7.2.4-1 above will gather regolith, bag it, and transfer these bags to a conveyor which will lift the bags into position (Figures 7.2.4-8 and 7.2.4-9). The base of the regolith bagging will need to be thicker to prevent the upper bags from falling out of position. The placement of the bags on the inflatable will be done in a circular fashion with each layer continuing entirely around the structure before the next is started. This is done so the structure is not placed under unequal stress which may cause stress points in the membrane.

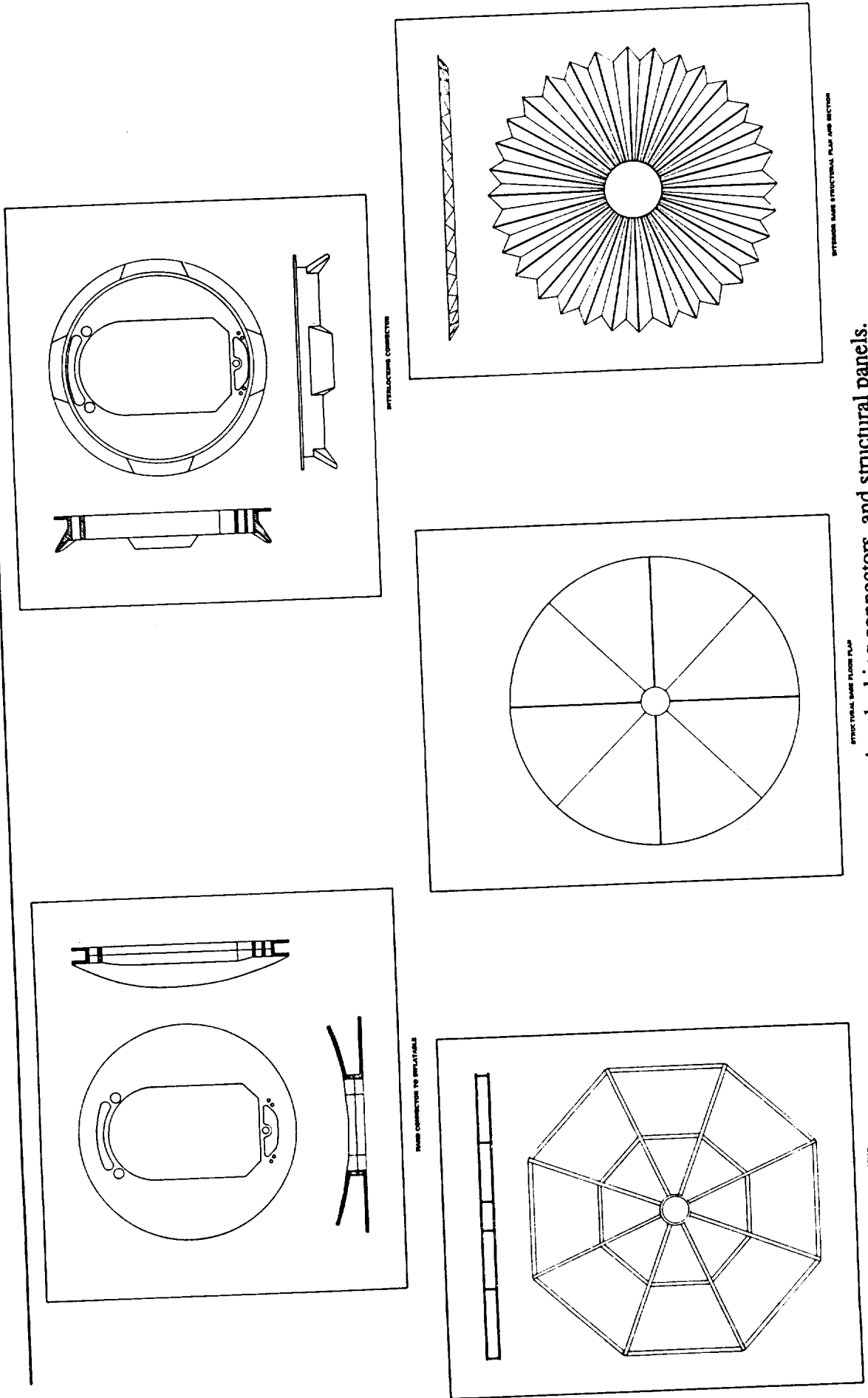

Figure 7.2.4-7. Hard connectors, interlocking connectors, and structural panels.

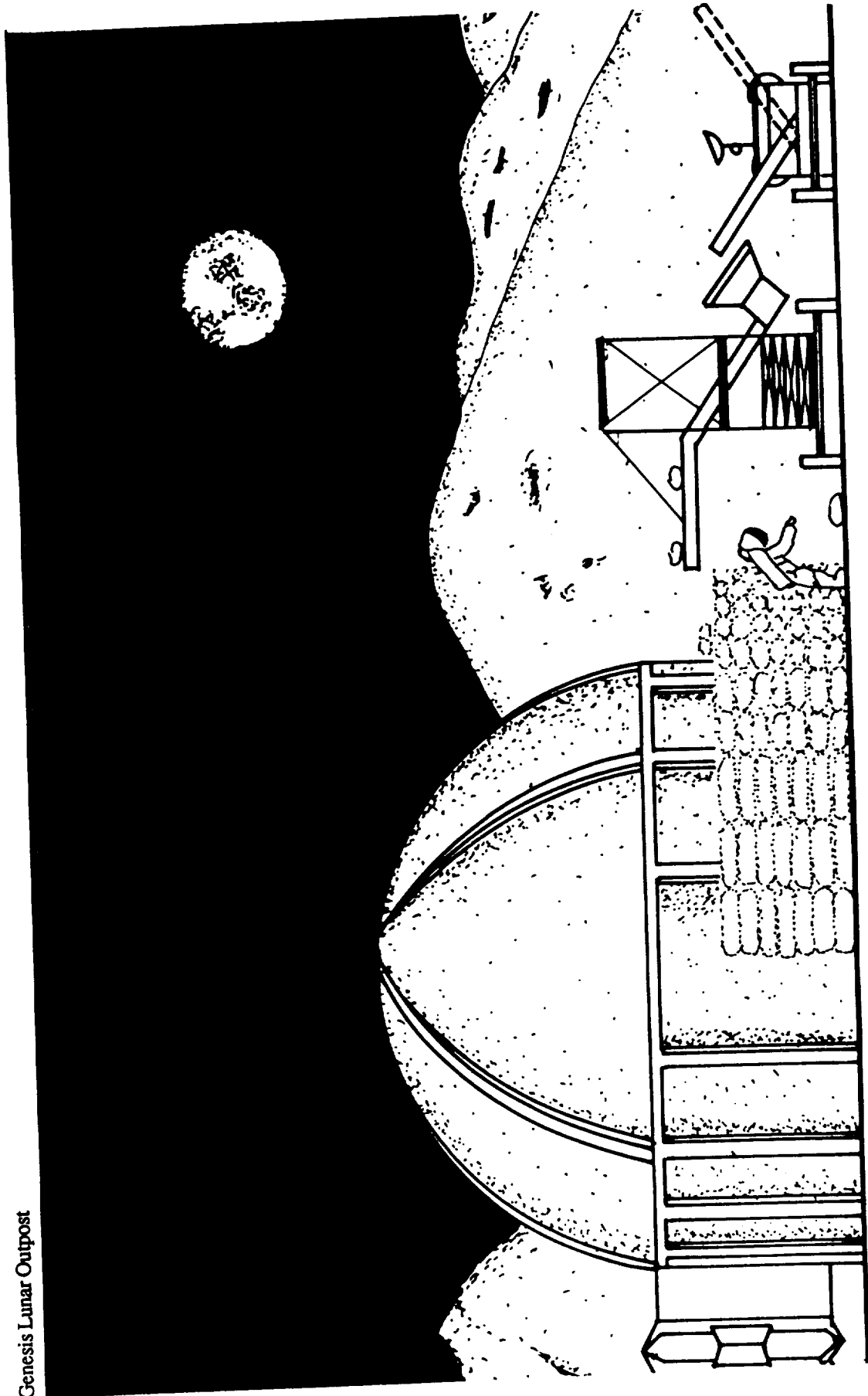

Figure 7.2.4-8. Regolith bagging and stacking - early phase.

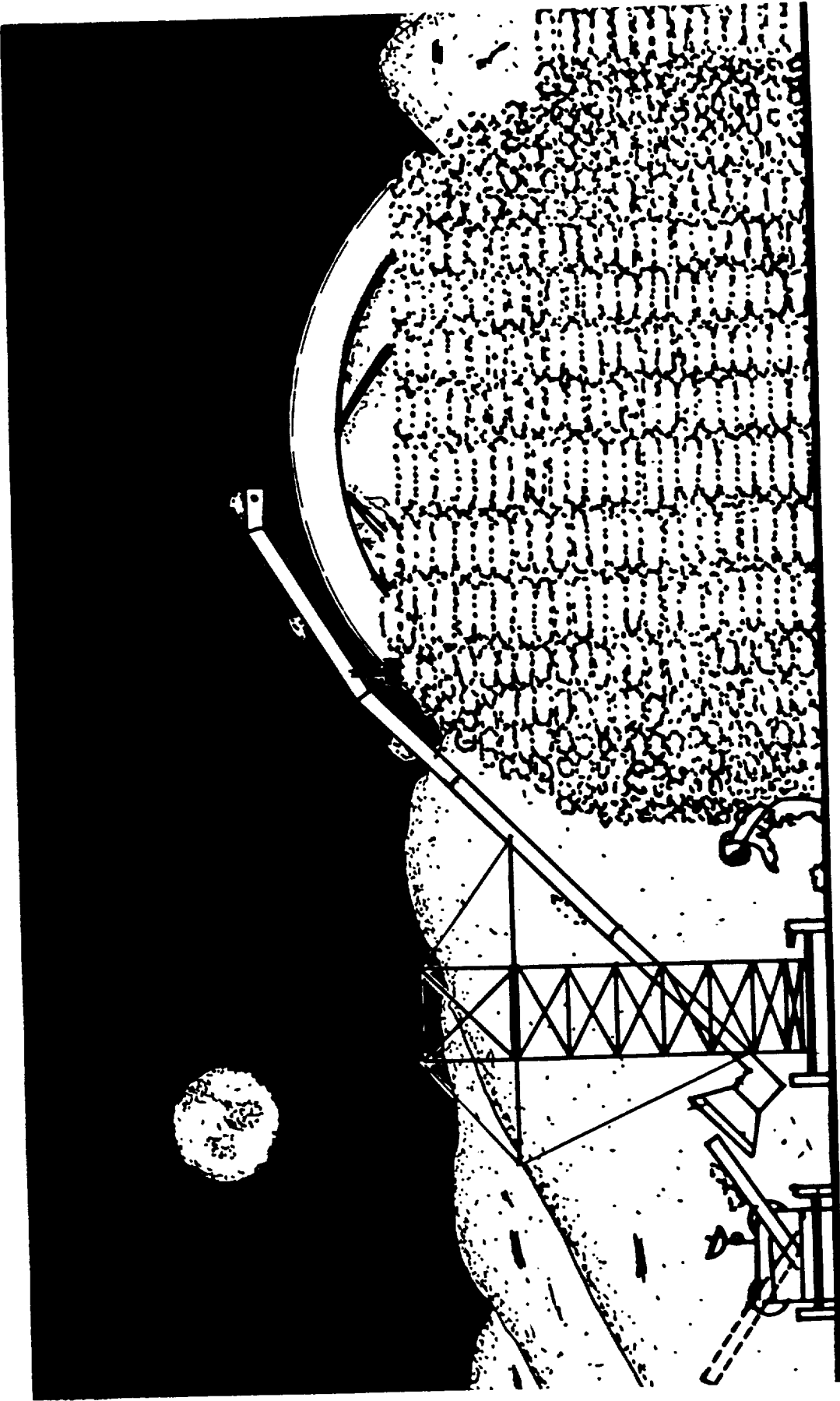

Figure 7.2.4-9. Regolith bagging and stacking near completion.

Genesis Lunar Outpost



## 8. REFERENCES

- Altman, I. (1975). The environment and social behavior: Privacy, personal space, territory and crowding. Monterey, CA. Brooks/Cole.
- Batelle, Columbus Division (1987). Advanced Space Transportation System Mission Analysis. Report for NASA/Johnson Space Center under contract no. NAS9-17356.
- Bluth, B.J. & Helppie, M. Soviet Space Stations as Analogs: Edition II, Section 4.1.2. NASA Grant NAGW-659, NASA Headquarters, Washington, D. C., August 1986, Mir Update, May 18, 1987.
- Cohen, S. & Weinstein, N. (1982) Nonauditory effects of noise on behavior and health. In G.W. Evans (Ed.), Environmental Stress. New York: Cambridge University Press.
- Evans, G., Stokals, D., & Carrere, S. Human Adaptation to Isolated and Confined Environments . NASA-CR-181502, NASA Grant NAG 2-387, April 1985 - July 1987.
- Eagle Engineering (1988). Conceptual Design of a Lunar Base Solar Power Plant. Houston, Texas, NASA contract NAS9-17878.
- Eagle Engineering (1988). Lunar Base Launch and Landing Facility Conceptual Design. Houston, Texas, NASA contract no. NAS9-17878.
- Eagle Engineering (1988). Lunar Surface Construction and Assembly Equipment Study. Houston, TX, NASA contract no. NAS9-17878.
- Hewes, D., Spady, A., & Harris, R (1966) Comparative Measurements of Man's Walking and Running Gaits in Earth and Simulated Lunar Gravity. NASA Technical Note D-3363. NASA/Langley Research Center.
- Interiors Magazine (nd). Human Dimensions. A Pocket Guide for Designers.
- Margaria, R. & Cavagna, G. (1964). "Human Locomotion in Subgravity." Aerospace Medicine, volume 35, no. 12.
- Mendell, W., (Ed.) (1985). Lunar Bases and Space Activities of the 21st Century. Houston, TX. Lunar and Planetary Institute. MIT (1987). International Space University Campus and Lunar Base Design. Space Habitat Design Workshop, MIT.
- MIT (1988). Mars Colony Design. Space Habitat Design Workshop, MIT.
- Moore, N. & Capps, S. (1989). Lunar Base Construction Shack. NASA/Johnson Space Center Internal Note JSC-23848, Man-Systems Division.

- Mortazavi, P. & Bagdigian, R. (1987). Status of the Space Station Water Reclamation and Management Subsystem. Marshall Space Flight Center, S.A.E. Technical Paper Series 871510.
- NASA (1982). Space and Planetary Environment Criteria Guidelines for Use in Space Vehicle Development. NASA TM 82478, 1982 revision.
- NASA (1985). Space Station Human Factors Research Review Volume III - Space Station Habitability and Function: Architectural Research. University of California - Berkeley, Department of Architecture.
- NASA (1989). Man-Systems Integration Standards. NASA STD-3000, Volumes I and II.
- NASA/Johnson Space Center Crew Systems Review. January 19, 1988. NASA/Johnson Space Center.
- Nealy, J. (1988). Solar-flare Shielding With Regolith at a Lunar Base Site. NASA Technical Paper 2869.
- Packard, R., ed. (1981). Architectural Graphic Standards, seventh edition. Wiley and Sons, New York.
- Podnieks, E. (1988). "Environmental Considerations for Lunar Base Engineering." Engineering, Construction, and Operations in Space. Johnson, S. and Wetzel, J., (Ed.), American Society of Civil Engineers, New York, New York.
- Polette, T. & Toups, L. (1988) "Phased Approach to Lunar Based Agriculture." Engineering, Construction, and Operations in Space. Johnson, S. and Wetzel, J., ed. American Society of Civil Engineers, New York, New York.
- Roberts, M. & Kennedy, K. (1989). "Inflatable Lunar Habitat." NASA/Johnson Space Center Engineering Activity Review Board.
- Sasakawa International Center for Space Architecture (SICSA) (1989). Partial Gravity Habitat Study. NASA/USRA Final Report.
- Stuster, J. (1986). Space Station Habitability Recommendations Based on a Systematic Comparative Analysis of Analogous Conditions. NASA Contractor Report 3943.
- Taylor, T., Spencer, J., & Rocha (1986). Space Station Architectural Elements and Issues Definition Study. NASA Contractor Report 3941.
- Toups, L. (1989). A Comparative Catalogue of Lunar Construction Techniques. Lockheed Engineering and Sciences Company, NASA contract no. NAS9-17900.
- Wise, J., et al. (1987). Interior Design for the Space Station Habitation Module. Space Design Research Group, University of Washington.

## 9. APPENDICES

### 9.1 A: Publications, Talks, and Interviews on Space Architecture

Space Architecture Design Group

Department of Architecture  
and

Center for Architecture and Urban Planning Research  
University of Wisconsin-Milwaukee

#### Books

Cordes, E.G., Moore, G.T., & Hansmann, T. (in preparation).  
Space architecture: A primer for the design of extraterrestrial  
environments. Milwaukee: University of Wisconsin-Milwaukee,  
Center for Architecture and Urban Planning Research.

#### Reports

Schnarsky, A.J., Cordes, E.G., Crabb, T., & Jacobs, M. (1988).  
Space architecture: Lunarbase scenarios (ed. by E.G. Cordes, G.T.  
Moore, & S.J. Frahm). Milwaukee: University of Wisconsin-  
Milwaukee, Center for Architecture and Urban Planning Re-

search, Report R88-1.

Baschiera, D.J., & 12 others (1989). Genesis lunar outpost:  
Program/requirements document for an early stage lunar outpost  
(ed. by J.P. Fieber & 5 others). Milwaukee: University of Wis-  
consin-Milwaukee, Center for Architecture and Urban Planning  
Research, Report R89-1.

Cordes, E.G. (1989). Lunar base studies. Unpublished M.Arch.  
thesis, School of Architecture and Urban Planning, University of  
Wisconsin-Milwaukee.

Cordes, E.G. (1989). Project Newton: A variable gravity re-  
search facility (2 vols.). Strasbourg, France: International Space  
University European Space Agency Publication, August.

Cordes, E.G., Moore, G.T., & Hansmann, T. (1989). Space  
architecture design workshop/studio: Space architecture reader (2  
vols.). Milwaukee: University of Wisconsin-Milwaukee, Center  
for Architecture and Urban Planning Research.

Hansmann, T. (1989, August). Inflatable lunar habitat mission  
operations level. Summer project report prepared for the NASA/  
USRA Advanced Design Program, Johnson Space Center, Hous-  
ton, Texas.

---

**Published Papers**

- Cordes, E.G. (1988). Computer-aided design and space architecture. *Academic Computing*, Vol. 3(2), Cover, 18-21, 49.
- Schnarsky, A.J. (1988). CAD as a tool of change: Architecture a changing profession. *Academic Computing*, September, Vol. 3(2), 22-24.
- Schnarsky, A.J. (1988). From the near side of the moon. *Wisconsin Architect*, July, 14-16.
- Moore, G.T. (in press). Environment-behavior issues in extraterrestrial space. In H. Pamir(Ed.), *Culture, space, history: Proceedings of the 11th international conference of the International Association for the Study of People and their Physical Surroundings*. Ankara, Turkey: METU Middle East Technical University.
- 

**Symposia**

- Moore, G.T. (Chair). (1989). Architects explore the final frontier. Workshop presented at the Environmental Design Research Association 21st annual conference, Urbana, Illinois, April.
- Moore, G.T. (Chair). Symposium on space architecture. Symposium to be presented at the 11th international conference of the International Association for the Study of People and their Physi-

---

cal Surroundings, METU Middle East Technical University, Ankara, Turkey, July.

---

**Lectures and Talks**

- Bell, L. (1987). Space architecture: Its frontiers and opportunities for practice and research. Lecture given at the School of Architecture and Urban Planning, University of Wisconsin-Milwaukee, November.
- Cordes, E.G., & Lovett, T.J. (1988). Lunar base designs. Video presentation at the NASA/Universities Space Research Association 4th Annual Advanced Design Conference, Kennedy Space Center, Cocoa Beach, Florida, May.
- Cordes, E.G., & Moore, G.T. (1988). Space architecture and computer-aided Design Applications. Video presentation at the A/E/C Systems '88 Space Station Design and Development Conference, Chicago, May.
- Cordes, E.G., & Patton, C.V. (1988). Space exploration: Feasible roles for planners. Paper presented at the Association of Collegiate Schools of Planning Conference, Buffalo, New York, October.
- Cordes, E.G. (1989). Lunar base studies. CAD-based video presentation at the NASA/Universities Space Research Association 5th Annual Advanced Design Conference, Marshall Space

Flight Center, Huntsville, Alabama, June.

Kalil, M., & Veliz, C. (1989). Two approaches to space design (C. Veliz's work presented by G.T. Moore). Seminar given at the School of Architecture and Urban Planning, University of Wisconsin-Milwaukee, September.

Kalil, M. (1989). An outward continuum. Friday Afternoon Live lecture given at the School of Architecture and Urban Planning, University of Wisconsin-Milwaukee, September.

Cordes, E.G. (1989). Technology transfer for the human environment: Space systems design and the role of architects. Paper presented at the Midwest Space Development Conference, West Lafayette, Indiana, October.

Cordes, E.G. (1989). Design of lunar and Martian living quarters. Talk given at the Retired Men's Club of Whitefish Bay, Wisconsin, November.

Moore, G.T. (1989). Industry/university cooperation in space architecture. Talk given to Astronautics Corporation of America, Milwaukee, Wisconsin, November.

Moore, G.T. (1989). Environment-behavior issues in extraterrestrial space. Invited lecture given at the Escuela de Arquitectura, Universidad de Puerto Rico, San Juan, Puerto Rico, December.

Moore, G.T., & Moths, J.H. (1990). Lunar space architecture. Talk given to the Greater Milwaukee Chapter of the Retired

Officers Association, January.

Moore, G.T., Moths, J.H., & Baschiera, D.J. (1990). Extraterrestrial habitats and how they will effect our futures. Talk given at the Young Astronauts Aviation and Aerospace Conference, Waukesha, Wisconsin, March.

Neubek, D. (1990). Recent work of the University of Houston SICSA Space Architecture Program. Seminar given at the School of Architecture and Urban Planning, University of Wisconsin-Milwaukee, March.

Andino, A. (1990). Recent work of the University of Puerto Rico Space Architecture Program. Seminar given at the School of Architecture and Urban Planning, University of Wisconsin-Milwaukee, April.

Baschiera, D.J., Gruenberger, M., Moths, J.H., Paruleski, K.L., Schroeder, C.W., & Crabb, T.M. (1990). Architects explore the final frontier. Workshop presented at the Environmental Design Research Association 21st Annual Conference, Urbana-Champaign, Illinois, April.

Baschiera, D.J., Fieber, J.P., Graff, P., Gruenberger, M., Kinde, M.R., Moss, S.E., Moths, J.H., Paruleski, K.L., Schleicher, S.A., & Schroeder, C.W. (1990). Genesis: Lunar Outpost. (G.T. Moore, Faculty Advisor). Design project presented at the Environmental Design Research Association 21st Annual Conference, Urbana-Champaign, Illinois, April.

#### Genesis Lunar Outpost

Moore, G.T., Baschiera, D.J., & Schleicher, S.A. (1990). Space architecture: The final frontier. Talk to be given to the University of Wisconsin-Milwaukee Guild for Learning in Retirement, April.

Moore, G.T. (1990). Environment-behavior issues in extraterrestrial space. Paper to be presented at the 11th international conference of the International Association for the Study of People and their Physical Surroundings, METU Middle East Technical University, Ankara, Turkey, July.

#### Exhibits

Space Architecture Design Group (1990). Genesis: Space architecture. Exhibit presented at the 1990 Aviation and Aerospace Conference, Brookfield and Waukesha, Wisconsin, March.

Space Architecture Design Group (1990). Space architecture: Laboratory and habitation modules for the moon. Poster and exhibit presented at the Environmental Design Research Association 21st Annual Conference, Urbana-Champaign, Illinois, April.

Space Architecture Design Group (1990). Recent work of the Space Architecture Design Group. Exhibit presented at After Friday Afternoon Live, School of Architecture and Urban Planning, University of Wisconsin-Milwaukee, April.

#### Interviews and Articles

Architects explore the final frontier (G.T. Moore). UWM Report, July 1989, Vol. 9(11), p. 1.

UWM School of Architecture grants (G.T. Moore). Milwaukee Business Journal, July 17, 1989.

Space architecture (G.T. Moore). Radio interview (with Kathleen Dunn), WTMJ, Milwaukee, July 18, 1989.

Bush favors space station on moon as step toward Mars (G.T. Moore & T.M. Crabb). Milwaukee Journal, July 20, 1989, p. 6A.

UWM team to design lunar living quarters (G.T. Moore, by Chester Sheard). Milwaukee Sentinel, July 20, 1989, Part 1, p. 3.

New space architecture program. Radio interview (G.T. Moore, with Bruce Winter & Rosanne McGuire), WUWM, Milwaukee, July 20 and 21, 1989.

Space architecture. Radio interview (G.T. Moore), WTVY-News, Madison, Wisconsin, July 21, 1989.

Space architecture. Television interview (G.T. Moore, with Kent Wainscot), 6:00 and 10:00 o'clock news, WISN-TV, Milwaukee, July 21, 1989.

University roundtable. Radio interview (G.T. Moore, E.G. Cordes, & T. Hansmann, with Ruane Hill), WUWM, Milwaukee,

September 30, 1989.

Space project: Team report. Television interview (G.T. Moore, J.H. Moths, J.P. Fieber, & M.R. Kinde, with Kathy Mykleby), 6:00 o'clock news, WISN-TV, Milwaukee, March 3, 1990.

Students told of space careers (D. Brandenstein, J.H. Moths, & G.T. Moore). Waukesha County Freeman, March 19, 1990.

Space architecture at UWM. Television interview (J. Alred, M. Gruenberger, & D.J. Baschiera with Bob Nenno), 6:00 O'clock news, WTMJ-TV, Milwaukee, March 22, 1990.

Architects explore the final frontier (G.T. Moore & 7 others & T.M. Crabb). Workshop abstract in R.I. Selby, K.H. Anthony, J. Choi & B. Orland (Eds.), Coming of age: Proceedings of the Environmental Design Research Association 21st Annual Conference (pp. 316-317). Washington, DC: Environmental Design Research Association.

Space architecture: Laboratory and habitation modules for the moon (D. Baschiera & 18 others). Poster abstract in R.I. Selby, K.H. Anthony, J. Choi & B. Orland (Eds.), Coming of age: Proceedings of the Environmental Design Research Association 21st Annual Conference (pp. 319-320). Washington, DC: Environmental Design Research Association.

Genesis: Lunar outpost (D. Baschiera & 9 others, G.T. Moore, & T. Hansmann). Design project abstract in R.I. Selby, K.H. Anthony, J. Choi & B. Orland (Eds.), Coming of age: Proceedings of

the Environmental Design Research Association 21st Annual Conference (pp. 321-322). Washington, DC: Environmental Design Research Association.

#### Awards

Genesis lunar outpost. Student Design Commendation Award from the Environmental Design Research Association, April 1990.

