

N91-11982

5-17  
300347

p-28

## Interagency Telemetry Arraying for Voyager-Neptune Encounter

D. W. Brown

TDA Engineering Office

W. D. Brundage

National Radio Astronomy Observatory

J. S. Ulvestad

Tracking Systems and Applications Section

S. S. Kent

Telecommunications Systems Section

K. P. Bartos

Radio Frequency and Microwave Subsystems Section

*The reception capability of the Deep Space Network (DSN) has been improved over the years by increasing both the size and number of antennas at each complex to meet spacecraft-support requirements. However, even more aperture was required for the final planetary encounters of the Voyager 2 spacecraft. This need was met by arraying one radio astronomy observatory with the DSN complex in the United States and another with the complex in Australia. Following a review of augmentation for the Uranus encounter, both the preparation at the National Radio Astronomy (NRAO) Very Large Array (VLA) and the Neptune encounter results for the Parkes-Canberra and VLA-Goldstone arrays are presented.*

### I. Introduction and Background

In August 1989, 12 years after launch, the Voyager 2 spacecraft encountered the planet Neptune and its moons. Imaging of the planet and the surface of Triton, the largest of the moons, ranked high on the list of experiments to be conducted over the several months surrounding closest approach. However, the steadily weakening signal received from the spacecraft as it receded from Earth tended to slow the rate at which images could be received by the Deep Space Network (DSN) and hence to reduce the quality and quantity of imaging data. Over the years, encoding modifications aboard Voyager 2 had been accomplished and the

ground reception capability had been steadily improved to regain communications capacity.

One approach was temporary augmentation of the DSN's own antennas at the Deep Space Communications Complexes around the world with suitable radio astronomy facilities. Beginning in 1981, studies were undertaken to identify, and negotiations to prepare, suitable candidates for the upcoming encounters with Uranus and then distant Neptune [1]. The first to receive serious attention was the Parkes Radio Telescope in Australia, operated by the Commonwealth Scientific and Industrial Research Organization (CSIRO). The European Space Agency (ESA)

was just in the process of contracting with the CSIRO to use Parkes in support of the Giotto mission to Comet Halley. Fortunately, the Giotto configuration at X-band (8.4 GHz) was compatible with Voyager's, and arrangements were made to share equipment and spacecraft-tracking time from late 1985 through the January and March 1986 encounters with Uranus and Comet Halley, respectively.

The Parkes-CDSCC Telemetry Array (PCTA) was thereby able to collect Voyager telemetry data at Parkes, transmit it in real time to the Canberra Deep Space Communications Complex (CDSCC) over a new microwave link, and combine it with the local DSN signal for improved data quality. Special recording capability was provided at each site so that data could be recovered at a later time in the event of outages of the real-time system. Following the Uranus encounter, the microwave link remained in place for cooperative use in astronomy and Very Long Baseline Interferometry (VLBI). The addition of Parkes to the Australian DSN complex<sup>1</sup> yielded an increase of approximately 50 percent in the CDSCC's reception capability for Uranus encounter [2].<sup>2</sup>

Meanwhile, in 1982, the interagency array studies identified the Very Large Array (VLA), near the Continental Divide in New Mexico, as a means of meeting the Neptune encounter reception needs.<sup>3</sup> This premier radio astronomy facility, operated by the National Radio Astronomy Observatory (NRAO) and sponsored by the National Science Foundation (NSF), consists of 27 antennas, each 25 m in diameter [3]. Configured in a "Y" arrangement with a 20-km radius, the array functions primarily as an astronomical mapping instrument with resolution comparable to that of optical telescopes. As was the case for the Uranus encounter, augmentation of the DSN in any given longitude (i.e., in Australia or the United States) would improve the data return for the total encounter by permitting data playback at a high rate from the Voyager tape recorder when the spacecraft was in view of the most sensitive (i.e., the arrayed) complexes. The VLA signal would combine with that of the Goldstone DSN complex to form the VLA-GDSCC Telemetry Array (VGTA), more than doubling the Goldstone Deep Space Communications Complex (GDSCC) capability, consisting of a

<sup>1</sup> At the Canberra site, the 64-m antenna was locally combined with one 34-m antenna.

<sup>2</sup> *PCTA System Requirements and Design, Including Subsystem Requirements*, Document 1200-2 (internal document), Jet Propulsion Laboratory, Pasadena, California, April 15, 1984.

<sup>3</sup> J. W. Layland, D. A. Bathker, D. W. Brown, R. C. Clauss, and C. E. Kohlhasse, *Potential VLA/DSN Arrayed Support to the Voyager at Neptune* (internal document), Jet Propulsion Laboratory, Pasadena, California, May 12, 1983.

70-m and one or two 34-m antennas. The PCTA would be reinstated to help maintain the global communications capability with Voyager [4].<sup>4</sup> In addition, for the Neptune encounter, the DSN was upgraded with a new 34-m antenna at the Madrid complex, and each of the DSN's 64-m antennas was enlarged to a 70-m diameter.

Early DSN experience in telemetry arraying including the early planetary encounters of the two Voyager spacecraft has been summarized [5]. Table 1 outlines the arraying occurrences of that period, as well as the configurations for the more recent Voyager encounters.

## II. Project Management

Early planning, studies, and tests in 1983, which were based upon initial visits to the VLA and on an exchange of letters between the directors of the NRAO and JPL in 1982, led to an effective project start in 1984 [6-8]. Even though 1984 was a year of heavy activity at JPL in preparation for the Uranus encounter, including the PCTA implementation, the first test of a single antenna at 8.4 GHz with a prototype front-end installation was accomplished in December. JPL supplied the feedhorn, and NRAO's Central Development Laboratory at Charlottesville, Virginia, provided the cooled field-effect transistor (FET) low-noise amplifier, with other front-end electronics supplied by the VLA Electronics Division. By early 1985, a Memorandum of Agreement between the NSF and NASA, as well as a Management Plan for a joint JPL-NRAO VGTA Project, had been signed.<sup>5</sup> The JPL TDA Engineering Office would have responsibility for the overall planning and management of the project, supported by implementation/preparation managers in JPL and the NRAO. An operations manager within JPL's TDA Mission Support Office and DSN Operations Office would be appointed.

The project was charged with the design, implementation, and operation necessary to deliver 40 spacecraft passes of arrayed support for the Voyager-Neptune encounter. At least 40 more monthly tests were conducted from late 1984 through early 1989. As compensation to the NRAO and the radio astronomy community, NASA agreed to fund permanent X-band (8.4-GHz) installations on all 28 VLA antennas (this included a spare), as well as to bear all direct costs attributable to the VLA's Voyager-related

<sup>4</sup> *PCTA System Requirements and Design, Update for Neptune Encounter*, Document 1200-2A (internal document), Jet Propulsion Laboratory, Pasadena, California, July 15, 1988.

<sup>5</sup> *Management Plan for the VLA-GDSCC Telemetry Array Project*, Document 1220-1 (internal document), Jet Propulsion Laboratory, Pasadena, California, March 15, 1985.

preparations and operation. As eventually implemented, the X-band became the VLA's most sensitive observing band; it has seen significant use in astronomy applications, including several experiments with the Goldstone Solar System Radar. Some further insight into the management aspects of the VGTA Project is provided in [9].

The on-site engineering, installation, test, and operation of the Parkes-Canberra array were managed, as they were for the Uranus encounter, by the staff at the CDSCC of the Australian Space Office of the Department of Industry, Technology and Commerce, in cooperation with the Parkes (CSIRO) staff.

### III. System Design

A high-level block diagram of the VLA-Goldstone system is shown in Fig. 1. The essential elements are

- (1) X-band (8.4-GHz) reception at the VLA and Goldstone
- (2) total spectrum combining of the 27 VLA signals
- (3) carrier demodulation to baseband at both sites
- (4) Earth-satellite data transmission to Goldstone
- (5) standard baseband arraying of two or three antennas at Goldstone
- (6) baseband combining of the two subarrays (VLA and GDSCC) at Goldstone
- (7) convolutional decoding and signal processing, and data transmission to JPL
- (8) symbol-stream recording at both sites to back up the real-time system
- (9) symbol-stream playback and combining at Goldstone

More detailed diagrams and descriptions are available.<sup>6</sup> The Parkes-Canberra system configuration was similar,<sup>7</sup> except that Parkes had a single aperture and the terrestrial microwave rather than the satellite link was used. A radio science open-loop recording system shared the DSN facilities and front-end system at Parkes.

In concept, both telemetry systems closely resembled the Uranus encounter configuration. Several sections of

<sup>6</sup> *VGTA System Requirements and Design*, Document 1220-2 (internal document), Jet Propulsion Laboratory, Pasadena, California, September 15, 1987.

<sup>7</sup> *PCTA System Requirements and Design, Update for Neptune Encounter*, Document 1200-2A (internal document), Jet Propulsion Laboratory, Pasadena, California, July 15, 1988.

this article describe in some detail the peculiarities of the VLA configuration, and the "Implementation" section outlines most of the changes in the telemetry-processing subsystems that were new for Neptune encounter. The following synopses describe the outcome of several VGTA design issues identified in the formal review of 1987.<sup>8</sup> Each topic represented either a potential show-stopper or a decision point in the implementation path.

#### A. VLA Front-End Design

Several of the design issues pertained to the front-end or radio-frequency performance of the VLA as adapted to Voyager needs. In particular, they concerned the low-noise amplifier, figure of merit (G/T), and the VLA signal-combining (autophasing) efficiency.

The baseline plan for the VLA 8.4-GHz systems utilized cooled FET receivers on each of the 28 (27 in use, plus one spare) VLA antennas. The first three receivers installed in 1984 and 1985 were FET systems as described in [10]. However, during this period, the technology of low-noise high-electron-mobility transistor (HEMT) amplifier systems was developing rapidly. These receivers offered the promise of a significant improvement in system temperature for the VLA antennas when the antennas operated in this band. A cooperative program among the NRAO, JPL, General Electric Co., and Cornell University had begun in 1984 to develop HEMT devices for several applications. Tests of HEMT amplifiers on the VLA, beginning in 1986, confirmed an improvement of 30 percent in overall system noise temperature, corresponding to an increase of 1.5 dB in the expected overall sensitivity of the VLA [11]. Because of this substantial improvement, all VLA antennas were ultimately equipped with HEMT amplifiers for the Neptune encounter.

The performance of the individual VLA antennas was investigated extensively from 1985 to 1989. This was a critical component of monthly tests at the VLA site. The performance of both FET- and HEMT-equipped antennas was tested via observations of natural radio sources; the results of these tests played a major role in the decision to utilize HEMT amplifiers. Tip-curve measurements made in late 1986 and early 1987 showed that average zenith system temperatures were 45 to 50 kelvins for the FET devices and 30 to 35 kelvins for the HEMT amplifiers. Antennas equipped with HEMTs later in the project showed even better performance, as lower-noise amplifiers became available [12].

<sup>8</sup> *VLA-Goldstone Array Formal Review* (internal document), Jet Propulsion Laboratory, Pasadena, California, July 1987.

The X-band aperture efficiencies of the antennas equipped with the JPL-designed feedhorn [13] were measured via VLA single-dish observations of radio sources of known flux density. Antenna sensitivities were found to be 0.110 K/jansky, giving aperture efficiencies of  $0.62 \pm 0.03$  [14]. These results combined with the system temperature measurements yielded an estimated zenith value of 49.7 dB/K for the gain-to-system-temperature (G/T) ratio of an individual antenna. At a 30-degree elevation angle, which would be characteristic of Voyager for the greater part of each day's pass, the total value of G/T would be 62.7 dB/K for 27 antennas added in phase. This result includes approximately 1 dB of loss resulting from quantization and the data gaps (discussed below) at the VLA. By comparison, a DSN 64-m antenna would have a G/T of 58.0 dB/K at the same elevation, so the HEMT-equipped VLA was predicted to be "worth" nearly three 64-m DSN antennas.

### B. Phasing 27 VLA Antennas

A key point glossed over above is that the 27 VLA antennas had to be summed in phase with one another. Random relative phases of the antennas would have reduced the VLA gain by approximately 7 dB—far more than the margin for receiving Voyager telemetry. Instrument phases change slowly, and extra path delays in the system are calibrated and subtracted out in real time. However, the fluctuating troposphere causes independent phase variations along the paths from the spacecraft to each individual antenna. This process can cause the antennas to lose phase coherence with one another and must be corrected by means of observations of a point radio source—in this case, Voyager. A correction is made in near-real time by determining the antenna phase adjustments that maximize the cross-correlated amplitude for the point source on each baseline. To "phase" the VLA during Voyager observations, a minimum broadband signal-to-noise ratio (SNR) on the Voyager signal was necessary for each cross-correlation. Early tests [7] showed that such a procedure was viable, and extensive tests and simulation refined the system design [15].

The NRAO's replacement of the VLA computers in late 1987 was a key ingredient in the signal combining, as it allowed the phase-determination procedure to make use of information on all 351 baselines of the VLA simultaneously, rather than to use only the 26 baselines to a single reference antenna. The enhancements in SNR achieved by means of both the computer improvements and the HEMT amplifiers were critical to the combining process. They allowed shorter integration times on the Voyager spacecraft to determine the phase adjustments; shorter integration

times meant more rapid feedback in the error-correction process. This, in turn, meant that the dynamic troposphere could be tracked even in the severe summer thunderstorms characteristic of the VLA location. During poor weather, the SNR takes a double hit. Increased system temperatures during thunderstorms make it more difficult to get enough SNR to determine the phases; at the same time, the phases fluctuate more rapidly, so the shortest possible integration time is desirable. Use of the HEMT amplifiers, rather than FET devices, was instrumental in keeping the signal-combining procedure robust even in the worst weather experienced during the encounter period.

### C. VLA Data Gap

Received signals at the antennas are returned for processing to the central electronics area by means of a buried waveguide system. Monitoring and control of the antennas, including the front-end electronics, are accomplished by time sharing through the same path. The resulting data interruption of 1.6 msec every 5/96 of a second was of immediate concern during initial planning. Studies were undertaken as early as 1982 to determine whether Voyager's concatenated coding scheme could tolerate these data gaps [6]. The Voyager data rates ranged from 4.8 to 21.6 kilobits per second (kbps), with convolutional inner code of rate 1/2, length 7, and Reed-Solomon outer code. Findings were that while the error rate on the inner code could be as high as about 1.5 percent at high SNR for the VLA signal processed in a stand-alone mode, the error-correction capability of the outer code would yield error-free performance comparable to standard performance, with less than 1 dB penalty. The projected design would perform somewhat better, at a typical symbol SNR (SSNR) of 3 dB, with equal contributions being made by the VLA and the Goldstone complex in the combining process. In this case, the convolutional bit error rate (BER) would be on the order of 0.001 percent, with an error-free threshold penalty of about 1/2 dB. Follow-up analysis was reported in [16].

Given confidence that the concatenated coding would bridge the gap, the VGTA Project went forward, undertaking a hardware evaluation of the gap effect, beginning late in 1985 and continuing through most of 1986. This evaluation consisted of a simulation of the partially gapped data stream processed through the telemetry system at the DSN Compatibility Test Area (CTA 21), followed by Reed-Solomon decoding and evaluation by the Voyager Project ground data system. Convolutional decoding results confirmed the modeling within statistical tolerances,<sup>9</sup>

<sup>9</sup> S. S. Kent, "VGTA Gap Testing at CTA 21," JPL IOMs 3393-86-22, 23, 33 (internal documents), Jet Propulsion Laboratory, Pasadena, California, March 1986.

and the Reed-Solomon threshold proved to be within the 1/2 dB model.<sup>10</sup> The "better than theory" conclusion for all these results, including the ungapped baseline, cast some doubt upon the calibration and, hence, upon the validity of the results. This discrepancy of a fraction of a decibel was later resolved as a misinterpretation of the analytical model with respect to the Reed-Solomon coding overhead factor.

One result of this simulation activity was greater concern at JPL regarding the expected impact of the data gap upon VGTA performance. On one hand, some Voyager planners learned of the gap for the first time, and on the other, the VGTA Project discovered that, while all of Voyager's Neptune data rates were doubly encoded, one-third of the 21.6-kbps frame was without Reed-Solomon protection. This segment consisted of uncompressed playback data from Voyager's tape recorder and was a prime consideration in the encounter data-recovery strategy. It was somewhat reluctantly accepted that there would be some snow<sup>11</sup> in the playback images (which were interlaced with error-free real-time images), depending upon Goldstone SSNR during the gap. Evaluation of actual performance would await the VLA stand-alone recordings of 1987 and the Neptune Dual Processor Program (NDPP) tests of 1988, discussed in Section V. Table 2 summarizes the results of modeling and simulation.

#### D. Satellite Communications Link

The long VGTA baseline led to consideration of a satellite communications link for transporting the telemetry data in real time from the VLA to Goldstone. A terrestrial microwave link in Australia for the Uranus encounter had performed exceptionally well, with less than 0.1 dB data degradation attributable to the microwave link. Based on the PCTA link performance, it was expected that a "video" satellite link would perform as well as the terrestrial microwave link had in Australia.

To verify the performance of a video link, the RCA Earth station located at Goldstone was used to make round-trip measurements to and from a domestic satellite. This link was normally used for space shuttle video transmissions. Tests were conducted to determine the round-trip time delay, the square-wave frequency response, the amplitude response, and the noise spectral density of the passband from 0.1 MHz to 7.0 MHz.

<sup>10</sup> S. Howard, *The VLA-Goldstone Telemetry Array* (internal document), Jet Propulsion Laboratory, Pasadena, California, February 5, 1987.

<sup>11</sup> Bit error rates in the range of 0.001 to 1 percent.

Additional testing was conducted by sending simulated telemetry data from Goldstone Signal Processing Center (SPC 10), via a fiber-optic link, to DSS 16 (the 26-m antenna) for transmission to the satellite and return to SPC 10, then measuring data degradation in terms of bit-error-rate performance. Results showed degradation to be less than 0.1 dB,<sup>12</sup> which had also been experienced in Australia. With DSS 14 (a 70-m antenna) simulating the VLA, DSS 15 (a 34-m antenna) simulating DSS 14, and with the RCA satellite link at DSS 16, the Voyager 2 spacecraft was tracked to demonstrate system performance.

Based on these results, a VGTA system requirements document<sup>13</sup> was developed and a contract awarded for a fully redundant link to include both dedicated transponders and Earth stations at each site. While the contractor resolved initial start-up problems of reliability and operability, extensive testing was conducted to determine link performance. After adding special 4.5-MHz low-pass nine-pole elliptical filters at both ends of the link to optimize the frequency response, expected results were obtained, with degradation of less than 0.1 dB.<sup>14</sup>

Because of the exposure to the New Mexico elements, particularly the wind, the VLA transmitting antenna was securely mounted on a concrete pad to ensure stability. The remainder of the equipment was housed in a transportable trailer. At Goldstone, the receiving antenna was also securely mounted on a concrete pad. The remainder of the equipment was housed within the SPC 10 communications facility. Link operating frequencies and siting considerations at the VLA were analyzed for possible radio-frequency interference with VLA operations.

#### E. Radio-Frequency Interference

Radio-frequency interference (RFI) could impact the reception of Voyager telemetry at any receiving site at any time, and while not specifically identified as a design issue, RFI was closely related to the HEMT low-noise amplifier (LNA) use and to the presence of the satellite communications transmitter.

Interference can occur from authorized emissions in or adjacent to the deep space frequency band, and also from

<sup>12</sup> S. S. Kent, "RCA Satellite Voyager Simulated Data Test Results," JPL IOM 3393-87-51 (internal document), Jet Propulsion Laboratory, Pasadena, California, March 31, 1987.

<sup>13</sup> *VGTA System Requirements, VLA-Goldstone DSN Intersite Communications*, Document 1220-5 (internal document), Jet Propulsion Laboratory, Pasadena, California, August 1, 1987.

<sup>14</sup> S. S. Kent, "VGTA SATCOM Test Results of 10/19/88," JPL IOM 3393-88-118 (internal document), Jet Propulsion Laboratory, Pasadena, California, October 26, 1988.

spurious emissions within the band or at subharmonics thereof. However, frequency coordination procedures can prevent RFI from fixed transmitters that share the 8400-MHz to 8450-MHz frequency allocation. JPL and NRAO frequency coordinators can also manage to control, or at least limit, RFI from spurious emissions in this band through knowledge of, and coordination with, operators of potential emitters. At the VLA, frequency coordination with the White Sands Missile Range and several Air Force bases eliminated potential RFI from fixed and airborne transmitters during Voyager operations.

Radio astronomy requires wideband receivers, so the NRAO designed the HEMT front ends with instantaneous bandwidth from 7.9 to 8.9 GHz, which means the gain and noise performance degrade slowly below and above this range. Consequently, very strong signals in the 7.5- to 9.5-GHz range could interfere with the Voyager signal through gain compression or intermodulation in the wideband VLA front end.

Coordination with the nearby Langmuir Laboratory for Atmospheric Research of the New Mexico Institute of Mining and Technology (NMIMT) and with the National Center for Atmospheric Research (NCAR) avoided a potentially serious RFI problem during the two months around Neptune encounter. During joint NMIMT and NCAR radar measurements of thunderstorms, NCAR flew its airborne 9.4-GHz radar at distances adequate to avoid damaging the VLA HEMT front ends. Both organizations ceased emitting during the hours of VLA preparation for and reception of Voyager telemetry. Earlier tests had confirmed that the NMIMT 9-GHz fixed radar, located at a 10,000-foot elevation and 43 km from the VLA center, would not damage the VLA HEMT front ends.

Much closer to home, JPL and NRAO eliminated spurious RFI emitters located at the VLA. Most notably, the exciter in the 6.3-GHz transmitter of the communications satellite link to Goldstone produced spurious emissions within several of the VLA radio astronomy frequency bands and at subharmonic frequencies.

From the beginning, the NRAO had expressed concerns about radio interference originating from an Earth station transmitter located in the vicinity of the 27-antenna array. The VLA frequency bands ranged from P-band through Ka-band, covering the frequency range of 0.3 GHz to 24.0 GHz; satellites operate in either C-band (5.925 to 6.425 GHz) or Ku-band (14.0 to 14.5 GHz).

Examination of the above bands showed the potential for direct interference in the Ka-band if the satellite oper-

ated in the lower portion of C-band, and in the Ku-band if the satellite operated in the upper portion thereof. Thus, the lower portion of C-band and upper portion of Ku-band were to be avoided in selecting the satellite transmitter frequencies. The actual frequencies used were in the C-band at 6.385 GHz (primary) and 6.345 GHz (backup).

This selection of frequencies presented no direct interference potentials for any of the VLA bands. However, the fourth harmonics of these did fall close enough to the Ka-band to cause the NRAO to impose effective isotropic radiated power (EIRP) limits on the level of maximum transmitter radiation in the band from 24.50 to 24.70 GHz. The limits imposed were  $-7$  dBW maximum total power in any 500-MHz band, with the satellite antenna to be located at least 150 meters from the nearest of the VLA antennas. Through the use of a fourth-harmonic filter in the output of the high-power transmitter, the estimated EIRP was  $-9$  dBW with a transmitted power level of 750 watts at C-band.

Although concerns about the direct interference had been resolved, the effects of exciter reference frequencies of 329.53125 and 321.03125 MHz remained questionable. Computations of possible interfering harmonic frequencies showed the potential for interference in several of the VLA bands.

Shortly following the transmitter installation, testing at the transmitter for spurious radiation levels showed that indeed there was potential for interference in both P-band (90 cm) and L-band (18 to 21 cm). Although some tests were conducted by normal VLA observation with favorable results, it was not feasible to scan the number of potential interfering frequencies with sufficient sensitivity in a reasonable period of time. The NRAO therefore conservatively imposed restrictions on the use of the transmitter "during all scheduled VLA observing at P-band and at L-band in spectral line mode and for long integration continuum observations."

Since this restriction imposed hardships on the ability to test and maintain the VGTA, further studies were conducted with the view of RFI shielding of the exciters. These studies concluded that additional shielding of at least 30 dB was required over the range of frequencies from 300 MHz to 1.4 GHz. Such an enclosure, with certified compliance to specification, was installed, yielding the confidence to remove the exciter operating restriction. This significantly enhanced the reliability and operating convenience of the link by permitting continuous operation during the summer months of weekly, and then daily, Voyager passes.

## F. VLA Facilities Augmentation

Electrical power reliability and the addition of real-time communications capability to transmit the data to the Goldstone Communications Complex were facilities changes anticipated in the VGTA Management Plan. Deterioration of the on-site power-distribution cables, as well as the need to increase the level of lightning protection, became additional challenges for the JPL-NRAO management team that were not envisioned at the outset. Each issue was resolved and the facilities were augmented to provide the level of reliability and service necessary to support the required availability figure.

VLA site personnel reported experiencing commercial power outages and fluctuations during summer thunderstorms or high-wind conditions associated with winter storms. The VLA site was instrumented in 1985 to determine the extent of the outages. With only one year of data, it became clear that the commercial power regularly dropped below 100 volts, a condition below the operating limits of the JPL electronic equipment to be used during encounter. Weather data correlated well with the frequent voltage transients and outages that occurred during inclement weather conditions.

DSN-standard power quality was required at the VLA site to support the encounter. An operational power system was located in Idaho and purchased in 1987 for the VLA application. The installation at the VLA was designed and installation completed in 1988 as a cooperative effort between the VLA facilities organization and JPL's Ground Antennas and Facilities Engineering Section.<sup>15,16</sup> The shortcomings of the existing commercial power system were overcome by installing two diesel-engine-driven generators, each rated to deliver 1,400 kW. Although one generator alone can normally supply the total power required, the two generators operated in parallel, each at 50 percent of rating. If a problem should cause automatic shutdown of either of the engine generators, the remaining generator would be fully capable of carrying the total power load of the site. This is the established mode of operation throughout the DSN, and it is referred to as "spinning reserve" mode.

The insulation on the direct burial cables that distribute power throughout the VLA site was gradually de-

teriorating, precipitating shorts to ground. Depending on the short location, as much as a whole arm of the "Y" could be taken out of service until the short was located and the faulty cable section was replaced. The one to two days to repair the fault were clearly in excess of the allowable mean-time-to-repair goal supporting the required availability figure. Special funding was obtained to replace the aging cables to the limit of "Y" utilization by the Voyager support configuration [17]. Replacement was completed in 1988.

Lightning struck on July 5, 1988! Evidence indicated that lightning entered the control building through an unprotected whip antenna, damaging several computers and disrupting telephone service. The adequacy of lightning protection was reviewed by an JPL/NRAO team, representatives from the Langmuir Laboratory for Atmospheric Research, and the Kennedy Space Center Lightning Safety Committee.<sup>17</sup> In addition to existing lightning rods on the control building, a lightning air terminal system above both the control building and satellite link terminal was recommended. Line suppressors and filters on all power, control, and data lines as they entered the control building or satellite terminal were to be added. The VLA facilities organization carried out the recommendations.

Lightning does strike twice. A videotape of the control building during a violent thunderstorm in August 1989 suggests that the newly installed lightning air terminal system intercepted a direct lightning strike and protected the installation without a detectable power surge or damage to equipment.

## G. System Availability

While an interagency array availability requirement of 80 percent was imposed for the PCTA Uranus-encounter configuration, the favorable experience for that encounter led to an implicit design goal on the order of 90 percent for the entire VGTA for the Neptune encounter. By applying the 98-percent requirement at both the VLA and Goldstone to the added telemetry-processing equipment at both sites, by setting a similar goal for the VLA "common" system, and by working to a goal of 99 percent for 25 out of the 27 VLA antennas on-line, an overall design expectation of 92 percent was established, subject to potential additional autophasing losses during bad weather.<sup>18</sup>

<sup>15</sup> J. Dorman, *Very Large Array Power System Facilities, Voyager-Neptune Encounter—1989 Implementation Plan* (internal document), Jet Propulsion Laboratory, Pasadena, California, February 11, 1987.

<sup>16</sup> *JPL-VLA Equipment Transfer Agreement For the VLA Power System Facilities* (internal document), Jet Propulsion Laboratory, Pasadena, California, January 31, 1989.

<sup>17</sup> R. Perley and K. Bartos, "Assessment and Recommendations Concerning VLA Site Lightning/Grounding Protection," JPL IOM 3330-88-018 (internal document), Jet Propulsion Laboratory, Pasadena, California, August 23, 1988.

<sup>18</sup> *VGTA System Requirements and Design*, Document 1220-2 (internal document), Jet Propulsion Laboratory, Pasadena, California, September 15, 1987.

Throughout the implementation, system reliability was given special attention. Not only were the existing and the new equipment scrutinized, but spares, mean time to recovery, and operational procedures were studied. It was not at all clear that some 30 antennas could be confidently and repeatedly sustained and operated, given the diverse geographical and organizational aspects of the array. NRAO studies [18] identified areas in need of additional sparing; the NRAO also planned modes of operation so as to achieve maximal redundancy. For example, all four VLA intermediate-frequency channels were included in the Voyager-encounter design to support spacecraft failure modes resulting in left-circular polarization and to provide a spare channel for each polarization of the 27 antennas—108 channels.

In aiming for a 98-percent availability of the VLA common system, the provision of on-site primary power and the additional lightning protection described above were critical factors. Examples of sparing actions were the provision of a spare on-line computer to support the multi-computer upgrade that the NRAO was concurrently (1986–87) undertaking and of a JPL-supplied “hot backup” rubidium frequency standard. Redundant on-line equipment was provided for virtually all the Goldstone array equipment as well as for all of the telemetry equipment at the VLA, with the exception of the receiver, which was fully spared and of a well-proven design.

All of these preparations, as well as the proficiency of the NRAO and DSN operations personnel at the VLA and Goldstone and of the special support personnel standing by at both sites, paid off handsomely. Several measures of the availability of the VGTA and PCTA arrays reported by the DSN were all in excess of 99 percent of the data reaching the ground. As for the VLA signal to the DSN interface, for the 40 passes from April 26 through September 28, 1989, the availability was 99.959 percent, with 25 antennas available 99.989 percent of the time [19].

#### IV. Implementation

The JPL implementation manager, functioning as a task manager in the line organization, had budgeting, scheduling, and reporting responsibilities for both the VGTA and PCTA implementations of the JPL subsystems. This included planning and scheduling coordination with both the NRAO and CDSCC, as well as project engineering functions for the VLA facilities augmentations in which JPL was involved. The overall VGTA implemen-

tation was covered in one internal document,<sup>19</sup> with the JPL subsystems detailed in another.<sup>20</sup>

For the VGTA, the VLA-Voyager preparation manager and the Central Development Laboratory (CDL) manager had responsibility for work undertaken by the NRAO. Implementation by the NRAO included design, fabrication, scheduling, installation, testing, training, and operations according to the *Management Plan for the VLA-GDSCC Telemetry Array Project*<sup>21</sup> and the *VLA Implementation Plan, VLA-Goldstone Telemetry Array* [20]. The CDL plan for the low-noise front ends is given in [21]. Installation into the VLA system was achieved with minimal disruption to mechanical and electronic systems, maintenance, upgrades, and observing schedules. The VLA observing schedules included normal testing of X-band as a standard VLA observing band, and periodic VGTA performance testing, as well as testing of the operational telemetry reception from Voyager.

The principal design changes for Neptune encounter, applicable to both the VGTA and PCTA, are briefly outlined below as an update to [2].

##### A. JPL Software

The PCTA Uranus-encounter implementation used integral microprocessor computers to perform all of its control and monitor functions. While the assemblies all ran ROM-based firmware, the array controller contained floppy disk drives that ran the operating system. The PCTA software, written in Pascal, was developed in the array controller. While this software/firmware system worked, it had many difficulties. The Pascal compiler errors were numerous, and much time was spent finding workarounds for them.

Since much of the software and firmware had to be modified for the VGTA Project, IBM PCs were employed as the control terminals to enable Microsoft “C” to be used as the programming language. Several problems were successfully solved so that the IBM PC/“C” language could be used in conjunction with the 8086 multibus system used in most of the hardware assemblies. Real-time interrupts were handled through the use of simple assembly language

<sup>19</sup> *Project Implementation Plan for the VLA-GDSCC Telemetry Array*, Document 1220-7 (internal document), Jet Propulsion Laboratory, Pasadena, California, November 15, 1987.

<sup>20</sup> H. Cooper, *VGTA/PCTA Implementation Plan* (internal document), Jet Propulsion Laboratory, Pasadena, California, January 20, 1987.

<sup>21</sup> *Management Plan for the VLA-GDSCC Telemetry Array Project*, Document 1220-1 (internal document), Jet Propulsion Laboratory, Pasadena, California, March 15, 1985.



routines that vectored the interrupt to the desired "C" routine and then performed the required end-of-interrupt operations. Several other problems were solved by using special utility programs [22]. A large benefit of the "C" language was that it resulted in a 20-percent decrease in code size with a 50-percent increase in speed.

## B. PCTA X-Band Front End

Arrangements were made with the European Space Agency (ESA) to borrow the dual-maser X-band front end that had been shared at Parkes for the Voyager-Uranus and Giotto-Comet Halley encounters. This consisted of a CSIRO-designed feedhorn, JPL-supplied waveguide assemblies, and ESA-procured traveling-wave masers of JPL design. Reimplementation for the Neptune encounter included an extensive refurbishment of the maser amplifiers, and new monitor and control equipment based upon standard DSN designs [4]. Custom features included remote monitoring of cryogenic functions to Tidbinbilla to facilitate maintenance during unattended periods and a noise-adding radiometer for antenna-pointing calibrations.

The Parkes telemetry implementation was coordinated with the Radio Science open-loop recording installation, sharing facilities and the X-band front end [23].

## C. Telemetry Receiver

The same basic receiver that was used for the Uranus encounter was also used for Neptune. Owing to the increased space loss (3.5 dB), the increased Doppler velocity change (350 kHz versus 120 kHz), and the increased acceleration (75 Hz/sec versus 9 Hz/sec) at encounter, some design changes had to be made in the receiver to accommodate the received signal.

The receiver was originally designed to operate at the Parkes facility in Australia, receiving an input signal at about 315 MHz that had been down-converted from X-band. This design was again employed for use at Parkes; however, at the VLA, the interface from the VLA receiver to the DSN receiver was made at a frequency of about 18.75 MHz. To accommodate this interface, an up-converter was designed to accept the 18.75-MHz signal and provide a signal at 315 MHz for input to the receiver.

The VLA was fixed-tuned for each pass at a frequency placing the received spectrum within special 8-MHz band-pass filters within the available 0-MHz to 50-MHz pass-band. The frequency of 18.75 MHz was chosen with consideration for aliasing of the VLA sampling response as well as of the following up-conversion process.

The acceleration rate of 0.9 Hz per second at Uranus allowed the existing 10.8-Hz loop bandwidth to be used. A bandwidth of 21.6 Hz was added for use at the Neptune encounter. This bandwidth provided the best compromise between loop SNR and acceleration capability. The increased Doppler change during encounter made it mandatory to program the first local oscillator of the receiver. This was done by inputting discrete ramps into the local-oscillator synthesizer. The ramp rate was determined by sampling the phase error in the loop and then applying the ramp to maintain this error at less than a preset amount.

For the Uranus encounter, predicted frequencies were input in the standard DSN format.<sup>22</sup> Since that format bore little relation to the Parkes receiver configuration and because of the added operational needs at the VLA, requirements were placed on the DSN Network Operations Control Center (NOCC) Support Subsystem to generate predictions for all interagency sites at the X-band received "sky" frequency. The VGTA/PCTA receiver acquisition design was modified to operate principally in this mode. Other options were provided, including the use of actual VLA/Parkes interface frequencies. These changes greatly facilitated operating procedures and improved acquisition times. Given any of the input options, the receiver would automatically acquire the spacecraft signal upon command.

## D. Very Long Baseline Combiner/ Long Baseline Combiner

The function of the baseband combiners included

- (1) ephemeris-driven differential delay to time-align the two baseband signals
- (2) cross-correlation of the two to measure the residual error in alignment
- (3) loop closure to track out this error
- (4) summation of the two data streams, after appropriate weighting according to the prevailing input SNRs

The combiners for Neptune were basically the same as at Canberra for the Uranus encounter, with the addition of more static delay at Goldstone to take into account the satellite-link delay from the VLA, an increase to four times the dynamic delay range for the longer VGTA baseline, and adjustment of the loop parameters, primarily to accommodate the lower input SNRs of the PCTA. The combiners for the two arrays were essentially identical but

<sup>22</sup> Track synthesizer frequency (TSF) and Doppler frequency.

for an outboard static-delay unit in the VGTA Very Long Baseline Combiner.

As related elsewhere in this article, power-level compensation during the VLA gap was required to optimize the bit error rate. Since the output data power level of the combiner resulted from summation of the VLA and Goldstone signals, the drop in data level during the gap depended upon the actual signal-to-noise ratio difference between the two complexes. Compensation was added immediately following the combiner and was synchronized to the gapped waveform. Several values of gain were provided. The level was set for a compromise between a constant noise power level for the demodulator-synchronizer and a constant signal power level for the decoder.

To meet reliability requirements, a backup combiner and compensator were operated in parallel with the operational equipment. In the event of problems with the on-line combiner, the backup combiner could be selected from the control terminal through appropriate commands.

### E. Test-Signal Generation

For the Uranus encounter, the test-signal generator (TSG) provided test signals at baseband and at 315 MHz. This made testing possible at the inputs to the receiver, the combiner, and the recording equipment as well as modulation of the X-band signal generator at Parkes for testing the complete system. The capability to add noise to the appropriate signals was incorporated into the TSG so that testing could be done at anticipated signal-to-noise levels. Ranges of SNR and power were designed to simulate encounter levels and provide  $\pm 10$ -dB margins. Having two baseband channels permitted dynamic simulation of the differential signal delay in combiner testing.

For the Neptune encounter, the TSG was modified to provide baseband signals only, with associated noise. The 315-MHz and the 18.75-MHz signal-generation capability was built into the receivers, along with a minimal modulation capability, to permit stand-alone testing of the receivers.

A major change in the test-signal generation came about because of the use of the satellite link between the VLA and Goldstone. No longer was it practical to send the test signal from Goldstone to the VLA, inject it into the receiver, and then return the demodulated baseband back to Goldstone for combining, data reduction, and performance evaluation; this would require the use of a two-way satellite link. To save such costs, the TSGs at Goldstone and Canberra were modified to be synchronized to those

at the VLA and at Parkes, respectively, through the use of 1 pulse per second (pps) timing signals derived from stable frequency and timing standards at all four sites. Also incorporated into the system design was the ability to measure the time delay between sites through the use of the 1-pps signals, as was required for baseband combiner initialization. Knowledge of intersite timing offsets was maintained through the Global Positioning System (GPS). The requirement of 1  $\mu$ sec, to facilitate tape playback alignment, was readily met. An added feature was the ability to generate convolutionally coded data so that the VGTA/PCTA equipment could conduct self-test through the convolutional decoders.

To further simulate the signal received at the VLA, the test-signal generator in the VLA receiver was capable of creating the 1.6-msec gap in the data. This capability made possible testing of the gap effect on the performance of the receiver, the baseband combiner, and the symbol-stream recording and combining. A gap simulator was also provided at Goldstone to allow gap performance testing on a stand-alone basis. This capability proved very valuable during the evaluation of the gap power-level compensation.

### F. Symbol-Stream Recording and Combining

The backup recording identified in Fig. 1 was deemed necessary to achieve the required reliability of 98 percent for the added equipment at each site, including the communication link, by permitting post-pass playback of the tapes at Goldstone or Canberra. During the Uranus encounter, PCTA baseband recordings were made by utilizing modified Mark III Data Acquisition Terminals (DATs). Use of the DATs was justified largely on the premise that most radio astronomy facilities already had such devices, which could be simply and quickly accessed for arraying purposes without impairing VLBI usage.

In the meantime, development work was under way at JPL to demonstrate the feasibility of symbol-stream recording and combining. This approach offered several advantages, including a lower recording density requirement (because the subcarrier had been removed), permitting the use of standard computer-compatible tape. The equipment would also prove to be simpler and more reliable than the complex adaptations necessary to utilize the DATs. By 1986, a demonstration of the symbol-stream capability had been accomplished [24] and a plan developed to utilize this technique for both the VGTA and PCTA at Neptune encounter.<sup>23</sup>

<sup>23</sup> H. Cooper, *VGTA/PCTA Symbol-Stream Recording and Combining Subsystem (SSRC) Plan* (internal document), Jet Propulsion Laboratory, Pasadena, California, June 2, 1986.

Because of the high reliability requirements imposed on the equipment, redundant recording channels were implemented at all four sites. The option to record both the local and remote signals at Goldstone and at Canberra was designed into the assemblies. The ability to play back and combine existed at all sites, thus permitting self-test at each site as well as operational combining at Goldstone and at Canberra. This test feature was used extensively during test and training periods.

To record symbols, standard DSN demodulator-synchronizer assemblies were incorporated into the design so as to remove the subcarrier. This also provided the ability to make symbol SNR estimates at the VLA and at Parkes as well as estimates of the baseband combiner inputs and output, which gave a measure of the real-time system performance. To assure valid recordings, the symbol-stream equipment also made SNR estimations during recording, as well as upon playback and combining.

While limited system test time did not permit resolution of some operability problems, bit-error-rate performance met expectations (see Section VI). Very little operational experience was gained, as the excellent reliability of the real-time system obviated the need (and hence the opportunity) to exercise fully the backup system during the encounter phase. In any case, the benefits and advantages of symbol-stream recording were well demonstrated.

## V. VGTA Test and Operations

Monthly tests were performed at the VLA from mid-1985 through mid-1989. As described earlier, these tests concentrated on radio-frequency performance and array phasing in the period from 1985 through 1987. Late in 1987, these tests began to include more examination of the VLA back-end system and the DSN telemetry equipment. The term "back end" refers generally to the central control room electronics (intermediate-frequency channels, correlator, summers) and the on-line computer system (antenna control, autophasing, monitoring).

Following the Voyager-Uranus encounter in 1986, some of the Parkes arraying equipment was temporarily installed at the VLA, together with a DSN convolutional decoder and recording equipment, to get a sample of the "real" data gap to confirm the simulations described earlier. By late spring of 1987, recordings were made of the decoded Voyager data stream at 7.2 kbps, the highest rate available during the cruise phase. These recordings were returned to the Voyager Project for analysis. Since intersite communications and Goldstone combining were not available

at that time, the stand-alone data stream was evaluated because it was the best available first look at the true gap effect. Results were comparable to the modeled  $1.5 \times 10^{-2}$  error rate. The first look at combined data and at the encounter data transmitted at rates of 14.4 and 21.6 kbps would await the Voyager Neptune Dual Processor Program (NDPP) tests.

Late in 1987, as part of an ongoing NRAO activity, the VLA on-line computer system was upgraded. The new computers, which were faster and had more memory, provided more flexibility and power in a variety of tasks for controlling and gathering data from the array. They also had none of the crashes that were common to the old computers, which had significant communication problems among a number of processing units. However, as with any new system, there were significant hurdles to be overcome. Much of the test time during the first half of 1988 was devoted to finding bugs in the system and checking new features that had been added.

Perhaps the most significant bug encountered was the signal "dropout," first observed in December 1987 with the new telemetry receiver and the new on-line system. These outages showed a variety of characteristics, but typically lasted on the order of one second. The typical occurrence rate was every 10 to 15 minutes. Although such glitches are tolerable for radio astronomers since they cause only a slight degradation in SNR, they would cause large gaps in telemetry streams.

Before the operating-system bug causing these dropouts was found, the Voyager NDPP tests were supported at the VLA in July 1988. These tests involved five Voyager tracks in which both the VLA and Goldstone participated, both to support checkout of the spacecraft encounter mode and to perform a preliminary evaluation of the VLA-Goldstone array. Although the dropouts were a major embarrassment during the NDPP test, the test objectives were met by minimizing the number of tasks to be performed by the operating system, thus keeping the signal outages to a tolerable level.

While the overall arraying system was not as yet in a mature state, the NDPP tests served to validate several key performance factors, including the effective G/T (in telemetry terms) of the then-existing 20 VLA antennas at 8.4 GHz,<sup>24</sup> the quality of the satellite data link, and the real-time signal combining at Goldstone [25]. A specific objective of one test period was the validation of the Reed-

---

<sup>24</sup> The antennas were outfitted at the average rate of nine per year from 1986 to the end of 1988.

Solomon error-correction threshold as regards the partially gapped data stream. The model and simulations were verified.<sup>25</sup>

After months of intensive strip-chart and triggered scope monitoring of the VLA signal output and of the detected carrier, the cause of the dominant dropout was diagnosed and fixed in September 1988 by a single character correction in the operating-system code. A number of other, smaller spikes and keyboard-induced anomalies continued and were gradually abated before committed Voyager operations began.

Installation of the majority of the JPL equipment at the VLA and at Goldstone occurred in 1988. As each of the major assemblies was completed, it was subjected to system testing in the engineering lab and the CTA 21 test facility before being shipped to its final destination for integration and on-site system testing, as outlined in the *VGTA System Test Requirements* document.<sup>26</sup> These tests included validation of most of the functions that had been exercised in the monthly test periods at the VLA, as well as validation of the complete Goldstone arraying configuration.

Monthly tests done late in 1988 continued with a variety of goals. Training of DSN operations personnel began, and procedures were developed for use during the encounter period. Software features of the new VLA computer system, including system status displays designed specifically for JPL use,<sup>27</sup> were iterated monthly. Observations of the spacecraft were made on a regular basis. Tests frequently involved varying the number of active antennas being combined so that typical encounter SNRs could be simulated with the prevailing data rate and understanding of the system throughput could be confirmed. Tests of radio-frequency interference caused by JPL equipment, particularly the satellite transmitter that shipped data to Goldstone, were made to determine the level of caution that was needed during normal astronomical observing.

As 1989 began, there were still unfinished VLA software tasks and several continuing anomalies. As planned in 1987, a suite of tests was developed and performed on a

<sup>25</sup> S. Howard, *Evaluation of VLA-Goldstone Telemetry Array Performance During the NDPP Test, 1988*, Document D-6112 (internal document), Jet Propulsion Laboratory, Pasadena, California, December 17, 1988.

<sup>26</sup> *VGTA System Test Requirements*, Document 1220-6 (internal document), Jet Propulsion Laboratory, Pasadena, California, November 1, 1987.

<sup>27</sup> *VGTA System Requirements and Design*, Document 1220-2 (internal document), Jet Propulsion Laboratory, Pasadena, California, September 15, 1987.

monthly basis; these tests followed the regular VLA software updates. Since freezing the VLA system for nine months was an unacceptable option, this set of tests served to verify that performance was proper in all items relevant to Voyager tracking. Relatively minor software changes were made for JPL purposes, in addition to other changes for astronomical use prior to the three-month software freeze for the encounter period.

One of the most significant continuing problems was the "anomalous BER,"<sup>28</sup> which occurred at high SNRs and had convolutional bit error rates (BERs) an order of magnitude or two higher than the model and early simulations would indicate.<sup>29</sup> As noted above, this would not degrade the Reed-Solomon threshold significantly, but the playback portion of the 21.6-kbps frame would be hit with more errors than expected. Immediately following the NDPP test, Voyager analysts made the discovery that all the errors were occurring during a gap—furthermore, at the end of the gap. Because the early simulations were performed at somewhat lower SNRs, which were nearer the system design point, it was not clear whether or not the problem might have been overlooked in the simulations. Consequently, while the system was being otherwise finalized, simulations were renewed at both CTA 21 and Goldstone, concentrating on the effect of the drop in total power level (as well as in SNR), during the gap, upon the DSN telemetry string.

By early 1989, a gap-triggered gain changer (gap power-level compensator), located between the baseband combiner and the decoder, was producing ideal performance at 7.2 kbps—again, the highest currently available rate. The opportunity to check performance at 14.4 and 21.6 kbps was awaited with high expectations as the encounter phase approached. But, alas, the compensation was not very effective at rates above 9.6 kbps. The system would fully meet requirements in the predominant Reed-Solomon mode, while the playbacks, although not meeting full expectation, would be processable and scientifically useful. Final acceptance of the VGTA system was based upon successful tracking of the Voyager 2 spacecraft, combining of the baseband and symbol-stream data at Goldstone, and delivery of the data to the Voyager Project, thus demonstrating that performance was within specifications.

Continued vigilance with the strip-chart recorder paid off spectacularly in May. One small oddity led to the realization of a timing problem immediately following the gap. The antenna phase switchers were being turned back on a

<sup>28</sup> First noted during the NDPP test at 14.4 kbps.

<sup>29</sup> S. Howard, *op cit.*

bit too late. The 280  $\mu$ sec or so of full noise, but no coherent VLA signal, was being bridged at the lower rates, but not at 14.4 kbps and higher. As was the case with the dropouts (discussed above), this had been a negligible SNR effect for astronomy. The NRAO proposed a succinct plan to fix the problem, complete with fallback plans to be used in the event of an unforeseen problem. By mid-June, with the fix,<sup>30</sup> the 21.6-kbps BER was as modeled. The playback errors would be minimal, as initially expected!

As noted above, VLA and DSN operations personnel had been heavily involved in the final stages of implementation and testing. Operations staffing consisted of two dedicated DSN personnel at each site, in addition to shift operators, all of whom were experienced in VGTA operations prior to the encounter phase. During critical operations, supporting specialists were available at the VLA and at Goldstone on short notice. Operations planning and other considerations, including intersite voice and predict transmission, are discussed elsewhere.<sup>31</sup>

From January through May 1989, a number of mission-readiness tests were performed to check the overall system preparation and the operating procedures. These tests also constituted the final training opportunities for the operations personnel in all their areas of responsibility, including items such as preparing the configuration files that controlled the VLA, monitoring the VLA performance, maintaining the operational status of the JPL equipment, transmitting data to Goldstone for combining, and making backup recordings of the data stream. These tests were successful and led naturally to delivery of the first committed Voyager data late in the spring of 1989.

A tribute to the thoroughness of the system testing is that it uncovered shortcomings early enough to enable corrective actions far enough ahead of the critical tracking periods to provide the confidence and the assurance that the data reception during encounter would be successful.

## VI. Telemetry Performance

Three fundamental measures of performance used to characterize the arrays were

- (1) front-end G/T, referenced to known radio sources
- (2) symbol signal-to-noise ratio (SSNR)

<sup>30</sup> A simple wiring change at each antenna.

<sup>31</sup> *Operations Planning for the VLA-GDSCC Telemetry Array*, Document 1220-8 (internal document), Jet Propulsion Laboratory, Pasadena, California, October 1988.

- (3) convolutional decoding bit error rate, measured as the error-correction rate in the Reed-Solomon decoding process

Two other measures were the estimation of the carrier-to-noise-density ratio and of the bit signal-to-noise ratio. These estimations were considered secondary, especially in the VGTA case, wherein the gapped signal caused errors of as much as one dB and more.

The front-end G/T was discussed in Section III; the following paragraphs summarize the telemetry performance.

### A. SSNR Performance

The first function of the symbol-stream recorders (see Fig. 1) at each site was baseband demodulation to detect symbols for recording. The demodulators also measured SSNR by means of "split-symbol moment estimation." In addition to serving the recording function, these demodulators thus provided the primary real-time performance data type. Similar units were a part of the standard processing stream and therefore provided a measure of the combined SSNR. The accuracy of the estimates was derived from calibration (at CTA 21) against the symbol error rate of a known sequence. With averaging, this accuracy, over the range of interest, was 0.1 to 0.2 dB. Table 3 presents typical performance at midpass for both arrays on two different days of the year (DOY) in 1989. As indicated, both arrays typically employed the 34-m high-efficiency (HEF) antennas at each DSCC; they occasionally included the 34-m standards, whose contribution was normally not required.

The VLA's observed performance typically exceeded that set out in the baseline design<sup>32</sup> by the factor of

$$\left[ \frac{62}{60} \text{ (efficiency)} \right] \times \left[ \frac{35}{32} \text{ (temperature)} \right] \\ \times \left[ \frac{26}{25} \text{ (available antennas)} \right] = 0.7 \text{ dB}$$

which, subtracted from the average residual in Table 3 of +1.2 dB, yields an inferred positive residual of 0.5 dB for the received Voyager signal, assuming that the pointing loss, combining loss, and receiver losses were nominal: 0.2, 0.1, and 0.4 dB, respectively. Calibrations of the intersite

<sup>32</sup> *VGTA System Requirements and Design*, Document 1220-2 (internal document), Jet Propulsion Laboratory, Pasadena, California, September 15, 1987.

link indicated losses of 0.1 dB or less, within the absolute uncertainty of the estimators. Observations of Voyager made at the VLA (independent of telemetry performance) during the early test phase would corroborate a stronger Voyager signal than predicted.

Subtracting this inferred 0.5 dB from the average Parkes residual of +0.3 dB suggests a shortfall in Parkes G/T of 0.2 dB, which is consistent with a reported typical system temperature of 23.5 K versus the design value of 22 K.<sup>33</sup> The reported antenna gain of 71.6 dBi at a 45-degree elevation angle is consistent with the baseline design value of 71.2 dBi at the Voyager elevation angle.

Similar reasoning suggests G/T actuals of +0.3 dB for CDSCC (70-m antenna + 34-m HEF antenna) and of +0.6 dB for GDSCC, as compared with the respective design values.<sup>34,35</sup> These deltas are partially explained by the known pessimism in the gain values for the 34-m HEF antennas in the referenced documents. A further consideration in this analysis may be differing star-calibration references used by the VLA and the DSN.

The typical indicated combining loss was 0.2 dB, which was the design goal but which was subject to the uncertainty of three simultaneous estimators. Losses of 0.1 dB or less were observed under closely controlled preshipment tests at JPL.

## B. Weather Diversity

The estimated SSNR of the combined signal at each complex was made available in real time to the Voyager Project, where it was plotted in conjunction with the bit error count as derived from the Reed-Solomon error-correction process (see Figs. 2 and 3). The bit error rate can be approximated by dividing the count by the bit rate times 48, the averaging time in seconds.

One of the virtues of arraying geographically separated sites is the protection offered against inclement weather. Figure 2 shows the performance for DOY 222 for most of the U.S. and Australian viewing period. The pass began with severe weather-caused degradation at Goldstone, such that for approximately two hours the VLA stand-alone signal was processed at the data rate of 14.4 kbps. The saturated correction count in that period reflects the

$1.5 \times 10^{-2}$  error rate of the gapped VLA data stream. As this signal format was fully coded, no data degradation was suffered. The full array of VLA + 70-m antenna + 34-m antenna was resumed for most of the pass after the weather cleared.

Shortly before the handover to Australia, the spacecraft sequenced to a data rate of 21.6 kbps, with expected PCTA performance. About three hours later, rain at Tidbinbilla took the system below the SSNR threshold of 0 dB, yielding uncorrected bit errors in the playback data as well as exceeding the Reed-Solomon error-correction threshold. Unfortunately, the Parkes contribution was insufficient to maintain adequate margin.

A few days later, as shown in Fig. 3, margins were maintained throughout, despite very severe weather at the VLA. The rise of correction rates at both ends of the Goldstone pass reflects the effect of the low elevation angle on the Goldstone SNR during the VLA data gaps in the manner expected. The SSNR shows a higher short-term variance than appears in Fig. 2, owing to the shorter integration times of the estimates. Figure 4 repeats the first half of Fig. 3(b), showing in more detail the constituent SSNRs. With a threshold of 0 dB, the Goldstone array (bottom trace) could have supported reception alone for about three hours (during midpass). On the other hand, the VLA alone would have supported real-time imaging for all but about one hour, although the unprotected playback data would have been severely impacted. With Goldstone and the VLA working together, support was 100 percent throughout, as evidenced by the low correction count of Fig. 3(a).

Figure 4 is taken from plotted data generated at Goldstone in real time. To provide visibility into the arraying operation, such plotting capability was implemented for each combining site. Four-color plots were generated, indicating the estimated SSNR of each complex and of the combined data stream, as well as the computed ideal sum of individual streams. Because the plots were updated several times per minute, they provided operations personnel with an immediate visual indication of the arraying operations' status. They also served, as indicated by Fig. 4, as an efficient means of after-the-fact engineering analysis.

Finally, Fig. 5 plots the VGTA performance on encounter day, with the several data rate changes. Weather and performance were flawless. By comparing the several traces, it was readily possible to distinguish between site anomalies and spacecraft maneuvers, which occurred at about 05:40 and 06:20 hours UT (Earth receive time).

<sup>33</sup> *PCTA System Requirements and Design, Update for Neptune Encounter*, Document 1200-2A (internal document), Jet Propulsion Laboratory, Pasadena, California, July 15, 1988.

<sup>34</sup> *Ibid.* [Reference is to entire document.]

<sup>35</sup> *VGTA System Requirements and Design*, Document 1220-2 (internal document), Jet Propulsion Laboratory, Pasadena, California, September 15, 1987.

### C. Bit-Error-Rate Performance

Table 4 lists the bit-error-rate performance for the VGTA under several typical conditions and as a function of time as the system was optimized. (The successive improvements were described under the "VGTA Test and Operations" section.) The domain<sup>36</sup> of the anomalous BER is noted in Table 2, which summarizes the design expectation. Final performance met or exceeded the expectation in all respects.<sup>37</sup>

The symbol-stream performance was initially equivalent to that achieved with the gap power-level compensation of the real-time system. The implication here was that the symbol-combiner-to-decoder interface level was more gap-tolerant than the equivalent real-time path, where the demodulator-synchronizer intervened. Performance of the symbol-stream mode was expected to be improved at high data rates with the VLA timing fix, as was the real-time data mode. Once the encounter period began, the real-time reliability was so high that no playbacks were fully processed. Data for this period are indicated "N/A" in Table 4.

PCTA bit-error-rate performance was statistically equivalent to the prevailing bit SNR (SSNR + 3 dB) and therefore was not monitored in detail, other than through the routine operation of the Voyager Project correction count plotters (Figs. 2 and 3).

### D. Imaging

Figures 6 through 9 illustrate the final performance of the VGTA at 21.6 kbps, the most sensitive rate, both in margin and format. Figure 6 is the fully encoded real-

time image of Neptune received about midpass on the day before encounter. As expected with the full Reed-Solomon coding, the image is error-free. The convolutional bit error rate of  $3.7 \times 10^{-5}$  at the time of the image is somewhat greater than the  $2 \times 10^{-5}$  average value of Table 4. It is well within the typical variance of the decoding process.

Figure 7 is a raw playback image of Triton, taken early in the encounter pass and played back two days later, where the elevation angle effects at Goldstone, together with the VLA data gap, are degrading the bit error rate to  $1.7 \times 10^{-4}$ . In the original glossy photograph, perhaps two dozen errors are seen in the dark part of the field. Figure 8 is the same image after "de-spike" processing, a smoothing algorithm used in the Multimission Image Processing System. No hits are visible, and the apparent resolution is undegraded. These two figures show that the system performed in the worst-case mode (convolutional coding only) with minimal visual bit-error impact. Comparable images taken before the fixes indicated in Table 4 show considerable visual degradation. And finally, Fig. 9, showing a segment of Triton, is again a raw playback image, taken at about midpass. A few hits are visible.

## VII. Conclusion

The successful implementation and operation of the interagency telemetry arrays permitted Voyager 2 spacecraft operation at 21.6 kbps for the full view period when Voyager was over Goldstone and Canberra, with the usual DSN 90-percent weather confidence (approximately 2 dB margin) as well as weather diversity for more catastrophic conditions, at all data rates. Together with the expansion of the 64-m antennas to 70 meters, interagency arraying doubled the science-data return from the Voyager-Neptune encounter.

It was further demonstrated that, for a special event, the resources of diverse agencies could be melded successfully and with high operational reliability.

<sup>36</sup>High data rates and SNRs, with significant VLA contribution.

<sup>37</sup>S. Howard, "GDSE Final Test Report for the Near Encounter Test (NET): Final Evaluation of Interagency Array Support," JPL IOM Voyager-GDSE-89-033 (internal document), Jet Propulsion Laboratory, Pasadena, California, July 27, 1989.

## Acknowledgments

The results described in this article were made possible by the dedication and effort of the many individuals of the engineering and operations teams at JPL and at the four arraying sites. Special notice is due the NRAO Central Development Laboratory for the low-noise amplifiers, providing two decibels added margin over the original baseline design for the VLA, and to Steve Howard of the Voyager Project for his invaluable assistance in analyzing the bit-error-rate performance of the VGTA throughout the simulation and test phase.

## References

- [1] J. W. Layland, A. M. Ruskin, D. A. Bathker, R. C. Rydgig, D. W. Brown, B. D. Madsen, R. C. Clauss, G. S. Levy, S. J. Kerridge, M. J. Klein, C. E. Kohlhase, J. I. Molinder, R. D. Shaffer, and M. R. Traxler, "Interagency Array Study Report," *TDA Progress Report 42-74*, vol. April-June 1983, Jet Propulsion Laboratory, Pasadena, California, pp. 117-148, August 15, 1983.
- [2] D. W. Brown, H. W. Cooper, J. W. Armstrong, and S. S. Kent, "Parkes-CDSCC Telemetry Array: Equipment Design," *TDA Progress Report 42-85*, vol. January-March 1986, Jet Propulsion Laboratory, Pasadena, California, pp. 85-110, May 15, 1986.
- [3] *An Introduction to the NRAO Very Large Array*, R. M. Hjellming, ed., National Radio Astronomy Observatory, Socorro, New Mexico, April 1983.
- [4] D. L. Trowbridge, J. R. Loreman, T. J. Brunzie, and R. Quinn, "An 8.4-GHz Dual-Maser Front-End System for Parkes Reimplementation," *TDA Progress Report 42-100*, vol. October-December 1989, Jet Propulsion Laboratory, Pasadena, California, pp. 301-319, February 15, 1990.
- [5] R. Stevens, "Applications of Telemetry Arraying in the DSN," *TDA Progress Report 42-72*, vol. October-December 1982, Jet Propulsion Laboratory, Pasadena, California, pp. 78-82, February 15, 1983.
- [6] L. J. Deutsch, "An Update on the Use of the VLA for Telemetry Reception," *TDA Progress Report 42-72*, vol. October-December 1982, Jet Propulsion Laboratory, Pasadena, California, pp. 51-60, February 15, 1983.
- [7] J. W. Layland, P. J. Napier, and A. R. Thompson, "A VLA Experiment — Planning for Voyager at Neptune," *TDA Progress Report 42-82*, vol. April-June 1985, Jet Propulsion Laboratory, Pasadena, California, pp. 136-142, August 15, 1985.
- [8] J. W. Layland and D. W. Brown, "Planning for VLA/DSN Arrayed Support to the Voyager at Neptune," *TDA Progress Report 42-82*, vol. April-June 1985, Jet Propulsion Laboratory, Pasadena, California, pp. 125-135, August 15, 1985.
- [9] K. Bartos and W. D. Brundage, "The Voyager 2 Neptune Encounter, A Management Challenge," *PM Network*, vol. III, no. 4, Project Management Institute, Webster, North Carolina, pp. 7-21, May 1989.



- [10] S. Weinreb, H. Dill, and R. Harris, *Low-Noise, 8.4 GHz, Cryogenic GASFET Front End*, VLBA Technical Report No. 1, National Radio Astronomy Observatory, Charlottesville, Virginia, August 29, 1984.
- [11] S. M. Petty, J. Bautista, and J. S. Ulvestad, "Readying the VLA for Voyager's Neptune Encounter: Cryogenic Amplifiers and Arraying Tests," *JPL Highlights 1987*, JPL Publication 400-329, Jet Propulsion Laboratory, Pasadena, California, pp. 32-34, November 1987.
- [12] W. D. Brundage, *NRAO VLA-GDSCC Telemetry Array Project, Quarterly Status Report*, National Radio Astronomy Observatory, Socorro, New Mexico, April-June 1987.
- [13] F. Manshadi, D. A. Bathker, and H. W. Marlin, "VLA Feedhorn for Voyager Encounter of Neptune," *TDA Progress Report 42-86*, vol. April-June 1986, Jet Propulsion Laboratory, Pasadena, California, pp. 216-226, August 15, 1986.
- [14] J. S. Ulvestad, G. M. Resch, and W. D. Brundage, "X-Band System Performance of the Very Large Array," *TDA Progress Report 42-92*, vol. October-December 1987, Jet Propulsion Laboratory, Pasadena, California, pp. 123-137, February 15, 1988.
- [15] J. S. Ulvestad, "Phasing the Antennas of the Very Large Array for Reception of Telemetry From Voyager 2 at Neptune Encounter," *TDA Progress Report 42-94*, vol. April-June 1988, Jet Propulsion Laboratory, Pasadena, California, pp. 257-273, August 15, 1988.
- [16] S. J. Dolinar, "VLA Telemetry Performance with Concatenated Coding for Voyager at Neptune," *TDA Progress Report 42-95*, vol. July-September 1988, Jet Propulsion Laboratory, Pasadena, California, pp. 112-133, November 15, 1988.
- [17] W. D. Brundage, *NRAO VLA-GDSCC Telemetry Array Project, Quarterly Status Report*, National Radio Astronomy Observatory, Socorro, New Mexico, January-March 1988.
- [18] W. D. Brundage, *VLA-GDSCC Telemetry Array Project, VLA Reliability Review No. 1*, National Radio Astronomy Observatory, Socorro, New Mexico, May 2, 1986.
- [19] W. D. Brundage, *NRAO VLA-GDSCC Telemetry Array Project, Final Quarterly Report*, National Radio Astronomy Observatory, Socorro, New Mexico, July-October 1989.
- [20] W. D. Brundage, *VLA Implementation Plan, VLA-Goldstone Telemetry Array*, National Radio Astronomy Observatory, Socorro, New Mexico, September 29, 1987.
- [21] *NRAO Voyager Front-End Construction Plan, Revision A*, National Radio Astronomy Observatory, Charlottesville, Virginia, February 15, 1985.
- [22] H. W. Cooper and L. R. Hileman, "Software Development for the VLA-GDSCC Telemetry Array Project," *TDA Progress Report 42-87*, vol. July-September 1986, Jet Propulsion Laboratory, Pasadena, California, pp. 174-178, November 15, 1986.
- [23] T. A. Rebold and J. F. Weese, "Parkes Radio Science System Design and Testing for Voyager Neptune Encounter," *TDA Progress Report 42-99*, vol. July-September 1989, Jet Propulsion Laboratory, Pasadena, California, pp. 189-205, November 15, 1989.

- [24] W. J. Hurd, J. Rabkin, M. D. Russell, B. Siev, H. W. Cooper, T. O. Anderson, and P. U. Winter, "Antenna Arraying of Voyager Telemetry Signals by Symbol Stream Combining," *TDA Progress Report 42-86*, vol. April-June 1986, Jet Propulsion Laboratory, Pasadena, California, pp. 131-142, August 15, 1986.
- [25] R. L. Horttor, D. W. Brown, and K. P. Bartos, "Readying the VLA for Voyager's Neptune Encounter: System Test and Performance," *JPL Highlights 1988*, JPL Publication 400-350, Jet Propulsion Laboratory, Pasadena, California, pp. 88-89, February 1989.

**Table 1. Twenty years of telemetry arraying**

Mission	Date <sup>a</sup>	Location of antennas	Antenna types	Combiners <sup>c</sup>
Pioneer 8	1970	Spain	26-m + 26-m	Passive BB
Mariner Venus-Mercury (Mercury)	Sept. '74	U.S.	64-m + 2 (26-m)	R&D BB
Voyager 1 (Jupiter)	Mar. '79	U.S.	64-m + 34-m	RTC
Voyager 2 (Jupiter)	Jul. '79	U.S.	64-m + 34-m	RTC
Pioneer 11 (Saturn)	Sep. '79	U.S.	64-m + 34-m	RTC
Voyager 1 (Saturn)	Aug. '80	All DSCCs	64-m + 34-m	RTC
Voyager 2 (Saturn)	Aug. '81	All DSCCs	64-m + 34-m	RTC
International Cometary Explorer (Giacobini-Zinner)	Sep. '85	All DSCCs Spain/U.S. Australia/Usuda	64-m + 34-m <sup>b</sup> 64-m + 64-m 64-m + 64-m	Passive BB SSRC R&D SSRC R&D
Voyager 2 (Uranus)	Jan. '86	Spain U.S. Australia	64-m + 34-m 64-m + 2 (34-m) 64-m + 2 (34-m) + Parkes 64-m	RTC/BBA RTC/BBA RTC/BBA + LBC + SSRC R&D
Voyager 2 (Neptune)	Aug. '89	Spain U.S.  Australia	70-m + 2 (34-m) 70-m + 2 (34-m) + VLA 27 (25-m)  70-m + 2 (34-m) + Parkes 64-m	RTC/BBA RTC/BBA + VLBC + SSRC RTC/BBA + LBC + SSRC

<sup>a</sup> Listing of month and year indicates encounter period.

<sup>b</sup> The Spain and U.S. 64-m antennas also combined dual channels with passive BB.

<sup>c</sup> BB = Baseband (symbol-modulated subcarrier).

LBC = Long Baseline Combiner (baseband at ~300 km).

RTC = Real-Time Combiner, first version (baseband at ~30 km).

RTC/BBA = Operational RTC—part of BBA (Baseband Assembly).

SSRC = Symbol-Stream Recording and Combining (non-real time).

VLBC = Very Long Baseline Combiner (baseband at ~1,000 km).

**Table 2. Gapped bit error rates<sup>a</sup>**

Reed-Solomon (R-S) Coded Performance		
Condition	Array SSNR	R-S BER
VLA SNR $\leftarrow$ GDSCC SNR	0.0 dB	$\leftarrow 1 \times 10^{-5}$
VLA SNR $\geq$ GDSCC SNR	+0.5 dB	$\leftarrow 1 \times 10^{-5}$
Convolutional Coded Performance		
Condition	Array SSNR	MCD <sup>b</sup> BER
VLA SNR $\leftarrow$ GDSCC SNR	0.0 dB	$< 5 \times 10^{-3}$
	+1.5	$< 5 \times 10^{-5}$
VLA SNR = GDSCC SNR	+0.5 dB	$< 5 \times 10^{-3}$
	+3.0 <sup>c</sup>	$< 5 \times 10^{-5}$
VLA SNR $\rightarrow$ GDSCC SNR	$> 0$ dB <sup>c</sup>	$< 2.5\%$ of GDSCC
VLA Stand-alone	$> 0$ dB	$< 1.5 \times 10^{-2}$

<sup>a</sup> *VGTA System Requirements and Design*, Table C-1, Document 1220-2 (internal document), Jet Propulsion Laboratory, Pasadena, California, September 15, 1987.

<sup>b</sup> Maximum-Likelihood Convolutional Decoder.

<sup>c</sup> Domain of BER anomaly.

**Table 3. Midpass SSNR performance<sup>a</sup>**

Date	SSNR, dB					
	Site	Actual Performance	Design Performance	Site	Actual Performance	Design Performance
DOY 239	GDSCC	0.1	-0.9	CDSCC	0.7	-0.2
	VLA	2.3	1.0	Parkes	-3.7	-4.0
	VGTA	4.2	2.8	PCTA	1.8	1.3
DOY 240	GDSCC	0.3	-0.9	CDSCC	2.25	1.5
	VLA	2.1	1.0	Parkes	-2.0	-2.3
	VGTA	4.1	2.8	PCTA	3.35	3.0

<sup>a</sup> The data rate was 21.6 kbps, except for the CDSCC, Parkes, and the PCTA on DOY 240, when it was 14.4 kbps. The GDSCC and CDSCC used 70-m + 34-m HEF antennas.

**Table 4. VGTA bit-error-rate performance**

Nominal midpass conditions			
Data rate	7.2 kbps	14.4 kbps	21.6 kbps
SSNR	~6 dB	~5 dB	~3 dB
Real-time combining BER performance under nominal midpass conditions			
NDPP/MRT <sup>a</sup> (BER anomaly)	$10^{-5}$	$2(10^{-5})/2(10^{-4})^c$	$2 \times 10^{-4}$
CDT/NET <sup>b</sup> (gap compensation)	$\ll 10^{-5}$	$2 \times 10^{-5}$	$3 \times 10^{-4}$
$\geq$ DOY 165 (timing fix)	N/A	$\ll 10^{-5}$	$2 \times 10^{-5}$
Symbol-stream combining (non-real-time) BER performance under nominal midpass conditions			
MRT <sup>a</sup> (BER anomaly)	$\ll 10^{-5}$	N/A	N/A
CDT/NET <sup>b</sup> (gap compensation)	N/A	$3 \times 10^{-5}$	$5 \times 10^{-4}$
$\geq$ DOY 165 (timing fix)	N/A	N/A	N/A

<sup>a</sup> NDPP/MRT = Neptune Dual Processor Program (Test)/Mission Readiness Tests.  
<sup>b</sup> CDT/NET = Configuration Demonstration Test/Near Encounter Test.  
<sup>c</sup> Greater than GDSCC stand-alone value during NDPP test; the MRT value is higher because of lower SNR.

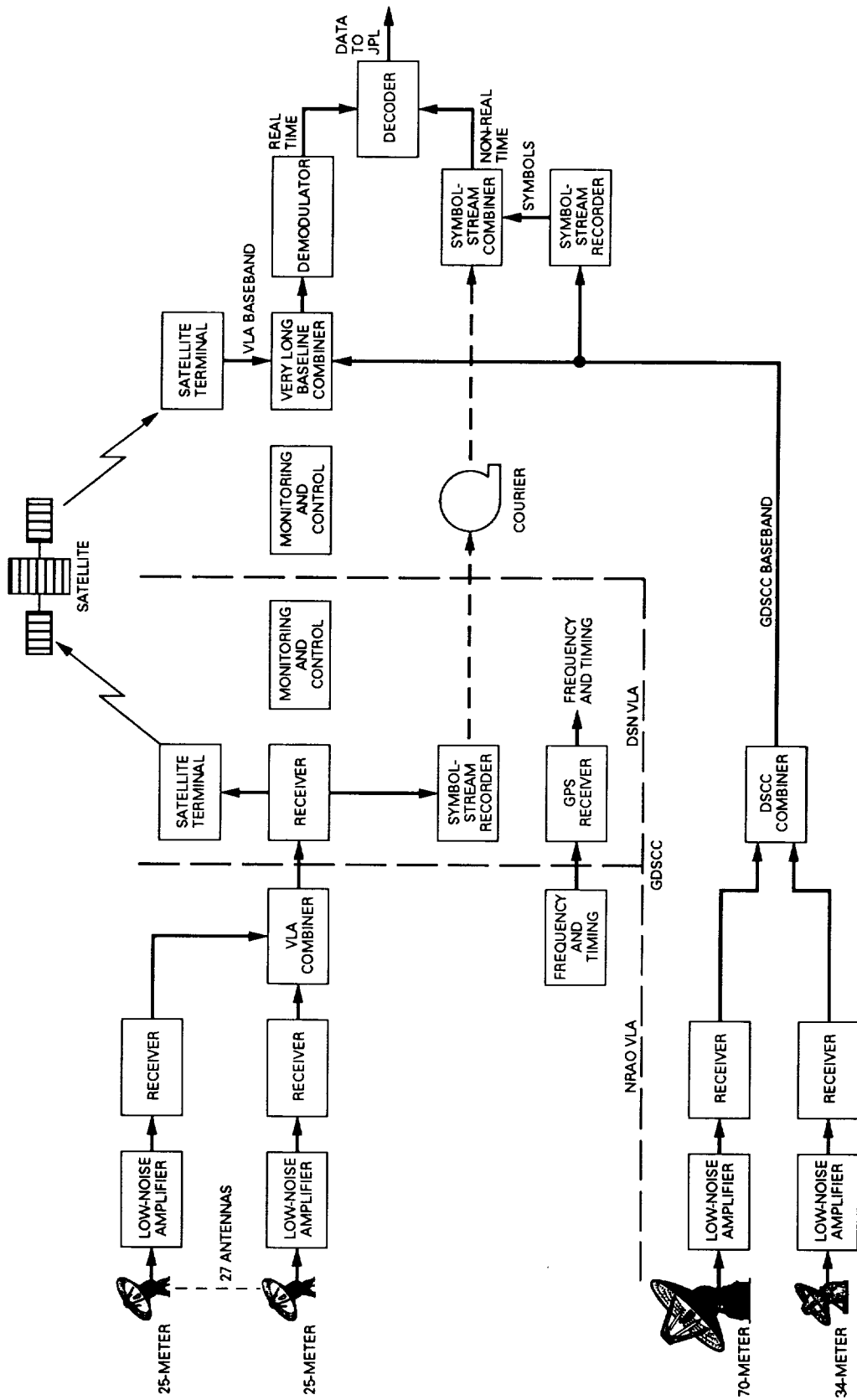

Fig. 1. The VGTA system.

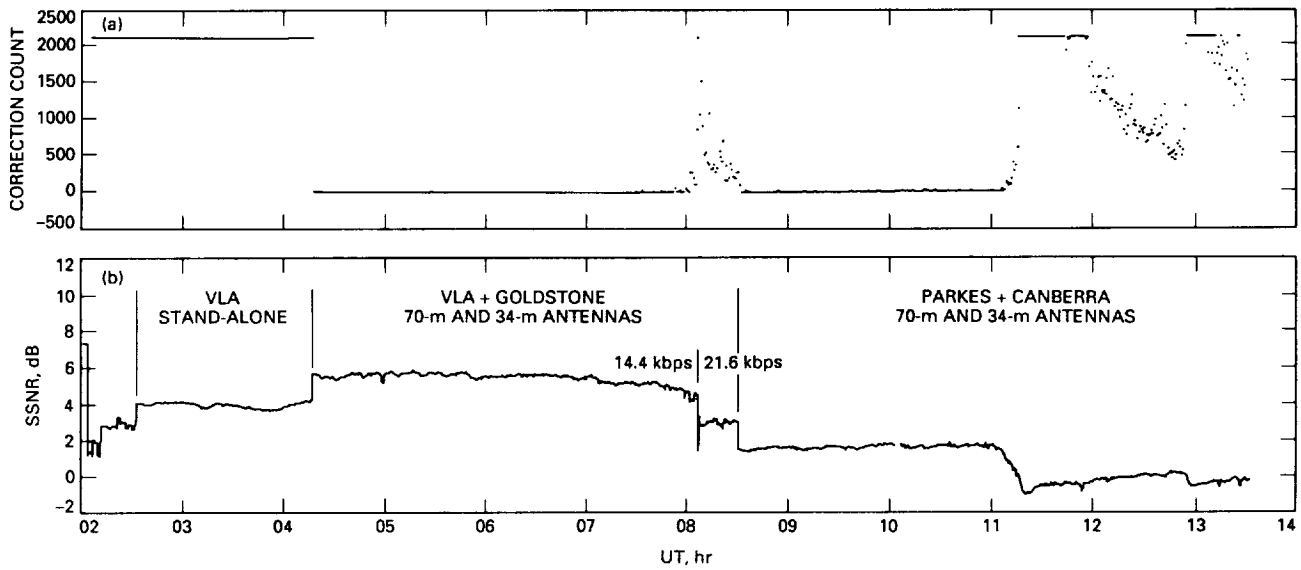

Fig. 2. Voyager data reception by VGTA and PCTA, day-of-year 222 (1989): (a) Reed-Solomon error-correction count, and (b) symbol SNR.

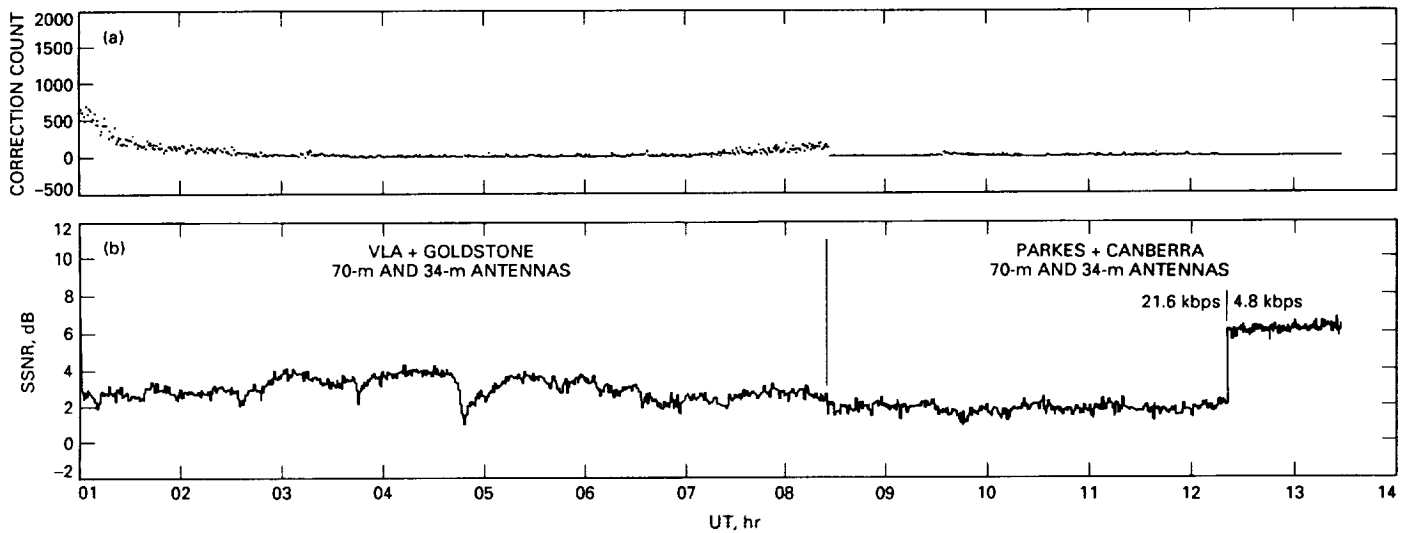

Fig. 3. Voyager data reception by VGTA and PCTA, day-of-year 228 (1989): (a) Reed-Solomon error-correction count, and (b) symbol SNR.

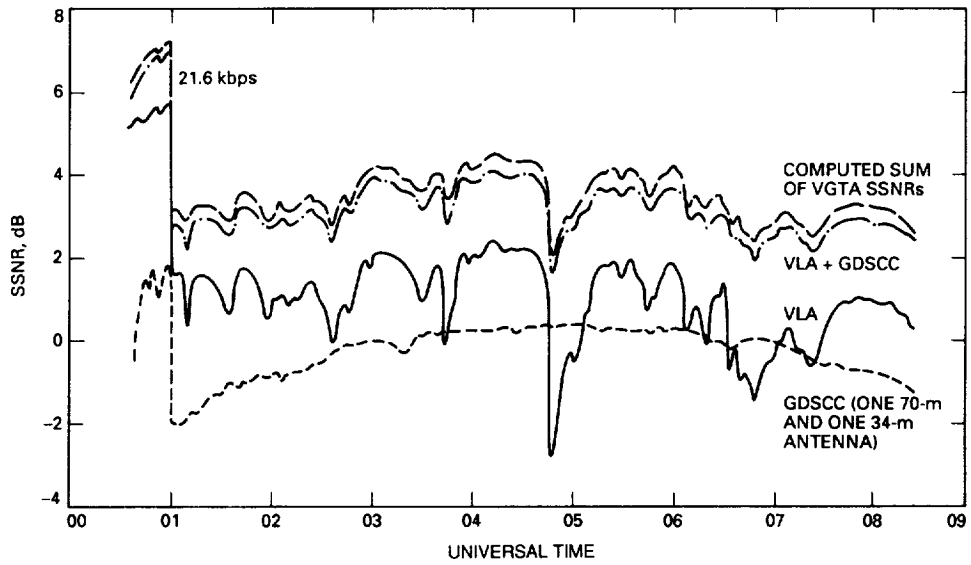

Fig. 4. Constituent symbol SNRs for the VGTA on day-of-year 228 (1989).

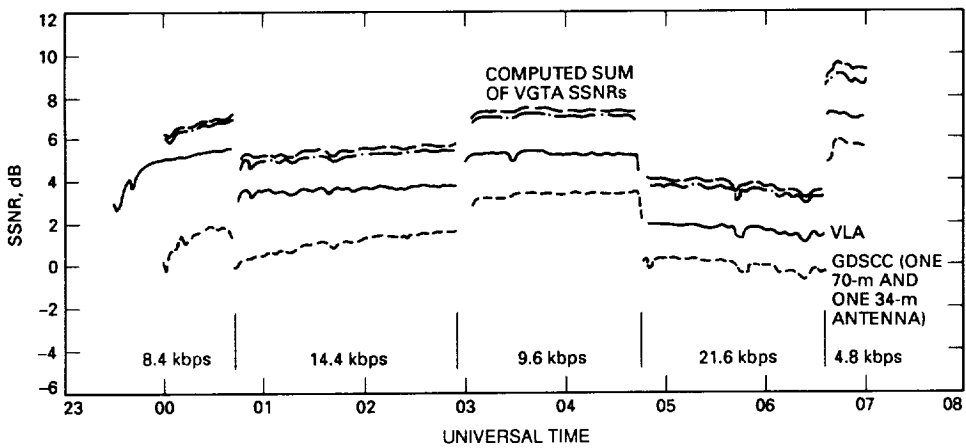
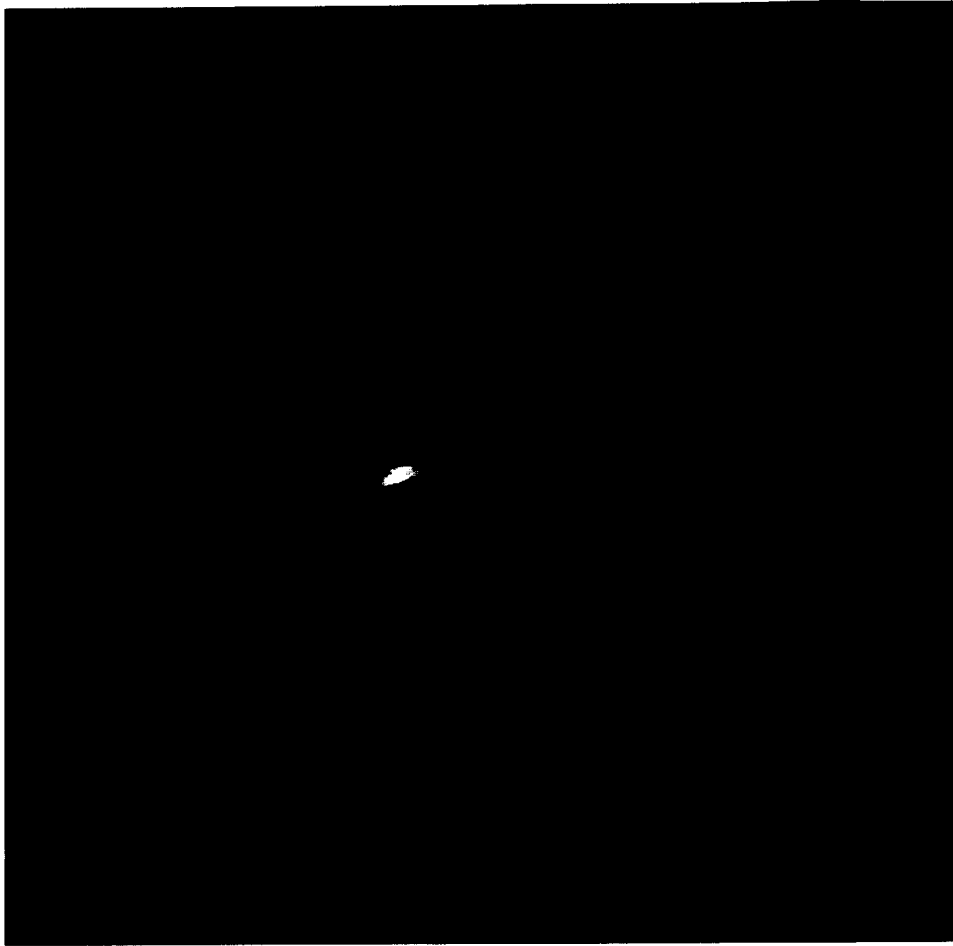

Fig. 5. Constituent symbol SNRs for the VGTA on day-of-year 237 (1989).





**Fig. 6. A Neptune image received by the VGTA on day-of-year 236 (1989) at 04:06 UT. Reed-Solomon coding; data rate = 21.6 kbps; SSNR = 4.4 dB; BER =  $3.7 \times 10^{-5}$ .**

ORIGINAL PAGE  
BLACK AND WHITE PHOTOGRAPH

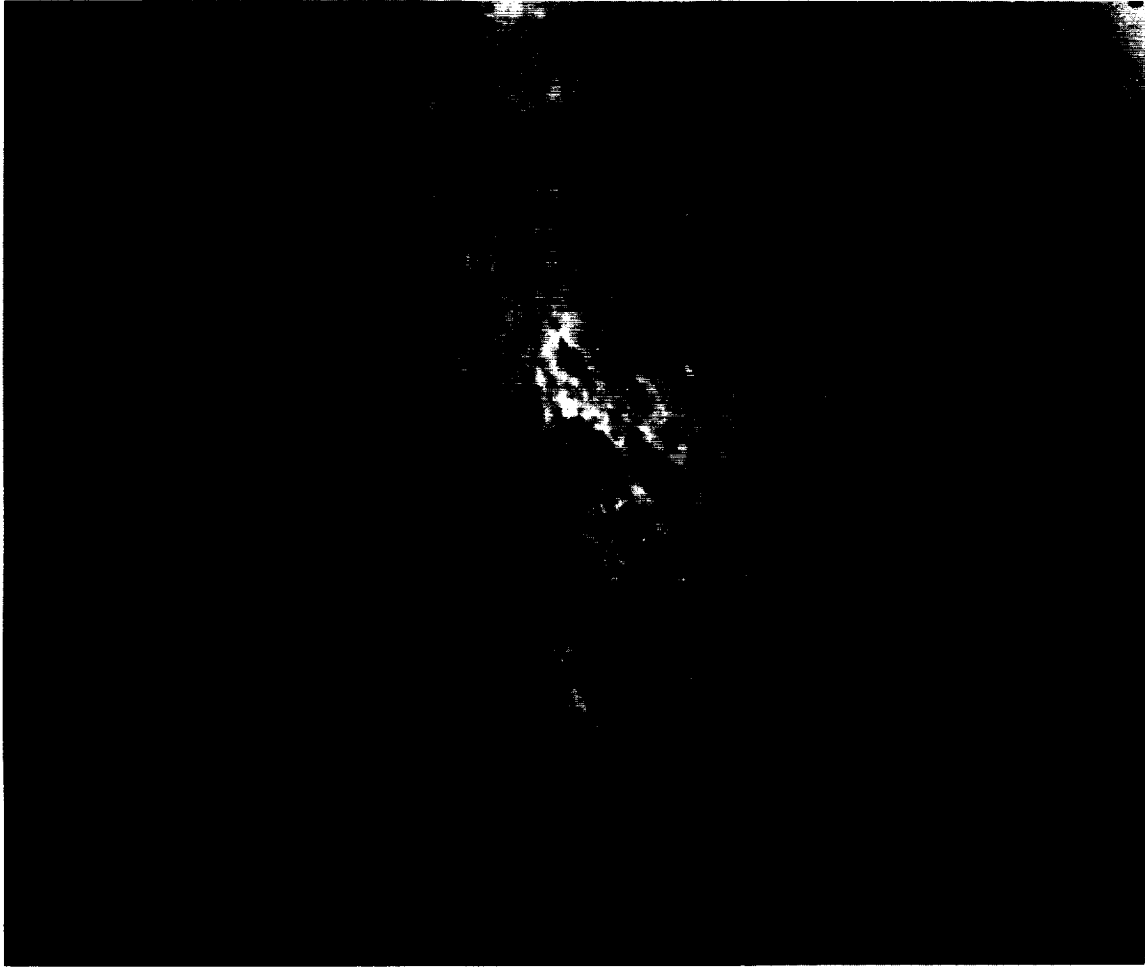

Fig. 7. A raw playback image of Triton, received by the VGTA on day-of-year 239 (1989) at 01:37 UT. Data rate = 21.6 kbps; SSNR = 3.4 dB; BER =  $1.7 \times 10^{-4}$ .

Figure 8  
BLACK AND WHITE PHOTOGRAPH

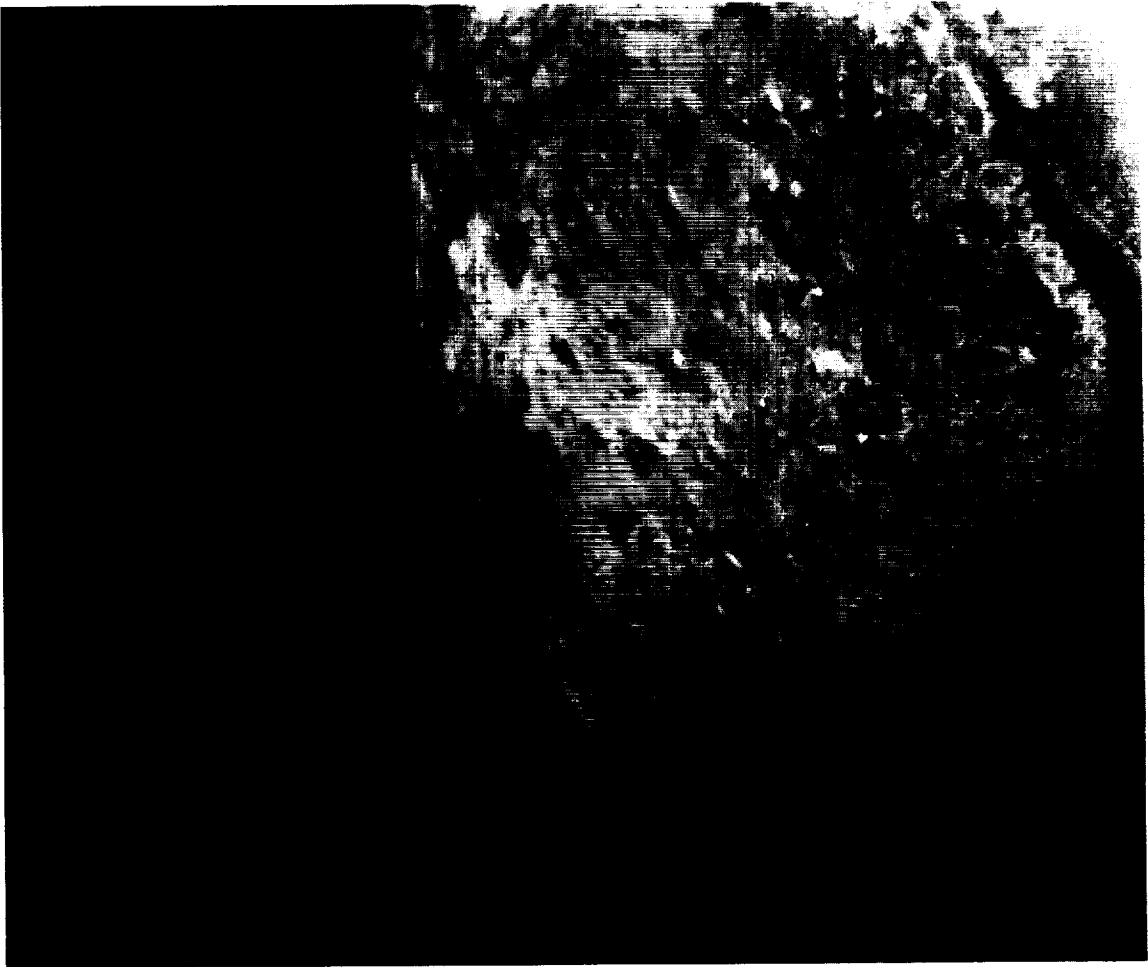

Fig. 8. The Triton image shown in Fig. 7 after de-spike processing.

CENTRAL PAGE  
BLACK AND WHITE PHOTOGRAPH



**Fig. 9. A raw playback image of Triton received by the VGTA on day-of-year 239 (1989) at 03:59 UT. Data rate = 21.6 kbps; SSNR = 4.2 dB; BER =  $5.4 \times 10^{-5}$ .**