

535364
208 53-61
V91-2173271
p.19

INTELLIGENT STRUCTURES

Edited by

K. P. CHONG, S.C. LIU

National Science Foundation, USA

and

J. C. LI

National Central University, Taiwan



ELSEVIER APPLIED SCIENCE
LONDON and NEW YORK

PARALLEL COMPUTATIONS AND CONTROL
OF ADAPTIVE STRUCTURES

K. C. Park and Kenneth Alvin
Department of Aerospace Engineering Sciences and
Center for Space Structures and Controls
University of Colorado, Campus Box 429
Boulder, Colorado 80309

and

W. K. Belvin
Spacecraft Dynamics Branch
NASA/Langley Research Center
Hampton, VA 23665

ABSTRACT

The equations of motion for structures with adaptive elements for vibration control are presented for parallel computations to be used as a software package for real-time control of flexible space structures. A brief introduction of the state-of-the-art parallel computational capability is also presented. Time marching strategies are developed for an effective use of massive parallel mapping, partitioning and the necessary arithmetic operations. An example is offered for the simulation of control-structure interaction on a parallel computer and the impact of the approach presented herein for applications in other disciplines than aerospace industry is assessed.

1. Introduction

Active suppression of structural vibrations or active control of flexible structures has made considerable progress in recent years. As a result, it is now possible to actively suppress vibrations in mechanical systems emanating from machine foundations, in robotic manufacturing arms, truss-space structures and automobile suspension systems. A common characteristic to these applications of active control theory has been its discrete actuators and discrete sensors, ranging from proof mass actuators and gyro

dampers to strain gages and accelerometers. Because most available discrete actuators are inertia force-oriented devices, actuation often triggers coupling between the actuator dynamics and structural transients. A practical consequence of such coupling is a limitation of achievable final residual vibration level if both the actuator and structure possess insufficient passive damping level. It is noted that structures made of high stiffness composite materials have very low intrinsic damping, hence limiting the achievable residual vibration level for space maneuvering and space disturbance rejection purposes. This has been a motivating factor for the development of distributed actuators and sensors which are often embedded as an integral part of the structure so that control force can be effectively maintained by strain actuation, thus alleviating the undesirable actuator dynamics associated with inertia-force actuation.

Various activities that are being pursued by many investigators on the subject of adaptive structures may be categorized into three major thrusts: device developments, control laws synthesis and experimental demonstrations, and hardware/software implementation. The device developments effort has been the objective of many material scientists [1-3]. As the applications needs increase it is expected that functionally more reliable electrostrictive and magnetostrictive elements will be available for use in active control/strain damping with improved product quality.

The study of control laws synthesis and demonstration employing adaptive elements has been one of the predominant activities in recent years. As scientists accumulate experience in the characterization of the coupling between the structure and the adaptive element, the applications will then be expanded from the current beam-like structures to the truss long beams, plates and shells. In order to effectively utilize as many adaptive elements as necessary for actively controlling the vibration of such large-scale structures in real-time operations, it will be imperative that the software/hardware components in the real-time control loop must be able to process data fast enough so that control commands and the measurements can be carried without saturating and/or jamming the control system.

With the advent of new technology in distributed actuators and sensors [4-9], it appears that a combination of decentralized/distributed and hierarchical control strategies can be a viable alternative to conventional centralized control strategies. The real-time computer control of such systems as well as design of such control systems through iterating on simulations and hardware realizations thus will require the processing of a vast amount of data from and to the distributed actuators and sensors. A significant part of such data processing for the decentralized actuators and sensors is planned to be self-managed, viz., there will be embedded microprocessors for each actuator and sensor pair or for each group of them. However, the necessary links between the decentralized control systems and the global control system as well as the necessary global control strategy will still require computational power far in excess of presently available real-time data processing capability. In addition, if one contemplates the performance of neural-network control or adaptive control for onboard real-time control of large-scale space structures, the computational need will dramatically increase beyond the current capability. As a case in point, even for the control of 20-bay truss beam vibrations by

three proof mass actuators and six sensors, NASA/Langley is relying on CRAY-XMP for adequate real-time data processing requirements.

The objective of this paper is thus to present a computational framework by which one can bring the two emerging new technologies together, namely, the distributed actuators and sensors and the parallel computing capability, toward the real-time control of vibrations in large structural systems such as space stations, space cranes and in-space construction facilities. We will then discuss the potential for applying such a space technology to mitigate and/or minimize the earthquake damage of ground structures such as high-rise buildings, bridges and lifeline equipment.

2. Models for Structures with Embedded Actuators and Sensors

The coupling between the structural behavior and an adaptive electrostrictive element, whether it is embedded or surface-mounted, is primarily due to the following constitutive relation [3,10-12]:

$$\begin{Bmatrix} e \\ \sigma \end{Bmatrix} = \begin{bmatrix} \epsilon & g \\ -g^T & c \end{bmatrix} \begin{Bmatrix} v \\ \epsilon \end{Bmatrix} \quad (1)$$

where e and v are the electrical displacement (charges/unit area) and the electric field (volt/unit area), σ and ϵ are the stress and strain, and ϵ , g and c are the constitutive coefficient matrices, respectively. For magnetostrictive elements, one needs to replace e and v by the magnetic field (H) and the magnetic induction (B), respectively, and the subsequent derivations will hold without any loss of generality.

The coupled equations of motion for the structure and the adaptive elements can proceed by augmenting the standard procedure for the structure with the electric transient equations plus the appropriate modification of the structural equilibrium equations that reflect the coupled constitutive equations (1). The resulting coupled structural-piezoelectric equations of motion take the following form [13-15]:

$$\left\{ \begin{array}{ll} \text{Structure:} & a) \quad M\ddot{q} + D\dot{q} + (K_s + K_a)q = f + Sa \\ & q(0) = q_0, \quad \dot{q}(0) = \dot{q}_0 \\ \text{Sensor Output:} & b) \quad y = H_p q + H_r \dot{q} + H_a a \\ \text{Actuator:} & c) \quad \dot{a} + \Theta a = B_a u - \bar{S}^T \begin{Bmatrix} q \\ \dot{q} \end{Bmatrix} \\ \text{Controller:} & d) \quad \dot{u} + Gu = Ly \end{array} \right. \quad (2)$$

where

$$a = \begin{Bmatrix} e \\ v \end{Bmatrix}, \quad u = \begin{Bmatrix} I_0 \\ V_0 \end{Bmatrix}$$

In the preceding equations, M is the mass matrix, D is the damping matrix, K_s is the stiffness matrix due to structural strain-displacement relations and K_a is the stiffness matrix due to the strain actuation. $f(t)$ is the applied force. S is the actuator projection matrix. H_p , H_r and H_a are the sensor calibration gain matrices, Θ is the actuator dynamic characteristics, B_a is the gain matrix that translates the applied current/charge and voltage into the corresponding strain and strain rate where \dot{S} is the transducer conversion gain. q is the generalized displacement vector and the superscript dot denotes time differentiation, and u is the control law that consists of the applied current (or charge), I_0 , and voltage across the electrostrictive devices, V_0 , G is the electric circuit characteristics, and L is the optimum direct feedback gain matrix. The case of dynamic compensations can be augmented to (2) by introducing an observer. But in subsequent discussions we limit ourselves to direct feedback cases only.

It is noted that the control laws, unlike conventional control-structure interaction systems, are not directly fed back into the structural equations. Instead, the controller is simply a regulator controlling the electric charge, the voltage or the current. These regulated electric quantities are then fed into the piezoelectric sensors and actuators. Hence, it is the piezoelectric actuation that triggers feedback into the structures.

3. Parallel Computations for the Dynamics of Adaptive Structures

The earliest recorded computational results in mechanics were the parabolic trajectory calculations of a falling body by Galileo [16]. Since then, most scientific computations have been carried out by anthropomorphic algorithms, viz., step-by-step binary and/or decimal arithmetics. To set the stage properly for the present objective, parallel computations of the dynamic response of structures with distributed adaptive elements, we recall a passage by Kepler to John Napier, the inventor of a logarithmic table:

Newton was essentially dependent upon the results of Kepler's calculations, and these calculations might not have been completed but for the aid of that logarithms afforded. Without the logarithms, ..., the development of modern science might have been very different [17].

In terms of the present day data processing requirement, Napier's logarithmic table in 1614 contained about 100 kilobytes, which was perhaps the most important computational aid to Kepler and Newton. Three and one-half centuries later we are witnessing gigabytes of tables being stored and retrieved at our disposal [18]. But these tables complement the weakness of the human mind and computational speed: long term memory and human arithmetic speed. In addition, for problems requiring a sequential nature of computations, i.e., ballistic trajectories which deal only with the position and velocity of a single shell or quasi-static equilibrium equations of a building structure, the computing activities do not interact with "time" and the computing efficiency affects only the manpower efficiency for completing the computational task.

There are many important scientific and engineering endeavors whose computations must be fast enough for real-time delivery of the computed results. A classical example was Richardson's lattice model for weather prediction by numerical process in 1922 [19]. The motivation for adopting such a lattice concept was due to the fact that the equation state at each lattice node takes on a different value set in time and an efficient way of interchanging and transmitting the nodal values at each time step was mandatory if the computations were to be carried out in real-time to predict the weather. Indeed, this was the dawn of the parallel computing era, even though the basic idea had to wait for its validity for 60 years. Today, many controls engineering activities have been implemented by using computers so that their intended functions can be monitored and controlled in real-time. These include chemical processing, autopiloting and vibration control of simple structures. It is important to note that the computational framework employed for such applications is based on sequential architecture. Hence, we believe that future improvements that can deal with large parameter models and large parameter controls must adopt a parallel computational framework. One such area is the dynamics and control of large structures with distributed/embedded adaptive elements.

In order to carry out the necessary parallel computations, there are three distinct steps that must be addressed: discretizing the structure into appropriate partitions, mapping the physical partitions onto the processors, and step advancing of the equation states. These will be discussed below.

3.1 Partitioning and Mapping of Adaptive Structures

Ideally, if the sensor and actuator leads fall on the discrete nodes, no spatial interpolation would be necessary. However, such a situation is either difficult to realize or may prohibit the use of spatially convolving sensors [20] that are known to filter certain harmonic signals for minimizing phase lag in the feedback loop. Hence, we will assume that the sensor and actuator characteristics can be interpolated to the discrete nodes; in this way the partition boundaries can be chosen arbitrarily regardless of the physical locations of the sensor and actuator leads. In addition, this approach can lead to a natural embedding of the sensor and actuator characteristics into the finite element or boundary integral structural models. Once the partitioning is accomplished, the next step is to map the discrete partitions for adaptive elements onto the corresponding multiprocessors.

Consider an adaptive structure that has been modeled as a set of discrete elements as shown in Fig. 1. In a sequential computing environment, in order to advance the necessary computations for the present states, the arithmetic operations are carried out step-by-step for each node at a time. Hence, each nodal-state computations is performed in a manner similar to one courier delivering and picking up all the mails throughout the entire routes. In a parallel computational environment, in contrast, there can be as many couriers as necessary who comb through the routes concurrently in order to pick up and deliver all the mail at once. One of the most popular concepts in executing such tasks is the hypercube architecture (see Fig. 2) whose every node

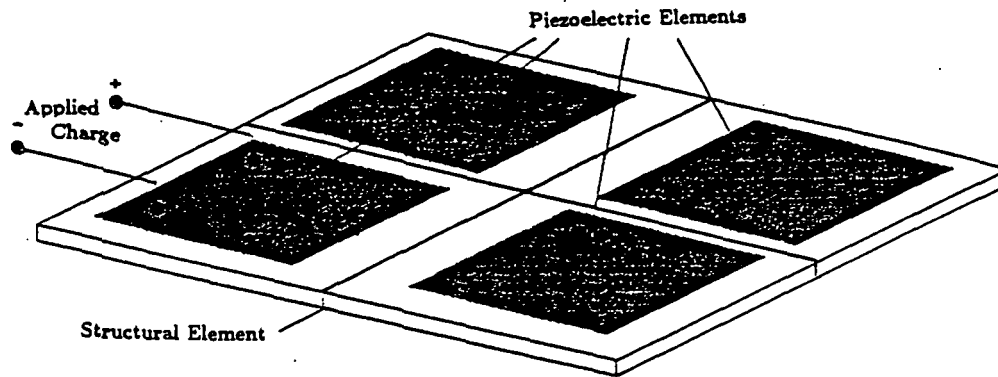

Fig. 1 Discrete Model of Adaptive Structures

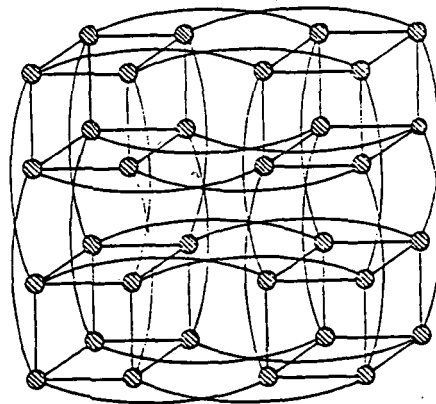

Fig. 2 Hypercube Interconnection Network of a
32-Processor
(each node represents a processor)

is associated with a processor. Thus, to process the necessary computations for an adaptive structure with 19 partitions, one can assign the 19 adaptive elements to 19 processors as shown in Fig. 3. The procedure for assigning the physical domain (elements) to the parallel processors with minimal interprocessor communications is called mapping.

Of several techniques available for the processor mapping of the computational domains [22], we will adopt a heuristic mapper developed by Farhat [23] since it can accommodate both the synchronous and asynchronous cases with robust and acceptable complexities. An application of this mapping technique for modeling a bulkhead substructure for massively parallel computing is shown in Fig. 4. A similar mapping can be used for parallel computations of adaptive structures.

3.2 Parallel Data Structure and Algorithms

We will assume that each processor is assigned to carry out all the necessary computations for at least one set of a sensor, an actuator, and a controller or a group of them. Therefore, the word *partition* does not necessarily imply a finite element: it can be a substructure, an element or even a sublayer within the composite layer that includes a sensor or an actuator. In carrying out the step-advancing in time, one may invoke an implicit or explicit direct time integration algorithm. When an implicit algorithm is employed, one needs to communicate not only the state variable vectors but also the associated matrices, i.e., the stiffness matrix, among the processors. Although we will show our results using implicit algorithms, we will, for illustrative purposes, restrict ourselves to an explicit direct time integration algorithm as it is intrinsically parallel and the data structure aspects can be explained more succinctly via an explicit algorithm. It should, however, be mentioned that the choice of the solution algorithm can greatly influence the design and implementation of the necessary mapping and data structure.

Consider the explicit integration of the equations of motion for the structure (2a) as recalled here:

$$M\ddot{q} + f_{int} = f + f_{cont} \quad (3)$$

where f_{int} and f_{cont} are the internal and applied control forces, respectively, given by

$$f_{int} = D\dot{q} + (K_s + K_a)q$$

$$f_{cont} = Sa$$

The use of the central difference algorithm to integrate (3) leads to the following difference equations in time

$$\begin{cases} \dot{q}^{n+\frac{1}{2}} = \dot{q}^{n-\frac{1}{2}} + hM^{-1}(f^n + f_{cont}^n - f_{int}^n) \\ q^{n+1} = q^n + h\dot{q}^{n+\frac{1}{2}} \end{cases} \quad (4)$$

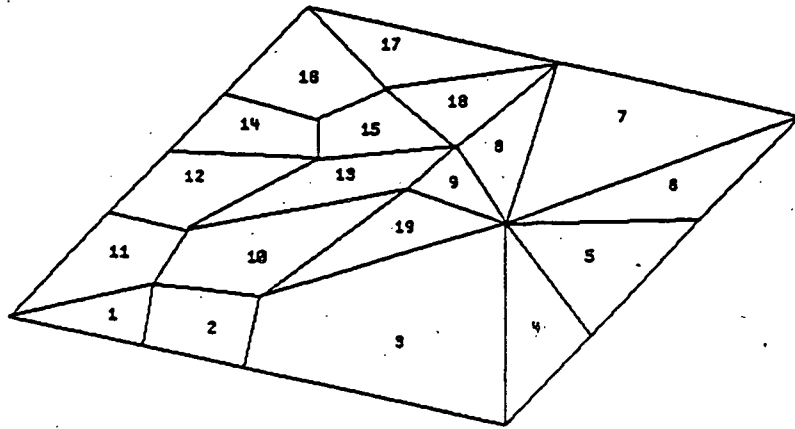

(Physical Domain)

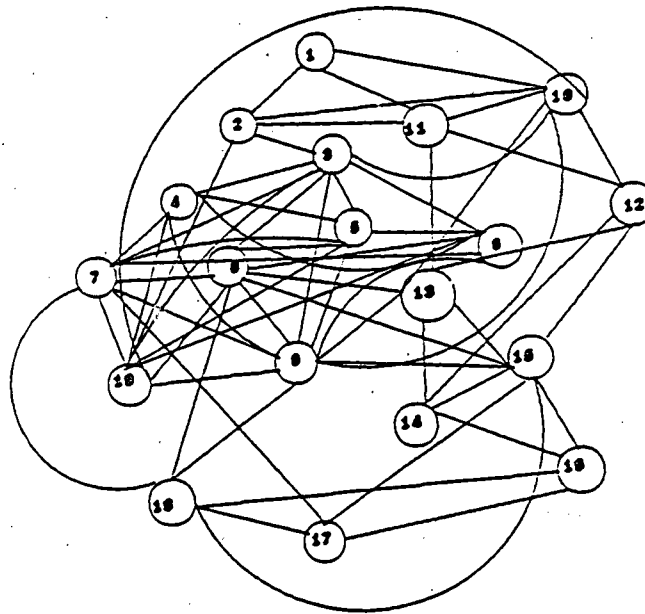

(Processor Configuration)

Fig. 3 Physical Domain and Its Mapping Onto Hypercube Processors

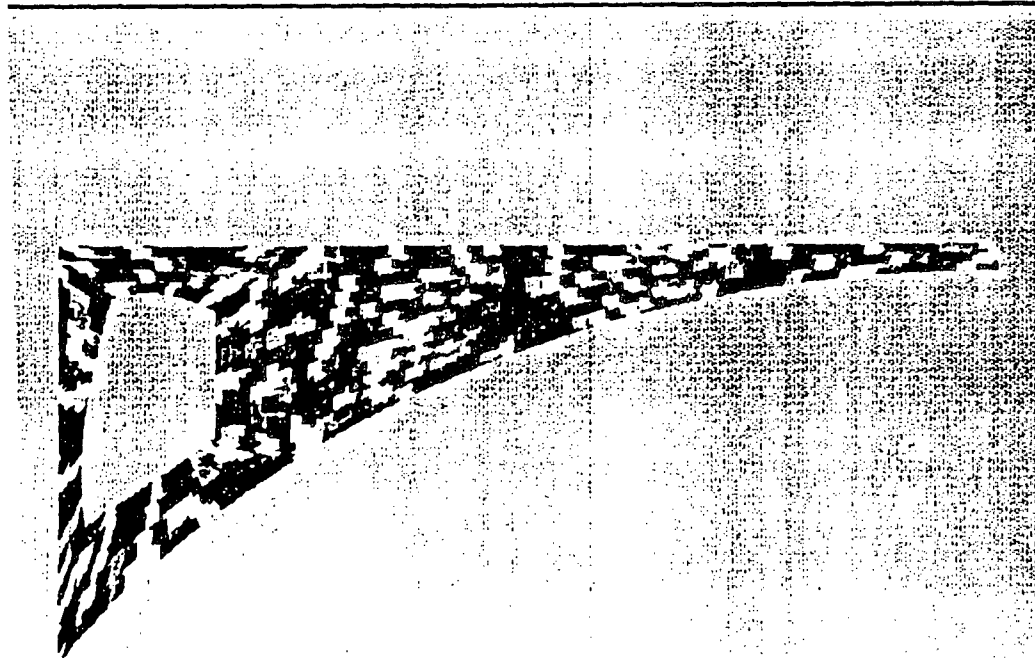

**Fig. 4 . Decomposition of the Structure with
"Finite Element Chips"**

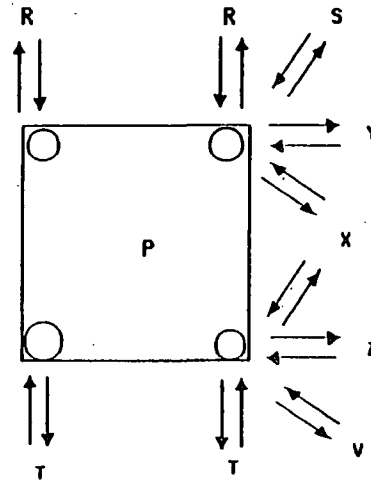
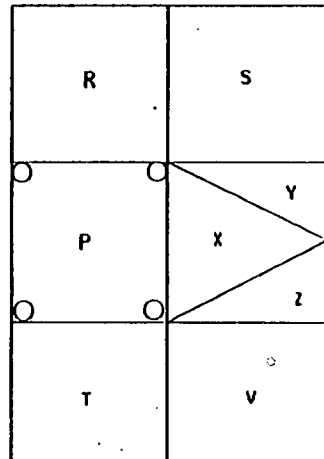

Fig. 5 Partitioning and Communication Requirement

4. Implementation and Illustrative Example

The mapping, partitioning and data structures above discussed have been implemented based on a shared-memory concurrent machine (Alliant FX/8) by modifying the software framework developed for finite element computations [26] and the control-structure interaction simulation and design software developed in [27, 28]. At present the following specialized systems of equations are implemented:

$$\left\{ \begin{array}{l} \text{Structure: } a) \quad M\ddot{q} + D\dot{q} + Kq = f + Bu + Gw \\ \qquad \qquad \qquad q(0) = q_0, \quad \dot{q}(0) = \dot{q}_0 \\ \text{Sensor Output: } b) \quad z = Hx + m \\ \text{Estimator: } c) \quad \dot{\bar{x}} = A\bar{x} + Ef + \bar{B}u + L(z - H\bar{x}) \\ \qquad \qquad \qquad \bar{x}(0) = 0 \\ \text{Control Force: } d) \quad u = -F\bar{x} \end{array} \right. \quad (6)$$

where

$$x = \begin{Bmatrix} q \\ \dot{q} \end{Bmatrix}, \quad \bar{x} = \begin{Bmatrix} \bar{q} \\ \dot{\bar{q}} \end{Bmatrix}$$

and

$$H = [H_d \quad H_v], \quad L = \begin{bmatrix} L_1 \\ L_2 \end{bmatrix}, \quad F = [F_1 \quad F_2]$$

It is noted that in the above implemented equations, we have merged the actuator and the control law equations into one by neglecting the actuator and control law dynamics. Instead, we have introduced an estimator equation as we do not have all the measurements needed for complete feedback. In the above equations, B and \bar{B} represent the input influence matrix for actuator locations whereas G and \bar{G} represent the disturbance locations. The vector q is the generalized displacement, w is a disturbance vector and the vector m is measurement noise. In Eq. (6b); z is the measured sensor output. The matrix H_d is the matrix of displacement sensor locations and H_v is the matrix of velocity sensor locations. The state estimator in Eq. (6c) may or may not be model based. The superscript \sim and $\dot{\sim}$ denote the estimated states and time differentiation respectively. The input command, u , is a function of the state estimator variables, \bar{q} and $\dot{\bar{q}}$, and F_1 and F_2 are control gains. The observer is governed by A , the state matrix representing the plant dynamics, and L , the filter gain matrix.

The software thus implemented was used to test its applicability to solve the control-structure interaction design of a model Earth Pointing Satellite (EPS), shown in Fig. 6, which is a derivative of a geostationary platform proposed for the study of Earth Observation Sciences. Two flexible antennas are attached to a truss bus. Typical missions involve pointing one antenna to earth, while tracking or scanning with

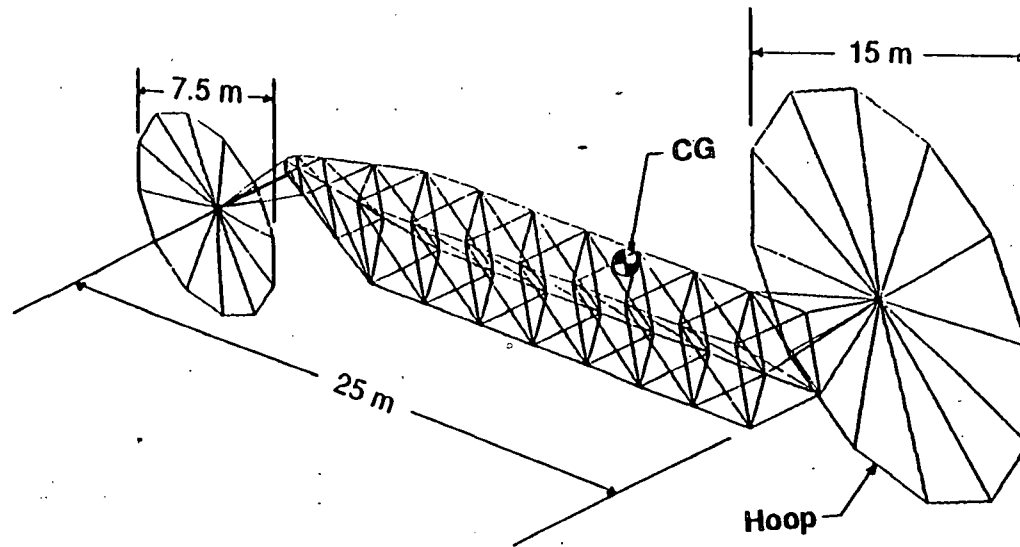

Fig. 6 Earth Pointing Satellite Structure

Table 1. EPS Vibration Frequencies (Hz.)

Mode No.	Frequency
(1 - 6)	0.000
(7)	0.242
(8)	0.406
(9)	0.565
(10)	0.656
(11,12)	0.888
(13)	1.438
(14)	1.536
(15,16)	1.776
(17,18)	3.026
(19)	3.513
(20)	3.531

A small disturbance force was applied to the nominal EPS system in the form of a reboost maneuver. The force acted at the center of gravity in the Y-axis direction for 0.1 seconds at a 10 N force level and from 0.1 to 0.2 seconds the force level was -10 N. The disturbance was removed after 0.2 seconds. Figure 7 shows the open-loop angular response about the X-axis of the 15 m antenna. A small amount of passive damping was assumed ($D = 0.0002 K$). The vibrational response produced more than 4.5μ radians of RMS pointing error due to this small reboost disturbance. Although many modes participate in the flexible body response, this particular reboost maneuver strongly excites modes near 4 Hz. The following paragraphs present an integrated control and structure design which seeks to lower the vibrational response of the EPS subject to some additional constraints. Figure 8 shows the closed-loop angular response about the X-axis of the 15 m antenna after design optimization. The pointing error is significantly reduced from that of the open-loop system shown.

5. Future Work and Discussions

The example problem analyzed in the previous section used a set of lumped actuators and localized sensors instead of distributed adaptive actuators and spatially integrated sensors. While such a model at best captures the adaptive elements used by Anderson et al. [29], Matsunaga [30], and Takahara [31], it can not simulate on a large scale the distributed usage of piezoelectric actuators and sensors proposed by de Luis [32], Rogers et al. [33], and Burk and Hubbard [34]. Our immediate future work will concentrate on the implementation of distributed adaptive elements and assess their practical applicability beyond the currently reported beam-like structural components. In this regard, we are exploring an adaptation of neural-network concepts [35] in the modeling and parallel computations of controlled structures with adaptive elements. Specifically, the limits of the applicability of distributed parameter modeling and control theory and discrete structures with discrete actuators and sensors, and their cross-over

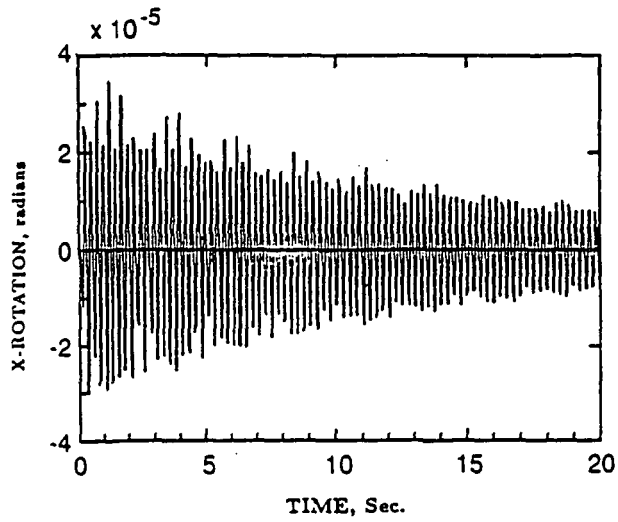

Fig. 7 Open-Loop Response of EPS Structure

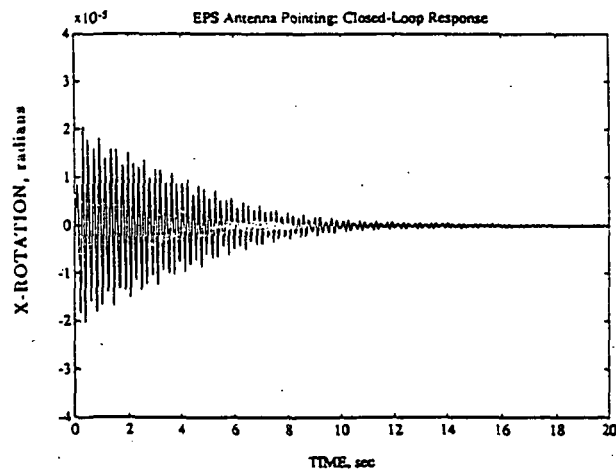

Fig. 8 Closed-Loop Response of Structure EPS

performance must be investigated. Design, modeling, simulation and testing criteria from such studies will provide greater insight into the eventual adoptions of adaptive structures as viable choice for future space systems design alternatives.

The real-time simulation procedures presented herein may be applicable to the vibration control of lifeline equipment, and secondarily in minimizing the damage of buildings during earthquakes. In this applications, the sensor measurements used herein can be directly applicable to the vibration and earthquake-causing forces on the structures. An idea that may prove to be crucial in this case is the use of earthquake-generated natural force as vibration minimization actuators forces. In other words, instead of trying to mitigate the earthquake-generating forces, exploit the natural forces instantly to activate certain vibration minimizing devices! Research along this line may in the end lead to the design of actuators attachable to the columns and floors, if properly triggered during earthquakes, can minimize damages based on the natural forces.

Acknowledgements

It is pleasure to acknowledge the support from NASA/Langley Research Center under Grant NAG-1-1021 and by Air Force Office of Scientific Research under Grant F49620-87-C-0074. We thank Dr. Spencer Wu of AFOSR and Dr. Ernst Armstrong of NASA/Langley Research Center for their encouragement during the course of this study. We thank Prof. Charbel Farhat for his assistance in data structures and implementation aspects employed in the present study.

References

1. Jaffe, B., Cook, W. and Jaffe, H., *Piezoelectric Ceramics*, Academic Press, London and New York, 1971.
2. Zelenka, J., *Piezoelectric Resonators and Their Applications*, Elsevier Science Publishing Co., Inc., New York, 1986.
3. Cross, L.E., Piezoelectric and electrostrictive sensors and actuators for adaptive structures and smart materials. In *Adaptive Structures*, ed. B.K. Wada, ASME, AD-Vol. 15, New York, 1989, pp. 9-17.
4. Forward, R.L., Electronic damping of vibrations in optical structures. *Journal of Applied Optics*, 1979, 18 (5), 690-697.
5. Crawley, E.F. and de Luis, J., Use of piezoelectric actuators as elements of intelligent structures. *AIAA Journal*, 1987, 25, (10), 1373-1385.
6. Bailey, T. and Hubbard, J.E., Distributed piezoelectric polymer active vibration control of a cantilever beam. *Journal of Guidance, Control, and Dynamics*, 1985, 8, (5).

7. Hanagud, S., Obal, M.W. and Calise, A.J., Optimal vibration control by the use of piezoceramic sensors and actuators, AIAA Paper No. 87-0959, presented at the 28th AIAA/ASME/ASCE/AHS Structures, Structural Dynamics and Materials Conference, Monterey, CA, April 1987, pp. 987-997.
8. Lee, C.K., Chiang, W.W., and O'Sullivan, T.C., Piezoelectric modal sensors and actuators achieving critical damping on a cantilevered plate. Proc. the 30th AIAA/ASME/ASCE/AHS Structures, Structural Dynamics and Materials Conf., AIAA, Washington D.C., 1989, pp. 2018-2026.
9. Baz, A. and Poh, S., Performance of an active control system with piezoelectric actuators. *Journal of Sound and Vibration*, 1988, 126, (2), 327-343.
10. Newnham, R.E., Skinner, D.P. and Cross, L.E., Connectivity and piezoelectric-pyroelectric composites. *Mat. Res. Bull.*, 1978, 13, 525.
11. Lee, C.K., Piezoelectric laminates for torsional and bending modal control: theory and experiment. Ph.D. Thesis, Cornell University, Ithica NY, 1987.
12. de Luis, J., Crawley, E.F. and Hall, S.R., Design and implementation of optimal controllers for intelligent structures using infinite order structural models. Report No. 3-89, Space Systems Laboratory, M.I.T., Cambridge, MA, 1989.
13. Tzou, H.S. and Tseng, C.I., Distributed piezoelectric sensor/actuator design for dynamic measurement/control of distributed parameter systems: a finite element approach. *Journal of Sound and Vibration* 1990, 137, (1).
14. Nailon, M., Coursant, R.H. and Besnier, F., Analysis of piezoelectric structures by a finite element method. *ACTA Electronica*, 1983, 25, (4), 341-362.
15. Hagood, N. and von Flotow, A., Modelling of piezoelectric actuator dynamics for active structural control. AIAA Paper No. 90-1087, Proceedings of the 31st AIAA/ASME/ASCE/AHS/ASC Structures, Structural Dynamics and Materials Conference, Long Beach, CA, April 1990, pp. 2242-2256.
16. Galileo, G., *Two New Sciences*, Dover Publication, New York, 1954, pp. 284-288.
17. Napier, M., *Memoirs of John Napier of Merchiston*, William Blackwood, Edinburgh, 1834, p. 501.
18. Anonymous, *Mathematica*, Wolfram Research, Inc., 1989.
19. Richardson, L. F., *Weather Prediction by Numerical Process*, Dover, New York. 1922, p. 219.
20. Miller, D., Collins, S. and Peltzman, S., Development of spatially convolving sensors for structural control applications. AIAA Paper No. 90-1127, Proceedings of the 31st AIAA/ASME/ASCE/AHS/ASC Structures, Structural Dynamics and Materials Conference, Long Beach, CA, April 1990, pp. 2283-2297.

21. Noor, A.K., Parallel processing in finite element structural analysis. In *Parallel Computations and Their Impact on Mechanics*, ed. A.K. Noor, American Society of Mechanical Engineers, New York, 1987, pp. 253-277.
22. Bokhari, S.H., On the mapping problem. *IEEE Transactions on Computers*, 1981, C-30, (3), 207-214.
23. Farhat, C., "On the mapping of massively parallel processors onto finite element graphs," *Computers & Structures*, Vol 32, No. 2, 347-354 (1989).
24. Farhat, C., Felippa, C.A. and Park, K.C., "Implementation Aspects of Concurrent Finite Element Computations," in *Parallel Computations and Their Impact on Mechanics*, American Society of Mechanical Engineers, New York, 1987, pp. 310-316.
25. Farhat, C., Sobh, N. and Park, K.C., "Transient Finite Element Computations on 65,536 Processors: The Connection Machine," Report No. CU-CSSC-89-01, Center for Space Structures and Controls, University of Colorado, February 1989, to appear in *International Journal on Numerical Methods in Engineering*, 1990.
26. Farhat, C., A simple and efficient automatic finite element decomposer. *Computers & Structures*, 1988, 28.
27. Park, K. C. and Belvin, W. K., "A Partitioned Solution Procedure for Control-Structure Interaction Simulations," to appear in *J. Guidance, Control and Dynamics*, 1990.
28. Belvin, W. K. and Park, K. C., "Computer Implementation of Analysis and Optimization Procedures for Control-Structure Interaction Problems," Proc. the 1990 AIAA Dynamics Specialist Conference, Paper No. AIAA-90-1194, Long Beach, Calif., 5-6 April 1990.
29. Anderson, E., Moore, D., Fanson, J. and Ealey, M., Development of an active member using piezoelectric and electrostrictive actuation for control of precision structures. AIAA Paper No. 90-1085, Proc. of the 31st AIAA/ASME/ASCE/AHS/ASC Structures, Structural Dynamics and Materials Conference, Long Beach, CA, April 1990, pp. 2221-2233.
30. Matsunaga, S. Miura, K. and Natori, M., A construction concept of large space structures using intelligent/adaptive structures. AIAA Paper No. 90-1128, Proceedings of the 31st AIAA/ASME/ASCE/AHS/ASC Structures, Structural Dynamics and Materials Conference, Long Beach, CA, April 1990, pp. 2298-2305.
31. Takahara, K, Kuwao, Shigeshara, M. Katoh, T., Motohashi, S. and Natori, M., Piezo linear actuators for adaptive truss structures. In *Adaptive Structures*, ed. B.K. Wada, ASME, 1989, pp. 83-88.

32. de Luis, J. and Crawley, E., Experimental results of active control on a prototype intelligent structure. AIAA Paper No. 90-1163, Proceedings of the 31st AIAA/ASME/ASCE/AHS/ASC Structures, Structural Dynamics and Materials Conference, Long Beach, CA, April 1990, pp. 2340-2350.
33. Rogers, C. and Ramaseshan, A., Investigation of embedded actuators using generalized laminated plate theory. AIAA Paper No. 90-1168, Proceedings of the 31st AIAA/ASME/ASCE/AHS/ASC Structures, Structural Dynamics and Materials Conference, Long Beach, CA, April 1990.
34. Burke, S. and Hubbard, J.E., Active vibration control of a simply-supported beam using a spatially distributed actuator. *IEEE Control Systems Magazine*, August 1987, 7, (6), 25-30.
35. Arbib, M.A., *Brains, Machines, and Mathematics*, 2nd Edition, Springer-Verlag, 1987.