

---

# Developmental Adaptations to Gravity in Animals

---

Alan R. Hargens

---

(NASA-TM-102228) DEVELOPMENTAL ADAPTATIONS  
TO GRAVITY IN ANIMALS (NASA) 23 p CSCL 06B

N91-22716

Unclas  
G3/55 0012374

February 1991



National Aeronautics and  
Space Administration

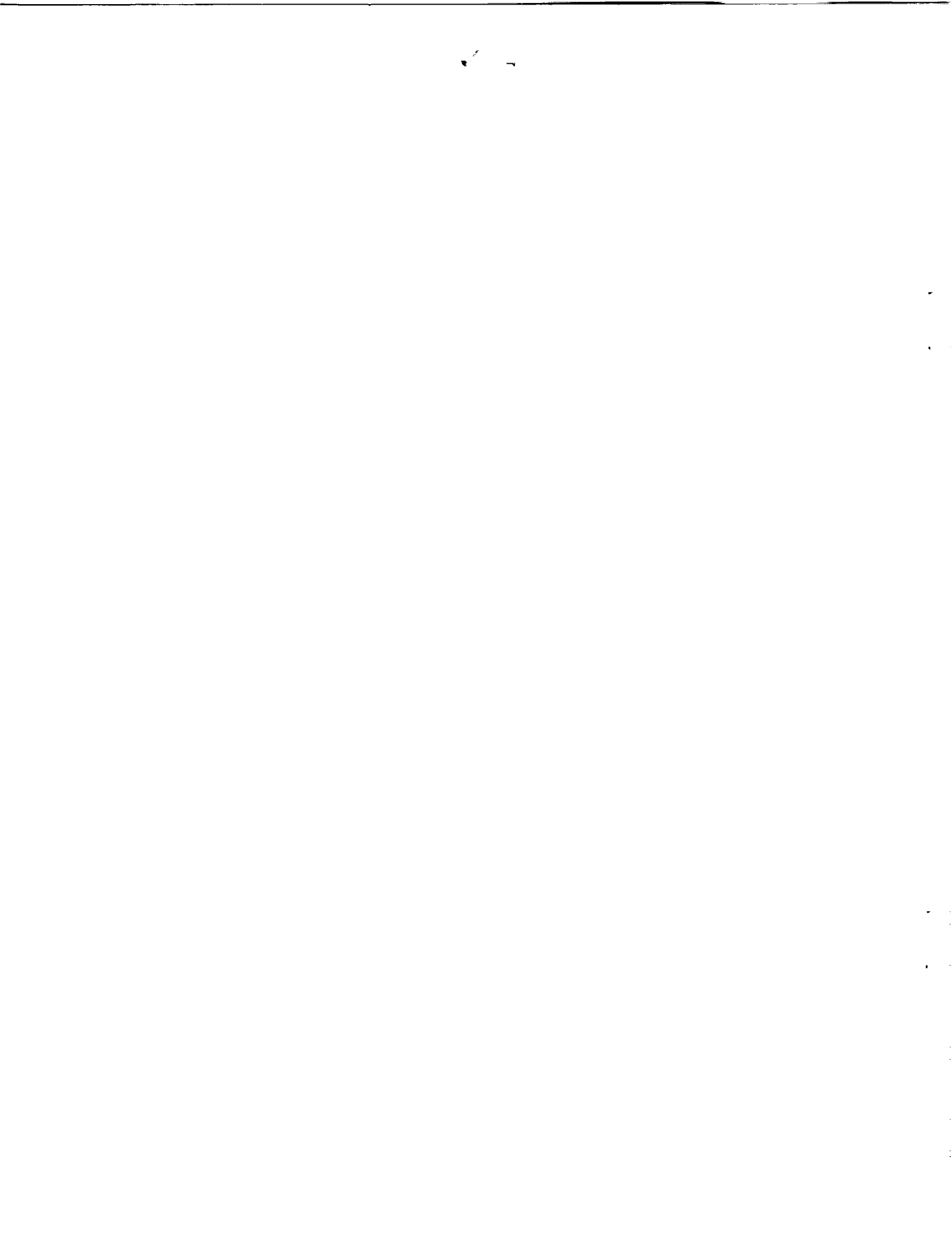

---

# Developmental Adaptations to Gravity in Animals

---

Alan R. Hargens, Ames Research Center, Moffett Field, California

February 1991



National Aeronautics and  
Space Administration

**Ames Research Center**  
Moffett Field, California 94035-1000



## TABLE OF CONTENTS

	Page
SUMMARY .....	1
INTRODUCTION .....	1
SWELLING PRESSURES OF THE INTERVERTEBRAL DISK .....	1
CELLULARITY AND NUTRITION OF THE RABBIT MENISCUS AS MODIFIED BY AGE .....	2
THE GIRAFFE AS A MODEL OF TISSUE-MORPHOLOGY ADAPTATIONS TO GRAVITATIONAL STRESS .....	3
CARDIOVASCULAR ADAPTATIONS TO GRAVITY IN THE GIRAFFE .....	5
REFERENCES .....	9
TABLE .....	12
FIGURES .....	12

PRECEDING PAGE BLANK NOT FILMED



## SUMMARY

Terrestrial animals have adapted to a constant gravitational stress over millions of years. Tissues of the cardiovascular system and lumbar spine in tall species of animals such as the giraffe are particularly well adapted to high and variable vectors of gravitational force. Swelling of the leg tissues in the giraffe is prevented by a variety of physiological mechanisms including (1) a natural "anti-gravity suit," (2) impermeable capillaries, (3) arterial-wall hypertrophy, (4) variable blood pressures during normal activity, and (5) a large-capacity lymphatic system. These adaptations, as well as a natural hypertension, maintain blood perfusion to the giraffe's brain. The intervertebral disk is another tissue that is uniquely adapted to gravitational stress. Tall and large terrestrial animals have higher swelling pressures than their smaller or aquatic counterparts. Finally, the meniscus of the rabbit knee provides information on the effects of aging and load-bearing on cartilaginous tissues. Such tissues within the joints of animals are important for load-bearing on Earth; these connective tissues may degenerate during long-duration space flight.

## INTRODUCTION

Life on Earth has evolved under the constant force of one gravitational unit (1g). The importance of this gravitational field as an environmental factor is supported by the extent and diversity of physiologic adaptations to pressure gradients in living systems. When the force of gravity is removed, some physiologic systems are greatly affected (Lenfant and Chiang, 1982). Various organs and organ systems exhibit unique mechanisms of adaptation to gravity to accommodate stresses caused by their columns of fluid and forces of movement (Hargens, 1986). Tissues of particular interest in this chapter include the intervertebral disk, the meniscus, and tissues of the cardiovascular system. The developing giraffe has served as an important experimental model to provide information about tissue adaptations for increased load-bearing with growth. Implications of the results of these studies will be extended to the microgravity environment of space.

These studies were supported by grants from the National Science Foundation (DCB-8409253), the National Institutes of Health (HL-32703), the National Geographic Society (3072-85), the Veterans Administration, and NASA. Professor Wouter van Hover and the Department of Zoology, University of Pretoria, provided giraffes and facilities for our 1985 giraffe physiology expedition. Dr. D.G.A. Meltzer and Roodeplaat Research Labs, Dr. Richard Burroughs and the National Zoological Gardens in Pretoria, and Dr. Frik J. Stegmann and the University of Pretoria Veterinary School at Onderstepoort contributed veterinary support for our giraffe studies. Dr. Paul Calle, of the Cheyenne Mountain Zoo, and the Cincinnati Zoo provided giraffe specimens.

## SWELLING PRESSURES OF THE INTERVERTEBRAL DISK

The intervertebral disk is an important weight-bearing tissue. Each disk consists of a negatively charged nucleus pulposus (primarily proteoglycan macromolecules) confined by a collagenous

annulus (fig. 1). The disk absorbs shocks and allows flexibility of the spine during various activities and postures. Increased loading on the spine during spinal muscle contraction or weight-bearing causes fluid loss from the disk, whereas decreased loading (e.g., during sleep) allows fluid influx into the disk. The disk is implicated in the etiology of back pain and the increased height of astronauts during weightlessness. However, little information is available about swelling pressures within the disk, because of methodological problems of measuring these pressures, which typically range between 1 and 3 atm. These swelling pressures are a function of fixed charge density of the proteoglycans, with a small contribution from their osmotic and excluded-volume effects (Maroudas et al., 1985).

Cavitation (air-bubble formation) on the side of the membrane opposite the sample of nucleus pulposus usually occurs when the swelling pressure of the nucleus pulposus is measured in a standard osmometer. With this in mind, we used a modification of the compression technique developed by Hammel and Scholander (1976) and Scholander et al. (1965) to approach thermodynamic equilibrium. We employed a compression-type osmometer (fig. 2) to investigate swelling pressures of the intervertebral disks of various animals as related to development and gravitational stress (e.g., terrestrial versus aquatic environment).

Fresh samples of the central, gelatinous nucleus pulposus were obtained from intervertebral disks of rats, rabbits, pigs, humans, and various aquatic species. In rabbits, swelling pressure increased from  $1.20 \pm 0.20$  atm at 3 mo to a maximum of  $5.05 \pm 0.85$  atm at 1 yr of age (fig. 3). Disks of older rabbits had lower swelling pressures, a finding that was previously documented in older humans (Urban and McMullin, 1985). Swelling pressures of mammalian disks were highest in the lumbar region. Swelling pressures of disks of aquatic species (frogs and various fishes) were essentially zero, correlating with the relatively low gravitational stress in their environment (fig. 4). In mammals, however, swelling pressures did not always correlate directly with degree of weight-bearing (weight of the animal, or quadrupedal versus bipedal stature), although the highest pressures measured were in the giraffe (fig. 5).

In summary, aging has a great effect on swelling pressure of the intervertebral disk. Disk herniation in humans seems to correlate with middle age, when swelling pressure of the nucleus pulposus is maximal. Aquatic species have the lowest swelling pressures, correlating with the relatively low gravitational stress in their environment. In mammals, this correlation with gravitational stress does not always exist, but better age or developmentally matched studies are needed to resolve this issue. The effects of weightlessness on intradiskal swelling pressures are currently under study in the Space Physiology Laboratory at Ames Research Center.

## **CELLULARITY AND NUTRITION OF THE RABBIT MENISCUS AS MODIFIED BY AGE**

The meniscus, an important load-bearing structure of the knee, is prone to degenerative midsubstance tears during middle age. It has been postulated that the central core of the meniscus is less well nourished than the periphery is, and that with aging a further nutritional loss induces a degenerative process that produces horizontal cleavage tears (Peters and Smillie, 1972).



Development of the rabbit meniscus was investigated as a function of growth (increased body weight) and age. We compared cell density, sulfate uptake, and the effects of a reproducible form of exercise—continuous passive motion (CPM)—versus immobilization (IMMOB) in menisci of young vs. old rabbits (Hargens et al., 1988). Forty-eight New Zealand white rabbits were used, of which 24 were young (0.5 yr, approx. 3 kg) and 24 were old (3.5–6.0 yr, approx. 5 kg). Each rabbit was killed by intravenous anesthetic overdose, after which  $^{35}\text{S}$ -labeled sodium sulfate (100  $\mu\text{Ci}$  in 0.1 ml saline) was injected into both knees. Moving each leg three times through its range of motion distributed the isotope throughout each knee. One limb was placed on a CPM device (fig. 6) for 4 hr (flexion range  $40^\circ$ – $130^\circ$  at 6 cycles/min), while the contralateral limb remained immobile. Medial and lateral menisci were then removed, given four 1-hr washings in 10% buffered formalin, sectioned, and processed for emulsion autoradiography. Serial sections were cut from the anterior, middle, and posterior meniscal thirds. The amount and location of sulfate uptake were determined by counting the number of labeled cells and the total number of cells in a counting grid placed over five distinct areas (fig. 7): regions 1, 3, and 4 represented the superficial margins, and regions 2 and 5 represented the central core. Differences between means were examined statistically by ANOVA or paired  $t$  tests with significance set at  $p < 0.05$ .

Total cell density of right and left knees combined was significantly lower for the old rabbits than that for the young rabbits in both medial menisci (fig. 8) and lateral menisci for every region. In the old rabbits, there was no significant regional variation in cell density, whereas in the young rabbits, the superficial regions 1, 3, and 4 had higher cell density than the central core regions 2 and 5. Young rabbits had significantly more labeled cells in superficial regions than in deep regions, but old rabbits had uniformly low numbers of labeled cells in all regions (fig. 9). CPM significantly increased the uptake of  $^{35}\text{S}$  sulfate in most of the superficial and deep regions of menisci of young rabbits, but had no effect on  $^{35}\text{S}$  sulfate uptake in the old rabbits. Similar results were obtained for the anterior, middle, and posterior thirds of both medial and lateral menisci.

These results suggest that CPM, a mild form of passive exercise or mechanical stress, may be more beneficial to young than to old menisci in increasing cellular activity and/or convective transport in avascular regions. Also, our results may provide insight into the etiology and healing capacity of degenerative midsubstance tears in menisci of young versus old patients.

## **THE GIRAFFE AS A MODEL OF TISSUE-MORPHOLOGY ADAPTATIONS TO GRAVITATIONAL STRESS**

Compared to our knowledge of its effects on bone and muscle, relatively little is known about the effects of microgravity on other load-bearing structures such as connective tissues. Furthermore, more studies of developmental biology are needed to elucidate mechanisms by which various tissues adapt to bearing increasing weight on Earth. Such investigations may provide important information concerning readaptation of space travelers to the Earth's gravity after prolonged weightlessness. With this knowledge, countermeasures against atrophy and/or degeneration of load-bearing tissues may be developed more easily.

The giraffe, *Giraffa camelopardalis*, is an important mammalian model for developmental studies of tissue adaptation to bearing increasing weight. Whereas giraffes develop in a quasi-weightless milieu as fetuses, after birth they must contend with increasing load-bearing in their dependent tissues as they grow to heights of over 5 m and weights of over 1000 kg.

### Cardiovascular and Meniscal Responses

We have obtained preliminary data concerning developmental alterations in load-bearing tissues of newborn and adult giraffes (Hargens et al., 1988). In this section, emphasis is placed on vascular-wall thickness in relation to local blood pressure and on meniscal adaptations to increased load-bearing in the developing giraffe. (Other load-bearing tissues such as bone, muscle, intervertebral disks, cartilage, ligaments, tendons, fascia, and veins await investigation.) Tissue samples were collected from four 5- to 6-yr-old, 3.5- to 4-m male and female giraffes in Africa, in 1985, and from three newborn and two 5-m female adult giraffes (ages 25 and 35) from the Cincinnati and Cheyenne Mountain zoos. Arteries were obtained from the neck and forelimbs (carotid and digital arteries, respectively) and fixed in 10% buffered formalin before processing. Arterioles and other microcirculatory vessels were sampled from skin and muscle of the head, neck, thorax, legs, and feet. Medial and lateral menisci were collected from the hindlimbs of two newborn and the two older female giraffes. Cell and vascular densities were measured in 6- $\mu$ m-thick cross sections of each meniscal region. The results indicate that cell densities are significantly higher, in most regions studied, in the menisci of newborn giraffes than in those of adult giraffes (fig. 10).

Arteries of the feet are sometimes exposed to blood pressures of greater than 400 mm Hg in adult giraffes (Hargens et al., 1987b). These vessels have developed pronounced smooth-muscle hypertrophy and narrowed lumens in response to their extraordinary blood pressures. Our previous finding of a less than normal arterial pressure gradient from heart to foot in the upright, stationary giraffe (Hargens et al., 1987a) suggests that the reduction in lumen cross-sectional area plays some role in blood pressure reduction in dependent tissues. The arterial wall hypertrophy was apparently confined to dependent vessels with diameters of over 400  $\mu$ m in adults, and was not observed in newborn giraffes or in vessels near the head in adult giraffes.

Although we did not have the opportunity to measure blood pressures in newborn giraffes, studies of humans (Guyton, 1977) and other species support the hypothesis that arterial pressures of baby giraffes are significantly lower at heart level and in dependent tissues than are those of adult giraffes. It was apparent that dependent arteries in adults had much thicker walls than did those in newborn giraffes (fig. 11). This arterial wall hypertrophy correlated directly with the degree of tissue dependency (table 1); wall-thickness-to-lumen-size ratios of large arteries increase from head to foot. In the tissues that we examined, arterial wall hypertrophy was restricted to vessels with outer diameters greater than 400  $\mu$ m.

The lower cell and vascular densities observed in adult giraffe menisci may be related to increased load-bearing and occlusion of the microcirculation during ambulation in the growing giraffe. In adult humans, blood perfusion of the meniscus is confined to its peripheral 10–25% (Danzig et al., 1983), and human menisci lose vascularity during development from fetus to adult (Clark and Ogden, 1983). Regions of the rat meniscus adapt differently, both morphologically and biochemically, to prolonged load-bearing exercise (Vailas et al., 1986). Other changes observed

during meniscal development in rabbit cell cultures include differentiation of cell types and proteoglycan-producing capacity (Webber et al., 1986). The lower cell density that we observed in adult giraffe specimens may represent an adaptation to decreased vascular density and poorer nutrition of central regions 2 and 5 as previously postulated by Smillie (1978). As reported earlier for the rat (Vailas et al., 1985), we observed calcium deposits in menisci of aged giraffes.

More studies of the developmental biology of giraffes are needed to elucidate mechanisms by which tissues adapt to aging and increased weight-bearing. Such knowledge may provide useful information for understanding the effects of weightlessness on load-bearing tissues and for developing countermeasures to aid readaptation of these tissues to normal gravity after prolonged space flight.

### CARDIOVASCULAR ADAPTATIONS TO GRAVITY IN THE GIRAFFE

This section reviews our recent results (Hargens et al., 1987a, 1987b) concerning hemodynamics and fluid balance in the giraffe as they pertain to gravitational physiology. By virtue of its stature, the giraffe provides a sensitive animal model for investigating adaptive mechanisms to high blood pressure in a normal gravitational field. Among the mammals, adult giraffes are unique because they grow to a height of 5 or 6 m and spend most of the time in an upright posture. Previous physiological studies of the giraffe have focused on arterial blood pressures at various levels of the head and neck (Goetz et al., 1960; Patterson et al., 1975; Van Citters et al., 1968; Warren, 1974). Briefly, these investigations demonstrated that arterial pressure near the giraffe heart, in order to provide sufficient blood pressure and perfusion to the brain, is about twice that in humans. An important question is how tall animals avoid pooling of their blood and other fluids in dependent tissues. If a 5.5-m-tall giraffe has a mean arterial pressure of 200 mm Hg at heart level, the mean arterial pressure in the feet may exceed 400 mm Hg, as previously stated. As reported by Warren (1974), the Danish physiologist August Krogh speculated that colloid osmotic pressure in the blood must be very high in giraffes' feet in order to prevent edema. Before our expedition in 1985, however, no one had actually measured colloid osmotic or hydrostatic pressures in blood or tissue of giraffe feet.

The forces that regulate transcapillary fluid balance were first identified by the British physiologist Ernest Starling (1896). Transcapillary fluid pressures are commonly called "Starling pressures," and are represented as  $P_c$ ,  $P_t$ ,  $\pi_c$  and  $\pi_t$  (fig. 12) in the following formulation of transcapillary fluid flow,  $J_c$ :

$$J_c = L_p A [(P_c - P_t) - \sigma_p (\pi_c - \pi_t)] \quad (1)$$

where  $L_p$  is fluid conductivity,  $A$  is the capillary membrane surface area, and  $\sigma_p$  is the protein reflection coefficient for the capillary membrane (Hargens, 1987).

During the 1985 expedition, eight 3- to 4-m male and female giraffes were studied with respect to their Starling pressures, regional blood flow, and histomorphology. (As part of a culling program in South Africa, two of these eight giraffes were killed by a local butcher, who allowed harvesting of multiple tissue samples from various regions of the giraffes' bodies.) Separately, arterial and venous

blood pressures were determined by using saline-filled, polyethylene catheters connected to pressure transducers kept level with each catheter tip. This method also allowed periodic sampling of arterial and venous blood for determination of colloid osmotic pressure by the technique of Aukland and Johnson (1974). Concurrently, interstitial fluid pressure,  $P_t$ , was measured by the wick catheter technique (Hargens et al., 1981), still maintaining the pressure transducer level with the catheter tip. Empty wick catheters were used to collect 5- $\mu$ l samples of interstitial fluid for determination of colloid osmotic pressure. Jugular vein pressures were measured as a function of hydrostatic height in three giraffes using the Millar Mikrotip transducer. These venous pressures,  $P_v$ , were determined without a saline-filled catheter because the pressure-sensing surface was at the catheter tip. These measurements were correlated with the results of studies of venous valve spacing in dissected veins. Local blood flow in neck and leg tissues were measured by the Xe-133 washout procedure (Henrikson, 1977). These initial studies were done with the giraffes in a stationary upright posture. The giraffes were sedated with a mixture of detomidine and azaparone during all catheterizations and bloodflow measurements. Subsequently, a radiotelemetry system was mounted in a backpack at the base of each giraffe's neck. This allowed continuous monitoring of blood and interstitial fluid pressures while the giraffe moved about during normal day and night activities.

Mean values for arterial and venous pressures qualitatively matched the expected gravitation pressure gradients, with the heart used as a reference for fluid discontinuity between the head and the foot (fig. 13). Although capillary blood pressure,  $P_c$ , was not measured directly in the giraffe, it is probably near  $P_v$  (150 mm Hg) in the feet and 10–20 mm Hg at the top of the neck (Hargens et al., 1987b). Surprisingly, blood colloid osmotic pressure,  $\pi_c$ , was identical in the giraffe and the human, thus  $\pi_c$  in the giraffe foot offers no unusual resorptive pressure for preventing dependent edema. Although some  $P_t$  measurements in the neck were negative, average body  $P_t$  ranged between 1 and 6 mm Hg, except under the tight skin and fascia of the extremities, where mean  $P_t$  was 44 mm Hg. Interestingly, interstitial fluid colloid osmotic pressure,  $\pi_t$ , was very low (1 mm Hg) except in foot samples, which were contaminated by blood. This finding provides evidence that giraffe capillaries are highly impermeable to plasma proteins and that  $\sigma_p$  approximates unity. This conclusion is supported by studies of peripheral lymph which indicated that only trace amounts of protein were present and  $\pi_{lymph}$  equalled zero.

Bloodflows in skeletal muscle of the neck and the leg at rest both averaged 4 ml  $\cdot$  min<sup>-1</sup>  $\cdot$  100g<sup>-1</sup>. Therefore, it is apparent that arteriolar smooth muscle is effective in normalizing bloodflow in the leg despite significantly higher arterial perfusion pressures. The presence of precapillary sphincters and pronounced arterial and arteriolar wall hypertrophy in dependent tissues were prominent findings of our giraffe histomorphometric studies.

Inserting our values for the Starling pressures into Eq. (1) yields a net resorptive pressure of -7 mm Hg in the giraffe neck and net filtration pressures of +88 to +152 mm Hg in tissues of the leg. These calculations suggest that giraffes in an upright, stationary posture are susceptible to dependent edema. However, our radiotelemetry data for the giraffe foot indicate that arterial pressure,  $P_a$ , (ranging from 70 to 380 mm Hg),  $P_v$  (-250 to +240 mm Hg) and  $P_t$  (-120 to +80 mm Hg) are highly variable during normal ambulation. Consequently, it appears that there is an effective pumping mechanism in the vascular and interstitial spaces for moving blood and interstitial fluid against gravity. The tight skin and fascial layers of the giraffe leg provide a functional "antigravity suit" to prevent pooling of blood and interstitial fluid in dependent tissues.

With regard to adaptation to high gravitational pressures in its cardiovascular system, the giraffe is certainly unique. The edema-preventing mechanisms detected in giraffe legs include (1) variable and sometimes negative  $P_v$  and  $P_t$ ; (2) impermeable capillary membranes to retain intravascular proteins; (3) arterial wall hypertrophy and vasoconstriction to reduce dependent bloodflow (Nilsson et al., 1988); (4) a prominent lymphatic system; and (5) skin and fascial antigravity suit combined with one-way valves in the veins and lymphatics to reduce venous capacity and to propel blood and peripheral lymph upward against a gravitational pressure gradient. This study demonstrates that intravascular and interstitial fluid pressures are highly variable during normal exercise and that studies of recumbent and upright stationary animals may give misleading information about transcapillary fluid balance. In zoos, sick giraffes die soon after assuming the recumbent position. Also, our results for static, upright animals provide an incomplete picture. Normal exercise with concomitant pumping of interstitial fluids, venous blood, and peripheral lymph (both of the latter aided by one-way valves) is important for edema prevention in dependent tissues. In this context, it is noteworthy that taller mammals (e.g., giraffes and humans) have tight fascial layers around their lower extremities, whereas shorter mammals (e.g., rats and rabbits) do not. The cyclical compression and decompression associated with muscular activity and the tight fascial enclosures (Sejersted et al., 1984) explain the highly variable  $P_a$ ,  $P_v$ , and  $P_t$  that were observed.

The existence of impermeable capillaries in the giraffe tends to raise  $\pi_c$  and lower  $\pi_t$ , but also, this relative impermeability may importantly reduce  $L_p$  through the capillary membrane, allowing the lymphatic system to carry away any excess interstitial fluid that forms. In addition, from our Xe-133 washout results, it is apparent that precapillary vasoconstriction normalizes blood flow and reduces the capillary filtration area in dependent tissues (see eq. (1)).

Some anatomical adaptations of giraffes and humans obviously represent developmental adjustments to high and variable gravitational pressures. For example, the important work of Williamson et al. (1971) documents that capillary basement membrane thickness increases twofold from neck muscle to leg muscle of adult giraffes and humans. On the other hand, such membranes in the human fetus are uniform and considerably thinner than those in children and adult humans. A thicker capillary membrane in dependent tissues of the adult provides anatomical evidence for lower permeability to plasma ultrafiltration across the capillary. In this context, it would be valuable to investigate alterations of edema-preventing parameters in human legs during long-term exposure to microgravity and subsequent readjustment to Earth's 1 g or to hypergravity conditions on a larger planet. It is possible that the smooth-muscle tone of precapillary arterioles and lymphatic vessels in dependent tissues is lost during long-term space flight in the absence of countermeasures. Long-term bed rest studies of edema-preventing mechanisms in humans may elucidate the time course of this postulated vascular deconditioning. The effect of long-term microgravity on fascia and other connective tissue structures needs careful assessment as well. Such studies should provide knowledge about mechanisms and rates of deconditioning and reconditioning in space travelers as well as in patients exposed to long-term bed rest.

The pressure gradient down the giraffe's jugular vein was about one-tenth that expected for a continuous column of blood (fig. 14). The nonhydrostatic pressure gradient indicates that blood flows down from the head in a discontinuous column and that circulation above heart level does not depend upon a siphonlike principle (Seymour and Johansen, 1987) as recently proposed (Badeer, 1986, 1988; Hicks and Badeer, 1989). Moreover, if the siphoning mechanism were important,

giraffes wouldn't need such high arterial pressures as those that we and others have measured at heart level. The abundance of valves in the head and distal neck compared to their sparseness in the proximal neck indicates their importance for preventing retrograde venous flow, as in the short periods when the giraffe's head is lowered below heart level during drinking.

The results obtained in these studies of the giraffe suggest avenues of future gravitational physiology research in giraffes and in other animals, including humans. For example, adaptations to head-down drinking in the giraffe require further study to determine whether intracranial hypertension is a problem in this posture. Cerebrospinal fluid pressures should be measured in various positions and activities. Lymphatic flow and pressures warrant detailed studies in upright giraffes and in patients exposed to long-term bed rest. More complete histomorphometric studies would provide information about the anatomical basis of the physiological mechanisms involved in edema prevention. Sleep patterns in the giraffe should be studied because of the lack of recumbency. Fascia and skin compliance should be studied in the legs of various animals. Studies of other gravity-sensitive animals (e.g., snakes (Lillywhite, 1985), and tall birds such as ostriches and flamingoes) are indicated. Finally, better and more complete studies of venous pressures from the head into the thoracic cavity and the right ventricle are needed.

## REFERENCES

- Aukland, K., and Johnson, H. M. (1974). A colloid osmometer for small fluid samples. *Acta Physiol. Scand.*, 90:485-490.
- Badeer, H. S. (1986). Does gravitational pressure of blood hinder flow to the brain of the giraffe? *Comp. Biochem. Physiol.*, 83A:207-211.
- Badeer, H. S. (1988). Haemodynamics of the jugular vein in the giraffe. *Nature*, 332:788-789.
- Clark, C. R., and Ogden, J. A. (1983). Development of the menisci of the human knee joint. *J. Bone Joint Surgery*, 65A:538-547.
- Danzig, L., Gonsalves, M. R., Resnick, D., and Akeson, W. H. (1983). Blood supply to the normal and abnormal menisci of human knee. *Clin. Orthop.*, 172:271-276.
- Glover, M. G., Hargens, A. R., Mahmood, M. M., Gott, S., Brown, M. D., and Garfin, S. R. (1991). A new technique for the in vitro measurement of nucleus pulposus swelling pressure. *J. Orthopaedic Res.*, 9:61-67.
- Goetz, R. H., Warren, J. V., Gauer, O. H., Patterson, J. L., Jr., Doyle, J. T., Keen, E. N., and McGregor, M. (1960). Circulation of the giraffe. *Circ. Res.*, 8:1049-1058.
- Guyton, A.C., (1977). *Basic Human Physiology: Normal Function and Mechanisms of Disease*. Philadelphia, W. B. Saunders, pp. 202-203, 887.
- Hammel, H. T., and Scholander, P. F. (1976). *Osmosis and Tensile Solvent.*, Berlin, Springer-Verlag, 133 pp.
- Hargens, A. R. (1986). *Tissue Nutrition and Viability*. New York, Springer-Verlag, 312 pp.
- Hargens, A. R. (1987). Interstitial fluid pressure and lymph flow. In *Handbook of Bioengineering*. Edited by R. Skalak and S. Chien. New York, McGraw-Hill, pp. 19.1-19.25.
- Hargens, A. R., Cologne, J. B., Menninger, F. J., Hogan, J. S., Tucker, B. J., and Peters, R. M. (1981). Normal transcapillary pressures in human skeletal muscle and subcutaneous tissues. *Microvasc. Res.*, 22:177-189.
- Hargens, A. R., Millard, R. W., Pettersson, K., and Johansen, K. (1987a). Gravitational haemodynamics and oedema prevention in the giraffe. *Nature*, 329:59-60.
- Hargens, A. R., Millard, R. W., Pettersson, K., van Hoven, W., Gershuni, D. H., and Johansen, K. (1987b). Transcapillary fluid balance in the giraffe. In *Interstitial-Lymphatic Liquid and Solute Movement, Advances in Microcirculation*, Volume 13. Edited by N. C. Staub, J. C. Hogg, and A. R. Hargens. Basel: S. Karger, pp. 195-202.

Hargens, A. R., Gershuni, D. H., Danzig, L. A., Millard, R. W., and Pettersson, K. (1988). Tissue adaptations to gravitational stress: newborn versus adult giraffes. *The Physiologist*, 31:S110-S113.

Henriksen, O. (1977). Local sympathetic reflex mechanism in regulation of blood flow in human subcutaneous adipose tissue. *Acta Physiol. Scand. Suppl.*, 450:1-48.

Hicks, J. W., and Badeer, H. S. (1989). Siphon mechanism in collapsible tubes: application to circulation of the giraffe head. *Am. J. Physiol.* 256:R567-R571

Lenfant, C., and Chiang S-T. (1982). Weightlessness: from Galileo to Apollo. In *A Companion to Animal Physiology*. Edited by C. R. Taylor, K. Johansen and L. Bolis. Cambridge, Cambridge Univ. Press, pp. 339-348.

Lillywhite, H. B. (1985). Postural edema and blood pooling in snakes. *Physiol. Zool.*, 58:759-766.

Maroudas, A., Ziv, I., Weisman, N., and Venn, M. (1985). Studies of hydration and swelling pressure in normal and osteoarthritic cartilage. *Biorheology*, 22:159-169.

Nilsson, O., Booj, S., Dahlstrom, A., Hargens, A. R., Millard, R. W., and Pettersson, K. S. (1988). Sympathetic innervation of the cardiovascular system in the giraffe. *Blood vessels*, 25:299-307.

Patterson, J. L., Jr., Goetz, R. H., Doyle, J. T., Warren, J. V., Gauer, O. H., Detweiler, D. K., Said, S. I., Hoernicke, H., McGregor, M., Keen, E. N., Smith, M. H., Jr., Hardie, E. L., Reynolds, M., Flatt, W. P., and Waldo, D. R. (1975). Cardiorespiratory dynamics in the ox and giraffe, with comparative observations on man and other mammals. *Ann. NY Acad. Sci.*, 127:393-413.

Peters, T. J., and Smillie, I. S. (1972). Studies on the chemical composition of the menisci of the knee joint with special reference to the horizontal cleavage lesion. *Clin. Orthop.*, 86:245-252.

Scholander, P. F., Hammel, H. T., Bradstreet, E. D., and Hemmingsen, E.A. (1965). Sap pressure in vascular plants. *Science*, 148:339-346.

Sejersted, O. M., Hargens, A. R., Kardel, K. R., Blom, P., Jensen, O., and Hermansen, L. (1984). Intramuscular fluid pressure during isometric contraction of human skeletal muscle. *J. Appl. Physiol.: Respirat. Environ. Exercise Physiol.*, 56:287-295.

Seymour, R. S. and Johansen, K. (1987). Blood flow uphill and downhill: does a siphon facilitate circulation above the heart? *Comp. Biochem. Physiol.*, 88A:167-170.

Smillie, I. S. (1978). *Injuries of the Knee Joint*, Edinburgh: Churchill Livingstone.

Starling, E. H. (1896). On the absorption of fluids from connective tissue spaces. *J. Physiol. (Lond.)*, 19:312-326.



Urban, J. P. G., and McMullin, J. (1985). Swelling pressure of the intervertebral disk. *Biorheology*, 22:145-157.

Vailas, A. C., Zernicke, R. F., Matsuda, J., Curwin, S., and Durivage, J. (1986). Adaptation of rat knee meniscus to prolonged exercise. *J. Appl. Physiol.*, 60:1031-1034.

Vailas, A. C., Zernicke, R. F., Matsuda, J., and Peller, D. (1985). Regional biochemical and morphological characteristics of rat knee meniscus. *Comp. Biochem. Physiol.*, 82B:283-285.

Van Citters, R. L., Kemper, S., and Franklin, D. L. (1968). Blood flow and pressure in the giraffe carotid artery. *Comp. Biochem. Physiol.*, 24:1035-1042.

Warren, J. V. (1974). The physiology of the giraffe. *Scient. Amer.*, 231(5):96-105.

Webber, R. J., Zitaglio, T., and Hough, A. J., Jr. (1986). In vitro cell proliferation and proteoglycan synthesis of rabbit meniscal fibrochondrocytes as a function of age and sex. *Arthritis Rheum.*, 29:1010-1016.

Williamson, J. R., Vogler, N. J., and Kilo, C. (1971). Regional variations in the width of the basement membrane of muscle capillaries in man and giraffe. *Am. J. Pathol.*, 63:359-370.

**Table 1. Ratios of smooth-muscle wall thickness/lumen ratios (w/r)  
for arteries from the neck to the feet of adult giraffes.  
(Modified from Hargens et al., 1988).**

Artery	w/r	Outer Diameter (mm)
Carotid	0.15-0.20	9.5-1.0
Brachial	0.33-0.43	5.5-7.5
Femoral	0.65-0.68	4.0-4.2
Ulnar	0.70	7.2
Radial	0.70	5.4
Metatarsal	0.51-0.81	3.1-4.8
Digital	0.56	4.0

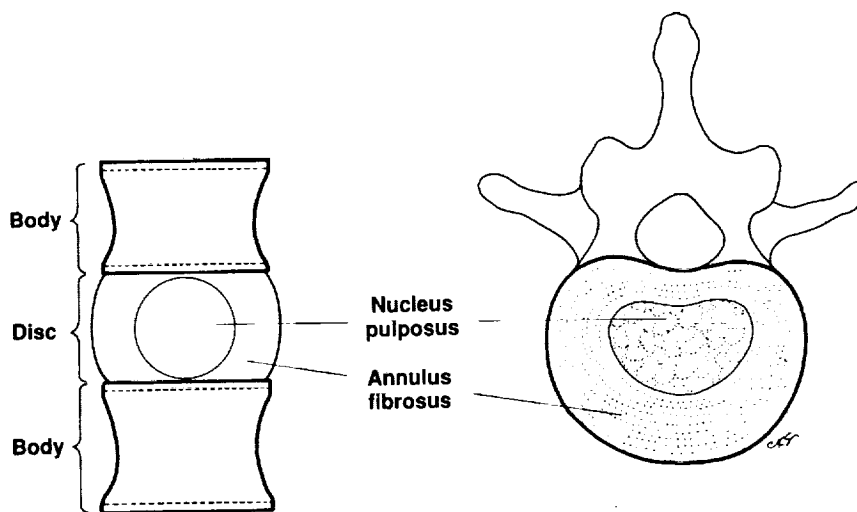

**Figure 1. Each intervertebral disk consists of a central, gelatinous nucleus pulposus that is confined by an annulus fibrosus and two vertebral bodies.**

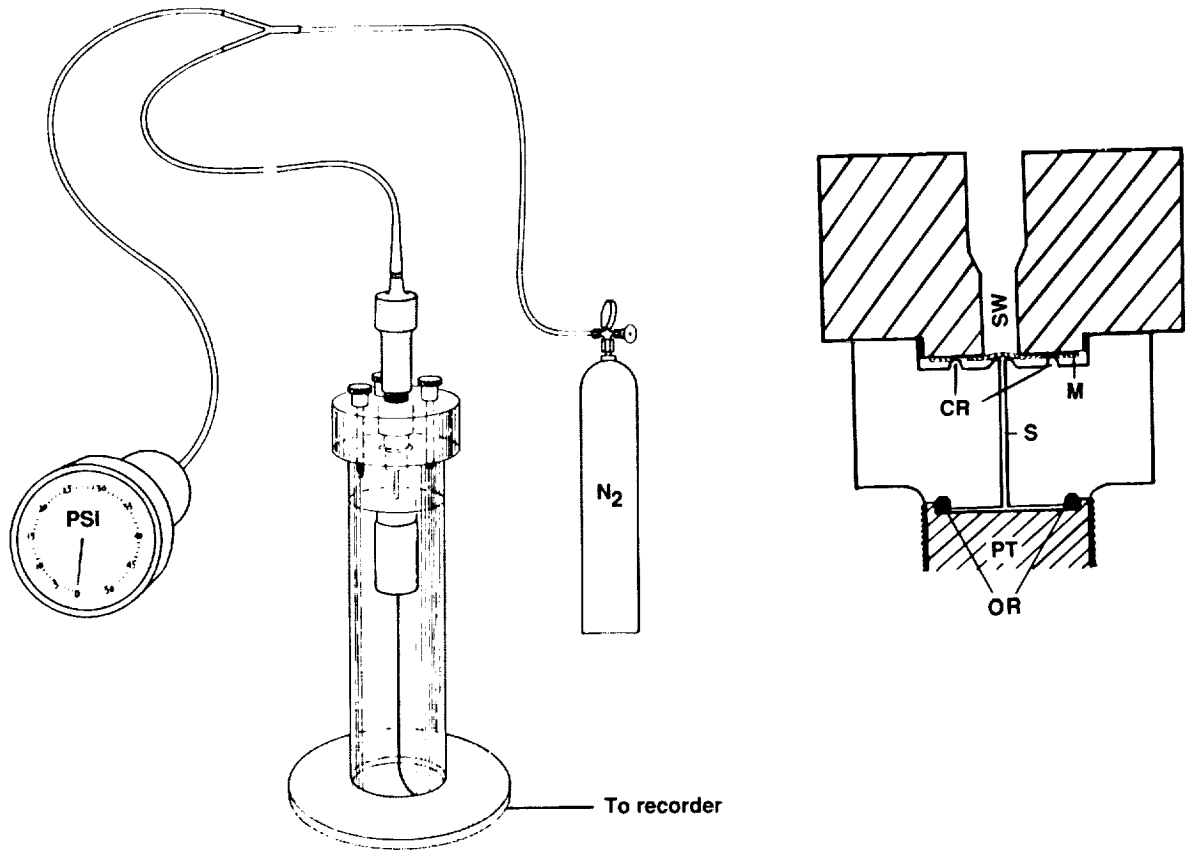

Figure 2. Compression-type osmometer for measuring swelling pressure of nucleus pulposus. Left: Plexiglas osmometer mounted on stand with nitrogen gas inlet at top. The osmometer is connected to a nitrogen gas source, a precision pressure gauge, and a pressure transducer. Trans-membrane pressure gradients are continuously monitored by a strip-chart recorder. Right: cross-section of osmometer with sealing of membrane by crimp rings (CR) on the screw-down Plexiglas plate. Nucleus pulposus is placed in the sample well (SW) on top of the membrane (M). Pressure gradients across the membrane are transmitted by the saline fluid column (S) and monitored by the pressure transducer (PT) which is fitted tightly to the bottom of the osmometer using an O-ring seal (OR). (From Glover, et al., 1991)

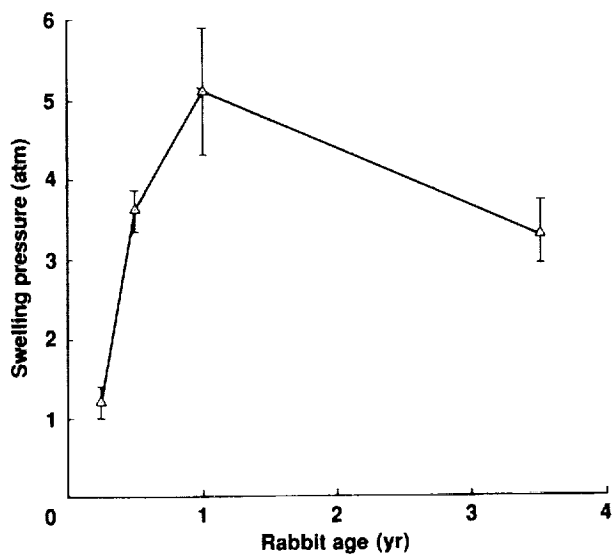

Figure 3. Swelling pressures of rabbit disks as related to age.







<u>Animal</u>	<u>Weight</u>	<u>Swelling pressure (atm)</u>
	Up to 5 kg	None
	Up to 500 g	< 0.01
	400 – 500 g	0.5 ± 0.05
	40 kg	0.8 ± 0.05
	60 kg	2.4 ± 0.1
	3.7 – 4.1 kg	3.7 ± 0.3

Figure 4. Swelling pressures of disks compared to species' weight.

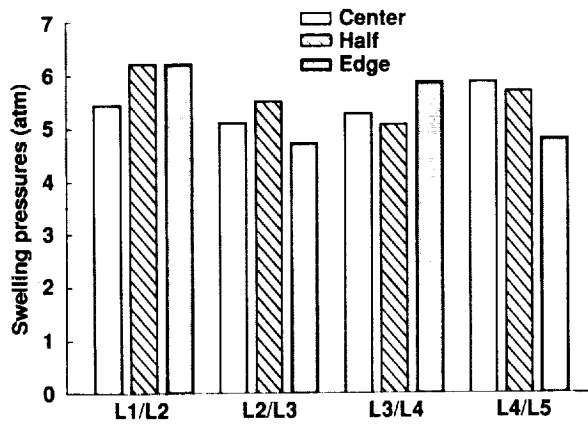

Figure 5. Swelling pressures within the giraffe lumbar spine.

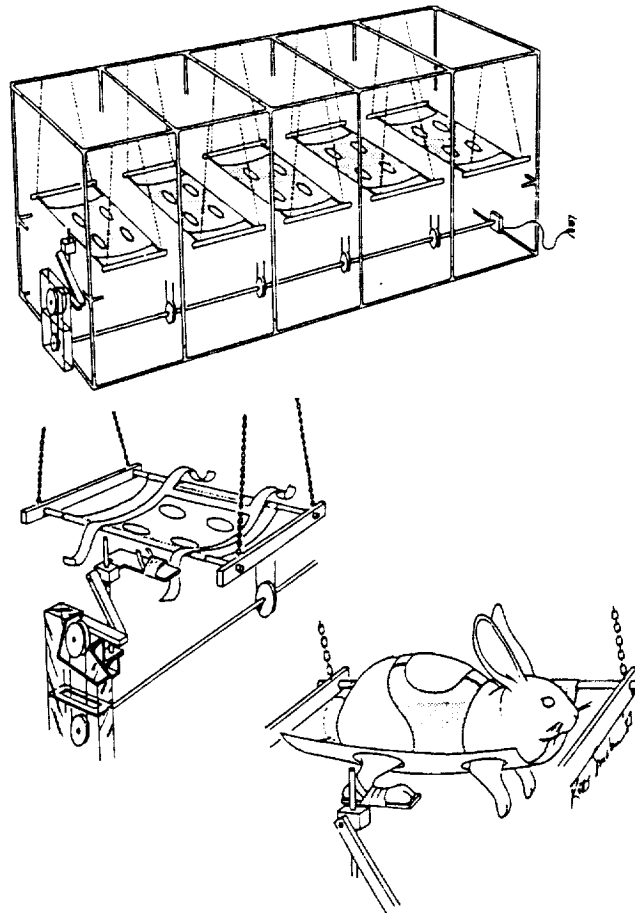

Figure 6. CPM device for studies of rabbit meniscus nutrition.

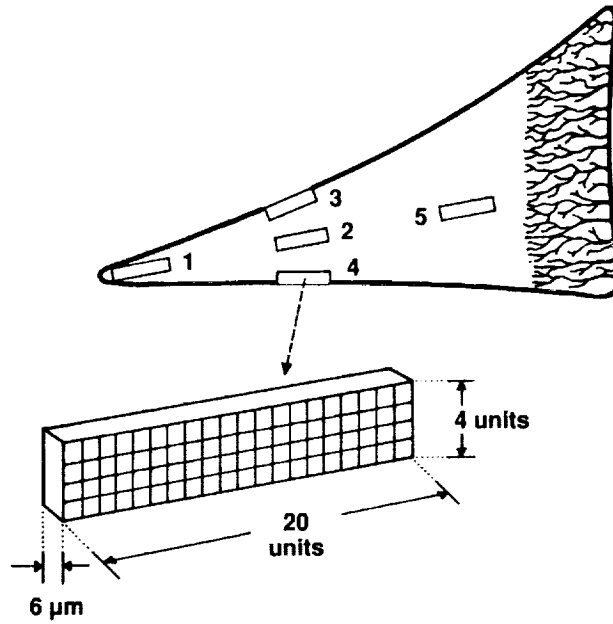

Figure 7. Cross-section of meniscus with regions of study depicted. Total volume of tissue studied in each block was  $243,000 \mu\text{m}^3$ .

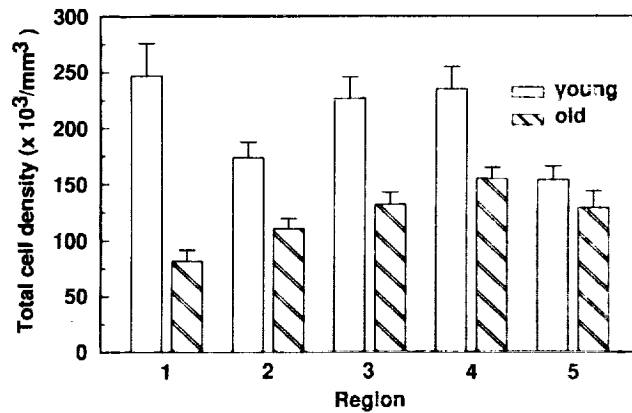

Figure 8. Cell densities in posterior medial menisci of old rabbits compared to those of young rabbits.

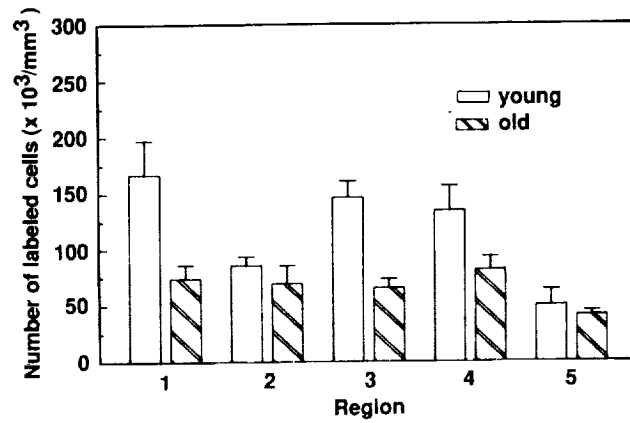

Figure 9. Metabolic activity of posterior medial meniscal cells old rabbits compared to those of young rabbits.

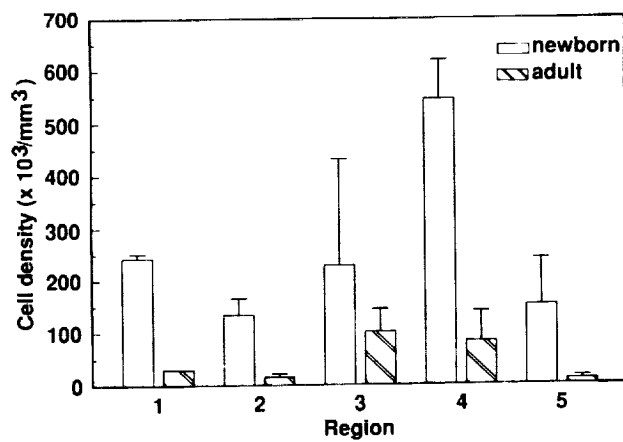

Figure 10. Meniscocyte density in anterior portion of lateral menisci from newborn versus adult giraffes.

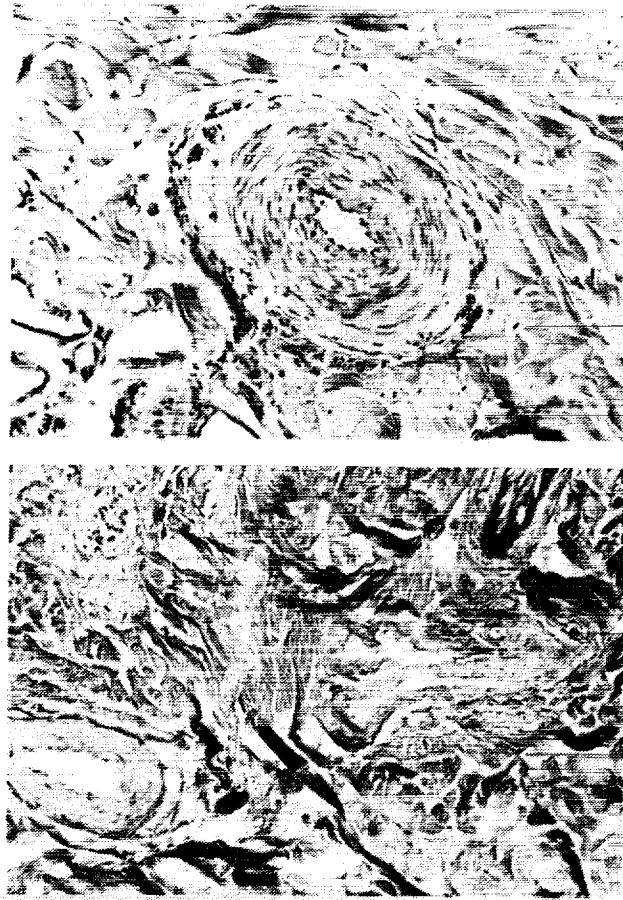

Figure 11. Four-hundred-micron-diameter arteries from foot skin of adult (top) compared to newborn (bottom left) giraffe. (From Hargens, et al., 1988)

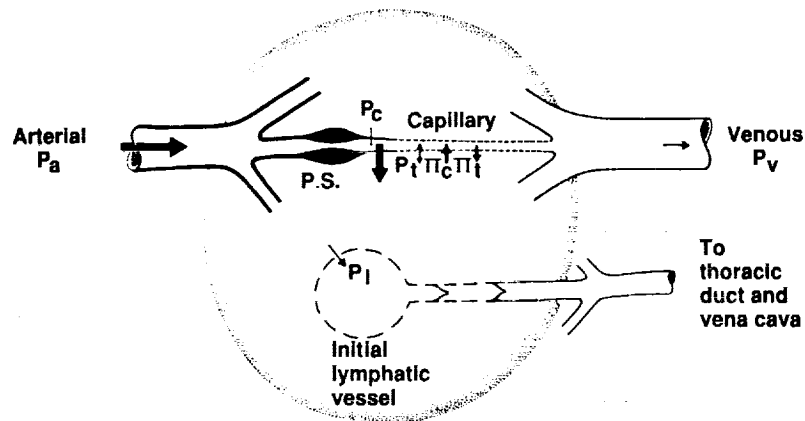

Figure 12. Starling pressures that govern fluid exchange across the capillary membrane are filtration pressures (capillary blood pressure,  $P_c$ , and interstitial fluid colloid osmotic pressure,  $\pi_t$ ) and resorptive pressure (blood colloid osmotic pressure,  $\pi_c$ ). Interstitial fluid pressure,  $P_t$ , is sometimes positive (favoring resorption) and sometimes negative (favoring filtration). Precapillary sphincter (P.S.) muscles regulate capillary flow and pressure, especially in dependent tissues. (From Hargens, 1987).



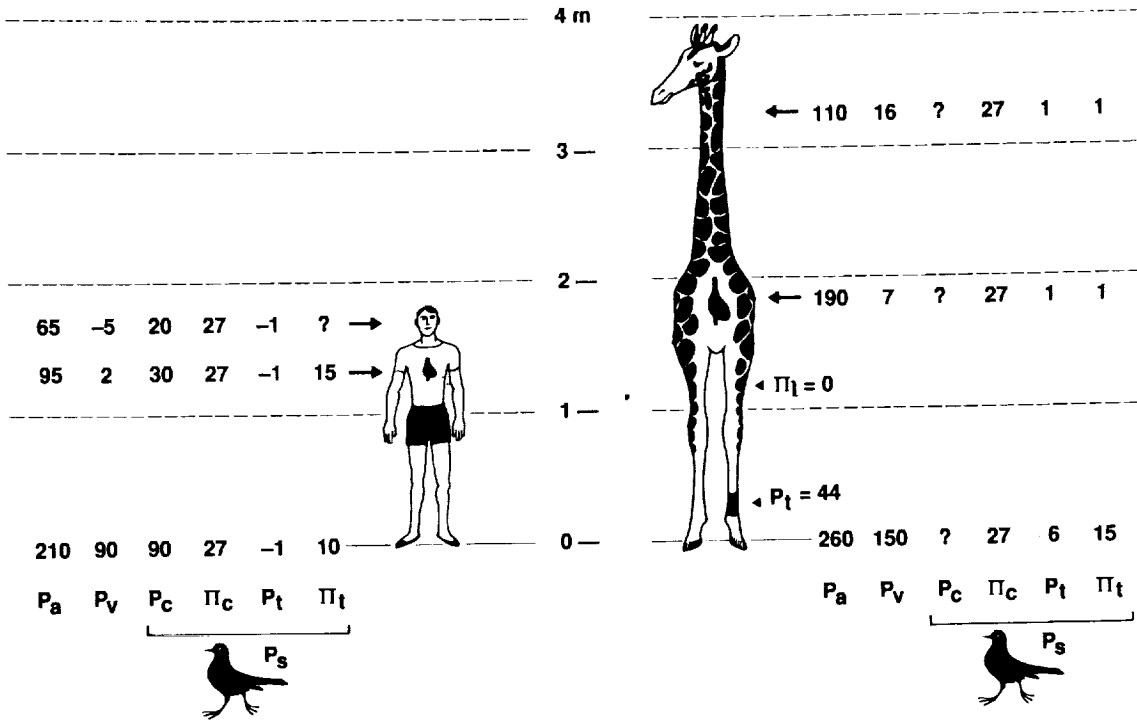

Figure 13. Mean arterial ( $P_a$ ), venous ( $P_v$ ), and Starling ( $P_c$ ,  $\pi_c$ ,  $P_t$ , and  $\pi_t$ ) pressures in giraffe (right) as compared to human (left) at hydrostatic levels between the head and feet.

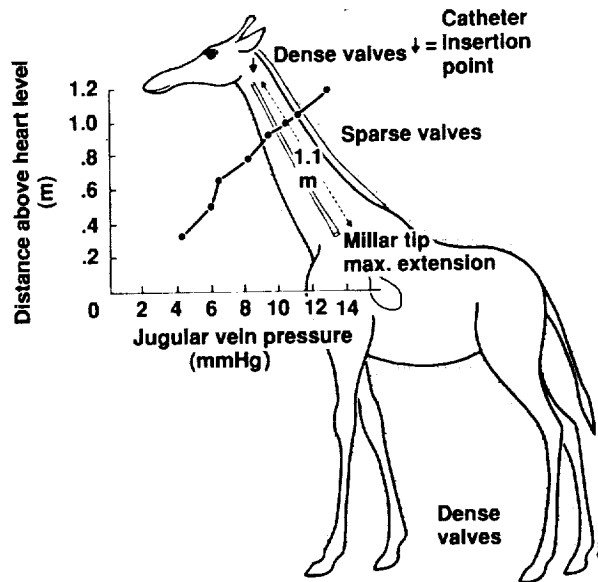

Figure 14. Pressure as a function of hydrostatic height in the jugular vein and intervalle distances in the giraffe neck and leg. (From Hargens, et al., 1987a).



# Report Documentation Page

1. Report No. NASA TM-102228		2. Government Accession No.		3. Recipient's Catalog No.	
4. Title and Subtitle Developmental Adaptations to Gravity in Animals			5. Report Date February 1991		
			6. Performing Organization Code		
7. Author(s) Alan R. Hargens			8. Performing Organization Report No. A-89232		
			10. Work Unit No. 199-21-12		
9. Performing Organization Name and Address Ames Research Center Moffett Field, CA 94035-1000			11. Contract or Grant No.		
			13. Type of Report and Period Covered Technical Memorandum		
12. Sponsoring Agency Name and Address National Aeronautics and Space Administration Washington, DC 20546-0001			14. Sponsoring Agency Code		
			15. Supplementary Notes This report was originally prepared as a book chapter.		
16. Abstract <p>Terrestrial animals have adapted to a constant gravitational stress over millions of years. Tissues of the cardiovascular system and lumbar spine in tall species of animals such as the giraffe are particularly well adapted to high and variable vectors of gravitational force. Swelling of the leg tissues in the giraffe is prevented by a variety of physiological mechanisms including (1) a natural "antigravity suit," (2) impermeable capillaries, (3) arterial-wall hypertrophy, (4) variable blood pressures during normal activity, and (5) a large-capacity lymphatic system. These adaptations, as well as a natural hypertension, maintain blood perfusion to the giraffe's brain. The intervertebral disk is another tissue that is uniquely adapted to gravitational stress. Tall and large terrestrial animals have higher swelling pressures than their smaller or aquatic counterparts. Finally, the meniscus of the rabbit knee provides information on the effects of aging and load-bearing on cartilaginous tissues. Such tissues within the joints of animals are important for load-bearing on Earth; these connective tissues may degenerate during long-duration space flight.</p>					
17. Key Words (Suggested by Author(s)) Developmental physiology, Meniscus, Aging, Intervertebral disk, Giraffe			18. Distribution Statement Unclassified-Unlimited  Subject Category - 55		
19. Security Classif. (of this report) Unclassified		20. Security Classif. (of this page) Unclassified		21. No. of Pages 22	22. Price A02