

PD 618-150

Voyager

7N-13-02

15283

P-177

# The Voyager Uranus Travel Guide

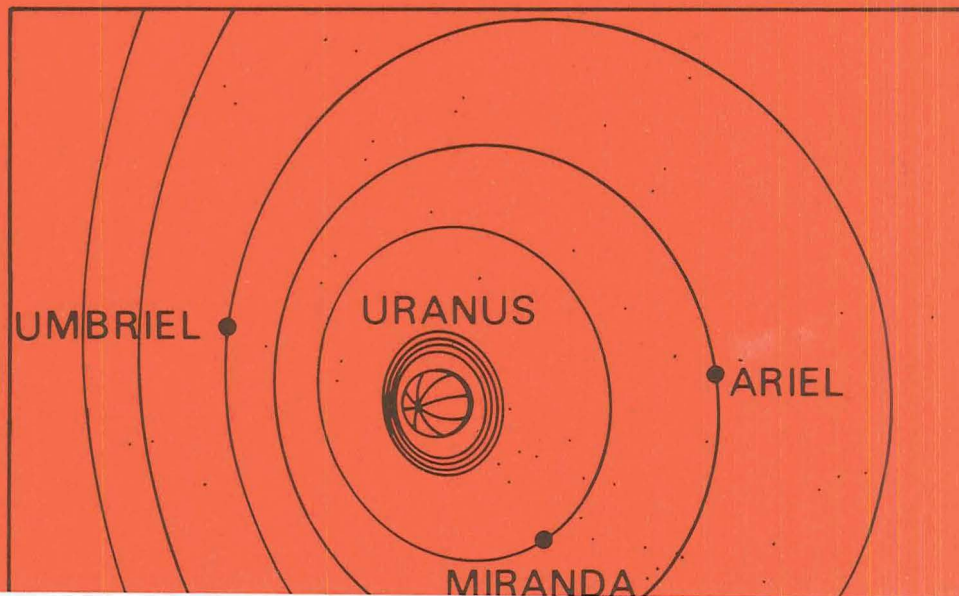

(NASA-CR-188441) THE VOYAGER URANUS TRAVEL  
GUIDE (JPL) 177 p

N91-71286

00/13 Unclas  
0015283

August 15, 1985

National Aeronautics and  
Space Administration

**JPL**

Jet Propulsion Laboratory  
California Institute of Technology  
Pasadena, California

JPL D-2580

**NASA FILE COPY**

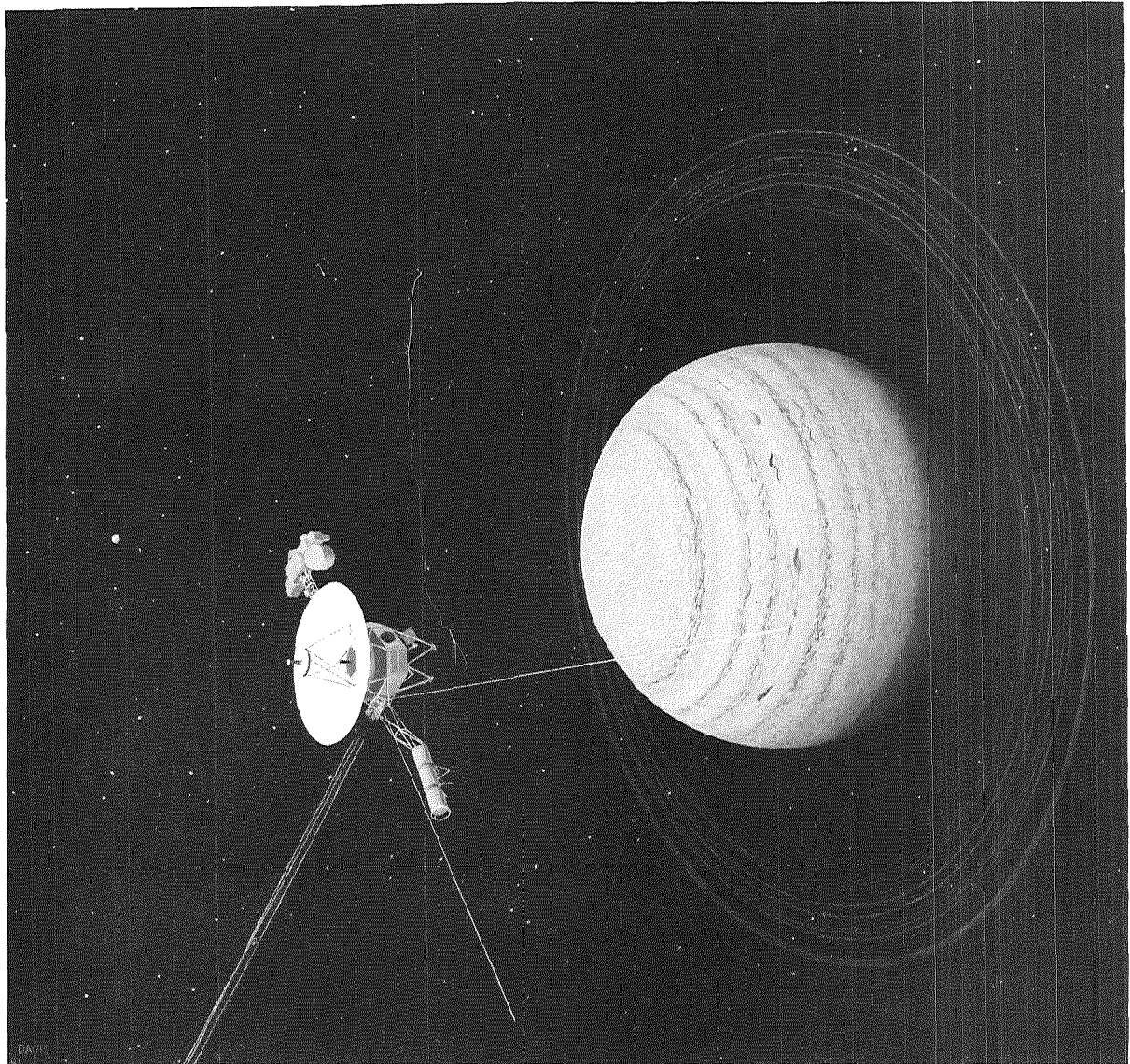

Voyager 2 approaches the sunlit hemisphere of the tilted gas giant known as Uranus. In this geometrically-accurate view, two hours before closest approach on January 24, 1986 we are able to spot the small orb of Umbriel (at 10 o'clock from the spacecraft), one of the five presently known moons of Uranus. Voyager 2 will also scan the nine narrow rings that are darker than coal dust.

THE VOYAGER URANUS TRAVEL GUIDE

Prepared by

Voyager Mission Planning Office Staff

Approved by: Charles Kohlhase

Charles Kohlhase

Manager, Mission Planning Office

The Voyager Project

## Table of Contents

	Page
1. Introduction .....	1
Voyager's Past .....	3
Anticipating Uranus .....	5
2. Uranus .....	7
Overview of the Planet .....	8
The Atmosphere of Uranus .....	11
The Magnetosphere of Uranus .....	12
The Satellites of Uranus .....	14
The Rings of Uranus .....	17
3. Getting The Job Done .....	19
Planning .....	19
Sequencing .....	22
Flight Operations .....	24
Commanding .....	25
Receiving Data .....	26
The Results .....	29
4. Scientific Objectives .....	31
Imaging Science Subsystem (ISS) .....	32
Infrared Interferometer Spectrometer and Radiometer (IRIS) .....	34
Ultraviolet Spectrometer (UVS) .....	36
Photopolarimeter Subsystem (PPS) .....	38
Radio Science Subsystem (RSS) .....	39
Fields and Particles Experiments .....	43
Planetary Radio Astronomy (PRA) .....	43
Magnetometer (MAG) .....	44
Particle Detectors .....	45



## Table of Contents

	Page
Plasma Subsystem (PLS) .....	45
Low-Energy Charged Particle (LECP) and Cosmic Ray Subsystem (CRS) .....	45
Plasma Wave Subsystem (PWS) .....	46
Sensor Engineering Characteristics .....	48
The Physics of the Optical Target Body Instruments .....	48
Science Links .....	52
5. Voyager Spacecraft .....	57
The High Gain Antenna .....	58
Spacecraft Attitude Control .....	60
Spacecraft Maneuvers .....	61
Scan Platform .....	63
Spacecraft Power Subsystem .....	64
Digital Tape Recorder .....	66
The Spacecraft Receiver .....	67
The Computer Command Subsystem .....	69
The Flight Data Subsystem .....	70
The Science Instruments .....	72
6. Mission Highlights .....	75
Pre-Encounter Test and Calibration Activities ..	76
Observatory Phase (OB) .....	79
Far Encounter Phase (FE) .....	80
Critical Late Activities .....	81
Near Encounter Phase (NE) .....	82
Post Encounter Phase (PE) .....	90
Contingency Sequences .....	92
Cruise to Neptune .....	94

## Table of Contents

	Page
7. What's New .....	95
Maintaining a Strong Signal .....	96
Discarding Unnecessary Picture Data .....	96
More Accuracy for Fewer Bits .....	97
Taking Good Pictures in Feeble Light Levels ....	98
Diagnosing the Health of the Actuators .....	101
Faster Response from the "Old" Robot .....	101
Big Changes in the Deep Space Network .....	102
The Bottom Line .....	103
8. Gee-Whiz Facts .....	105
Overall Mission .....	105
Voyager Spacecraft .....	107
Navigation .....	110
Science .....	111
The Future .....	112
9. How Far and How Fast .....	113
The Great Escape .....	114
Voyager 2 at Uranus .....	117
Key Events, Distances, and Speeds .....	120
10. Jupiter and Saturn Highlights .....	125
Jupiter .....	125
Jupiter's Rings .....	128
Jupiter's Moons .....	128
Jupiter's Magnetosphere .....	132
Saturn .....	132
Saturn's Rings .....	135
Saturn's Moons .....	137
Saturn's Magnetosphere .....	140

## Table of Contents

	Page
11. To Neptune and Beyond .....	143
The Neptune Kingdom .....	144
Neptune and Triton Encounter Planning .....	146
Post-Neptune Cruise Science .....	148
12. Project Functional Areas .....	159
13. Acknowledgments .....	165
14. Index .....	167

The most beautiful experience we can have is the mysterious. It is the fundamental emotion that stands at the cradle of true art and true science.

Einstein

## 1. INTRODUCTION

Congratulations! You are now the proud owner of a Voyager Uranus Travel Guide, hereafter simply called the Guide. Its purpose is to explain in simple language, including numerous illustrations, the Voyager-2 plans to examine Uranus and its moons, rings, particles, and fields. The Guide will also contain a variety of interesting facts about the Voyager mission, both past and future.

Before jumping into the Uranus mission particulars, we should briefly review the basic elements of an unmanned space mission. These elements are shown in Figure 1-1. You must, of course, have a SPACECRAFT capable of carrying a variety of sensors to the destination in order to conduct the SCIENCE you have in mind. The spacecraft cannot escape from Earth's gravity well without the help of a LAUNCH VEHICLE, an expendable set of rocket stages in the olden days or a reusable Space Transportation System, or Shuttle, with a high-energy upper stage in the future.

No launch vehicle or spacecraft has an error-free guidance system, and so the process of NAVIGATION is necessary to deliver the spacecraft to a precise location at the destination. As shown in Figure 1-2, the navigation process uses range and doppler measurements from huge tracking antennas to estimate the spacecraft location to an accuracy of 1000-3000 km (620-1860 mi). As the spacecraft nears the destination, it takes pictures of natural satellites against a star background (optical navigation) to improve its position estimate to better than 100 km (62 mi). If the spacecraft flight path is off course, mission controllers send commands that cause the spacecraft to use small thrusters to correct its course.



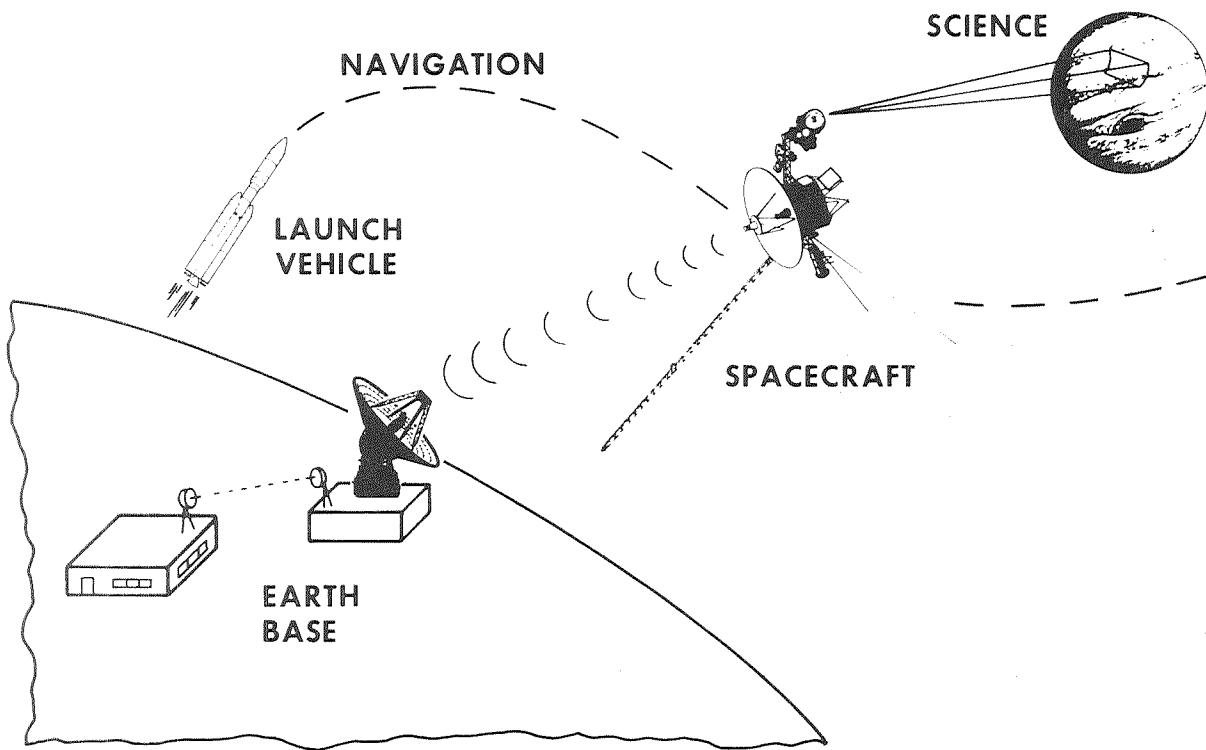
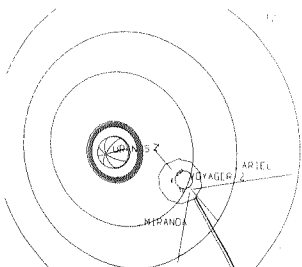

Figure 1-1. These are the five basic elements of an unmanned space mission. Earth Base is comprised of a large complex of people, computers, communication lines, and tracking antennas. A manned space mission has a sixth element, the human crew for whom life support systems are required.

As you have guessed by now, Voyager needs a lot of support from EARTH BASE, which consists of a vast complex of people, computers, communication lines, and special equipment. Voyager can cruise happily along, locked onto the sun and a guide star, even using onboard fault protection logic to react to problems, but it still needs to hear from Earth regarding its activity plan.

A group of scientists decide upon an observation they would like Voyager to make. Flight team personnel from such areas as mission planning, science support, spacecraft engineering, flight operations, and sequence implementation, schedule and design the observation into a master activity timeline. As shown in



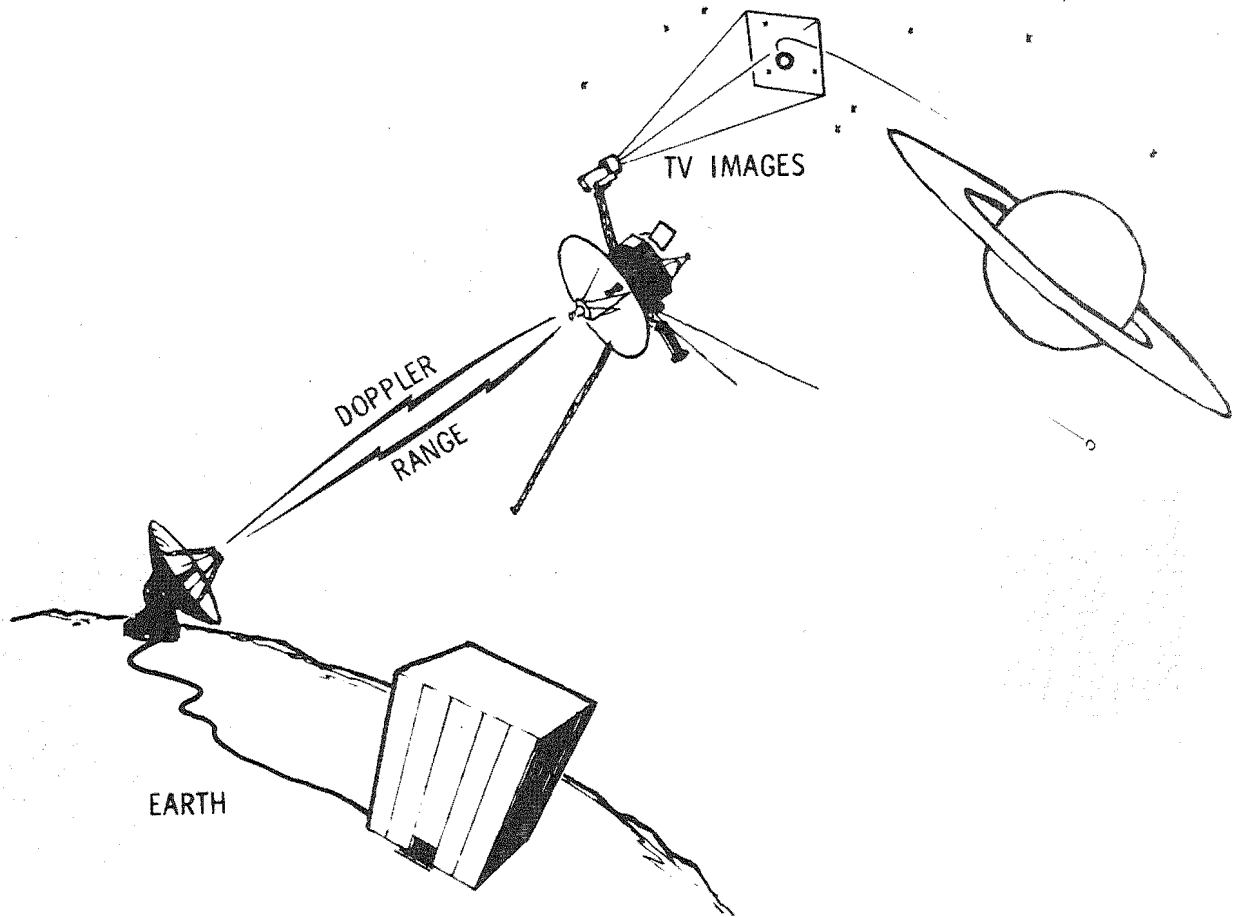

Figure 1-2. Navigators from Earth Base use radio tracking data and satellite-star images to estimate Voyager's position and heading.

Figure 1-3, several steps are taken before Voyager finally carries out these instructions from Earth. Since Voyager has its own internal clock, desired activities can be loaded into its computers many days before they are to be executed. Each set of activities is termed a command load.

### Voyager's Past

The Voyager mission has had quite a past. As shown in Figure 1-4, two spacefaring robots were launched from Earth in 1977, bound for the giant planets of the outer solar system. These amazing machines are like distant extensions of human sensory organs, having already exposed the once-secret lives

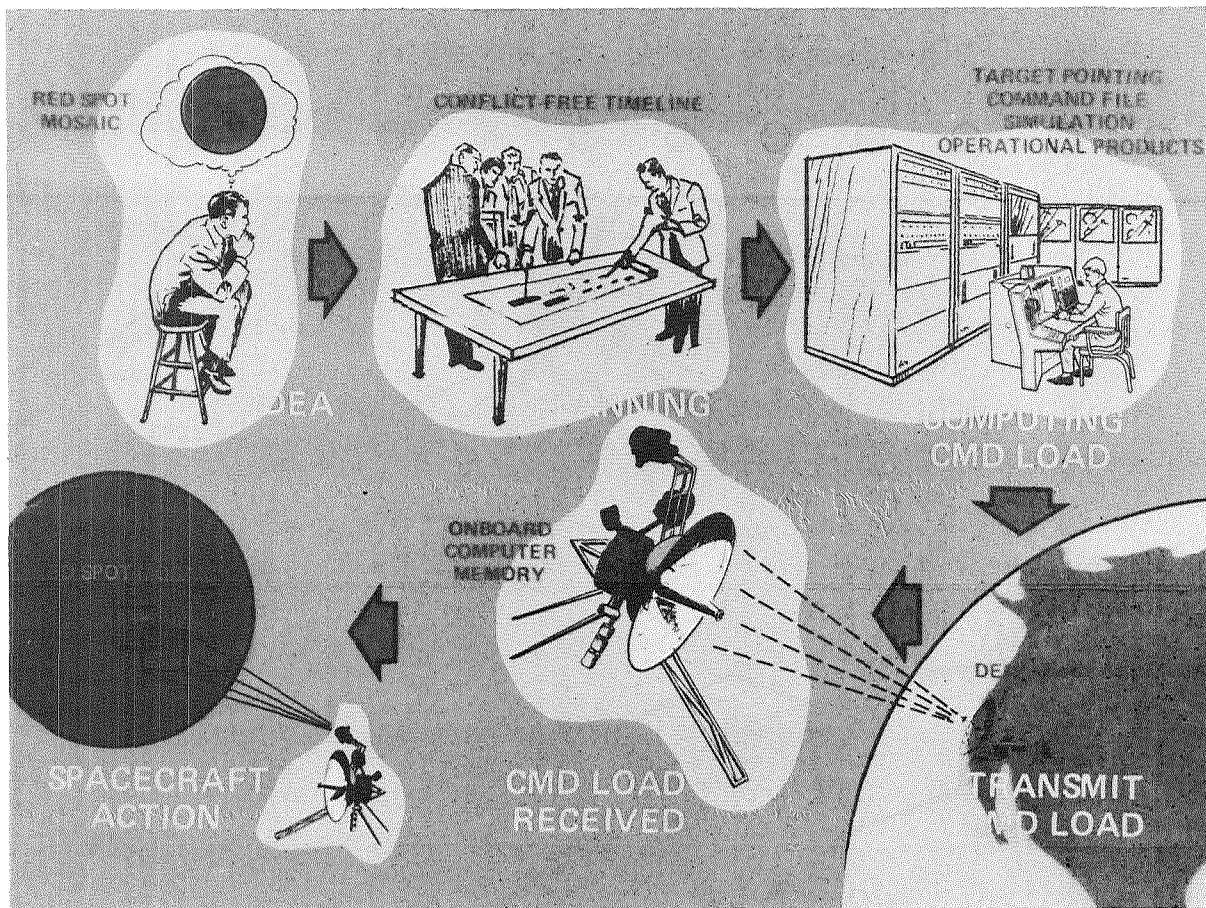
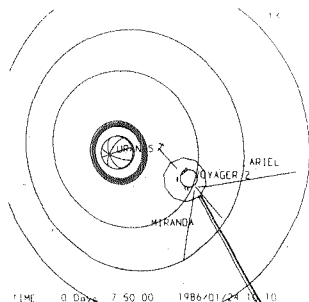

Figure 1-3. Many steps are necessary to develop activity sequences that Voyager will eventually execute.

of some three dozen worlds. Like remote tourists in never-never land, they have snapped pictures to reveal Saturn's dazzling necklace of 10,000 strands. Millions of ice particles and car-sized bergs race along each of the million-kilometer-long strands, with the traffic flow orchestrated by the combined gravitational tugs of Saturn and a retinue of moons and moonlets.

The Voyagers have shown us the erupting volcanos of golden Io, the colorful and dynamic atmosphere of gargantuan Jupiter and its centuries-old Great Red Spot, the smooth water-ice surface of Europa that may hide an ocean beneath, the strange world of Titan with its dense atmosphere and variety of hydrocarbons that slowly



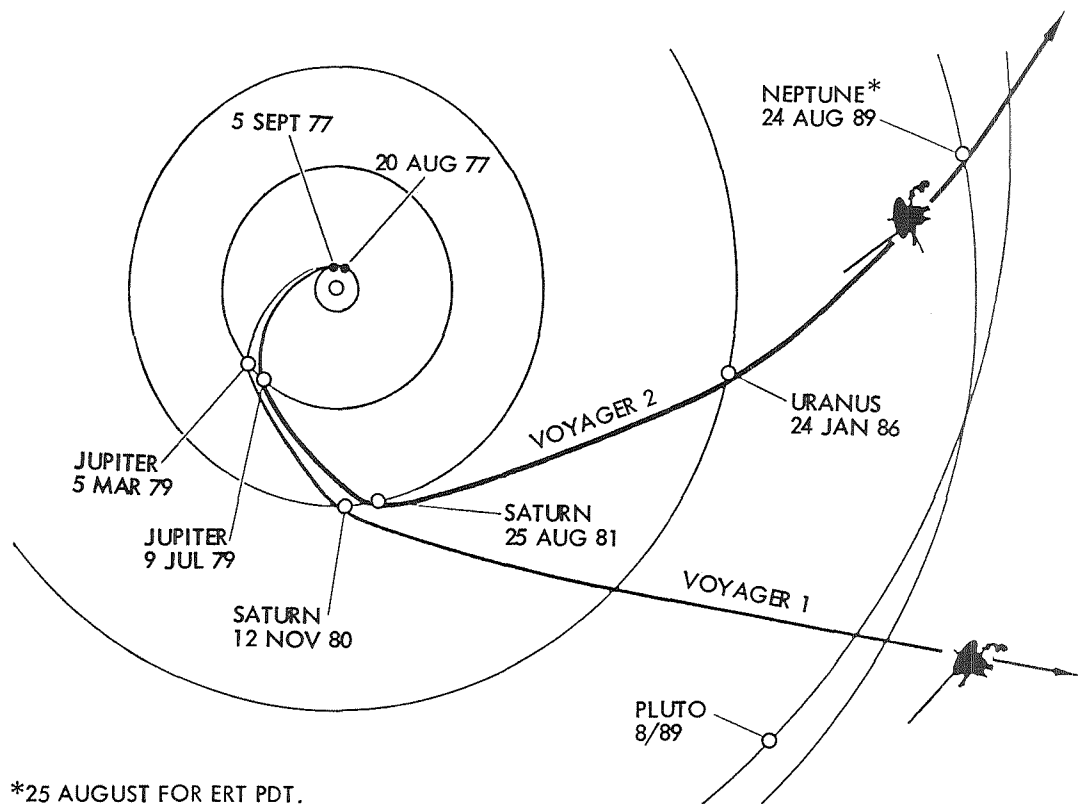

Figure 1-4. Voyager 2 remains near the ecliptic plane, but Voyager 1 was deflected upwards by its pass beneath Saturn. Accelerated by gravity assist, the Voyagers will cross the orbits of the outermost known planets by the turn of the decade, racing onward to escape from the solar system.

fall upon strange seas of ethane and methane, the small moon Mimas that was nearly destroyed by an ancient collision, and the many other wonders that have expanded the dimensions of our knowledge.

Anticipating Uranus

Can Uranus, discovered by Sir William Herschel in 1781, possibly provide a level of excitement and wealth of new discoveries even close to those of the Jupiter and Saturn encounters? The pale greenish-blue gas giant lies nearly on its side, with Voyager 2 approaching the sunlit southern hemisphere (per International Astronomical Union [IAU]



convention, although many "right-hand-rule" devotees would say sunlit northern hemisphere). This may lead to unusual weather patterns, since we are familiar with planets whose equatorial regions typically rotate beneath and are warmed by the Sun.

Uranus is encircled by at least five moons and nine narrow rings. The moons range in diameter from 500 km (310 mi) for innermost Miranda to 1630 km (1010 mi) for outermost Oberon. All moons appear denser and darker than might normally be expected of such small frozen worlds. Their surfaces consist of water ice plus varying amounts of some dark, carbon-like material.

In April of 1984, Drs. Bradford Smith and Richard Terrile of the Voyager Imaging Team used a CCD (charge-coupled device) at the Las Campanas Observatory in Chile to record images of the rings of Uranus. Unlike the shiny rings of Saturn, the rings around Uranus are extremely dark, reflecting only two percent of the incident sunlight. Rich Terrile exclaimed that "ground-up charcoal is twice as bright".

Aside from the above scientific tidbits, which will be explored more completely in the next chapter, there should be an air of drama during execution of the encounter sequences. The round-trip communication time will be 5.5 hours; we will be slewing the scan platform that became stuck for a period following the Saturn encounter; we will be using an onboard computer to compress the number of picture bits sent back to Earth; and we will be programming Voyager 2 to perform several "image motion compensation" attitude maneuvers to allow the cameras to take sharper images. The bottom line? There should be plenty of excitement and surprises during the upcoming encounter.

The future of Voyager 2 is looming with suspense as we wonder about the mysterious kingdoms of Uranus and eventually Neptune. The purpose of this Guide is to tell a piece of that story, thereby kindling our human quest to understand worlds beyond Earth that comprise a small region of the larger cosmos.

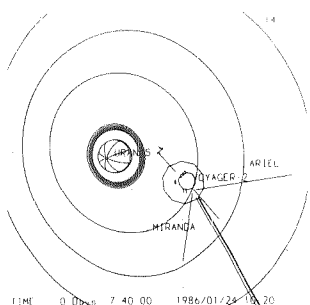

The Universe is not only queerer than we suppose, but queerer than we can suppose.

J.B.S. Haldane

## 2. URANUS

Welcome to the greenish-blue giant known as Uranus! It continues to remain veiled and mysterious several months before encounter, allowing us to see only small near-featureless images of a pale aqua planet that hides the customary signs of atmospheric circulation patterns. Not to worry, however. At Voyager's speed, each week carries our sensors nearly 9 million kilometers (5.5 million miles) closer to the giant. By using different camera filters and a bit of ground-based image enhancement, we hope to unveil the giant.

The Uranian system also contains a mysterious ring system so dark that it may not be seen until the last moment, as well as satellites with relatively dark surfaces and potentially unusual density distributions.

We possess few clues about the origin of the giant's unique orientation in space, with the planetary equator and the orbital planes of the rings and five presently-known satellites all lying nearly perpendicular to the orbital plane of the solar system.

Another type of uncertainty facing the mission to Uranus is the absence of a precursor mission. At Jupiter and Saturn, the Pioneer spacecraft acted like scouts to test the hazards of the local radiation environment, and the spinning little craft provided some preliminary data to guide the later science sequence design. Voyager 2 will be the first robot to experience the Uranian environment, but its flyby observations should make it possible for a twenty-first-century follow-on mission to Uranus to "tailor" its observations, perhaps even dropping a probe into the atmosphere.

This chapter of the Guide presents only a limited set of facts about the Uranian system and a lot more educated guesses (called physical models) which attempt to describe the planet and its poorly understood satellites and rings. We will use Voyager 2 to learn about Uranus by planning a sequence of science observations or "links" at the appropriate times and geometries. In the remainder of this chapter, the use of bracketed numbers will refer to the top priority science links identified in Table 4-1 of Chapter 4.

### Overview of The Planet

Uranus is the seventh planet from the Sun and almost a twin to Neptune, the eighth planet and outermost of the giant planets. Unknown to the ancients due to its dimness, slow apparent motion in the sky, and small size (4.2 seconds of arc), Uranus was not discovered until 1781 by the English astronomer Sir William Herschel. The methane in its atmosphere strongly absorbs red light, leaving the primary colors of green and blue to dominate its appearance.

Uranus orbits the Sun every 84 years and maintains a distance from the Sun of some nineteen times the Earth-Sun distance (19 AU). The planet is fifteen times more massive than the Earth and four times the Earth's diameter, giving it a mean density 1.18 times that of water.

In early 1986, Uranus, its rings, and satellites present a very unusual bulls-eye orientation with an illuminated south pole pointed almost directly at the Earth. A glance at Figure 2-1 shows this is not always the case, since its axis remains fixed in space during its 84-year journey about the Sun. While no one understands how the Uranian system was turned on its side, calculations show that during its formation an Earth-sized body traveling some 64,000 km/hour (40,000 mph) could have supplied the required collision force.

As seen in Figure 2-2, the present unique bulls-eye orientation of the Uranian system means that most of the significant events of the Voyager encounter will be compressed into a quarter-day interval,

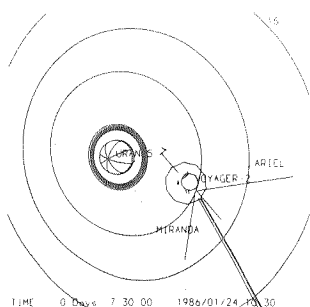

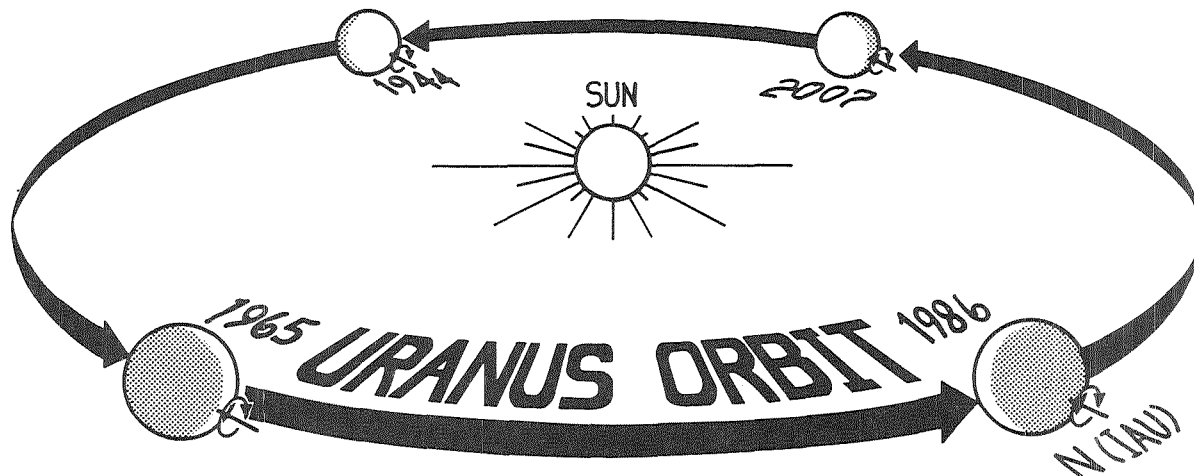

Figure 2-1. Each of Uranus' four seasons are 21 years long. When Voyager 2 arrives in 1986, the southern hemisphere will be in extended daylight.

rather than the more leisurely days that characterized the Jupiter and Saturn encounters.

Due to its near-featureless appearance, the planet's rotation rate is presently not known by any direct observation, but is believed by indirect evidence to be around 16 hours. The Voyager Project experimenters will attempt to identify and track cloud features in an effort to directly determine the rotation period of the Uranus atmosphere. In addition, any rotation period found by tracking cloud features would be compared with the variability (like a rotating radio beacon) of the planet's kilometric radio emission as measured by the PRA.

Ground-based telescopic observations suggest a unique fact about the Uranian heat balance. The planet receives only 1/360 of the Earth's allocation of the solar radiation per unit area, and the thermal energy radiated by Uranus appears to just balance that absorbed from the Sun. The other three giant planets show an excess radiation of thermal energy. If, in fact, Uranus has no internal heat source, there may be a rather less dynamic planetary wind regime than was found on Jupiter and Saturn. During the upcoming encounter, detailed



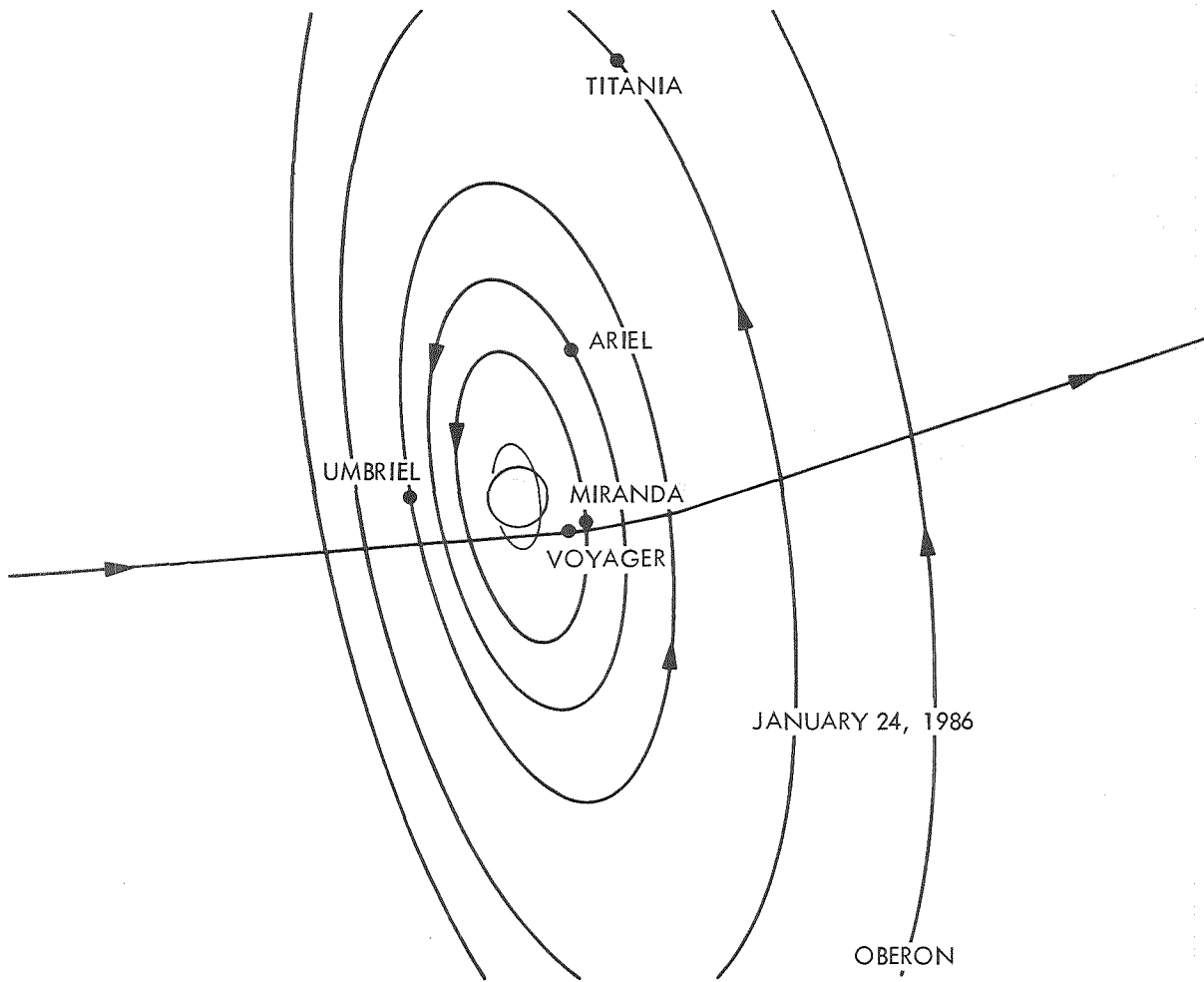
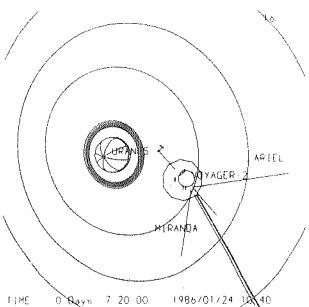

Figure 2-2. With Uranus tilted on its axis, the orbital paths of its five known satellites resemble the rings of an immense archery target as Voyager 2 approaches the southern sunlit hemisphere on January 24, 1986. Fifty-five minutes before Uranus closest approach, the spacecraft will pass Miranda at a range of 29,000 km (18,000 mi).

observations are being planned to measure more precisely the global heat budget [1,2].

Based upon estimates of a 16-hour rotation rate and oblateness obtained from ring dynamics, self-consistent models of the Uranian interior provide a composition by mass of 43% rocky core, 38% icy



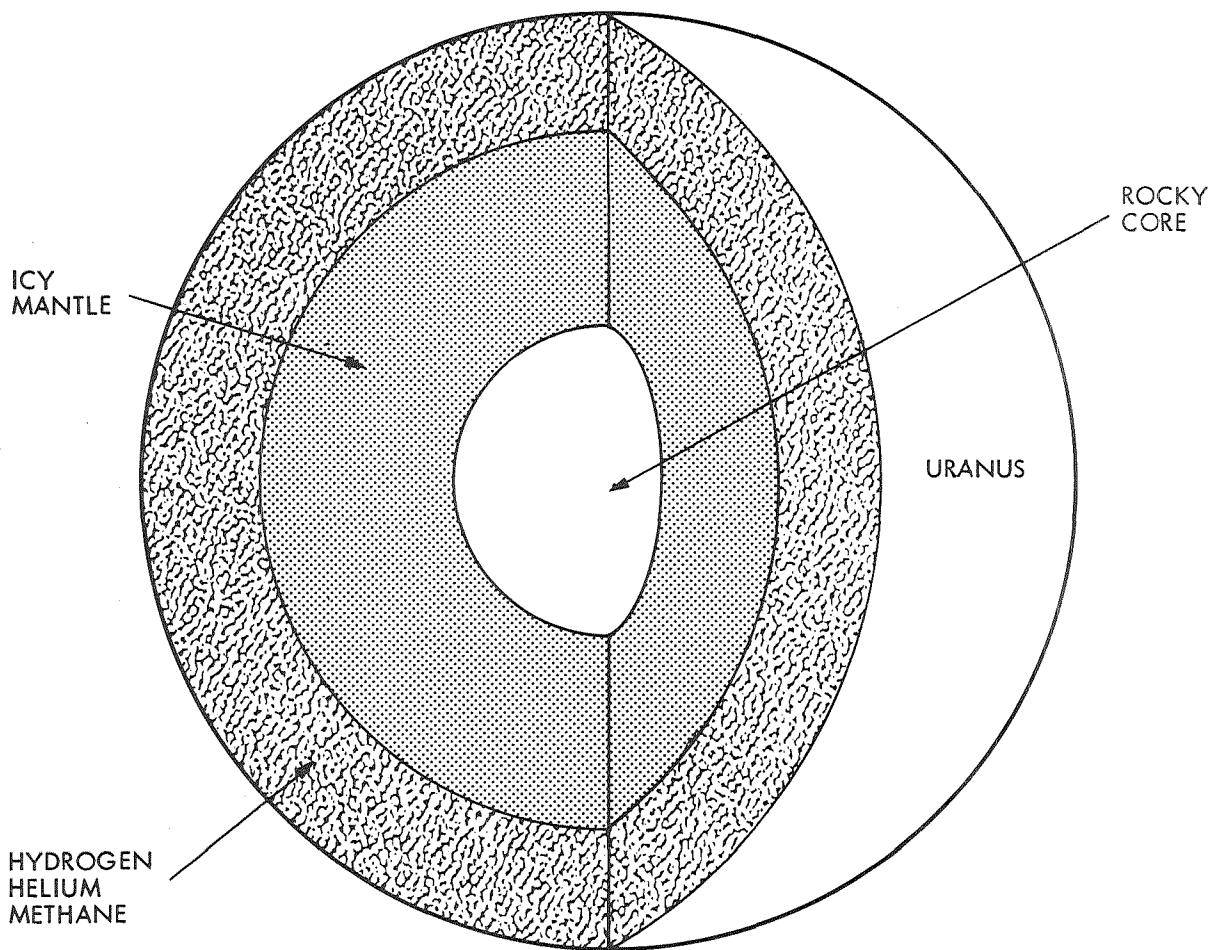

Figure 2-3. Uranus is 4 times wider and 15 times heavier than Earth. Strong methane concentrations absorb red light, leaving a pale aqua color.

mantle, and the remainder mostly hydrogen, helium, and methane gas. A simplified sketch of the Uranus interior is shown in Figure 2-3. Both Uranus and Neptune have relatively more mass in their cores than in their outer envelopes, making them denser than Jupiter and Saturn. Being less dense than the inner planets, however, they represent a distinct and special planetary category within the solar system.

#### The Atmosphere of Uranus

Nothing is known directly about the dynamics of the atmosphere of Uranus as no motions have been observed from

ground-based telescopes, although recent infrared images have shown some shading. Do the Uranian winds blow 1600 km/hr (1000 mph) near equatorial regions like those on Saturn, or are the winds little more than puffs that would not stir the surface of a mill pond on a late summer evening? No one knows! The combination of a rapid rotation rate, unusual thermal balance, and aspect geometry (where the poles alternately face the Sun every 42 years) may lead to some very strange atmospheric circulation features.

At the cloud tops of Uranus, temperatures measure a chilly  $-160^{\circ}\text{C}$  ( $-256^{\circ}\text{F}$ ), some  $70^{\circ}\text{C}$  ( $126^{\circ}\text{F}$ ) below that of the coldest Antarctic night ever recorded on Earth. The temperature at the planet's center probably reaches several thousand degrees. These frigid cloud top temperatures are close to those where gases like methane ( $\text{CH}_4$ ) and possibly acetylene ( $\text{C}_2\text{H}_2$ ) and ethane ( $\text{C}_2\text{H}_6$ ) turn to clouds or snow (Figure 2-4). No one knows the true amount of hydrogen ( $\text{H}_2$ ) and helium (He) in the Uranian atmosphere, even though they must comprise the bulk of the gases present. The planetary occultation experiment [3,7] should shed more light onto this uncertain corner of planetary physics.

Models of the Uranian atmosphere also suggest that the equatorial regions are hazier at higher altitudes than polar regions. Thus at the poles Voyager may see into deeper layers of methane and perhaps even find acetylene and ethane hydrocarbon snow. Several occultation observations have been designed to accomplish this objective [4,5,6,7].

### The Magnetosphere of Uranus

The Voyager spacecraft is approaching the planet Uranus without direct prior knowledge of the existence of a magnetic field or solid estimates of density and shape of the surrounding envelope of charged particles known as the magnetosphere. Are the auroral ultraviolet emissions and dark rings clues to a strong trapped particle environment, perhaps even Jupiter-like, with radiation levels easily capable of killing a human in short order? Or will the Voyager magnetometer survey something

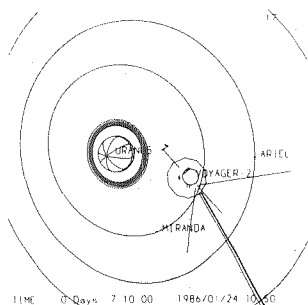

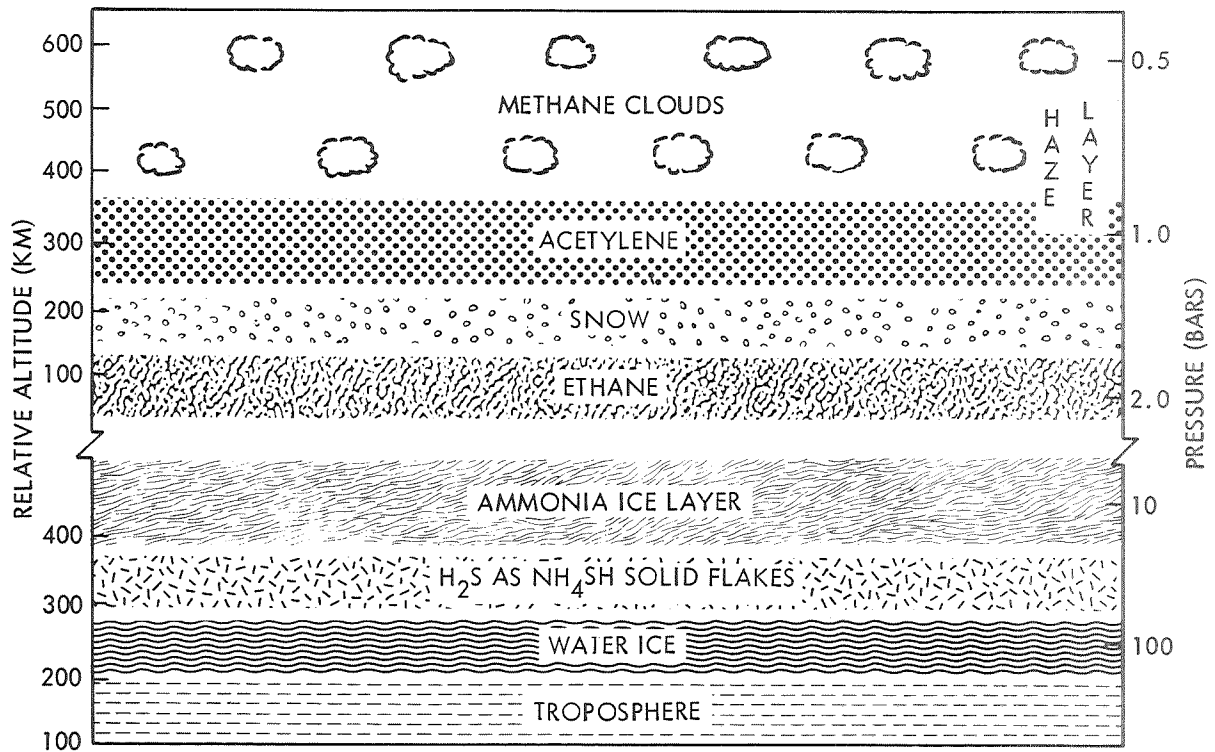

Figure 2-4. Clouds of methane absorb red light and give Uranus a pale aqua color. Beneath these clouds, we would expect to find a layer of acetylene and ethane snow before reaching deeper layers of ammonia and water ices, laced with hydrogen sulfide particles.

like the minimal Venus field? The latter is not intrinsic to Venus, but is "induced" by an interaction with the solar wind.

The Uranian magnetosphere will probably have a very unusual shape and physical properties as the peculiar orientation (Figure 2-5) of the planetary axis allows direct absorption of the solar wind particles onto the south pole to maintain a relatively permanent (no diurnal change) ionosphere [24,25,26]. It is only an assumption that the planet's magnetic axis aligns with the rotational axis; recall that Jupiter has a  $10^\circ$  offset between the two; Earth's dipole field has an even larger offset from the rotation axis. Another item of great interest to the scientific community is whether any Uranian satellites are sources or sinks of energetic



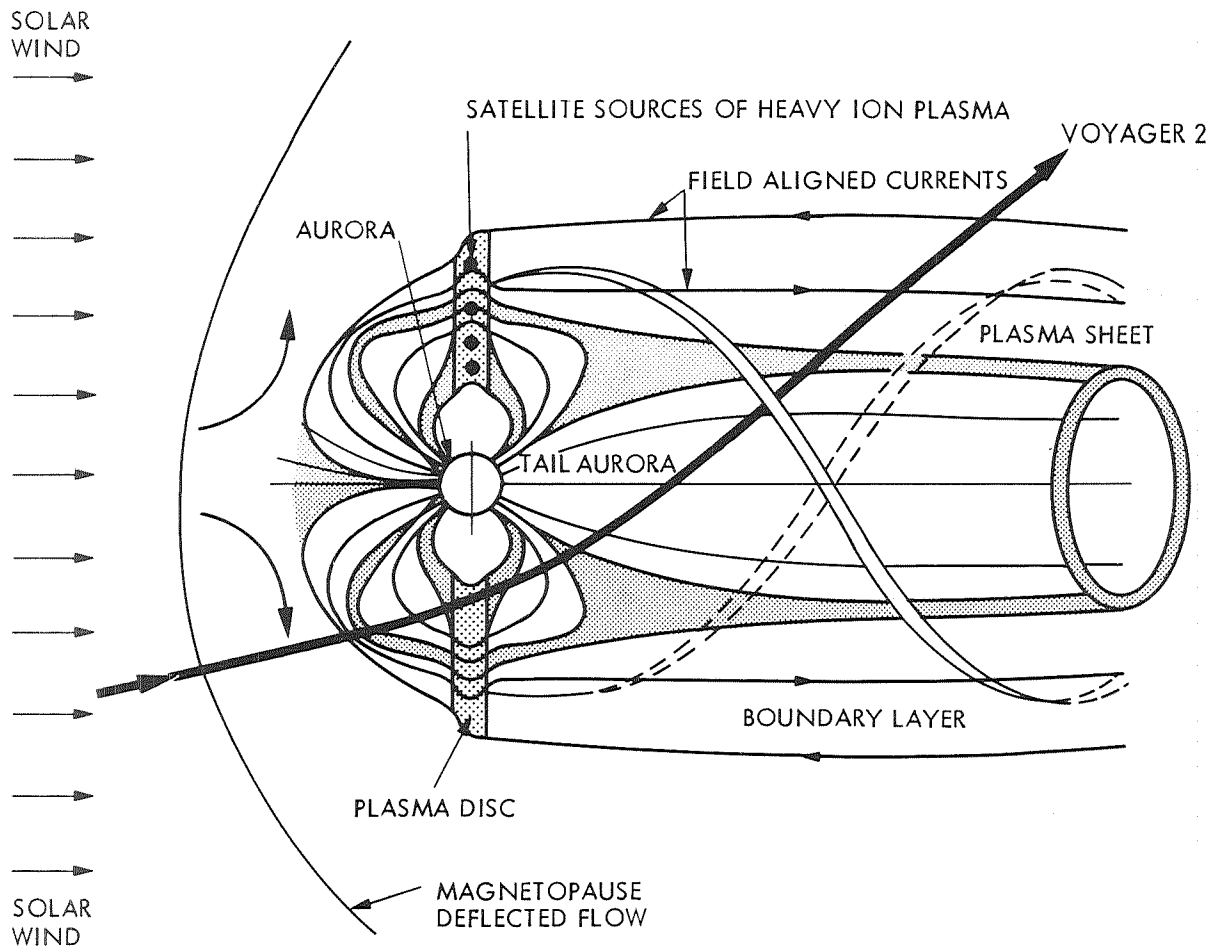

Figure 2-5. The magnetosphere, inferred by the auroral UV emissions, is unique because of the "pole-on" aspect to the solar wind particles.

particles in the magnetosphere as was found in the region near Jupiter's satellite Io.

The Satellites of Uranus

Then, my queen, in silence sad,  
 Trip we after the night's shade;  
 We the globe can compass soon,  
 Swifter than the wandering moon.

Oberon speaking in Act 4 Scene 1 of Shakespeare's "Midsummer Nights Dream."

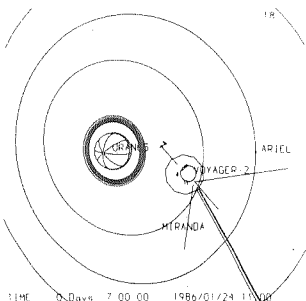

Six years after his discovery of the planet, Herschel discovered the two largest outer Uranian satellites Oberon and Titania. In 1851, William Lassell found Ariel and Umbriel, while Miranda's discovery was delayed until 1948 when G. Kuiper first saw this faint satellite. As shown in Figure 2-6, Uranus, unlike the other three outer giant planets, has no large sized satellites with diameters exceeding 2000 km (1250 mi).

Another unusual feature is that, except for Miranda, Uranian satellites seem to increase in density the further away we move from the planet. Ariel and Umbriel have mean densities a little more than water and probably have extensive icy mantles surrounding a small rocky core. Titania and Oberon have mean densities very close to that of rocks found on the Earth and, by contrast to the other two satellites, may have only a thin icy crust. It should be noted, however, that present density estimates are sufficiently uncertain that a uniform density twice that of water could fit all five satellites.

This is a reversal of the situation found at Jupiter where satellites close to the planet are more dense. At Saturn there is little compositional difference with distance from the planet. Our knowledge of the diameters of the satellites should improve dramatically [16,17,18,20,21]. However, only the estimate of the mass of Miranda has a chance of being substantially improved by the quick Voyager flyby.

Another indication of the unusual character of the Uranian satellites are their relatively dark surfaces which are thought to be covered by a mixture of ices of water, methane, and ammonia, and also a dark substance, all at a mean temperature near  $-193^{\circ}\text{C}$  ( $-315^{\circ}\text{F}$ ). Ground-based measurements of the Uranian satellites indicate similar infrared absorption and reflective properties to Hyperion, one of Saturn's outer satellites. Perhaps during the early history of the formation of Uranus, the event that tilted the planet's axis also influenced the formation of the Uranian satellites (from the planetary products "splashed" into near-Uranus space by the collision) and left their surfaces covered with a

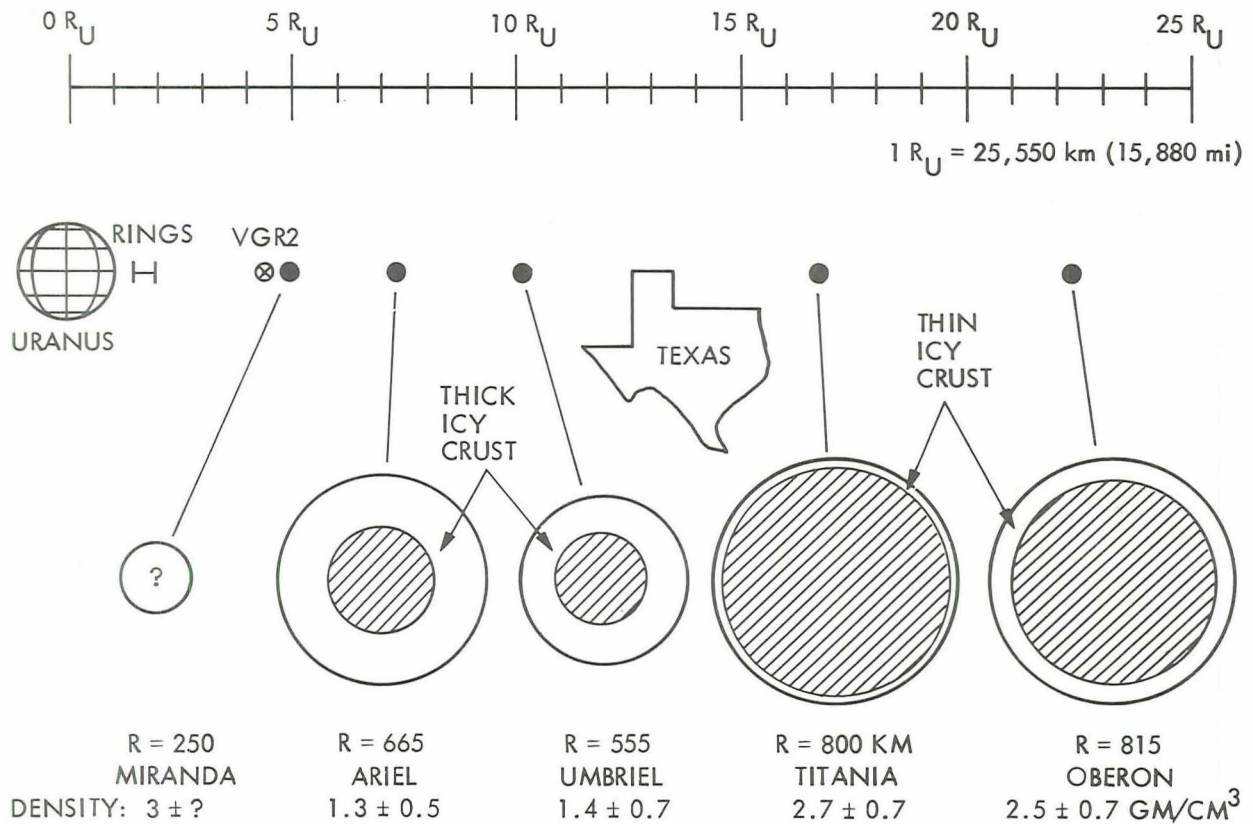
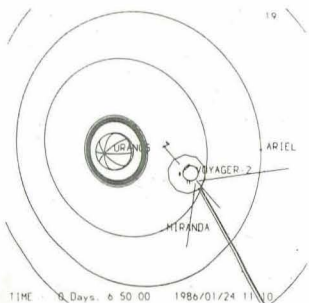

Figure 2-6. Except for Miranda, the satellite densities may increase, rather than decrease, with distance from Uranus.

mixture of frosty ice and primordial dark rocky material.

If not a primordial origin for the Uranian satellite surfaces, then some high energy source might have darkened the methane ice. Lab experiments have confirmed that dark-red organic polymers can form when methane is subjected to energetic radiation. Possible sources of energy are cosmic gamma radiation, ultraviolet light, and energetic particles from the Uranian magnetosphere. Other possible materials that might account for surface darkening are magnetite and various silicates that may have been carried to the surface by volcanic activity. The debate on these questions surrounding the satellite surface properties [16,18,19,22,23] may be better focused after the Voyager encounter.



Finally, Voyager 2 will be searching for small satellites that may be at the L4 or L5 Lagrangian points in the orbits of the five presently known moons. A few of these Lagrangian-point satellites were discovered in the Saturn system. Voyager 2 will also be searching for small satellites orbiting near the edges of the rings [8,10].

### The Rings Of Uranus

The discovery, in 1977, of several thin rings during a stellar occultation of Uranus by James Elliott (using the NASA Kuiper Airborne Observatory) stimulated further activity by a number of ground-based astronomers. In the following years, astronomers discovered a system of nine narrow rings moving with uniform precision about the planet. They are shown to scale in Figure 2-7. In size, they have an average circumference of 290,000 km (180,000 miles) and are located between 41,830 km (26,000 mi) and 51,600 km (32,000 mi) from the planet's center.

Eight of the nine rings are nearly circular and very narrow, less than 11 km (7 mi) in width, although the outermost ring varies in distance from Uranus by 800 km (500 mi) and has a variable width of 20 to 96 km (12 to 60 mi). As they reflect only 2% of the incident light, the rings are darker than coal dust. Are the Uranian rings blackened by the same process that produces less severe darkening of the satellite surfaces? While no one knows the answer, Voyager 2 will hopefully discover more details about the ring thickness, ring widths, composition, and particle sizes [8,9,10,11,12,13,14]. Guardian or shepherding moonlets [8,10] will be watched for.

When one compares the ring systems of the various outer planets, only Saturn seems to possess extensive bright rings. In contrast, Uranus and Jupiter's rings are dark and narrow. The newly discovered Neptunian ring is probably thin and irregular, possibly discontinuous. The physical relationships between the Uranian rings and those found at Jupiter and Neptune may not be clear until after the Neptune encounter in 1989.

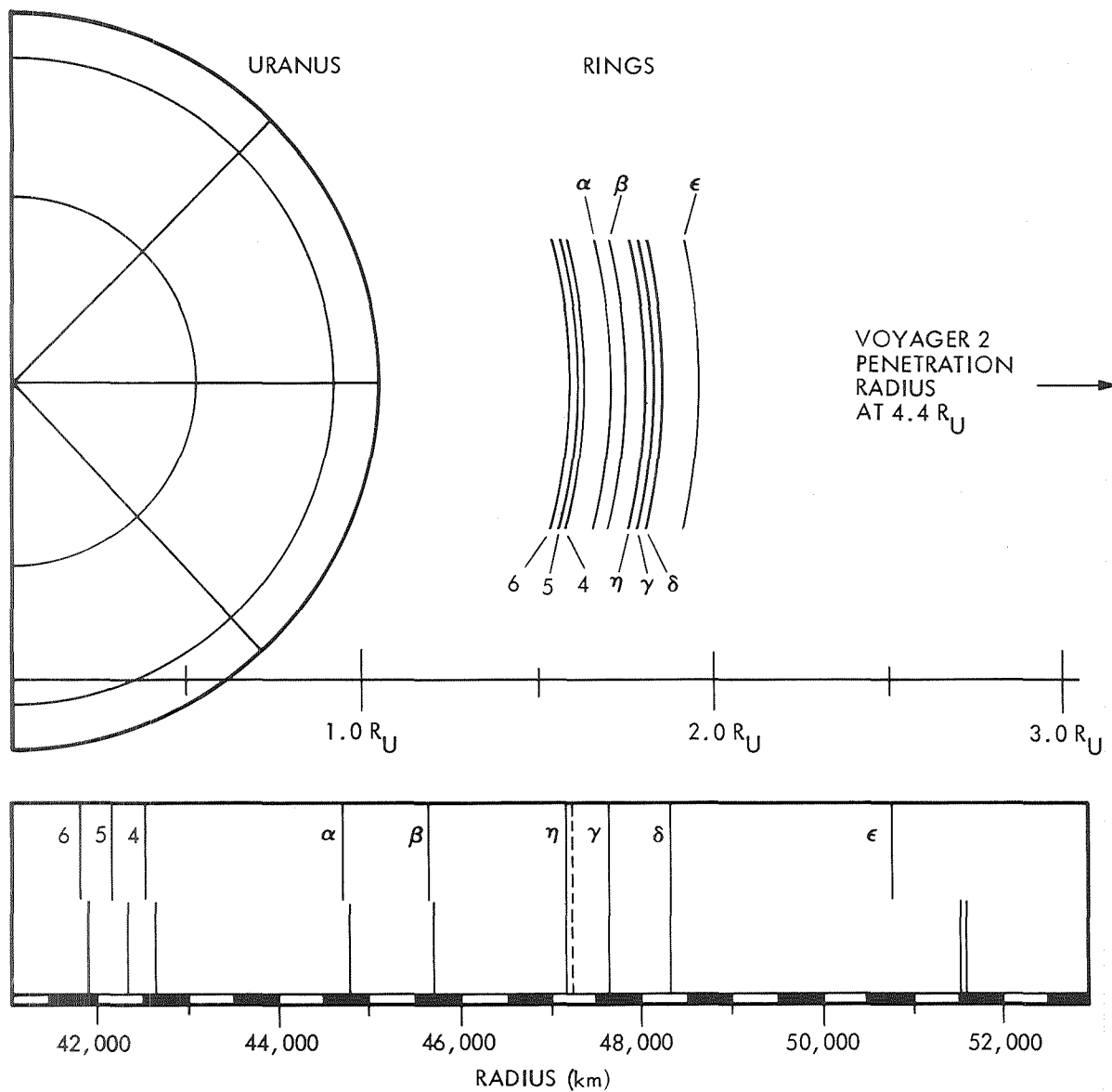
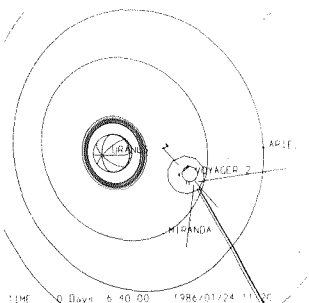

Figure 2-7. Uranus has nine narrow rings that are darker than coal dust. Some of the rings are non-circular and have variable width.

In some sense, the observations made of the ring system since 1977 had to serve in place of a Pioneer-like precursor mission to Uranus. Because of the precision of numerous star occultation measurements, we know quite a bit about the Uranian ring system. This information has been extremely valuable in designing the Voyager-2 science observational sequences.



Let your soul stand cool and composed before a million universes.

Walt Whitman

### 3. GETTING THE JOB DONE

When you are asked to think about space missions to the planets, you will probably think about stuff. Tangible stuff. You might think about the spacecraft, over 800 kilograms (nearly one ton) of structure and electronics gear. You might think of giant antennas to receive the signals from outer space. You might think of control centers with video displays and red, green, and yellow lights.

But you might not think of people, plans, and coordination. You should. This is the intangible stuff from which planetary missions are made. Voyager people is the theme which will run through this chapter of the Guide. Their performance through January 1986 will determine if Voyager Uranus earns a gold medal.

The gold medal, reminiscent of the XXIIIrd Olympiad held in Los Angeles in 1984, provides us a good comparison. The Voyager encounter with Uranus is an Olympian event, in terms of cost, complexity, number of people, and world-wide extent.

#### Planning

Start with the Voyager scientists. There are 130 Voyager investigators at universities, observatories, and aerospace companies all over the United States plus Canada, England, France and Germany. The Investigators are Voyager's competitors, selected in a competitive process at least as intense as the Olympic trials. They are supported by half again their number of research assistants and students. The investigators formulate the basic questions to be answered about Uranus, its satellites, and its neighborhood.

These questions require that Voyager 2 make specific observations at Uranus under just the right conditions. To match questions with observations requires a vast amount of information about the spacecraft and about Uranus. For example, just where is the spacecraft, just where are the satellites of Uranus, and what direction must the spacecraft look to see the satellites. Determining the spacecraft position is the job of a 10-member group of spacecraft navigators at JPL who determine both the spacecraft location and the rocket motor burns needed to correct the location.

Determining the Uranian satellite locations is initially the job of another 10-member group of orbit experts, some at JPL and some at places like the Universities of Texas and Virginia. They take the latest information available to refine the positions of Uranus and its satellites. Remember, Uranus travels around the Sun so slowly that only 2.5 Uranian years have passed since its discovery and less than 6 Uranian months have passed since the discovery of its satellite Miranda. It's no wonder that there is still some uncertainty about precise locations, but these ephemeris experts can predict the satellite positions to accuracies of 5,000 km (3,100 mi) or better many months in advance of the encounter.

The spacecraft navigators, however, are after even better accuracies. They are equipped with some pretty fancy orbit determination computer programs that solve for the simultaneous positions of all bodies. Their most important data for updating the orbital elements of the satellites will be Voyager-2 images of the satellites against a known star background. By using the narrow-angle TV camera to shoot satellite-star images until a few days before closest approach, these real-time navigators can estimate satellite positions relative to Uranus to 100 km (62 mi) or better. This is equivalent to locating the finish line for the marathon to an accuracy of 1/18 of an inch.

Okay, so we know where everything is. What's our master plan? We have limited resources and a rigid time schedule, but we want the greatest possible mission return. The Mission Planning Office (MPO)

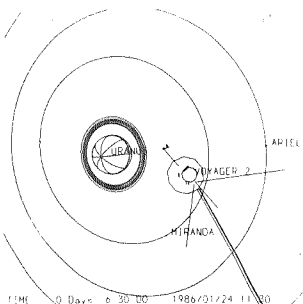

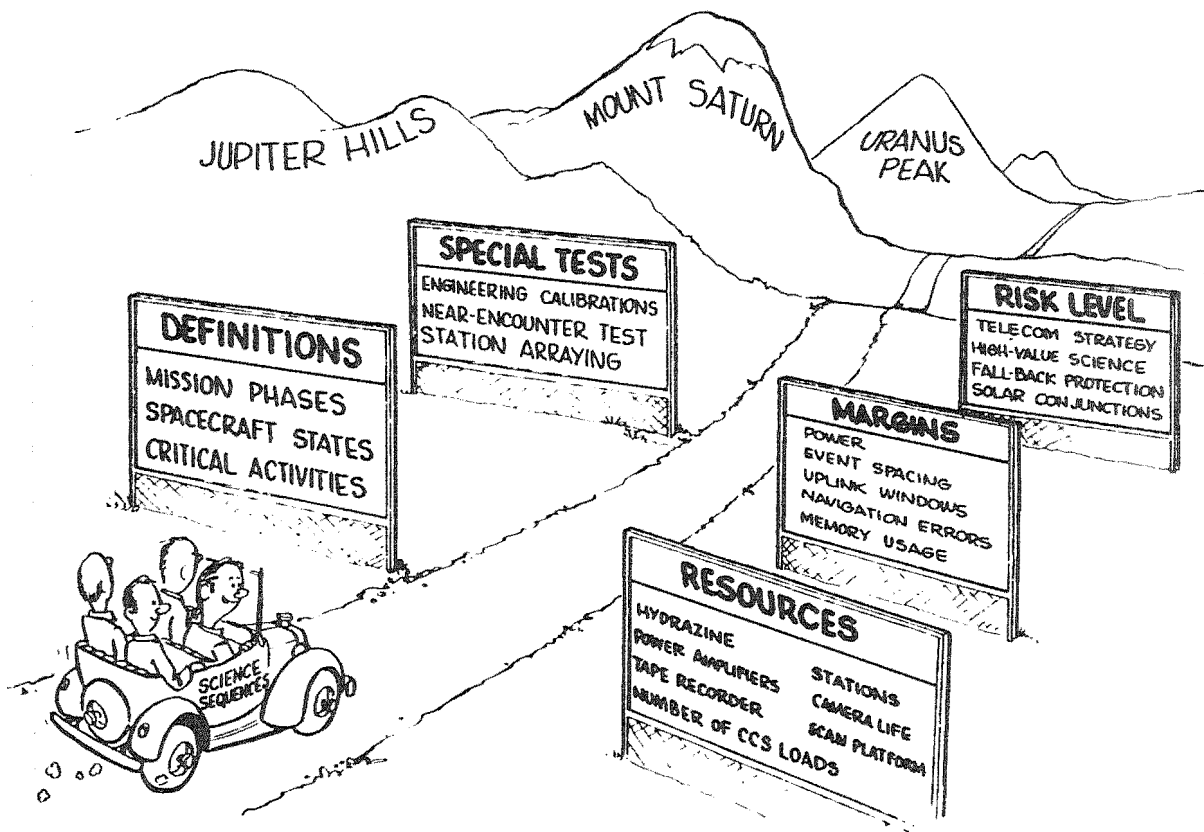

Figure 3-1. Mission planning establishes guidelines for the use of project consumables and helps define the envelope within which the sequences will be developed.

has the task of preparing a large collection of "guidelines and constraints" that govern how the project resources and spacecraft consumables will be used to achieve high-value science return, while maintaining an acceptable level of risk. As suggested by the cartoon sketch of Figure 3-1, the guidelines establish the envelope within which the mission sequences will be designed, implemented, and executed. The MPO function is analogous to that of the Los Angeles Olympic Organizing Committee. The time span is even the same. Many of the basic decisions which were essential to the Uranus encounter were made in the mid-1970s, well before launch.

Given knowledge of the satellite and target locations with time, scan platform pointing and observing conditions can



be computed. The Science Investigation Support (SIS) Team at JPL, about 30 strong, act as the focus for the detailed science planning. Representatives for each experiment interact with investigators and other parts of the Voyager Project. The result is an integrated plan for all observations intended.

It is not uncommon for the investigators to desire conflicting observations. To resolve these conflicts, the Voyager Science Steering Group (SSG), comprised of the Principal Investigators, meets regularly at JPL to review the observation plans. The members of the SSG make the science decisions required to ensure that the observation plans will yield the best Uranus science.

### Sequencing

As soon as the final observation plan is ready, primary responsibility passes to the sequence development engineers. The Sequence Team consists of about 30 members at JPL who flesh out the observation plans with the instrument and spacecraft commands required to produce the desired results. The Sequence Team ensures that no operating constraints are violated and that all of the instructions to the spacecraft will fit into its computer memory. The Voyager-2 computer, the Computer Command Subsystem (CCS), has roughly 2500 words of memory reserved for sequencing. Two words are required for a simple instruction: one to specify the event to take place, the other to specify the time of occurrence. For a period of high activity such as Uranus near-encounter, CCS words are always at a premium.

The Spacecraft Team, about 60 engineers strong at JPL, is responsible for the health and optimal use of the spacecraft. It must analyze the spacecraft engineering telemetry in order to determine how the spacecraft is performing and plan the engineering sequences which are needed for the observation plans to succeed. Roughly half the Spacecraft Team will be engaged in planning at any given time, the rest will be involved with data analysis. Engineering sequences, such as spacecraft maneuvers, are

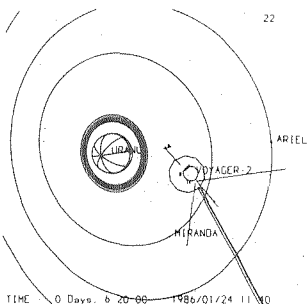

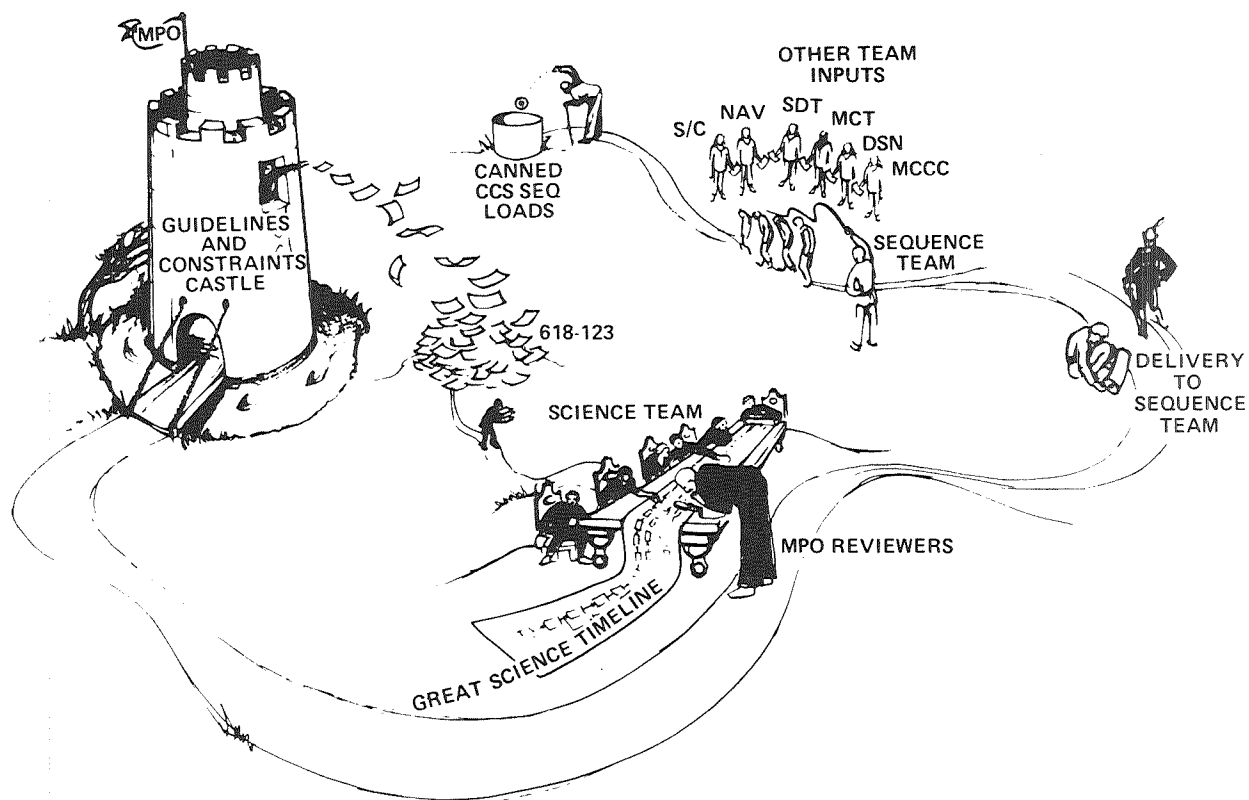

Figure 3-2. People often have humorous ways to view their working interrelationships, and Voyager is no exception (early version of "ye olde sequence design process").

passed from the Spacecraft Team planners to the Sequence Team for incorporation into the CCS loads.

The total sequence design process from MPO guidelines through on-the-shelf CCS loads typically requires many months of technical interactions, give and take, teamwork, and of course decisions. During such a process, the people often develop humorous ways of viewing their roles. Figure 3-2 is a several-years-old cartoon sketch of the process, but is still close enough to today's perceptions to warrant its inclusion in the Guide.

Once a CCS load has been built and verified, it is ready to be sent to the Voyager-2 spacecraft. The final step by the

Sequence Team is to process a CCS load from a text listing of commands to the stream of 1s and 0s (bits) which will actually be received by the spacecraft. Stored on magnetic computer tape, this binary command stream is passed to the Flight Operations Office (FOO).

### Flight Operations

The FOO, comprised of about 40 engineers located at JPL, is the real operator of the spacecraft. The FOO controls all transmissions to the spacecraft and receives all data at JPL from the spacecraft. It is responsible for coordinating the Voyager Project's activities with operational organizations outside the Voyager Project, such as NASA's Deep Space Network (DSN), JPL's multi-mission control center, and Goddard Spaceflight Center's NASCOM communications network.

Scheduling is one of FOO's most important activities. If a CCS load contains a critical observation of the Uranus atmosphere near encounter, the appropriate DSN ground antennas must be tracking Voyager 2 at that time, or the information returned from the spacecraft will fall on deaf ears.

During the Uranus encounter the DSN will track not only Voyagers 1 and 2, but also Pioneers 10, 11 and 12, the Russian Vega Halley probes, the European Space Agency's Giotto Halley probe, the Japanese probes MST-5 and Planet A, and the Giacobini-Zinner comet probe ICE. It may also be asked to track three earlier Pioneers (6, 7, and 9) and Helios. With such a demand for its services, the DSN scheduling process is involved, indeed.

Representatives of the FOO meet with representatives of other projects far in advance of the requested coverage dates to hammer out an equitable allocation of DSN antenna support to all projects. Using MPO guidelines, the tracking schedule which results is used in the generation of observation plans by the Science Investigation Support Teams, the Navigation Team, the Spacecraft Team and the Sequence Team. The amount of tracking which a spacecraft receives in any period depends on the relative importance

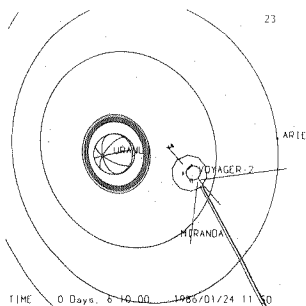

of that period to its mission. Voyager 2 will receive the full resources of the DSN during its Uranus fly-by, but will receive only sporadic tracking six weeks later during the Comet Halley encounters.

### Commanding

With the command tape prepared and the DSN and NASCOM scheduled, the CCS load can be transmitted, or up-linked, to Voyager 2. The tape will be played into the Voyager Command System, the command stream formatted to the Ground Communication Facility (GCF) standards, and sent via GCF to the transmitting Deep Space Communications Complex (DSCC). GCF uses a combination of communication satellite links and conventional ground circuits to link together JPL and the DSCC, just as the TV networks did to broadcast the Los Angeles Games around the world. As the GCF message containing the command stream reaches the DSCC, it is checked for correct reception and the GCF formatting bits removed. It is then routed to the transmitting station and sent.

There are three DSCC located in California, Australia, and Spain. These locations were chosen at widely-separated longitudes to provide essentially continuous tracking capability to any interplanetary spacecraft. The equipment at each site is similar.

The Goldstone DSCC is located near Goldstone Dry Lake in the heart of the Mojave Desert in California. Three antennas at Goldstone support Voyager 2: DSS 12, a 34m (112 ft) diameter antenna which can both transmit and receive; DSS 14, a 64m (210 ft) diameter antenna which can both transmit and receive; and DSS 15, a 34m (112 ft) diameter antenna which can only receive. For increased performance, more than one antenna can be used simultaneously in array to increase the received signal from Voyager 2 (see Chapter 7, What's New). The Goldstone DSCC is operated for NASA by JPL with a staff of 165 engineers and technicians. An additional cadre of managers, development engineers, and programmers for the DSN reside in Pasadena, CA.

The Canberra DSCC is located in the semi-arid rolling hills of New South Wales at Tidbinbilla, not far from the Australian Capital Territory of Canberra. Three antennas at Canberra support Voyager 2: DSS 42, a 34m (112 ft) transmit/receive station; DSS 43, a 64m (210 ft) transmit/receive station; and DSS 45, a 34m (112 ft) receive only station. In addition, because Australia has the best view of the Voyager-2 Uranus encounter, the Parkes Radio Observatory located 320 km (200 mi) to the northwest of Tidbinbilla will be used for extra performance (see Chapter 7, What's New). The Canberra DSCC is operated for NASA by 170 engineers and technicians from the Australian Dept. of Science.

The Madrid DSCC is located in the foothills at Robledo, Spain, near the capital city of Madrid. Two antennas at Madrid support Voyager 2: DSS 61, a 34m (112 ft) transmit/receive antenna, and DSS 63, a 64m (210 ft) transmit/receive antenna. The Madrid DSCC is operated for NASA by the Spanish National Institute for Aerospace Techniques (INTA) with about 220 engineers and technicians (see Figure 3-3). Voice communications, basically a continuous phone call, are maintained between all three DSCC and the Network Operations Control Center in Pasadena, CA.

We left the command load just radiating from the DSS antenna on its way to Voyager 2. Even at the speed of light, the first command will not arrive at Voyager for 2.75 hours, and acknowledgement of its receipt can't be seen at Earth until 5.5 hours after it was sent. Data telemetered from Voyager 2 is 2.75 hours old the instant it is received. This time lag complicates operations greatly. Imagine driving a car where the gauge readings and even the sights seen out of the windows are over 2 hr old, and the response to turning the steering wheel or applying the brake is 2 hr in the future! Luckily, there is less traffic on the way to Uranus than there is on the Los Angeles freeways.

### Receiving Data

The data received are of enormous value. First

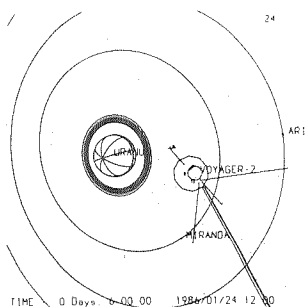

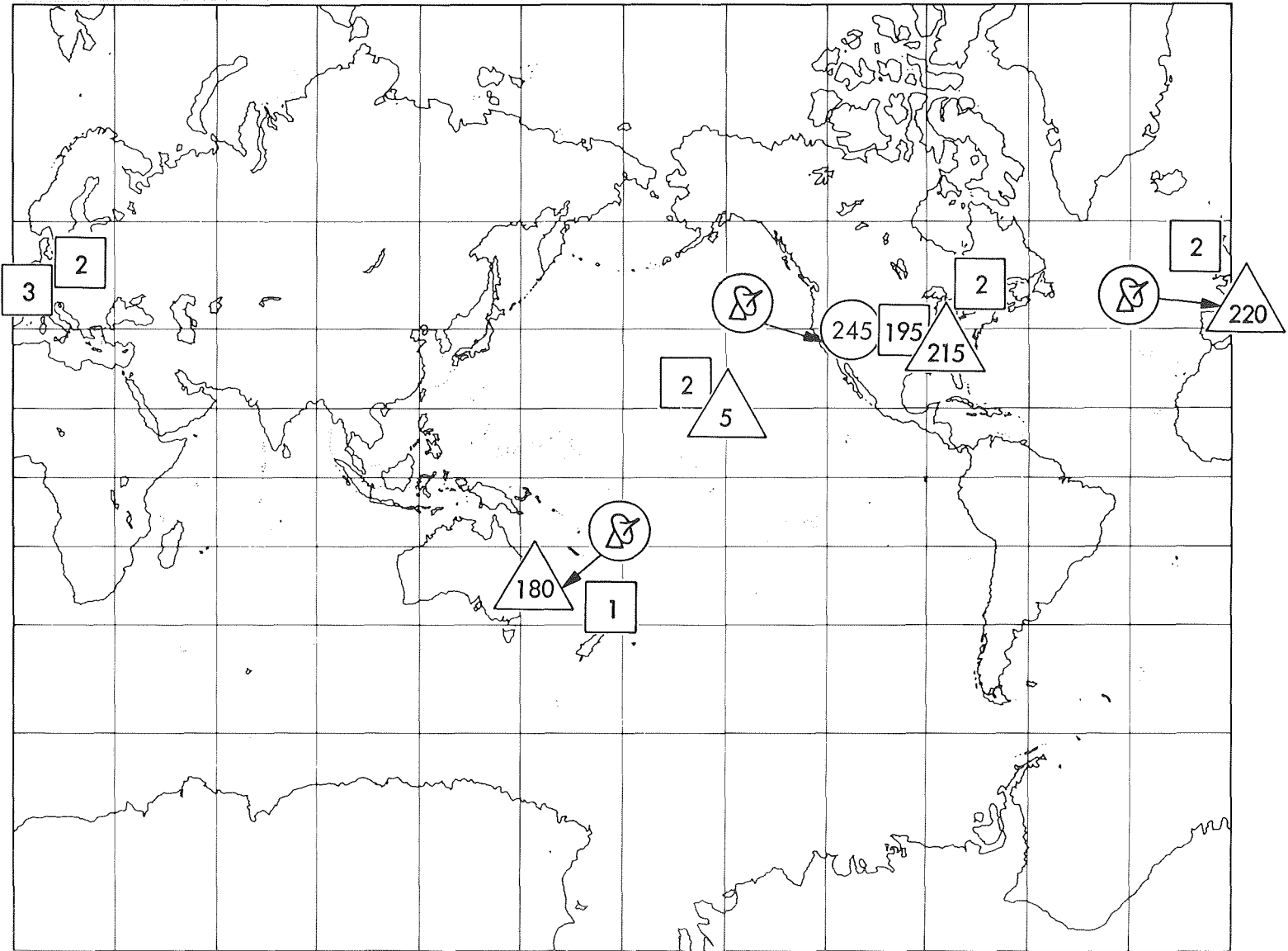

Figure 3-3. The Voyager family consists of full-time Voyager people (○), part-time Voyager people (□) and multi-mission support people (△).

there is telemetry which consists of information describing the performance of the spacecraft and its instruments and the science measurements themselves. The telemetry is identified with spacecraft time so that a complete reconstruction of the state of the spacecraft can be used to determine the health of all engineering and science subsystems, and to aid in science interpretation.

Second there are navigation data. One type is doppler data which is contained in the Voyager-2 radio signal itself and is dependent upon the relative motion between the spacecraft and tracking antenna. Another is range data which provides a distance measurement from the spacecraft to the tracking antenna. A third uses simultaneous tracking by two stations of first the spacecraft, then a quasar of known characteristics to get a different type of doppler data. Finally, optical navigation video images relate the spacecraft and planetary body positions to the location of stars.

All of these data are both relayed via GCF to JPL and recorded at the DSCC. This way any gaps can be recovered after the fact if any data are lost on the way to their ultimate user. The first users are the Mission Control Team, the Navigation Team, and the Spacecraft Team. Essential engineering measurements and status indicators are displayed as they are received so that corrective action may be initiated at any sign of a problem.

The entire data stream is routed through the Ground Data System (GDS) to JPL, to be processed by an assemblage of some 55 people and various computers at JPL. Here the telemetry is read and identified, then reassembled by measurement rather than as a serial stream. If coding has been applied, it is decoded. Imaging is transferred to the Multi-mission Image Processing Laboratory (MIPL) to be converted from digital picture elements into pictures. If the imaging has been compressed (see Chapter 7), MIPL reverses the compression. During this process the images can be enhanced to bring out subtle features and, in some cases, even corrected for errors.

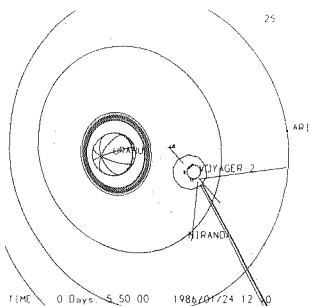

All imaging and non-imaging data are collected and processed into Experiment Data Records (EDR), which contain all available science and engineering data from a given instrument. The EDRs are the basic delivery of observed data to the investigators. A companion record, the Supplementary Experiment Data Record (SEDR) contains the best estimate of the conditions under which the observations were taken.

### The Results

As the encounter with Uranus approaches, delivery of the data to the Investigators will become easier because they will be migrating to JPL. As the pace quickens, monthly Investigator meetings will become daily meetings and, finally, a single, near-continuous meeting at closest approach. Ideas will be exchanged furiously as they strive to understand the details of a new planetary system. When the last of the Uranus data are safely acquired, the scientists will retreat with the data to their own institutions to begin the intensive process of converting measurements into answers to those fundamental questions raised in Chapter 2.

That won't be the end, however. Archived, the Voyager-2 Uranus data will be available for years to scientists the world over. It is a safe bet that somewhere today there are tens or hundreds of elementary school students who, in the early twenty-first century, will be writing Doctoral dissertations based on their study of the Voyager-2 Uranus data. And that, in the year of the XXVIIth Olympiad, will be Voyager's real gold medal.



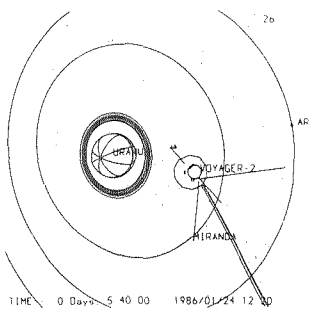

Man masters nature not by force but by understanding.  
This is why science has succeeded...

Jacob Bronowski

#### 4. SCIENTIFIC OBJECTIVES

You are about to go where no one has gone before. You don't know quite what to expect, but you do know how to plan your activities for the big arrival. After all, you are a veteran at doing this sort of thing. In Chapter 2, you prepared a shopping list of things you would like to find out about this mysterious place called Uranus.

You know that everything you learn will come via one of your 11 extended senses. So for each item on your shopping list, you select which of your 11 senses will be the most useful in acquiring the new knowledge. Trying to describe the Victoria waterfall with a dictaphone has some merit, but is not nearly as effective as taking a wide-angle color slide.

In Chapter 6, you plan the order in which you want to acquire each item on the list. You want to spend as much time as possible "looking" and as little time as possible turning your head. Also in Chapter 6, you decide upon the proper time to make each observation. Taking a picture after the sun has set won't net much, unless you are trying to photograph lightning or the northern lights.

The Voyager spacecraft has 11 senses. These senses can be conveniently divided up into 2 types: those that point at something (called target body sensors) and those that don't (called fields and particles sensors). The target body sensors are the first five listed below (assuming that RSS "points" at Earth), and the remaining six instruments are the fields and particles sensors.

<u>Name</u>	<u>Acronym</u>
IMAGING SCIENCE SUBSYSTEM	ISS
INFRARED INTERFEROMETER SPECTROMETER & RADIOMETER	IRIS
ULTRAVIOLET SPECTROMETER	UVS
PHOTOPOLARIMETER SUBSYSTEM	PPS
RADIO SCIENCE SUBSYSTEM	RSS
PLANETARY RADIO ASTRONOMY SUBSYSTEM	PRA
MAGNETOMETER SUBSYSTEM	MAG
PLASMA SUBSYSTEM	PLS
LOW-ENERGY CHARGED PARTICLE SUBSYSTEM	LECP
COSMIC RAY SUBSYSTEM	CRS
PLASMA WAVE SUBSYSTEM	PWS

This chapter contains a description of how each of the sensors works, a summary of their engineering characteristics, what types of new knowledge each of the sensors can provide, and finally, a wrap-up discussion of the fundamental physics upon which the sensors are based.

### Imaging Science Subsystem (ISS)

Most of Earth's creatures have evolved with the ability to see a certain kind of light, called visible light. There are many other types of light which are invisible to our eyes, such as infrared and ultraviolet. It is most natural, therefore, when sending a spacecraft off to unknown places, for humans to include at least one sensor that is sensitive to visible light. Voyager has two science sensors designed primarily for visible light operation: the ISS and the PPS.

The ISS consists of two TV cameras and associated control electronics. The ISS functions just like a pair of 35mm cameras. Both the ISS and a 35mm camera work on exactly the same principle of nature. Both devices record the intensity of light reflected from the object one is photographing. A 35mm camera records the light on film. The ISS converts the light into electrical signals, which are either sent directly to the Earth or stored on the spacecraft on the equivalent of a VCR.

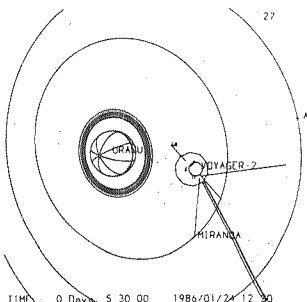

With a normal 35mm camera you have the ability to configure the camera to take a wide variety of pictures, under a wide variety of circumstances. Available to the photographer are various lenses, filters, motor drives, aperture settings, exposure times, and film speeds. The ISS has many of the same capabilities.

Instead of interchangeable lenses, the ISS has two separate cameras: one with the relative equivalence of a 200mm lens and the other with the equivalence of a 1500mm lens. To an Earth-based photographer, both would be considered telephoto cameras (normal being 55mm), but to the Voyager Imaging Team the former is known as the "wide-angle" camera. On each ISS camera, the lens is fixed. The ISS has the ability to shutter pictures one-after-another or to shutter pictures at widely separated times.

The wide-angle ISS camera has eight different filters available. The 1500mm telephoto (also called the narrow-angle) ISS camera has six different filters available. Each camera has a "clear filter" that permits the greatest amount of light to pass through to the camera. The other filters all work on the same principle. They permit specified types of light to pass through and block all other types of light from reaching the camera detector. Both cameras possess a violet, blue, orange, and green filter. The narrow-angle camera also possesses an ultraviolet filter. The wide-angle camera also contains three filters explicitly designed to detect sodium near Io, methane at both Jupiter and Saturn, and methane at Uranus and Neptune.

Both ISS cameras are fixed aperture devices. However, one may vary the exposure time from .005 seconds to 15.36 seconds. Time exposures which are integer multiples of 48 seconds are also possible. This capability is critical because the sunlight reaching Uranus is 13.5 times dimmer than at Jupiter. The ISS cameras store pictures in the form of electrical impulses. Thus, except for the choice between the narrow-angle camera and the "faster" wide-angle camera, the ability to select a fast or slow film does not exist for the ISS.

Because each succeeding planet that Voyager encounters is further away from the Earth, the rate at which pictures can be transmitted from the spacecraft to the Earth decreases. Each ISS picture consists of over 5 million electrical impulses or bits. At Jupiter, Voyager could send back a maximum of 75 pictures per hour. At Uranus, Voyager will be able to send back a maximum of only 12-17 pictures per hour. This lower rate of sending back pictures is accomplished by having the ISS compress the 5 million bits per picture to only 2 million bits, then feed these bits into the telemetry stream at a lower rate than was done at Jupiter. Without this compression capability and the DSN arraying (Chapter 7), only 7 pictures per hour would be possible from Uranus.

The ISS is used to observe and record the visible characteristics of planets, atmospheres, moons, and rings. These visible characteristics include the sizes, colors, brightnesses, and surface textures of these objects. In addition, groups of ISS pictures are used to map the surfaces of moons.

Finally, the Voyager Navigation Team uses ISS pictures of various moons against backgrounds of stars in known positions to accurately determine where the spacecraft is located at the time the picture was taken. This technique is known as optical navigation.

#### Infrared Interferometer Spectrometer and Radiometer (IRIS)

The IRIS is essentially a very specialized type of camera. It comes equipped with a permanently attached telephoto lens. The IRIS uses a sensor that can "see" a particular type of light called infrared light. Infrared means less than or below red. Infrared is light that is next to and below the red light that our eyes can see. The IRIS actually acts as two separate instruments. On the one hand, the IRIS is a very sophisticated thermometer. On the other hand, the IRIS is a device that can determine when certain types of elements or compounds are present in an atmosphere or on a surface.

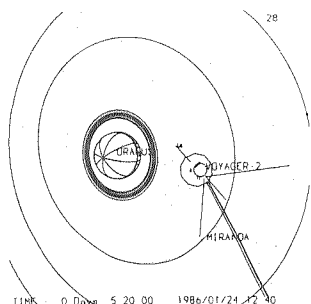

Any solid, liquid, or gas that has a temperature above absolute zero emits heat energy. The amount and "color" of heat energy that the substance emits is dependent upon its temperature. For each temperature, the amount and "color" of heat energy emitted is approximately defined by a "black body" radiation curve.

The IRIS can determine the distribution of heat energy a body or substance is emitting, which then allows us to determine the temperature of that body or substance. In the special case of an atmosphere, the IRIS can determine the temperature of the atmosphere at various altitudes, producing what is called a temperature profile.

By measuring the total amount of heat energy that a planet is emitting, and comparing this to the total amount of energy received from the sun, scientists can determine if the planet is generating heat in its interior. Some planets (e.g., Jupiter and Saturn) emit about twice as much heat energy as they receive. The terrestrial planets (Mercury, Venus, Earth, and Mars) generate little or no heat in their interior and therefore reradiate to space the same amount of heat energy they receive from the Sun.

The IRIS can also determine if certain elements and molecules are present in a particular atmosphere or on a particular surface. The physical principle that permits this type of element/molecule determination is the following. Atoms consist of one or more protons (and sometimes neutrons) in a nucleus, surrounded by the same number of "orbiting" electrons. Light energy (for example, from the Sun) may at any time strike the atom. The atom may absorb the light energy. The atom is now unstable. It has too much energy. It must release the excess. It does so by emitting the energy (Figure 4-1). If the emitted energy is infrared energy, the IRIS can detect the emission. More commonly, continuous infrared (heat) energy being emitted from deeper, warmer layers is selectively absorbed at discrete infrared colors.

Each atom or molecule will emit or absorb energy of one or more colors (wavelength or frequency). It is known from

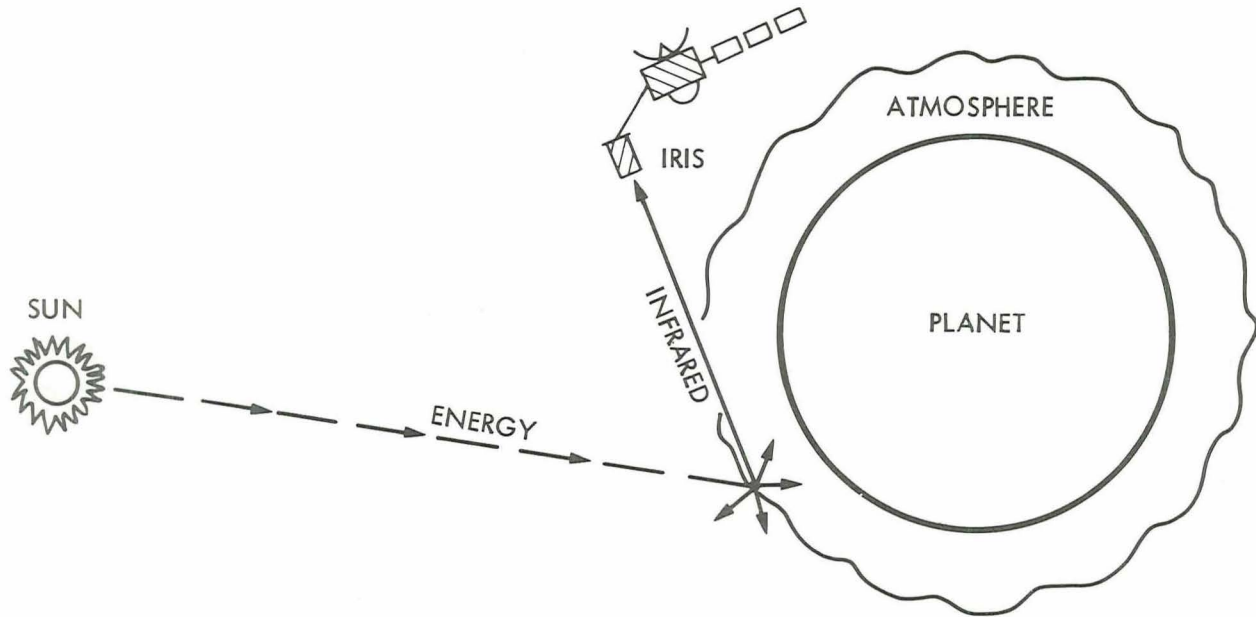

Figure 4-1. Certain molecules in the atmosphere absorb the energy from "sunlight", then emit infrared "light" which the IRIS can "see".

laboratory studies what wavelengths are emitted or absorbed by a particular element or compound. To detect this element or compound, all you have to do is see the appropriate color or colors being emitted or absorbed in the infrared data collected by IRIS.

Using this procedure, IRIS has detected hydrogen, helium, water, methane, acetylene, ethane, ammonia, phosphine, germane, and deuterated methane in the upper atmospheres of Jupiter and Saturn.

Ultraviolet Spectrometer (UVS)

The UVS is also essentially a very specialized type of camera. However, instead of using a lens, the UVS limits the area of sky it looks at by using a series of "blinders" called aperture plates. It is sensitive to a particular type of light called ultraviolet light. "Ultraviolet" means more than or beyond violet.

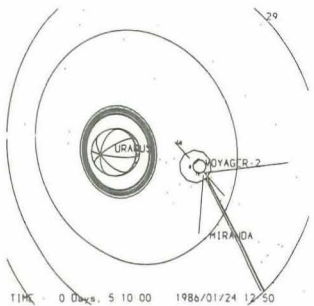

Ultraviolet light is next to and above the violet light that our eyes can see. It is also responsible for those "bronze gods and goddesses" and "pink lobsters" seen on summer beaches.

The UVS is used to determine when certain atoms or molecules are present, or when certain physical processes are going on. It works on basically the same physical principle as the IRIS. The UVS looks for specific colors of light that certain elements and compounds are known to emit or absorb.

The Sun emits a large range of colors of light. If sunlight passes through an atmosphere, certain elements and molecules in the atmosphere will absorb very specific frequencies of light. If the UVS, when looking at filtered sunlight, notices the absence of any of these specific colors (wavelengths), then particular elements and/or compounds have been detected. This process is called identifying elements or compounds by atomic or molecular absorption (Figure 4-2).

The UVS can only use the atomic absorption technique when it is in a position to look back at the Sun (or a suitably bright star), through a planetary or satellite atmosphere. This geometry is called a solar (or stellar) occultation.

The UVS has used these emission and absorption techniques to detect hydrogen, helium, methane, ethane, acetylene, sodium, sulfur, nitrogen, and oxygen. The UVS, like IRIS, can be used, in principle, to detect most of the gasses and their photochemical products found in the atmospheres of the giant planets.

In addition, the UVS is sensitive to energy that is emitted when lightning occurs (under certain conditions), to energy that is emitted when an auroral display is going on, and to energy emitted from particles independently orbiting the planets.

Finally, the UVS can be used to study the stars. The UVS can determine when certain elements are present in various



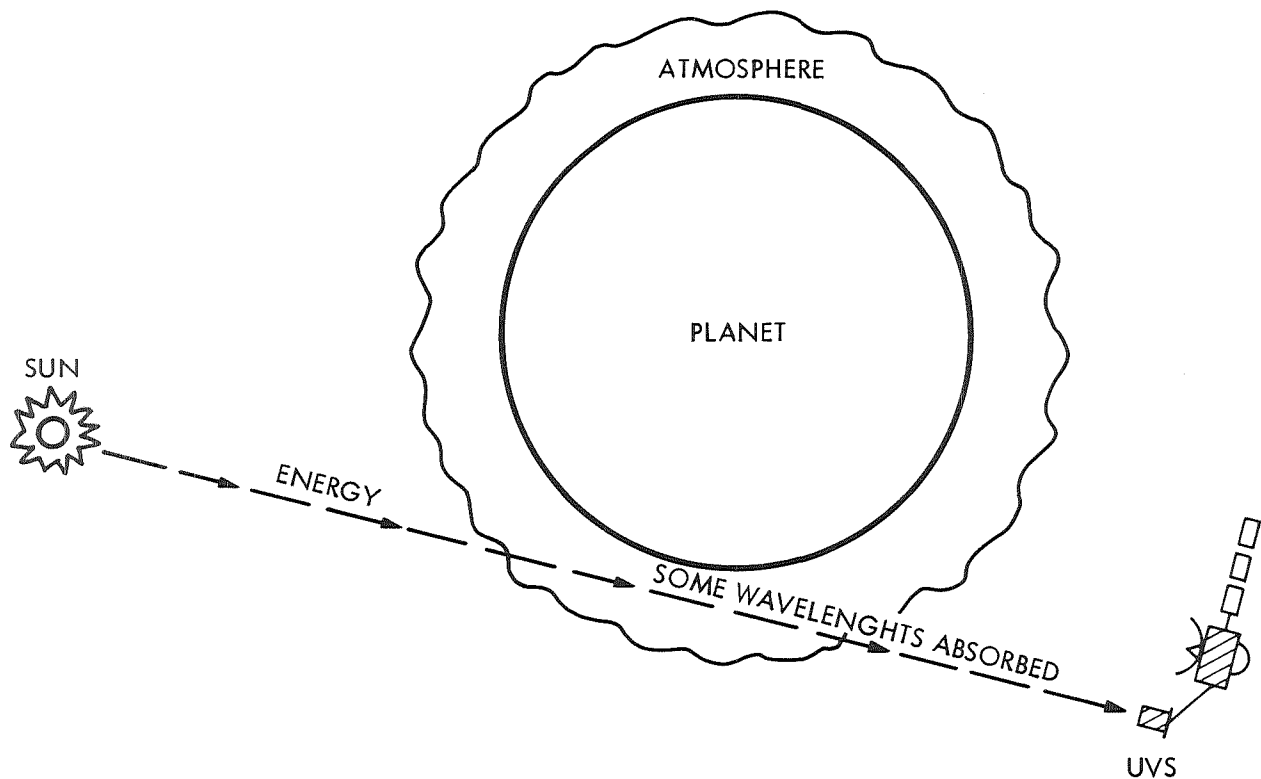
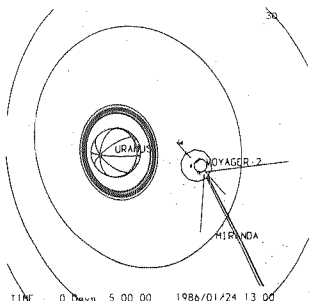

Figure 4-2. Certain molecules in the atmosphere can absorb particular wavelengths from the sun's energy, and the UVS can spot these missing "lines".

stars. The UVS instruments on both Voyagers have been used for years as stellar observatories. The UVS is making fundamental contributions to ultraviolet astronomy.

Photopolarimeter Subsystem (PPS)

The PPS is the last of the 5 specialized cameras on board Voyager. The PPS is very much like the ISS telephoto camera in that it has a very high magnification telephoto lens. It is unlike the ISS telephoto camera in that each PPS measurement produces one pixel, whereas each ISS image consists of 800 lines, with each line consisting of 800 pixels. Of the Voyager science sensors that are primarily sensitive to visible light (the two ISS cameras and the PPS), the PPS is by far the most sensitive.



The PPS allows the most flexibility in adapting the camera to varying circumstances. The PPS has 4 different aperture settings. The PPS can use 3 separate color filters, and 4 separate polarizing filters. The PPS has 2 separate commandable sensitivities, thus giving it the equivalence of two film speeds to work with.

The PPS works on exactly the same principle of nature as the ISS cameras. The PPS studies how light changes as it is reflected from or absorbed by objects of interest. Such "objects" include the surfaces of moons, constituents of atmospheres, and ring particles. The PPS can infer the texture and composition of a solid surface, the density, particle sizes, and composition of a planetary ring, and the existence, sizes, and composition of outer-atmospheric particles.

Perhaps the most fascinating PPS observation is the stellar occultation (Figure 4-3). The PPS is sensitive enough to light to be able to track a star as it moves behind a semi-solid object. Planetary rings or the thin part of a planetary or satellite atmosphere are examples of what is meant by semi-solid objects. Planetary rings are nothing more than a collection of billions of small objects in orbit close together about the same planet. The rings are not solid, so light can pass through. The PPS is used to track a star of known brightness, as it passes behind a set of rings. How much light passes through is an indication of how thick the rings are, and where gaps are located. The PPS stellar occultation technique produced a bounty of information about the complex structure of Saturn's rings.

#### Radio Science Subsystem (RSS)

All of the sensors on the spacecraft, except for the RSS, are called passive sensors. A passive sensor must wait for energy or particles to come to it before it can see anything. A passive sensor must have another source create the energy or particles that it sees.

There is another type of sensor, called an active sensor.

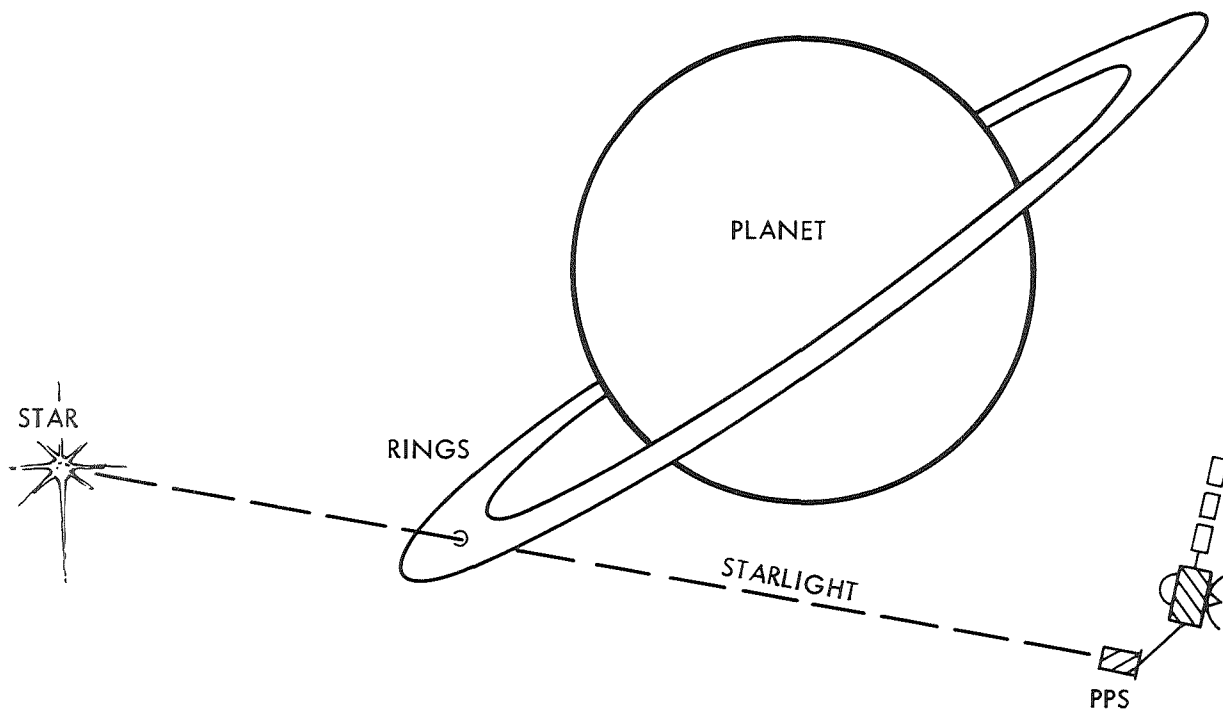
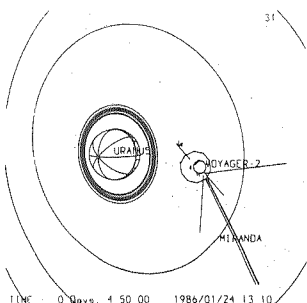

Figure 4-3. Like watching a flashlight moving behind a picket fence, the PPS can precisely measure the amount of starlight passing through the "gaplets" in a planetary ring system.

An active sensor creates its own energy and sends it out at the target of interest. The RSS is the only active sensor on the Voyager spacecraft.

The RSS is essentially a radio transmitter. It is, in fact, the same radio transmitter that is used to communicate from the spacecraft to the Earth. In reality, the Radio Science sensors are the instrumentation located on the tracking stations on Earth. The RSS is capable of transmitting stable carrier frequencies at both S and X band using an Ultra Stable Oscillator (USO) onboard the spacecraft. To achieve even more stable carrier frequencies, the RSS can receive and retransmit an extremely precise signal sent from the DSN antennae. As a sensor, the RSS is used in 4 basic and totally different experiments.



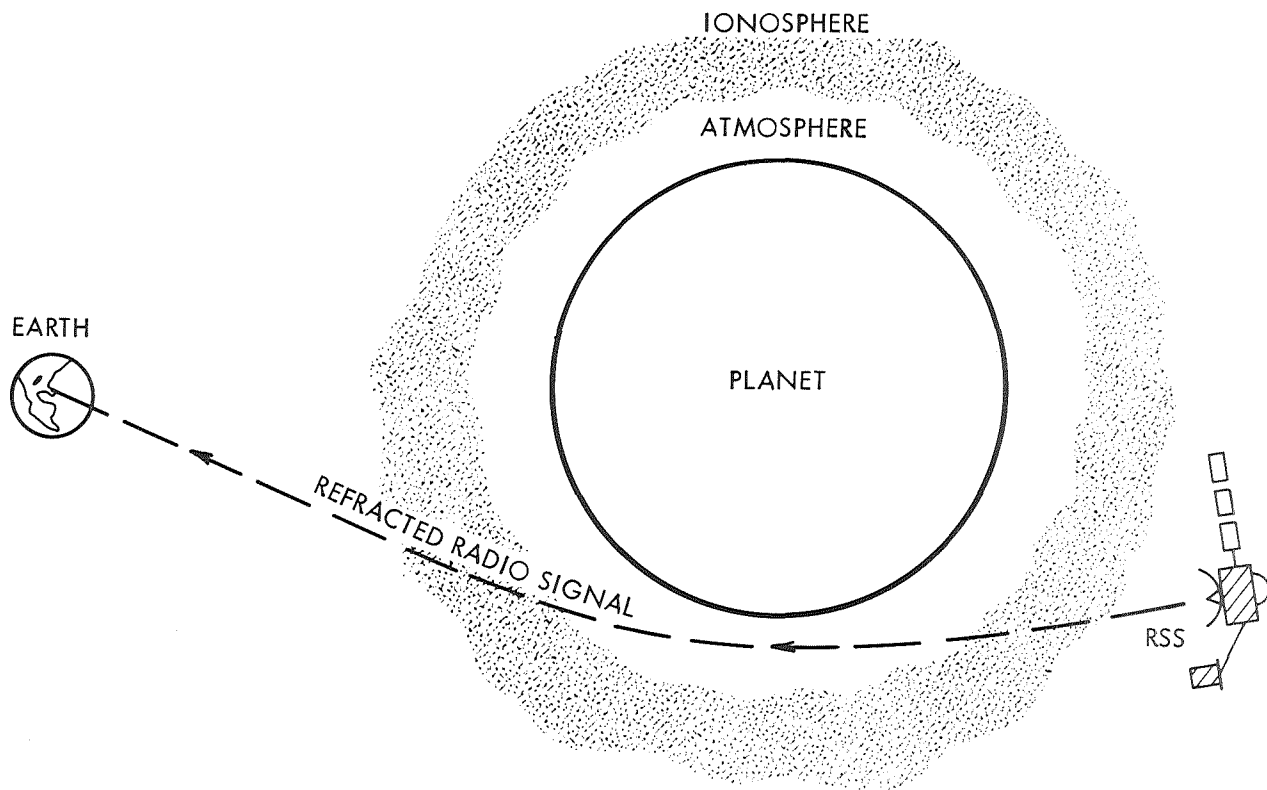

Figure 4-4. The Radio Science Subsystem uses the spacecraft radio transmitter to beam a signal through the ionosphere and neutral atmosphere for detection by the DSN antennas on Earth. The signal changes allow an estimate of the density, temperature, and pressure of the atmosphere.

- (1) The RSS is used to probe both planetary and satellite atmospheres. When the spacecraft is about to pass behind, or come out from behind, a planet or a moon with an atmosphere, the spacecraft's communications antenna is pointed near (but not directly at) the Earth. The radio signal passes through the atmosphere of interest.

The signal will be bent and slowed by the atmosphere (a process called refraction). The spacecraft antenna is pointed such that the bent radio signal reaches the Earth (Figure 4-4). This viewing geometry is called an Earth occultation.

From the changes in the frequency of the X-band and S-band signals, the temperature and pressure of the atmosphere at different altitudes can be calculated. The atmospheric density can be calculated from the amount the atmosphere bends the signal. If an ionosphere exists outside the atmosphere, it will also change the radio signal. Studies of the corona of the Sun are carried out in a similar fashion when the spacecraft passes behind the Sun as viewed from Earth.

- (2) The second type of RSS experiment involves directing the X-band radio signal through planetary rings. When the spacecraft is behind (from the Earth's point of view) a set of planetary rings, the antenna is pointed directly at the Earth. The signal passes through the rings and is received on the Earth. Changes in the X-band and S-band signal intensities and frequencies can be used to estimate the number, size, shape, and thickness of the rings, and the sizes of the particles that make up the rings.
- (3) The third type of RSS experiment is the determination of the mass of a planet or moon that the spacecraft passes at close range. The principle that this experiment works on is the Doppler principle.

When the radio transmitter sends a signal, it sends that signal at a well known frequency. Any change in speed (acceleration) that the spacecraft experiences will cause the frequency of the radio signal reflected by the spacecraft to change. The amount of frequency change is only dependent on the change in speed of the spacecraft.

When the spacecraft passes close to a planet or moon, the planet or moon pulls on the spacecraft, causing its speed to increase during approach and decrease during departure. The amount of change in speed depends only upon the mass of the planet or moon and the distance of the spacecraft from the planet or moon. Thus, by measuring the change in frequency

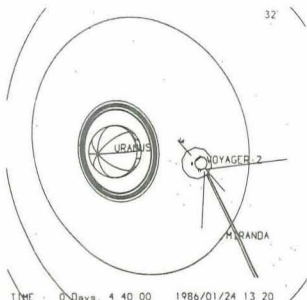

of the transmitted radio signal, the mass of the planet or moon can be estimated.

- (4) The final RSS experiment is a test of General Relativity. The Theory of General Relativity predicts a change in the frequency of a radio signal, when the signal's source passes near any massive body. Each time the Voyager spacecraft passes close to a planet, the radio transmitter carrier frequency change is measured and compared to the change predicted by General Relativity. So far, General Relativity has passed the test each time.

### Fields and Particles Experiments

There are six F&P-type sensors. The PRA is designed to measure radio waves from the Sun and planets. The remaining five sensors are particularly interested in measuring solar-related phenomena.

The Sun, as a consequence of fusing 4 hydrogen nuclei together to produce 1 helium nucleus, ejects mass and energy, more or less uniformly in all directions. The energy is ejected in the form of light and heat. The mass is ejected in the form of protons, neutrons, and electrons by themselves, and in various combinations. The mass flowing out from the sun is called the solar wind, and it travels at an average speed of about 400 km/sec (nearly 900,000 mph), but can "gust" to over twice this average speed.

The Voyager spacecraft is equipped with 5 sensors designed to detect the solar wind and its interaction with the various planets and moons of the outer solar system. These sensors are: the Magnetometer (MAG), the Plasma Subsystem (PLS), the Low-Energy Charged Particle Subsystem (LECP), the Cosmic Ray Subsystem (CRS), and the Plasma Wave Subsystem (PWS).

### Planetary Radio Astronomy (PRA)

The PRA is, in essence, a sophisticated radio receiver,

attached to a pair of 10 meter (33 foot) rabbit ears. The PRA listens for radio signals produced by the Sun and the planets, their magnetospheres, and lightning. Both the Jupiter and Saturn systems produced such signals.

The PRA works in one of two ways. If you tune your radio to one station and leave it there, you are operating in the single frequency mode. If you knew which station you wanted to listen to, this is how you would most likely choose to tune your radio receiver.

Consider, however, a second case. Suppose you knew that there was going to be a college football (soccer) game broadcast at 1 PM on Saturday, but you didn't know the station. You would start your radio receiver at the extreme left end of the radio dial, and sweep across. You would stop at each station long enough to recognize the signal. If it wasn't the game, you would pass on to the next station. If none of the stations were broadcasting the game (perhaps because it was on FM and you are tuning the AM band), you would have surveyed the entire band. This is how the PRA works in its scanning mode.

### Magnetometer (MAG)

Although the MAG can detect some of the effects of the solar wind on the outer planets and moons, its primary job is to measure changes in the Sun's magnetic field with distance and time, and to determine if each of the outer planets has a magnetic field, and how the moons and rings of the outer planets interact with those magnetic fields. If it detects a planetary magnetic field, its job then becomes to measure the characteristics of the magnetic field.

The MAG can be visualized as 4 sets of compasses. Each set of compasses consists of 3 compasses, mounted at right angles to each other. Two of the compass sets are very sensitive, and hence can detect weak magnetic field strengths, as weak as 1/10,000 the strength of the magnetic field of the Earth's surface. The other two sets are not nearly so sensitive, and are designed to

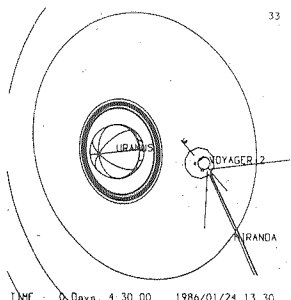

detect large magnetic field strengths, some 20 times stronger than the Earth's magnetic field.

### Particle Detectors

The CRS, PLS, and LECP all detect the impact of electrically-charged particles. The difference between the 3 sensors is that the PLS basically looks for the lowest-energy particles, and the LECP and CRS look for higher-energy particles. All 3 sensors work the same way. They sense particles that hit them.

### Plasma Subsystem (PLS)

A "plasma" is a gas or "soup" of charged particles. It typically consists of electrons and positively-charged nuclei, where the latter have been produced when the original atoms lost one or more of their electrons. The PLS looks for the lowest-energy particles. It also has the ability to look for particles moving at particular speeds. The PLS can be imagined as a piece of wood with a variable amount of syrup in front of the wood. The syrup slows the particle down so that it can just hit the wood and stick to it. Up to a point, if one wants to look for faster particles, one simply puts more syrup in front of the wood. In actuality, the PLS steps through various amounts of "syrup" looking for particles moving at various speeds.

### Low-Energy Charged Particle (LECP) and Cosmic Ray Subsystem (CRS)

The LECP and CRS look for particles of higher energy than the PLS, at overlapping energy ranges. The LECP has the broadest energy range of the three particle sensors. The CRS looks only for very energetic particles, and has the highest sensitivity.

The LECP can be imagined as a piece of wood, with the particles of interest playing the role of bullets. The faster a bullet moves, the deeper it will penetrate the wood. Thus, the depth of penetration measures the speed of the particles. The number of bullet holes over time indicates how many



particles there are in various places in the solar wind, and at the various outer planets. The orientation of the wood indicates the direction from which the particles came.

The CRS looks for particles with the highest energies of all. Very energetic particles can be found at planets that have large amounts of trapped energy (like Jupiter). Particles with the highest-known energies come from other stars. The CRS looks for both.

No attempt is made to slow or capture the super-energetic particles. They simply pass completely through the CRS. However, in passing through, the particles leave signs that they were there. Thus, the CRS can be visualized as simply a piece of wood that the bullets pass completely through. One simply counts the bullet holes, to know when a high speed particle impacted, and how often. The CRS has seven separate "pieces of wood" oriented in different directions, and looking for different types of highly-energetic particles.

#### Plasma Wave Subsystem (PWS)

The PWS, like the PRA, is essentially a radio receiver and amplifier. It listens for signals at frequencies that the human ear could hear (audio frequencies). The PWS shares the 10 meter (33 foot) pair of rabbit ears with the PRA. The PWS normally operates in a scanning mode. If you tuned your radio receiver first to one station, then another, then another, up to 16 stations, you would be operating your receiver as the PWS does when it is scanning.

The PWS has a second mode of operation. It can simultaneously listen to all the stations on its audio band. This mode is used most frequently when the spacecraft is near a planet. This mode can operate simultaneously with the scanning mode.

The PWS samples the behavior of plasmas in and around planetary magnetospheres by measuring the radio waves generated by those plasmas. It can also detect planetary lightning and the presence of

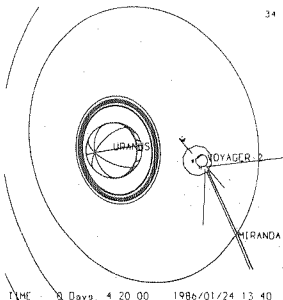

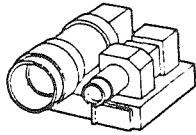

**ISS**  
**THE IMAGING SCIENCE SUBSYSTEM** CONSISTS OF TWO TELEVISION-TYPE CAMERAS MOUNTED ON A SCAN PLATFORM. ONE OF THE CAMERAS HAS A 200 mm WIDE-ANGLE LENS WITH AN APERTURE OF  $f/3$ , WHILE THE OTHER USES A 1,500 mm  $f/8.5$  LENS TO PRODUCE NARROW-ANGLE IMAGES.

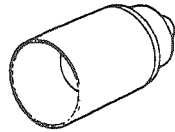

**PPS**  
**THE PHOTOPOLARIMETER SYSTEM** CONSISTS OF A 0.2 m TELESCOPE FITTED WITH FILTERS AND POLARIZATION ANALYZERS AND IS MOUNTED ON A SCAN PLATFORM. IT COVERS EIGHT WAVELENGTHS IN THE REGION BETWEEN 235  $\mu\text{m}$  AND 750  $\mu\text{m}$ .

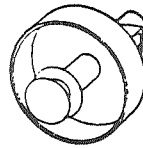

**IRIS**  
**THE INFRARED RADIOMETER INTERFEROMETER AND SPECTROMETER** MEASURES RADIATION IN TWO REGIONS OF THE INFRARED SPECTRUM, FROM 2.5 TO 50  $\mu\text{m}$  AND FROM 0.3 TO 2.0  $\mu\text{m}$ .

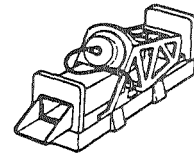

**UVS**  
**THE ULTRAVIOLET SPECTROMETER** COVERS THE WAVELENGTH RANGE OF 40  $\mu\text{m}$  TO 180  $\mu\text{m}$  LOOKING AT PLANETARY ATMOSPHERES AND INTERPLANETARY SPACE.

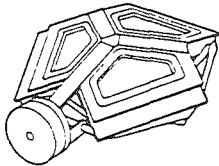

**PLS**  
**THE PLASMA EXPERIMENT** STUDIES THE PROPERTIES OF THE VERY HOT IONIZED GASES THAT EXIST IN THE INTERPLANETARY REGIONS. THE INSTRUMENT CONSISTS OF TWO PLASMA DETECTORS, ONE POINTING IN THE DIRECTION OF THE EARTH AND THE OTHER AT A RIGHT ANGLE TO THE FIRST.

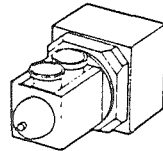

**LECP**  
**THE LOW-ENERGY CHARGED PARTICLE EXPERIMENT** USES TWO SOLID-STATE DETECTOR SYSTEMS MOUNTED ON A ROTATING PLATFORM. THE TWO SUBSYSTEMS CONSIST OF THE LOW ENERGY PARTICLE TELESCOPE (LEPT) AND THE LOW ENERGY MAGNETOSPHERIC PARTICLE ANALYZER (LEMPA).

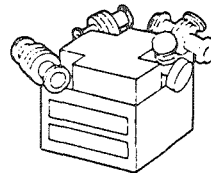

**CRS**  
**THE COSMIC RAY DETECTOR SYSTEM** IS DESIGNED TO MEASURE THE ENERGY SPECTRUM OF ELECTRONS AND COSMIC RAY NUCLEI. THE EXPERIMENT USES THREE INDEPENDENT SYSTEMS: A HIGH-ENERGY TELESCOPE SYSTEM (HETS), A LOW-ENERGY TELESCOPE SYSTEM (LETS), AND AN ELECTRON TELESCOPE (TET).

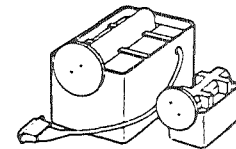

**MAG**  
**THE MAGNETIC FIELDS EXPERIMENT** CONSISTS OF FOUR MAGNETOMETERS; TWO ARE LOW-FIELD INSTRUMENTS MOUNTED ON A 10 m BOOM AWAY FROM THE FIELD OF THE SPACECRAFT, WHILE THE OTHER TWO ARE HIGH-FIELD MAGNETOMETERS MOUNTED ON THE BODY OF THE SPACECRAFT.

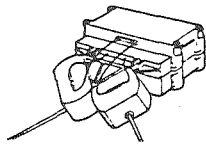

**PWS AND PRA**  
**TWO SEPARATE EXPERIMENTS, THE PLASMA WAVE SYSTEM AND THE PLANETARY RADIO ASTRONOMY EXPERIMENT, SHARE THE USE OF THE TWO LONG ANTENNAS WHICH STRETCH OUT AT RIGHT-ANGLES TO ONE ANOTHER FORMING A "V". THE PWS COVERS A FREQUENCY RANGE OF 10 Hz - 56 kHz. THE PRA RECEIVER COVERS TWO FREQUENCY BANDS, THE FIRST IN THE RANGE OF 20.4 kHz TO 1,300 kHz, AND THE SECOND BETWEEN 2.3 MHz AND 40.5 MHz.**

**RSS**  
**THE INVESTIGATIONS OF THE RADIO SCIENCE SYSTEM ARE BASED ON THE RADIO EQUIPMENT WHICH IS ALSO USED FOR TWO-WAY COMMUNICATIONS BETWEEN THE EARTH AND VOYAGER. FOR EXAMPLE, THE TRAJECTORY OF THE SPACECRAFT CAN BE MEASURED ACCURATELY FROM THE RADIO SIGNALS IT TRANSMITS; ANALYSIS OF THE FLIGHT PATH AS IT PASSES NEAR A PLANET OR SATELLITE MAKES IT POSSIBLE TO DETERMINE THE MASS, DENSITY AND SHAPE OF THE OBJECT IN QUESTION. THE RADIO SIGNALS ARE ALSO STUDIED AT OCCULTATIONS FOR INFORMATION ABOUT THE OCCULTING BODY'S ATMOSPHERE AND IONOSPHERE.**

Figure 4-5. Each Voyager spacecraft carries a science payload of 110 Kg (240 lb) that uses 100 watts of power. Eleven investigations are designed to return complementary science across a broad spectrum.

tiny ring particles that strike the spacecraft while it flies through the plane of the rings.

### Sensor Engineering Characteristics

Figure 4-5 (courtesy Jupiter, Hunt and Moore, Rand McNally & Co., 1981) provides a brief summary of the engineering characteristics of each of the eleven Voyager scientific sensors. Prior to launch, an attempt was made to perfectly align the optical instrument fields-of-view when they were mounted on the scan platform. This enables them to provide complementary information as they all view the same target.

As you might imagine, it is not easy to align relatively bulky electronic equipment to ultra high precision. However, as shown in Figure 4-6, the alignment mechanics did a first-class job, being within  $0.1^\circ$  of their objective.

### The Physics of the Optical Target Body Instruments

If you're still with us, you must be quite interested in how the Voyager sensors learn about other worlds. So now is the time for your physics refresher, to tie off some of the basic concepts. The Voyager optical sensors that actually point at something (the ISS, IRIS, UVS and PPS) all work on the same basic principles of atomic physics.

All matter in the universe above absolute zero temperature is undergoing some type of atomic (including molecular) motion. In fact, temperature is nothing more than the measure of the average amount of motion of a group of atoms or molecules. Matter that is hotter (higher in temperature) is simply moving faster.

When an atom or molecule absorbs or releases energy, it may do so only in certain ways. The central (and founding) idea of Quantum Mechanics is that matter may absorb or release energy only in "chunks" or quanta. This idea was conceived of and published by Max Planck in 1900. Five years later, Albert Einstein extended the

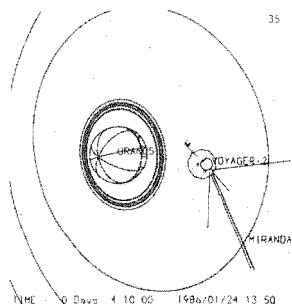

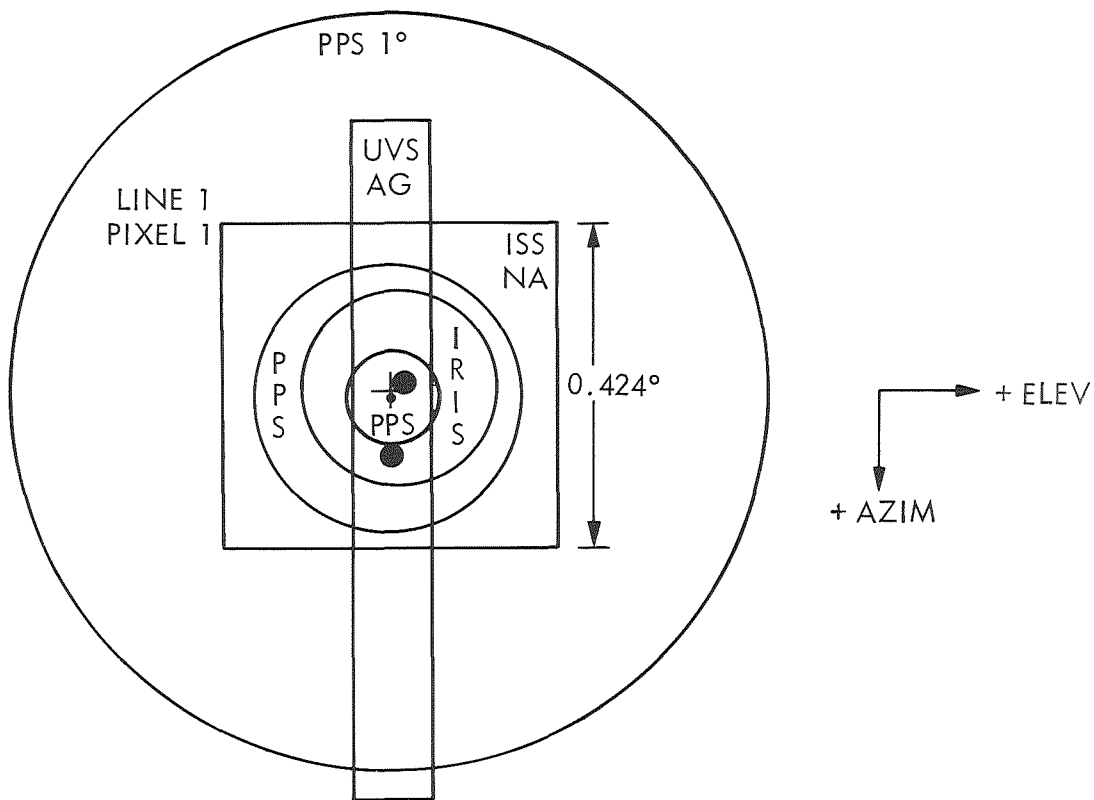
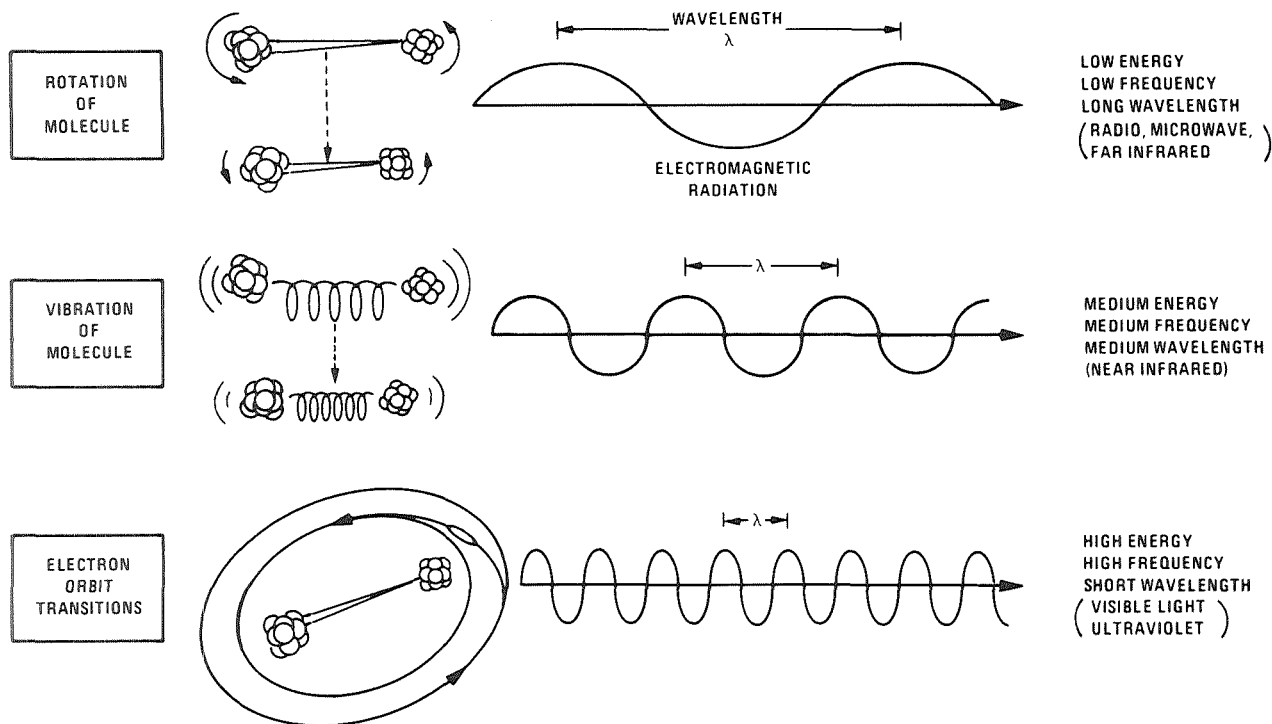

Figure 4-6. An attempt was made to perfectly align (for complementary science) the viewing axes of the scan platform optical instruments before launch, but slight misalignments of up to  $0.1^\circ$  were unavoidable when mounting fairly bulky instrument packages.

idea, by postulating that energy itself can only exist in quantized amounts, i.e., in integer multiples of some fundamental amount of energy. These two ideas form the intellectual starting point for Quantum Mechanics (of which, Atomic Physics is but a branch).

We have been loosely using the term "atomic motion", but we can see in Figure 4-7 that we must visualize three distinct types of motion. Molecules, consisting of two or more atoms, may rotate and vibrate at different discrete energy levels. A molecule may absorb a specific quantum of energy, thereby moving to a higher energy state, or it may release a quantum of energy in the form of an electromagnetic wave. The lowest



KEY EQUATIONS:  $C = f\lambda$ ,  $E = hf$

Figure 4-7. All matter above absolute zero temperature is constantly in motion, absorbing and re-emitting energy. Molecules, consisting of two or more atoms, can possess rotational and vibrational energy, as well as electron orbit transfers. Single atoms, however, typically possess only the orbital transfers of electrons.

energy state changes are associated with changes in the rotational energy of the molecule.

Both molecules and individual atoms can undergo relatively large energy state changes whenever their orbital electrons jump between specific orbits, again experiencing discrete energy-level changes characteristic of the particular molecule or atom in question. As shown in both Figures 4-7 and 4-8, these electron orbit transitions result in greater energy-state changes than those associated with changes in molecular rotation and vibration states.

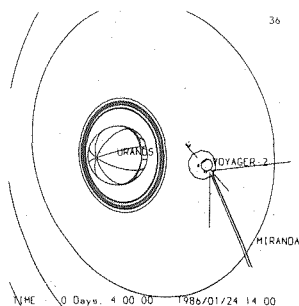

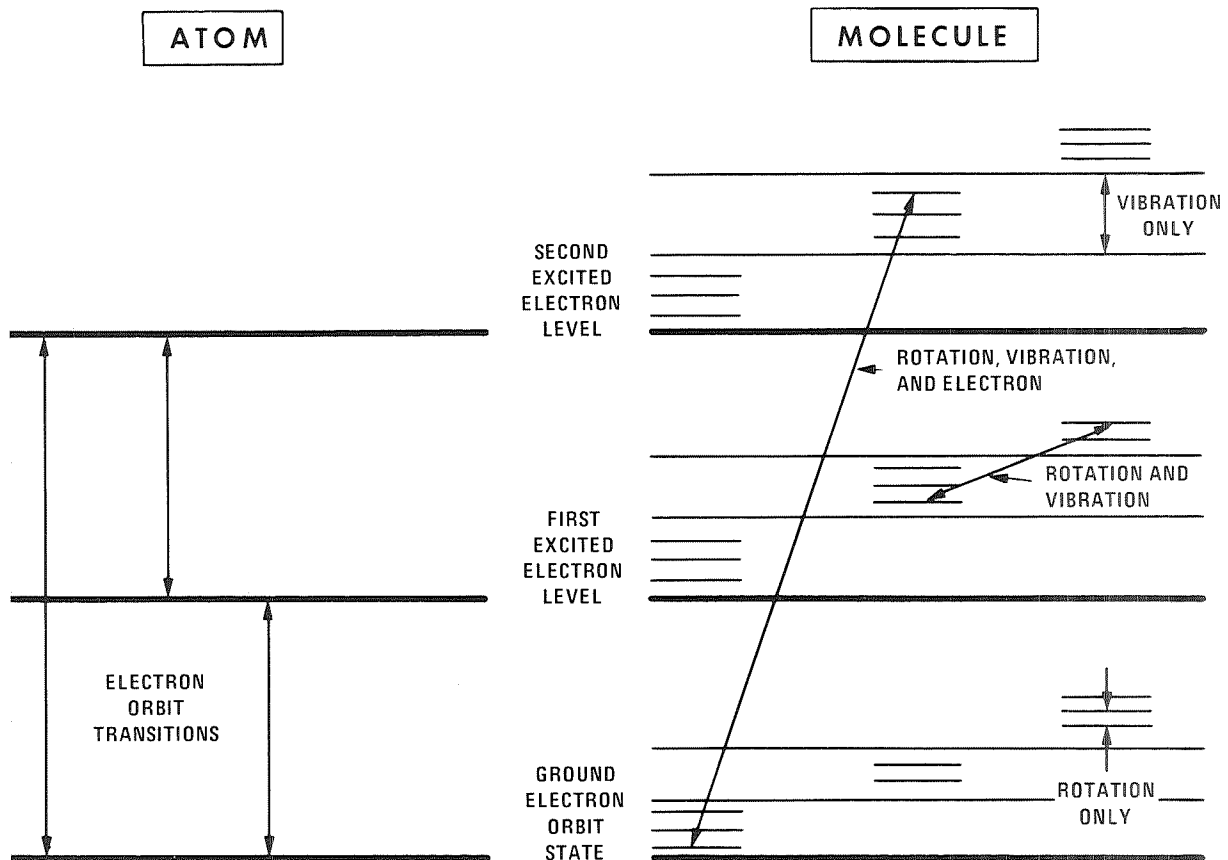

Figure 4-8. Molecules and atoms can only absorb and re-emit discrete packets of energy. The exact values of these energy level changes are unique to different molecules and atoms, acting like fingerprints to identify the matter in question.

As each change in energy level is unique, a particular type of atom or molecule may be identified when either light (more generally, an electromagnetic wave) of a frequency it is known to emit is present, or when light of a frequency it is known to absorb is absent. The former is known as atomic or molecular emission. The latter is known as atomic or molecular absorption. Both techniques are used by the Voyager optical target body sensors to identify the presence of particular atoms and molecules.

The frequencies of light that a diatomic or polyatomic molecule can absorb or emit can be calculated. By determining,

in advance, the atoms and molecules that one wants to locate, one can determine the range of electro-magnetic frequencies that must be detectable. Once the desired range of frequencies is known, one can design sensors sensitive to those frequencies that will indicate the presence of the particular matter one is looking for.

Figure 4-9 shows both the range of wavelengths that the Voyager optical target body sensors can sense, and some of the atoms and molecules that emit or absorb energy within this wavelength range. One can see the large number of molecules detectable by the IRIS (uses infrared), hence the importance of preserving the instrument health to Neptune if possible.

### Science Links

The Voyager spacecraft is a very complex machine. As such, it must be told what to do. To use a particular sensor to make a desired observation, a list of instructions must be generated to tell the sensor what to do and when to do it. This list of instructions is called a science link.

The science links have a well-defined naming convention. The first letter designates the instrument (P = PPS, R = IRIS, U = UVS, V = ISS OR TV, X = RSS S/X-band, A = PRA, W = PWS, and F = F&P = LECP/CRS/PLS/MAG). Link name first letters can also refer to Engineering or Navigation activities. The second letter in the link name designates the target body (P = planet, R = rings, M = Miranda, A = Ariel, U = Umbriel, T = Titania, O = Oberon, S = System, H = Helios or Sun, \* = Star, and C = Calibration). The remaining letters and numbers in each link name provide a shorthand description of the observation.

The scientific goals of the Uranus encounter were summarized in Chapter 2. This chapter has summarized how Voyager's sensors work. Table 4-1 summarizes the most important science links that will be used in the upcoming Uranus encounter. The table shows which sensor has been chosen to accomplish which scientific goal, and when the observation will be made. The start

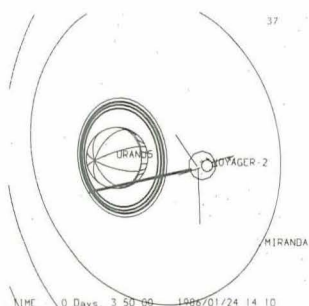

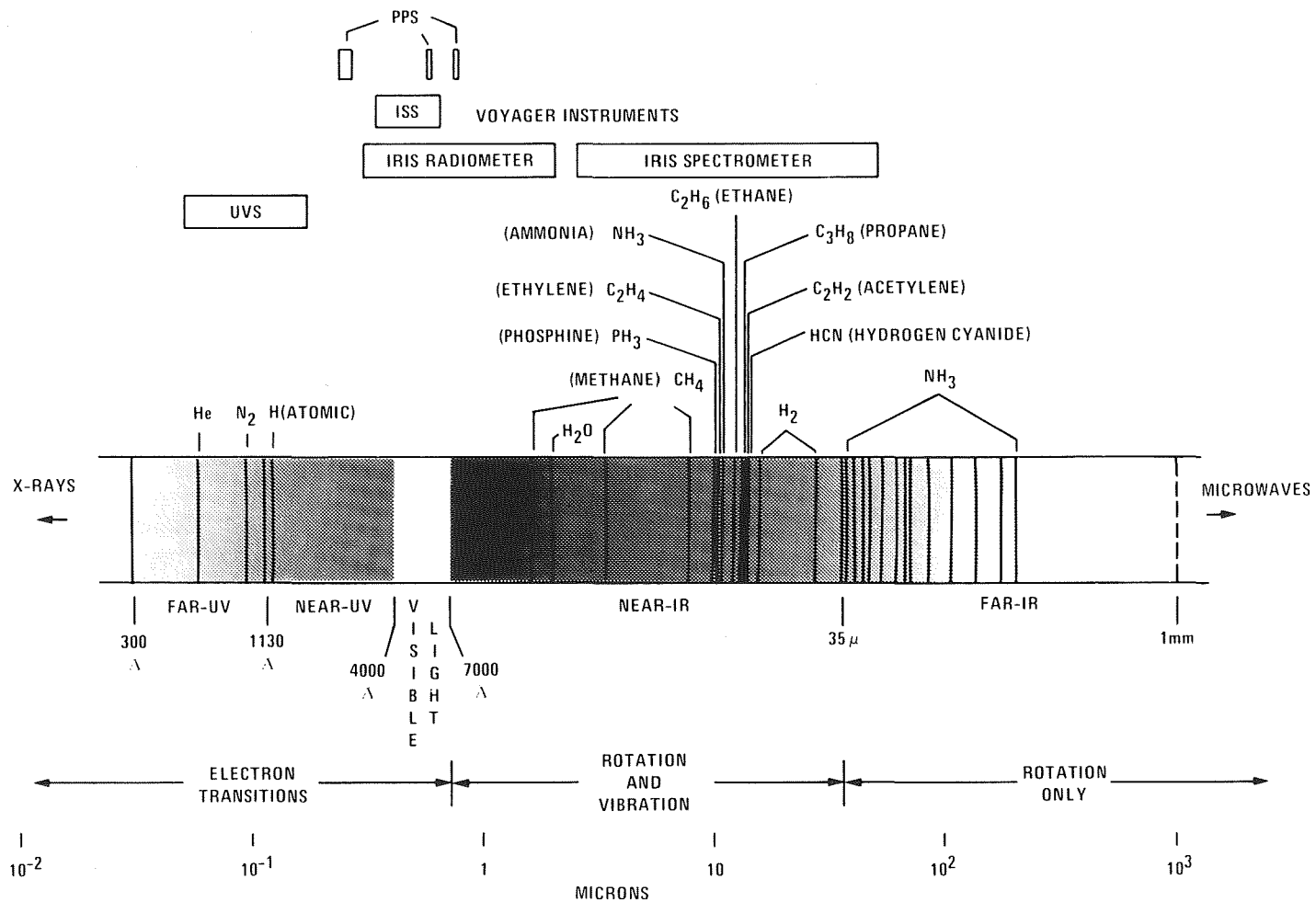

Figure 4-9. Voyager's optical instruments cover a respectable range of the electromagnetic spectrum, enabling the detection of many possible substances. We must thank such great scientific pioneers as Planck, Newton, Bohr, Sommerfeld, Einstein, Heisenberg, and Schrodinger.



time is given in hours relative to Uranus closest approach, with negative before and positive after closest approach. Additional information on these major science observations is provided in Figure 6-4 and Table 9-1.

Table 4-1. There are 33 priority-1 science observational link executions out of a total of 1400 link executions during the 114-day Uranus encounter period. 25 of these top priority links occur between U-10 hours and U+10 hours.

	LINK	START TIME	GOAL	SENSOR
P L A N E T	1. RPDISK	U-9D 15H U+8D 21H	URANUS THERMAL EMISSION	IRIS
	2. PPVPHOT	U-6.9H U-2.7H U-0.3H U+11.5H	URANUS SOLAR ENERGY ABSORPTION	PPS,ISS
	3. RPOCCPT	U-5.6H	URANUS ATMOSPHERIC COMPOSITION	IRIS
	4. UPGPEGIN	U-0.7H	UPPER ATMOSPHERIC COMPOSITION	UVS,PPS
	5. UPGPEGEG	U+0.2H	UPPER ATMOSPHERIC COMPOSITION	UVS,PPS
	6. UPHOCC	U+2.1H	UPPER ATMOSPHERIC COMPOSITION	UVS
	7. XPOCC	U+2.2H	ATMOSPHERIC AND IONOSPHERIC STRUCTURE	RSS
R I N G S	8. VRMOS1	U-23.1H	LOW PHASE ANGLE RING MOSAIC	ISS
	9. PRSIGSAG	U-13.3H	$\epsilon$ , $\delta$ RING RADIAL STRUCTURE	PPS,UVS
	10. VRXING	U-0.9H	RING PLANE CROSSING IMAGES	ISS
	11. PRBETPER	U+0.5H U+1.4H	RING RADIAL STRUCTURE	PPS,UVS
	12. XROCC	U+1.4H U+4.3H	RING RADIAL STRUCTUR AND PARTICLE SIZE	RSS
	13. VRHIPHAS	U+3.3H	HIGH PHASE ANGLE RING IMAGING	ISS
	14. VRMOS2	U+18.5H	HIGH PHASE ANGLE RING MOSAIC	ISS

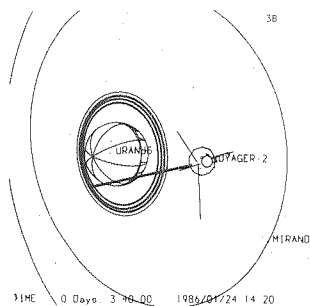

S A T E L L I T E S	15.	VUCOLOR	U-17.7H	UMBRIEL BEST RESOLUTION COLOR	ISS
	16.	VOBEST	U-9.2H	OBERON BEST RESOLUTION (ALSO COLOR)	ISS
	17.	VTCOLOR	U-8.9H	TITANIA BEST RESOLUTION COLOR	ISS
	18.	VUBEST	U-6.3H	UMBRIEL BEST RESOLUTION	ISS
	19.	VTBEST	U-3.7H	TITANIA BEST RESOLUTION MOSAIC	ISS
	20.	VACOLOR	U-3.4H	ARIEL BEST RESOLUTION COLOR	ISS
	21.	VMCOLOR	U-3.0H	MIRANDA BEST RESOLUTION COLOR	ISS
	22.	VABEST	U-1.8H	ARIEL BEST RESOLUTION MOSAIC	ISS
	23.	VMBEST	U-1.3H	MIRANDA BEST RESOLUTION MOSAIC	ISS
M A G S P H *	24.	UPAURMOS	U-8.3H U+9.7H	URANUS AURORA MAPPING	UVS
	25.	F.LSTEP	U-13.7H	HIGH RATE PARTICLE SEARCH	LECP
	26.	PLS.ROLL	U-3.3H	ALIGNS PLS FOR PLASMA SHEET SEARCH	PLS

\* MAGNETOSPHERE

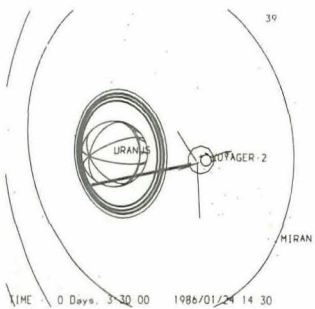

One wonders if their messages came long ago, hurtling into the swamp of the steaming coal forests, the bright projectile clambered over by hissing reptiles, and the delicate instruments running mindlessly down with no report.

Loren Eiseley

## 5. THE VOYAGER SPACECRAFT

You have become acquainted in the last chapter with each of the science instruments and their objectives. The objectives can only be carried out by delivering the spacecraft to the Uranian system along the chosen trajectory, properly orienting the spacecraft so its instruments may point at the proper celestial bodies, powering the instruments, giving instructions to them, and channeling the science information obtained by the instruments to the radio subsystem for transmission to Earth. In other words, a complex infrastructure is necessary to support the science instruments. This chapter describes the spacecraft and the way it operates.

### The Bus

The basic structure of the spacecraft is called the bus. It is a decagonal (10 sided) structure (see Figure 5-1). The symmetry axis of the bus is called the z-axis, or roll axis. The spacecraft is designed to roll about this axis by firing tiny jets, fueled by hydrazine, which are attached to the bus. The spacecraft will usually be aligned so this z-axis points at Earth.

Each of the ten sides of the bus contains a bay that houses various electronic assemblies. Bay 1, for example, contains the radio transmitters. The bays are numbered from 1 to 10 (numbered clockwise as seen from Earth).

Two additional turn axes, in the plane of the decagon and

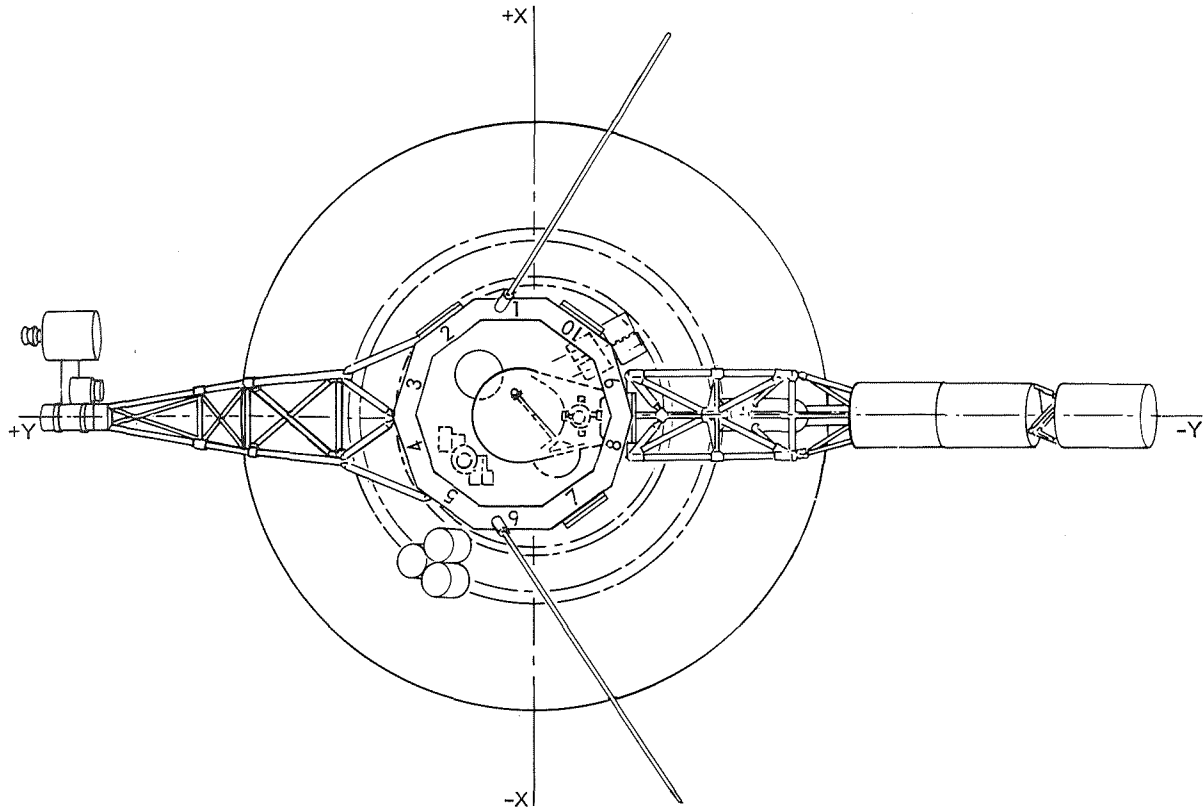
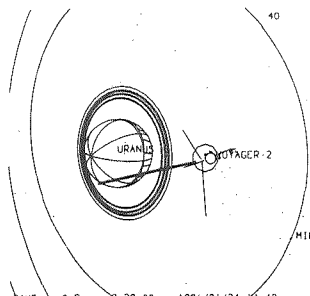

Figure 5-1. The central part of the Voyager spacecraft "bus" is a decagon (ten-sided) structure of "bays" that houses various subsystems and electronics. The "pitch" X-axis and "yaw" Y-axis may also be seen in this sketch.

at right angles to each other, are needed to give the spacecraft full maneuverability. These are the x-axis and the y-axis shown in Figure 5-1. The x-axis is called the pitch axis and the y-axis is called the yaw axis. In the aircraft industry, the convention is x for roll, y for pitch, and z for yaw.

### The High Gain Antenna

On most spacecraft, a small antenna dish sits on the spacecraft bus and is steerable. But Voyager is different; it may almost be said that the spacecraft bus sits on the high gain antenna (see



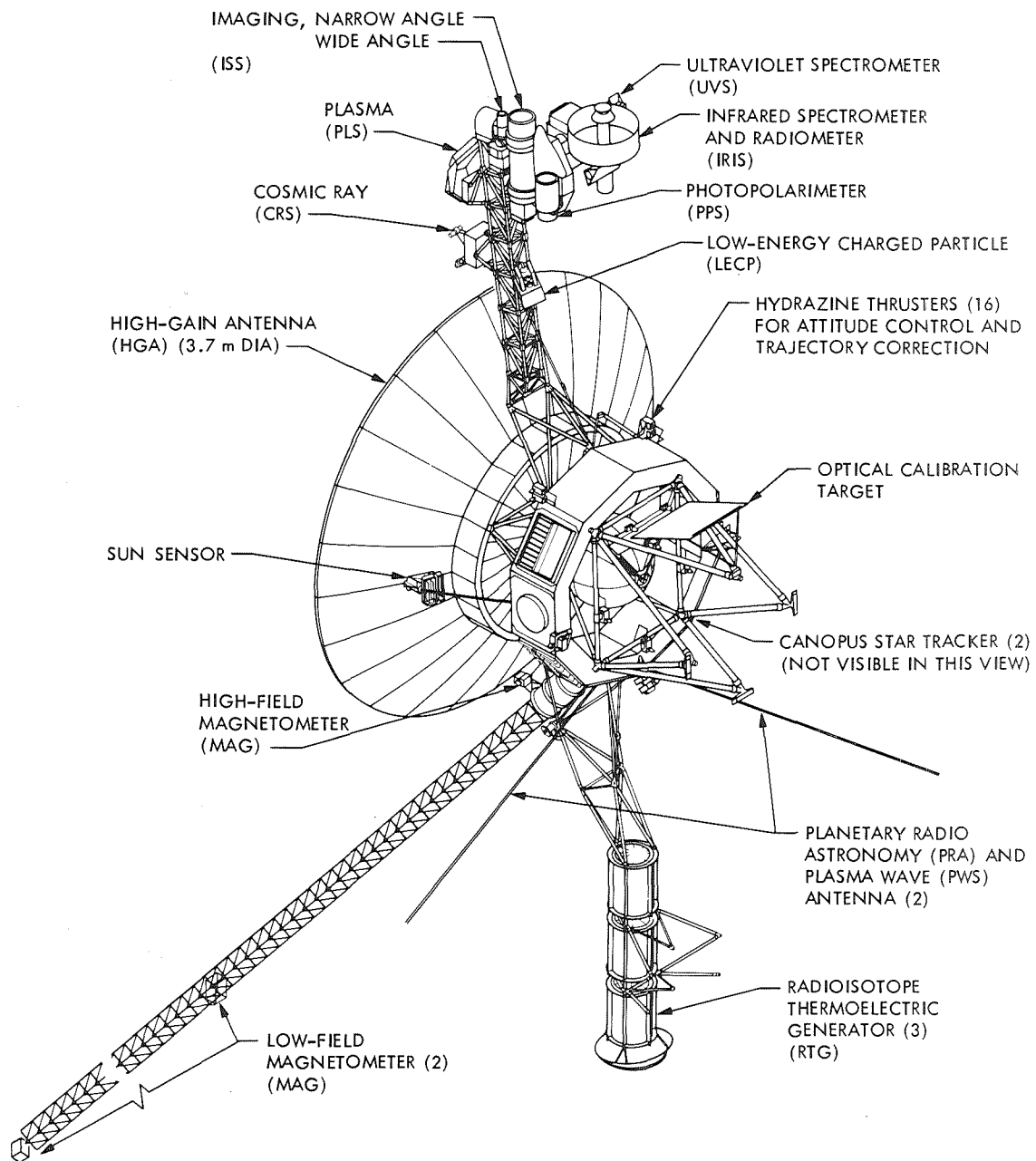

Figure 5-2. The Voyager spacecraft has a mass of 825 Kg, is nuclear-electric powered, consists of about five million equivalent electronic parts, and uses onboard computer fault detection and response to protect itself.

Figures 5-1 and 5-2). The reason for this, obviously, is that the antenna dish must be very large (3.7 meters, or 12 feet in diameter) to send a signal back to Earth from the vast distances of the outer planets. This dish is called the High Gain Antenna (HGA) because it focuses the radio energy into a highly concentrated narrow beam. The half-power points of the HGA are 0.5 degrees off axis for the X-Band and 2.3 degrees for the S-Band. There is also a Low Gain Antenna, but it is not used anymore except in response to certain onboard faults.

The HGA transmits data to Earth on two frequency channels. One, at about 8.4 GHz (gigahertz) (8400 Megahertz), is the X-Band channel, which contains science and engineering telemetry data. For comparison, the FM radio band is centered around 100 megahertz. The X-band downlink telemetry data rates vary from 4.8 to 21.6 Kbps (kilo-bits per second). The other channel, around 2.3 GHz, is in the S-Band. This channel is configured to contain only engineering data on the health and state of the spacecraft at the low-rate of 40 bps.

### Spacecraft Attitude Control

There are two classes of spacecraft: spin stabilized and three-axis stabilized. The former, such as Pioneer spacecraft, obtain stabilization by spinning so that the entire spacecraft acts as a gyroscope. Three-axis-stabilized spacecraft, such as Voyager, maintain a fixed orientation, or attitude, in space except when maneuvering.

Spacecraft stabilization, as well as spacecraft motion (maneuvering), is controlled by an onboard computer is the Attitude and Articulation Control Subsystem (AACS). This computer also controls scan platform motion.

Voyager has two ways of maintaining its attitude: by gyro control and by celestial control. Gyro control is used for special purposes and short periods of time, up to several hours.

In celestial control mode, Voyager maintains its fixed attitude in space by viewing the Sun and

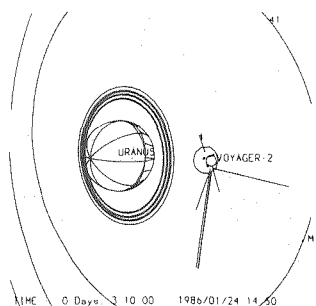

a bright star, such as Canopus, Alkaid, Fomalhaut, or Achernar. If the spacecraft should drift from its proper orientation by more than a certain angle (called the deadband), the AACS will issue commands to fire the tiny attitude-control thrusters (hydrazine jets) to bring it back to proper orientation.

The sensor instruments used to track the Sun and star are the Sun Sensor (mounted on the High Gain Antenna) and the Canopus Star Tracker (CST), so named because Canopus is usually the preferred star to use. Canopus, the second brightest star in the sky, is a southern hemisphere star and is only barely visible from the southern United States.

When it comes to pointing precision, the Voyager spacecraft does a first-class job. Figure 5-3 shows the celestial sensor and gyro accuracies, the limit cycle deadband, and the final scan platform pointing accuracy.

#### Spacecraft Maneuvers

There are many types of spacecraft maneuvers. We choose one that is fairly simple, and also somewhat common, to use as an example - this is the Stellar Reference Change.

Canopus is used almost exclusively as the reference star by Voyager 2 during interplanetary cruise (Voyager 1 uses Regulus). There are times during encounter, however, when Canopus is not suitable. For example, the planet might be on the other side of the bus from the scan platform when Canopus is the lock star. Imaging the planet would then be impossible because of spacecraft obscuration. In this case, an alternate star is chosen which is on the other side of the sky from Canopus, and the Stellar Reference Change maneuver is required.

The maneuver is controlled by the AACS computer. First, the spacecraft goes to gyro control (all-axis inertial mode). Then the AACS fires the hydrazine thrusters to start the spacecraft turning about the roll axis (z-axis). The turn rate is precisely controlled by the AACS. This is done by



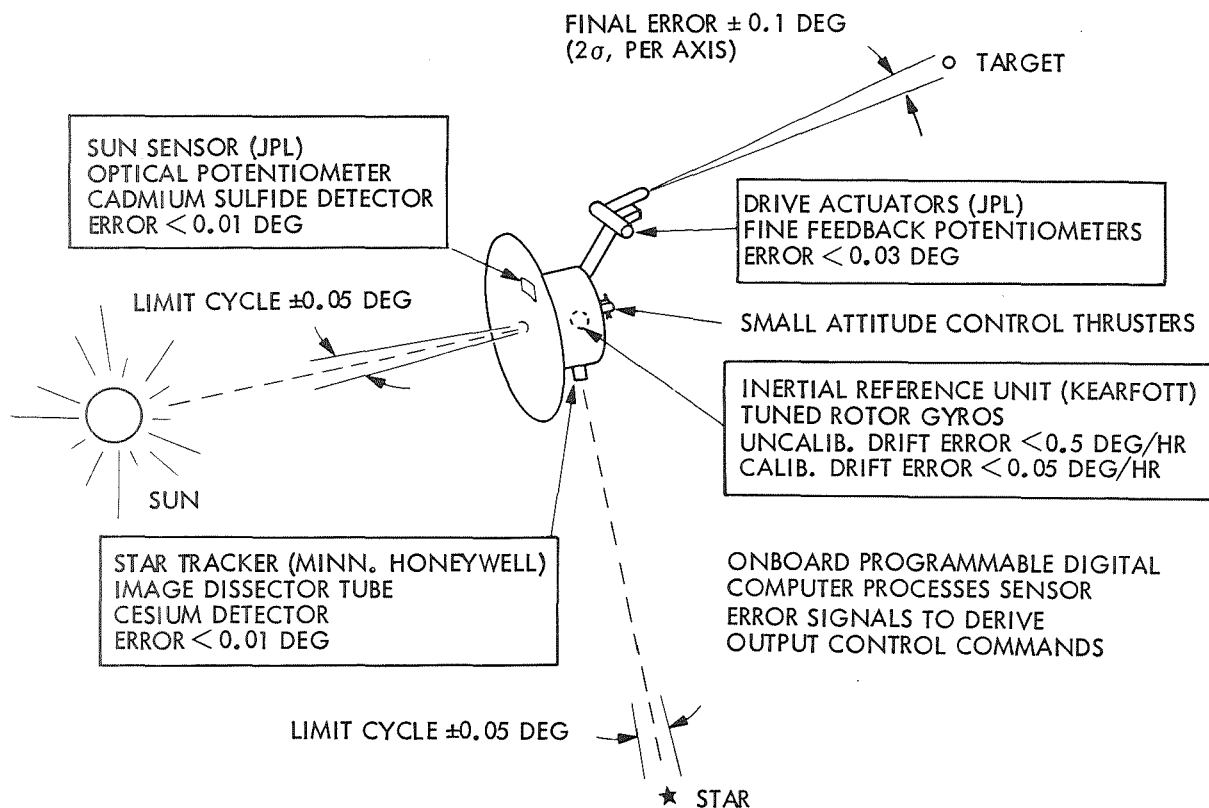
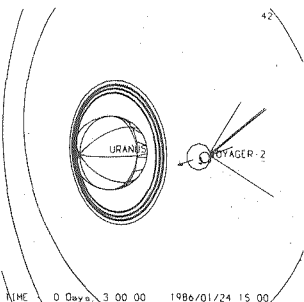

Figure 5-3. When it comes to pointing precision, the Voyager spacecraft is quite an amazing machine.

using the gyros to estimate the actual turn angle, then using AACS software to estimate the turn rate and to fire the thrusters when appropriate to match a chosen standard turn rate. This standard rate may be chosen to be the nominal turn rate (0.18 degrees per second) or a new higher turn rate (0.30 degrees per second).

After the spacecraft has been turning for the prescribed time, the AACS fires the opposite set of thrusters to halt the turn. Since the turn is about the axis pointing toward Earth, the sun will have "coned" around this axis and be at a different spot on the sun sensor plate. The sun sensor then locks onto the sun in its new position. (This displacement of the sun from the roll axis is called the sun sensor bias.)

Finally, the star tracker locks onto the new reference star, and the spacecraft is returned from gyro control to celestial control.



## Scan Platform

Several appendages are attached to the spacecraft bus. These are the HGA (discussed above), the magnetometer boom, the PRA antenna (rabbit ears), the RTG boom (supplying power), and the Scan Platform. These are all shown in Figure 5-2, a completed view of the spacecraft.

Many of the science instruments are on the Scan Platform, including those that need to be pointed at the target body (the planet, a star, or one of the satellites). A glance at Figure 5-2 will show you why it is necessary to mount these instruments on such a long boom. If they were mounted on the bus, they could not look backwards because of obscuration by the high gain antenna. These instruments need to be away from the bus to be able to see around the HGA to look backwards, as during post-encounter. By placing the scan platform on the other side of the bus from the radioactive power source, the spacecraft mass distribution is balanced.

The scan platform has motors and gears (called actuators) which slew the platform to point in various directions. If you imagine "up" as being in the direction of the HGA boresight (generally toward Earth), then a motion up or down is accomplished by an elevation slew, and a motion to the right or left is accomplished by an azimuth slew. These are called, for short, El slews and Az slews. The convention is chosen that the  $180^\circ$  azimuth position is in the y-z plane. The locations and appearance of the actuators are shown in Figures 5-4 and 5-5.

Almost 100 minutes after Voyager-2 closest approach to Saturn in 1981, the azimuth motion of the scan platform unexpectedly halted, and science data were lost from the instruments that require pointing. Apparently this seizure was due to heavy use of high-rate slews to move the scan platform at 1 deg/sec, causing a vital lubricant to migrate away from a tiny shaft-gear interface (spinning at 170 rpm), which then expanded slightly with the additional heat, finally leading to a seizure. Attempts to resume scan platform motion took two days.

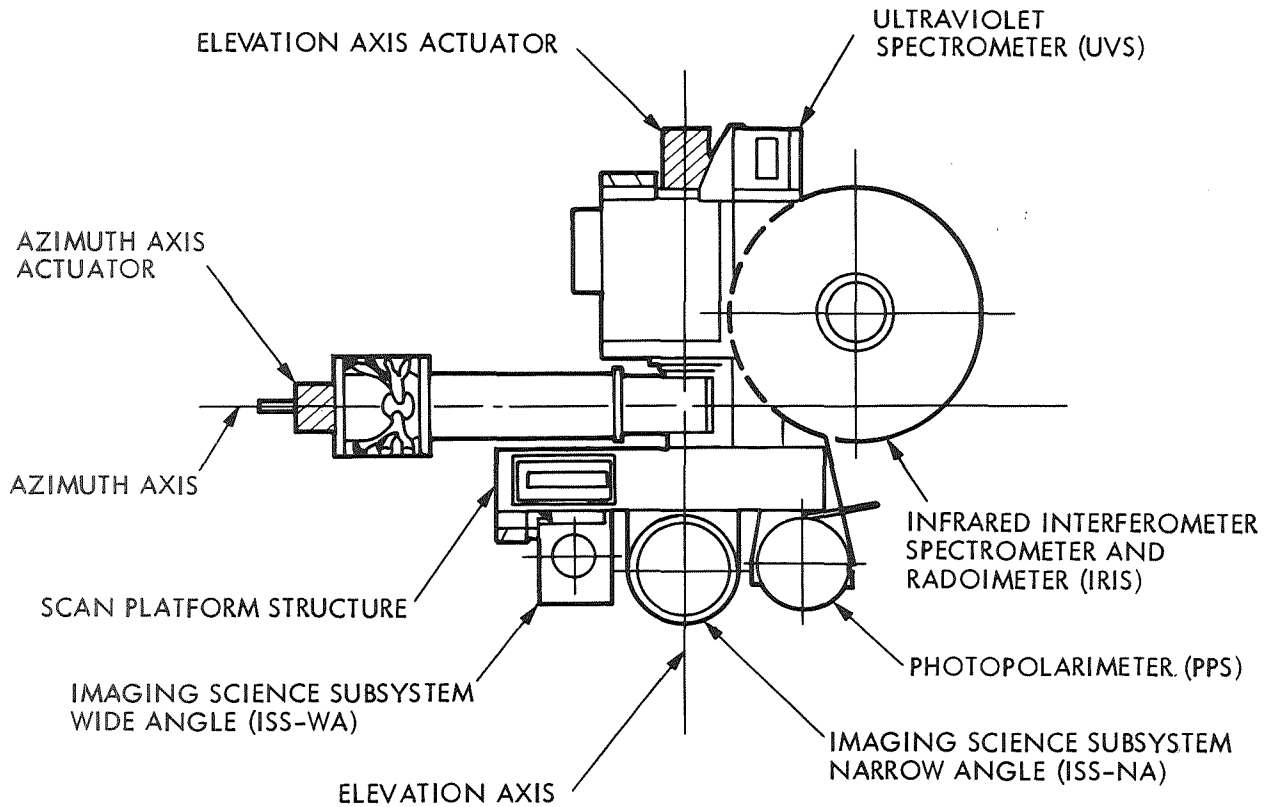
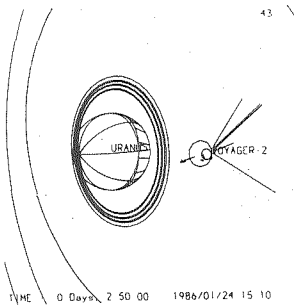

Figure 5-4. This view of the Voyager scan platform shows the locations of the two electric motors known as "actuators" that drive the platform to look in different directions.

Needless to say, the faster slews will not be used during the Uranus encounter, except for four medium-rate slews used to capture critical science observations. All other slews will not exceed the low rate of 0.08 deg/sec. Nevertheless, the scan platform motion will be monitored quite closely by the torque margin test (TMT) (see Chapter 6). A contingency near-encounter sequence has been prepared for use just in case this test should indicate the likelihood of the scan platform motion sticking again.

Spacecraft Power Subsystem

Spacecraft electrical power is supplied from three Radioisotope Thermoelectric Generators (RTG)



# VOYAGER SCAN ACTUATOR

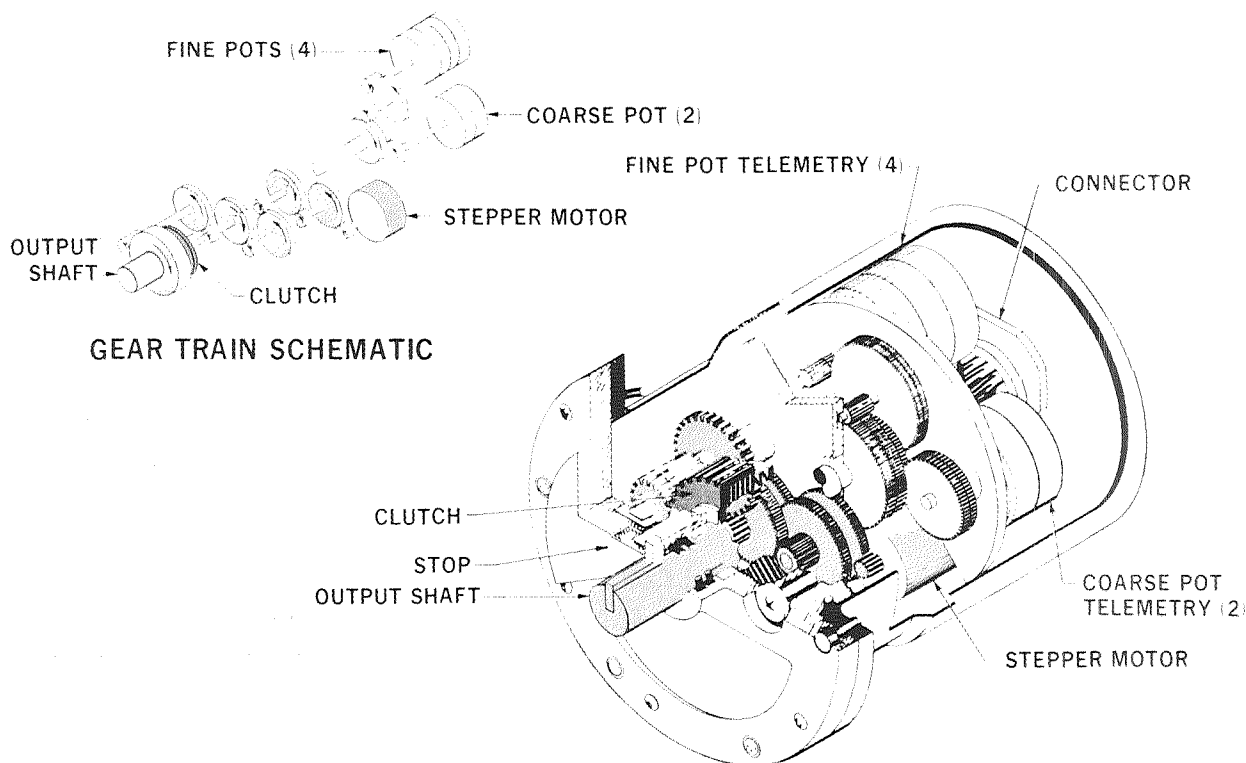

Figure 5-5. Small electric motors drive the Voyager scan platform about "azimuth" and "elevation" axes. The Voyager-2 azimuth actuator stuck shortly after the Saturn encounter, but is running again and will be used for the Uranus encounter.

which are miniature nuclear power plants that convert about 7000 watts of heat into some 400 watts of electricity. These lie along the RTG boom, away from the spacecraft bus and opposite the scan platform (see Figure 5-2.)

At launch the power output from the RTGs was 475 watts. However, the power output decreases by about 7 watts each year due to several causes, including the half-life of the fissionable plutonium dioxide and degradation of the silicon-germanium thermocouples. The power output of the Voyager-2 RTGs for each of the planetary encounters is given below:

Jupiter	448 watts
Saturn	429 watts
Uranus	398 watts
Neptune	372 watts (projected)

The power requirements of the spacecraft are constrained to be less than the RTG output, and excess power is dissipated through the shunt regulator as heat. The difference between the available power and the power used in running the spacecraft is called the "power margin". Since the power available is substantially less for Uranus than for previous encounters, great care is taken to plan the power management strategy. For example, S-Band high-power state cannot regularly be used, and several other key power loads have to be turned off (at some risk) to use the S-Band high-power state for the Earth Occultation Experiment.

There are project guidelines that require this power margin be kept fairly large (above 12 watts) as a safeguard against power surges or miscalculations which might cause the spacecraft to try to draw more power than is available. Were this to happen, the onboard computer has a fault protection algorithm that could turn off power to some subsystems to reduce power consumption. This would be a major inconvenience and, if it happened during encounter, would cause loss of science data. But this is an example of how the spacecraft is designed to protect itself.

### Digital Tape Recorder

There are occasions when the Voyager spacecraft cannot immediately send science telemetry data to Earth. These occasions could occur during a spacecraft maneuver when the HGA is not pointed at Earth, or during the time the spacecraft is behind the planet (Earth Occultation). Also, it is no longer possible to send certain types of data (such as PWS and PRA high-rate frames) directly into the telemetry stream because the data rate is too high to be received without error. In all these instances the Digital Tape Recorder (DTR) is available to store the data for later playback to Earth.

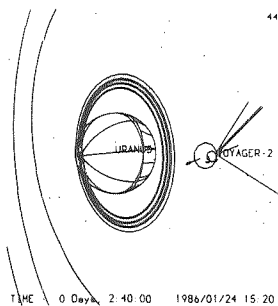

The DTR has three speeds in use at Uranus encounter. But rather than citing the speed in inches per second, as for conventional tape recorders, the speed is cited in units of information per second, kilobits per second (Kbps). The three speeds are: 115.2 Kbps (record only); 21.6 Kbps (playback only); and 7.2 Kbps (both record and playback).

There are 8 tracks on the DTR. Each of these can hold up to 12 images if only images are recorded. This is seldom the case since data from other instruments need to be recorded also.

As can be imagined, the experimenters often like to record more data than the tape recorder has the capacity to store. (This is a consequence of Parkinson's Law.) Thus, DTR data management is a critical concern. It is important to get the data played back quickly so that the tape recorder can be filled again. But playbacks interfere with science gathering and require certain DSN configurations which are not always available. So data management during busy periods remains a challenging task.

#### The Spacecraft Receiver

Periodically, instructions are sent from the ground to the spacecraft. These instructions, called commands, are modulated onto radio signal and are transmitted at 16 bits per second by one of the DSN tracking stations. Travelling at the speed of light, they will reach the spacecraft at Uranus in about 2 hours, 45 minutes.

The radio signal carrying the commands is picked up by the spacecraft HGA. The receiver strips the subcarrier from the carrier and sends it to the Command Detector Unit (CDU). Here the commands are demodulated (removed from the subcarrier) and converted to digital form. The commands are then sent to the Computer Command Subsystem (CCS).

On April 6, 1978, a failure protection algorithm in the CCS automatically switched from the prime to the backup receiver. But the backup receiver was discovered to have a failed tracking loop capacitor. Soon after a commanded return to the prime receiver, it suddenly failed. Seven days later, the fault protection algorithm switched back to the crippled backup receiver. Because of these two failures, different procedures are used for commanding Voyager 2 than are used for Voyager 1.

If the second receiver were to fail, there would be no way to command the spacecraft to execute further activity. We would not be able to point the scan platform instruments at their targets nor point the HGA at Earth. We could not have a successful encounter. To protect against failure of the remaining receiver, a special CCS Load has been placed in the CCS. This contingency Back-up Mission Load (BML) contains a few commands that will allow some science to be gathered in the event that the regular encounter CCS Loads cannot be received by the spacecraft because of receiver failure. There are several designs for the BML, each resident in the CCS over a different interval of time.

The receiver was designed to lock onto the signal in order to follow shifts in frequency, but this function is no longer possible due to a failure of the the tracking loop capacitor in the receiver. (These shifts in frequency are doppler shifts that result from changes in the relative velocity between the spacecraft and the DSN antenna due primarily to the Earth's rotation.) In commanding Voyager 1, the DSN transmits at a constant frequency and the receiver locks onto and follows the moving frequency.

However, for Voyager 2 the failed tracking loop capacitor makes it necessary for the received signal to be at a constant frequency. To accommodate the doppler shifts, it is then necessary for the DSN tracking station to transmit at the moving frequency. If the transmitted frequency is not within 96 Hertz of the receiver rest frequency, then Voyager 2 will turn a deaf ear on instructions from Earth. Furthermore, an unpredicted

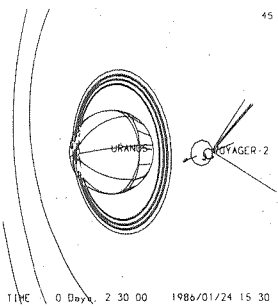

temperature change of as little as 0.25° C in the receiver will shift the rest frequency by 96 Hertz from its predicted value. All of these factors complicate the process of sending commands to Voyager 2.

### The Computer Command Subsystem

The Computer Command Subsystem (CCS) consists of two identical computer processors, their software algorithms, and some associated electronic hardware. The CCS is the central controller of the spacecraft (the brain of the spacecraft, if you will). Figure 5-6 shows the CCS in relation to the AACS and FDS computers, as well as to the DTR (the main component in the Data Storage Subsystem) and other subsystems.

The CCS has two main functions: to carry out instructions from the ground to operate the spacecraft to perform housekeeping functions and to gather science data; and to be ever alert for a problem with or malfunction of any of the various spacecraft subsystems and to respond to it.

The latter of of these CCS functions is carried out by a series of software routines called Failure Protection Algorithms (FPAs). These algorithms, which occupy roughly ten percent of the CCS memory, make the spacecraft semi-autonomous and able to act quickly to protect itself. This is important because of the long delay time required for a response to the problem from Earth five and a half hours roundtrip light time, plus the reaction time of the engineers to detect the problem and prepare the proper response. In many instances such a delay would be intolerable.

The other of the CCS functions, storing and processing commands from Earth, allows the spacecraft to act as an intelligent robot to carry out its science gathering functions in strict accordance with the carefully developed mission plan.

It is convenient to send up one transmission to the spacecraft which contains most or all of the commands needed to operate it for a period of time, ranging from 30 days



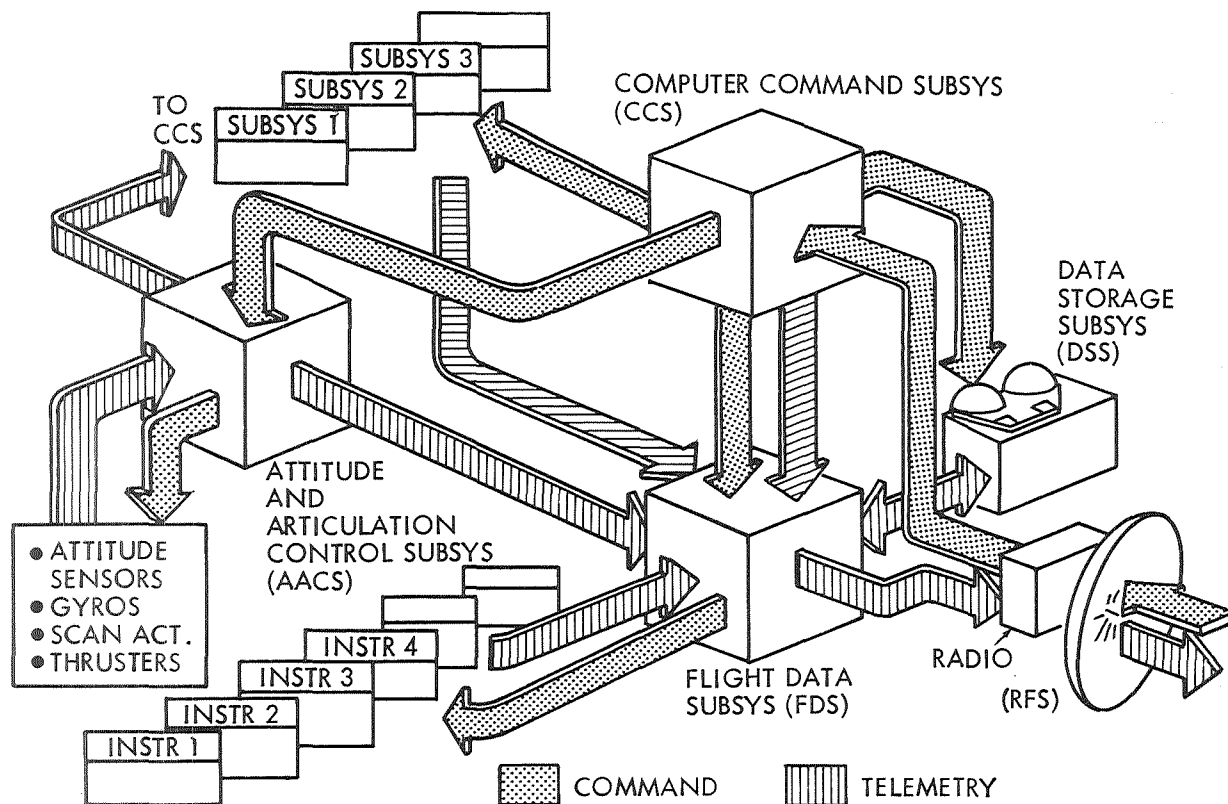
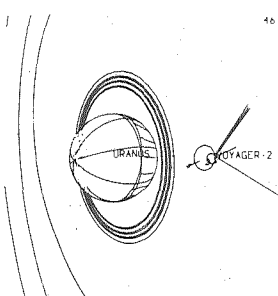

Figure 5-6. Voyager's three computer subsystems contain nearly 33,000 words of memory storage, with the Computer Command Subsystem directing most of the activities.

during Observatory Phase to only two days during Near Encounter. Each of these transmissions nearly fills the remaining (non-FPA) memory in the two CCS computers, and the contents of each of these transmissions is called a CCS Load. Each CCS Load is given an identifying number. "A" loads refer to Voyager 1, and "B" loads to Voyager 2. Examples include A621, B701, B702, etc. The next chapter contains a timeline which shows each of the encounter CCS Loads.

### The Flight Data Subsystem

There is two-way communication with the Voyager spacecraft. Uplink contains the command data discussed above; the downlink contains the science and engineering telemetry data.



The engineering data, generally at 40 bits per second, are on the S-Band downlink and are embedded in science telemetry data on the X-Band downlink as well. Engineering data report on the status of the instruments, on the health of the various spacecraft subsystems, and on the spacecraft attitude and scan platform position.

The science data (the results of the science observations) are on the high data rate channel (4.8 to 21.6 Kbps) and are downlinked only on X-Band. (See above discussion of the HGA for transmission frequencies of S-Band and X-Band.)

The telemetry data are assembled, or formatted, by the Flight Data Subsystem (FDS), which is comprised of two reprogrammable digital computers and associated encoding hardware. Besides collecting and formatting the telemetry data, the FDS also performs a few other tasks.

The FDS does some data processing on the ISS data in a process called "image data compression" (IDC). In this process, the FDS throws away redundant data, leaving fewer bits to put into the telemetry data stream. (See Ch. 7 for further discussion of IDC.) Image data compression requires a change in the way the FDS computers were used at Jupiter and Saturn. Rather than use the secondary FDS processor as a "hot backup" for the primary computer (both containing the identical software), at Uranus encounter the FDS computers are used in a "dual processor mode." In this mode the two processors work in parallel and each perform different functions, effectively doubling the computer memory and time available for computing tasks.

The FDS "encodes" the telemetry data. In this process, redundant bits are added to the telemetry data in such a way that bits lost in the static may be reconstructed (i.e., intelligently guessed at). For example, the Golay encoding process adds 3600 to every 3600 bits of raw science data telemetered to Earth. However, the more efficient Reed-Solomon encoding process only adds 1200 bits to every 3600 bits of raw science data sent to Earth. (See Ch. 7 for further

discussion of Reed-Solomon encoding.)

The FDS also provides appropriate instrument control for the science instruments and the digital tape recorder. For example, control data for the imaging instruments in an "imaging parameter table" in FDS memory provides instructions for imaging shutter modes, filter choices and exposure levels for each camera.

One of the FDS computer memories has lost a block of 256 memory locations, out of a total of 8192. This is a rather minor failure. However, the loss of 512 more words from the primary memory would be serious, for it would mean we would have to abandon the dual processor mode, and hence the valuable image data compression capability.

### The Science Instruments

There are eleven scientific experiments on Voyager 2, and the locations of their instruments are shown in Figure 5-2. Figure 4-5 gives sketches and brief descriptions of each of the instruments. Of these, only four are not located on the scan platform or its supporting boom. The Magnetometer uses its own boom; the Planetary Radio Astronomy (PRA) experiment shares the rabbit ear antennae with the Plasma Wave Subsystem (PWS); and the Radio Science Subsystem (RSS) uses the radio beams from the HGA.

Four instruments on the scan platform that require accurate pointing are the Imaging Science Subsystem (ISS) wide and narrow-angle cameras, the Ultraviolet Spectrometer (UVS), the Infrared Interferometer Spectrometer (IRIS) and the Photopolarimeter Subsystem (PPS). Figure 4-6 shows the relative fields of view of these instruments, and their pointing offsets from each other. These instruments may all make observations simultaneously.

Note the long rectangular UVS slit. For some observations this slit needs to be aligned in a particular direction, requiring a spacecraft roll maneuver.

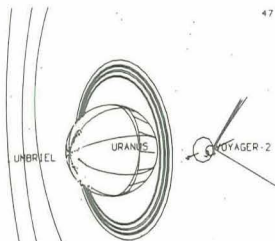

The remaining three instruments on the scan platform boom are fields and particles experiments. These are the Cosmic Ray Subsystem (CRS), the Low Energy Charged Particle experiment (LECP), and the Plasma Subsystem (PLS).

All of these experiments except for RSS send their observational data to the FDS to be formatted into telemetry. All of them, except RSS and ISS, contribute data to a telemetry format called "general science and engineering" (GS&E). This GS&E telemetry data mode has a downlink data rate of 4800 or 7200 bps, depending on the type of encoding the FDS uses, but the information content (symbols per second) is 3600 bps. The PRA, for example, contributes 266 bits per second (bps), and the IRIS contributes 1120 bps, out of this total of 3600 bps.

The ISS has several data formats of its own, at higher data rates because of the large number of data bits required to define a picture. Real-time data rates of 8,400 and 14,400 bps allow the images to be immediately returned to Earth in the telemetry stream. Non-compressed images may be recorded on the tape recorder at 115,200 bps, then returned at a slower playback rate to Earth at a later time. Two other experiments, PRA and PWS, can also provide a high data rate, and periodically short bursts of these data are put onto the DTR at 115,200 bps for later playback at a slower rate.

You have read in Chapter 4 about the working and objectives of each of the science instruments. This chapter has dealt with the way in which the spacecraft provides the necessary support to operate these instruments and return their data to Earth. The next chapter will discuss the overall mission highlights, including many of the most important science activities.

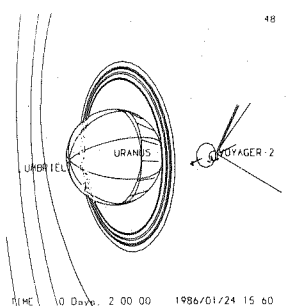

Some men see things as they are and say, why? I dream of things that never were and say, why not?

George Bernard Shaw

## 6. MISSION HIGHLIGHTS

On January 24, 1986, at about 1800 GMT (10 AM PST), the Voyager 2 spacecraft will make its closest approach to the planet Uranus while on a fly-by trajectory that will take it on to the planet Neptune. At the time of Uranus encounter, the spacecraft will have been travelling for 1625 days (4y 5m 12d) since its encounter with the planet Saturn, and 3078 days (8y 5m 4d) since its departure from Earth on August 20, 1977.

As the spacecraft approaches Uranus, the planet will appear larger and larger, and spacecraft activities will become more complex, reaching a crescendo the day or two around closest approach. Then, looking backwards, the spacecraft will observe Uranus appearing to shrink as it recedes into the distance.

Encounter activities begin nearly three months prior to closest approach, in the first week of November 1985. They extend through the third week of February 1986, for an encounter duration of just over 16 weeks. Voyager begins its cruise phase to Neptune just prior to the time a fleet of spacecraft encounter Halley's comet in late February and March 1986.

If we include the final one-month cruise load immediately preceding the start of the encounter period, the total twenty-week period of Voyager intensive activities can be divided into five phases. The starting and ending dates of these phases are listed in Table 6-1, and they are also shown on the overview timeline (Figure 6-1).

Since Uranus is so far away, it is necessary to array several antennas to receive a strong enough signal from the spacecraft to support high data rates. This arraying is shown

in the bar chart at the bottom of Figure 6-1. The baseline of the bar chart indicates no arraying but continuous coverage by 64-meter antennas. A bar above the baseline may have a height of 1, 2 or 3, indicating arraying at one or more DSN complexes at Goldstone (California), Canberra (Australia), and Madrid (Spain).

TABLE 6-1: Dates of Phases

Pre-Encounter Test & Calibration	Oct. 7 to Nov. 4	GMT
Observatory Phase (OB)	Nov. 4 to Jan. 10	
Far Encounter Phase (FE)	Jan. 10 to Jan. 22	
Near Encounter Phase (NE)	Jan. 22 to Jan. 26	
Post Encounter Phase (PE)	Jan. 26 to Feb. 25	

### Pre-Encounter Test and Calibration Activities

Before beginning the actual Uranus encounter activities, certain functions of the spacecraft need to be tested, and science instruments need to be calibrated. These activities are carried out in several of the late cruise loads, with special emphasis on the final cruise load (B624).

Several tests are performed during B624 in October. The very important Near Encounter Test (NET) will be an operations readiness test of the encounter configuration of the DSN tracking stations, the Ground Data System (GDS), and the plans and procedures of the Voyager Flight Team. It will, in a sense, be a dress rehearsal for the Near Encounter Phase.

Of special interest will be an active sequence of spacecraft maneuvers, a test of the radio science occultation-related activities, a spacecraft power-margin test, and a careful analysis of the receiver best-lock-frequency profile. The Voyager Flight Team will assess the spacecraft performance as it executes critical portions of the Near-Encounter CCS Load B752 for the simulated time period from U-2 to U+6 hours, including the Miranda image motion compensation (IMC) maneuver. Wide-angle images of star fields will be periodically shuttered to measure the spacecraft turning and pointing accuracy.

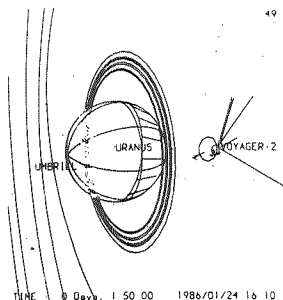

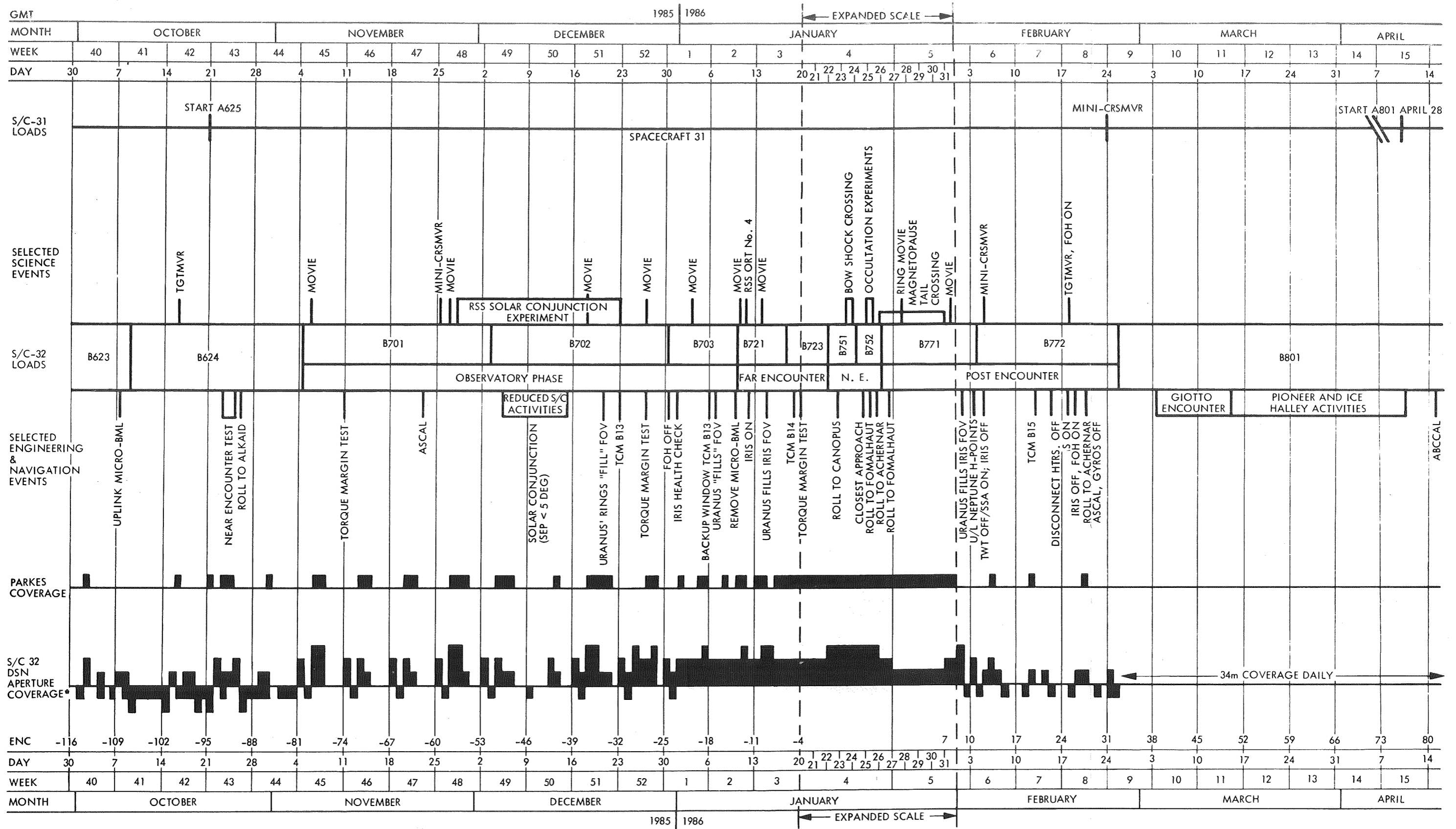

\*BASELINE CONTINUOUS 64m; EACH ABOVE-LINE BLOCK INDICATES AN ARRAYED DSCC; EACH BELOW-LINE BLOCK INDICATES LOSS OF CDSCC OR MDSCC.

Figure 6-1. The Uranus "encounter period" runs from 11/4/85 to 2/25/86, with the most intense activities occurring within a few days of closest approach. This overview timeline shows a number of key science and engineering activities, tracking station support, and sequence load boundaries.





The NET will also include a close match of the medium-rate scan platform slews designed for B752, as well as a possible update of the movable block and selected encounter parameters.

The instrument calibrations are always an important part of any science experiment. An example of an instrument calibration would be to plunge a Celsius thermometer into a glass of ice water. The temperature reading should be zero. If it is not, then the thermometer is miscalibrated and will not give true readings. What you would like to know is how far off the temperature readings are.

Another example might be to calibrate your camera's light meter. You would shoot a picture at the exposure setting indicated by your light meter; then, bracket it by shooting the same picture one stop above and below the indicated setting. Looking at the resulting three pictures would tell you whether your light meter is inaccurate and, if so, in which direction and by how much.

A major calibration performed on the spacecraft during the CCS Load B624 is the Target Maneuver (TGMVR). This provides the basic calibrations of the ISS and the IRIS radiometer by viewing a target plate, affixed to the spacecraft, which has known photometric response.

#### Observatory Phase (OB)

The Observatory Phase is divided into three CCS Loads: B701, B702, and B703. This phase provides the first extended opportunity to observe Uranus at better than ground-based resolution. (The narrow-angle camera achieved resolution as good as Earth-based telescopes around March 1985). The Imaging Subsystem (i.e., TV cameras) will monitor the long-term atmospheric motion through several color filters.

A glance at Figure 6-1 will show several movies in the OB phase and the Far Encounter (FE) Phase. Each of these movies will take images for about 38 hours, or just over two complete rotations of the planet. These movies will track atmospheric

features and help establish wind velocities and other meteorological features in the atmosphere of Uranus.

The Ultraviolet Spectrometer (UVS) will observe emissions from the Uranian system, searching for hydrogen and other gases in the space between the satellites and Uranus, providing clues to the composition of Uranus, or possibly satellites, from which these gases escaped. It will also search for and monitor ultraviolet light from Uranus auroral emissions, which mimic the aurora borealis on Earth.

The RSS solar conjunction experiment will measure the electron density and variations of the Sun's atmosphere. This experiment is possible because the sun passes almost directly between the spacecraft and the Earth, so that the S- and X-Band radio beams pass through the Sun's atmosphere.

The mini-cruise science maneuver (CRSMVR) consists of 4 yaw turns followed by 4 roll turns. During this maneuver the magnetometer is calibrated, the UVS makes measurements of the interplanetary medium, and the fields and particles experiments take science data.

In the trajectory correction maneuver TCMB13, hydrazine thrusters are fired to correct the spacecraft trajectory to assure that the spacecraft is headed in precisely the right direction and arrives at Uranus within 12 minutes of the desired arrival time. A backup window is provided in the unlikely case the TCM is not properly executed.

#### Far Encounter Phase (FE)

Far Encounter Phase is divided into two CCS Loads, B721 and B723. (There once was a B722 but it was divided between the other two loads). As the distance to Uranus decreases and its size appears to increase, it becomes necessary to take a mosaic of images (an enlarged grid of pictures) in order to obtain complete coverage of the planet and ring system with the narrow angle camera. Satellite and detailed ring observations are begun by the Imaging experiment.

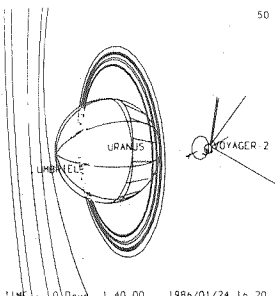

IRIS observations of Uranus begin in FE. For example, the high-priority RPDISK observation, made when the disk of the planet fills the IRIS field of view, is designed to assist in determining the global heat balance of the planet and whether energy is generated in the core of the planet.

Also in FE, many optical navigation frames are taken of the satellites against the background stars. These provide, by triangulation, the precise position of the spacecraft as it approaches the Uranian system.

TCMB14 is performed to make final corrections in the target-plane aiming coordinates, but it may not make corrections (depending upon propellant allocations) to the arrival time unless it is more than several minutes off the desired 18:00 GMT nominal.

#### Critical Late Activities

Many critical activities occur on the ground and on the spacecraft during the final week before Uranus closest approach. These activities, shown in Figure 6-2, make last-minute health checks of the scan platform and make late navigation-based updates to the timing and scan platform pointing for critical NE science observations.

A final Torque Margin Test (TMT) is performed on the scan platform actuators 4.5 days before closest approach. This test provides the last chance to determine whether the scan platform motion is normal and, if it is not, still provides time to update and transmit the contingency sequence of science activities in case the test indicates excessive friction in the platform drive train.

The B752 Late Ephemeris Update makes scan platform pointing updates just prior to uplink of the load, based on the latest knowledge of the trajectories of the spacecraft, planet, and satellites.

But even this may not be good enough. Our orbit knowledge continues to improve significantly as a result of

the latest optical navigation images. Use of this improved knowledge is necessary to optimize the mission. But the lateness of these optical navigation frames requires that special commands (late stored updates) be sent to the spacecraft to update timing and pointing parameters again.

The most challenging of these late updates involves the Miranda IMC maneuver. Because the spacecraft passes so close to Miranda, even these late updates may be unable to capture the satellite in all of the images that we would like. That is why the Miranda IMC design is begun well before the other late stored updates. The final Miranda IMC design won't be available until just 30 hours prior to its execution on the spacecraft.

The other late stored updates are the movable block time shift, the XPOCC vernier timing adjustment, the LECP stepping cyclic, the UVS limb drift slew tweak, and several other scan platform pointing adjustments. Indeed, people and computers must be performing at top efficiency during these final few days before Voyager 2 races past Uranus.

### Near Encounter Phase (NE)

The Near Encounter Phase has two CCS Loads, B751 and B752. During the NE Phase, the highest resolution observations will be made of the planet, its rings, and satellites. The structure of the magnetosphere will be characterized by the Fields and Particles experiments. Perturbations on spacecraft velocity will be used to improve our knowledge of the masses of Uranus and Miranda.

The Planetary Radio Astronomy (PRA) and Plasma Wave Subsystem (PWS) are expected to receive short range radio emissions from Uranus and, perhaps, its rings. The Radio Science Subsystem (RSS), Photopolarimeter Subsystem (PPS), and Ultraviolet Spectrometer (UVS) will make Earth, star, and Sun occultation measurements, respectively, to characterize the Uranian atmosphere and the ring system. The UVS will also be used for near-polar atmospheric occultation measurements of the star Gamma Pegasi.

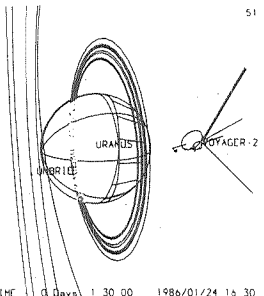

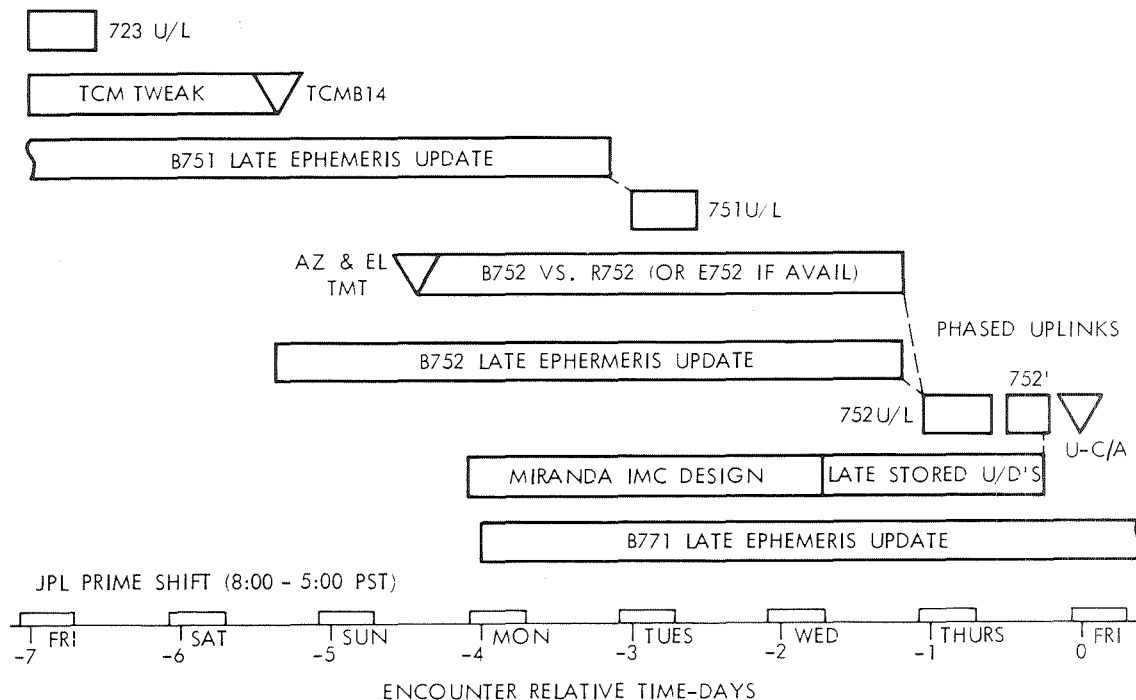

Figure 6-2. The Voyager Flight Team will be working many long and busy hours during the final week before Uranus closest approach, endeavoring to update the observational sequences to the latest navigational solutions.

The activities of most of the Near Encounter Phase may be seen in Figures 6-3 and 6-4. Figure 6-3 shows the Near Encounter Mission and Maneuver Profile. At the bottom of this timeline, relative times are given as times before or after closest approach (CA) to Uranus. The lower part of the timeline shows the boundaries of the CCS Loads, the command uplink windows for transmitting these CCS Loads to the spacecraft, and the command moratorium (that period of time needed for the receiver "rest" frequency to be predictable with sufficient accuracy to receive commands from Earth).

You will note that the official command moratorium overlaps the time when commands will, in fact, very likely be sent to the spacecraft containing the contents of CCS Load B771. The command moratorium is caused by switching the power state of the S-band transmitter from low to high power for the radio

science Earth Occultation experiment; even with a reduction in the X-band power level, the net heat changes are sufficient to alter the temperature, and thus the frequency, of the receiver. It is hoped that the actual command moratorium will not last as long as the official command moratorium.

The upper part of Figure 6-3 shows the spacecraft maneuvers being performed during Near Encounter. The first of these maneuvers is a change of reference stars from Alkaid to Canopus. (Alkaid is also known as eta Ursa Majoris. It is the end star in the handle of the Big Dipper.) This maneuver is accomplished by a roll turn. The change from Alkaid to Canopus is required in order to give the spacecraft an orientation appropriate for F&P measurements in the outer magnetosphere. (Alkaid provided an orientation which allowed UVS system scans to avoid looking at bright UV stars in the background Milky Way.) Then, between -10 hours and -2 hours (before closest approach) there are a whole series of maneuvers, including a roll back to the reference star Canopus at -8h 44m. The other maneuvers, for satellite observations, are described below.

TABLE 6-2

VOBEST	best images of Oberon (R)	-9h 15m
VTCOLOR	color images of Titania (R)	-8h 51m
VUBEST	best images of Umbriel	-6h 15m
VTBEST	best images of Titania (R)	-3h 45m
VACOLOR	color images of Ariel	-3h 25m
VMCOLOR	color images if Miranda	-3h 1m
VABEST	best images of Ariel	-1h 53m
VMBEST	best images of Miranda	-1h 25m

These observations all require Image Motion Compensation (IMC) maneuvers. They employ gyro drift turns to rotate the spacecraft at a rate that matches (as closely as possible) the motion of the satellite. Thus, when the camera is shuttered, the image smear that would otherwise result is practically eliminated. Those observations designated (R) also employ roll turns to reduce azimuth slewing.

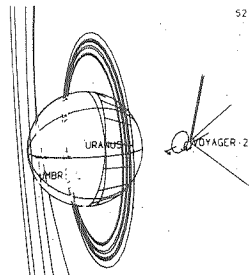

### NEAR ENCOUNTER MISSION AND MANEUVER PROFILE

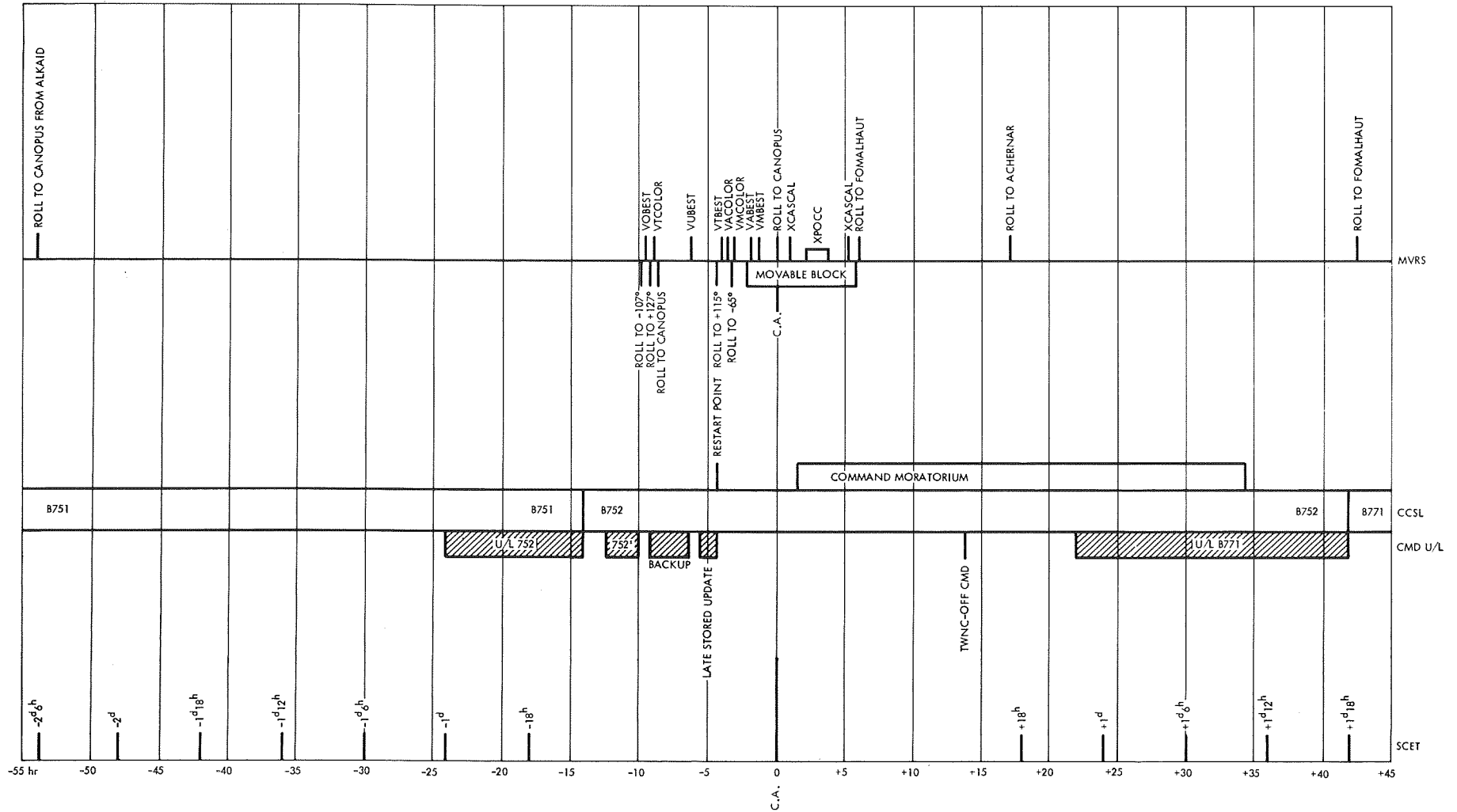

Figure 6-3. The near-encounter time period contains several roll maneuvers. These are used to change lock stars, improve sensor orientations, or avoid excessive usage of the scan platform azimuth actuator.



Prior to the VMCOLOR observation, the spacecraft is rolled to  $-65^\circ$  from Canopus for PLS measurements of a possible near-equatorial plasma sheet. As can be seen from Figure 6-3, there is another roll back to Canopus near closest approach. This roll is necessary to re-establish spacecraft alignment knowledge prior to critical planetary occultation experiments.

Science observations are categorized as Priority 1, 2, or 3. There are 24 Priority-1 (necessary to accomplish major scientific objectives) observational "links" in NE, with some executed more than once. These are listed in Tables 4-1 and 9-1, and are shown in Figure 6-4. The only Priority-1 observations outside of NE are the RPDISK observations by IRIS in FE and PE.

Figure 6-3 shows a "movable block"; Figure 6-5 shows the Movable Block Timeline in more detail. Note on Figure 6-5 the 12-minute gap in activity preceding and following the movable block. This dead time is placed here so that the movable block may be moved, as a unit, up to twelve minutes earlier or later to accommodate navigation delivery errors in arrival time at closest approach. These errors can be reduced by the use of TCMB13 and TCMB14. However, it is possible to save hydrazine fuel by not completely correcting the timing trajectory error, and to accommodate it instead by the movable block. The fuel thus saved is available for the continuing journey to Neptune and beyond.

You will note that the last two Image Motion Compensation (IMC) maneuvers are inside the movable block. This is because the precise timing for them is critical. The most difficult of these maneuvers is the Miranda IMC, for it will stretch the capability of the gyro-drift turns almost to their limit of two degrees per minute per axis. Also, the spacecraft will fly close enough to Miranda that it may be possible to improve our knowledge of its mass.

As the spacecraft crosses Uranus' ring plane at U-43m, the PWS will record 3 frames (144 seconds) of high rate plasma wave data, preceded by 2 frames of PRA data. These observations are to detect tiny

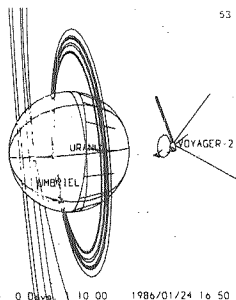

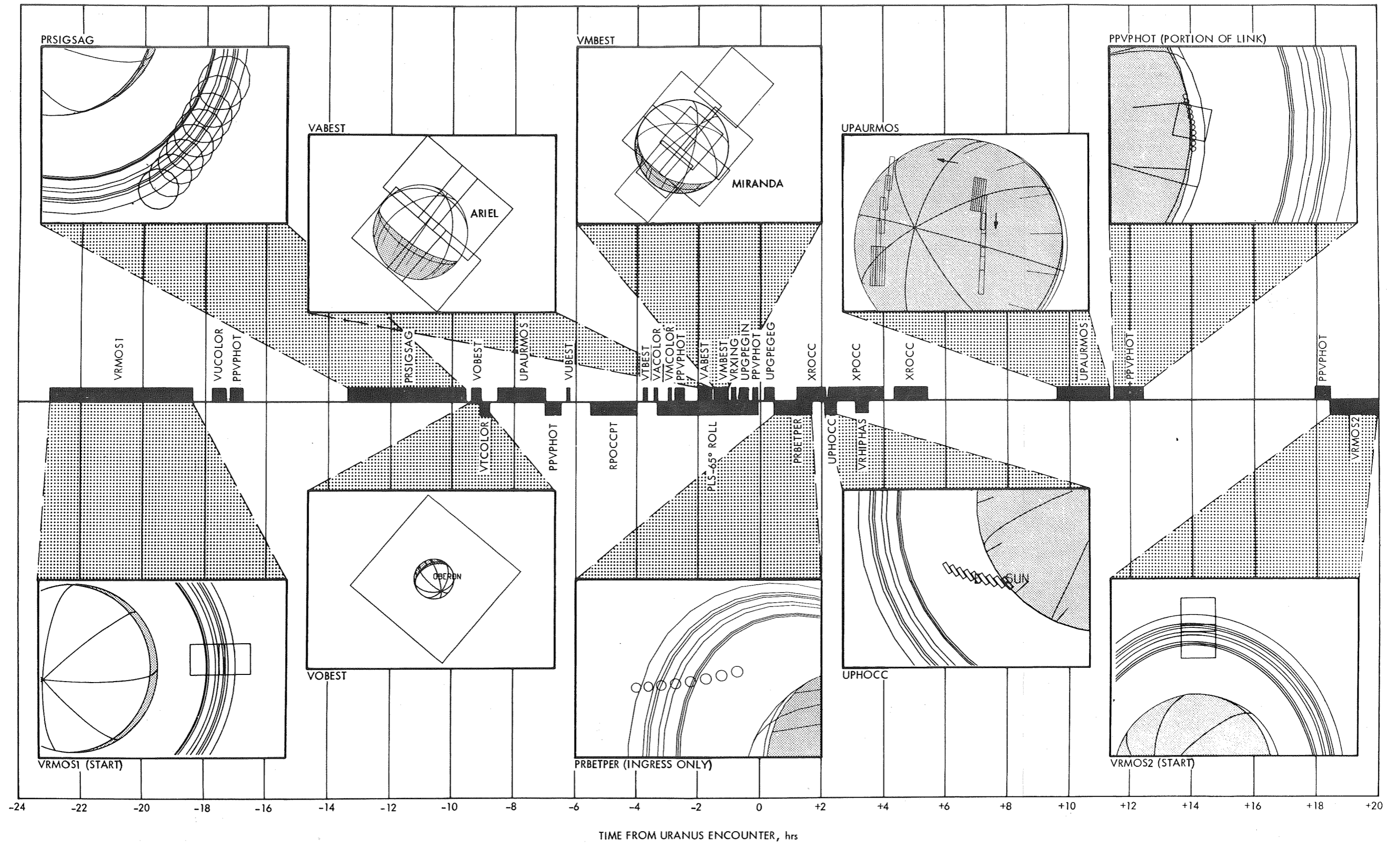

Figure 6-4. Most of the 25 priority-1 science observational "links" occur during the near-encounter period. Inserts show the geometrical appearance of several of these vital measurements.



particles in the plane of the rings. The spacecraft will not pass close to the nine known rings themselves. Just minutes before ring plane crossing, the wide angle camera will take 4 images of the rings.

Right after ring plane crossing, the UVS and PPS will observe the star Gamma Pegasi (third brightest star in the constellation Pegasus) as it appears to pass behind (be occulted by) the planet. Thus the starlight passes through the Uranian atmosphere. These observations, in conjunction with the Sun occultation later, will enable scientists to determine the chemical composition and temperature profile of the Uranian atmosphere.

The PPVPHOT observation, occurring between the Gamma Pegasi ingress and egress portions, observes Uranus with the PPS to help determine the amount of solar energy absorbed by the planet, thereby contributing to our knowledge of the global heat balance of Uranus.

Following the Gamma Pegasi egress observation are two other star observations of Beta Perseii being occulted by the rings. These observations, again by the PPS and UVS, give a star intensity profile, which translates to a measurement of an opacity profile (location of rings and gaps) of the rings at two different azimuthal positions.

Using the gravity-assist trajectory corridor to reach Neptune, the spacecraft passes behind Uranus as seen from Earth (see Figure 9-4), giving an opportunity for the Earth and Sun occultations. The Earth Occultation Experiment (XPOCC) is a radio science experiment, which uses the spacecraft's S- and X-Band radio beams to probe the Uranian atmosphere. During XPOCC, the spacecraft state is changed: the S-Band transmitter is put in high power and, for power load compensation, the X-Band transmitter is changed to low power. Also, telemetry is turned off to concentrate power in the carrier.

Before and after XPOCC, the Earth is occulted by the rings, giving the opportunity for the RSS Ring Occultation

Experiment (XROCC) to provide data on particle sizes and distributions. The movable block ends after XROCC egress, followed by a roll to Fomalhaut as lock star at about U + 6h. Fomalhaut gives reasonably good spacecraft orientation for F&P instruments and provides views of the planet by scan platform instruments unhampered by spacecraft obscuration.

The VRHIPHAS observation takes high-phase images of the rings during the radio science XPOCC maneuver. These images should provide important information on the ring structure and particle sizes.

The last observation shown on Figure 6-5 is the UVS observation of the star Nu Geminorum (UPNUGEM) which, like the similar observation of Gamma Pegasi, will help determine the constituents and structure of the Uranian atmosphere.

At U + 17 h. 30 m., there is a roll to Achernar, which gives a better orientation for the F&P instruments.

#### Post Encounter Phase (PE)

The Post Encounter phase is divided into two CCS Loads: B771 and B772. In this phase the scan platform instruments make lower resolution, high-phase-angle (dark side) observations of the planet and rings. A time-lapse movie of the rings is made in B771. A search for new faint rings between known rings and Oberon's orbit is feasible, since presumed forward scattering of sunlight would make the rings more visible from this vantage point.

Between closest approach and up to January 28, the spacecraft will be within the magnetotail (if Uranus has a magnetic field). During this time the F&P instruments will provide data on the "downstream" magnetic field of Uranus.

There is a roll to Fomalhaut at the start of B771. The change from Achernar is needed because there would be spacecraft obscuration to the PPS and ISS wide angle camera when using Achernar for celestial reference.

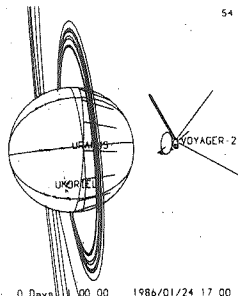

MOVABLE BLOCK TIMELINE

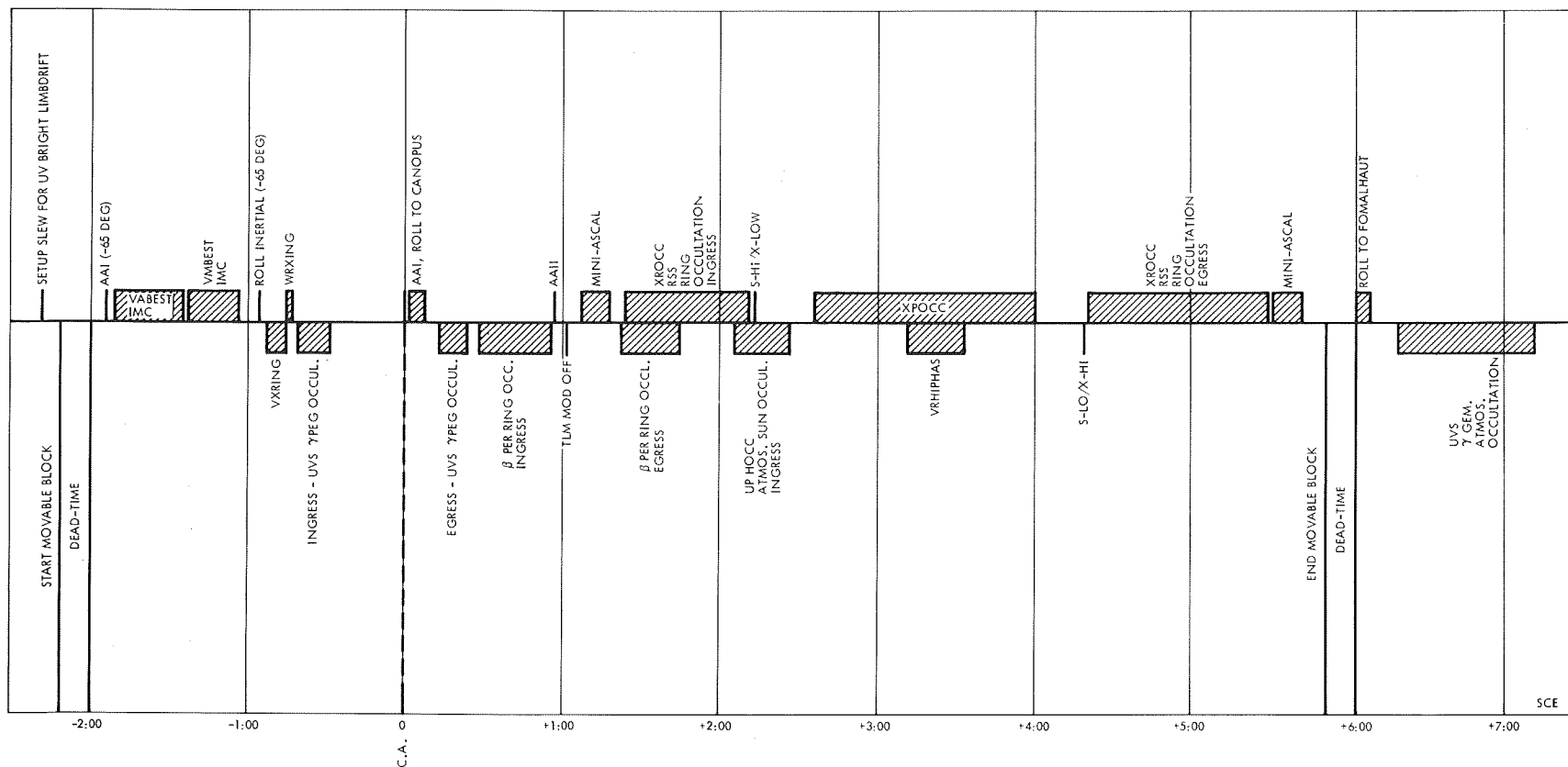

Figure 6-5. In order to use less of a precious consumable known as hydrazine (like fuel), the Voyager navigators may not correct all of the flight time error, allowing  $\pm 12$  minutes of variation about the nominal arrival time of 18:00 GMT on 1/24/86. This is dealt with by including many science observations within a "movable block" that can be shifted once the navigation timing is known.

Neptune "H-Points" are uplinked during the first day of B772. These commands will reside in the spacecraft's computer at least for the next few months (until the uplink of BML-5) and, should the receiver fail, will be on board at Neptune encounter to reconfigure the spacecraft and point the high gain antenna at Earth.

CCS Load B772 contains four spacecraft maneuvers. The first of these is a mini-cruise-science maneuver (FCRSMVR), similar to the one in CCS Load B701. The second maneuver is the trajectory correction maneuver, TCMB15. This is the longest TCM thruster-firing period to date for Voyager 2, about 3 hours. While the spacecraft would go on to the vicinity of Neptune (roughly 34,000 km or 21,000 mi "ENE" of Neptune, but 2 days late in arrival time) without this TCM being performed, TCMB15 will bring the spacecraft much closer to the desired encounter conditions over the north polar region at the desired arrival time.

The third maneuver in B772 is a target plate calibration maneuver (TGTMVR), used for a post-encounter calibration of the ISS and IRIS instruments. The last maneuver is a roll back to Achernar as a reference star, for better F&P instrument alignment. The spacecraft will remain on Achernar for the first several months of cruise to Neptune.

### Contingency Sequences

In operating an aging spacecraft, it is good practice to anticipate possible mechanical and electrical problems that might occur in one of the spacecraft support subsystems described in Chapter 5. This is especially true for the NE phase. Otherwise, a failure of one of the subsystems, were it to occur just prior to NE, would not permit enough time to redesign the CCS Loads to accommodate the failure.

The Voyager Mission Planning Office (MPO) has identified 5 specific spacecraft subsystem failure modes that are of more than idle concern. Some level of advanced preparation (contingency planning) has been done for each of these potential failure modes. These are:

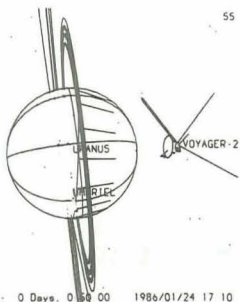



- 1) A failure of the remaining spacecraft receiver;
- 2) A slowing or seizure of the scan platform azimuth actuator (Az anomaly);
- 3) A slowing or seizure of the scan platform elevation actuator (El anomaly);
- 4) A failure in one of the two CCS processors or memories;
- 5) A failure in one of the two FDS processors or memories.

Protection against a receiver failure is given by the Backup Mission Load (BML) that is resident in the CCS during the OB Phase and part of FE. If the receiver fails, then further commanding is impossible, but some level of encounter activity would still be captured by the BML.

Failure of the scan platform azimuth actuator is protected for NE by a contingency sequence, R752, that has been developed and placed on the shelf. If a failure occurs early, then other CCS loads could be converted to substitute roll turns for azimuth slews.

A failure of the elevation actuator is believed by some to be less likely than for the azimuth actuator. A fall-back sequence using yaw or pitch maneuvers is difficult to design effectively, is tape-recorder-space constrained for the number of off-Earth maneuvers, and can capture only a fraction of the nominal scan platform science observations. Thus, no contingency sequence for such a failure has been developed. However, a development plan has been carefully worked out, so that such sequences could be developed if the need arises.

In the case of possible FDS or CCS failures, the project will develop backup loads S752 and C752 far enough that they could be flown with a minimum of additional work. Many other contingencies were considered by the MPO, but a detailed discussion is beyond the scope of this Guide.



## Cruise to Neptune

As Figure 6-1 shows, Uranus Encounter officially ends on February 25. There is one more spacecraft maneuver to be performed to wrap-up the post-encounter calibrations. This is the ABCCAL, which is needed to calibrate the RSS Earth Occultation experiment, for which precise knowledge of the high gain antenna pointing is necessary. However, this maneuver must be postponed until mid-April because of the high activity of the Halley comet spacecraft, Giotto, Vega and Planet-A, and the supporting Halley observations of the ICE and Pioneer Venus spacecraft.

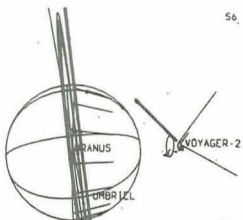

Damn the solar system. Bad light; planets too distant; pestered with comets; feeble contrivance; could make a better one myself.

Lord Francis Jeffrey

7. WHAT'S NEW

Imagine yourself at an international speedway watching a conference between designer, mechanic, and driver on how to win a long distance endurance race with a decade-old-model racing car. Typically, the driver and other members of the team will brainstorm together in a cycle of design, test, and simulation to guarantee any projected new performance of their race car.

To have any hope of success against stiff odds, the team will try to invent new ways to squeeze extra performance out of their aging machine by the use of special engine tune-ups, new driving techniques, and by making special efforts to conserve fuel, tires, and other consumables to avoid frequent change-outs at the speedway pit-stop.

The analogy of winning an international competition using an old racing car illustrates how the Voyager Flight Team has prepared for another race - to Uranus and beyond. The benefit of upgrading an aging (but well designed) one-ton robot is a first-class look at the two outermost giant planets of the solar system. Furthermore, this will be achieved at a modest additional cost beyond that spent for the primary Jupiter/Saturn mission. When compared to the billion or so dollars that a newly designed Outer Planets Mission would cost, not to mention the necessity of waiting well into the next century for results, the Voyager-2 mission to Uranus and Neptune is a bargain at a fraction of the new mission cost!

While use of the international speedway's repair facilities allows our race-car team to update its old machine to compete in the race on Earth, the Voyager Flight Team cannot call back the Voyager spacecraft to Earth from its

distant location. However, the Flight Team can reprogram the Voyager's six on-board computers to effect new strategies to win the race to Uranus and beyond. Reconfiguration of the spacecraft computer memories is somewhat equivalent to choosing a new racing driver with more experience (e.g., with a better performing brain and superior motor skills).

### Maintaining a Strong Signal

With Uranus at nearly four times the Earth-to-Jupiter distance of 779 million km (483 million miles), the maximum data rate supportable by the signal-to-noise ratio (SNR) would fall by a factor of nearly sixteen (square-of-distance penalty) unless the Voyager Flight Team could pull some rabbits out of a hat.

At Saturn (10 AU), the maximum data rate supportable by the SNR was 44,000 bits per second, while at Uranus (19 AU) it will be 21,600 bits per second. The arraying of tracking antennas, plus a few other tricks described below, allow us to arrest the natural fall of the SNR to only half (not 1/4) when Voyager 2 reaches Uranus.

The Voyager Project has called upon additional resources beyond the NASA/JPL operated Deep Space Network (DSN) for data acquisition at the Uranus encounter. The DSN is teaming up with the Australian government-owned Parkes radio astronomy 64m antenna for the Uranus encounter, so that the three antennas (one 64m and two 34m) of the DSN facility in Canberra will combine signals with the Parkes antenna via a 320 km (200 mi) microwave link. By simultaneous tracking of the Voyager from all four antennas during the Uranus encounter period, the DSN and Parkes radio observatories will achieve a significant increase in the combined signal strength (SNR), which is proportional to the square of the antenna diameter, to help defeat another square law.

### Discarding Unnecessary Picture Data

Even the arraying of all four antennas over Australia cannot completely overcome the infamous

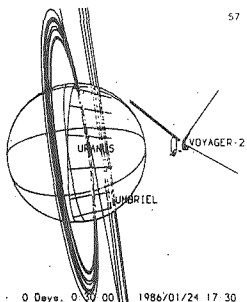

square-of-distance penalty. The Voyager Flight Team has therefore developed a clever scheme to preprocess the imaging data to reduce the total number of bits required for a TV picture from Uranus. They have used a special software routine known as Image Data Compression (IDC) in the on-board Flight Data Subsystem (FDS) backup computer, newly reconfigured for this task.

Uncompressed Voyager TV images contain 800 lines, 800 dots (pixels) per line, and 8 bits per pixel. This means that every uncompressed TV image requires over five million bits for a complete image. Much of the information in a typical television image of a planetary system is frequently dark space or low contrast cloud features. Therefore, by saving the differences in adjacent pixel grey levels rather than the full 8-bit values, IDC can reduce by 60% or more the number of bits that characterize each image and thus the transmission time for a complete TV image from Uranus to the Earth.

As a rule, the reconstructed compressed image will be indistinguishable from the uncompressed image, as the IDC scheme loses no information for low contrast scenes. Even for scenes with rapidly changing pixel intensities, such as for the Saturn ring image shown in Figure 7-1, only minor line clipping occurs near the left and right-hand edges of the frame.

#### More Accuracy for Fewer Bits

Another trick devised to beat the distance-square penalty is the use of an on-board "experimental" Reed-Solomon (RS) data encoder. For those of you who know about secret codes used to hide information in the context of spy thrillers, it may be reassuring to learn that there are also codes designed to preserve the "truth" of information. Data sent to the Earth passes through an interstellar plasma that may phase modulate the signals with noise, e.g., turn a "correct" 0 bit into a "wrong" 1 bit, or vice versa.

Encoding these data has a price, and that paid for the old Golay encoding algorithm (used at Jupiter and Saturn) was

one code bit overhead for every data bit (100%). The new RS encoding scheme reduces this overhead to the vicinity of 20%. In addition, it reduces the number of bit errors from 5 in 100,000 to only 1 in a million! And there are rumors of further encoding efficiencies being considered for the Neptune encounter.

Figure 7-2, though a bit technical, shows how we use the FDS computers and encoders to process the science data. The former scheme was appropriate for the Jupiter and Saturn encounters because of the high data rates and the desire for redundant FDS programs. For the Uranus and Neptune encounters, however, we must use the new scheme to more efficiently return science data under the conditions of much lower data rates.

### Taking Good Pictures in Feeble Light Levels

There is still another penalty imposed on the Uranus encounter by the distance-square law. Reflected solar visual radiation from the Uranian system is received by the spacecraft instruments at very reduced light levels (some 360 times fainter than at Earth). The resulting longer exposure times make smear (picture blurring) of rapidly moving targets (Uranian satellites) much more of a problem than at Jupiter or Saturn. The problem facing Voyager engineers is somewhat analagous to a situation confronting a photographer in a dimly lit room without a flash. To offset the required long exposure times, he must steady his camera on a tripod, use very sensitive film, or open the camera aperture. If his subject is moving, he must smoothly slew his camera to "track" the target, much as a WWII tail gunner in a B17 had to do during many combat missions.

Though not new to Voyager, it will be necessary to use the spacecraft gyroscopes to smoothly execute image motion compensation (IMC) turns to track several satellites during the near-encounter phase.

With the Voyager flying along in a zero gravity environment, the start-stop motion of its

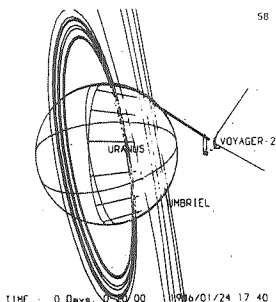

ORIGINAL PAGE  
BLACK AND WHITE PHOTOGRAPH

Figure 7-1. Each Voyager image at Jupiter and Saturn contained five million binary bits of data. In order to cope with the reduced data rates from remote Uranus and Neptune, onboard data compression will difference adjacent pixel brightness levels to return only two million bits per picture. No information will be lost in low-contrast scenes, but minor losses near edges may occur for contrast-varying scenes.

## VOYAGER AT SATURN



## VOYAGER AT URANUS

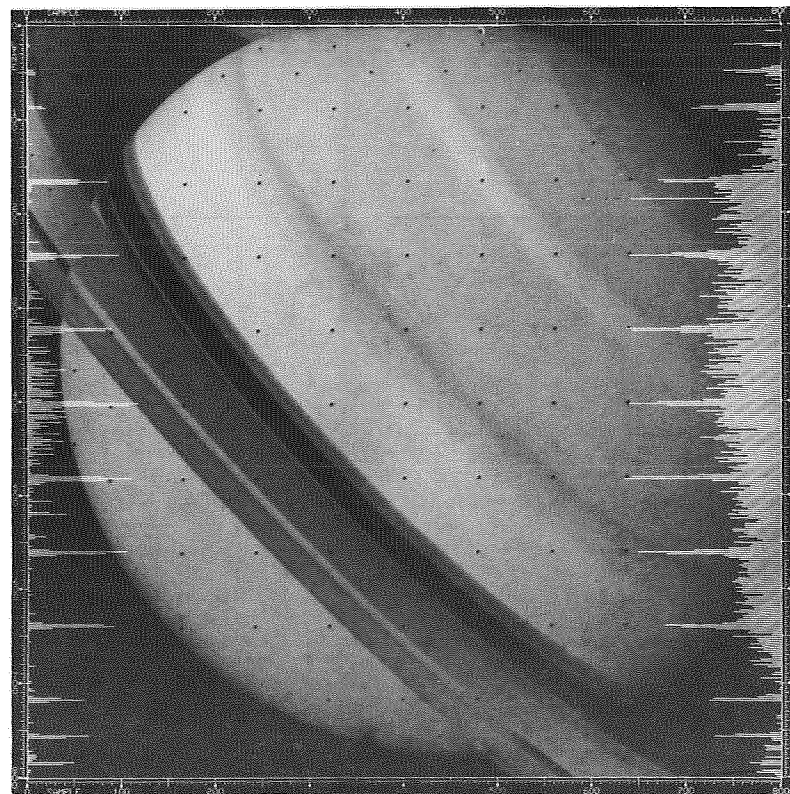
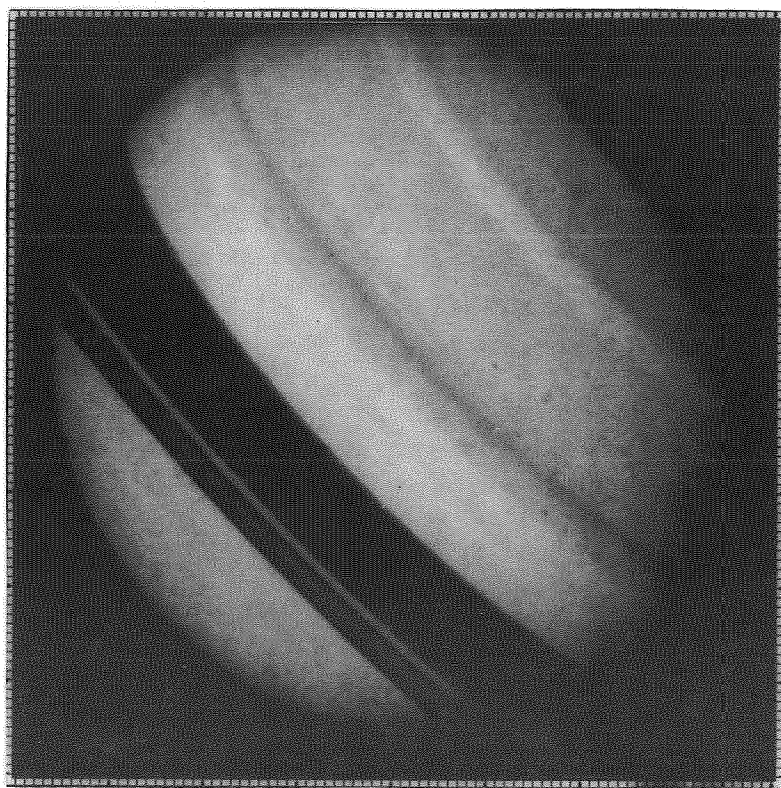
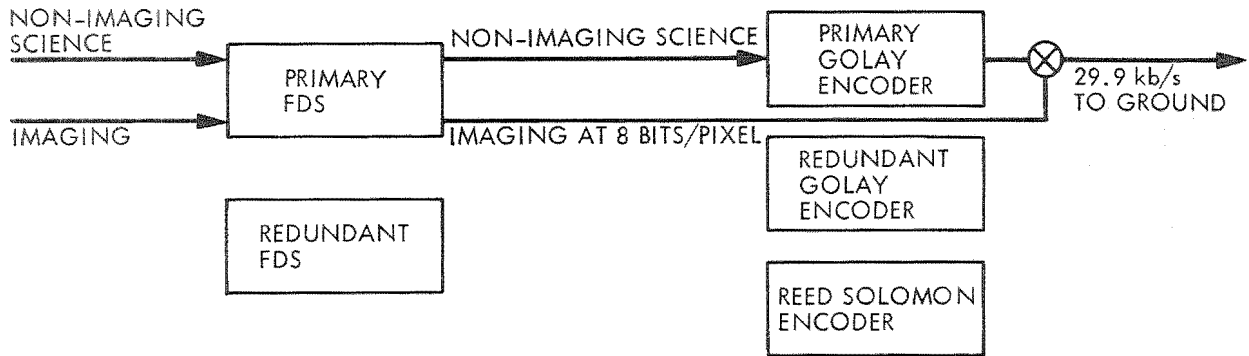
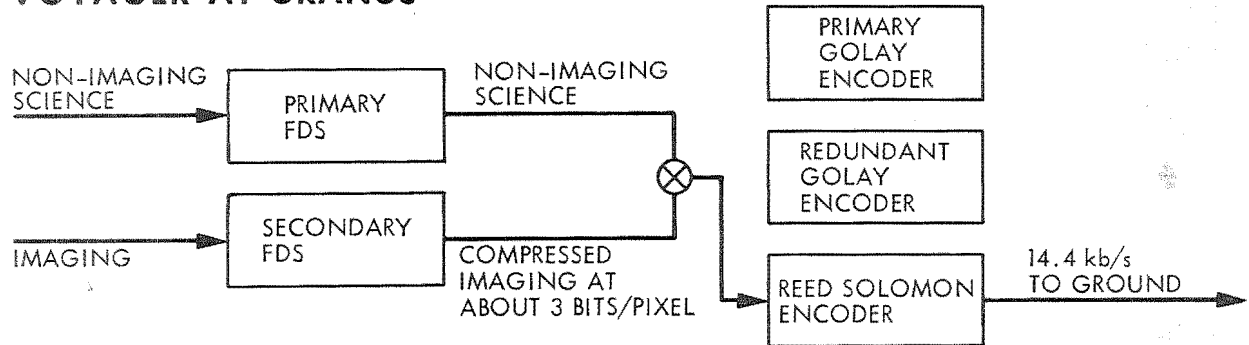
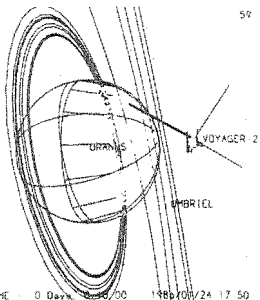

Figure 7-2. As data rates continue to shrink with the increasing communication distances to Uranus and Neptune, Voyager engineers have devised more efficient schemes to process scientific data for transmission to Earth. Image data compression and better encoding to reduce bit error levels have been the solution to this challenge.

tape recorder can add more jiggle to the spacecraft's natural limit cycle motion. To reduce these types of disturbances, the Voyager Flight Team has devised new software that fires the spacecraft thrusters to offset the extra limit cycle motion caused by the tape recorder start-stop impulses. In addition, ways to reduce pulse duration of the spacecraft's tiny attitude control thrusters have been created to provide for a steadier spacecraft and thus decrease the number of blurred television images.



## Diagnosing the Health of the Actuators

The Voyager spacecraft has performed relatively well during the past eight years, with only a few hardware anomalies. For example, 100 minutes after Voyager 2 flew by Saturn closest approach on August 25th of 1981, the scan platform (S/P) stopped during a high rate azimuth slew to a new target due to a temporary seizure in a small actuator gear chain. Since that time, the Voyager Flight Team has devised a strategy to conserve S/P usage and operate the small drive actuators at lower speeds.

In addition, a new method of checking the S/P actuator bearing health, called a Torque Margin Test (TMT), was developed to indirectly measure the amount of friction in the gear chain. This has been accomplished by reprogramming one of the Voyager-2 on-board computers to vary the duration or "width" of the electrical current pulses to the stepper motor that drives the actuator gear train (see Figure 5-5). Even a healthy actuator would fail to move the S/P if the stepper motor pulse width was reduced so low that it could not generate a minimum torque to overcome the normal frictional losses in the system.

The TMT strategy is to use these reduced pulse widths and note whether the S/P slews at reduced or intermittent rates (see Chapter 5). The health of an actuator is gauged by the minimum pulse width required to slew the S/P at the normally expected rate. An increase in this minimum pulse width may indicate degradation due to increased frictional losses from an unhealthy actuator. There are plans to use the TMT during the Uranus encounter period to periodically monitor the actuator performance (see Chapter 6).

## Faster Response From The "Old" Robot

The Voyager engineers have also added a new spacecraft maneuver capability to perform higher-rate commanded roll turns in time-critical periods of the encounter. This capability to roll at 0.3 deg/sec will be used to conserve the worrisome gears by selectively substituting spacecraft roll



maneuvers for S/P azimuth movement, and to prepare for a contingency backup in the remote possibility of another S/P seizure.

The Voyager engineers, knowing that the previous gyro-controlled IMC maximum rates were too slow to track Miranda during the mad dash past Uranus, have done some more reprogramming of the onboard computers to overcome this hurdle. Instead of the former capability (at Saturn) of 70 deg/hour (sum of all three axis rates), Voyager will be able to perform gyro-drift turns as fast as 120 deg/hour for each axis, simultaneously. Because of this, we are looking for some nice sharp images of Miranda.

### Big Changes In The Deep Space Network

Waiting to capture the Voyager data from Uranus will be a new multimillion-dollar Mark IVA configuration of the Deep Space Network. The eight DSN antennas, located in three complexes around the world, are scheduled to be controlled and operated according to an advanced concept of command, communications, and control (C<sup>3</sup>) that uses totally new microprocessors and software distributed over a Local Area Network (LAN).

Each individual antenna and its co-located electronics should be operative unattended except for maintenance. A Complex Monitor Control (CMC) operator configures electronic resources, located in the new Signal Processor Center (SPC) at each complex, for each antenna at the complex. No longer will each antenna individually require a complete set of dedicated electronics to fulfill downlink telemetry, command, ranging, or long-baseline navigation functions.

Another new capability is that faulty equipment should be quickly replaced by the CMC operator if required, thus preserving vital science data during critical moments of the encounter. Like any new large and complex system implementation, the Mark IVA has had its teething problems, but these are scheduled to be resolved by the start of the Uranus encounter.

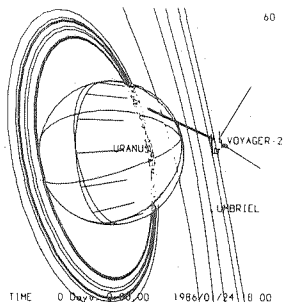

Each flight project like Voyager will be assigned to one or more Link Monitor Control (LMC) console operators. While the CMC operator configures the electronics for each antenna to support a particular schedule, the LMC operator assures the required data processing support for individual spacecraft and controls antenna performance via the LAN.

The "arraying" of antennas is a scheme whereby all antennas are receiving the Voyager signals, and baseband combining is used to achieve a greater signal-to-noise (SNR) ratio. Three LMC operators are required to support Voyager whenever the DSN CDSCC and Parkes antennas are scheduled to be fully arrayed. This new Mark IVA capability to array antennas for additional SNR is, of course, vital to the success of the Voyager encounter at Uranus.

### The Bottom Line

This overview provides some idea why the Voyager Flight Team will win the race to Uranus and beyond; because it, JPL, and NASA are determined to provide, at very little cost to the American people, a manyfold increase in the science knowledge of this giant planet by continually upgrading the capabilities of the amazing flying robot - the Voyager spacecraft.

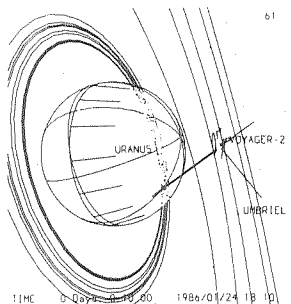

11HC 0-0894-100-00 1986/01/24 1B 1D

The heavens call to you, and circle around you, displaying to you their eternal splendors, and your eyes gaze only to Earth.

Dante

## 8. GEE-WHIZ FACTS

The Voyager mission was approved in May of 1972, received the dedicated efforts of many skilled personnel for over a decade, and has returned more new knowledge about the outer planets than had existed in all of the preceding history of astronomy and planetary science. And the two Voyager machines are still performing like champs.

It must come as no surprise that there are many remarkable, or "gee-whiz", facts associated with the various aspects of the Voyager mission. These tidbits have been summarized in this chapter according to their appropriate categories. Several may seem difficult to believe, but they are all true and accurate.

### Overall Mission

1. The total cost of the Voyager mission from May 1972 through the Uranus encounter is somewhat less than 600 million dollars. This may sound very expensive at first blush, but the fantastic returns are a bargain when we place the costs in the proper perspective. It is important to realize that:
  - (a) on a per-capita basis, this is only 20 cents per U.S. resident per year, or about half the cost of a candy bar each year.
  - (b) relative to the total U.S. federal budget, this is a very tiny fraction, an amount spent in only 80 minutes out of a single workday.

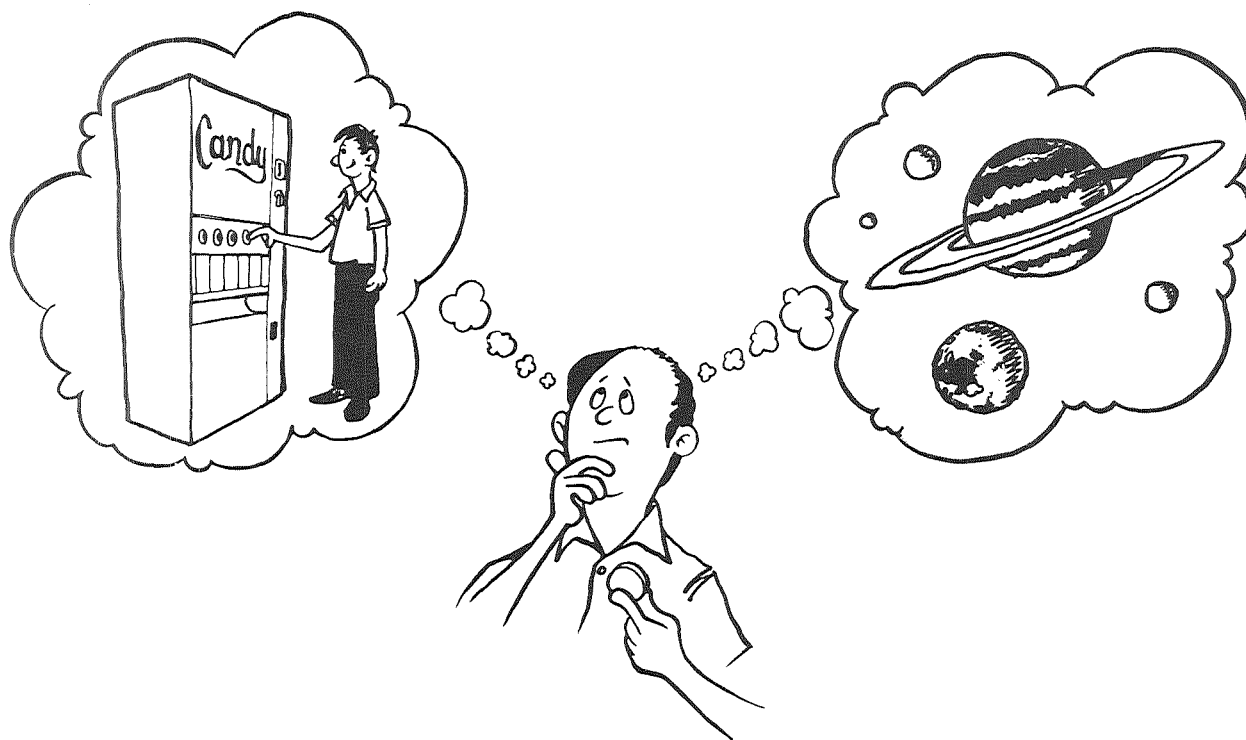
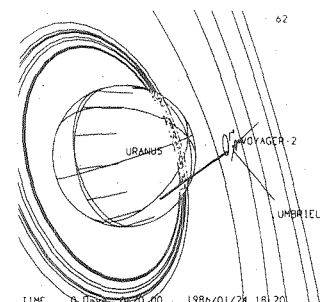

Figure 8-1. On a U.S. resident per-capita basis, Voyager is a remarkable bargain at 20 cents per year.

2. A total of 10,000 person-years will have been devoted to the Voyager project through the Uranus encounter. This is equivalent to one-third the amount of effort needed to complete the great pyramid at Giza to King Cheops.
3. A total of four trillion bits of scientific data will have been returned to Earth by both Voyager spacecraft at the completion of the Uranus encounter. This represents a sufficient number of bits to encode over 5,000 complete sets of the Encyclopedia Britannica.
4. The sensitivity of our deep-space tracking antennas located around the world is truly amazing. Each antenna must capture Voyager information from a signal so weak that the power striking the antenna is only  $10^{-16}$  watts. A modern-day electronic digital



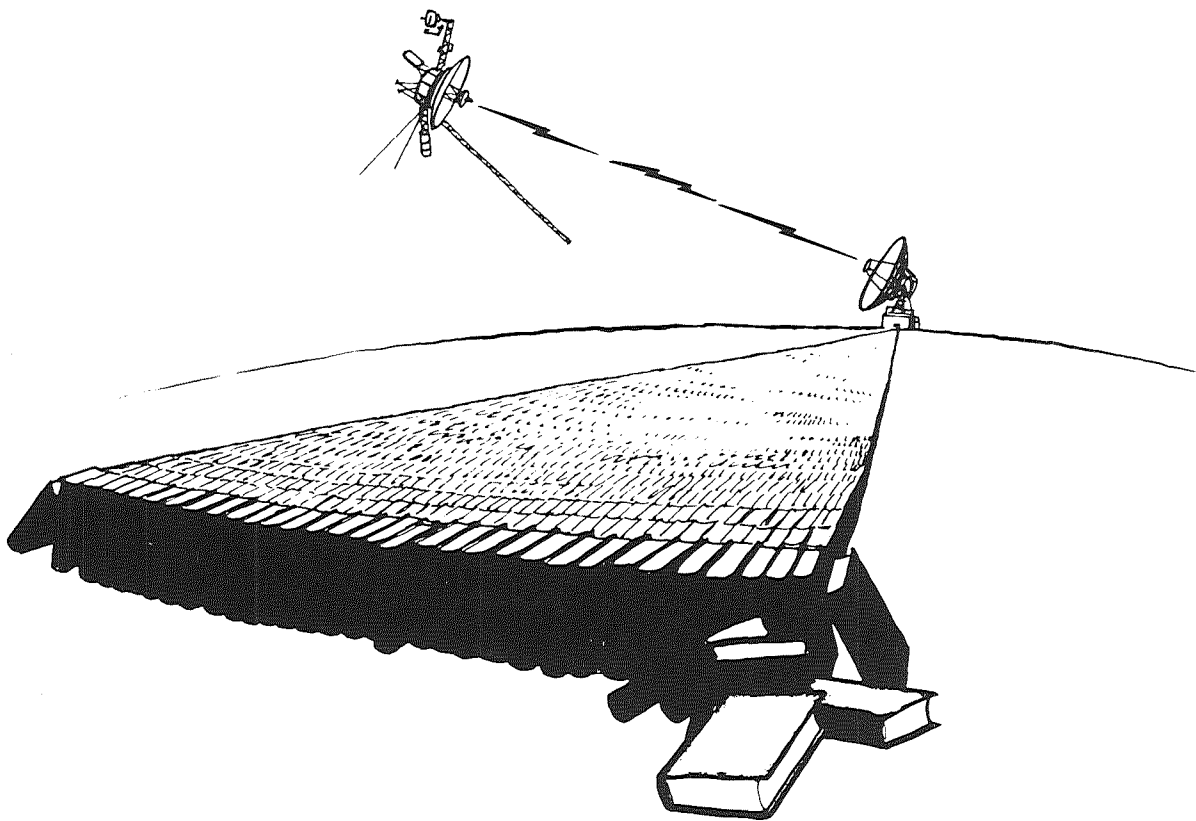

Figure 8-2. Both Voyagers have returned four trillion bits of science data since launch, equivalent in information bits to that needed to encode 5,000 sets of the Encyclopedia Britannica.

watch operates at a power level 100 billion times greater than this feeble level.

### Voyager Spacecraft

1. Each Voyager spacecraft is comprised of 65,000 individual parts. Many of these parts have a large number of "equivalent" parts such as transistors. One computer memory alone contains over one million equivalent parts, with each spacecraft containing five million equivalent parts. Since a color TV set contains about 2500 equivalent parts, each Voyager may have the equivalent electronic circuit complexity of some 2,000 color TV sets.

2. Like the HAL computer aboard the ship Discovery from the famous science fiction story 2001: A Space Odyssey, each Voyager is equipped with autonomous fault protection computer programming. The Voyager system is one of the most sophisticated ever designed for a deep-space probe. There are over a dozen fault protection routines, each capable of covering a multitude of possible failures. The spacecraft can place itself in a safe state in a matter of only seconds or minutes, critical for its survival when round-trip communication times from Earth approach several hours for a spacecraft journeying to the remote outer solar system.
3. Each Voyager had to be specifically designed and protected to withstand the large radiation dosage during the Jupiter swingby. This was accomplished through selection of radiation-hardened parts and shielding of very sensitive parts. Had an unprotected human passenger ridden aboard Voyager 1 during its Jupiter encounter, he would have received a radiation dose equal to one thousand times the lethal level.
4. Each Voyager spacecraft can point the scientific instruments on its scan platform to an accuracy of one-tenth of a degree. This is equivalent to pointing a stick at a phonograph record from a distance of one football-field length.
5. In order to avoid the smearing of Voyager television pictures during the camera shutter and exposure time interval, spacecraft angular rates must be extremely small to hold the cameras as steady as possible. Each spacecraft is so steady that angular rates are 15 times slower than the hour hand on a clock. But even this will not be quite steady enough at Neptune, where light levels are 900 times fainter than those on Earth. Spacecraft engineers are already devising ways to make Voyager 30 times steadier than the hour hand on a clock.
6. The electronics aboard each nearly one-ton Voyager spacecraft can operate on only 400

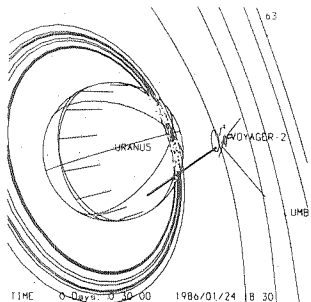

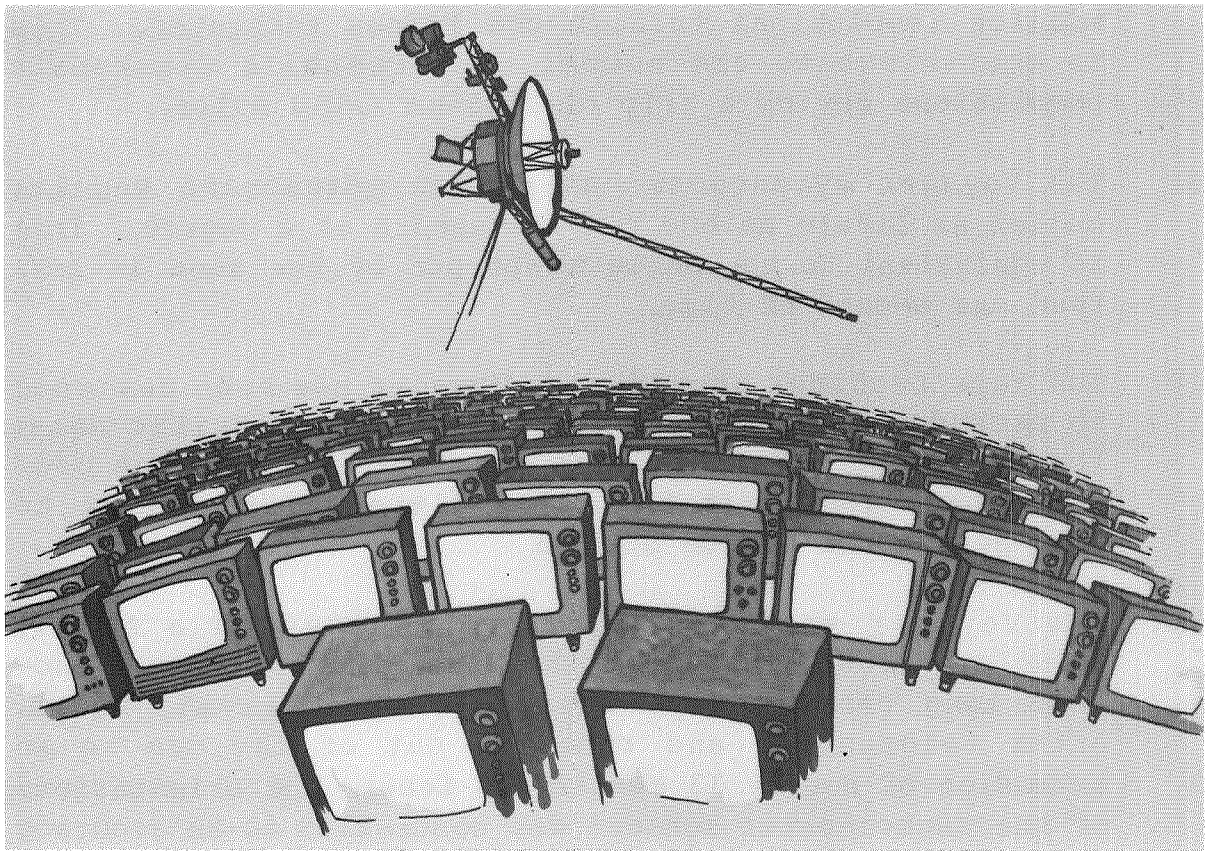

Figure 8-3. Each Voyager spacecraft consists of about 5,000,000 equivalent electronic parts - comparable to some 2,000 color TV sets.

watts of power, or roughly one-fourth that used by an average residential home in the west.

7. A set of small thrusters provides each Voyager with the capability for attitude control and trajectory correction. Each of these tiny rockets has a thrust of only three ounces. In the absence of friction, on a level road, it would take nearly 6 hours to accelerate a large car up to a speed of 48 km/hr (30 mph) using one of these thrusters.
8. Each Voyager scan platform can be moved about two axes of rotation. A thumb-sized motor in the gear train drive assembly (that turns 9,000 revolutions for each single revolution of the scan platform) will have rotated four



million revolutions through the Uranus encounter. This is equivalent to the number of automobile crankshaft revolutions during a trip of 2180 km (1350 miles).

9. The Voyager gyroscopes can detect spacecraft angular motion as little as one ten-thousandth of a degree. This is equivalent to the angle swept out by the moon in less than one second of time.
10. The tape recorder aboard each Voyager has been designed to record and playback a great deal of scientific data. The tape should not begin to wear out until it has been moved back and forth through a distance comparable to that across the United States.
11. The Voyager magnetometers are mounted on a frail, spindly, fiber-glass boom that was unfurled from a two-foot long can shortly after injection leaving Earth. After telescoping and rotating out of the can to an extension of nearly 13 meters (43 feet), the orientations of the magnetometer sensors was controlled to an accuracy better than two degrees.

### Navigation

1. Each Voyager used the enormous gravity field of Jupiter to be hurled on to Saturn, experiencing a Sun-relative speed increase of 35,000 mph. Total energy within the solar system must be conserved, but Jupiter was slowed in its solar orbit by only one foot per trillion years. Additional gravity-assist swingbys of Saturn and Uranus are necessary for Voyager 2 to complete its Grand Tour flight to Neptune.
2. The Voyager delivery accuracy at Uranus of 100 km (62 miles), divided by the trip distance or arc length traveled of 4,954,162,560 km (3,078,373,888 miles), is equivalent to the feat of sinking a 2520-km (1560-mile) golf putt, assuming that the golfer can make a few vernier adjustments while the ball is rolling across this incredibly long green.

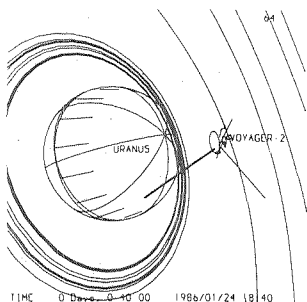

3. Hydrazine, known by the chemical formula of  $N_2H_4$ , is the propellant used whenever Voyager's small thrusters fire to maintain spacecraft attitude or adjust the flight path to the target. Considering how far Voyager has traveled on a relatively small amount of propellant, it has averaged a remarkable 57 million km per liter (134 million miles per gallon). After it flies by Neptune and coasts out of the solar system, this economy will get better and better!

### Science

1. The resolution of each Voyager narrow-angle television camera is sharp enough to read a newspaper headline at a distance of 1 km (.62 miles).
2. Pele, the largest of the volcanos seen on Jupiter's moon Io, is throwing sulfur and sulfur-dioxide products to heights 30 times greater than Mount Everest, and the fallout zone covers an area the size of France. The Mount St. Helens eruption is but a tiny hiccup in comparison (admittedly, Io's surface-level gravity is some six times weaker than that of Earth).
3. The smooth water ice surface of Jupiter's moon Europa may hide an ocean beneath, but many scientists believe any past oceans have turned to slush or ice. In 2010: Odyssey Two, Arthur C. Clarke wraps his story around the possibility of life developing within the oceans of Europa.
4. The rings of Saturn appeared to the Voyagers as a dazzling necklace of 10,000 strands. Millions of ice particles and car-sized bergs race along each of the million-kilometer-long strands, with the traffic flow orchestrated by the combined gravitational tugs of Saturn and a retinue of moons and moonlets.
5. Saturn's largest moon Titan was seen as a strange world with its dense atmosphere and variety of hydrocarbons that slowly fall upon seas of ethane and methane. To

some scientists, Titan, with its principally nitrogen atmosphere, seemed like a small Earth whose evolution had long ago been halted by the arrival of its ice age, perhaps deep-freezing a few organic relics beneath its present surface.

### The Future

1. The solar system does not end at the orbit of Pluto, the ninth planet. Nor does it end at the heliopause boundary, where the solar wind can no longer continue to expand outward against the interstellar wind. It extends over a thousand times farther out where a swarm of small cometary nuclei are barely held in orbit by the Sun's feeble gravity. The two Voyager robots will race past the orbit of Pluto by the end of this decade. But even at speeds of over 35,000 mph, it will take nearly 20,000 years for the Voyagers to reach the comet swarm. By this time, they will have traveled a distance of one light-year, or nearly 25% of the distance to Proxima Centauri, the nearest star.
2. Barring any serious spacecraft subsystem failures, the Voyagers may survive until the early twenty-first century, when diminishing power and hydrazine levels may prevent further operation. Were it not for these dwindling consumables and the possibility of losing lock on the faint Sun, our tracking antennas could continue to "talk" with the Voyagers for another century or two! Refer to Table 11-1.
3. Refer to Chapter 11 for some amazing facts about the flights of the two Voyager spacecraft past other stars several millennia into the future.

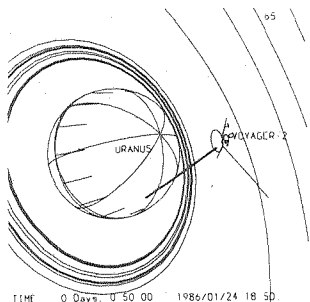

Man belongs wherever he wants to go.

Wernher Von Braun

## 9. HOW FAR AND HOW FAST

Prepare yourself to enter into a new realm of distance, speed and time as measured by the flights of the Voyager spacecraft. No longer can you think in terms of an automobile trip, say from Los Angeles to New York, a distance of 2500 miles with a driving time of 50 hours at an average speed of 50 miles per hour (mph). Also, you'll need to become familiar with metric units, in which case the same road trip becomes 4030 kilometers at a speed of 80 kilometers per hour. More importantly though, you must vastly expand the distance dimensions used to measure the flights of spacecraft that have trip durations of many years.

Because of the large distances between planetary bodies, it is often convenient to express these distances in terms of Astronomical Units (AU), where 1 AU is defined as the mean distance of the Earth from the Sun and equals 149,600,000 kilometers or 93 million miles. In order to put this distance into proper perspective, consider the fact that it would take you 212 years of non-stop driving at 80km/hr (50 mph) to travel just 1 AU. Even a Mach 2.5 supersonic transport would take almost 6 years non-stop.

### The Grand Tour

Figure 1-4 of the Introduction shows the paths followed by the twin Voyager spacecraft as they spiral outward from their Earth launch points in 1977. Both Voyagers have had close encounters with Jupiter and Saturn, but only Voyager 2 will continue on to Uranus and Neptune. This occurs because of two reasons. Firstly, the unique "Grand Tour" alignment of Earth, Jupiter, Saturn, Uranus, and Neptune occurs for only three consecutive launch years out of every 177 years, and 1977 was one of those golden celestial moments. And secondly,

Voyager 1 arrived at Saturn first and successfully scanned the top-priority moon Titan, freeing the late-arriving Voyager 2 from the Titan obligation, thereby allowing it to be targeted on to Uranus.

Figure 9-1 projects the paths of the Voyager spacecraft until the year 2000 A.D. It also includes the paths of the Pioneer 10 and 11 spacecraft that were launched in 1972 and 1973. These four spacecraft are the very first that will escape the gravity of our solar system as they continue their unending journeys into the Milky Way galaxy at speeds of "only" a few AU per year. For Voyager 1, the 3.5 AU/yr departure speed is 60,000 km/hr (37,000 mph), while for Voyager 2 the departure speed is 58,000 km/hr (36,000 mph). Although this may seem fast by terrestrial standards, you'll soon realize that it is excruciatingly slow by interstellar standards.

Figure 9-2 presents a three dimensional view of the Voyager and Pioneer spacecraft trajectories. This oblique view provides a better perspective, and it also illustrates that the Pioneer 10 and 11 spacecraft are departing our solar system near the ecliptic plane, albeit in opposite directions. Meanwhile, in order to encounter Titan prior to Saturn closest approach, Voyager 1 was deflected above the ecliptic plane at an angle of about 35 degrees.

After the Uranus and Neptune encounters, Voyager 2 will depart beneath the ecliptic plane at an angle of approximately 47 degrees. This latter departure condition results from Project plans to obtain a 10,000 km (6200 mi) flyby of the satellite Triton after skimming over the north pole of Neptune at an altitude of just 3500 km (2200 mi).

### The Great Escape

From Figures 9-1 and 9-2, it can be seen that Pioneer 10 has a headstart on the other spacecraft, having already passed the orbit of Neptune at a solar radius of 30 AU. However, Voyager 1 will be first to cross over Pluto's eccentric inclined orbit in 1988 at a

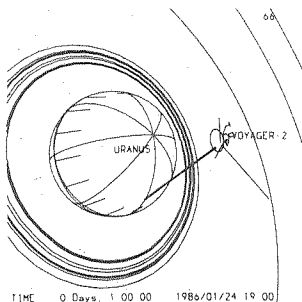

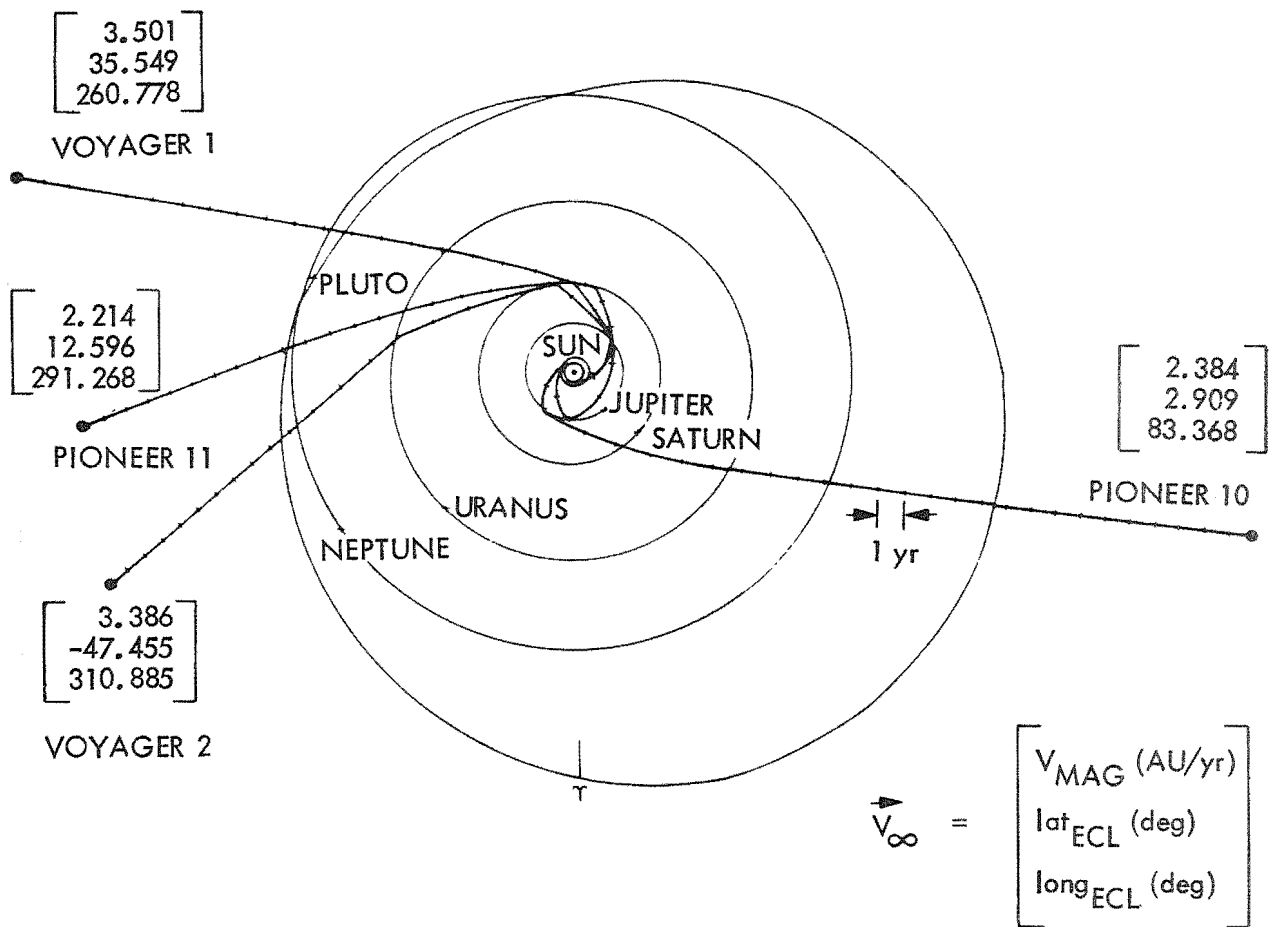

Figure 9-1. This is an ecliptic plane projection of the Voyager and Pioneer flight paths. All will escape from the solar system, but the faster-moving Voyagers will win the race. Planet and spacecraft positions are shown in 2000 A.D.

distance of about 29 AU, when Pluto's orbit is inside that of Neptune's. Pioneer 11 will cross over the Uranian orbit slightly before Voyager 2's encounter, but Voyager 2 will be the first to reach (and encounter) Neptune. Because of the significant speed advantage of the two Voyager spacecraft, they will gradually outdistance the Pioneers in the twenty-first Century.

A future (very challenging) goal for Voyager is to reach the Heliopause boundary (see Figure 11-5) with operational spacecraft at a distance of 50-150 AU.

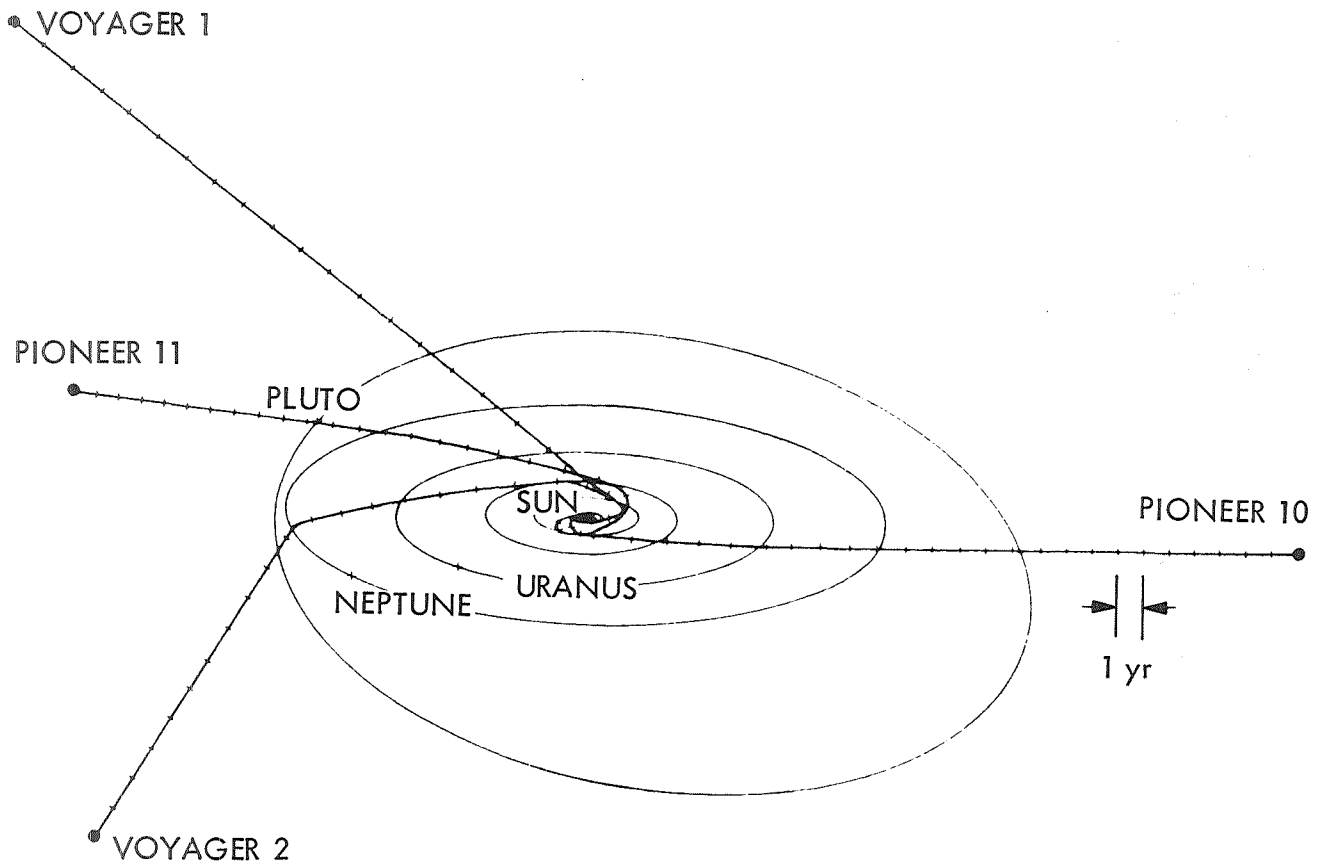
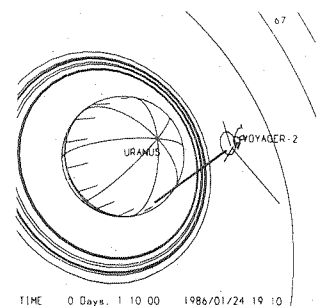

Figure 9-2. Gravity assist has deflected the two Voyagers out of the ecliptic plane. Flying "under" Saturn, Voyager 1 was lofted at a  $35^\circ$  angle above the ecliptic. Flying "over" Neptune, Voyager 2 will be flung beneath the ecliptic at an angle of  $47^\circ$ . Planet and spacecraft positions are shown in 2000 A.D.

However, minimum spacecraft power requirements appear unattainable after the year 2015, when Voyagers 1 and 2 will be at distances from the Sun of 130 AU and 110 AU, respectively. Far beyond the heliopause, at the very edge of our solar system, the Voyagers will fly through Oort's cloud of cometary nuclei. However, at the cloud's great distance of 65,000 AU (about 1 light-year), the Voyagers will not arrive for another 20,000 years.



## Voyager 2 At Uranus

Relative to an observer on Uranus, the Voyager-2 spacecraft is approaching from generally the Sun's direction at a speed of about 53,000 km/hr (33,000 mph). Meanwhile, Uranus is orbiting the Sun at a mean radius of 19 AU with a speed in excess of 24,000 km/hr (15,000 mph), but the tilted giant still takes 84 years to complete just one orbit. By the Uranus closest approach time of 18:00 GMT on January 24, 1986, the spacecraft will have travelled a distance of more than 33 AU along its heliocentric path since leaving Earth nearly 8 1/2 years ago.

Relative to an observer on the spacecraft, the Uranian system with its 5 known satellites and 9 known rings, resembles an enormous bulls-eye target nearly 1,200,000 km (750,000 mi) across as shown by Figure 9-3. This expanse is over three times the Earth-Moon distance of 380,000 km (240,000 mi). Uranus itself is truly a giant planet with a diameter of 52,400 km (32,600 mi) when compared to Earth at 12,800 km (7,900 mi). This represents a diametric ratio of 4.1 and a volumetric ratio of 69 times that of Earth. It is significant to note that the path of Voyager 2 must pass slightly within the orbit of Miranda in order to provide the proper gravitational deflection to continue on to Neptune. The exact timing of 18:00 GMT was selected to optimize the geometry for Miranda coverage using image motion compensation.

Another interesting view of the Uranian encounter is shown by Figure 9-4 as you look down upon the passage of the spacecraft through the satellite orbital plane, followed by both Earth and solar occultations by Uranus and its rings. The radial distance of Uranus closest approach is 107,000 km (67,000 mi) or about twice its diameter. At the time of closest approach, a radio signal being sent from the spacecraft to Earth will take 2 hours and 45 minutes to reach Earth. This means you will see the data transmitted at the time of closest approach back on Earth at 20:45 GMT or 12:45 PST Friday, January 24, 1986. The most intense time for media coverage will run from about 12 hours before to 36 hours after (allowing for recorder playbacks) this time.



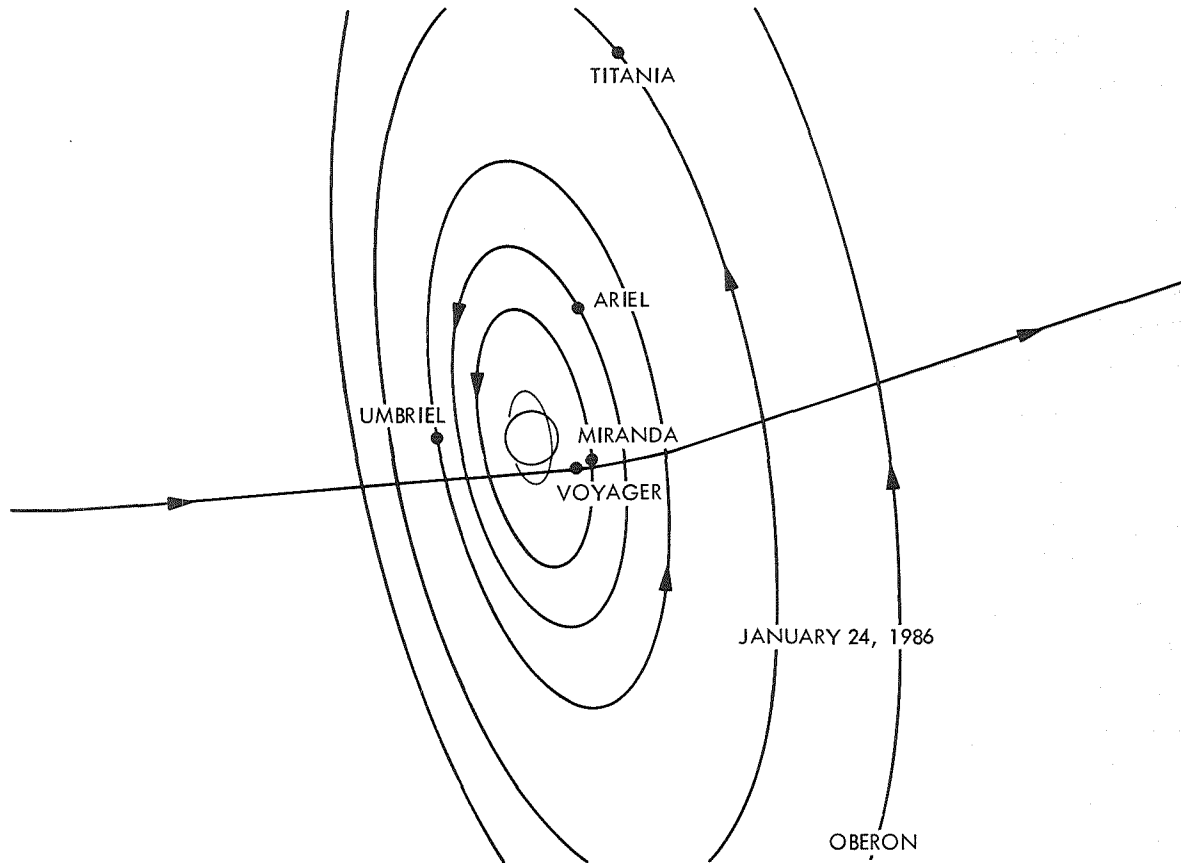
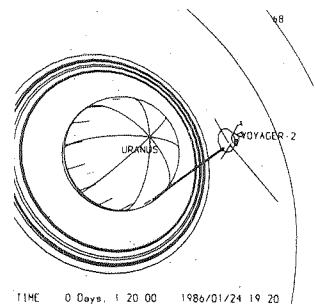

Figure 9-3. With Uranus tilted on its axis, the orbital paths of its five known satellites resemble the rings of an immense archery target as Voyager 2 approaches the southern sunlit hemisphere on January 24, 1986. Fifty-five minutes before Uranus closest approach, the spacecraft will pass Miranda at a range of 29,000 km (18,000 mi). Voyager-2 and satellite positions are shown at the instant of spacecraft closest approach to Uranus.

The satellites of Uranus are quite small in size compared to the Galilean satellites at Jupiter, Saturn's Titan, Neptune's Triton, and our own Moon. Even Oberon, the largest of the Uranian satellites, has a diameter less than half that of the Moon's 3500 km



VOYAGER 2 AT URANUS

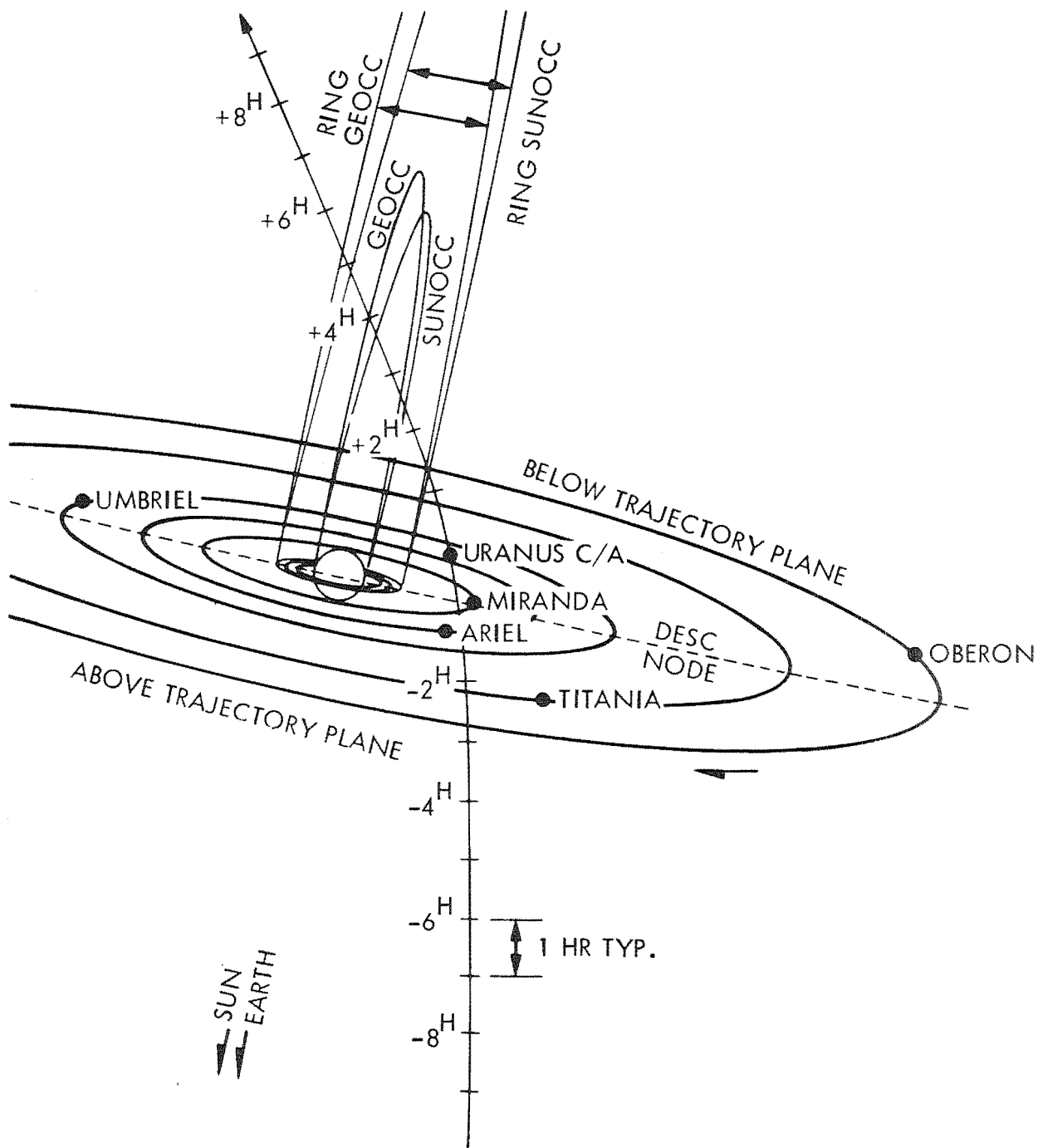

Figure 9-4. We are looking down from above the Uranus system in a direction perpendicular to the plane of the Voyager-2 trajectory. Most of the "action" takes place within a few hours about closest approach.

(2200 mi). These satellites orbit the planet at speeds ranging from 11,000 km/hr (7,000 mph) for Oberon, the outermost satellite, to 24,000 km/hr (15,000 mph) for Miranda, the innermost satellite. Their orbital periods range from 1.4 days for Miranda to 13.5 days for Oberon.

### Key Events, Distances, and Speeds

Table 9-1 provides a list of key events during the Voyager-2 approach and encounter with Uranus. For those priority-1 science "links" that have been included, the times shown refer to the link start times.

Finally, many outside news people like to know spacecraft distance (how far) and speed (how fast) at almost any time the urge strikes to want these facts. For "8-place precision", the Voyager Navigation Team must be consulted, and, of course, the requester must specify the relative-to body for distance or speed.

However, for those who would be content with approximate values, they may find Figures 9-5 and 9-6 quite useful. After all, in the time it takes to say "Voyager 2 is two billion, eight hundred and forty-one million, three hundred and twelve thousand, two hundred and fifty-three kilometers from Earth", the spacecraft has moved 160 km (100 mi) and Earth has moved 300 km (185 mi)! And, if the listener wants to repeat back the number for verification, well ... you get the idea.

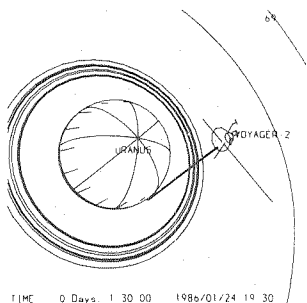

Table 9-1  
 Voyager-2 Key Events  
 For Uranus Encounter Period

Event # Description	Uranus-Relative Spacecraft Time	Earth-Received Pacific Standard Time	Distance From Body (km/mi in 1,000's)
Observatory Phase	U-81 <sup>d</sup> 05 <sup>h</sup> 18 <sup>m</sup>	11/04/85, 07:27 AM	103,542/64,340
Solar Conjunction	U-45 <sup>d</sup> 16 <sup>h</sup> 56 <sup>m</sup>	12/09/85, 07:49 PM	58,335/36,249
TCMB13	U-32 <sup>d</sup> 00 <sup>h</sup> 44 <sup>m</sup>	12/23/85, 12:01 PM	40,929/25,433
RPDISK	U-09 <sup>d</sup> 15 <sup>h</sup> 25 <sup>m</sup>	01/14/86, 09:20 PM	12,365/7,863
TCMB14	U-05 <sup>d</sup> 07 <sup>h</sup> 34 <sup>m</sup>	01/19/86, 05:11 AM	6,888/4,280
Last TMT	U-04 <sup>d</sup> 09 <sup>h</sup> 50 <sup>m</sup>	01/20/86, 02:10 PM	5,710/3,549
VRMOS1	U-00 <sup>d</sup> 23 <sup>h</sup> 05 <sup>m</sup>	01/23/86, 01:40 PM	1,277/794
VUCOLOR	U-00 <sup>d</sup> 17 <sup>h</sup> 43 <sup>m</sup>	01/23/86, 07:02 PM	995/618
F.LSTEP	U-00 <sup>d</sup> 13 <sup>h</sup> 28 <sup>m</sup>	01/23/86, 11:17 PM	764/475
PRSIGSAG	U-00 <sup>d</sup> 13 <sup>h</sup> 19 <sup>m</sup>	01/23/86, 11:26 PM	756/470
VOBEST (R)	U-00 <sup>d</sup> 09 <sup>h</sup> 12 <sup>m</sup>	01/24/86, 06:48 AM	534/332
20 Uranus Radii	U-00 <sup>d</sup> 09 <sup>h</sup> 01 <sup>m</sup>	01/24/86, 03:44 AM	524/326
VTCOLOR (R)	U-00 <sup>d</sup> 08 <sup>h</sup> 51 <sup>m</sup>	01/24/86, 07:07 PM	515/320
UPAUMOS	U-00 <sup>d</sup> 08 <sup>h</sup> 20 <sup>m</sup>	01/24/86, 04:25 AM	487/303
PPVPHOT	U-00 <sup>d</sup> 06 <sup>h</sup> 56 <sup>m</sup>	01/24/86, 05:49 AM	411/255
VUBEST (R)	U-00 <sup>d</sup> 06 <sup>h</sup> 15 <sup>m</sup>	01/25/86, 04:13 PM	375/233
RPOCCPT	U-00 <sup>d</sup> 05 <sup>h</sup> 34 <sup>m</sup>	01/24/86, 07:11 AM	312/194
10 Uranus Radii	U-00 <sup>d</sup> 04 <sup>h</sup> 07 <sup>m</sup>	01/24/86, 08:38 AM	262/163
VTBEST (R)	U-00 <sup>d</sup> 03 <sup>h</sup> 44 <sup>m</sup>	01/25/86, 04:48 PM	242/150
VACOLOR (R)	U-00 <sup>d</sup> 03 <sup>h</sup> 24 <sup>m</sup>	01/25/86, 10:58 AM	225/140
ROLL	U-00 <sup>d</sup> 03 <sup>h</sup> 15 <sup>m</sup>	01/24/86, 09:30 AM	218/135
VMCOLOR (R)	U-00 <sup>d</sup> 02 <sup>h</sup> 59 <sup>m</sup>	01/25/86, 11:18 AM	204/127
Titania C/A	U-00 <sup>d</sup> 02 <sup>h</sup> 49 <sup>m</sup>	01/24/86, 09:56 AM	365/227
PPVPHOT	U-00 <sup>d</sup> 02 <sup>h</sup> 46 <sup>m</sup>	01/24/86, 09:59 AM	194/121
VABEST (R)	U-00 <sup>d</sup> 01 <sup>h</sup> 51 <sup>m</sup>	01/25/86, 12:14 PM	153/95
Oberon C/A	U-00 <sup>d</sup> 01 <sup>h</sup> 47 <sup>m</sup>	01/24/86, 10:58 AM	471/293
Ariel C/A	U-00 <sup>d</sup> 01 <sup>h</sup> 38 <sup>m</sup>	01/24/86, 11:07 AM	127/79
VMBEST (R)	U-00 <sup>d</sup> 01 <sup>h</sup> 23 <sup>m</sup>	01/25/86, 01:31 PM	135/84
Miranda C/A	U-00 <sup>d</sup> 00 <sup>h</sup> 55 <sup>m</sup>	01/24/86, 11:50 AM	29/18
VRKING (R)	U-00 <sup>d</sup> 00 <sup>h</sup> 52 <sup>m</sup>	01/25/86, 03:58 PM	119/74
Descending Node	U-00 <sup>d</sup> 00 <sup>h</sup> 43 <sup>m</sup>	01/24/86, 12:01 PM	115/71
UPGPEGIN	U-00 <sup>d</sup> 00 <sup>h</sup> 42 <sup>m</sup>	01/24/86, 12:03 PM	115/71
PPVPHOT	U-00 <sup>d</sup> 00 <sup>h</sup> 22 <sup>m</sup>	01/24/86, 12:23 PM	110/68
Uranus C/A	U-00 <sup>d</sup> 00 <sup>h</sup> 00 <sup>m</sup>	01/24/86, 12:45 PM	107/66
UPGPEGEG	U+00 <sup>d</sup> 00 <sup>h</sup> 14 <sup>m</sup>	01/24/86, 12:59 PM	109/68
PRBETPER Ingress	U+00 <sup>d</sup> 00 <sup>h</sup> 26 <sup>m</sup>	01/24/86, 01:11 PM	110/68
PRBETPER Egress (R)	U+00 <sup>d</sup> 01 <sup>h</sup> 22 <sup>m</sup>	01/27/86, 10:15 AM	135/84
XROCC	U+00 <sup>d</sup> 01 <sup>h</sup> 24 <sup>m</sup>	01/24/86, 02:09 PM	136/85
ε Ring Earth Occ In	U+00 <sup>d</sup> 01 <sup>h</sup> 44 <sup>m</sup>	01/24/86, 02:29 PM	148/92
6 Ring Earth Occ In	U+00 <sup>d</sup> 02 <sup>h</sup> 03 <sup>m</sup>	01/24/86, 02:48 PM	161/100

Table 9-1  
 Voyager-2 Key Events  
 For Uranus Encounter Period  
 -continued -

Event * Description	Uranus-Relative Spacecraft Time	Earth-Received Pacific Standard Time	Distance From Body (km/mi in 1,000's)
UPHOCC (R)	U+00 <sup>d</sup> 02 <sup>h</sup> 06 <sup>m</sup>	01/27/86, 10:45 AM	164/102
XPOCC	U+00 <sup>d</sup> 02 <sup>h</sup> 12 <sup>m</sup>	01/24/86, 02:57 PM	168/104
Umbra Ingress	U+00 <sup>d</sup> 02 <sup>h</sup> 25 <sup>m</sup>	01/24/86, 03:10 PM	178/111
Earth Occ. Ingress	U+00 <sup>d</sup> 02 <sup>h</sup> 36 <sup>m</sup>	01/24/86, 03:21 PM	186/116
Umbriel C/A	U+00 <sup>d</sup> 02 <sup>h</sup> 53 <sup>m</sup>	01/24/86, 03:38 PM	325/202
VRHIPHAS (R)	U+00 <sup>d</sup> 03 <sup>h</sup> 12 <sup>m</sup>	01/26/86, 12:45 PM	235/146
Umbra Egress	U+00 <sup>d</sup> 03 <sup>h</sup> 44 <sup>m</sup>	01/24/86, 04:29 PM	243/151
Earth Occ. Egress	U+00 <sup>d</sup> 04 <sup>h</sup> 02 <sup>m</sup>	01/24/86, 04:47 PM	258/160
10 Uranus Radii	U+00 <sup>d</sup> 04 <sup>h</sup> 07 <sup>m</sup>	01/24/86, 04:52 PM	262/163
6 Ring Earth Occ Eg	U+00 <sup>d</sup> 04 <sup>h</sup> 35 <sup>m</sup>	01/24/86, 05:20 PM	286/178
ε Ring Earth Occ Eg	U+00 <sup>d</sup> 04 <sup>h</sup> 54 <sup>m</sup>	01/24/86, 05:39 PM	303/188
20 Uranus Radii	U+00 <sup>d</sup> 09 <sup>h</sup> 01 <sup>m</sup>	01/24/86, 09:46 PM	524/326
UPAURMOS	U+00 <sup>d</sup> 09 <sup>h</sup> 42 <sup>m</sup>	01/24/86, 10:27 PM	56 1/349
PPVPHOT	U+00 <sup>d</sup> 11 <sup>h</sup> 27 <sup>m</sup>	01/25/86, 00:12 AM	682/424
VRMOS2	U+00 <sup>d</sup> 18 <sup>h</sup> 37 <sup>m</sup>	01/25/86, 07:22 AM	1,040/646
RPDISK	U+08 <sup>d</sup> 21 <sup>h</sup> 31 <sup>m</sup>	02/02/86, 10:16 AM	11,460/7,121
TCMB15	U+20 <sup>d</sup> 21 <sup>h</sup> 28 <sup>m</sup>	02/14/86, 10:13 AM	26,731/16,610
End Post Enc.Phase	U+31 <sup>d</sup> 19 <sup>h</sup> 42 <sup>m</sup>	02/25/86, 08:27 AM	40,717/25,301

\* Start times are shown for non-instantaneous events listed. Distances are always relative to Uranus, except for satellite closest approach (C/A) events.

R Indicates data are recorded on spacecraft: Earth-received time indicates ground receipt of playback data.

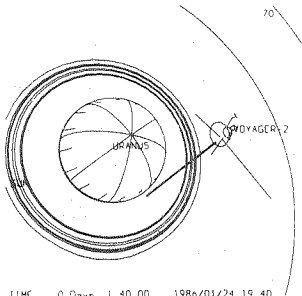

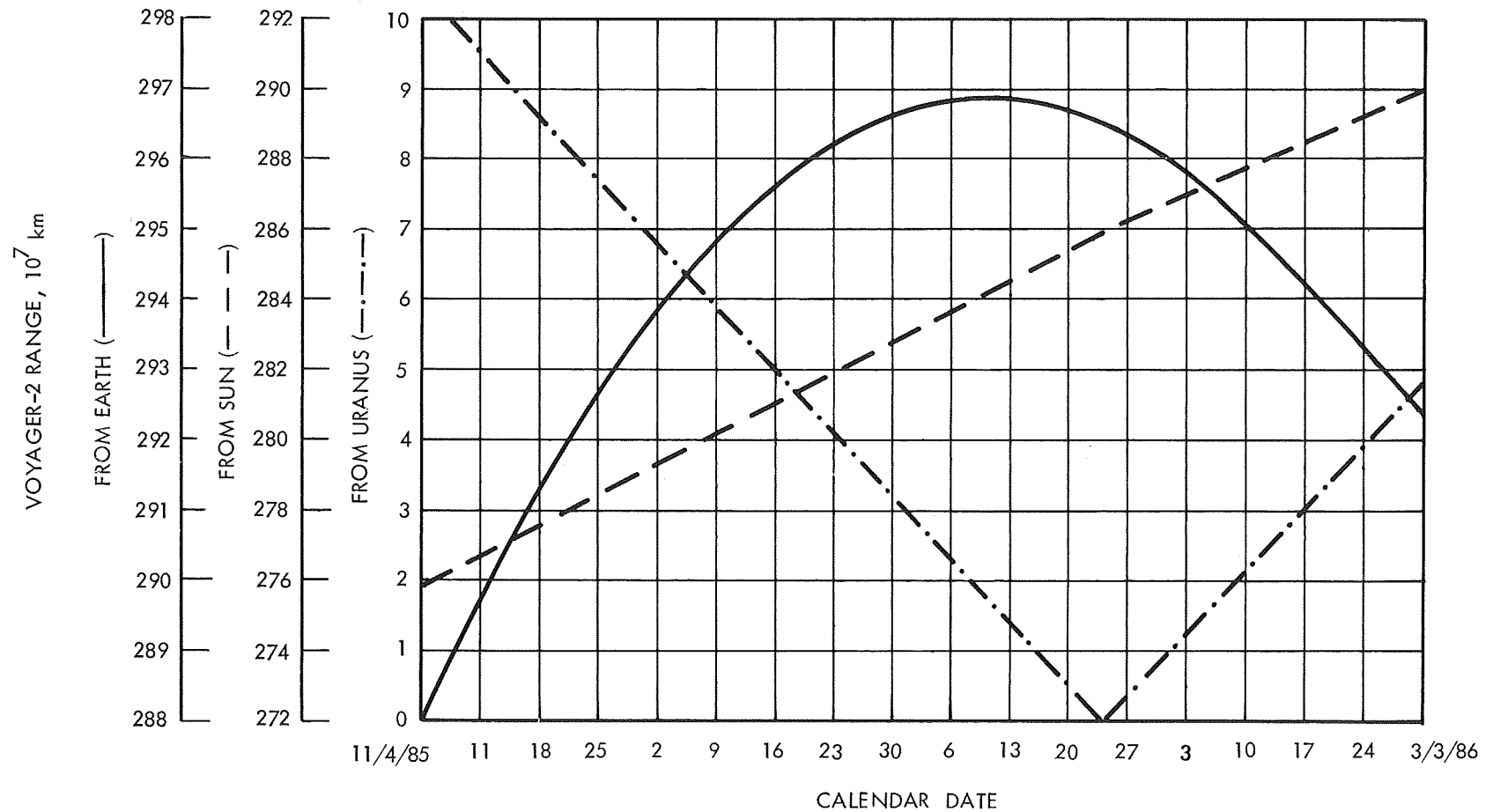
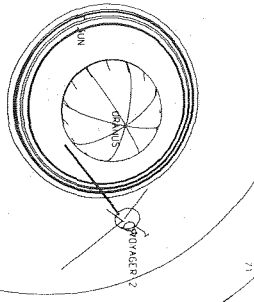

Figure 9-5. These ranges should be accurate enough for most information purposes. In fact, in the time it takes to quote an "eight-place" figure, all of the bodies have moved a few hundred kilometers.



124

VOYAGER-2 SPEED, km/sec

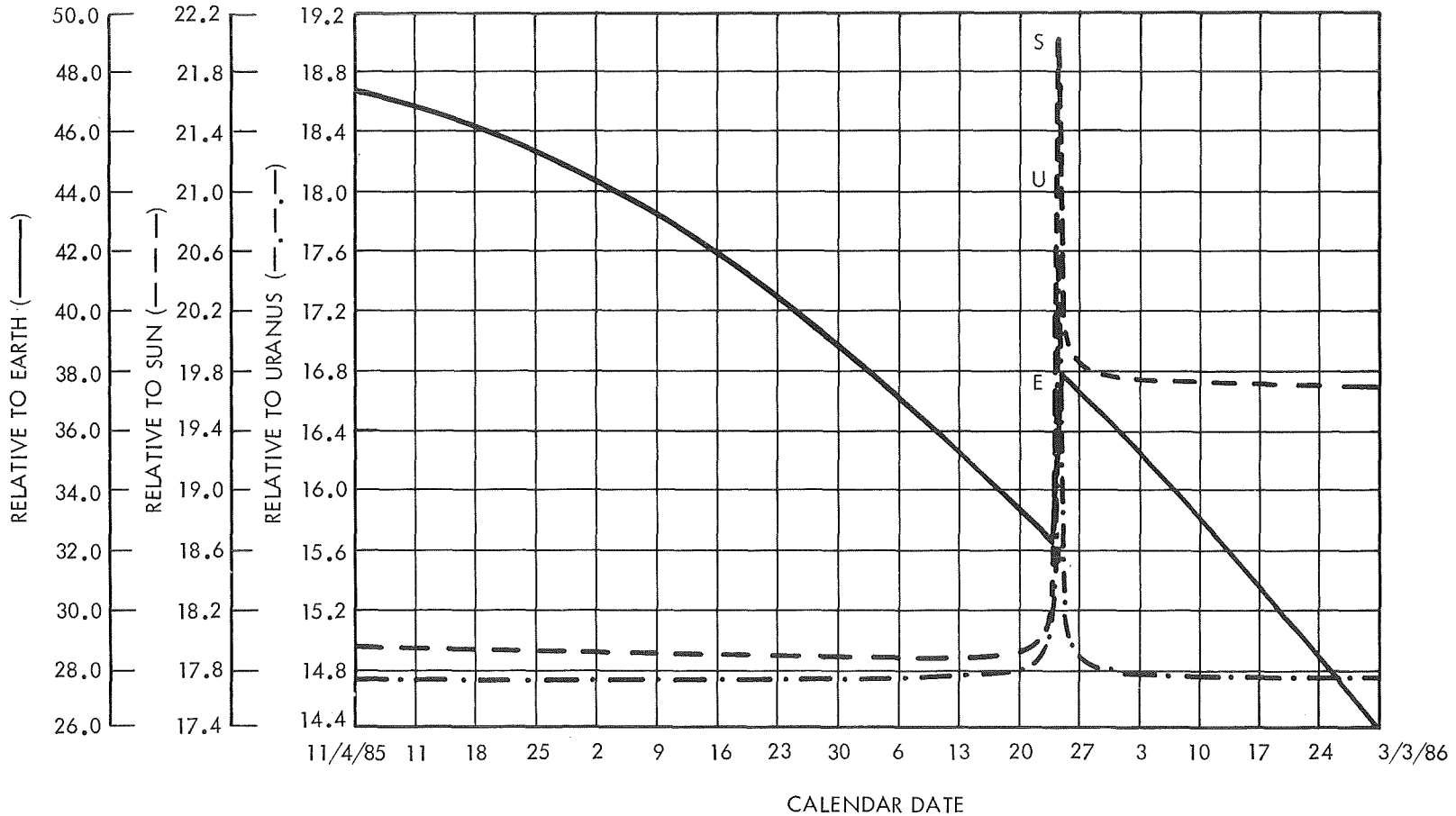

Figure 9-6. Truly, everything is relative. When you ask how fast Voyager 2 is moving, you must specify "relative to what". Remember that 1 km/sec is roughly 2230 mph!

Look here, upon this picture,  
and on this ... the front of Jove himself.

Shakespeare

## 10. JUPITER AND SATURN HIGHLIGHTS

You have been traveling for over 8 years. You have seen many of the most amazing sights accessible to man. You are about to go where no man has ever gone before, and see things that no man has ever seen before. Before undertaking the next part of your journey, you stop to consider what you have accomplished so far.

### Jupiter

After a year and a half of cruise following the twin launches, you were ready for your first two (of six) planetary encounters, a pair of observing periods that lasted about 8 months. The twin encounters started in January of 1979. Voyager 1's closest approach to Jupiter occurred on March 5th, and Voyager 2's on July 9th. The twin encounters ended in August of 1979. During that time, you showed mankind that gargantuan Jupiter is a real place, with colors and characteristics that make it unique among all that is known.

- (1) It was known from previous explorers that Jupiter (Figure 10-1) is a giant ball of gas, composed primarily of hydrogen and helium, with small amounts of methane, ammonia, phosphorus, water vapor, and various hydrocarbons. Voyager found that helium comprises 11% of the volume (20% of the mass) of the outer atmosphere of Jupiter. This is very close to the helium abundance that we measure in our sun.
- (2) It had been known from Earth-based observations that the outer atmosphere appears in an alternating pattern of belts and zones. Zones are generally lighter in color, higher in altitude, colder, and dominated by



frozen ammonia ice crystals. Belts are generally darker in color, lower in altitude, and warmer. The location and dimensions of the belts and zones change with time. The belt and zone structure extends from the equator to at least 60 degrees latitude in both hemispheres.

- (3) There is a very stable system of winds in the outer atmosphere that do not shift in location with time. Thus, at times, wind patterns and belts and/or zones will align with each other. At other times, there will be little or no correlation.
- (4) The highest wind speed is about 150 meters/second (335 miles/hour) and occurs at the equator. The wind speeds generally decrease in each jet stream as one goes higher in latitude. In both hemispheres, above the mid-latitudes, adjacent jet streams flow in opposite directions, i.e., easterly then westerly.
- (5) The Great Red Spot, a raging storm about twice the size of the Earth and at least 400 years old, rotates in an anti-cyclonic direction (with a period of 6 days), indicating that it is a high pressure region (rather than a low pressure region as with Earth's cyclones). Other smaller storm-like structures within the atmosphere (including the so-called "white ovals") rotate anti-cyclonically, indicating that they are also high pressure regions. Some of the smaller storms interact with the Great Red Spot and with each other.
- (6) There is cloud-top lightning globally, as well as accompanying high intensity radio-frequency "whistlers". There are massive auroral emissions in the high latitudes, and a strong UV emission over the entire disk of the planet (indicating a hot thermo-sphere).
- (7) Scientists are baffled by the coloring agent in the Great Red Spot. Elemental sulfur, phosphorus, germanium oxide, and various carbon compounds have been proposed, but it is not yet known for certain what is responsible for the brilliant reds that give

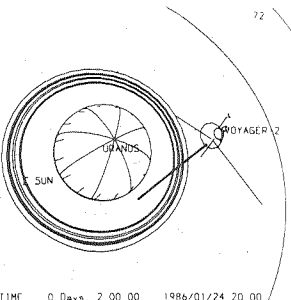

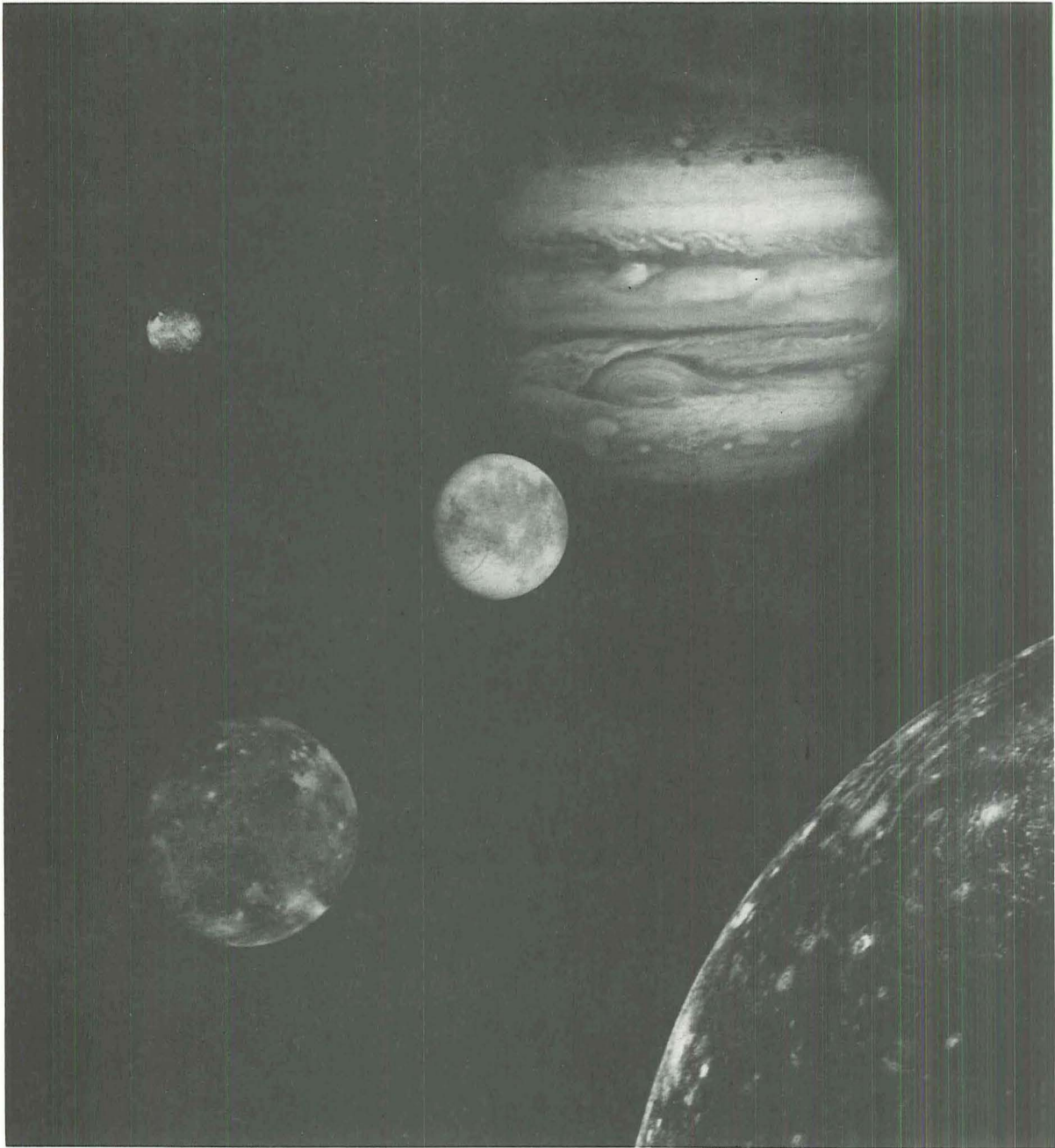

Figure 10-1. The Great Red Spot "Eye" of Jupiter gazes at us in this collage of Voyager images that includes the four Galilean satellites.

the Great Red Spot its name. For that matter, the coloring agents and mechanism for the entire outer atmosphere are not well understood.

- (8) Jupiter temperatures range from -113 degrees C (-170 degrees F) at the top of the clouds, to about -108 degrees C (-161 degrees F) where the atmospheric pressure equals that of Earth, to an estimated 25,000 degrees C (45,000 degrees F) under the enormous pressure at the planet's center. Jupiter maintains both poles at the same temperature as its equator, at least in the outer atmosphere.

### Jupiter's rings

- (1) Jupiter has a small set of previously unobserved very thin rings (Figure 10-2). The rings, at their thickest point, are no more than 30 kilometers (19 miles) thick. Typical ring particle size is only a few micrometers, producing strong forward scattering of light, making the rings impossible to see from Earth.
- (2) The ring particles are not shiny in back-scattered light like the rings of Saturn, implying a local source for ring material (perhaps Amalthea, Adrastea, Metis and/or Thebe). The very fine ring material extends from about  $2.54 R_J$  down to the outer atmosphere fringes.

### Jupiter's Moons

- (1) The satellite Io had no less than 9 volcanoes active sometime during the Voyager encounter (Figure 10-3). Io is the only body other than Earth positively known (Venus is strongly suspected) to have active volcanoes. 6 of the 9 volcanoes were active over the 4 months between the Voyager 1 and 2 encounters. Plumes from the volcanoes were observed as high as 300 kilometers (190 miles) above the surface of Io.
- (2) Material ejected from the volcanoes forms a torus about Jupiter, extending roughly from

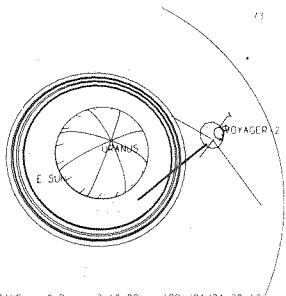

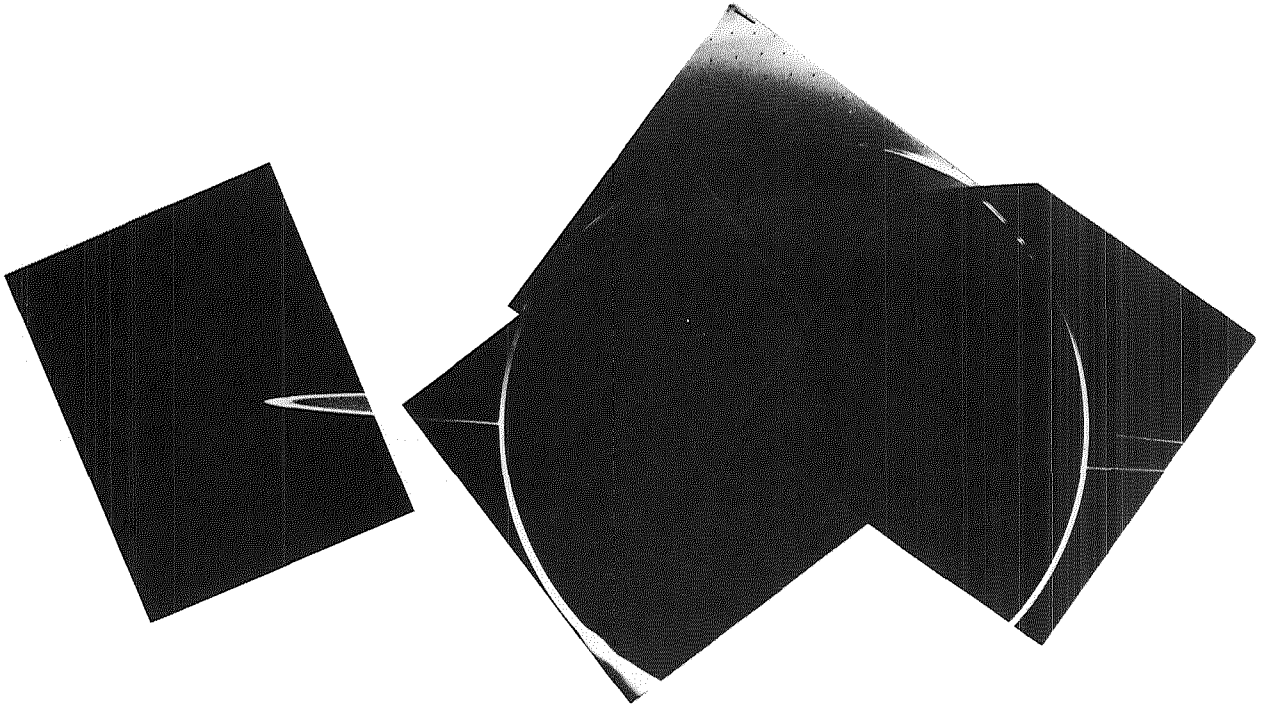

Figure 10-2. This montage of Voyager-2 images reveals Jupiter's narrow ring of tiny particles in forward-scattered sunlight.

the orbit of Io to the outer atmosphere of Jupiter. This material is the source of the charged particles that provide the high latitude auroral emissions.

- (3) Io volcanism appears to consist primarily of sulfur and sulfur compounds, with massive flows of these materials covering the surface, and a possible very tenuous atmosphere of sulfur dioxide.
- (4) Hot spots were measured on Io, indicating a hot interior. The heating is thought to be caused by gravitationally induced stresses within the moon, by two separate mechanisms. Both mechanisms result from Io's close elliptical orbit about Jupiter.

When Io is closest to Jupiter, the difference in gravitational attraction towards Jupiter between Io's

front and back hemispheres is the most intense. This difference acts to elongate Io towards Jupiter. When Io is farthest from Jupiter, this difference is least, and the elongation is least. The changing elongation (75 meters, or 250 feet, every 42 hours) heats up Io.

In addition, Io does not always keep the same surface point towards Jupiter. From Io's viewpoint, Jupiter moves slowly in the sky (from side to side) during Io's orbit. This causes a second form of gravitational stress, causing Io's shape to suffer a lateral shear, causing the second heating mechanism. These two heating mechanisms drive the active volcanoes on Io.

- (5) Europa has a very smooth, uncratered surface, suggesting "recent" geological activity. The elevation difference between the lowest valley and the highest mountain on Europa is estimated to be less than 200 meters (650 feet). There is speculation that Europa may contain an ocean beneath its 5 kilometer (3 mile) thick solid icy surface. (This speculation formed the basis for the recent novel and motion picture, 2010: Odyssey Two.)
- (6) Both Ganymede and Callisto have heavy impact cratering (Figure 10-1). Ganymede's surface indicates that there has been some tectonic motion of crustal plates. Callisto's surface gives no evidence of geological activity during the few billion years following the early episode of cratering.
- (7) Ganymede is now known to be the largest moon in the solar system. Previously, Titan had been accorded the honor. It was not until Voyager 1 had encountered Titan, and measured its "hard" diameter via the radio occultation experiment, that we knew for sure Ganymede was the largest moon.
- (8) A very accurate determination of the sizes, masses, densities and orbital elements of the 4 Galilean satellites was made.

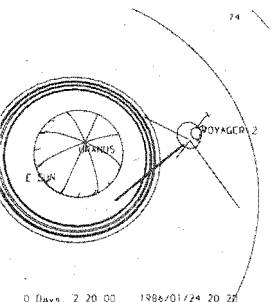

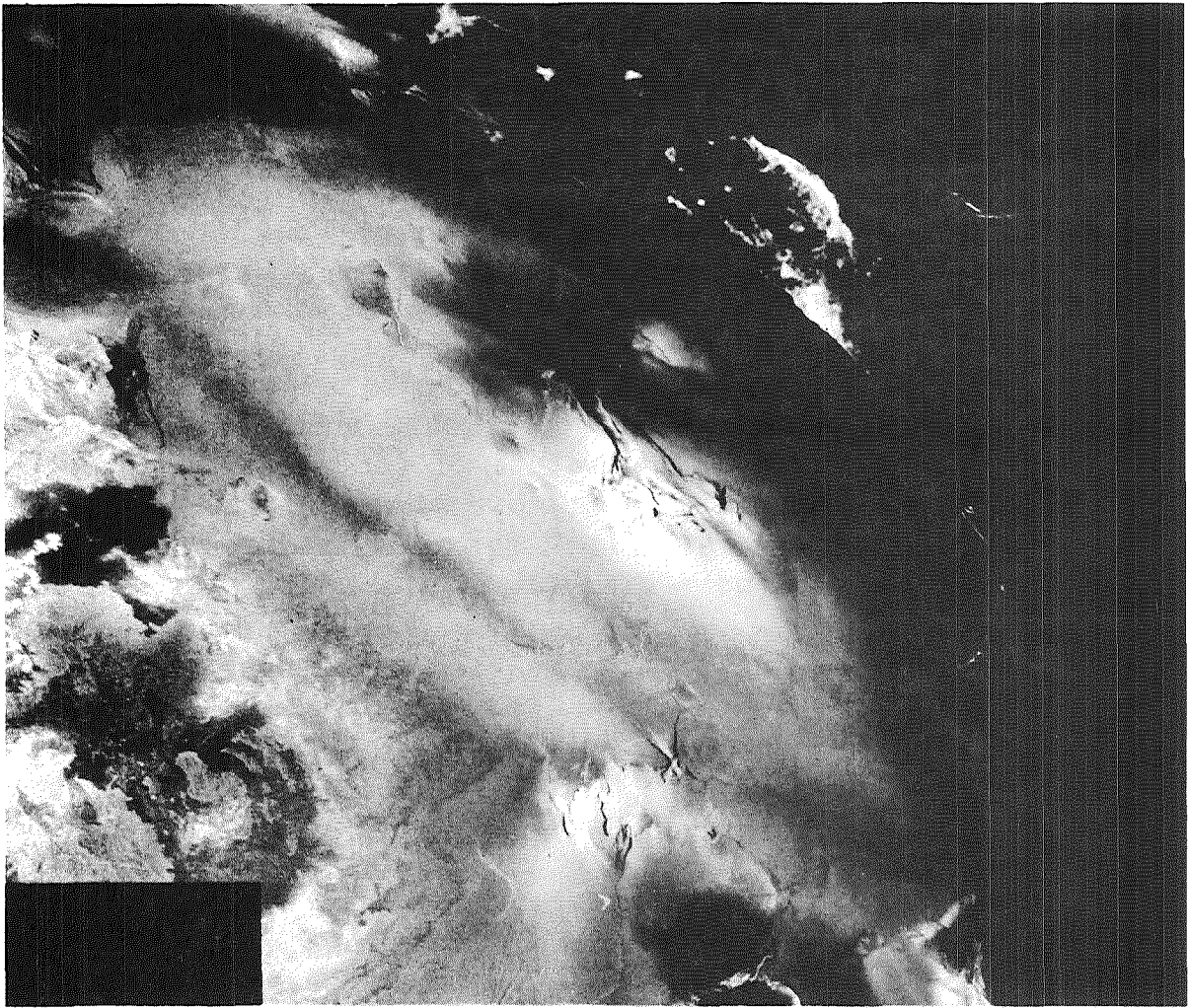

Figure 10-3. Pele, the largest of Io's volcanoes, spews sulfur products to heights 30 times greater than Mount Everest, falling to cover an area the size of France.

- (9) Three tiny satellites were discovered in the Voyager imagery. Metis and Adrastea, each about 40 kilometers (24 miles) in diameter, were found to be orbiting just outside the newly discovered rings, at 1.79 and 1.80 Jupiter radii ( $R_J$ ), respectively. In addition, Thebe, about twice the size of Metis or Adrastea, was found outside the orbit of Amalthea, at 3.1  $R_J$ . The total number of moons known to orbit about Jupiter is now 16.



## Jupiter's Magnetosphere

- (1) Jupiter's magnetosphere is the largest object in the solar system, being 10 times the diameter of the sun.
- (2) An electric current of more than 5 million amperes flows in the magnetic flux tube linking Io and Jupiter. This current is 5 times the amount of current predicted before Voyager 1's arrival.
- (3) The hot Io sulfur and oxygen plasma torus emits intense UV radiation. The temperature of the sulfur and oxygen ions was measured to be more than 100,000 degrees C (180,000 degrees F). Some of these ions are accelerated to more than 10% of the speed of light.
- (4) The magnetopause location varies, from less than 50  $R_J$  to more than 100  $R_J$ , depending upon the intensity of the solar wind.
- (5) Voyager 1 confirmed the existence of a Jupiter magnetotail. Voyager 2 observed that the magnetotail may extend beyond the orbit of Saturn.
- (6) Low frequency (kilometric) radio emissions depend on latitude.
- (7) Though first discovered by Pioneer 10, Voyager 1 confirmed the intense radiation field of trapped particles surrounding Jupiter. A human passenger riding Voyager 1 during its close Jupiter flyby would have received a dose of 400,000 Rads, or roughly 1,000 times the lethal level!

## Saturn

A nearly two-year cruise from Jupiter to Saturn followed. Whereas Voyagers 1 and 2 were the third and fourth spacecraft to visit Jupiter, they were the second and third spacecraft to visit Saturn. (Pioneers 10 and 11 both preceded Voyager to Jupiter, and Pioneer 11

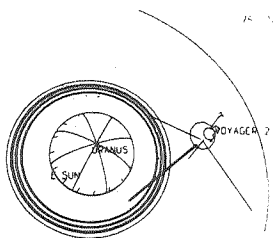

preceded Voyager to Saturn.) Voyager 1 started its encounter with Saturn in August of 1980, made its closest approach on November 12th, and ended its encounter in December. Voyager 2 started its encounter in May of 1981, made its closest approach on August 25th, and ended its encounter in September.

These two encounters captured mankind's first quality observations of the Saturnian system. For the first time, Saturn was a place, not just a pinpoint of light in the night sky. And the rings, those marvelous rings, were magnificent beyond anyone's possible imagination!

- (1) Saturn, too, was known to be a giant ball of gas (Figure 10-4), composed primarily of hydrogen and helium, with small amounts of ammonia, methane, phosphene, and various hydrocarbons. Voyager found that helium comprises 7% of the volume of the outer atmosphere of Saturn. The missing helium (the expected number was 11%) may be gravitationally separating from hydrogen in the planet's interior.
- (2) Saturn radiates out about 80% more energy than it receives from the sun. The gravitational separation hypothesis could also account for the observed excess thermal energy radiated by Saturn.
- (3) The overall structure of the outer Saturnian atmosphere (Figure 10-4) is the same as Jupiter's: alternating zones and belts extending from the equator to at least 60 degrees latitude, with the highest wind speed at the equator of 475 meters/second (1060 miles/hour), decreasing as one goes up in latitude, and with alternating east-west jet streams starting at the mid-latitudes of both hemispheres.
- (4) Within each belt or zone, the maximum wind velocity tends to occur at the center, rather than at either edge. The zonal wind patterns are symmetric about the equator, implying deep circulation within the atmosphere.



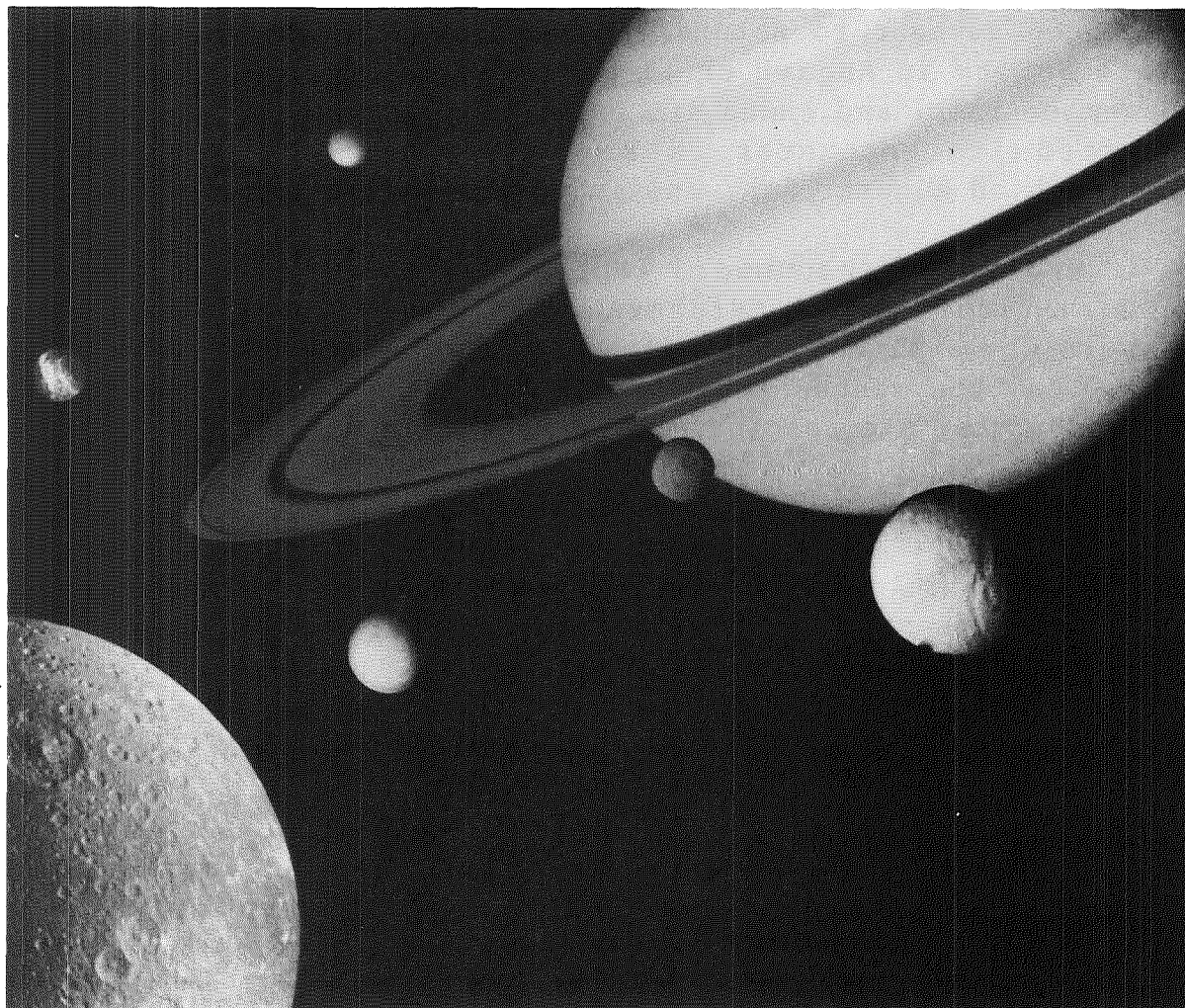
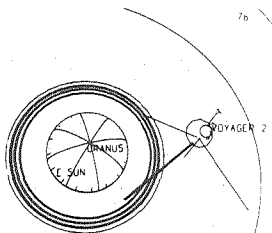

Figure 10-4. Saturn, its rings, and its six largest moons appear in this montage of Voyager 1 and 2 images.

- (5) The zone and belt structure is not so easily observable on Saturn, due to a high altitude haze (due to Saturn's coldness) that tends to wash color and brightness differences out.
- (6) The high pressure anti-cyclonically rotating "storms" observed all over Jupiter were observed on Saturn only above the mid-latitudes. There is a Saturnian storm analogous to Jupiter's Great Red Spot. The Saturnian "Little Red Spot" is about the size of



the Earth, and resides in the southern Saturnian Latitudes.

- (7) Both classical high latitude auroral emissions and previously unobserved low latitude aurora-like emissions exist on Saturn. In addition, lightning was observed, but only in the low latitudes.
- (8) Saturn, like Jupiter, emits radio-frequencies. These emissions were used to determine that Saturn rotates with a period of  $10^{\text{h}}39^{\text{m}}15^{\text{s}}$ .
- (9) The density of Saturn is less than that of water. The huge planet could actually float in a vast cosmic water ocean, were one available.

### Saturn's Rings

- (1) Very few of the observed characteristics of the rings of Saturn were expected (Figure 10-5). The rings are enormously more complex than previously thought. The classical A, B, and C-rings actually consist of countless thousands of ringlets of dirty water ice particles and bergs. The large number of ringlets (and gaplets) is due to a very complex gravitational interaction between each orbiting ring particle and 1) all other orbiting ring particles, 2) the planet Saturn, and 3) each of the Saturnian moons.
- (2) Gravitational resonances, acting on ring particles orbiting in periods that are integer multiples of the periods of the Saturnian moons, cause standing spiral density waves. Spiral density waves cause a varying radial density of ring particles (ringlets and gaplets). Spiral density waves were predicted in the rings of Saturn before Voyager 1's arrival. These waves have been observed in the A-ring, and are thought to be the cause of its structure. Spiral density waves have not been observed in the B-ring, and only rarely in the C-ring. There is no presently accepted explanation for the observed structure of the B and C-rings.

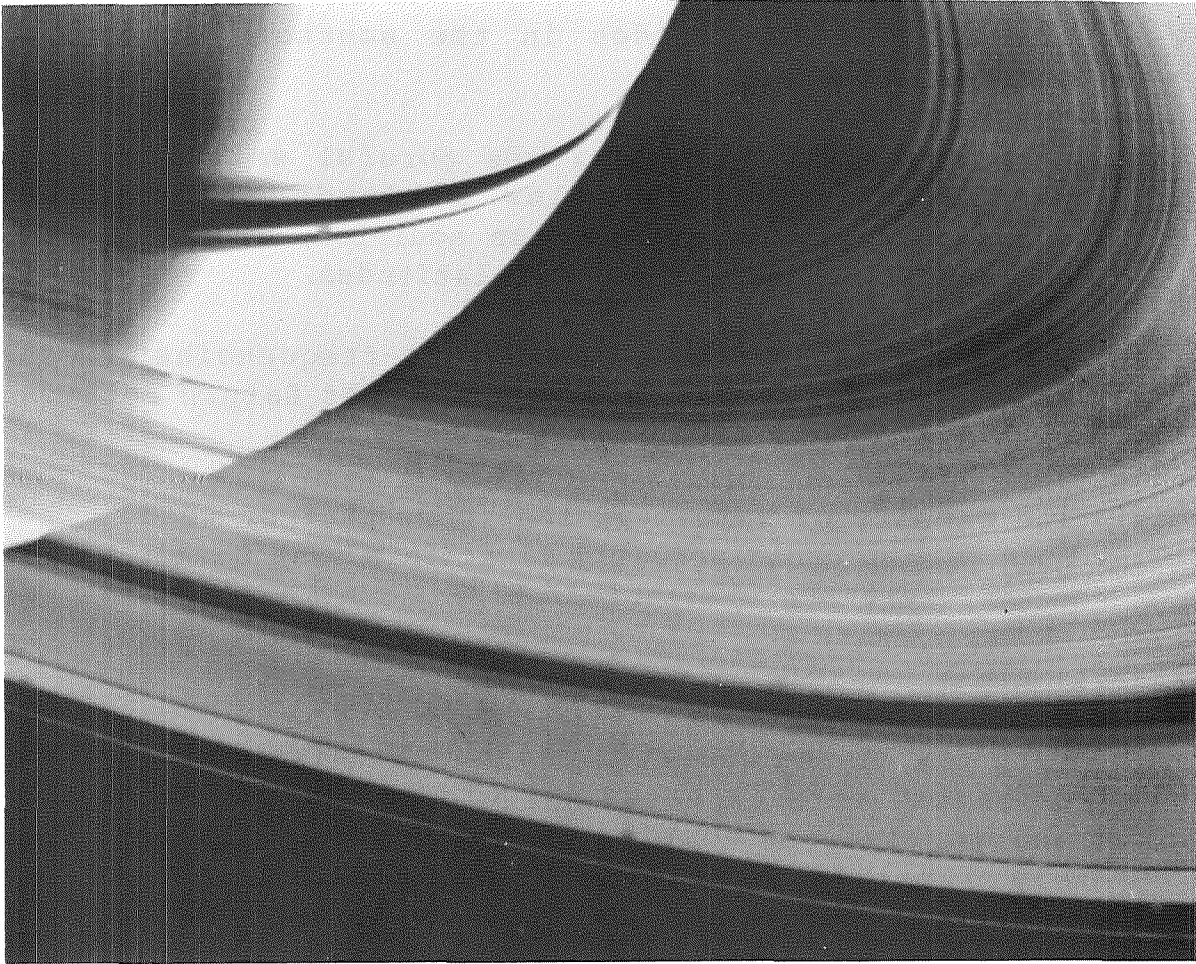
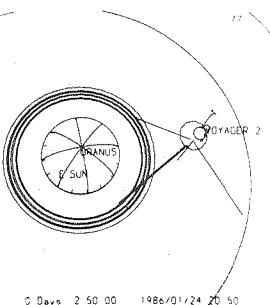

Figure 10-5. Looking back at Saturn, Voyager 1 captured this remarkable image that reveals the elaborate structure of "ringlets" and "gaplets", including the famous Cassini and Encke divisions, as well as the string-like F-ring.

- (3) The existence of the sometimes "braided" F-ring was confirmed. The discovery of the D-ring and G-ring was made.
- (4) The A, B, and C-rings contain both elliptical and discontinuous ringlets. The outer edge of the B-ring is not circular.



- (5) Ring particle sizes in the A, B, and C-rings range from sugar grains to houses, with a mean size comparable to a VW bug. The B-ring tends to have larger particles. The C-ring tends to have smaller particles. The size distribution in each of the rings varies radially.
- (6) The A-ring has a very sharp outer edge, implying some containment mechanism. The containment mechanism appears to be a Voyager-discovered small satellite orbiting just outside the A-ring.
- (7) The F-ring has very sharp inner and outer edges. The containment mechanisms are a pair of Voyager-discovered "shepherding" satellites, orbiting just inside and outside the F-ring (Figure 10-6). The existence of these satellites was predicted before Voyager discovered them!
- (8) "Clouds" of micrometer-sized particles, possibly electro-statically levitated above the ring plane, form as "spokes" and corotate with the B-ring. The "clouds" appear to be "created" on the dark side of Saturn, rotate around with the B-ring, then dissipate as a result of their differing Keplerian periods with distance from Saturn.
- (9) There are strong theoretical arguments in favor of the vast ring system of orbiting ice particles and bergs being on the average less than 20 meters (66 feet) thick. The radial diameter of the main ring system is some 280,000 kilometers (174,000 miles). The rings, to scale, may be more than 10,000 times thinner than a phonograph record. The rings are known to change their thickness with time, and are thought to be warped out of plane as much as  $\pm 1,000$  meters (3280 feet). This then makes the rings an extremely thin, warped, time varying phonograph record.

### Saturn's Moons

- (1) Two enormous craters were discovered: a crater one-



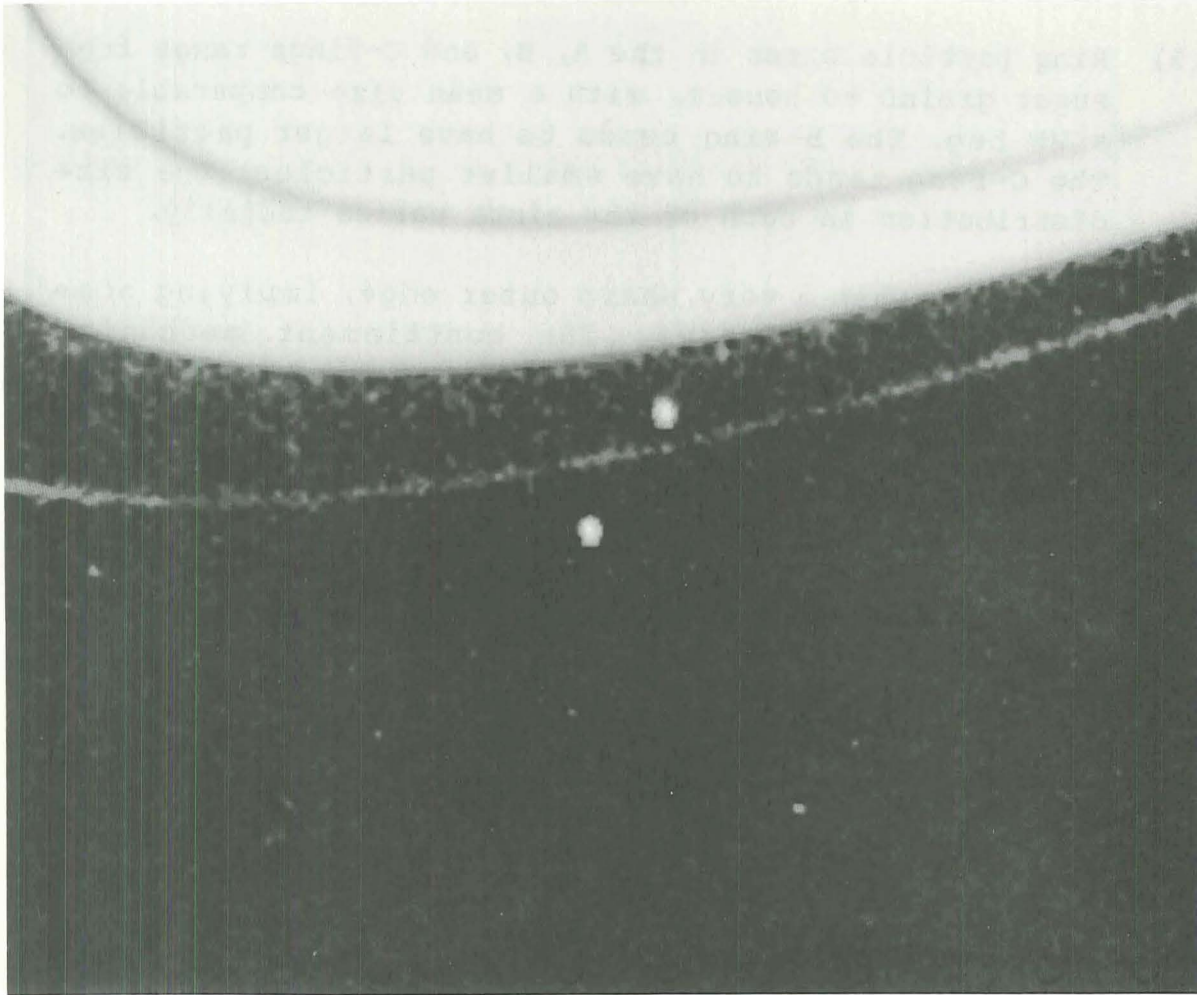
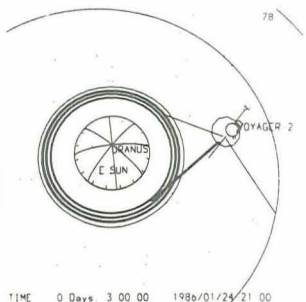

Figure 10-6. This Voyager-2 image confirms the existence of two small satellites, one orbiting on either side of the F-ring. These satellites are responsible for confining the particles into a narrow band, as well as for the braiding observed by Voyager 1.

third the diameter of Mimas, and a crater nearly 40% of the diameter of Tethys (Figure 10-4). The meteoric impact that led to the latter crater is thought to have created a huge chasm that runs around three-quarters of the surface of Tethys. The large crater on Tethys appears to exhibit the largest impact-crater-to-moon ratio in the solar system.



- (2) Enceladus has a surface nearly devoid of impact craters in places, indicating "recent" geological activity, possibly due to "tidal" heating.
- (3) Iapetus has both a light and a dark hemisphere (Figure 10-4). The light to dark contrast is the largest of any known body in the solar system. The dark surface has very sharply defined edges and contains no visible impact craters, suggesting that the dark material may have formed after methane flowed out from inside Iapetus. Methane turns very black after having its carbon-hydrogen bonds broken by sunlight.
- (4) Phoebe is the first satellite observed to be in non-synchronous rotation with respect to the planet that it orbits. Phoebe was known to be in an inclined, retrograde orbit. The plane of Phoebe's orbit is much closer to the ecliptic plane than to Saturn's equatorial plane. The moon was observed to have a dark reddish surface. These facts suggest that Phoebe may well be a captured asteroid.
- (5) The solid surface diameter of Titan was measured at 5150 kilometers (3195 miles), revealing it to be the second largest moon in the solar system. (It was previously thought to be the largest.) In addition, the near surface atmospheric pressure of 1.5 bars and temperature of 94 degrees K (-290 degrees F) were determined.
- (6) Titan is the only moon in the solar system known to have a dense atmosphere. The atmosphere of Titan is 90% nitrogen, with methane and probably argon as the other main constituents, and trace amounts of carbon monoxide, ethane, propane, acetylene, diacetylene, hydrogen cyanide, cyanoacetylene, cyanogen, and carbon dioxide.
- (7) The atmosphere of Titan contains a main and several subsidiary haze layers. The combination of "clouds" and haze in the atmosphere prevented any surface detail from being observed. The haze layer extends to an

altitude of 200 kilometers (125 miles), with some detached aerosol layers as high as 750 kilometers (465 miles). There is speculation that Titan may have a liquid ethane-methane-nitrogen ocean covering some or all of its surface.

- (8) Three new satellites were discovered by Voyager 1: one orbiting just outside the A-ring (named Atlas) and two "shepherding" satellites on either side of the F-ring (named Prometheus and Pandora). The total number of satellites known to orbit Saturn is now 17. (Known is defined as having enough observations to be able to calculate a well-defined set of orbital elements.) There is evidence indicating that there may be a more.
- (9) For the first time, accurate measurements of the diameters of the 17 known satellites could be made. A more accurate measurement of the masses of Tethys, Rhea, and Iapetus was made as a result of Radio Science celestial mechanics investigations.
- (10) Hyperion has a dark surface of irregular shape. It is spinning about its minimum-moment-of-inertia axis with the spin vector fixed in inertial space 20 to 30 degrees above the moon's orbital plane. This situation makes Hyperion the object in the solar system most like Uranus. (Uranus' spin vector is almost in its orbital plane.) Hyperion is the second body known to be in non-synchronous rotation.

### Saturn's Magnetosphere

- (1) Saturn was known to have a magnetic field. The magnetosphere contains a magnetic field basically dipolar in nature and aligned with Saturn's axis of rotation to within 1 degree.
- (2) The magnetopause location varies from less than 14 Saturn radii ( $R_S$ ) to more than 30  $R_S$  depending upon the intensity of the solar wind.

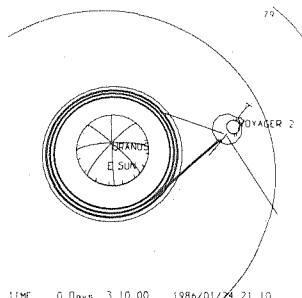

- (3) Inside  $7 R_S$  there is a torus of hydrogen and oxygen ions, probably originating from the sputtering of water ice from the surfaces of Dione and Tethys.
- (4) There is also a torus of neutral hydrogen atoms extending from  $8 R_S$  to  $25 R_S$  probably originating from the atmosphere of Titan.



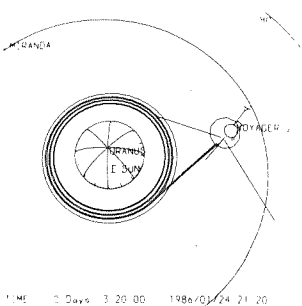

Stars scribble in our eyes the frosty sagas, the  
gleaming cantos of unvanquished space.

Hart Crane

#### 11. TO NEPTUNE AND BEYOND

Long before the January 24, 1986 Voyager-2 Uranus encounter, planning was underway for an August 24/25, 1989 encounter with Neptune. This will be the fourth and last swing-by on the epic Grand Tour of the four giant outer planets. It is indeed a fitting occasion to celebrate the twelfth anniversary of its launch.

A close encounter with the distant planet Pluto is not possible, as illustrated by Figure 1-4 of the Introduction. Recall that while Voyager 1 appears to be headed in the general direction of Pluto, the spacecraft is departing at an angle of 35 degrees above the ecliptic plane as illustrated in Figure 9-2. Pluto, with its moon Charon, must wait for another day to be visited by some future spacecraft as yet unplanned. However, Voyager 2 will be visiting the large Neptunian moon Triton, which is similar to Pluto in size, albedo, and color.

In order to insure that the Voyager-2 spacecraft will be able to complete its final planetary tour at Neptune, mission planning for the Voyager Neptune Interstellar Mission (VNIM) started several months before the Uranus encounter. It was necessary to jointly allocate critical spacecraft resources for both the Uranus and Neptune encounters. Fortunately, there appear to be adequate consumables to accomplish this task, with little penalty extracted at either encounter, although some operational design margins (such as power) will be slim by earlier standards.

Other spacecraft performance limits that become critical are telecommunications because of the greatly increased range to Earth, and imaging smear because of the very long exposure

times required with light levels 900 times fainter than those on Earth. Talking with the spacecraft becomes more of an operational burden as well, because of the 8.2-hour two-way light time.

### The Neptune Kingdom

Neptune is truly at the outskirts of the solar system, some 30 AU from the Sun or nearly 4.5 billion km (2.8 billion miles). Neptune takes 165 years to orbit the Sun and therefore has seasons 41 years long. It is invisible to the naked eye despite being the fourth largest planet in the solar system, having been discovered in 1846 based upon mathematical calculations of Uranus' orbit perturbations. Triton, Neptune's largest moon, was discovered only days later. Little new information has been obtainable, even using today's powerful telescopes, except for some recent observations of partial rings just inside three Neptune radii from the planet center.

As far as we know, Neptune should appear as a slightly oblate bluish-green ball with a diameter of 48,600 km (30,200 mi), or nearly four times the diameter of Earth. Because of its largely gaseous nature, the mass is only about 17 times that of Earth. Neptune's polar axis, like Earth's, has only a moderate tilt of 28 degrees. It is estimated that the rotation rate of the outer atmosphere is about 18 hours.

Current theory predicts that all the gaseous planets have rocky cores of roughly the same size, but the relative amounts of different materials surrounding the cores vary significantly. All of the Jovian planet envelopes are composed primarily of hydrogen and helium, but Uranus and Neptune have greater relative amounts of methane, ammonia, and water in various states. Also, Neptune is thought to be still warm; Voyager will measure the net heat loss, thereby enabling a theoretical model of the heat source to be produced. Figure 11-1 refers to these fundamental evolutionary differences.

Neptune has at least two known moons, Triton and Nereid, which are quite different from each

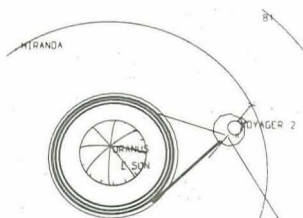

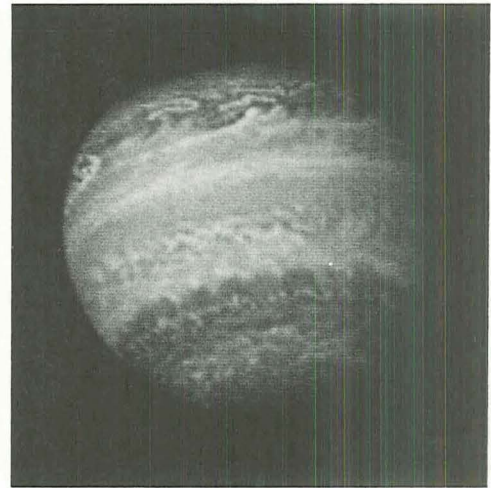
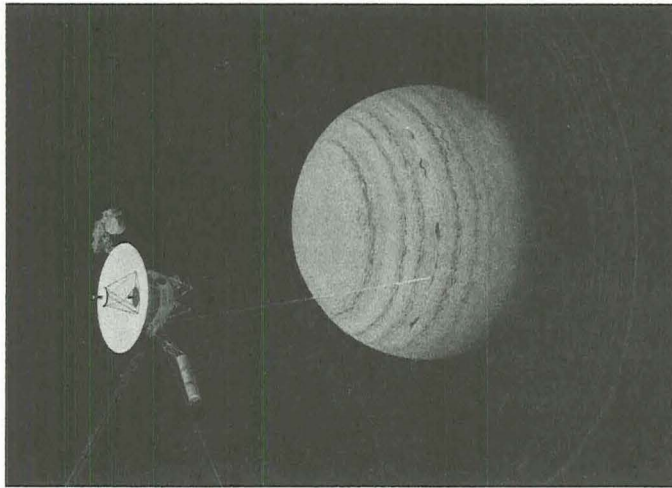
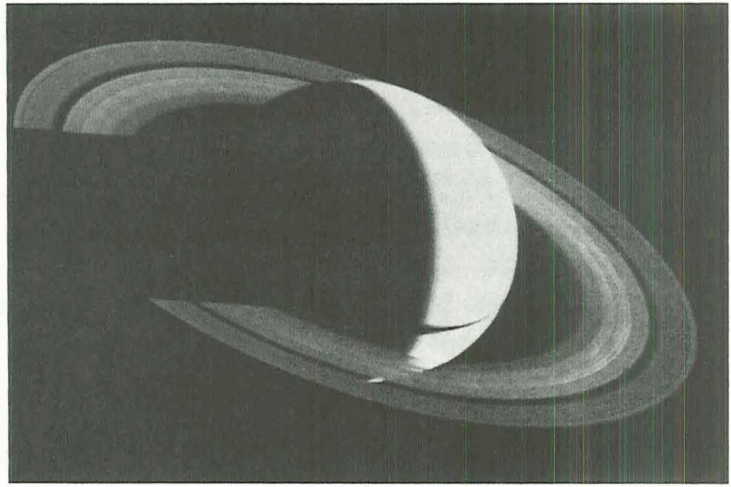

Figure 11-1. Jupiter, Saturn, and Uranus each represent a different stage in the evolution of a gas planet. Jupiter is still hot with energy left over from its formation. Saturn is in a second stage and is cooling. Uranus is in a third stage and has little internal heat remaining. Neptune doesn't fit the pattern, however, because it is still relatively warm.

other. The larger, Triton, has a diameter of about 3,500 km (2,200 mi) and is comparable in size to our own Moon. Unlike any of the other large moons in the solar system, Triton's orbit is retrograde, i.e., it is moving in a direction opposite to Neptune's rotation. Furthermore, Triton's orbit is tilted about 20 degrees with respect to Neptune's equatorial plane and is located about 350,000 km (220,000 mi) distant from the parent body, again similar to our Moon. However, Triton's orbital period is only about 6 days compared to 27 days for the Moon.

Nereid, only some 330 km (200 mi) in diameter, travels in the most highly eccentric orbit of any known satellite in the solar system. It has an orbital period very close to one year, and it is most likely a captured asteroid or comet.

#### Neptune and Triton Encounter Planning

Without the availability of a gravity-assist corridor to continue to Pluto, a multitude of trajectory options were studied in order to assess the relative science value of spacecraft observations made from each potential Neptune fly-by mission. In the end, after months of debate, the science community agreed that a dual close encounter with both Neptune and Triton would be most desirable, especially since the satellite geometry would permit a reasonably good Earth occultation by Neptune as well as a diametric Earth occultation at Triton.

The resulting trajectory, as depicted by Figure 11-2, involves a special spacecraft velocity-change maneuver, just after the Uranus encounter, that will advance the arrival of the spacecraft at Neptune in order to allow for the proper phasing with Triton.

If all goes as planned, Voyager 2 will skim over the north pole of Neptune a mere 3500 km (2200 mi) above the gaseous surface at 21:00 PDT (spacecraft time), August 24, 1989. The gravitational force of Neptune will cause the spacecraft to veer sharply downward, through both Earth and solar occultation regions

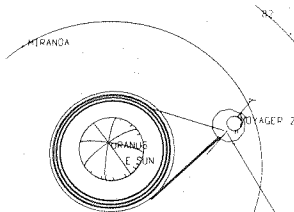

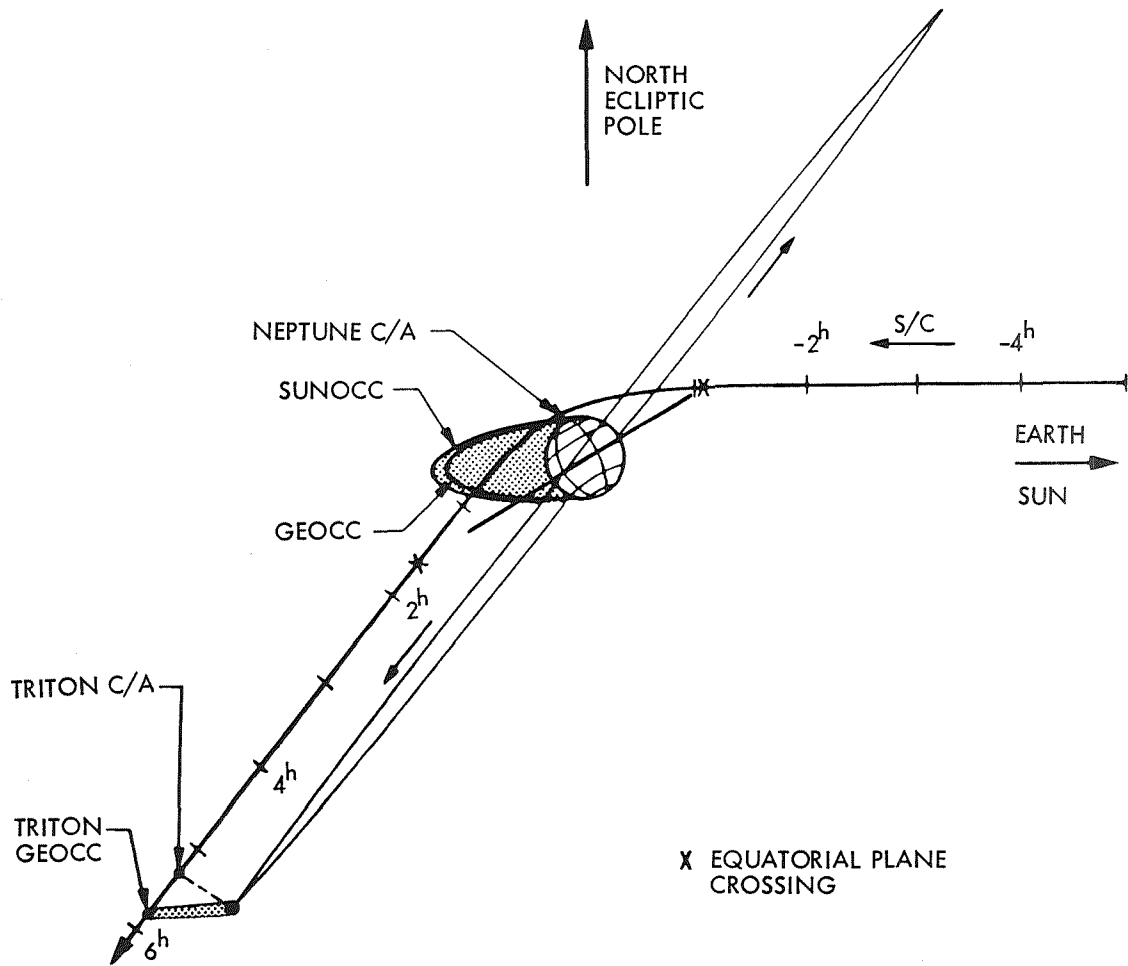

Figure 11-2. Voyager 2, skirting just outside a possible Neptune ring, will dive over the north pole at a distance of only 3500 km (2200 mi), headed for a close encounter with the large and unusual moon Triton some five hours later.

by Neptune and out towards the orbit of Triton. At about 5 hrs and 10 min after Neptune closest approach, Voyager 2 will pass within about 8200 km (5100 mi) of Triton's surface.

Although Triton may have a thin atmosphere of methane and nitrogen, the surface is expected to be visible to Voyager's cameras, allowing detection of surface features, including possible oceans of liquid nitrogen (Figure 11-3) that have been suggested by Earth-based infrared observations. Shortly



after Triton closest approach, the spacecraft will pass behind the satellite to create the Earth occultation so highly valued by radio science investigators. This occultation will provide information about Triton's thin atmosphere, as well as an accurate measurement of the large moon's diameter.

Also shown in Figure 11-2 is an equatorial region around Neptune that appears to contain a tenuous ring of particles which may be discontinuous or fragmented. Based upon stellar occultation observations made from Earth in July 1984, it is believed these arcs of ring material do not extend beyond about 3 Neptune radii or 73,000 km (45,000 mi). However, the penetration point of the inbound spacecraft in the equatorial plane is only 3.2 Neptune radii, leaving a margin of about 5,000 km (3100 mi). Naturally, scientists and the Voyager Project are eagerly awaiting new information to confirm that the current desired trajectory can be flown without concern over a possible collision hazard for the spacecraft.

Figure 11-4 is a painting that shows Voyager 2 as it looks back towards the Earth (after passing both Neptune and Triton) some 7 hours after the closest approach to the planet. Only narrowly-lit crescents will arc across the southern limbs as Voyager 2 departs forever from the remote realm of Neptune and Triton.

### Post-Neptune Cruise Science

Following the Voyager-2 exploration of the Neptune system, you may wonder what's in store next for our robot spacecraft. They will have completed their unprecedented planetary encounters with the four giant outer planets, and will have also gathered invaluable interplanetary information as well. Furthermore, it is expected that both spacecraft will remain alive and vital for many years to come unless some unexpected failure were to occur.

There is no immediate concern about limited onboard resources, thanks to a little advanced planning, as illustrated by the lifetime predictions shown in Table 11-1. Remember, the Voyagers and the

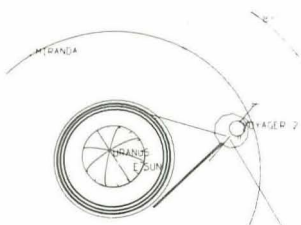

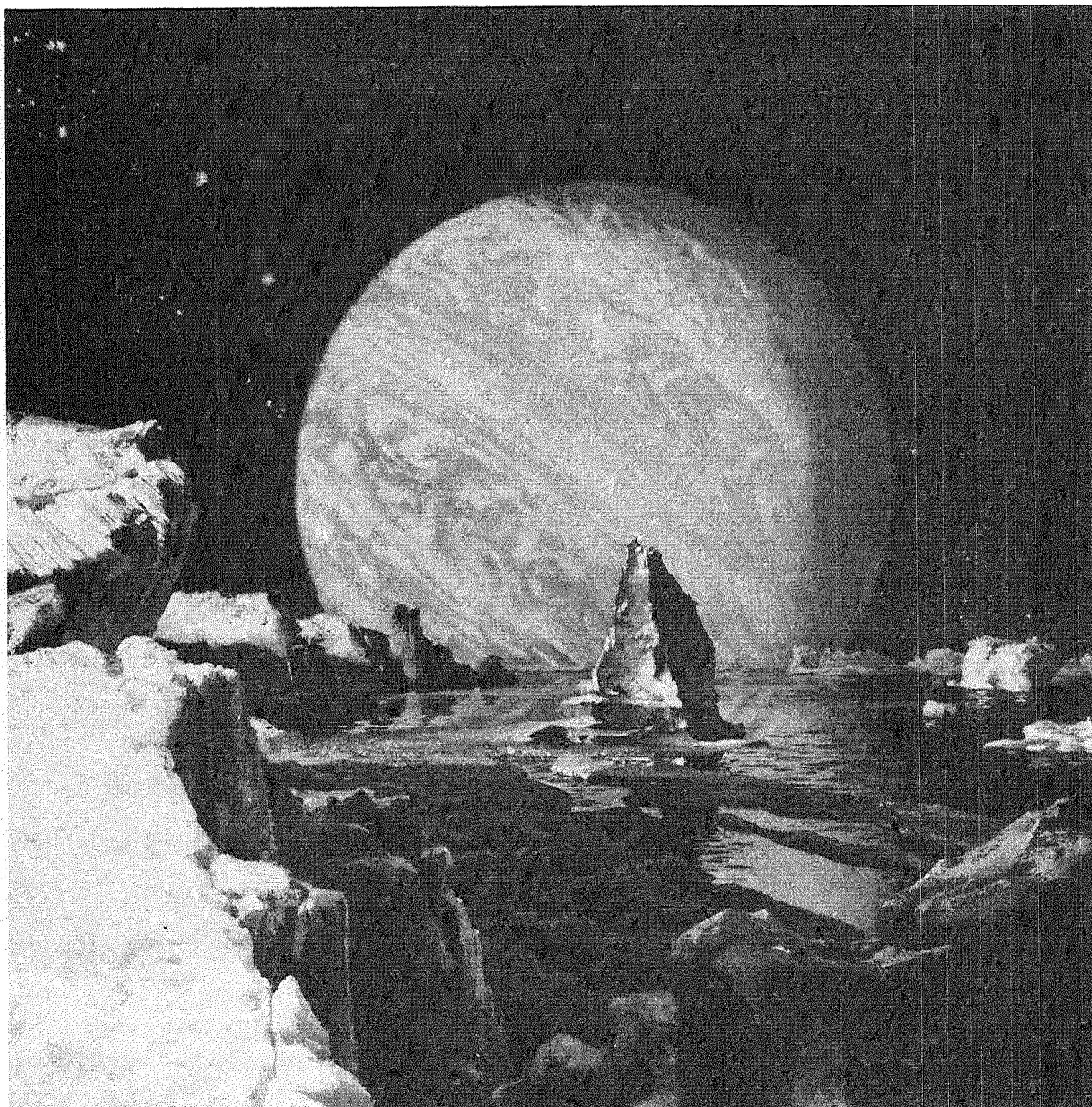

**Figure 11-3.** The large moon Triton, with an estimated diameter of 3500 km (2200 miles), may prove the show-stopper at Neptune. Larger than Earth's moon, it may have a thin atmosphere of nitrogen and methane, with very shallow lakes of liquid nitrogen on a surface partially covered by methane ice. Its reddish hue, like that of Saturn's moon Titan, suggests that sunlight may be breaking down the methane and creating a variety of organic particles in the form of hydrocarbon-based aerosols.



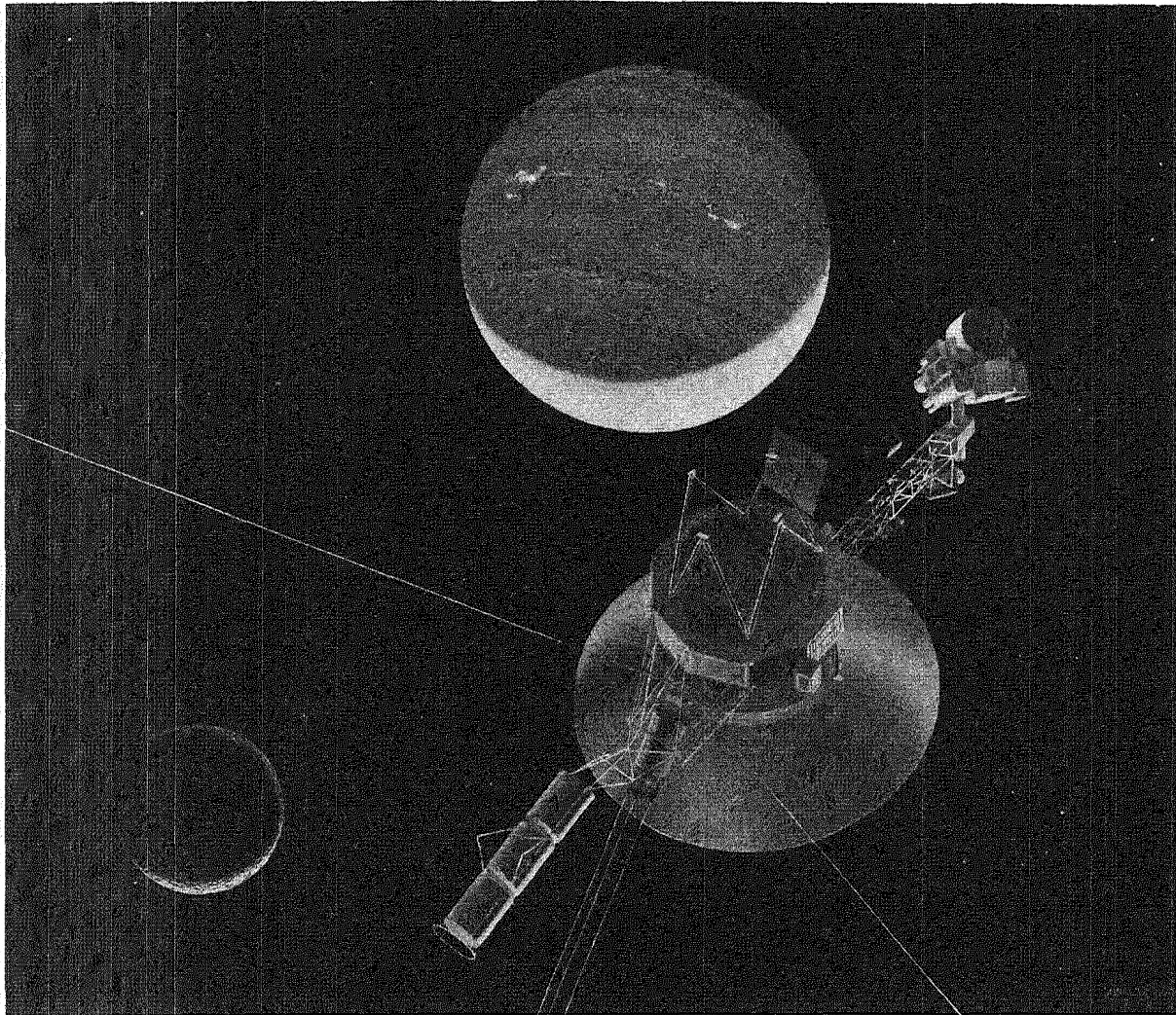
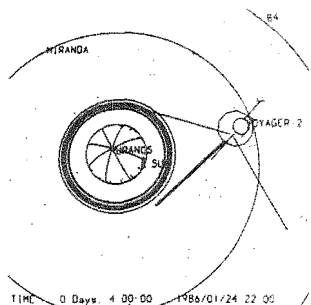

Figure 11-4. A computer graphic precision "template" was used by space artist Don Davis to create this looking-back view at seven hours past Voyager-2 Neptune closest approach. After diving over the north pole and being deflected downward, Voyager 2 must be content to view narrowly-lit crescents on the southern limbs of remote Neptune and Triton.

Pioneers will be the very first spacecraft to continue their voyages into the outer reaches of the solar system to the heliopause and beyond. Obviously, this represents a unique opportunity to continue to



extend the scientific charting of our solar system as well as to gather new information about ultraviolet emissions from galactic sources.

With a little luck, one or perhaps even both of the Voyagers may be alive and well at the crossing of the heliopause boundary, where the interstellar medium restricts the outward flow of the solar wind and confines it within a magnetic bubble called the heliosphere. This is a key scientific objective stated in the VNIM Project Plan. The exact location of this boundary is not known, and it will most likely vary as a function of solar departure direction as depicted by Figure 11-5. However, it is believed to be located between 50 and 150 AU in the direction of travel for both Voyagers and Pioneer 11.

From Table 11-1, note that the sun sensor may be the first resource limitation to occur at about 80 AU in the year 2001 for Voyager 1 and 2006 for Voyager 2, but there is an excellent chance that the sun sensor will continue to function well beyond 80 AU. Thereafter minimal power requirements of 230 watts would be reached in about the year 2015 when the spacecraft would be at heliocentric distances of 130 and 110 AU for Voyagers 1 and 2, respectively. Now you can better understand how chance may play a role in our hopes of obtaining data at the heliopause.

Typical scientific objectives to be addressed by interplanetary observations are:

Characterization of the solar wind evolution with distance from the Sun (MAG, PLS, LECP, CRS).

Observation and characterization of the Sun's magnetic field reversal (MAG, PLS, LECP, CRS).

Search for low-energy cosmic rays (CRS, LECP).

Characterization of particle acceleration mechanisms in the interplanetary medium (MAG, PLS, LECP, PWS).

Table 11-1. It has often been observed that the valiant Voyager robots may survive the turn of the century, barring a sudden electronic failure. This table provides lifetime estimates for each of several factors, assessed independently from the earlier expirations of other factors.

LIMITED RESOURCE	LIMITING FACTORS	DISTANCE (A.U.)	FINAL YEAR
Hydrazine	Active cruise (includes attitude mnvrs)	120 - 77	2012 - 2005
	Quiet cruise (wide deadband)	217 - 137	2040 - 2023
RTG Power	Full F&P Science (273 W)	95 - 77	2005
	Minimal Power (230 W)	130 - 110	2015
Downlink Telemetry (20 bps)	70m DSN Antenna	530	2130 - 2140
	70/34/34m Array	620	2155 - 2165
Spacecraft Receiver for Commanding	70m DSN Antenna and 400 KW xmtr	800	2206 - 2217
Sun Sensor Sensitivity	Intensity too weak for lowest gate setting	≥80	≥2001 - 2006

Note: Voyager-1 distances and final years shown first, and Voyager 2 second.

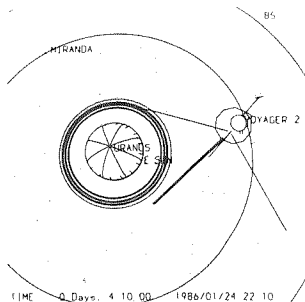

Search for evidence of interstellar hydrogen and helium and an interstellar wind (UVS, PLS).

Observation and characterization of the heliospheric boundary where effects of the solar wind terminate (MAG, PLS, LECP, CRS, PWS).

In addition, interplanetary observations will be made (on a target-of-opportunity basis) to:

Search for radio emissions from the Sun in an environment well removed from planetary sources (PRA, PWS).

Search for and characterize galactic sources of extreme ultraviolet emissions (UVS).

Improve astrometric parallax measurements for selected stars using the substantially longer Voyager-Earth baselines (ISS).

At the conclusion of the VNIM on December 31, 1989, Voyager 1 will be at approximately 40 AU and 33 degrees north ecliptic latitude. Voyager 2 will be at approximately 31 AU and slightly south of the ecliptic plane. Both spacecraft will continue to escape from the solar system toward the solar apex, and communications could be maintained as long as the spacecraft continue to function. Logically, an extended mission should be conducted in anticipation of penetrating the boundary between the solar wind and the interstellar medium, allowing measurements to be made of interstellar fields and particles unmodulated by the solar plasma.

### To The Stars

The solar system does not end at the orbit of Pluto, the ninth planet. Nor does it end at the heliopause boundary, where the solar wind can no longer continue to expand outward against the interstellar wind. It extends over a thousand times farther out where a swarm of small cometary nuclei are barely held in orbit by the Sun's feeble gravity (at that great distance).

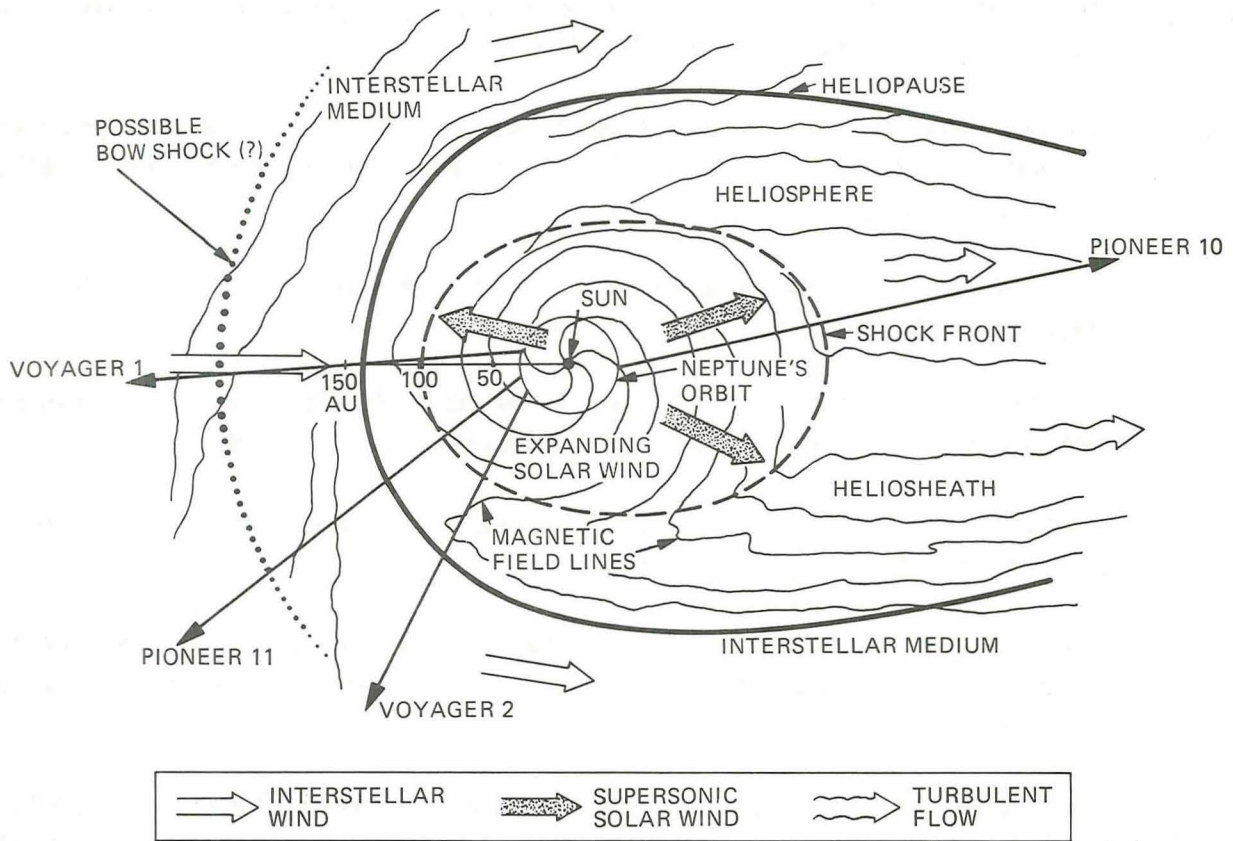
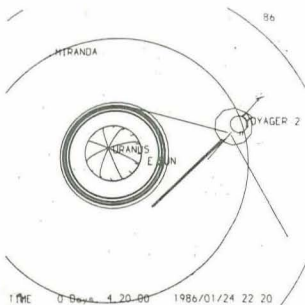

Figure 11-5. The Pioneer and Voyager spacecraft are shown as they depart from the heliosphere model that forms a magnetic bubble. Of particular interest is the determination of the heliopause boundary where the solar wind interacts with the interstellar wind.

The two Voyager robots will race past the orbit of Pluto by the end of this decade. As indicated in Table 11-1, barring random (5% chance per year) electronic failures, they may even survive until several years after the turn of the century. But even at speeds of over 35,000 mph, it will take nearly 20,000 years for the Voyagers to reach the comet swarm. By this time, they will have traveled a distance of one light-year, or nearly 25% of the distance to Proxima Centauri, the nearest star.

After the Voyagers have left the remote realm of comets, they will make their way slowly to



other star systems. Affixed to each robot emissary from Earth is a gold-coated copper phonograph record designed by Carl Sagan and a small group of scientists and friends. The choice of a record was motivated by its ability to hold a large amount of information, and by the launching of the Voyagers during the one-hundredth anniversary of the invention of the phonograph record by Thomas Edison.

Each record contains 118 photographs of our planet, ourselves, and our civilization; almost 90 minutes of the world's greatest music; an audio essay of special sounds; and greetings in almost sixty languages. An aluminum protective cover should ensure survival of the record for one hundred million years against the occasional impacts from interplanetary and interstellar dust grains.

Though appealing to the human imagination, the possibility is extremely low that an extraterrestrial being will discover one of the Voyagers, rendezvous with it, and play out the contents of the record. But it is still exciting to calculate the Voyager flight paths into the distant future, searching for close encounters with other star systems.

As the Voyager and Pioneer spacecraft travel out of the solar system, they will eventually attain their asymptotic departure directions, as seen on the sky of the current epoch. Figure 11-6(a) is a star map of the current epoch, in Earth-equatorial coordinates, showing the ecliptic plane and the constellations which fall within  $\pm 50^\circ$  declination. The time histories of the coordinates of Pioneers 10 and 11, Voyager 1, and a portion of Voyager 2, as they advance toward their asymptotic directions, are also shown on the figure.

Because the Voyager-2 flyby of Neptune will be over the north pole, the departure trajectory will be deflected substantially south of the ecliptic and Earth equator, into the south polar area of the celestial sphere. Figure 11-6(b) is a star map of this region, again in Earth-equatorial coordinates and for the current epoch. The remaining portion of the coordinate time history of Voyager 2, as it approaches its asymptotic direction, is depicted on this figure.



Plotting the departure trajectories against the background stars on the celestial sphere immediately suggests that, in the future (distant in human terms, close in geologic or astronomical terms), the trajectories of these four spacecraft may carry them past several other stars. Because of the slow speeds of the spacecraft (compared to the stellar distance scale) and the resulting long time intervals, and because of the space velocities of stars during this interval, it would not be expected that stars currently located in the direction of the outgoing asymptote would be the most likely candidates for stellar flybys. In order to determine if specific stellar flybys occur for these four spacecraft, it is necessary to propagate both the spacecraft positions and the star positions in order to search for future "close" encounters.

In about 40,000 years, Voyager 1 will pass within 1.6 light-years of AC+79 3888, an aging star in the constellation of Camelopardus, at the boundary near the Little Dipper. Though only one-third the size of our sun, it could harbor planets. Also in 40,000 years, Voyager 2 will fly within 1.5 light-years of Ross 248, a small star in the constellation of Andromeda. Radiation bursts from Ross 248 suggest unfavorable conditions for life-bearing planets.

Voyager 2 is not doomed to sail the cosmic seas in an eternal trek of absolute solitude. For in 285,000 years, it will pass within 3.5 light-years of Sirius, the brightest star other than the Sun in Earth's heavens. The dog star and its white dwarf pup, in the constellation of Canis Major, will appear as a bright beacon to the deceased robot craft.

No doubt, it has become evident that the Voyager spacecraft are traveling far too slow for even a modest penetration into interstellar space within our lifetimes. Follow-on deep space missions in the twenty-first century will use a new propulsion technology such as Nuclear Electric Propulsion (NEP). These new spacecraft could develop solar system exit velocities on the order of 8 to 13 AU/yr compared to Voyager 2's 3.4 AU/yr.

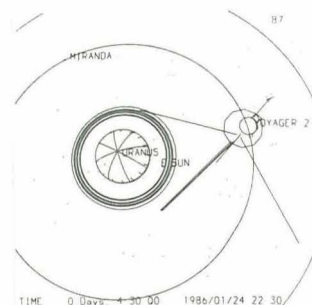

(a) STARS BETWEEN  $\pm 50^\circ$  DECLINATION

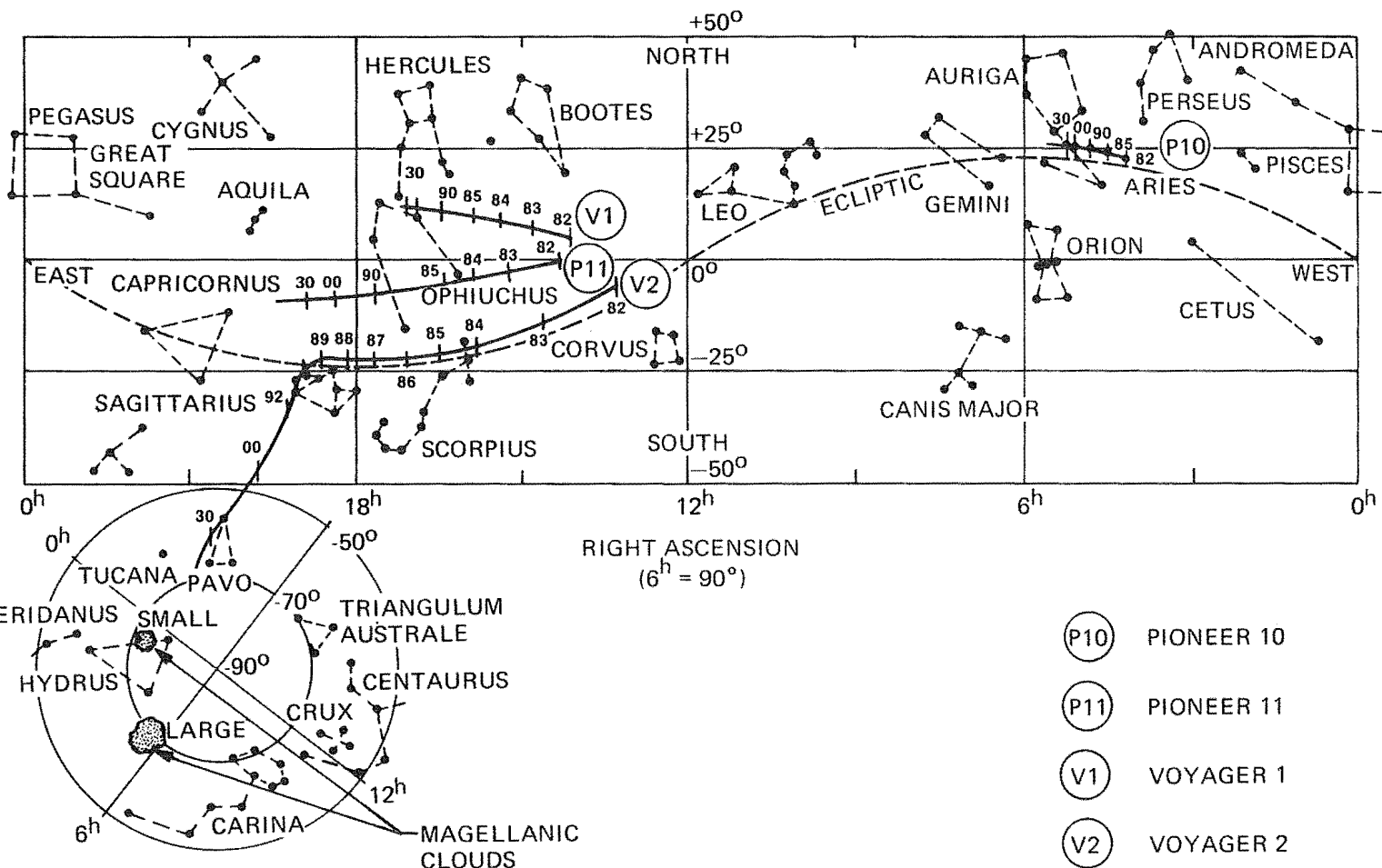

(b) SOUTH POLAR STARS

Figure 11-6. The departure directions of the escaping spacecraft are shown as time-varying traces plotted against the current stellar background of stars in Earth equatorial coordinates. In the tens-of-thousands of years that the spacecraft will take to approach even the closest star, the stellar background will have greatly changed because the stars and our own Sun are in ceaseless motion throughout the galaxy.



Still you say that's too slow. Are we therefore captive to an aging Sun that drifts about the Milky Way Galaxy at a mean distance of 1.7 trillion AU with a period of only 245 million years? Only time will tell, but we must press forward and hope that a technological breakthrough can be achieved.

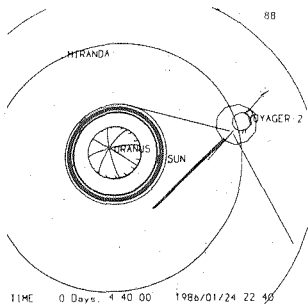

We must welcome the future, remembering that soon it will be the past; and we must respect the past, remembering that once it was all that was humanly possible.

George Santayana

## 12. PROJECT FUNCTIONAL AREAS

The Voyager successes at Jupiter and Saturn would never have happened without the extra-special efforts of many dedicated people, and the same will be true for Voyager's future. During the Uranus encounter, there will be some 200 people directly supporting the project, as well as many more around the world (see Chapter 3) that help us communicate with the two Voyagers.

The purpose of this final Guide chapter is to identify several key people associated with the various project functional areas. After all, if you were planning a tour of Europe, there would always be a number of questions not covered in your trip brochure. You would naturally consult one of the trip leaders for answers to your special questions.

An effort has been made in Table 12-1 to identify the most basic functional areas and the appropriate cognizant personnel. It is always difficult to select a few specific individuals when so many people are associated with Voyager, but a line must inevitably be drawn somewhere. When using Table 12-1, it is assumed that any cognizant person for a given functional area can answer questions for those subareas contained to the right of the given area. For those of you who wish to see the precise and complete project organization, Table 12-2 has been provided.

During the actual encounter, the JPL Public Information Office will of course answer questions from outside people, or will refer these questions to one or more of the people listed in Table 12-1.

It is finally time to bring the Guide to a close, and thank the many people who helped in its preparation and review. We are all looking forward to an exciting and rewarding encounter with the tilted giant and his kingdom of moons and rings.

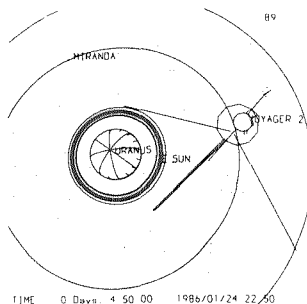

TABLE 12-1  
Key Personnel

VOYAGER OPERATIONS FUNCTIONS				
OVERALL PROJECT           R. Laeser G. Textor C. Kohlhase R. Rudd	SCIENCE  E. Stone E. Miner P. deVries	PRINCIPAL INVESTIGATORS	B. Smith (ISS)	
			L. Broadfoot (UVS)	
			A. Lane (PPS)	
				R. Hanel (IRIS)
				L. Tyler (RSS)
				J. Warwick (PRA)
				N. Ness (MAG)
				H. Bridge (PLS)
				F. Scarf (PWS)
				T. Krimigis (LECP)
				E. Stone (CRS)
		SCIENCE PLANNING AND OPERATIONS		P. Doms
	ENGINEERING	SPACECRAFT		H. Marderness
	W. McLaughlin D. Wolff	SEQUENCING		R. Morris
NAVIGATION			D. Gray	
OPERATIONS  D. Griffith T. Adamski	MISSION CONTROL		B. Toyoshima	
	MULTI-MISSION TRACKING NETWORK		M. Traxler T. Fogle	
	MULTI-MISSION CONTROL CENTER		R. Polansky D. Beauchamp	
VOYAGER DATA SYSTEM DEVELOPMENT				
	SPACECRAFT		M. Urban	
	GROUND		A. Sacks	

Table 12-2. Some 200 Voyager people will be trying for a Uranus gold medal in January of 1986.

# VOYAGER PROJECT ORGANIZATION

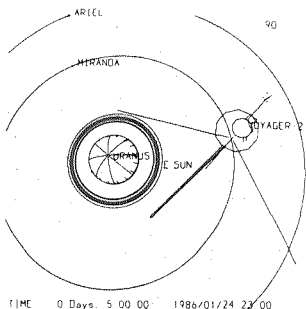
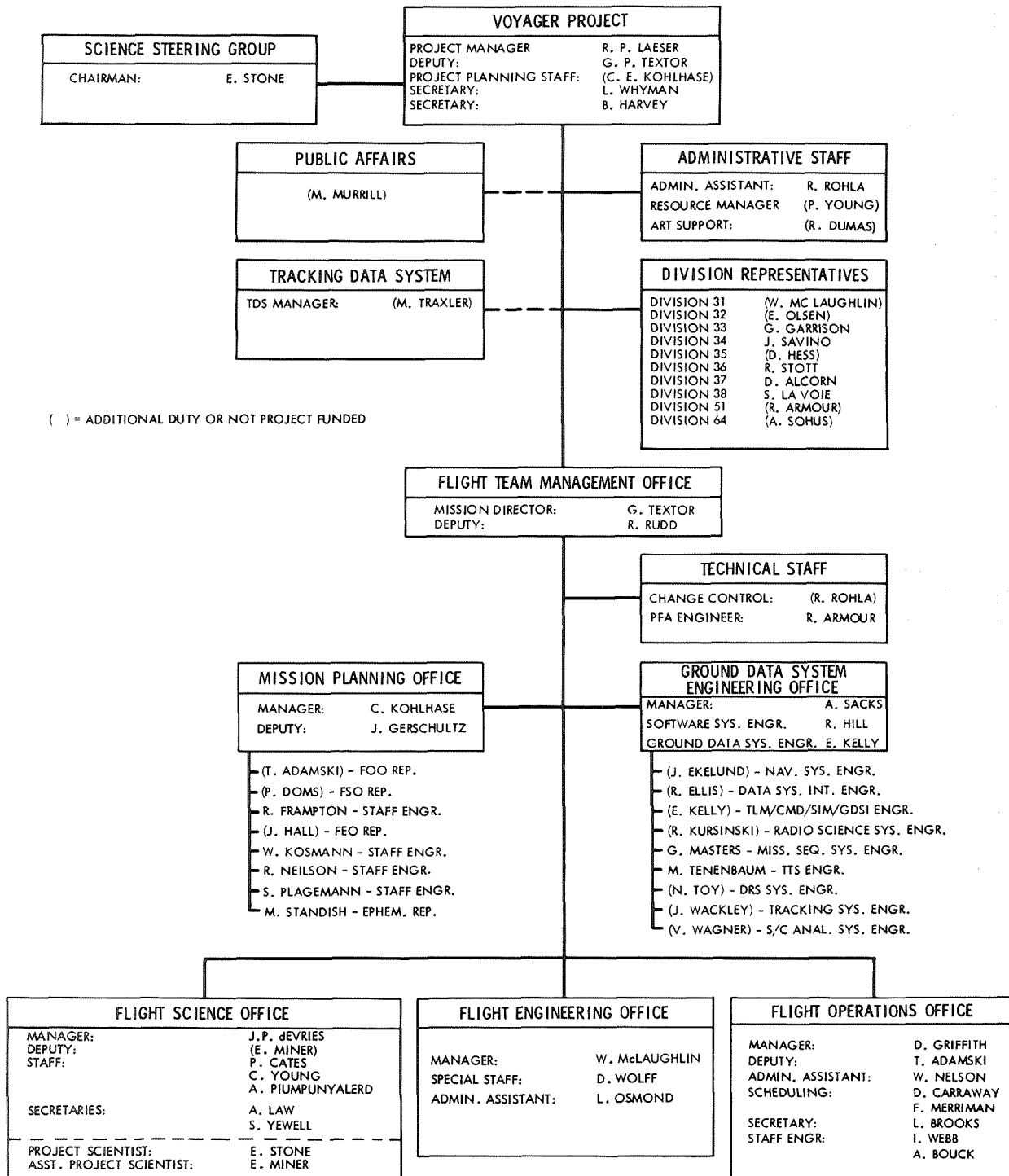
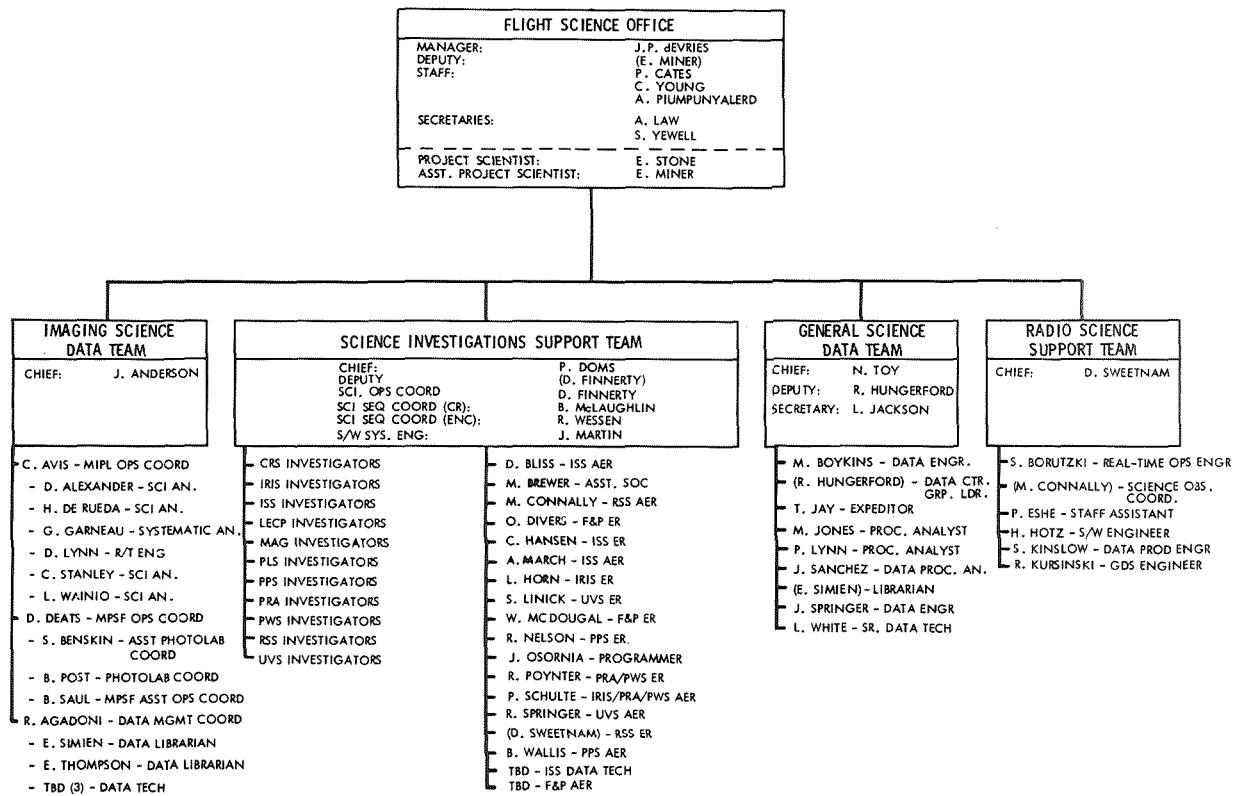

Table 12-2. - continued -



( ) = ADD'L DUTY

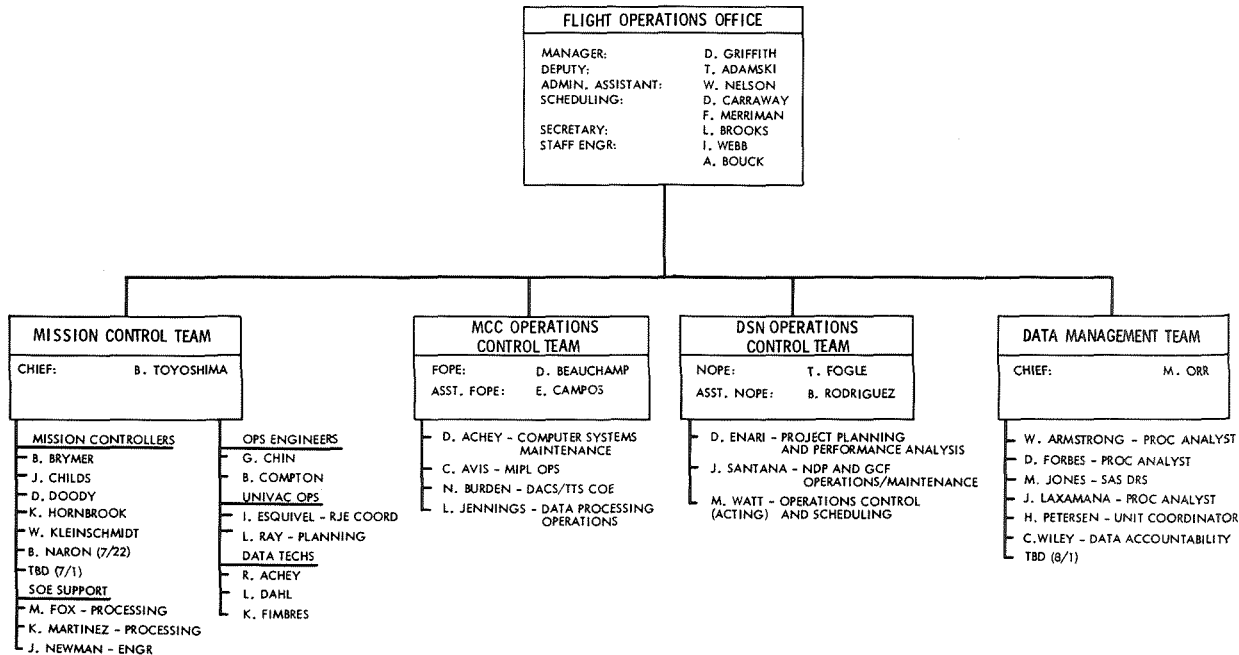
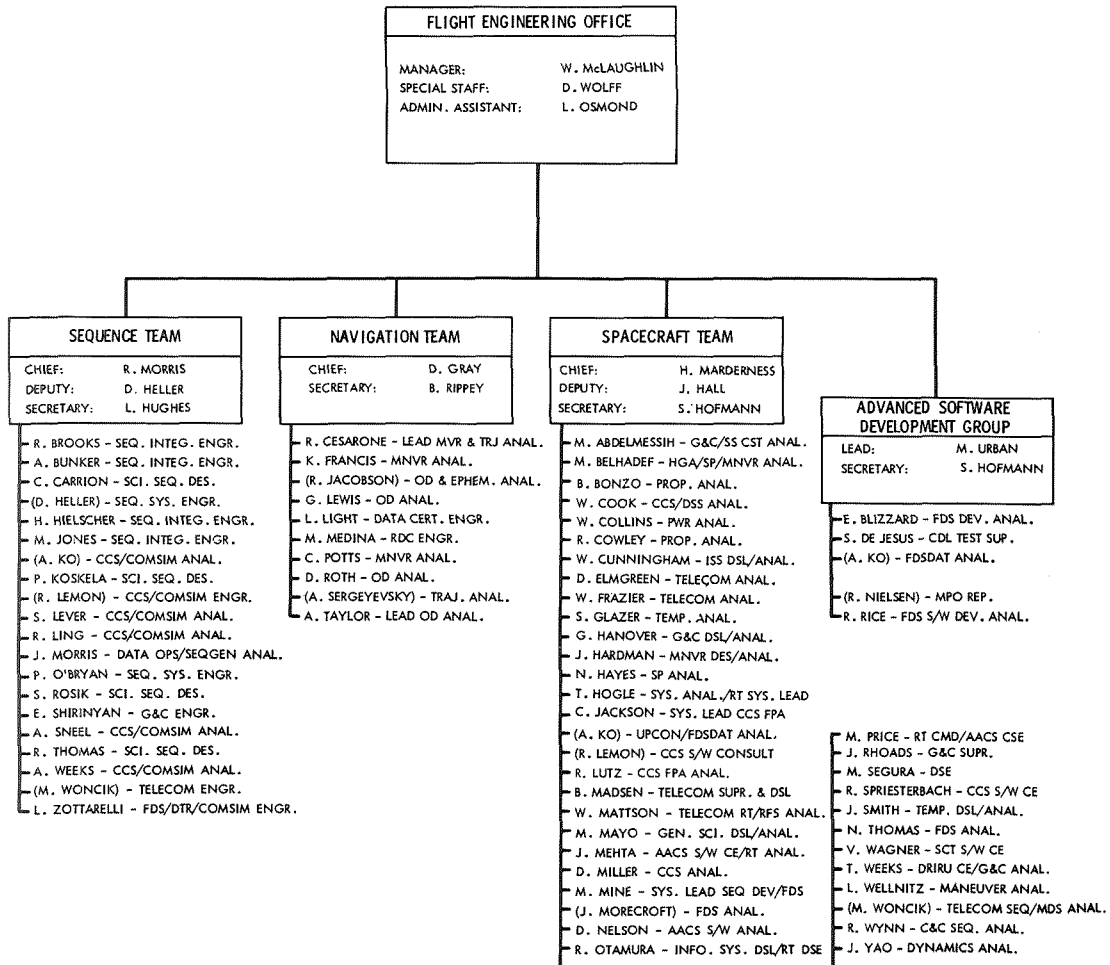
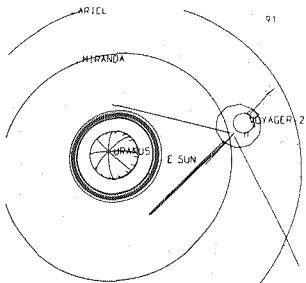

Table 12-2. - continued -



DATE: 8-14-85



The mind of man is capable of anything - because everything is in it, all the past as well as all the future.

Joseph Conrad

### 13. ACKNOWLEDGEMENTS

The Voyager quest is a team effort, and all players have contributed in various ways to this Guide. Special thanks are extended to the following people for their labors in the preparation of this document: R. C. Dumas, R. V. Frampton, J. W. Gerschultz, C. E. Kohlhase, W. J. Kosmann, R. A. Neilson, S. H. Plagemann, and L. F. Whyman.

Thanks are also in order for the exceptional review of this Guide by D. M. Wolff, and for the use of the computer graphics software of J. F. Blinn in producing the Uranus flyby flip-page movie.





The only certainty in the remote future is that radically new things will be happening.

Freeman Dyson

14. INDEX

Achernar . . . . . 61, 90, 92  
Actuators, Scan Platform . . . . . 63-64, 100, 109-110  
Alkaid . . . . . 61, 84  
Andromeda (Ross 248) . . . . . 156  
Antenna, Spacecraft High Gain (HGA) . . . . . 15-16, 58-60, 63, 67, 72, 106  
Ariel . . . . . 15-16, 121  
Arraying . . . . . 26, 75-76, 96, 102-103  
Astronomical Unit (AU) . . . . . 96, 113, 151-158  
Attitude & Articulation Control Subsystem (AACS). . . . . 60-62, 70  
Attitude Control . . . . . 60, 61, 109  
Axes, Spacecraft . . . . . 57-58, 61, 63  
  
Back-up Mission Load (BML) . . . . . 68, 93  
Bus, Spacecraft . . . . . 57-58  
  
Calibration, Science Instruments . . . . . 79, 94  
Camelopardus (AC +79 3888) . . . . . 156  
Canis Major (Sirius) . . . . . 156  
Canopus . . . . . 61, 84  
Canopus Star Tracker (CST) . . . . . 59, 62  
Charge-Coupled Device (CCD) . . . . . 6, 22-23  
Computer Command Subsystem (CCS) . . . . . 22, 69-70  
Command Moratorium . . . . . 68-69, 83-84  
Contingency Sequences . . . . . 92-93  
Cosmic Ray Subsystem (CRS) . . . . . 59, 72-73, 92, 151, 153  
Cost, Voyager Mission . . . . . 105-106  
Cruise Science Maneuver (CRSMVR) . . . . . 80  
  
Data Return . . . . . 106, 112  
Deadband (Limit Cycle Motion) . . . . . 62, 100, 108  
Deep Space Network (DSN) . . . . . 24-26, 96, 102-103, 106, 152  
    Arraying . . . . . 26, 75-76, 102-103, 152

Canberra DSCC . . . . .	26, 96
Complex Monitor Control (CMC) . . . . .	102-103
Goldstone DSCC . . . . .	25
Link Monitor Control (LMC) . . . . .	102-103
Madrid DSCC . . . . .	26
Mark IVA Conversion . . . . .	102-103
Signal Processing Center (SPC) . . . . .	102-103
Digital Tape Recorder (DTR) . . . . .	66-67, 102-103, 110
Discoveries . . . . .	3-5, 125-141
Distance . . . . .	.96, 110, 113-120, 123, 152, 155-158
Doppler Shift . . . . .	42-43
Earth . . . . .	41, 113, 155
Ecliptic Plane . . . . .	116, 147, 155
Event Times . . . . .	117, 121-122
Exposure Times . . . . .	34, 98-99, 143-144
Failure Protection Algorithm (FPA) . . . . .	66-69, 108
Far Encounter Phase . . . . .	80-81
Flight Data Subsystem (FDS) . . . . .	70-72, 97-98
Flight Operations Office (FOO) . . . . .	24-25
Fomalhaut . . . . .	61, 90
General Relativity, Test of . . . . .	43
Golay Data Encoder . . . . .	71, 97, 100
Grand Tour . . . . .	113-114, 143
Ground Communications Facility (GCF) . . . . .	25
Ground Data System (GDS) . . . . .	28
Halley Comet Missions . . . . .	24, 94
Heliopause . . . . .	115, 150-154
Hydrazine . . . . .	61, 111, 152
Image Data Compression (IDC) . . . . .	34, 71, 97, 100
Image Motion Compensation (IMC) . . . . .	6, 84, 86, 98-99, 102
Imaging Science Subsystem (ISS) . . . . .	32-34, 47, 49, 72-73, 111, 153
Infrared Interferometer and Spectrometer (IRIS) . . . . .	34-36, 47, 49, 52, 64, 72-73, 81
Instruments, Science . . . . .	32, 59, 63, 72-73
Instruments, Calibrations . . . . .	79, 94

Jupiter . . . . .	4, 113, 118, 125-131, 145
Atmosphere . . . . .	125-128
Magnetosphere . . . . .	108, 132
Rings . . . . .	128, 129
Satellites . . . . .	110, 128-131
Key Events . . . . .	120-121
Lagrangian Satellites . . . . .	17
Lifetimes . . . . .	151, 152
Light Travel Time . . . . .	117, 144
Light Year . . . . .	116, 154, 156
Limit Cycle Motion (Deadband) . . . . .	62, 100, 108
Low Energy Charged Particle Experiment (LECP) . . . . .	45-49, 72, 73, 151, 153
Magnetometer (MAG) . . . . .	44-45, 47, 49, 72-73, 110, 151, 153
Maneuvers, Spacecraft . . . . .	61, 84
Milky Way . . . . .	114, 158
Miranda . . . . .	15-16, 86, 102, 117, 121
Mission Elements . . . . .	1-4
Mission Control Team (MCT) . . . . .	28
Mission Planning Office (MPO) . . . . .	20-21, 24, 92-93
Movable Block . . . . .	85-86, 91
Multi-mission Image Processing Laboratory (MIPL) . . . . .	28
NASA Communications Network (NASCOM) . . . . .	24
Navigation . . . . .	1-3, 28, 110-111
Navigation Team . . . . .	20, 28, 34, 120
Near Encounter Test (NET) . . . . .	76, 79
Near Encounter Phase . . . . .	82-90
Neptune . . . . .	92-94, 108, 114, 116, 143-150
Nereid . . . . .	144, 146
Oberon . . . . .	15-16, 118, 120-121
Observatory Phase . . . . .	79-80, 121
Occultations . . . . .	12, 37, 39, 41, 66-67, 89-90, 121-122, 146-147
Oort's Cloud . . . . .	116, 153
Optical Navigation . . . . .	1, 34, 76, 82
Parkes Antenna . . . . .	26, 96, 103

Personnel, Voyager Project . . . . .	106, 159-164
Phonograph Record . . . . .	155
Photopolarimeter Subsystem (PPS). . . . .	38-40, 47, 49, 64, 89
Pioneer Spacecraft . . . . .	7, 18, 24, 60, 114-115, 150-155
Plasma Science Subsystem (PLS) . . . . .	45, 47, 86, 151, 153
Planetary Radio Astronomy (PRA) . . . . .	9, 43-44, 47, 86, 89, 151, 153
Plasma Wave Subsystem (PWS) . . . . .	46-48, 82, 86, 89, 151, 153
Pluto . . . . .	112, 114, 143, 153-154
Pointing . . . . .	108
Post Encounter Phase . . . . .	90, 92
Power, Spacecraft . . . . .	64-66, 108-109, 116, 151-152
Priority-1 Science . . . . .	52-55, 86, 120-122
Proxima Centuri . . . . .	112, 154
Public Information Office (PIO) . . . . .	159
Radio Science Subsystem (RSS) . . . . .	39-43, 47, 89-90, 148
Radioisotope Thermoelectric Generator (RTG) . . . . .	59, 64-66, 152
Receiver, Spacecraft (Failure of) . . . . .	67-69
Reed-Solomon (RS) Data Encoder . . . . .	71, 97, 100
Resolution . . . . .	108
Rings . . . . .	4, 7, 17-18, 42, 89, 111, 121-122, 128-129, 135-137, 144
Satellites . . . . .	4-5, 14-16, 111-113, 118, 121-122, 128-131, 137-140
Saturn . . . . .	4, 97, 113-114, 132-141, 145
Atmosphere . . . . .	133-135
Magnetosphere . . . . .	140-141
Rings. . . . .	111, 135-137
Satellites . . . . .	111-112, 137-140
Scan Platform . . . . .	63-65, 101-102, 108-109
Actuators . . . . .	64-65
Siezure . . . . .	63, 93, 101-102
Science Links . . . . .	52-53, 84, 151, 153
Science Investigation Support Team (SIS). . . . .	22
Sequencing . . . . .	2, 6, 22-23
Sirius . . . . .	156
Smear . . . . .	98-100, 108, 143-144
Solar Conjunction Activities . . . . .	80
Solar System . . . . .	113-114

Spacecraft	
Bus . . . . .	57-58
Overview . . . . .	107-110
Resources . . . . .	143, 152
Team (SCT) . . . . .	22-24
Speed . . . . .	43, 113-114, 117, 120, 124
Stars . . . . .	37-40, 153-158
Star Occultations . . . . .	39
Sun Occultation . . . . .	37, 89
Sun Sensor (SS) . . . . .	59, 61-62, 152
Target Plate Maneuver (TGTMVR) . . . . .	79, 92
TCMB 13 . . . . .	80, 121
TCMB 14 . . . . .	81, 121
TCMB 15 . . . . .	92, 121, 122
Telecommunications . . . . .	71, 73, 96-98, 106, 152
Thruster Pulse Width Reduction . . . . .	100
Time . . . . .	114-116, 152-158
Titania . . . . .	15-16, 121
Torque Margin Test (TMT) . . . . .	64, 81, 101, 121
Trajectory . . . . .	75, 110, 114, 119, 146-149, 155-157
Triton . . . . .	114, 143-147, 150
Turns, Spacecraft Commanded High Rate . . . . .	61-62, 101-102
Ultraviolet Subsystem (UVS) . . . . .	36-39, 47, 49, 64, 72-73, 80, 82, 89-90, 153
Umbriel . . . . .	15-16, 121
Uranian System . . . . .	5-18, 117-120, 143-145
Uranus	
Atmosphere . . . . .	11-13
Internal Structure . . . . .	10-11
Magnetosphere . . . . .	12-14
Satellites . . . . .	14-17
Rings . . . . .	17-18
Voyager Neptune Interstellar Mission (VNIM) . . . . .	143, 151, 153