

NASA
Reference
Publication
1256

August 1991

Mission Description and
In-Flight Operations of
ERBE Instruments on ERBS
and NOAA 9 Spacecraft

*November 1984 Through
January 1986*

William L. Weaver,
Kathryn A. Bush,
Chris J. Harris,
Clayton E. Howerton,
and Carol J. Tolson

(NASA-RP-1256) MISSION DESCRIPTION AND
IN-FLIGHT OPERATIONS OF ERBE INSTRUMENTS ON
ERBS AND NOAA 9 SPACECRAFT, NOVEMBER 1984 -
JANUARY 1986 (NASA) 282 P CSCL 04A

N92-10208

Unclas
0000170
H1/43

NASA

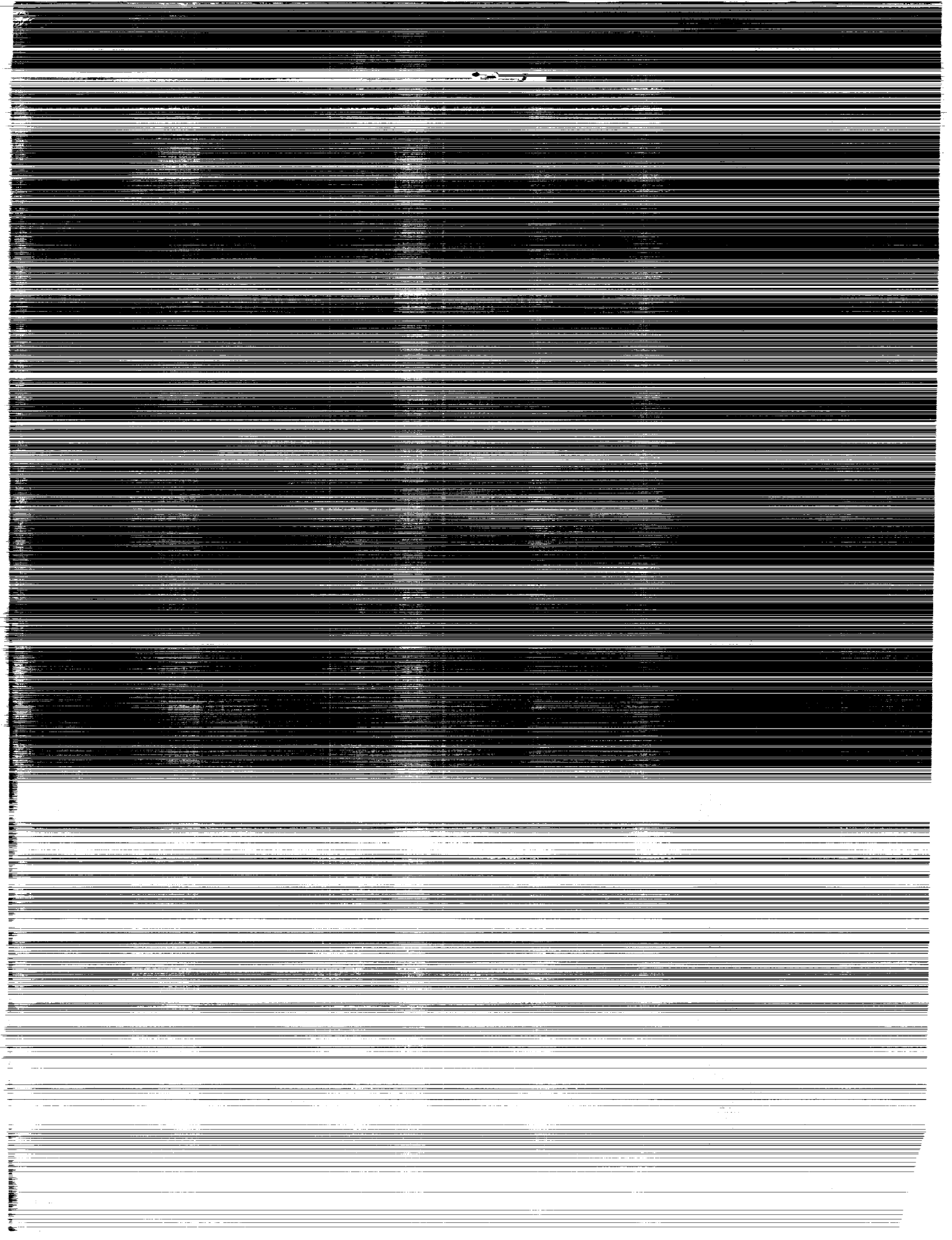

**NASA
Reference
Publication
1256**

1991

**Mission Description and
In-Flight Operations of
ERBE Instruments on ERBS
and NOAA 9 Spacecraft**

*November 1984 Through
January 1986*

William L. Weaver
*Langley Research Center
Hampton, Virginia*

Kathryn A. Bush,
Chris J. Harris,
Clayton E. Howerton,
and Carol J. Tolson
*ST Systems Corporation (STX)
Hampton, Virginia*



National Aeronautics and
Space Administration
Office of Management
Scientific and Technical
Information Program



Contents

Abstract	1
Introduction	1
Nomenclature	1
Acronyms and Abbreviations	1
Symbols	2
Mission Overview	2
Mission Design and Implementation	2
Data Processing and Validation and Distribution of Science Data Products	3
Instrument Design and Operational Capabilities	4
Instrument Design	4
Instrument Operational Capabilities	5
Data Output	6
Coordinate Systems and In-Flight Geometry	7
General Discussion and Analysis of Mission and Instrument Operations	8
ERBS Spacecraft	8
Mission Operational Responsibilities and Activities	8
Earth-Viewing Measurement Operations	9
Calibrations	10
Special Operations	10
Operational Anomalies	11
Monitoring and Analysis of Instrument Housekeeping Measurements	12
NOAA 9 Spacecraft	13
Mission Operational Responsibilities and Activities	13
Earth-Viewing Measurements and Calibrations	14
Operational Anomalies	14
Monitoring and Analysis of Instrument Housekeeping Measurements	15
Discussion and Analysis of Operations Month by Month	15
Introduction	15
ERBS Spacecraft Operations	16
<i>ERBS spacecraft—November 1984</i>	16
<i>ERBS spacecraft—December 1984</i>	18
<i>ERBS spacecraft—January 1985</i>	19
<i>ERBS spacecraft—February 1985</i>	20
<i>ERBS spacecraft—March 1985</i>	21
<i>ERBS spacecraft—April 1985</i>	22
<i>ERBS spacecraft—May 1985</i>	22
<i>ERBS spacecraft—June 1985</i>	23
<i>ERBS spacecraft—July 1985</i>	23
<i>ERBS spacecraft—August 1985</i>	23
<i>ERBS spacecraft—September 1985</i>	24
<i>ERBS spacecraft—October 1985</i>	24



<i>ERBS spacecraft—November 1985</i>	25
<i>ERBS spacecraft—December 1985</i>	26
<i>ERBS spacecraft—January 1986</i>	26
NOAA 9 Spacecraft Operations	27
<i>NOAA 9 spacecraft—February 1985</i>	27
<i>NOAA 9 spacecraft—March 1985</i>	27
<i>NOAA 9 spacecraft—April 1985</i>	28
<i>NOAA 9 spacecraft—May 1985</i>	28
<i>NOAA 9 spacecraft—June 1985</i>	28
<i>NOAA 9 spacecraft—July 1985</i>	29
<i>NOAA 9 spacecraft—August 1985</i>	29
<i>NOAA 9 spacecraft—September 1985</i>	29
<i>NOAA 9 spacecraft—October 1985</i>	30
<i>NOAA 9 spacecraft—November 1985</i>	30
<i>NOAA 9 spacecraft—December 1985</i>	30
<i>NOAA 9 spacecraft—January 1986</i>	30
Concluding Remarks	31
Data Coverage and Archival	31
Operations During Normal Earth-Viewing Measurements	31
Calibrations	32
Solar Environment and Its Effect on the Response and Operation of Instruments	32
Anomalies in the Operation of the Azimuth and Elevation Beams	33
Acknowledgments	33
References	34
Tables	35
Figures	196
Appendix A—Description of Instrument Calibration Procedures and Data From Typical Calibration	228
Calibration Procedures	228
Data From In-Flight Calibrations	229
Nonscanner Calibration	229
Scanner Calibration	230
Sun-Spacecraft Geometry During Solar Calibrations	231
Appendix B—Earth-Sun-Spacecraft Geometry of Earth-Orbiting Satellites	251
Appendix C—ERBE Instrument Data During Typical Periods of Normal In-Orbit Operation	256

Tables

Table 1. Summary Information for RAT and PAT Tapes Archived at the NSSDC . . .	35
Table 2. Spectral Characteristics of ERBE Instrument Detectors	50
Table 3. Operational and Pulse Discrete Commands for Instruments	51
Table 4. Scan Profiles of Scanner Instrument	55
Table 5. List of Data Output by Instruments	57
Table 6. Normal In-Flight Operational Modes of Instruments	59
Table 7. List of Operational Commands Executed by Instruments on ERBS Spacecraft	61
Table 8. List of Operational Commands Executed by Instruments on NOAA 9 Spacecraft	139
Table 9. Characteristics of ERBS and NOAA 9 Orbits on January 1, 1985, and January 1, 1986	194
Table 10. Edit Limits for Key Instrument Housekeeping Measurements	195

Figures

Figure 1. Overview of ERBE data processing	196
Figure 2. Diagram of ERBE instruments illustrating coordinate axes	197
Figure 3. Spacecraft coordinate systems and alignment of axes with instrument axes	198
Figure 4. Alignment between spacecraft and their local horizon coordinates	199
Figure 5. Beta angles (β) for ERBS and NOAA 9 spacecraft orbits	200
Figure 6. Beta angles (β) for ERBS and NOAA 9 spacecraft orbits for each month	201
Figure 7. Daily values of minimum, mean, and maximum scan angles of elevation beam on scanner instrument	206
Figure 8. Daily values of minimum, mean, and maximum housekeeping measurements from nonscanner instrument on ERBS spacecraft	208
Figure 9. Daily values of minimum, mean, and maximum housekeeping measurements from scanner instrument on ERBS spacecraft	214
Figure 10. Daily values of minimum, mean, and maximum housekeeping measurements from nonscanner instrument on NOAA 9 spacecraft	218
Figure 11. Daily values of minimum, mean, and maximum housekeeping measurements from scanner instrument on NOAA 9 spacecraft	224

Appendix A Tables

Table A1. ERBE Instrument Preprogrammed (Automated) Calibration Sequences	232
Table A2. Modified Nonscanner Solar Calibration Sequence Used on ERBS Spacecraft Beginning December 3, 1984	234
Table A3. Azimuth Angle Load Command Sequences	235
Table A4. Preinternal Nonscanner Calibration Command Sequences	236
Table A5. Combined Internal and Solar Calibration Sequences Used Aboard ERBS Spacecraft	237
Table A6. Combined Internal and Solar Calibration Sequences Used Aboard NOAA 9 Spacecraft	239
Table A7. Commands Used in Calibrations Aboard ERBS Spacecraft on December 3, 1984	242

Appendix A Figures

Figure A1. Nonscanner instrument output data during entire calibration period for ERBS on December 3, 1984	245
Figure A2. Output of nonscanner radiometric detectors during ERBS solar calibration on December 3, 1984	247
Figure A3. Scanner output during internal calibration on ERBS on December 3, 1984	248
Figure A4. Response of shortwave detector during ERBS solar calibration	250
Figure A5. Solar azimuth and elevation angles in instrument coordinates on ERBS on December 3, 1984	250

Appendix B Figures

Figure B1. Geometry of Earth-orbiting spacecraft and relationship to Sun	253
Figure B2. Position of Sun at point in Earth-orbiting spacecraft	253
Figure B3. Earth-Sun-spacecraft geometry in a plane containing the Sun and orbit momentum vectors	254
Figure B4. Sun azimuth and elevation angles for ERBS orbit on September 3, 1985	255

Appendix C Figures

Figure C1. Spacecraft and solar position data for ERBS spacecraft orbit on September 3, 1985	259
Figure C2. Instrument output from nonscanner instrument on ERBS spacecraft for September 3, 1985	262
Figure C3. Instrument output from scanner instrument on ERBS spacecraft for September 3, 1985	264
Figure C4. Spacecraft and solar position data for ERBS spacecraft orbit on June 10, 1985	266
Figure C5. Instrument output from nonscanner instrument on ERBS spacecraft for June 10, 1985	269
Figure C6. Instrument output from scanner instrument on ERBS spacecraft for June 10, 1985	271

Abstract

Instruments of the Earth Radiation Budget Experiment (ERBE) are operating on three different Earth-orbiting spacecraft. The Earth Radiation Budget Satellite (ERBS) is operated by the National Aeronautics and Space Administration, and the NOAA 9 and NOAA 10 weather satellites are operated by the National Oceanic and Atmospheric Administration. An overview is presented of the ERBE mission, in-orbit environments, and instrument design and operational features. An overview of science data processing and validation procedures is presented. In-flight operations are described for the ERBE instruments aboard the ERBS and NOAA 9 spacecraft for the period from November 1984 through January 1986. This period covers the first 15 months of operation of the instruments on ERBS and the first 12 months of operation of the instruments on NOAA 9. Calibrations and other operational procedures are described, and operational and instrument housekeeping data are presented and discussed.

Introduction

The objective of the Earth Radiation Budget Experiment (ERBE) is to determine long-term trends in monthly averages of the Earth's longwave and shortwave radiation fields. Three sets of ERBE instruments were launched into Earth orbits. The ERBS spacecraft was launched into a 57° inclination orbit in October 1984, and NOAA 9 and NOAA 10 were launched into Sun-synchronous orbits in December 1984 and September 1986, respectively. The ERBE mission concept is described in reference 1. The ERBE nonscanner instrument is described in reference 2, and the scanner instrument is described in references 3 and 4.

References 5 and 6 discuss results derived from data acquired during the first few months of operation of the ERBE instruments aboard the ERBS spacecraft. Reference 6 also describes the prelaunch instrument calibration efforts and the postlaunch flight data analysis that was performed to validate the ERBE science data. Archival of ERBE science data at the National Space Science Data Center was begun in February 1986, and archival of the first year of ERBE science data from the ERBS and NOAA 9 spacecraft was completed in March 1990.

This paper presents an overview of the ERBE mission design, in-orbit environment, and the design and operational features of the ERBE instruments, as well as an overview of the data processing and distribution system. In-flight operations are discussed for the first year of the ERBS and NOAA 9 missions. Mission operations are discussed in an overview and in a month-by-month format. The ERBS data cover the period from November 1984 through January 1986, and the NOAA 9 data cover the period from February 1985 through January 1986.

Nomenclature

Acronyms and Abbreviations

ACR	active cavity radiometer
AVHRR	Advanced Very High Resolution Radiometer
CAL	calibration
DAC	digital-to-analog converter
Det	detector
ERBE	Earth Radiation Budget Experiment
ERBS	Earth Radiation Budget Satellite
FOV	field of view
FOVL	FOV limiter
GSFC	Goddard Space Flight Center
Hex	hexadecimal
HIRS	High-Resolution Infrared Radiometer Sounder
HK	housekeeping
INT	internal
IVT	Instrument Validation Tape
LaRC	Langley Research Center
LW	longwave
MAM	Mirror Attenuator Mosaic
MFOV	medium field of view
NASA	National Aeronautics and Space Administration
NESDIS	National Environmental Satellite and Data Information Service

NOAA	National Oceanic and Atmospheric Administration
NORAD	North American Aerospace Defense Command
NS	nonscanner
NSSDC	National Space Science Data Center
PAT	Processed Archival Tape
POCC	Payload Operations and Control Center
QC	quality control
RAT	Raw Archival Tape
SAGE	Stratospheric Aerosol and Gas Experiment
SAS	solar aspect sensor
SC	scanner
SMA	Solar Monitor Assembly on nonscanner instrument
SOCC	Satellite Operations and Control Center
SOL	solar
SW	shortwave
SWICS	Shortwave Internal Calibration Source
TDRSS	Tracking and Data Relay Satellite System
temp.	temperature
TIROS	Television Infrared Radiometer Orbiting Satellite
TOA	top of atmosphere
TOT	total
UT	universal time
WFOV	wide field of view

Symbols

\hat{N}	unit vector in direction of orbit angular momentum
\hat{R}	unit vector to Sun
\hat{V}	unit vector in direction of spacecraft velocity
X, Y, Z	coordinate axes

α	azimuth angle, deg
β	angle between Sun and orbit angular momentum vectors, deg
ζ	zenith angle in local orbital reference coordinate system, deg
θ	elevation angle of Earth's limb, deg
ϕ	elevation (scan) angle, deg
Subscripts:	
E	ERBS
LH	local horizon
N	NOAA
NS	nonscanner
S	Sun
SC	scanner

Mission Overview

Mission Design and Implementation

The goal of the Earth Radiation Budget Experiment is to produce monthly averages of longwave and shortwave radiation parameters on the Earth at regional to global scales. Preflight mission analysis led to a three-spacecraft system to provide the geographic and temporal sampling required to meet this goal (ref. 7). Three nearly identical sets of instruments were built and launched on three separate spacecraft. These instruments differ principally in the spacecraft interface electronics and in the field-of-view limiters for the nonscanner instruments required because of differences in the spacecraft orbit altitudes.

The ERBS spacecraft was launched by Space Shuttle *Challenger* in October 1984 and was the first spacecraft to carry ERBE instruments into orbit. ERBS was designed and built by Ball Aerospace Systems under contract to the NASA Goddard Space Flight Center (GSFC), and ERBS was the first spacecraft dedicated to NASA science experiments to be launched by the Space Shuttle. ERBS carries the Stratospheric Aerosols and Gas Experiment (SAGE II) in addition to the ERBE instruments. The Payload Operation and Control Center (POCC) at GSFC directs operations of the ERBS spacecraft and the ERBE and SAGE II instruments, employing both ground stations and the Tracking and Data Relay Satellite System (TDRSS) network. Spacecraft and instrument telemetry data are received at GSFC where the data are processed by the Information Processing Division that provides ERBE and

SAGE II experiment tapes to the NASA Langley Research Center (LaRC).

The second and third spacecraft launched with ERBE instruments are Television Infrared Radiometer Orbiting Satellite (TIROS) N-class spacecraft, which are part of the NOAA operational meteorological satellite series. The NOAA 9 and NOAA 10 spacecraft were launched in December 1984 and September 1986, respectively. The NOAA spacecraft include other instruments, such as the Advanced Very High Resolution Radiometer (AVHRR) and the High-Resolution Infrared Radiometer Sounder (HIRS), which provide NOAA with data for near-real-time weather forecasting. Both spacecraft are in nearly Sun-synchronous orbits. The equator-crossing times of the ascending nodes for the NOAA 9 and NOAA 10 orbits at launch were 14:30 UT and 19:30 UT, respectively, where UT denotes universal time. The Satellite Operations and Control Center (SOCC) at the National Environmental Satellite and Data Information Service (NESDIS) operates the NOAA spacecraft. NOAA also provides decommutation processing of the telemetry data and generates ERBE data tapes for LaRC.

NASA tracks the ERBS spacecraft, and the North American Aerospace Defense Command (NORAD) tracks the NOAA spacecraft. The tracking data are provided to GSFC where orbit ephemeris data are calculated for all three spacecraft and provided on magnetic tapes to LaRC.

Data Processing and Validation and Distribution of Science Data Products

The Langley Research Center has the responsibility of processing and validating all science data from the ERBE mission and of distributing the resulting data products to the science community. The processing and validation of the data are done in close cooperation with the ERBE science team members who provide the required science data processing algorithms. The ERBE data processing system at LaRC uses a modular software subsystems approach to process the ERBE data, starting with the input telemetry and ephemeris data from GSFC and NOAA and ending with the production of the required science data products.

The diagram in figure 1 shows the major steps in the science data processing, together with the primary input and output data products. The first step in this processing procedure is to ingest 24 hours of telemetry data from the ERBS, NOAA 9, or NOAA 10 spacecraft into the front-end processing

subsystem of the Data Processing System. The processing at this step accounts for spacecraft differences and for differences in the data acquisition and handling systems of the ERBS and TIROS N satellites. The data are organized into a format that is common to data from GSFC and NOAA. Extensive data quality editing and evaluation are performed, including the checking of quality flags appended by the tracking networks and processing systems at GSFC and NOAA. The operational status of the instruments is determined, and all instrument housekeeping data and selected spacecraft housekeeping measurements are converted to engineering units and edited. Pointing vectors for the optical axes of the detectors are calculated in a local horizon coordinate system at the spacecraft.

The 8-day ephemeris data sets are processed and validated separately before combining them with the corresponding telemetry data. Orbital data are tested for consistency with data from the previous week, and tests are performed to verify the consistency of the orbit calculations between 1-minute data points. The tests include checks for in-plane and out-of-plane consistency and precision. The routine verification processing and other analyses performed to verify the accuracy of the ephemeris data have generally demonstrated accurate orbit determination for both the ERBS and NOAA spacecraft (ref. 8).

The next major processing stage begins with the merging of the output data from telemetry processing with data output from ephemeris processing. The field-of-view (FOV) locations on a surface at the top of the Earth's atmosphere (TOA) are determined for every radiometric measurement. The FOV locations are more critical for the scanner measurements than those of the nonscanner because of the smaller FOV of the scanner instrument. A FOV accuracy analysis reported in reference 8 has shown that the calculated locations of the scanner measurements are well within the FOV footprint of the instrument on the Earth. A Raw Archival Tape (RAT), containing the raw Earth-located radiometric measurements, is generated at this processing stage. The RAT, which provides a historical record of the raw measurements, is archived at the National Space Science Data Center (NSSDC) in Greenbelt, Maryland.

At this processing stage, the raw measurements for each radiometric detector are also converted to incident radiances at the spacecraft. The conversion algorithms employ calibration coefficients that are based primarily on ground-based calibration data, but which are updated with results from in-flight calibrations. An Instrument Validation Tape (IVT) that

combines all known information about the detector measurements into a single data record is produced.

In the inversion processing stage, data from the scanner detectors are used to identify the type of scene or source at the TOA that produced the raw radiometric measurements. Based on the scene type and geographical location, the scanner measurements are adjusted to account for changes in the spectral response in each detector. Using the selected scene type, one of several angular directional models is selected for inverting or reducing the measurements from satellite altitude to radiant fluxes at the TOA. The nonscanner measurements are inverted using scene information determined during scanner data processing and two different inversion algorithms. One algorithm employs geometric shape factors and the other employs numerical filtering. An archival product, called the Processed Archival Tape (PAT), is produced at this point to retain detailed time histories of estimates of the radiant fluxes at the TOA.

The time-ordered estimates of TOA fluxes are sorted into spatial sequences for both the scanner and nonscanner measurements, grouping all estimates for a month together on a regional basis. A full calendar month of estimates is then retrieved for each region of the Earth. Hourly, daily, and monthly estimates of several different parameters are derived by interpolation using directional models that describe the temporal variation of the radiation budget components. Archival products of monthly averages of radiation components for both the scanner and nonscanner are produced at this point.

Several archival products are produced at the final stage of data processing (fig. 1). The nested averages product gives values of the scanner and nonscanner fluxes from each instrument averaged over various spatial scales. The processing at this stage also combines data from all available spacecraft to produce a combined-satellite product of TOA fluxes averaged over the same spatial scales. An archival product of solar monitor measurements is also produced to provide time histories of solar calibration data. Finally, a scene validation product is produced that combines ERBE data with measurements from the AVHRR and the HIRS instruments. Data from these two NOAA instruments are used to validate the scene identification algorithm. All archival data products are distributed first to the ERBE Science Team for review and validation and then to NSSDC for archival.

Table 1 presents summary information about the RAT and PAT tapes for both ERBS and NOAA 9

spacecraft for each month of operation covered in this paper. The information includes the percentage of data output on the RAT and on the PAT, the date of archival at the NSSDC, and a notation on special operational events during the month.

Table 1 presents the data from ERBS and NOAA 9 in chronological order. However, the data were not processed in that order. To validate the operation of the instruments and the data processing system, a single month was selected from each quarter of the first year of operation of both satellites. These months were April, July, and October 1985 and January 1986. For ERBS, November 1984 was also selected as a validation month. Within each of these months, 4 days at weekly intervals were chosen for intensive evaluation. During the initial data processing, these days were used for repeated testing of the algorithms and coefficients for interpreting the instrument measurements. The Data Management and Science Team members at LaRC analyzed and validated all the data products from these months before the data were distributed to other Science Team members for final review. After approval from the Science Team, the data products were archived at the NSSDC for access by the wider science community.

Instrument Design and Operational Capabilities

Instrument Design

An overview of the instruments and their operational features and capabilities is provided in this section. This information, together with the description of the in-flight coordinate systems in the next section, will be helpful in following the discussion of the in-flight operations and analysis. More information on the design of the ERBE instruments can be found in references 2 and 3.

The ERBE nonscanner and scanner instruments (see fig. 2) have several important design features in common. The baseplate attaches the instrument structurally to a spacecraft, and the pedestal houses the major part of the instrument electronics. The contamination covers were designed to protect the detectors from gases and aerosols until the instruments were uncaged and checked out in orbit. Both instruments have rotating azimuth and elevation beams, thus giving them the capability to rotate the optical axes of the detectors in two degrees of freedom. The fixed and rotating coordinate axes systems of the instruments are described in the next section. Both instruments can perform two different types of in-flight calibrations: solar calibrations using the Sun

as the calibration source, and internal calibrations using temperature-controlled blackbodies and special Shortwave Internal Calibration Sources (SWICS). Both instruments have microprocessors that process and execute ground-commanded or stored commands to direct and control their operation.

The nonscanner instrument, shown in figure 2(a), consists of five detectors located on the head assembly. Four of these detectors have coaligned optical axes for making Earth-viewing measurements, and the fifth detector (the solar monitor) is designed to measure the radiant output of the Sun. The four Earth-viewing detectors are unchopped, active cavity radiometers (ACR's). Each detector sub-assembly consists of a reference cavity and an active cavity. (See ref. 2 for details.) Two of the detectors have wide-field-of-view (WFOV) apertures allowing the detectors to view the entire disk of the Earth; the other two detectors have medium field-of-view (MFOV) apertures that restrict their Earth fields of view to circles with diameters of about 10° in a great-circle arc, or about 1100 km across. The solar ports are openings whose viewing axes are aligned approximately with the viewing axis of the solar monitor, through which the Earth-viewing detectors can view the Sun during solar calibrations. The solar monitor consists of an unfiltered, chopped ACR designed to measure direct solar radiation as a means for calibrating the Earth-viewing detectors. The response time of each of the detectors is about 1 sec.

Two of the Earth-viewing nonscanner detectors (one WFOV and one MFOV) and the solar monitor detector measure total radiation, and the other two Earth-viewing detectors measure shortwave radiation. The spectral characteristics of the five detectors are listed in table 2(a). The shortwave spectral bands are achieved by use of fused silica-dome filters placed over the detectors.

The nonscanner instrument has two internal calibration sources. A temperature-controlled blackbody is used to calibrate the total detectors, and the SWICS assembly is used to check the stability of the shortwave detector. The SWICS has a tungsten filament lamp source coupled to a fiber optic assembly to illuminate the shortwave detector. The tungsten lamp is driven by a constant current source that can be commanded to three levels of output, in addition to a zero (off) level.

The scanner instrument has three coaligned detectors that are located on the instrument as illustrated in figure 2(b). Each detector consists of an active and a compensating thermistor bolometer flake. The three detectors are essentially identical in design

except for optical filters on two of the detectors that restrict their spectral ranges to only a portion of the Earth's radiation bandwidth. (See ref. 3 for more detail.) The spectral characteristics of the three scanner detectors are listed in table 2(b). Each detector has a solid-angle spatial field of view defined approximately by a 3° angle in the scan plane and a 4.5° angle in a plane that includes the sensor optical axis and is normal to the scan plane. The response time of the detectors is about 12 msec.

Like the nonscanner instrument, the scanner instrument has two internal calibration sources. The longwave and total blackbodies are used to calibrate the longwave and total-radiation detectors, and the SWICS assembly is used to check the stability of the shortwave detector. The scanner-instrument SWICS consists of a tungsten filament lamp in an optics module that is designed to provide a uniform, diffuse short-wavelength source to the scanner-instrument short-wavelength channel. The output of the lamp is monitored by a silicon photodiode to permit normalization of instrument response to the lamp output.

The Mirror Attenuator Mosaic (MAM) assembly of the scanner instrument directs attenuated, diffuse solar energy to the instrument as the Sun moves across the MAM viewing window during solar calibrations. The MAM complements the calibration capability of the scanner instrument SWICS by providing an additional input source to the shortwave detectors and the shortwave portion of the output of the total detectors.

Instrument Operational Capabilities

Both ERBE instruments can operate in several different modes, thus permitting the collection of radiation measurements over a wide range of operational conditions. Each instrument has its own microprocessor to control and direct the various operations. The operation of an instrument can be controlled in two ways: (1) through operation commands, which can change the operational mode of an instrument or store data required in a mode command, and (2) through pulse discrete commands whose functions are to open and close electrical relays.

Table 3 lists the operational and pulse discrete commands for the instruments. Note that two separate commands (on and off) are required for all functions controlled by a pulse discrete command. There are two basic types of instrument operation commands: (1) mode commands, which modify the actual operations of the instrument, and (2) data storage commands, which input and store data required

for some operational modes. A mode command requires a single three-digit hexadecimal (Hex) value, whereas a data storage command requires three values: an address value to identify the mode command affected by the data and two data bytes containing the data values required. The first digit of a mode command is "8," and the final two digits identify the specific command to be executed. The first digit of a data address command is "4," and the final two digits identify the mode command to receive the data. A "2" in the first digit of a data command is followed by two digits that represent the high-byte part of the actual data value to be stored. A "1" in the first digit of a data command is followed by two digits that represent the low-byte part of the data value.

A new mode command can be processed and executed in 32 seconds by either instrument on both spacecraft. This instrument execution period is based on the major frame period of the telemetry system of the NOAA 9 spacecraft. The three data storage commands must be executed in the specific order of address command, high-byte data, and low-byte data. Thus, a new set of data to be used in a mode command requires 96 seconds to process and store.

Each instrument has several operational categories. (See table 3.) An instrument can be directed to change operational modes within each operational category independent of its specific mode within other categories. For example, the scanner instrument can be directed to rotate in azimuth from 0° to 180° while the instrument remains in any one of the allowable scan modes.

Both instruments can operate at azimuth angles between 0° and 180° . The azimuth beam can be commanded directly to rotate to 0° , 9° , or 180° , or it can be commanded to rotate to the azimuth angle stored at the appropriate data storage address when commanded to rotate to azimuth angle position A or B. Note that the nonscanner has only one commandable azimuth angle position, A.

Table 3(a) shows that the nonscanner elevation beam can operate at three positions: 0° (nadir), 78° (solar ports), and 180° (stow or internal calibration position). The scanner instrument, however, has three Earth scan modes, a stow mode, and a solar calibration or MAM scan mode. (See table 3(b).) The MAM scan mode is used to view the Sun in the MAM window during solar calibrations, and the stow mode is used to stow the instrument against risk of danger.

Table 4 lists the nominal scan elevation-angle positions and views (Earth, space, MAM, and inter-

nal) for each of the 74 radiometric measurements in a 4-second scan cycle for the normal Earth scan mode, the short scan mode, and the solar calibration or MAM scan mode. In the normal Earth scan mode the detectors make 8 measurements while viewing space and then make 62 measurements while scanning the Earth from limb to limb. The detectors then accelerate to the position of the internal calibration sources for four measurements before retracing to begin another scan cycle. The short scan mode is identical to the normal Earth scan mode except that the scan beam stops when it reaches a scan position of about 142° (view still on Earth), where the remaining 12 measurements in the scan cycle are made. The short Earth scan mode is used to prevent the detectors from directly viewing the Sun when it is above the Earth limb.

The nonscanner Solar Monitor Assembly (SMA) shutter command causes the solar monitor shutter to cycle on and off to chop the solar input to the solar monitor detector during solar calibrations. The detector heaters control the temperatures of the heat sinks that surround the Earth-viewing radiometric detectors to the temperature values that are stored at the address of the heat sink data commands. The solar port heater command heats the solar ports, and the blackbody heater command heats the blackbody sources to the temperature values stored at the appropriate addresses. A detector calibration heater command produces a bias in the output of all the Earth-viewing radiometric detectors at one of three different levels. These biases prevent the output of the detectors from going off scale during internal and solar calibrations. The SWICS commands activate the shortwave internal calibration sources for calibration of the shortwave detectors.

When an instrument receives one of the automated calibration mode commands (8A1 or 8A2) listed in table 3, it executes a sequence of commands that is preprogrammed into the instrument computer memory. No other commands can be executed by an instrument while an automated calibration sequence is in progress. Appendix A describes these automated calibration sequences and how they are used in conjunction with other commands during calibrations. Appendix A also presents data acquired during typical calibrations and describes the in-orbit geometry during solar calibrations.

Data Output

The ERBE nonscanner instrument output consists of a complete cycle of radiometric and house-keeping measurements every 16 seconds, and the scanner instrument output consists of four 4-second

scan cycles of radiometric and housekeeping measurements during the same 16-second period. The ERBS spacecraft telemetry system has a 16-second major frame period and processes and transmits a 16-second cycle of the ERBE instrument output and other data every major frame. The telemetry system on the NOAA 9 spacecraft has a 32-second major frame period and processes two 16-second cycles of ERBE-related data every major frame.

A list of the data output by both instruments in a 16-second record is shown in table 5, which indicates the specific instrument data that are on the RAT and PAT and the units of each data quantity. Note that the RAT contains all the data output by each instrument and that most of the housekeeping measurements have been converted to engineering units. The PAT, on the other hand, contains the converted values of the radiometric measurements and none of the housekeeping data. The nonscanner instrument data in a 16-second cycle consist of 100 radiometric measurements (20 each from the 5 radiometric detectors) and 80 housekeeping measurements. Measurements from the five radiometric detectors are made every 0.8 second in the order shown in table 5(a). Nonscanner instrument housekeeping data are sampled at 4-, 8-, or 16-second intervals. The housekeeping data include temperature and voltage measurements, azimuth and elevation position data, and instrument command and status information.

Each of the 3 scanner detectors makes 120 measurements in a 4-second scan cycle. This is true for all instrument scan modes, and the measurements of the three detectors are all made within a few microseconds of each other. Only 74 of the 120 measurements from a detector are sampled and output in a 4-second scan cycle. The first eight measurements in a scan cycle, which are made while viewing space (see table 4), are used to derive a zero-reference measurement for the 4-second scan; and the measurement at any other scan position is corrected by subtracting the value of the reference measurement. In addition to the 74 radiometric measurements for each of the three radiometric detectors, a 4-second scan cycle of data consists of the 74 scan position angles that correspond to the radiometric measurements and a set of housekeeping data. A complete list of scanner radiometric and instrument housekeeping data for a 16-second record (four scan cycles) is shown in table 5(b). The scanner housekeeping data include temperature and voltage measurements, azimuth and elevation-position data, and operational command and status information.

Coordinate Systems and In-Flight Geometry

A familiarity with Earth-Sun-spacecraft geometry and associated in-flight coordinate systems is helpful in understanding in-flight operations and instrument data output. Pertinent coordinate systems and in-flight geometry are described here, beginning with a description of the instrument coordinate axes. An additional description of the general Earth-Sun-spacecraft geometry is given in appendix B, which illustrates the important role that the Sun plays in Earth radiation measurement missions.

When discussing detector pointing vectors, it is convenient to assume that the origin of a set of coordinate axes is at the focal point of the detector of interest. Figures 2(a) and 2(b) illustrate the fixed and rotating axes systems of the nonscanner and scanner instruments, respectively. The fixed axes of the nonscanner instrument are noted by the subscript NS , and the fixed axes of the scanner instrument are noted by the subscript SC . The axes of the rotating azimuth beam are noted by the subscript α , and the axes of the rotating elevation beam are noted by the subscript ϕ .

The azimuth beam of either instrument has a single degree of freedom relative to the fixed axes, permitting the entire head assembly (the structure below the pedestal) to rotate about the fixed X -axis. The rotating α -axes are coaligned with the fixed axes when the azimuth angle α is zero. A positive rotation (clockwise) about the fixed X -axis of either instrument produces a positive azimuth angle (α), which is measured from the fixed Z -axis. The azimuth beam of either instrument can rotate between angles of 0° and 180° .

The nonscanner elevation beam can rotate in one degree of freedom relative to the azimuth beam, permitting the optical axes of the four Earth-viewing detectors to rotate about the Y_α -axis. Figure 2(a) shows the alignment of the rotating ϕ -axes with the fixed and rotating α -axes of the nonscanner instrument when the elevation angle ϕ is zero. A negative (counterclockwise) rotation about the rotating Y_α -axis of the nonscanner instrument produces a positive elevation angle (ϕ), which is measured from the fixed X -axis. The elevation beam can operate at 0° (nadir), 78° (solar ports), and 180° (internal calibration source). The optical axis of the solar monitor is fixed on the azimuth beam at an elevation angle of 78° , which is 12° down from the spacecraft horizon.

Like its counterpart on the nonscanner instrument, the elevation or scanner beam shown in

figure 2(b) can rotate in one degree of freedom relative to the azimuth beam, permitting the optical axes of the three Earth-viewing detectors to rotate about the Y_α -axis. A positive rotation about the rotating Y_α -axis produces a positive scan (elevation) angle ϕ , which is measured from the rotating Z_α -axis. Figure 2(b) shows the alignment of the rotating ϕ -axes when the elevation or scan angle is 90° . The Z_ϕ -axis is aligned with the optical axes of the Earth-viewing detectors and is, therefore, aligned with the rotating Z_α -axis when the angle ϕ is 0° . The scanner elevation beam can rotate between angles of 14° (the space look position for Earth scan modes) and 233° (the position of MAM). The optical axis of the MAM assembly is fixed on the azimuth beam at an elevation angle of 11° (down from the horizon).

Figure 3 illustrates how the fixed axes of the ERBE instruments are aligned with the axes of the spacecraft on which they are mounted. The ERBS spacecraft axes have the subscript notation E (ERBS), and NOAA spacecraft axes have the subscript notation N (NOAA). As in figure 2, NS refers to nonscanner instrument and SC refers to scanner instrument. Note that only the orientation of these axis systems is important, not the locations of their origins. The positive Y -axis of the ERBS spacecraft is in the direction in which the solar panels are tilted, and the positive Z -axis of the NOAA spacecraft is parallel to the axis of the boom that supports the spacecraft solar panel.

Figure 4 illustrates how the axes of the two spacecraft are aligned with their respective in-flight local horizon axes and on which side of the orbit the Sun is positioned relative to the orbit plane or spacecraft velocity vector. Here, \hat{V}_{LH} is the component of the spacecraft velocity vector in the local horizon plane, \hat{N} is the orbit angular momentum vector, and X_{LH} and Z_{LH} are local nadir vectors for NOAA 9 and ERBS, respectively. Shown also in figure 4 is the position of an instrument azimuth beam (α -axes system) relative to the local horizon system when the instrument rotating azimuth axes are aligned with the fixed axes.

The attitude or orientation angles of a spacecraft, which are provided in the telemetry data, are defined relative to the specific local horizon system in which the spacecraft operates. The spacecraft attitude angles and the azimuth and elevation angles of the instruments are used to compute the pointing vectors of the primary radiometric detectors, as well as those of the solar monitor and MAM, in the appropriate local horizon system of figure 4. The pointing vectors for the ERBS spacecraft of figure 4(a) are then trans-

formed into the NOAA 9 local horizon system of figure 4(b), so that all pointing vectors have a common local horizon system. The pointing vectors in this common axes system are used to compute the Earth locations of the primary radiometric measurements. A detailed description of how the pointing vectors and the Earth locations of the scanner detector measurements are computed is given in reference 8.

When the ERBS spacecraft is flying X -axis forward (i.e., the positive X -axis is in the direction of the positive spacecraft velocity vector), the Sun is normally on the right side of the ERBS orbit (looking down range or down the velocity vector). When the Sun crosses the ERBS orbit plane from right to left, the spacecraft is yawed (i.e., rotated about the nadir (or Z_E) axis) 180° to reposition the solar panels so that they tilt to the left side of the orbit. About 36 days later, when the Sun again crosses the orbit plane, this time from left to right, the spacecraft is again rotated 180° . The NOAA 9 spacecraft is in an approximate Sun-synchronous orbit, and the spacecraft always flies with its Y -axis along the negative of the velocity vector with the Sun on the left side of the orbit.

Appendix B describes a local-horizon coordinate axes system in which the Sun's position is normally calculated. The azimuth and elevation angles of the Sun in this system can be related directly to the Sun angles in the instrument axes systems of the ERBE nonscanner and scanner instruments described earlier in this section.

General Discussion and Analysis of Mission and Instrument Operations

The discussion in this section deals separately with the instruments aboard each spacecraft. The discussion for a spacecraft begins with a brief description of operational responsibilities and procedures. Next, a discussion follows of operational activities to check out and evaluate the instruments after launch and orbit insertion. An overview of calibrations and normal Earth-viewing operations is presented, followed by a discussion of special operations, operational anomalies, and an analysis of the instrument housekeeping measurements.

ERBS Spacecraft

Mission Operational Responsibilities and Activities

The ERBS spacecraft and the ERBE instruments aboard it are controlled and operated by NASA at its

Payload Operations and Control Center (POCC) at the Goddard Space Flight Center, Greenbelt, Maryland. The LaRC ERBE personnel are responsible for planning changes in the instrument operation, and the plans are coordinated with POCC personnel who implement the changes. Most of the operational mode commands are executed from commands stored in the spacecraft computer memory. However, commands are sometimes sent directly to the instruments during real-time communication contacts for immediate execution.

The operational status of the instruments and housekeeping measurements are monitored directly at the ERBS POCC during real-time passes. Procedures to follow when problems are detected have been worked out between the operations control and LaRC personnel. Sometimes the procedures require notification of LaRC personnel. A telecommunication link between LaRC and the ERBS spacecraft via the POCC has permitted LaRC personnel to do limited real-time monitoring of the ERBE instrument operations and housekeeping data. This communication link has proven particularly valuable when the resolution of spacecraft or instrument problems has required participation by LaRC personnel.

The ERBS spacecraft was launched into an initial low Earth orbit on October 5, 1984, by the Space Shuttle *Challenger* and into its final orbit on October 10 by its own propulsion system. Several non-scanner internal calibrations were performed between October 10 and October 23. The nonscanner instrument contamination covers were released on October 23. The elevation beam was then rotated to the nadir, or Earth-viewing position, and the instrument began making normal Earth-viewing measurements. The first solar calibration of the nonscanner instrument was on October 25, and additional solar calibrations were performed on October 25 and 29 and November 1. The internal and solar calibrations employed the automated sequences listed in tables A1(a) and A1(c), respectively.

Several scanner instrument internal calibrations were performed between October 10 and October 23 with the elevation beam still in the caged (stowed) position. These calibrations used the automated sequences listed in table A1(b). The scanner instrument was uncaged on October 23 and some of the instrument operational scan modes were exercised, thus causing the detectors to make measurements while viewing the inside of the contamination covers. The contamination covers were released on November 5 with the instrument in the stow position. The instrument was then commanded to the

normal Earth scan mode where it began making normal Earth-viewing measurements.

Table 6 lists the operational modes in which the instruments normally operated during the period of this paper. However, changes from the normal operational modes have been required to obtain calibration data, and the instruments have sometimes operated in special operational modes. Tables 7(a) and 7(b) list the operational mode commands executed by the nonscanner and scanner instruments, respectively, aboard the ERBS spacecraft during the time period of this paper. Tables 8(a) and 8(b) list the same information for the instruments on the NOAA 9 spacecraft. The tables include a description of each mode command executed, its hexadecimal command code, and the date and time of command execution (in hours, minutes, and seconds of Universal Time (UT) and in minutes of universal day). Spacecraft yaw and pitch maneuvers of the ERBS spacecraft are also noted in table 7.

Earth-Viewing Measurement Operations

This section discusses operations when the instruments were making Earth-viewing measurements, which was over 97 percent of the time. Table 6 also shows the temperature values for those commands that require input data. Appendix C discusses data acquired from both instruments on the ERBS spacecraft during a typical period when the instruments were in the operational modes of table 6.

The nonscanner instrument on ERBS normally operated at an azimuth beam angle of 0° and an elevation beam position of 0° . In this configuration the solar monitor assembly was normally on the Sun's side of the orbit. The scanner instrument normally operated at an azimuth angle of 180° and in the normal Earth scan mode. In this operational configuration, the detectors were positioned to view space on the dark side of the orbit at the beginning of each scan cycle. See the "Instrument Operational Capabilities" section (p. 5) and table 4 for a description of the normal Earth scan mode of operation.

All heaters and calibration sources remained off on both spacecraft that are controlled by mode commands during normal operations, except for the non-scanner detector heaters and solar port heaters. Table 6 also lists the normal status or positions of the power relays for both instruments (On = Closed; Off = Open). The positions of these relays, except for those marked with asterisks, are controlled by pulse discrete commands. (See table 3.) The instrument power and either the pulse A or pulse B switches must be on for an instrument to respond to

mode commands and produce output data. The non-scanner calibration power must be on for the detector calibration mode command to activate the calibration heaters, and thus the detector calibration power switch remained on at all times. On the other hand, the scanner blackbody calibration heater is controlled directly by a pulse discrete command. Therefore, the pulse discrete scanner heater commands were inserted into the scanner internal calibration sequences to turn the scanner calibration heaters on and off at the times required (table A1).

Power to the azimuth and elevation motors is controlled directly by the azimuth and elevation mode commands, respectively. The azimuth motor power for either instrument is turned on when a new azimuth mode command is executed and is turned off when the rotation is completed. The elevation motor power for an instrument is turned off and on in the same way by elevation mode commands. The elevation motor power of the scanner instrument on the ERBS spacecraft remained on at all times except during the few cases when the scan head was stowed because of risk to the detectors. The azimuth motor power for either instrument and the elevation motor power for the nonscanner instrument are turned on only for the periods required to respond to azimuth and elevation mode commands.

Calibrations

Most of the in-flight instrument operational mode commands were associated with instrument calibrations. (See table 7.) Appendix A describes the pre-programmed, or automated, instrument calibration sequences used for the instruments on the ERBS spacecraft and how these sequences have been combined with additional commands to facilitate in-flight calibrations. During most of the time period of this paper, internal and solar calibrations of both instruments were performed on alternate Wednesdays. However, there were exceptions to this 2-week calibration procedure, primarily as a result of the extreme beta angles (β) of the ERBS orbit. These calibrations have provided a time history of calibration data that covers the time period of this paper.

Special Operations

For several days in January and August 1985, the ERBS scanner instrument operated with the azimuth beam positioned at 90° for along-track scanning instead of at the normal cross-track azimuth position of 180° . During these periods the scan elevation-beam rotation was in the plane of the orbit. Thus, the field

of view of the Earth measurements during these periods was centered on a line along the orbit ground track. These measurements provided data with a different set of viewing angles than those for the normal cross-track measurements.

Twice during the first year of operation, the ERBS spacecraft was pitched (rotated about the spacecraft Y-axis) 180° . The pitch maneuvers were performed on November 21, 1984, and October 19, 1985. In both instances, β was near 90° (see figs. 5 and 6) so that the Sun was nearly in the orbit plane. The times of the pitch maneuvers are indicated in table 7. With the spacecraft upside down, the scanner detectors made measurements while viewing space in the normal Earth scan mode. The nonscanner detectors made measurements while viewing cold space and while directly viewing the Sun. Table 7 indicates there were a number of commands executed by both instruments during the spacecraft pitch maneuvers. Further discussion of the pitch maneuvers is given in the "Discussion and Analysis of Operations Month by Month" section. (See p. 15.)

A variation in β of the ERBS orbit has resulted in periodic changes to the normal operations of the scanner instruments. Table 9(a) lists some important characteristics of the ERBS spacecraft orbit on January 1, 1985, and January 1, 1986. Table 9(b) shows the same information for the NOAA 9 orbit. The ERBS spacecraft orbit is slightly elliptical. However, the resulting differences in minimum and maximum altitudes have not impacted the ERBE instrument data collection or mission operations. The rotation rate of -3.95 deg/day of the right ascension of the ascending node of the ERBS orbit produces a range of β during the year from 10° to 170° . (See fig. 5(a).) This variation in β has impacted the operations of the ERBE instruments and has produced a wide range of heating conditions for the instruments. The effects of β on the ERBS mission operations and on the instrument housekeeping temperatures are discussed in the "Monitoring and Analysis of Instrument Housekeeping Measurements" section. (See p. 15.) A more general description of how β affects Sun angles at the spacecraft and on the Earth is given in appendix B.

When β is between 10° and 90° for the ERBS orbit, the Sun is on the left side of the orbit, looking downrange. Figure 4(a) (with the X-axis backward) illustrates the geometry for this case. The spacecraft positive X-axis points uprange along the negative velocity vector, and the scanner instrument elevation beam rotates from right to left as one looks down the velocity vector from behind the spacecraft. When β is between 90° and 170° , the Sun is on the right side of the orbit (as illustrated in fig. 4(a)) with

the X-axis forward. In this case, the spacecraft X-axis is pointed downrange and the elevation beam scans from left to right. When β approaches 90° from either direction, the ERBS spacecraft is yawed (rotated about the Z- or nadir axis) 180° to reposition the spacecraft solar panels to tilt to the Sun's side of the orbit. About every 36 days, $\beta = 90^\circ$. The dates and times of the 180° yaw turns are indicated in table 7. During most of the 180° yaw turns, both instruments continued to operate in their normal modes. However, data acquired during the yaw turns are not included in the science data products because the locations of the measurements on the Earth are questionable.

During several days in June and August 1985, β was less than 24° (see figs. 5 and 6), and the ERBS spacecraft was in sunlight continuously during the period. Full-Sun orbits also occurred during several days in December 1984 and in February and December 1985 when β was greater than 156° . The scanner instrument operated in the short scan mode during most of these full-Sun periods, except in December 1985 when it operated at an azimuth position of 145° . These operations were performed to prevent the scanner instrument detectors from directly scanning the Sun when the Sun was above the limb of the Earth and below the horizon of the spacecraft at an azimuth angle α of 180° . (See table 4 for a description of the short Earth scan mode.) Regularly scheduled calibrations were not performed during the full-Sun periods. Normally, a set of calibrations were performed immediately prior and after the full-Sun periods. Appendix B shows that during the periods of full Sun, the Sun terminator is continuously in the limb-to-limb view of the Earth. Therefore, during these periods, the nonscanner WFOV detectors do not view any regions of the Earth that are totally illuminated or totally dark.

Operational Anomalies

Azimuth-beam rotation anomalies were experienced in orbit for both the nonscanner and scanner instruments aboard the ERBS spacecraft. The azimuth rotation problem is inherent in the design of the azimuth position sensors. The position indicator uses a light source to sense the position, and the design permits exposure to external light, which causes the output counter to reset. The problem is more difficult to deal with because the angular position system senses relative instead of absolute angular position.

Azimuth-beam rotation anomalies were a source of concern from February 1985 until the end of

the period covered by this paper. Problems associated with the azimuth-beam rotation design required significant increases in software development and increased the data processing burden. The major concern was with the scanner instrument. Azimuth-beam position errors can cause mislocation of scanner instrument measurements and can result in the detectors directly scanning the Sun. After a solar calibration in February 1985, anomalous behavior of the azimuth beam on the scanner instrument led to the detectors directly scanning the Sun. As a result of scanning the Sun, the spectral characteristics of the scanner total detector were modified significantly. An analysis was required to determine the actual angle of the azimuth beam of the scanner instrument during the first several days in March 1985 because of the azimuth-beam rotation anomaly in February.

No problems were experienced during elevation-beam rotations of the nonscanner instruments. However, rotation problems were encountered with the elevation beams of the scanner instruments on both the ERBS and NOAA 9 spacecraft during normal Earth-viewing operations and internal calibrations. There was sluggishness in beam rotations of both scanner instruments from time to time, and sometimes the beams hung up or hesitated during normal scan cycles. Analysis using a coastline detection algorithm reported in reference 8 indicated that the problem did not cause serious mislocations in the fields of view of the measurements from the scanner detectors.

One effect of the sluggishness of the elevation beams was to cause misalignment of the radiometric detectors with the internal calibration sources. During some internal calibrations, the misalignment significantly affected the response of the shortwave detectors to the shortwave internal calibration sources. The effect of the scanner elevation beam problem on the output of the scanner instrument detectors during internal calibration is discussed further in appendix A. The scanner elevation problem was investigated in 1985, and the analysis and results of that investigation are reported in reference 9. The investigators concluded that the problem was caused by a faulty bearing lubrication design. Like the azimuth-beam problem, the scanner elevation-beam problem significantly added to the software development and processing burden and also restricted instrument operations.

If the scanner elevation beam is operating smoothly and uniformly in the normal Earth scan mode, the mean value of the 74 scan angles in a 4-second scan period is about 87.9° . The corresponding mean value is about 84.3° when the instrument is operating smoothly in the short Earth scan mode.

Figure 7 shows values of the mean, minimum, and maximum scan angles for both spacecraft for each day during the time period of this paper. Unedited values are based on all scan angles recorded for the day, and edited values are based on data that include only those scan angles that have passed rigorous range and rate-of-change edit tests.

When the computed values based on edited and unedited scan-angle data show corresponding deviations from the true mean, as seen in early January and early February 1985, it means that the degree of elevation-beam sluggishness was not sufficiently severe to cause many angles to be rejected by the editing process. However, when the mean values based on edited and unedited averages are different, as was the case during many days in April through July 1985, it means that some scan angles are excluded during the editing process, probably as a result of sluggish elevation-beam motion. Most of the upward spikes in the data indicate solar calibrations. Periods in December 1984 and in June and August 1985 when the instrument operated in the short Earth scan mode to avoid scanning the Sun are apparent in the data. During the hot-orbit period in February 1985, the instrument operated in the short Earth scan mode for about 3 days and then was stowed for about 5 days.

Monitoring and Analysis of Instrument Housekeeping Measurements

Monitoring housekeeping measurements of the instruments on the ERBS spacecraft was especially important because of the wide range of β angles that produced a large variation in heating on the instruments and required changes in normal operational modes. In the real-time monitoring procedure, the housekeeping measurements were checked against both yellow limits, which indicate that an instrument may be approaching a critical condition, and red limits, which indicate that the instrument is at risk of being damaged. On a few occasions during the time period of this paper, some instrument housekeeping temperatures exceeded their yellow-limit values during some orbits. However, all instrument housekeeping temperatures and voltages have generally remained well within their red-limit bounds.

Analysis of instrument housekeeping measurements performed during the ERBE data processing has produced additional information on the behavior of the housekeeping measurements. The processing produces a complete history of the actual measured values of all housekeeping temperatures and voltages, and it accumulates the minimum, mean, and maximum values of all housekeeping measurements for

each day. The processing includes testing the value of every housekeeping measurement to determine if the value is within specified limits and if its rate of change is less than a specified value. Values used to test the magnitudes and rate changes of selected housekeeping measurements of the instruments on the ERBS spacecraft are listed in table 10. These edit limits are significantly more restrictive than those employed in the real-time monitoring process mentioned above. The more restrictive limits are employed because the output of the radiometric detectors may be affected by temperature or voltage changes before the health of the instrument is actually threatened. The processing procedure identifies data values that exceed the expected input limits.

Figures 8 and 9 are plots of the daily minimum, mean, and maximum values for selected housekeeping measurements of the ERBE instruments aboard the ERBS spacecraft. The plots cover the period from November 1984 through January 1986. Values of the nonscanner heat sink and aperture temperatures and the scanner detector temperatures are computed to a higher resolution than the plotted values, and this difference accounts for the strange-looking behavior of the plotted values of these parameters. The computed resolutions of the nonscanner heat sink and aperture temperatures are 0.013° and 0.010° , respectively, and the computed resolution of the scanner detector temperature is 0.001° . Differences in the minimum, mean, and maximum values of a given housekeeping measurement on a given day were primarily due to in-orbit variations in Sun angles. Changes from day to day in values of the housekeeping measurements are primarily due to changes in the β angle. In general, values of temperatures increased as β approached minimum and maximum extremes. More discussion on β effects is given in appendix B.

The heat sink, aperture, and field-of-view limiter temperatures of the nonscanner instruments (see figs. 8(a), 8(b), and 8(c), respectively) all affect the radiometric output of the Earth-viewing detectors. The heat sink and aperture temperatures of the Earth-viewing detectors are tightly controlled, and therefore their effects are not modeled in the radiometric data-conversion algorithms. However, when values of these measurements are flagged because they fail limit tests, the corresponding radiometric data are rejected from further science data processing.

The heat sink and aperture temperatures varied only about one-tenth or two-tenths of a degree during the 15-month period covered by this paper (figs. 8(a) and 8(b)). The spikes usually indicate calibrations,

and the periods of sustained elevated temperatures are correlated with minimum and maximum values of β . Temperatures of the solar monitor heat sinks and apertures (fig. 8(d)) are not controlled, and their values are more variable than those of the Earth-viewing detectors. Therefore, the effects of the variations of the solar monitor temperatures are modeled in the radiometric data-conversion algorithms during processing of data acquired during solar calibrations. However, because of the extreme heating conditions, solar calibrations are not normally performed during these full-Sun periods.

Temperatures of the FOV limiters of the non-scanner instrument are not controlled, but their values are accurately measured and are included in the radiometric data-conversion algorithms. These temperatures are very sensitive to β (fig. 8(c)). The maximum values occur when $\beta \approx 24^\circ$ or 156° . (The Sun is very near the limb of the Earth.) Some of the FOV limiter temperatures approached their upper-limit edit values when $\beta \approx 24^\circ$ or 156° in December 1984 and in February, June, August, and December 1985. The two small spikes in November 1984 and October 1985 occurred during the period when the spacecraft was pitched 180° .

The blackbodies are used primarily during internal calibrations of the instruments, and variations in their temperatures do not affect the output of the radiometric detectors during normal operation (fig. 8(e)). The nonscanner electronic slice 3 and power converter temperatures (fig. 8(f)) are used primarily in the real-time data monitoring procedures. They are called passive measurements because these temperatures are available in the telemetry data stream even if the ERBE instruments are powered down. These housekeeping temperatures are very sensitive to variations in β , and like the FOV limiter temperatures, their maximum values on ERBS correlate with the periods of β that produce full-Sun conditions (fig. 6). The effects of the spacecraft pitch maneuvers are apparent in most of the housekeeping temperatures (fig. 8).

The temperatures of the detectors varied less than 0.4° during the time period of the paper, and the largest variations are correlated with the periods of minimum and maximum β (fig. 9(a)). The effects of the detector temperatures are still modeled in the radiometric data-conversion algorithms of the scanner instruments. The digital-to-analog converter (DAC) voltages all drifted gradually during the period of this paper (fig. 9(b)). However, the gradual changes in the values of these output voltages have not affected the output of the scanner radiometric detectors, and thus edit-limit values are not shown in

table 10. The instantaneous rate of change in the values of the DAC voltages affects the output of the detectors, and the effects of the rate changes are modeled in the radiometric data-conversion algorithms.

Values of the temperatures of the blackbodies and the two passive analog temperatures from the scanner instrument (figs. 9(c) and 9(d)) are included for comparison with the corresponding measurements on the nonscanner instrument (figs. 8(e) and 8(f)). These temperatures exhibit behavior similar to that for corresponding time periods of the nonscanner instrument and correlate with variations in the β angle of the ERBS orbit. The sharp upward spikes in the blackbody temperatures occur when the blackbody heaters are turned on during internal calibrations. The effects of the spacecraft pitch maneuvers in November 1984 and October 1985 are apparent in the blackbody and passive analog temperatures.

NOAA 9 Spacecraft

Mission Operational Responsibilities and Activities

The NOAA 9 spacecraft and the ERBE instruments aboard it are controlled and operated by the NOAA Satellite Operations and Control Center (SOCC) located in Suitland, Maryland. The operational status of the instruments and housekeeping measurements are monitored during real-time contacts with the spacecraft by SOCC personnel. Procedures to follow when problems are detected have been worked out between the operations control and LaRC personnel, and some of the procedures require notification of LaRC personnel. A telecommunication link between LaRC and NOAA 9 spacecraft via the SOCC has permitted LaRC personnel to do limited real-time monitoring of the ERBE instrument operations and housekeeping data. This communication link has been very helpful, particularly when the resolution of spacecraft or instrument problems has required participation by LaRC personnel.

The NOAA 9 spacecraft was launched into orbit December 12, 1984. Several internal calibrations of the nonscanner instrument were performed before the nonscanner contamination covers were released on December 24. The first nonscanner solar calibration was performed on December 24, and several internal and solar calibrations were performed during January 1985.

Several internal calibrations were performed prior to uncaging the scanner instrument on January 15, 1985. After the instrument was uncaged it was tested in its different scan modes. On January 17 the instrument was commanded to the normal Earth scan

mode, and it remained in that mode while scanning inside the contamination covers until the covers were released on January 31. The instrument was commanded to the normal Earth scan mode, and it began normal Earth-viewing operations. An internal calibration was performed after contamination cover release on January 31, and the instrument was declared operational as of February 1, 1985.

During most of the first year of operation, the ERBE instruments aboard the NOAA 9 spacecraft operated in their normal modes while making Earth-viewing radiation measurements. However, changes in mode operation have been required to obtain calibration data. Also, for August 2-9, 1985, the scanner instrument operated at the along-track azimuth-beam position of 90° instead of the normal cross-track position of 180° . Tables 8(a) and 8(b) list the operational mode commands executed by the ERBE nonscanner and scanner instruments, respectively, on the NOAA 9 spacecraft from February 1985 through January 1986.

The NOAA 9 orbit was nearly Sun-synchronous (see table 9), and β varied only about 15° from January 1, 1985, to January 1, 1986. (See fig. 5(b).) The resulting in-orbit solar environment was more benign and much less variable than that for the ERBS spacecraft. There were no periods during the year when the spacecraft was in full-Sun orbits, and no special spacecraft or instrument operations were required to be performed because of the solar environment. However, β was about 4° less on January 1, 1986, than it was a year earlier. Also, the local time of the ascending node is 16 minutes later on January 1, 1986, than it was a year earlier. These differences result from a faster-than-nominal rate of change in the right ascension of the ascending node of the orbit.

Earth-Viewing Measurements and Calibrations

Table 6 lists the modes in which the ERBE instruments aboard NOAA 9 normally operated for each operational category, together with the data values used during the period for the mode commands that required input data.

The nonscanner instrument on the NOAA 9 spacecraft was expected to operate at an azimuth angle of 170° to prevent interference with the Solar Backscatter Ultraviolet (SBUV) instrument. In fact, the azimuth-beam rotation problem resulted in operation at an azimuth angle of 180° most of the time. The nonscanner instrument normally operated at the Earth-viewing or nadir-pointing elevation-beam position. The scanner instrument normally operated

at the cross-track azimuth-beam position of 0° and in the normal Earth scan mode. Like the scanner instrument on the ERBS spacecraft, the scanner instrument detectors on NOAA 9 spacecraft viewed space on the dark side of the orbit and scanned the Earth from dark to sunlit regions.

All heaters and calibration sources controlled by mode commands remained off during normal operation, except for the nonscanner detector heaters and solar port heaters. Table 6 lists the normal status of the power relays for both instruments on the NOAA 9 spacecraft. The normal positions of the relays are the same as those for the instruments on the ERBS spacecraft.

Most of the in-flight instrument operational mode commands were associated with instrument calibrations. (See table 8.) Appendix A describes the pre-programmed, or automated, instrument calibration sequences used for the instruments on the ERBS spacecraft and how these sequences have been combined with auxiliary commands to facilitate in-flight calibrations. During most of the period of this paper, internal and solar calibrations of both instruments were performed on alternate Wednesdays. These calibrations have provided a time history of calibration data that covers the period of this paper.

Operational Anomalies

Rotation anomalies occurred frequently with the azimuth beam of the nonscanner instrument on the NOAA 9 spacecraft. These anomalies resulted in the azimuth beam of the nonscanner instrument operating most of the time at a beam position of 180° instead of the desired position of 170° . The azimuth-beam position of the nonscanner instrument is sometimes shown on the RAT products as 170° when, in fact, the azimuth beam is actually positioned at 180° . Earth locations of the nonscanner measurements were sometimes calculated using the erroneous position of 170° . However, this error does not affect the accuracy of the locations of the measurements because the detectors are nadir-pointing during normal operation. Problems with azimuth-beam rotations of the instruments on the NOAA 9 spacecraft were a continuing concern, but no serious mishaps ever occurred, such as the one with the scanner instrument on the ERBS spacecraft in February 1985.

Sluggishness in the scanner instrument elevation-beam rotation occurred from time to time, and the elevation beam actually hung up a few times for short periods. As was the case with the scanner instrument on ERBS, the elevation-beam sluggishness affected the output of the scanner detectors during

internal calibrations because of detector misalignment with the internal calibration sources. The data of figure 7(b) indicate elevation-beam sluggishness of the scanner instrument on the NOAA 9 spacecraft for several periods during the first year of operation. The differences between the unedited and edited values of the daily means of the scan angles are greater than those for the scanner on the ERBS spacecraft. These differences were primarily due to values of the scan angle being rejected at the position of the internal calibration sources.

Monitoring and Analysis of Instrument Housekeeping Measurements

On a few occasions during the time period of this paper, some instrument housekeeping temperatures exceeded their yellow-limit values during some orbits. On one occasion in March 1985, the electronic slice 3 temperature of the scanner instrument exceeded the red-limit value, and the scanner instrument was stowed and powered down for a few hours. However, all instrument housekeeping temperatures and voltages have generally remained well within their red-limit bounds.

Table 10 shows the values used in the data processing at LaRC to test the magnitudes and rates of change of selected key housekeeping measurements of the instruments on the NOAA 9 spacecraft. As was the case with ERBS, these limits are much more restrictive than those used in the real-time monitoring.

Figures 10 and 11 are plots of the minimum, mean, and maximum values of key housekeeping measurements for the instruments on the NOAA 9 spacecraft for each day from February 1985 through January 1986. Differences in the values of the housekeeping measurements during a given day are about the same as those for the instruments on the ERBS spacecraft (figs. 8 and 9). However, day-to-day variations in the values of the measurements are not nearly as large as those for the instruments on the ERBS spacecraft because of the smaller variation in the values of the β angle (figs. 5 and 6).

The only variations (0.10°) in the values of the heat sink temperatures of the nonscanner instrument on NOAA 9 occurred during calibrations, and the aperture temperatures varied by only about 0.20° (figs. 10(a) and 10(b)). The behavior of these controlled temperatures was about the same as that for the instruments on the ERBS spacecraft (figs. 8(a) and 8(b)). The mean values of the solar monitor heat sink and aperture temperatures (fig. 10(d)) were nearly constant for β angles above about 57° , and the

maximum values of the temperatures occurred near the minimum value of β (fig. 5(b)).

There was only a slight change in the day-to-day values of the nonscanner field-of-view limiter, blackbody, and passive analog temperatures (figs. 10(c), 10(e), and 10(f)), and the highest values occurred near minimum β (figs. 5 and 6). The spikes in these housekeeping measurements correspond to the periods when the blackbodies were turned on during internal calibrations.

The temperatures of the scanner detectors on the NOAA 9 spacecraft varied about 0.1° during the period covered by this paper, and this variation is only about a quarter of the variation observed for the scanner detectors on the ERBS spacecraft (fig. 11(a)). However, the instrument was turned off for about 12 hours on March 20 because the electronic slice 3 temperature exceeded the red limit. The time when the instrument was turned off is reflected in all the scanner measurements presented in figure 11. The DAC voltages (fig. 11(b)), like those for the instrument on the ERBS spacecraft, all drifted during the first year of operation. The blackbody (fig. 11(c)) and passive analog (fig. 11(d)) temperatures show only a small day-to-day variation, but the times when the blackbodies are turned on during internal calibrations are reflected as spikes in the data.

Discussion and Analysis of Operations Month by Month

Introduction

This section discusses spacecraft and instrument operations for the ERBS and NOAA 9 spacecraft separately for each month, beginning with November 1984 (the first month for which data were archived) and continuing through January 1986. The discussion addresses "percent of data archived" (the percentage of 16-second records archived; see table 1), β angles (see figs. 5 and 6 and appendix B), spacecraft maneuvers (see tables 1, 7, and 8), instrument calibrations (see tables 1, 7, and 8 and appendix A), and other instrument operations (see tables 1, 7, and 8). During most of the period covered in this discussion, the instruments were in their normal operating modes. Special operations are discussed in detail.

Table 1 summarizes spacecraft and instrument operations for both the ERBS and NOAA 9 spacecraft for each month, and it also gives the percentage of data archived to both the RAT and PAT products. An archived record can contain fill data and/or poor quality data that are flagged as bad. However, the percentage of data archived is usually a good

approximation of the percentage of usable data, particularly for data from the ERBS spacecraft. Differences between the RAT and PAT data percentages arise because of data quality problems and because of constraints imposed on the data archived to the PAT. Data quality problems are rarely encountered in the ERBS data, and this is reflected in the small differences, generally less than 1 percent, between the percentages of data archived to the ERBS RAT and PAT. On calibration days the differences are generally on the order of 3 percent, since some data collected during calibrations do not meet the constraints discussed below. On days on which spacecraft maneuvers, such as pitch or yaw maneuvers, are performed, the differences are generally greater than 3 percent, again because some data collected during these maneuvers do not pass the constraints discussed below. Data recovery was nearly always greater from the ERBS spacecraft than from the NOAA 9 spacecraft. The losses in data recovery, as well as the larger differences between the NOAA 9 RAT and PAT data percentages, occur because of less efficient data processing procedures at NOAA. The less efficient procedures at NOAA reflect the fact that NOAA 9 is an operational weather satellite, whereas ERBS is dedicated to the ERBE and SAGE II instruments.

Data included on the RAT are not included on the PAT if certain constraints are not met. For the nonscanner instrument these constraints are that the instrument power must be on, the instrument must be elevated to nadir (Earth-viewing), the instrument must not be in solar or internal calibration mode, and certain quality indicator flags must be set. For the scanner instrument the constraints are that the instrument power must be on, the azimuth motor power must be off, the instrument must not be in solar calibration mode, the instrument must be in one of the Earth-viewing scan modes, and certain quality indicator flags must be set. These constraints ensure that no record is written to the PAT that does not contain at least one good scanner or nonscanner measurement.

Table 7 lists all the operational mode commands executed by the nonscanner and scanner instruments on the ERBS spacecraft during the first 15 months of their operation. Table 8 lists all operational mode commands executed by the nonscanner and scanner instruments on NOAA 9 during the first 12 months of their operation. Most of the commands seen in tables 7 and 8 are associated with calibrations. A description of the calibration sequences is given in appendix A. Tables 7 and 8 are based on the command echo word from the telemetry data processing, which

is an echo of the last command executed by the instrument. Occasionally, a data dropout will obscure a command that was actually received and executed by the instrument, and thus the commands listed in tables 7 and 8 may not exactly reflect instrument operations. When this occurs, it will be noted in the text and tables. Figures 5 and 6 show the β angles for ERBS and NOAA 9 for the entire year and for each month covered in this discussion. Figure 7 shows the daily mean scan angle for both the ERBS and NOAA 9 scanner instruments. Figures 8–11 show the responses of instrument housekeeping temperatures and voltages to the operations discussed in this section, as well as the effects of changes in Earth-Sun-spacecraft geometry.

ERBS Spacecraft Operations

ERBS spacecraft—November 1984. November 1984 was the first month for which ERBE science data were processed for archival, and it was the first of five ERBE data validation months. It was the first data month to be archived to the RAT, in February 1986, and the fifth data month to be archived to the PAT, in July 1988. (See table 1(a).) Although the nonscanner instrument was operational and making Earth-viewing measurements from the beginning of the month, the scanner instrument contamination cover was not released until November 5. Thus, no data from either instrument for the first 4 days in November are included on the RAT or PAT. All nonscanner instrument data on the PAT are valid. However, since the scanner instrument contamination cover was not released until 13:03 UT and Earth-viewing operations did not begin until 15:57 UT on November 5, scanner instrument data on the PAT for times prior to 15:57 UT on November 5 should be ignored. The percentage of data for the month archived to the RAT was 86.58 and to the PAT was 84.77. A 21-percent data loss for the PAT occurred on November 21 because data collected during the pitch maneuver were not archived. Excluding those days for which no data were archived (November 1–4), the percentage of data archived in November was 99.90 for the RAT and 97.81 for the PAT.

As table 7 shows, extensive instrument operations, including numerous nonscanner and scanner internal and solar calibrations, were executed during this month. In addition, the first of many routine yaw maneuvers was performed successfully on November 20, 1984, and the first of two pitch maneuvers was performed on November 21, 1984. The following discussion presents a description of instrument operations followed by a description of the

solar environment and spacecraft operations. In subsequent months, the discussion of instrument operations will follow that of spacecraft operations.

Successful internal calibrations of the nonscanner instrument were performed on November 5, 12, 20, and 26, 1984. The internal calibration of November 5 was the first performed on the ERBS nonscanner instrument after normal operations began. All nonscanner internal calibrations used the automated command sequence in table A1(a). About 100 minutes (approximately one orbit) before the calibration began, the detectors were rotated to the internal calibration source and the WFOV and MFOV blackbody heaters were turned on to temperature level 1. The heaters remained on until the detectors were rotated back to the nadir position just prior to the beginning of the internal calibration. This was a normal procedure for internal calibrations to allow the detectors to become acclimated to the warm internal calibration source prior to the beginning of the actual calibration sequence. The automated sequence ends with the detectors at the internal calibration source, and an additional command to elevate the detectors to the nadir position has to be executed following the last command (SWICS off) in the calibration sequence. No Earth-viewing data are collected during the nonscanner internal calibrations. During all ERBS nonscanner instrument internal calibrations, the MFOV shortwave detector output saturated when the calibration heater was turned on at level 3, and the detector failed to respond when the SWICS was turned on at level 1. A more detailed discussion of calibrations is given in appendix A, and data are presented there for a typical calibration.

Successful solar calibrations of the nonscanner instrument were also performed on November 5, 12, 20, and 26, 1984. The nonscanner solar calibration performed on November 5 began a few minutes after the internal calibration ended and used the automated calibration sequence in table A1(c). This sequence was used until December 3, 1984, when it was replaced with the modified sequence listed in table A2. An explanation of the need for the replacement sequence is given in appendix A. A more detailed discussion of spacecraft and Sun geometry is given in appendix B. The entire sequence of commands associated with the nonscanner internal and solar calibrations lasts about 4 hours. Note that table 7(a) shows that the nonscanner instrument azimuth data were transmitted three times on November 20, 1984. Normally, the azimuth data are loaded once before the beginning of the internal calibration. There is no apparent reason for the duplicate transmissions. The nonscanner instrument was stowed from 11:10 UT to

15:59 UT on November 5 during the release of the scanner instrument contamination cover.

On November 5, 1984, with the detectors scanning the inside of the contamination cover, a scanner internal calibration was performed at 9:11 UT using the automated command sequence in table A1(b). At 11:06 UT on November 5, the scanner instrument was stowed in preparation for the release of the contamination cover. At 13:03 UT the azimuth beam was rotated to 180°. This rotation triggered the release of the contamination cover and positioned the azimuth beam for normal scan operations. The scanner instrument was commanded to the normal Earth scan mode of operation at 15:57 UT, about 3 hours after the opening of the contamination cover. This was the beginning of the ERBE scanner instrument science data collection.

A second scanner internal calibration was performed at about 19:42 UT on November 5, 1984, the first with the detectors viewing the Earth. The scanner instrument does not change scan modes during internal calibrations, and Earth-viewing data acquired during normal scanner internal calibrations are normally included in the final science products. During the calibrations the SWICS is turned on at three different levels to coincide with the times in a scan cycle when the detectors are viewing the calibration sources. More detailed information on scanner internal calibrations and the data acquired during a typical internal calibration is presented in appendix A. Scanner internal calibrations were performed each day on November 6–12, and again on November 20 and 26.

The first scanner solar calibration was performed on November 20, 1984, by using the automated sequence shown in table A1(d). Prior to the solar calibration, the instrument was commanded to the short Earth scan mode to prevent the instrument from scanning the Sun while the azimuth beam was rotating to 0°. The azimuth beam was rotated to 0° to reset the azimuth position counter to a reference value before beginning the rotations required during the solar calibration. The azimuth beam was commanded to position A while continuing the short scan mode. At 10:53 UT the instrument was commanded to the MAM scan mode (see table 4) so that the detectors scanned cold space through the MAM window before viewing the Sun. After scanning cold space at azimuth position A, the scanner instrument rotated to azimuth position B, thus allowing the Sun to pass through the detector fields of view. The instrument then rotated back to position A where the detectors again scanned cold space through the MAM window. The instrument was commanded to the short scan

mode at 11:11 UT in preparation for the rotation back to the normal azimuth position of 180° . The instrument then resumed its normal Earth-viewing operations. A second scanner solar calibration was performed on November 26 following the same sequence of commands. (See table A1(d).) More discussion on scanner solar calibrations is given in appendix A.

The significant variation in the β angle of the ERBS orbit results in periodic changes to the normal operations of the scanner instruments. For a more complete discussion on β , see the "Special Operations" section (p. 10). During November 1984, β decreased from about 53° at the beginning of the month to about 49° on November 5, and then increased to about 128° by the end of the month. (See fig. 6(a).) The spacecraft was configured with its X -axis rearward and the Sun on the left side of the orbit from the beginning of the month until November 20. The first spacecraft yaw maneuver was performed on November 20 at 12:44 UT when β approached 90° . Although β did not reach 90° until November 21, the yaw maneuver was performed 1 day earlier in preparation for a pitch maneuver that was scheduled for the 21st. Normally, yaw maneuvers are performed when β approaches 90° from either direction, about every 36 days. After the yaw maneuver on November 20, the spacecraft flew with its X -axis forward and the Sun on the right side of the orbit for the remainder of the month.

During the yaw rotation on November 20, 1984, the nonscanner instrument remained in its normal Earth-viewing elevation mode, a practice that has continued with subsequent yaw maneuvers. The nonscanner measurements made during yaw maneuvers are not, however, included in the primary science data products because of uncertainty in the spacecraft attitude angles. The scanner instrument elevation beam was rotated to the internal calibration position (stow) at 12:36 UT prior to the yaw maneuver, where it remained until about 13:25 UT, well after the yaw maneuver was completed. The practice of stowing the scanner instrument during yaw maneuvers continued through April 1985, after which the scanner instrument was left in its normal operating mode during yaw maneuvers.

The first of two 180° spacecraft pitch maneuvers was performed on November 21, 1984, when the Sun was very near the spacecraft orbit plane. The second maneuver was performed on October 19, 1985. The pitch maneuvers were requested by the ERBE Science Teams to obtain instrument data while the spacecraft was flying upside down. The upside-down orientation permitted the instruments to make radiometric measurements while viewing space and op-

erating in their normal Earth-viewing scan modes. The scanner instrument test was designed to obtain measurements needed to determine the in-flight electronic noise offsets of the detectors while operating at each elevation position in the normal Earth scan mode. This was the only method by which scanner instrument radiometric measurements could be obtained at all Earth-viewing elevation-beam angles while viewing space in the normal Earth scan mode of operation.

During the pitch maneuver on November 21, 1984, the spacecraft flew upside down for approximately 4 hours. Both the scanner and nonscanner instruments were stowed during the pitch-over maneuver at about 12:50 UT, and again when the spacecraft was pitched back to its normal attitude position of 0° at about 17:11 UT. At 14:22 UT the nonscanner instrument was commanded out of stow and began operating in its normal Earth-viewing elevation mode (in this case, viewing space). The nonscanner instrument executed several commands, such as heaters on and off and various azimuth rotations. In addition to viewing space while in the normal Earth-viewing elevation mode of operation, the nonscanner instrument also made measurements while viewing the Sun directly. The instrument was then stowed for about 30 minutes while several commands were executed. The instrument returned to its normal Earth-viewing elevation mode (still viewing space) at 15:59 UT and remained there for about an hour. At 17:03 UT it was stowed in preparation for the spacecraft rotation back to the normal attitude position. The sequence of operations performed during the pitch maneuver is listed in table 7(a).

The scanner instrument was in stow for the first 2 hours after the pitch maneuver began. The instrument then viewed space while operating in its normal Earth-viewing scan mode for approximately 80 minutes. The scanner instrument was stowed when the Sun was nearly overhead to prevent the detectors from scanning the Sun and was left in stow until after the spacecraft had returned to its normal attitude. Data collected during this period were used to characterize the electronic offsets of the detectors at each scan position.

ERBS spacecraft—December 1984. December 1984 was the first calendar month during which ERBE scanner and nonscanner instruments aboard the ERBS spacecraft collected Earth-viewing data every day. The percentage of data archived to the RAT was 99.86 and to the PAT was 99.55. (See table 1(b).)

The β angle increased from about 130° at the beginning of the month to 170° on December 12, and then decreased to about 97° on December 31. The December 12 β of 170° was the maximum for the year (figs. 5 and 6(a)). Because of the high β , the spacecraft operated in full sunlight from about December 7–18. This was the first month during which the ERBS spacecraft operated in full-Sun conditions. Similar conditions were experienced by the spacecraft in June 1985 when β attained its annual minimum value of 10° , and in December 1985 when β again attained a maximum value of 170° . The β angles and Earth-Sun-spacecraft geometry are discussed in detail in appendix B. The effects of extreme β angles on ERBS instrument operations are discussed in the "Special Operations" section (p. 10).

The extreme β conditions resulted in a much hotter operational environment than that for November, thus causing heating conditions that affected instrument housekeeping temperatures. For the non-scanner instrument these heating effects are clearly seen in the housekeeping temperatures, such as the FOV limiter temperatures of the Earth-viewing channels (fig. 8(c)), the solar monitor heat sink and aperture temperatures (fig. 8(d)), and the blackbody temperatures (fig. 8(e)). For the scanner instrument these heating effects can be seen in the total and longwave blackbody temperatures (fig. 9(c)) and in the passive analog temperatures (fig. 9(d)).

The spacecraft operated with its X -axis positive during the entire month of December 1984. Since β never reached 90° , there was no yaw maneuver during this month.

The non-scanner instrument operated in the normal Earth-viewing elevation mode and at the normal azimuth position of 0° for the entire month except during calibrations. Successful internal and solar calibrations were performed on December 3, 10, and 17, 1984. A successful internal calibration was also performed on December 26. (See table 7(a).) The solar calibration attempted on December 26 was unsuccessful because new azimuth angle data had not been transmitted to the instrument before it was rotated to azimuth angle position A. Thus, the instrument was commanded to the azimuth angle position for the previous solar calibration, and the Sun did not pass through the fields of view of the detectors. A successful solar calibration was performed on December 28 to make up for the calibration missed on December 26.

The automated non-scanner solar calibration command sequence, which was used in previous solar calibrations, was replaced with a new sequence

of commands beginning with the December 3 non-scanner solar calibration (table A2). The new sequence had to be executed from the spacecraft memory bank rather than from an instrument-stored pre-programmed instrument command sequence. During previous solar calibrations, which used level 1 to bias the detector heaters, the output of the MFOV total radiometric detector had gone off scale while viewing the Sun directly. The new sequence uses level 2 instead of level 1 to bias the detector heaters. (See table 7(a).) The output of all four detectors is affected by the bias level change because the four bias heaters cannot be commanded individually. Another change from the automated command sequence was to leave the solar port heaters on, as they normally are during Earth-viewing operations, during the entire calibration sequence instead of turning them on and off several times as was done in the automated sequence. The new calibration sequence was used for all subsequent non-scanner solar calibrations performed during the period of this paper. (See appendix A.)

The scanner instrument operated in the normal Earth scan mode and at the normal operating azimuth position of 180° except during calibrations and from December 6–19, when it operated in the short scan mode to prevent the detectors from directly scanning the Sun during full-Sun conditions. Successful internal and solar calibrations of the scanner instrument were performed on December 3, and an additional internal calibration was successfully performed on December 26. A solar calibration attempted on this day was unsuccessful because the azimuth angle data for positions A and B were not transmitted to the instrument before the instrument was rotated in azimuth. Thus, the azimuth beam rotated to the azimuth positions for the previous solar calibration, and the Sun did not pass through the MAM window.

Figure 7(a) shows that the daily mean scan position of the scanner instrument varied throughout the year, starting at the end of December. This variation in mean scan position was due to sluggishness in the scanner instrument elevation beam motion. One effect of this irregular scan beam motion is misalignment of the detectors at the internal calibration source positions during internal calibrations. This problem is discussed in more detail in the "Operational Anomalies" section (p. 14).

ERBS spacecraft—January 1985. The percentage of data archived to the RAT was 99.90 and to the PAT was 99.20 for January 1985. (See table 1(c).)

The β angle decreased from 94° on January 1 to 54° on January 17, and then increased to about 86°

on January 31. (See figs. 5 and 6(a).) The spacecraft was configured with its X -axis positive from the beginning of the month until 22:40 UT on January 3. At that time a 180° spacecraft yaw maneuver was performed, and for the remainder of the month the spacecraft flew with its positive X -axis negative.

The nonscanner instrument operated in the nadir or Earth-viewing elevation mode and at the normal azimuth position of 0° during the month of January except during calibrations. Successful nonscanner internal and solar calibrations were performed on January 9 and 23. (See table 7(a).) A data dropout occurred at the end of the solar calibration on January 23 with the result that two commands, detector bias heater off and elevate to nadir, were not echoed in the data and thus are not included in table 7(a). Analysis of the data indicated that these commands actually were sent and that the data dropout did not affect the calibration.

The scanner instrument operated at the along-track azimuth position of 90° from January 16–28. This was the first of two along-track scanner operations; the second was in August 1985. During both periods of along-track scanning, the scanner instrument operated in the normal Earth scan mode with the Earth portion of the scan in the direction opposite that of the spacecraft velocity vector. The along-track scan provides validation measurements for the bidirectional models used in the ERBE data processing. In the along-track azimuth position, the instrument scans in the orbital plane looking forward and aft, thus viewing regions of the Earth from multiple angles.

Scanner internal and solar calibrations were successfully performed on January 9, and an additional successful internal calibration was performed on January 23. (See table 7(b).) The scanner instrument was stowed during the yaw maneuver on January 3 from 22:31 UT to 23:10 UT. The instrument operated in the short scan mode from 19:24 UT to 19:31 UT on January 16 while it was rotating to the along-track azimuth position, and again from 21:02 UT to 21:08 UT on January 28 while it was rotating back to the cross-track azimuth position. During the rest of the month, the instrument operated in the normal Earth scan mode except while the solar calibration was performed on January 9. The scanner instrument elevation beam continued to experience irregular motion during this month. (See fig. 7(a).)

ERBS spacecraft—February 1985. The percentage of data archived to the RAT was 98.85 for February 1985. Scanner instrument data for February 20–28 are included in the RAT, but they contain

incorrect azimuth-beam angles and detector pointing vectors and should be used with caution. Nonscanner instrument data on the RAT are valid for the entire month. Because of erroneous azimuth position values reported by the scanner instrument for February 20–28, no data were archived to the PAT for either instrument for this period, and the PAT archival rate was only 66.51 percent for the month. (See table 1(d).)

The β angle increased from about 89° on February 1 to about 158° on February 21, the maximum for the month, and then decreased to about 142° at the end of the month. (See figs. 5 and 6(a).) The spacecraft was in full or near-full Sun from February 19–24, and both the scanner and nonscanner instruments experienced above-normal heating for February 18–25. A comparison of the instrument housekeeping temperatures for February 1985 and December 1984 (figs. 8 and 9) shows a dog-ear (two-maxima) pattern in December that is not present in February. This dog-ear pattern is also evident during the hot-orbit periods in June and December 1985, whereas the temperature pattern of August 1985 is similar to that of February 1985. A comparison of the β angles in figure 6 with the temperature data in figure 8 shows that maximum temperatures occur when β is near 24° or 156° , which is the elevation angle of the Earth's limb as viewed from the spacecraft. In June and December β passes through 24° and 156° , respectively, fairly rapidly on its way to and from the extreme values of 10° and 170° . In February and August β remains near 24° and 156° , respectively, for several days. Thus, the heating effects on the ERBE instruments are more sustained during these months. These heating effects are seen in both the nonscanner instrument (see, for example, the solar monitor heat sink and aperture temperatures in fig. 8(d)) and in the scanner instrument (see, for example, the blackbody temperatures in fig. 9(c)).

The spacecraft was configured with its X -axis negative until about 15:06 UT on February 1. At that time a 180° yaw maneuver was performed, and for the remainder of the month the spacecraft operated with its X -axis positive. Prior to the yaw maneuver, at 14:51 UT, the scanner instrument was commanded to stow. It returned to the normal Earth scan mode at 15:30 UT.

The nonscanner instrument operated in the normal nadir or Earth-viewing elevation mode and at the normal azimuth position of 0° during the month of February except during the internal and solar calibrations on February 6 and 20. However, the nonscanner instrument data for February 20–28 are not

included on the PAT because of problems with the scanner instrument.

On February 1 the scanner instrument was stowed during the yaw maneuver. Successful internal and solar calibrations of the scanner instrument were performed on February 6. A solar calibration was also performed on February 20, and an additional scanner internal calibration was performed on February 26. On February 17 the instrument was commanded to the short scan mode to prevent the detectors from scanning the Sun as the orbit approached full-Sun conditions. The instrument remained in the short scan mode until the solar calibration performed on February 20. The scanner instrument elevation beam continued to behave sluggishly during February. (See fig. 7(a).)

A scanner internal calibration attempted on February 20 was not successful because the scanner instrument was still in short Earth scan mode, which does not include scanning the internal calibration sources. (See table 4.) The scanner solar calibration on February 20 was successful, and the instrument was stowed after the calibration until February 25 when it was commanded to return to the normal Earth scan mode of operation. An analysis of data after February 25 indicated that the scanner instrument azimuth beam did not return to its normal cross-track position of 180° after the solar calibration on February 20, even though the azimuth position output showed it to be at 180° . The azimuth beam apparently remained at or near the space-after-Sun calibration position of 35.9° until the next solar calibration on March 6. The radiometric measurements at the internal sources during the scanner internal calibration on February 26 indicate that the detectors were probably being affected by direct sunlight during this calibration.

This azimuth-beam problem, which is believed to have been caused by Sun interference with the azimuth position sensor, resulted in the scanner instrument detectors sensing direct sunlight during portions of some orbits from February 27 through March 2. All scanner radiometric measurements on the RAT that were made after the instrument was returned to the normal Earth scan mode on February 25 should be treated with extreme caution because of this problem. It is likely that the detectors not only scanned the Sun on February 28 but also were actually pointed directly at the Sun during some scans while making the eight space clamp measurements.

ERBS spacecraft—March 1985. The percentage of data archived to the RAT was 99.95 and to the

PAT was 99.41 for the month of March 1985. (See table 1(e).)

The β angle decreased continually during March from about 140° to 28° at the end of the month. Some heating effects due to the low β angles at the end of the month can be seen in the housekeeping temperature plots (figs. 8 and 9). The spacecraft was configured with its X -axis positive from the beginning of the month until 15:07 UT on March 13. At that time a 180° yaw maneuver was performed and the spacecraft operated with its X -axis negative for the remainder of the month. The scanner instrument was stowed from 14:56 UT to 15:35 UT for the yaw maneuver.

The nonscanner instrument operated in its normal Earth-viewing elevation mode and at its normal azimuth position of 0° for the entire month except during calibrations. Successful internal and solar calibrations were performed on March 6 and 20.

Successful scanner internal and solar calibrations were performed on March 6 and 20. After the March 6 calibrations, the instrument operated in the normal Earth scan mode and at the normal azimuth position of 180° except during the March 20 solar calibration and during the short time that it was in stow on March 13 for the yaw maneuver. The scanner instrument experienced some irregular elevation beam motion throughout the month. (See fig. 7(a).)

The scanner instrument azimuth beam had not returned to its normal cross-track position of 180° after the solar calibration on February 20, even though the azimuth position output showed it to be at 180° . The azimuth beam apparently remained at or near the space-after-Sun calibration position of 35.9° until the next solar calibration on March 6. This problem is believed to have been caused by Sun interference with the azimuth position sensor. This problem is addressed in the "Operational Anomalies" section (p. 14).

Analysis of scanner instrument coastline crossings data for March 4 using the techniques discussed in reference 8 indicated that the scanner instrument azimuth beam was at about 35.9° from February 20 until March 6. Therefore, Earth locations of the scanner measurements from March 1 to the time of the solar calibration on March 6 were determined using instrument pointing vectors computed for a scanner instrument azimuth position of 35.9° .

The output data from all three scanner instrument detectors were examined for effects of detector Sun damage, and only the shortwave part of

the total detector output showed a change. The output of the shortwave and longwave detectors was unaffected. The filtered radiance from the shortwave part of the total detector was decreased by 6.5 percent. This problem has been corrected for data on the PAT tape by changing the model of the spectral response of the total detector that is used in the spectral correction algorithms. This new model is applied during the unfiltering process to all ERBS scanner instrument data acquired after March 1, 1985. The new spectral correction model is applied to the data after the RAT tapes are generated. Therefore, the daytime total detector data on the RAT tapes from March 1, 1985, onward are modified by the sunburn problem. The nighttime data from the total channel are unaffected.

ERBS spacecraft--April 1985. April 1985 is one of the five ERBE validation months. It is the second data month for which data were archived to the RAT (March 1986) and the first for which data were archived to the PAT (December 1987). The percentage of data archived for the month to the RAT was 98.49 and that to the PAT was 98.12. (See table 1(f).) However, some data were lost during April 18-20 because of ground station problems.

The β angle increased from about 29° at the beginning of April to about 123° on April 30. The spacecraft operated in near-full-Sun conditions on April 1 and 2 when β was less than 30° (fig. 6(a)). Heating effects caused by the low β can be seen at the end of March and the beginning of April in the housekeeping temperature plots, such as those for the nonscanner instrument solar monitor heat sink temperatures and the scanner instrument passive analog temperatures shown in figures 8(d) and 9(d), respectively. The spacecraft was configured with its X -axis negative from the beginning of the month until 15:06 UT on April 21 when a 180° yaw maneuver was performed. The spacecraft operated with its X -axis positive for the remainder of the month.

The nonscanner instrument operated in the normal Earth-viewing elevation mode and at the normal azimuth position of 0° for the entire month except during calibrations. Successful internal and solar calibrations of the nonscanner instrument were performed on April 3 and 17.

The scanner instrument operated in the short scan mode from 3:36 UT on April 1 until 18:45 UT on April 2 to prevent the detectors from scanning the Sun during this time of low β . The instrument was stowed from 14:57 UT to 15:36 UT on April 21 for the yaw maneuver. Other than these periods and during calibrations, the scanner instrument operated

in the normal Earth scan mode and at the normal azimuth position of 180° . Successful internal and solar calibrations of the scanner instrument were performed on April 3 and 17.

The scanner instrument elevation beam began to experience motion problems after the solar calibration on April 17. Although similar problems had been seen in previous months, this was the first month during which the problems were severe enough to cause differences between the edited and unedited mean scan positions for periods when the instrument was in normal Earth scan mode. (See fig. 7(a).) These problems continued throughout the rest of April and all of May. Elevation-beam motion problems were also evident, although less severe, in June, July, and August. Figure 7(a) shows that for these months the edited mean scan position was less than the unedited mean value. This is indicative of the sluggish scanner instrument problem discussed in the "Operational Anomalies" section (p. 14). Sluggishness results in misalignment of the detectors with the internal calibration sources. Since the values that are being edited out are in the neighborhood of 190° , the edited mean values are reduced. An analysis of scan position data for several days in April and May confirmed that the elevation beam was not properly aligned at 190° at scan position 71.

ERBS spacecraft--May 1985. Data coverage was nearly 100 percent for every day in May 1985. As shown in table 1(g), the percentage of data archived to the RAT was 99.98 and to the PAT was 98.92.

The β angle increased from about 125° at the beginning of the month to a maximum of about 130° on May 6, and then decreased to about 52° at the end of the month. The spacecraft was configured with its X -axis positive from the beginning of the month until 13:23 UT on May 22 when a 180° yaw maneuver was performed. The spacecraft operated with its X -axis negative for the remainder of the month. This was the first month since the launch of ERBS that the scanner instrument was not stowed during a yaw maneuver. Instead, the scanner instrument continued to operate in its normal Earth scan mode during this maneuver, and during all subsequent yaw maneuvers throughout the life of the instrument.

The nonscanner instrument operated in the normal Earth-viewing elevation mode and at the normal 0° azimuth position for the entire month except during calibrations. Successful internal and solar calibrations were performed on May 1, 8, and 29.

The scanner instrument also operated in the normal Earth-viewing scan mode and at the normal 180° azimuth position for the entire month except during

calibrations. Successful internal and solar scanner calibrations were performed on May 1, 8, and 29.

The scanner instrument elevation beam continued to behave erratically during May. The scan beam hung up during many scans, and sometimes the beam did not return to the space clamp position of 14° . During several days of the month the scan beam behaved sluggishly at the beginning of a scan, even though the scan was successfully completed. One effect of this sluggishness was misalignment of the detectors at the internal calibration positions during scanner internal calibrations. A more complete discussion of the elevation beam anomaly is presented in the "Operational Anomalies" section (p. 14). It is believed that the editing algorithms flagged any bad scan beam-position data caused by these problems and that pointing vectors of the radiometric detectors were correctly calculated.

ERBS spacecraft—June 1985. The percentage of data archived to the RAT was 99.88 and to the PAT was 99.49 for June 1985. (See table 1(h).)

The β angle decreased from about 49° on June 1 to about 10° on June 12, and then it increased to about 79° by the end of the month. Since β never reached 90° during June, there was no yaw maneuver and the spacecraft operated with its X -axis negative during the entire month. The 10° β angle on June 10 was the lowest value for the year, as shown in figures 5 and 6(a). Because of the low β , the spacecraft was operating in full-Sun conditions from June 6–18. These conditions were similar to those experienced by the spacecraft in December 1984 and December 1985 when β attained its annual maximum value of 170° .

As discussed in the "Special Operations" section (p. 10), extreme β angles cause heating conditions that affect instrument housekeeping temperatures. These heating effects are clearly seen for the non-scanner instrument in, for example, the FOV limiter temperatures of the Earth-viewing detectors (fig. 8(c)) and the solar monitor heat sink and aperture temperatures (fig. 8(d)). For the scanner instrument these heating effects are clearly seen in, for example, the total and longwave blackbody temperatures (fig. 9(c)) and the passive analog temperatures (fig. 9(d)).

The non-scanner instrument operated in the normal Earth-viewing elevation mode and at the normal 0° azimuth position for the entire month, except during calibrations. Successful internal and solar calibrations were performed on June 18 and 26. An

additional internal calibration was successfully performed on June 12. (See table 7(a).)

The scanner instrument operated in the short scan mode from June 5–20 to prevent the detectors from scanning the Sun during this full-Sun period. During the rest of the month the scanner instrument operated in the normal Earth scan mode and at the normal azimuth operating position of 180° except during the solar calibration performed on June 26. A successful internal calibration was also performed on June 26. (See table 7(b).)

The scanner instrument elevation beam continued to show sluggishness. (See fig. 7(a).) This resulted in a misalignment of the scanner instrument detectors with the internal calibration sources during the internal calibration on June 26.

ERBS spacecraft—July 1985. July 1985 was one of the five ERBE validation months. This was the third data month to be archived to the RAT (September 1986) and the second to be archived to the PAT (February 1988). The percentage of data archived to the RAT was 98.22 and to the PAT was 97.85. (See table 1(i).) A 7-percent data loss occurred on July 5, and losses greater than 20 percent occurred on July 11 and 29 because of accidental magnetic tape degaussing at a ground station.

The β angle increased from about 82° at the beginning of the month to a maximum of about 126° on July 18, and then decreased to about 100° at the end of the month. The spacecraft was configured with the X -axis negative from the beginning of the month until 15:36 UT on July 4. A yaw maneuver was performed at this time to rotate the spacecraft to X -axis positive. Both the scanner and non-scanner instruments remained in their normal Earth-viewing modes during the yaw maneuver.

The non-scanner instrument operated in the normal Earth-viewing elevation mode and at the normal 0° azimuth position for the entire month, except during calibrations. Successful internal and solar calibrations were performed on July 10 and 24.

The scanner instrument operated in the normal Earth scan mode and at the normal 180° azimuth position for the entire month, except during calibrations. Successful internal and solar calibrations were performed on July 10 and 24. The scanner instrument elevation beam problem seen in previous months also occurred in July. (See fig. 7(a).) Again, this problem resulted in misalignment of the scanner instrument detectors with the internal calibration sources during internal calibrations.

ERBS spacecraft—August 1985. The percentage of data archived to the RAT was 99.72 and to the PAT was 98.77 in August 1985. (See table 1(j).) Although this was not a validation month, August was the third data month archived to the PAT (April 1988) because of the special along-track operation that was performed.

The β angle decreased from about 97° at the beginning of the month to a minimum of about 21° on August 23, and then it increased to about 41° by the end of the month. The spacecraft was configured with its X -axis positive from the beginning of the month until 13:22 UT on August 2 when a 180° yaw maneuver was performed. The spacecraft operated with its X -axis negative for the remainder of the month. The spacecraft was in full- or near-full-Sun conditions for August 19–29 when β was less than 30° . The heating effects on the instrument housekeeping temperatures were similar to those seen during the full-Sun condition of February 19–24.

The nonscanner instrument operated in its normal Earth-viewing elevation mode and at its normal 0° azimuth position for the entire month, except during calibrations. Successful nonscanner internal and solar calibrations were performed on August 7 and 21. Several nonscanner instrument housekeeping temperatures, such as the FOV limiter (FOVL) temperatures, increased significantly during the full-Sun conditions of August 19–29. (See fig. 8(c).)

The scanner instrument operated in the normal Earth scan mode and at the normal 180° azimuth position from the beginning of the month until August 7 when successful internal and solar calibrations were performed. After the calibrations on August 7, the scanner instrument was rotated to an along-track azimuth position where it remained until August 14. This was the second and last time that the instrument operated at the along-track azimuth position. The instrument continued to operate in the normal Earth scan mode during this period to provide validation data for the bidirectional models of typical Earth scenes used in the ERBE data processing. The Earth portion of the scan was in the direction opposite that of the spacecraft velocity vector. The NOAA 9 scanner instrument also operated at an along-track azimuth position of 90° from August 2–9, overlapping the ERBS along-track operation by 2 days. The ERBS scanner instrument returned to its normal operating azimuth position of 180° on August 14. The scanner instrument operated in the short scan mode for August 14–29 to prevent the detectors from scanning the Sun during this full-Sun period. During this period several scanner instrument house-

keeping temperatures increased significantly, such as the blackbody temperatures shown in figure 9(c). The instrument returned to its normal Earth scan mode on August 29 and remained in this mode through the end of the month. The scanner instrument elevation beam problems seen in previous months were still evident in August, but to a lesser degree.

ERBS spacecraft—September 1985. Data coverage was almost 100 percent for every day in September 1985 except for the 16th when a TDRSS scheduling problem caused a data loss of about 40 percent. The percentage of data archived to the RAT was 98.52 and to the PAT was 98.11. (See table 1(k).)

The β angle increased from about 44° at the beginning of the month to about 150° at the end of the month. There were no periods during the month when the spacecraft was in full Sun for an entire orbit. However, a full-Sun condition was approached at the end of the month when β was near 150° , resulting in solar effects similar to those of April 1985. However, the scanner instrument was not commanded to the short scan mode at this time, as it had been in April. The heating effects can be seen in the nonscanner instrument housekeeping temperatures shown, such as in the FOV limiter temperatures (fig. 8(c)) and in the solar monitor heat sink temperatures (fig. 8(d)). The heating effects can also be seen in the scanner instrument housekeeping temperatures, such as in the blackbody temperatures and passive analog temperatures shown in figures 9(c) and 9(d).

The spacecraft was configured with its X -axis negative from the beginning of the month until 13:42 UT on September 12. A 180° yaw maneuver was performed at this time and the spacecraft operated with its X -axis positive for the remainder of the month.

The nonscanner instrument operated in the normal Earth-viewing elevation mode and at the normal 0° azimuth position for the entire month except during calibrations. Successful nonscanner internal and solar calibrations were performed on September 4 and 18.

The scanner instrument operated in the normal Earth scan mode and at the normal 180° azimuth position for the entire month except during calibrations. Successful scanner internal and solar calibrations were performed on September 4 and 18. The scanner instrument elevation-beam problem seen in previous months was still evident, but to a lesser degree.

ERBS spacecraft—October 1985. October 1985 was one of the five ERBE validation months. This was the fourth data month to be archived to the RAT (October 1986) and the fourth archived to the PAT (May 1988). The percentage of data archived to the RAT was 99.93 and to the PAT was 98.52. (See table 1(l).) Instrument and spacecraft operations reduced the amount of Earth-viewing data more than usual. About 24 percent of the data for October 19 and about 9 percent of the data for October 20 were not archived to the PAT because of this.

The β angle decreased from about 150° at the beginning of the month to about 53° at the end of the month. The spacecraft operated with its X -axis positive from the beginning of the month until about 14:38 UT on October 18. At this time a 180° yaw maneuver was performed, and for the remainder of the month the spacecraft operated with its X -axis negative. The yaw maneuver was performed a day earlier than normal (β was not quite 90°) to prepare for the pitch maneuver scheduled for the following day.

The second of two pitch maneuvers was performed on October 19. The first pitch maneuver had been performed in November 1984. At 19:53 UT on October 19 the spacecraft performed a 180° pitch maneuver when the Sun was very near the spacecraft orbit plane. (See table 7.) The pitch maneuver was requested by the ERBE Science Team primarily to confirm the values of the electronic offsets of the scanner instruments, which had been determined from the data obtained during the pitch maneuver on November 21, 1984. During the pitch maneuver, the scanner and nonscanner instruments made measurements while viewing space in their normal Earth-viewing elevation modes. The nonscanner instrument also made measurements while viewing the Sun directly. The spacecraft returned to its normal operating attitude of 0° at 23:40 UT on October 19.

As was done during the November pitch maneuver, the nonscanner instrument was commanded to stow before the "pitch-over" and again before the "pitch-back" maneuvers. Nearly 1 hour after the spacecraft began flying upside down, the nonscanner instrument elevation beam was commanded to the normal nadir position, thus permitting the instrument to view space while flying upside down. During the next 3 hours, several heater commands and azimuth rotations were executed. The nonscanner instrument was stowed for the pitch-back maneuver on October 20, and it remained in stow for about 2 hours after the spacecraft had returned to its normal operating attitude of 0° . The nonscanner instrument returned to its normal Earth-viewing elevation mode

at 2:00 UT on October 20. (Refer to table 7(a) for the operations performed during the pitch maneuver.)

The scanner instrument did not follow the same sequence of commands as those issued during the November pitch maneuver. In addition, an analysis of the data showed that the instrument did not respond normally to some of the scan mode commands listed in table 7(b). The scanner instrument was commanded to stow and then to go to the MAM scan mode prior to the pitch-over command that occurred at 19:53 UT. The instrument was in the MAM scan mode prior to the pitch-back maneuver at 23:40 UT on October 19, and it remained in that scan mode until about 2:30 UT on October 20 when it finally returned to normal Earth scan mode.

Successful internal and solar calibrations of the nonscanner instrument were performed on October 2, 16, 20, and 31. A successful internal calibration was also performed on October 30. A solar calibration was attempted on October 30, but it was unsuccessful because no new azimuth angle data were sent, with the result that the instrument rotated to the angles whose values were still in memory from the previous calibration. As a result, the Sun did not pass through the fields of view of the detectors. Note that there were two internal calibrations performed on October 20, 1985, the day after the pitch maneuver. (See table 7(a).)

Scanner internal and solar calibrations were successfully performed on October 2 and 16. No further scanner instrument calibrations were performed during October because of the scanner instrument problems experienced on October 19 and 20 in conjunction with the pitch maneuver. Because of the problems encountered in changing scan modes during the pitch maneuver on the 19th, all subsequent scanner instrument operations were performed with the instrument in normal Earth scan mode. The scanner instrument continued to experience some sluggishness during normal operations. (See fig. 7(a).)

ERBS spacecraft—November 1985. The percentage of data archived to the RAT was 98.72 and to the PAT was 98.54 for November 1985. (See table 1(m).) Thirteen percent of the data for November 3 and 25 percent of the data for November 15 were not recovered because of operational problems at the GSFC.

The β angle decreased from about 51° at the beginning of the month to a minimum of about 49° on November 5, and then it increased to about 129° by the end of the month. The spacecraft was configured with its X -axis negative from the beginning of the month until 15:02 UT on November 21 when a 180°

yaw maneuver was performed. The spacecraft operated with its X -axis positive for the remainder of the month.

The nonscanner instrument operated in its normal Earth-viewing elevation mode and at its normal 0° azimuth position for the entire month except during calibrations. Successful nonscanner internal and solar calibrations were performed on November 13 and 27.

The scanner instrument operated in its normal Earth scan mode and at the normal 180° azimuth position for the entire month. No scanner calibrations were performed during November because of the scanner instrument problems experienced in October 1985. The scanner instrument elevation-beam problems seen in previous months were still evident in October. (See fig. 7(a).)

ERBS spacecraft - December 1985. The percentage of data archived to the RAT was 99.12 and to the PAT was 98.99 for December 1985. (See table 1(n).) About 22 percent of the data for December 15 were lost at the GSFC because of operational problems.

The β angle increased from about 132° at the beginning of the month to a maximum of about 170° on December 11, and then it decreased to about 94° by the end of the month. The 170° β angle on December 11 was the maximum for the year. (See figs. 5 and 6(a).) Because of the extreme β angle, the spacecraft operated in full- or near-full-Sun conditions from December 5-18, resulting in a hotter-than-normal operating environment. These conditions were similar to those of December 1984 when β also reached its annual maximum value of 170° and to those of June 1985 when β reached its annual minimum value of 10° . Figures 8 and 9 show the responses of the nonscanner and scanner instrument housekeeping temperatures to full-Sun conditions.

The spacecraft was configured with its X -axis positive from the beginning of the month until 15:14 UT on December 31 when a 180° yaw maneuver was performed. The spacecraft operated with its X -axis negative for the remainder of the month.

The nonscanner instrument operated in the normal Earth-viewing elevation mode and at the normal 0° azimuth position for the entire month except during calibrations. Successful nonscanner internal calibrations were performed on December 4, 18, and 25, and successful solar calibrations were performed on December 18 and 25. (See table 7(a).) A solar calibration was attempted on December 4, but three commands necessary to perform the calibration (el-

evate to solar ports, azimuth to position A, and detector bias heater on at level 2) were not sent and the calibration attempt was unsuccessful. Although the SMA shutter did cycle on and off, the instrument was not at a position to detect the Sun. On December 18 the same data storage commands were sent to the instrument twice, but this did not affect the calibrations.

The scanner instrument was rotated to an azimuth of 145° at 20:15 UT on December 5 and remained there until 13:40 UT on December 18 to prevent the detectors from directly scanning the Sun during this full-Sun period. This was the first month that scanner instrument azimuth rotation was used for full-Sun operating conditions. During previous months the scanner instrument operated in the short scan mode during full-Sun conditions. However, because of the problems encountered in changing scan modes during the pitch maneuver on October 19, the scanner instrument was left in the normal Earth scan mode for all operations after October 1985.

The scanner instrument operated in its normal Earth scan mode for the entire month. The scanner instrument azimuth beam operated at 180° for the entire month except during the full-Sun period of December 5-18 when it operated at 145° . Successful scanner internal calibrations were performed on December 18 and 25. These were the first scanner instrument calibrations performed since October 16, 1985. No scanner internal calibration was performed on December 4 because the spacecraft was approaching full-Sun conditions at that time. A set of azimuth angle load commands was sent to the instrument on December 4 in preparation for the azimuth rotation to 145° on December 5. No scanner solar calibrations were performed in December. Scanner solar calibrations were discontinued as a result of the problems encountered in changing scan modes during the pitch maneuver performed on October 19, 1985.

The scanner instrument experienced some irregular elevation-beam motion throughout the month. (See fig. 7(a).) One effect of this problem is misalignment of the detectors with the internal calibration sources during scanner internal calibrations. Figure 7(a) shows that the edited and unedited scan angles were the same, indicating that the elevation-beam problem was not severe enough to cause scan angle data to be edited out during processing.

ERBS spacecraft - January 1986. January 1986 was the last of the five ERBE validation months. This was the fifth data month archived to the RAT (October 1986) and the sixth archived to the PAT (August 1988). The August 1985 data were archived

to the PAT before the January 1986 data, even though August 1985 was not a validation month, because of the along-track operation that was performed in August. The percentage of January 1986 data archived to the RAT was 99.95 and to the PAT was 99.76. (See table 1(o).)

The β angle decreased from about 92° at the beginning of the month to about 54° on January 16, and then it increased to about 88° by the end of the month. The spacecraft was configured with its negative X -axis pointing along the spacecraft velocity vector from the beginning of the month until 15:01 UT on January 31 when a 180° yaw maneuver was performed. The spacecraft operated with the X -axis positive for the remainder of the month.

Successful internal and solar calibrations of the nonscanner instrument were performed on January 8 and 22. The instrument operated in the normal Earth-viewing elevation mode and the azimuth beam operated at the normal 0° position throughout the month except during calibrations.

The scanner instrument operated in the normal Earth scan mode and at the normal azimuth position of 180° during the entire month. Successful scanner internal calibrations were performed on January 8 and 22. No scanner solar calibrations were performed in January. There was some irregularity in the scanner instrument elevation-beam motion during this month. One effect of this was misalignment of the scanner instrument detectors with the internal calibration sources during internal calibrations.

NOAA 9 Spacecraft Operations

NOAA 9 spacecraft—February 1985. The NOAA 9 spacecraft was launched into orbit in December 1984, and during the months of December 1984 and January 1985 the ERBE instruments aboard this satellite were evaluated in preparation for normal operations. This evaluation included four sets of internal and solar calibrations of the nonscanner instrument and several internal calibrations of the scanner instrument. February 1985 is the first month for which NOAA 9 data were processed for archival. Therefore, this is the first month for which ERBE data are available from both the ERBS and NOAA 9 satellites. Since February 1985 was not a validation month, the data were not archived until recently. The RAT was archived in November 1989 and the PAT was archived in February 1990. The percentage of data archived to the RAT was 91.29 and to the PAT was 89.63 for the month of February 1985. (See table 1(d).) The β angle remained nearly constant at about 57° for the month of February.

The nonscanner instrument operated in the nadir or Earth-viewing elevation mode during the month, except during periods of calibration. The instrument operated at 180° during the month, except during calibration periods, even though it was reporting an azimuth position of 170° . Earth locations of nonscanner instrument measurements were computed using an azimuth angle of 170° , but the effect of this incorrect azimuth on the accuracy of the locations is negligible because the detectors are nadir-pointing. Nonscanner internal and solar calibrations were successfully performed on February 2, 6, 13, and 20 using the combined calibration sequences outlined in table A6(a). Two commands are missing from the calibration sequence for the internal calibrations on February 2, and one command is missing from the internal calibration on February 13 because of data dropouts. An analysis indicated that these commands were, in fact, sent to and executed by the instrument.

The scanner instrument operated in the normal Earth scan mode and at the normal 0° azimuth position for the entire month except during calibrations. Scanner internal calibrations were successfully performed on February 6, 13, 14, and 20. The first scanner solar calibrations were successfully performed on February 14 and 20 using the combined calibration sequences outlined in table A6(b).

NOAA 9 spacecraft—March 1985. The percentage of data archived to the RAT was 91.85 and to the PAT was 90.75 for the month of March 1985. (See table 1(e).) The β angle decreased from about 57° at the beginning of the month to about 56.7° at the end of the month.

The nonscanner instrument operated in its normal Earth-viewing elevation mode except during calibrations. Data indicate that the instrument operated at an azimuth position of 180° for the entire month except during calibrations. Successful nonscanner internal and solar calibrations were performed on March 6 and 20.

Successful scanner internal and solar calibrations were performed on March 6, and a solar calibration was also performed on March 20. The scanner instrument operated in the normal Earth scan mode and at the normal 0° azimuth position except during calibrations and during a stow operation on March 20. The electronic slice 3 temperature (fig. 11(d)) increased to above-normal values late on March 19, and the scanner instrument was stowed and the instrument powered off at 1:18 UT on March 20. The temperatures decreased significantly with the instrument in stow, and the instrument was powered back

on at 13:23 UT. However, the scanner instrument remained in stow until 14:51 UT on March 20 when a solar calibration was performed. The scanner instrument resumed operation in its normal Earth scan mode after the solar calibration. None of the scanner instrument temperatures exceeded their critical operating limits, and instrument performance was not affected by the higher-than-normal temperatures.

NOAA 9 spacecraft—April 1985. April 1985 was one of four NOAA 9 data validation months. This was the first NOAA 9 data month to be archived to the RAT, in March 1986, and also the first archived to the PAT, in March 1988. The percentage of data archived to the RAT was 91.65 and to the PAT was 88.90. (See table 1(f).) The β angle increased from about 56.8° at the beginning of the month to about 57.9° at the end of the month.

The nonscanner instrument operated in its normal Earth-viewing elevation mode for the entire month except during calibrations. Although the instrument output indicated that the azimuth position was 170° throughout the month except during solar calibrations, analysis indicated that it was operating at 180° . Successful nonscanner internal and solar calibrations were performed on April 3 and 17.

The scanner instrument operated in the normal Earth scan mode and at the normal azimuth position of 0° for the entire month except during calibrations. Successful scanner internal and solar calibrations were performed on April 3 and 17.

The scanner instrument experienced elevation-beam motion problems throughout the month of April. As figure 7(b) shows, edited mean scan-position values were less than unedited mean values, which is an indication of the sluggish scanner instrument problem discussed in the "Operational Anomalies" section of this paper (p. 14). When such sluggishness occurs, the scanner instrument detectors may not be aligned with the internal calibration sources during the internal calibrations. Such misalignment occurred during both the April 3 and April 17 internal calibrations, and it is most evident at scan position 71, the first of the four internal calibration positions.

NOAA 9 spacecraft—May 1985. The percentage of data archived to the RAT was 88.62 and to the PAT was 87.42 for the month of May 1985. (See table 1(g).) The data for May 11 were not available from NOAA. The β angle increased from about 57.9° at the beginning of the month to about 60.4° at the end of the month.

The nonscanner instrument operated in its normal Earth-viewing elevation mode throughout the month except during calibrations. Successful internal and solar calibrations were performed on May 8 and 29. A data dropout occurred during the internal calibration on May 8, but it did not affect the calibration. The nonscanner instrument operated at an azimuth position of 180° , instead of the normal azimuth of 170° , from May 1-29 except during solar calibrations. The azimuth beam returned to the proper position of 170° after the solar calibration on May 29.

The scanner instrument operated in the normal Earth scan mode and at the normal 0° azimuth position for the entire month except during calibrations. Successful internal and solar calibrations were performed on May 8 and 29. The scanner instrument elevation-beam motion problem observed in April was much less severe in May. (See fig. 7(b).)

NOAA 9 spacecraft—June 1985. The percentage of data archived to the RAT was 89.12 and to the PAT was 87.14 for the month of June 1985. (See table 1(h).) Data were not available from NOAA for June 1 and 2. Excluding these 2 days, the percentage of data on the RAT was 95.48 and on the PAT was 93.37. The β angle increased from about 60.5° to about 61.9° at the end of the month. This was the maximum β for the year.

The nonscanner instrument operated in its normal Earth-viewing elevation mode throughout the month, except during calibrations. Successful internal and solar calibrations were performed on June 12 and 26. The nonscanner instrument operated at its normal 170° azimuth position from the beginning of the month until the solar calibration of June 12. After this calibration the instrument returned to an azimuth position of 180° , where it remained through the end of the month except during the solar calibration on June 26.

The scanner instrument operated in its normal Earth scan mode and at its normal 0° azimuth position for the entire month except during calibrations. Successful scanner internal and solar calibrations were performed on June 12. The scanner instrument elevation-beam motion problem seen in previous months got significantly worse after the June 12 calibration. (See fig. 7(b).) The problem was most severe at the end of the month. Both the scanner solar and internal calibrations attempted on June 26 were affected by this improper scan motion. Misalignment of the detectors at the internal calibration positions occurred during the internal calibration. The solar calibration was unsuccessful

because the detectors did not scan to the MAM position during the time that the Sun was in the MAM field of view.

NOAA 9 spacecraft—July 1985. July 1985 was one of the four NOAA 9 data validation months. This was the second NOAA 9 data month to be archived to the RAT (January 1987) and also the second archived to the PAT (September 1988). The percentage of data archived to the RAT was 88.87 and to the PAT was 90.53. (See table 1(i).) No RAT was archived for July 18 because LaRC was unable to read the NOAA input tape for that date until after the RAT's for the month had been archived. The input tape was successfully processed later, and a RAT and PAT were generated for July 18. The β angle decreased from 61.9° on the first of the month, its maximum value for the year, to about 60.2° at the end of the month.

The nonscanner instrument operated in its normal Earth-viewing elevation mode throughout the month except during calibrations. The nonscanner instrument operated at an azimuth position of 180° , instead of its normal position of 170° , throughout the month except during solar calibrations. Successful nonscanner internal and solar calibrations were performed on July 10 and 24.

The scanner instrument operated in its normal Earth scan mode and at its normal 0° azimuth position for the entire month except during calibrations. Successful scanner internal and solar calibrations were performed on July 10 and 24. The scanner instrument elevation-beam problems continued throughout July. The primary effect of the problem was misalignment of the scanner instrument detectors with the internal calibration sources at the first internal calibration position during internal calibrations.

NOAA 9 spacecraft—August 1985. The percentage of data archived to the RAT was 91.61 and to the PAT was 90.79 for the month of August 1985. (See table 1(j).) No data were received from NOAA for August 1 and 2. Excluding these 2 days, the percentage of data on the RAT was 97.93 and on the PAT was 97.05. The β angle decreased from about 60.1° to about 55.2° during August.

Nonscanner internal and solar calibrations were successfully performed on August 7 and 21. The nonscanner instrument operated in its normal Earth-viewing elevation mode except during calibrations. The nonscanner instrument operated at an azimuth position of 180° , instead of the intended 170° , from the beginning of the month until the solar calibration on August 7. After this calibration the azimuth beam

returned to the normal 170° position and remained there until the solar calibration on August 21. Upon completion of this calibration, the azimuth beam returned to 180° instead of the normal operating position of 170° and remained there through the end of the month.

The scanner instrument operated in the normal Earth scan mode for the entire month except during solar calibrations. The scanner instrument operated at the along-track azimuth position of 90° for August 2–9. This period included 2 days, August 7–9, during which the ERBS scanner instrument was also operating at the along-track azimuth position. This was the only period during which the NOAA 9 scanner instrument operated at the along-track azimuth position. In this azimuth position the Earth portion of a scan is in the direction of the spacecraft velocity vector. On August 9 the scanner instrument was rotated back to its normal operating position of 0° , where it remained for the rest of the month except during solar calibrations. Successful scanner internal calibrations were performed on August 7, while the instrument was operating at the along-track azimuth position, and on August 21, and a successful solar calibration was also performed on August 21. Because of continuing irregular behavior of the scanner instrument elevation beam (see fig. 7(b)), there was some misalignment of the scanner instrument detectors with the internal calibration sources during internal calibrations. The elevation-beam sluggishness observed during August was slightly improved over that observed in July.

NOAA 9 spacecraft—September 1985. The percentage of data archived to the RAT was 89.83 and to the PAT was 88.29 for the month of September 1985. (See table 1(k).) The β angle decreased from about 55° to about 49.8° .

The nonscanner instrument operated in its normal Earth-viewing elevation mode for the entire month except during calibrations. The nonscanner instrument azimuth position was 180° , instead of the intended 170° , for the entire month except during solar calibrations. Successful nonscanner internal and solar calibrations were performed on September 4 and 18.

The scanner instrument operated in its normal Earth scan mode and at its normal azimuth position of 0° for the entire month except during calibrations. Successful internal calibrations were performed on September 4 and 18. A successful scanner solar calibration was performed on September 4. The solar calibration attempted on September 18 was not successful because the elevation beam hung up while

operating in the MAM scan mode, and the detectors did not view the Sun properly in the MAM window. The instrument returned to the normal Earth scan mode after the calibration, but the scanner instrument elevation beam continued to behave irregularly. There was some misalignment of the detectors at the internal calibration positions during the internal calibrations because of continuing elevation-beam motion problems. (See fig. 7(b).)

NOAA 9 spacecraft—October 1985. October 1985 was one of the four NOAA 9 data validation months. This was the third NOAA 9 data month to be archived to the RAT (March 1987) and the fourth archived to the PAT (December 1988). The percentage of data archived to the RAT was 85.47 and to the PAT was 80.49. (See table 1(l).) No data were available for October 29. The RAT for October 27 was not archived because LaRC was unable to read the input tape before the RAT's for the month were archived. The input tape was successfully processed later after the RAT archival date, and the RAT and PAT were generated. The β angle decreased from about 49.7° to about 46.9° during the month.

The nonscanner instrument operated in the normal Earth-viewing elevation mode and at an azimuth position of 180° for the entire month except during calibrations. Nonscanner internal and solar calibrations were successfully performed on October 2, 16, and 30.

The scanner instrument operated in the normal Earth scan mode and at the normal 0° azimuth position for the entire month except during calibrations. Scanner internal and solar calibrations were successfully performed on October 2, 16, and 30. There was some misalignment of the detectors at the internal calibration positions during the internal calibrations because of continuing problems with the scanner instrument elevation-beam motion. (See fig. 7(b).)

NOAA 9 spacecraft—November 1985. The percentage of data archived to the RAT was 91.14 and to the PAT was 82.29 for the month of November 1985. (See table 1(m).) The β angle reached its minimum value for the year of about 46.9° on November 4 and then increased to about 48.3° by the end of the month.

Except during calibrations, the nonscanner instrument operated in the normal Earth-viewing elevation mode for the entire month. Successful nonscanner internal and solar calibrations were performed on November 13 and 27. The nonscanner instrument azimuth beam operated at 180° instead of 170° for the entire month except during solar calibrations.

Successful internal and solar calibrations of the scanner instrument were performed on November 13 and 27. Except during solar calibrations, the scanner instrument operated in the normal Earth scan mode and at the normal cross-track azimuth angle of 0° for the entire month. Even though the scanner instrument sluggishness problem continued, it showed improvement over previous months. The primary effect of the sluggishness was misalignment of the scanner instrument detectors at the internal calibration position during internal calibrations. (See fig. 7(b).)

NOAA 9 spacecraft—December 1985. The percentage of data archived to the RAT was 87.50 and to the PAT was 86.02 for the month of December 1985. (See table 1(e).) The β angle increased from about 48.3° to about 51.3° .

The nonscanner instrument operated in its normal Earth-viewing elevation mode for the entire month except during calibrations. The azimuth beam operated at 180° during the entire month except during solar calibrations. Nonscanner internal and solar calibrations were performed successfully on December 11. Calibrations were also performed on December 25, but a 100-minute data dropout resulted in the loss of all the data during the internal calibration and a portion of the data at the beginning of the solar calibration. The data were recovered for the entire period when the Sun was in the field of view of the nonscanner instrument detectors. However, because of the data dropout, the flags that mark a solar calibration are not set properly in the archived data.

Except during periods of calibration, the scanner instrument operated in the normal Earth scan mode and at the normal cross-track azimuth-beam position of 0° . Scanner internal and solar calibrations were performed on December 11 and 25. The scanner instrument elevation-beam problem continued in December with some improvement over October and November. (See fig. 7(b).) During both internal calibrations, there was some misalignment of the detectors with the internal calibration sources.

NOAA 9 spacecraft—January 1986. January 1986 was the last of the four NOAA 9 data validation months. This was the fourth NOAA 9 data month to be archived to the RAT (August 1988) and the third archived to the PAT (November 1988). The percentage of data archived to the RAT was 94.55 and to the PAT was 92.89 for the month of January. (See table 1(o).) The β angle increased from about 51.4° to about 52.9° during January.

Successful internal and solar calibrations of the nonscanner instrument were performed on

January 22. The instrument operated in the nadir, or Earth-viewing elevation mode, during the month except during calibrations. The azimuth beam operated at 180° , instead of the normal 170° , for the entire month except during the solar calibration.

The scanner instrument operated in the normal Earth scan mode and at the normal cross-track azimuth position of 0° , except during solar calibration periods. Successful internal and solar calibrations were performed on January 22. The scanner instrument detectors were misaligned with the internal calibration sources during the internal calibration because of continuing irregular scanner instrument elevation-beam motion.

Concluding Remarks

An overview of the Earth Radiation Budget Experiment (ERBE) mission has been presented that includes science objectives, data processing and archival strategy, and the design and operational capabilities of the instruments. In-flight operations and data acquisition have been discussed for the first 15 months of the mission, November 1984 through January 1986. Archival at the National Space Science Data Center (NSSDC) of ERBE science data for the period was begun in February 1986 and completed in March 1990. The discussion includes normal and special operations of the spacecraft and instruments, operational anomalies, and the responses of the instruments to the in-orbit and seasonal variations of the solar environment. Appendixes discuss calibration procedures, data obtained during typical periods of calibration and normal Earth-viewing operations, and a general discussion of the solar environment for Earth-orbiting spacecraft. This paper is a valuable reference and source of information for people who analyze or utilize ERBE data.

An analysis of ERBE mission operations for the period from November 1984 through January 1986 leads to the following notable results and conclusions.

Data Coverage and Archival

The collection of ERBE science data for archival began in November 1984 for the ERBE instruments aboard the Earth Radiation Budget Satellite (ERBS) (operated by NASA) and in February 1985 for the ERBE instruments aboard the NOAA 9 spacecraft (operated by the National Oceanic and Atmospheric Administration). The first ERBE data were archived to the Raw Archival Tape (RAT) in February 1986 and to the Processed Archival Tape (PAT) in March 1986. Archival of the first year of data

was completed in November 1989 to the RAT and in March 1990 to the PAT.

Data coverage was consistent throughout the first 15 months of operation of the ERBE instruments aboard the ERBS spacecraft. The monthly average rate for data archived to the RAT was 99 percent and to the PAT was 97 percent. There were more data losses and the data coverage was somewhat more variable during the first 12 months of operation of the ERBE instruments aboard the NOAA 9 spacecraft. The monthly average rate of data archived to the RAT was 92 percent. The minimum amount archived to the RAT was 87 percent in December 1985 and the maximum amount was 98 percent in August 1985. The monthly average rate of data archived to the PAT was 89 percent. The minimum amount archived to the PAT was 82 percent in November 1985 and the maximum amount was 97 percent in August 1985. These percentages do not include days for which no data were archived.

Operations During Normal Earth-Viewing Measurements

For more than 97 percent of the time, the ERBE nonscanner and scanner instruments on the ERBS and NOAA 9 spacecraft made Earth-viewing radiation measurements. The nonscanner instruments on both spacecraft operated in the nadir (Earth-viewing) elevation mode during Earth-measurement operations. The Solar Monitor Assembly (SMA) shutter on both nonscanner instruments remained off during normal operations. The detector and solar port heaters remained on during normal operations, but all other heaters, including those that control the output of the calibration sources, remained off. The temperatures of the heat sinks and apertures of the four Earth-viewing detectors on both nonscanner instruments are critical to the normal operation of the instruments and were controlled to nearly constant values during normal operation.

The scanner instruments on both spacecraft operated in the normal Earth scan mode and at a cross-track azimuth position most of the time. A typical scan cycle originated on the dark side of the orbit where the space measurements were made, and the scan motion across the Earth was in the direction of the Sun side of the orbit. During full-Sun periods of the ERBS spacecraft orbit, the scanner instrument on that spacecraft operated in either the short Earth scan mode or at the azimuth position of 145° to prevent the detectors from directly scanning the Sun.

During periods in January and August 1985, the scanner instrument on the ERBS spacecraft operated

at an along-track azimuth position so that the scan plane was approximately in the orbit plane. The scanner instrument on the NOAA 9 spacecraft operated at an along-track azimuth position during a few days in August 1985, which included two of the days during which the scanner on ERBS was also at an along-track azimuth position.

Calibrations

Internal and solar calibrations of both the non-scanner and scanner instruments on both the ERBS and NOAA 9 spacecraft were generally performed on Wednesdays at 14-day intervals during the period of this paper. Additional calibrations of all ERBE instruments were performed during the first few months after they were launched into orbit. The normal calibration schedule for the instruments on the ERBS spacecraft was altered during full-Sun periods. During these periods regularly scheduled calibrations were not performed. Instead, a set of calibrations was normally performed immediately prior to and after the full-Sun periods.

During the first 15 months of operation of the ERBE instruments aboard the ERBS spacecraft, 35 successful internal calibrations and 21 successful solar calibrations were performed on the scanner instrument. In addition, 40 successful internal calibrations and 37 successful solar calibrations were performed on the nonscanner instrument. Almost all calibrations attempted were successful. One scanner and three nonscanner solar calibrations that were attempted were unsuccessful because the instruments were commanded to incorrect azimuth positions. One scanner internal calibration that was attempted was unsuccessful because the instrument was operating in the short scan mode at the time that the calibration was attempted, and thus the detectors did not scan to the internal calibration position. Scanner solar calibrations were discontinued after October 1985.

During the first 12 months of operation of the ERBE instruments aboard the NOAA 9 spacecraft, 25 successful internal calibrations and 21 successful solar calibrations were performed on the scanner instrument. In addition, 25 successful internal and 26 successful solar calibrations were performed on the nonscanner instrument. As with the instruments on the ERBS spacecraft, almost all calibrations attempted were successful. Data from one nonscanner internal calibration were lost because of a data dropout. Two scanner solar calibrations were unsuccessful because sluggishness in the motion of the instrument elevation beam prevented the detec-

tors from properly scanning to the Mirror Attenuator Mosaic (MAM) position.

Solar Environment and Its Effect on the Response and Operation of Instruments

The precession rate of the line of nodes of the ERBS spacecraft orbit is about -3.95 deg/day. The precession rate for a Sun-synchronous orbit is about 1 deg/day. Thus, relative to the Sun, the orbit is precessing about -5 deg/day. This precession rate causes the Sun to cross the orbit plane about every 36 days and produces a range of β between 10° and 170° . When β is less than 24° or greater than 156° , the ERBS spacecraft is in sunlight continuously. These conditions occurred five times during the first 15 months of operation of the ERBS spacecraft. During periods when β was near 24° and 156° , significant increases in the average values of housekeeping temperatures of the scanner and non-scanner instruments occurred. However, the operational, critical, nonscanner heat sink and aperture temperatures and the scanner detector temperatures were not affected significantly.

A variation in the β angle also requires changes in the operation of the instrument and spacecraft. About every 36 days when the Sun crosses the plane of the ERBS orbit, the spacecraft is rotated 180° about the nadir axis to reposition the solar panels to tilt toward the Sun side of the orbit. The yaw maneuver also has the effect of reorienting the ERBE instrument so that the primary Earth scan motion is from the dark to the Sun side of the orbit. Twice during the first year of operation, the spacecraft was pitched 180° when the Sun was approximately in the orbit plane. When β was less than 24° or greater than 156° , the ERBE scanner instrument operated either in the short Earth scan mode or at an off-cross-track azimuth angle to prevent the detectors from directly scanning the Sun.

The precession of the line of nodes of the NOAA 9 orbit is nearly synchronous with the apparent motion of the Sun about the Earth. The β angle during the first year varied from 47° to 62° , and the resulting solar heating was more benign and less variable than that of the ERBS orbit. There were no significant changes in the day-to-day values of instrument housekeeping temperatures. There were no periods when the spacecraft was in sunlight continuously, and no changes in the operation of the spacecraft or instruments were required because of changes in the β angle.

The output of the radiometric detectors of both instruments on both spacecraft responded to in-orbit

changes of the Sun angle while operating in their normal Earth-viewing modes. The in-orbit response to solar heating was quite apparent in the output of the scanner detectors at the space clamp and internal calibration positions of each scan. The solar heating effect was also apparent in the output of the solar monitor nonscanner detector that normally viewed space. The largest responses of the instruments occurred at spacecraft sunrise and sunset, and the degree of response was a function of β . The output of the wide-field-of-view nonscanner detectors showed spikes at sunrise and sunset, indicating that the instruments were sensing direct solar input.

Anomalies in the Operation of the Azimuth and Elevation Beams

Problems with the operation of the azimuth beams of the instruments occurred in orbit on all four instruments. The azimuth-beam problem was in the angular position sensor, which sometimes caused the beam to rotate to a wrong azimuth angle and/or to output an erroneous position. It is believed that the problem was caused by stray light impinging on the position sensor. The most serious result of faulty operation of an azimuth beam was the scanning of the Sun by the detectors of the scanner instrument on the ERBS spacecraft in February 1985. This problem was a continuing concern during the period of this paper and added significantly to the data validation effort.

Problems occurred in orbit with the operation of the elevation beams of both scanner instruments.

Sluggish elevation-beam rotation of the scanner instruments was observed from time to time, and occasionally a beam would hang up during a scan. One of the effects of sluggishness in the scanner elevation-beam rotation was to cause misalignment of the radiometric detectors with the internal calibration sources. This misalignment sometimes resulted in a nonuniform response of the shortwave detector to the internal calibration source during internal calibrations. The elevation-beam problem was a concern throughout the period of this paper and required changes to the operational data processing software. The scanner elevation-beam problem was the subject of an investigation in 1985 which concluded that the problem was caused by a faulty bearing lubrication design.

Acknowledgments

The authors wish to thank the following people whose support contributed to the success of this paper: Alice T. Fan of STX, who generated the quality plots for the appendixes, Yvonne M. Seaman of STX, who created the drawings and sketches, and Richard N. Green of LaRC, whose advice and assistance in the area of Earth-Sun-spacecraft geometry helped shape the content and presentation of appendix B.

NASA Langley Research Center
Hampton, VA 23665-5225
May 24, 1991

References

1. Barkstrom, Bruce R.: The Earth Radiation Budget Experiment (ERBE). *Bull. American Meteorol. Soc.*, vol. 65, no. 11, Nov. 1984, pp. 1170-1185.
2. Luther, M. R.; Cooper, J. E.; and Taylor, G. R.: The Earth Radiation Budget Experiment Nonscanning Instrument. *Reviews Geophys.*, vol. 24, no. 2, May 1986, pp. 391-399.
3. Kopia, Leonard P.: The Earth Radiation Budget Experiment Scanning Instrument. *Reviews Geophys.*, vol. 24, no. 2, May 1986, pp. 400-406.
4. Kopia, Leonard P.; and Lee, Robert B., III: Earth Radiation Budget Experiment (ERBE) Scanner Instrument. *Long-Term Monitoring of the Earth's Radiation Budget*, Bruce R. Barkstrom, ed., Volume 1299 of SPIE Proceedings Series, Soc. of Photo-Optical Instrumentation Engineers, 1990, pp. 61-79.
5. ERBE Science Team: First Data From the Earth Radiation Budget Experiment (ERBE). *Bull. American Meteorol. Soc.*, vol. 67, no. 7, July 1986, pp. 818-824.
6. Smith, G. Louis; Barkstrom, Bruce R.; and Harrison, Edwin F.: The Earth Radiation Budget Experiment: Early Validation Results. *Adv. Space Res.*, vol. 7, no. 3, 1987, pp. (3)167-(3)177.
7. Harrison, Edwin F.; Minnis, Patrick; and Gibson, Gary G.: Orbital and Cloud Cover Sampling Analyses for Multisatellite Earth Radiation Budget Experiments. *J. Spacecr. & Rockets*, vol. 20, no. 5, Sept./Oct. 1983, pp. 491-495.
8. Hoffman, Lawrence H.; Weaver, William L.; and Kibler, James F.: *Calculation and Accuracy of ERBE Scanner Measurement Locations*. NASA TP-2670, 1987.
9. Watson, N. D.; Miller, J. B.; Taylor, L. V.; Lovell, J. B.; Cox, J. W.; Fedors, J. C.; Kopia, L. P.; Holloway, R. M.; and Bradley, O. H.: *Earth Radiation Budget Experiment (ERBE) Scanner Instrument Anomaly Investigation*. NASA TM-87636, 1985.

Table 1. Summary Information for RAT and PAT Tapes Archived at the NSSDC

[For explanation of abbreviations, see "Nomenclature" on p. 1]

(a) November 1984^a

ERBS spacecraft			Day of month	NOAA 9 spacecraft (not operational)		
Percentage of data on—		Special events		Percentage of data on—		Special events
RAT	PAT			RAT	PAT	
0.00	0.00		1			
0.00	0.00		2			
0.00	0.00		3			
0.00	0.00		4			
100.00	79.44	SC INT, all NS CAL's	5			
100.00	100.00	SC INT CAL	6			
100.00	99.81	SC INT CAL	7			
99.31	99.15	SC INT CAL	8			
100.00	99.80	SC INT CAL	9			
100.00	98.94	SC INT CAL	10			
99.83	99.02	SC INT CAL	11			
99.06	98.78	SC INT, all NS CAL's	12			
100.00	99.96		13			
100.00	99.81		14			
100.00	99.91		15			
100.00	99.17		16			
100.00	99.85		17			
99.37	99.07		18			
100.00	99.89		19			
100.00	95.31	All CAL's, Yaw (-) to (+)	20			
100.00	78.85	Pitch, 180°	21			
100.00	100.00		22			
100.00	99.98		23			
100.00	100.00		24			
100.00	99.93		25			
99.85	96.94	All CAL's	26			
100.00	100.00		27			
100.00	99.96		28			
100.00	99.63		29			
99.96	99.74		30			

	<u>ERBS</u>	<u>NOAA 9</u>
^a Percentage of data for all days in month on—		
RAT	86.58	
PAT	84.77	
Percentage of data for days in month with data on—		
RAT	99.80	
PAT	97.81	
Date on which tape was archived at the NSSDC:		
RAT	Feb. 1986	
PAT	July 1988	

Table 1. Continued

(b) December 1984^a

ERBS spacecraft			Day of month	NOAA 9 spacecraft (not operational)		
Percentage of data on		Special events		Percentage of data on -		Special events
RAT	PAT			RAT	PAT	
100.00	99.98		1			
100.00	99.87		2			
100.00	97.20	All CAL's	3			
100.00	100.00		4			
100.00	99.98		5			
100.00	99.98		6			
99.98	99.74		7			
97.31	97.09		8			
99.87	99.76		9			
100.00	99.80	NS CAL's	10			
100.00	99.94		11			
100.00	99.98		12			
100.00	99.76		13			
100.00	99.85		14			
100.00	99.94		15			
100.00	99.96		16			
100.00	99.91	NS CAL's	17			
100.00	99.91		18			
100.00	99.39		19			
100.00	99.93		20			
99.85	99.63		21			
100.00	99.98		22			
100.00	99.87		23			
100.00	99.83		24			
99.85	99.83		25			
100.00	97.26	SC and NS INT CAL	26			
100.00	99.59		27			
100.00	99.93	NS SOL CAL	28			
98.83	98.50		29			
100.00	99.93		30			
99.85	99.83		31			

^aPercentage of data for all days in month on—

RAT 99.86
 PAT 99.55

Percentage of data for days in month with data on—

RAT 99.86
 PAT 99.55

Date on which tape was archived at the NSSDC:

RAT Nov. 1988
 PAT Aug. 1989

ERBS

NOAA 9

Table 1. Continued

(c) January 1985^a

ERBS spacecraft			Day of month	NOAA 9 spacecraft (not operational)		
Percentage of data on---		Special events		Percentage of data on---		Special events
RAT	PAT			RAT	PAT	
100.00	99.94		1			
100.00	99.91		2			
98.93	96.94	Yaw turn (+) to (-)	3			
99.80	99.39		4			
100.00	99.91		5			
100.00	99.94		6			
100.00	99.93		7			
100.00	99.85		8			
99.37	96.33	All CAL's	9			
100.00	88.07		10			
100.00	99.61		11			
100.00	99.78		12			
99.78	99.72		13			
99.89	99.63		14			
100.00	99.85		15			
100.00	100.00		16			
100.00	99.93		17			
99.48	98.98		18			
100.00	99.98		19			
99.87	99.69		20			
100.00	99.98		21			
100.00	99.91		22			
100.00	99.52	SC INT, all NS CAL's	23			
100.00	99.89		24			
99.96	99.83		25			
99.87	99.76		26			
100.00	99.83		27			
99.85	99.20		28			
100.00	100.00		29			
100.00	100.00		30			
100.00	99.98		31			

	ERBS	NOAA 9
^a Percentage of data for all days in month on---		
RAT	99.90	
PAT	99.20	
Percentage of data for days in month with data on---		
RAT	99.90	
PAT	99.20	
Date on which tape was archived at the NSSDC:		
RAT	Dec. 1987	
PAT	Aug. 1989	

Table 1. Continued

(d) February 1985^a

ERBS spacecraft			Day of month	NOAA 9 spacecraft		
Percentage of data on—		Special events		Percentage of data on—		Special events
RAT	PAT			RAT	PAT	
100.00	98.15	Yaw turn (-) to (+)	1	90.85	90.13	
100.00	99.74		2	92.81	88.63	
100.00	99.94		3	75.31	66.20	
100.00	99.91		4	66.35	64.96	
100.00	99.94		5	98.11	97.39	
100.00	97.48	All CAL's	6	99.72	95.67	
100.00	99.96		7	100.00	93.54	
99.96	99.80		8	93.56	91.13	
99.89	99.83		9	93.31	93.19	
96.91	96.91		10	99.89	99.83	
76.67	76.65		11	92.59	91.91	
100.00	100.00		12	92.69	92.02	
100.00	100.00		13	65.11	65.02	
100.00	99.43		14	90.85	90.28	
94.96	94.81		15	98.93	98.35	
100.00	99.93		16	99.59	99.43	
100.00	99.93		17	14.61	14.46	
100.00	99.96		18	94.24	94.11	
100.00	99.96		19	99.70	99.20	
100.00	0.00	SC SOL, all NS CAL's	20	99.93	97.72	
100.00	0.00		21	100.00	98.78	
99.52	0.00		22	99.91	99.67	
100.00	0.00		23	99.06	98.87	
100.00	0.00		24	100.00	99.48	
100.00	0.00		25	99.93	99.17	
100.00	0.00	SC INT CAL	26	99.19	97.48	
100.00	0.00		27	99.96	93.37	
100.00	0.00		28	100.00	99.76	

	<u>ERBS</u>	<u>NOAA 9</u>
^a Percentage of data for all days in month on		
RAT	98.85	91.29
PAT	66.51	89.63
Percentage of data for days in month with data on—		
RAT	98.85	91.29
PAT	98.02	89.63
Date on which tape was archived at the NSSDC:		
RAT	July 1989	Nov. 1989
PAT	Dec. 1989	Feb. 1990

Table 1. Continued

(e) March 1985^a

ERBS spacecraft		Special events	Day of month	NOAA 9 spacecraft		Special events
Percentage of data on --				Percentage of data on --		
RAT	PAT			RAT	PAT	
100.00	99.91	All CAL's	1	86.24	85.93	All CAL's
100.00	99.93		2	79.41	78.65	
100.00	99.93		3	99.87	98.74	
100.00	99.91		4	92.43	92.13	
100.00	99.98		5	100.00	98.78	
100.00	97.69		6	92.33	91.83	
100.00	99.46		7	100.00	99.78	
100.00	99.78		8	99.94	99.33	
100.00	99.85		9	92.65	92.15	
100.00	99.78		10	100.00	99.72	
100.00	99.94		11	75.43	74.94	
100.00	100.00		12	93.28	92.74	
100.00	98.17	Yaw turn (+) to (-)	13	100.00	99.46	SC SOL, all NS CAL's
100.00	99.89	14	100.00	99.85		
100.00	99.76	15	99.76	97.50		
100.00	99.50	16	43.00	42.94		
100.00	99.83	17	91.02	90.80		
100.00	99.93	18	100.00	99.81		
99.78	99.67	All CAL's	19	98.54	98.15	
99.50	95.59		20	92.02	75.04	
100.00	99.67		21	99.56	99.19	
100.00	99.28		22	99.85	98.87	
100.00	99.94		23	100.00	99.87	
99.20	95.78		24	93.26	93.04	
100.00	99.83		25	99.93	99.17	
100.00	99.70		26	99.44	98.98	
100.00	99.83		27	99.96	97.93	
100.00	99.83		28	100.00	98.91	
100.00	99.98		29	72.46	72.30	
100.00	99.94		30	53.57	53.50	
100.00	99.48	31	93.39	93.19		

	<u>ERBS</u>	<u>NOAA 9</u>
^a Percentage of data for all days in month on--		
RAT	99.95	91.85
PAT	99.41	90.75
Percentage of data for days in month with data on--		
RAT	99.95	91.85
PAT	99.41	90.75
Date on which tape was archived at the NSSDC:		
RAT	Sept. 1988	Sept. 1988
PAT	Oct. 1989	Oct. 1989

Table 1. Continued

(f) April 1985^a

ERBS spacecraft			Day of month	NOAA 9 spacecraft		
Percentage of data on—		Special events		Percentage of data on—		Special events
RAT	PAT			RAT	PAT	
100.00	99.93	All CAL's	1	100.00	99.74	All CAL's
100.00	99.87		2	98.65	98.44	
100.00	97.04		3	100.00	99.39	
100.00	99.74		4	93.20	87.04	
100.00	99.94		5	96.65	68.65	
100.00	99.96		6	99.50	99.06	
100.00	99.94		7	99.83	99.41	
100.00	99.94		8	30.09	29.85	
100.00	99.81		9	67.81	55.00	
99.98	99.72		10	92.52	92.09	
100.00	99.98		11	99.96	99.06	
99.98	99.56		12	89.85	84.54	
99.96	99.81		13	89.52	87.50	
100.00	99.91		14	87.56	87.33	
100.00	99.26		15	99.74	99.57	
100.00	99.94	All CAL's	16	85.17	84.33	All CAL's
99.76	96.96		17	90.46	88.96	
81.28	81.15		18	86.31	84.67	
88.33	88.31	Yaw turn (-) to (+)	19	99.91	97.11	
85.26	85.06		20	99.65	96.78	
100.00	98.06		21	99.80	95.22	
100.00	100.00	22	78.02	77.20		
100.00	100.00	23	92.39	92.07		
100.00	99.98	24	93.41	92.46		
100.00	99.93	25	96.81	96.02		
100.00	99.96	26	91.44	90.13		
100.00	99.91	27	99.37	96.54		
100.00	99.96	28	99.89	98.39		
100.00	99.98	29	99.39	98.85		
100.00	100.00	30	92.56	91.44		

	<u>ERBS</u>	<u>NOAA 9</u>
^a Percentage of data for all days in month on—		
RAT	98.49	91.65
PAT	98.12	88.90
Percentage of data for days in month with data on—		
RAT	98.49	91.65
PAT	98.12	88.90
Date on which tape was archived at the NSSDC:		
RAT	Mar. 1986	Mar. 1986
PAT	Dec. 1987	Mar. 1988

Table 1. Continued

(g) May 1985^a

ERBS spacecraft			Day of month	NOAA 9 spacecraft		
Percentage of data on—		Special events		Percentage of data on—		Special events
RAT	PAT			RAT	PAT	
100.00	97.19	All CAL's	1	100.00	99.52	All CAL's
100.00	99.96		2	93.37	92.87	
100.00	99.67		3	87.28	85.94	
100.00	100.00		4	99.65	99.02	
100.00	99.67		5	99.89	99.46	
99.93	95.56		6	97.35	96.06	
100.00	97.67		7	94.15	92.94	
100.00	97.26	All CAL's	8	92.70	90.28	
100.00	99.89		9	85.89	85.17	
100.00	99.98		10	92.89	92.13	
100.00	100.00		11	0.00	0.00	
100.00	99.98		12	37.41	37.17	
100.00	99.76		13	78.46	77.83	
100.00	100.00		14	99.78	98.69	
100.00	99.98		15	99.85	98.41	
100.00	100.00		16	77.78	76.85	
100.00	99.94		17	99.02	97.87	
100.00	99.74		18	92.67	90.56	
100.00	99.96		19	97.93	96.48	
100.00	100.00		20	77.46	76.70	
100.00	99.91		21	85.30	84.41	
100.00	97.93	Yaw turn (+) to (-)	22	99.30	98.22	
99.98	87.85		23	99.02	97.44	
99.98	99.74		24	99.57	98.54	
99.93	99.76		25	99.11	96.52	
99.94	99.41		26	98.85	95.83	
99.91	99.50		27	99.59	98.26	
99.94	99.61		28	78.76	77.70	
99.98	97.20	All CAL's	29	96.80	94.72	
99.96	99.80		30	95.56	94.09	
99.94	99.56		31	91.74	90.48	

	<u>ERBS</u>	<u>NOAA 9</u>
^a Percentage of data for all days in month on—		
RAT	99.98	88.62
PAT	98.92	87.42
Percentage of data for days in month with data on—		
RAT	99.98	91.57
PAT	98.92	90.34
Date on which tape was archived at the NSSDC:		
RAT	Nov. 1988	Feb. 1989
PAT	Aug. 1989	Oct. 1989

Table 1. Continued

(h) June 1985^a

ERBS spacecraft			Day of month	NOAA 9 spacecraft		
Percentage of data on—		Special events		Percentage of data on—		Special events
RAT	PAT			RAT	PAT	
99.87	99.48		1	0.00	0.00	
99.96	99.83		2	0.00	0.00	
99.96	99.91		3	98.56	95.59	
100.00	99.94		4	95.26	93.07	
99.98	99.93		5	85.85	75.87	
99.96	99.96		6	96.54	94.69	
99.89	99.31		7	92.78	90.69	
100.00	99.93		8	91.91	85.09	
100.00	99.98		9	71.37	70.57	
99.89	99.22		10	99.76	97.93	
99.98	99.43		11	99.31	97.89	
99.80	98.33	NS INT CAL	12	95.24	93.70	All CAL's
99.70	98.89		13	96.67	93.76	
99.96	99.65		14	88.67	87.69	
99.98	99.89		15	99.61	98.39	
99.72	98.37		16	99.56	97.39	
100.00	100.00		17	92.96	91.00	
99.93	99.76	All NS CAL's	18	98.43	97.07	
100.00	99.98		19	99.17	96.74	
100.00	99.93		20	99.93	99.06	
98.35	97.80		21	92.00	90.93	
99.87	99.80		22	92.48	91.22	
100.00	100.00		23	99.43	97.50	
100.00	99.98		24	99.06	96.70	
99.96	99.93		25	99.67	98.04	
99.98	97.15	All CAL's	26	99.93	98.80	SC INT, all NS CAL's
99.85	99.20		27	93.00	91.20	
99.96	99.76		28	99.78	98.94	
99.87	99.30		29	98.20	96.83	
100.00	99.94		30	98.46	97.94	

	<u>ERBS</u>	<u>NOAA 9</u>
^a Percentage of data for all days in month on—		
RAT	99.88	89.12
PAT	99.49	87.14
Percentage of data for days in month with data on—		
RAT	99.88	95.48
PAT	99.49	93.37
Date on which tape was archived at the NSSDC:		
RAT	Dec. 1988	Apr. 1989
PAT	July 1989	Oct. 1989

Table 1. Continued

(i) July 1985^a

ERBS spacecraft			Day of month	NOAA 9 spacecraft		
Percentage of data on —		Special events		Percentage of data on—		Special events
RAT	PAT			RAT	PAT	
99.87	99.72	Yaw turn (-) to (+)	1	94.52	92.00	
99.72	99.33		2	92.26	80.76	
99.98	99.89		3	64.80	60.39	
99.98	98.13		4	99.11	98.43	
93.44	93.39		5	88.93	88.30	
99.87	99.81		6	94.11	92.72	
99.94	99.93		7	91.85	91.41	
100.00	99.81		8	92.19	91.13	
99.96	99.94		9	99.59	98.04	
99.98	97.24		All CAL's	10	99.07	
73.46	73.37		11	92.56	91.44	
99.87	99.54		12	92.89	91.65	
100.00	99.98		13	84.50	83.44	
99.96	99.94		14	78.93	78.15	
100.00	99.96		15	97.31	95.41	
100.00	100.00		16	89.65	87.44	
99.96	99.94		17	92.28	91.13	
99.81	99.57		18	0.00	98.74	
100.00	100.00		19	99.50	98.63	
100.00	99.19		20	100.00	99.22	
99.87	99.70	All CAL's	21	100.00	98.80	All CAL's
99.76	99.46		22	98.93	98.13	
100.00	99.96		23	94.80	93.59	
99.81	96.89		24	71.69	70.67	
99.81	99.56		25	71.04	70.33	
99.85	99.65		26	99.85	99.37	
100.00	100.00		27	97.39	96.31	
99.96	99.85		28	92.87	92.24	
80.00	79.98		29	97.93	97.30	
99.98	99.80		30	99.39	97.15	
99.93	99.72		31	87.15	86.33	

	<u>ERBS</u>	<u>NOAA 9</u>
^a Percentage of data for all days in month on—		
RAT	98.22	88.87
PAT	97.85	90.53
Percentage of data for days in month with data on—		
RAT	98.22	91.84
PAT	97.85	90.53
Date on which tape was archived at the NSSDC:		
RAT	Sept. 1986	Jan. 1987
PAT	Feb. 1988	Sept. 1988

Table 1. Continued

(j) August 1985^a

ERBS spacecraft			Day of month	NOAA 9 spacecraft		
Percentage of data on—		Special events		Percentage of data on—		Special events
RAT	PAT			RAT	PAT	
99.70	99.50		1	0.00	0.00	
99.02	96.70	Yaw turn (+) to (-)	2	0.00	0.00	
99.98	99.98		3	98.09	96.74	
100.00	99.96		4	99.17	98.69	
100.00	99.98		5	92.24	91.50	
100.00	99.91		6	90.67	90.04	
100.00	97.26	All CAL's	7	99.31	98.30	SC INT, all NS CAL's
100.00	99.76		8	99.85	98.74	
100.00	99.33		9	99.94	98.02	
100.00	99.96		10	99.98	99.28	
99.80	98.24		11	99.98	99.57	
99.65	99.61		12	97.78	97.06	
100.00	99.46		13	92.44	89.93	
99.91	99.81		14	99.83	99.09	
99.41	98.00		15	96.43	95.30	
100.00	99.98		16	99.70	99.37	
99.98	99.70		17	99.74	99.24	
100.00	96.67		18	99.20	97.24	
95.57	87.26		19	100.00	99.06	
100.00	99.93		20	99.89	99.46	
100.00	99.61	All NS CAL's	21	100.00	99.43	All CAL's
100.00	99.96		22	92.54	92.26	
99.89	99.72		23	99.63	98.93	
100.00	98.52		24	99.11	98.31	
100.00	97.56		25	99.41	99.07	
99.83	99.48		26	99.91	99.56	
100.00	99.69		27	92.61	90.87	
99.98	99.80		28	99.96	99.09	
99.87	98.98		29	99.96	98.72	
99.98	99.96		30	92.98	92.70	
98.74	97.57		31	99.61	98.98	

^aPercentage of data for all days in month on—

	ERBS	NOAA 9
RAT	99.72	91.61
PAT	98.77	90.79
Percentage of data for days in month with data on—		
RAT	99.72	97.93
PAT	98.77	97.05
Date on which tape was archived at the NSSDC:		
RAT	Jan. 1988	Aug. 1989
PAT	Apr. 1988	Dec. 1989

Table 1. Continued

(k) September 1985^a

ERBS spacecraft			Day of month	NOAA 9 spacecraft		
Percentage of data on—		Special events		Percentage of data on—		Special events
RAT	PAT			RAT	PAT	
99.98	99.98	All CAL's	1	99.98	99.06	All CAL's
99.96	99.76		2	99.91	99.13	
100.00	100.00		3	99.19	99.02	
99.98	97.04		4	99.59	98.76	
100.00	99.87		5	99.44	98.35	
100.00	99.31		6	69.26	68.70	
100.00	99.96		7	96.06	94.13	
99.94	99.70		8	99.54	98.41	
99.98	99.93		9	99.98	98.91	
100.00	99.91		10	92.43	90.31	
99.94	98.69	Yaw turn (-) to (+)	11	99.48	98.48	
100.00	98.13		12	99.63	97.63	
99.87	99.56		13	99.39	98.30	
100.00	99.93		14	99.69	93.39	
99.91	99.85	15	97.22	96.19	SC INT, all NS CAL's	
58.98	58.63	16	95.61	94.61		
99.91	99.83	17	96.54	95.44		
99.93	97.19	18	99.91	98.74		
99.98	99.89	19	89.98	87.72		
99.98	99.94	20	67.04	63.98		
98.37	98.17	21	85.09	84.33		
99.87	99.67	22	71.52	70.85		
99.85	99.70	23	93.15	92.24		
99.87	99.69	24	97.26	95.72		
99.48	99.26	25	99.78	98.35		
99.94	99.94	26	48.50	48.22		
99.89	99.89	27	29.70	29.65		
99.93	99.85	28	98.52	97.76		
99.98	99.98	29	73.20	65.46		
100.00	100.00	30	98.35	96.87		

	<u>ERBS</u>	<u>NOAA 9</u>
^a Percentage of data for all days in month on—		
RAT	98.52	89.83
PAT	98.11	88.29
Percentage of data for days in month with data on—		
RAT	98.52	89.83
PAT	98.11	88.29
Date on which tape was archived at the NSSDC:		
RAT	Jan. 1989	May 1989
PAT	July 1989	Nov. 1989

Table 1. Continued

(1) October 1985^a

ERBS spacecraft			Day of month	NOAA 9 spacecraft		
Percentage of data on		Special events		Percentage of data on		Special events
RAT	PAT			RAT	PAT	
99.98	99.93		1	99.70	97.31	
100.00	97.26	All CAL's	2	98.76	97.89	All CAL's
99.94	99.93		3	99.59	87.89	
100.00	99.96		4	72.09	67.61	
100.00	99.94		5	92.56	89.63	
99.93	99.87		6	99.87	94.81	
99.96	99.94		7	99.35	90.85	
100.00	99.98		8	80.33	64.52	
100.00	99.76		9	93.41	92.91	
99.87	99.83		10	89.63	79.37	
100.00	100.00		11	86.72	66.89	
99.98	99.96		12	99.74	98.78	
99.91	99.91		13	95.43	83.44	
99.41	98.76		14	80.85	74.17	
99.98	99.96		15	96.33	90.76	
99.87	96.96	All CAL's	16	89.94	89.33	All CAL's
99.78	99.74		17	100.00	99.87	
99.93	98.02	Yaw turn (+) to (-)	18	86.07	84.02	
99.91	75.91	Pitch maneuver	19	92.43	82.07	
100.00	91.15	All NS CAL's	20	99.57	95.87	
100.00	99.96		21	87.07	86.48	
100.00	99.96		22	98.39	78.37	
99.96	99.80		23	90.50	73.83	
99.87	99.24		24	92.52	91.44	
99.98	99.96		25	78.09	72.63	
100.00	99.89		26	80.06	52.02	
100.00	99.72		27	0.00	75.56	
100.00	99.85		28	93.04	79.00	
100.00	99.98		29	0.00	0.00	
99.67	98.98	NS INT CAL's	30	91.65	80.37	All CAL's
100.00	99.96	All NS CAL's	31	85.76	77.56	

^aPercentage of data for all days in month on—

	ERBS	NOAA 9
RAT	99.93	85.47
PAT	98.52	80.49
Percentage of data for days in month with data on—		
RAT	99.93	91.36
PAT	98.52	83.18
Date on which tape was archived at the NSSDC:		
RAT	Oct. 1986	Mar. 1987
PAT	May 1988	Dec. 1988

Table 1. Continued

(m) November 1985^a

ERBS spacecraft			Day of month	NOAA 9 spacecraft		
Percentage of data on -		Special events		Percentage of data on		Special events
RAT	PAT			RAT	PAT	
99.98	99.96	All NS CAL's	1	92.30	79.70	All CAL's
99.98	99.96		2	95.69	77.65	
87.31	87.30		3	92.89	83.22	
100.00	100.00		4	81.48	79.43	
100.00	99.94		5	90.80	76.93	
99.98	99.87		6	99.74	67.35	
99.98	99.81		7	93.20	80.33	
100.00	99.78		8	94.30	94.09	
100.00	100.00		9	99.94	99.74	
100.00	99.96		10	92.56	92.33	
100.00	99.96		11	85.00	67.24	
99.98	99.89		12	85.39	67.54	
100.00	99.85		13	94.19	93.48	
99.74	99.50	14	85.52	77.46		
75.19	74.85	15	87.19	72.94		
100.00	99.98	16	99.94	92.98		
99.98	99.85	17	79.26	78.94		
100.00	99.98	18	99.94	86.63		
99.98	99.91	19	99.81	98.56		
99.83	99.00	20	96.09	77.83		
99.98	97.93	Yaw turn (-) to (+)	21	91.11	84.70	
100.00	100.00	22	92.91	92.43		
99.94	99.91	23	86.74	83.57		
100.00	99.98	24	78.33	77.37		
100.00	100.00	25	83.81	83.57		
100.00	99.81	26	93.15	79.26		
99.87	99.76	All NS CAL's	27	99.94	95.69	All CAL's
99.89	99.76	28	96.83	93.04		
99.93	99.91	29	80.91	60.70		
99.91	99.87	30	85.09	73.87		

	<u>ERBS</u>	<u>NOAA 9</u>
^a Percentage of data for all days in month on -		
RAT	98.72	91.14
PAT	98.54	82.29
Percentage of data for days in month with data on—		
RAT	98.72	91.14
PAT	98.54	82.29
Date on which tape was archived at the NSSDC:		
RAT	Apr. 1989	Aug. 1989
PAT	Aug. 1989	Dec. 1989

Table 1. Continued

(n) December 1985^a

ERBS spacecraft			Day of month	NOAA 9 spacecraft		
Percentage of data on—		Special events		Percentage of data on—		Special events
RAT	PAT			RAT	PAT	
99.89	99.80	NS INT CAL	1	90.43	88.20	All CAL's
100.00	100.00		2	70.20	65.50	
99.96	99.93		3	86.24	73.30	
100.00	99.98		4	100.00	99.02	
100.00	99.85		5	78.61	77.91	
99.89	99.81		6	86.26	85.30	
100.00	100.00		7	99.94	99.11	
99.81	99.70		8	98.20	97.22	
100.00	99.94		9	81.22	80.33	
100.00	99.98		10	99.70	98.22	
100.00	99.85		11	77.72	76.54	
100.00	99.94		12	95.22	94.31	
100.00	99.98		13	69.22	67.59	
100.00	99.96		14	78.07	77.44	
78.06	77.96		15	93.15	91.85	
95.50	95.44		16	99.28	98.67	
100.00	99.96		17	88.33	87.24	
100.00	99.76	SC INT, all NS CAL's	18	91.31	89.81	All SC, NS SOL CAL's
100.00	99.96		19	61.41	60.72	
100.00	100.00		20	96.20	95.46	
99.96	99.94		21	80.06	79.56	
99.98	99.91	22	73.28	72.74		
100.00	99.67	23	90.09	89.46		
99.98	99.94	24	79.37	78.80		
99.98	99.69	25	87.15	86.57		
99.98	99.98	26	94.80	94.37		
99.98	99.91	27	83.04	82.09		
99.96	99.96	28	91.87	89.80		
100.00	99.98	29	99.91	99.11		
99.87	99.87	30	93.28	92.54		
100.00	98.15	Yaw turn (+) to (-)	31	98.91	97.85	

	<u>ERBS</u>	<u>NOAA 9</u>
^a Percentage of data for all days in month on—		
RAT	99.12	87.50
PAT	98.99	86.02
Percentage of data for days in month with data on—		
RAT	99.12	87.50
PAT	98.99	86.02
Date on which tape was archived at the NSSDC:		
RAT	May 1989	Nov. 1989
PAT	Aug. 1989	Mar. 1990

Table 1. Concluded

(o) January 1986^a

ERBS spacecraft			Day of month	NOAA 9 spacecraft		
Percentage of data on—		Special events		Percentage of data on—		Special events
RAT	PAT			RAT	PAT	
99.93	99.87		1	79.67	78.30	
100.00	99.93		2	72.13	71.81	
99.98	99.94		3	99.70	99.22	
100.00	99.96		4	99.94	99.61	
99.91	99.67		5	99.94	99.56	
99.94	99.76		6	98.93	98.07	
99.96	99.83		7	98.91	97.80	
100.00	99.65	SC INT, all NS CAL's	8	99.63	97.02	
99.93	99.91		9	93.15	93.00	
100.00	99.96		10	82.24	81.39	
100.00	99.89		11	92.74	92.30	
100.00	99.91		12	99.80	99.50	
99.50	99.43		13	85.98	85.80	
100.00	99.98		14	99.89	99.48	
100.00	99.30		15	99.17	96.44	
100.00	99.91		16	99.87	94.20	
100.00	100.00		17	99.87	93.15	
99.98	99.78		18	100.00	98.00	
100.00	99.98		19	93.39	92.02	
99.98	99.98		20	100.00	99.48	
99.96	99.89		21	93.46	90.33	
99.98	99.70	SC INT, all NS CAL's	22	92.67	86.04	All CAL's
100.00	100.00		23	99.89	94.44	
99.63	99.52		24	97.94	95.41	
100.00	99.93		25	87.31	86.50	
100.00	99.81		26	99.94	99.06	
99.94	99.91		27	99.91	99.76	
99.96	99.20		28	72.06	71.31	
99.98	99.89		29	99.65	97.96	
100.00	99.93		30	99.98	99.52	
99.94	98.06	Yaw turn (-) to (+)	31	93.35	92.96	

	<u>ERBS</u>	<u>NOAA 9</u>
^a Percentage of data for all days in month on—		
RAT	99.95	94.55
PAT	99.76	92.89
Percentage of data for days in month with data on—		
RAT	99.95	94.55
PAT	99.76	92.89
Date on which tape was archived at the NSSDC:		
RAT	Oct. 1986	Aug. 1988
PAT	Aug. 1988	Nov. 1988

Table 2. Spectral Characteristics of ERBE Instrument Detectors

(a) Nonscanner detectors

Detector	Spectral range, μm
Medium field of view:	
Shortwave	0.2 to 5.0
Total	0.2 to >50.0
Wide field of view:	
Shortwave	0.2 to 5.0
Total	0.2 to >50.0
Solar monitor	0.2 to >50.0

(b) Scanner detectors

Detector	Spectral range, μm
Shortwave	0.2 to 4.9
Longwave	5.0 to 50.0
Total	<0.2 to >200.0

Table 3. Operational and Pulse Discrete Commands for Instruments

(a) Nonscanner instrument

1. Mode commands

Command description	Hex value
Azimuth to 0° position	811
Azimuth to 90° position	812
Azimuth to 180° position	813
Azimuth to position A	814
Elevation to internal source (stow)	821
Elevation to solar ports	822
Elevation to nadir (Earth view)	823
SMA shutter cycle on	831
SMA shutter cycle off	832
Detector heaters on	841
Detector heaters off	842
Solar port heaters on	851
Solar port heaters off	852
WFOV blackbody heater off	861
WFOV blackbody heater to temperature 1	862
WFOV blackbody heater to temperature 2	863
MFOV blackbody heater off	871
MFOV blackbody heater to temperature 1	872
MFOV blackbody heater to temperature 2	873
Detector calibration heater off	881
Detector calibration heater level 1	882
Detector calibration heater level 2	883
Detector calibration heater level 3	884
SWICS off	891
SWICS level 1	892
SWICS level 2	893
SWICS level 3	894
Internal calibration sequence	8A1
Solar calibration sequence	8A2

Table 3. Continued

(a) Concluded

2. Data storage commands

Command description	Hex value
Address for azimuth position A	419
Address for MFOV total heat sink temperature	422
Address for MFOV SW heat sink temperature	42B
Address for WFOV total heat sink temperature	434
Address for WFOV SW heat sink temperature	43D
Address for solar port temperature	446
Address for MFOV blackbody temperature 1	461
Address for MFOV blackbody temperature 2	463
Address for WFOV blackbody temperature 1	465
Address for WFOV blackbody temperature 2	467
Data, most significant byte	2xx
Data, least significant byte	1xx

3. Pulse discrete commands

Command description
Turn on instrument power
Turn off instrument power
Turn on pulse load bus A power
Turn off pulse load bus A power
Turn on pulse load bus B power
Turn off pulse load bus B power
Turn on standby heater power
Turn off standby heater power

Table 3. Continued

(b) Scanner instrument

1. Mode commands

Command description	Hex value
Azimuth to 0° position	811
Azimuth to 90° position	812
Azimuth to 180° position	813
Azimuth to position A	814
Azimuth to position B	815
Azimuth scan between 0° and position A	816
Scan to stow position	821
Normal Earth scan	822
Nadir Earth scan	823
Short Earth scan	824
MAM scan	825
SWICS off	891
SWICS at level 3	892
SWICS at level 3—modulated	893
SWICS at level 2	894
SWICS at level 2—modulated	895
SWICS at level 1	896
SWICS at level 1—modulated	897
Internal calibration sequence	8A1
Solar calibration sequence	8A2

2. Data storage commands

Command description	Hex value
Address for azimuth position A	419
Address for azimuth position B	41B
Data, most significant byte	2xx
Data, least significant byte	1xx

Table 3. Concluded

(b) Concluded

3. Pulse discrete commands

Command description
Turn on instrument power
Turn off instrument power
Turn on pulse load bus A power
Turn off pulse load bus A power
Turn on pulse load bus B power
Turn off pulse load bus B power
Turn on standby heater power (pedestal)
Turn off standby heater power (pedestal)
Turn on standby heater power (head)
Turn off standby heater power (head)
Turn on pulse bus series relay
Turn off pulse bus series relay
Turn on blackbody heater bus power
Turn off blackbody heater bus power

Table 4. Scan Profiles of Scanner Instrument

[Scan angle is given in degrees; footnotes are given at end of table^a]

Scan position	Normal Earth mode		Short Earth mode		MAM scan mode	
	Scan angle	View	Scan angle	View	Scan angle	View
1	14.00	Space	14.0	Space	163.00	Space
2	↓	↓	↓	↓	↓	↓
3						
4						
5						
6						
7						
8	↓	↓	↓	↓	↓	↓
9	23.00	Earth	23.00	Earth	(b)	Transit
10	25.22	↓	25.22	↓	↓	↓
11	27.45		27.45			
12	29.67		29.67			
13	31.89		31.89			
14	34.12		34.12			
15	36.34		36.34			
16	38.56		38.56			
17	40.79		40.79			
18	43.01		43.01		233.00	MAM
19	45.23		45.23		↓	↓
20	47.46		47.46			
21	49.68		49.68			
22	51.90		51.90			
23	54.13		54.13			
24	56.35		56.35			
25	58.57		58.57			
26	60.80		60.80			
27	63.02		63.02			
28	65.24		65.24			
29	67.47		67.47			
30	69.69		69.69			
31	71.91		71.91			
32	74.14		74.14			
33	76.36		76.36			
34	78.58		78.58			
35	80.81		80.81			
36	83.03		83.03			
37	85.25		85.25			
38	87.48		87.48			
39	89.70		89.70			
40	91.92		91.92			
41	94.15		94.15			
42	96.37		96.37			
43	98.59		98.59			
44	100.82	↓	100.82	↓	↓	↓

Table 4. Concluded

Scan position	Normal Earth mode		Short Earth mode		MAM scan mode	
	Scan angle	View	Scan angle	View	Scan angle	View
45	103.04	Earth	103.04	Earth	233.00	MAM
46	105.26	↓	105.26	↓	↓	↓
47	107.49	↓	107.49	↓	↓	↓
48	109.71	↓	109.71	↓	↓	↓
49	111.93	↓	111.93	↓	↓	↓
50	114.16	↓	114.16	↓	↓	↓
51	116.38	↓	116.38	↓	↓	↓
52	118.60	↓	118.60	↓	↓	↓
53	120.83	↓	120.83	↓	↓	↓
54	123.05	↓	123.05	↓	↓	↓
55	125.27	↓	125.27	↓	↓	↓
56	127.50	↓	127.50	↓	↓	↓
57	129.72	↓	129.72	↓	↓	↓
58	131.94	↓	131.94	↓	↓	↓
59	134.17	↓	134.17	↓	↓	↓
60	136.39	↓	136.39	↓	↓	↓
61	138.61	↓	138.61	↓	↓	↓
62	140.84	↓	140.84	↓	↓	↓
63	143.06	↓	142.00	↓	↓	↓
64	145.28	↓	↓	↓	↓	↓
65	147.51	↓	↓	↓	(b)	Transit
66	149.73	↓	↓	↓	↓	↓
67	151.95	↓	↓	↓	↓	↓
68	154.18	↓	↓	↓	↓	↓
69	156.40	↓	↓	↓	↓	↓
70	158.62	↓	↓	↓	↓	↓
71	190.00	INT CAL	142.00	Earth	190.00	INT CAL
72	↓	↓	↓	↓	↓	↓
73	↓	↓	↓	↓	↓	↓
74	↓	↓	↓	↓	↓	↓

^aScan angle is the elevation angle ϕ that is defined in the "Coordinate Systems and In-Flight Geometry" section (p. 7) and is shown in figure 2(b).

^bNot calculated.

Table 5. List of Data Output by Instruments

(a) Nonscanner instrument

Data description	RAT units	PAT units	Measurement interval, sec	Measurements per 16 sec
WFOV total radiometric	Counts	W/m ²	0.8	20
WFOV SW radiometric	↓	↓	↓	↓
MFOV total radiometric	↓	↓	↓	↓
MFOV SW radiometric	↓	↓	↓	↓
Solar monitor radiometric	↓	Not on PAT	↓	↓
Command echo	↓	↓	16	1
Instrument status	↓	↓	↓	↓
Elevation drive position	deg	↓	↓	↓
MFOV total aperture temperature	°C	↓	↓	↓
MFOV SW aperture temperature	↓	↓	↓	↓
Solar monitor heat sink temperature	↓	↓	↓	↓
WFOV total aperture temperature	↓	↓	↓	↓
WFOV SW aperture temperature	↓	↓	↓	↓
MFOV total FOV limiter temperature	↓	↓	↓	↓
MFOV SW limiter temperature	↓	↓	↓	↓
Calibration heater voltage	V	↓	↓	↓
Solar monitor aperture temperature	°C	↓	↓	↓
WFOV total FOV limiter temperature	↓	↓	↓	↓
WFOV SW FOV limiter temperature	↓	↓	↓	↓
Beam electronics board temperature	↓	↓	↓	↓
Solar monitor baffle temperature	↓	↓	↓	↓
Azimuth drive position	deg	↓	8	2
WFOV total heat sink temperature	°C	↓	↓	↓
WFOV SW heat sink temperature	↓	↓	↓	↓
MFOV total heat sink temperature	↓	↓	↓	↓
MFOV SW heat sink temperature	↓	↓	↓	↓
WFOV blackbody temperature	↓	↓	↓	↓
MFOV blackbody temperature	↓	↓	↓	↓
WFOV solar port temperature	↓	↓	↓	↓
MFOV solar port temperature	↓	↓	↓	↓
SWICS photodiode temperature	↓	↓	↓	↓
SWICS amplifier output	V	↓	↓	↓
Temperature reference voltage	V	↓	↓	↓
SAS azimuth sine	Counts	↓	4	4
SAS azimuth cosine	↓	↓	↓	↓
SAS elevation sine	↓	↓	↓	↓
SAS elevation cosine	↓	↓	↓	↓
SAS coarse data	↓	↓	↓	↓

Table 5. Concluded

(b) Scanner instrument

Data description	RAT units	PAT units	Measurement interval, sec	Measurements per 16 sec
Total radiometric	Counts	$W/m^2/sr$	0.033	296
LW radiometric	↓	↓	↓	↓
SW radiometric	↓	↓	↓	↓
Scan position	deg	Not on PAT	↓	↓
Command echo	Counts	↓	4	4
Instrument status	Counts	↓	↓	↓
Azimuth position	deg	↓	↓	↓
Total detector temperature	°C	↓	↓	↓
LW detector temperature	↓	↓	↓	↓
SW detector temperature	↓	↓	↓	↓
Total blackbody temperature	↓	↓	↓	↓
LW blackbody temperature	↓	↓	↓	↓
SWICS photodiode temperature	↓	↓	↓	↓
Detector positive bias voltage	V	↓	↓	↓
Detector negative bias voltage	↓	↓	↓	↓
Total drift balance DAC voltage	↓	↓	↓	↓
LW drift balance DAC voltage	↓	↓	↓	↓
SW drift balance DAC voltage	↓	↓	↓	↓
Temperature reference voltage 1	↓	↓	↓	↓
Temperature reference voltage 2	↓	↓	↓	↓
SW MAM temperature	°C	↓	↓	↓
Total MAM baffle temperature	↓	↓	↓	↓
SW MAM baffle temperature	↓	↓	↓	↓
Total MAM temperature	↓	↓	↓	↓
SWICS amplifier output (1)	V	↓	↓	↓
SWICS amplifier output (2)	↓	↓	↓	↓
SWICS amplifier output (3)	↓	↓	↓	↓

Table 6. Normal In-Flight Operational Modes of Instruments

[On = Closed; Off = Open]

(a) Nonscanner

1. Operational modes

Mode category	Normal operational mode	
	ERBS	NOAA 9
Azimuth-beam position	0°	170°
Elevation-beam position	0° (nadir)	0° (nadir)
SMA shutter operation	Off	Off
Detector heaters	On	On
Solar port heaters	On	On
WFOV blackbody heaters	Off	Off
MFOV blackbody heaters	Off	Off
Detector calibration heater	Off	Off
SW internal calibration source	Off	Off
Internal calibration sequence	Not in	Not in
Solar calibration sequence	Not in	Not in

2. Data for mode commands

Operational mode	Temperature, °C	
	ERBS	NOAA 9
WFOV shortwave heat sink temp.	33.6	33.6
WFOV total heat sink temp.	↓	↓
MFOV shortwave heat sink temp.	↓	↓
MFOV total heat sink temp.	↓	↓
WFOV SW blackbody temp. level 1	20.0	20.0
WFOV TOT blackbody temp. level 1	↓	↓
MFOV SW blackbody temp. level 2	↓	↓
MFOV TOT blackbody temp. level 2	↓	↓
Solar port temp.	20.5	20.5

3. Bi-level switch indicators

Description	Normal operations	
	ERBS	NOAA 9
Instrument power	On	On
Pulse load bus A	On	On
Pulse load bus B	Off	Off
Standby heater power	Off	Off
Instrument heater power ^a	On	On
Calibration heater bias power ^a	On	On
Azimuth motor power ^a	Off	Off
Elevation motor power ^a	Off	Off

^aControlled by mode commands.

Table 6. Concluded

(b) Scanner

1. Operational modes

Mode category	Normal operational mode	
	ERBS	NOAA 9
Azimuth-beam position	180°	0°
Scan mode	Normal Earth	Normal Earth
SW internal calibration source	Off	Off
Internal calibration sequence	Not in	Not in
Solar calibration sequence	Not in	Not in

2. Bi-level switch indicators

Description	Normal operations	
	ERBS	NOAA 9
Instrument power	On	On
Pulse load bus A	On	On
Pulse load bus B	Off	Off
Standby heater power (pedestal)	↓	↓
Blackbody calibration heater power	↓	↓
Standby heater power (head)	↓	↓
Azimuth motor power ^a	↓	↓
Elevation motor power ^a	On	On

^aControlled by mode commands.

Table 7. List of Operational Commands Executed by Instruments on ERBS Spacecraft

(a) Nonscanner commands

Date	Universal time		Hex command	Event description
	hr:min:sec	Minutes of day		
Begin azimuth angle load commands for solar calibration				
11/05/84	00:54:09	54	419	Address azimuth position A
↓	00:54:41	55	2xx	Data command, high byte
	00:55:45	56	1xx	Data command, low byte
End azimuth angle load commands (A = 48.0°)				
11/05/84	02:53:05	173	821	Elevate to internal source (stow)
↓	02:54:09	174	862	WFOV blackbody heater on at temp. 1
	02:54:41	175	872	MFOV blackbody heater on at temp. 1
	04:30:09	270	823	Elevate to nadir (Earth)
Begin internal calibration sequence				
11/05/84	04:31:13	271	8A1	Begin internal calibration
↓	04:31:45	272	881	Detector bias heater off
	04:32:17	272	852	Solar port heaters off
	04:32:49	273	821	Elevate to internal source (stow)
	04:33:21	273	851	Solar port heaters on
	04:35:29	275	882	Detector bias heater on at level 1
	04:37:37	278	892	SWICS on at level 3
	04:41:05	281	881	Detector bias heater off
	04:44:33	285	862	WFOV blackbody heater on at temp. 1
	04:45:05	285	872	MFOV blackbody heater on at temp. 1
	04:46:09	286	891	SWICS off
	04:59:29	299	883	Detector bias heater on at level 2
	05:01:37	302	893	SWICS on at level 2
	05:04:39	305	881	Detector bias heater off
	05:08:33	309	863	WFOV blackbody heater on at temp. 2
	05:09:05	309	873	MFOV blackbody heater on at temp. 2
	05:10:09	310	891	SWICS off
	05:23:29	323	884	Detector bias heater on at level 3
	05:25:37	326	894	SWICS on at level 1
	05:27:45	328	881	Detector bias heater off
	05:30:25	330	852	Solar port heaters off
	05:31:29	331	861	WFOV blackbody heater off
	05:32:01	332	871	MFOV blackbody heater off
	05:32:33	333	851	Solar port heaters on
↓	05:33:05	333	891	SWICS off
End internal calibration sequence				
11/05/84	05:40:33	341	823	Elevate to nadir (Earth)

Table 7. Continued

(a) Continued

Date	Universal time		Hex command	Event description
	hr:min:sec	Minutes of day		
Begin solar calibration sequence				
11/05/84 ↓	05:51:45	352	8A2	Begin solar calibration
	05:52:17	352	852	Solar port heaters off
	05:52:49	353	822	Elevate to solar ports (Sun)
	05:53:21	353	814	Azimuth to position A
	05:53:53	354	882	Detector bias heater on at level 1
	06:03:29	363	851	Solar port heaters on
	06:04:01	364	831	SMA shutter cycle on
	06:34:57	395	832	SMA shutter cycle off
	06:35:29	395	852	Solar port heaters off
	06:36:01	396	811	Azimuth to 0°
	06:36:33	397	881	Detector bias heater off
	06:46:09	406	823	Elevate to nadir (Earth)
	06:46:41	407	851	Solar port heaters on
End solar calibration sequence				
11/05/84	11:10:09	670	821	Elevate to internal source (stow)
11/05/84	15:59:13	959	823	Elevate to nadir (Earth)
Begin azimuth angle load commands for solar calibration				
11/12/84 ↓	05:50:41	351	419	Address azimuth position A
	05:54:57	355	2xx	Data command, high byte
	05:56:33	357	1xx	Data command, low byte
End azimuth angle load commands (A = 58.2°)				
11/12/84 ↓	15:44:17	944	821	Elevate to internal source (stow)
	15:44:49	945	862	WFOV blackbody heater on at temp. 1
	15:45:21	945	872	MFOV blackbody heater on at temp. 1
	17:21:21	1041	823	Elevate to nadir (Earth)
Begin internal calibration sequence				
11/12/84 ↓	17:22:25	1042	8A1	Begin internal calibration
	17:22:57	1043	881	Detector bias heater off
	17:23:29	1043	852	Solar port heaters off
	17:24:01	1044	821	Elevate to internal source (stow)
	17:24:33	1045	851	Solar port heaters on
	17:26:41	1047	882	Detector bias heater on at level 1
	17:28:49	1049	892	SWICS on at level 3
	17:32:01	1052	881	Detector bias heater off
	17:35:45	1056	862	WFOV blackbody heater on at temp. 1
	17:36:17	1056	872	MFOV blackbody heater on at temp. 1
	17:37:21	1057	891	SWICS off
	17:50:41	1071	883	Detector bias heater on at level 2
	17:52:49	1073	893	SWICS on at level 2
	17:56:01	1076	881	Detector bias heater off

Table 7. Continued

(a) Continued

Date	Universal time		Hex command	Event description
	hr:min:sec	Minutes of day		
11/12/84 ↓	17:59:45	1080	863	WFOV blackbody heater on at temp. 2
	18:00:17	1080	873	MFOV blackbody heater on at temp. 2
	18:01:21	1081	891	SWICS off
	18:14:41	1095	884	Detector bias heater on at level 3
	18:16:49	1097	894	SWICS on at level 1
	18:18:57	1099	881	Detector bias heater off
	18:21:37	1102	852	Solar port heaters off
	18:22:41	1103	861	WFOV blackbody heater off
	18:23:13	1103	871	MFOV blackbody heater off
	18:23:45	1104	851	Solar port heaters on
18:24:17	1104	891	SWICS off	
End internal calibration sequence				
11/12/84	18:31:13	1111	823	Elevate to nadir (Earth)
Begin solar calibration sequence				
11/12/84 ↓	18:37:37	1118	8A2	Begin solar calibration
	18:38:09	1118	852	Solar port heaters off
	18:38:41	1119	822	Elevate to solar ports (Sun)
	18:39:13	1119	814	Azimuth to position A
	18:39:45	1120	882	Detector bias heater on at level 1
	18:49:21	1129	851	Solar port heaters on
	18:49:53	1130	831	SMA shutter cycle on
	19:20:49	1161	832	SMA shutter cycle off
	19:21:21	1161	852	Solar port heaters off
	19:21:53	1162	811	Azimuth to 0°
	19:22:25	1162	881	Detector bias heater off
	19:32:01	1172	823	Elevate to nadir (Earth)
	19:32:33	1173	851	Solar port heaters on
End solar calibration sequence.				
Begin azimuth angle load commands for solar calibration				
11/20/84 ↓	04:11:29	251	419	Address azimuth position A
	04:12:01	252	2xx	Data command, high byte
	04:15:13	255	1xx	Data command, low byte
End azimuth angle load commands (A = 84.6°)				
11/20/84 ↓	06:43:29	403	821	Elevate to internal source (stow)
	06:44:01	404	862	WFOV blackbody heater on at temp. 1
	06:44:33	405	872	MFOV blackbody heater on at temp. 1
Begin azimuth angle load commands, repeat of above				
11/20/84 ↓	07:27:45	448	419	Address azimuth position A
	07:28:17	448	2xx	Data command, high byte
	07:28:49	449	1xx	Data command, low byte
End azimuth angle load commands (A = 84.6°)				
11/20/84	08:20:33	501	823	Elevate to nadir (Earth)

Table 7. Continued

(a) Continued

Date	Universal time		Hex command	Event description	
	hr:min:sec	Minutes of day			
Begin internal calibration sequence					
11/20/84 ↓	08:21:05	501	8A1	Begin internal calibration	
	08:21:37	502	881	Detector bias heater off	
	08:22:09	502	852	Solar port heaters off	
	08:22:41	503	821	Elevate to internal source (stow)	
	08:23:13	503	851	Solar port heaters on	
	08:25:21	505	882	Detector bias heater on at level 1	
	08:27:29	507	892	SWICS on at level 3	
	08:30:41	511	881	Detector bias heater off	
	08:34:25	514	862	WFOV blackbody heater on at temp. 1	
	08:34:57	515	872	MFOV blackbody heater on at temp. 1	
	08:36:01	516	891	SWICS off	
	08:49:21	529	883	Detector bias heater on at level 2	
	08:51:29	531	893	SWICS on at level 2	
	08:54:41	535	881	Detector bias heater off	
	08:58:25	538	863	WFOV blackbody heater on at temp. 2	
	08:58:57	539	873	MFOV blackbody heater on at temp. 2	
	09:00:01	540	891	SWICS off	
	09:13:21	553	884	Detector bias heater on at level 3	
	09:15:29	555	894	SWICS on at level 1	
	09:17:37	558	881	Detector bias heater off	
	09:20:17	560	852	Solar port heaters off	
	09:21:21	561	861	WFOV blackbody heater off	
	09:21:53	562	871	MFOV blackbody heater off	
	09:22:25	562	851	Solar port heaters on	
	09:22:57	563	891	SWICS off	
	End internal calibration sequence.				
	Begin azimuth angle load commands for solar calibration				
	11/20/84 ↓	09:24:01	564	419	Address azimuth position A
09:25:05		565	2xx	Data command, high byte	
09:26:09		566	1xx	Data command, low byte	
End azimuth angle load commands ($A = 84.6^\circ$)					
11/20/84	09:30:25	570	823	Elevate to nadir (Earth)	
Begin solar calibration sequence					
11/20/84 ↓	10:32:17	632	8A2	Begin solar calibration	
	10:32:49	633	852	Solar port heaters off	
	10:33:21	633	822	Elevate to solar ports (Sun)	
	10:33:53	634	814	Azimuth to position A	
	10:34:25	634	882	Detector bias heater on at level 1	

Table 7. Continued

(a) Continued

Date	Universal time		Hex command	Event description
	hr:min:sec	Minutes of day		
11/20/84 ↓	10:44:01	644	851	Solar port heaters on
	10:44:33	645	831	SMA shutter cycle on
	11:15:29	675	832	SMA shutter cycle off
	11:16:01	676	852	Solar port heaters off
	11:16:33	677	811	Azimuth to 0°
	11:17:05	677	881	Detector bias heater off
	11:26:41	687	823	Elevate to nadir (Earth)
	11:27:13	687	851	Solar port heaters on
End solar calibration sequence				
11/20/84	12:44			Yaw maneuver to X-axis positive
11/21/84	12:41:21	761	821	Elevate to internal source (stow)
11/21/84 ↓	12:50			Spacecraft pitch to 180°
	14:22:41	863	823	Elevate to nadir (space)
	14:26:57	867	882	Detector bias heater on at level 1
	15:22:57	923	881	Detector bias heater off
	15:27:45	928	821	Elevate to internal source (stow)
	15:33:05	933	882	Detector bias heater on at level 1
	15:35:45	936	892	SWICS on at level 3
	15:38:57	939	881	Detector bias heater off
	15:41:37	942	891	SWICS off
	15:42:41	943	812	Azimuth to 90°
	15:59:45	960	823	Elevate to nadir (space)
	16:04:01	964	882	Detector bias heater on at level 1
	17:00:01	1020	881	Detector bias heater off
	17:03:45	1024	821	Elevate to internal source (stow)
17:08:01	1028	811	Azimuth to 0°	
17:11				Spacecraft pitch to 0°
11/21/84	17:42:09	1062	823	Elevate to nadir (Earth)
Begin azimuth angle load commands for solar calibration				
11/26/84 ↓	03:36:49	217	419	Address azimuth position A
	03:37:21	217	2xx	Data command, high byte
	03:38:25	218	1xx	Data command, low byte
End azimuth angle load commands (A = 71.03°)				
11/26/84 ↓	04:53:05	293	821	Elevate to internal source (stow)
	04:54:09	294	862	WFOV blackbody heater on at temp. 1
	04:54:41	295	872	MFOV blackbody heater on at temp. 1
	06:30:09	390	823	Elevate to nadir (Earth)

Table 7. Continued

(a) Continued

Date	Universal time		Hex command	Event description
	hr:min:sec	Minutes of day		
Begin internal calibration sequence				
11/26/84 ↓	06:31:13	391	8A1	Begin internal calibration
	06:31:45	392	881	Detector bias heater off
	06:32:17	392	852	Solar port heaters off
	06:32:49	393	821	Elevate to internal source (stow)
	06:33:21	393	851	Solar port heaters on
	06:35:29	395	882	Detector bias heater on at level 1
	06:37:37	398	892	SWICS on at level 3
	06:40:49	401	881	Detector bias heater off
	06:44:33	405	862	WFOV blackbody heater on at temp. 1
	06:45:05	405	872	MFOV blackbody heater on at temp. 1
	06:46:09	406	891	SWICS off
	06:59:29	419	883	Detector bias heater on at level 2
	07:01:37	422	893	SWICS on at level 2
	07:04:49	425	881	Detector bias heater off
	07:08:33	429	863	WFOV blackbody heater on at temp. 2
	07:09:05	429	873	MFOV blackbody heater on at temp. 2
	07:10:09	430	891	SWICS off
	07:23:29	443	884	Detector bias heater on at level 3
	07:25:37	446	894	SWICS on at level 1
	07:27:45	448	881	Detector bias heater off
07:30:25	450	852	Solar port heaters off	
07:31:29	451	861	WFOV blackbody heater off	
07:32:01	452	871	MFOV blackbody heater off	
07:32:33	453	851	Solar port heaters on	
07:33:05	453	891	SWICS off	
End internal calibration sequence				
11/26/84	07:40:33	461	823	Elevate to nadir (Earth)
Begin solar calibration sequence				
11/26/84 ↓	07:46:57	467	8A2	Begin solar calibration
	07:47:29	467	852	Solar port heaters off
	07:48:01	468	822	Elevate to solar ports (Sun)
	07:48:33	469	814	Azimuth to position A
	07:49:05	469	882	Detector bias heater on at level 1
	07:58:41	479	851	Solar port heaters on
	07:59:13	479	831	SMA shutter cycle on
	08:30:09	510	832	SMA shutter cycle off
	08:30:41	511	852	Solar port heaters off
	08:31:13	511	811	Azimuth to 0°
	08:31:45	512	881	Detector bias heater off
	08:41:21	521	823	Elevate to nadir (Earth)
	08:41:53	522	851	Solar port heaters on
End solar calibration sequence				

Table 7. Continued

(a) Continued

Date	Universal time		Hex command	Event description
	hr:min:sec	Minutes of day		
Begin azimuth angle load commands for solar calibration				
12/03/84	01:41:05	101	419	Address azimuth position A
↓	01:41:37	102	2xx	Data command, high byte
	01:42:41	103	1xx	Data command, low byte
End azimuth angle load commands (A = 39.98°)				
12/03/84	06:15:45	376	821	Elevate to internal source (stow)
↓	06:16:17	376	862	WFOV blackbody heater on at temp. 1
	06:16:49	377	872	MFOV blackbody heater on at temp. 1
	07:52:49	473	823	Elevate to nadir (Earth)
Begin internal calibration sequence				
12/03/84	07:53:53	474	8A1	Begin internal calibration
↓	07:54:25	474	881	Detector bias heater off
	07:54:57	475	852	Solar port heaters off
	07:55:29	475	821	Elevate to internal source (stow)
	07:56:01	476	851	Solar port heaters on
	07:58:09	478	882	Detector bias heater on at level 1
	08:00:17	480	892	SWICS on at level 3
	08:03:29	483	881	Detector bias heater off
	08:07:13	487	862	WFOV blackbody heater on at temp. 1
	08:07:45	488	872	MFOV blackbody heater on at temp. 1
	08:08:49	489	891	SWICS off
	08:22:09	502	883	Detector bias heater on at level 2
	08:24:17	504	893	SWICS on at level 2
	08:27:29	507	881	Detector bias heater off
	08:31:13	511	863	WFOV blackbody heater on at temp. 2
	08:31:45	512	873	MFOV blackbody heater on at temp. 2
	08:32:49	513	891	SWICS off
	08:46:09	526	884	Detector bias heater on at level 3
	08:48:17	528	894	SWICS on at level 1
	08:50:25	530	881	Detector bias heater off
	08:53:05	533	852	Solar port heaters off
	08:54:09	534	861	WFOV blackbody heater off
	08:54:41	535	871	MFOV blackbody heater off
	08:55:13	535	851	Solar port heaters on
	08:55:45	536	891	SWICS off
End internal calibration sequence				
12/03/84	09:02:41	543	823	Elevate to nadir (Earth)
Begin modified solar calibration sequence				
12/03/84	09:10:09	550	822	Elevate to solar ports (Sun)
↓	09:10:41	551	814	Azimuth to position A
	09:11:13	551	883	Detector bias heater on at level 2

Table 7. Continued

(a) Continued

Date	Universal time		Hex command	Event description
	hr:min:sec	Minutes of day		
12/03/84 ↓	09:21:21	561	831	SMA shutter cycle on
	09:52:17	592	832	SMA shutter cycle off
	09:53:21	593	811	Azimuth to 0°
	09:53:53	594	881	Detector bias heater off
	10:03:29	603	823	Elevate to nadir (Earth)
End modified solar calibration sequence. Begin azimuth angle load commands for solar calibration				
12/10/84 ↓	09:44:49	585	419	Address azimuth position A
	09:45:21	585	2xx	Data command, high byte
	09:48:01	588	1xx	Data command, low byte
End azimuth angle load commands (A = 2.78°)				
12/10/84 ↓	15:23:29	923	821	Elevate to internal source (stow)
	15:24:01	924	862	WFOV blackbody heater on at temp. 1
	15:24:33	925	872	MFOV blackbody heater on at temp. 1
	17:00:33	1021	823	Elevate to nadir (Earth)
Begin internal calibration sequence				
12/10/84 ↓	17:01:05	1021	8A1	Begin internal calibration
	17:01:37	1022	881	Detector bias heater off
	17:02:09	1022	852	Solar port heaters off
	17:02:41	1023	821	Elevate to internal source (stow)
	17:03:13	1023	851	Solar port heaters on
	17:05:21	1025	882	Detector bias heater on at level 1
	17:07:29	1027	892	SWICS on at level 3
	17:10:41	1031	881	Detector bias heater off
	17:14:25	1034	862	WFOV blackbody heater on at temp. 1
	17:14:57	1035	872	MFOV blackbody heater on at temp. 1
	17:16:01	1036	891	SWICS off
	17:29:21	1049	883	Detector bias heater on at level 2
	17:31:29	1051	893	SWICS on at level 2
	17:34:41	1055	881	Detector bias heater off
	17:38:25	1058	863	WFOV blackbody heater on at temp. 2
	17:38:57	1059	873	MFOV blackbody heater on at temp. 2
	17:40:01	1060	891	SWICS off
	17:53:21	1073	884	Detector bias heater on at level 3
	17:55:29	1075	894	SWICS on at level 1
	17:57:37	1078	881	Detector bias heater off
	18:00:17	1080	852	Solar port heaters off
18:01:21	1081	861	WFOV blackbody heater off	
18:01:53	1082	871	MFOV blackbody heater off	
18:02:25	1082	851	Solar port heaters on	
18:02:57	1083	891	SWICS off	
End internal calibration sequence				
12/10/84	18:10:25	1090	823	Elevate to nadir (Earth)

Table 7. Continued

(a) Continued

Date	Universal time		Hex command	Event description
	hr:min:sec	Minutes of day		
Begin modified solar calibration sequence				
12/10/84 ↓	18:59:29	1139	822	Elevate to solar ports (Sun)
	19:00:01	1140	814	Azimuth to position A
	19:00:33	1141	883	Detector bias heater on at level 2
	19:10:41	1151	831	SMA shutter cycle on
	19:41:37	1182	832	SMA shutter cycle off
	19:42:41	1183	811	Azimuth to 0°
	19:43:13	1183	881	Detector bias heater off
	19:52:49	1193	823	Elevate to nadir (Earth)
End modified solar calibration sequence.				
Begin azimuth angle load commands for solar calibration				
12/17/84 ↓	07:46:57	467	419	Address azimuth position A
	07:47:29	467	2xx	Data command, high byte
	07:48:33	469	1xx	Data command, low byte
End azimuth angle load commands (A = 21.53°)				
12/17/84 ↓	07:58:41	479	821	Elevate to internal source (stow)
	07:59:13	479	862	WFOV blackbody heater on at temp. 1
	07:59:45	480	872	MFOV blackbody heater on at temp. 1
	09:35:45	576	823	Elevate to nadir (Earth)
Begin internal calibration sequence				
12/17/84 ↓	09:36:49	577	8A1	Begin internal calibration
	09:37:21	577	881	Detector bias heater off
	09:37:53	578	852	Solar port heaters off
	09:38:25	578	821	Elevate to internal source (stow)
	09:38:57	579	851	Solar port heaters on
	09:41:05	581	882	Detector bias heater on at level 1
	09:43:13	583	892	SWICS on at level 3
	09:46:25	586	881	Detector bias heater off
	09:50:09	590	862	WFOV blackbody heater on at temp. 1
	09:50:41	591	872	MFOV blackbody heater on at temp. 1
	09:51:45	592	891	SWICS off
	10:05:05	605	883	Detector bias heater on at level 2
	10:07:13	607	893	SWICS on at level 2
	10:10:25	610	881	Detector bias heater off
	10:14:09	614	863	WFOV blackbody heater on at temp. 2
	10:14:41	615	873	MFOV blackbody heater on at temp. 2
	10:15:45	616	891	SWICS off
	10:29:05	629	884	Detector bias heater on at level 3
	10:31:13	631	894	SWICS on at level 1
	10:33:21	633	881	Detector bias heater off
10:36:01	636	852	Solar port heaters off	

Table 7. Continued

(a) Continued

Date	Universal time		Hex command	Event description
	hr:min:sec	Minutes of day		
12/17/84 ↓	10:37:05	637	861	WFOV blackbody heater off
	10:37:37	638	871	MFOV blackbody heater off
	10:38:09	638	851	Solar port heaters on
	10:38:41	639	891	SWICS off
End internal calibration sequence				
12/17/84	10:45:37	646	823	Elevate to nadir (Earth)
Begin modified solar calibration sequence				
12/17/84 ↓	10:53:05	653	822	Elevate to solar ports (Sun)
	10:53:37	654	814	Azimuth to position A
	10:54:09	654	883	Detector bias heater on at level 2
	11:04:17	664	831	SMA shutter cycle on
	11:35:13	695	832	SMA shutter cycle off
	11:36:17	696	811	Azimuth to 0°
	11:36:49	697	881	Detector bias heater off
	11:46:25	706	823	Elevate to nadir (Earth)
End modified solar calibration sequence.				
Begin azimuth angle load commands (incomplete)				
12/26/84	02:43:29	163	419	Address azimuth position A
End azimuth angle load commands				
12/26/84 ↓	04:49:53	290	821	Elevate to internal source (stow)
	04:50:25	290	862	WFOV blackbody heater on at temp. 1
	04:50:57	291	872	MFOV blackbody heater on at temp. 1
	06:26:57	387	823	Elevate to nadir (Earth)
Begin internal calibration sequence				
12/26/84 ↓	06:28:01	388	8A1	Begin internal calibration
	06:28:33	389	881	Detector bias heater off
	06:29:05	389	852	Solar port heaters off
	06:29:37	390	821	Elevate to internal source (stow)
	06:30:09	390	851	Solar port heaters on
	06:32:17	392	882	Detector bias heater on at level 1
	06:34:25	394	892	SWICS on at level 3
	06:37:37	398	881	Detector bias heater off
	06:41:21	401	862	WFOV blackbody heater on at temp. 1
	06:41:53	402	872	MFOV blackbody heater on at temp. 1
	06:42:57	403	891	SWICS off
	06:56:17	416	883	Detector bias heater on at level 2
	06:58:25	418	893	SWICS on at level 2
	07:01:37	422	881	Detector bias heater off
	07:05:21	425	863	WFOV blackbody heater on at temp. 2
	07:05:53	426	873	MFOV blackbody heater on at temp. 2
	07:06:57	427	891	SWICS off
	07:20:17	440	884	Detector bias heater on at level 3

Table 7. Continued

(a) Continued

Date	Universal time		Hex command	Event description
	hr:min:sec	Minutes of day		
12/26/84 ↓	07:22:25	442	894	SWICS on at level 1
	07:24:33	445	881	Detector bias heater off
	07:27:13	447	852	Solar port heaters off
	07:28:17	448	861	WFOV blackbody heater off
	07:28:49	449	871	MFOV blackbody heater off
	07:29:21	449	851	Solar port heaters on
	07:29:53	450	891	SWICS off
End internal calibration sequence				
12/26/84	07:36:49	457	823	Elevate to nadir (Earth)
Begin modified solar calibration sequence				
12/26/84 ↓	07:44:17	464	822	Elevate to solar ports (Sun)
	07:44:49	465	814	Azimuth to position A
	07:45:21	465	883	Detector bias heater on at level 2
	07:55:29	475	831	SMA shutter cycle on
	08:26:25	506	832	SMA shutter cycle off
	08:27:29	507	811	Azimuth to 0°
	08:28:01	508	881	Detector bias heater off
08:37:37	518	823	Elevate to nadir (Earth)	
End modified solar calibration sequence.				
Begin azimuth angle load commands for solar calibration				
12/28/84 ↓	01:28:17	88	419	Address azimuth position A
	01:28:49	89	2xx	Data command, high byte
	01:29:21	89	1xx	Data command, low byte
End azimuth angle load commands (A = 69.68°).				
Begin modified solar calibration sequence				
12/28/84 ↓	08:07:13	487	822	Elevate to solar ports (Sun)
	08:07:45	488	814	Azimuth to position A
	08:08:17	488	883	Detector bias heater on at level 2
	08:18:25	498	831	SMA shutter cycle on
	08:49:21	529	832	SMA shutter cycle off
	08:50:25	530	811	Azimuth to 0°
	08:50:57	531	881	Detector bias heater off
	09:00:33	541	823	Elevate to nadir (Earth)
End modified solar calibration sequence				
01/03/85	22:40			Yaw maneuver to X-axis negative
Begin azimuth angle load commands for solar calibration				
01/09/85 ↓	03:08:33	189	419	Address azimuth position A
	03:09:05	189	2xx	Data command, high byte
	03:09:37	190	1xx	Data command, low byte
End azimuth angle load commands (A = 65.48°)				
01/09/85 ↓	06:38:09	398	821	Elevate to internal source (stow)
	06:38:41	399	862	WFOV blackbody heater on at temp. 1
	06:39:13	399	872	MFOV blackbody heater on at temp. 1
	08:15:13	495	823	Elevate to nadir (Earth)

Table 7. Continued

(a) Continued

Date	Universal time		Hex command	Event description
	hr:min:sec	Minutes of day		
Begin internal calibration sequence				
01/09/85 ↓	08:16:17	496	8A1	Begin internal calibration
	08:16:49	497	881	Detector bias heater off
	08:17:21	497	852	Solar port heaters off
	08:17:53	498	821	Elevate to internal source (stow)
	08:18:25	498	851	Solar port heaters on
	08:20:33	501	882	Detector bias heater on at level 1
	08:22:41	503	892	SWICS on at level 3
	08:25:53	506	881	Detector bias heater off
	08:29:37	510	862	WFOV blackbody heater on at temp. 1
	08:30:09	510	872	MFOV blackbody heater on at temp. 1
	08:31:13	511	891	SWICS off
	08:48:01	528	893	SWICS on at level 2
	08:49:53	530	881	Detector bias heater off
	08:53:37	534	863	WFOV blackbody heater on at temp. 2
	08:54:09	534	873	MFOV blackbody heater on at temp. 2
	08:55:13	535	891	SWICS off
	09:08:33	549	884	Detector bias heater on at level 3
	09:10:41	551	894	SWICS on at level 1
	09:12:49	553	881	Detector bias heater off
	09:15:29	555	852	Solar port heaters off
	09:16:33	557	861	WFOV blackbody heater off
09:17:05	557	871	MFOV blackbody heater off	
09:17:37	558	851	Solar port heaters on	
09:18:09	558	891	SWICS off	
End internal calibration sequence				
01/09/85	09:25:05	565	823	Elevate to nadir (Earth)
Begin modified solar calibration sequence				
01/09/85 ↓	09:32:33	573	822	Elevate to solar ports (Sun)
	09:33:05	573	814	Azimuth to position A
	09:33:37	574	883	Detector bias heater on at level 2
	09:43:45	584	831	SMA shutter cycle on
	10:14:41	615	832	SMA shutter cycle off
	10:15:45	616	811	Azimuth to 0°
	10:16:17	616	881	Detector bias heater off
10:25:53	626	823	Elevate to nadir (Earth)	
End modified solar calibration sequence.				
Begin azimuth angle load commands for solar calibration				
01/23/85 ↓	06:00:49	361	419	Address azimuth position A
	06:01:21	361	2xx	Data command, high byte
	06:02:25	362	1xx	Data command, low byte
End azimuth angle load commands (A = 60.53°)				

Table 7. Continued

(a) Continued

Date	Universal time		Hex command	Event description
	hr:min:sec	Minutes of day		
01/23/85 ↓	12:44:33	765	821	Elevate to internal source (stow)
	12:45:05	765	862	WFOV blackbody heater on at temp. 1
	12:45:37	766	872	MFOV blackbody heater on at temp. 1
	14:21:37	862	823	Elevate to nadir (Earth)
Begin internal calibration sequence				
01/23/85 ↓	14:22:41	863	8A1	Begin internal calibration
	14:23:13	863	881	Detector bias heater off
	14:23:45	864	852	Solar port heaters off
	14:24:17	864	821	Elevate to internal source (stow)
	14:24:49	865	851	Solar port heaters on
	14:26:57	867	882	Detector bias heater on at level 1
	14:29:05	869	892	SWICS on at level 3
	14:32:17	872	881	Detector bias heater off
	14:36:01	876	862	WFOV blackbody heater on at temp. 1
	14:36:33	877	872	MFOV blackbody heater on at temp. 1
	14:37:37	878	891	SWICS off
	14:50:57	891	883	Detector bias heater on at level 2
	14:53:05	893	893	SWICS on at level 2
	14:56:17	896	881	Detector bias heater off
	15:00:01	900	863	WFOV blackbody heater on at temp. 2
	15:00:33	901	873	MFOV blackbody heater on at temp. 2
	15:01:37	902	891	SWICS off
	15:14:57	915	884	Detector bias heater on at level 3
	15:17:05	917	894	SWICS on at level 1
	15:19:13	919	881	Detector bias heater off
	15:21:53	922	852	Solar port heaters off
	15:22:57	923	861	WFOV blackbody heater off
	15:23:29	923	871	MFOV blackbody heater off
	15:24:01	924	851	Solar port heaters on
15:24:33	925	891	SWICS off	
End internal calibration sequence				
01/23/85	15:31:29	931	823	Elevate to nadir (Earth)
Begin modified solar calibration sequence				
01/23/85 ↓	15:38:57	939	822	Elevate to solar ports (Sun)
	15:39:29	939	814	Azimuth to position A
	15:40:01	940	883	Detector bias heater on at level 2
	15:50:09	950	831	SMA shutter cycle on
	16:21:05	981	832	SMA shutter cycle off
	16:22:09	982	811	Azimuth to 0°
Data dropout, missed two commands. End modified solar calibration sequence				
02/01/85	15:06			Yaw maneuver to X-axis positive

Table 7. Continued

(a) Continued

Date	Universal time		Hex command	Event description
	hr:min:sec	Minutes of day		
Begin azimuth angle load commands for solar calibration				
02/06/85 ↓	00:06:41	7	419	Address azimuth position A
	00:07:13	7	2xx	Data command, high byte
	00:07:45	8	1xx	Data command, low byte
End azimuth angle load commands (A = 70.88°)				
02/06/85 ↓	09:58:41	599	821	Elevate to internal source (stow)
	09:59:13	599	862	WFOV blackbody heater on at temp. 1
	10:00:17	600	872	MFOV blackbody heater on at temp. 1
	11:35:45	696	823	Elevate to nadir (Earth)
Begin internal calibration sequence				
02/06/85 ↓	11:36:49	697	8A1	Begin internal calibration
	11:37:21	697	881	Detector bias heater off
	11:37:53	698	852	Solar port heaters off
	11:38:25	698	821	Elevate to internal source (stow)
	11:38:57	699	851	Solar port heaters on
	11:41:05	701	882	Detector bias heater on at level 1
	11:43:13	703	892	SWICS on at level 3
	11:46:25	706	881	Detector bias heater off
	11:50:09	710	862	WFOV blackbody heater on at temp. 1
	11:50:41	711	872	MFOV blackbody heater on at temp. 1
	11:51:45	712	891	SWICS off
	12:05:05	725	883	Detector bias heater on at level 2
	12:07:13	727	893	SWICS on at level 2
	12:10:25	730	881	Detector bias heater off
	12:14:09	734	863	WFOV blackbody heater on at temp. 2
	12:14:41	735	873	MFOV blackbody heater on at temp. 2
	12:15:45	736	891	SWICS off
	12:29:05	749	884	Detector bias heater on at level 3
	12:31:13	751	894	SWICS on at level 1
	12:33:21	753	881	Detector bias heater off
	12:36:01	756	852	Solar port heaters off
	12:37:05	757	861	WFOV blackbody heater off
	12:37:37	758	871	MFOV blackbody heater off
	12:38:09	758	851	Solar port heaters on
12:38:41	759	891	SWICS off	
End internal calibration sequence				
02/06/85	12:45:37	766	823	Elevate to nadir (Earth)
Begin modified solar calibration sequence				
02/06/85 ↓	12:53:05	773	822	Elevate to solar ports (Sun)
	12:53:37	774	814	Azimuth to position A
	12:54:09	774	883	Detector bias heater on at level 2
	13:04:17	784	831	SMA shutter cycle on

Table 7. Continued

(a) Continued

Date	Universal time		Hex command	Event description
	hr:min:sec	Minutes of day		
02/06/85 ↓	13:35:13	815	832	SMA shutter cycle off
	13:36:17	816	811	Azimuth to 0°
	13:36:49	817	881	Detector bias heater off
	13:46:25	826	823	Elevate to nadir (Earth)
End modified solar calibration sequence.				
Begin azimuth angle load commands for solar calibration				
02/20/85 ↓	05:41:05	341	419	Address azimuth position A
	05:41:37	342	2xx	Data command, high byte
	05:42:41	343	1xx	Data command, low byte
End azimuth angle load commands (A = 20.4°)				
02/20/85 ↓	09:43:45	584	821	Elevate to internal source (stow)
	09:44:17	584	862	WFOV blackbody heater on at temp. 1
	09:44:49	585	872	MFOV blackbody heater on at temp. 1
	11:20:49	681	823	Elevate to nadir (Earth)
Begin internal calibration sequence				
02/20/85 ↓	11:21:21	681	8A1	Begin internal calibration
	11:21:53	682	881	Detector bias heater off
	11:22:25	682	852	Solar port heaters off
	11:22:57	683	821	Elevate to internal source (stow)
	11:23:29	683	851	Solar port heaters on
	11:25:37	686	882	Detector bias heater on at level 1
	11:27:45	688	892	SWICS on at level 3
	11:30:57	691	881	Detector bias heater off
	11:34:41	695	862	WFOV blackbody heater on at temp. 1
	11:35:13	695	872	MFOV blackbody heater on at temp. 1
	11:36:17	696	891	SWICS off
	11:49:37	710	883	Detector bias heater on at level 2
	11:51:45	712	893	SWICS on at level 2
	11:54:57	715	881	Detector bias heater off
	11:58:41	719	863	WFOV blackbody heater on at temp. 2
	11:59:13	719	873	MFOV blackbody heater on at temp. 2
	12:00:17	720	891	SWICS off
	12:13:37	734	884	Detector bias heater on at level 3
	12:15:45	736	894	SWICS on at level 1
	12:17:53	738	881	Detector bias heater off
12:20:33	741	852	Solar port heaters off	
12:21:37	742	861	WFOV blackbody heater off	
12:22:09	742	871	MFOV blackbody heater off	
12:22:41	743	851	Solar port heaters on	
12:23:13	743	891	SWICS off	
End internal calibration sequence				
02/20/85	12:30:41	751	823	Elevate to nadir (Earth)

Table 7. Continued

(a) Continued

Date	Universal time		Hex command	Event description
	hr:min:sec	Minutes of day		
Begin modified solar calibration sequence				
02/20/85 ↓	12:37:37	758	822	Elevate to solar ports (Sun)
	12:38:09	758	814	Azimuth to position A
	12:38:41	759	883	Detector bias heater on at level 2
	12:48:49	769	831	SMA shutter cycle on
	13:19:45	800	832	SMA shutter cycle off
	13:20:49	801	811	Azimuth to 0°
	13:21:21	801	881	Detector bias heater off
	13:30:57	811	823	Elevate to nadir (Earth)
End modified solar calibration sequence.				
Begin azimuth angle load commands for solar calibration				
03/06/85 ↓	03:44:49	225	419	Address azimuth position A
	03:45:21	225	2xx	Data command, high byte
	03:45:53	226	1xx	Data command, low byte
End azimuth angle load commands (A = 60.9°)				
03/06/85 ↓	07:48:01	468	821	Elevate to internal source (stow)
	07:48:33	469	862	WFOV blackbody heater on at temp. 1
	07:49:37	470	872	MFOV blackbody heater on at temp. 1
	09:25:05	565	823	Elevate to nadir (Earth)
Begin internal calibration sequence				
03/06/85 ↓	09:26:09	566	8A1	Begin internal calibration
	09:26:41	567	881	Detector bias heater off
	09:27:13	567	852	Solar port heaters off
	09:27:45	568	821	Elevate to internal source (stow)
	09:28:17	568	851	Solar port heaters on
	09:30:25	570	882	Detector bias heater on at level 1
	09:32:33	573	892	SWICS on at level 3
	09:35:45	576	881	Detector bias heater off
	09:39:29	579	862	WFOV blackbody heater on at temp. 1
	09:40:01	580	872	MFOV blackbody heater on at temp. 1
	09:41:05	581	891	SWICS off
	09:54:25	594	883	Detector bias heater on at level 2
	09:56:33	597	893	SWICS on at level 2
	09:59:45	600	881	Detector bias heater off
	10:03:29	603	863	WFOV blackbody heater on at temp. 2
	10:04:01	604	873	MFOV blackbody heater on at temp. 2
	10:05:05	605	891	SWICS off
	10:18:25	618	884	Detector bias heater on at level 3
	10:20:33	621	894	SWICS on at level 1
	10:22:41	623	881	Detector bias heater off
	10:25:21	625	852	Solar port heaters off
	10:26:25	626	861	WFOV blackbody heater off
	10:26:57	627	871	MFOV blackbody heater off

Table 7. Continued

(a) Continued

Date	Universal time		Hex command	Event description
	hr:min:sec	Minutes of day		
03/06/85	10:27:29	627	851	Solar port heaters on
03/06/85	10:28:01	628	891	SWICS off
End internal calibration sequence				
03/06/85	10:34:57	635	823	Elevate to nadir (Earth)
Begin modified solar calibration sequence				
03/06/85 ↓	10:42:25	642	822	Elevate to solar ports (Sun)
	10:42:57	643	814	Azimuth to position A
	10:43:29	643	883	Detector bias heater on at level 2
	10:53:37	654	831	SMA shutter cycle on
	11:24:33	685	832	SMA shutter cycle off
	11:25:37	686	811	Azimuth to 0°
	11:26:09	686	881	Detector bias heater off
	11:35:45	696	823	Elevate to nadir (Earth)
End modified solar calibration sequence				
03/13/85	15:07			Yaw maneuver to X-axis negative
Begin azimuth angle load commands for solar calibration				
03/20/85 ↓	01:27:45	88	419	Address azimuth position A
	01:28:17	88	2xx	Data command, high byte
	01:29:53	90	1xx	Data command, low byte
End azimuth angle load commands (A = 58.13°)				
03/20/85 ↓	09:35:13	575	821	Elevate to internal source (stow)
	09:35:45	576	862	WFOV blackbody heater on at temp. 1
	09:36:17	576	872	MFOV blackbody heater on at temp. 1
	11:11:45	672	823	Elevate to nadir (Earth)
Begin internal calibration sequence				
03/20/85 ↓	11:12:49	673	8A1	Begin internal calibration
	11:13:21	673	881	Detector bias heater off
	11:13:53	674	852	Solar port heaters off
	11:14:25	674	821	Elevate to internal source (stow)
	11:14:57	675	851	Solar port heaters on
	11:17:05	677	882	Detector bias heater on at level 1
	11:19:13	679	892	SWICS on at level 3
	11:22:25	682	881	Detector bias heater off
	11:26:09	686	862	WFOV blackbody heater on at temp. 1
	11:26:41	687	872	MFOV blackbody heater on at temp. 1
	11:27:45	688	891	SWICS off
	11:41:05	701	883	Detector bias heater on at level 2
	11:43:13	703	893	SWICS on at level 2
	11:46:25	706	881	Detector bias heater off
	11:50:09	710	863	WFOV blackbody heater on at temp. 2
	11:50:41	711	873	MFOV blackbody heater on at temp. 2
	11:51:45	712	891	SWICS off
	12:05:05	725	884	Detector bias heater on at level 3

Table 7. Continued

(a) Continued

Date	Universal time		Hex command	Event description
	hr:min:sec	Minutes of day		
03/20/85 ↓	12:07:13	727	894	SWICS on at level 1
	12:09:21	729	881	Detector bias heater off
	12:12:01	732	852	Solar port heaters off
	12:13:05	733	861	WFOV blackbody heater off
	12:13:37	734	871	MFOV blackbody heater off
	12:14:09	734	851	Solar port heaters on
	12:14:41	735	891	SWICS off
End internal calibration sequence				
03/20/85	12:22:09	742	823	Elevate to nadir (Earth)
Begin modified solar calibration sequence				
03/20/85 ↓	12:29:05	749	822	Elevate to solar ports (Sun)
	12:29:37	750	814	Azimuth to position A
	12:30:09	750	883	Detector bias heater on at level 2
	12:40:17	760	831	SMA shutter cycle on
	13:11:13	791	832	SMA shutter cycle off
	13:12:17	792	811	Azimuth to 0°
	13:12:49	793	881	Detector bias heater off
13:22:25	802	823	Elevate to nadir (Earth)	
End modified solar calibration sequence.				
Begin azimuth angle load commands for solar calibration				
04/03/85 ↓	03:59:45	240	419	Address azimuth position A
	04:00:17	240	2xx	Data command, high byte
	04:00:49	241	1xx	Data command, low byte
End azimuth angle load commands (A = 29.7°)				
04/03/85 ↓	14:09:21	849	821	Elevate to internal source (stow)
	14:09:53	850	862	WFOV blackbody heater on at temp. 1
	14:10:25	850	872	MFOV blackbody heater on at temp. 1
	15:46:25	946	823	Elevate to nadir (Earth)
Begin internal calibration sequence				
04/03/85 ↓	15:46:57	947	8A1	Begin internal calibration
	15:47:29	947	881	Detector bias heater off
	15:48:01	948	852	Solar port heaters off
	15:48:33	949	821	Elevate to internal source (stow)
	15:49:05	949	851	Solar port heaters on
	15:51:13	951	882	Detector bias heater on at level 1
	15:53:21	953	892	SWICS on at level 3
	15:56:33	957	881	Detector bias heater off
	16:00:17	960	862	WFOV blackbody heater on at temp. 1
	16:00:49	961	872	MFOV blackbody heater on at temp. 1
	16:01:53	962	891	SWICS off
	16:15:13	975	883	Detector bias heater on at level 2
	16:17:21	977	893	SWICS on at level 2
	16:20:33	981	881	Detector bias heater off

Table 7. Continued

(a) Continued

Date	Universal time		Hex command	Event description
	hr:min:sec	Minutes of day		
04/03/85 ↓	16:24:17	984	863	WFOV blackbody heater on at temp. 2
	16:24:49	985	873	MFOV blackbody heater on at temp. 2
	16:25:53	986	891	SWICS off
	16:39:13	999	884	Detector bias heater on at level 3
	16:41:21	1001	894	SWICS on at level 1
	16:43:29	1003	881	Detector bias heater off
	16:46:09	1006	852	Solar port heaters off
	16:47:13	1007	861	WFOV blackbody heater off
	16:47:45	1008	871	MFOV blackbody heater off
	16:48:17	1008	851	Solar port heaters on
	16:48:49	1009	891	SWICS off
End internal calibration sequence				
04/03/85	16:56:17	1016	823	Elevate to nadir (Earth)
Begin modified solar calibration sequence				
04/03/85 ↓	17:03:13	1023	822	Elevate to solar ports (Sun)
	17:03:45	1024	814	Azimuth to position A
	17:04:17	1024	883	Detector bias heater on at level 2
	17:14:25	1034	831	SMA shutter cycle on
	17:45:21	1065	832	SMA shutter cycle off
	17:46:25	1066	811	Azimuth to 0°
	17:46:57	1067	881	Detector bias heater off
	17:56:33	1077	823	Elevate to nadir (Earth)
End modified solar calibration sequence.				
Begin azimuth angle load commands for solar calibration				
04/17/85 ↓	05:38:25	338	419	Address azimuth position A
	05:38:57	339	2xx	Data command, high byte
	05:40:01	340	1xx	Data command, low byte
End azimuth angle load commands (A = 79.58°)				
04/17/85 ↓	10:34:57	635	821	Elevate to internal source (stow)
	10:35:29	635	862	WFOV blackbody heater on at temp. 1
	10:36:01	636	872	MFOV blackbody heater on at temp. 1
	12:12:01	732	823	Elevate to nadir (Earth)
Begin internal calibration sequence				
04/17/85 ↓	12:13:05	733	8A1	Begin internal calibration
	12:13:37	734	881	Detector bias heater off
	12:14:09	734	852	Solar port heaters off
	12:14:41	735	821	Elevate to internal source (stow)
	12:15:13	735	851	Solar port heaters on
	12:17:21	737	882	Detector bias heater on at level 1
	12:19:29	739	892	SWICS on at level 3
	12:22:41	743	881	Detector bias heater off
	12:26:25	746	862	WFOV blackbody heater on at temp. 1
	12:26:57	747	872	MFOV blackbody heater on at temp. 1

Table 7. Continued

(a) Continued

Date	Universal time		Hex command	Event description
	hr:min:sec	Minutes of day		
04/17/85 ↓	12:28:01	748	891	SWICS off
	12:41:21	761	883	Detector bias heater on at level 2
	12:43:29	763	893	SWICS on at level 2
	12:46:41	767	881	Detector bias heater off
	12:50:25	770	863	WFOV blackbody heater on at temp. 2
	12:50:57	771	873	MFOV blackbody heater on at temp. 2
	12:52:01	772	891	SWICS off
	13:05:21	785	884	Detector bias heater on at level 3
	13:07:29	787	894	SWICS on at level 1
	13:09:37	790	881	Detector bias heater off
	13:12:17	792	852	Solar port heaters off
	13:13:21	793	861	WFOV blackbody heater off
	13:13:53	794	871	MFOV blackbody heater off
	13:14:25	794	851	Solar port heaters on
	13:14:57	795	891	SWICS off
End internal calibration sequence				
04/17/85	13:21:53	802	823	Elevate to nadir (Earth)
Begin modified solar calibration sequence				
04/17/85 ↓	13:28:49	809	822	Elevate to solar ports (Sun)
	13:29:21	809	814	Azimuth to position A
	13:29:53	810	883	Detector bias heater on at level 2
	13:40:01	820	831	SMA shutter cycle on
	14:10:57	851	832	SMA shutter cycle off
	14:12:01	852	811	Azimuth to 0°
	14:12:33	853	881	Detector bias heater off
	14:22:09	862	823	Elevate to nadir (Earth)
End modified solar calibration sequence				
04/21/85	15:06			Yaw maneuver to X-axis positive
Begin azimuth angle load commands for solar calibration				
05/01/85 ↓	05:26:41	327	419	Address azimuth position A
	05:27:13	327	2xx	Data command, high byte
	05:28:17	328	1xx	Data command, low byte
End azimuth angle load commands ($A = 53.7^\circ$)				
05/01/85 ↓	09:26:41	567	821	Elevate to internal source (stow)
	09:27:45	568	862	WFOV blackbody heater on at temp. 1
	09:28:17	568	872	MFOV blackbody heater on at temp. 1
	11:03:45	664	823	Elevate to nadir (Earth)
Begin internal calibration sequence				
05/01/85 ↓	11:04:49	665	8A1	Begin internal calibration
	11:05:21	665	881	Detector bias heater off
	11:05:53	666	852	Solar port heaters off
	11:06:25	666	821	Elevate to internal source (stow)
	11:06:57	667	851	Solar port heaters on

Table 7. Continued

(a) Continued

Date	Universal time		Hex command	Event description
	hr:min:sec	Minutes of day		
05/01/85 ↓	11:09:05	669	882	Detector bias heater on at level 1
	11:11:13	671	892	SWICS on at level 3
	11:14:25	674	881	Detector bias heater off
	11:18:09	678	862	WFOV blackbody heater on at temp. 1
	11:18:41	679	872	MFOV blackbody heater on at temp. 1
	11:19:45	680	891	SWICS off
	11:33:05	693	883	Detector bias heater on at level 2
	11:35:13	695	893	SWICS on at level 2
	11:38:25	698	881	Detector bias heater off
	11:42:09	702	863	WFOV blackbody heater on at temp. 2
	11:42:41	703	873	MFOV blackbody heater on at temp. 2
	11:43:45	704	891	SWICS off
	11:57:05	717	884	Detector bias heater on at level 3
	11:59:13	719	894	SWICS on at level 1
	12:01:21	721	881	Detector bias heater off
	12:04:01	724	852	Solar port heaters off
	12:05:05	725	861	WFOV blackbody heater off
	12:05:37	726	871	MFOV blackbody heater off
	12:06:09	726	851	Solar port heaters on
12:06:41	727	891	SWICS off	
End internal calibration sequence				
05/01/85	12:14:09	734	823	Elevate to nadir (Earth)
Begin modified solar calibration sequence				
05/01/85 ↓	12:21:05	741	822	Elevate to solar ports (Sun)
	12:21:37	742	814	Azimuth to position A
	12:22:09	742	883	Detector bias heater on at level 2
	12:32:17	752	831	SMA shutter cycle on
	13:03:13	783	832	SMA shutter cycle off
	13:04:17	784	811	Azimuth to 0°
	13:04:49	785	881	Detector bias heater off
13:14:25	794	823	Elevate to nadir (Earth)	
End modified solar calibration sequence.				
Begin azimuth angle load commands for solar calibration				
05/08/85 ↓	05:12:17	312	419	Address azimuth position A
	05:12:49	313	2xx	Data command, high byte
	05:13:53	314	1xx	Data command, low byte
End azimuth angle load commands (A = 49.58°)				
05/08/85 ↓	09:18:09	558	821	Elevate to internal source (stow)
	09:18:41	559	862	WFOV blackbody heater on at temp. 1
	09:19:13	559	872	MFOV blackbody heater on at temp. 1
	10:55:13	655	823	Elevate to nadir (Earth)

Table 7. Continued

(a) Continued

Date	Universal time		Hex command	Event description
	hr:min:sec	Minutes of day		
Begin internal calibration sequence				
05/08/85 ↓	10:56:17	656	8A1	Begin internal calibration
	10:56:49	657	881	Detector bias heater off
	10:57:21	657	852	Solar port heaters off
	10:57:53	658	821	Elevate to internal source (stow)
	10:58:25	658	851	Solar port heaters on
	11:00:33	661	882	Detector bias heater on at level 1
	11:02:41	663	892	SWICS on at level 3
	11:05:53	666	881	Detector bias heater off
	11:09:37	670	862	WFOV blackbody heater on at temp. 1
	11:10:09	670	872	MFOV blackbody heater on at temp. 1
	11:11:13	671	891	SWICS off
	11:24:33	685	883	Detector bias heater on at level 2
	11:26:41	687	893	SWICS on at level 2
	11:29:53	690	881	Detector bias heater off
	11:33:37	694	863	WFOV blackbody heater on at temp. 2
	11:34:09	694	873	MFOV blackbody heater on at temp. 2
	11:35:13	695	891	SWICS off
	11:48:33	709	884	Detector bias heater on at level 3
	11:50:41	711	894	SWICS on at level 1
	11:52:49	713	881	Detector bias heater off
11:55:29	715	852	Solar port heaters off	
11:56:33	717	861	WFOV blackbody heater off	
11:57:05	717	871	MFOV blackbody heater off	
11:57:37	718	851	Solar port heaters on	
11:58:09	718	891	SWICS off	
End internal calibration sequence				
05/08/85	12:05:05	725	823	Elevate to nadir (Earth)
Begin modified solar calibration sequence				
05/08/85 ↓	12:12:01	732	822	Elevate to solar ports (Sun)
	12:12:33	733	814	Azimuth to position A
	12:13:05	733	883	Detector bias heater on at level 2
	12:23:13	743	831	SMA shutter cycle on
	12:54:09	774	832	SMA shutter cycle off
	12:55:13	775	811	Azimuth to 0°
	12:55:45	776	881	Detector bias heater off
13:05:21	785	823	Elevate to nadir (Earth)	
End modified solar calibration sequence				
05/22/85	13:23			Yaw maneuver to X-axis negative

Table 7. Continued

(a) Continued

Date	Universal time		Hex command	Event description
	hr:min:sec	Minutes of day		
Begin azimuth angle load commands for solar calibration				
05/29/85	04:24:17	264	419	Address azimuth position A
↓	04:24:49	265	2xx	Data command, high byte
	04:25:53	266	1xx	Data command, low byte
End azimuth angle load commands (A = 60.3°)				
05/29/85	09:17:05	557	821	Elevate to internal source (stow)
↓	09:17:37	558	862	WFOV blackbody heater on at temp. 1
	09:18:09	558	872	MFOV blackbody heater on at temp. 1
↓	10:54:09	654	823	Elevate to nadir (Earth)
Begin internal calibration sequence				
05/29/85	10:55:13	655	8A1	Begin internal calibration
↓	10:55:45	656	881	Detector bias heater off
	10:56:17	656	852	Solar port heaters off
	10:56:49	657	821	Elevate to internal source (stow)
	10:57:21	657	851	Solar port heaters on
	10:59:29	659	882	Detector bias heater on at level 1
	11:01:37	662	892	SWICS on at level 3
	11:04:49	665	881	Detector bias heater off
	11:08:33	669	862	WFOV blackbody heater on at temp. 1
	11:09:05	669	872	MFOV blackbody heater on at temp. 1
	11:10:09	670	891	SWICS off
	11:23:29	683	883	Detector bias heater on at level 2
	11:25:37	686	893	SWICS on at level 2
	11:28:49	689	881	Detector bias heater off
	11:32:33	693	863	WFOV blackbody heater on at temp. 2
	11:33:05	693	873	MFOV blackbody heater on at temp. 2
	11:34:09	694	891	SWICS off
	11:47:29	707	884	Detector bias heater on at level 3
	11:49:37	710	894	SWICS on at level 1
	11:51:45	712	881	Detector bias heater off
	11:54:25	714	852	Solar port heaters off
	11:55:29	715	861	WFOV blackbody heater off
	11:56:01	716	871	MFOV blackbody heater off
	11:56:33	717	851	Solar port heaters on
↓	11:57:05	717	891	SWICS off
End internal calibration sequence				
05/29/85	12:04:01	724	823	Elevate to nadir (Earth)

Table 7. Continued

(a) Continued

Date	Universal time		Hex command	Event description
	hr:min:sec	Minutes of day		
Begin modified solar calibration sequence				
05/29/85 ↓	12:11:29	731	822	Elevate to solar ports (Sun)
	12:12:01	732	814	Azimuth to position A
	12:12:33	733	883	Detector bias heater on at level 2
	12:22:41	743	831	SMA shutter cycle on
	12:53:37	774	832	SMA shutter cycle off
	12:54:41	775	811	Azimuth to 0°
	12:55:13	775	881	Detector bias heater off
	13:04:49	785	823	Elevate to nadir (Earth)
End modified solar calibration sequence				
06/12/85 ↓	09:00:33	541	821	Elevate to internal source (stow)
	09:01:05	541	862	WFOV blackbody heater on at temp. 1
	09:01:37	542	872	MFOV blackbody heater on at temp. 1
	10:37:05	637	823	Elevate to nadir (Earth)
Begin internal calibration sequence				
06/12/85 ↓	10:38:09	638	8A1	Begin internal calibration
	10:38:41	639	881	Detector bias heater off
	10:39:13	639	852	Solar port heaters off
	10:39:45	640	821	Elevate to internal source (stow)
	10:40:17	640	851	Solar port heaters on
	10:42:25	642	882	Detector bias heater on at level 1
	10:44:33	645	892	SWICS on at level 3
	10:47:45	648	881	Detector bias heater off
	10:51:29	651	862	WFOV blackbody heater on at temp. 1
	10:52:01	652	872	MFOV blackbody heater on at temp. 1
	10:53:05	653	891	SWICS off
	11:06:25	666	883	Detector bias heater on at level 2
	11:08:33	669	893	SWICS on at level 2
	11:11:45	672	881	Detector bias heater off
	11:15:29	675	863	WFOV blackbody heater on at temp. 2
	11:16:01	676	873	MFOV blackbody heater on at temp. 2
	11:17:05	677	891	SWICS off
	11:30:25	690	884	Detector bias heater on at level 3
	11:32:33	693	894	SWICS on at level 1
	11:34:41	695	881	Detector bias heater off
	11:37:21	697	852	Solar port heaters off
11:38:25	698	861	WFOV blackbody heater off	
11:38:57	699	871	MFOV blackbody heater off	
11:39:29	699	851	Solar port heaters on	
	11:40:01	700	891	SWICS off
End internal calibration sequence				
06/12/85	11:47:29	707	823	Elevate to nadir (Earth)

Table 7. Continued

(a) Continued

Date	Universal time		Hex command	Event description
	hr:min:sec	Minutes of day		
Begin azimuth angle load commands for solar calibration				
06/18/85 ↓	01:35:45	96	419	Address azimuth position A
	01:36:17	96	2xx	Data command, high byte
	01:36:49	97	1xx	Data command, low byte
End azimuth angle load commands (A = 26.33°)				
06/18/85 ↓	08:49:21	529	821	Elevate to internal source (stow)
	08:49:53	530	862	WFOV blackbody heater on at temp. 1
	08:50:25	530	872	MFOV blackbody heater on at temp. 1
	10:26:25	626	823	Elevate to nadir (Earth)
Begin internal calibration sequence				
06/18/85 ↓	10:27:29	627	8A1	Begin internal calibration
	10:28:01	628	881	Detector bias heater off
	10:28:33	629	852	Solar port heaters off
	10:29:05	629	821	Elevate to internal source (stow)
	10:29:37	630	851	Solar port heaters on
	10:31:45	632	882	Detector bias heater on at level 1
	10:33:53	634	892	SWICS on at level 3
	10:37:05	637	881	Detector bias heater off
	10:40:49	641	862	WFOV blackbody heater on at temp. 1
	10:41:21	641	872	MFOV blackbody heater on at temp. 1
	10:42:25	642	891	SWICS off
	10:55:45	656	883	Detector bias heater on at level 2
	10:57:53	658	893	SWICS on at level 2
	11:01:05	661	881	Detector bias heater off
	11:04:49	665	863	WFOV blackbody heater on at temp. 2
	11:05:21	665	873	MFOV blackbody heater on at temp. 2
	11:06:25	666	891	SWICS off
	11:19:45	680	884	Detector bias heater on at level 3
	11:21:53	682	894	SWICS on at level 1
	11:24:01	684	881	Detector bias heater off
	11:26:41	687	852	Solar port heaters off
11:27:45	688	861	WFOV blackbody heater off	
11:28:17	688	871	MFOV blackbody heater off	
11:28:49	689	851	Solar port heaters on	
11:29:21	689	891	SWICS off	
End internal calibration sequence				
06/18/85	11:36:17	696	823	Elevate to nadir (Earth)
Begin modified solar calibration sequence				
06/18/85 ↓	11:43:45	704	822	Elevate to solar ports (Sun)
	11:44:17	704	814	Azimuth to position A
	11:44:49	705	883	Detector bias heater on at level 2
	11:54:57	715	831	SMA shutter cycle on

Table 7. Continued

(a) Continued

Date	Universal time		Hex command	Event description
	hr:min:sec	Minutes of day		
06/13/85 ↓	12:25:53	746	832	SMA shutter cycle off
	12:26:57	747	811	Azimuth to 0°
	12:27:29	747	881	Detector bias heater off
	12:37:05	757	823	Elevate to nadir (Earth)
End modified solar calibration sequence. Begin azimuth angle load commands for solar calibration				
06/26/85 ↓	05:08:33	309	419	Address azimuth position A
	05:09:05	309	2xx	Data command, high byte
	05:09:37	310	1xx	Data command, low byte
End azimuth angle load commands (A = 61.43°)				
06/26/85 ↓	08:49:21	529	821	Elevate to internal source (stow)
	08:49:53	530	862	WFOV blackbody heater on at temp. 1
	08:50:25	530	872	MFOV blackbody heater on at temp. 1
	10:26:25	626	823	Elevate to nadir (Earth)
Begin internal calibration sequence				
06/26/85 ↓	10:27:29	627	8A1	Begin internal calibration
	10:28:01	628	881	Detector bias heater off
	10:28:33	629	852	Solar port heaters off
	10:29:05	629	821	Elevate to internal source (stow)
	10:29:37	630	851	Solar port heaters on
	10:31:45	632	882	Detector bias heater on at level 1
	10:33:53	634	892	SWICS on at level 3
	10:37:05	637	881	Detector bias heater off
	10:40:49	641	862	WFOV blackbody heater on at temp. 1
	10:41:21	641	872	MFOV blackbody heater on at temp. 1
	10:42:25	642	891	SWICS off
	10:55:45	656	883	Detector bias heater on at level 2
	10:57:53	658	893	SWICS on at level 2
	11:01:05	661	881	Detector bias heater off
	11:04:49	665	863	WFOV blackbody heater on at temp. 2
	11:05:21	665	873	MFOV blackbody heater on at temp. 2
	11:06:25	666	891	SWICS off
	11:19:45	680	884	Detector bias heater on at level 3
	11:21:53	682	894	SWICS on at level 1
	11:24:01	684	881	Detector bias heater off
11:26:41	687	852	Solar port heaters off	
11:27:45	688	861	WFOV blackbody heater off	
11:28:17	688	871	MFOV blackbody heater off	
11:28:49	689	851	Solar port heaters on	
11:29:21	689	891	SWICS off	
End internal calibration sequence				
06/26/85	11:36:17	696	823	Elevate to nadir (Earth)

Table 7. Continued

(a) Continued

Date	Universal time		Hex command	Event description
	hr:min:sec	Minutes of day		
Begin modified solar calibration sequence				
06/26/85 ↓	11:43:45	704	822	Elevate to solar ports (Sun)
	11:44:17	704	814	Azimuth to position A
	11:44:49	705	883	Detector bias heater on at level 2
	11:54:57	715	831	SMA shutter cycle on
	12:25:53	746	832	SMA shutter cycle off
	12:26:57	747	811	Azimuth to 0°
	12:27:29	747	881	Detector bias heater off
	12:37:05	757	823	Elevate to nadir (Earth)
End modified solar calibration sequence				
07/04/85	15:36			Yaw maneuver to X-axis positive
Begin azimuth angle load commands for solar calibration				
07/10/85 ↓	02:52:32	173	419	Address azimuth position A
	02:53:04	173	2xx	Data command, high byte
	02:54:08	174	1xx	Data command, low byte
End azimuth angle load commands (A = 66.08°)				
07/10/85 ↓	09:14:24	554	821	Elevate to internal source (stow)
	09:14:56	555	862	WFOV blackbody heater on at temp. 1
	09:15:28	555	872	MFOV blackbody heater on at temp. 1
	10:51:28	651	823	Elevate to nadir (Earth)
Begin internal calibration sequence				
07/10/85 ↓	10:52:32	653	8A1	Begin internal calibration
	10:53:04	653	881	Detector bias heater off
	10:53:36	654	852	Solar port heaters off
	10:54:08	654	821	Elevate to internal source (stow)
	10:54:40	655	851	Solar port heaters on
	10:56:48	657	882	Detector bias heater on at level 1
	10:58:56	659	892	SWICS on at level 3
	11:02:08	662	881	Detector bias heater off
	11:05:52	666	862	WFOV blackbody heater on at temp. 1
	11:06:24	666	872	MFOV blackbody heater on at temp. 1
	11:07:28	667	891	SWICS off
	11:20:48	681	883	Detector bias heater on at level 2
	11:22:56	683	893	SWICS on at level 2
	11:26:08	686	881	Detector bias heater off
	11:29:52	690	863	WFOV blackbody heater on at temp. 2
	11:30:24	690	873	MFOV blackbody heater on at temp. 2
	11:31:28	691	891	SWICS off
	11:44:48	705	884	Detector bias heater on at level 3
	11:46:56	707	894	SWICS on at level 1
	11:49:04	709	881	Detector bias heater off

Table 7. Continued

(a) Continued

Date	Universal time		Hex command	Event description
	hr:min:sec	Minutes of day		
07/10/85 ↓	11:51:44	712	852	Solar port heaters off
	11:52:48	713	861	WFOV blackbody heater off
	11:53:20	713	871	MFOV blackbody heater off
	11:53:52	714	851	Solar port heaters on
	11:54:24	714	891	SWICS off
End internal calibration sequence				
07/10/85	12:01:20	721	823	Elevate to nadir (Earth)
Begin modified solar calibration sequence				
07/10/85 ↓	12:08:48	729	822	Elevate to solar ports (Sun)
	12:09:20	729	814	Azimuth to position A
	12:09:52	730	883	Detector bias heater on at level 2
	12:20:00	740	831	SMA shutter cycle on
	12:50:56	771	832	SMA shutter cycle off
	12:52:00	772	811	Azimuth to 0°
	12:52:32	773	881	Detector bias heater off
13:02:08	782	823	Elevate to nadir (Earth)	
End modified solar calibration sequence.				
Begin azimuth angle load commands for solar calibration				
07/24/85 ↓	05:27:12	327	419	Address azimuth position A
	05:27:44	328	2xx	Data command, high byte
	05:28:48	329	1xx	Data command, low byte
End azimuth angle load commands (A = 59.4°)				
07/24/85 ↓	08:53:04	533	821	Elevate to internal source (stow)
	08:54:08	534	862	WFOV blackbody heater on at temp. 1
	08:54:40	535	872	MFOV blackbody heater on at temp. 1
	10:30:08	630	823	Elevate to nadir (Earth)
Begin internal calibration sequence				
07/24/85 ↓	10:31:12	631	8A1	Begin internal calibration
	10:31:44	632	881	Detector bias heater off
	10:32:16	632	852	Solar port heaters off
	10:32:48	633	821	Elevate to internal source (stow)
	10:33:20	633	851	Solar port heaters on
	10:35:28	635	882	Detector bias heater on at level 1
	10:37:36	638	892	SWICS on at level 3
	10:40:48	641	881	Detector bias heater off
	10:44:32	645	862	WFOV blackbody heater on at temp. 1
	10:45:04	645	872	MFOV blackbody heater on at temp. 1
	10:46:08	646	891	SWICS off
	10:59:28	659	883	Detector bias heater on at level 2
	11:01:36	662	893	SWICS on at level 2
	11:04:48	665	881	Detector bias heater off
	11:08:32	669	863	WFOV blackbody heater on at temp. 2
	11:09:04	669	873	MFOV blackbody heater on at temp. 2

Table 7. Continued

(a) Continued

Date	Universal time		Hex command	Event description
	hr:min:sec	Minutes of day		
07/24/85 ↓	11:10:08	670	891	SWICS off
	11:23:28	683	884	Detector bias heater on at level 3
	11:25:36	686	894	SWICS on at level 1
	11:27:44	688	881	Detector bias heater off
	11:30:24	690	852	Solar port heaters off
	11:31:28	691	861	WFOV blackbody heater off
	11:32:00	692	871	MFOV blackbody heater off
	11:32:32	693	851	Solar port heaters on
	11:33:04	693	891	SWICS off
End internal calibration sequence				
07/24/85	11:40:32	701	823	Elevate to nadir (Earth)
Begin modified solar calibration sequence				
07/24/85 ↓	11:48:00	708	822	Elevate to solar ports (Sun)
	11:48:32	709	814	Azimuth to position A
	11:49:04	709	883	Detector bias heater on at level 2
	11:59:12	719	831	SMA shutter cycle on
	12:30:08	750	832	SMA shutter cycle off
	12:31:12	751	811	Azimuth to 0°
	12:31:44	752	881	Detector bias heater off
	12:41:20	761	823	Elevate to nadir (Earth)
End modified solar calibration sequence				
08/02/85	13:22			Yaw maneuver to X-axis negative
Begin azimuth angle load commands for solar calibration				
08/07/85 ↓	01:40:00	100	419	Address azimuth position A
	01:40:32	101	2xx	Data command, high byte
	01:41:04	101	1xx	Data command, low byte
End azimuth angle load commands (A = 72.98°)				
08/07/85 ↓	10:44:00	644	821	Elevate to internal source (stow)
	10:44:32	645	862	WFOV blackbody heater on at temp. 1
	10:45:04	645	872	MFOV blackbody heater on at temp. 1
	12:21:04	741	823	Elevate to nadir (Earth)
Begin internal calibration sequence				
08/07/85 ↓	12:21:36	742	8A1	Begin internal calibration
	12:22:08	742	881	Detector bias heater off
	12:22:40	743	852	Solar port heaters off
	12:23:12	743	821	Elevate to internal source (stow)
	12:23:44	744	851	Solar port heaters on
	12:25:52	746	882	Detector bias heater on at level 1
	12:28:00	748	892	SWICS on at level 3
	12:31:12	751	881	Detector bias heater off
	12:34:56	755	862	WFOV blackbody heater on at temp. 1
	12:35:28	755	872	MFOV blackbody heater on at temp. 1
	12:36:32	757	891	SWICS off

Table 7. Continued

(a) Continued

Date	Universal time		Hex command	Event description
	hr:min:sec	Minutes of day		
08/07/85 ↓	12:49:52	770	883	Detector bias heater on at level 2
	12:52:00	772	893	SWICS on at level 2
	12:55:12	775	881	Detector bias heater off
	12:58:56	779	863	WFOV blackbody heater on at temp. 2
	12:59:28	779	873	MFOV blackbody heater on at temp. 2
	13:00:32	781	891	SWICS off
	13:13:52	794	884	Detector bias heater on at level 3
	13:16:00	796	894	SWICS on at level 1
	13:18:08	798	881	Detector bias heater off
	13:20:48	801	852	Solar port heaters off
	13:21:52	802	861	WFOV blackbody heater off
	13:22:24	802	871	MFOV blackbody heater off
	13:22:56	803	851	Solar port heaters on
	13:23:28	803	891	SWICS off
End internal calibration sequence				
08/07/85	13:30:56	811	823	Elevate to nadir (Earth)
Begin modified solar calibration sequence				
08/07/85 ↓	13:37:52	818	822	Elevate to solar ports (Sun)
	13:38:24	818	814	Azimuth to position A
	13:38:56	819	883	Detector bias heater on at level 2
	13:49:04	829	831	SMA shutter cycle on
	14:20:00	860	832	SMA shutter cycle off
	14:21:04	861	811	Azimuth to 0°
	14:21:36	862	881	Detector bias heater off
14:31:12	871	823	Elevate to nadir (Earth)	
End modified solar calibration sequence.				
Begin azimuth angle load commands for solar calibration				
08/21/85 ↓	00:13:36	14	419	Address azimuth position A
	00:14:08	14	2xx	Data command, high byte
	00:15:12	15	1xx	Data command, low byte
End azimuth angle load commands (A = 20.78°)				
08/21/85 ↓	08:39:44	520	821	Elevate to internal source (stow)
	08:40:16	520	862	WFOV blackbody heater on at temp. 1
	08:40:48	521	872	MFOV blackbody heater on at temp. 1
	10:16:16	616	823	Elevate to nadir (Earth)
Begin internal calibration sequence				
08/21/85 ↓	10:17:20	617	8A1	Begin internal calibration
	10:17:52	618	881	Detector bias heater off
	10:18:24	618	852	Solar port heaters off
	10:18:56	619	821	Elevate to internal source (stow)
	10:19:28	619	851	Solar port heaters on
	10:21:36	622	882	Detector bias heater on at level 1

Table 7. Continued

(a) Continued

Date	Universal time		Hex command	Event description
	hr:min:sec	Minutes of day		
08/21/85 ↓	10:23:44	624	892	SWICS on at level 3
	10:26:56	627	881	Detector bias heater off
	10:30:40	631	862	WFOV blackbody heater on at temp. 1
	10:31:12	631	872	MFOV blackbody heater on at temp. 1
	10:32:16	632	891	SWICS off
	10:45:36	646	883	Detector bias heater on at level 2
	10:47:44	648	893	SWICS on at level 2
	10:50:56	651	881	Detector bias heater off
	10:54:40	655	863	WFOV blackbody heater on at temp. 2
	10:55:12	655	873	MFOV blackbody heater on at temp. 2
	10:56:16	656	891	SWICS off
	11:09:36	670	884	Detector bias heater on at level 3
	11:11:44	672	894	SWICS on at level 1
	11:13:52	674	881	Detector bias heater off
	11:16:32	677	852	Solar port heaters off
	11:17:36	678	861	WFOV blackbody heater off
	11:18:08	678	871	MFOV blackbody heater off
11:18:40	679	851	Solar port heaters on	
11:19:12	679	891	SWICS off	
End internal calibration sequence				
08/21/85	11:26:40	687	823	Elevate to nadir (Earth)
Begin modified solar calibration sequence				
08/21/85 ↓	11:33:36	694	822	Elevate to solar ports (Sun)
	11:34:08	694	814	Azimuth to position A
	11:34:40	695	883	Detector bias heater on at level 2
	11:44:48	705	831	SMA shutter cycle on
	12:15:44	736	832	SMA shutter cycle off
	12:16:48	737	811	Azimuth to 0°
	12:17:20	737	881	Detector bias heater off
12:26:56	747	823	Elevate to nadir (Earth)	
End modified solar calibration sequence.				
Begin azimuth angle load commands for solar calibration				
09/04/85 ↓	01:23:28	83	419	Address azimuth position A
	01:24:00	84	2xx	Data command, high byte
	01:25:04	85	1xx	Data command, low byte
End azimuth angle load commands (A = 57.0°)				
09/04/85 ↓	10:08:48	609	821	Elevate to internal source (stow)
	10:09:20	609	862	WFOV blackbody heater on at temp. 1
	10:09:52	610	872	MFOV blackbody heater on at temp. 1
	11:45:52	706	823	Elevate to nadir (Earth)

Table 7. Continued

(a) Continued

Date	Universal time		Hex command	Event description
	hr:min:sec	Minutes of day		
Begin internal calibration sequence				
09/04/85 ↓	11:46:56	707	8A1	Begin internal calibration
	11:47:28	707	881	Detector bias heater off
	11:48:00	708	852	Solar port heaters off
	11:48:32	709	821	Elevate to internal source (stow)
	11:49:04	709	851	Solar port heaters on
	11:51:12	711	882	Detector bias heater on at level 1
	11:53:20	713	892	SWICS on at level 3
	11:56:32	717	881	Detector bias heater off
	12:00:16	720	862	WFOV blackbody heater on at temp. 1
	12:00:48	721	872	MFOV blackbody heater on at temp. 1
	12:01:52	722	891	SWICS off
	12:15:12	735	883	Detector bias heater on at level 2
	12:17:20	737	893	SWICS on at level 2
	12:20:32	741	881	Detector bias heater off
	12:24:16	744	863	WFOV blackbody heater on at temp. 2
	12:24:48	745	873	MFOV blackbody heater on at temp. 2
	12:25:52	746	891	SWICS off
	12:39:12	759	884	Detector bias heater on at level 3
	12:41:20	761	894	SWICS on at level 1
	12:43:28	763	881	Detector bias heater off
	12:46:08	766	852	Solar port heaters off
	12:47:12	767	861	WFOV blackbody heater off
	12:47:44	768	871	MFOV blackbody heater off
12:48:16	768	851	Solar port heaters on	
12:48:48	769	891	SWICS off	
End internal calibration sequence				
09/04/85	12:55:44	776	823	Elevate to nadir (Earth)
Begin modified solar calibration sequence				
09/04/85 ↓	13:03:12	783	822	Elevate to solar ports (Sun)
	13:03:44	784	814	Azimuth to position A
	13:04:16	784	883	Detector bias heater on at level 2
	13:14:24	794	831	SMA shutter cycle on
	13:45:20	825	832	SMA shutter cycle off
	13:46:24	826	811	Azimuth to 0°
	13:46:56	827	881	Detector bias heater off
13:56:32	837	823	Elevate to nadir (Earth)	
End modified solar calibration sequence				
09/12/85	13:42			Yaw maneuver to X-axis positive
Begin azimuth angle load commands for solar calibration				
09/18/85 ↓	01:04:16	64	419	Address azimuth position A
	01:04:48	65	2xx	Data command, high byte
	01:06:24	66	1xx	Data command, low byte
End azimuth angle load commands (A = 62.7°)				

Table 7. Continued

(a) Continued

Date	Universal time		Hex command	Event description
	hr:min:sec	Minutes of day		
09/18/85 ↓	08:56:16	536	821	Elevate to internal source (stow)
	08:56:48	537	862	WFOV blackbody heater on at temp. 1
	08:57:20	537	872	MFOV blackbody heater on at temp. 1
	10:33:20	633	823	Elevate to nadir (Earth)
Begin internal calibration sequence				
09/18/85 ↓	10:34:24	634	8A1	Begin internal calibration
	10:34:56	635	881	Detector bias heater off
	10:35:28	635	852	Solar port heaters off
	10:36:00	636	821	Elevate to internal source (stow)
	10:36:32	637	851	Solar port heaters on
	10:38:40	639	882	Detector bias heater on at level 1
	10:40:48	641	892	SWICS on at level 3
	10:44:00	644	881	Detector bias heater off
	10:47:44	648	862	WFOV blackbody heater on at temp. 1
	10:48:16	648	872	MFOV blackbody heater on at temp. 1
	10:49:20	649	891	SWICS off
	11:02:40	663	883	Detector bias heater on at level 2
	11:04:48	665	893	SWICS on at level 2
	11:08:00	668	881	Detector bias heater off
	11:11:44	672	863	WFOV blackbody heater on at temp. 2
	11:12:16	672	873	MFOV blackbody heater on at temp. 2
	11:13:20	673	891	SWICS off
	11:26:40	687	884	Detector bias heater on at level 3
	11:28:48	689	894	SWICS on at level 1
	11:30:56	691	881	Detector bias heater off
	11:33:36	694	852	Solar port heaters off
	11:34:40	695	861	WFOV blackbody heater off
	11:35:12	695	871	MFOV blackbody heater off
	11:35:44	696	851	Solar port heaters on
11:36:16	696	891	SWICS off	
End internal calibration sequence				
09/18/85	11:43:12	703	823	Elevate to nadir (Earth)
Begin modified solar calibration sequence				
09/18/85 ↓	11:50:40	711	822	Elevate to solar ports (Sun)
	11:51:12	711	814	Azimuth to position A
	11:51:44	712	883	Detector bias heater on at level 2
	12:01:52	722	831	SMA shutter cycle on
	12:32:48	753	832	SMA shutter cycle off
	12:33:52	754	811	Azimuth to 0°
	12:34:24	754	881	Detector bias heater off
	12:44:00	764	823	Elevate to nadir (Earth)
End modified solar calibration sequence				

Table 7. Continued

(a) Continued

Date	Universal time		Hex command	Event description
	hr:min:sec	Minutes of day		
Begin azimuth angle load commands for solar calibration				
10/02/85 ↓	00:45:36	46	419	Address azimuth position A
	00:46:08	46	2xx	Data command, high byte
	00:47:44	48	1xx	Data command, low byte
End azimuth angle load commands (A = 29.18°)				
10/02/85 ↓	10:19:28	619	821	Elevate to internal source (stow)
	10:20:00	620	862	WFOV blackbody heater on at temp. 1
	10:20:32	621	872	MFOV blackbody heater on at temp. 1
	11:56:32	717	823	Elevate to nadir (Earth)
Begin internal calibration sequence				
10/02/85 ↓	11:57:04	717	8A1	Begin internal calibration
	11:57:36	718	881	Detector bias heater off
	11:58:08	718	852	Solar port heaters off
	11:58:40	719	821	Elevate to internal source (stow)
	11:59:12	719	851	Solar port heaters on
	12:01:20	721	882	Detector bias heater on at level 1
	12:03:28	723	892	SWICS on at level 3
	12:06:40	727	881	Detector bias heater off
	12:10:24	730	862	WFOV blackbody heater on at temp. 1
	12:10:56	731	872	MFOV blackbody heater on at temp. 1
	12:12:00	732	891	SWICS off
	12:25:20	745	883	Detector bias heater on at level 2
	12:27:28	747	893	SWICS on at level 2
	12:30:40	751	881	Detector bias heater off
	12:34:24	754	863	WFOV blackbody heater on at temp. 2
	12:34:56	755	873	MFOV blackbody heater on at temp. 2
	12:36:00	756	891	SWICS off
	12:49:20	769	884	Detector bias heater on at level 3
	12:51:28	771	894	SWICS on at level 1
	12:53:36	774	881	Detector bias heater off
	12:56:16	776	852	Solar port heaters off
	12:57:20	777	861	WFOV blackbody heater off
	12:57:52	778	871	MFOV blackbody heater off
12:58:24	778	851	Solar port heaters on	
12:58:56	779	891	SWICS off	
End internal calibration sequence				
10/02/85	13:06:24	786	823	Elevate to nadir (Earth)
Begin modified solar calibration sequence. NOTE: Azimuth angles were not loaded				
10/02/85 ↓	13:13:52	794	822	Elevate to solar ports (Sun)
	13:14:24	794	814	Azimuth to position A
	13:14:56	795	883	Detector bias heater on at level 2
	13:25:04	805	831	SMA shutter cycle on

Table 7. Continued

(a) Continued

Date	Universal time		Hex command	Event description
	hr:min:sec	Minutes of day		
10/02/85 ↓	13:56:00	836	832	SMA shutter cycle off
	13:57:04	837	811	Azimuth to 0°
	13:57:36	838	881	Detector bias heater off
	14:07:12	847	823	Elevate to nadir (Earth)
End modified solar calibration sequence. Begin azimuth angle load commands for solar calibration				
10/16/85 ↓	01:22:56	83	419	Address azimuth position A
	01:23:28	83	2xx	Data command, high byte
	01:24:00	84	1xx	Data command, low byte
End azimuth angle load commands (A = 76.5°)				
10/16/85 ↓	09:54:24	594	821	Elevate to internal source (stow)
	09:54:56	595	862	WFOV blackbody heater on at temp. 1
	09:55:28	595	872	MFOV blackbody heater on at temp. 1
	11:31:28	691	823	Elevate to nadir (Earth)
Begin internal calibration sequence				
10/16/85 ↓	11:32:32	693	8A1	Begin internal calibration
	11:33:04	693	881	Detector bias heater off
	11:33:36	694	852	Solar port heaters off
	11:34:08	694	821	Elevate to internal source (stow)
	11:34:40	695	851	Solar port heaters on
	11:36:48	697	882	Detector bias heater on at level 1
	11:38:56	699	892	SWICS on at level 3
	11:42:08	702	881	Detector bias heater off
	11:45:52	706	862	WFOV blackbody heater on at temp. 1
	11:46:24	706	872	MFOV blackbody heater on at temp. 1
	11:47:28	707	891	SWICS off
	12:00:48	721	883	Detector bias heater on at level 2
	12:02:56	723	893	SWICS on at level 2
	12:06:08	726	881	Detector bias heater off
	12:09:52	730	863	WFOV blackbody heater on at temp. 2
	12:10:24	730	873	MFOV blackbody heater on at temp. 2
	12:11:28	731	891	SWICS off
	12:24:48	745	884	Detector bias heater on at level 3
	12:26:56	747	894	SWICS on at level 1
	12:29:04	749	881	Detector bias heater off
12:31:44	752	852	Solar port heaters off	
12:32:48	753	861	WFOV blackbody heater off	
12:33:20	753	871	MFOV blackbody heater off	
12:33:52	754	851	Solar port heaters on	
12:34:24	754	891	SWICS off	
End internal calibration sequence				
10/16/85	12:41:20	761	823	Elevate to nadir (Earth)

Table 7. Continued

(a) Continued

Date	Universal time		Hex command	Event description
	hr:min:sec	Minutes of day		
Begin modified solar calibration sequence				
10/16/85 ↓	12:48:48	769	822	Elevate to solar ports (Sun)
	12:49:20	769	814	Azimuth to position A
	12:49:52	770	883	Detector bias heater on at level 2
	13:00:00	780	831	SMA shutter cycle on
	13:30:56	811	832	SMA shutter cycle off
	13:32:00	812	811	Azimuth to 0°
	13:32:32	813	881	Detector bias heater off
	13:42:08	822	823	Elevate to nadir (Earth)
End modified solar calibration sequence				
10/18/85	14:38			Yaw maneuver to X-axis negative
10/18/85 ↓	18:01:20	1081	872	MFOV blackbody heater on at temp. 1
	18:15:12	1095	821	Elevate to internal source (stow)
	18:16:48	1097	861	WFOV blackbody heater off
	18:17:20	1097	871	MFOV blackbody heater off
	18:26:56	1107	861	WFOV blackbody heater off
	19:53			Spacecraft pitch to 180°
	20:47:12	1247	823	Elevate to nadir (space)
	21:01:04	1261	882	Detector bias heater on at level 1
	22:08:48	1329	883	Detector bias heater on at level 2
	22:14:08	1334	881	Detector bias heater off
	22:24:16	1344	882	Detector bias heater on at level 1
	22:24:48	1345	812	Azimuth to 90°
	23:28:16	1408	881	Detector bias heater off
	23:29:20	1409	821	Elevate to internal source (stow)
23:30:24	1410	811	Azimuth to 0°	
23:40			Spacecraft pitch to 0°	
10/20/85 ↓	00:23:44	24	862	WFOV blackbody heater on at temp. 1
	00:24:16	24	872	MFOV blackbody heater on at temp. 1
	02:00:16	120	823	Elevate to nadir (Earth)
Begin internal calibration sequence				
10/20/85 ↓	02:01:20	121	8A1	Begin internal calibration
	02:01:52	122	881	Detector bias heater off
	02:02:24	122	852	Solar port heaters off
	02:02:56	123	821	Elevate to internal source (stow)
	02:03:28	123	851	Solar port heaters on
	02:05:36	126	882	Detector bias heater on at level 1
	02:07:44	128	892	SWICS on at level 3
	02:10:56	131	881	Detector bias heater off
	02:14:40	135	862	WFOV blackbody heater on at temp. 1
	02:15:12	135	872	MFOV blackbody heater on at temp. 1
	02:16:16	136	891	SWICS off
	02:29:36	150	883	Detector bias heater on at level 2
	02:31:44	152	893	SWICS on at level 2

Table 7. Continued

(a) Continued

Date	Universal time		Hex command	Event description
	hr:min:sec	Minutes of day		
10/20/85 ↓	02:34:56	155	881	Detector bias heater off
	02:38:40	159	863	WFOV blackbody heater on at temp. 2
	02:39:12	159	873	MFOV blackbody heater on at temp. 2
	02:40:16	160	891	SWICS off
	02:53:36	174	884	Detector bias heater on at level 3
	02:55:44	176	894	SWICS on at level 1
	02:57:52	178	881	Detector bias heater off
	03:00:32	181	852	Solar port heaters off
	03:01:36	182	861	WFOV blackbody heater off
	03:02:08	182	871	MFOV blackbody heater off
	03:02:40	183	851	Solar port heaters on
	03:03:12	183	891	SWICS off
End internal calibration sequence				
10/20/85	03:10:08	190	823	Elevate to nadir (Earth)
Begin azimuth angle load commands for solar calibration				
10/20/85 ↓	04:45:04	285	419	Address azimuth position A
	04:45:36	286	2xx	Data command, high byte
	04:46:08	286	1xx	Data command, low byte
End azimuth angle load commands ($A = 86.93^\circ$)				
10/20/85 ↓	14:37:04	877	821	Elevate to internal source (stow)
	14:37:36	878	862	WFOV blackbody heater on at temp. 1
	14:38:08	878	872	MFOV blackbody heater on at temp. 1
	16:14:08	974	823	Elevate to nadir (Earth)
Begin internal calibration sequence				
10/20/85 ↓	16:15:12	975	8A1	Begin internal calibration
	16:15:44	976	881	Detector bias heater off
	16:16:16	976	852	Solar port heaters off
	16:16:48	977	821	Elevate to internal source (stow)
	16:17:20	977	851	Solar port heaters on
	16:19:28	979	882	Detector bias heater on at level 1
	16:21:36	982	892	SWICS on at level 3
	16:24:48	985	881	Detector bias heater off
	16:28:32	989	862	WFOV blackbody heater on at temp. 1
	16:29:04	989	872	MFOV blackbody heater on at temp. 1
	16:30:08	990	891	SWICS off
	16:43:28	1003	883	Detector bias heater on at level 2
	16:45:36	1006	893	SWICS on at level 2
	16:48:48	1009	881	Detector bias heater off
	16:52:32	1013	863	WFOV blackbody heater on at temp. 2
	16:53:04	1013	873	MFOV blackbody heater on at temp. 2
	16:54:08	1014	891	SWICS off
	17:07:28	1027	884	Detector bias heater on at level 3
	17:09:36	1030	894	SWICS on at level 1
	17:11:44	1032	881	Detector bias heater off
	17:14:24	1034	852	Solar port heaters off

Table 7. Continued

(a) Continued

Date	Universal time		Hex command	Event description
	hr:min:sec	Minutes of day		
10/20/85 ↓	17:15:28	1035	861	WFOV blackbody heater off
	17:16:00	1036	871	MFOV blackbody heater off
	17:16:32	1037	851	Solar port heaters on
	17:17:04	1037	891	SWICS off
End internal calibration sequence				
10/20/85	17:24:00	1044	823	Elevate to nadir (Earth)
Begin modified solar calibration sequence				
10/20/85 ↓	17:30:56	1051	822	Elevate to solar ports (Sun)
	17:31:28	1051	814	Azimuth to position A
	17:32:00	1052	883	Detector bias heater on at level 2
	17:42:08	1062	831	SMA shutter cycle on
	18:13:04	1093	832	SMA shutter cycle off
	18:14:08	1094	811	Azimuth to 0°
	18:14:40	1095	881	Detector bias heater off
	18:24:16	1104	823	Elevate to nadir (Earth)
End modified solar calibration sequence				
10/30/85 ↓	10:08:16	608	821	Elevate to internal source (stow)
	10:08:48	609	862	WFOV blackbody heater on at temp. 1
	10:09:20	609	872	MFOV blackbody heater on at temp. 1
	11:45:20	705	823	Elevate to nadir (Earth)
Begin internal calibration sequence				
10/30/85 ↓	11:46:24	706	8A1	Begin internal calibration
	11:47:12	707	881	Detector bias heater off
	11:47:28	707	852	Solar port heaters off
	11:48:00	708	821	Elevate to internal source (stow)
	11:48:32	709	851	Solar port heaters on
	11:50:40	711	882	Detector bias heater on at level 1
	11:52:48	713	892	SWICS on at level 3
	11:56:00	716	881	Detector bias heater off
	11:59:44	720	862	WFOV blackbody heater on at temp. 1
	12:00:16	720	872	MFOV blackbody heater on at temp. 1
	12:01:20	721	891	SWICS off
	12:14:40	735	883	Detector bias heater on at level 2
	12:16:48	737	893	SWICS on at level 2
	12:20:00	740	881	Detector bias heater off
	12:23:44	744	863	WFOV blackbody heater on at temp. 2
	12:24:16	744	873	MFOV blackbody heater on at temp. 2
	12:25:20	745	891	SWICS off
	12:38:40	759	884	Detector bias heater on at level 3
	12:40:48	761	894	SWICS on at level 1
	12:42:56	763	881	Detector bias heater off

Table 7. Continued

(a) Continued

Date	Universal time		Hex command	Event description
	hr:min:sec	Minutes of day		
10/30/85 ↓	12:45:36	766	852	Solar port heaters off
	12:46:40	767	861	WFOV blackbody heater off
	12:47:12	767	871	MFOV blackbody heater off
	12:47:44	768	851	Solar port heaters on
	12:48:16	768	891	SWICS off
End internal calibration sequence				
10/30/85	12:55:12	775	823	Elevate to nadir (Earth)
Begin modified solar calibration sequence				
10/30/85 ↓	13:02:40	783	822	Elevate to solar ports (Sun)
	13:03:12	783	814	Azimuth to position A
	13:03:44	784	883	Detector bias heater on at level 2
	13:13:52	794	831	SMA shutter cycle on
	13:44:48	825	832	SMA shutter cycle off
	13:45:52	826	811	Azimuth to 0°
	13:46:24	826	881	Detector bias heater off
	13:56:00	836	823	Elevate to nadir (Earth)
End modified solar calibration sequence.				
Begin azimuth angle load commands for solar calibration				
10/31/85 ↓	05:40:00	340	419	Address azimuth position A
	05:40:32	341	2xx	Data command, high byte
	05:41:36	342	1xx	Data command, low byte
End azimuth angle load commands (A = 52.58°)				
10/31/85 ↓	08:44:00	524	821	Elevate to internal source (stow)
	08:44:32	525	862	WFOV blackbody heater on at temp. 1
	08:45:04	525	872	MFOV blackbody heater on at temp. 1
	10:20:32	621	823	Elevate to nadir (Earth)
Begin internal calibration sequence				
10/31/85 ↓	10:21:36	622	8A1	Begin internal calibration
	10:22:08	622	881	Detector bias heater off
	10:22:40	623	852	Solar port heaters off
	10:23:12	623	821	Elevate to internal source (stow)
	10:23:44	624	851	Solar port heaters on
	10:25:52	626	882	Detector bias heater on at level 1
	10:28:00	628	892	SWICS on at level 3
	10:31:12	631	881	Detector bias heater off
	10:34:56	635	862	WFOV blackbody heater on at temp. 1
	10:35:28	635	872	MFOV blackbody heater on at temp. 1
	10:36:32	637	891	SWICS off
	10:49:52	650	883	Detector bias heater on at level 2
	10:52:00	652	893	SWICS on at level 2
	10:55:12	655	881	Detector bias heater off
	10:58:56	659	863	WFOV blackbody heater on at temp. 2

Table 7. Continued

(a) Continued

Date	Universal time		Hex command	Event description
	hr:min:sec	Minutes of day		
10/31/85 ↓	10:59:28	659	873	MFOV blackbody heater on at temp. 2
	11:00:32	661	891	SWICS off
	11:13:52	674	884	Detector bias heater on at level 3
	11:16:00	676	894	SWICS on at level 1
	11:18:08	678	881	Detector bias heater off
	11:20:48	681	852	Solar port heaters off
	11:21:52	682	861	WFOV blackbody heater off
	11:22:24	682	871	MFOV blackbody heater off
	11:22:56	683	851	Solar port heaters on
	11:23:28	683	891	SWICS off
End internal calibration sequence				
10/31/85	11:30:56	691	823	Elevate to nadir (Earth)
Begin modified solar calibration sequence				
10/31/85 ↓	11:37:52	698	822	Elevate to solar ports (Sun)
	11:38:24	698	814	Azimuth to position A
	11:38:56	699	883	Detector bias heater on at level 2
	11:49:04	709	831	SMA shutter cycle on
	12:20:00	740	832	SMA shutter cycle off
	12:21:04	741	811	Azimuth to 0°
	12:21:36	742	881	Detector bias heater off
	12:31:12	751	823	Elevate to nadir (Earth)
End modified solar calibration sequence.				
Begin azimuth angle load commands for solar calibration				
11/13/85 ↓	06:32:48	393	419	Address azimuth position A
	06:33:20	393	2xx	Data command, high byte
	06:34:24	394	1xx	Data command, low byte
End azimuth angle load commands (A = 62.03°)				
11/13/85 ↓	09:49:04	589	821	Elevate to internal source (stow)
	09:49:36	590	862	WFOV blackbody heater on at temp. 1
	09:50:08	590	872	MFOV blackbody heater on at temp. 1
	11:26:08	686	823	Elevate to nadir (Earth)
Begin internal calibration sequence				
11/13/85 ↓	11:26:40	687	8A1	Begin internal calibration
	11:27:12	687	881	Detector bias heater off
	11:27:44	688	852	Solar port heaters off
	11:28:16	688	821	Elevate to internal source (stow)
	11:28:48	689	851	Solar port heaters on
	11:30:56	691	882	Detector bias heater on at level 1
	11:33:04	693	892	SWICS on at level 3
	11:36:16	696	881	Detector bias heater off
	11:40:00	700	862	WFOV blackbody heater on at temp. 1
	11:40:32	701	872	MFOV blackbody heater on at temp. 1

Table 7. Continued

(a) Continued

Date	Universal time		Hex command	Event description
	hr:min:sec	Minutes of day		
11/13/85 ↓	11:41:36	702	891	SWICS off
	11:54:56	715	883	Detector bias heater on at level 2
	11:57:04	717	893	SWICS on at level 2
	12:00:16	720	881	Detector bias heater off
	12:04:00	724	863	WFOV blackbody heater on at temp. 2
	12:04:32	725	873	MFOV blackbody heater on at temp. 2
	12:05:36	726	891	SWICS off
	12:18:56	739	884	Detector bias heater on at level 3
	12:21:04	741	894	SWICS on at level 1
	12:23:12	743	881	Detector bias heater off
	12:25:52	746	852	Solar port heaters off
	12:26:56	747	861	WFOV blackbody heater off
	12:27:28	747	871	MFOV blackbody heater off
	12:28:00	748	851	Solar port heaters on
	12:28:32	749	891	SWICS off
End internal calibration sequence				
11/13/85	12:36:00	756	823	Elevate to nadir (Earth)
Begin modified solar calibration sequence				
11/13/85 ↓	12:42:56	763	822	Elevate to solar ports (Sun)
	12:43:28	763	814	Azimuth to position A
	12:44:00	764	883	Detector bias heater on at level 2
	12:54:08	774	831	SMA shutter cycle on
	13:25:04	805	832	SMA shutter cycle off
	13:26:08	806	811	Azimuth to 0°
	13:26:40	807	881	Detector bias heater off
	13:36:16	816	823	Elevate to nadir (Earth)
End modified solar calibration sequence				
11/21/85	15:02			Yaw maneuver to X-axis positive
Begin azimuth angle load commands for solar calibration				
11/27/85 ↓	04:23:44	264	419	Address azimuth position A
	04:24:16	264	2xx	Data command, high byte
	04:25:52	266	1xx	Data command, low byte
End azimuth angle load commands (A = 63.23°)				
11/27/85 ↓	10:09:20	609	821	Elevate to internal source (stow)
	10:09:52	610	862	WFOV blackbody heater on at temp. 1
	10:10:24	610	872	MFOV blackbody heater on at temp. 1
	11:46:24	706	823	Elevate to nadir (Earth)
Begin internal calibration sequence				
11/27/85 ↓	11:47:28	707	8A1	Begin internal calibration
	11:48:00	708	881	Detector bias heater off
	11:48:32	709	852	Solar port heaters off
	11:49:04	709	821	Elevate to internal source (stow)
	11:49:36	710	851	Solar port heaters on

Table 7. Continued

(a) Continued

Date	Universal time		Hex command	Event description
	hr:min:sec	Minutes of day		
11/27/85 ↓	11:51:44	712	882	Detector bias heater on at level 1
	11:53:52	714	892	SWICS on at level 3
	11:57:04	717	881	Detector bias heater off
	12:00:48	721	862	WFOV blackbody heater on at temp. 1
	12:01:20	721	872	MFOV blackbody heater on at temp. 1
	12:02:24	722	891	SWICS off
	12:15:44	736	883	Detector bias heater on at level 2
	12:17:52	738	893	SWICS on at level 2
	12:21:04	741	881	Detector bias heater off
	12:24:48	745	863	WFOV blackbody heater on at temp. 2
	12:25:20	745	873	MFOV blackbody heater on at temp. 2
	12:26:24	746	891	SWICS off
	12:39:44	760	884	Detector bias heater on at level 3
	12:41:52	762	894	SWICS on at level 1
	12:44:00	764	881	Detector bias heater off
	12:46:40	767	852	Solar port heaters off
	12:47:44	768	861	WFOV blackbody heater off
	12:48:16	768	871	MFOV blackbody heater off
	12:48:48	769	851	Solar port heaters on
12:49:20	769	891	SWICS off	
End internal calibration sequence				
11/27/85	12:56:16	776	823	Elevate to nadir (Earth)
Begin modified solar calibration sequence				
11/27/85 ↓	13:08:32	789	822	Elevate to solar ports (Sun)
	13:09:04	789	814	Azimuth to position A
	13:09:36	790	883	Detector bias heater on at level 2
	13:19:44	800	831	SMA shutter cycle on
	13:50:40	831	832	SMA shutter cycle off
	13:51:44	832	811	Azimuth to 0°
	13:52:16	832	881	Detector bias heater off
	14:01:52	842	823	Elevate to nadir (Earth)
End modified solar calibration sequence.				
Begin azimuth angle load commands for solar calibration				
12/04/85 ↓	04:12:32	253	419	Address azimuth position A
	04:13:04	253	2xx	Data command, high byte
	04:13:36	254	1xx	Data command, low byte
End azimuth angle load commands (A = 32.03°)				
12/04/85 ↓	10:00:48	601	821	Elevate to internal source (stow)
	10:01:20	601	862	WFOV blackbody heater on at temp. 1
	10:01:52	602	872	MFOV blackbody heater on at temp. 1
	11:37:52	698	823	Elevate to nadir (Earth)

Table 7. Continued

(a) Continued

Date	Universal time		Hex command	Event description
	hr:min:sec	Minutes of day		
Begin internal calibration sequence				
12/04/85 ↓	11:38:56	699	8A1	Begin internal calibration
	11:39:28	699	881	Detector bias heater off
	11:40:00	700	852	Solar port heaters off
	11:40:32	701	821	Elevate to internal source (stow)
	11:41:04	701	851	Solar port heaters on
	11:43:12	703	882	Detector bias heater on at level 1
	11:45:20	705	892	SWICS on at level 3
	11:48:32	709	881	Detector bias heater off
	11:52:16	712	862	WFOV blackbody heater on at temp. 1
	11:52:48	713	872	MFOV blackbody heater on at temp. 1
	11:53:52	714	891	SWICS off
	12:07:12	727	883	Detector bias heater on at level 2
	12:09:20	729	893	SWICS on at level 2
	12:12:32	733	881	Detector bias heater off
	12:16:16	736	863	WFOV blackbody heater on at temp. 2
	12:16:48	737	873	MFOV blackbody heater on at temp. 2
	12:17:52	738	891	SWICS off
	12:31:12	751	884	Detector bias heater on at level 3
	12:33:20	753	894	SWICS on at level 1
	12:35:28	755	881	Detector bias heater off
12:38:08	758	852	Solar port heaters off	
12:39:12	759	861	WFOV blackbody heater off	
12:39:44	760	871	MFOV blackbody heater off	
12:40:16	760	851	Solar port heaters on	
12:40:48	761	891	SWICS off	
End internal calibration sequence				
12/04/85	12:47:44	768	823	Elevate to nadir (Earth)
Begin partial solar calibration sequence. NOTE: First three commands were not sent				
12/04/85 ↓	13:06:24	786	831	SMA shutter cycle on
	13:37:20	817	832	SMA shutter cycle off
	13:38:24	818	811	Azimuth to 0°
	13:38:56	819	881	Detector bias heater off
	13:48:32	829	823	Elevate to nadir (Earth)
Begin azimuth angle load commands for solar calibration				
12/18/85 ↓	02:12:00	132	419	Address azimuth position A
	02:13:04	133	2xx	Data command, high byte
	02:14:08	134	1xx	Data command, low byte
End azimuth angle load commands (A = 28.88°)				
12/18/85 ↓	08:27:28	507	821	Elevate to internal source (stow)
	08:28:00	508	862	WFOV blackbody heater on at temp. 1
	08:28:32	509	872	MFOV blackbody heater on at temp. 1

Table 7. Continued

(a) Continued

Date	Universal time		Hex command	Event description
	hr:min:sec	Minutes of day		
Begin azimuth angle load commands, repeat of above				
12/18/85 ↓	08:49:52	530	419	Address azimuth position A
	08:50:24	530	2xx	Data command, high byte
	08:51:28	531	1xx	Data command, low byte
End azimuth angle load commands ($A = 28.88^\circ$)				
12/18/85	10:04:32	605	823	Elevate to nadir (Earth)
Begin internal calibration sequence				
12/18/85 ↓	10:05:04	605	8A1	Begin internal calibration
	10:05:36	606	881	Detector bias heater off
	10:06:08	606	852	Solar port heaters off
	10:06:40	607	821	Elevate to internal source (stow)
	10:07:12	607	851	Solar port heaters on
	10:09:20	609	882	Detector bias heater on at level 1
	10:11:28	611	892	SWICS on at level 3
	10:14:40	615	881	Detector bias heater off
	10:18:24	618	862	WFOV blackbody heater on at temp. 1
	10:18:56	619	872	MFOV blackbody heater on at temp. 1
	10:20:00	620	891	SWICS off
	10:33:20	633	883	Detector bias heater on at level 2
	10:35:28	635	893	SWICS on at level 2
	10:38:40	639	881	Detector bias heater off
	10:42:24	642	863	WFOV blackbody heater on at temp. 2
	10:42:56	643	873	MFOV blackbody heater on at temp. 2
	10:44:00	644	891	SWICS off
	10:57:20	657	884	Detector bias heater on at level 3
	10:59:28	659	894	SWICS on at level 1
	11:01:36	662	881	Detector bias heater off
11:04:16	664	852	Solar port heaters off	
11:05:20	665	861	WFOV blackbody heater off	
11:05:52	666	871	MFOV blackbody heater off	
11:06:24	666	851	Solar port heaters on	
11:06:56	667	891	SWICS off	
End internal calibration sequence				
12/18/85	11:14:24	674	823	Elevate to nadir (Earth)
Begin modified solar calibration sequence				
12/18/85 ↓	11:21:20	681	822	Elevate to solar ports (Sun)
	11:21:52	682	814	Azimuth to position A
	11:22:24	682	883	Detector bias heater on at level 2
	11:32:32	693	831	SMA shutter cycle on
	12:03:28	723	832	SMA shutter cycle off
	12:04:32	725	811	Azimuth to 0°
	12:05:04	725	881	Detector bias heater off
12:14:40	735	823	Elevate to nadir (Earth)	
End modified solar calibration sequence				

Table 7. Continued

(a) Continued

Date	Universal time		Hex command	Event description
	hr:min:sec	Minutes of day		
Begin azimuth angle load commands for solar calibration				
12/25/85 ↓	02:47:44	168	419	Address azimuth position A
	02:48:16	168	2xx	Data command, high byte
	02:49:20	169	1xx	Data command, low byte
End azimuth angle load commands (A = 60.23°)				
12/25/85 ↓	09:42:08	582	821	Elevate to internal source (stow)
	09:42:40	583	862	WFOV blackbody heater on at temp. 1
	09:43:44	584	872	MFOV blackbody heater on at temp. 1
	11:19:12	679	823	Elevate to nadir (Earth)
Begin internal calibration sequence				
12/25/85 ↓	11:20:16	680	8A1	Begin internal calibration
	11:20:48	681	881	Detector bias heater off
	11:21:20	681	852	Solar port heaters off
	11:21:52	682	821	Elevate to internal source (stow)
	11:22:24	682	851	Solar port heaters on
	11:24:32	685	882	Detector bias heater on at level 1
	11:26:40	687	892	SWICS on at level 3
	11:29:52	690	881	Detector bias heater off
	11:33:36	694	862	WFOV blackbody heater on at temp. 1
	11:34:08	694	872	MFOV blackbody heater on at temp. 1
	11:35:12	695	891	SWICS off
	11:48:32	709	883	Detector bias heater on at level 2
	11:50:40	711	893	SWICS on at level 2
	11:53:52	714	881	Detector bias heater off
	11:57:36	718	863	WFOV blackbody heater on at temp. 2
	11:58:08	718	873	MFOV blackbody heater on at temp. 2
	11:59:12	719	891	SWICS off
	12:12:32	733	884	Detector bias heater on at level 3
	12:14:40	735	894	SWICS on at level 1
	12:16:48	737	881	Detector bias heater off
	12:19:28	739	852	Solar port heaters off
12:20:32	741	861	WFOV blackbody heater off	
12:21:04	741	871	MFOV blackbody heater off	
12:21:36	742	851	Solar port heaters on	
12:22:08	742	891	SWICS off	
End internal calibration sequence				
12/25/85	12:29:04	749	823	Elevate to nadir (Earth)
Begin modified solar calibration sequence				
12/25/85 ↓	14:17:20	857	822	Elevate to solar ports (Sun)
	14:17:52	858	814	Azimuth to position A
	14:18:24	858	883	Detector bias heater on at level 2
	14:28:32	869	831	SMA shutter cycle on

Table 7. Continued

(a) Continued

Date	Universal time		Hex command	Event description	
	hr:min:sec	Minutes of day			
12/25/85 ↓	14:59:28	899	832	SMA shutter cycle off	
	15:00:32	901	811	Azimuth to 0°	
	15:01:04	901	881	Detector bias heater off	
	15:10:40	911	823	Elevate to nadir (Earth)	
End modified solar calibration sequence					
12/31/85	15:14			Yaw maneuver to X-axis negative	
Begin azimuth angle load commands for solar calibration					
01/08/86 ↓	03:11:12	191	419	Address azimuth position A	
	03:11:44	192	2xx	Data command, high byte	
	03:12:48	193	1xx	Data command, low byte	
End azimuth angle load commands (A = 66.6°)					
01/08/86 ↓	08:20:00	500	821	Elevate to internal source (stow)	
	08:20:32	501	862	WFOV blackbody heater on at temp. 1	
	08:21:04	501	872	MFOV blackbody heater on at temp. 1	
	09:57:04	597	823	Elevate to nadir (Earth)	
Begin internal calibration sequence					
01/08/86 ↓	09:58:08	598	8A1	Begin internal calibration	
	09:58:40	599	881	Detector bias heater off	
	09:59:12	599	852	Solar port heaters off	
	09:59:44	600	821	Elevate to internal source (stow)	
	10:00:16	600	851	Solar port heaters on	
	10:02:24	602	882	Detector bias heater on at level 1	
	10:04:32	605	892	SWICS on at level 3	
	10:07:44	608	881	Detector bias heater off	
	10:11:28	611	862	WFOV blackbody heater on at temp. 1	
	10:12:00	612	872	MFOV blackbody heater on at temp. 1	
	10:13:04	613	891	SWICS off	
	10:26:24	626	883	Detector bias heater on at level 2	
	10:28:32	629	893	SWICS on at level 2	
	10:31:44	632	881	Detector bias heater off	
	10:35:28	635	863	WFOV blackbody heater on at temp. 2	
	10:36:00	636	873	MFOV blackbody heater on at temp. 2	
	10:37:04	637	891	SWICS off	
	10:50:24	650	884	Detector bias heater on at level 3	
	10:52:32	653	894	SWICS on at level 1	
	10:54:40	655	881	Detector bias heater off	
	10:57:20	657	852	Solar port heaters off	
	10:58:24	658	861	WFOV blackbody heater off	
	10:58:56	659	871	MFOV blackbody heater off	
	10:59:28	659	851	Solar port heaters on	
	11:00:00	660	891	SWICS off	
	End internal calibration sequence				

Table 7. Continued

(a) Continued

Date	Universal time		Hex command	Event description
	hr:min:sec	Minutes of day		
01/08/86	11:06:56	667	823	Elevate to nadir (Earth)
Begin modified solar calibration sequence				
01/08/86 ↓	11:14:24	674	822	Elevate to solar ports (Sun)
	11:14:56	675	814	Azimuth to position A
	11:15:28	675	883	Detector bias heater on at level 2
	11:25:36	686	831	SMA shutter cycle on
	11:56:32	717	832	SMA shutter cycle off
	11:57:36	718	811	Azimuth to 0°
	11:58:08	718	881	Detector bias heater off
	12:07:44	728	823	Elevate to nadir (Earth)
End modified solar calibration sequence.				
Begin azimuth angle load commands for solar calibration				
01/22/86 ↓	02:32:48	153	419	Address azimuth position A
	02:33:20	153	2xx	Data command, high byte
	02:33:52	154	1xx	Data command, low byte
End azimuth angle load commands (A = 59.48°)				
01/22/86 ↓	09:35:12	575	821	Elevate to internal source (stow)
	09:35:44	576	862	WFOV blackbody heater on at temp. 1
	09:36:48	577	872	MFOV blackbody heater on at temp. 1
	11:12:16	672	823	Elevate to nadir (Earth)
Begin internal calibration sequence				
01/22/86 ↓	11:13:20	673	8A1	Begin internal calibration
	11:13:52	674	881	Detector bias heater off
	11:14:24	674	852	Solar port heaters off
	11:14:56	675	821	Elevate to internal source (stow)
	11:15:28	675	851	Solar port heaters on
	11:17:36	678	882	Detector bias heater on at level 1
	11:19:44	680	892	SWICS on at level 3
	11:22:56	683	881	Detector bias heater off
	11:26:40	687	862	WFOV blackbody heater on at temp. 1
	11:27:12	687	872	MFOV blackbody heater on at temp. 1
	11:28:16	688	891	SWICS off
	11:41:36	702	883	Detector bias heater on at level 2
	11:43:44	704	893	SWICS on at level 2
	11:46:56	707	881	Detector bias heater off
	11:50:40	711	863	WFOV blackbody heater on at temp. 2
	11:51:12	711	873	MFOV blackbody heater on at temp. 2
	11:52:16	712	891	SWICS off
	12:05:36	726	884	Detector bias heater on at level 3
	12:07:44	728	894	SWICS on at level 1
	12:09:52	730	881	Detector bias heater off
12:12:32	733	852	Solar port heaters off	

Table 7. Continued

(a) Concluded

Date	Universal time		Hex command	Event description
	hr:min:sec	Minutes of day		
01/22/86 ↓	12:13:36	734	861	WFOV blackbody heater off
	12:14:08	734	871	MFOV blackbody heater off
	12:14:40	735	851	Solar port heaters on
	12:15:12	735	891	SWICS off
End internal calibration sequence				
01/22/86	12:22:08	742	823	Elevate to nadir (Earth)
Begin modified solar calibration sequence				
01/22/86 ↓	12:29:36	750	822	Elevate to solar ports (Sun)
	12:30:08	750	814	Azimuth to position A
	12:30:40	751	883	Detector bias heater on at level 2
	12:40:48	761	831	SMA shutter cycle on
	13:11:44	792	832	SMA shutter cycle off
	13:12:48	793	811	Azimuth to 0°
	13:13:20	793	881	Detector bias heater off
13:22:56	803	823	Elevate to nadir (Earth)	
End modified solar calibration sequence				
01/31/86	15:01			Yaw maneuver to X-axis positive

Table 7. Continued

(b) Scanner commands

Date	Universal time		Hex command	Event description
	hr:min:sec	Minutes of day		
Begin internal calibration sequence				
11/05/84 ↓	09:11:13	551	8A1	Begin internal calibration
	09:11:45	552	897	SWICS on at level 1 modulated
	09:13:21	553	895	SWICS on at level 2 modulated
	09:14:57	555	893	SWICS on at level 3 modulated
	09:16:33	557	891	SWICS off
	09:19:13	559	Pulse	Blackbody calibration heaters on
	09:19:45	560	897	SWICS on at level 1 modulated
	09:21:21	561	895	SWICS on at level 2 modulated
	09:22:57	563	893	SWICS on at level 3 modulated
	09:24:33	565	891	SWICS off
	09:43:13	583	Pulse	Blackbody calibration heaters off
	09:43:45	584	897	SWICS on at level 1 modulated
	09:45:21	585	895	SWICS on at level 2 modulated
	09:46:57	587	893	SWICS on at level 3 modulated
	09:48:33	589	891	SWICS off
End internal calibration sequence				
11/05/84	11:06:25	666	821	Scan to stow
Release contamination covers				
11/05/84	13:03:13	783	813	Azimuth to 180°
11/05/84	15:57:05	957	822	Normal scan mode
Begin internal calibration sequence				
11/05/84 ↓	19:42:41	1183	8A1	Begin internal calibration
	19:43:13	1183	897	SWICS on at level 1 modulated
	19:44:49	1185	895	SWICS on at level 2 modulated
	19:46:25	1186	893	SWICS on at level 3 modulated
	19:48:01	1188	891	SWICS off
	19:50:41	1191	Pulse	Blackbody calibration heaters on
	19:51:13	1191	897	SWICS on at level 1 modulated
	19:52:49	1193	895	SWICS on at level 2 modulated
	19:54:25	1194	893	SWICS on at level 3 modulated
	19:56:01	1196	891	SWICS off
	20:14:41	1215	Pulse	Blackbody calibration heaters off
	20:15:13	1215	897	SWICS on at level 1 modulated
	20:16:49	1217	895	SWICS on at level 2 modulated
	20:18:25	1218	893	SWICS on at level 3 modulated
	20:20:01	1220	891	SWICS off
End internal calibration sequence.				
Begin internal calibration sequence				
11/06/84 ↓	04:20:33	261	8A1	Begin internal calibration
	04:21:05	261	897	SWICS on at level 1 modulated
	04:22:41	263	895	SWICS on at level 2 modulated
	04:24:17	264	893	SWICS on at level 3 modulated

Table 7. Continued

(b) Continued

Date	Universal time		Hex command	Event description
	hr:min:sec	Minutes of day		
11/06/84 ↓	04:25:53	266	891	SWICS off
	04:28:33	269	Pulse	Blackbody calibration heaters on
	04:29:05	269	897	SWICS on at level 1 modulated
	04:30:41	271	895	SWICS on at level 2 modulated
	04:32:17	272	893	SWICS on at level 3 modulated
	04:33:53	274	891	SWICS off
	04:52:33	293	Pulse	Blackbody calibration heaters off
	04:53:05	293	897	SWICS on at level 1 modulated
	04:54:41	295	895	SWICS on at level 2 modulated
	04:56:17	296	893	SWICS on at level 3 modulated
	04:57:53	298	891	SWICS off
End internal calibration sequence. Begin internal calibration sequence				
11/07/84 ↓	01:20:17	80	8A1	Begin internal calibration
	01:20:49	81	897	SWICS on at level 1 modulated
	01:22:25	82	895	SWICS on at level 2 modulated
	01:24:01	84	893	SWICS on at level 3 modulated
	01:25:37	86	891	SWICS off
	01:28:17	88	Pulse	Blackbody calibration heaters on
	01:28:49	89	897	SWICS on at level 1 modulated
	01:30:25	90	895	SWICS on at level 2 modulated
	01:32:01	92	893	SWICS on at level 3 modulated
	01:33:37	94	891	SWICS off
	01:52:17	112	Pulse	Blackbody calibration heaters off
	01:52:49	113	897	SWICS on at level 1 modulated
	01:54:25	114	895	SWICS on at level 2 modulated
	01:56:01	116	893	SWICS on at level 3 modulated
	01:57:37	118	891	SWICS off
End internal calibration sequence. Begin internal calibration sequence				
11/08/84 ↓	03:03:13	183	8A1	Begin internal calibration
	03:03:45	184	897	SWICS on at level 1 modulated
	03:05:21	185	895	SWICS on at level 2 modulated
	03:06:57	187	893	SWICS on at level 3 modulated
	03:08:33	189	891	SWICS off
	03:11:13	191	Pulse	Blackbody calibration heaters on
	03:11:45	192	897	SWICS on at level 1 modulated
	03:13:21	193	895	SWICS on at level 2 modulated
	03:14:57	195	893	SWICS on at level 3 modulated
	03:16:33	197	891	SWICS off
		03:35:13	215	Pulse

Table 7. Continued

(b) Continued

Date	Universal time		Hex command	Event description
	hr:min:sec	Minutes of day		
11/08/84 ↓	03:35:45	216	897	SWICS on at level 1 modulated
	03:37:21	217	895	SWICS on at level 2 modulated
	03:38:57	219	893	SWICS on at level 3 modulated
	03:40:33	221	891	SWICS off
End internal calibration sequence. Begin internal calibration sequence				
11/09/84 ↓	07:57:37	478	8A1	Begin internal calibration
	07:58:09	478	897	SWICS on at level 1 modulated
	07:59:45	480	895	SWICS on at level 2 modulated
	08:01:21	481	893	SWICS on at level 3 modulated
	08:02:57	483	891	SWICS off
	08:05:37	486	Pulse	Blackbody calibration heaters on
	08:06:09	486	897	SWICS on at level 1 modulated
	08:07:45	488	895	SWICS on at level 2 modulated
	08:09:21	489	893	SWICS on at level 3 modulated
	08:10:57	491	891	SWICS off
	08:29:37	510	Pulse	Blackbody calibration heaters off
	08:30:09	510	897	SWICS on at level 1 modulated
	08:31:45	512	895	SWICS on at level 2 modulated
	08:33:21	513	893	SWICS on at level 3 modulated
08:34:57	515	891	SWICS off	
End internal calibration sequence. Begin internal calibration sequence				
11/10/84 ↓	07:00:33	421	8A1	Begin internal calibration
	07:01:05	421	897	SWICS on at level 1 modulated
	07:02:41	423	895	SWICS on at level 2 modulated
	07:04:17	424	893	SWICS on at level 3 modulated
	07:05:53	426	891	SWICS off
	07:08:33	429	Pulse	Blackbody calibration heaters on
	07:09:05	429	897	SWICS on at level 1 modulated
	07:10:41	431	895	SWICS on at level 2 modulated
	07:12:17	432	893	SWICS on at level 3 modulated
	07:13:53	434	891	SWICS off
	07:32:33	453	Pulse	Blackbody calibration heaters off
	07:33:05	453	897	SWICS on at level 1 modulated
	07:34:41	455	895	SWICS on at level 2 modulated
	07:36:17	456	893	SWICS on at level 3 modulated
07:37:53	458	891	SWICS off	
End internal calibration sequence. Begin internal calibration sequence				
11/11/84 ↓	18:07:13	1087	8A1	Begin internal calibration
	18:07:45	1088	897	SWICS on at level 1 modulated
	18:09:21	1089	895	SWICS on at level 2 modulated
	18:10:57	1091	893	SWICS on at level 3 modulated

Table 7. Continued

(b) Continued

Date	Universal time		Hex command	Event description
	hr:min:sec	Minutes of day		
11/11/84 ↓	18:12:33	1093	891	SWICS off
	18:15:13	1095	Pulse	Blackbody calibration heaters on
	18:15:45	1096	897	SWICS on at level 1 modulated
	18:17:21	1097	895	SWICS on at level 2 modulated
	18:18:57	1099	893	SWICS on at level 3 modulated
	18:20:33	1101	891	SWICS off
	18:39:13	1119	Pulse	Blackbody calibration heaters off
	18:39:45	1120	897	SWICS on at level 1 modulated
	18:41:21	1121	895	SWICS on at level 2 modulated
	18:42:57	1123	893	SWICS on at level 3 modulated
	18:44:33	1125	891	SWICS off
End internal calibration sequence. Begin internal calibration sequence				
11/12/84 ↓	17:22:25	1042	8A1	Begin internal calibration
	17:22:57	1043	897	SWICS on at level 1 modulated
	17:24:33	1045	895	SWICS on at level 2 modulated
	17:26:09	1046	893	SWICS on at level 3 modulated
	17:27:45	1048	891	SWICS off
	17:30:25	1050	Pulse	Blackbody calibration heaters on
	17:30:57	1051	897	SWICS on at level 1 modulated
	17:32:33	1053	895	SWICS on at level 2 modulated
	17:34:09	1054	893	SWICS on at level 3 modulated
	17:35:45	1056	891	SWICS off
	17:54:25	1074	Pulse	Blackbody calibration heaters off
	17:54:57	1075	897	SWICS on at level 1 modulated
	17:56:33	1077	895	SWICS on at level 2 modulated
	17:58:09	1078	893	SWICS on at level 3 modulated
	17:59:45	1080	891	SWICS off
	End internal calibration sequence. Begin azimuth angle load commands for solar calibration			
11/20/84 ↓	04:06:41	247	419	Address azimuth position A
	07:20:49	441	2xx	Data command, high byte
	07:21:53	442	1xx	Data command, low byte
	07:23:29	443	41B	Address azimuth position B
	07:24:01	444	2xx	Data command, high byte
	07:26:09	446	1xx	Data command, low byte
End azimuth angle load commands (A = 99.6°, B = 84.6°). Begin internal calibration sequence				
11/20/84 ↓	08:21:37	502	8A1	Begin internal calibration
	08:22:09	502	897	SWICS on at level 1 modulated
	08:23:45	504	895	SWICS on at level 2 modulated
	08:25:21	505	893	SWICS on at level 3 modulated
	08:26:57	507	891	SWICS off

Table 7. Continued

(b) Continued

Date	Universal time		Hex command	Event description
	hr:min:sec	Minutes of day		
11/20/84 ↓	08:29:37	510	Pulse	Blackbody calibration heaters on
	08:30:09	510	897	SWICS on at level 1 modulated
	08:31:45	512	895	SWICS on at level 2 modulated
	08:33:21	513	893	SWICS on at level 3 modulated
	08:34:57	515	891	SWICS off
	08:53:37	534	Pulse	Blackbody calibration heaters off
	08:54:09	534	897	SWICS on at level 1 modulated
	08:55:45	536	895	SWICS on at level 2 modulated
	08:57:21	537	893	SWICS on at level 3 modulated
08:58:57	539	891	SWICS off	
End internal calibration sequence				
11/20/84	10:39:45	640	824	Short scan mode
11/20/84	10:40:17	640	811	Azimuth to 0°
Begin solar calibration sequence				
11/20/84 ↓	10:45:37	646	8A2	Begin solar calibration
	10:46:09	646	824	Short scan mode
	10:46:41	647	811	Azimuth to 0°
	10:47:13	647	814	Azimuth to position A
	10:53:05	653	825	MAM (solar) scan mode
	10:58:25	658	815	Azimuth to position B
	11:04:49	665	814	Azimuth to position A
	11:11:13	671	824	Short scan mode
	11:11:45	672	813	Azimuth to 180°
11:16:33	677	822	Normal scan mode	
End solar calibration sequence				
11/20/84 ↓	12:36:33	757	821	Scan to stow
	12:44			Yaw maneuver to X-axis positive
	13:25:37	806	822	Normal scan mode
Begin 180° pitch procedure				
11/21/84 ↓	12:41:21	761	821	Scan to stow
	12:50			Pitch spacecraft 180°
	15:01:37	902	822	Normal scan mode
	16:21:05	981	821	Scan to stow
	17:11			Pitch spacecraft 0°
17:42:09	1062	822	Normal scan mode	
End 180° pitch procedure.				
Begin azimuth angle load commands for solar calibration				
11/26/84 ↓	03:39:29	219	419	Address azimuth position A
	03:40:01	220	2xx	Data command, high byte
	03:41:05	221	1xx	Data command, low byte
	03:42:09	222	41B	Address azimuth position B
	03:42:41	223	2xx	Data command, high byte
03:43:45	224	1xx	Data command, low byte	
End azimuth angle load commands (A = 86.1°, B = 71.1°)				

Table 7. Continued

(b) Continued

Date	Universal time		Hex command	Event description
	hr:min:sec	Minutes of day		
Begin internal calibration sequence				
11/26/84 ↓	06:31:13	391	8A1	Begin internal calibration
	06:31:45	392	897	SWICS on at level 1 modulated
	06:33:21	393	895	SWICS on at level 2 modulated
	06:34:57	395	893	SWICS on at level 3 modulated
	06:36:33	397	891	SWICS off
	06:39:13	399	Pulse	Blackbody calibration heaters on
	06:39:45	400	897	SWICS on at level 1 modulated
	06:41:21	401	895	SWICS on at level 2 modulated
	06:42:57	403	893	SWICS on at level 3 modulated
	06:44:33	405	891	SWICS off
	07:03:13	423	Pulse	Blackbody calibration heaters off
	07:03:45	424	897	SWICS on at level 1 modulated
	07:05:21	425	895	SWICS on at level 2 modulated
	07:06:57	427	893	SWICS on at level 3 modulated
07:08:33	429	891	SWICS off	
End internal calibration sequence				
11/26/84	07:53:21	473	824	Short scan mode
11/26/84	07:53:53	474	811	Azimuth to 0°
Begin solar calibration sequence				
11/26/84 ↓	07:59:13	479	8A2	Begin solar calibration
	07:59:45	480	824	Short scan mode
	08:00:17	480	811	Azimuth to 0°
	08:00:49	481	814	Azimuth to position A
	08:06:41	487	825	MAM (solar) scan mode
	08:12:01	492	815	Azimuth to position B
	08:18:25	498	814	Azimuth to position A
	08:24:49	505	824	Short scan mode
	08:25:21	505	813	Azimuth to 180°
	08:30:09	510	822	Normal scan mode
End solar calibration sequence.				
Begin azimuth angle load commands for solar calibration				
12/03/84 ↓	01:44:49	105	419	Address azimuth position A
	01:45:21	105	2xx	Data command, high byte
	01:46:25	106	1xx	Data command, low byte
	01:47:29	107	41B	Address azimuth position B
	01:48:01	108	2xx	Data command, high byte
	01:49:05	109	1xx	Data command, low byte
End azimuth angle load commands (A = 55.2°, B = 40.2°)				

Table 7. Continued

(b) Continued

Date	Universal time		Hex command	Event description
	hr:min:sec	Minutes of day		
Begin internal calibration sequence				
12/03/84 ↓	07:53:53	474	8A1	Begin internal calibration
	07:54:25	474	897	SWICS on at level 1 modulated
	07:56:01	476	895	SWICS on at level 2 modulated
	07:57:37	478	893	SWICS on at level 3 modulated
	07:59:13	479	891	SWICS off
	08:01:53	482	Pulse	Blackbody calibration heaters on
	08:02:25	482	897	SWICS on at level 1 modulated
	08:04:01	485	895	SWICS on at level 2 modulated
	08:05:37	486	893	SWICS on at level 3 modulated
	08:07:13	487	891	SWICS off
	08:25:53	506	Pulse	Blackbody calibration heaters off
	08:26:25	506	897	SWICS on at level 1 modulated
	08:28:01	508	895	SWICS on at level 2 modulated
	08:29:37	510	893	SWICS on at level 3 modulated
	08:31:13	511	891	SWICS off
End internal calibration sequence				
12/03/84	09:16:01	556	824	Short scan mode
12/03/84	09:16:33	557	811	Azimuth to 0°
Begin solar calibration sequence				
12/03/84 ↓	09:21:21	561	8A2	Begin solar calibration
	09:21:53	562	824	Short scan mode
	09:22:25	562	811	Azimuth to 0°
	09:22:57	563	814	Azimuth to position A
	09:28:49	569	825	MAM (solar) scan mode
	09:34:09	574	815	Azimuth to position B
	09:40:33	581	814	Azimuth to position A
	09:46:57	587	824	Short scan mode
	09:47:29	587	813	Azimuth to 180°
	09:52:17	592	822	Normal scan mode
End solar calibration sequence				

Table 7. Continued

(b) Continued

Date	Universal time		Hex command	Event description
	hr:min:sec	Minutes of day		
Begin Sun avoidance operation				
12/06/84	22:36:33	1357	824	Short scan mode
12/19/84	19:02:09	1142	822	Normal scan mode
End Sun avoidance operation.				
Begin internal calibration sequence				
12/26/84 ↓	06:28:01	388	8A1	Begin internal calibration
	06:28:33	389	897	SWICS on at level 1 modulated
	06:30:09	390	895	SWICS on at level 2 modulated
	06:31:45	392	893	SWICS on at level 3 modulated
	06:33:21	393	891	SWICS off
	06:36:01	396	Pulse	Blackbody calibration heaters on
	06:36:33	397	897	SWICS on at level 1 modulated
	06:38:09	398	895	SWICS on at level 2 modulated
	06:39:45	400	893	SWICS on at level 3 modulated
	06:41:21	401	891	SWICS off
	07:00:01	420	Pulse	Blackbody calibration heaters off
	07:00:33	421	897	SWICS on at level 1 modulated
	07:02:09	422	895	SWICS on at level 2 modulated
	07:03:45	424	893	SWICS on at level 3 modulated
	07:05:21	425	891	SWICS off
End internal calibration sequence				
12/26/84	07:50:09	470	824	Short scan mode
12/26/84	07:50:41	471	811	Azimuth to 0°
Begin solar calibration sequence				
12/26/84 ↓	07:55:29	475	8A2	Begin solar calibration
	07:56:01	476	824	Short scan mode
	07:56:33	477	811	Azimuth to 0°
	07:57:05	477	814	Azimuth to position A
	08:02:57	483	825	MAM (solar) scan mode
	08:08:17	488	815	Azimuth to position B
	08:14:41	495	814	Azimuth to position A
	08:21:05	501	824	Short scan mode
	08:21:37	502	813	Azimuth to 180°
	08:26:25	506	822	Normal scan mode
End solar calibration sequence				
01/03/85 ↓	22:31:13	1351	821	Scan to stow
	22:40			Yaw maneuver to X-axis negative
	23:10:41	1391	822	Normal scan mode

Table 7. Continued

(b) Continued

Date	Universal time		Hex command	Event description
	hr:min:sec	Minutes of day		
Begin azimuth angle load commands for solar calibration				
01/09/85 ↓	03:10:41	191	419	Address azimuth position A
	03:11:13	191	2xx	Data command, high byte
	03:12:17	192	1xx	Data command, low byte
	03:13:21	193	41B	Address azimuth position B
	03:13:53	194	2xx	Data command, high byte
	03:14:57	195	1xx	Data command, low byte
End azimuth angle load commands (A = 80.63°, B = 65.63°).				
Begin internal calibration sequence				
01/09/85 ↓	08:16:17	496	8A1	Begin internal calibration
	08:16:49	497	897	SWICS on at level 1 modulated
	08:18:25	498	895	SWICS on at level 2 modulated
	08:20:01	500	893	SWICS on at level 3 modulated
	08:21:37	502	891	SWICS off
	08:24:17	504	Pulse	Blackbody calibration heaters on
	08:24:49	505	897	SWICS on at level 1 modulated
	08:26:25	506	895	SWICS on at level 2 modulated
	08:28:01	508	893	SWICS on at level 3 modulated
	08:29:37	510	891	SWICS off
	08:48:17	528	Pulse	Blackbody calibration heaters off
	08:48:49	529	897	SWICS on at level 1 modulated
	08:50:25	530	895	SWICS on at level 2 modulated
	08:52:01	532	893	SWICS on at level 3 modulated
08:53:37	534	891	SWICS off	
End internal calibration sequence				
01/09/85	09:38:57	579	824	Short scan mode
01/09/85	09:39:29	579	811	Azimuth to 0°
Begin solar calibration sequence				
01/09/85 ↓	09:44:17	584	8A2	Begin solar calibration
	09:44:49	585	824	Short scan mode
	09:45:21	585	811	Azimuth to 0°
	09:45:53	586	814	Azimuth to position A
	09:51:45	592	825	MAM (solar) scan mode
	09:57:05	597	815	Azimuth to position B
	10:03:29	603	814	Azimuth to position A
	10:09:53	610	824	Short scan mode
	10:10:25	610	813	Azimuth to 180°
	10:15:13	615	822	Normal scan mode
End solar calibration sequence				
01/16/85	19:24:33	1165	824	Short scan mode

Table 7. Continued

(b) Continued

Date	Universal time		Hex command	Event description
	hr:min:sec	Minutes of day		
Begin along-track operation				
01/16/85	19:26:41	1167	812	Azimuth to 90°
01/16/85	19:31:29	1171	822	Normal scan mode
Begin internal calibration sequence				
01/23/85 ↓	14:22:41	863	8A1	Begin internal calibration
	14:23:13	863	897	SWICS on at level 1 modulated
	14:24:49	865	895	SWICS on at level 2 modulated
	14:26:25	866	893	SWICS on at level 3 modulated
	14:28:01	868	891	SWICS off
	14:30:41	871	Pulse	Blackbody calibration heaters on
	14:31:13	871	897	SWICS on at level 1 modulated
	14:32:49	873	895	SWICS on at level 2 modulated
	14:34:25	874	893	SWICS on at level 3 modulated
	14:36:01	876	891	SWICS off
	14:54:41	895	Pulse	Blackbody calibration heaters off
	14:55:13	895	897	SWICS on at level 1 modulated
	14:56:49	897	895	SWICS on at level 2 modulated
	14:58:25	898	893	SWICS on at level 3 modulated
	15:00:01	900	891	SWICS off
End internal calibration sequence				
01/28/85	21:02:41	1263	824	Short scan mode
End along-track operation				
01/28/85	21:04:17	1264	813	Azimuth to 180°
01/28/85	21:08:01	1268	822	Normal scan mode
02/01/85 ↓	14:51:29	891	821	Scan to stow
	15:06			Yaw maneuver to X-axis positive
	15:30:57	931	822	Normal scan mode
Begin azimuth angle load commands for solar calibration				
02/06/85 ↓	00:08:49	9	419	Address azimuth position A
	00:09:21	9	2xx	Data command, high byte
	00:10:25	10	1xx	Data command, low byte
	00:11:29	11	41B	Address azimuth position B
	00:12:01	12	2xx	Data command, high byte
	00:13:05	13	1xx	Data command, low byte
End azimuth angle load commands (A = 86.03°, B = 71.03°).				
Begin internal calibration sequence				
02/06/85 ↓	11:36:49	697	8A1	Begin internal calibration
	11:37:21	697	897	SWICS on at level 1 modulated
	11:38:57	699	895	SWICS on at level 2 modulated
	11:40:33	701	893	SWICS on at level 3 modulated
	11:42:09	702	891	SWICS off
	11:44:49	705	Pulse	Blackbody calibration heaters on
	11:45:21	705	897	SWICS on at level 1 modulated

Table 7. Continued

(b) Continued

Date	Universal time		Hex command	Event description
	hr:min:sec	Minutes of day		
02/06/85 ↓	11:46:57	707	895	SWICS on at level 2 modulated
	11:48:33	709	893	SWICS on at level 3 modulated
	11:50:09	710	891	SWICS off
	12:08:49	729	Pulse	Blackbody calibration heaters off
	12:09:21	729	897	SWICS on at level 1 modulated
	12:10:57	731	895	SWICS on at level 2 modulated
	12:12:33	733	893	SWICS on at level 3 modulated
	12:14:09	734	891	SWICS off
End internal calibration sequence				
02/06/85	12:58:57	779	824	Short scan mode
02/06/85	12:59:29	779	811	Azimuth to 0°
Begin solar calibration sequence				
02/06/85 ↓	13:04:17	784	8A2	Begin solar calibration
	13:04:49	785	824	Short scan mode
	13:05:21	785	811	Azimuth to 0°
	13:05:53	786	814	Azimuth to position A
	13:11:45	792	825	MAM (solar) scan mode
	13:17:05	797	815	Azimuth to position B
	13:23:29	803	814	Azimuth to position A
	13:29:53	810	824	Short scan mode
	13:30:25	810	813	Azimuth to 180°
	13:35:13	815	822	Normal scan mode
End solar calibration sequence.				
Begin Sun avoidance operation				
02/17/85	15:08:01	908	824	Short scan mode
Begin azimuth angle load commands for solar calibration				
02/20/85 ↓	05:32:01	332	419	Address azimuth position A
	05:33:05	333	2xx	Data command, high byte
	05:34:09	334	1xx	Data command, low byte
	05:35:13	335	41B	Address azimuth position B
	05:35:45	336	2xx	Data command, high byte
	05:36:49	337	1xx	Data command, low byte
End azimuth angle load commands (A = 35.93°, B = 20.93°).				
Begin internal calibration sequence				
02/20/85 ↓	11:21:53	682	8A1	Begin internal calibration
	11:22:25	682	897	SWICS on at level 1 modulated
	11:24:01	684	895	SWICS on at level 2 modulated
	11:25:37	686	893	SWICS on at level 3 modulated
	11:27:13	687	891	SWICS off
	11:29:53	690	Pulse	Blackbody calibration heaters on
	11:30:25	690	897	SWICS on at level 1 modulated
	11:32:01	692	895	SWICS on at level 2 modulated
	11:33:37	694	893	SWICS on at level 3 modulated
	11:35:13	695	891	SWICS off

Table 7. Continued

(b) Continued

Date	Universal time		Hex command	Event description
	hr:min:sec	Minutes of day		
02/20/85 ↓	11:53:53	714	Pulse	Blackbody calibration heaters off
	11:54:25	714	897	SWICS on at level 1 modulated
	11:56:01	716	895	SWICS on at level 2 modulated
	11:57:37	718	893	SWICS on at level 3 modulated
	11:59:13	719	891	SWICS off
End internal calibration sequence				
02/20/85	12:42:57	763	824	Short scan mode
02/20/85	12:43:29	763	811	Azimuth to 0°
Begin solar calibration sequence				
02/20/85 ↓	12:48:49	769	8A2	Begin solar calibration
	12:49:21	769	824	Short scan mode
	12:49:53	770	811	Azimuth to 0°
	12:50:25	770	814	Azimuth to position A
	12:56:17	776	825	MAM (solar) scan mode
	13:01:37	782	815	Azimuth to position B
	13:08:01	788	814	Azimuth to position A
	13:14:25	794	824	Short scan mode
	13:14:57	795	813	Azimuth to 180°
13:19:45	800	822	Normal scan mode	
End solar calibration sequence				
02/20/85	21:56:01	1316	821	Scan to stow
02/25/85	18:27:29	1107	822	Normal scan mode
End Sun avoidance operation.				
Begin internal calibration sequence				
02/26/85 ↓	03:00:33	181	8A1	Begin internal calibration
	03:01:05	181	897	SWICS on at level 1 modulated
	03:02:41	183	895	SWICS on at level 2 modulated
	03:04:17	184	893	SWICS on at level 3 modulated
	03:05:53	186	891	SWICS off
	03:08:33	189	Pulse	Blackbody calibration heaters on
	03:09:05	189	897	SWICS on at level 1 modulated
	03:10:41	191	895	SWICS on at level 2 modulated
	03:12:17	192	893	SWICS on at level 3 modulated
	03:13:53	194	891	SWICS off
	03:32:33	213	Pulse	Blackbody calibration heaters off
	03:33:05	213	897	SWICS on at level 1 modulated
	03:34:41	215	895	SWICS on at level 2 modulated
	03:36:17	216	893	SWICS on at level 3 modulated
03:37:53	218	891	SWICS off	
End internal calibration sequence.				
Begin azimuth angle load commands for solar calibration				
03/06/85 ↓	03:39:29	219	419	Address azimuth position A
	03:40:01	220	2xx	Data command, high byte
	03:41:05	221	1xx	Data command, low byte

Table 7. Continued

(b) Continued

Date	Universal time		Hex command	Event description
	hr:min:sec	Minutes of day		
03/06/85 ↓	03:42:09	222	41B	Address azimuth position B
	03:42:41	223	2xx	Data command, high byte
	03:43:45	224	1xx	Data command, low byte
End azimuth angle load commands (A = 75.98°, B = 60.98°).				
Begin internal calibration sequence				
03/06/85 ↓	09:26:09	566	8A1	Begin internal calibration
	09:26:41	567	897	SWICS on at level 1 modulated
	09:28:17	568	895	SWICS on at level 2 modulated
	09:29:53	570	893	SWICS on at level 3 modulated
	09:31:29	571	891	SWICS off
	09:34:09	574	Pulse	Blackbody calibration heaters on
	09:34:41	575	897	SWICS on at level 1 modulated
	09:36:17	576	895	SWICS on at level 2 modulated
	09:37:53	578	893	SWICS on at level 3 modulated
	09:39:29	579	891	SWICS off
	09:58:09	598	Pulse	Blackbody calibration heaters off
	09:58:41	599	897	SWICS on at level 1 modulated
	10:00:17	600	895	SWICS on at level 2 modulated
10:01:53	602	893	SWICS on at level 3 modulated	
10:03:29	603	891	SWICS off	
End internal calibration sequence				
03/06/85	10:48:17	648	824	Short scan mode
03/06/85	10:48:49	649	811	Azimuth to 0°
Begin solar calibration sequence				
03/06/85 ↓	10:53:37	654	8A2	Begin solar calibration
	10:54:09	654	824	Short scan mode
	10:54:41	655	811	Azimuth to 0°
	10:55:13	655	814	Azimuth to position A
	11:01:05	661	825	MAM (solar) scan mode
	11:06:25	666	815	Azimuth to position B
	11:12:49	673	814	Azimuth to position A
	11:19:13	679	824	Short scan mode
	11:19:45	680	813	Azimuth to 180°
	11:24:33	685	822	Normal scan mode
End solar calibration sequence				
03/13/85 ↓	14:56:17	896	821	Scan to stow
	15:07			Yaw maneuver to X-axis negative
	15:35:45	936	822	Normal scan mode
Begin azimuth angle load commands for solar calibration				
03/20/85 ↓	01:31:29	91	419	Address azimuth position A
	01:32:01	92	2xx	Data command, high byte
	01:33:05	93	1xx	Data command, low byte

Table 7. Continued

(b) Continued

Date	Universal time		Hex command	Event description
	hr:min:sec	Minutes of day		
03/20/85 ↓	01:34:09	94	41B	Address azimuth position B
	01:34:41	95	2xx	Data command, high byte
	01:35:45	96	1xx	Data command, low byte
	07:56:33	477	419	Address azimuth position A
	07:57:05	477	2xx	Data command, high byte
	07:58:09	478	1xx	Data command, low byte
	07:59:13	479	41B	Address azimuth position B
	08:00:17	480	2xx	Data command, high byte
	08:01:21	481	1xx	Data command, low byte
End azimuth angle load commands ($A = 73.2^\circ$, $B = 58.2^\circ$).				
Begin internal calibration sequence				
03/20/85 ↓	11:12:49	673	8A1	Begin internal calibration
	11:13:21	673	897	SWICS on at level 1 modulated
	11:14:57	675	895	SWICS on at level 2 modulated
	11:16:33	677	893	SWICS on at level 3 modulated
	11:18:09	678	891	SWICS off
	11:20:49	681	Pulse	Blackbody calibration heaters on
	11:21:21	681	897	SWICS on at level 1 modulated
	11:22:57	683	895	SWICS on at level 2 modulated
	11:24:33	685	893	SWICS on at level 3 modulated
	11:26:09	686	891	SWICS off
	11:44:49	705	Pulse	Blackbody calibration heaters off
	11:45:21	705	897	SWICS on at level 1 modulated
	11:46:57	707	895	SWICS on at level 2 modulated
	11:48:33	709	893	SWICS on at level 3 modulated
	11:50:09	710	891	SWICS off
End internal calibration sequence				
03/20/85	12:35:29	755	824	Short scan mode
03/20/85	12:36:01	756	811	Azimuth to 0°
Begin solar calibration sequence				
03/20/85 ↓	12:40:49	761	8A2	Begin solar calibration
	12:41:21	761	824	Short scan mode
	12:41:53	762	811	Azimuth to 0°
	12:42:25	762	814	Azimuth to position A
	12:48:17	768	825	MAM (solar) scan mode
	12:53:37	774	815	Azimuth to position B
	13:00:01	780	814	Azimuth to position A
	13:06:25	786	824	Short scan mode
	13:06:57	787	813	Azimuth to 180°
	13:11:45	792	822	Normal scan mode
	End solar calibration sequence			
04/01/85	03:36:49	217	824	Short scan mode
04/02/85	18:45:37	1126	822	Normal scan mode

Table 7. Continued

(b) Continued

Date	Universal time		Hex command	Event description
	hr:min:sec	Minutes of day		
Begin azimuth angle load commands for solar calibration				
04/03/85 ↓	02:16:17	136	419	Address azimuth position A
	02:16:49	137	2xx	Data command, high byte
	02:17:53	138	1xx	Data command, low byte
	02:20:01	140	41B	Address azimuth position B
	02:20:33	141	2xx	Data command, high byte
	02:21:37	142	1xx	Data command, low byte
End azimuth angle load commands (A = 45.0°, B = 30.0°).				
Begin internal calibration sequence				
04/03/85 ↓	15:47:29	947	8A1	Begin internal calibration
	15:48:01	948	897	SWICS on at level 1 modulated
	15:49:37	950	895	SWICS on at level 2 modulated
	15:51:13	951	893	SWICS on at level 3 modulated
	15:52:49	953	891	SWICS off
	15:55:29	955	Pulse	Blackbody calibration heaters on
	15:56:01	956	897	SWICS on at level 1 modulated
	15:57:37	958	895	SWICS on at level 2 modulated
	15:59:13	959	893	SWICS on at level 3 modulated
	16:00:49	961	891	SWICS off
	16:19:29	979	Pulse	Blackbody calibration heaters off
	16:20:01	980	897	SWICS on at level 1 modulated
	16:21:37	982	895	SWICS on at level 2 modulated
	16:23:13	983	893	SWICS on at level 3 modulated
	16:24:49	985	891	SWICS off
End internal calibration sequence				
04/03/85	17:10:09	1030	824	Short scan mode
04/03/85	17:10:41	1031	811	Azimuth to 0°
Begin solar calibration sequence				
04/03/85 ↓	17:15:29	1035	8A2	Begin solar calibration
	17:16:01	1036	824	Short scan mode
	17:16:33	1037	811	Azimuth to 0°
	17:17:05	1037	814	Azimuth to position A
	17:22:57	1043	825	MAM (solar) scan mode
	17:28:17	1048	815	Azimuth to position B
	17:34:41	1055	814	Azimuth to position A
	17:41:05	1061	824	Short scan mode
	17:41:37	1062	813	Azimuth to 180°
17:46:25	1066	822	Normal scan mode	
End solar calibration sequence				

Table 7. Continued

(b) Continued

Date	Universal time		Hex command	Event description
	hr:min:sec	Minutes of day		
Begin azimuth angle load commands for solar calibration				
04/17/85 ↓	05:41:37	342	419	Address azimuth position A
	05:42:41	343	2xx	Data command, high byte
	05:43:45	344	1xx	Data command, low byte
	05:45:21	345	41B	Address azimuth position B
	05:45:53	346	2xx	Data command, high byte
	05:46:57	347	1xx	Data command, low byte
End azimuth angle load commands (A = 94.58°, B = 79.58°).				
Begin internal calibration sequence				
04/17/85 ↓	12:13:05	733	8A1	Begin internal calibration
	12:13:37	734	897	SWICS on at level 1 modulated
	12:15:13	735	895	SWICS on at level 2 modulated
	12:16:49	737	893	SWICS on at level 3 modulated
	12:18:25	738	891	SWICS off
	12:21:05	741	Pulse	Blackbody calibration heaters on
	12:21:37	742	897	SWICS on at level 1 modulated
	12:23:13	743	895	SWICS on at level 2 modulated
	12:24:49	745	893	SWICS on at level 3 modulated
	12:26:25	746	891	SWICS off
	12:45:05	765	Pulse	Blackbody calibration heaters off
	12:45:37	766	897	SWICS on at level 1 modulated
	12:47:13	767	895	SWICS on at level 2 modulated
	12:48:49	769	893	SWICS on at level 3 modulated
12:50:25	770	891	SWICS off	
End internal calibration sequence				
04/17/85	13:35:13	815	824	Short scan mode
04/17/85	13:35:45	816	811	Azimuth to 0°
Begin solar calibration sequence				
04/17/85 ↓	13:41:05	821	8A2	Begin solar calibration
	13:41:37	822	824	Short scan mode
	13:42:09	822	811	Azimuth to 0°
	13:42:41	823	814	Azimuth to position A
	13:48:33	829	825	MAM (solar) scan mode
	13:53:53	834	815	Azimuth to position B
	14:00:17	840	814	Azimuth to position A
	14:06:41	847	824	Short scan mode
	14:07:13	847	813	Azimuth to 180°
14:12:01	852	822	Normal scan mode	
End solar calibration sequence				
04/21/85 ↓	14:57:21	897	821	Scan to stow
	15:06			Yaw maneuver to X-axis positive
	15:36:49	937	822	Normal scan mode

Table 7. Continued

(b) Continued

Date	Universal time		Hex command	Event description
	hr:min:sec	Minutes of day		
Begin azimuth angle load commands for solar calibration				
05/01/85 ↓	03:03:45	184	419	Address azimuth position A
	03:04:17	184	2xx	Data command, high byte
	03:05:21	185	1xx	Data command, low byte
	03:06:25	186	41B	Address azimuth position B
	03:06:57	187	2xx	Data command, high byte
	03:08:01	188	1xx	Data command, low byte
End azimuth angle load commands (A = 68.93°, B = 53.93°).				
Begin internal calibration sequence				
05/01/85 ↓	11:04:49	665	8A1	Begin internal calibration
	11:05:21	665	897	SWICS on at level 1 modulated
	11:06:57	667	895	SWICS on at level 2 modulated
	11:08:33	669	893	SWICS on at level 3 modulated
	11:10:09	670	891	SWICS off
	11:12:49	673	Pulse	Blackbody calibration heaters on
	11:13:21	673	897	SWICS on at level 1 modulated
	11:14:57	675	895	SWICS on at level 2 modulated
	11:16:33	677	893	SWICS on at level 3 modulated
	11:18:09	678	891	SWICS off
	11:36:49	697	Pulse	Blackbody calibration heaters off
	11:37:21	697	897	SWICS on at level 1 modulated
	11:38:57	699	895	SWICS on at level 2 modulated
	11:40:33	701	893	SWICS on at level 3 modulated
11:42:09	702	891	SWICS off	
End internal calibration sequence				
05/01/85	12:26:57	747	824	Short scan mode
05/01/85	12:27:29	747	811	Azimuth to 0°
Begin solar calibration sequence				
05/01/85 ↓	12:32:17	752	8A2	Begin solar calibration
	12:32:49	753	824	Short scan mode
	12:33:21	753	811	Azimuth to 0°
	12:33:53	754	814	Azimuth to position A
	12:39:45	760	825	MAM (solar) scan mode
	12:45:05	765	815	Azimuth to position B
	12:51:29	771	814	Azimuth to position A
	12:57:53	778	824	Short scan mode
	12:58:25	778	813	Azimuth to 180°
	13:03:13	783	822	Normal scan mode
End solar calibration sequence				

Table 7. Continued

(b) Continued

Date	Universal time		Hex command	Event description
	hr:min:sec	Minutes of day		
Begin azimuth angle load commands for solar calibration				
05/08/85 ↓	01:06:57	67	419	Address azimuth position A
	01:07:29	67	2xx	Data command, high byte
	01:08:33	69	1xx	Data command, low byte
	01:09:37	70	41B	Address azimuth position B
	01:10:09	70	2xx	Data command, high byte
	01:11:13	71	1xx	Data command, low byte
End azimuth angle load commands (A = 64.8°, B = 49.8°).				
Begin internal calibration sequence				
05/08/85 ↓	10:56:17	656	8A1	Begin internal calibration
	10:56:49	657	897	SWICS on at level 1 modulated
	10:58:25	658	895	SWICS on at level 2 modulated
	11:00:01	660	893	SWICS on at level 3 modulated
	11:01:37	662	891	SWICS off
	11:04:17	664	Pulse	Blackbody calibration heaters on
	11:04:49	665	897	SWICS on at level 1 modulated
	11:06:25	666	895	SWICS on at level 2 modulated
	11:08:01	668	893	SWICS on at level 3 modulated
	11:09:37	670	891	SWICS off
	11:28:17	688	Pulse	Blackbody calibration heaters off
	11:28:49	689	897	SWICS on at level 1 modulated
	11:30:25	690	895	SWICS on at level 2 modulated
	11:32:01	692	893	SWICS on at level 3 modulated
	11:33:37	694	891	SWICS off
End internal calibration sequence				
05/08/85	12:17:53	738	824	Short scan mode
05/08/85	12:18:25	738	811	Azimuth to 0°
Begin solar calibration sequence				
05/08/85 ↓	12:23:13	743	8A2	Begin solar calibration
	12:23:45	744	824	Short scan mode
	12:24:17	744	811	Azimuth to 0°
	12:24:49	745	814	Azimuth to position A
	12:30:41	751	825	MAM (solar) scan mode
	12:36:01	756	815	Azimuth to position B
	12:42:25	762	814	Azimuth to position A
	12:48:49	769	824	Short scan mode
	12:49:21	769	813	Azimuth to 180°
	12:54:09	774	822	Normal scan mode
End solar calibration sequence				
05/22/85	13:23			Yaw maneuver to X-axis negative

Table 7. Continued

(b) Continued

Date	Universal time		Hex command	Event description
	hr:min:sec	Minutes of day		
Begin azimuth angle load commands				
05/29/85 ↓	00:06:41	7	419	Address azimuth position A
	00:07:13	7	2xx	Data command, high byte
	00:08:17	8	1xx	Data command, low byte
	00:09:21	9	41B	Address azimuth position B
	00:10:25	0	2xx	Data command, high byte
	00:11:29	1	1xx	Data command, low byte
End azimuth angle load commands (A = 75.38°, B = 60.38°).				
Begin internal calibration sequence				
05/29/85 ↓	10:55:13	655	8A1	Begin internal calibration
	10:55:45	656	897	SWICS on at level 1 modulated
	10:57:21	657	895	SWICS on at level 2 modulated
	10:58:57	659	893	SWICS on at level 3 modulated
	11:00:33	661	891	SWICS off
	11:03:13	663	Pulse	Blackbody calibration heaters on
	11:03:45	664	897	SWICS on at level 1 modulated
	11:05:21	665	895	SWICS on at level 2 modulated
	11:06:57	667	893	SWICS on at level 3 modulated
	11:08:33	669	891	SWICS off
	11:27:13	687	Pulse	Blackbody calibration heaters off
	11:27:45	688	897	SWICS on at level 1 modulated
	11:29:21	689	895	SWICS on at level 2 modulated
	11:30:57	691	893	SWICS on at level 3 modulated
	11:32:33	693	891	SWICS off
End internal calibration sequence				
05/29/85	12:17:53	738	824	Short scan mode
05/29/85	12:18:25	738	811	Azimuth to 0°
Begin solar calibration sequence				
05/29/85 ↓	12:23:13	743	8A2	Begin solar calibration
	12:23:45	744	824	Short scan mode
	12:24:17	744	811	Azimuth to 0°
	12:24:49	745	814	Azimuth to position A
	12:30:41	751	825	MAM (solar) scan mode
	12:36:01	756	815	Azimuth to position B
	12:42:25	762	814	Azimuth to position A
	12:48:49	769	824	Short scan mode
	12:49:21	769	813	Azimuth to 180°
	12:54:09	774	822	Normal scan mode
End solar calibration sequence.				
Begin Sun avoidance scan operation				
06/05/85	19:49:05	1189	824	Short scan mode
06/20/85	14:22:09	862	822	Normal scan mode
End Sun avoidance scan operation				

Table 7. Continued

(b) Continued

Date	Universal time		Hex command	Event description
	hr:min:sec	Minutes of day		
Begin azimuth angle load commands for solar calibration				
06/26/85 ↓	01:22:25	82	419	Address azimuth position A
	01:22:57	83	2xx	Data command, high byte
	01:24:01	84	1xx	Data command, low byte
	01:25:05	85	41B	Address azimuth position B
	01:25:37	86	2xx	Data command, high byte
	01:26:41	87	1xx	Data command, low byte
End azimuth angle load commands (A = 76.5°, B = 61.5°).				
Begin internal calibration sequence				
06/26/85 ↓	10:27:29	627	8A1	Begin internal calibration
	10:28:01	628	897	SWICS on at level 1 modulated
	10:29:37	630	895	SWICS on at level 2 modulated
	10:31:13	631	893	SWICS on at level 3 modulated
	10:32:49	633	891	SWICS off
	10:35:29	635	Pulse	Blackbody calibration heaters on
	10:36:01	636	897	SWICS on at level 1 modulated
	10:37:37	638	895	SWICS on at level 2 modulated
	10:39:13	639	893	SWICS on at level 3 modulated
	10:40:49	641	891	SWICS off
	10:59:29	659	Pulse	Blackbody calibration heaters off
	11:00:01	660	897	SWICS on at level 1 modulated
	11:01:37	662	895	SWICS on at level 2 modulated
	11:03:13	663	893	SWICS on at level 3 modulated
11:04:49	665	891	SWICS off	
End internal calibration sequence				
06/26/85	11:49:37	710	824	Short scan mode
06/26/85	11:50:41	711	811	Azimuth to 0°
Begin solar calibration sequence				
06/26/85 ↓	11:55:29	715	8A2	Begin solar calibration
	11:56:01	716	824	Short scan mode
	11:56:33	717	811	Azimuth to 0°
	11:57:05	717	814	Azimuth to position A
	12:02:57	723	825	MAM (solar) scan mode
	12:08:17	728	815	Azimuth to position B
	12:14:41	735	814	Azimuth to position A
	12:21:05	741	824	Short scan mode
	12:21:37	742	813	Azimuth to 180°
	12:26:25	746	822	Normal scan mode
End solar calibration sequence				
07/04/85	15:36			Yaw maneuver to X-axis positive

Table 7. Continued

(b) Continued

Date	Universal time		Hex command	Event description
	hr:min:sec	Minutes of day		
Begin azimuth angle load commands for solar calibration				
07/10/85 ↓	00:40:48	41	419	Address azimuth position A
	00:41:20	41	2xx	Data command, high byte
	00:42:24	42	1xx	Data command, low byte
	00:44:00	44	41B	Address azimuth position B
	00:44:32	45	2xx	Data command, high byte
	00:45:36	46	1xx	Data command, low byte
End azimuth angle load commands (A = 81.23°, B = 66.23°).				
Begin internal calibration sequence				
07/10/85 ↓	10:52:32	653	8A1	Begin internal calibration
	10:53:04	653	897	SWICS on at level 1 modulated
	10:54:40	655	895	SWICS on at level 2 modulated
	10:56:16	656	893	SWICS on at level 3 modulated
	10:57:52	658	891	SWICS off
	11:00:32	661	Pulse	Blackbody calibration heaters on
	11:01:04	661	897	SWICS on at level 1 modulated
	11:02:40	663	895	SWICS on at level 2 modulated
	11:04:16	664	893	SWICS on at level 3 modulated
	11:05:52	666	891	SWICS off
	11:24:32	685	Pulse	Blackbody calibration heaters off
	11:25:04	685	897	SWICS on at level 1 modulated
	11:26:40	687	895	SWICS on at level 2 modulated
	11:28:16	688	893	SWICS on at level 3 modulated
11:29:52	690	891	SWICS off	
End internal calibration sequence				
07/10/85	12:14:40	735	824	Short scan mode
07/10/85	12:15:12	735	811	Azimuth to 0°
Begin solar calibration sequence				
07/10/85 ↓	12:20:00	740	8A2	Begin solar calibration
	12:20:32	741	824	Short scan mode
	12:21:04	741	811	Azimuth to 0°
	12:21:36	742	814	Azimuth to position A
	12:27:28	747	825	MAM (solar) scan mode
	12:32:48	753	815	Azimuth to position B
	12:39:12	759	814	Azimuth to position A
	12:45:36	766	824	Short scan mode
	12:46:08	766	813	Azimuth to 180°
	12:50:56	771	822	Normal scan mode
End solar calibration sequence				

Table 7. Continued

(b) Continued

Date	Universal time		Hex command	Event description
	hr:min:sec	Minutes of day		
Begin azimuth angle load commands for solar calibration				
07/24/85 ↓	05:30:24	330	419	Address azimuth position A
	05:30:56	331	2xx	Data command, high byte
	05:33:04	333	1xx	Data command, low byte
	05:34:08	334	41B	Address azimuth position B
	05:34:40	335	2xx	Data command, high byte
	05:35:44	336	1xx	Data command, low byte
End azimuth angle load commands (A = 74.48°, B = 59.48°).				
Begin internal calibration sequence				
07/24/85 ↓	10:31:12	631	8A1	Begin internal calibration
	10:31:44	632	897	SWICS on at level 1 modulated
	10:33:20	633	895	SWICS on at level 2 modulated
	10:34:56	635	893	SWICS on at level 3 modulated
	10:36:32	637	891	SWICS off
	10:39:12	639	Pulse	Blackbody calibration heaters on
	10:39:44	640	897	SWICS on at level 1 modulated
	10:41:20	641	895	SWICS on at level 2 modulated
	10:42:56	643	893	SWICS on at level 3 modulated
	10:44:32	645	891	SWICS off
	11:03:12	663	Pulse	Blackbody calibration heaters off
	11:03:44	664	897	SWICS on at level 1 modulated
	11:05:20	665	895	SWICS on at level 2 modulated
	11:06:56	667	893	SWICS on at level 3 modulated
11:08:32	669	891	SWICS off	
End internal calibration sequence				
07/24/85	11:53:20	713	824	Short scan mode
07/24/85	11:54:24	714	811	Azimuth to 0°
Begin solar calibration sequence				
07/24/85 ↓	11:59:12	719	8A2	Begin solar calibration
	11:59:44	720	824	Short scan mode
	12:00:16	720	811	Azimuth to 0°
	12:00:48	721	814	Azimuth to position A
	12:06:40	727	825	MAM (solar) scan mode
	12:12:00	732	815	Azimuth to position B
	12:18:24	738	814	Azimuth to position A
	12:24:48	745	824	Short scan mode
	12:25:20	745	813	Azimuth to 180°
	12:30:08	750	822	Normal scan mode
End solar calibration sequence				
08/02/85	13:22			Yaw maneuver to X-axis negative

Table 7. Continued

(b) Continued

Date	Universal time		Hex command	Event description
	hr:min:sec	Minutes of day		
Begin azimuth angle load commands for solar calibration				
08/07/85 ↓	01:34:08	94	419	Address azimuth position A
	01:34:40	95	2xx	Data command, high byte
	01:35:44	96	1xx	Data command, low byte
	01:36:48	97	41B	Address azimuth position B
	01:37:20	97	2xx	Data command, high byte
	01:38:24	98	1xx	Data command, low byte
End azimuth angle load commands (A = 88.13°, B = 73.13°).				
Begin internal calibration sequence				
08/07/85 ↓	12:22:08	742	8A1	Begin internal calibration
	12:22:40	743	897	SWICS on at level 1 modulated
	12:24:16	744	895	SWICS on at level 2 modulated
	12:25:52	746	893	SWICS on at level 3 modulated
	12:27:28	747	891	SWICS off
	12:30:08	750	Pulse	Blackbody calibration heaters on
	12:30:40	751	897	SWICS on at level 1 modulated
	12:32:16	752	895	SWICS on at level 2 modulated
	12:33:52	754	893	SWICS on at level 3 modulated
	12:35:28	755	891	SWICS off
	12:54:08	774	Pulse	Blackbody calibration heaters off
	12:54:40	775	897	SWICS on at level 1 modulated
	12:56:16	776	895	SWICS on at level 2 modulated
	12:57:52	778	893	SWICS on at level 3 modulated
	12:59:28	779	891	SWICS off
End internal calibration sequence				
08/07/85	13:44:16	824	824	Short scan mode
08/07/85	13:44:48	825	811	Azimuth to 0°
Begin solar calibration sequence				
08/07/85 ↓	13:50:08	830	8A2	Begin solar calibration
	13:50:40	831	824	Short scan mode
	13:51:12	831	811	Azimuth to 0°
	13:51:44	832	814	Azimuth to position A
	13:57:36	838	825	MAM (solar) scan mode
	14:02:56	843	815	Azimuth to position B
	14:09:20	849	814	Azimuth to position A
	14:15:44	856	824	Short scan mode
	14:16:16	856	813	Azimuth to 180°
	14:21:04	861	822	Normal scan mode
End solar calibration sequence				

Table 7. Continued

(b) Continued

Date	Universal time		Hex command	Event description
	hr:min:sec	Minutes of day		
Begin along-track scan operation				
08/07/85	16:06:40	967	812	Azimuth to 90°
Resume cross-track scan operation				
08/14/85	12:36:00	756	813	Azimuth to 180°
Begin Sun-avoidance scan operation				
08/19/85	01:26:40	87	824	Short scan mode
08/29/85	14:15:44	856	822	Normal scan mode
End Sun avoidance scan operation.				
Begin azimuth angle load commands for solar calibration				
09/04/85 ↓	06:57:52	418	419	Address azimuth position A
	06:58:56	419	2xx	Data command, high byte
	07:00:00	420	1xx	Data command, low byte
	07:01:04	421	41B	Address azimuth position B
	07:01:36	422	2xx	Data command, high byte
	07:02:40	423	1xx	Data command, low byte
End azimuth angle load commands (A = 72.08°, B = 57.08°).				
Begin internal calibration sequence				
09/04/85 ↓	11:46:56	707	8A1	Begin internal calibration
	11:47:28	707	897	SWICS on at level 1 modulated
	11:49:04	709	895	SWICS on at level 2 modulated
	11:50:40	711	893	SWICS on at level 3 modulated
	11:52:16	712	891	SWICS off
	11:55:28	715	Pulse	Blackbody calibration heaters on
	11:55:28	715	897	SWICS on at level 1 modulated
	11:57:04	717	895	SWICS on at level 2 modulated
	11:58:40	719	893	SWICS on at level 3 modulated
	12:00:16	720	891	SWICS off
	12:19:28	739	Pulse	Blackbody calibration heaters off
	12:19:28	739	897	SWICS on at level 1 modulated
	12:21:04	741	895	SWICS on at level 2 modulated
	12:22:40	743	893	SWICS on at level 3 modulated
12:24:16	744	891	SWICS off	
End internal calibration sequence				
09/04/85	13:09:36	790	824	Short scan mode
09/04/85	13:10:08	790	811	Azimuth to 0°
Begin solar calibration sequence				
09/04/85 ↓	13:14:56	795	8A2	Begin solar calibration
	13:15:28	795	824	Short scan mode
	13:16:00	796	811	Azimuth to 0°
	13:16:32	797	814	Azimuth to position A
	13:22:24	802	825	MAM (solar) scan mode

Table 7. Continued

(b) Continued

Date	Universal time		Hex command	Event description
	hr:min:sec	Minutes of day		
09/04/85 ↓	13:27:44	808	815	Azimuth to position B
	13:34:08	814	814	Azimuth to position A
	13:40:32	821	824	Short scan mode
	13:41:04	821	813	Azimuth to 180°
	13:45:52	826	822	Normal scan mode
End solar calibration sequence				
09/12/85	13:42			Yaw maneuver to X-axis positive
Begin azimuth angle load commands for solar calibration				
09/18/85 ↓	01:09:04	69	419	Address azimuth position A
	01:09:36	70	2xx	Data command, high byte
	01:10:40	71	1xx	Data command, low byte
	01:11:44	72	41B	Address azimuth position B
	01:12:16	72	2xx	Data command, high byte
	01:13:20	73	1xx	Data command, low byte
End azimuth angle load commands (A = 77.78°, B = 62.78°). begin internal calibration sequence				
09/18/85 ↓	10:34:24	634	8A1	Begin internal calibration
	10:34:56	635	897	SWICS on at level 1 modulated
	10:36:32	637	895	SWICS on at level 2 modulated
	10:38:08	638	893	SWICS on at level 3 modulated
	10:39:44	640	891	SWICS off
	10:42:24	642	Pulse	Blackbody calibration heaters on
	10:42:56	643	897	SWICS on at level 1 modulated
	10:44:32	645	895	SWICS on at level 2 modulated
	10:46:08	646	893	SWICS on at level 3 modulated
	10:47:44	648	891	SWICS off
	11:06:24	666	Pulse	Blackbody calibration heaters off
	11:06:56	667	897	SWICS on at level 1 modulated
	11:08:32	669	895	SWICS on at level 2 modulated
	11:10:08	670	893	SWICS on at level 3 modulated
	11:11:44	672	891	SWICS off
End internal calibration sequence				
09/18/85	11:56:32	717	824	Short scan mode
09/18/85	11:57:04	717	811	Azimuth to 0°
Begin solar calibration sequence				
09/18/85 ↓	12:01:52	722	8A2	Begin solar calibration
	12:02:24	722	824	Short scan mode
	12:02:56	723	811	Azimuth to 0°
	12:03:28	723	814	Azimuth to position A
	12:09:20	729	825	MAM (solar) scan mode
	12:14:40	735	815	Azimuth to position B

Table 7. Continued

(b) Continued

Date	Universal time		Hex command	Event description
	hr:min:sec	Minutes of day		
09/18/85 ↓	12:21:04	741	814	Azimuth to position A
	12:27:28	747	824	Short scan mode
	12:28:00	748	813	Azimuth to 180°
	12:32:48	753	822	Normal scan mode
End solar calibration sequence. Begin azimuth angle load commands for solar calibration				
10/02/85 ↓	00:49:20	49	419	Address azimuth position A
	00:49:52	50	2xx	Data command, high byte
	00:50:56	51	1xx	Data command, low byte
	00:52:00	52	41B	Address azimuth position B
	00:52:32	53	2xx	Data command, high byte
	00:53:36	54	1xx	Data command, low byte
End azimuth angle load commands (A = 44.63°, B = 29.63°). Begin internal calibration sequence				
10/02/85 ↓	11:57:36	718	8A1	Begin internal calibration
	11:58:08	718	897	SWICS on at level 1 modulated
	11:59:44	720	895	SWICS on at level 2 modulated
	12:01:20	721	893	SWICS on at level 3 modulated
	12:02:56	723	891	SWICS off
	12:05:36	726	Pulse	Blackbody calibration heaters on
	12:06:08	726	897	SWICS on at level 1 modulated
	12:07:44	728	895	SWICS on at level 2 modulated
	12:09:20	729	893	SWICS on at level 3 modulated
	12:10:56	731	891	SWICS off
	12:29:36	750	Pulse	Blackbody calibration heaters off
	12:30:08	750	897	SWICS on at level 1 modulated
	12:31:44	752	895	SWICS on at level 2 modulated
	12:33:20	753	893	SWICS on at level 3 modulated
	12:34:56	755	891	SWICS off
End internal calibration sequence				
10/02/85	13:19:44	800	824	Short scan mode
10/02/85	13:20:16	800	811	Azimuth to 0°
Begin solar calibration sequence				
10/02/85 ↓	13:25:04	805	8A2	Begin solar calibration
	13:25:36	806	824	Short scan mode
	13:26:08	806	811	Azimuth to 0°
	13:26:40	807	814	Azimuth to position A
	13:32:32	813	825	MAM (solar) scan mode
	13:37:52	818	815	Azimuth to position B
	13:44:16	824	814	Azimuth to position A
	13:50:40	831	824	Short scan mode

Table 7. Continued

(b) Continued

Date	Universal time		Hex command	Event description
	hr:min:sec	Minutes of day		
10/02/85	13:51:12	831	813	Azimuth to 180°
10/02/85	13:56:00	836	822	Normal scan mode
End solar calibration sequence.				
Begin azimuth angle load commands for solar calibration				
10/16/85 ↓	01:25:04	85	419	Address azimuth position A
	01:25:36	86	2xx	Data command, high byte
	01:26:40	87	1xx	Data command, low byte
	01:27:44	88	41B	Address azimuth position B
	01:28:16	88	2xx	Data command, high byte
	01:29:20	89	1xx	Data command, low byte
End azimuth angle load commands (A = 91.58°, B = 76.58°).				
begin internal calibration sequence				
10/16/85 ↓	11:32:32	693	8A1	Begin internal calibration
	11:33:04	693	897	SWICS on at level 1 modulated
	11:34:40	695	895	SWICS on at level 2 modulated
	11:36:16	696	893	SWICS on at level 3 modulated
	11:37:52	698	891	SWICS off
	11:40:32	701	Pulse	Blackbody calibration heaters on
	11:41:04	701	897	SWICS on at level 1 modulated
	11:42:40	703	895	SWICS on at level 2 modulated
	11:44:16	704	893	SWICS on at level 3 modulated
	11:45:52	706	891	SWICS off
	12:04:32	725	Pulse	Blackbody calibration heaters off
	12:05:04	725	897	SWICS on at level 1 modulated
	12:06:40	727	895	SWICS on at level 2 modulated
	12:08:16	728	893	SWICS on at level 3 modulated
	12:09:52	730	891	SWICS off
End internal calibration sequence				
10/16/85	12:54:40	775	824	Short scan mode
10/16/85	12:55:12	775	811	Azimuth to 0°
Begin solar calibration sequence				
10/16/85 ↓	13:00:00	780	8A2	Begin solar calibration
	13:00:32	781	824	Short scan mode
	13:01:04	781	811	Azimuth to 0°
	13:01:36	782	814	Azimuth to position A
	13:07:28	787	825	MAM (solar) scan mode
	13:12:48	793	815	Azimuth to position B
	13:19:12	799	814	Azimuth to position A
	13:25:36	806	824	Short scan mode
	13:26:08	806	813	Azimuth to 180°
	13:30:56	811	822	Normal scan mode
End solar calibration sequence				
10/18/85	14:38			Yaw maneuver to X-axis negative

Table 7. Continued

(b) Continued

Date	Universal time		Hex command	Event description
	hr:min:sec	Minutes of day		
Begin 180° pitch procedure				
10/19/85 ↓	18:05:36	1086	821	Scan to stow
	18:07:12	1087	825	MAM (solar) scan mode
	18:20:32	1101	821	Scan to stow
	18:23:12	1103	825	MAM (solar) scan mode
	19:53			Spacecraft pitch 180°
	21:33:04	1293	822	Normal scan mode
	21:38:24	1298	825	MAM (solar) scan mode
	21:39:28	1299	822	Normal scan mode
	22:55:12	1375	825	MAM (solar) scan mode
	23:40			Spacecraft pitch to 0°
End 180° pitch procedure				
10/20/85 ↓	00:30:08	30	822	Normal scan mode
	00:33:52	34	825	MAM (solar) scan mode
	00:36:00	36	824	Short scan mode
	00:37:36	38	822	Normal scan mode
NOTE: Normal scan command failed until about 02:30				
11/21/85	15:02			Yaw maneuver to X-axis positive
Begin azimuth angle load commands for solar calibration				
12/04/85 ↓	17:49:04	1069	419	Address azimuth position A
	17:49:36	1070	2xx	Data command, high byte
	17:50:40	1071	1xx	Data command, low byte
	17:51:44	1072	41B	Address azimuth position B
	17:52:16	1072	2xx	Data command, high byte
	17:53:20	1073	1xx	Data command, low byte
End azimuth angle load commands (A = 179.03°, B = 144.98°).				
Begin Sun-avoidance operation				
12/05/85	20:15:12	1215	815	Azimuth to position B (145°)
Begin internal calibration sequence				
12/18/85 ↓	10:05:36	606	8A1	Begin internal calibration
	10:06:08	606	897	SWICS on at level 1 modulated
	10:07:44	608	895	SWICS on at level 2 modulated
	10:09:20	609	893	SWICS on at level 3 modulated
	10:10:56	611	891	SWICS off
	10:13:36	614	Pulse	Blackbody calibration heaters on
	10:14:08	614	897	SWICS on at level 1 modulated
	10:15:44	616	895	SWICS on at level 2 modulated
	10:17:20	617	893	SWICS on at level 3 modulated
	10:18:56	619	891	SWICS off
	10:37:36	638	Pulse	Blackbody calibration heaters off
	10:38:08	638	897	SWICS on at level 1 modulated
	10:39:44	640	895	SWICS on at level 2 modulated
	10:41:20	641	893	SWICS on at level 3 modulated
	10:42:56	643	891	SWICS off
	End internal calibration sequence			

Table 7. Continued

(b) Continued

Date	Universal time		Hex command	Event description
	hr:min:sec	Minutes of day		
12/18/85	13:40:32	821	813	Azimuth to 180°
End Sun-avoidance operation. Begin internal calibration sequence				
12/25/85 ↓	11:20:16	680	8A1	Begin internal calibration
	11:20:48	681	897	SWICS on at level 1 modulated
	11:22:24	682	895	SWICS on at level 2 modulated
	11:24:00	684	893	SWICS on at level 3 modulated
	11:25:36	686	891	SWICS off
	11:28:16	688	Pulse	Blackbody calibration heaters on
	11:28:48	689	897	SWICS on at level 1 modulated
	11:30:24	690	895	SWICS on at level 2 modulated
	11:32:00	692	893	SWICS on at level 3 modulated
	11:33:36	694	891	SWICS off
	11:52:36	712	Pulse	Blackbody calibration heaters off
	11:52:48	713	897	SWICS on at level 1 modulated
	11:54:24	714	895	SWICS on at level 2 modulated
	11:56:00	716	893	SWICS on at level 3 modulated
11:57:36	718	891	SWICS off	
End internal calibration sequence				
12/31/85	15:14			Yaw maneuver to X-axis negative
Begin internal calibration sequence				
01/08/86 ↓	09:58:08	598	8A1	Begin internal calibration
	09:58:40	600	897	SWICS on at level 1 modulated
	10:00:16	600	895	SWICS on at level 2 modulated
	10:01:52	602	893	SWICS on at level 3 modulated
	10:03:28	603	891	SWICS off
	10:06:08	606	Pulse	Blackbody calibration heaters on
	10:06:40	607	897	SWICS on at level 1 modulated
	10:08:16	608	895	SWICS on at level 2 modulated
	10:09:52	610	893	SWICS on at level 3 modulated
	10:11:28	611	891	SWICS off
	10:30:08	630	Pulse	Blackbody calibration heaters off
	10:30:40	631	897	SWICS on at level 1 modulated
	10:32:16	632	895	SWICS on at level 2 modulated
	10:33:52	634	893	SWICS on at level 3 modulated
10:35:28	635	891	SWICS off	
End internal calibration sequence. Begin internal calibration sequence				
01/22/86 ↓	11:13:20	673	8A1	Begin internal calibration
	11:13:52	674	897	SWICS on at level 1 modulated
	11:15:28	675	895	SWICS on at level 2 modulated
	11:17:04	677	893	SWICS on at level 3 modulated
	11:18:40	679	891	SWICS off

Table 7. Concluded

(b) Concluded

Date	Universal time		Hex command	Event description
	hr:min:sec	Minutes of day		
01/22/86 ↓	11:21:20	681	Pulse	Blackbody calibration heaters on
	11:21:52	682	897	SWICS on at level 1 modulated
	11:23:28	683	895	SWICS on at level 2 modulated
	11:25:04	685	893	SWICS on at level 3 modulated
	11:26:40	687	891	SWICS off
	11:45:20	705	Pulse	Blackbody calibration heaters off
	11:45:52	706	897	SWICS on at level 1 modulated
	11:47:28	707	895	SWICS on at level 2 modulated
	11:49:04	709	893	SWICS on at level 3 modulated
	11:50:40	711	891	SWICS off
End internal calibration sequence				
01/31/86	15:01			Yaw maneuver to X-axis positive

Table 8. List of Operational Commands Executed by
Instruments on NOAA 9 Spacecraft

(a) Nonscanner commands

Date	Universal time		Hex command	Event description
	hr:min:sec	Minutes of day		
Data dropout - missed two commands				
02/02/85	12:58:12	778	872	MFOV blackbody heater on at temp. 1
02/02/85	13:11:32	792	823	Elevate to nadir (Earth)
Begin internal calibration sequence				
02/02/85 ↓	13:12:04	792	8A1	Begin internal calibration
	13:12:36	793	881	Detector bias heater off
	13:13:08	793	852	Solar port heaters off
	13:13:40	794	821	Elevate to internal source (stow)
	13:14:12	794	851	Solar port heaters on
	13:16:20	796	882	Detector bias heater on at level 1
	13:18:28	798	892	SWICS on at level 3
	13:21:40	802	881	Detector bias heater off
	13:25:24	805	862	WFOV blackbody heater on at temp. 1
	13:25:56	806	872	MFOV blackbody heater on at temp. 1
	13:27:00	807	891	SWICS off
	13:40:20	820	883	Detector bias heater on at level 2
	13:42:28	822	893	SWICS on at level 2
	13:45:40	826	881	Detector bias heater off
	13:49:24	829	863	WFOV blackbody heater on at temp. 2
	13:49:56	830	873	MFOV blackbody heater on at temp. 2
	13:51:00	831	891	SWICS off
	14:04:20	844	884	Detector bias heater on at level 3
	14:06:28	846	894	SWICS on at level 1
	14:08:36	849	881	Detector bias heater off
	14:11:16	851	852	Solar port heaters off
	14:12:20	852	861	WFOV blackbody heater off
	14:12:52	853	871	MFOV blackbody heater off
	14:13:24	853	851	Solar port heaters on
14:13:56	854	891	SWICS off	
End internal calibration sequence.				
Begin azimuth angle load commands for solar calibration				
02/02/85 ↓	14:16:36	857	419	Address azimuth position A
	14:17:08	857	2xx	Data command, high byte
	14:17:40	858	1xx	Data command, low byte
End azimuth angle load commands (A = 123.75°).				
Begin solar calibration sequence				
02/02/85 ↓	14:18:12	858	8A2	Begin solar calibration
	14:18:44	859	852	Solar port heaters off
	14:19:16	859	822	Elevate to solar ports (Sun)
	14:19:48	860	814	Azimuth to position A

Table 8. Continued

(a) Continued

Date	Universal time		Hex command	Event description
	hr:min:sec	Minutes of day		
02/02/85 ↓	14:20:20	860	882	Detector bias heater on at level 1
	14:29:56	870	851	Solar port heaters on
	14:30:28	870	831	SMA shutter cycle on
	15:01:24	901	832	SMA shutter cycle off
	15:01:56	902	852	Solar port heaters off
	15:02:28	902	813	Azimuth to 180°
	15:03:00	903	881	Detector bias heater off
	15:12:36	913	823	Elevate to nadir (Earth)
	15:13:08	913	851	Solar port heaters on
End solar calibration sequence. Begin azimuth angle load commands for 170°				
02/02/85 ↓	15:18:28	918	419	Address azimuth position A
	15:19:00	919	2xx	Data command, high byte
	15:19:32	920	1xx	Data command, low byte
End azimuth angle load commands (A = 170.0°)				
02/02/85	15:20:04	920	814	Azimuth to position A
02/06/85 ↓	10:45:56	646	821	Elevate to internal source (stow)
	10:46:28	646	862	WFOV blackbody heater on at temp. 1
	11:01:56	662	872	MFOV blackbody heater on at temp. 1
	12:28:52	749	823	Elevate to nadir (Earth)
Begin internal calibration sequence				
02/06/85 ↓	12:29:24	749	8A1	Begin internal calibration
	12:29:56	750	881	Detector bias heater off
	12:30:28	750	852	Solar port heaters off
	12:31:00	751	821	Elevate to internal source (stow)
	12:31:32	752	851	Solar port heaters on
	12:33:40	754	882	Detector bias heater on at level 1
	12:35:48	756	892	SWICS on at level 3
	12:39:00	759	881	Detector bias heater off
	12:42:44	763	862	WFOV blackbody heater on at temp. 1
	12:43:16	763	872	MFOV blackbody heater on at temp. 1
	12:44:20	764	891	SWICS off
	12:57:40	778	883	Detector bias heater on at level 2
	12:59:48	780	893	SWICS on at level 2
	13:03:00	783	881	Detector bias heater off
	13:06:44	787	863	WFOV blackbody heater on at temp. 2
	13:07:16	787	873	MFOV blackbody heater on at temp. 2
	13:08:20	788	891	SWICS off
	13:21:40	802	884	Detector bias heater on at level 3
13:23:48	804	894	SWICS on at level 1	
13:25:56	806	881	Detector bias heater off	

Table 8. Continued

(a) Continued

Date	Universal time		Hex command	Event description
	hr:min:sec	Minutes of day		
02/06/85 ↓	13:28:36	809	852	Solar port heaters off
	13:29:40	810	861	WFOV blackbody heater off
	13:30:12	810	871	MFOV blackbody heater off
	13:30:44	811	851	Solar port heaters on
	13:31:16	811	891	SWICS off
End internal calibration sequence. Begin azimuth angle load commands				
02/06/85 ↓	13:33:56	814	419	Address azimuth position A
	13:34:28	814	2xx	Data command, high byte
	13:35:00	815	1xx	Data command, low byte
End azimuth angle load commands (A = 123.68°). Begin solar calibration sequence for solar calibration				
02/06/85 ↓	13:35:32	816	8A2	Begin solar calibration
	13:36:04	816	852	Solar port heaters off
	13:36:36	817	822	Elevate to solar ports (Sun)
	13:37:08	817	814	Azimuth to position A
	13:37:40	818	882	Detector bias heater on at level 1
	13:47:16	827	851	Solar port heaters on
	13:47:48	828	831	SMA shutter cycle on
	14:18:44	859	832	SMA shutter cycle off
	14:19:16	859	852	Solar port heaters off
	14:19:48	860	813	Azimuth to 180°
	14:20:20	860	881	Detector bias heater off
	14:29:56	870	823	Elevate to nadir (Earth)
	14:30:28	870	851	Solar port heaters on
	End solar calibration sequence. Begin azimuth angle load commands for 170°			
02/06/85 ↓	14:35:48	876	419	Address azimuth position A
	14:36:20	876	2xx	Data command, high byte
	14:36:52	877	1xx	Data command, low byte
End azimuth angle load commands (A = 170.0°)				
02/06/85	14:37:24	877	814	Azimuth to position A
Data dropout - missed one command				
02/13/85 ↓	11:15:16	675	862	WFOV blackbody heater on at temp. 1
	11:29:08	689	872	MFOV blackbody heater on at temp. 1
	12:56:04	776	823	Elevate to nadir (Earth)
Begin internal calibration sequence				
02/13/85 ↓	12:56:36	777	8A1	Begin internal calibration
	12:57:08	777	881	Detector bias heater off
	12:57:40	778	852	Solar port heaters off
	12:58:12	778	821	Elevate to internal source (stow)
	12:58:44	779	851	Solar port heaters on
	13:00:52	781	882	Detector bias heater on at level 1

Table 8. Continued

(a) Continued

Date	Universal time		Hex command	Event description
	hr:min:sec	Minutes of day		
02/13/85 ↓	13:03:00	783	892	SWICS on at level 3
	13:06:12	786	881	Detector bias heater off
	13:09:56	790	862	WFOV blackbody heater on at temp. 1
	13:10:28	790	872	MFOV blackbody heater on at temp. 1
	13:11:32	792	891	SWICS off
	13:24:52	805	883	Detector bias heater on at level 2
	13:27:00	807	893	SWICS on at level 2
	13:30:12	810	881	Detector bias heater off
	13:33:56	814	863	WFOV blackbody heater on at temp. 2
	13:34:28	814	873	MFOV blackbody heater on at temp. 2
	13:35:32	816	891	SWICS off
	13:48:52	829	884	Detector bias heater on at level 3
	13:51:00	831	894	SWICS on at level 1
	13:53:08	833	881	Detector bias heater off
	13:55:48	836	852	Solar port heaters off
	13:56:52	837	861	WFOV blackbody heater off
	13:57:24	837	871	MFOV blackbody heater off
	13:57:56	838	851	Solar port heaters on
	13:58:28	838	891	SWICS off
End internal calibration sequence.				
Begin azimuth angle load commands for solar calibration				
02/13/85 ↓	14:01:08	841	419	Address azimuth position A
	14:01:40	842	2xx	Data command, high byte
	14:02:12	842	1xx	Data command, low byte
End azimuth angle load commands (A = 123.68°).				
Begin solar calibration sequence				
02/13/85 ↓	14:02:44	843	8A2	Begin solar calibration
	14:03:16	843	852	Solar port heaters off
	14:03:48	844	822	Elevate to solar ports (Sun)
	14:04:20	844	814	Azimuth to position A
	14:04:52	845	882	Detector bias heater on at level 1
	14:14:28	854	851	Solar port heaters on
	14:15:00	855	831	SMA shutter cycle on
	14:45:56	886	832	SMA shutter cycle off
	14:46:28	886	852	Solar port heaters off
	14:47:00	887	813	Azimuth to 180°
	14:47:32	888	881	Detector bias heater off
	14:57:08	897	823	Elevate to nadir (Earth)
	14:57:40	898	851	Solar port heaters on
	End solar calibration sequence.			
Begin azimuth angle load commands for 170°				
02/13/85 ↓	15:03:00	903	419	Address azimuth position A
	15:03:32	904	2xx	Data command, high byte
	15:04:04	904	1xx	Data command, low byte
End azimuth angle load commands (A = 170.0°)				

Table 8. Continued

(a) Continued

Date	Universal time		Hex command	Event description
	hr:min:sec	Minutes of day		
02/13/85	15:04:36	905	814	Azimuth to position A
02/20/85 ↓	09:58:28	598	821	Elevate to internal source (stow)
	09:59:00	599	862	WFOV blackbody heater on at temp. 1
	10:14:28	614	872	MFOV blackbody heater on at temp. 1
	11:41:24	701	823	Elevate to nadir (Earth)
Begin internal calibration sequence				
02/20/85 ↓	11:41:56	702	8A1	Begin internal calibration
	11:42:28	702	881	Detector bias heater off
	11:43:00	703	852	Solar port heaters off
	11:43:32	704	821	Elevate to internal source (stow)
	11:44:04	704	851	Solar port heaters on
	11:46:12	706	882	Detector bias heater on at level 1
	11:48:20	708	892	SWICS on at level 3
	11:51:32	712	881	Detector bias heater off
	11:55:16	715	862	WFOV blackbody heater on at temp. 1
	11:55:48	716	872	MFOV blackbody heater on at temp. 1
	11:56:52	717	891	SWICS off
	12:10:12	730	883	Detector bias heater on at level 2
	12:12:20	732	893	SWICS on at level 2
	12:15:32	736	881	Detector bias heater off
	12:19:16	739	863	WFOV blackbody heater on at temp. 2
	12:19:48	740	873	MFOV blackbody heater on at temp. 2
12:20:52	741	891	SWICS off	
Data dropout - missed one command				
02/20/85 ↓	12:37:40	758	894	SWICS on at level 1
	12:38:28	758	881	Detector bias heater off
	12:41:08	761	852	Solar port heaters off
	12:42:12	762	861	WFOV blackbody heater off
	12:42:44	763	871	MFOV blackbody heater off
	12:43:16	763	851	Solar port heaters on
	12:43:48	764	891	SWICS off
End internal calibration sequence.				
Begin azimuth angle load commands for solar calibration				
02/20/85 ↓	12:46:28	766	419	Address azimuth position A
	12:47:00	767	2xx	Data command, high byte
	12:47:32	768	1xx	Data command, low byte
End azimuth angle load commands (A = 123.68°)				
02/20/85 ↓	12:48:04	768	8A2	Begin solar calibration
	12:48:36	769	852	Solar port heaters off
	12:49:08	769	822	Elevate to solar ports (Sun)
	12:49:40	770	814	Azimuth to position A

Table 8. Continued

(a) Continued

Date	Universal time		Hex command	Event description
	hr:min:sec	Minutes of day		
02/20/85 ↓	12:50:12	770	882	Detector bias heater on at level 1
	12:59:48	780	851	Solar port heaters on
	13:00:20	780	831	SMA shutter cycle on
	13:31:16	811	832	SMA shutter cycle off
	13:31:48	812	852	Solar port heaters off
	13:32:20	812	813	Azimuth to 180°
	13:32:52	813	881	Detector bias heater off
	13:42:28	822	823	Elevate to nadir (Earth)
	13:43:00	823	851	Solar port heaters on
Begin azimuth angle load commands for 170°				
02/20/85 ↓	13:48:20	828	419	Address azimuth position A
	13:48:52	829	2xx	Data command, high byte
	13:49:24	829	1xx	Data command, low byte
End azimuth angle load commands (A = 170.0°)				
02/20/85	13:49:56	830	814	Azimuth to position A
03/06/85 ↓	09:11:00	551	821	Elevate to internal source (stow)
	09:11:32	552	862	WFOV blackbody heater on at temp. 1
	09:27:00	567	872	MFOV blackbody heater on at temp. 1
	10:53:56	654	823	Elevate to nadir (Earth)
Begin internal calibration sequence				
03/06/85 ↓	10:54:28	654	8A1	Begin internal calibration
	10:55:00	655	881	Detector bias heater off
	10:55:32	656	852	Solar port heaters off
	10:56:04	656	821	Elevate to internal source (stow)
	10:56:36	657	851	Solar port heaters on
	10:58:44	659	882	Detector bias heater on at level 1
	11:00:52	661	892	SWICS on at level 3
	11:04:04	664	881	Detector bias heater off
	11:07:48	668	862	WFOV blackbody heater on at temp. 1
	11:08:20	668	872	MFOV blackbody heater on at temp. 1
	11:09:24	669	891	SWICS off
	11:22:44	683	883	Detector bias heater on at level 2
	11:24:52	683	893	SWICS on at level 2
	11:28:04	688	881	Detector bias heater off
	11:31:48	692	863	WFOV blackbody heater on at temp. 2
	11:32:20	692	873	MFOV blackbody heater on at temp. 2
	11:33:24	693	891	SWICS off
	11:46:44	707	884	Detector bias heater on at level 3
	11:48:52	709	894	SWICS on at level 1
		11:51:00	711	881

Table 8. Continued

(a) Continued

Date	Universal time		Hex command	Event description
	hr:min:sec	Minutes of day		
03/06/85 ↓	11:53:40	714	852	Solar port heaters off
	11:54:44	715	861	WFOV blackbody heater off
	11:55:16	715	871	MFOV blackbody heater off
	11:55:48	716	851	Solar port heaters on
	11:56:20	716	891	SWICS off
End internal calibration sequence.				
Begin azimuth angle load commands for solar calibration				
03/06/85 ↓	11:59:00	719	419	Address azimuth position A
	11:59:32	720	2xx	Data command, high byte
	12:00:04	720	1xx	Data command, low byte
End azimuth angle load commands ($A = 123.98^\circ$).				
Begin solar calibration sequence				
03/06/85 ↓	12:00:36	721	8A2	Begin solar calibration
	12:01:08	721	852	Solar port heaters off
	12:01:40	722	822	Elevate to solar ports (Sun)
	12:02:12	722	814	Azimuth to position A
	12:02:44	723	882	Detector bias heater on at level 1
	12:12:20	732	851	Solar port heaters on
	12:12:52	733	831	SMA shutter cycle on
	12:43:48	764	832	SMA shutter cycle off
	12:44:20	764	852	Solar port heaters off
	12:44:52	765	813	Azimuth to 180°
	12:45:24	765	881	Detector bias heater off
	12:55:00	775	823	Elevate to nadir (Earth)
	12:55:32	776	851	Solar port heaters on
End solar calibration sequence.				
Begin azimuth angle load commands for 170°				
03/06/85 ↓	13:00:52	781	419	Address azimuth position A
	13:01:24	781	2xx	Data command, high byte
	13:01:56	782	1xx	Data command, low byte
End azimuth angle load commands ($A = 170.0^\circ$)				
03/06/85	13:02:28	782	814	Azimuth to position A
03/20/85 ↓	10:05:56	606	821	Elevate to internal source (stow)
	10:06:28	606	862	WFOV blackbody heater on at temp. 1
	10:21:56	622	872	MFOV blackbody heater on at temp. 1
	11:48:52	709	823	Elevate to nadir (Earth)
Begin internal calibration sequence				
03/20/85 ↓	11:49:24	709	8A1	Begin internal calibration
	11:49:56	710	881	Detector bias heater off
	11:50:28	710	852	Solar port heaters off
	11:51:00	711	821	Elevate to internal source (stow)
	11:51:32	712	851	Solar port heaters on
	11:53:40	714	882	Detector bias heater on at level 1

Table 8. Continued

(a) Continued

Date	Universal time		Hex command	Event description
	hr:min:sec	Minutes of day		
Begin solar calibration sequence				
03/20/85 ↓	11:55:48	716	892	SWICS on at level 3
	11:59:00	719	881	Detector bias heater off
	12:02:44	723	862	WFOV blackbody heater on at temp. 1
	12:03:16	723	872	MFOV blackbody heater on at temp. 1
	12:04:20	724	891	SWICS off
	12:17:40	738	883	Detector bias heater on at level 2
	12:19:48	740	893	SWICS on at level 2
	12:23:00	743	881	Detector bias heater off
	12:26:44	747	863	WFOV blackbody heater on at temp. 2
	12:27:16	747	873	MFOV blackbody heater on at temp. 2
	12:28:20	748	891	SWICS off
	12:41:40	762	884	Detector bias heater on at level 3
	12:43:48	764	894	SWICS on at level 1
	12:45:56	766	881	Detector bias heater off
	12:48:36	769	852	Solar port heaters off
	12:49:40	770	861	WFOV blackbody heater off
	12:50:12	770	871	MFOV blackbody heater off
	12:50:44	771	851	Solar port heaters on
12:51:16	771	891	SWICS off	
End internal calibration sequence.				
Begin azimuth angle load commands for solar calibration				
03/20/85 ↓	12:53:56	774	419	Address azimuth position A
	12:54:28	774	2xx	Data command, high byte
	12:55:00	775	1xx	Data command, low byte
End azimuth angle load commands (A = 124.2°).				
Begin solar calibration sequence				
03/20/85 ↓	12:55:32	776	8A2	Begin solar calibration
	12:56:04	776	852	Solar port heaters off
	12:56:36	777	822	Elevate to solar ports (Sun)
	12:57:08	777	814	Azimuth to position A
	12:57:40	778	882	Detector bias heater on at level 1
	13:07:16	787	851	Solar port heaters on
	13:07:48	788	831	SMA shutter cycle on
	13:38:44	819	832	SMA shutter cycle off
	13:39:16	819	852	Solar port heaters off
	13:39:48	820	813	Azimuth to 180°
	13:40:20	820	881	Detector bias heater off
	13:49:56	830	823	Elevate to nadir (Earth)
	13:50:28	830	851	Solar port heaters on
End solar calibration sequence.				
Begin azimuth angle load commands for 170°				
03/20/85 ↓	13:55:48	836	419	Address azimuth position A
	13:56:20	836	2xx	Data command, high byte
	13:56:52	837	1xx	Data command, low byte
End azimuth angle load commands (A = 170.0°)				

Table 8. Continued

(a) Continued

Date	Universal time		Hex command	Event description
	hr:min:sec	Minutes of day		
03/20/85	13:57:24	837	814	Azimuth to position A
04/03/85 ↓	14:25:08	865	821	Elevate to internal source (stow)
	14:25:40	866	862	WFOV blackbody heater on at temp. 1
	14:41:08	881	872	MFOV blackbody heater on at temp. 1
	16:08:04	968	823	Elevate to nadir (Earth)
Begin internal calibration sequence				
04/03/85 ↓	16:08:36	969	8A1	Begin internal calibration
	16:09:08	969	881	Detector bias heater off
	16:09:40	970	852	Solar port heaters off
	16:10:12	970	821	Elevate to internal source (stow)
	16:10:44	971	851	Solar port heaters on
	16:12:52	973	882	Detector bias heater on at level 1
	16:15:00	975	892	SWICS on at level 3
	16:18:12	978	881	Detector bias heater off
	16:21:56	982	862	WFOV blackbody heater on at temp. 1
	16:22:28	982	872	MFOV blackbody heater on at temp. 1
	16:23:32	984	891	SWICS off
	16:36:52	997	883	Detector bias heater on at level 2
	16:39:00	999	893	SWICS on at level 2
	16:42:12	1002	881	Detector bias heater off
	16:45:56	1006	863	WFOV blackbody heater on at temp. 2
	16:46:28	1006	873	MFOV blackbody heater on at temp. 2
	16:47:32	1008	891	SWICS off
	17:00:52	1021	884	Detector bias heater on at level 3
	17:03:00	1023	894	SWICS on at level 1
	17:05:08	1025	881	Detector bias heater off
	17:07:48	1028	852	Solar port heaters off
17:08:52	1029	861	WFOV blackbody heater off	
17:09:24	1029	871	MFOV blackbody heater off	
17:09:56	1030	851	Solar port heaters on	
17:10:28	1030	891	SWICS off	
End internal calibration sequence.				
Begin azimuth angle load commands for solar calibration				
04/03/85 ↓	17:13:08	1033	419	Address azimuth position A
	17:13:40	1034	2xx	Data command, high byte
	17:14:12	1034	1xx	Data command, low byte
End azimuth angle load commands (A = 124.13°).				
Begin solar calibration sequence				
04/03/85 ↓	17:14:44	1035	8A2	Begin solar calibration
	17:15:16	1035	852	Solar port heaters off
	17:15:48	1036	822	Elevate to solar ports (Sun)
	17:16:20	1036	814	Azimuth to position A
↓	17:16:52	1037	882	Detector bias heater on at level 1

Table 8. Continued

(a) Continued

Date	Universal time		Hex command	Event description
	hr:min:sec	Minutes of day		
04/03/85 ↓	17:26:28	1046	851	Solar port heaters on
	17:27:00	1047	831	SMA shutter cycle on
	17:57:56	1078	832	SMA shutter cycle off
	17:58:28	1078	852	Solar port heaters off
	17:59:00	1079	813	Azimuth to 180°
	17:59:32	1080	881	Detector bias heater off
	18:09:08	1089	823	Elevate to nadir (Earth)
	18:09:40	1090	851	Solar port heaters on
End solar calibration sequence. Begin azimuth angle load commands for 170°				
04/03/85 ↓	18:15:00	1095	419	Address azimuth position A
	18:15:32	1096	2xx	Data command, high byte
	18:16:04	1096	1xx	Data command, low byte
End azimuth angle load commands (A = 170.0°)				
04/03/85	18:16:36	1097	814	Azimuth to position A
04/17/85 ↓	10:13:24	613	821	Elevate to internal source (stow)
	10:13:56	614	862	WFOV blackbody heater on at temp. 1
	10:29:24	629	872	MFOV blackbody heater on at temp. 1
	11:56:20	716	823	Elevate to nadir (Earth)
Begin internal calibration sequence				
04/17/85 ↓	11:56:52	717	8A1	Begin internal calibration
	11:57:24	717	881	Detector bias heater off
	11:57:56	718	852	Solar port heaters off
	11:58:28	718	821	Elevate to internal source (stow)
	11:59:00	719	851	Solar port heaters on
	12:01:08	721	882	Detector bias heater on at level 1
	12:03:16	723	892	SWICS on at level 3
	12:06:28	726	881	Detector bias heater off
	12:10:12	730	862	WFOV blackbody heater on at temp. 1
	12:10:44	731	872	MFOV blackbody heater on at temp. 1
	12:11:48	732	891	SWICS off
	12:25:08	745	883	Detector bias heater on at level 2
	12:27:16	747	893	SWICS on at level 2
	12:30:28	750	881	Detector bias heater off
	12:34:12	754	863	WFOV blackbody heater on at temp. 2
	12:34:44	755	873	MFOV blackbody heater on at temp. 2
	12:35:48	756	891	SWICS off
	12:49:08	769	884	Detector bias heater on at level 3
	12:51:16	771	894	SWICS on at level 1
	12:53:24	773	881	Detector bias heater off
	12:56:04	776	852	Solar port heaters off
	12:57:08	777	861	WFOV blackbody heater off
	12:57:40	778	871	MFOV blackbody heater off

Table 8. Continued

(a) Continued

Date	Universal time		Hex command	Event description
	hr:min:sec	Minutes of day		
04/17/85	12:58:12	778	851	Solar port heaters on
04/17/85	12:58:44	779	891	SWICS off
End internal calibration sequence.				
Begin azimuth angle load commands for solar calibration				
04/17/85	13:01:24	781	419	Address azimuth position A
↓	13:01:56	782	2xx	Data command, high byte
	13:02:28	782	1xx	Data command, low byte
End azimuth angle load commands (A = 123.75°).				
Begin solar calibration sequence				
04/17/85	13:03:00	783	8A2	Begin solar calibration
↓	13:03:32	784	852	Solar port heaters off
	13:04:04	784	822	Elevate to solar ports (Sun)
	13:04:36	785	814	Azimuth to position A
	13:05:08	785	882	Detector bias heater on at level 1
	13:14:44	795	851	Solar port heaters on
	13:15:16	795	831	SMA shutter cycle on
	13:46:12	826	832	SMA shutter cycle off
	13:46:44	827	852	Solar port heaters off
	13:47:16	827	813	Azimuth to 180°
	13:47:48	828	881	Detector bias heater off
	13:57:24	837	823	Elevate to nadir (Earth)
	13:57:56	838	851	Solar port heaters on
End solar calibration sequence.				
Begin azimuth angle load commands for 170°				
04/17/85	14:03:16	843	419	Address azimuth position A
↓	14:03:48	844	2xx	Data command, high byte
	14:04:20	844	1xx	Data command, low byte
End azimuth angle load commands (A = 170.0°)				
04/17/85	14:04:52	845	814	Azimuth to position A
Begin internal calibration sequence.				
Data dropout				
05/08/85	09:53:08	593	821	Elevate to internal source (stow)
↓	09:53:40	594	862	WFOV blackbody heater on at temp. 1
	10:09:08	609	872	MFOV blackbody heater on at temp. 1
Data dropout - missed five commands				
05/08/85	11:38:44	699	851	Solar port heaters on
↓	11:40:52	701	882	Detector bias heater on at level 1
	11:43:00	703	892	SWICS on at level 3
	11:46:12	706	881	Detector bias heater off
	11:49:56	710	862	WFOV blackbody heater on at temp. 1
	11:50:28	710	872	MFOV blackbody heater on at temp. 1
	11:51:32	712	891	SWICS off
	12:04:52	725	883	Detector bias heater on at level 2

Table 8. Continued

(a) Continued

Date	Universal time		Hex command	Event description
	hr:min:sec	Minutes of day		
05/08/85 ↓	12:07:00	727	893	SWICS on at level 2
	12:10:12	730	881	Detector bias heater off
	12:13:56	734	863	WFOV blackbody heater on at temp. 2
	12:14:28	734	873	MFOV blackbody heater on at temp. 2
	12:15:32	736	891	SWICS off
	12:28:52	749	884	Detector bias heater on at level 3
	12:31:00	751	894	SWICS on at level 1
	12:33:08	753	881	Detector bias heater off
	12:35:48	756	852	Solar port heaters off
	12:36:52	757	861	WFOV blackbody heater off
	12:37:24	757	871	MFOV blackbody heater off
	12:37:56	758	851	Solar port heaters on
12:38:28	758	891	SWICS off	
End internal calibration sequence. Begin azimuth angle load commands for solar calibration				
05/08/85 ↓	12:41:08	761	419	Address azimuth position A
	12:41:40	762	2xx	Data command, high byte
	12:42:12	762	1xx	Data command, low byte
End azimuth angle load commands (A = 122.33°). Begin solar calibration sequence				
05/08/85 ↓	12:42:44	763	8A2	Begin solar calibration
	12:43:16	763	852	Solar port heaters off
	12:43:48	764	822	Elevate to solar ports (Sun)
	12:44:20	764	814	Azimuth to position A
	12:44:52	765	882	Detector bias heater on at level 1
	12:54:28	774	851	Solar port heaters on
	12:55:00	775	831	SMA shutter cycle on
	13:25:56	806	832	SMA shutter cycle off
	13:26:28	806	852	Solar port heaters off
	13:27:00	807	813	Azimuth to 180°
	13:27:32	808	881	Detector bias heater off
	13:37:08	817	823	Elevate to nadir (Earth)
13:37:40	818	851	Solar port heaters on	
End solar calibration sequence. Begin azimuth angle load commands for 170°				
05/08/85 ↓	13:43:00	823	419	Address azimuth position A
	13:43:32	824	2xx	Data command, high byte
	13:44:04	824	1xx	Data command, low byte
End azimuth angle load commands (A = 170.0°)				
05/08/85	13:44:36	825	814	Azimuth to position A
05/29/85 ↓	09:31:16	571	821	Elevate to internal source (stow)
	09:31:48	572	862	WFOV blackbody heater on at temp. 1
	09:47:16	587	872	MFOV blackbody heater on at temp. 1
	11:14:12	674	823	Elevate to nadir (Earth)

Table 8. Continued

(a) Continued

Date	Universal time		Hex command	Event description
	hr:min:sec	Minutes of day		
Begin internal calibration sequence				
05/29/85 ↓	11:14:44	675	8A1	Begin internal calibration
	11:15:16	675	881	Detector bias heater off
	11:15:48	676	852	Solar port heaters off
	11:16:20	676	821	Elevate to internal source (stow)
	11:16:52	677	851	Solar port heaters on
	11:19:00	679	882	Detector bias heater on at level 1
	11:21:08	681	892	SWICS on at level 3
	11:24:20	684	881	Detector bias heater off
	11:28:04	688	862	WFOV blackbody heater on at temp. 1
	11:28:36	689	872	MFOV blackbody heater on at temp. 1
	11:29:40	690	891	SWICS off
	11:43:00	703	883	Detector bias heater on at level 2
	11:45:08	705	893	SWICS on at level 2
	11:48:20	708	881	Detector bias heater off
	11:52:04	712	863	WFOV blackbody heater on at temp. 2
	11:52:36	713	873	MFOV blackbody heater on at temp. 2
	11:53:40	714	891	SWICS off
	12:07:00	727	884	Detector bias heater on at level 3
	12:09:08	729	894	SWICS on at level 1
	12:11:16	731	881	Detector bias heater off
	12:13:56	734	852	Solar port heaters off
12:15:00	735	861	WFOV blackbody heater off	
12:15:32	736	871	MFOV blackbody heater off	
12:16:04	736	851	Solar port heaters on	
12:16:36	737	891	SWICS off	
End internal calibration sequence.				
Begin azimuth angle load commands for solar calibration				
05/29/85 ↓	12:19:16	739	419	Address azimuth position A
	12:19:48	740	2xx	Data command, high byte
	12:20:20	740	1xx	Data command, low byte
End azimuth angle load commands (A = 120.45°).				
Begin solar calibration sequence				
05/29/85 ↓	12:20:52	741	8A2	Begin solar calibration
	12:21:24	741	852	Solar port heaters off
	12:21:56	742	822	Elevate to solar ports (Sun)
	12:22:28	742	814	Azimuth to position A
	12:23:00	743	882	Detector bias heater on at level 1
	12:32:36	753	851	Solar port heaters on
	12:33:08	753	831	SMA shutter cycle on
	13:04:04	784	832	SMA shutter cycle off
	13:04:36	785	852	Solar port heaters off
	13:05:08	785	813	Azimuth to 180°
	13:05:40	786	881	Detector bias heater off

Table 8. Continued

(a) Continued

Date	Universal time		Hex command	Event description
	hr:min:sec	Minutes of day		
05/29/85	13:15:16	795	823	Elevate to nadir (Earth)
05/29/85	13:15:48	796	851	Solar port heaters on
End solar calibration sequence.				
Begin azimuth angle load commands for 170°				
05/29/85	13:21:08	801	419	Address azimuth position A
↓	13:21:40	802	2xx	Data command, high byte
	13:22:12	802	1xx	Data command, low byte
End azimuth angle load commands (A = 170.0°)				
05/29/85	13:22:44	803	814	Azimuth to position A
06/12/85	10:24:37	625	821	Elevate to internal source (stow)
↓	10:25:09	625	862	WFOV blackbody heater on at temp. 1
	10:40:37	641	872	MFOV blackbody heater on at temp. 1
	12:07:33	728	823	Elevate to nadir (Earth)
Begin internal calibration sequence				
06/12/85	12:08:05	728	8A1	Begin internal calibration
↓	12:08:37	729	881	Detector bias heater off
	12:09:09	729	852	Solar port heaters off
	12:09:41	730	821	Elevate to internal source (stow)
	12:10:13	730	851	Solar port heaters on
	12:12:21	732	882	Detector bias heater on at level 1
	12:14:29	734	892	SWICS on at level 3
	12:17:41	738	881	Detector bias heater off
	12:21:25	741	862	WFOV blackbody heater on at temp. 1
	12:21:57	742	872	MFOV blackbody heater on at temp. 1
	12:23:01	743	891	SWICS off
	12:36:21	756	883	Detector bias heater on at level 2
	12:38:29	758	893	SWICS on at level 2
	12:41:41	762	881	Detector bias heater off
	12:45:25	765	863	WFOV blackbody heater on at temp. 2
	12:45:57	766	873	MFOV blackbody heater on at temp. 2
	12:47:01	767	891	SWICS off
	13:00:21	780	884	Detector bias heater on at level 3
	13:02:29	782	894	SWICS on at level 1
	13:04:37	785	881	Detector bias heater off
	13:07:17	787	852	Solar port heaters off
	13:08:21	788	861	WFOV blackbody heater off
	13:08:53	789	871	MFOV blackbody heater off
	13:09:25	789	851	Solar port heaters on
13:09:57	790	891	SWICS off	
End internal calibration sequence				

Table 8. Continued

(a) Continued

Date	Universal time		Hex command	Event description
	hr:min:sec	Minutes of day		
Begin azimuth angle load commands for solar calibration				
06/12/85 ↓	13:12:37	793	419	Address azimuth position A
	13:13:09	793	2xx	Data command, high byte
	13:13:41	794	1xx	Data command, low byte
End azimuth angle load commands (A = 119.4°).				
Begin solar calibration sequence				
06/12/85 ↓	13:14:13	794	8A2	Begin solar calibration
	13:14:45	795	852	Solar port heaters off
	13:15:17	795	822	Elevate to solar ports (Sun)
	13:15:49	796	814	Azimuth to position A
	13:16:21	796	882	Detector bias heater on at level 1
	13:25:57	806	851	Solar port heaters on
	13:26:29	806	831	SMA shutter cycle on
	13:57:25	837	832	SMA shutter cycle off
	13:57:57	838	852	Solar port heaters off
	13:58:29	838	813	Azimuth to 180°
	13:59:01	839	881	Detector bias heater off
↓	14:08:37	849	823	Elevate to nadir (Earth)
	14:09:09	849	851	Solar port heaters on
End solar calibration sequence.				
Begin azimuth angle load commands for 170°				
06/12/85 ↓	14:14:29	854	419	Address azimuth position A
	14:15:01	855	2xx	Data command, high byte
	14:15:33	856	1xx	Data command, low byte
End azimuth angle load commands (A = 170.0°)				
06/12/85	14:16:05	856	814	Azimuth to position A
06/26/85 ↓	09:35:33	576	821	Elevate to internal source (stow)
	09:36:05	576	862	WFOV blackbody heater on at temp. 1
	09:51:33	592	872	MFOV blackbody heater on at temp. 1
	11:18:29	678	823	Elevate to nadir (Earth)
Begin internal calibration sequence				
06/26/85 ↓	11:19:01	679	8A1	Begin internal calibration
	11:19:33	680	881	Detector bias heater off
	11:20:05	680	852	Solar port heaters off
	11:20:37	681	821	Elevate to internal source (stow)
	11:21:09	681	851	Solar port heaters on
	11:23:17	683	882	Detector bias heater on at level 1
	11:25:25	685	892	SWICS on at level 3
	11:28:37	689	881	Detector bias heater off
	11:32:21	692	862	WFOV blackbody heater on at temp. 1
	11:32:53	693	872	MFOV blackbody heater on at temp. 1
	↓	11:33:57	694	891

Table 8. Continued

(a) Continued

Date	Universal time		Hex command	Event description
	hr:min:sec	Minutes of day		
06/26/85 ↓	11:47:17	707	883	Detector bias heater on at level 2
	11:49:25	709	893	SWICS on at level 2
	11:52:37	713	881	Detector bias heater off
	11:56:21	716	863	WFOV blackbody heater on at temp. 2
	11:56:53	717	873	MFOV blackbody heater on at temp. 2
	12 17:57	718	891	SWICS off
	12:11:17	731	884	Detector bias heater on at level 3
	12:13:25	733	894	SWICS on at level 1
	12:15:33	736	881	Detector bias heater off
	12:18:13	738	852	Solar port heaters off
	12:19:17	739	861	WFOV blackbody heater off
	12:19:49	740	871	MFOV blackbody heater off
	12:20:21	740	851	Solar port heaters on
12:20:53	741	891	SWICS off	
End internal calibration sequence.				
Begin azimuth angle load commands for solar calibration				
06/26/85 ↓	12:23:33	744	419	Address azimuth position A
	12:24:05	744	2xx	Data command, high byte
	12:24:37	745	1xx	Data command, low byte
End azimuth angle load commands (A = 118.8°).				
Begin solar calibration sequence				
06/26/85 ↓	12:25:09	745	8A2	Begin solar calibration
	12:25:41	746	852	Solar port heaters off
	12:26:13	746	822	Elevate to solar ports (Sun)
	12:26:45	747	814	Azimuth to position A
	12:27:17	747	882	Detector bias heater on at level 1
	12:36:53	757	851	Solar port heaters on
	12:37:25	757	831	SMA shutter cycle on
	13:08:21	788	832	SMA shutter cycle off
	13:08:53	789	852	Solar port heaters off
	13:09:25	789	813	Azimuth to 180°
	13:09:57	790	881	Detector bias heater off
	13:19:33	800	823	Elevate to nadir (Earth)
13:20:05	800	851	Solar port heaters on	
End solar calibration sequence.				
Begin azimuth angle load commands for 170°				
06/26/85 ↓	13:25:25	805	419	Address azimuth position A
	13:25:57	806	2xx	Data command, high byte
	13:26:29	806	1xx	Data command, low byte
End azimuth angle load commands (A = 170.0°)				
06/26/85	13:27:01	807	814	Azimuth to position A
07/10/85	10:27:48	628	821	Elevate to internal source (stow)
07/10/85	10:28:20	628	862	WFOV blackbody heater on at temp. 1

Table 8. Continued

(a) Continued

Date	Universal time		Hex command	Event description
	hr:min:sec	Minutes of day		
07/10/85	10:43:48	644	872	MFOV blackbody heater on at temp. 1
07/10/85	12:10:44	731	823	Elevate to nadir (Earth)
Begin internal calibration sequence				
07/10/85 ↓	12:11:16	731	8A1	Begin internal calibration
	12:11:48	732	881	Detector bias heater off
	12:12:20	732	852	Solar port heaters off
	12:12:52	733	821	Elevate to internal source (stow)
	12:13:24	733	851	Solar port heaters on
	12:15:32	736	882	Detector bias heater on at level 1
	12:17:40	738	892	SWICS on at level 3
	12:20:52	741	881	Detector bias heater off
	12:24:36	745	862	WFOV blackbody heater on at temp. 1
	12:25:08	745	872	MFOV blackbody heater on at temp. 1
	12:26:12	746	891	SWICS off
	12:39:32	760	883	Detector bias heater on at level 2
	12:41:40	762	893	SWICS on at level 2
	12:44:52	765	881	Detector bias heater off
	12:48:36	769	863	WFOV blackbody heater on at temp. 2
	12:49:08	769	873	MFOV blackbody heater on at temp. 2
	12:50:12	770	891	SWICS off
	13:03:32	784	884	Detector bias heater on at level 3
	13:05:40	786	894	SWICS on at level 1
	13:07:48	788	881	Detector bias heater off
	13:10:28	790	852	Solar port heaters off
	13:11:32	792	861	WFOV blackbody heater off
	13:12:04	792	871	MFOV blackbody heater off
13:12:36	793	851	Solar port heaters on	
13:13:08	793	891	SWICS off	
End internal calibration sequence.				
Begin azimuth angle load commands for solar calibration				
07/10/85 ↓	13:15:48	796	419	Address azimuth position A
	13:16:20	796	2xx	Data command, high byte
	13:16:52	797	1xx	Data command, low byte
End azimuth angle load commands (A = 118.95°).				
Begin solar calibration sequence				
07/10/85 ↓	13:17:24	797	8A2	Begin solar calibration
	13:17:56	798	852	Solar port heaters off
	13:18:28	798	822	Elevate to solar ports (Sun)
	13:19:00	799	814	Azimuth to position A
	13:19:32	800	882	Detector bias heater on at level 1
	13:29:08	809	851	Solar port heaters on
	13:29:40	810	831	SMA shutter cycle on
	14:00:36	841	832	SMA shutter cycle off

Table 8. Continued

(a) Continued

Date	Universal time		Hex command	Event description
	hr:min:sec	Minutes of day		
07/10/85 ↓	14:01:08	841	852	Solar port heaters off
	14:01:40	842	813	Azimuth to 180°
	14:02:12	842	881	Detector bias heater off
	14:11:48	852	823	Elevate to nadir (Earth)
	14:12:20	852	851	Solar port heaters on
End solar calibration sequence.				
Begin azimuth angle load commands for 170°				
07/10/85 ↓	14:17:40	858	419	Address azimuth position A
	14:18:12	858	2xx	Data command, high byte
	14:18:44	859	1xx	Data command, low byte
End azimuth angle load commands (A = 170.0°)				
07/10/85	14:19:16	859	814	Azimuth to position A
07/24/85 ↓	09:37:40	578	821	Elevate to internal source (stow)
	09:38:12	578	862	WFOV blackbody heater on at temp. 1
	09:53:40	594	872	MFOV blackbody heater on at temp. 1
	11:20:36	681	823	Elevate to nadir (Earth)
Begin internal calibration sequence				
07/24/85 ↓	11:21:08	681	8A1	Begin internal calibration
	11:21:40	682	881	Detector bias heater off
	11:22:12	682	852	Solar port heaters off
	11:22:44	683	821	Elevate to internal source (stow)
	11:23:16	683	851	Solar port heaters on
	11:25:24	685	882	Detector bias heater on at level 1
	11:27:32	688	892	SWICS on at level 3
	11:30:44	691	881	Detector bias heater off
	11:34:28	694	862	WFOV blackbody heater on at temp. 1
	11:35:00	695	872	MFOV blackbody heater on at temp. 1
	11:36:04	696	891	SWICS off
	11:49:24	709	883	Detector bias heater on at level 2
	11:51:32	712	893	SWICS on at level 2
	11:54:44	715	881	Detector bias heater off
	11:58:28	718	863	WFOV blackbody heater on at temp. 2
	11:59:00	719	873	MFOV blackbody heater on at temp. 2
	12:00:04	720	891	SWICS off
	12:13:24	733	884	Detector bias heater on at level 3
	12:15:32	736	894	SWICS on at level 1
	12:17:40	738	881	Detector bias heater off
	12:20:20	740	852	Solar port heaters off
	12:21:24	741	861	WFOV blackbody heater off
	12:21:56	742	871	MFOV blackbody heater off
	12:22:28	742	851	Solar port heaters on
12:23:00	743	891	SWICS off	
End internal calibration sequence				

Table 8. Continued

(a) Continued

Date	Universal time		Hex command	Event description
	hr:min:sec	Minutes of day		
Begin azimuth angle load commands for solar calibration				
07/24/85	12:25:40	746	419	Address azimuth position A
↓	12:26:12	746	2xx	Data command, high byte
↓	12:26:44	747	1xx	Data command, low byte
End azimuth angle load commands (A = 119.78°).				
Begin solar calibration sequence				
07/24/85	12:27:16	747	8A2	Begin solar calibration
↓	12:27:48	748	852	Solar port heaters off
↓	12:28:20	748	822	Elevate to solar ports (Sun)
↓	12:28:52	749	814	Azimuth to position A
↓	12:29:24	749	882	Detector bias heater on at level 1
↓	12:39:00	759	851	Solar port heaters on
↓	12:39:32	760	831	SMA shutter cycle on
↓	13:10:28	790	832	SMA shutter cycle off
↓	13:11:00	791	852	Solar port heaters off
↓	13:11:32	792	813	Azimuth to 180°
↓	13:12:04	792	881	Detector bias heater off
↓	13:21:40	802	823	Elevate to nadir (Earth)
↓	13:22:12	802	851	Solar port heaters on
End solar calibration sequence.				
Begin azimuth angle load commands for 170°				
07/24/85	13:27:32	808	419	Address azimuth position A
↓	13:28:04	808	2xx	Data command, high byte
↓	13:28:36	809	1xx	Data command, low byte
End azimuth angle load commands (A = 170.0°)				
07/24/85	13:29:08	809	814	Azimuth to position A
08/07/85	10:29:24	629	821	Elevate to internal source (stow)
↓	10:29:56	630	862	WFOV blackbody heater on at temp. 1
↓	10:45:24	645	872	MFOV blackbody heater on at temp. 1
↓	12:12:20	732	823	Elevate to nadir (Earth)
Begin internal calibration sequence				
08/07/85	12:12:52	733	8A1	Begin internal calibration
↓	12:13:24	733	881	Detector bias heater off
↓	12:13:56	734	852	Solar port heaters off
↓	12:14:28	734	821	Elevate to internal source (stow)
↓	12:15:00	735	851	Solar port heaters on
↓	12:17:08	737	882	Detector bias heater on at level 1
↓	12:19:16	739	892	SWICS on at level 3
↓	12:22:28	742	881	Detector bias heater off
↓	12:26:12	746	862	WFOV blackbody heater on at temp. 1
↓	12:26:44	747	872	MFOV blackbody heater on at temp. 1
↓	12:27:48	748	891	SWICS off
↓	12:41:08	761	883	Detector bias heater on at level 2
↓	12:43:16	763	893	SWICS on at level 2

Table 8. Continued

(a) Continued

Date	Universal time		Hex command	Event description
	hr:min:sec	Minutes of day		
08/07/85 ↓	12:46:28	766	881	Detector bias heater off
	12:50:12	770	863	WFOV blackbody heater on at temp. 2
	12:50:44	771	873	MFOV blackbody heater on at temp. 2
	12:51:48	772	891	SWICS off
	13:05:08	785	884	Detector bias heater on at level 3
	13:07:16	787	894	SWICS on at level 1
	13:09:24	789	881	Detector bias heater off
	13:12:04	792	852	Solar port heaters off
	13:13:08	793	861	WFOV blackbody heater off
	13:13:40	794	871	MFOV blackbody heater off
	13:14:12	794	851	Solar port heaters on
13:14:44	795	891	SWICS off	
End internal calibration sequence.				
Begin azimuth angle load commands for solar calibration				
08/07/85 ↓	13:17:24	797	419	Address azimuth position A
	13:17:56	798	2xx	Data command, high byte
	13:18:28	798	1xx	Data command, low byte
End azimuth angle load commands ($A = 115.2^\circ$).				
Begin solar calibration sequence				
08/07/85 ↓	13:19:00	799	8A2	Begin solar calibration
	13:19:32	800	852	Solar port heaters off
	13:20:04	800	822	Elevate to solar ports (Sun)
	13:20:36	801	814	Azimuth to position A
	13:21:08	801	882	Detector bias heater on at level 1
	13:30:44	811	851	Solar port heaters on
	13:31:16	811	831	SMA shutter cycle on
	14:02:12	842	832	SMA shutter cycle off
	14:02:44	843	852	Solar port heaters off
	14:03:16	843	813	Azimuth to 180°
	14:03:48	844	881	Detector bias heater off
	14:13:24	853	823	Elevate to nadir (Earth)
	14:13:56	854	851	Solar port heaters on
End solar calibration sequence.				
Begin azimuth angle load commands for 170°				
08/07/85 ↓	14:19:16	859	419	Address azimuth position A
	14:19:48	860	2xx	Data command, high byte
	14:20:20	860	1xx	Data command, low byte
End azimuth angle load commands ($A = 170.0^\circ$)				
08/07/85	14:20:52	861	814	Azimuth to position A
08/21/85 ↓	09:39:16	579	821	Elevate to internal source (stow)
	09:39:48	580	862	WFOV blackbody heater on at temp. 1
	09:55:16	595	872	MFOV blackbody heater on at temp. 1
	11:22:12	682	823	Elevate to nadir (Earth)

Table 8. Continued

(a) Continued

Date	Universal time		Hex command	Event description
	hr:min:sec	Minutes of day		
Begin internal calibration sequence				
08/21/85 ↓	11:22:44	683	8A1	Begin internal calibration
	11:23:16	683	881	Detector bias heater off
	11:23:48	684	852	Solar port heaters off
	11:24:20	684	821	Elevate to internal source (stow)
	11:24:52	685	851	Solar port heaters on
	11:27:00	687	882	Detector bias heater on at level 1
	11:29:08	689	892	SWICS on at level 3
	11:32:20	692	881	Detector bias heater off
	11:36:04	696	862	WFOV blackbody heater on at temp. 1
	11:36:36	697	872	MFOV blackbody heater on at temp. 1
	11:37:40	698	891	SWICS off
	11:51:00	711	883	Detector bias heater on at level 2
	11:53:08	713	893	SWICS on at level 2
	11:56:20	716	881	Detector bias heater off
	12:00:04	720	863	WFOV blackbody heater on at temp. 2
	12:00:36	721	873	MFOV blackbody heater on at temp. 2
	12:01:40	722	891	SWICS off
	12:15:00	735	884	Detector bias heater on at level 3
	12:17:08	737	894	SWICS on at level 1
	12:19:16	739	881	Detector bias heater off
	12:21:56	742	852	Solar port heaters off
12:23:00	743	861	WFOV blackbody heater off	
12:23:32	744	871	MFOV blackbody heater off	
12:24:04	744	851	Solar port heaters on	
12:24:36	745	891	SWICS off	
End internal calibration sequence.				
Begin azimuth angle load commands for solar calibration				
08/21/85 ↓	12:27:16	747	419	Address azimuth position A
	12:27:48	748	2xx	Data command, high byte
	12:28:20	748	1xx	Data command, low byte
End azimuth angle load commands (A = 123.75°).				
Begin solar calibration sequence				
08/21/85 ↓	12:28:52	749	8A2	Begin solar calibration
	12:29:24	749	852	Solar port heaters off
	12:29:56	750	822	Elevate to solar ports (Sun)
	12:30:28	750	814	Azimuth to position A
	12:31:00	751	882	Detector bias heater on at level 1
	12:40:36	761	851	Solar port heaters on
	12:41:08	761	831	SMA shutter cycle on
	13:12:04	792	832	SMA shutter cycle off
	13:12:36	793	852	Solar port heaters off
	13:13:08	793	813	Azimuth to 180°

Table 8. Continued

(a) Continued

Date	Universal time		Hex command	Event description
	hr:min:sec	Minutes of day		
08/21/85 ↓	13:13:40	794	881	Detector bias heater off
	13:23:16	803	823	Elevate to nadir (Earth)
	13:23:48	804	851	Solar port heaters on
End solar calibration sequence.				
Begin azimuth angle load commands for 170°				
08/21/85 ↓	13:29:08	809	419	Address azimuth position A
	13:29:40	810	2xx	Data command, high byte
	13:30:12	810	1xx	Data command, low byte
End azimuth angle load commands (A = 170.0°)				
08/21/85	13:30:44	811	814	Azimuth to position A
09/04/85 ↓	10:30:28	630	821	Elevate to internal source (stow)
	10:31:00	631	862	WFOV blackbody heater on at temp. 1
	10:46:28	646	872	MFOV blackbody heater on at temp. 1
	12:13:24	733	823	Elevate to nadir (Earth)
Begin internal calibration sequence				
09/04/85 ↓	12:13:56	734	8A1	Begin internal calibration
	12:14:28	734	881	Detector bias heater off
	12:15:00	735	852	Solar port heaters off
	12:15:32	736	821	Elevate to internal source (stow)
	12:16:04	736	851	Solar port heaters on
	12:18:12	738	882	Detector bias heater on at level 1
	12:20:20	740	892	SWICS on at level 3
	12:23:32	744	881	Detector bias heater off
	12:27:16	747	862	WFOV blackbody heater on at temp. 1
	12:27:48	748	872	MFOV blackbody heater on at temp. 1
	12:28:52	749	891	SWICS off
	12:42:12	762	883	Detector bias heater on at level 2
	12:44:20	764	893	SWICS on at level 2
	12:47:32	768	881	Detector bias heater off
	12:51:16	771	863	WFOV blackbody heater on at temp. 2
	12:51:48	772	873	MFOV blackbody heater on at temp. 2
	12:52:52	773	891	SWICS off
	13:06:12	786	884	Detector bias heater on at level 3
	13:08:20	788	894	SWICS on at level 1
	13:10:28	790	881	Detector bias heater off
	13:13:08	793	852	Solar port heaters off
	13:14:12	794	861	WFOV blackbody heater off
	13:14:44	795	871	MFOV blackbody heater off
	13:15:16	795	851	Solar port heaters on
13:15:48	796	891	SWICS off	
End internal calibration sequence				

Table 8. Continued

(a) Continued

Date	Universal time		Hex command	Event description
	hr:min:sec	Minutes of day		
Begin azimuth angle load commands for solar calibration				
09/04/85 ↓	13:18:28	798	419	Address azimuth position A
	13:19:00	799	2xx	Data command, high byte
	13:19:32	800	1xx	Data command, low byte
End azimuth angle load commands (A = 126.45°).				
Begin solar calibration sequence				
09/04/85 ↓	13:20:04	800	8A2	Begin solar calibration
	13:20:36	801	852	Solar port heaters off
	13:21:08	801	822	Elevate to solar ports (Sun)
	13:21:40	802	814	Azimuth to position A
	13:22:12	802	882	Detector bias heater on at level 1
	13:31:48	812	851	Solar port heaters on
	13:32:20	812	831	SMA shutter cycle on
	14:03:16	843	832	SMA shutter cycle off
	14:03:48	844	852	Solar port heaters off
	14:04:20	844	813	Azimuth to 180°
	14:04:52	845	881	Detector bias heater off
	14:14:28	854	823	Elevate to nadir (Earth)
14:15:00	855	851	Solar port heaters on	
End solar calibration sequence.				
Begin azimuth angle load commands for 170°				
09/04/85 ↓	14:20:20	860	419	Address azimuth position A
	14:20:52	861	2xx	Data command, high byte
	14:21:24	861	1xx	Data command, low byte
End azimuth angle load commands (A = 170.0°)				
09/04/85	14:21:56	862	814	Azimuth to position A
09/18/85 ↓	09:39:48	580	821	Elevate to internal source (stow)
	09:40:20	580	862	WFOV blackbody heater on at temp. 1
	09:55:48	596	872	MFOV blackbody heater on at temp. 1
	11:22:44	683	823	Elevate to nadir (Earth)
Begin internal calibration sequence				
09/18/85 ↓	11:23:16	683	8A1	Begin internal calibration
	11:23:48	684	881	Detector bias heater off
	11:24:20	684	852	Solar port heaters off
	11:24:52	685	821	Elevate to internal source (stow)
	11:25:24	685	851	Solar port heaters on
	11:27:32	688	882	Detector bias heater on at level 1
	11:29:40	690	892	SWICS on at level 3
	11:32:52	693	881	Detector bias heater off
	11:36:36	697	862	WFOV blackbody heater on at temp. 1
	11:37:08	697	872	MFOV blackbody heater on at temp. 1
	11:38:12	698	891	SWICS off

Table 8. Continued

(a) Continued

Date	Universal time		Hex command	Event description
	hr:min:sec	Minutes of day		
09/18/85 ↓	11:51:32	712	883	Detector bias heater on at level 2
	11:53:40	714	893	SWICS on at level 2
	11:56:52	717	881	Detector bias heater off
	12:00:36	721	863	WFOV blackbody heater on at temp. 2
	12:01:08	721	873	MFOV blackbody heater on at temp. 2
	12:02:12	722	891	SWICS off
	12:15:32	736	884	Detector bias heater on at level 3
	12:17:40	738	894	SWICS on at level 1
	12:19:48	740	881	Detector bias heater off
	12:22:28	742	852	Solar port heaters off
	12:23:32	744	861	WFOV blackbody heater off
	12:24:04	744	871	MFOV blackbody heater off
	12:24:36	745	851	Solar port heaters on
	12:25:08	745	891	SWICS off
End internal calibration sequence. Begin azimuth angle load commands for solar calibration				
09/18/85 ↓	12:27:48	748	419	Address azimuth position A
	12:28:20	748	2xx	Data command, high byte
	12:28:52	749	1xx	Data command, low byte
End azimuth angle load commands (A = 129.23°). Begin solar calibration sequence				
09/18/85 ↓	12:29:24	749	8A2	Begin solar calibration
	12:29:56	750	852	Solar port heaters off
	12:30:28	750	822	Elevate to solar ports (Sun)
	12:31:00	751	814	Azimuth to position A
	12:31:32	752	882	Detector bias heater on at level 1
	12:41:08	761	851	Solar port heaters on
	12:41:40	762	831	SMA shutter cycle on
	13:12:36	793	832	SMA shutter cycle off
	13:13:08	793	852	Solar port heaters off
	13:13:40	794	813	Azimuth to 180°
	13:14:12	794	881	Detector bias heater off
	13:23:48	804	823	Elevate to nadir (Earth)
	13:24:20	804	851	Solar port heaters on
End solar calibration sequence. Begin azimuth angle load commands for 170°				
09/18/85 ↓	13:29:40	810	419	Address azimuth position A
	13:30:12	810	2xx	Data command, high byte
	13:30:44	811	1xx	Data command, low byte
End azimuth angle load commands (A = 170.0°)				
09/18/85	13:31:16	811	814	Azimuth to position A
10/02/85 ↓	10:30:28	630	821	Elevate to internal source (stow)
	10:31:00	631	862	WFOV blackbody heater on at temp. 1
	10:46:28	646	872	MFOV blackbody heater on at temp. 1
	12:13:24	733	823	Elevate to nadir (Earth)

Table 8. Continued

(a) Continued

Date	Universal time		Hex command	Event description
	hr:min:sec	Minutes of day		
Begin internal calibration sequence				
10/02/85 ↓	12:13:56	734	8A1	Begin internal calibration
	12:14:28	734	881	Detector bias heater off
	12:15:00	735	852	Solar port heaters off
	12:15:32	736	821	Elevate to internal source (stow)
	12:16:04	736	851	Solar port heaters on
	12:18:12	738	882	Detector bias heater on at level 1
	12:20:20	740	892	SWICS on at level 3
	12:23:32	744	881	Detector bias heater off
	12:27:16	747	862	WFOV blackbody heater on at temp. 1
	12:27:48	748	872	MFOV blackbody heater on at temp. 1
	12:28:52	749	891	SWICS off
	12:42:12	762	883	Detector bias heater on at level 2
	12:44:20	764	893	SWICS on at level 2
	12:47:32	768	881	Detector bias heater off
	12:51:16	771	863	WFOV blackbody heater on at temp. 2
	12:51:48	772	873	MFOV blackbody heater on at temp. 2
	12:52:52	773	891	SWICS off
	13:06:12	786	884	Detector bias heater on at level 3
	13:08:20	788	894	SWICS on at level 1
	13:10:28	790	881	Detector bias heater off
13:13:08	793	852	Solar port heaters off	
13:14:12	794	861	WFOV blackbody heater off	
13:14:44	795	871	MFOV blackbody heater off	
13:15:16	795	851	Solar port heaters on	
13:15:48	796	891	SWICS off	
End internal calibration sequence.				
Begin azimuth angle load commands for solar calibration				
10/02/85 ↓	13:18:28	798	419	Address azimuth position A
	13:19:00	799	2xx	Data command, high byte
	13:19:32	800	1xx	Data command, low byte
Begin solar calibration sequence ($A = 131.7^\circ$)				
10/02/85 ↓	13:20:04	800	8A2	Begin solar calibration
	13:20:36	801	852	Solar port heaters off
	13:21:08	801	822	Elevate to solar ports (Sun)
	13:21:40	802	814	Azimuth to position A
	13:22:12	802	882	Detector bias heater on at level 1
	13:31:48	812	851	Solar port heaters on
	13:32:20	812	831	SMA shutter cycle on
	14:03:16	843	832	SMA shutter cycle off
	14:03:48	844	852	Solar port heaters off
	14:04:20	844	813	Azimuth to 180°

Table 8. Continued

(a) Continued

Date	Universal time		Hex command	Event description
	hr:min:sec	Minutes of day		
10/02/85	14:04:52	845	881	Detector bias heater off
↓	14:14:28	854	823	Elevate to nadir (Earth)
	14:15:00	855	851	Solar port heaters on
End solar calibration sequence.				
Begin azimuth angle load commands for 170°				
10/02/85	14:20:20	860	419	Address azimuth position A
↓	14:20:52	861	2xx	Data command, high byte
	14:21:24	861	1xx	Data command, low byte
End azimuth angle load commands (A = 170.0°)				
10/02/85	14:21:56	862	814	Azimuth to position A
10/16/85	09:39:16	579	821	Elevate to internal source (stow)
↓	09:39:48	580	862	WFOV blackbody heater on at temp. 1
	09:55:16	595	872	MFOV blackbody heater on at temp. 1
	11:22:12	682	823	Elevate to nadir (Earth)
Begin internal calibration sequence				
10/16/85	11:22:44	683	8A1	Begin internal calibration
↓	11:23:16	683	881	Detector bias heater off
	11:23:48	684	852	Solar port heaters off
	11:24:20	684	821	Elevate to internal source (stow)
	11:24:52	685	851	Solar port heaters on
	11:27:00	687	882	Detector bias heater on at level 1
	11:29:08	689	892	SWICS on at level 3
	11:32:20	692	881	Detector bias heater off
	11:36:04	696	862	WFOV blackbody heater on at temp. 1
	11:36:36	697	872	MFOV blackbody heater on at temp. 1
	11:37:40	698	891	SWICS off
	11:51:00	711	883	Detector bias heater on at level 2
	11:53:08	713	893	SWICS on at level 2
	11:56:20	716	881	Detector bias heater off
	12:00:04	720	863	WFOV blackbody heater on at temp. 2
	12:00:36	721	873	MFOV blackbody heater on at temp. 2
	12:01:40	722	891	SWICS off
	12:15:00	735	884	Detector bias heater on at level 3
	12:17:08	737	894	SWICS on at level 1
	12:19:16	739	881	Detector bias heater off
	12:21:56	742	852	Solar port heaters off
	12:23:00	743	861	WFOV blackbody heater off
	12:23:32	744	871	MFOV blackbody heater off
	12:24:04	744	851	Solar port heaters on
↓	12:24:36	745	891	SWICS off
End internal calibration sequence				

Table 8. Continued

(a) Continued

Date	Universal time		Hex command	Event description
	hr:min:sec	Minutes of day		
Begin azimuth angle load commands for solar calibration				
10/16/85	12:27:16	747	419	Address azimuth position A
↓	12:27:48	748	2xx	Data command, high byte
↓	12:28:20	748	1xx	Data command, low byte
End azimuth angle load commands ($A = 133.43^\circ$).				
Begin solar calibration sequence				
10/16/85	12:28:52	749	8A2	Begin solar calibration
↓	12:29:24	749	852	Solar port heaters off
↓	12:29:56	750	822	Elevate to solar ports (Sun)
↓	12:30:28	750	814	Azimuth to position A
↓	12:31:00	751	882	Detector bias heater on at level 1
↓	12:40:36	761	851	Solar port heaters on
↓	12:41:08	761	831	SMA shutter cycle on
↓	13:12:04	792	832	SMA shutter cycle off
↓	13:12:36	793	852	Solar port heaters off
↓	13:13:08	793	813	Azimuth to 180°
↓	13:13:40	794	881	Detector bias heater off
↓	13:23:16	803	823	Elevate to nadir (Earth)
↓	13:23:48	804	851	Solar port heaters on
End solar calibration sequence.				
Begin azimuth angle load commands for 170°				
10/16/85	13:29:08	809	419	Address azimuth position A
↓	13:29:40	810	2xx	Data command, high byte
↓	13:30:12	810	1xx	Data command, low byte
End azimuth angle load commands ($A = 170.0^\circ$)				
10/16/85	13:30:44	811	814	Azimuth to position A
10/30/85	10:30:28	630	821	Elevate to internal source (stow)
↓	10:31:00	631	862	WFOV blackbody heater on at temp. 1
↓	10:46:28	646	872	MFOV blackbody heater on at temp. 1
↓	12:13:24	733	823	Elevate to nadir (Earth)
Begin internal calibration sequence				
10/30/85	12:13:56	734	8A1	Begin internal calibration
↓	12:14:28	734	881	Detector bias heater off
↓	12:15:00	735	852	Solar port heaters off
↓	12:15:32	736	821	Elevate to internal source (stow)
↓	12:16:04	736	851	Solar port heaters on
↓	12:18:12	738	882	Detector bias heater on at level 1
↓	12:20:20	740	892	SWICS on at level 3
↓	12:23:32	744	881	Detector bias heater off
↓	12:27:16	747	862	WFOV blackbody heater on at temp. 1
↓	12:27:48	748	872	MFOV blackbody heater on at temp. 1
↓	12:28:52	749	891	SWICS off

Table 8. Continued

(a) Continued

Date	Universal time		Hex command	Event description
	hr:min:sec	Minutes of day		
10/30/85 ↓	12:42:12	762	883	Detector bias heater on at level 2
	12:44:20	764	893	SWICS on at level 2
	12:47:32	768	881	Detector bias heater off
	12:51:16	771	863	WFOV blackbody heater on at temp. 2
	12:51:48	772	873	MFOV blackbody heater on at temp. 2
	12:52:52	773	891	SWICS off
	13:06:12	786	884	Detector bias heater on at level 3
	13:08:20	788	894	SWICS on at level 1
	13:10:28	790	881	Detector bias heater off
	13:13:08	793	852	Solar port heaters off
	13:14:12	794	861	WFOV blackbody heater off
	13:14:44	795	871	MFOV blackbody heater off
	13:15:16	795	851	Solar port heaters on
	13:15:48	796	891	SWICS off
End internal calibration sequence.				
Begin azimuth angle load commands for solar calibration				
10/30/85 ↓	13:18:28	798	419	Address azimuth position A
	13:19:00	799	2xx	Data command, high byte
	13:19:32	800	1xx	Data command, low byte
End azimuth angle load commands (A = 134.25°).				
Begin solar calibration sequence				
10/30/85 ↓	13:20:04	800	8A2	Begin solar calibration
	13:20:36	801	852	Solar port heaters off
	13:21:08	801	822	Elevate to solar ports (Sun)
	13:21:40	802	814	Azimuth to position A
	13:22:12	802	882	Detector bias heater on at level 1
	13:31:48	812	851	Solar port heaters on
	13:32:20	812	831	SMA shutter cycle on
	14:03:16	843	832	SMA shutter cycle off
	14:03:48	844	852	Solar port heaters off
	14:04:20	844	813	Azimuth to 180°
	14:04:52	845	881	Detector bias heater off
	14:14:28	854	823	Elevate to nadir (Earth)
14:15:00	855	851	Solar port heaters on	
End solar calibration sequence.				
Begin azimuth angle load commands for 170°				
10/30/85 ↓	14:20:20	860	419	Address azimuth position A
	14:20:52	861	2xx	Data command, high byte
	14:21:24	861	1xx	Data command, low byte
End azimuth angle load commands (A = 170.0°)				

Table 8. Continued

(a) Continued

Date	Universal time		Hex command	Event description
	hr:min:sec	Minutes of day		
10/30/85	14:21:56	862	814	Azimuth to position A
11/13/85 ↓	09:39:16	579	821	Elevate to internal source (stow)
	09:39:48	580	862	WFOV blackbody heater on at temp. 1
	09:55:16	595	872	MFOV blackbody heater on at temp. 1
	11:22:12	682	823	Elevate to nadir (Earth)
Begin internal calibration sequence				
11/13/85 ↓	11:22:44	683	8A1	Begin internal calibration
	11:23:16	683	881	Detector bias heater off
	11:23:48	684	852	Solar port heaters off
	11:24:20	684	821	Elevate to internal source (stow)
	11:24:52	685	851	Solar port heaters on
	11:27:00	687	882	Detector bias heater on at level 1
	11:29:08	689	892	SWICS on at level 3
	11:32:20	692	881	Detector bias heater off
	11:36:04	696	862	WFOV blackbody heater on at temp. 1
	11:36:36	697	872	MFOV blackbody heater on at temp. 1
	11:37:40	698	891	SWICS off
	11:51:00	711	883	Detector bias heater on at level 2
	11:53:08	713	893	SWICS on at level 2
	11:56:20	716	881	Detector bias heater off
	12:00:04	720	863	WFOV blackbody heater on at temp. 2
	12:00:36	721	873	MFOV blackbody heater on at temp. 2
	12:01:40	722	891	SWICS off
	12:15:00	735	884	Detector bias heater on at level 3
	12:17:08	737	894	SWICS on at level 1
	12:19:16	739	881	Detector bias heater off
	12:21:56	742	852	Solar port heaters off
	12:23:00	743	861	WFOV blackbody heater off
	12:23:32	744	871	MFOV blackbody heater off
	12:24:04	744	851	Solar port heaters on
12:24:36	745	891	SWICS off	
End internal calibration sequence.				
Begin azimuth angle load commands for solar calibration				
11/13/85 ↓	12:27:16	747	419	Address azimuth position A
	12:27:48	748	2xx	Data command, high byte
	12:28:20	748	1xx	Data command, low byte
End azimuth angle load commands (A = 134.1°).				
Begin solar calibration sequence				
11/13/85 ↓	12:28:52	749	8A2	Begin solar calibration
	12:29:24	749	852	Solar port heaters off
	12:29:56	750	822	Elevate to solar ports (Sun)
	12:30:28	750	814	Azimuth to position A
	12:31:00	751	882	Detector bias heater on at level 1

Table 8. Continued

(a) Continued

Date	Universal time		Hex command	Event description
	hr:min:sec	Minutes of day		
Begin internal calibration sequence				
11/13/85 ↓	12:40:36	761	851	Solar port heaters on
	12:41:08	761	831	SMA shutter cycle on
	13:12:04	792	832	SMA shutter cycle off
	13:12:36	793	852	Solar port heaters off
	13:13:08	793	813	Azimuth to 180°
	13:13:40	794	881	Detector bias heater off
	13:23:16	803	823	Elevate to nadir (Earth)
	13:23:48	804	851	Solar port heaters on
End solar calibration sequence.				
Begin azimuth angle load commands for 170°				
11/13/85 ↓	13:29:08	809	419	Address azimuth position A
	13:29:40	810	2xx	Data command, high byte
	13:30:12	810	1xx	Data command, low byte
End azimuth angle load commands (A = 170.0°)				
11/13/85	13:30:44	811	814	Azimuth to position A
11/27/85 ↓	10:30:28	630	821	Elevate to internal source (stow)
	10:31:00	631	862	WFOV blackbody heater on at temp. 1
	10:46:28	646	872	MFOV blackbody heater on at temp. 1
	12:13:24	733	823	Elevate to nadir (Earth)
	12:13:56	734	8A1	Begin internal calibration
	12:14:28	734	881	Detector bias heater off
	12:15:00	735	852	Solar port heaters off
	12:15:32	736	821	Elevate to internal source (stow)
	12:16:04	736	851	Solar port heaters on
	12:18:12	738	882	Detector bias heater on at level 1
	12:20:20	740	892	SWICS on at level 3
	12:23:32	744	881	Detector bias heater off
	12:27:16	747	862	WFOV blackbody heater on at temp. 1
	12:27:48	748	872	MFOV blackbody heater on at temp. 1
	12:28:52	749	891	SWICS off
	12:42:12	762	883	Detector bias heater on at level 2
	12:44:20	764	893	SWICS on at level 2
	12:47:32	768	881	Detector bias heater off
	12:51:16	771	863	WFOV blackbody heater on at temp. 2
	12:51:48	772	873	MFOV blackbody heater on at temp. 2
	12:52:52	773	891	SWICS off
	13:06:12	786	884	Detector bias heater on at level 3
	13:08:20	788	894	SWICS on at level 1
	13:10:28	790	881	Detector bias heater off
	13:13:08	793	852	Solar port heaters off
	13:14:12	794	861	WFOV blackbody heater off

Table 8. Continued

(a) Continued

Date	Universal time		Hex command	Event description
	hr:min:sec	Minutes of day		
11/27/85	13:14:44	795	871	MFOV blackbody heater off
↓	13:15:16	795	851	Solar port heaters on
	13:15:48	796	891	SWICS off
End internal calibration sequence.				
Begin azimuth angle load commands for solar calibration				
11/27/85	13:18:28	798	419	Address azimuth position A
↓	13:19:00	799	2xx	Data command, high byte
	13:19:32	800	1xx	Data command, low byte
End azimuth angle load commands (A = 133.13°).				
Begin solar calibration sequence				
11/27/85	13:20:04	800	8A2	Begin solar calibration
↓	13:20:36	801	852	Solar port heaters off
	13:21:08	801	822	Elevate to solar ports (Sun)
	13:21:40	802	814	Azimuth to position A
	13:22:12	802	882	Detector bias heater on at level 1
	13:31:48	812	851	Solar port heaters on
	13:32:20	812	831	SMA shutter cycle on
	14:03:16	843	832	SMA shutter cycle off
	14:03:48	844	852	Solar port heaters off
	14:04:20	844	813	Azimuth to 180°
	14:04:52	845	881	Detector bias heater off
	14:14:28	854	823	Elevate to nadir (Earth)
↓	14:15:00	855	851	Solar port heaters on
End solar calibration sequence.				
Begin azimuth angle load commands for 170°				
11/27/85	14:20:20	860	419	Address azimuth position A
↓	14:20:52	861	2xx	Data command, high byte
	14:21:24	861	1xx	Data command, low byte
End azimuth angle load commands (A = 170.0°)				
11/27/85	14:21:56	862	814	Azimuth to position A
12/11/85	09:40:20	580	821	Elevate to internal source (stow)
↓	09:40:52	581	862	WFOV blackbody heater on at temp. 1
	09:56:20	596	872	MFOV blackbody heater on at temp. 1
	11:23:16	683	823	Elevate to nadir (Earth)
Begin internal calibration sequence				
12/11/85	11:23:48	684	8A1	Begin internal calibration
↓	11:24:20	684	881	Detector bias heater off
	11:24:52	685	852	Solar port heaters off
	11:25:24	685	821	Elevate to internal source (stow)
	11:25:56	686	851	Solar port heaters on
	11:28:04	688	882	Detector bias heater on at level 1
↓	11:30:12	690	892	SWICS on at level 3

Table 8. Continued

(a) Continued

Date	Universal time		Hex command	Event description
	hr:min:sec	Minutes of day		
12/11/85 ↓	11:33:24	693	881	Detector bias heater off
	11:37:08	697	862	WFOV blackbody heater on at temp. 1
	11:37:40	698	872	MFOV blackbody heater on at temp. 1
	11:38:44	699	891	SWICS off
	11:52:04	712	883	Detector bias heater on at level 2
	11:54:12	714	893	SWICS on at level 2
	11:57:24	717	881	Detector bias heater off
	12:01:08	721	863	WFOV blackbody heater on at temp. 2
	12:01:40	722	873	MFOV blackbody heater on at temp. 2
	12:02:44	723	891	SWICS off
	12:16:04	736	884	Detector bias heater on at level 3
	12:18:12	738	894	SWICS on at level 1
	12:20:20	740	881	Detector bias heater off
	12:23:00	743	852	Solar port heaters off
	12:24:04	744	861	WFOV blackbody heater off
	12:24:36	745	871	MFOV blackbody heater off
	12:25:08	745	851	Solar port heaters on
12:25:40	746	891	SWICS off	
End internal calibration sequence.				
Begin azimuth angle load commands for solar calibration				
12/11/85 ↓	12:28:20	748	419	Address azimuth position A
	12:28:52	749	2xx	Data command, high byte
	12:29:24	749	1xx	Data command, low byte
End azimuth angle load commands (A = 131.7°).				
Begin solar calibration sequence				
12/11/85 ↓	12:29:56	750	8A2	Begin solar calibration
	12:30:28	750	852	Solar port heaters off
	12:31:00	751	822	Elevate to solar ports (Sun)
	12:31:32	752	814	Azimuth to position A
	12:32:04	752	882	Detector bias heater on at level 1
	12:41:40	762	851	Solar port heaters on
	12:42:12	762	831	SMA shutter cycle on
	13:13:08	793	832	SMA shutter cycle off
	13:13:40	794	852	Solar port heaters off
	13:14:12	794	813	Azimuth to 180°
	13:14:44	795	881	Detector bias heater off
	13:24:20	804	823	Elevate to nadir (Earth)
	13:24:52	805	851	Solar port heaters on
End solar calibration sequence.				
Begin azimuth angle load commands for 170°				
12/11/85 ↓	13:30:12	810	419	Address azimuth position A
	13:30:44	811	2xx	Data command, high byte
	13:31:16	811	1xx	Data command, low byte

Table 8. Continued

(a) Continued

Date	Universal time		Hex command	Event description
	hr:min:sec	Minutes of day		
End azimuth angle load commands ($A = 170.0^\circ$)				
12/11/85	13:31:48	812	814	Azimuth to position A
12/25/85 ↓	10:32:36	633	821	Elevate to internal source (stow)
	10:33:08	633	862	WFOV blackbody heater on at temp. 1
	10:48:36	649	872	MFOV blackbody heater on at temp. 1
Data dropout: missed all internal calibration commands and the first six solar calibration commands. Partial solar calibration sequence				
12/25/85 ↓	13:46:12	826	831	SMA shutter cycle on
	14:05:24	845	832	SMA shutter cycle off
	14:05:56	846	852	Solar port heaters off
	14:06:28	846	813	Azimuth to 180°
	14:07:00	847	881	Detector bias heater off
	14:16:36	857	823	Elevate to nadir (Earth)
	14:17:08	857	851	Solar port heaters on
End solar calibration sequence. Begin azimuth angle load commands for 170°				
12/25/85 ↓	14:22:28	862	419	Address azimuth position A
	14:23:00	863	2xx	Data command, high byte
	14:23:32	864	1xx	Data command, low byte
End azimuth angle load commands ($A = 170.0^\circ$)				
12/25/85	15:14:04	864	814	Azimuth to position A
01/22/86 ↓	10:36:21	636	821	Elevate to internal source (stow)
	10:36:53	637	862	WFOV blackbody heater on at temp. 1
	10:52:21	652	872	MFOV blackbody heater on at temp. 1
	12:19:17	739	823	Elevate to nadir (Earth)
Begin internal calibration sequence				
01/22/86 ↓	12:19:49	740	8A1	Begin internal calibration
	12:20:21	740	881	Detector bias heater off
	12:20:53	741	852	Solar port heaters off
	12:21:25	741	821	Elevate to internal source (stow)
	12:21:57	742	851	Solar port heaters on
	12:24:05	744	882	Detector bias heater on at level 1
	12:26:13	746	892	SWICS on at level 3
	12:29:25	749	881	Detector bias heater off
	12:33:09	753	862	WFOV blackbody heater on at temp. 1
	12:33:41	754	872	MFOV blackbody heater on at temp. 1
	12:34:45	755	891	SWICS off
	12:48:05	768	883	Detector bias heater on at level 2
	12:50:13	770	893	SWICS on at level 2
	12:53:25	773	881	Detector bias heater off
	12:57:09	777	863	WFOV blackbody heater on at temp. 2
	12:57:41	778	873	MFOV blackbody heater on at temp. 2

Table 8. Continued

(a) Concluded

Date	Universal time		Hex command	Event description
	hr:min:sec	Minutes of day		
01/22/86 ↓	12:58:45	779	891	SWICS off
	13:12:05	792	884	Detector bias heater on at level 3
	13:14:13	794	894	SWICS on at level 1
	13:16:21	796	881	Detector bias heater off
	13:19:01	799	852	Solar port heaters off
	13:20:05	800	861	WFOV blackbody heater off
	13:20:37	801	871	MFOV blackbody heater off
	13:21:09	801	851	Solar port heaters on
	13:21:41	802	891	SWICS off
End internal calibration sequence.				
Begin azimuth angle load commands for solar calibration				
01/22/86 ↓	13:24:21	804	419	Address azimuth position A
	13:24:53	805	2xx	Data command, high byte
	13:25:25	805	1xx	Data command, low byte
End azimuth angle load commands ($A = 128.25^\circ$).				
Begin solar calibration sequence				
01/22/86 ↓	13:25:57	806	8A2	Begin solar calibration
	13:26:29	806	852	Solar port heaters off
	13:27:01	807	822	Elevate to solar ports (Sun)
	13:27:33	808	814	Azimuth to position A
	13:28:05	808	882	Detector bias heater on at level 1
	13:37:41	818	851	Solar port heaters on
	13:38:13	818	831	SMA shutter cycle on
	14:09:09	849	832	SMA shutter cycle off
	14:09:41	850	852	Solar port heaters off
	14:10:13	850	813	Azimuth to 180°
	14:10:45	851	881	Detector bias heater off
	14:20:21	860	823	Elevate to nadir (Earth)
	14:20:53	861	851	Solar port heaters on
End solar calibration sequence.				
Begin azimuth angle load commands for 170°				
01/22/86 ↓	14:26:13	866	419	Address azimuth position A
	14:26:45	867	2xx	Data command, high byte
	14:27:17	867	1xx	Data command, low byte
End azimuth angle load commands ($A = 170.0^\circ$)				
01/22/86	14:27:49	868	814	Azimuth to position A

Table 8. Continued

(b) Scanner commands

Date	Universal time		Hex command	Event description
	hr:min:sec	Minutes of day		
Begin internal calibration sequence				
02/06/85 ↓	11:02:28	662	8A1	Begin internal calibration
	11:03:00	663	897	SWICS on at level 1 modulated
	11:04:36	665	895	SWICS on at level 2 modulated
	11:06:12	666	893	SWICS on at level 3 modulated
	11:07:48	668	891	SWICS off
	11:10:28	670	Pulse	Blackbody calibration heaters on
	11:11:00	671	897	SWICS on at level 1 modulated
	11:12:36	673	895	SWICS on at level 2 modulated
	11:14:12	674	893	SWICS on at level 3 modulated
	11:15:48	676	891	SWICS off
	11:34:28	694	Pulse	Blackbody calibration heaters off
	11:35:00	695	897	SWICS on at level 1 modulated
	11:36:36	697	895	SWICS on at level 2 modulated
	11:38:12	698	893	SWICS on at level 3 modulated
11:39:48	700	891	SWICS off	
End internal calibration sequence.				
Begin internal calibration sequence				
02/13/85 ↓	11:29:40	690	8A1	Begin internal calibration
	11:30:12	690	897	SWICS on at level 1 modulated
	11:31:48	692	895	SWICS on at level 2 modulated
	11:33:24	693	893	SWICS on at level 3 modulated
	11:35:00	695	891	SWICS off
	11:37:40	698	Pulse	Blackbody calibration heaters on
	11:38:12	698	897	SWICS on at level 1 modulated
	11:39:48	700	895	SWICS on at level 2 modulated
	11:41:24	701	893	SWICS on at level 3 modulated
	11:43:00	703	891	SWICS off
	12:01:40	722	Pulse	Blackbody calibration heaters off
	12:02:12	722	897	SWICS on at level 1 modulated
	12:03:48	724	895	SWICS on at level 2 modulated
	12:05:24	725	893	SWICS on at level 3 modulated
	12:07:00	727	891	SWICS off
	End internal calibration sequence.			
Begin internal calibration sequence				
02/14/85 ↓	14:25:40	866	8A1	Begin internal calibration
	14:26:12	866	897	SWICS on at level 1 modulated
	14:27:48	868	895	SWICS on at level 2 modulated
	14:29:24	869	893	SWICS on at level 3 modulated
	14:31:00	871	891	SWICS off
	14:33:40	874	Pulse	Blackbody calibration heaters on
	14:34:12	874	897	SWICS on at level 1 modulated

Table 8. Continued

(b) Continued

Date	Universal time		Hex command	Event description
	hr:min:sec	Minutes of day		
02/14/85 ↓	14:35:48	876	895	SWICS on at level 2 modulated
	14:37:24	877	893	SWICS on at level 3 modulated
	14:39:00	879	891	SWICS off
	14:57:40	898	Pulse	Blackbody calibration heaters on
	14:58:12	898	897	SWICS on at level 1 modulated
	14:59:48	900	895	SWICS on at level 2 modulated
	15:01:24	901	893	SWICS on at level 3 modulated
	15:03:00	903	891	SWICS off
End internal calibration sequence. Begin azimuth angle load commands for solar calibration				
02/14/85 ↓	15:44:04	944	419	Address azimuth position A
	15:44:36	945	2xx	Data command, high byte
	15:45:08	945	1xx	Data command, low byte
	15:45:40	946	41B	Address azimuth position B
	15:46:12	946	2xx	Data command, high byte
	15:46:44	947	1xx	Data command, low byte
End azimuth angle load commands (A = 108.53°, B = 123.53°). Begin solar calibration sequence				
02/14/85 ↓	15:47:16	947	8A2	Begin solar calibration
	15:47:48	948	824	Short scan mode
	15:48:20	948	811	Azimuth to 0°
	15:48:52	949	814	Azimuth to position A
	15:53:40	954	825	MAM (solar) scan mode
	15:59:00	959	815	Azimuth to position B
	16:05:24	965	814	Azimuth to position A
	16:10:44	971	824	Short scan mode
	16:11:16	971	811	Azimuth to 0°
	16:16:04	976	822	Normal scan mode
End solar calibration sequence. Begin internal calibration sequence				
02/20/85 ↓	10:15:00	615	8A1	Begin internal calibration
	10:15:32	616	897	SWICS on at level 1 modulated
	10:17:08	617	895	SWICS on at level 2 modulated
	10:18:44	619	893	SWICS on at level 3 modulated
	10:20:20	620	891	SWICS off
	10:23:00	623	Pulse	Blackbody calibration heaters on
	10:23:32	624	897	SWICS on at level 1 modulated
	10:25:08	625	895	SWICS on at level 2 modulated
	10:26:44	627	893	SWICS on at level 3 modulated
	10:28:20	628	891	SWICS off
	10:47:00	647	Pulse	Blackbody calibration heaters off
	10:47:32	648	897	SWICS on at level 1 modulated
	10:49:08	649	895	SWICS on at level 2 modulated
	10:50:44	651	893	SWICS on at level 3 modulated
	10:52:20	652	891	SWICS off
End internal calibration sequence				

Table 8. Continued

(b) Continued

Date	Universal time		Hex command	Event description
	hr:min:sec	Minutes of day		
Begin azimuth angle load commands for solar calibration				
02/20/85 ↓	14:40:04	880	419	Address azimuth position A
	14:40:36	881	2xx	Data command, high byte
	14:41:08	881	1xx	Data command, low byte
	14:41:40	882	41B	Address azimuth position B
	14:42:12	882	2xx	Data command, high byte
	14:42:44	883	1xx	Data command, low byte
End azimuth angle load commands (A = 108.53°, B = 123.53°).				
Begin solar calibration sequence				
02/20/85 ↓	14:43:16	883	8A2	Begin solar calibration
	14:43:48	884	824	Short scan mode
	14:44:20	884	811	Azimuth to 0°
	14:44:52	885	814	Azimuth to position A
	14:49:40	890	825	MAM (solar) scan mode
	14:55:00	895	815	Azimuth to position B
	15:01:24	901	814	Azimuth to position A
	15:06:44	907	824	Short scan mode
	15:07:16	907	811	Azimuth to 0°
	15:12:04	912	822	Normal scan mode
End solar calibration sequence.				
Begin internal calibration sequence				
03/06/85 ↓	09:27:32	568	8A1	Begin internal calibration
	09:28:04	568	897	SWICS on at level 1 modulated
	09:29:40	570	895	SWICS on at level 2 modulated
	09:31:16	571	893	SWICS on at level 3 modulated
	09:32:52	573	891	SWICS off
	09:35:32	576	Pulse	Blackbody calibration heaters on
	09:36:04	576	897	SWICS on at level 1 modulated
	09:37:40	578	895	SWICS on at level 2 modulated
	09:39:16	579	893	SWICS on at level 3 modulated
	09:40:52	581	891	SWICS off
	09:59:32	600	Pulse	Blackbody calibration heaters off
	10:00:04	600	897	SWICS on at level 1 modulated
	10:01:40	602	895	SWICS on at level 2 modulated
	10:03:16	603	893	SWICS on at level 3 modulated
10:04:52	605	891	SWICS off	
End internal calibration sequence.				
Begin azimuth angle load commands for solar calibration				
03/06/85 ↓	13:53:08	833	419	Address azimuth position A
	13:53:40	834	2xx	Data command, high byte
	13:54:12	834	1xx	Data command, low byte
	13:54:44	835	41B	Address azimuth position B
	13:55:16	835	2xx	Data command, high byte
	13:55:48	836	1xx	Data command, low byte
End azimuth angle load commands (A = 108.83°, B = 123.83°)				

Table 8. Continued

(b) Continued

Date	Universal time		Hex command	Event description
	hr:min:sec	Minutes of day		
Begin solar calibration sequence				
03/06/85 ↓	13:56:20	836	8A2	Begin solar calibration
	13:56:52	837	824	Short scan mode
	13:57:24	837	811	Azimuth to 0°
	13:57:56	838	814	Azimuth to position A
	14:02:44	843	825	MAM (solar) scan mode
	14:08:04	848	815	Azimuth to position B
	14:14:28	854	814	Azimuth to position A
	14:19:48	860	824	Short scan mode
	14:20:20	860	811	Azimuth to 0°
	14:25:08	865	822	Normal scan mode
End solar calibration sequence				
03/20/85	01:18:28	78	821	Scan to stow
Begin azimuth angle load commands for solar calibration				
03/20/85 ↓	14:47:32	888	419	Address azimuth position A
	14:48:04	888	2xx	Data command, high byte
	14:48:36	889	1xx	Data command, low byte
	14:49:08	889	41B	Address azimuth position B
	14:49:40	890	2xx	Data command, high byte
14:50:12	890	1xx	Data command, low byte	
End azimuth angle load commands (A = 109.05°, B = 124.05°).				
Begin solar calibration sequence				
03/20/85 ↓	14:50:44	891	8A2	Begin solar calibration
	14:51:16	891	824	Short scan mode
	14:51:48	892	811	Azimuth to 0°
	14:52:20	892	814	Azimuth to position A
	14:57:08	897	825	MAM (solar) scan mode
	15:02:28	902	815	Azimuth to position B
	15:08:52	909	814	Azimuth to position A
	15:14:12	914	824	Short scan mode
	15:14:44	915	811	Azimuth to 0°
	15:19:32	920	822	Normal scan mode
End solar calibration sequence.				
Begin internal calibration sequence				
04/03/85 ↓	14:41:40	882	8A1	Begin internal calibration
	14:42:12	882	897	SWICS on at level 1 modulated
	14:43:48	884	895	SWICS on at level 2 modulated
	14:45:24	885	893	SWICS on at level 3 modulated
	14:47:00	887	891	SWICS off
	14:49:40	890	Pulse	Blackbody calibration heaters on
	14:50:12	890	897	SWICS on at level 1 modulated
	14:51:48	892	895	SWICS on at level 2 modulated
	14:53:24	893	893	SWICS on at level 3 modulated

Table 8. Continued

(b) Continued

Date	Universal time		Hex command	Event description
	hr:min:sec	Minutes of day		
04/03/85 ↓	14:55:00	895	891	SWICS off
	14:13:40	914	Pulse	Blackbody calibration heaters off
	15:14:12	914	897	SWICS on at level 1 modulated
	15:15:48	916	895	SWICS on at level 2 modulated
	15:17:24	917	893	SWICS on at level 3 modulated
	15:19:00	919	891	SWICS off
End internal calibration sequence. Begin azimuth angle load commands for solar calibration				
04/03/85 ↓	19:06:44	1147	419	Address azimuth position A
	19:07:16	1147	2xx	Data command, high byte
	19:07:48	1148	1xx	Data command, low byte
	19:08:20	1148	41B	Address azimuth position B
	19:08:52	1149	2xx	Data command, high byte
	19:09:24	1149	1xx	Data command, low byte
End azimuth angle load commands (A = 108.98°, B = 123.98°). Begin solar calibration sequence				
04/03/85 ↓	19:09:56	1150	8A2	Begin solar calibration
	19:10:28	1150	824	Short scan mode
	19:11:00	1151	811	Azimuth to 0°
	19:11:32	1152	814	Azimuth to position A
	19:16:20	1156	825	MAM (solar) scan mode
	19:21:40	1162	815	Azimuth to position B
	19:28:04	1168	814	Azimuth to position A
	19:33:24	1173	824	Short scan mode
	19:33:56	1174	811	Azimuth to 0°
19:38:44	1179	822	Normal scan mode	
End solar calibration sequence. Begin internal calibration sequence				
04/17/85 ↓	10:29:56	630	8A1	Begin internal calibration
	10:30:28	630	897	SWICS on at level 1 modulated
	10:32:04	632	895	SWICS on at level 2 modulated
	10:33:40	634	893	SWICS on at level 3 modulated
	10:35:16	635	891	SWICS off
	10:37:56	638	Pulse	Blackbody calibration heaters on
	10:38:28	638	897	SWICS on at level 1 modulated
	10:40:04	640	895	SWICS on at level 2 modulated
	10:41:40	642	893	SWICS on at level 3 modulated
	10:43:16	643	891	SWICS off
	11:01:56	662	Pulse	Blackbody calibration heaters off
	11:02:28	662	897	SWICS on at level 1 modulated
	11:04:04	664	895	SWICS on at level 2 modulated
	11:05:40	666	893	SWICS on at level 3 modulated
11:07:16	667	891	SWICS off	
End internal calibration sequence				

Table 8. Continued

(b) Continued

Date	Universal time		Hex command	Event description
	hr:min:sec	Minutes of day		
Begin azimuth angle load commands for solar calibration				
04/17/85 ↓	14:55:32	896	419	Address azimuth position A
	14:56:04	896	2xx	Data command, high byte
	14:56:36	897	1xx	Data command, low byte
	14:57:08	897	41B	Address azimuth position B
	14:57:40	898	2xx	Data command, high byte
	14:58:12	898	1xx	Data command, low byte
End azimuth angle load commands (A = 108.6°, B = 123.6°).				
Begin solar calibration sequence				
04/17/85 ↓	14:58:44	899	8A2	Begin solar calibration
	14:59:16	899	824	Short scan mode
	14:59:48	900	811	Azimuth to 0°
	15:00:20	900	814	Azimuth to position A
	15:05:08	905	825	MAM (solar) scan mode
	15:10:28	910	815	Azimuth to position B
	15:16:52	917	814	Azimuth to position A
	15:22:12	922	824	Short scan mode
	15:22:44	923	811	Azimuth to 0°
15:27:32	928	822	Normal scan mode	
End solar calibration sequence.				
Begin internal calibration sequence				
05/08/85 ↓	10:09:40	610	8A1	Begin internal calibration
	10:10:12	610	897	SWICS on at level 1 modulated
	10:11:48	612	895	SWICS on at level 2 modulated
	10:13:24	613	893	SWICS on at level 3 modulated
	10:15:00	615	891	SWICS off
	10:17:40	618	Pulse	Blackbody calibration heaters on
	10:18:12	618	897	SWICS on at level 1 modulated
	10:19:48	620	895	SWICS on at level 2 modulated
	10:21:24	621	893	SWICS on at level 3 modulated
	10:23:00	623	891	SWICS off
	10:41:40	642	Pulse	Blackbody calibration heaters off
	10:42:12	642	897	SWICS on at level 1 modulated
	10:43:48	644	895	SWICS on at level 2 modulated
	10:45:24	645	893	SWICS on at level 3 modulated
10:47:00	647	891	SWICS off	
End internal calibration sequence.				
Begin azimuth angle load commands for solar calibration				
05/08/85 ↓	14:34:44	875	419	Address azimuth position A
	14:35:16	875	2xx	Data command, high byte
	14:35:48	876	1xx	Data command, low byte

Table 8. Continued

(b) Continued

Date	Universal time		Hex command	Event description
	hr:min:sec	Minutes of day		
05/08/85 ↓	14:36:20	876	41B	Address azimuth position B
	14:36:52	877	2xx	Data command, high byte
	14:37:24	877	1xx	Data command, low byte
End azimuth angle load commands (A = 107.18°, B = 122.18°). Begin solar calibration sequence				
05/08/85 ↓	14:37:56	878	8A2	Begin solar calibration
	14:38:28	878	824	Short scan mode
	14:39:00	879	811	Azimuth to 0°
	14:39:32	880	814	Azimuth to position A
	14:44:20	884	825	MAM (solar) scan mode
	14:49:40	890	815	Azimuth to position B
	14:56:04	896	814	Azimuth to position A
	15:01:24	901	824	Short scan mode
	15:01:56	902	811	Azimuth to 0°
15:06:44	907	822	Normal scan mode	
End solar calibration sequence. Begin internal calibration sequence				
05/29/85 ↓	09:47:48	588	8A1	Begin internal calibration
	09:48:20	588	897	SWICS on at level 1 modulated
	09:49:56	590	895	SWICS on at level 2 modulated
	09:51:32	592	893	SWICS on at level 3 modulated
	09:53:08	593	891	SWICS off
	09:55:48	596	Pulse	Blackbody calibration heaters on
	09:56:20	596	897	SWICS on at level 1 modulated
	09:57:56	598	895	SWICS on at level 2 modulated
	09:59:32	600	893	SWICS on at level 3 modulated
	10:01:08	601	891	SWICS off
	10:19:48	620	Pulse	Blackbody calibration heaters off
	10:20:20	620	897	SWICS on at level 1 modulated
	10:21:56	622	895	SWICS on at level 2 modulated
	10:23:32	624	893	SWICS on at level 3 modulated
10:25:08	625	891	SWICS off	
End internal calibration sequence. Begin azimuth angle load commands for solar calibration				
05/29/85 ↓	14:13:24	853	419	Address azimuth position A
	14:13:56	854	2xx	Data command, high byte
	14:14:28	854	1xx	Data command, low byte
	14:15:00	855	41B	Address azimuth position B
	14:15:32	856	2xx	Data command, high byte
14:16:04	856	1xx	Data command, low byte	
End azimuth angle load commands (A = 105.38°, B = 120.38°)				

Table 8. Continued

(b) Continued

Date	Universal time		Hex command	Event description
	hr:min:sec	Minutes of day		
Begin solar calibration sequence				
05/29/85 ↓	14:16:36	857	8A2	Begin solar calibration
	14:17:08	857	824	Short scan mode
	14:17:40	858	811	Azimuth to 0°
	14:18:12	858	814	Azimuth to position A
	14:23:00	863	825	MAM (solar) scan mode
	14:28:20	868	815	Azimuth to position B
	14:34:44	875	814	Azimuth to position A
	14:40:04	880	824	Short scan mode
	14:40:36	881	811	Azimuth to 0°
14:45:24	885	822	Normal scan mode	
End solar calibration sequence.				
Begin internal calibration sequence				
06/12/85 ↓	10:41:09	641	8A1	Begin internal calibration
	10:41:41	642	897	SWICS on at level 1 modulated
	10:43:17	643	895	SWICS on at level 2 modulated
	10:44:53	645	893	SWICS on at level 3 modulated
	10:46:29	646	891	SWICS off
	10:47:09	649	Pulse	Blackbody calibration heaters on
	10:49:41	650	897	SWICS on at level 1 modulated
	10:51:17	651	895	SWICS on at level 2 modulated
	10:52:53	653	893	SWICS on at level 3 modulated
	10:54:29	654	891	SWICS off
	11:13:09	673	Pulse	Blackbody calibration heaters off
	11:13:41	674	897	SWICS on at level 1 modulated
	11:15:17	675	895	SWICS on at level 2 modulated
	11:16:53	677	893	SWICS on at level 3 modulated
11:18:29	678	891	SWICS off	
End internal calibration sequence.				
Begin azimuth angle load commands for solar calibration				
06/12/85 ↓	15:06:13	906	419	Address azimuth position A
	15:06:45	907	2xx	Data command, high byte
	15:07:17	907	1xx	Data command, low byte
	15:07:49	908	41B	Address azimuth position B
	15:08:21	908	2xx	Data command, high byte
15:08:53	909	1xx	Data command, low byte	
End azimuth angle load commands (A = 104.33°, B = 119.33°).				
Begin solar calibration sequence				
06/12/85 ↓	15:09:25	909	8A2	Begin solar calibration
	15:09:57	910	824	Short scan mode
	15:10:29	910	811	Azimuth to 0°
	15:11:01	911	814	Azimuth to position A

Table 8. Continued

(b) Continued

Date	Universal time		Hex command	Event description
	hr:min:sec	Minutes of day		
06/12/85 ↓	15:15:49	916	825	MAM (solar) scan mode
	15:21:09	921	815	Azimuth to position B
	15:27:33	928	814	Azimuth to position A
	15:32:53	933	824	Short scan mode
	15:33:25	933	811	Azimuth to 0°
	15:38:13	938	822	Normal scan mode
End solar calibration sequence. Begin internal calibration sequence				
06/26/85 ↓	09:52:05	592	8A1	Begin internal calibration
	09:52:37	593	897	SWICS on at level 1 modulated
	09:54:13	594	895	SWICS on at level 2 modulated
	09:55:49	596	893	SWICS on at level 3 modulated
	09:57:25	597	891	SWICS off
	10:00:05	600	Pulse	Blackbody calibration heaters on
	10:00:37	601	897	SWICS on at level 1 modulated
	10:02:13	602	895	SWICS on at level 2 modulated
	10:03:49	604	893	SWICS on at level 3 modulated
	10:05:25	605	891	SWICS off
	10:24:05	624	Pulse	Blackbody calibration heaters off
	10:24:37	625	897	SWICS on at level 1 modulated
	10:26:13	626	895	SWICS on at level 2 modulated
	10:27:49	628	893	SWICS on at level 3 modulated
10:29:25	629	891	SWICS off	
End internal calibration sequence. Begin azimuth angle load commands for solar calibration				
06/26/85 ↓	14:17:09	857	419	Address azimuth position A
	14:17:41	858	2xx	Data command, high byte
	14:18:13	858	1xx	Data command, low byte
	14:18:45	859	41B	Address azimuth position B
	14:19:17	859	2xx	Data command, high byte
	14:19:49	860	1xx	Data command, low byte
End azimuth angle load commands (A = 103.73°, B = 118.73°). Begin solar calibration sequence				
06/26/85 ↓	14:20:21	860	8A2	Begin solar calibration
	14:20:53	861	824	Short scan mode
	14:21:25	861	811	Azimuth to 0°
	14:21:57	862	814	Azimuth to position A
	14:26:45	867	825	MAM (solar) scan mode
	14:32:05	872	815	Azimuth to position B
	14:38:29	878	814	Azimuth to position A
	14:43:49	884	824	Short scan mode
	14:44:21	884	811	Azimuth to 0°
	14:49:09	889	822	Normal scan mode
End solar calibration sequence				

Table 8. Continued

(b) Continued

Date	Universal time		Hex command	Event description
	hr:min:sec	Minutes of day		
Begin internal calibration sequence				
07/10/85 ↓	10:44:20	644	8A1	Begin internal calibration
	10:44:52	645	897	SWICS on at level 1 modulated
	10:46:28	646	895	SWICS on at level 2 modulated
	10:48:04	648	893	SWICS on at level 3 modulated
	10:49:40	650	891	SWICS off
	10:52:20	652	Pulse	Blackbody calibration heaters on
	10:52:52	653	897	SWICS on at level 1 modulated
	10:54:28	654	895	SWICS on at level 2 modulated
	10:56:04	656	893	SWICS on at level 3 modulated
	10:57:40	658	891	SWICS off
	11:16:20	676	Pulse	Blackbody calibration heaters off
	11:16:52	677	897	SWICS on at level 1 modulated
	11:18:28	678	895	SWICS on at level 2 modulated
	11:20:04	680	893	SWICS on at level 3 modulated
11:21:40	682	891	SWICS off	
End internal calibration sequence.				
Begin azimuth angle load commands for solar calibration				
07/10/85 ↓	15:09:24	909	419	Address azimuth position A
	15:09:56	910	2xx	Data command, high byte
	15:10:28	910	1xx	Data command, low byte
	15:11:00	911	41B	Address azimuth position B
	15:11:32	912	2xx	Data command, high byte
	15:12:04	912	1xx	Data command, low byte
End azimuth angle load commands (A = 103.8°, B = 118.8°).				
Begin solar calibration sequence				
07/10/85 ↓	15:12:36	913	8A2	Begin solar calibration
	15:13:08	913	824	Short scan mode
	15:13:40	914	811	Azimuth to 0°
	15:14:12	914	814	Azimuth to position A
	15:19:00	919	825	MAM (solar) scan mode
	15:24:20	924	815	Azimuth to position B
	15:30:44	931	814	Azimuth to position A
	15:36:04	936	824	Short scan mode
	15:36:36	937	811	Azimuth to 0°
	15:41:24	941	822	Normal scan mode
End solar calibration sequence.				
Begin internal calibration sequence				
07/24/85 ↓	09:54:12	594	8A1	Begin internal calibration
	09:54:44	595	897	SWICS on at level 1 modulated
	09:56:20	596	895	SWICS on at level 2 modulated
	09:57:56	598	893	SWICS on at level 3 modulated
	09:59:32	600	891	SWICS off

Table 8. Continued

(b) Continued

Date	Universal time		Hex command	Event description
	hr:min:sec	Minutes of day		
07/24/85 ↓	10:02:12	602	Pulse	Blackbody calibration heaters on
	10:02:44	603	897	SWICS on at level 1 modulated
	10:04:20	604	895	SWICS on at level 2 modulated
	10:05:56	606	893	SWICS on at level 3 modulated
	10:07:32	608	891	SWICS off
	10:26:12	626	Pulse	Blackbody calibration heaters off
	10:26:44	627	897	SWICS on at level 1 modulated
	10:28:20	628	895	SWICS on at level 2 modulated
	10:29:56	630	893	SWICS on at level 3 modulated
	10:31:32	632	891	SWICS off
End internal calibration sequence. Begin azimuth angle load commands for solar calibration				
07/24/85 ↓	14:19:48	860	419	Address azimuth position A
	14:20:20	860	2xx	Data command, high byte
	14:20:52	861	1xx	Data command, low byte
	14:21:24	861	41B	Address azimuth position B
	14:21:56	862	2xx	Data command, high byte
	14:22:28	862	1xx	Data command, low byte
End azimuth angle load commands (A = 104.7°, B = 119.7°). Begin solar calibration sequence				
07/24/85 ↓	14:23:00	863	8A2	Begin solar calibration
	14:23:32	864	824	Short scan mode
	14:24:04	864	811	Azimuth to 0°
	14:24:36	865	814	Azimuth to position A
	14:29:24	869	825	MAM (solar) scan mode
	14:34:44	875	815	Azimuth to position B
	14:41:08	881	814	Azimuth to position A
	14:46:28	886	824	Short scan mode
	14:47:00	887	811	Azimuth to 0°
	14:51:48	892	822	Normal scan mode
End solar calibration sequence. Begin along-track operation during data dropout				
08/03/85	00:00:04		812	Azimuth to 90°
Begin internal calibration sequence				
08/07/85 ↓	10:45:56	646	8A1	Begin internal calibration
	10:46:28	646	897	SWICS on at level 1 modulated
	10:48:04	648	895	SWICS on at level 2 modulated
	10:49:40	650	893	SWICS on at level 3 modulated
	10:51:16	651	891	SWICS off
	10:53:56	654	Pulse	Blackbody calibration heaters on
	10:54:28	654	897	SWICS on at level 1 modulated
	10:56:04	656	895	SWICS on at level 2 modulated
		10:57:40	658	893

Table 8. Continued

(b) Continued

Date	Universal time		Hex command	Event description
	hr:min:sec	Minutes of day		
08/07/85 ↓	10:59:16	659	891	SWICS off
	11:17:56	678	Pulse	Blackbody calibration heaters off
	11:18:28	678	897	SWICS on at level 1 modulated
	11:20:04	680	895	SWICS on at level 2 modulated
	11:21:40	682	893	SWICS on at level 3 modulated
	11:23:16	683	891	SWICS off
End internal calibration sequence				
08/09/85	14:33:40	874	811	Azimuth to 0°
Resume cross-track operation. Begin internal calibration sequence				
08/21/85 ↓	09:55:48	596	8A1	Begin internal calibration
	09:56:20	596	897	SWICS on at level 1 modulated
	09:57:56	598	895	SWICS on at level 2 modulated
	09:59:32	600	893	SWICS on at level 3 modulated
	10:01:08	601	891	SWICS off
	10:03:48	604	Pulse	Blackbody calibration heaters on
	10:04:20	604	897	SWICS on at level 1 modulated
	10:05:56	606	895	SWICS on at level 2 modulated
	10:07:32	608	893	SWICS on at level 3 modulated
	10:09:08	609	891	SWICS off
	10:27:48	628	Pulse	Blackbody calibration heaters off
	10:28:20	628	897	SWICS on at level 1 modulated
	10:29:56	630	895	SWICS on at level 2 modulated
	10:31:32	632	893	SWICS on at level 3 modulated
	10:33:08	633	891	SWICS off
End internal calibration sequence. Begin azimuth angle load commands for solar calibration				
08/21/85 ↓	14:20:52	861	419	Address azimuth position A
	14:21:24	861	2xx	Data command, high byte
	14:21:56	862	1xx	Data command, low byte
	14:22:28	862	41B	Address azimuth position B
	14:23:00	863	2xx	Data command, high byte
14:23:32	864	1xx	Data command, low byte	
End azimuth angle load commands (A = 108.6°, B = 123.6°). Begin solar calibration sequence				
08/21/85 ↓	14:24:04	864	8A2	Begin solar calibration
	14:24:36	865	824	Short scan mode
	14:25:08	865	811	Azimuth to 0°
	14:25:40	866	814	Azimuth to position A
	14:30:28	870	825	MAM (solar) scan mode
	14:35:48	876	815	Azimuth to position B
	14:42:12	882	814	Azimuth to position A
	14:47:32	888	824	Short scan mode
	14:48:04	888	811	Azimuth to 0°
	14:52:52	893	822	Normal scan mode
End solar calibration sequence				

Table 8. Continued

(b) Continued

Date	Universal time		Hex command	Event description
	hr:min:sec	Minutes of day		
Begin internal calibration sequence				
09/04/85 ↓	10:47:00	647	8A1	Begin internal calibration
	10:47:32	648	897	SWICS on at level 1 modulated
	10:49:08	649	895	SWICS on at level 2 modulated
	10:50:44	651	893	SWICS on at level 3 modulated
	10:52:20	652	891	SWICS off
	10:55:00	655	Pulse	Blackbody calibration heaters on
	10:55:32	656	897	SWICS on at level 1 modulated
	10:57:08	657	895	SWICS on at level 2 modulated
	10:58:44	659	893	SWICS on at level 3 modulated
	11:00:20	660	891	SWICS off
	11:19:00	679	Pulse	Blackbody calibration heaters off
	11:19:32	680	897	SWICS on at level 1 modulated
	11:21:08	681	895	SWICS on at level 2 modulated
	11:22:44	683	893	SWICS on at level 3 modulated
	11:24:20	684	891	SWICS off
End internal calibration sequence.				
Begin azimuth angle load commands for solar calibration				
09/04/85 ↓	15:12:36	913	419	Address azimuth position A
	15:13:08	913	2xx	Data command, high byte
	15:13:40	914	1xx	Data command, low byte
	15:14:12	914	41B	Address azimuth position B
	15:14:44	915	2xx	Data command, high byte
	15:15:16	915	1xx	Data command, low byte
End azimuth angle load commands (A = 111.3°, B = 126.3°).				
Begin solar calibration sequence				
09/04/85 ↓	15:15:48	916	8A2	Begin solar calibration
	15:16:20	916	824	Short scan mode
	15:16:52	917	811	Azimuth to 0°
	15:17:24	917	814	Azimuth to position A
	15:22:12	922	825	MAM (solar) scan mode
	15:27:32	928	815	Azimuth to position B
	15:33:56	934	814	Azimuth to position A
	15:39:16	939	824	Short scan mode
	15:39:48	940	811	Azimuth to 0°
	15:44:36	945	822	Normal scan mode
End solar calibration sequence.				
Begin internal calibration sequence				
09/18/85 ↓	09:56:20	596	8A1	Begin internal calibration
	09:56:52	597	897	SWICS on at level 1 modulated
	09:58:28	598	895	SWICS on at level 2 modulated
	10:00:04	600	893	SWICS on at level 3 modulated

Table 8. Continued

(b) Continued

Date	Universal time		Hex command	Event description
	hr:min:sec	Minutes of day		
09/18/85 ↓	10:01:40	602	891	SWICS off
	10:04:20	604	Pulse	Blackbody calibration heaters on
	10:04:52	605	897	SWICS on at level 1 modulated
	10:06:28	606	895	SWICS on at level 2 modulated
	10:08:04	608	893	SWICS on at level 3 modulated
	10:09:40	610	891	SWICS off
	10:28:20	628	Pulse	Blackbody calibration heaters off
	10:28:52	629	897	SWICS on at level 1 modulated
	10:30:28	630	895	SWICS on at level 2 modulated
	10:32:04	632	893	SWICS on at level 3 modulated
10:33:40	634	891	SWICS off	
End internal calibration sequence. Begin azimuth angle load commands for solar calibration				
09/18/85 ↓	14:21:24	861	419	Address azimuth position A
	14:21:56	862	2xx	Data command, high byte
	14:22:28	862	1xx	Data command, low byte
	14:23:00	863	41B	Address azimuth position B
	14:23:32	864	2xx	Data command, high byte
14:24:04	864	1xx	Data command, low byte	
End azimuth angle load commands (A = 114.08°, B = 129.08°). Begin solar calibration sequence				
09/18/85 ↓	14:24:36	865	8A2	Begin solar calibration
	14:25:08	865	824	Short scan mode
	14:25:40	866	811	Azimuth to 0°
	14:26:12	866	814	Azimuth to position A
	14:31:00	871	825	MAM (solar) scan mode
	14:36:20	876	815	Azimuth to position B
	14:42:44	883	814	Azimuth to position A
	14:48:04	888	824	Short scan mode
	14:48:36	889	811	Azimuth to 0°
14:53:24	893	822	Normal scan mode	
End solar calibration sequence. Begin internal calibration sequence				
10/02/85 ↓	10:47:00	647	8A1	Begin internal calibration
	10:47:32	648	897	SWICS on at level 1 modulated
	10:49:08	649	895	SWICS on at level 2 modulated
	10:50:44	651	893	SWICS on at level 3 modulated
	10:52:20	652	891	SWICS off
	10:55:00	655	Pulse	Blackbody calibration heaters on
	10:55:32	656	897	SWICS on at level 1 modulated
	10:57:08	657	895	SWICS on at level 2 modulated
	10:58:44	659	893	SWICS on at level 3 modulated
	11:00:20	660	891	SWICS off

Table 8. Continued

(b) Continued

Date	Universal time		Hex command	Event description
	hr:min:sec	Minutes of day		
10/02/85 ↓	11:19:00	679	Pulse	Blackbody calibration heaters off
	11:19:32	680	897	SWICS on at level 1 modulated
	11:21:08	681	895	SWICS on at level 2 modulated
	11:22:44	683	893	SWICS on at level 3 modulated
	11:24:20	684	891	SWICS off
End internal calibration sequence. Begin azimuth angle load commands for solar calibration				
10/02/85 ↓	15:12:36	913	419	Address azimuth position A
	15:13:08	913	2xx	Data command, high byte
	15:13:40	914	1xx	Data command, low byte
	15:14:12	914	41B	Address azimuth position B
	15:14:44	915	2xx	Data command, high byte
	15:15:16	915	1xx	Data command, low byte
End azimuth angle load commands (A = 116.55°, B = 131.55°). Begin solar calibration sequence				
10/02/85 ↓	15:15:48	916	8A2	Begin solar calibration
	15:16:20	916	824	Short scan mode
	15:16:52	917	811	Azimuth to 0°
	15:17:24	917	814	Azimuth to position A
	15:22:12	922	825	MAM (solar) scan mode
	15:27:32	928	815	Azimuth to position B
	15:33:56	934	814	Azimuth to position A
	15:39:16	939	824	Short scan mode
	15:39:48	940	811	Azimuth to 0°
	15:44:36	945	822	Normal scan mode
End solar calibration sequence. Begin internal calibration sequence				
10/16/85 ↓	09:55:48	596	8A1	Begin internal calibration
	09:56:20	596	897	SWICS on at level 1 modulated
	09:57:56	598	895	SWICS on at level 2 modulated
	09:59:32	600	893	SWICS on at level 3 modulated
	10:01:08	601	891	SWICS off
	10:03:48	604	Pulse	Blackbody calibration heaters on
	10:04:20	604	897	SWICS on at level 1 modulated
	10:05:56	606	895	SWICS on at level 2 modulated
	10:07:32	608	893	SWICS on at level 3 modulated
	10:09:08	609	891	SWICS off
	10:27:48	628	Pulse	Blackbody calibration heaters off
	10:28:20	628	897	SWICS on at level 1 modulated
	10:29:56	630	895	SWICS on at level 2 modulated
	10:31:32	632	893	SWICS on at level 3 modulated
	10:33:08	633	891	SWICS off
End internal calibration sequence				

Table 8. Continued

(b) Continued

Date	Universal time		Hex command	Event description
	hr:min:sec	Minutes of day		
Begin azimuth angle load commands for solar calibration				
10/16/85 ↓	14:21:24	861	419	Address azimuth position A
	14:21:56	862	2xx	Data command, high byte
	14:22:28	862	1xx	Data command, low byte
	14:23:00	863	41B	Address azimuth position B
	14:23:32	864	2xx	Data command, high byte
	14:24:04	864	1xx	Data command, low byte
End azimuth angle load commands (A = 118.28°, B = 133.28°).				
Begin solar calibration sequence				
10/16/85 ↓	14:24:36	865	8A2	Begin solar calibration
	14:25:08	865	824	Short scan mode
	14:25:40	866	811	Azimuth to 0°
	14:26:12	866	814	Azimuth to position A
	14:31:00	871	825	MAM (solar) scan mode
	14:36:20	876	815	Azimuth to position B
	14:42:44	883	814	Azimuth to position A
	14:48:04	888	824	Short scan mode
	14:48:36	889	811	Azimuth to 0°
	14:53:24	893	822	Normal scan mode
End solar calibration sequence.				
Begin internal calibration sequence				
10/30/85 ↓	10:47:00	647	8A1	Begin internal calibration
	10:47:32	648	897	SWICS on at level 1 modulated
	10:49:08	649	895	SWICS on at level 2 modulated
	10:50:44	651	893	SWICS on at level 3 modulated
	10:52:20	652	891	SWICS off
	10:55:00	655	Pulse	Blackbody calibration heaters on
	10:55:32	656	897	SWICS on at level 1 modulated
	10:57:08	657	895	SWICS on at level 2 modulated
	10:58:44	659	893	SWICS on at level 3 modulated
	11:00:20	660	891	SWICS off
	11:19:00	679	Pulse	Blackbody calibration heaters off
	11:19:32	680	897	SWICS on at level 1 modulated
	11:21:08	681	895	SWICS on at level 2 modulated
	11:22:44	683	893	SWICS on at level 3 modulated
	11:24:20	684	891	SWICS off
End internal calibration sequence.				
Begin azimuth angle load commands for solar calibration				
10/30/85 ↓	15:12:04	912	419	Address azimuth position A
	15:12:36	913	2xx	Data command, high byte
	15:13:08	913	1xx	Data command, low byte
	15:13:40	914	41B	Address azimuth position B
	15:14:12	914	2xx	Data command, high byte
	15:14:44	915	1xx	Data command, low byte
End azimuth angle load commands (A = 119.1°, B = 134.1°)				

Table 8. Continued

(b) Continued

Date	Universal time		Hex command	Event description
	hr:min:sec	Minutes of day		
Begin solar calibration sequence				
10/30/85 ↓	15:15:16	915	8A2	Begin solar calibration
	15:15:48	916	824	Short scan mode
	15:16:20	916	811	Azimuth to 0°
	15:16:52	917	814	Azimuth to position A
	15:21:40	922	825	MAM (solar) scan mode
	15:27:00	927	815	Azimuth to position B
	15:33:24	933	814	Azimuth to position A
	15:38:44	939	824	Short scan mode
	15:39:16	939	811	Azimuth to 0°
Data dropout: no commands were missed				
10/30/85	17:24:20	1044	822	Normal scan mode
End solar calibration sequence. Begin internal calibration sequence				
11/13/85 ↓	09:55:48	596	8A1	Begin internal calibration
	09:56:20	596	897	SWICS on at level 1 modulated
	09:57:56	598	895	SWICS on at level 2 modulated
	09:59:32	600	893	SWICS on at level 3 modulated
	10:01:08	601	891	SWICS off
	10:03:48	604	Pulse	Blackbody calibration heaters on
	10:04:20	604	897	SWICS on at level 1 modulated
	10:05:56	606	895	SWICS on at level 2 modulated
	10:07:32	608	893	SWICS on at level 3 modulated
	10:09:08	609	891	SWICS off
	10:27:48	628	Pulse	Blackbody calibration heaters off
	10:28:20	628	897	SWICS on at level 1 modulated
	10:29:56	630	895	SWICS on at level 2 modulated
	10:31:32	632	893	SWICS on at level 3 modulated
	10:33:08	633	891	SWICS off
End internal calibration sequence. Begin azimuth angle load commands for solar calibration				
11/13/85 ↓	14:20:52	861	419	Address azimuth position A
	14:21:24	861	2xx	Data command, high byte
	14:21:56	862	1xx	Data command, low byte
	14:22:28	862	41B	Address azimuth position B
	14:23:00	863	2xx	Data command, high byte
	14:23:32	864	1xx	Data command, low byte
End azimuth angle load commands (A = 118.88°, B = 133.88°). Begin solar calibration sequence				
11/13/85 ↓	14:24:04	864	8A2	Begin solar calibration
	14:24:36	865	824	Short scan mode
	14:25:08	865	811	Azimuth to 0°
	14:25:40	866	814	Azimuth to position A

Table 8. Continued

(b) Continued

Date	Universal time		Hex command	Event description
	hr:min:sec	Minutes of day		
11/13/85 ↓	14:30:28	870	825	MAM (solar) scan mode
	14:35:48	876	815	Azimuth to position B
	14:42:12	882	814	Azimuth to position A
	14:47:32	888	824	Short scan mode
	14:48:04	888	811	Azimuth to 0°
	14:52:52	893	822	Normal scan mode
End solar calibration sequence. Begin internal calibration sequence				
11/27/85 ↓	10:47:00	647	8A1	Begin internal calibration
	10:47:32	648	897	SWICS on at level 1 modulated
	10:49:08	649	895	SWICS on at level 2 modulated
	10:50:44	651	893	SWICS on at level 3 modulated
	10:52:20	652	891	SWICS off
	10:55:00	655	Pulse	Blackbody calibration heaters on
	10:55:32	656	897	SWICS on at level 1 modulated
	10:57:08	657	895	SWICS on at level 2 modulated
	10:58:44	659	893	SWICS on at level 3 modulated
	11:00:20	660	891	SWICS off
	11:19:00	679	Pulse	Blackbody calibration heaters off
	11:19:32	680	897	SWICS on at level 1 modulated
	11:21:08	681	895	SWICS on at level 2 modulated
	11:22:44	683	893	SWICS on at level 3 modulated
11:24:20	684	891	SWICS off	
End internal calibration sequence. Begin azimuth angle load commands for solar calibration				
11/27/85 ↓	15:12:04	912	419	Address azimuth position A
	15:12:36	913	2xx	Data command, high byte
	15:13:08	913	1xx	Data command, low byte
	15:13:40	914	41B	Address azimuth position B
	15:14:12	914	2xx	Data command, high byte
	15:14:44	915	1xx	Data command, low byte
End azimuth angle load commands (A = 117.98°, B = 132.98°). Begin solar calibration sequence				
11/27/85 ↓	15:15:16	915	8A2	Begin solar calibration
	15:15:48	916	824	Short scan mode
	15:16:20	916	811	Azimuth to 0°
	15:16:52	917	814	Azimuth to position A
	15:21:40	922	825	MAM (solar) scan mode
	15:27:00	927	815	Azimuth to position B
	15:33:24	933	814	Azimuth to position A
	15:38:44	939	824	Short scan mode
	15:39:16	939	811	Azimuth to 0°
	15:44:04	944	822	Normal scan mode
End solar calibration sequence				

Table 8. Continued

(b) Continued

Date	Universal time		Hex command	Event description
	hr:min:sec	Minutes of day		
Begin internal calibration sequence				
12/11/85 ↓	09:56:52	597	8A1	Begin internal calibration
	09:57:24	597	897	SWICS on at level 1 modulated
	09:59:00	599	895	SWICS on at level 2 modulated
	10:00:36	601	893	SWICS on at level 3 modulated
	10:02:12	602	891	SWICS off
	10:04:52	605	Pulse	Blackbody calibration heaters on
	10:05:24	605	897	SWICS on at level 1 modulated
	10:07:00	607	895	SWICS on at level 2 modulated
	10:08:36	609	893	SWICS on at level 3 modulated
	10:10:12	610	891	SWICS off
	10:28:52	629	Pulse	Blackbody calibration heaters off
	10:29:24	629	897	SWICS on at level 1 modulated
	10:31:00	631	895	SWICS on at level 2 modulated
	10:32:36	633	893	SWICS on at level 3 modulated
10:34:12	634	891	SWICS off	
End internal calibration sequence.				
Begin azimuth angle load commands for solar calibration				
12/11/85 ↓	14:21:56	862	419	Address azimuth position A
	14:22:28	862	2xx	Data command, high byte
	14:23:00	863	1xx	Data command, low byte
	14:23:32	864	41B	Address azimuth position B
	14:24:04	864	2xx	Data command, high byte
14:24:36	865	1xx	Data command, low byte	
End azimuth angle load commands (A = 116.55°, B = 131.55°).				
Begin solar calibration sequence				
12/11/85 ↓	14:25:08	865	8A2	Begin solar calibration
	14:25:40	866	824	Short scan mode
	14:26:12	866	811	Azimuth to 0°
	14:26:44	867	814	Azimuth to position A
	14:31:32	872	825	MAM (solar) scan mode
	14:36:52	877	815	Azimuth to position B
	14:43:16	883	814	Azimuth to position A
	14:48:36	889	824	Short scan mode
	14:49:08	889	811	Azimuth to 0°
14:53:56	894	822	Normal scan mode	
End solar calibration sequence.				
Begin internal calibration sequence				
12/25/85 ↓	10:49:08	649	8A1	Begin internal calibration
	10:49:40	650	897	SWICS on at level 1 modulated
	10:51:16	651	895	SWICS on at level 2 modulated
	10:52:52	653	893	SWICS on at level 3 modulated

Table 8. Continued

(b) Continued

Date	Universal time		Hex command	Event description
	hr:min:sec	Minutes of day		
12/25/85 ↓	10:54:28	654	891	SWICS off
	10:57:08	657	Pulse	Blackbody calibration heaters on
	10:57:40	658	897	SWICS on at level 1 modulated
	10:59:16	659	895	SWICS on at level 2 modulated
	11:00:52	661	893	SWICS on at level 3 modulated
	11:02:28	662	891	SWICS off
	11:21:08	681	Pulse	Blackbody calibration heaters off
	11:21:40	682	897	SWICS on at level 1 modulated
	11:23:16	683	895	SWICS on at level 2 modulated
	11:24:52	685	893	SWICS on at level 3 modulated
	11:26:28	686	891	SWICS off
End internal calibration sequence. Begin azimuth angle load commands for solar calibration				
12/25/85 ↓	15:14:12	914	419	Address azimuth position A
	15:14:44	915	2xx	Data command, high byte
	15:15:16	915	1xx	Data command, low byte
	15:15:48	916	41B	Address azimuth position B
	15:16:20	916	2xx	Data command, high byte
	15:16:52	917	1xx	Data command, low byte
End azimuth angle load commands (A = 115.05°, B = 130.05°). Begin solar calibration sequence				
12/25/85 ↓	15:17:24	917	8A2	Begin solar calibration
	15:17:56	918	824	Short scan mode
	15:18:28	918	811	Azimuth to 0°
	15:19:00	919	814	Azimuth to position A
	15:23:48	924	825	MAM (solar) scan mode
	15:29:08	929	815	Azimuth to position B
	15:35:32	936	814	Azimuth to position A
	15:40:52	941	824	Short scan mode
	15:41:24	941	811	Azimuth to 0°
	15:46:12	946	822	Normal scan mode
End solar calibration sequence. Begin internal calibration sequence				
01/22/86 ↓	10:52:53	653	8A1	Begin internal calibration
	10:53:25	653	897	SWICS on at level 1 modulated
	10:55:01	655	895	SWICS on at level 2 modulated
	10:56:37	657	893	SWICS on at level 3 modulated
	10:58:13	658	891	SWICS off
	11:00:53	661	Pulse	Blackbody calibration heaters on
	11:01:25	661	897	SWICS on at level 1 modulated
	11:03:01	663	895	SWICS on at level 2 modulated
	11:04:37	665	893	SWICS on at level 3 modulated

Table 8. Concluded

(b) Concluded

Date	Universal time		Hex command	Event description
	hr:min:sec	Minutes of day		
01/22/86 ↓	11:06:13	666	891	SWICS off
	11:24:53	685	Pulse	Blackbody calibration heaters off
	11:25:25	685	897	SWICS on at level 1 modulated
	11:27:01	687	895	SWICS on at level 2 modulated
	11:28:37	689	893	SWICS on at level 3 modulated
	11:30:13	690	891	SWICS off
End internal calibration sequence.				
Begin azimuth angle load commands for solar calibration				
01/22/86 ↓	15:18:29	918	419	Address azimuth position A
	15:19:01	919	2xx	Data command, high byte
	15:19:33	920	1xx	Data command, low byte
	15:20:05	920	41B	Address azimuth position B
	15:20:37	921	2xx	Data command, high byte
	15:21:09	921	1xx	Data command, low byte
End azimuth angle load commands (A = 113.1°, B = 128.1°).				
Begin solar calibration sequence				
01/22/86 ↓	15:21:41	922	8A2	Begin solar calibration
	15:22:13	922	824	Short scan mode
	15:22:45	923	811	Azimuth to 0°
	15:23:17	923	814	Azimuth to position A
	15:28:05	928	825	MAM (solar) scan mode
	15:33:25	933	815	Azimuth to position B
	15:39:49	940	814	Azimuth to position A
	15:45:09	945	824	Short scan mode
	15:45:41	946	811	Azimuth to 0°
	15:50:29	950	822	Normal scan mode
End solar calibration sequence				

Table 9. Characteristics of ERBS and NOAA 9 Orbits on January 1, 1985, and January 1, 1986

(a) ERBS spacecraft

Parameter	Value at beginning of year—	
	1985	1986
Semimajor axis, km	6981	6981
Eccentricity	0.00189	0.00141
Inclination, deg	57.00	56.99
Period, min	96.75	96.75
Mean altitude, km	611.28	611.01
Minimum altitude, km	599.65	600.37
Maximum altitude, km	630.08	625.67
Mean anomaly rate, deg/min	3.72	3.72
Argument of perigee rate of change, deg/day	1.75	1.76
Rotation rate of right ascension of ascending node, deg/day	-3.95	-3.97
Local time of ascending node, hr:min of day	23:17	23:25

(b) NOAA 9 spacecraft

Parameter	Value at beginning of year—	
	1985	1986
Semimajor axis, km	7230	7230
Eccentricity	0.00198	0.00117
Inclination, deg	98.93	98.98
Period, min	102.00	101.97
Mean altitude, km	866.63	866.38
Minimum altitude, km	847.95	855.73
Maximum altitude, km	879.01	878.71
Mean anomaly rate, deg/min	3.53	3.53
Argument of perigee rate of change, deg/day	-2.83	-2.82
Rotation rate of right ascension of ascending node, deg/day	1.000	1.003
Local time of ascending node, hr:min of day	14:20	14:36

Table 10. Edit Limits for Key Instrument Housekeeping Measurements

[For explanation of abbreviations, see "Nomenclature" on p. 1]

(a) Nonscanner instrument

Measurement	Telemetry subsystem edit limits					
	Low limit	Unit	High limit	Unit	Rate of change	Unit
ERBS spacecraft						
Heat sink temp. of Earth	33.55	°C	33.75	°C	0.005	°C/sec
Heat sink temp. of solar monitor	0	↓	30.0	↓	0.00625	↓
Aperture temp. of all Earth	33.0	↓	34.2	↓	0.003125	↓
Aperture temp. of solar monitor	0	↓	30.0	↓	0.025	↓
FOVL temp. — all	0	↓	35.0	↓	0.025	↓
WFOV blackbody temp.	10.0	↓	30.0	↓	0.00625	↓
MFOV blackbody temp.	10.0	↓	30.0	↓	0.00625	↓
Slice 3 temp.	0	↓	40.0	↓	0.0625	↓
NOAA 9 spacecraft						
Heat sink temp. of Earth	33.5	°C	33.7	°C	0.005	°C/sec
Heat sink temp. of solar monitor	0	↓	30.0	↓	0.00625	↓
Aperture temp. of all Earth	33.0	↓	34.0	↓	0.003125	↓
Aperture temp. of solar monitor	0	↓	30.0	↓	0.03125	↓
FOVL temp. — all	0	↓	30.0	↓	0.025	↓
WFOV blackbody temp.	10.0	↓	30.0	↓	0.00625	↓
MFOV blackbody temp.	10.0	↓	30.0	↓	0.00625	↓
Slice 3 temp.	0	↓	40.0	↓	0.0625	↓

(b) Scanner instrument

Measurement	Telemetry subsystem edit limits					
	Low limit	Unit	High limit	Unit	Rate of change	Unit
ERBS spacecraft						
Det temp. — all	37.5	°C	38.5	°C	0.01	°C/sec
DAC voltages — all	(a)		(a)		0.0125	V/sec
LW blackbody temp.	0	°C	50.0	°C	0.1	°C/sec
TOT blackbody temp.	0	↓	50.0	↓	0.1	↓
Slice 3 temp.	0	↓	49.0	↓	0.0625	↓
Box beam temp.	10.0	↓	35.0	↓	0.0625	↓
NOAA 9 spacecraft						
Det temp. — all	37.5	°C	38.5	°C	0.01	°C/sec
DAC voltages — all	(a)		(a)		0.0125	V/sec
LW blackbody temp.	0	°C	50.0	°C	0.1	°C/sec
TOT blackbody temp.	0	↓	50.0	↓	0.1	↓
Slice 3 temp.	0	↓	49.0	↓	0.0625	↓
Box beam temp.	10.0	↓	35.0	↓	0.0625	↓

^aNot applicable.

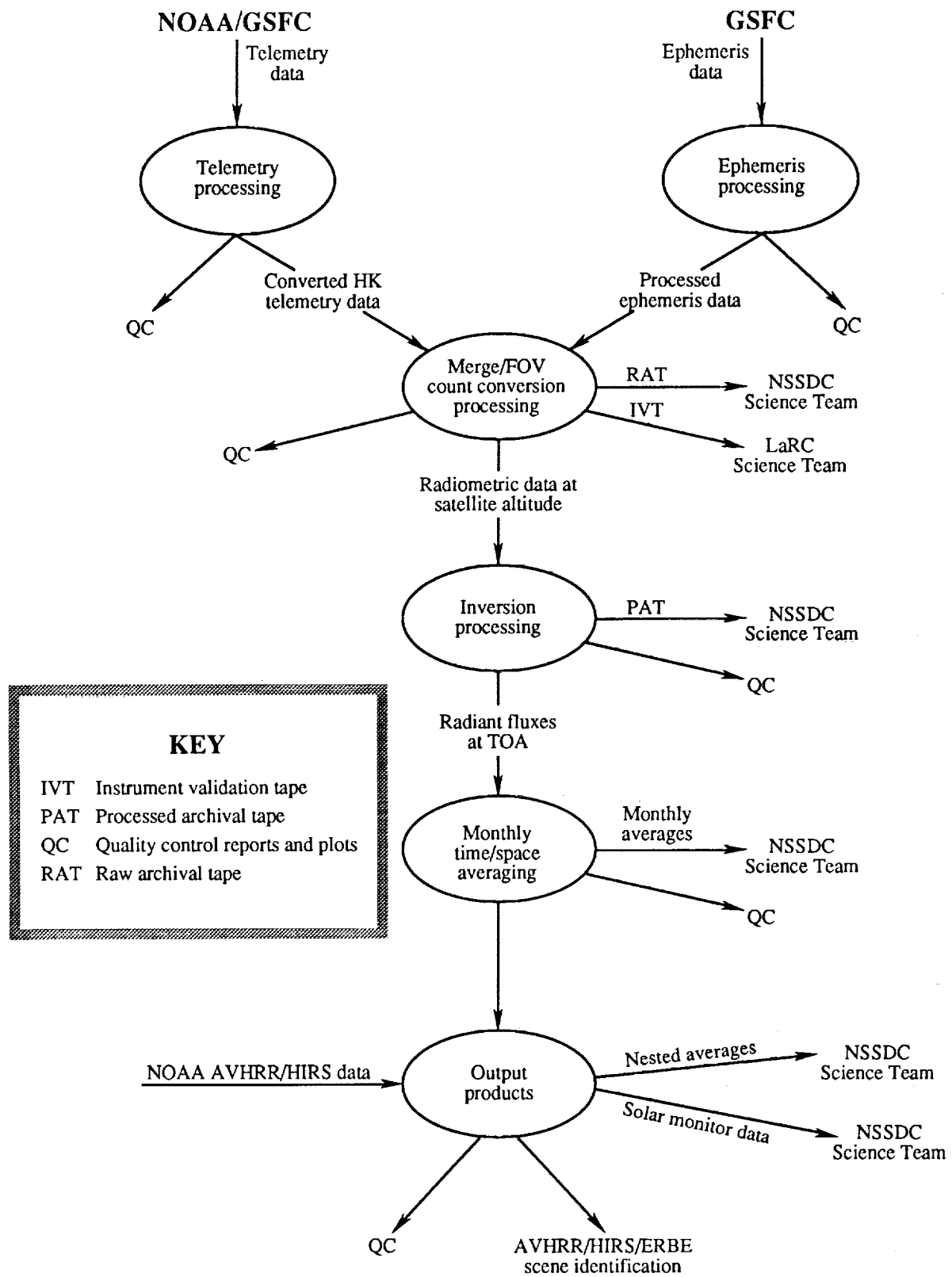
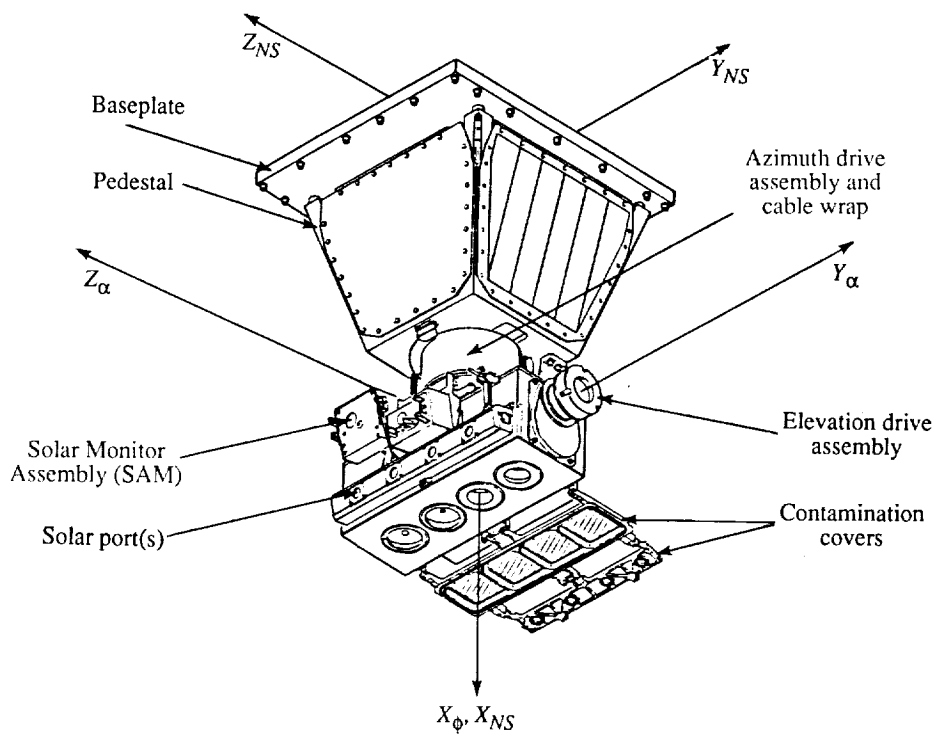
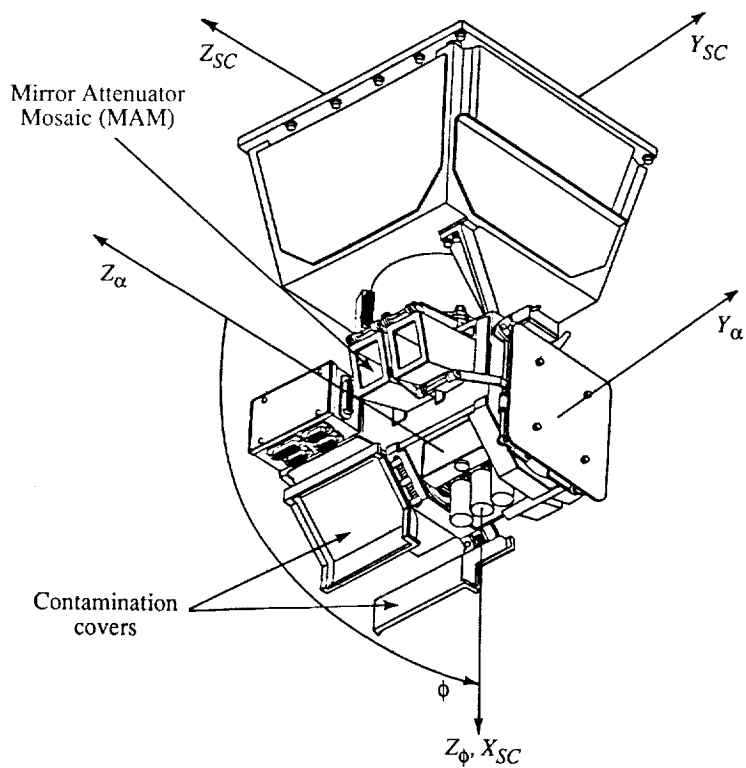

Figure 1. Overview of ERBE data processing.



(a) Nonscanner.



(b) Scanner.

Figure 2. Diagram of ERBE instruments illustrating coordinate axes.

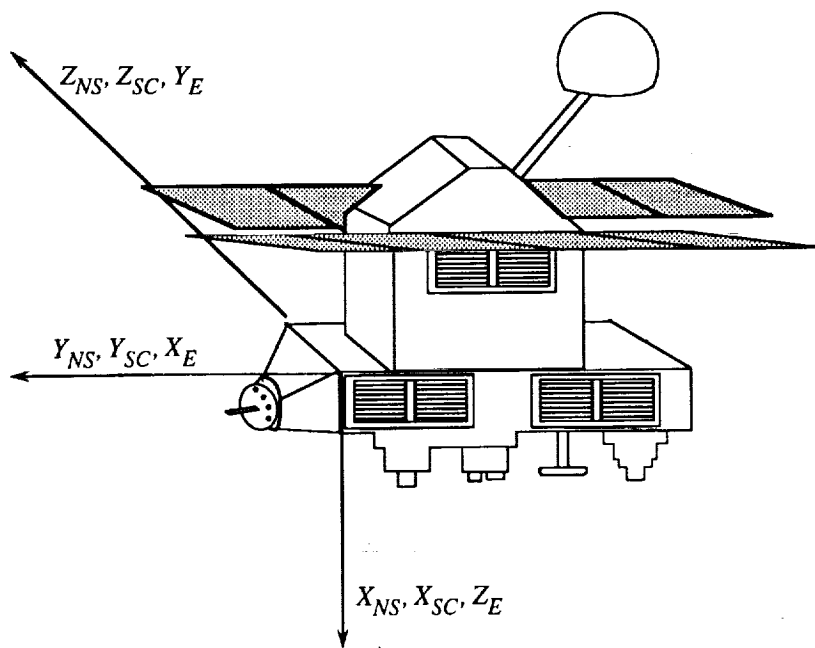

(a) ERBS spacecraft.

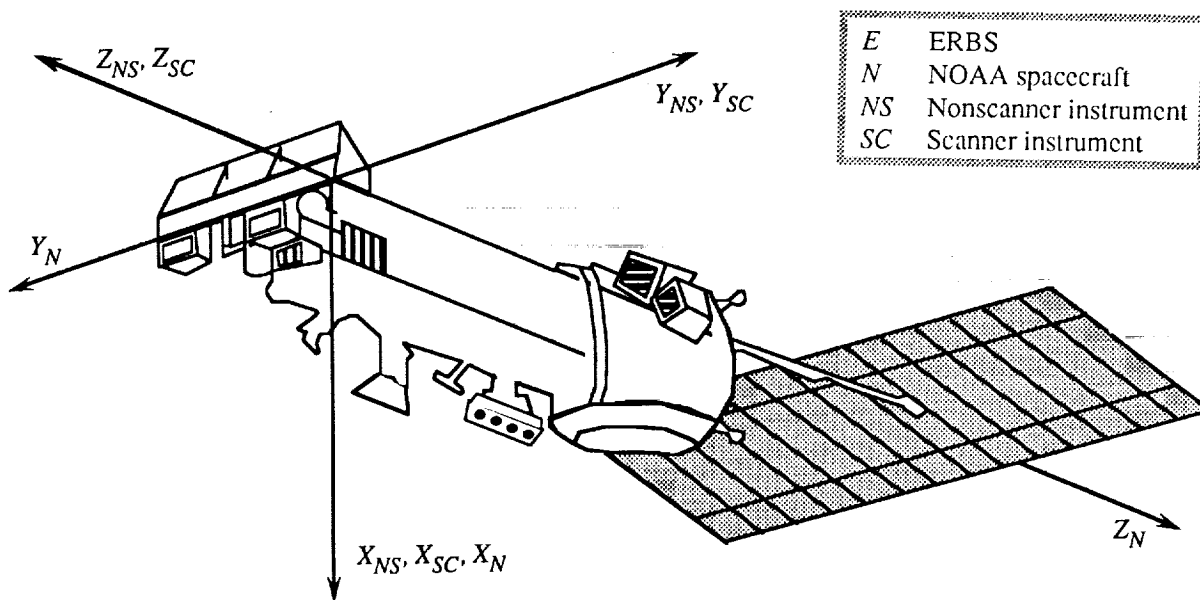

(b) NOAA 9 spacecraft.

Figure 3. Spacecraft coordinate systems and alignment of axes with instrument axes.

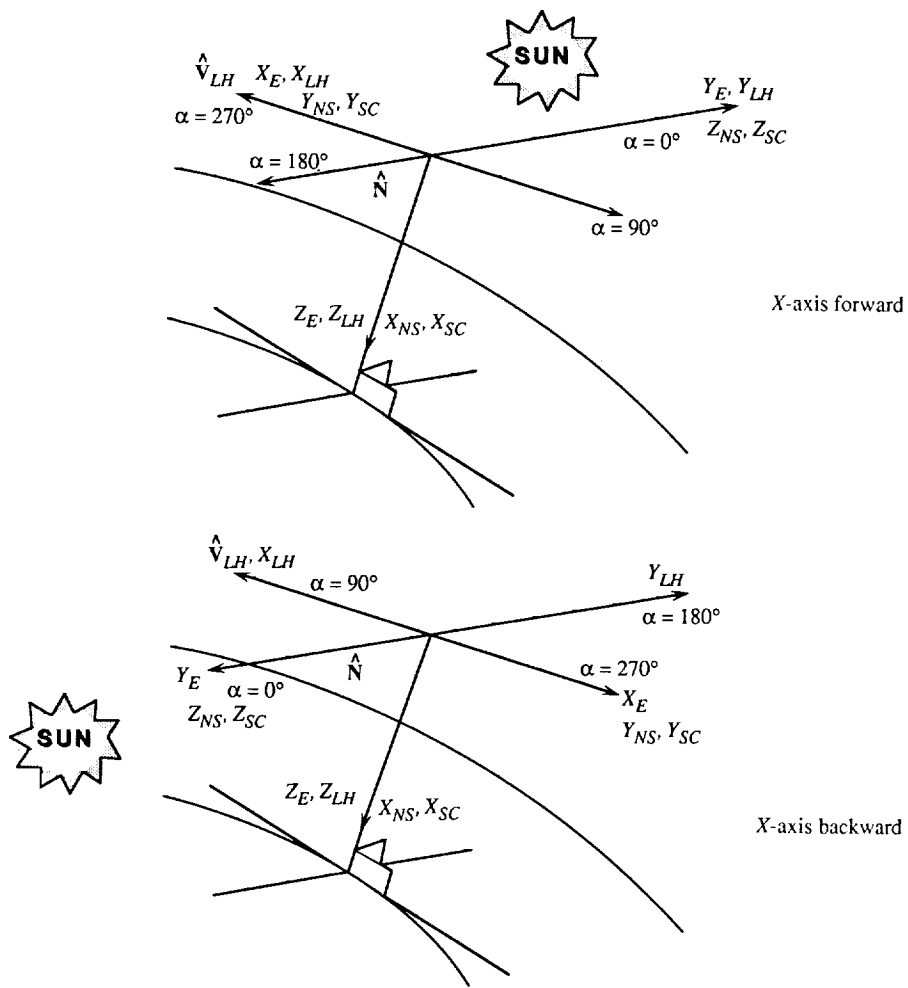

(a) ERBS spacecraft.

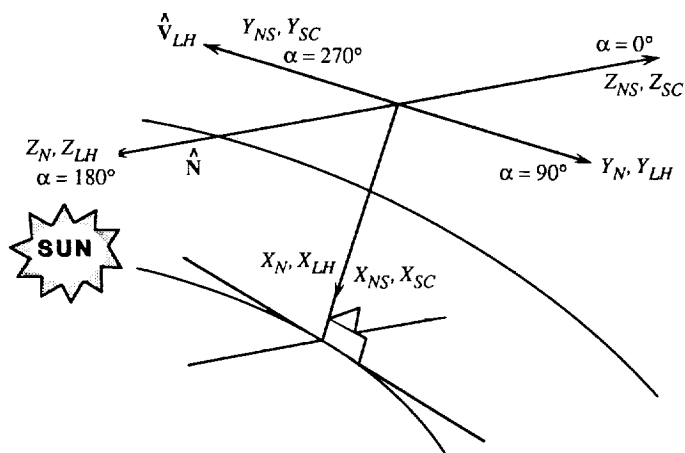

(b) NOAA 9 spacecraft.

Figure 4. Alignment between spacecraft and their local horizon coordinates.

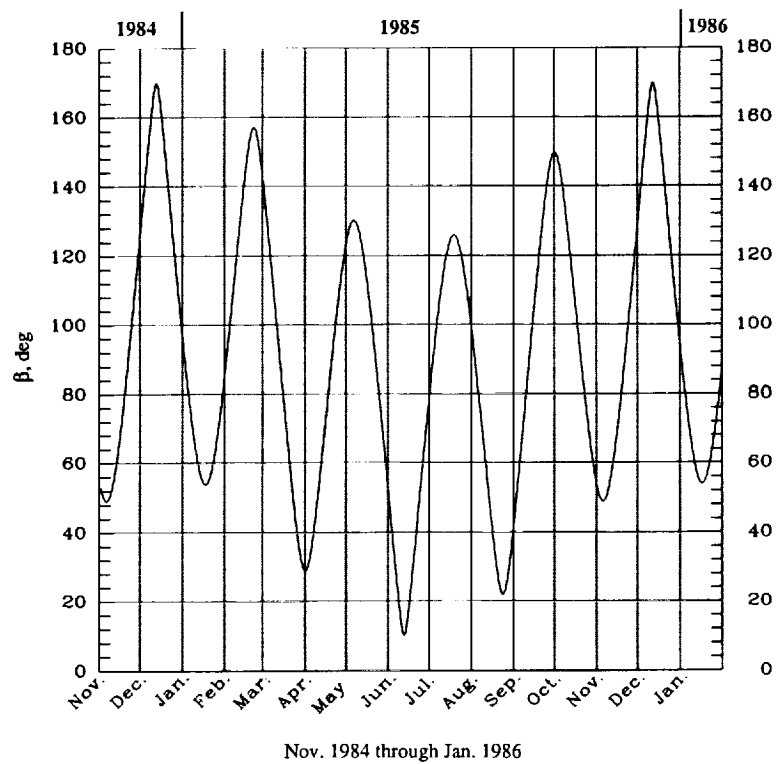

(a) ERBS spacecraft for November 1984 through January 1986.

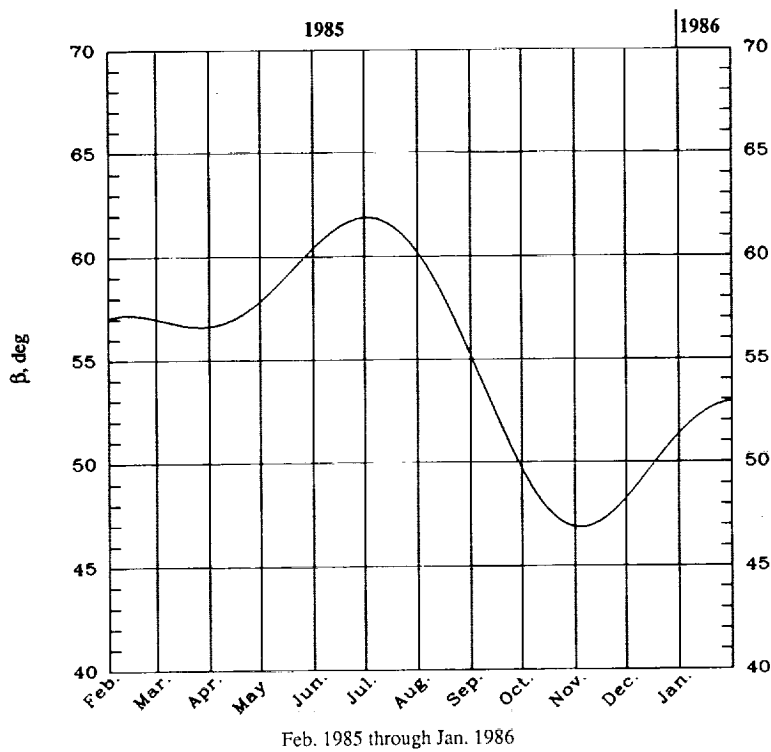

(b) NOAA 9 spacecraft for February 1985 through January 1986.

Figure 5. Beta angles (β) for ERBS and NOAA 9 spacecraft orbits.

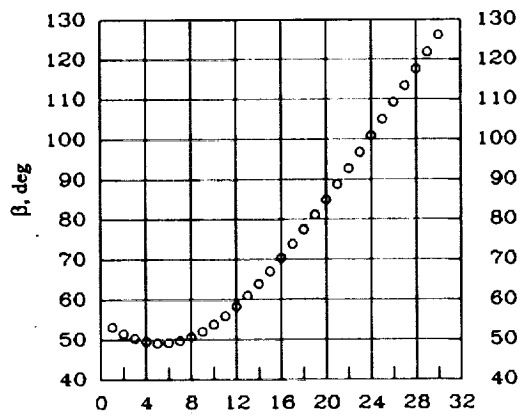

November 1984

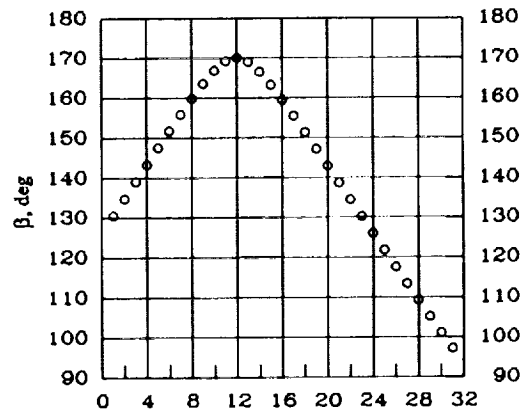

December 1984

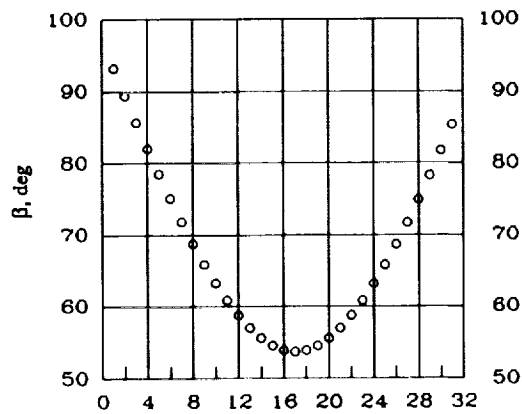

January 1985

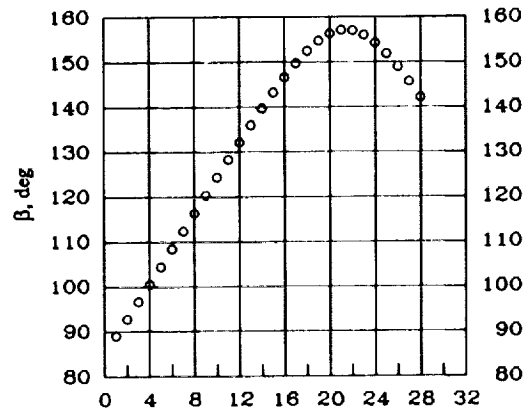

February 1985

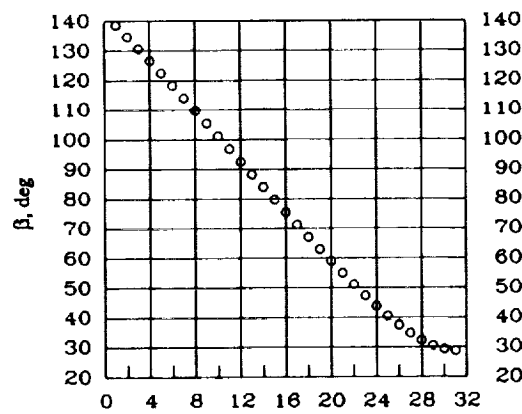

March 1985

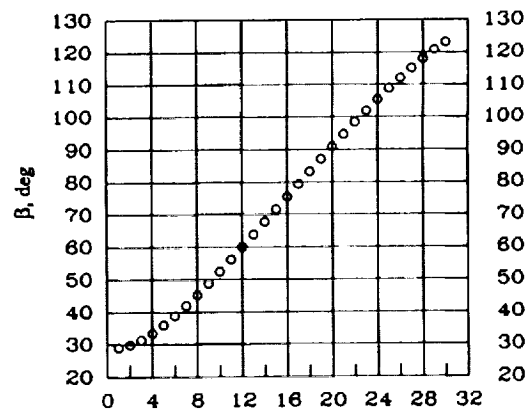

April 1985

(a) ERBS spacecraft.

Figure 6. Beta angles (β) for ERBS and NOAA 9 spacecraft orbits for each month.

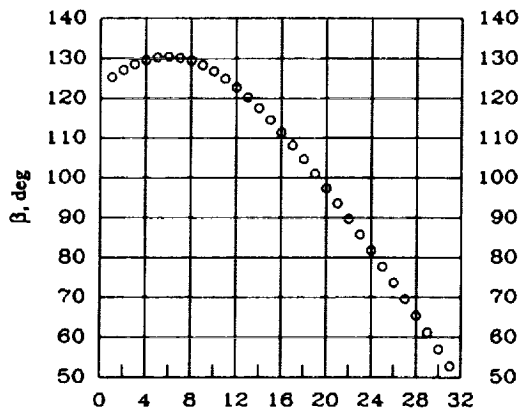

May 1985

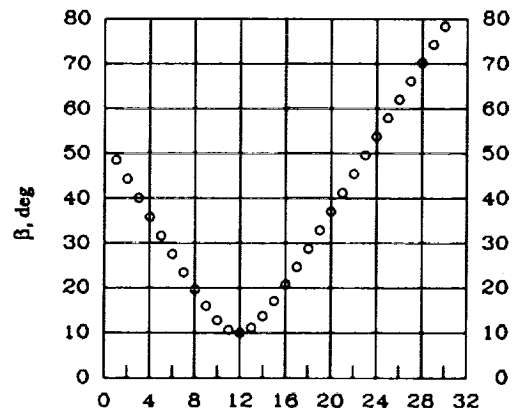

June 1985

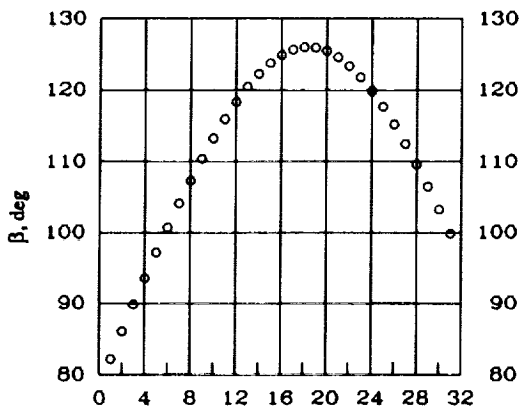

July 1985

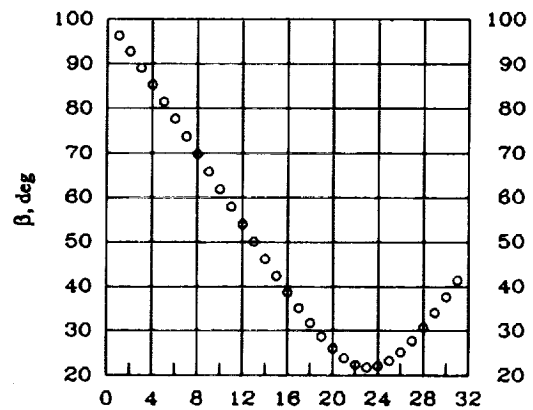

August 1985

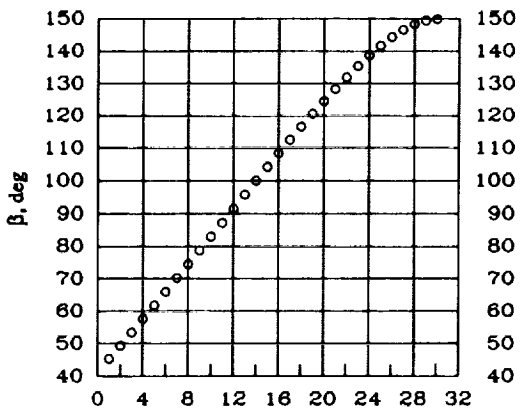

September 1985

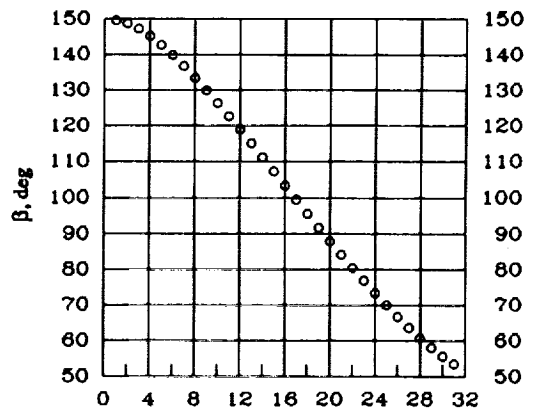

October 1985

(a) Continued.

Figure 6. Continued.

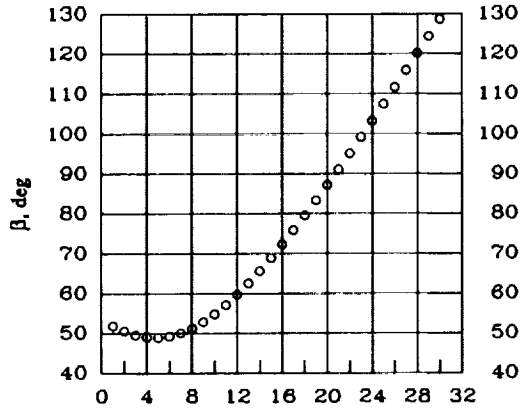

November 1985

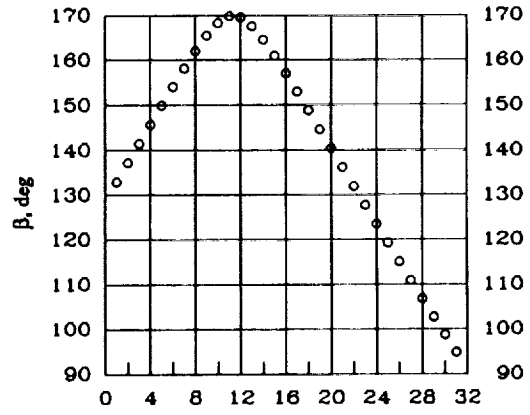

December 1985

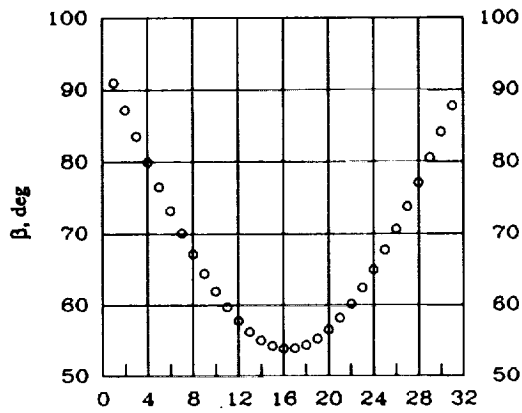

January 1986

(a) Concluded.

Figure 6. Continued.

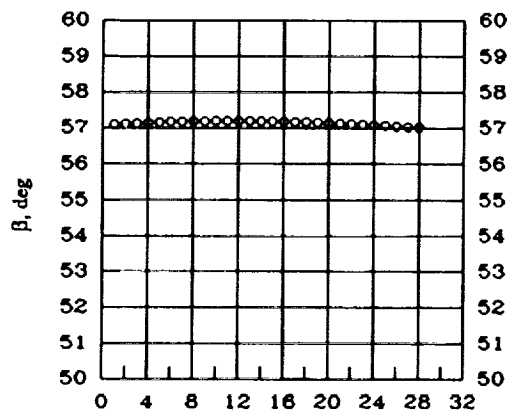

February 1985

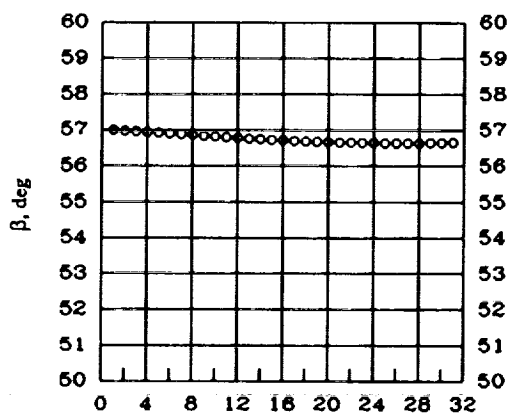

March 1985

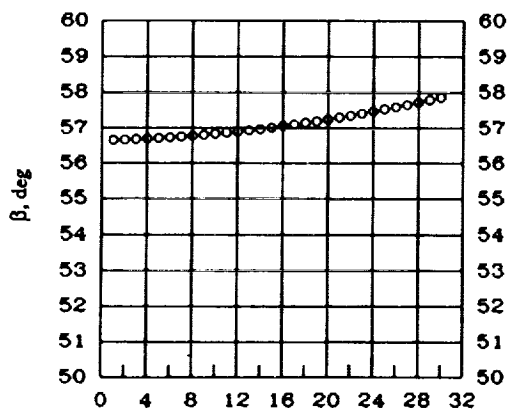

April 1985

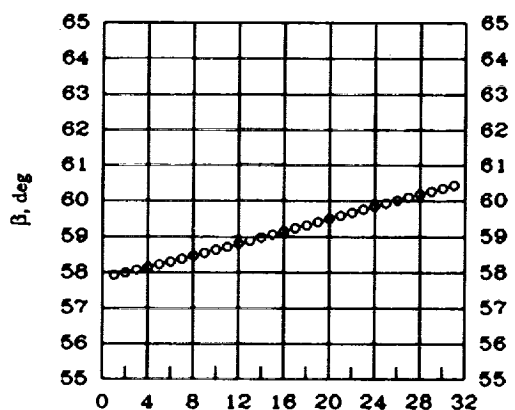

May 1985

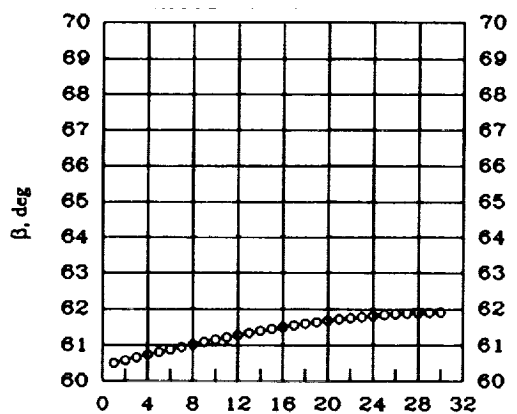

June 1985

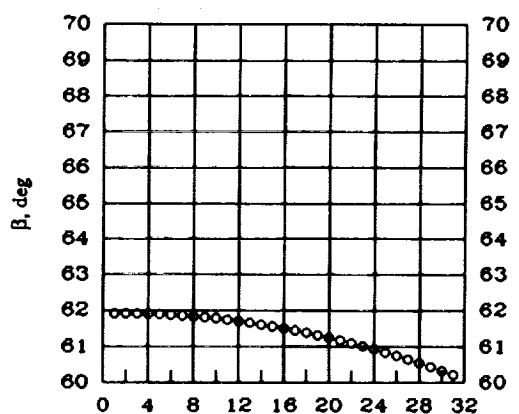

July 1985

(b) NOAA 9 spacecraft.

Figure 6. Continued.

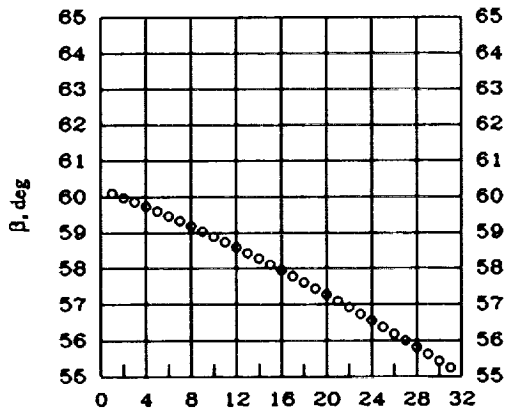

August 1985

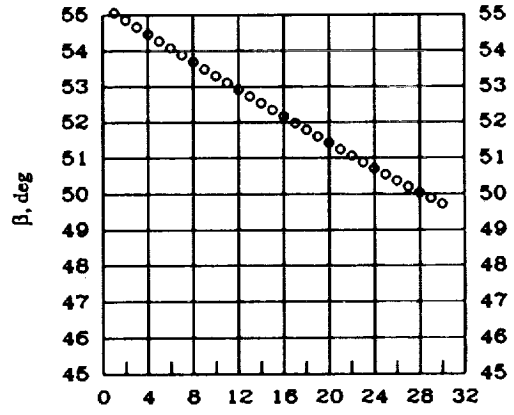

September 1985

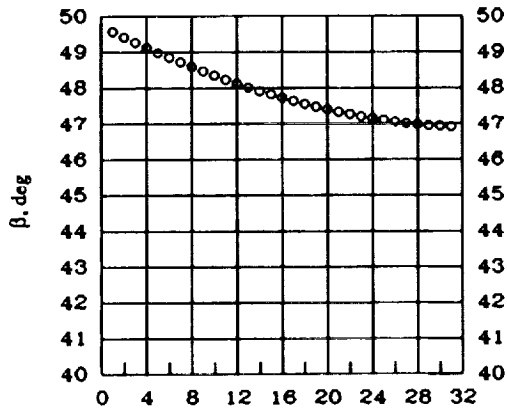

October 1985

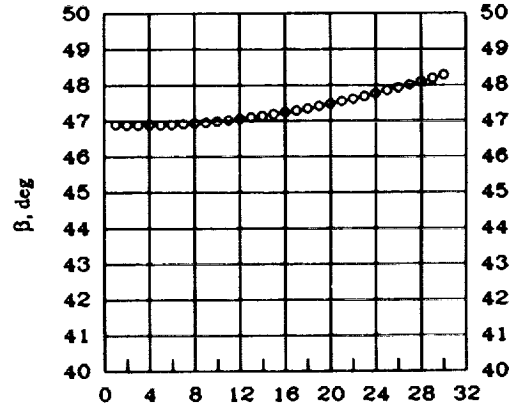

November 1985

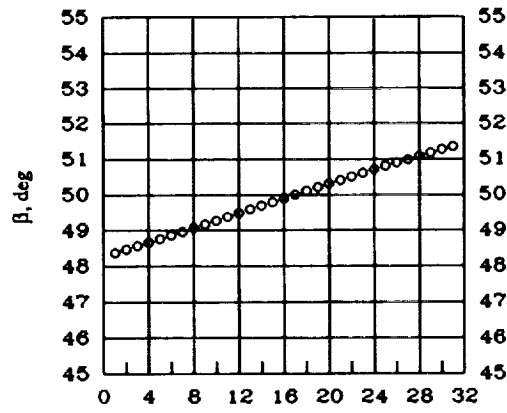

December 1985

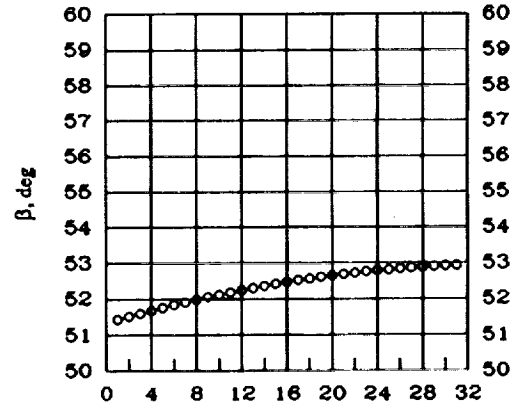

January 1986

(b) Concluded.

Figure 6. Concluded.

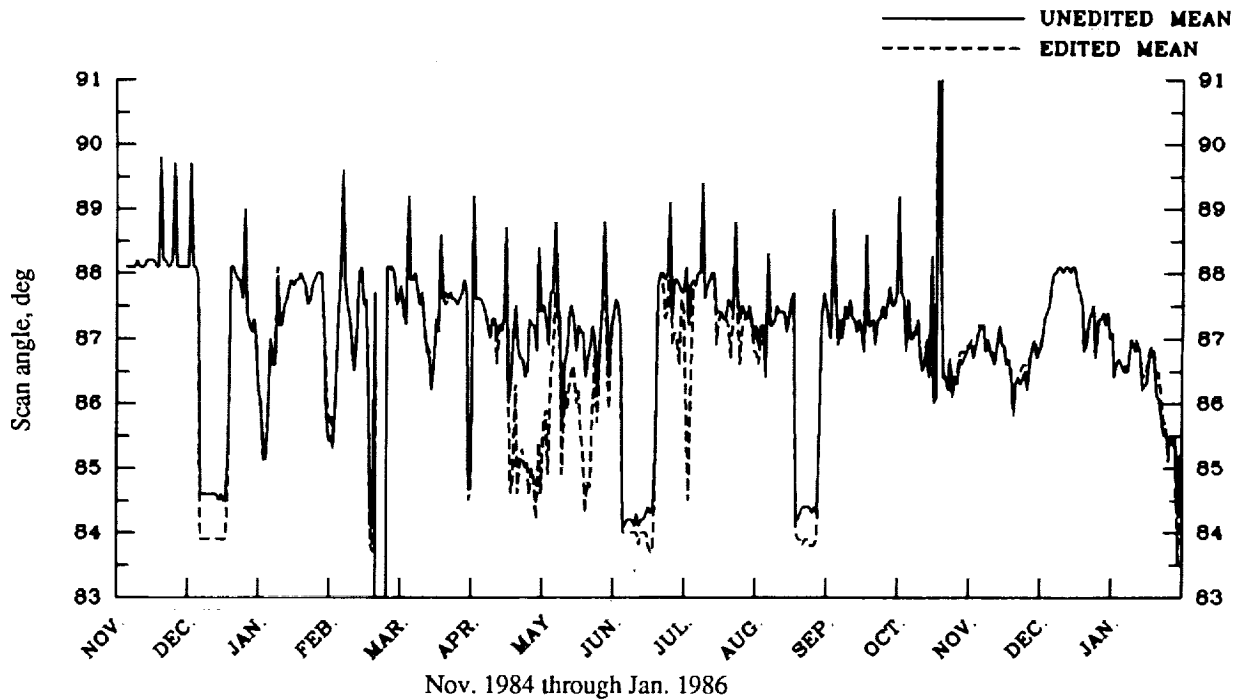
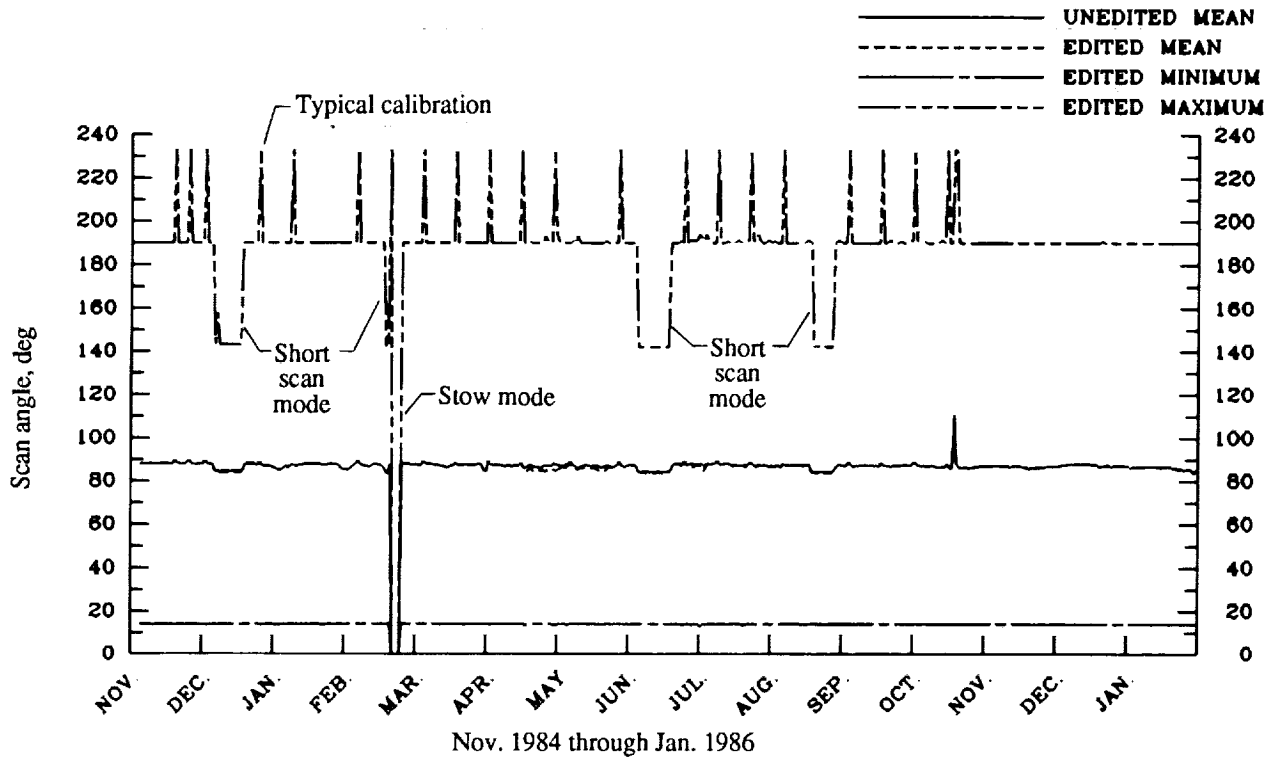

(a) ERBS spacecraft.

Figure 7. Daily values of minimum, mean, and maximum scan angles of elevation beam on scanner instrument.

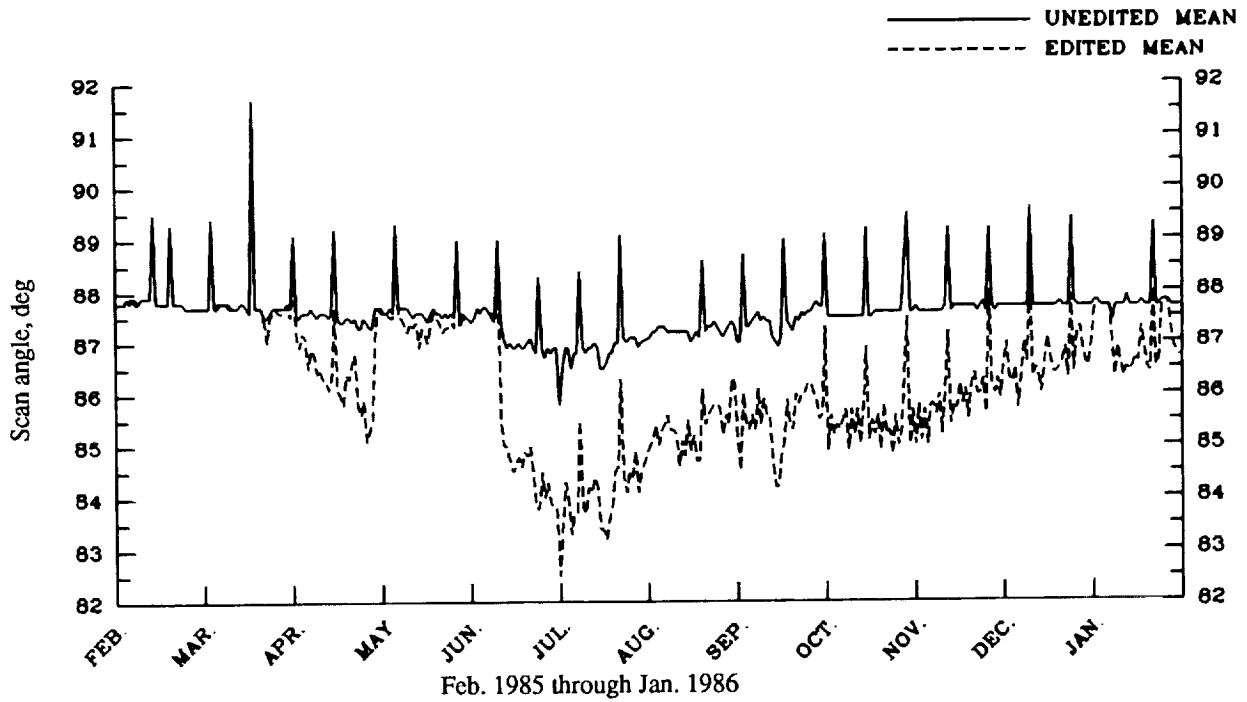
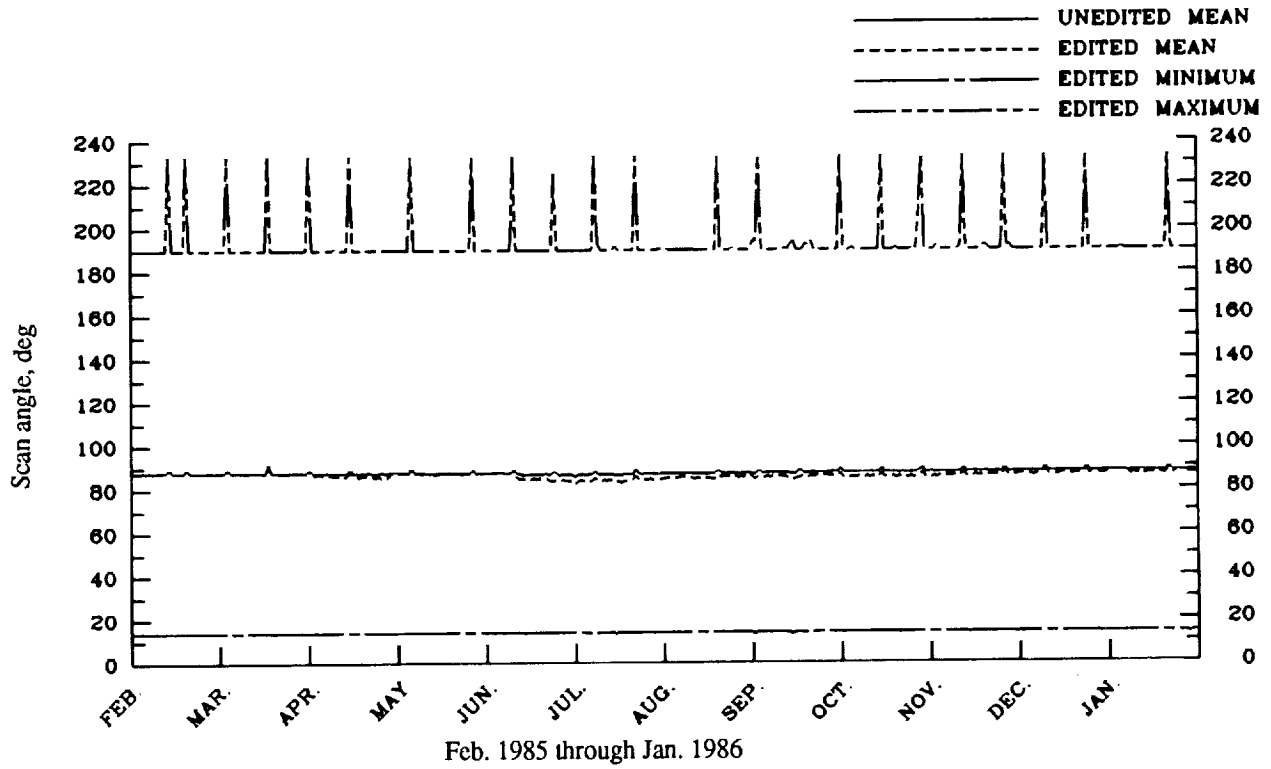

(b) NOAA 9 spacecraft.

Figure 7. Concluded.

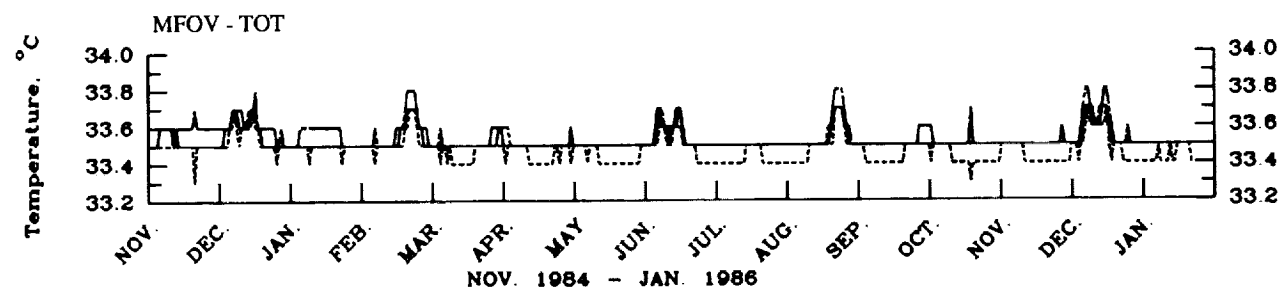
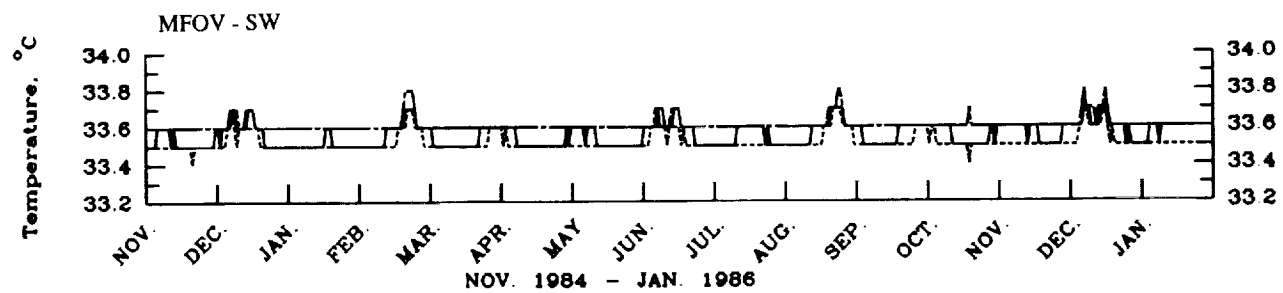
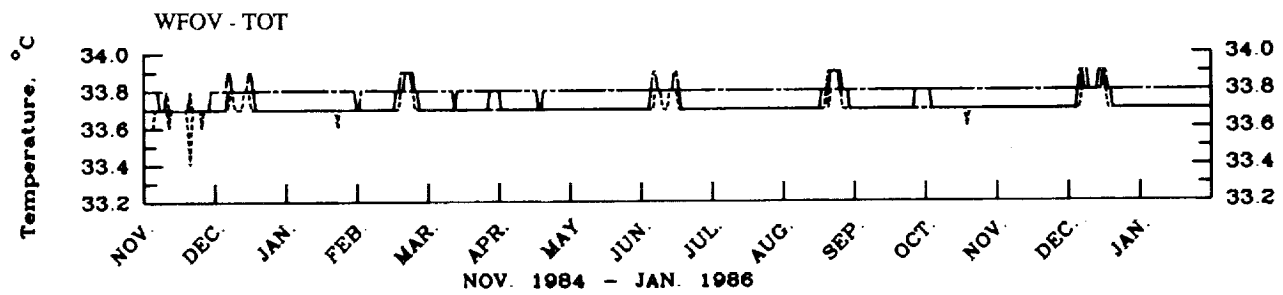
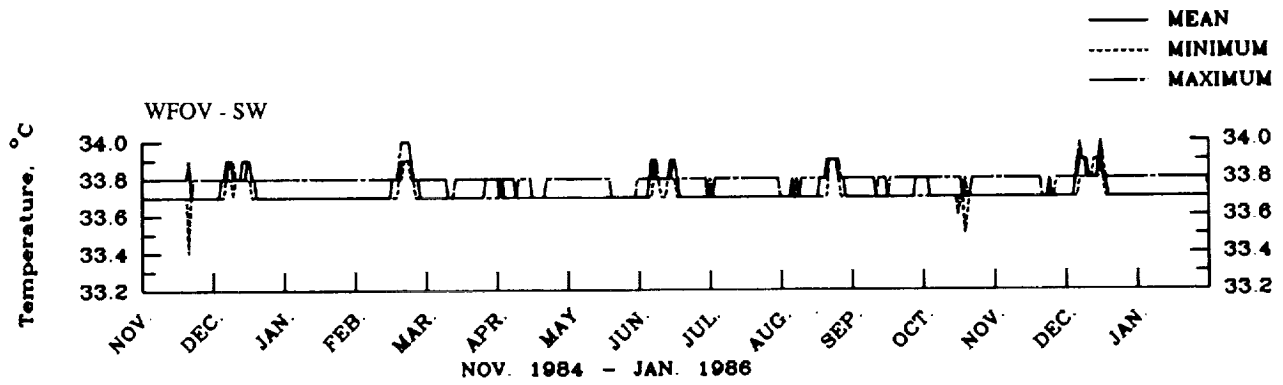

(b) Aperture temperatures. Earth-viewing detectors.

Figure 8. Continued.

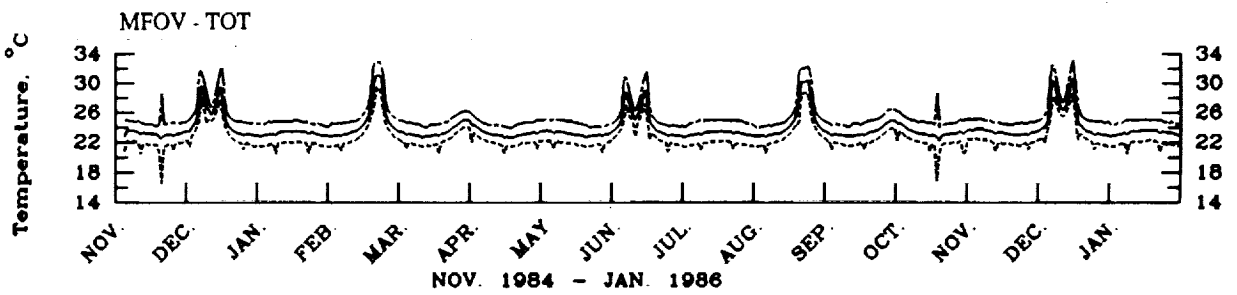
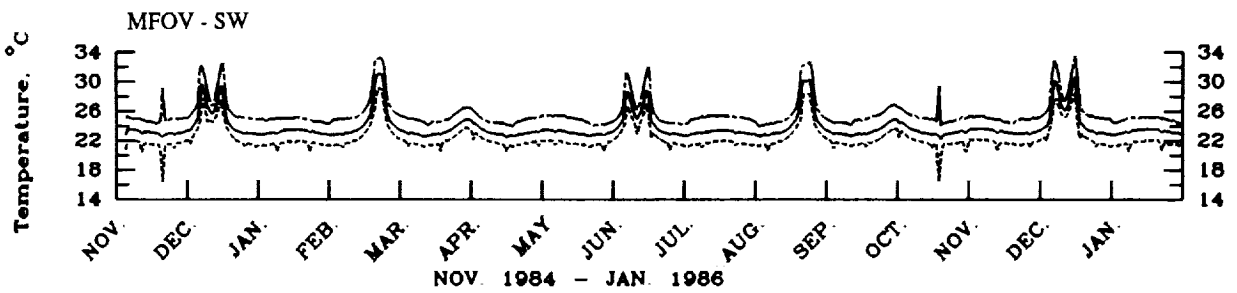
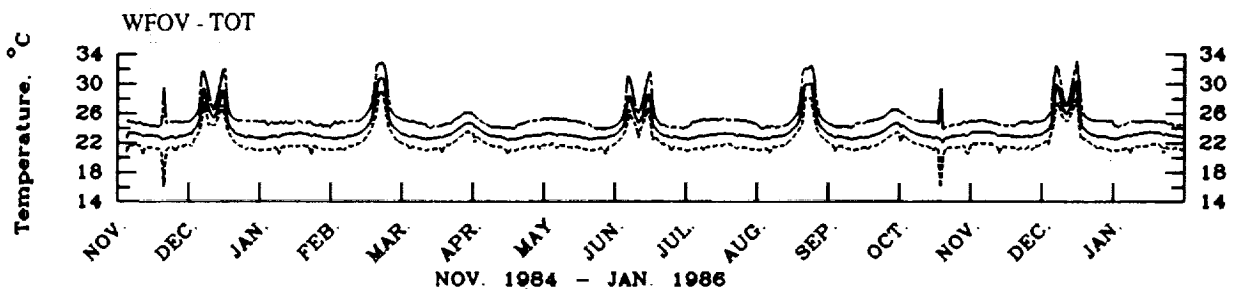
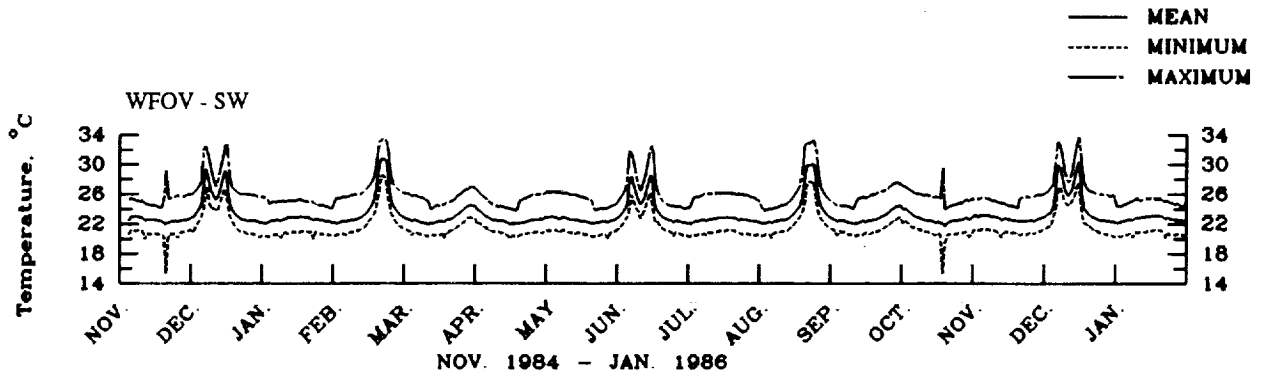

(c) Field-of-view limiter temperatures. Earth-viewing detectors.

Figure 8. Continued.

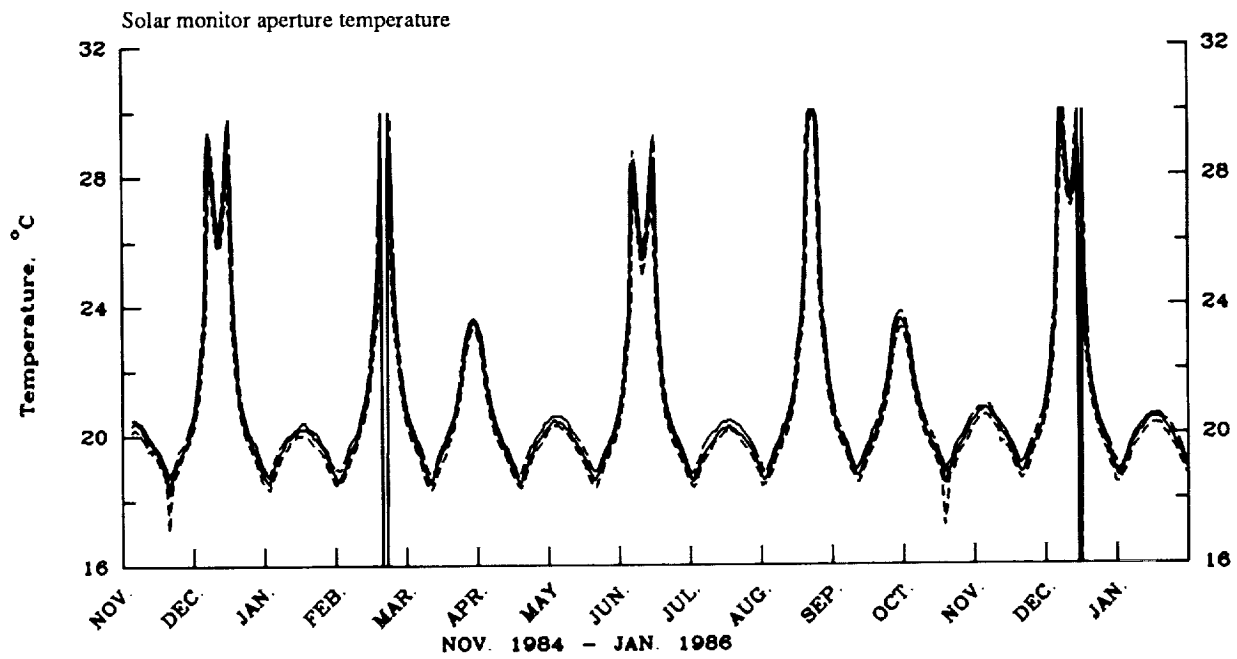
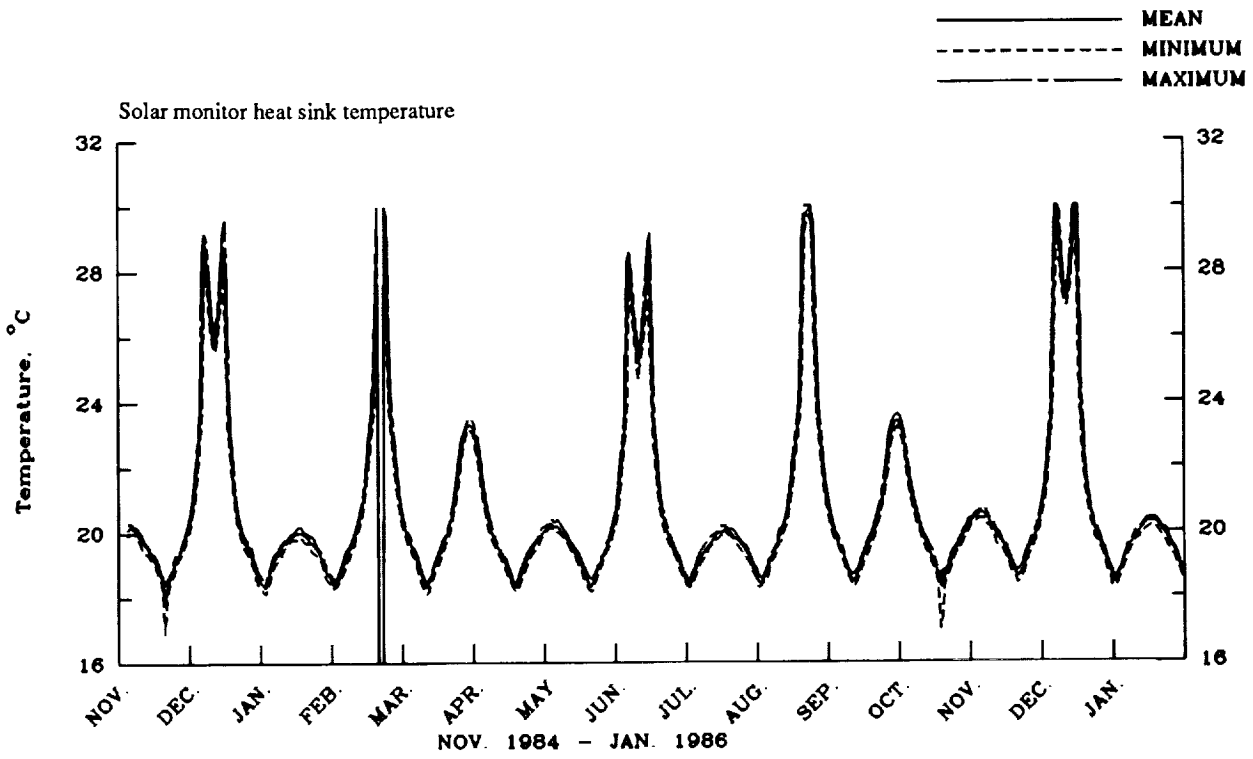

(d) Solar monitor heat sink and aperture temperatures.

Figure 8. Continued.

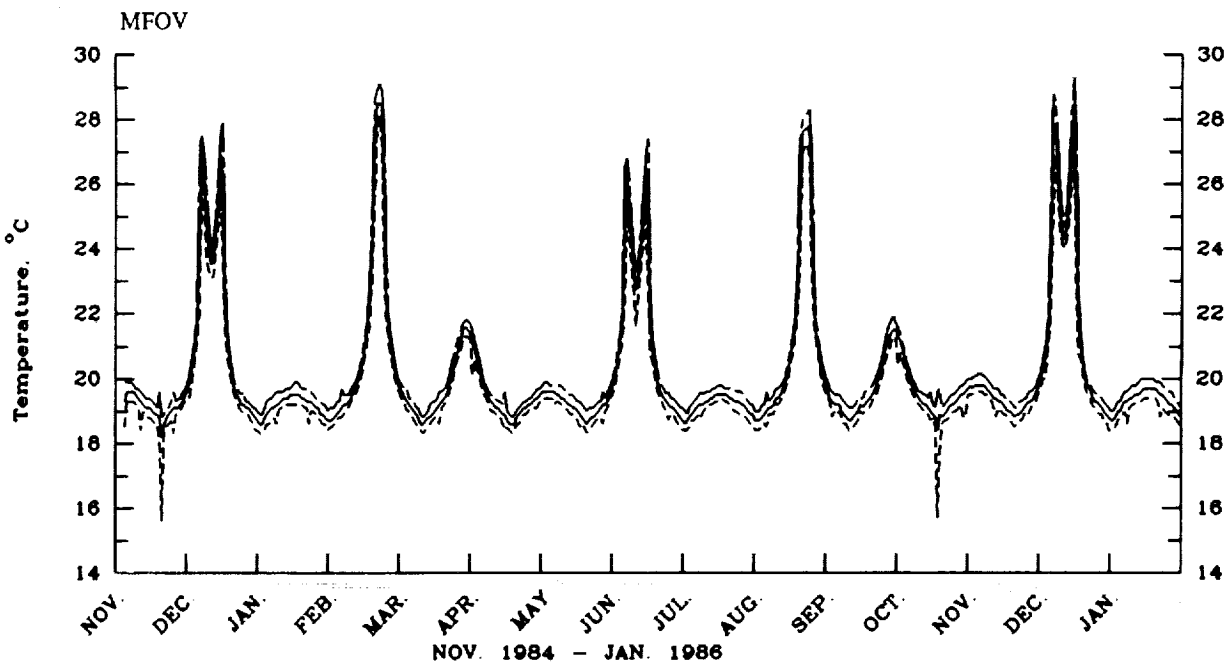
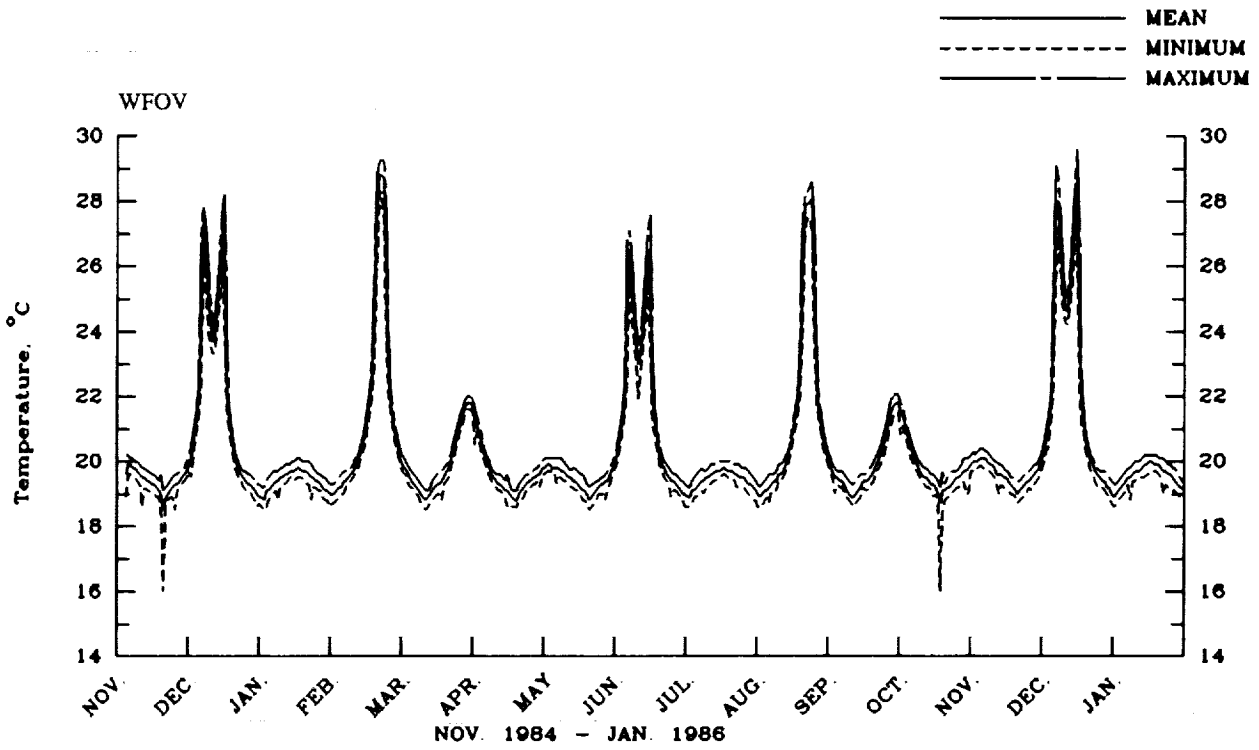

(e) Blackbody temperatures.

Figure 8. Continued.

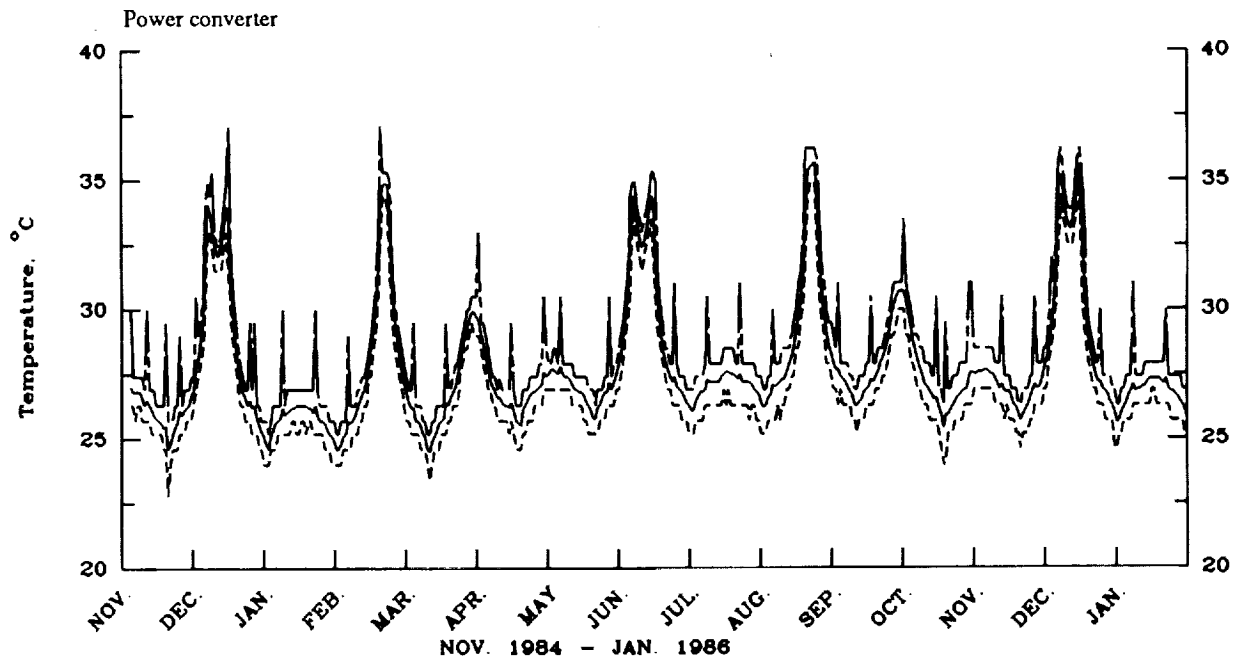
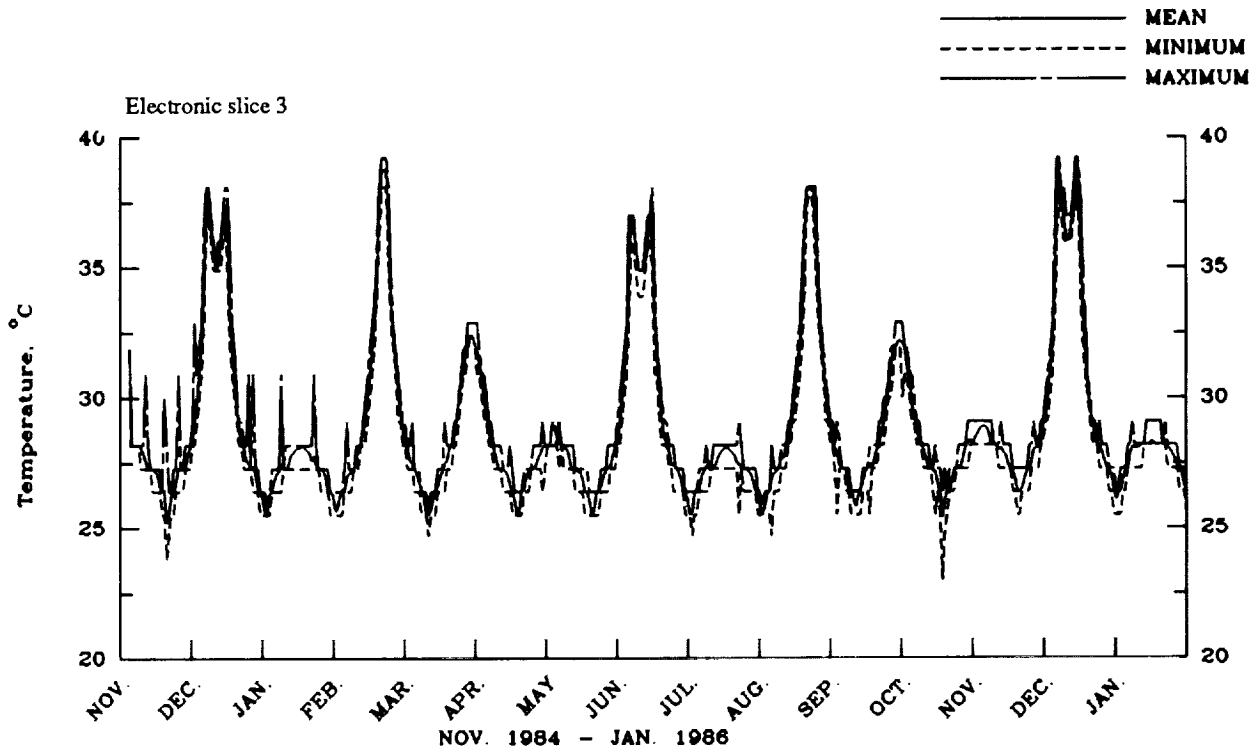

(f) Passive analog temperatures.

Figure 8. Concluded.

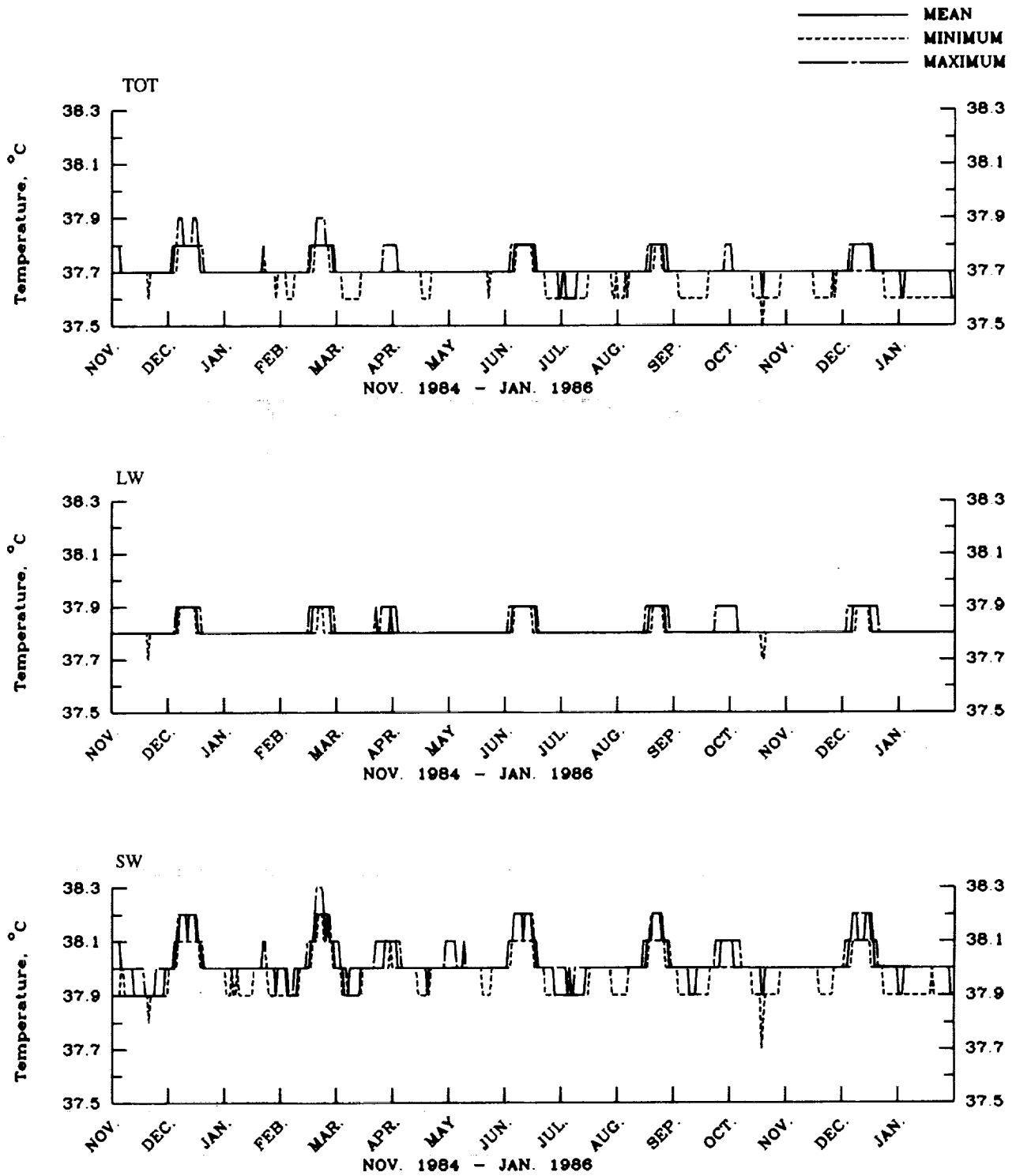

(a) Detector temperatures.

Figure 9. Daily values of minimum, mean, and maximum housekeeping measurements from scanner instrument on ERBS spacecraft.

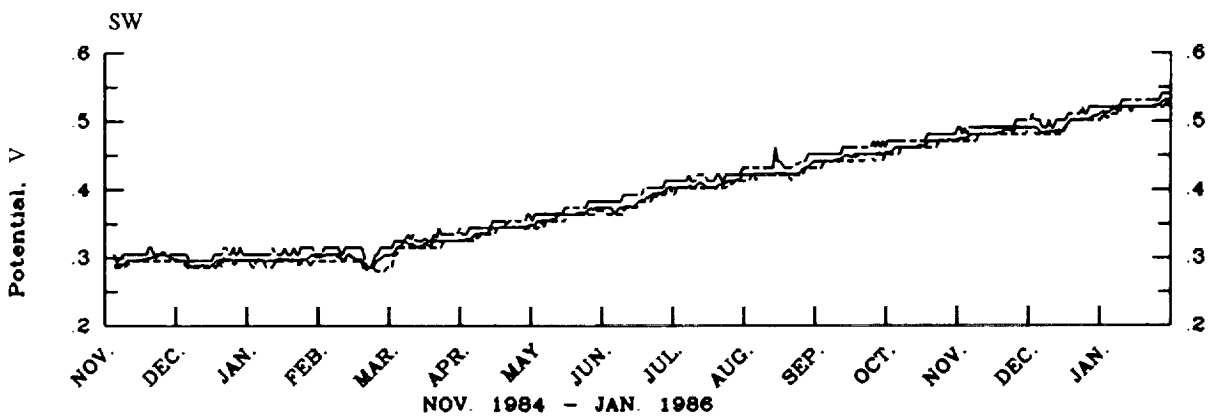
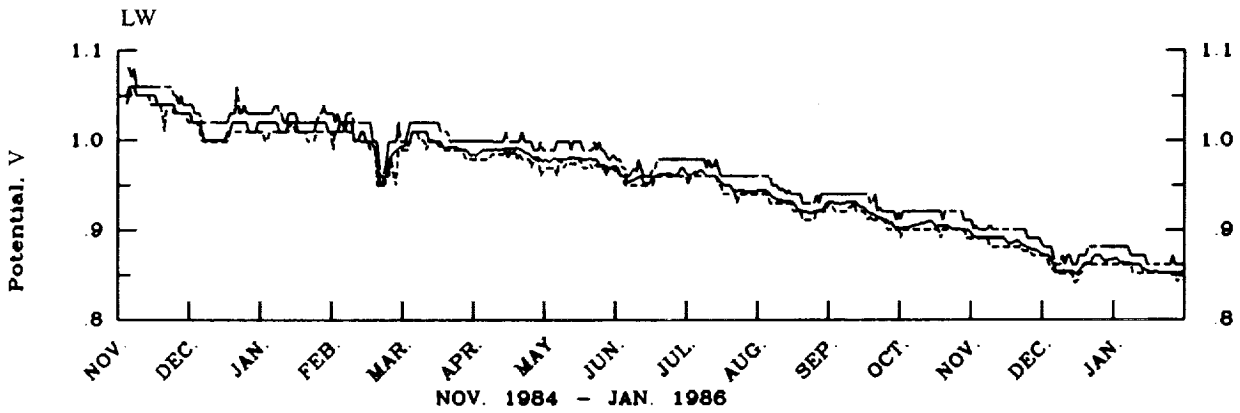
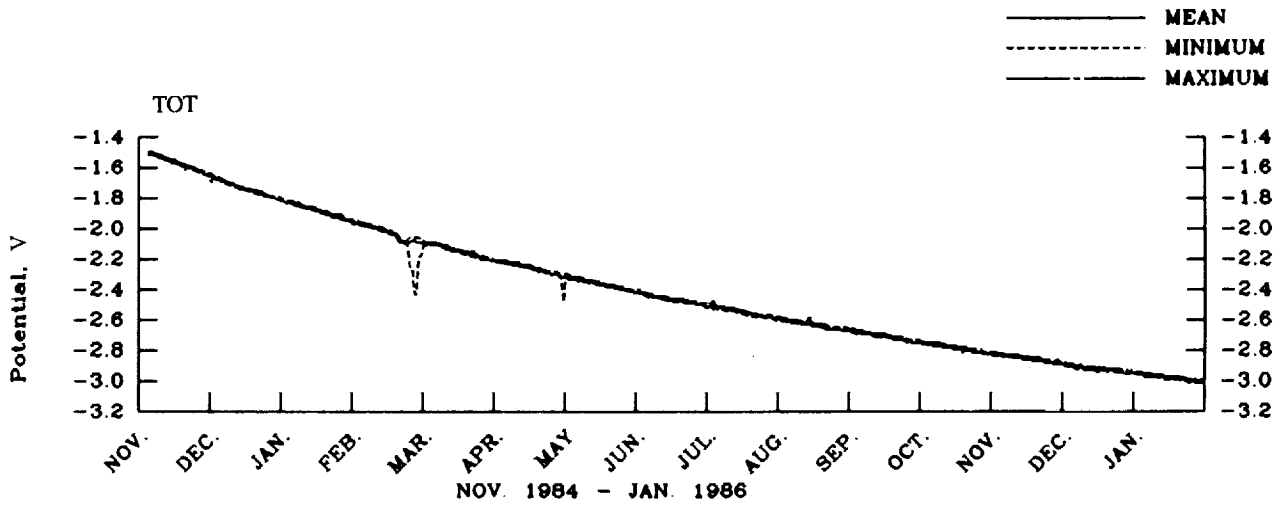

(b) Digital-to-analog (DAC) voltages.

Figure 9. Continued.

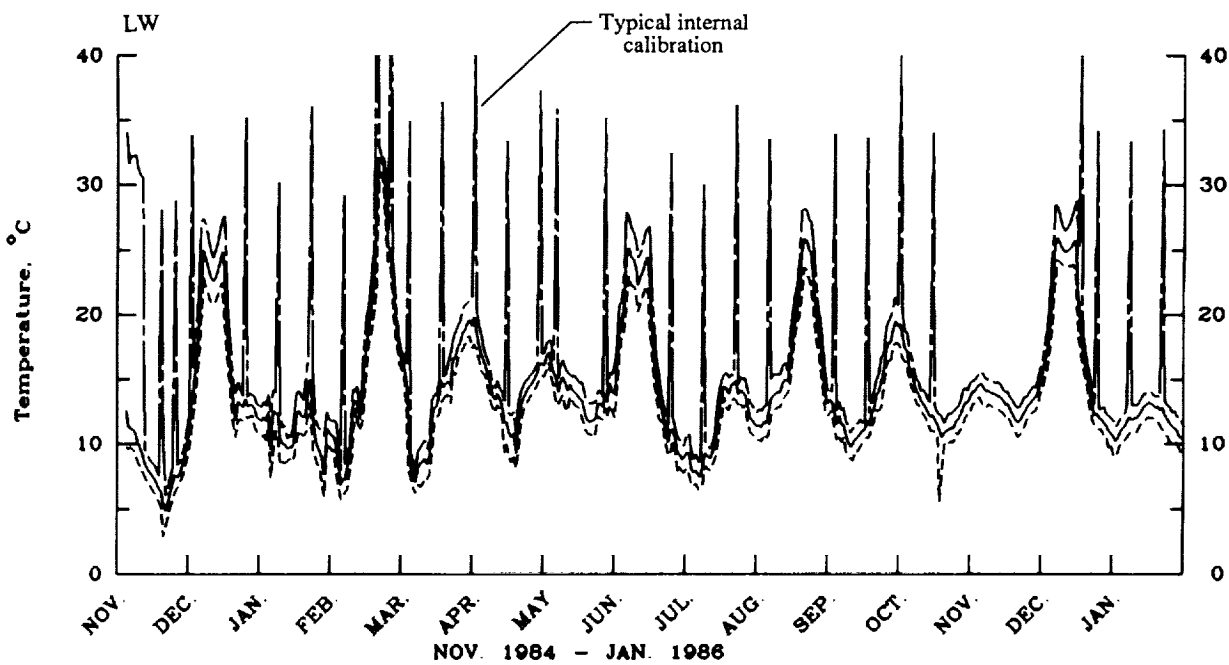
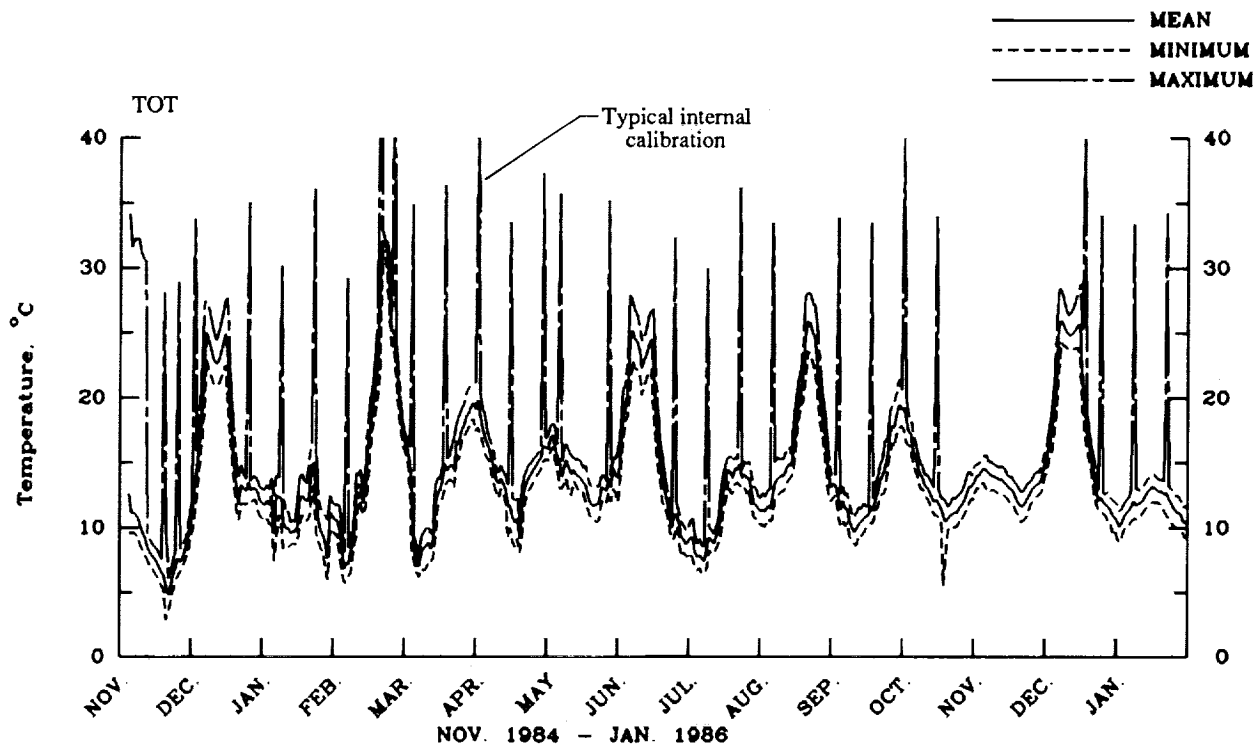

(c) Blackbody temperatures.

Figure 9. Continued.

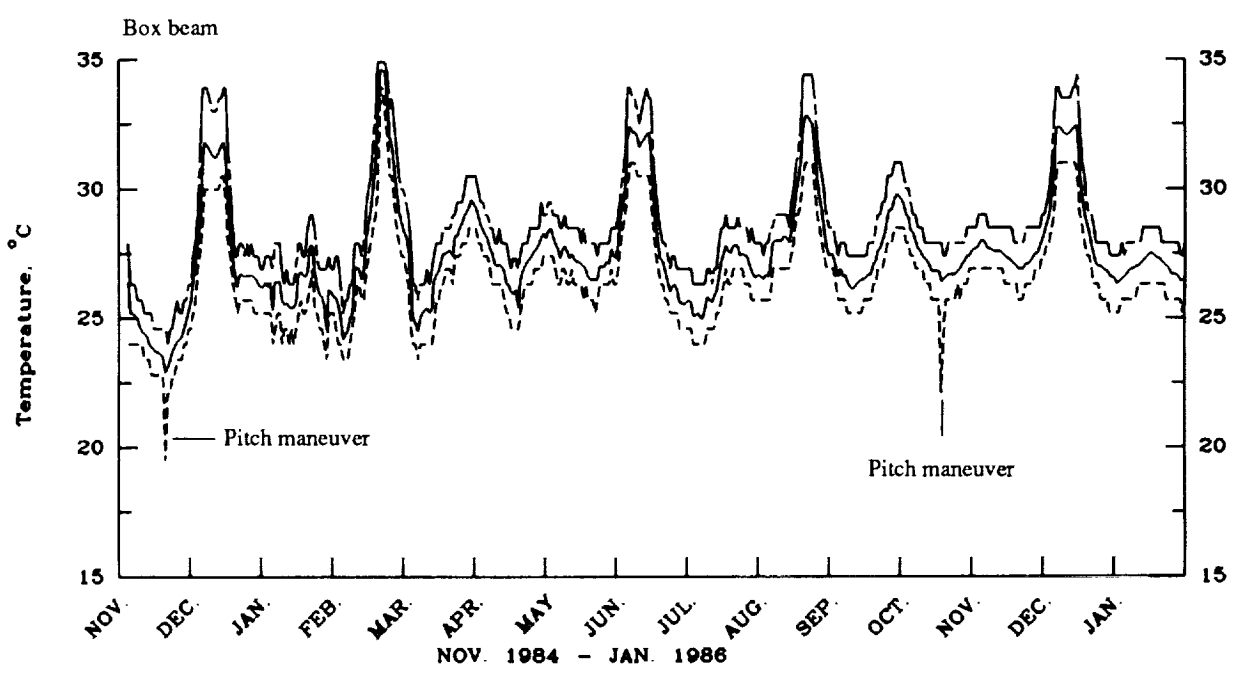
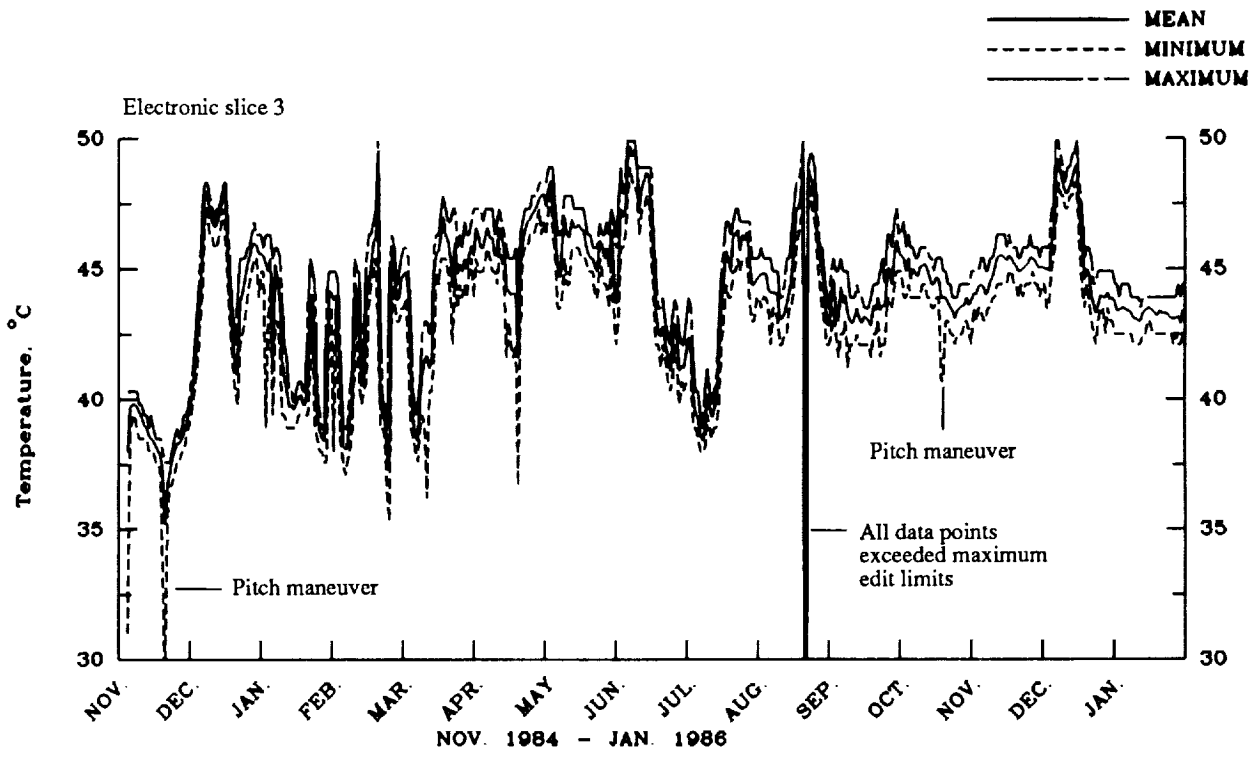

(d) Passive analog temperatures.

Figure 9. Concluded.

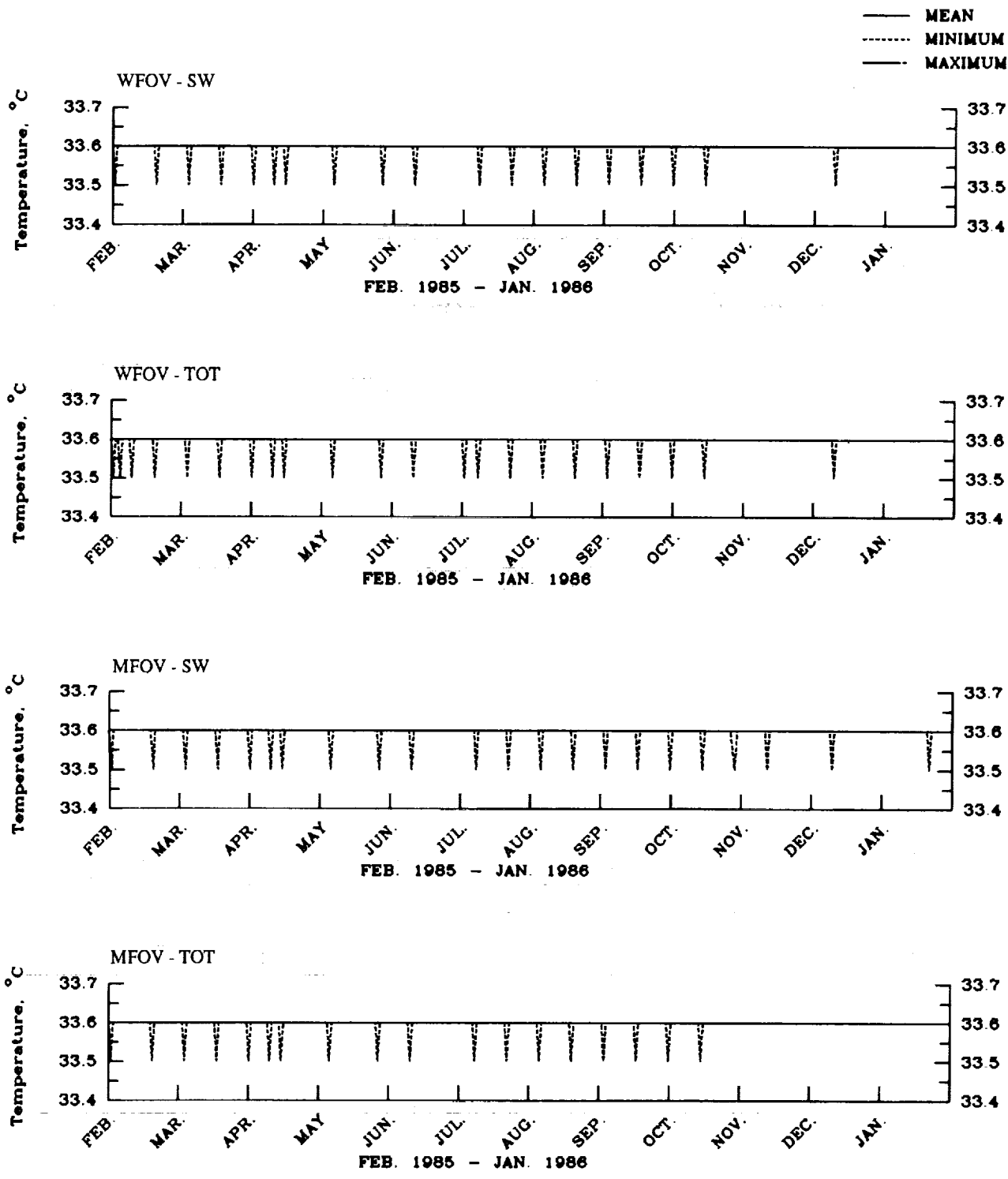

(a) Heat sink temperatures. Earth-viewing detectors.

Figure 10. Daily values of minimum, mean, and maximum housekeeping measurements from nonscanner instrument on NOAA 9 spacecraft.

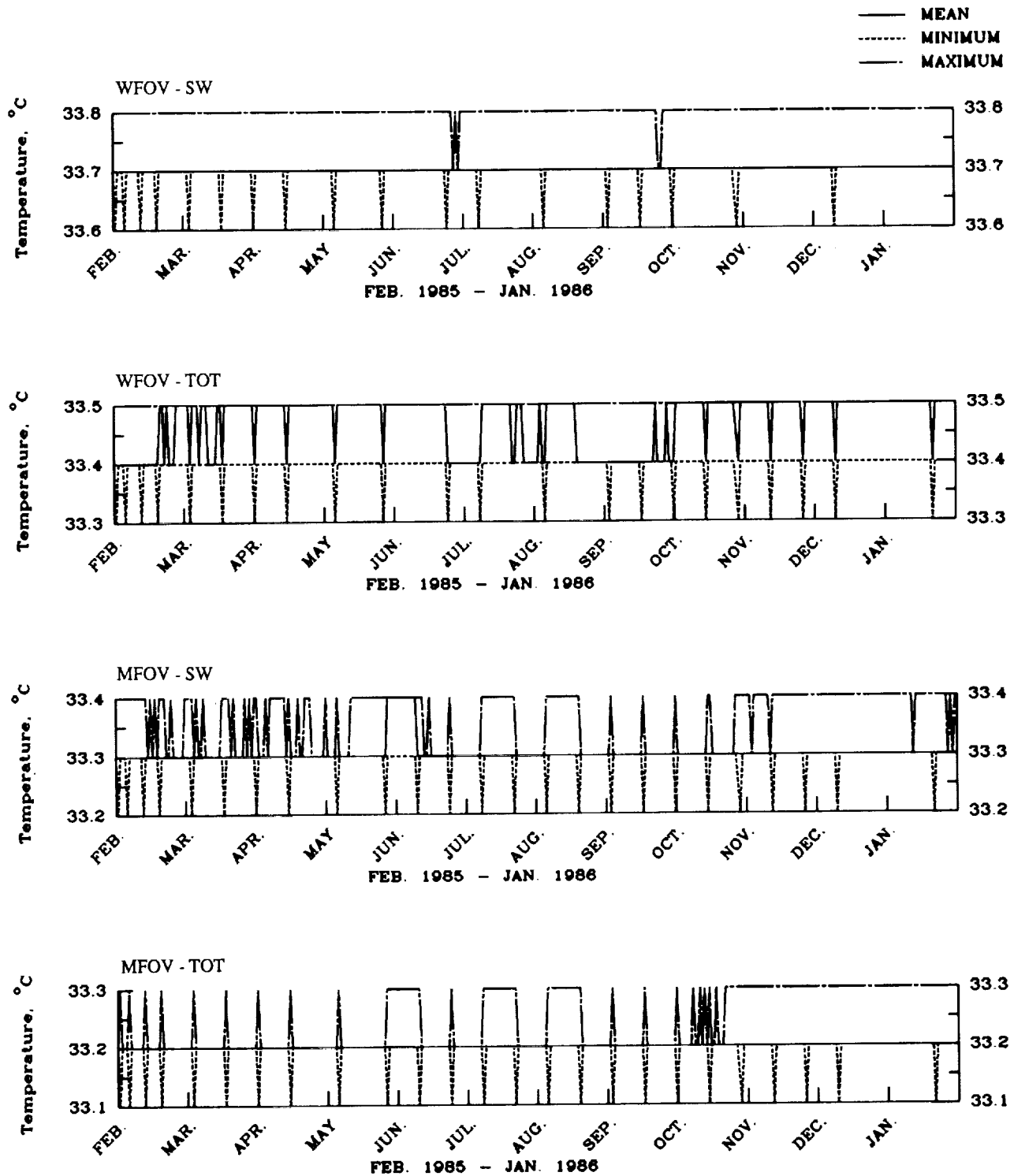

(b) Aperture temperatures. Earth-viewing detectors.

Figure 10. Continued.

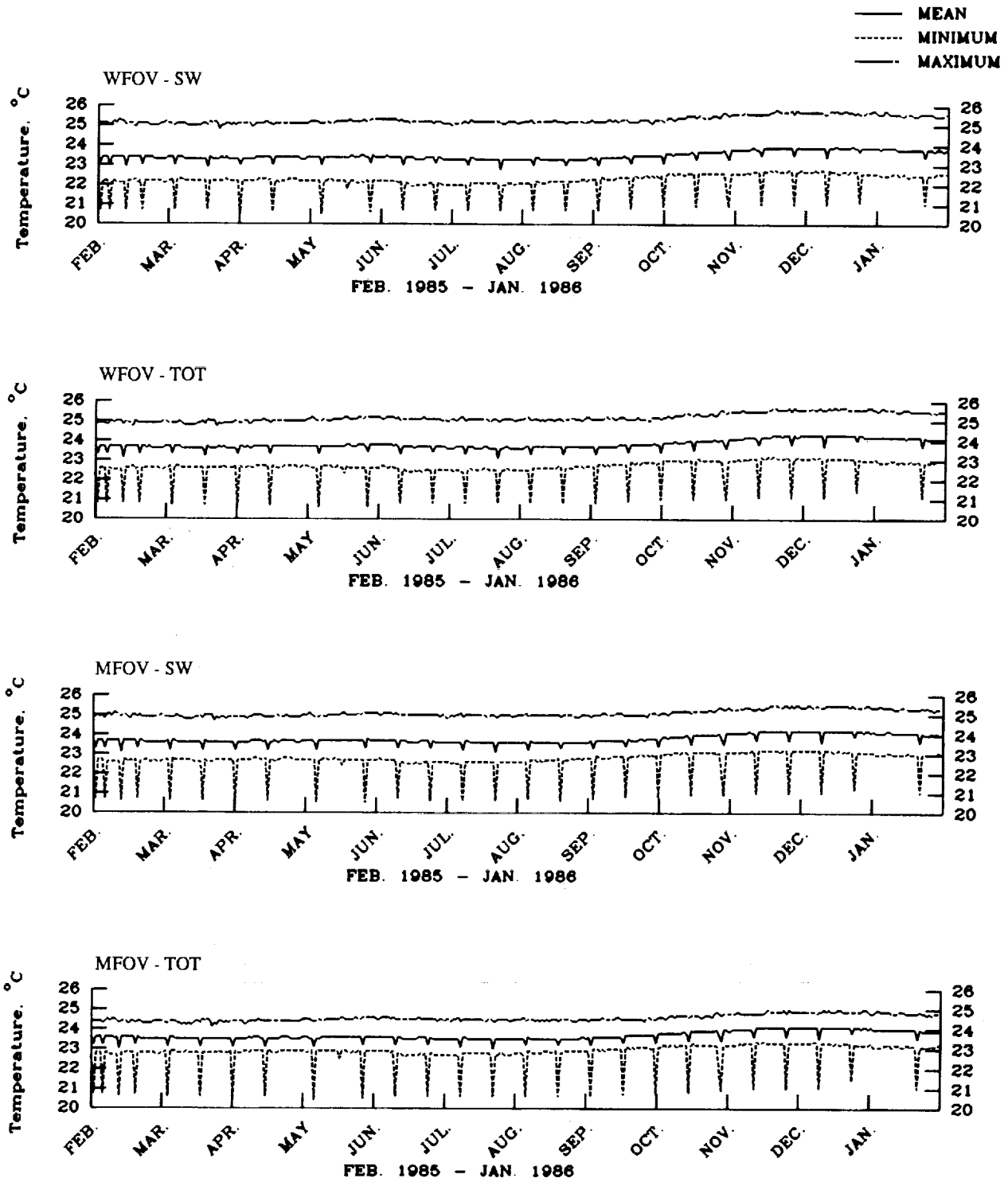

(c) Field-of-view limiter temperatures. Earth-viewing detectors.

Figure 10. Continued.

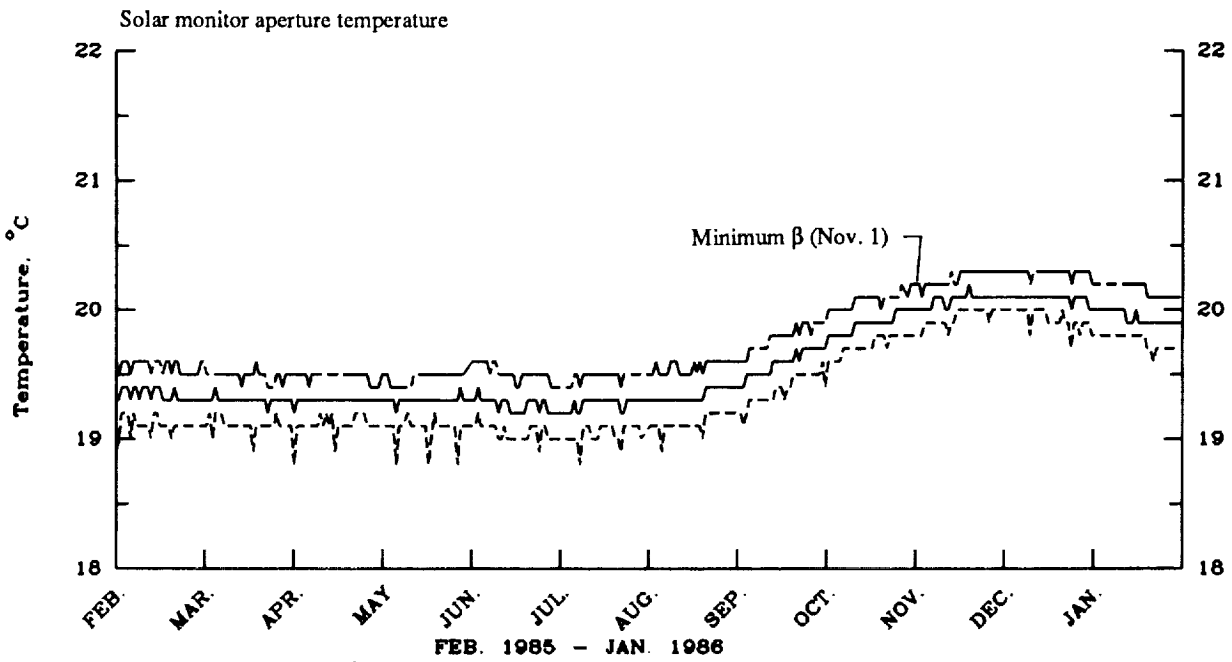
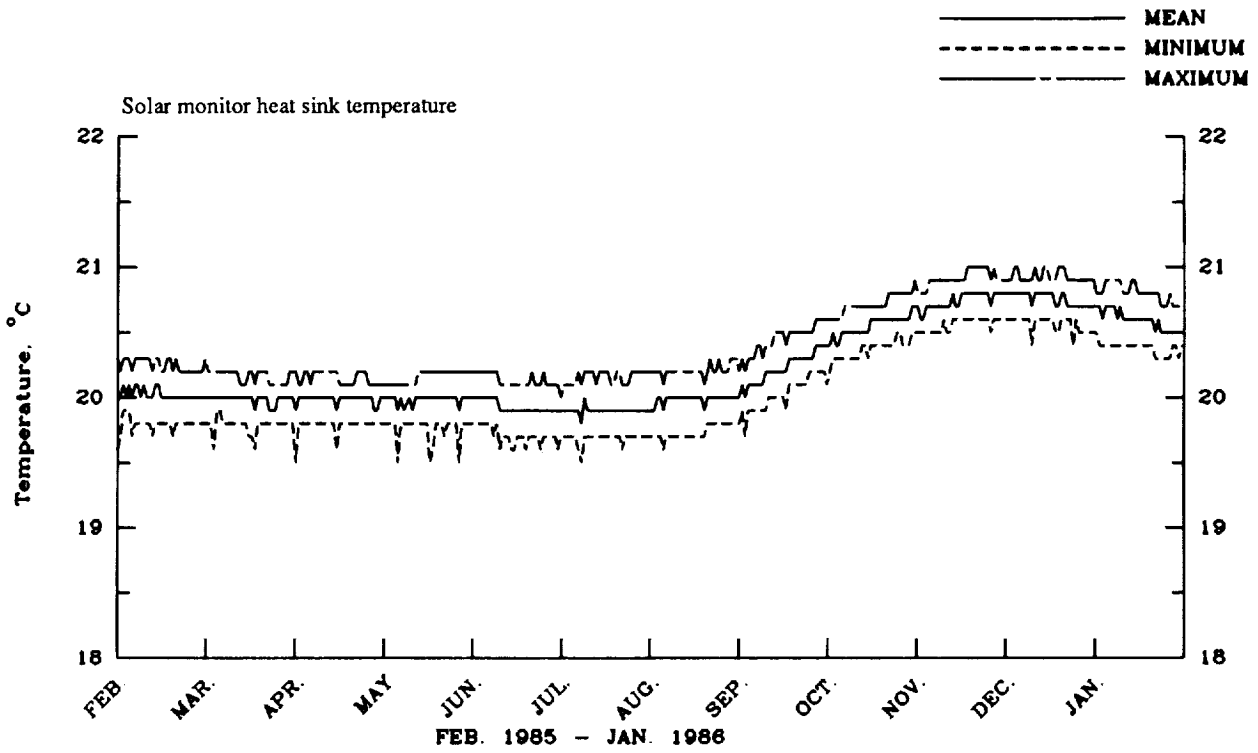

(d) Solar monitor heat sink and aperture temperatures.

Figure 10. Continued.

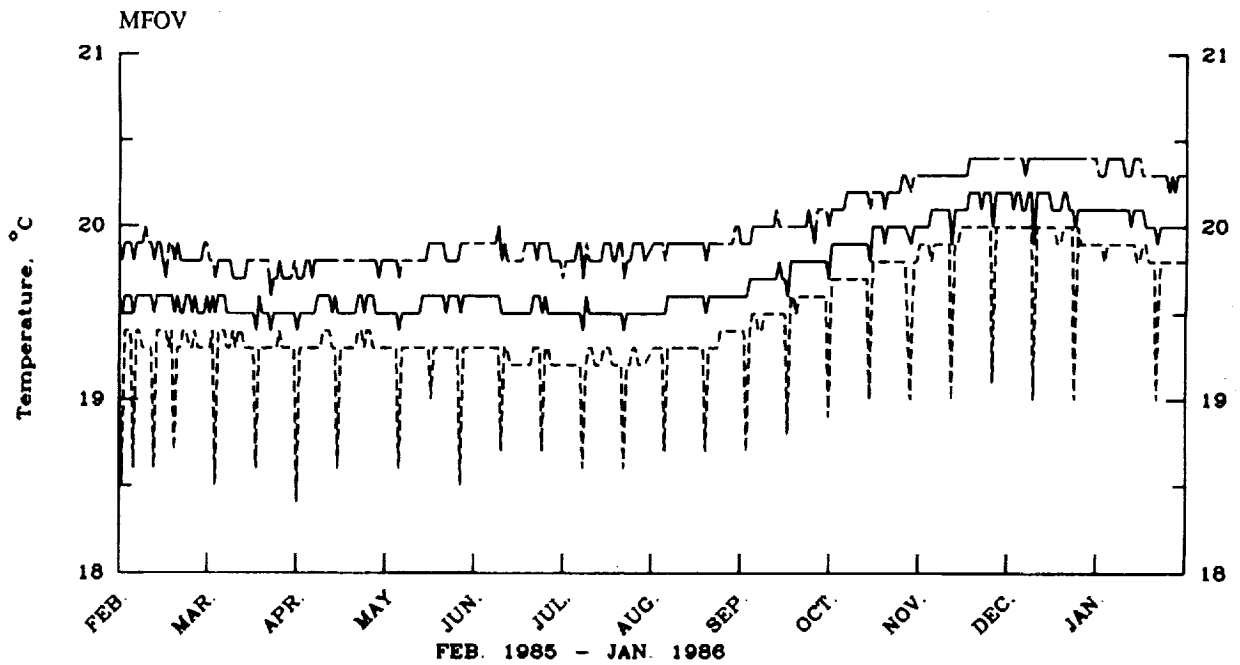
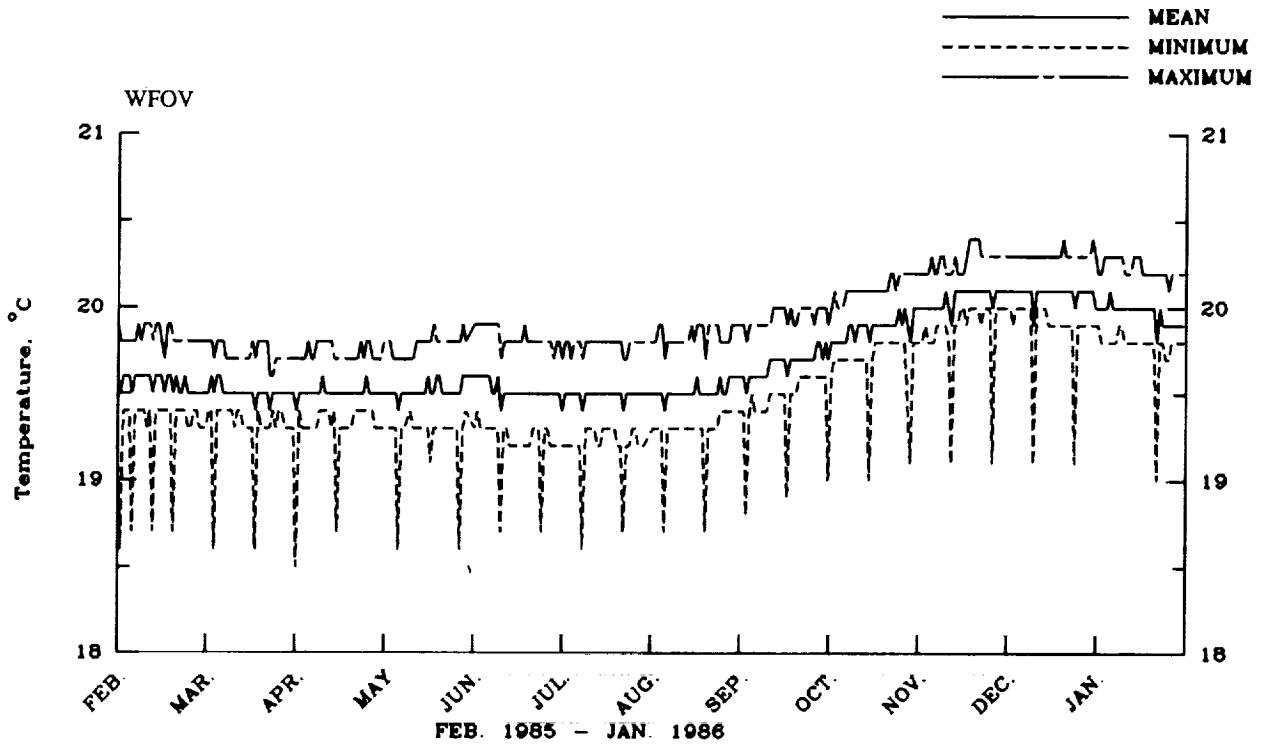

(e) Blackbody temperatures.

Figure 10. Continued.

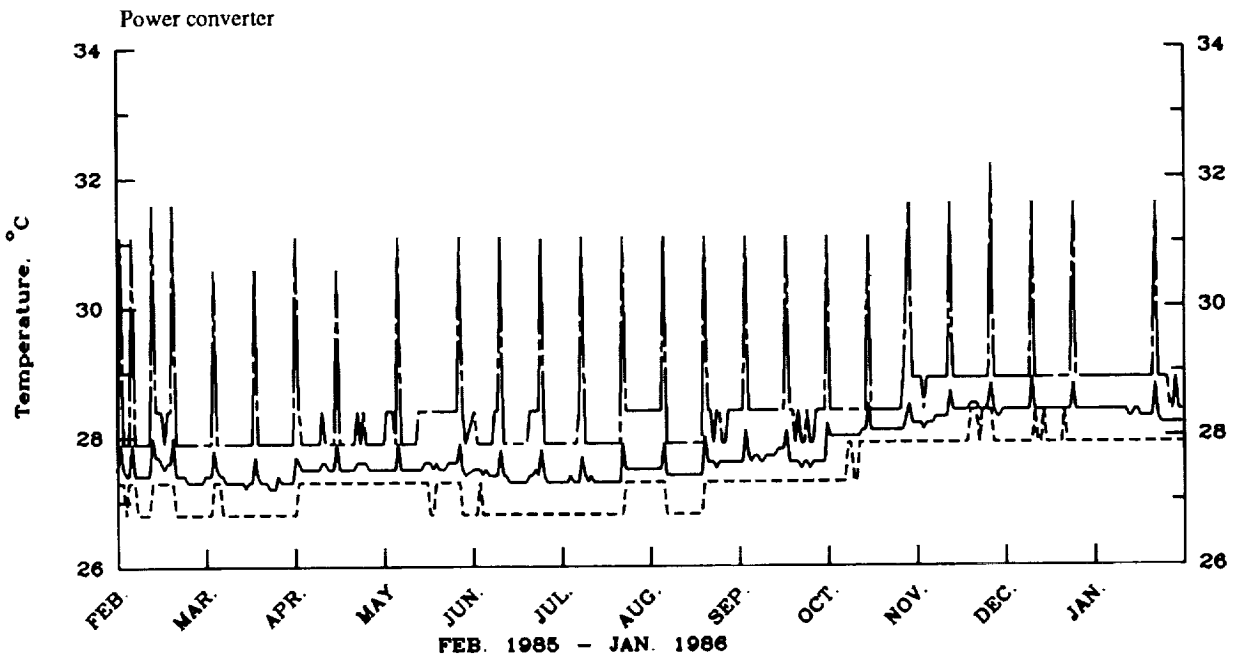
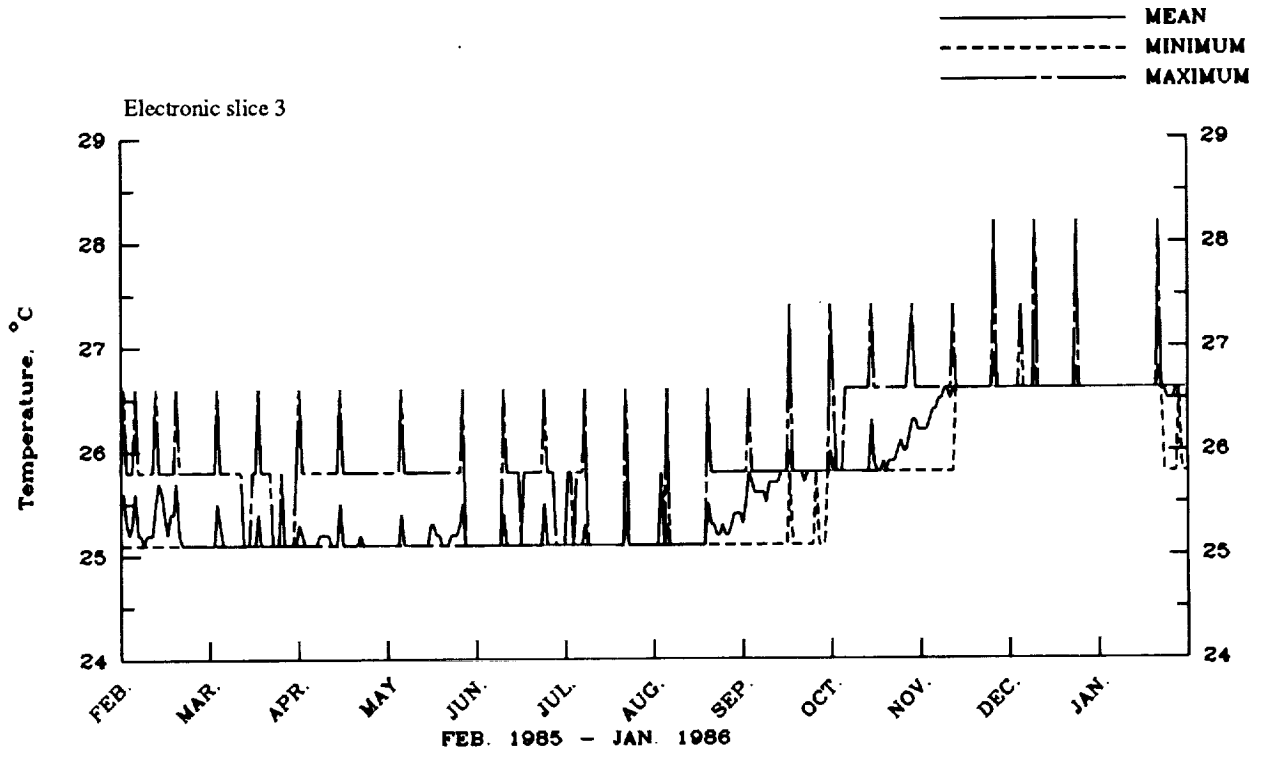

(f) Passive analog temperatures.

Figure 10. Concluded.

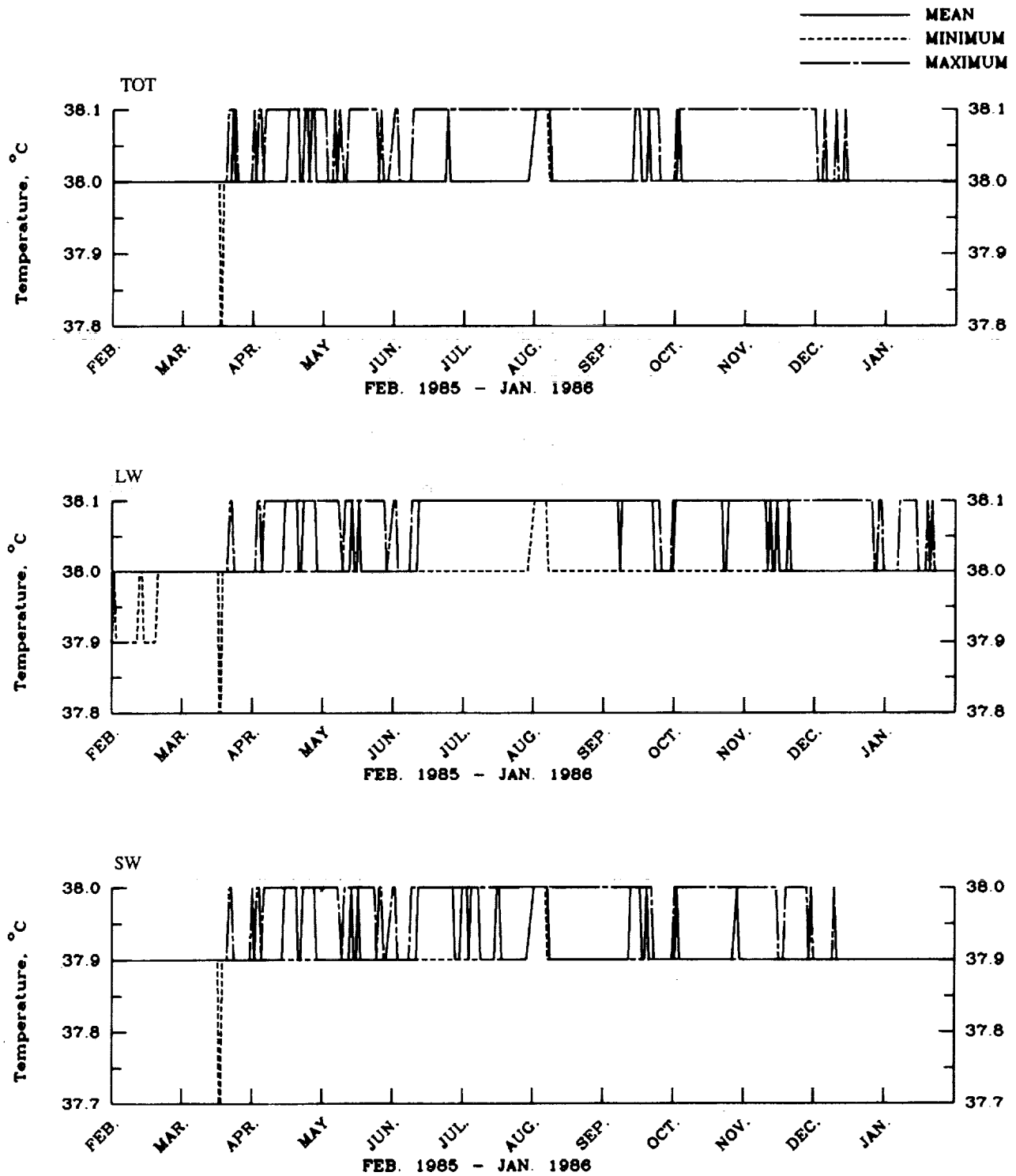

(a) Detector temperatures.

Figure 11. Daily values of minimum, mean, and maximum housekeeping measurements from scanner instrument on NOAA 9 spacecraft.

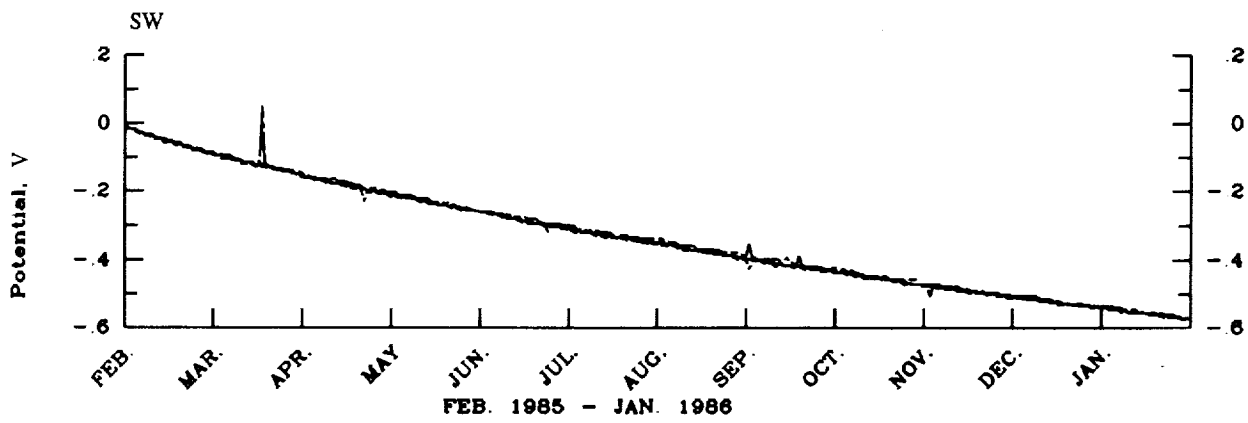
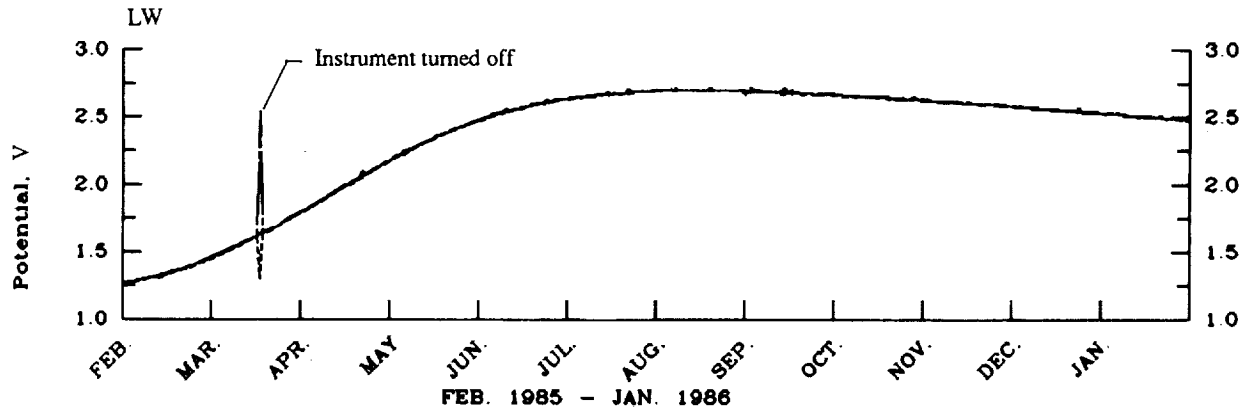
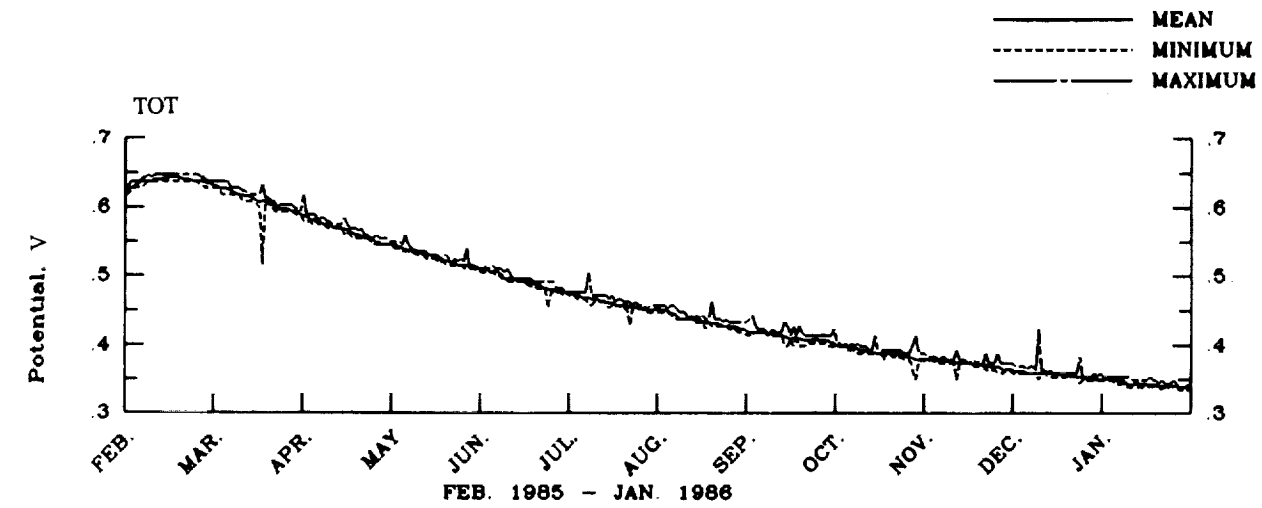

(b) Digital-to-analog (DAC) voltages.

Figure 11. Continued.

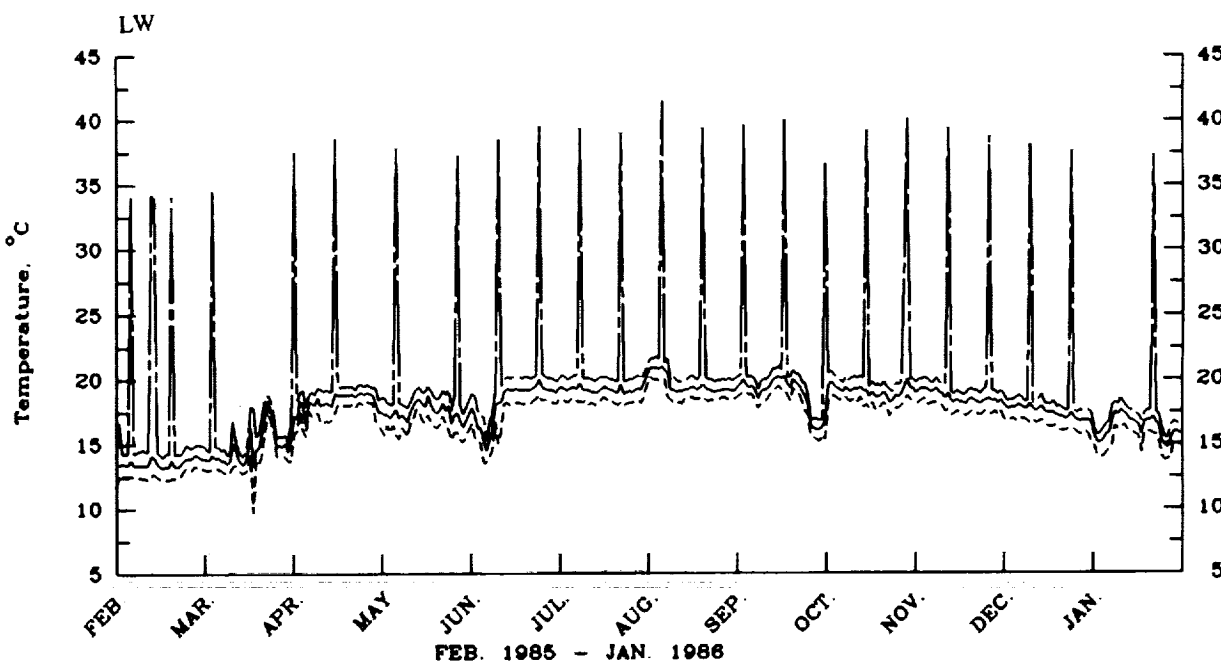
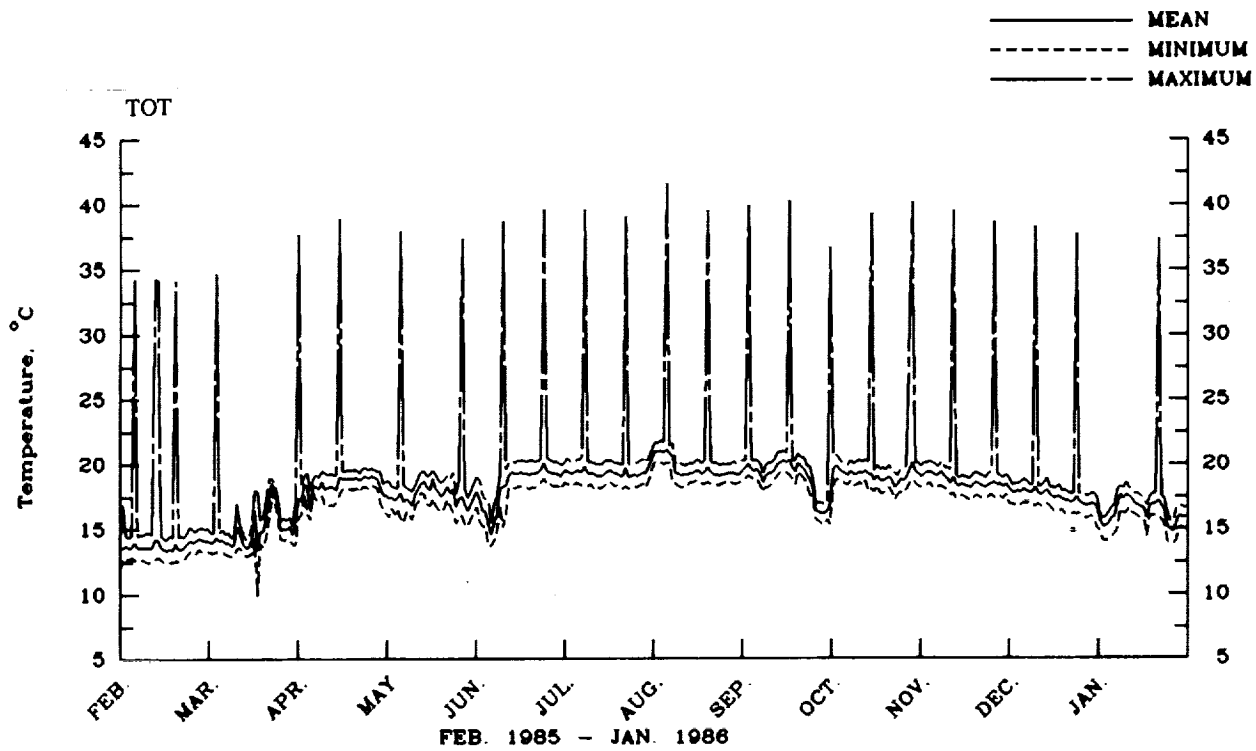

(c) Blackbody temperatures.

Figure 11. Continued.

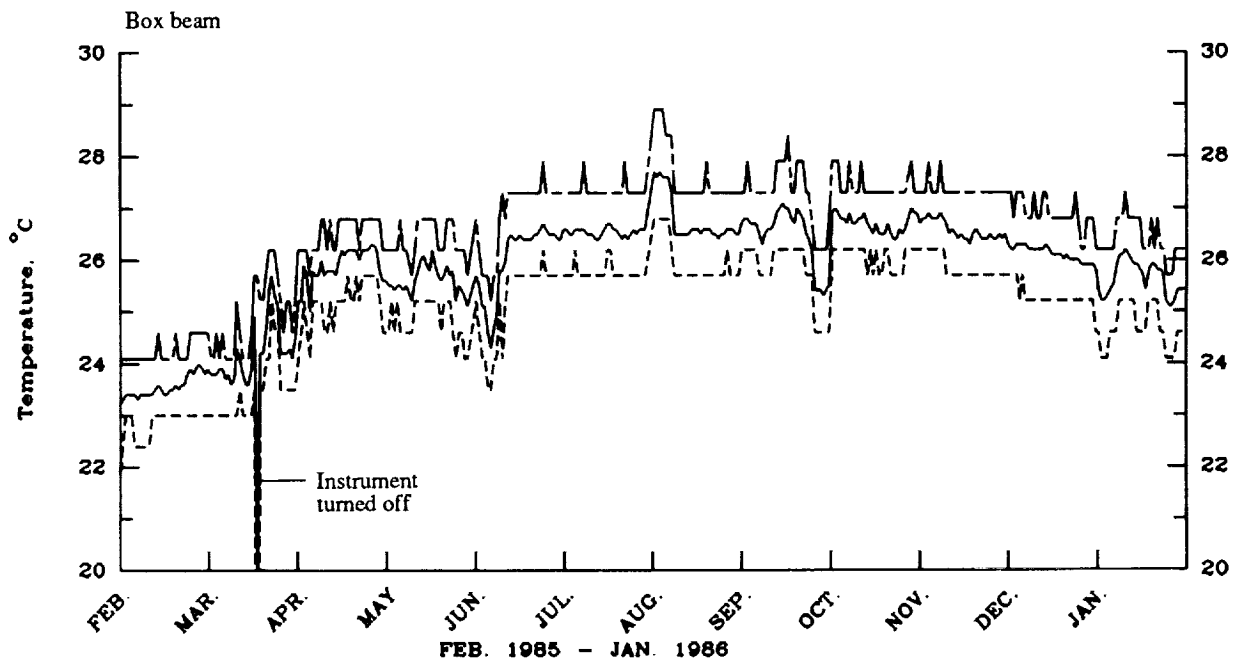
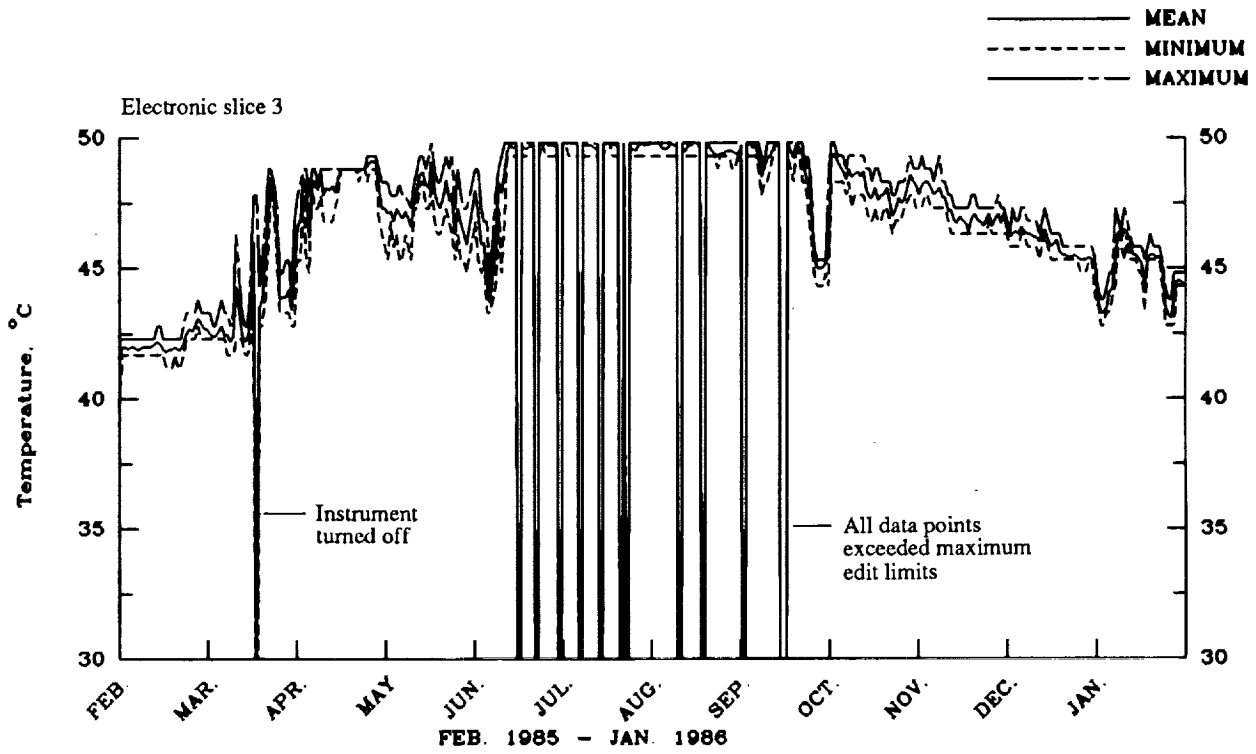

(d) Passive analog temperatures.

Figure 11. Concluded.

Appendix A

Description of Instrument Calibration Procedures and Data From Typical Calibration

This appendix describes the ERBE instrument calibration procedures and discusses how calibrations are performed in flight. The discussion begins with a description of the preprogrammed (automated) calibration sequences and then describes how these are combined with other commands to form longer command sequences that are usually employed during in-flight calibrations. Earth-Sun-spacecraft geometry during a solar calibration is described. Finally, data are discussed for a typical set of calibrations performed with the instruments aboard the ERBS spacecraft.

Calibration Procedures

Table A1 lists the commands in each of the four calibration sequences that were preprogrammed into the ERBE instruments during fabrication. When an instrument receives the appropriate calibration sequence command (Hex 8A1 or 8A2), the commands that follow are executed by the instrument in the order and at the relative times listed in the tables. While an instrument is executing an automated calibration sequence, the instrument will not execute any other mode commands. The internal calibration sequences for both the nonscanner and scanner instruments (table A1) are the same for the instruments on both spacecraft. However, the automated solar calibration sequences differ between the two spacecraft as can be seen in tables A1(c) and A1(d). The differences in the solar calibration sequences are due to the fact that the instruments on the ERBS and NOAA 9 spacecraft normally operate at different azimuth angles. (See table 6.)

The automated calibration sequences of table A1 were employed in all calibrations of ERBE instruments on the NOAA 9 spacecraft for the entire first year of their operation. The automated sequences were also used for both scanner calibrations and for the nonscanner internal calibrations during the first 15 months of operation of the ERBS spacecraft. However, a modified version of the automated solar calibration sequence was used for calibrations of the nonscanner instrument aboard the ERBS spacecraft beginning on December 3, 1984. The change was required because the detector output was being saturated (the output was driven off scale) while viewing the Sun during calibrations. The nonscanner

solar calibration sequence was modified to produce a bias in the output of the detectors at level 2, which prevented output of the detectors from being saturated. The modified solar calibration sequence for ERBS also included other changes. Table A2 lists the commands in the new (modified) calibration sequence and compares them with the commands in the old (automated) calibration sequence. The commands in the new calibration sequence are executed from tables stored in the ERBS spacecraft computer memory in the order and at the relative times listed. There is no actual calibration sequence command in the new sequence, and relative times are reckoned from the time when the instrument is commanded to rotate in elevation to the solar ports (Hex 822).

Some additional instrument commands are usually executed in conjunction with the commands in the calibration sequences of tables A1 and A2. The Sun azimuth angle data must be loaded via instrument data storage commands prior to the time that the mode command is issued to begin execution of a solar calibration sequence. (See the discussion on p. 5 in the "Instrument Operational Capabilities" section.) The azimuth angle data storage commands are executed via sequences stored in a spacecraft computer memory. Table A3 lists the command sequences for loading and storing azimuth angle data for solar calibrations of the nonscanner and scanner instruments aboard the two spacecraft.

The internal calibration sequences for the nonscanner instruments are preceded by a special set of auxiliary mode commands (table A4). The commands in these sequences were added to the calibration commands to permit the Earth-viewing detectors to become acclimated to the output of the internal calibration sources prior to the beginning of the internal calibrations. Initiation of the automated internal calibration sequences begins in less than a minute after the end of the sequences listed in table A4. The commands in the sequences are identical for the instruments on both spacecraft. However, it can be seen that the relative times at which the commands in a sequence are executed are different for the instruments on the ERBS and NOAA 9 spacecraft.

Most of the calibrations of a specific instrument on a spacecraft have employed a single command sequence that includes the internal and solar calibration sequences and all other associated auxiliary commands. The commands in these combined calibration sequences are listed in tables A5 and A6 for calibrations of instruments on the ERBS and NOAA 9 spacecraft, respectively. All commands in a combined calibration sequence are executed at the relative times shown. Recall that all commands in an

automated sequence (except for the first command) are executed from the instrument computer memory. Therefore, only those commands in tables A5 and A6 that are noted by asterisks are required to be stored in a spacecraft computer memory. The entire sequence for the nonscanner solar calibrations on the ERBS spacecraft is executed out of memory because an automated series is not employed. The command sequences to load the required Sun azimuth angle data are included in the combined calibration sequences used on the NOAA 9 spacecraft. (See table A6.) However, the load sequence of the Sun azimuth angle data is not part of the combined sequences used on the ERBS spacecraft (see table A5), and the Sun angle data are always loaded prior to the initiation of the combined sequence.

The combined nonscanner calibration sequences (tables A5(a) and A6(a)) begin with the command to elevate the detectors to the internal calibration sources, and all subsequent command times are reckoned relative to the execution of that command. As noted earlier, the Sun azimuth data load commands are included in the combined sequence employed on the NOAA 9 spacecraft. Table A6(a) shows an azimuth data load command before and after the solar calibration. The second set of azimuth data is required to rotate the nonscanner azimuth beam back to its normal operating angle of 170° . Table A5(a) shows that a new command "Elevate to nadir" has been added between the internal and solar calibration portions of the combined nonscanner calibration sequence used on the ERBS spacecraft.

The combined scanner calibration sequences (tables A5(b) and A6(b)) begin with the execution of the automated internal calibration sequence command, and execution times of all subsequent commands are reckoned from the time of their execution. Two commands (steps 14 and 15) are included between the internal and solar portions of the combined sequence for the ERBS spacecraft. The command at step 15 ensures that the solar calibration will begin with the azimuth beam positioned at 0° (which is already the case for the instrument on NOAA 9). The preceding command "Short scan mode" ensures that the azimuth rotation from 180° to 0° will not result in the scanner detectors directly viewing the Sun.

Data From In-Flight Calibrations

Calibrations on December 3, 1984, of the instruments on the ERBS spacecraft are discussed to illustrate data from a typical set of instrument calibrations. Calibrations of both instruments employed the combined internal and solar calibration sequences listed in table A5.

Nonscanner Calibration

Table A7(a) lists the commands and the times (UT and minutes of day) when the commands were executed for the combined nonscanner and solar calibrations performed on December 3, 1984. The Sun azimuth angle data required for the solar calibration were loaded prior to the execution of the first command in this sequence. Figure A1(a) shows the output of the four normally Earth-viewing nonscanner detectors from about 25 minutes before the start of the automated internal calibration sequence (07:53:53 UT or 474 minutes) and ending nearly 3 hours later. A decrease in the raw counts for the output of a detector indicates an increase in input radiation. The data plots begin with the four detectors still viewing the internal calibration sources in preparation for the beginning of the actual calibration sequence. The detector calibration heaters were turned on at their three different levels during the internal calibration. (See table A7(a).) This procedure, which causes the scale of the output of the detectors to be biased upward at three progressively higher values, prevents the output of the detectors from being driven off scale when responding to the output of the calibration sources. The calibration heaters remain off during normal Earth-viewing operations, and the first turnoff of the detectors at 07:54:25 UT had no effect on the calibration heaters because the heaters were already off.

Figure A1(b) shows the variation of the blackbody and solar port temperature measurements during the same period as the radiometric data shown in figure A1(a). The blackbody heater levels 1 and 2 were both set to produce a blackbody temperature of about 19.5° . Turning the blackbody heaters on and off, therefore, had very little effect on the actual blackbody temperatures that were already at an ambient temperature very close to 19.5° . The solar port temperatures, however, reflect sharp changes in temperature when the solar port heaters were turned off and on during the calibration.

Table A7(a) shows that the SWICS is turned on at each of its three output levels 2 minutes and 8 seconds after the detector bias heater is turned on at a new level. The output of the shortwave detectors (fig. A1(a)) shows that the shortwave detectors, which view the SWICS during internal calibrations, responded sharply as the SWICS output was turned on at level 3 at 08:00:17 UT (480 minutes), level 2 at 08:24:17 UT (504 minutes), and level 1 at 08:48:17 UT (528 minutes). The automated internal calibration sequence ended with the last SWICS off command at 08:55:45 UT, and the elevation beam

was rotated back to nadir at 09:02:41 UT in preparation for the beginning of the solar calibration.

The modified solar calibration sequence began at 09:10:09 UT when the elevation beam was rotated to the solar ports (78.0°). The azimuth beam was rotated to the Sun position (39.98°) at 09:10:41 UT, where it remained until after the Sun had passed through the field of view of the detectors. The output of the four detectors in figure A1(a) shows the effect of turning on the detector bias heaters at level 2 at 09:11:13 UT (551 minutes), a few minutes before the Sun is in the field of view of the detectors.

The SMA shutter-on command, which blocks and unblocks (effectively opening and closing) the solar monitor window every 32 seconds, was on for a 30-minute period that included the time when the sun crossed the solar monitor field of view. The operation of the solar monitor shutter during this period permitted measurements to be made before and after the Sun passed through the field of view of the detectors. Figure A2 shows the response of three of the nonscanner detectors during a 10-minute period that included the period when the Sun was in the field of view of the detectors. The output of the MFOV total radiation detector is presented in figure A2(a). Figure A2(b) shows the output of the WFOV shortwave detector superimposed on the output of the solar monitor detector. The 32-second period of the shutter on the solar monitor is apparent in the output of that detector. All three detectors show some response to the Sun for about 6.5 minutes, and the response was constant at a maximum value for about 3.0 minutes.

Scanner Calibration

The scanner internal calibrations are performed with the instrument operating in the normal Earth scan mode (the normal mode for internal calibrations). The primary calibration data are obtained while the detectors view the internal calibration sources located at an elevation angle of 190° . (See table 4.) Four measurements are made at the internal calibration sources (positions 71-74). During the calibration, the output of the calibration sources varies in the preprogrammed sequence of table A5(b). The SWICS is cycled through its three levels of output three different times. The blackbody heaters are turned on 32 seconds before the beginning of the second set of SWICS commands and turned off 32 seconds before the beginning of the third set. Turning the blackbody heaters on and off is by pulse discrete commands rather than by normal mode commands.

Table A7(b) lists the commands and the times (UT and minutes of day) when the commands were

executed for the combined scanner internal and solar calibrations performed on December 3, 1984. Figure A3(a) presents the output from the shortwave and longwave radiometric detectors from the scanner instrument during the period of the internal calibration on December 3. These data have been corrected by subtracting out the values measured at scan position 1. The shortwave detector response is shown for the first and fourth internal calibration measurements (71 and 74, respectively) in the first scan cycle of each 16-second period. These measurements are made while the detectors are viewing the internal calibration sources at an elevation angle of about 190° . The nonuniform (ragged) response of the shortwave detector for measurement 71 is caused by angular misalignment of the detectors with the calibrations source. The response at measurement 71 is typical for internal calibrations. However, during many calibrations, the misalignment and resulting effects on the detector output have been significantly worse than those shown in figure A3(a). The smoother response of the shortwave detector for 74 is also typical. The smoother response reflects the more precise alignment of the detector with the internal calibration source after the elevation beam has had time to settle in at the required elevation beam angle of 190° . The misalignment problem is inherent in the design of the scanner elevation-beam drive mechanism. The elevation-beam design and the associated problems are discussed in reference 8.

Figure A3(b) shows the temperatures of the blackbodies during the scanner internal calibration. The blackbody temperatures are seen to increase from the time that the heater was turned on at 08:01:53 UT (481 minutes) until it was turned off at 08:25:53 UT (506 minutes). Figure A3(a) shows the response of the longwave detector to the blackbody output for measurement 74. The longwave detector shows an increased response during the periods that the SWICS is on.

The automated scanner solar calibration on December 3 began at 09:21:21 UT (table A7(b)). The Sun azimuth angle (angle B) was 40.20° and the space-view angle (angle A) was 55.2° . Figure A4 shows the response of the scanner shortwave detector at the MAM (a scan angle of 233° - scan position 40) from 565 to 595 minutes. The measurements have been corrected by subtracting the output measured at scan position 1. Figure A4 also shows the instrument azimuth angle during the solar calibration. The period includes the entire time that the scanner was in the MAM scan mode and the detectors were viewing space and Sun in the MAM window. This response to the Sun is typical with a decline in the

output as the Sun angle changes across the field of view of the MAM. The exposure time of the detector to the Sun was about 6 minutes (from 574 to 580 minutes). The effects of some of the azimuth-beam rotations are also evident in the response of the detector. This response is interesting because one would expect the effect to have been removed by subtracting the value of the detector output at position 1.

Sun-Spacecraft Geometry During Solar Calibrations

The ERBS spacecraft was flying X -axis forward at the time of the calibrations on December 3, 1984, with the Sun on the right side of the orbit. (See fig. 4(a) for in-flight coordinate reference.) Figures 5(a) and 6(a) indicate that the Sun's β angle was about 139° . Figure A5 shows the position of the Sun in the orbit reference coordinate system described in appendix C. The cone elevation angle defined in appendix C has been modified to illustrate the ac-

tual elevation angles in the two different instrument axes systems. (See fig. 2.) To an observer at the origin of the orbit reference axis system, the Sun appears to cone counterclockwise about the orbit angular momentum vector. Note that this coning motion is about the negative Y -axis of the ERBS spacecraft axes system illustrated in figure 4(a). The cone half-angle is the radius of the circle in figure A5. The cone half-angle is about 41.0° , or 180.00° minus β .

Solar calibrations of the nonscanner and scanner instruments can be performed only at Sun elevation angles corresponding to the fixed elevation angles of the Solar Monitor Assembly (78°) and the MAM (11°). Recall that the azimuth beams of the instruments can rotate only between 0° and 180° . Therefore, the calibrations on December 3 could be performed only at azimuth angles near 40° . The actual angles to which the instruments were rotated to view the Sun during the solar calibration were 39.98° and 40.20° for the nonscanner and scanner, respectively.

Table A1. ERBE Instrument Preprogrammed (Automated) Calibration Sequences

[Footnotes are given at end of table]

(a) Nonscanner internal calibration

Step	Elapsed UT		Hex command	Event description
	hr:min:sec			
1	00:00:00		8A1	Begin internal calibration
2	00:00:32		881	Detector bias heater off
3	00:01:04		852	Solar port heaters off
4	00:01:36		821	Elevate to internal source (stow)
5	00:02:08		851	Solar port heaters on
6	00:04:16		882	Detector bias heater on at level 1
7	00:06:24		892	SWICS on at level 3
8	00:09:36		881	Detector bias heater off
9	00:13:20		862	WFOV blackbody heater on at temp. 1
10	00:13:52		872	MFOV blackbody heater on at temp. 1
11	00:14:56		891	SWICS off
12	00:28:16		883	Detector bias heater on at level 2
13	00:30:24		893	SWICS on at level 2
14	00:33:36		881	Detector bias heater off
15	00:37:20		863	WFOV blackbody heater on at temp. 2
16	00:37:52		873	MFOV blackbody heater on at temp. 2
17	00:38:56		891	SWICS off
18	00:52:16		884	Detector bias heater on at level 3
19	00:54:24		894	SWICS on at level 1
20	00:56:32		881	Detector bias heater off
21	00:59:12		852	Solar port heaters off
22	01:00:16		861	WFOV blackbody heater off
23	01:00:48		871	MFOV blackbody heater off
24	01:01:20		851	Solar port heaters on
25	01:01:52		891	SWICS off

(b) Scanner internal calibration

Step	Elapsed UT		Hex command	Event description
	hr:min:sec			
1	00:00:00		8A1	Begin internal calibration
2	00:00:32		897	SWICS on at level 1 modulated
3	00:02:08		895	SWICS on at level 2 modulated
4	00:03:44		893	SWICS on at level 3 modulated
5	00:05:20		891	SWICS off
	00:08:00			Discrete command inserted ^a
6	00:08:32		897	SWICS on at level 1 modulated
7	00:10:08		895	SWICS on at level 2 modulated
8	00:11:44		893	SWICS on at level 3 modulated
9	00:13:20		891	SWICS off
	00:32:00			Discrete command inserted ^b
10	00:32:32		897	SWICS on at level 1 modulated
11	00:34:08		895	SWICS on at level 2 modulated
12	00:35:44		893	SWICS on at level 3 modulated
13	00:37:20		891	SWICS off

Table A1. Concluded

(c) Nonscanner solar calibration

Step	Elapsed UT		Hex command	Event description
	hr:min:sec			
1	00:00:00		8A2	Begin solar calibration
2	00:00:32		852	Solar port heaters off
3	00:01:04		822	Elevate to solar ports (Sun)
4	00:01:36		814	Azimuth to position A
5	00:02:08		882	Detector bias heater on at level 1
6	00:11:44		851	Solar port heaters on
7	00:12:16		831	SMA shutter cycle on
8	00:28:48			(c)
8	00:43:12		832	SMA shutter cycle off
9	00:43:44		852	Solar port heaters off
10 (ERBS)	00:44:16		811	Azimuth to 0°
10 (NOAA 9)	00:44:16		813	Azimuth to 180°
11	00:44:48		881	Detector bias heater off
12	00:54:24		823	Elevate to nadir (Earth)
13	00:54:56		851	Solar port heaters on

(d) Scanner solar calibration

Step	Elapsed UT		Hex command	Event description
	hr:min:sec	hr:min:sec		
1	00:00:00	00:00:00	8A2	Begin solar calibration
2	00:00:32	00:00:32	824	Short scan mode
3	00:01:04	00:01:04	811	Azimuth to 0°
4	00:01:36	00:01:36	814	Azimuth to position A
5	00:07:28	00:06:24	825	MAM (solar) scan mode
6	00:12:48	00:11:44	815	Azimuth to position B
7	00:16:00	00:15:14		(c)
7	00:19:12	00:18:08	814	Azimuth to position A
8	00:25:36	00:23:28	824	Short scan mode
9 (NOAA 9)		00:24:00	811	Azimuth to 0°
9 (ERBS)	00:26:08		813	Azimuth to 180°
10	00:30:56	00:28:48	822	Normal scan mode

^aPulse command CF15 issued: Blackbody calibration heaters on.

^bPulse command CF16 issued: Blackbody calibration heaters off. (See table 3(b).)

^cThe Sun crosses the center of the detector field of view.

Table A2. Modified Nonscanner Solar Calibration Sequence
Used on ERBS Spacecraft Beginning December 3, 1984

Step		Elapsed UT	Hex command	Event description
Automated	Modified	hr:min:sec		
1				
2				
3	1	00:00:00	822	Elevate to solar ports (Sun)
4	2	00:00:32	814	Azimuth to position A
5	3	00:01:04	883	Detector bias heater on at level 2
6				
7	4	00:11:12	831	SMA shutter cycle on
		00:26:40		(a)
8	5	00:42:08	832	SMA shutter cycle off
9				
10	6	00:43:12	811	Azimuth to 0° (ERBS)
11	7	00:43:44	881	Detector bias heater off
12	8	00:53:20	823	Elevate to nadir (Earth)
13				

^aThe Sun crosses the center of the detector field of view.

Table A3. Azimuth Angle Load Command Sequences

(a) ERBS nonscanner solar azimuth sequence

Step	Elapsed UT		Hex command	Event description
	hr:min:sec			
1	00:00:00		419	Address azimuth position A
2	00:00:32		2xx	Data command, high byte
3	00:01:36		1xx	Data command, low byte

(b) ERBS scanner solar azimuth sequence

Step	Elapsed UT		Hex command	Event description
	hr:min:sec			
1	00:00:00		419	Address azimuth position A
2	00:00:32		2xx	Data command, high byte
3	00:01:36		1xx	Data command, low byte
4	00:02:40		41B	Address azimuth position B
5	00:03:12		2xx	Data command, high byte
6	00:04:16		1xx	Data command, low byte

(c) NOAA 9 nonscanner solar azimuth sequence

Step	Elapsed UT		Hex command	Event description
	hr:min:sec			
1	00:00:00		419	Address azimuth position A
2	00:00:32		2xx	Data command, high byte
3	00:01:04		1xx	Data command, low byte

(d) NOAA 9 scanner solar azimuth sequence

Step	Elapsed UT		Hex command	Event description
	hr:min:sec			
1	00:00:00		419	Address azimuth position A
2	00:00:32		2xx	Data command, high byte
3	00:01:04		1xx	Data command, low byte
4	00:01:36		41B	Address azimuth position B
5	00:02:08		2xx	Data command, high byte
6	00:02:40		1xx	Data command, low byte

(e) NOAA 9 nonscanner normal operating azimuth angle

Step	Elapsed UT		Hex command	Event description
	hr:min:sec			
1	00:00:00		419	Address azimuth position A
2	00:00:32		2xx	Data command, high byte
3	00:01:04		1xx	Data command, low byte
4	00:01:36		814	Azimuth to position A

Table A4. Preinternal Nonscanner Calibration Command Sequences

(a) ERBS spacecraft

Step	Elapsed UT		Hex command	Event description
	hr:min:sec			
1	00:00:00		821	Elevate to internal source (stow)
2	00:00:32		862	WFOV blackbody heater on at temp. 1
3	00:01:04		872	MFOV blackbody heater on at temp. 1
4	01:37:04		823	Elevate to nadir (Earth)

(b) NOAA 9 spacecraft

Step	Elapsed UT		Hex command	Event description
	hr:min:sec			
1	00:00:00		821	Elevate to internal source (stow)
2	00:00:32		862	WFOV blackbody heater on at temp. 1
3	00:16:00		872	MFOV blackbody heater on at temp. 1
4	01:42:56		823	Elevate to nadir (Earth)

Table A5. Combined Internal and Solar Calibration Sequences
Used Aboard ERBS Spacecraft

[Footnotes are given at end of table]

(a) Nonscanner commands

Step	Elapsed UT	Hex command	Event description
	hr:min:sec		
Begin preinternal calibration sequence			
1	00:00:00	^a 821	Elevate to internal source (stow)
2	00:00:32	^a 862	WFOV blackbody heater on at temp. 1
3	00:01:04	^a 872	MFOV blackbody heater on at temp. 1
4	01:37:04	^a 823	Elevate to nadir (Earth)
End preinternal calibration sequence.			
Begin internal calibration sequence			
5	01:38:08	^a 8A1	Begin internal calibration
6	01:38:40	881	Detector bias heater off
7	01:39:12	852	Solar port heaters off
8	01:39:44	821	Elevate to internal source (stow)
9	01:40:16	851	Solar port heaters on
10	01:42:24	882	Detector bias heater on at level 1
11	01:44:32	892	SWICS on at level 3
12	01:47:44	881	Detector bias heater off
13	01:51:28	862	WFOV blackbody heater on at temp. 1
14	01:52:00	872	MFOV blackbody heater on at temp. 1
15	01:53:04	891	SWICS off
16	02:06:24	883	Detector bias heater on at level 2
17	02:08:32	893	SWICS on at level 2
18	02:11:44	881	Detector bias heater off
19	02:15:28	863	WFOV blackbody heater on at temp. 2
20	02:16:00	873	MFOV blackbody heater on at temp. 2
21	02:17:04	891	SWICS off
22	02:30:24	884	Detector bias heater on at level 3
23	02:32:32	894	SWICS on at level 1
24	02:34:40	881	Detector bias heater off
25	02:37:20	852	Solar port heaters off
26	02:38:24	861	WFOV blackbody heater off
27	02:38:56	871	MFOV blackbody heater off
28	02:39:28	851	Solar port heaters on
29	02:40:00	891	SWICS off
End internal calibration sequence			
30	02:46:56	^a 823	Elevate to nadir (Earth)
Begin modified solar calibration sequence			
31	02:54:24	^a 822	Elevate to solar ports (Sun)
32	02:54:56	^a 814	Azimuth to position A
33	02:55:28	^a 883	Detector bias heater on at level 2
34	03:05:36	^a 831	SMA shutter cycle on
	03:21:04		(b)
35	03:36:32	^a 832	SMA shutter cycle off
36	03:37:36	^a 811	Azimuth to 0°
37	03:38:08	^a 881	Detector bias heater off
38	03:47:44	^a 823	Elevate to nadir (Earth)
End solar calibration sequence			

Table A5. Concluded

(b) Scanner commands

Step	Elapsed UT	Hex command	Event description
	hr:min:sec		
Begin internal calibration sequence			
1	00:00:00	^a 8A1	Begin internal calibration
2	00:00:32	897	SWICS on at level 1 modulated
3	00:02:08	895	SWICS on at level 2 modulated
4	00:03:44	893	SWICS on at level 3 modulated
5	00:05:20	891	SWICS off
	00:08:00		Discrete command inserted ^c
6	00:08:32	897	SWICS on at level 1 modulated
7	00:10:08	895	SWICS on at level 2 modulated
8	00:11:44	893	SWICS on at level 3 modulated
9	00:13:20	891	SWICS off
	00:32:00		Discrete command inserted ^d
10	00:32:32	897	SWICS on at level 1 modulated
11	00:34:08	895	SWICS on at level 2 modulated
12	00:35:44	893	SWICS on at level 3 modulated
13	00:37:20	891	SWICS off
End internal calibration sequence			
14	01:22:08	^a 824	Short scan mode
15	01:22:40	^a 811	Azimuth to 0°
Begin solar calibration sequence			
16	01:27:28	^a 8A2	Solar calibration sequence
17	01:28:00	824	Short scan mode
18	01:28:32	811	Azimuth to 0°
19	01:29:04	814	Azimuth to position A
20	01:34:56	825	MAM (solar) scan mode
21	01:40:16	815	Azimuth to position B
	01:43:18		(b)
22	01:46:40	814	Azimuth to position A
23	01:53:04	824	Short scan mode
24	01:53:36	813	Azimuth to 180°
25	01:58:24	822	Normal scan mode
End solar calibration sequence			

^aNot part of the automated command sequence.

^bThe Sun crosses the center of the detector field of view.

^cPulse command CF15 issued: Blackbody calibration heaters on.

^dPulse command CF16 issued: Blackbody calibration heaters off. (See table 3(b).)

Table A6. Combined Internal and Solar Calibration Sequences
Used Aboard NOAA 9 Spacecraft

[Footnotes are given at end of table]

(a) Nonscanner commands

Step	Elapsed UT		Hex command	Event description
	hr:min:sec			
Begin preinternal calibration sequence				
1	00:00:00		^a 821	Elevate to internal source (stow)
2	00:00:32		^a 862	WFOV blackbody heater on at temp. 1
3	00:16:00		^a 872	MFOV blackbody heater on at temp. 1
4	01:42:56		^a 823	Elevate to nadir (Earth)
Begin internal calibration sequence				
5	01:43:28		^a 8A1	Begin internal calibration
6	01:44:00		881	Detector bias heater off
7	01:44:32		852	Solar port heaters off
8	01:45:04		821	Elevate to internal source (stow)
9	01:45:36		851	Solar port heaters on
10	01:47:44		882	Detector bias heater on at level 1
11	01:49:52		892	SWICS on at level 3
12	01:53:04		881	Detector bias heater off
13	01:56:48		862	WFOV blackbody heater on at temp. 1
14	01:57:20		872	MFOV blackbody heater on at temp. 1
15	01:58:24		891	SWICS off
16	02:11:44		883	Detector bias heater on at level 2
17	02:13:52		893	SWICS on at level 2
18	02:17:04		881	Detector bias heater off
19	02:20:48		863	WFOV blackbody heater on at temp. 2
20	02:21:20		873	MFOV blackbody heater on at temp. 2
21	02:22:24		891	SWICS off
22	02:35:44		884	Detector bias heater on at level 3
23	02:37:52		894	SWICS on at level 1
24	02:40:00		881	Detector bias heater off
25	02:42:40		852	Solar port heaters off
26	02:43:44		861	WFOV blackbody heater off
27	02:44:16		871	MFOV blackbody heater off
28	02:44:48		851	Solar port heaters on
29	02:45:20		891	SWICS off
End internal calibration sequence.				
Begin azimuth angle load commands				
30	02:48:00		^a 419	Address azimuth position A
31	02:48:32		^a 2xx	Data command, high byte
32	02:49:04		^a 1xx	Data command, low byte
End azimuth angle load commands				

Table A6. Continued

(a) Concluded

Step	Elapsed UT	Hex command	Event description
	hr:min:sec		
Begin solar calibration sequence			
33	02:49:36	^a 8A2	Solar calibration sequence
34	02:50:08	852	Solar port heaters off
35	02:50:40	822	Elevate to solar ports (Sun)
36	02:51:12	814	Azimuth to position A
37	02:51:44	882	Detector bias heater on at level 1
38	03:01:20	851	Solar port heaters on
39	03:01:52	831	SMA shutter cycle on
	03:16:30		(b)
40	03:32:48	832	SMA shutter cycle off
41	03:33:20	852	Solar port heaters off
42	03:33:52	813	Azimuth to 180°
43	03:34:24	881	Detector bias heater off
44	03:44:00	823	Elevate to nadir (Earth)
45	03:44:32	851	Solar port heaters on
End solar calibration sequence.			
Begin azimuth angle load commands			
46	03:49:52	419	Address azimuth position A
47	03:50:24	2xx	Data command, high byte
48	03:50:56	1xx	Data command, low byte
49	03:51:28	814	Azimuth to position A
End azimuth angle load commands			

Table A6. Concluded

(b) Scanner commands

Step	Elapsed UT		Hex command	Event description
	hr:min:sec			
Begin internal calibration sequence				
1	00:00:00		8A1	Begin internal calibration
2	00:00:32		897	SWICS on at level 1 modulated
3	00:02:08		895	SWICS on at level 2 modulated
4	00:03:44		893	SWICS on at level 3 modulated
5	00:05:20		891	SWICS off
	00:08:00			Discrete command inserted ^c
6	00:08:32		897	SWICS on at level 1 modulated
7	00:10:08		895	SWICS on at level 2 modulated
8	00:11:44		893	SWICS on at level 3 modulated
9	00:13:20		891	SWICS off
	00:32:00			Discrete command inserted ^d
10	00:32:32		897	SWICS on at level 1 modulated
11	00:34:08		895	SWICS on at level 2 modulated
12	00:35:44		893	SWICS on at level 3 modulated
13	00:37:20		891	SWICS off
End internal calibration sequence.				
Begin azimuth angle load commands				
14	04:25:36		419	Address azimuth position A
15	04:26:08		2xx	Data command, high byte
16	04:26:40		1xx	Data command, low byte
17	04:27:12		41B	Address azimuth position B
18	04:27:44		2xx	Data command, high byte
19	04:28:16		1xx	Data command, low byte
End azimuth angle load commands.				
Begin solar calibration sequence				
20	04:28:48		8A2	Solar calibration sequence
21	04:29:20		824	Short scan mode
22	04:29:52		811	Azimuth to 0°
23	04:30:24		814	Azimuth to position A
24	04:35:12		825	MAM (solar) scan mode
25	04:40:32		815	Azimuth to position B
26	04:43:44			(b)
27	04:46:56		814	Azimuth to position A
28	04:52:16		824	Short scan mode
29	04:52:48		811	Azimuth to 0°
30	04:57:36		822	Normal scan mode
End solar calibration sequence				

^aNot part of the automated command sequence.

^bThe Sun crosses the center of the detector field of view.

^cPulse command CF15 issued: Blackbody calibration heaters on.

^dPulse command CF16 issued: Blackbody calibration heaters off. (See table 3(b).)

Table A7. Commands Used in Calibrations Aboard ERBS Spacecraft
on December 3, 1984

[Footnotes are given at end of table]

(a) Nonscanner commands

Universal time		Hex command	Event description
hr:mn:sec	Minutes of day		
Begin azimuth angle load commands (table A3(a))			
01:41:05	101.08	419	Address azimuth position A
01:41:05	101.08	419	Address azimuth position A
01:41:37	101.62	2xx	Data command, high byte
01:42:41	102.68	1xx	Data command, low byte
End azimuth angle load commands.			
Begin additional internal calibration sequence (table A4(a))			
06:15:45	375.75	821	Elevate to internal source (stow)
06:16:17	376.28	862	WFOV blackbody heater on at temp. 1
06:16:49	376.82	872	MFOV blackbody heater on at temp. 1
07:52:49	472.82	823	Elevate to nadir (Earth)
End additional internal calibration sequence.			
Begin automated internal calibration sequence (table A1(a))			
07:53:53	473.88	8A1	Begin internal calibration
07:54:25	474.42	881	Detector bias heater off
07:54:57	474.95	852	Solar port heaters off
07:55:29	475.48	821	Elevate to internal source (stow)
07:56:01	476.02	851	Solar port heaters on
07:58:09	478.15	882	Detector bias heater on at level 1
08:00:17	480.28	892	SWICS on at level 3
08:03:29	483.48	881	Detector bias heater off
08:07:13	487.22	862	WFOV blackbody heater on at temp. 1
08:07:45	487.75	872	MFOV blackbody heater on at temp. 1
08:08:49	488.82	891	SWICS off
08:22:09	502.15	883	Detector bias heater on at level 2
08:24:17	504.28	893	SWICS on at level 2
08:27:29	507.48	881	Detector bias heater off
08:31:13	511.22	863	WFOV blackbody heater on at temp. 2
08:31:45	511.75	873	MFOV blackbody heater on at temp. 2
08:32:49	512.82	891	SWICS off
08:46:09	526.15	884	Detector bias heater on at level 3
08:48:17	528.28	894	SWICS on at level 1
08:50:25	530.42	881	Detector bias heater off
08:53:05	533.08	852	Solar port heaters off
08:54:09	534.15	861	WFOV blackbody heater off
08:54:41	534.68	871	MFOV blackbody heater off
08:55:13	535.22	851	Solar port heaters on
08:55:45	535.75	891	SWICS off
End automated internal calibration sequence			

Table A7. Continued

(a) Concluded

Universal time		Hex command	Event description
hr:mn:sec	Minutes of day		
09:02:41	542.68	823	Elevate to nadir (Earth)
Begin modified solar calibration sequence (table A2)			
09:10:09	550.15	822	Elevate to solar ports (Sun)
09:10:41	550.68	814	Azimuth to position A
09:11:13	551.22	883	Detector bias heater on at level 2
09:21:21	561.35	831	SMA shutter cycle on
09:36:49			(a)
09:52:17	592.28	832	SMA shutter cycle off
09:53:21	593.35	811	Azimuth to 0°
09:53:53	593.88	881	Detector bias heater off
10:03:29	603.48	823	Elevate to nadir (Earth)
End modified solar calibration sequence			

Table A7. Concluded

(b) Scanner commands

Universal time		Hex command	Event description
hr:mn:sec	Minutes of day		
Begin azimuth angle load commands (table A3(b))			
01:44:49	104.82	419	Address azimuth position A
01:45:21	105.35	2xx	Data command, high byte
01:46:25	106.42	1xx	Data command, low byte
01:47:29	107.48	41B	Address azimuth position B
01:48:01	108.02	2xx	Data command, high byte
01:49:05	109.08	1xx	Data command, low byte
End azimuth angle load commands.			
Begin automated internal calibration sequence (table A1(b))			
07:53:53	473.88	8A1	Begin internal calibration
07:54:25	474.42	897	SWICS on at level 1 modulated
07:56:01	476.02	895	SWICS on at level 2 modulated
07:57:37	477.62	893	SWICS on at level 3 modulated
07:59:13	479.22	891	SWICS off
08:01:53	481.88		Discrete command inserted ^b
08:02:25	482.42	897	SWICS on at level 1 modulated
08:04:01	484.02	895	SWICS on at level 2 modulated
08:05:37	485.62	893	SWICS on at level 3 modulated
08:07:13	487.22	891	SWICS off
08:25:53	505.88		Discrete command inserted ^c
08:26:25	506.42	897	SWICS on at level 1 modulated
08:28:01	508.02	895	SWICS on at level 2 modulated
08:29:37	509.62	893	SWICS on at level 3 modulated
08:31:13	511.22	891	SWICS off
End automated internal calibration sequence			
09:16:01	556.02	824	Short scan mode
09:16:33	556.55	811	Azimuth to 0°
Begin automated solar calibration sequence (table A1(d))			
09:21:21	561.35	8A2	Solar calibration sequence
09:21:53	561.88	824	Short scan mode
09:22:25	562.42	811	Azimuth to 0°
09:22:57	562.95	814	Azimuth to position A
09:28:49	568.82	825	MAM (solar) scan mode
09:34:09	574.15	815	Azimuth to position B
09:37:53	577.89		(a)
09:40:33	580.55	814	Azimuth to position A
09:46:57	586.95	824	Short scan mode
09:47:29	587.48	813	Azimuth to 180°
09:52:17	592.28	822	Normal scan mode
End automated solar calibration sequence			

^aThe Sun crosses the center of the detector field of view.

^bPulse command CF15 issued: Blackbody calibration heaters on.

^cPulse command CF16 issued: Blackbody calibration heaters off. (See table 3(b).)

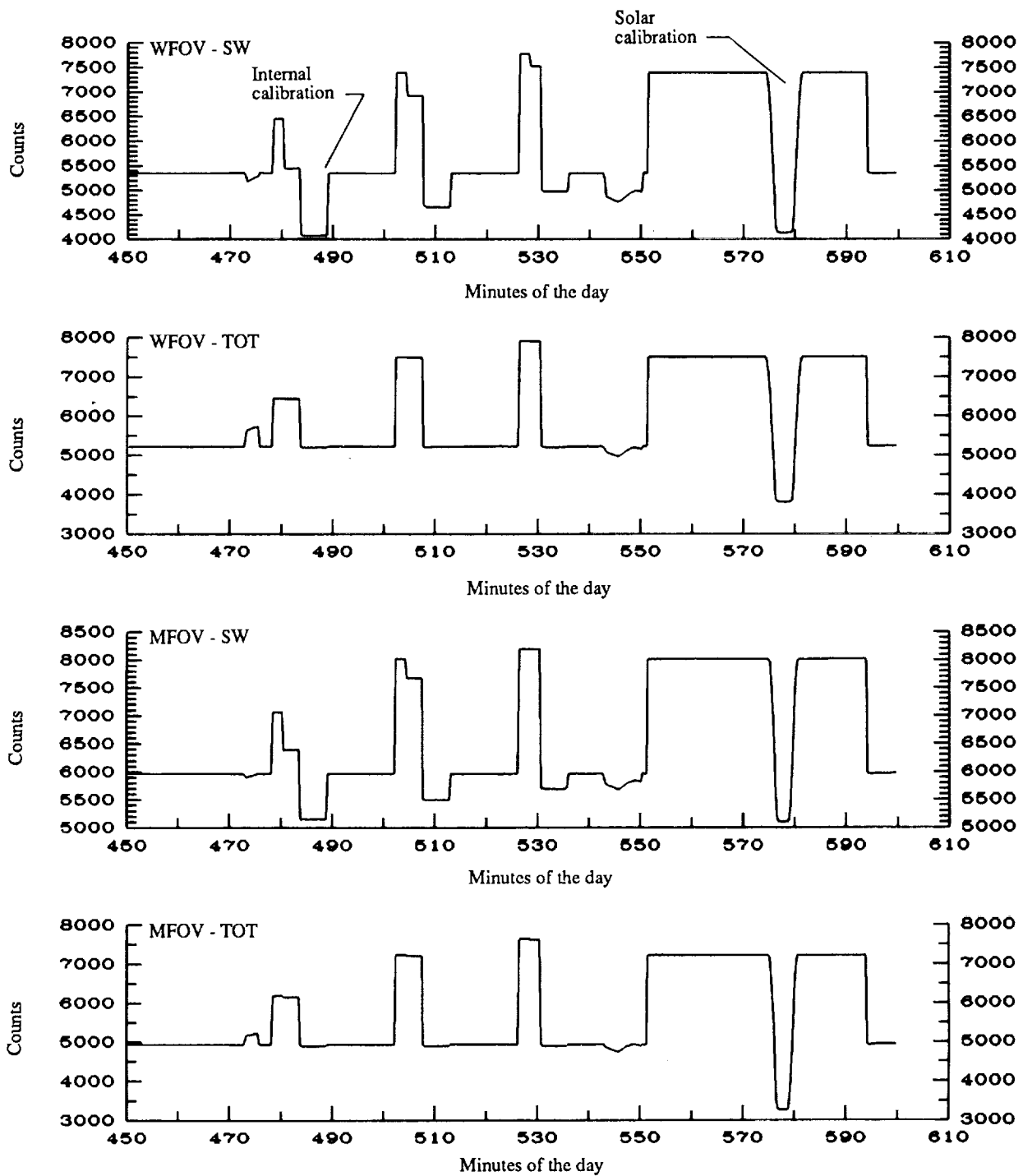

(a) Radiometric data.

Figure A1. Nonscanner instrument output data during entire calibration period for ERBS on December 3, 1984.

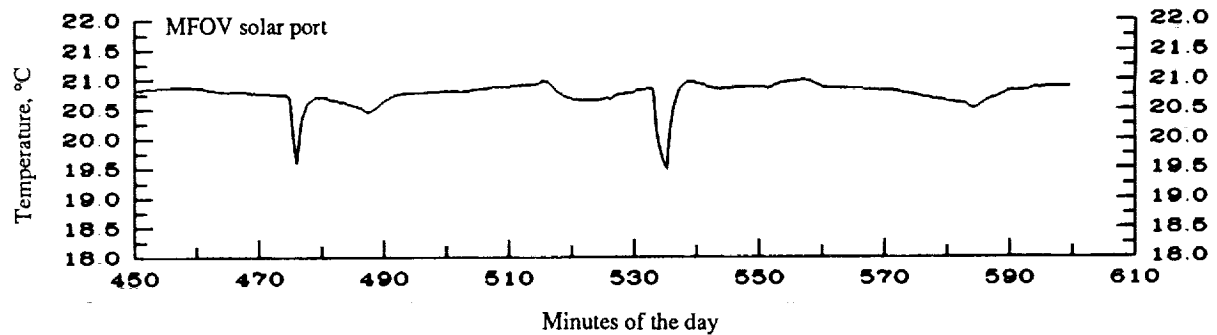
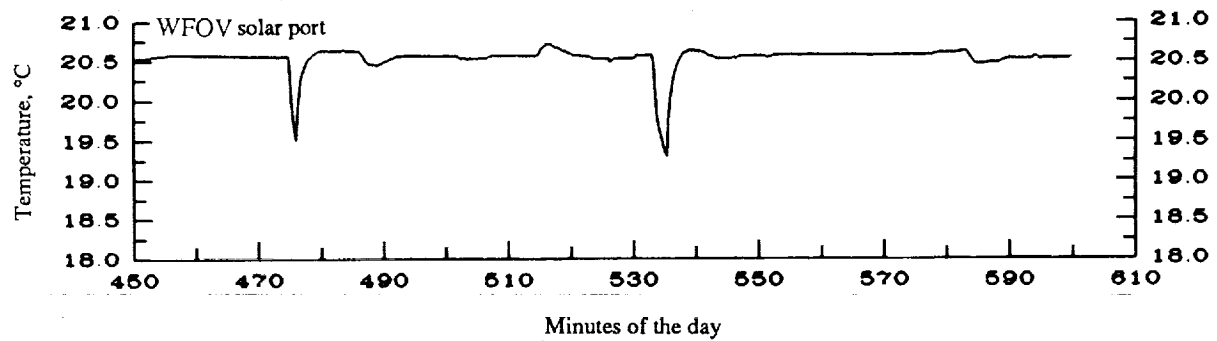
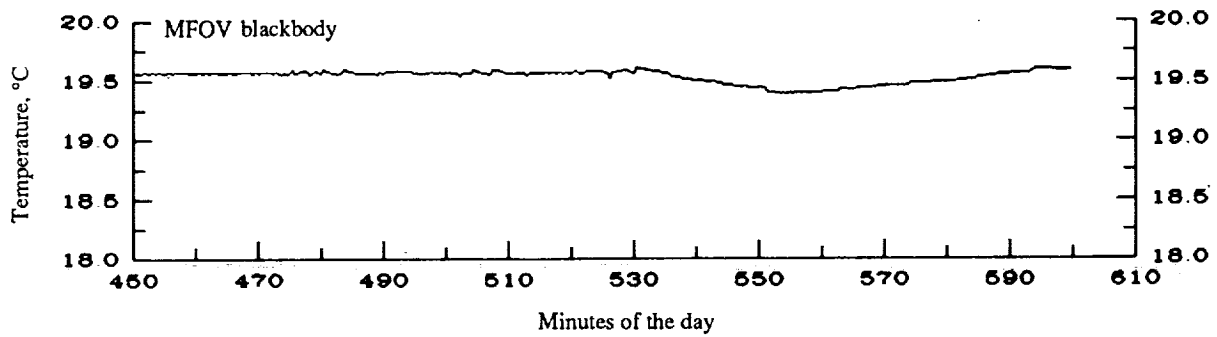
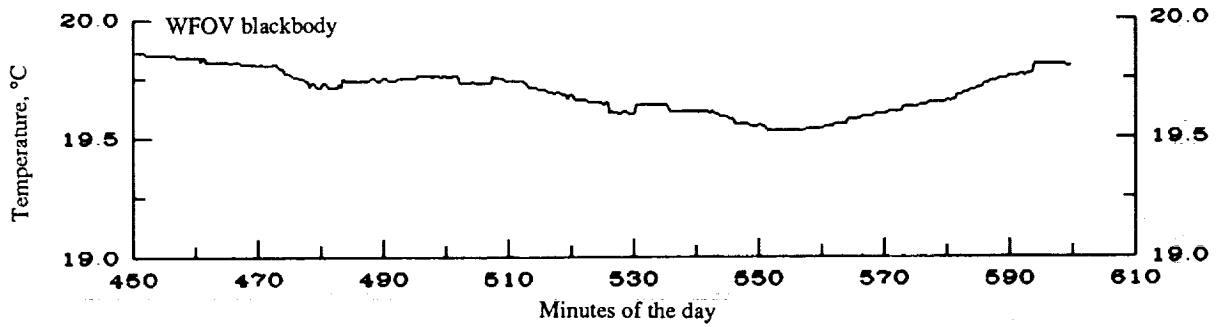

(b) Housekeeping temperatures.

Figure A1. Concluded.

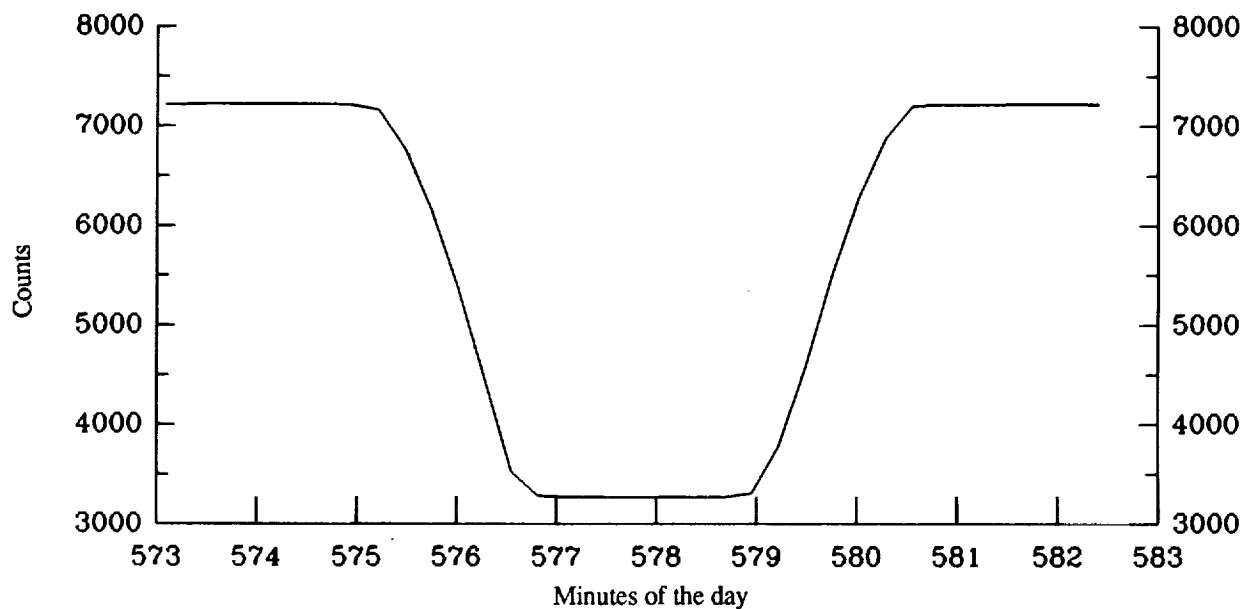

(a) MFOV total radiation detector.

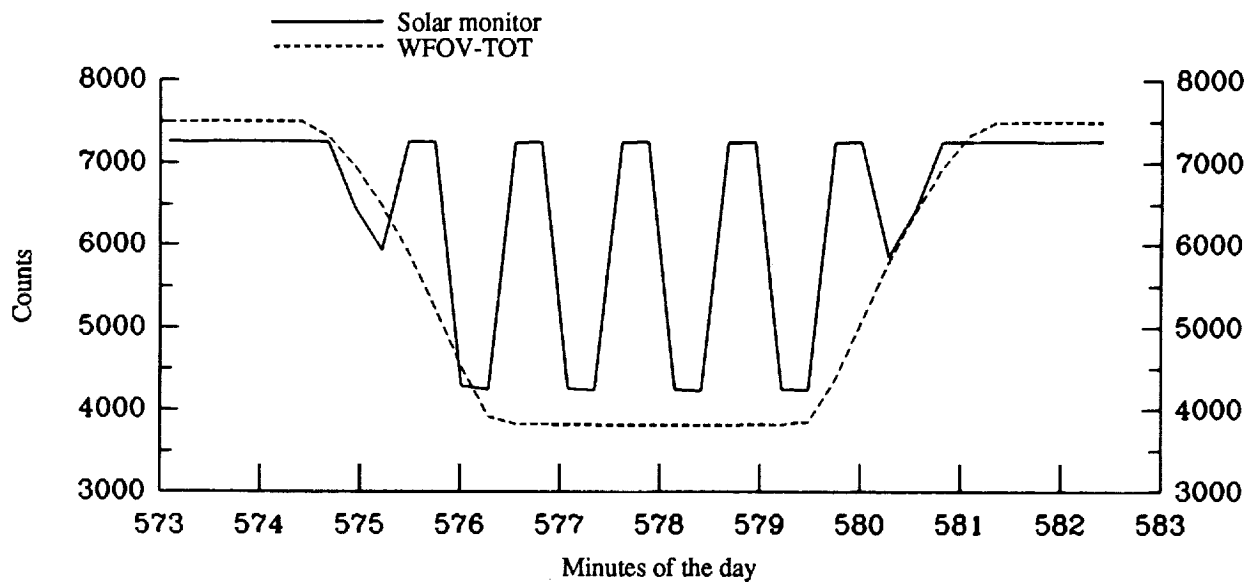

(b) WFOV shortwave and solar monitor detectors.

Figure A2. Output of nonscanner radiometric detectors during ERBS solar calibration on December 3, 1984.

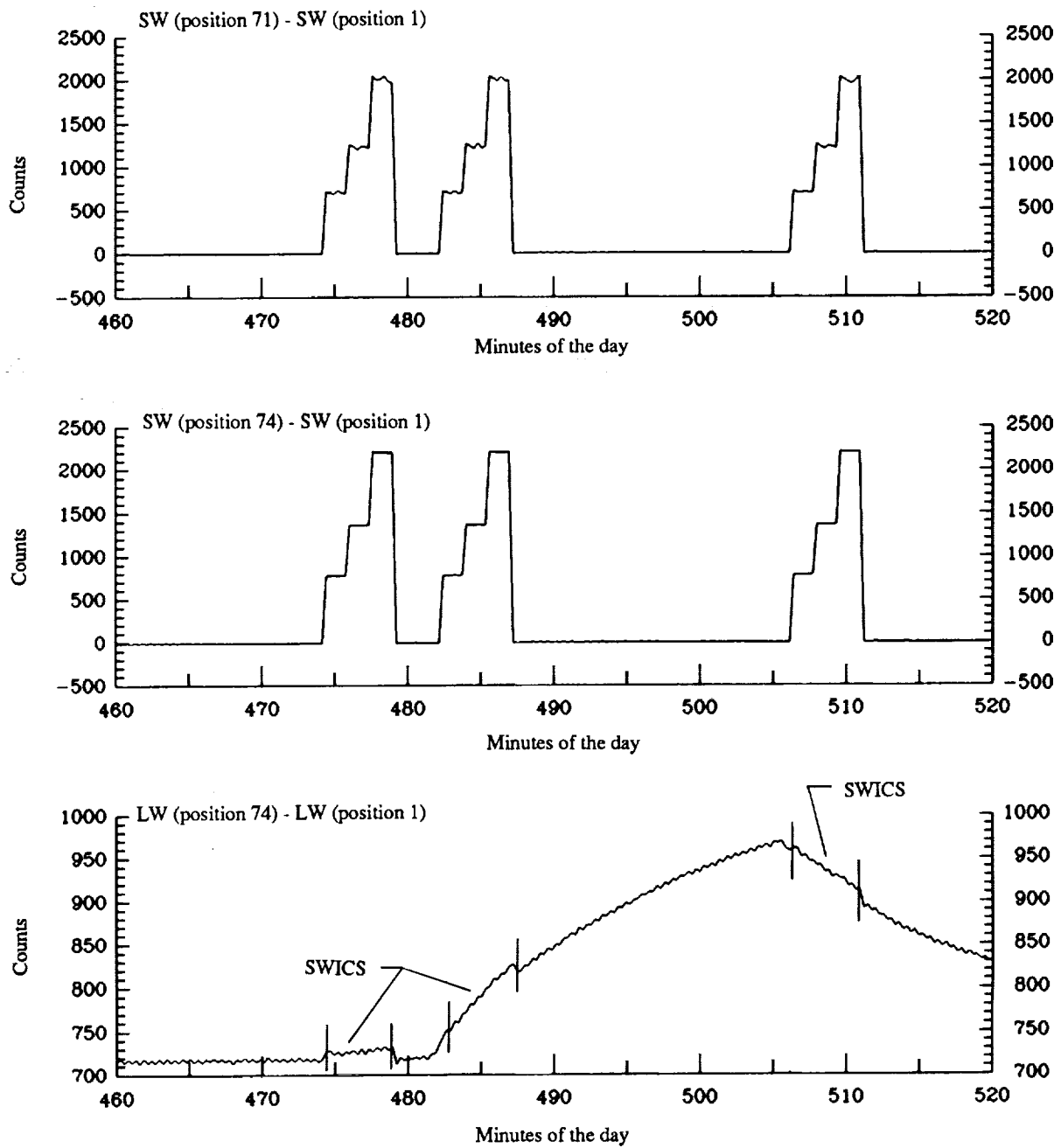

(a) Detector output.

Figure A3. Scanner output during internal calibration on ERBS on December 3, 1984.

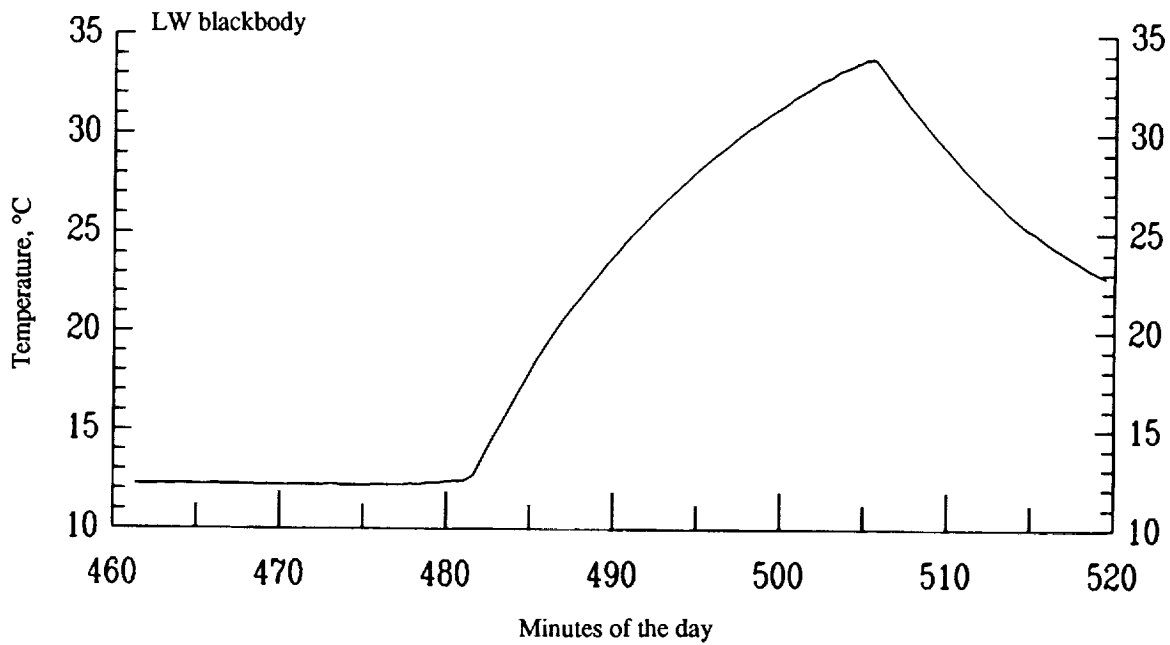
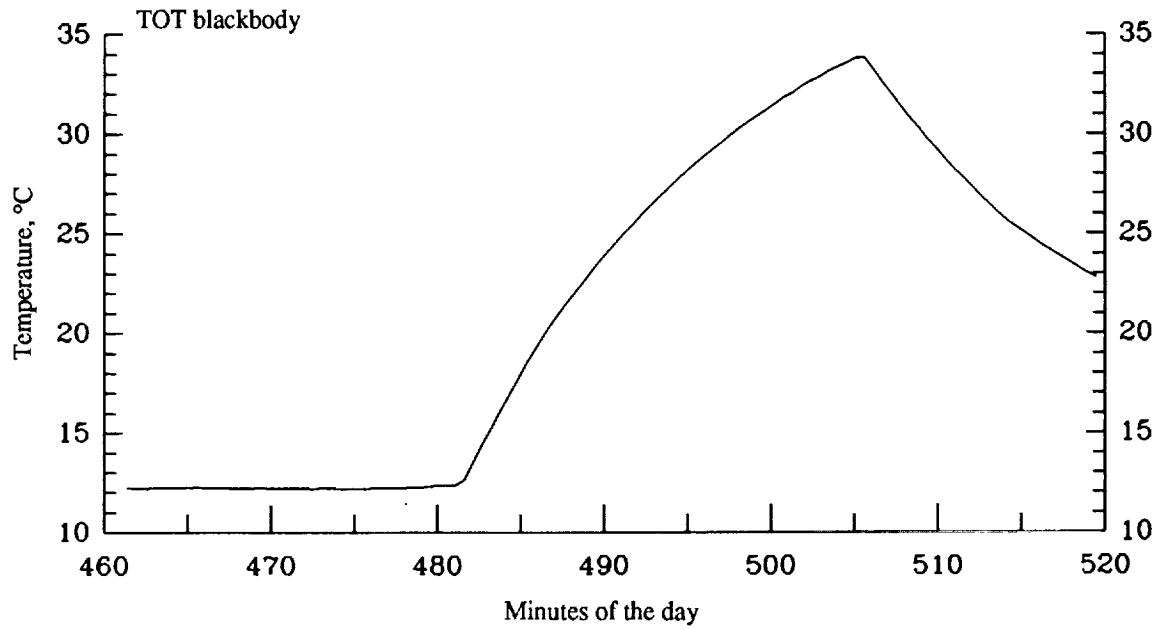

(b) Blackbody temperature.

Figure A3. Concluded.

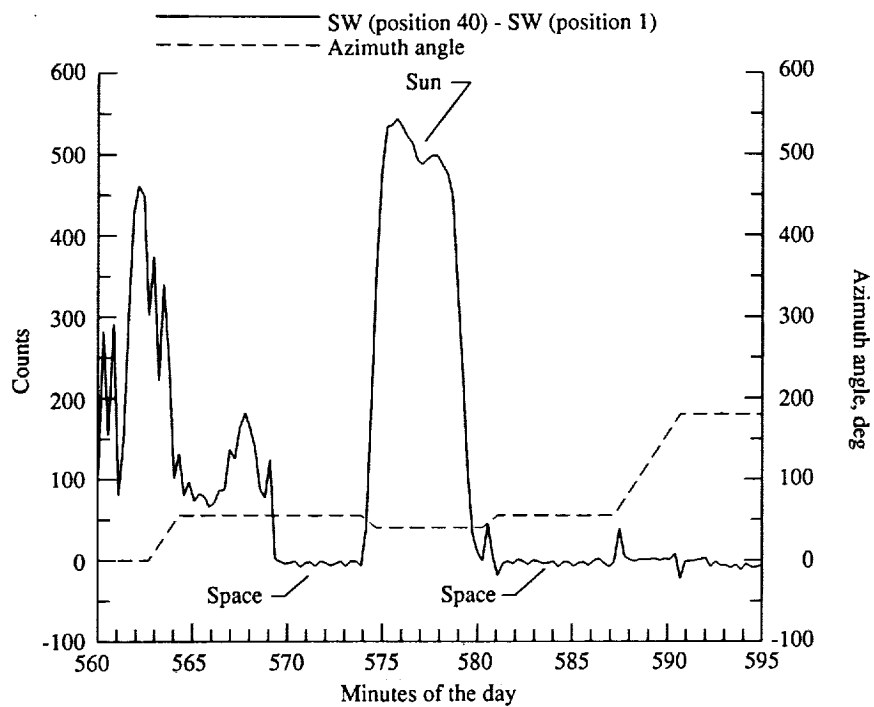

Figure A4. Response of shortwave detector during ERBS solar calibration.

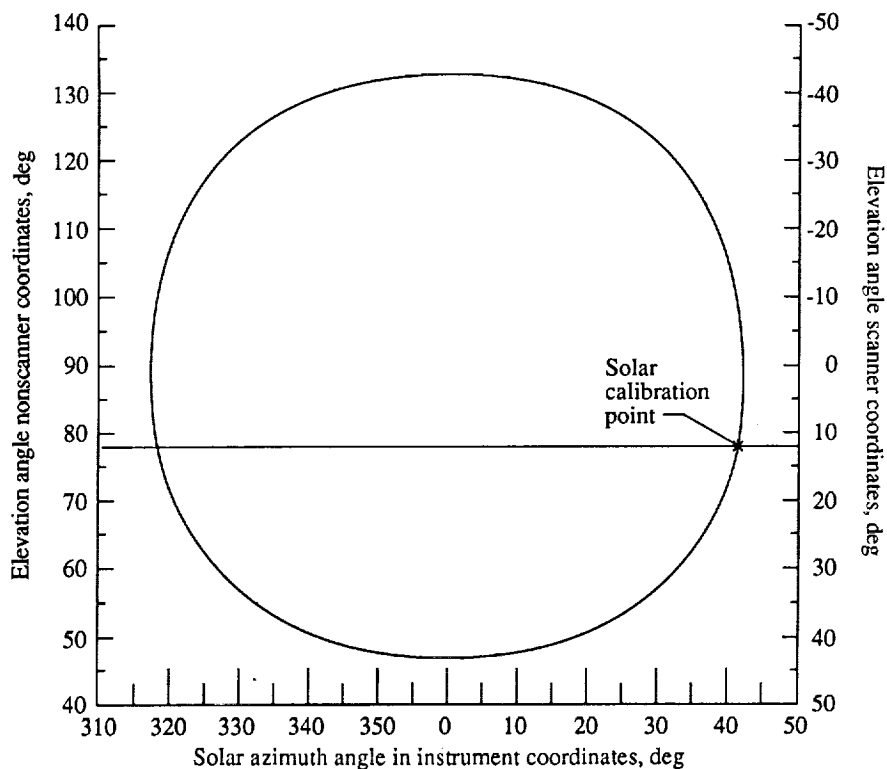

Figure A5. Solar azimuth and elevation angles in instrument coordinates on ERBS on December 3, 1984.

Appendix B

Earth-Sun-Spacecraft Geometry of Earth-Orbiting Satellites

The beta angle (β), the angle between the Sun and the angular momentum vector of an Earth-orbiting spacecraft, plays a very important role in Earth radiation measurement missions, such as ERBE. This appendix discusses β for Earth-orbiting spacecraft, in general, and for the ERBS and NOAA 9 spacecraft orbits, in particular. It shows how the value of β affects the variation of Sun angles at points within an orbit and on regions on the Earth viewed from those points. In-orbit Sun angles and the attendant effects on instrument operations are discussed for a typical orbit of the ERBS spacecraft.

Figure B1 illustrates the Earth-Sun-spacecraft geometry of an Earth-orbiting spacecraft in a celestial coordinate system where

h	spacecraft altitude
$\hat{\mathbf{N}}$	unit vector in direction of orbit angular momentum
P	arbitrary point
$\hat{\mathbf{R}}$	unit vector in direction of spacecraft position
$\hat{\mathbf{R}}_S$	unit vector in direction of Sun
r	radius of Earth
$\hat{\mathbf{X}}, \hat{\mathbf{Y}}, \hat{\mathbf{Z}}$	axes of celestial coordinate system ($\hat{\mathbf{X}}$ -axis points to first point of Aries, $\hat{\mathbf{Y}}$ -axis is in equatorial plane, and $\hat{\mathbf{Z}}$ -axis points to celestial pole)
$\hat{\mathbf{X}}', \hat{\mathbf{Y}}', \hat{\mathbf{Z}}'$	coordinates defined in figure B3
λ_S, δ_S	right ascension and declination, respectively, of Sun
Ω, i	right ascension of ascending node and inclination of orbit, respectively

The Sun β is defined in this paper as the angle between the orbit angular momentum and Sun vectors. (See fig. B1.)

The components of the Sun unit vector in the celestial coordinate system of figure B1 can be defined in terms of the right ascension λ_S and declination δ_S of the Sun as

$$\hat{\mathbf{R}}_{S,X} = \cos \delta_S \cos \lambda_S$$

$$\hat{\mathbf{R}}_{S,Y} = \cos \delta_S \sin \lambda_S$$

$$\hat{\mathbf{R}}_{S,Z} = \sin \delta_S$$

Likewise, the angular momentum vector can be defined in terms of the right ascension of the orbit ascending node Ω and inclination i as

$$N_X = \sin \Omega \sin i$$

$$N_Y = -\cos \Omega \sin i$$

$$N_Z = \cos i$$

The β angle can then be determined by the relationship

$$\begin{aligned} \beta &= \arccos(\hat{\mathbf{N}} \cdot \hat{\mathbf{R}}_S) \\ &= \arccos(\sin i \cos \delta_S \sin(\Omega - \lambda_S) + \cos i \sin \delta_S) \end{aligned}$$

The declination of the Sun varies from -23.5° to 23.5° during the year. The change in the right ascension of the Sun has a mean value for the year of $360/365.25$ deg/day, but the value varies from the mean because the orbit of the Earth about the Sun is not completely circular. The inclination of most spacecraft orbits is constant. However, Ω varies for most spacecraft orbits because the orbits are designed to have some specified rate of change for the right ascension of the ascending node ($\dot{\Omega}$). In all cases, then, the difference $(\Omega - \lambda_S)$ also varies.

The inclination of the ERBS orbit is constant at about 57.0° and the rate of change in the right ascension of the ascending node is about -3.95 deg/day (table 9). This large value of $\dot{\Omega}$ results in a large variation of β for the year. The β values of the ERBS orbit varied between 10° , near the summer (June) solstice, and 170° , near the winter (December) solstice. The large value of $\dot{\Omega}$ also results in the Sun crossing the orbit plane about every 36 days. The β value is less than 90° when the Sun is on the port side of the spacecraft and is greater than 90° when the Sun is on the starboard side.

The NOAA 9 spacecraft orbit is nearly Sun-synchronous and has a constant inclination angle of about 98.96° . The resulting variation in β during the year is about 15° (fig. 5(b)).

We now look at how the value of β affects the Sun angles at arbitrary points within an orbit and on regions of the Earth viewed from those points. The angular position of the Sun relative to an arbitrary point P in the orbit is illustrated in figure B2. The Sun's angular position can be defined by the spherical coordinates, α (azimuth angle) and either ζ (zenith angle) or ϕ (elevation angle). The angle α is measured counterclockwise about the vector $\hat{\mathbf{R}}$

from the negative \hat{N} -axis. The angles ζ and ϕ are given, respectively, by

$$\zeta = \arccos(\hat{R} \cdot \hat{R}_S) \quad \text{and} \quad \phi = 180^\circ - \zeta$$

Now look at the orbit geometry of figure B1 in a different perspective by forming a new set of Cartesian coordinates whose X -axis is \hat{X}' and is defined by

$$\hat{X}' = (\hat{N} \times \hat{R}_S) / \sin \beta$$

where $\hat{N} \times \hat{R}_S$ is the vector cross product. Since \hat{X}' is perpendicular to \hat{N} , it is in the orbit plane, and since it is also perpendicular to \hat{R}_S , it is on the Sun terminator. The new coordinate system is illustrated in figure B3, where \hat{X}' is normal to and points out of the page and the Y - and Z -axes are defined, respectively, as

$$\hat{Y}' = \hat{N} \quad \text{and} \quad \hat{Z}' = \hat{X}' \times \hat{Y}'$$

The orbit plane is in the $\hat{X}' - \hat{Z}'$ plane, and the orbit ground track crosses the terminator on ascent at the point where the spacecraft position vector is along the positive \hat{X}' -axis. The Sun elevation angle is 90° at the point of terminator crossing, and the colatitude of the point can be determined by

$$\text{Colatitude} = \arccos(\hat{X}' \cdot \hat{Z})$$

From figure B3 it can be seen that the minimum value of the Sun elevation angle is $90^\circ - \beta$ and that the maximum value is $90^\circ + \beta$. The elevation angle of the limb of the Earth is dependent only on the spacecraft altitude and is defined by

$$\theta = \arcsin[r/(r+h)]$$

where r is the radius of the Earth and h is the spacecraft altitude.

If $\beta > 90^\circ - \theta$, there will be points in the orbit where the limb-to-limb views on the Earth are in full sunlight and also some points where the views are in total darkness. However, if $\beta < 90^\circ - \theta$, then all limb-to-limb regions viewed from the orbit will contain the terminator and, thus, will be in part sunlight and part shade continuously. The spacecraft itself will enter shade during an orbit only if $\beta > 90^\circ - \theta$.

Figure B4 illustrates the variation of the Sun azimuth angle versus elevation angle (as defined in fig. B2) for a typical orbit of the ERBS spacecraft. The data are plotted at 1-minute intervals for the orbit that begins at 500 minutes on September 3, 1985. The spacecraft was flying X -axis rearward with the Sun on the starboard side of the spacecraft (fig. 4(a)). The value of β was about 53° (fig. 6(a)). From a position on the ERBS spacecraft, the Sun would appear to cone counterclockwise about the orbit momentum vector. The half-angle of the cone motion is equal to the value of β . The Sun azimuth angles of figure B4 are measured from the negative \hat{N} -axis, whereas the azimuth beam rotations of the ERBE instruments on the ERBS spacecraft are measured from the positive \hat{N} -axis (fig. 4). Thus, the values of the Sun azimuth angle in the coordinate systems of the instruments rotate about a value of 0° instead of 180° as shown in figure B4.

The Sun is below the limb of the Earth at all points in the orbit with elevation angles less than 66° and is above the horizon of the spacecraft at elevation angles greater than 90° . The scanner detectors, which normally scan in the $0^\circ - 180^\circ$ azimuth plane on the ERBS spacecraft, do not risk viewing the Sun during normal operations when β is greater than $24 (90^\circ - \theta)$. During several days in February, June, August, and December, β was less than 24° . (See fig. 6.) During these full-Sun periods, the scanner was operated in the short scan mode or at an azimuth angle of 145° to prevent the detectors from directly scanning the Sun. The Earth-Sun-spacecraft geometry and its effects on the output of the ERBE instruments are discussed in appendix C for the first 500 minutes of September 3, 1985.

Nonscanner solar calibrations must be performed at points in the orbit where the Sun elevation angle is very nearly 78° , which is the elevation angle of the solar monitor detector and the solar ports. The corresponding elevation angle of the MAM in the scanner instrument coordinate system is 12° . To perform a solar calibration, an instrument azimuth beam is rotated to the azimuth angle whose corresponding elevation angle is 78° . The points are indicated in figure B4 where the solar calibrations could have been performed for this orbit on September 3, 1985. See appendix A for further explanation of solar calibrations.

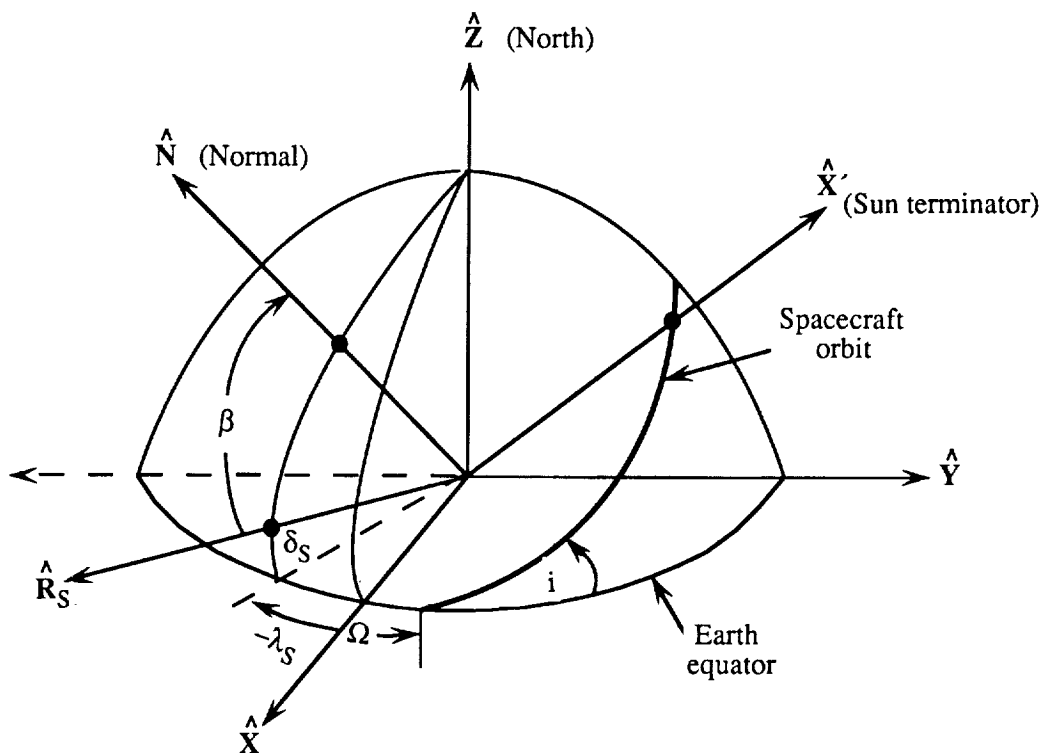

Figure B1. Geometry of Earth-orbiting spacecraft and relationship to Sun.

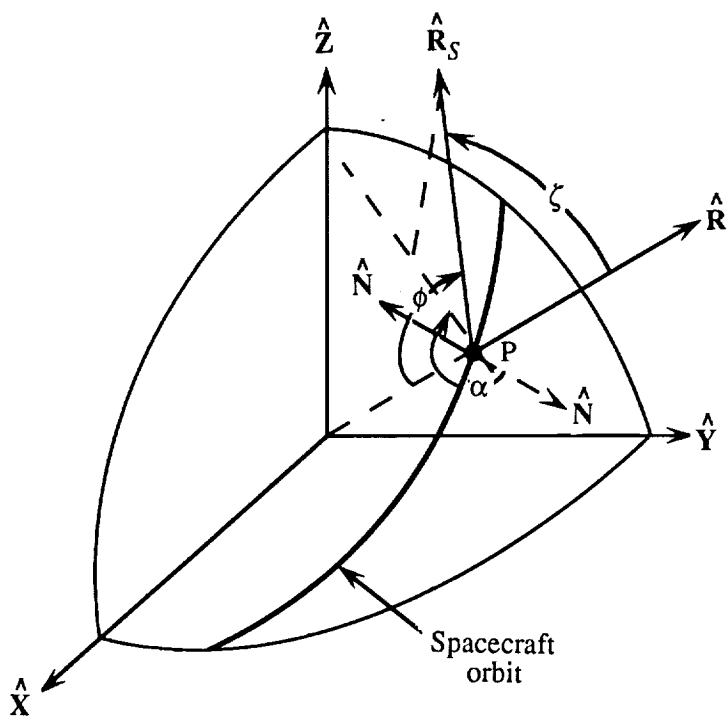

Figure B2. Position of Sun at point in Earth-orbiting spacecraft.

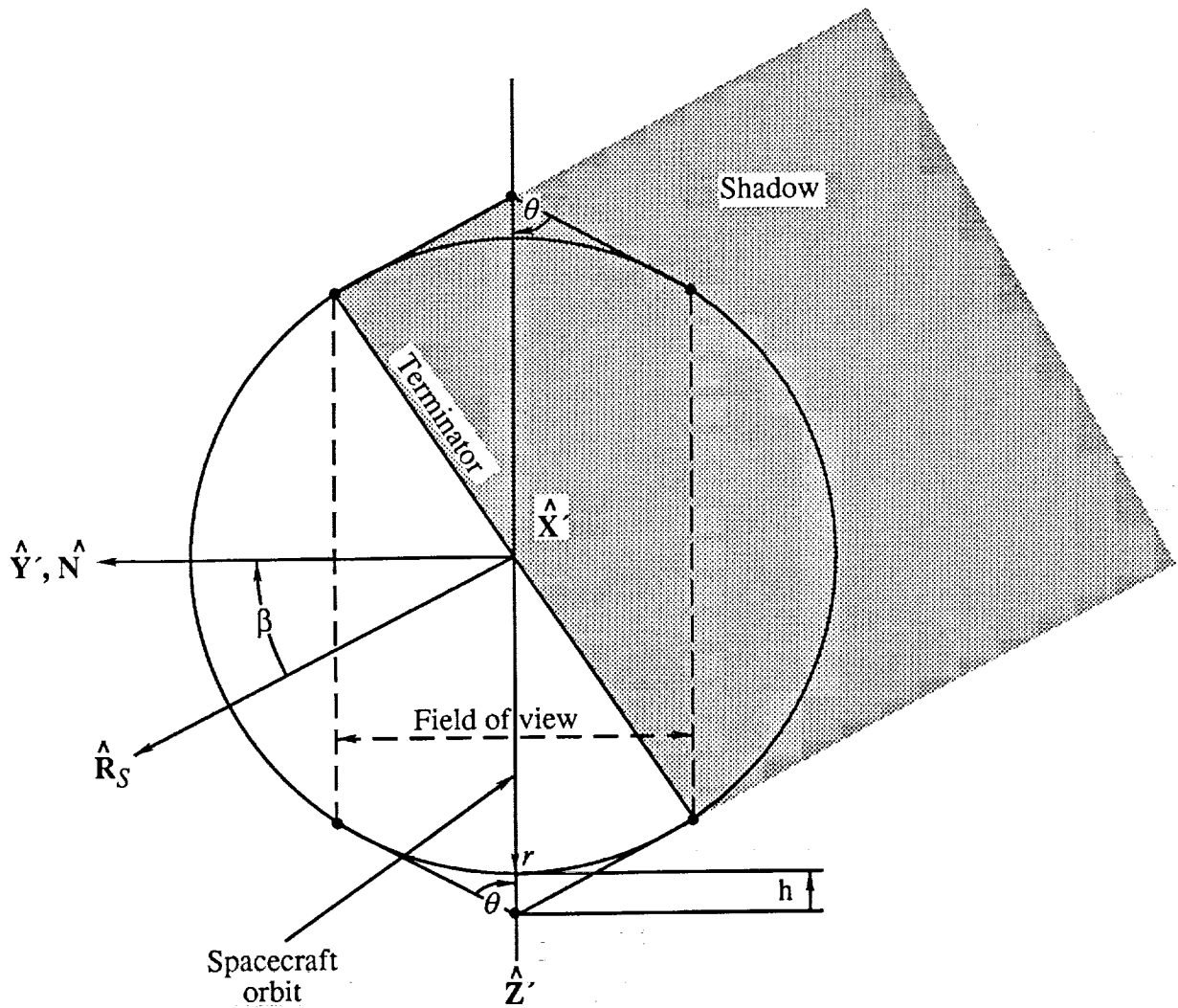

Figure B3. Earth-Sun-spacecraft geometry in a plane containing the Sun and orbit momentum vectors.

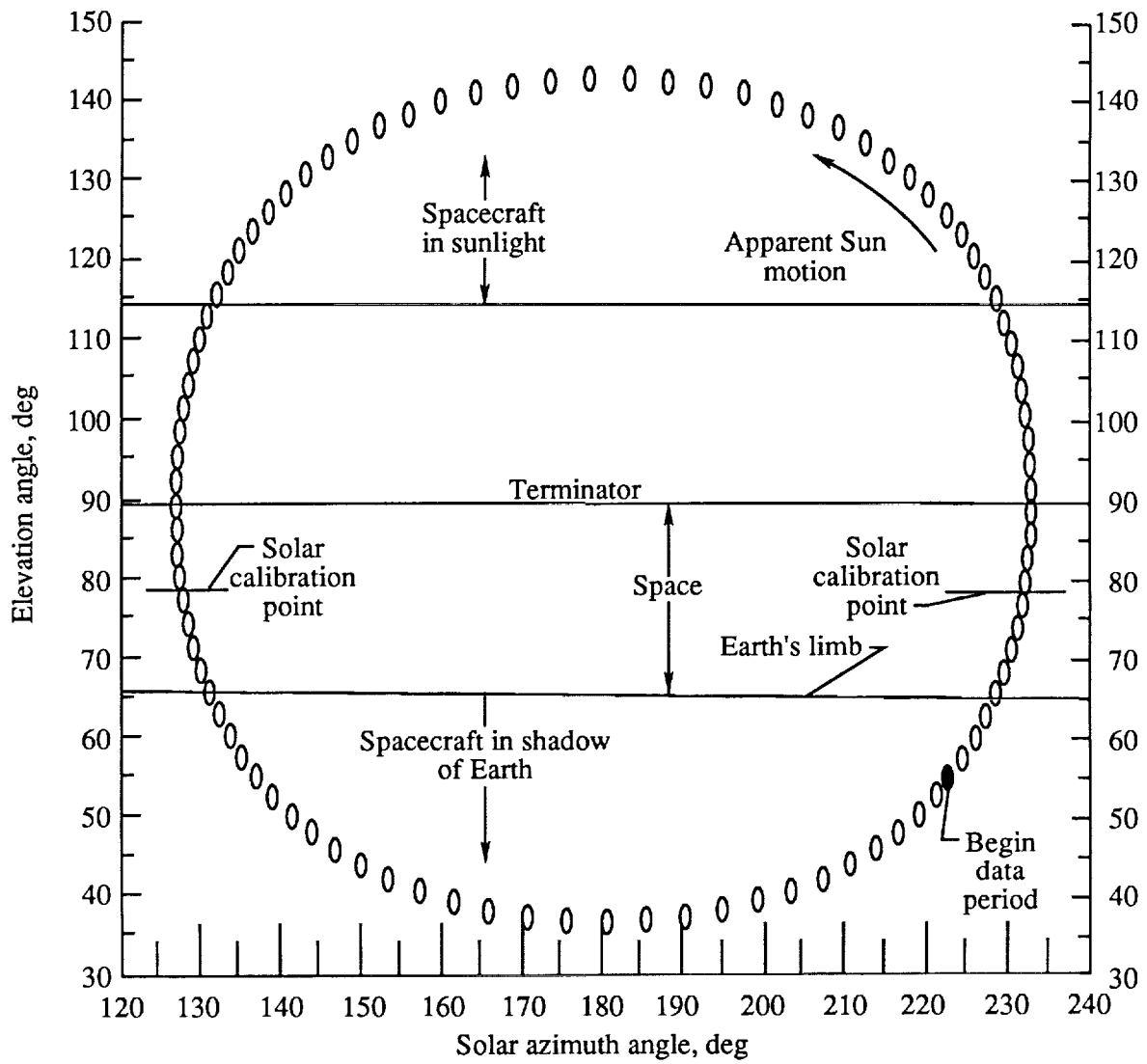

Figure B4. Sun azimuth and elevation angles for ERBS orbit on September 3, 1985.

Appendix C

ERBE Instrument Data During Typical Periods of Normal In-Orbit Operation

Data output from the ERBE instruments aboard the ERBS spacecraft and the corresponding in-orbit environment are presented and discussed for the period from 500 to 1000 minutes on two different days in 1985. Data are discussed for two different β angle conditions of the ERBS spacecraft orbit. The first data set is for September 3, 1985, when β had a mean value of about 53.5° . During this period, the Earth as viewed from the spacecraft was in full sunlight during some portions of each orbit and in total darkness for some portions. A value of β of 53.5° is about the average for the NOAA 9 orbit during the period of this paper (fig. 5(b)). The in-orbit effects of solar input on the output of the instruments for the ERBS data on September 3 are about typical for the β range for the NOAA 9 orbits. The second data set is for June 10, 1985, during which β had a mean value of about 12.5° . The Sun was above the Earth's limb during the entire data period. The spacecraft was in sunlight continuously, and the Earth as viewed from the spacecraft was in partial sunlight continuously. Appendix B provides general information on how β affects the in-orbit variations of Sun angles.

Figure C1(a) is a plot of the ERBS spacecraft ground track from 500 to 1000 minutes on September 3, 1985. The data are plotted at 1-minute intervals. The data period covers about five orbit revolutions (orbits 4965–4969). The period begins with the spacecraft over the west coast of South America and ends with the spacecraft about 25° east of Australia. When the spacecraft was at the nodal crossing of the first orbit (orbit 4965), the position of the Sun was about 7.5° north latitude and about 45° east longitude.

Figure C1(b) shows plots of solar beta (β), azimuth (α), and elevation (ϕ) angles at the spacecraft for the 500-minute period, and figure C1(c) is a plot of the solar azimuth angle versus elevation angle for the first orbit of the 500-minute period. The solar azimuth angle in figure C1(c) differs from that in figure B4 (same orbit) because the azimuth angle of an instrument is measured from an axis that is rotated 180° from that in figure C1(c). The maximum Sun elevation angle (fig. C1(b)) of 143° ($90^\circ + \beta$) occurred during the ascent of each orbit at -14.0° south latitude, and the minimum elevation angle of 37.0° ($90^\circ - \beta$) occurred during orbit descent at 14.0° north latitude. Both sunset and sunrise occurred during orbit descent at latitudes of 55.0° north and -35.0° south, respectively. The spacecraft was in to-

tal darkness at elevation angles less than 66° and in full sunlight at elevation angles greater than 114° .

Figure C2(a) shows plots of the output of the nonscanner radiometric detectors, and figure C2(b) shows housekeeping temperatures from the nonscanner instruments aboard the ERBS spacecraft for the 500-minute data period on September 3, 1985. The raw output of the nonscanner detectors decreases with radiation input. The data are plotted at 16-second intervals, and each data point is the first of 20 measurements sampled in a 16-second period. The distance along the Earth's ground track between the center of each consecutive 16-second measurement is about 110 km. This is only a fraction of the distance across the Earth's field of view of either the MFOV or WFOV detectors. Therefore, there is overlap between the fields of view of many of the consecutive 16-second measurements plotted in figure C2(a).

The spikes in the output of the WFOV Earth-viewing nonscanner detectors (fig. C2(a)) are caused by the detectors responding to direct sunlight at sunrise and sunset. The detectors can sense the Sun at the Earth's limb because the WFOV detectors have fields of view that encompass slightly more than the limb-to-limb disk of the Earth as viewed from the spacecraft. The successful performance of WFOV detectors requires them to have fields of view large enough to include this "space ring." Unfortunately, the resulting response to the Sun at sunrise and sunset virtually invalidates the measurements made by these detectors for several minutes during each orbit. The flat portions of the output of the SW nonscanner detectors represent periods when these detectors are viewing completely dark regions of the Earth. The MFOV detectors have fields of view smaller than those of the WFOV detectors, and the periods during each orbit when the MFOV detectors view totally dark regions are significantly longer than those of the WFOV detectors.

The output of the nonscanner solar monitor detector, which is viewing space during this normal data period, responds to the in-orbit variation in solar heating. It can be assumed that the Earth-viewing detectors also respond to the in-orbit variations in solar input, but the specific response to the Sun is masked by the larger radiation input from the Earth. Two of the instrument housekeeping temperatures plotted in figure C2(b) show significant responses to the in-orbit solar input. The most sensitive of these temperatures is the FOV limiter temperature of the total-radiation WFOV detector. The changes in the FOV temperature are especially sharp at sunrise and sunset. The in-orbit variation of this temperature is typical of that for the temperatures

of the FOV limiters on all four Earth-viewing detectors. The effects on the output of the Earth-viewing detectors due to changes in the temperatures of the FOV limiters are modeled in the radiation conversion algorithms.

Figures C3(a) and C3(b) show plots of the raw output of the scanner radiometric detectors at two different scan positions. The plotted data at scan position 39 have been corrected by subtracting out the corresponding measurements at scan position 1. The raw output of the scanner detectors increases with radiation input. The data are plotted at 16-second intervals, and each data point is the first of four measurements made at the specific scan angle during the 16-second period. The Earth's fields of view of the measurements at scan position 39 are centered approximately at nadir (see table 4), and therefore at about the center of the fields of view of the non-scanner measurements.

The along-track distance across the Earth's field of view of a scanner measurement is about 36 km, and the along-track distance between each 16-second measurement plotted in figure C3(a) is about 112 km. However, the distance between two consecutive 4-second measurements made at nadir is only 28 km, and thus there is along-track overlap between two consecutive 4-second scanner measurements.

A comparison of the data in figures C2(a) and C3(a) shows that the output of the scanner detectors at nadir is more sensitive to the along-track variations in the Earth's radiation field than the output of either the MFOV or WFOV nonscanner detectors.

The response of the scanner detectors to solar heating at the space look position (scan position 1) when the spacecraft first enters sunlight at about 600 minutes is quite apparent in the output of the SW and LW detectors shown in figure C3(b). The solar heating, as well as other spurious effects, is accounted for at any scan position by subtracting the radiation measured at the space clamp position from the measurement at that position. This technique should be valid if a detector output (in radiance) due to solar input is the same at all scan positions as that at the space look position.

Figure C4 shows plots of the ground track data and Sun-angle data for the ERBS orbit from 500 to 1000 minutes on June 10, 1985, a period when the Earth was approaching the point of the summer solstice. The data period begins with the spacecraft near 45° north latitude and 175.0° west longitude. When the spacecraft was at the nodal crossing of orbit 3700 (the first full orbit in the period), the

position of the Sun was 23.0° north latitude and 35° east longitude.

Figure C4(b) shows that the Sun β decreased during the period and had a mean value of about 12.8°. Figures C4(b) and C4(c) show that the Sun was well above the Earth's limb (Sun elevation of 66.0°) during the period, so there was no sunrise or sunset relative to the spacecraft. The scanner instrument operated in the short scan mode from June 5 until June 20 to prevent the detectors from scanning the Sun. The maximum Sun elevation angle (103°) occurred during orbit descent at -38.0° south latitude, and the minimum elevation angle occurred during ascent at 30.0° north latitude. The spacecraft crossed the Earth terminator at -34.5° south latitude on ascent and at 34.5° north latitude on descent.

The output of the WFOV detectors (fig. C5(a)) shows no spikes because there was no sunrise or sunset, and the output of the WFOV SW detector shows no periods of constant output because the WFOV detectors did not view any regions that were totally dark. The WFOV and MFOV total-radiation detectors show abrupt increases in output at about the time that the Sun elevation angle is 90° and decreasing. This is the time when the spacecraft crosses the Sun terminator during orbit descent. The output of the solar monitor detector is not much different from that on September 3, but it is a little smoother because of the absence of Sun ingress and egression.

The mean values of the nonscanner instrument temperatures plotted in figure C5(b) decrease during the data period. This decrease is consistent with plots of the daily averages of these temperatures in June 1985 (figs. 8(c)-8(e)). The maximum values of the daily means of these temperatures occurred on June 7 at $\beta \approx 24^\circ$ as β decreased toward the minimum of 10° on June 12.

Figure C6(a) shows the output of the scanner detectors at scan position 39, which has been corrected by subtracting out the measurement at scan position 1. The output of the detectors at scan position 1 is shown in figure C6(b). The overall response of all three scanner detectors at scan position 1 (first space clamp measurement) is much smoother on June 10 than on September 3 because of the absence of Sun ingress and egression. Therefore, the effects of in-orbit heating on the output of the detectors while viewing the Earth should be more effectively accounted for in the data conversion algorithms during full-Sun periods. The scale shift at about 950 minutes seen in the output of the total detector at scan

position 1 is typical of shifts that occur in the output of all scanner detectors from time to time because of an automatic detector-bridge rebalance feature. These shifts occur in the output of a detector at all

scan positions, and thus the effects are corrected by subtracting out the reference measurement derived at the space clamp position.

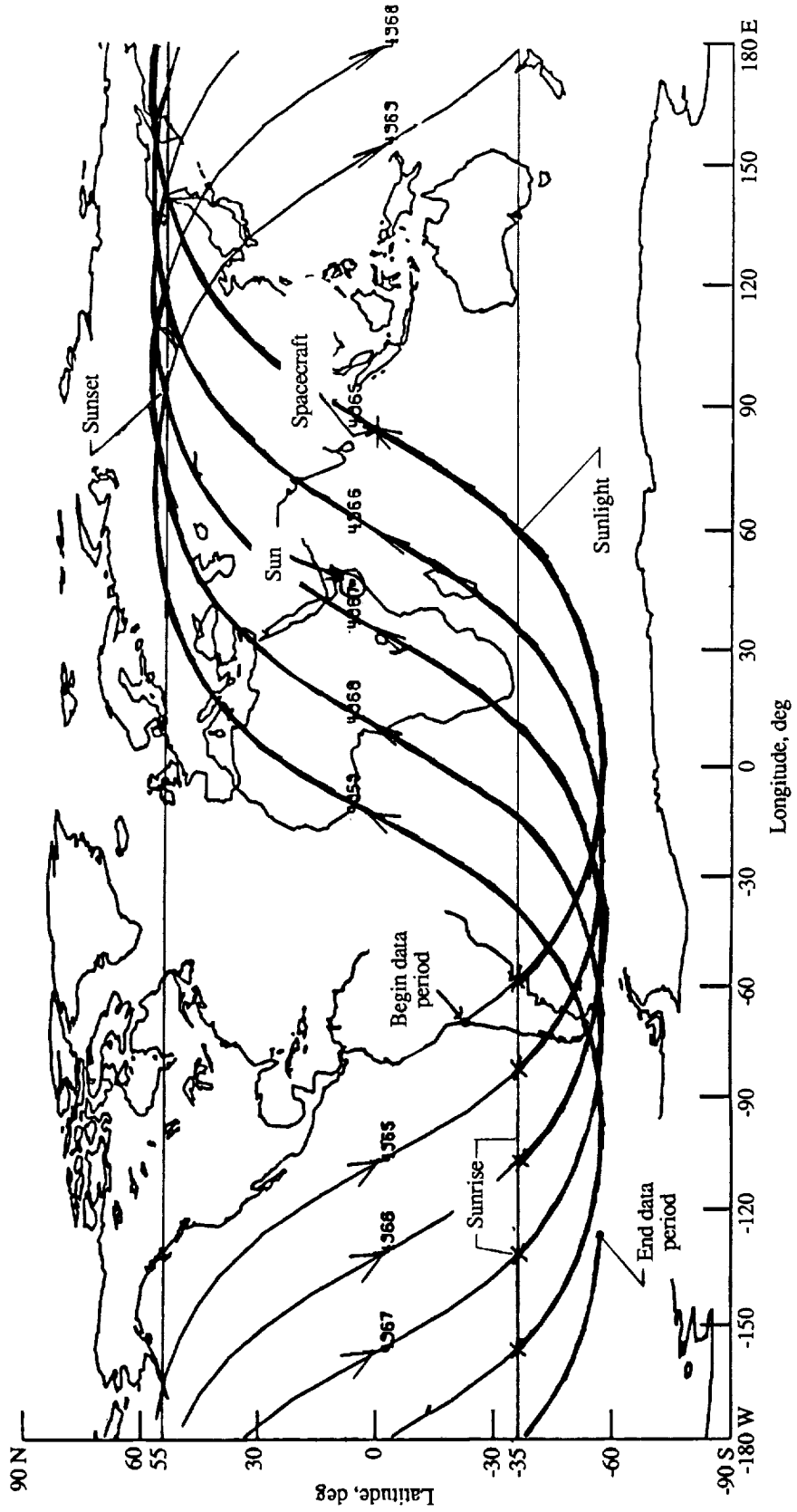

(a) Ground track.

Figure C1. Spacecraft and solar position data for ERBS spacecraft orbit on September 3, 1985.

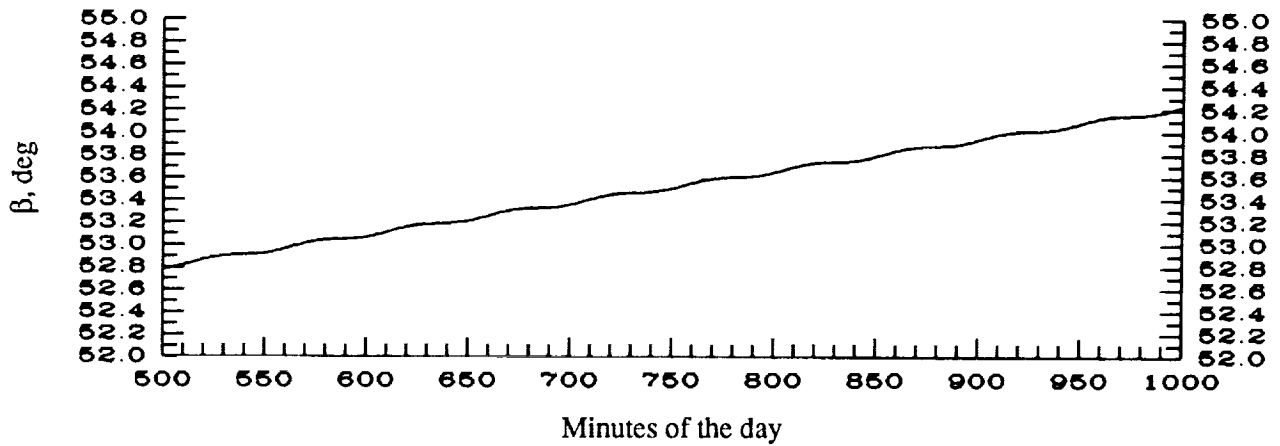
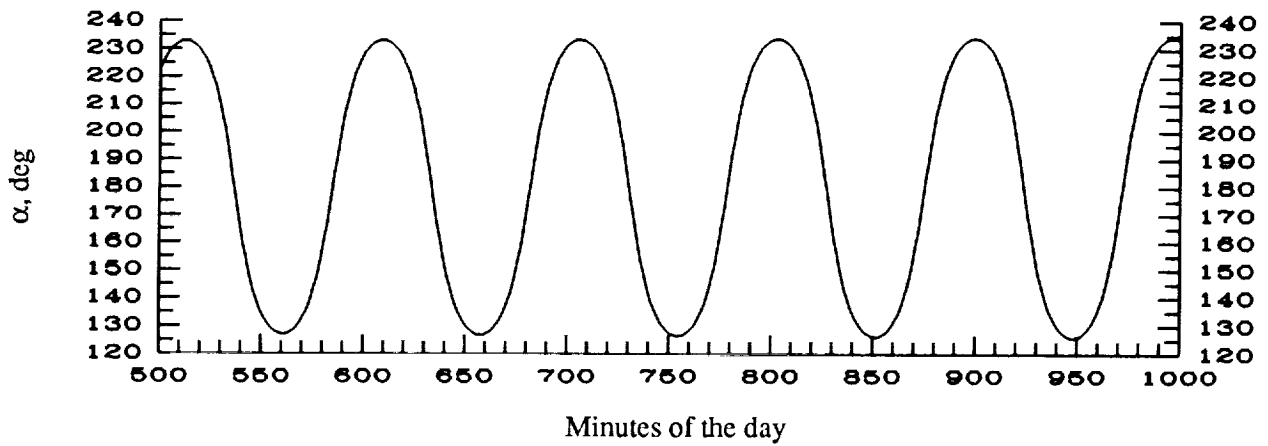
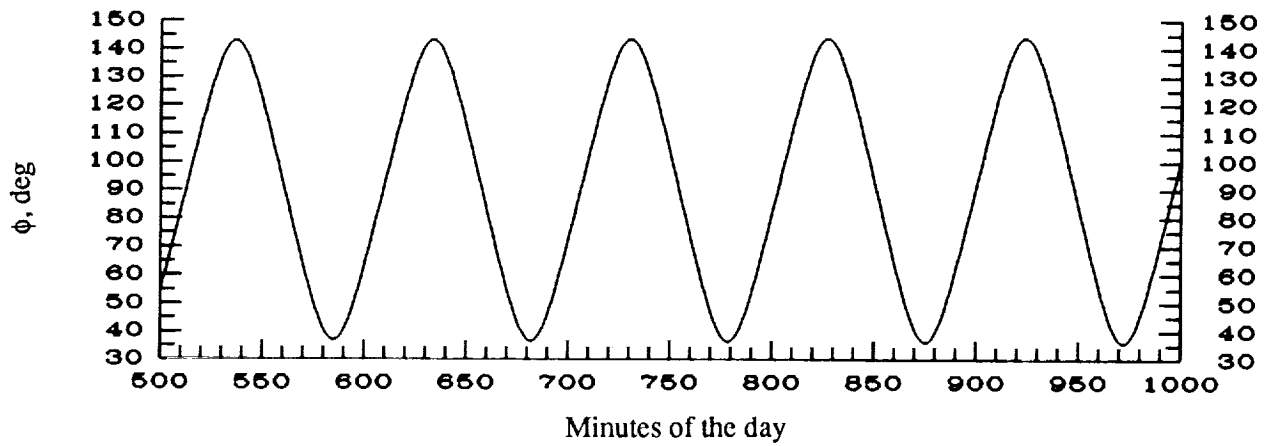

(b) Solar beta (β), azimuth (α), and elevation (ϕ) angles in coordinate system shown in figure B2.

Figure C1. Continued.

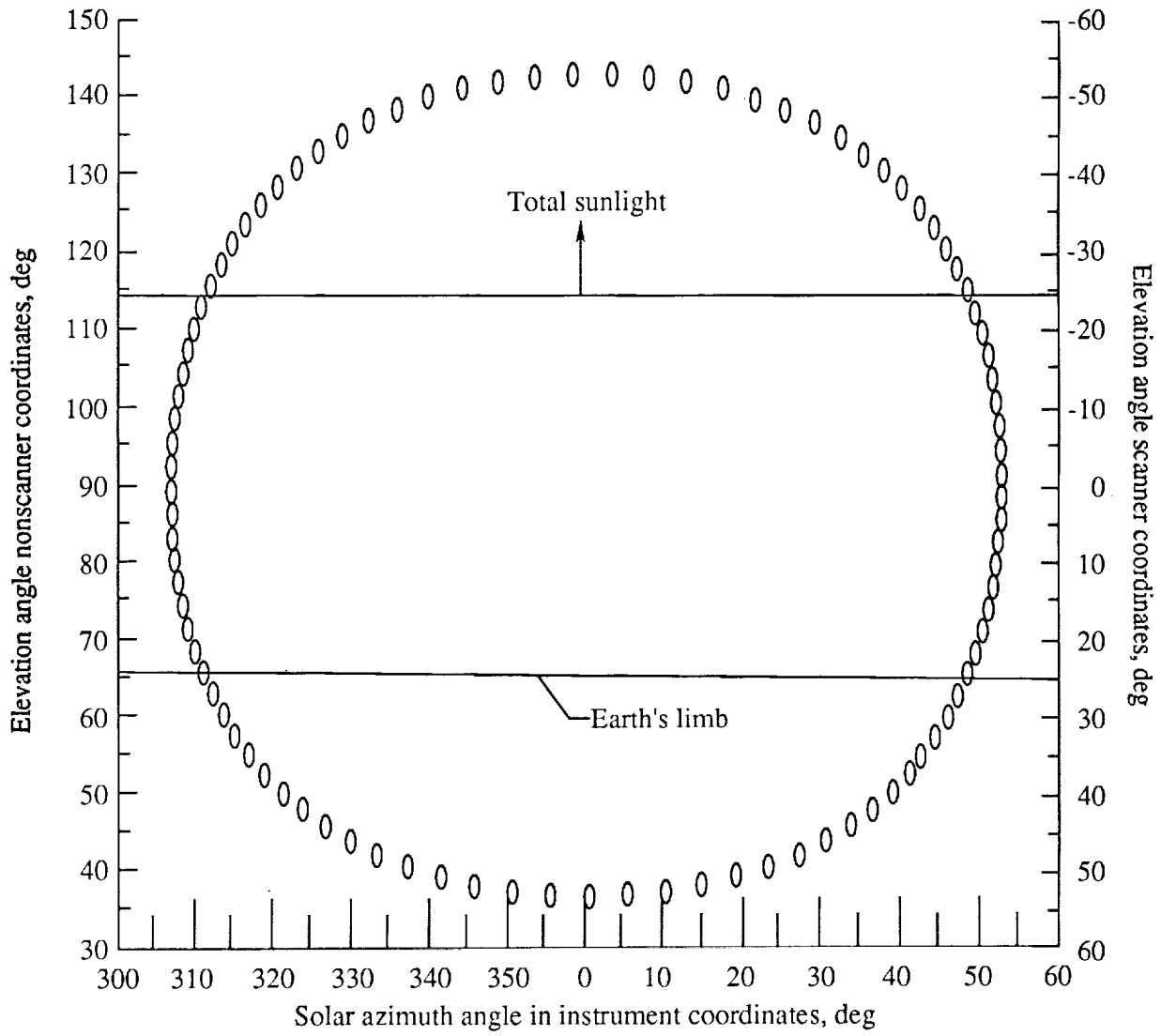

(c) Solar azimuth and elevation angles in instrument coordinates.

Figure C1. Concluded.

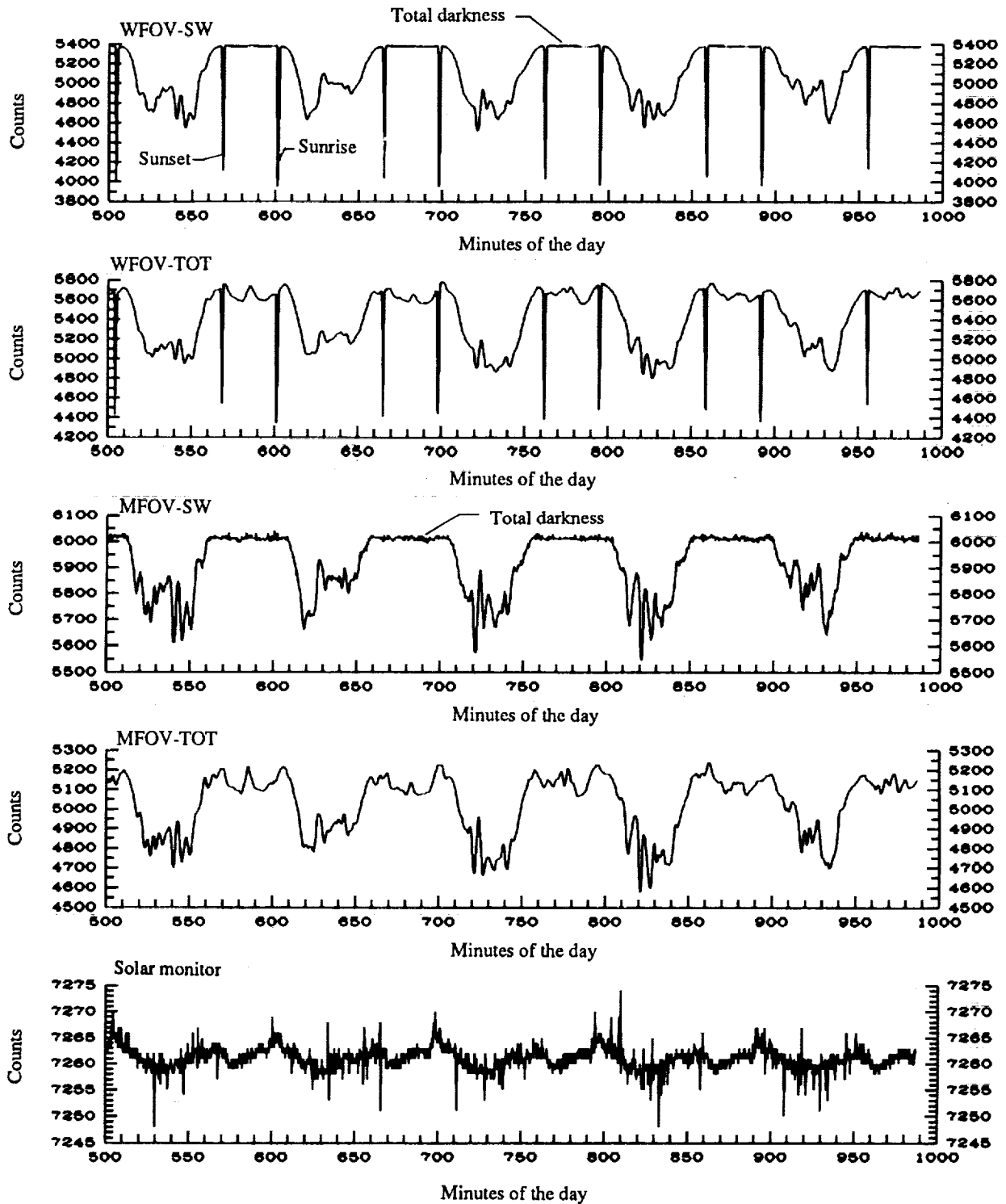

(a) Radiometric data.

Figure C2. Instrument output from nonscanner instrument on ERBS spacecraft for September 3, 1985.

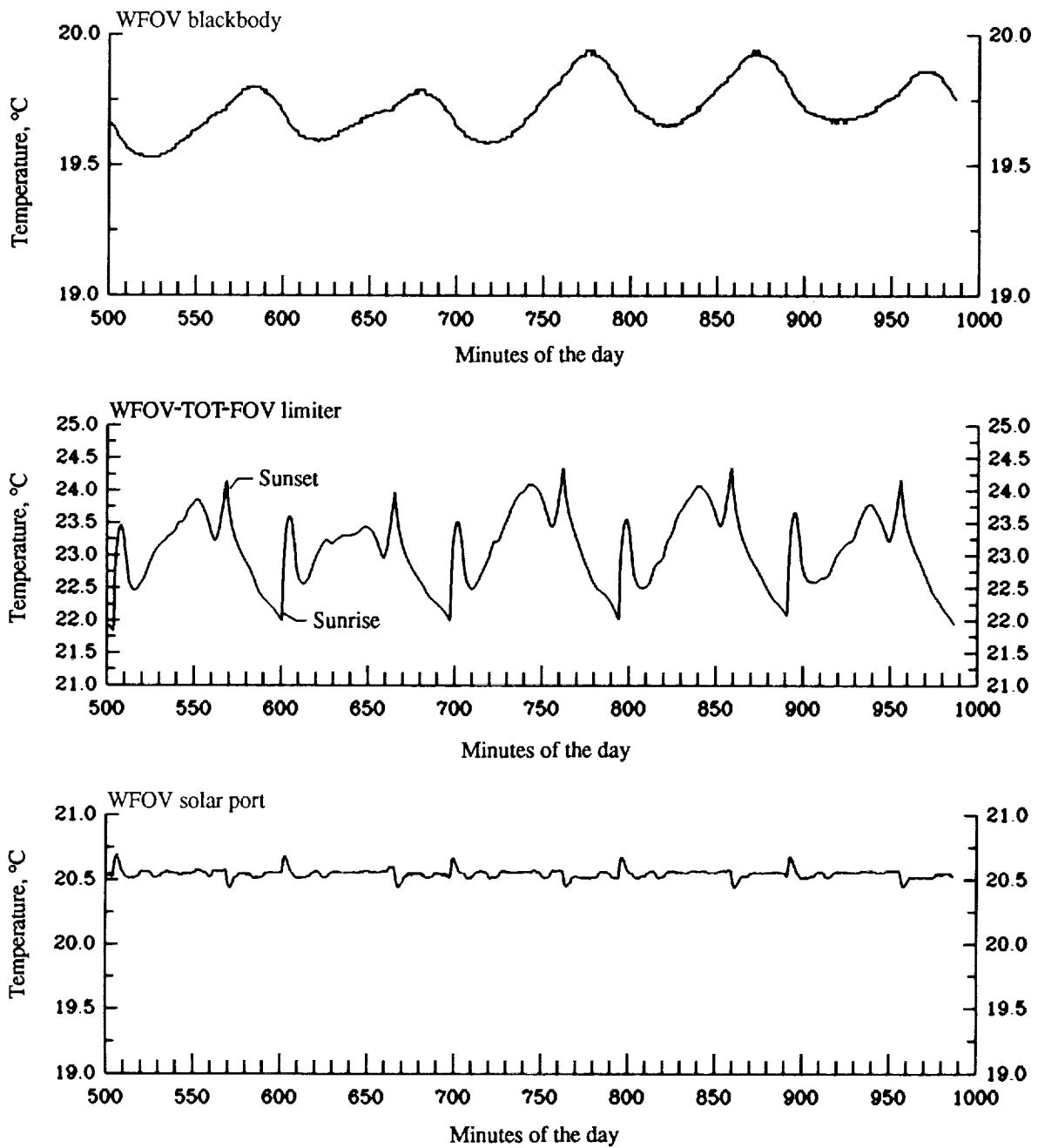

(b) Housekeeping temperature measurements.

Figure C2. Concluded.

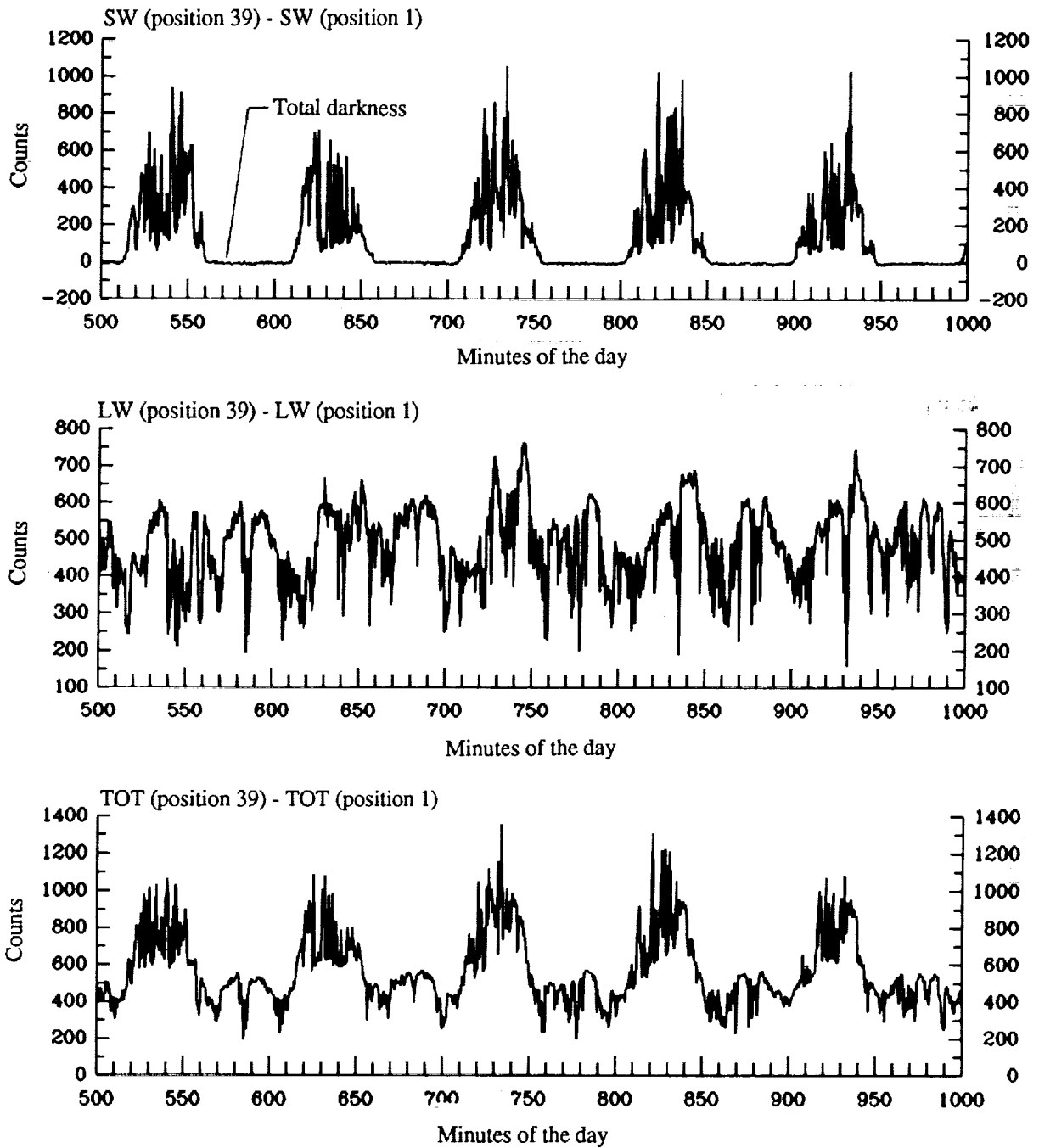

(a) Radiometric data for scan position 39 (nadir).

Figure C3. Instrument output from scanner instrument on ERBS spacecraft for September 3, 1985.

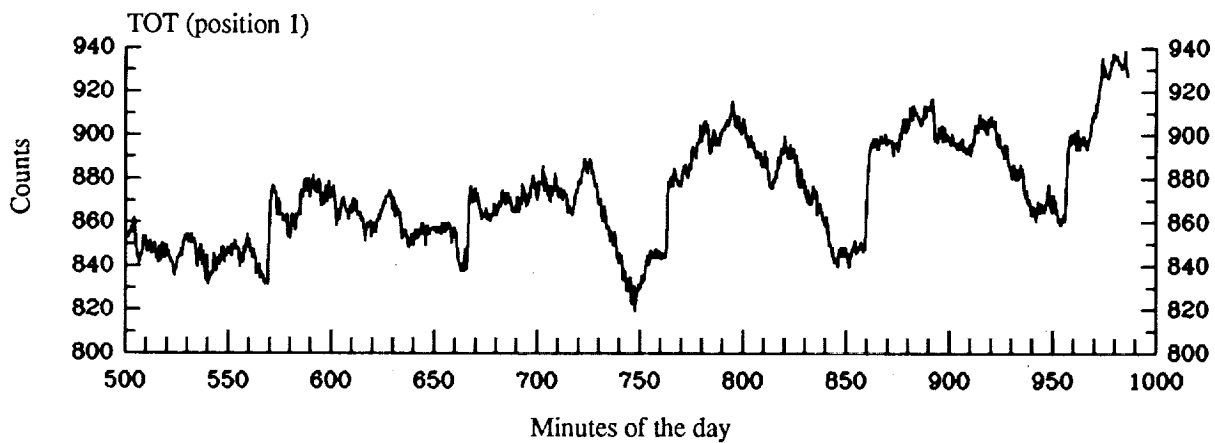
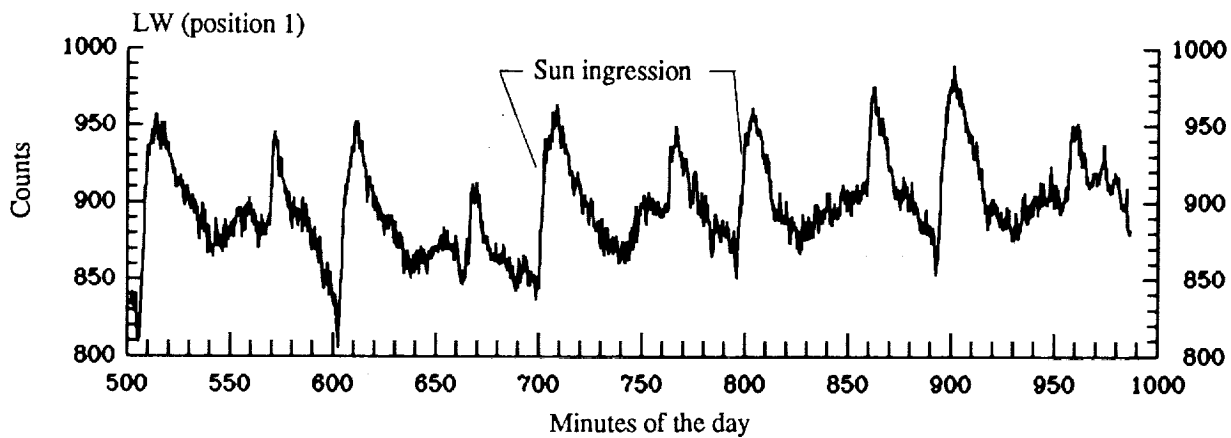
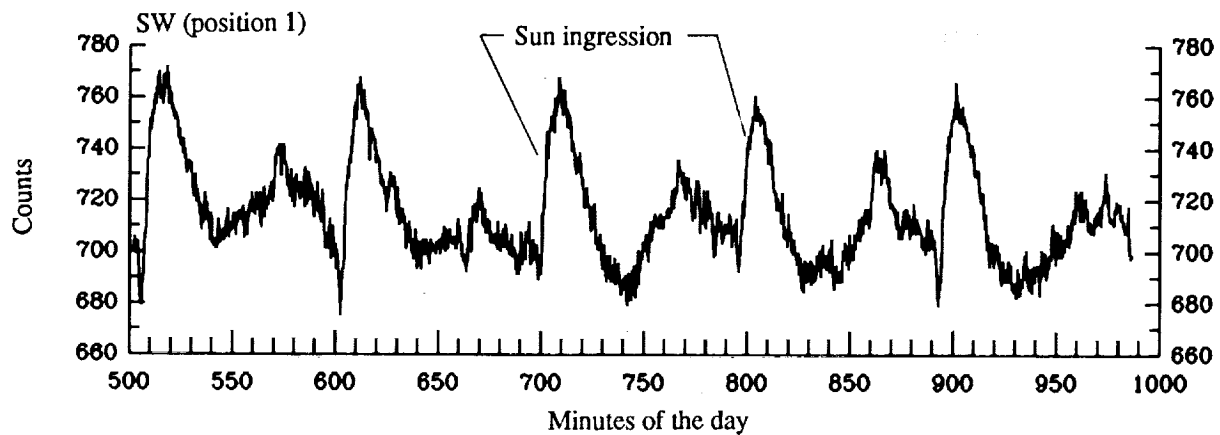

(b) Radiometric data for scan position 1 (space look).

Figure C3. Concluded.

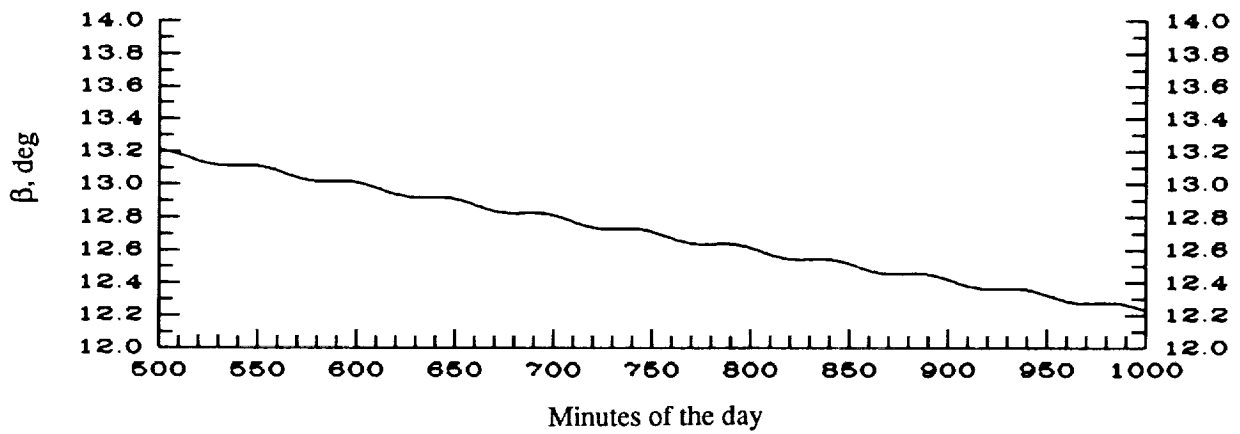
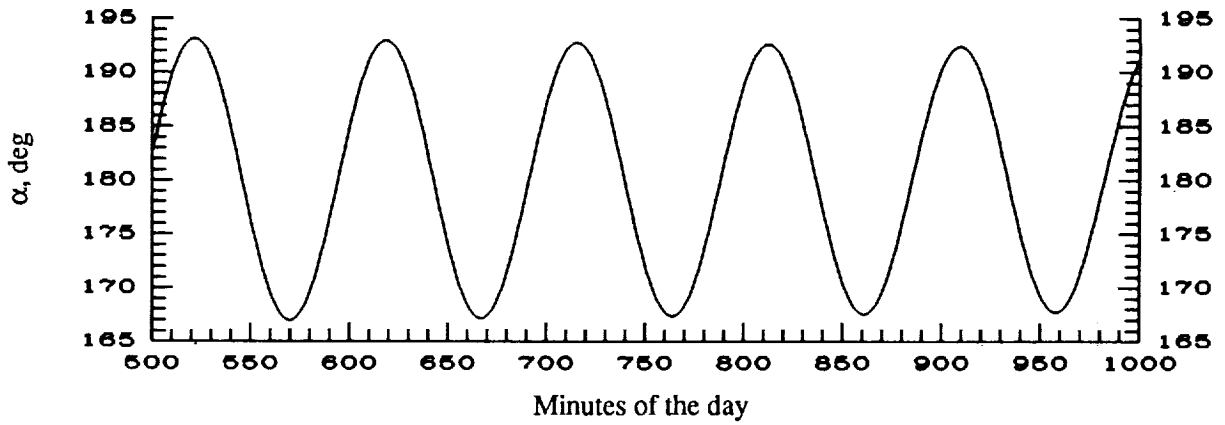
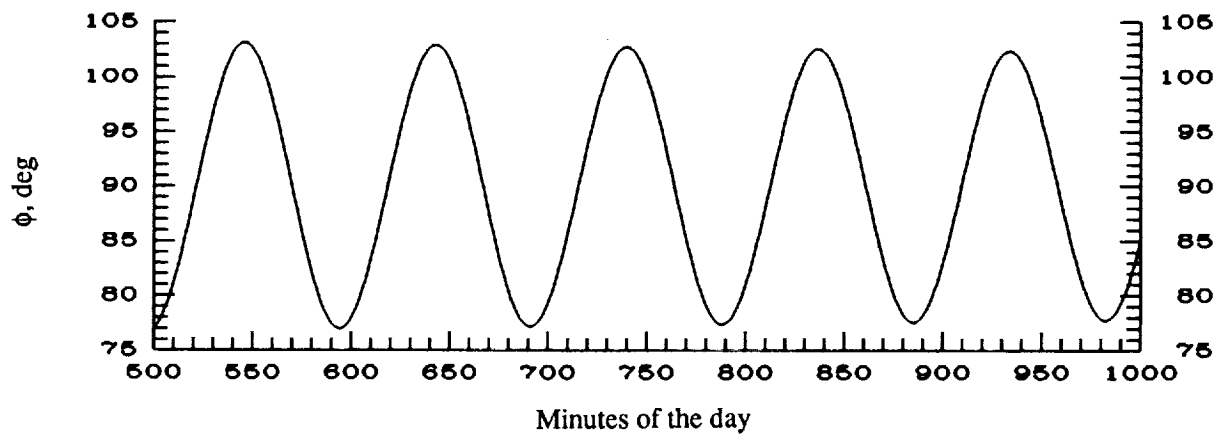

(b) Solar beta (β), azimuth (α), and elevation (ϕ) angles in coordinate system shown in figure B2.

Figure C4. Continued.

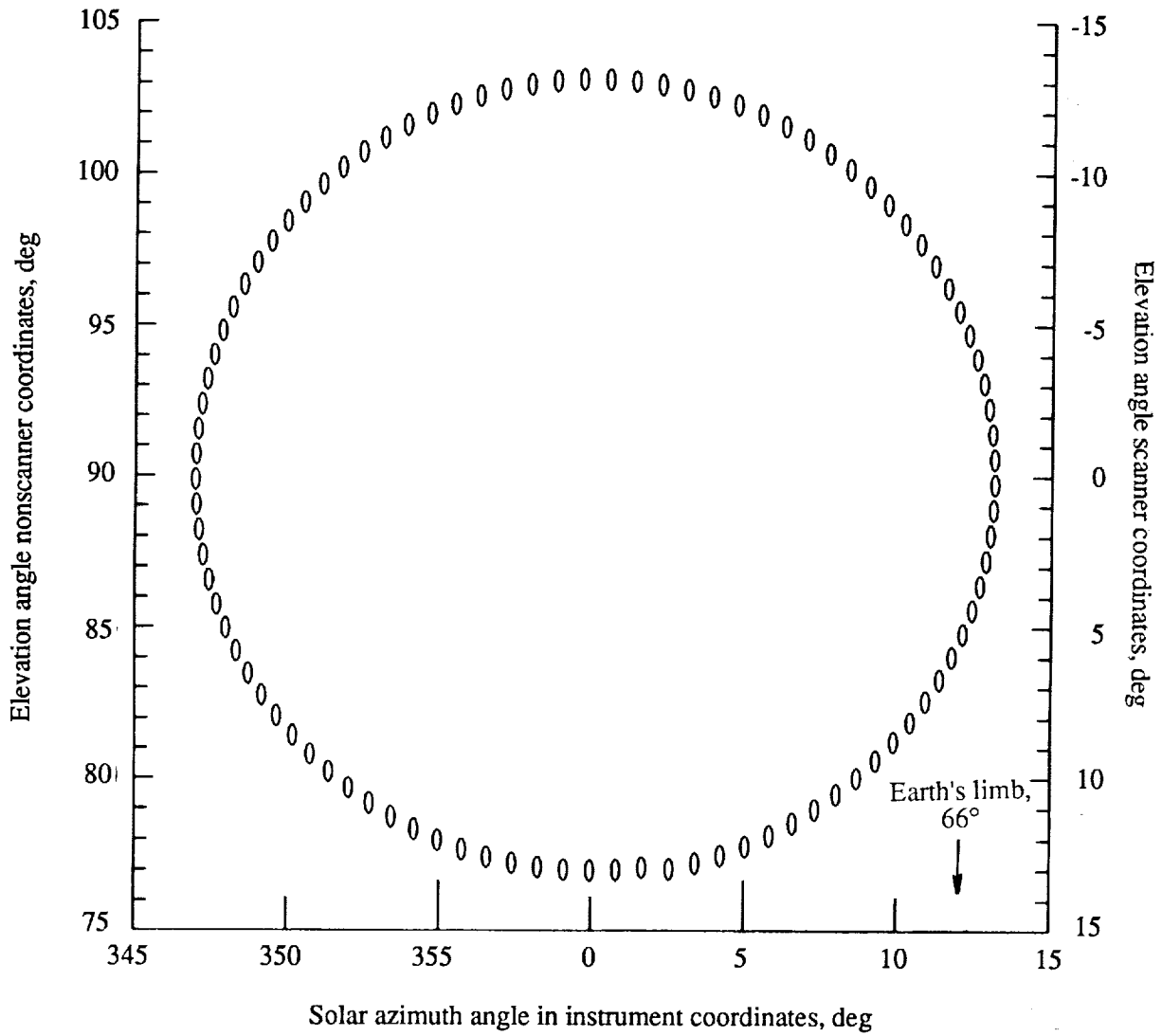

(c) Solar azimuth and elevation angles in instrument coordinates.

Figure C4. Concluded.

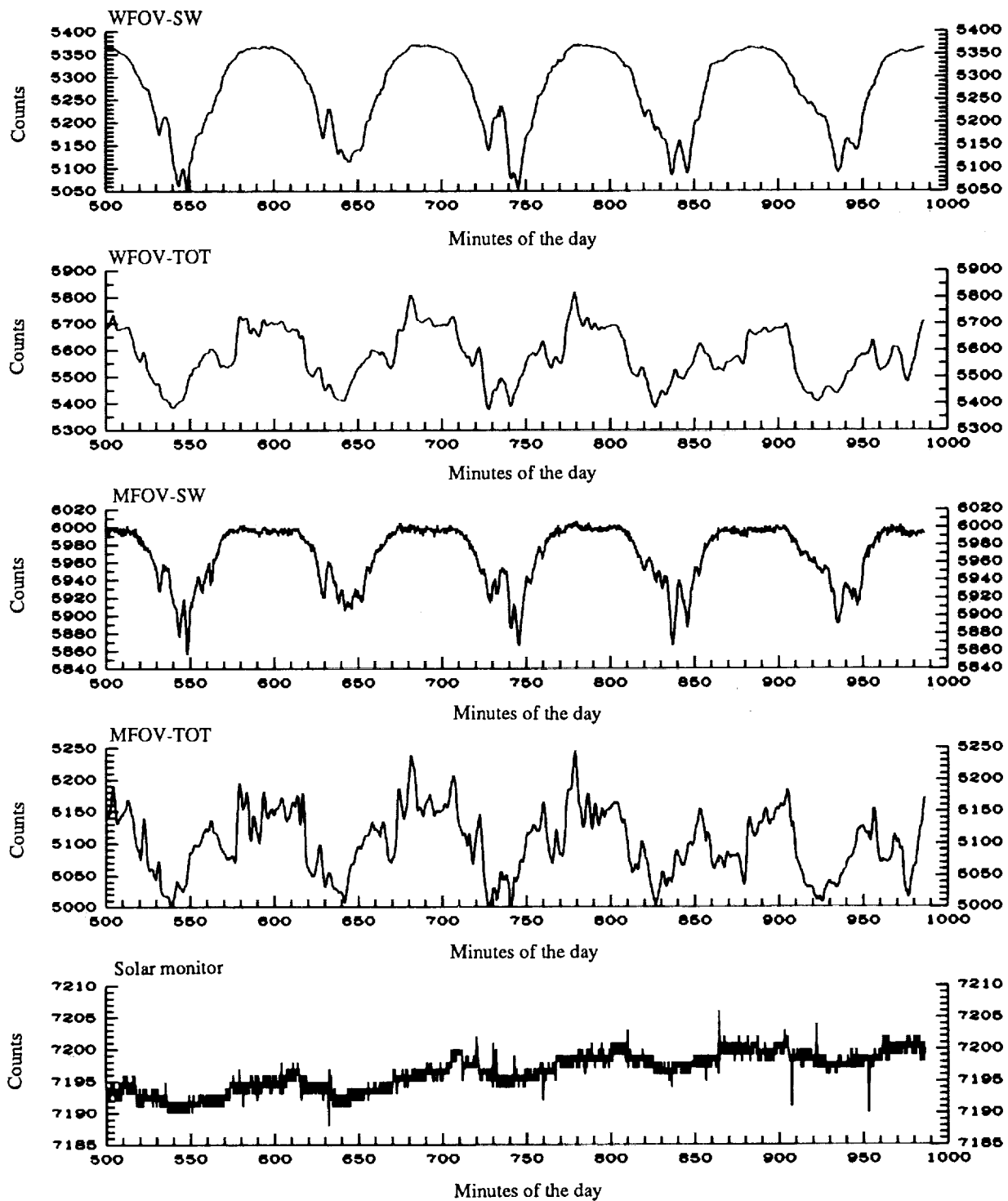

(a) Radiometric data.

Figure C5. Instrument output from nonscanner instrument on ERBS spacecraft for June 10, 1985.

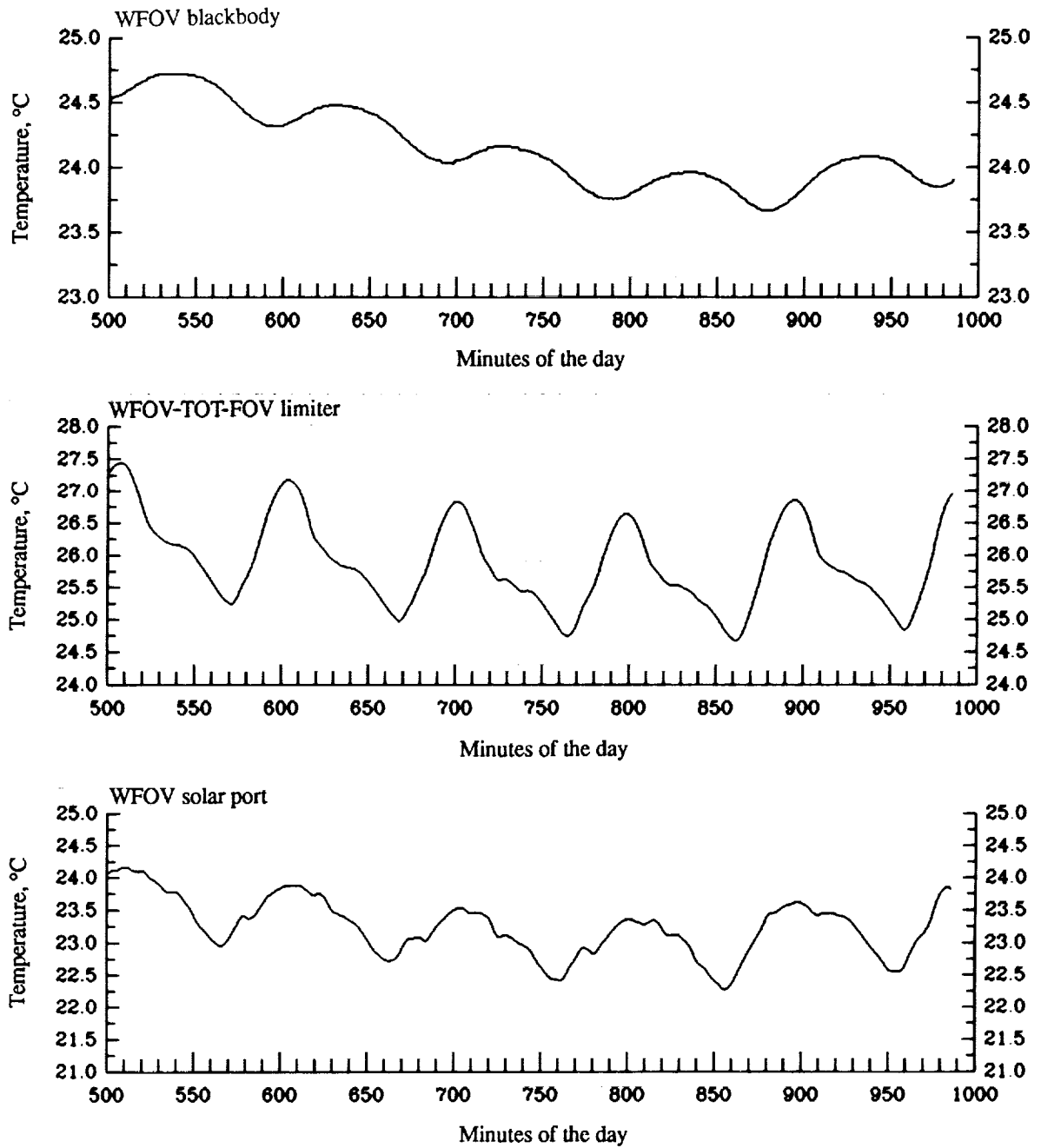

(b) Housekeeping temperature measurements.

Figure C5. Concluded.

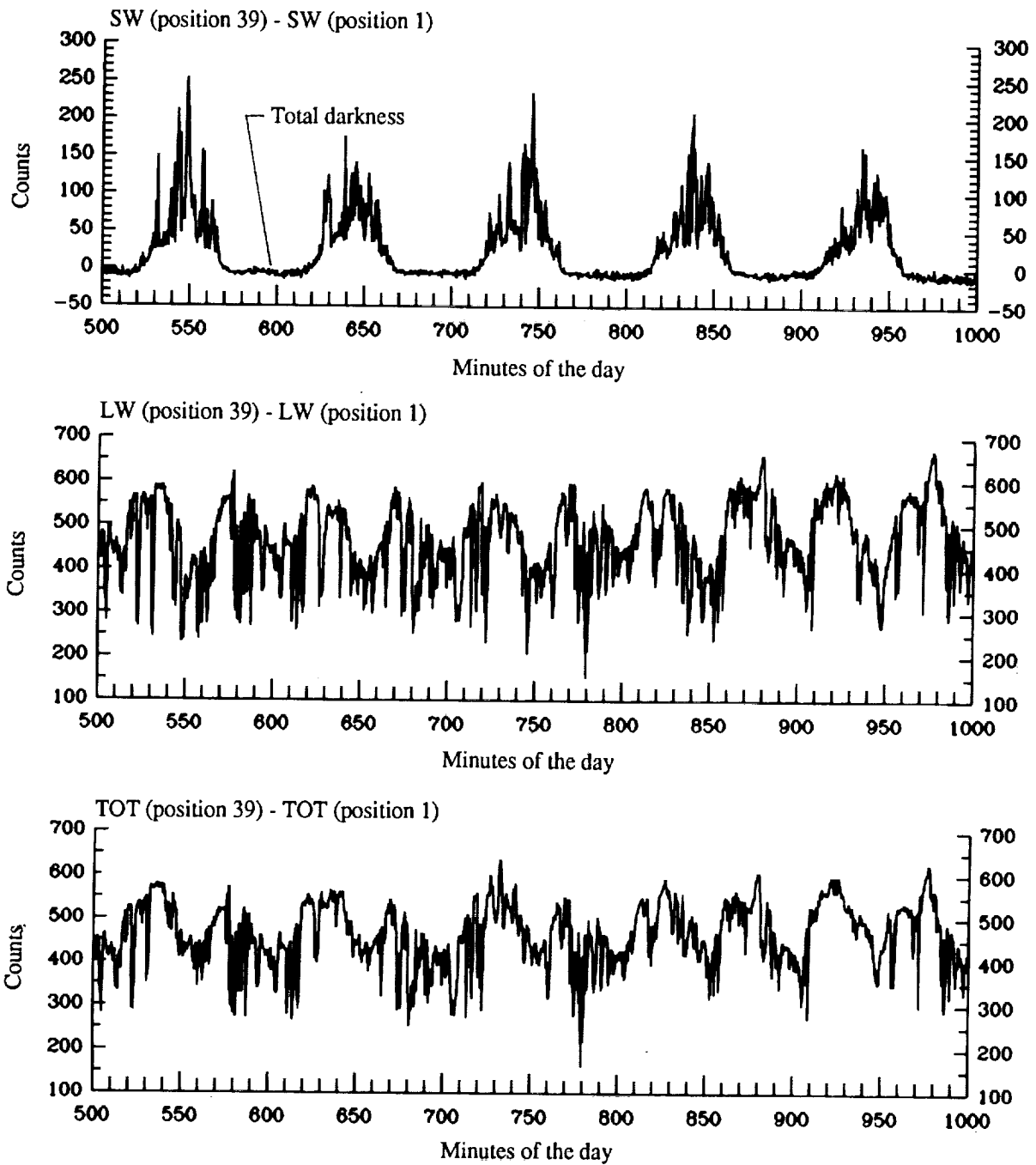

(a) Radiometric data for scan position 39 (nadir).

Figure C6. Instrument output from scanner instrument on ERBS spacecraft for June 10, 1985.

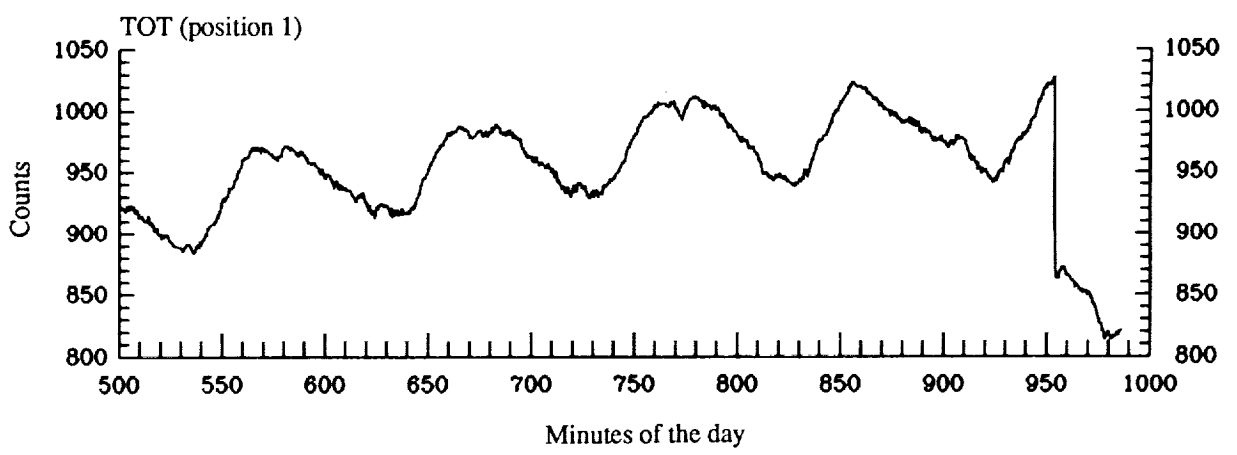
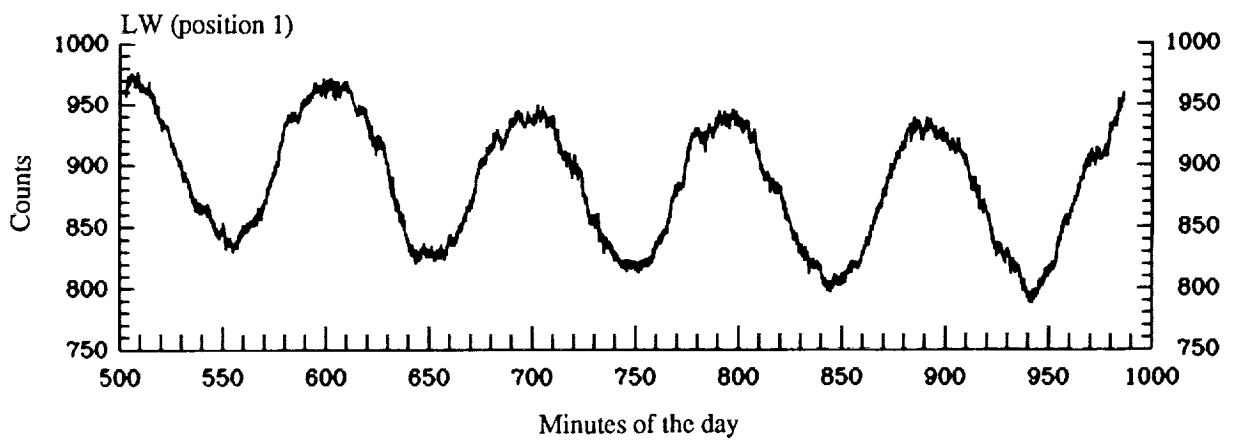
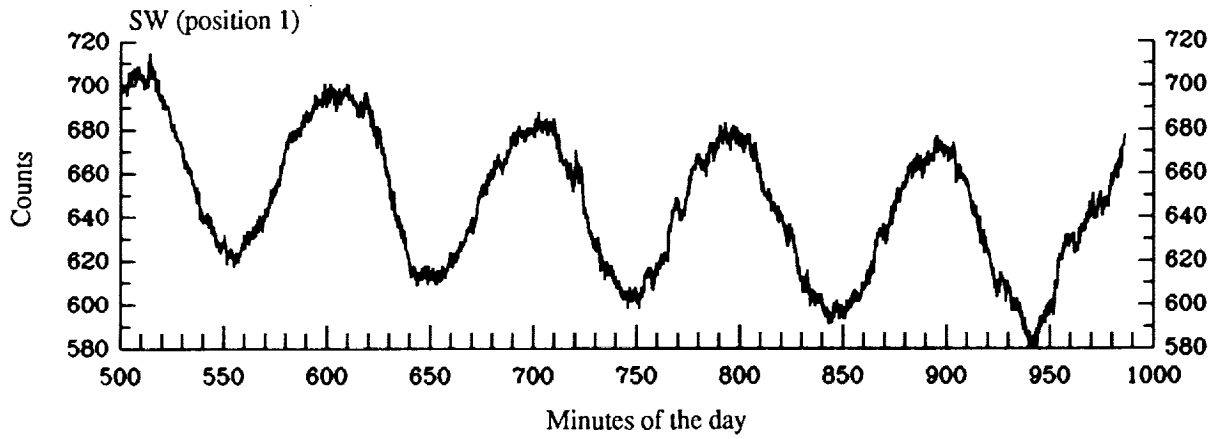

(b) Radiometric data for scan position 1 (space look).

Figure C6. Concluded.



Report Documentation Page

1. Report No. NASA RP-1256		2. Government Accession No.		3. Recipient's Catalog No.	
4. Title and Subtitle Mission Description and In-Flight Operations of ERBE Instruments on ERBS and NOAA 9 Spacecraft <i>November 1984 Through January 1986</i>		5. Report Date August 1991		6. Performing Organization Code	
		8. Performing Organization Report No. L-16895		10. Work Unit No. 665-45-20	
7. Author(s) William L. Weaver, Kathryn A. Bush, Chris J. Harris, Clayton E. Howerton, and Carol J. Tolson		11. Contract or Grant No.		13. Type of Report and Period Covered Reference Publication	
9. Performing Organization Name and Address NASA Langley Research Center Hampton, VA 23665-5225		14. Sponsoring Agency Code		15. Supplementary Notes William L. Weaver: Langley Research Center, Hampton, Virginia. Kathryn A. Bush, Chris J. Harris, Clayton E. Howerton, and Carol J. Tolson: ST Systems Corporation (STX), Hampton, Virginia.	
		12. Sponsoring Agency Name and Address National Aeronautics and Space Administration Washington, DC 20546-0001		16. Abstract Instruments of the Earth Radiation Budget Experiment (ERBE) are operating on three different Earth-orbiting spacecraft. The Earth Radiation Budget Satellite (ERBS) is operated by the National Aeronautics and Space Administration, and the NOAA 9 and NOAA 10 weather satellites are operated by the National Oceanic and Atmospheric Administration. An overview is presented of the ERBE mission, in-orbit environments, and instrument design and operational features. An overview of science data processing and validation procedures is presented. In-flight operations are described for the ERBE instruments aboard the ERBS and NOAA 9 spacecraft for the period from November 1984 through January 1986. This period covers the first 15 months of operation of the instruments on ERBS and the first 12 months of operation of the instruments on NOAA 9. Calibrations and other operational procedures are described, and operational and instrument housekeeping data are presented and discussed.	
17. Key Words (Suggested by Author(s)) ERBE Earth radiation budget Instrument operation Mission analysis Orbital environment		18. Distribution Statement Unclassified—Unlimited Subject Category 43			
19. Security Classif. (of this report) Unclassified	20. Security Classif. (of this page) Unclassified	21. No. of Pages 281	22. Price A13		

