

Control Center Technology

Conference Proceedings

(NASA-CP-10081) CONTROL CENTER TECHNOLOGY
CONFERENCE PROCEEDINGS (NASA) 641 p
CSCL 14B

N92-12010
--THRU--
N92-12032
Unclas
0039602

505510

G3/14

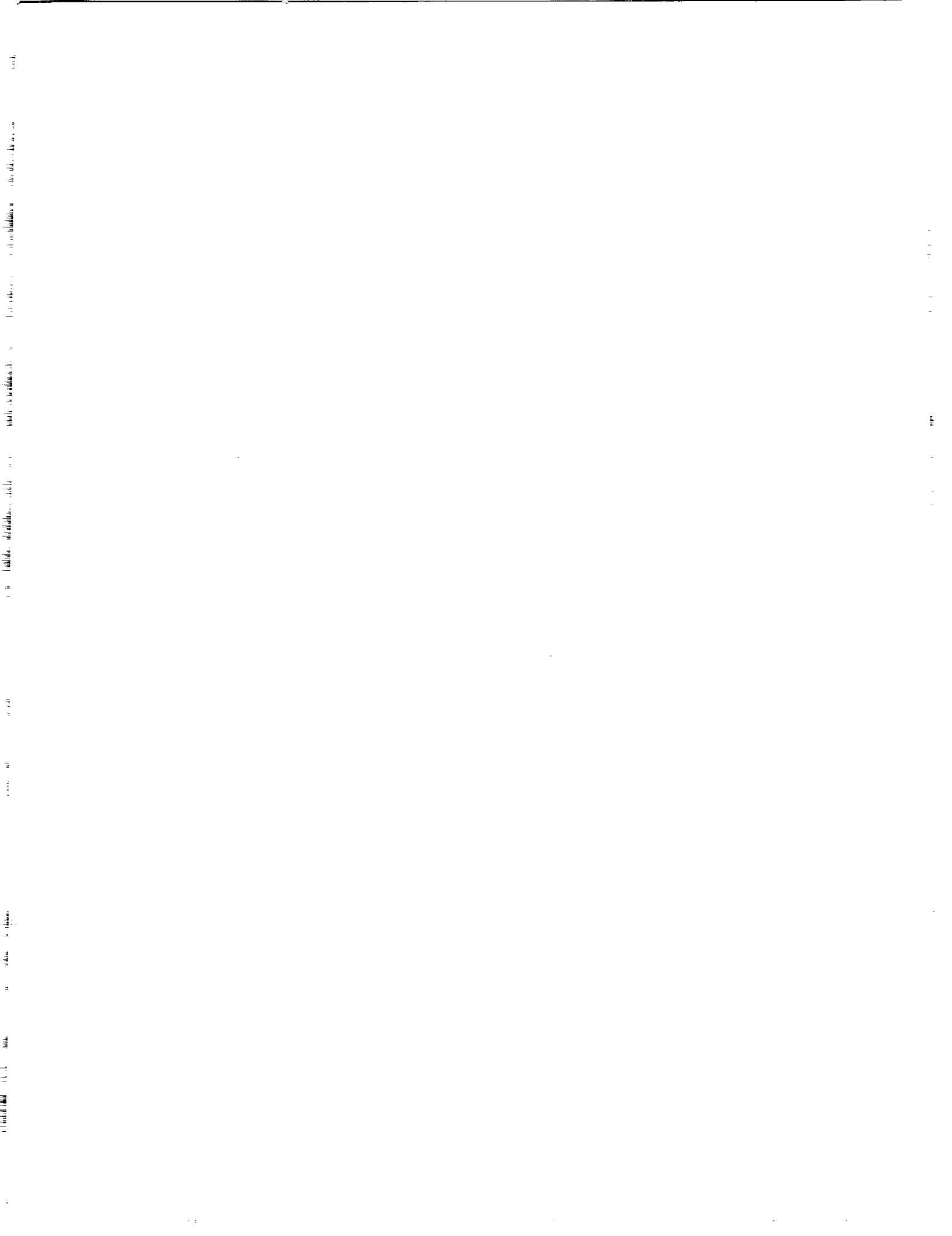

Control Center Technology

*Conference
Proceedings*

*Proceedings of a conference
held at the University of Houston-Clear Lake
Houston, Texas
June 18-20, 1991
Co-Sponsored by
NASA Lyndon B. Johnson Space Center
and the University of Houston-Clear Lake*



NASA

1991

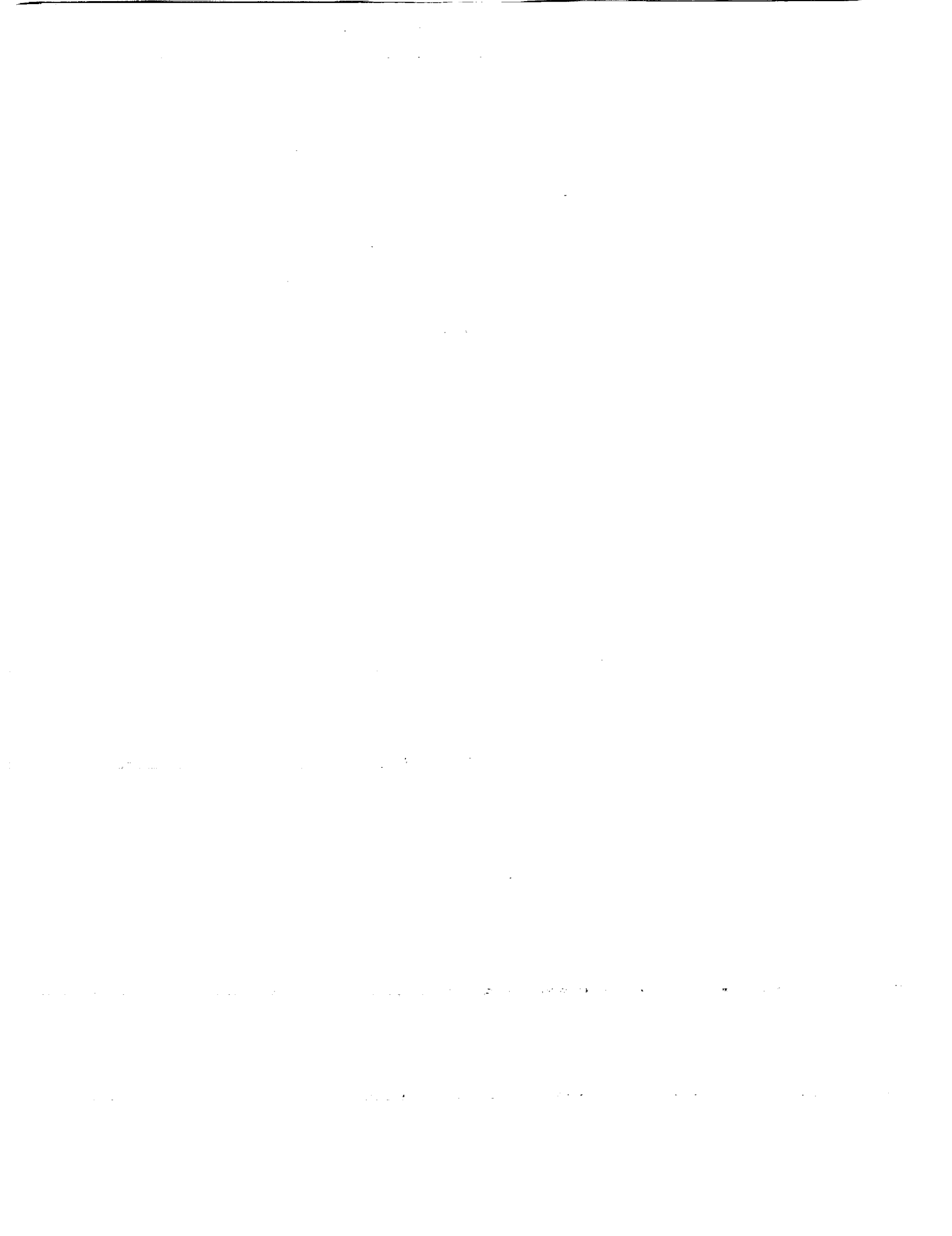

Clear Lake

2700 Bay Area Boulevard, Box 258
Houston, Texas 77058-1088
713 • 282-2223

Welcome to the Control Center Technology Conference.

On behalf of the Control Center Technology Conference (CCTC) steering committee, the University of Houston - Clear Lake, and an outstanding team of presenters, I wish to thank you for your interest in the work and the knowledge that the participants have provided to the NASA and aerospace community. We believe that you will find that these proceedings match your expectations in regard to timeliness, quality, and vision.

The CCTC's themes encompass architectures, applications, and technologies. Within each theme area, each session has been selected on the basis of the relevance of the speakers' research and operations experience to the overall goals for the national space program. There is a balance of basic and applied research, technology transfer, visionary and reality based planning, and the 'real world' of operations and lessons learned. In total, these proceedings should prove to be a guide for engineering and management planning for years.

It is important to note that the CCTC is a product of cooperation among government, industry and academic institutions. Quality is enhanced; costs are reduced; and goals are attained more readily through teamwork. The confluence of expertise at the conference is but one example of success of the team strategy. The NASA leadership, and especially the efforts of Bob Holkan, deserve commendation and recognition for their support of team efforts to accomplish the complex of organizing and preparing such a superb conference.

As you read the proceedings, remember that your ideas are important to the speakers whose work is presented here. If you have ideas that can contribute to the infusion of new technologies into mission control, contact us, so we can let the speakers know of your interest. As exemplified by the welcoming letter from Mr. Kranz, Director, Mission Operations Directorate, NASA's commitment is to maintaining a dialog for the exchange of techniques and information. These proceedings add to the dialog, but should be but a step in the process. Future meetings and future discussions are essential.

Again, thanks for your interest and your participation. All of us involved in the conference have enjoyed working with you.

Sincerely,

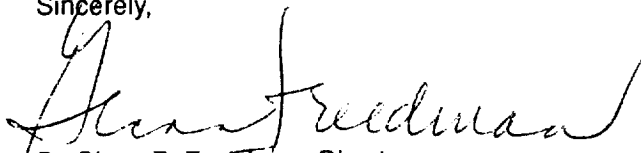

Dr. Glenn B. Freedman, Director
Software Engineering Professional Education Center



National Aeronautics and
Space Administration



Lyndon B. Johnson Space Center
Houston, Texas
77058

To All Conference Attendees:

The Mission Operations Directorate has an aggressive plan for infusing new technology into the Mission Control Center (Shuttle Operations), while at the same time efforts to develop a Space Station Control Center have moved into early implementation phases. To achieve success, a great deal of work involving many key decisions will be accomplished over the next several years.

To assure success in these control center projects as they evolve over the next decade, it is appropriate to establish an ongoing dialog with other personnel engaged in similar endeavors. The time is right for the sharing of ideas, lessons learned, and for establishing visions for the future.

The Johnson Space Center and the University of Houston - Clear Lake are jointly sponsoring an Aerospace Control Center Technical Conference from June 18-20, 1991. This conference will provide a broad range of information on aerospace control center efforts in progress across Government and industry.

It is my desire that this conference provide the opportunity for the exchange of information, the establishment of contacts, and that it may lead to an ongoing effort to share information and techniques across the Agency and industry. I hope that you will consider helping to make this conference a success through your active participation.

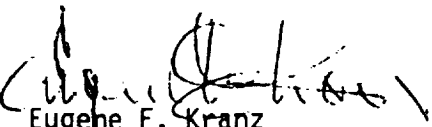
Eugene F. Kranz
Director, Mission Operations



Contents

B-2 and Other Military Flight Test Control Center Current Technologies	1
JPL's Space Flight Operations Center Development Project Overview	33
Kennedy Space Center Launch Processing System (LPS) and the Test Checkout and Monitoring System 2 (TCMS 2)	53
NASA Ames-Dryden Integrated Test Facility	83
Conviction...Why We Are In Space	107
Space Shuttle Mission Control Center Upgrade (MCCU)	125
Space Station Control Center (SSCC)	209
Air Force Satellite Control Network	237
Rockwell Downey Mission Support Room (MSR) and Data Display & Review (DDR) Room Upgrade	281
Real Time Data Systems (RTDS)	303
SHARP – Spacecraft Health Automated Reasoning Prototype – Real Time Expert Systems	337
Planning Systems at Pioneer Mission Control	363
Automation for Deep Space Vehicle Monitoring	381
Control Center Operations at the Goddard Space Flight Center	401
Huntsville Operations Support Center	423
Real Time Data System Application	443
Solar Mesosphere Explorer Control Center and OASIS	467
MacSPOC-Orbital Trajectory Calculations on a Laptop Computer	493
Advanced Technologies for Mission Control Centers	505
Advanced Laptop and Small Personal Computer Technology	549
MOD Control Center Automated Information Systems Security Evolution	589
Mission Critical Technology Development	615
Future Applications of Artificial Intelligence to Mission Control Centers	635

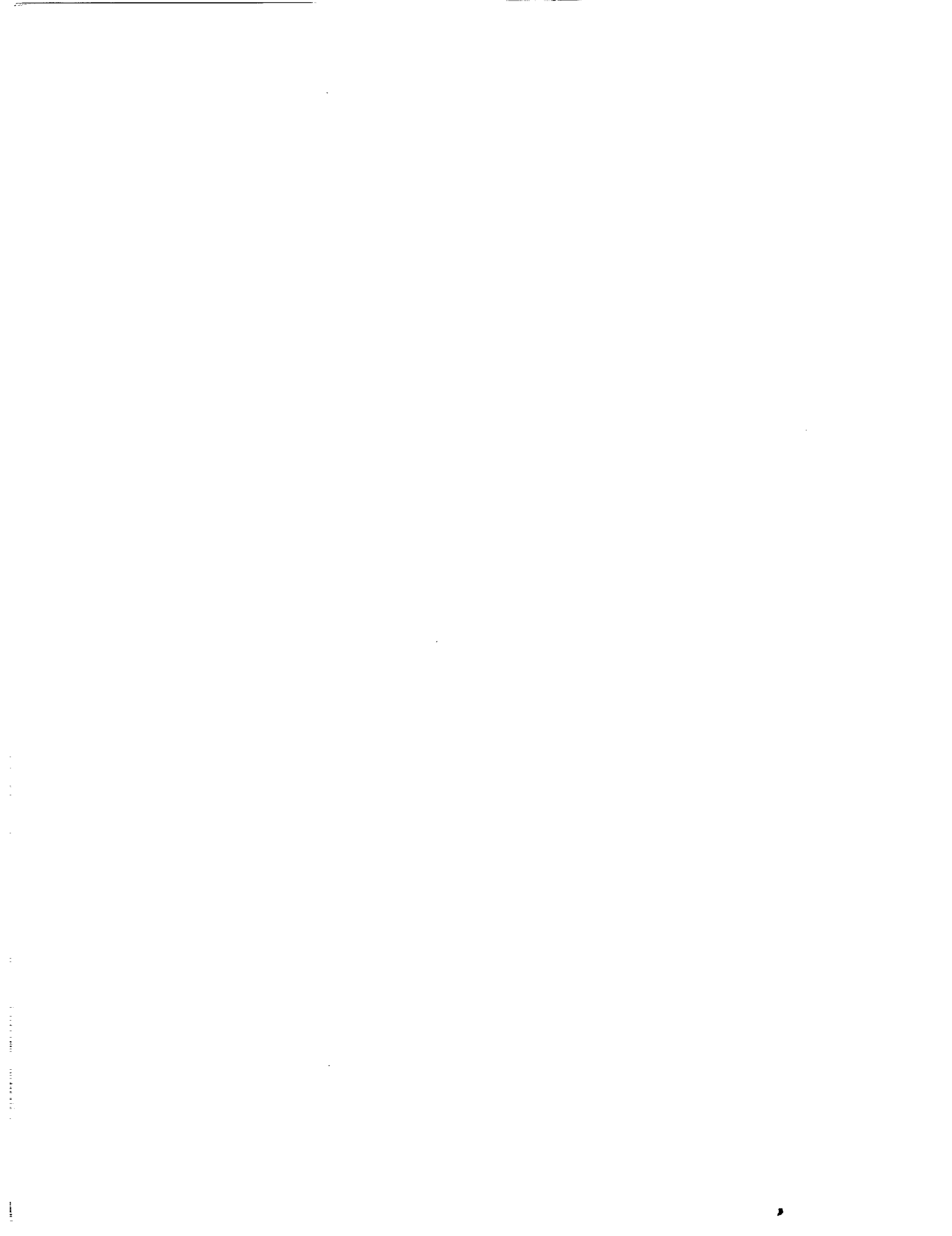

**B-2 AND OTHER CURRENT FLIGHT TEST
CONTROL CENTER SYSTEM ARCHITECTURES**



CZ790293

COMPUTER SCIENCES CORPORATION

Jerry Hill
Network Systems Division
Realtime Data Systems Center
Lompoc, California

N92-12011

P-32

51-14

18 June 1991

OVERVIEW

<u>CLIENT</u>	<u>SYSTEMS</u>	<u>OBJECTIVE</u>
USAF-EAFB	B-2 Test Support Facility (TSF)	B-2 Flight Testing
USN-PMTC	Telemetry Processing System (TPS)	Weapon (Missile) Testing
USN-NATC	Real-Time Telemetry Processing System (RTPS III)	Aircraft Flight Testing



KEY POINTS / THEME

- **TELEMETRY PROCESSING INDEPENDENT OF SOURCE**
- **GENERIC SYSTEM / SOFTWARE**
- **TIME HOMOGENEITY**
- **LOW LATENCY NETWORKS**
- **DISTRIBUTED PROCESSING**
- **ALL DATA AVAILABLE TO ALL WORKSTATIONS**
- **RECALL OF DATA IN REALTIME**
- **NO FREEZE H/C**
- **TEAM CONCEPT**
 - CSC Continuity
 - Client Involvement

**TEST SUPPORT FACILITY
MISSION CONTROL ROOM**

The Test Support Facility (TSF) is comprised of three (soon to be four) control rooms. Each control room contains:

1. Two Large Screen Displays.
2. Ten high resolution, rasterized, color displays with up to 1000 user-defined displays.
3. Three alphanumeric terminals.
4. 128 stripchart pens.

The TSF provides the following processing capabilities:

1. Process two, 1.2 Mb/Sec telemetry sources.
2. Engineering Unit (EU) conversion of 156K samples per second.
3. FM processing of 72 channels with aggregate rate of 300 K samples per second.
4. Maximum number of measurements defineable is 10,000.
5. Record 300K samples per second with aggregate on-line archival of up to 3 Terabytes for 3 control rooms (one year's data).

Test Support Facility PERFORMANCE SUMMARY

- **SUPPORT 3 SIMULTANEOUS MISSIONS**
- **SINGLE MISSION REQUIREMENTS**
 - Three 1.2 Mbit PCM
 - One FM (72 Channels)
 - 10,000 Measurements / 300,00 sps / 156,000 EUC
- **FACILITY REQUIREMENTS**
 - One Year of Mission Data On-Line (3 Terabytes)
 - Two Minute Retrieval of Any Mission
 - Two Floors: 1 Computer Room (10,000 sq. ft.)
3 Mission Control Rooms (5,600 sq. ft.)

TSE CONFIGURATION

The TSE architecture is made up of the following subsystems and components.

Flight Monitoring System (FMS) - Each of three FMSs supports a Mission Control Room. An FMS consists of three mini-computers providing a combined processing capacity of approximately 20 MIPS. There is one processor assigned to each of three functions: Acquisition, History Recording and Display. A telemetry front end provides bit and frame synchronization, decommutation and EU conversion prior to receipt by the mini-computers. Additionally, the front end drives 128 stripchart recorders.

1. Acquisition ingests telemetry data from 72 FM channels with an aggregate rate of 300Ksps and from two 1.2Mb PCM streams. Processing provides EU conversion, time tagging for time-homogeneous data and stripchart recording. Fast Fourier Transforms and other compute-intensive processing are supported by an array processor coupled to the acquisition processor. All bit sync, frame sync and decommutation are performed in the special purpose telemetry front end.
2. Realtime display provides display processing for 10 color graphics terminals, three alphanumeric terminals and two large screen displays.
3. History recording is performed for all telemetry data received. This includes 300Ksps raw or 156Ksps EU converted data. Recorded data may be "recalled" from the history recording subsystem in realtime.

Flight Monitoring System (FMS) Common Functions - Several functions are shared by all control rooms via a high speed network communications link. These functions are described below:

An on-line, mass storage, archival system is available to all control rooms. This Storage Archival System (SAS) provides three trillion bytes (3 terabytes) of archived storage from which files of up to 123MB can be accessed within 90 seconds.

A pool of Engineering Workstations (FMSs) is available to all control rooms. The primary function of these workstations is to provide telemetry processing and display definitions for the three Flight Monitoring Systems.

Time Space Position Information (TSPI) is provided for all FMSs from the TSPI processors over the network communications link. This information is used to direct intercepts, bomb drops and other operations requiring exact vehicle position and track prediction information.

TSF ARCHITECTURE

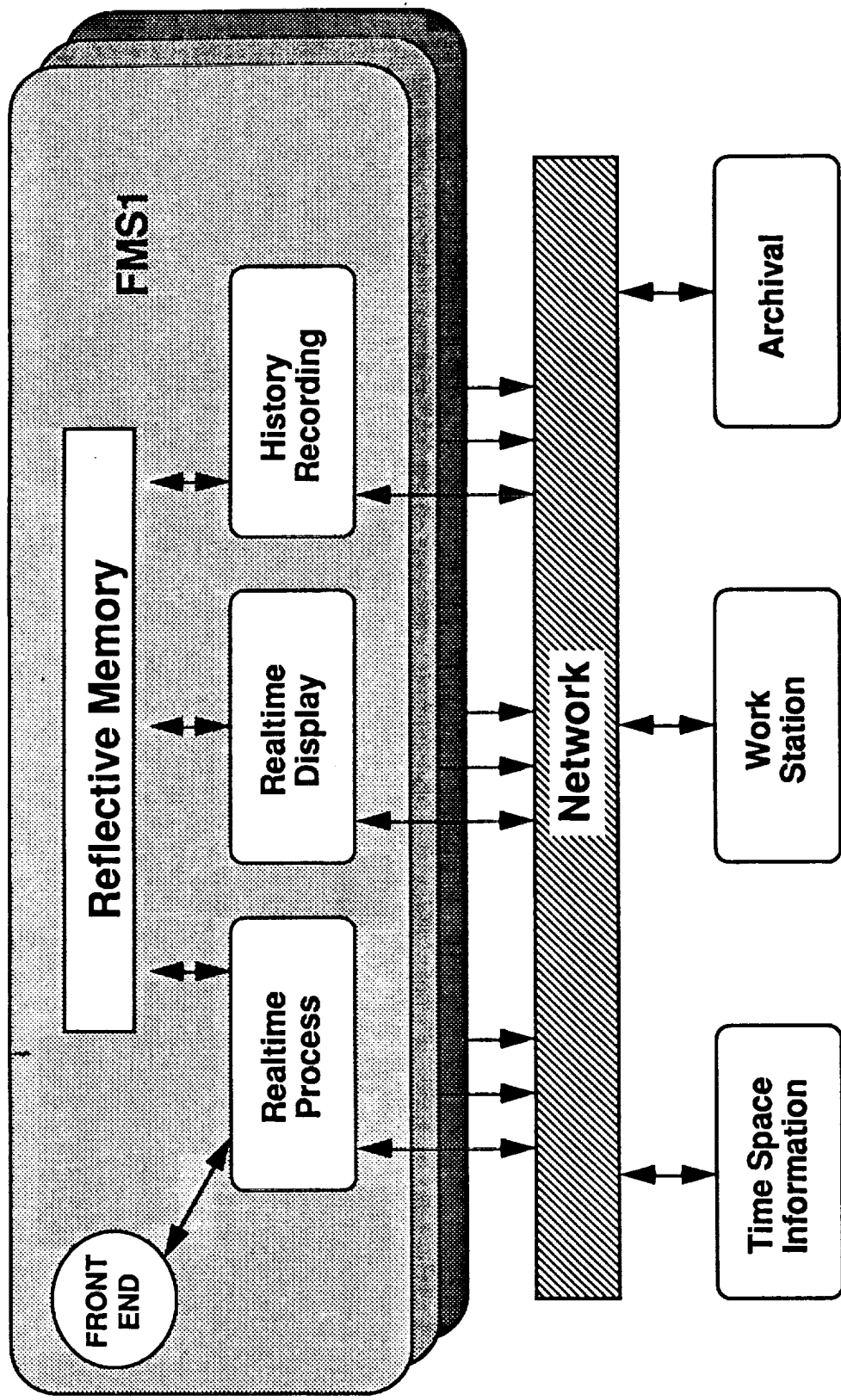

B-2 EVOLUTION

A fourth Flight Monitoring System (FMS) is being added to the existing three FMSs in the TSF. This upgrade will be functionally transparent to the operation and consist of the following replacements:

1. Two of the three FMS mini computers replaced with a single, more powerful mini.
2. Ten graphics terminals replaced with workstations.
3. Three terabyte Storage Archival System replaced with a 6 terabyte system.

Intelligence for processing operator commands from the current graphics terminals resides in the minis. This processing will be performed in the workstation with the workstation retaining all graphics display functionality previously exhibited by the existing display stations. This will be done while not modifying existing software. The goal is to only add more hardware and software, providing for a single system from a maintenance perspective.

A Yourdon analysis was performed using a CASE tool to insure all interfaces were thoroughly understood and documented before the upgrade was attempted.

Test Support Facility EVOLUTION

- **REPLACE DISPLAY HOST WITH A WORKSTATION BASED OPEN SOLUTION**
- **USE THE UMN TO ENABLE SEAMLESS ARCHITECTURE**
- **PROVIDE LIFE CYCLE UPDATES OF PROCESSOR/DISKS**
- **DOUBLE THE CAPACITY/DENSITY OF VERY LARGE ARCHIVE**

RTPS III CAPABILITIES

The Realtime Processing System (third generation) upgrades the current flight test capability to state-of-the-art systems. RTPS III consists a Control Center, made up of six control rooms, and is expandable to at least eight. Each Control Center has the following capabilities:

1. Process as many as four 10Mb PCM sources.
2. Process as many as 64 FM channels with an aggregate throughput of 200Ksps.
3. Perform EU conversion at 200Ksps.
4. Record EU data in frame format and order at 160Ksps.
5. Define 2K telemetry measurements.
6. Time homogeneous CVT and recording buffers.
7. Recall of recorded data for display during realtime.
8. No-freeze hardcopy of graphics and alphanumeric displays.

RTPS III BLOCK DIAGRAM

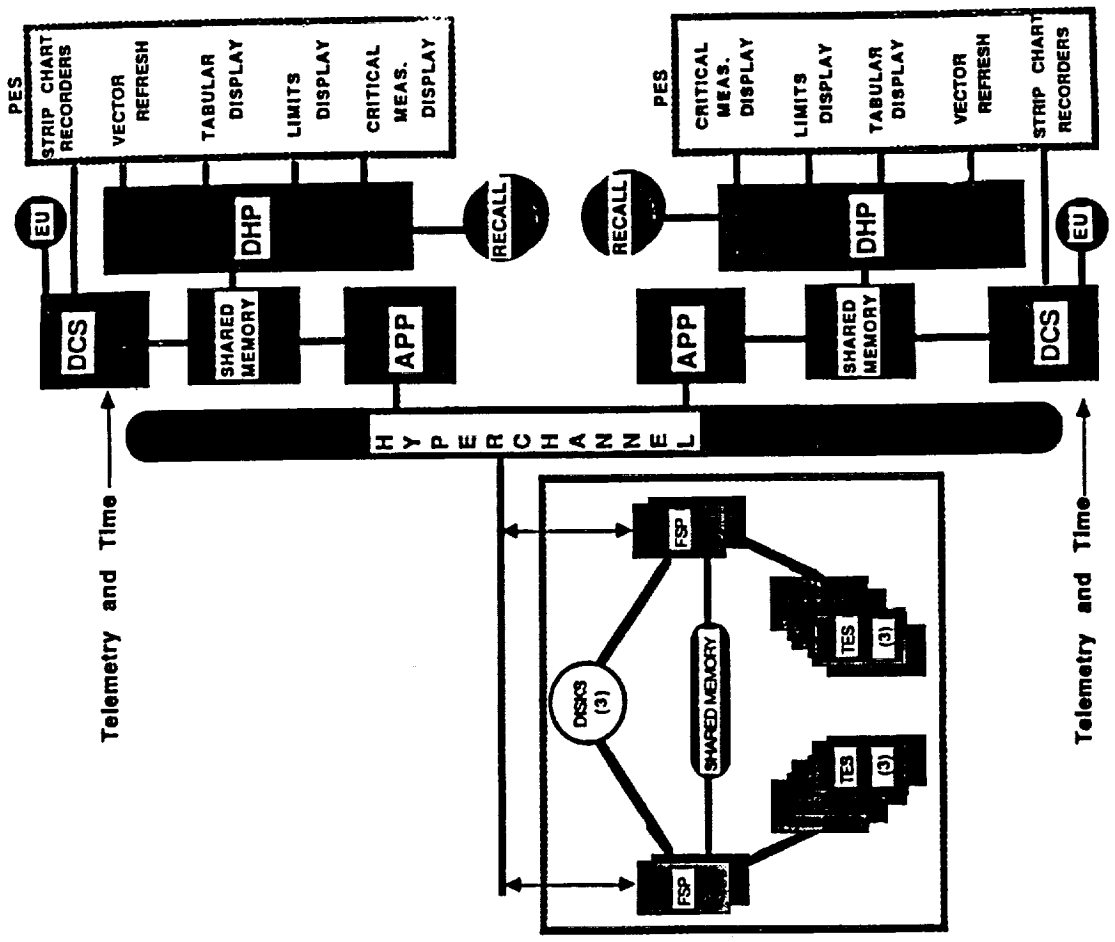

CONTROL CENTER ARCHITECTURE

Each of six control rooms consists of a triad of mini-computers with a connecting shared memory system. Each CPU in the triad represents a subsystem performing a major system function. The six control rooms share a common file management system, accessible over a high-speed network.

Data Channel Subsystem - The Data Channel Subsystem provides for bit sync., frame sync., decommutation and time tagging, EU conversion and recording, limit checking, stripchart recording and data distribution. This subsystem consists of a special purpose front end working in tandem with, and driven by, one of three mini-computers. CVT data are provided to shared memory by the CPU and via DMA from the front end. Note that all bit sync, frame sync and decommutation are performed in the special purpose telemetry front end.

Display Host Processor - The Display Host Processor drives the control center displays from the CVT data provided by the Data Channel Subsystem. These data are also recorded in a circular mass storage file from whence they may be recalled and displayed on either of the two graphics displays during realtime. Control and display devices provided by this subsystem are:

1. Two monochrome graphics (vector refresh) terminals.
2. Two Critical Measurement Displays (12 selectable measurements each LED panel).
3. Two fixed-function keyboards (64, one-keystroke functions).
4. Two limits displays (color).
5. Two tabular displays with graphics capability (color).
6. Two lazer hardcopy devices for vector refresh terminals.
7. Two color hardcopy devices for color graphics terminals.
8. 128 stripchart channels (driven from Data Channel Subsystem processing).

Application Subsystem - The Application Subsystem consists of a 10 MIP mini-computer and associated array processor. This subsystem provides user-defined, compute-intensive processing. Data are provided by the Display Host Processor and Data Channel Subsystem through the shared memory interface. Processed data and derived measurements are returned to those two subsystems from the Applications Subsystem through the same interface.

File System Processor - The File System Processor Subsystem provides operation definition for all operations conducted from any control room. Telemetry formats and processing are described by the Telemetry Engineer. Files are generated for distribution, on the high-speed network, to the applicable control room processors for control of all processing and display directives associated with a specific operation.

Cost: The capabilities described above were provided for an average cost of \$3.3M control room, including the File System and high-speed network.

TELEMETRY PROCESSING SYSTEM CAPABILITIES

The Telemetry Processing System (TPS) was 22 months in development and is currently undergoing factory acceptance testing in Lompoc, California. Installation at the Pacific Missile Test Center at Pt. Mugu is scheduled for August, 1991. The TPS consists of four processing subsystems (TPSS) that are switchable between four control rooms. TPS capabilities for each control room are as follows:

1. Process up to eight telemetry input sources including:
 - a. Four 10Mb PCM links.
 - b. FM (20 channels, aggregate of 300Ksps).
 - c. Two PAM links.
2. Perform EU conversion at 400Ksps (Mix = 80% Ax + b, 10% 5th Order Polynomial and 10% Table Lookup).
3. Recording of 360Ksps EU converted measurements.
4. Define up to 16K measurements.
5. Playback of digital data from mass storage.
6. Recall of recorded data in realtime.

TPS ARCHITECTURE

The TPS architecture consists of four control rooms supported by four processing subsystems. Processing subsystems are switchable between control rooms. The special purpose telemetry front end is interfaced to the host through a proprietary high-speed data interface. CVT data are provided to all workstations over an Ethernet interface. Data are provided to the Range Central Site Computers over a high-speed (100Mbps) network. Workstations in a control room can receive data from any two processing subsystems simultaneously. Data from any of the processing systems can be provided to all four of the control rooms simultaneously. Stripcharts in the control rooms are driven directly from the special purpose telemetry front end. All bit sync, frame sync and decommutation functions are performed by the special purpose telemetry front end. The specific subsystems are as follows:

Telemetry Front End Subsystem - The TFESS performs bit sync., frame sync., decommutation, ID and time tagging, EU conversion, stripchart processing. Data are provided to the Telemetry Processing Subsystem (TPSS) and Telemetry Display Subsystem (TDSS) over the Intelligent Data Interface (IDI)/Universal Memory Network (UMN) high-speed data network.

Telemetry Processing Subsystem - The TPSS controls the TFESS, and provides processed data to the TDSS workstations. The interface to the TDSS is Ethernet. Data are transmitted to and received from the Range Central Site Computers over the Telemetry Data Network (a 100Mb link). A second Ethernet link provides communication with the Software Development Station and the Telemetry Decommutation and Processing System.

Telemetry Display Subsystem - The TDSS receives data from the TPSS over Ethernet and from the TFESS through the UMN interface. Data are displayed on four 19" color graphics workstation monitors. Every workstation has access to all measurements in given subsets, as defined in a database distributed prior to the operation. Data may be recorded to the local workstation disk and recalled in realtime. A TDSS consists of:

1. Four workstations with 19" color graphics monitor and local mass storage.
2. One color hardcopy device shared by four workstations.
3. Four monochrome hardcopy devices (one per workstation).
4. 64 stripchart pens.

Software Development Station - The SDS provides a system for software development and for creation of operation definition files. Files defining an operation are built by Telemetry and Project Engineers at either the SDS or the TPSS and distributed to the appropriate subsystems during operation initialization. These

files define display formats, EU conversion parameters, stripchart channel assignments and telemetry channels to be processed, as well as providing assignment of telemetry IDs to workstations.

TPS ARCHITECTURE

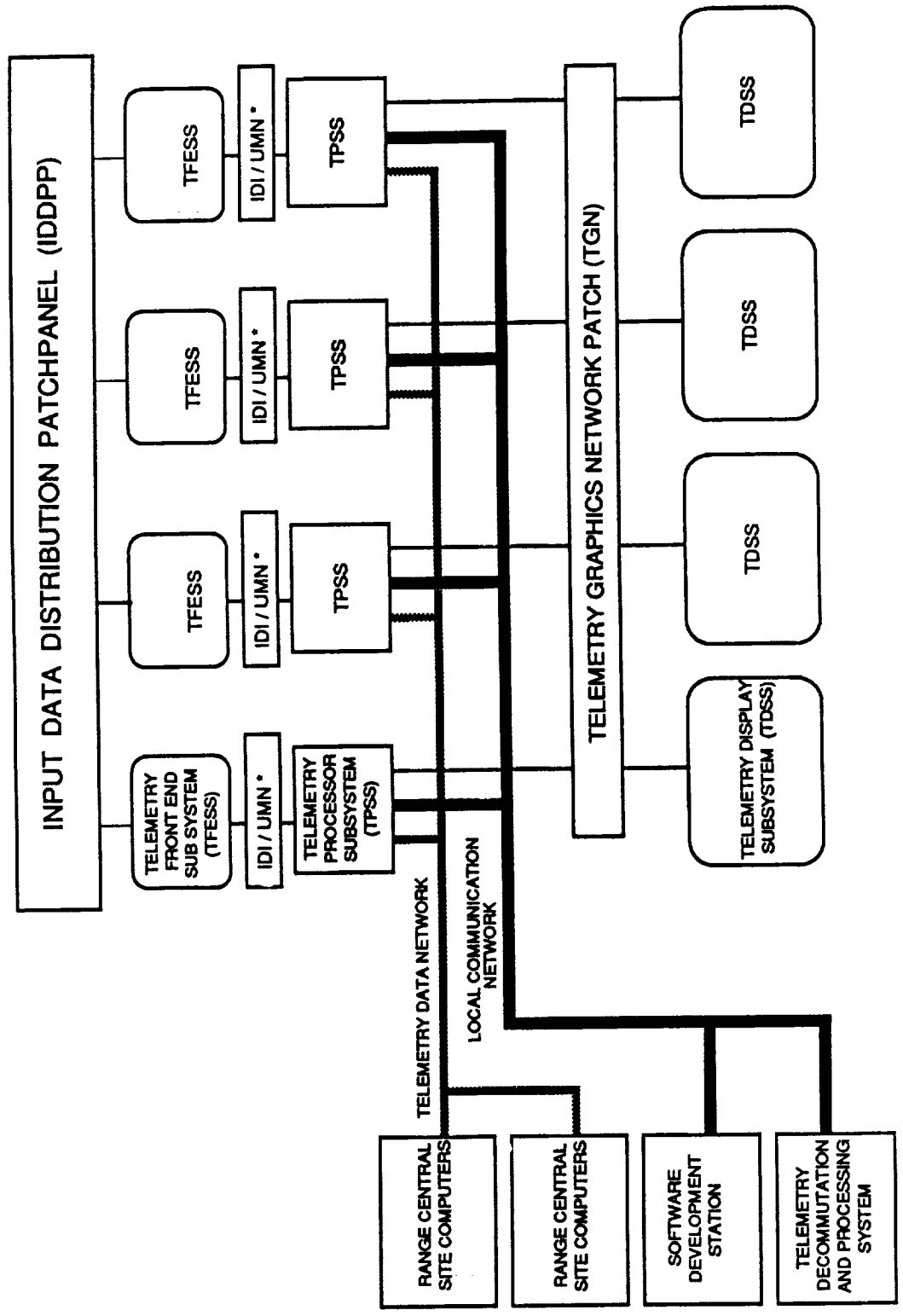

TPS FACILITIES

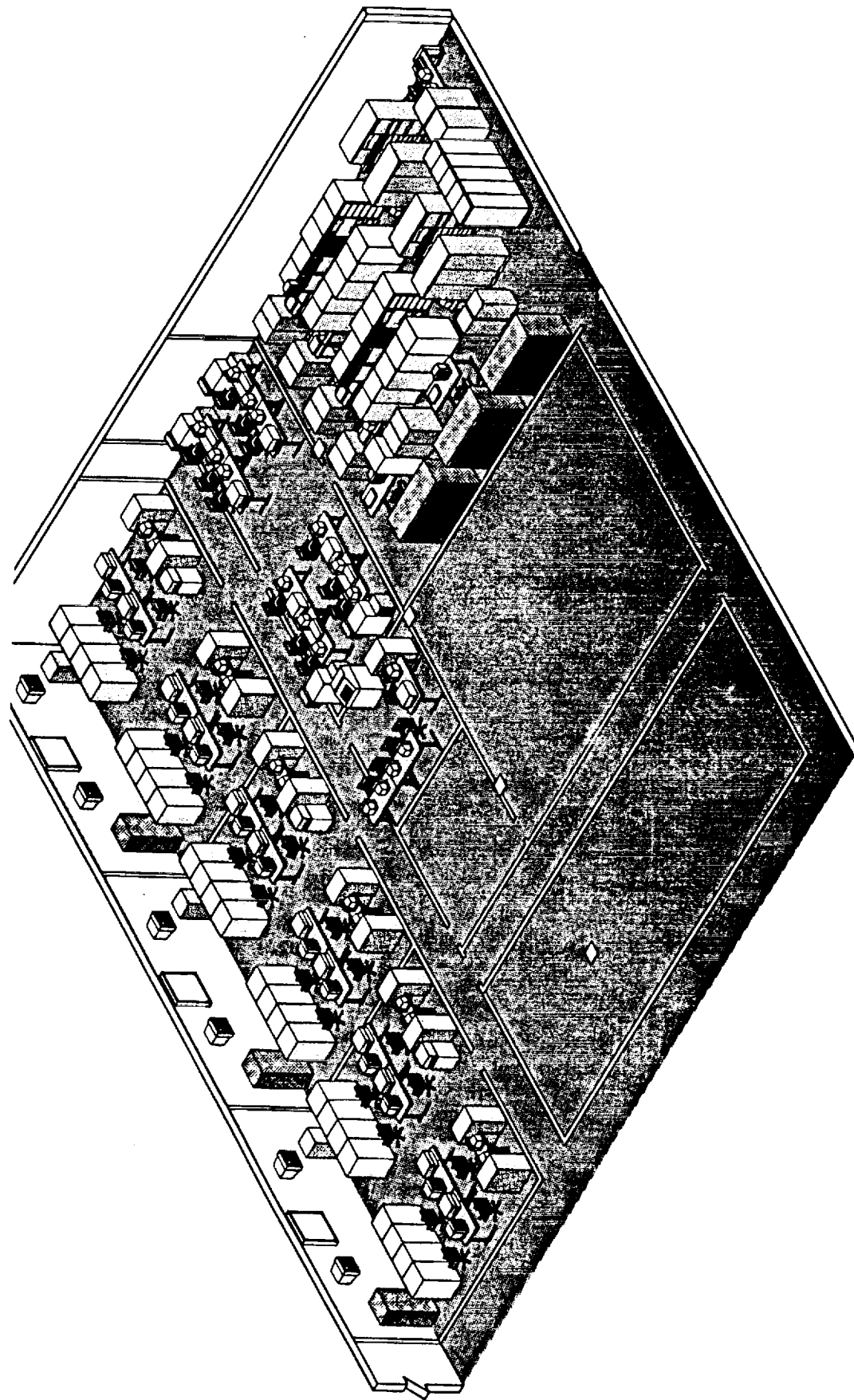

TPS OPERATIONS CONTROL ROOM

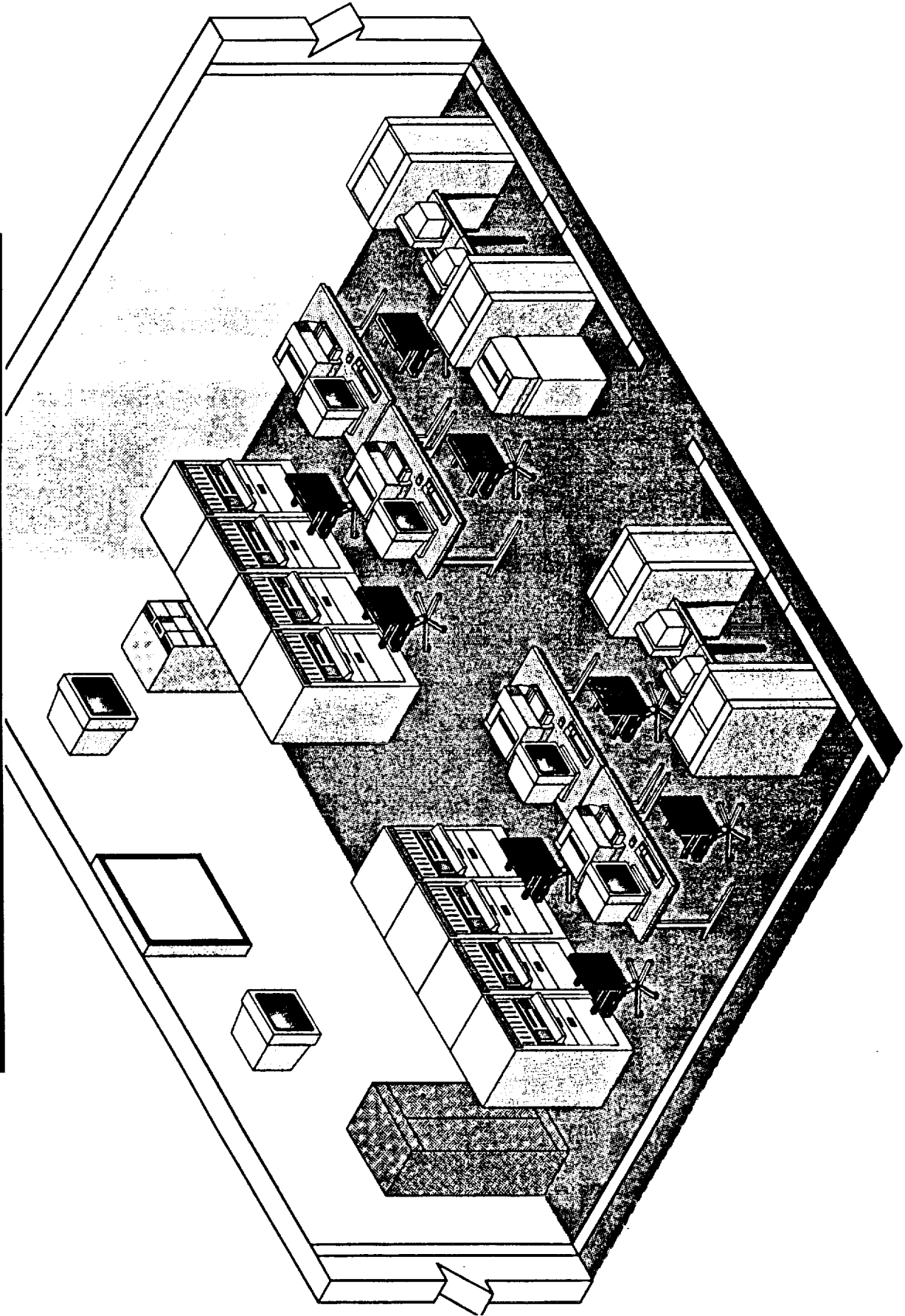

TPS PERFORMANCE SUMMARY

- **SUPPORT 4 SIMULTANEOUS MISSIONS**
 - Anticipate 780 Flights Per Year

- **SINGLE MISSION REQUIREMENTS**
 - Four 10 Mbit PCM (Embedded 1553)
 - Multiplexed FM (20 Channels / 300,000 sps)
 - Analog to Digital FM (32 Channels / 500,000 sps)
 - Two PAM (128 Parameters / Stream / 125,000 sps)
 - 16,000 Measurements / 500,000 sps / 400,000 EUC

- **FACILITY REQUIREMENTS**
 - One Floor: 1 Computer Room, 3 Mission Control Rooms
 - Any Front End to Any or All Display Rooms
 - 100,000 sps Data Transfer to/from Cyber



TPS SOLUTION CHARACTERISTICS

- **FIBER OPTIC INTERFACE**
- **FIBER PATCH PANEL**
 - Security
 - Configuration Flexibility
- **CUSTOM CARD DESIGN BETWEEN FRONT END AND HOST**
 - Cyber Conversion
 - Strip Chart Processing and Control
- **USE OF UNIVERSAL MEMORY NETWORK (UMN) - SHARED MEMORY**
 - Simplified Strip Chart Data and Control Issues
 - Solved Cyber Data Conversion Problem
 - Downsized Host Requirement to Enable Use of DEC 6220
 - Enabled Use of DEC VAX in a Real-Time Environment

RDSC TELEMETRY SYSTEM CAPABILITIES

INSTALLED SYSTEMS	IFDAPS	B-2 TSF	RTPS III	UTTR	TEST PILOT SCHOOL	TPS
Number of Streams	5	3	6	2	1	4
FM Input (in samples per second)	36 Channels Aggregate 250,000	72 Channels Aggregate 300,000	64 Channels Aggregate 200,000	None	16 Channels Aggregate 300,000	20 Channels Aggregate 300,000
PCM Input	3 Sources 5 MB/Sec per Source	2 Sources 1.2 MB/Sec per Source	4 Sources 10 MB/Sec per Source	1 Source 1.28 MB/Sec	2 Sources 1.2 MB/Sec per Source	4 Sources 10 MB/Sec per Source
Engineering Unit Conversion	20,000 samples per sec.	156,000 samples per sec.	200,000 samples per second	14,000 samples per sec.	156,000 samples per second	400,000 samples per sec.
History Recording (in samples per second)	EU: 20,000 RAW: 35,000	EU: 156,000 RAW: 300,000	EU: 162,000	EU: 14,000	EU: 100,000	EU Untagged: 360,000 EU ID Tagged: 180,000
Maximum Number of Measurands	4,096	10,000	2,000	4,096	4,096	16,312
Graphics Terminals	6 Color	10 Color	2	1 Color	3 Color	4 Color
Alphanumeric Terminals	6	3	6 Color	1	3	4
Strip Chart Pens	128	128	64	32	8	64

HYPOTHETICAL COMPOSITE SYSTEM CAPABILITY

PCM INPUT	FM INPUT	ENG. UNIT CONV.	HISTORY RECORDING	MAXIMUM NO. OF MEAS.	GRAPHICS TERMINALS	STRIP CHART PENS
4 Sources 10 MB/Sec per Source	72 Channels Aggregate 300,000	400,000 samples per sec.	EU Untagged: 360,000 EU ID Tagged: 180,000	16,312	100 -SUN -SGI	256



SEAMLESS ACQUISITION AND PROCESSING

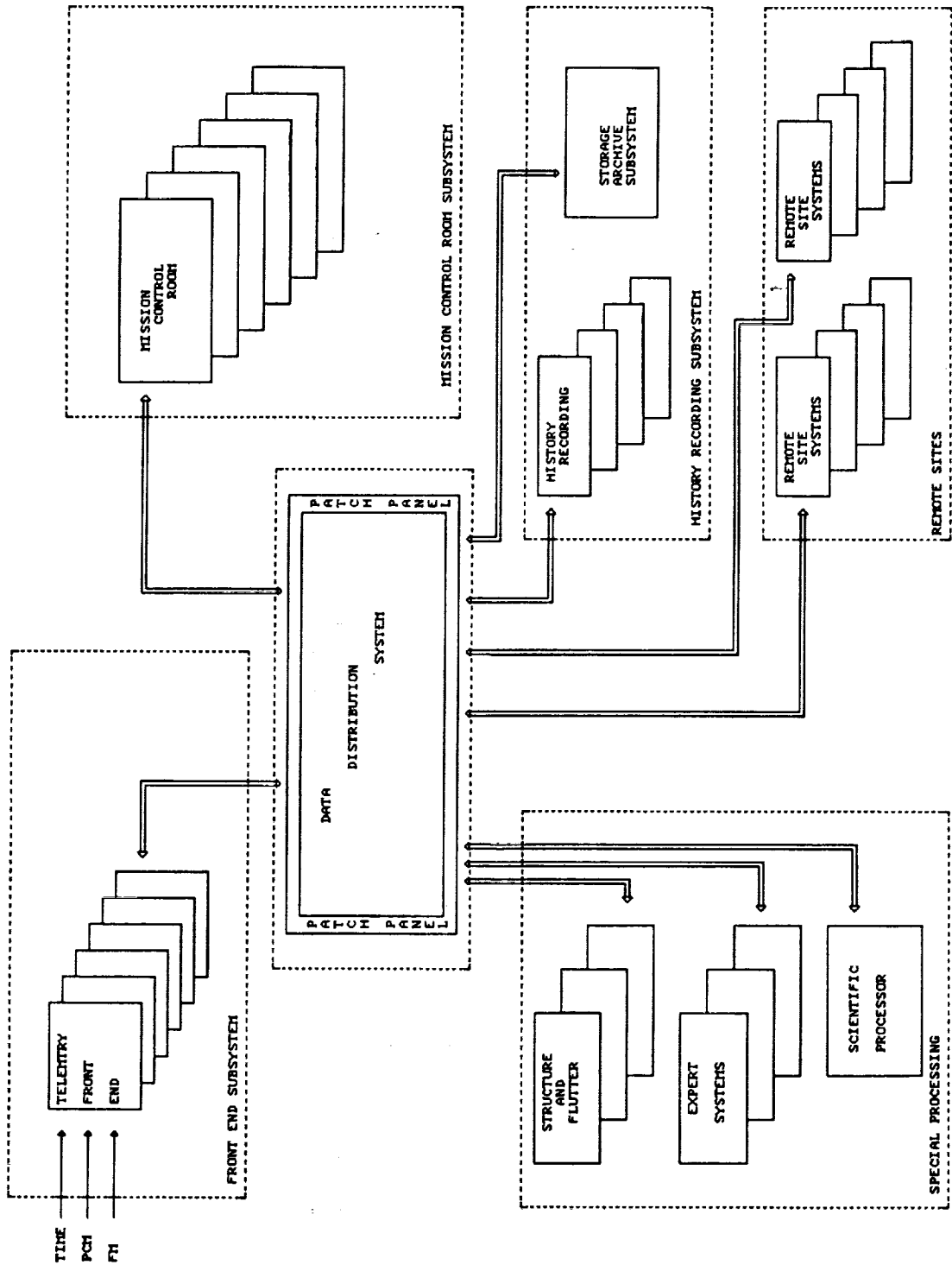

CSC DEVELOPMENT PRINCIPLES

CSC's approach to designing and implementing systems may be defined in three words: involvement, process and automation.

Involvement implies a team made up of representatives of all parties concerned with the success of the system. It is an "egoless" team not concerned with who receives credit for success. Client, integrator, users and other contractors are all involved in defining requirements, goals and user products and interfaces. The desired products and external interfaces are defined and documented along with goals before requirements are written. This is done rapidly with the knowledge that the result will be maintained as a working document that will reach maturity only when the system is complete. This "user" document(s) provides an informed basis for defining requirements. When the "team" agrees that the requirements are as complete as can be reasonably expected, the design phase begins. Just as the contractors and users were involved in the requirements analysis and definition phase, so is the client involved in the design phase. It is equally important to keep engineers, programmers and support staff involved. This is done by keeping them informed on the progress of the project and listening to their ideas on possible improvements to the development process; management has no monopoly on good ideas. Keeping all parties involved engenders enthusiasm for and helps insure success of the project.

Process determines the manner in which the development is managed. The process is defined by a methodology which is tailored to the specific application. It takes full advantage of Commercial Off-The-Shelf (COTS) hardware and software and encourages the use of software that can be transported between systems. The methodology provides for design, code and test standards. It provides for a means of defining the system functions as detailed by the requirements specification and for assigning requirements to system and subsystem components down to the software module or hardware component level. The methodology provides for the mapping of requirements to the lowest level system components and for meticulously defining interfaces at all levels of system design. The methodology provides for breaking a large complex problem into smaller logical pieces that can be recognized as something that the implementor has done before. The more experience the "team" has in a particular discipline, the earlier in the decomposition this recognition occurs and the lower is the development cost.

The facility must always be considered in the total process. CSC develops a Site Preparation Requirements Equipment Installation Plan (SPREIP) for every project. Power supplies, facility layout, exact cable distances, air conditioning and other related items are analyzed and fed into the total development process in order to influence design as necessary and eliminate any surprises when correction may prove very costly. This falls in line with CSC's general development philosophy of identifying interface problems as early in the development phase as possible. Correction of

interface problems late in the development phase or in the test phase has been responsible for large cost overruns on many projects.

Automation refers to the application of "tools" to the analysis, design and development processes. A universally recognized tool is Computer Aided Design (CAD) with automatic placement and signal routing for PC components. Tools supporting programmers, such as debugging aids, dynamic and static performance analysis packages, source code maintenance and text editors are readily available. CSC uses these tools to the maximum extent possible and constantly polls the industry for the latest development tools. Configuration management tools have been developed by CSC. CSC uses both their own configuration management tools and those provided by the vendors.

Computer Aided Software Engineering (CASE) tools are available, but not as universally accepted throughout the industry as tools such as CAD and software debuggers. CSC has been using CASE tools successfully for several years. CASE not only provides automation for the design phase, but it integrates design and documentation into a single process, something that is not possible without automation. The problem some developers have with CASE is that they expect the tool to perform the process for them. Before CASE can be successfully applied, the methodology associated with the particular CASE tool must be thoroughly understood. CASE can be applied most profitably if it is networked, giving all developers access to the process narratives and logic diagrams (i.e., data flows, structure charts, etc.). It is also important that the CASE tool provide the user with an acceptable word processing capability and data dictionary. Not all CASE tools contain these capabilities. CSC understands the misgivings voiced by some developers using CASE, but believes that these misgivings are rarely the fault of the CASE tool, but rather the developer's unrealistic expectations. CSC will continue to use CASE and other design and development tools and participate in their expanded use in the industry.

Automation is also used in performance monitoring and tracking estimated vs. actual progress in terms of measurable schedule and cost variances. CSC project managers use tools such as Super Project, Timeline and Lotus to provide objective monitoring of a project's progress. Which tool is used is dependent upon the needs of the project and the specific project manager's personal experience with a particular tool. The importance of these tools cannot be overestimated for the insight they give managers in developing and modifying plans to achieve the original project goals.

interface problems late in the development phase or in the test phase has been responsible for large cost overruns on many projects.

Automation refers to the application of "tools" to the analysis, design and development processes. A universally recognized tool is Computer Aided Design (CAD) with automatic placement and signal routing for PC components. Tools supporting programmers, such as debugging aids, dynamic and static performance analysis packages, source code maintenance and text editors are readily available. CSC uses these tools to the maximum extent possible and constantly polls the industry for the latest development tools. Configuration management tools have been developed by CSC. CSC uses both their own configuration management tools and those provided by the vendors.

Computer Aided Software Engineering (CASE) tools are available, but not as universally accepted throughout the industry as tools such as CAD and software debuggers. CSC has been using CASE tools successfully for several years. CASE not only provides automation for the design phase, but it integrates design and documentation into a single process, something that is not possible without automation. The problem some developers have with CASE is that they expect the tool to perform the process for them. Before CASE can be successfully applied, the methodology associated with the particular CASE tool must be thoroughly understood. CASE can be applied most profitably if it is networked, giving all developers access to the process narratives and logic diagrams (i.e., data flows, structure charts, etc.). It is also important that the CASE tool provide the user with an acceptable word processing capability and data dictionary. Not all CASE tools contain these capabilities. CSC understands the misgivings voiced by some developers using CASE, but believes that these misgivings are rarely the fault of the CASE tool, but rather the developer's unrealistic expectations. CSC will continue to use CASE and other design and development tools and participate in their expanded use in the industry.

Automation is also used in performance monitoring and tracking estimated vs. actual progress in terms of measurable schedule and cost variances. CSC project managers use tools such as Super Project, Timeline and Lotus to provide objective monitoring of a project's progress. Which tool is used is dependent upon the needs of the project and the specific project manager's personal experience with a particular tool. The importance of these tools cannot be overestimated for the insight they give managers in developing and modifying plans to achieve the original project goals.

DEVELOPMENT APPROACH

- **TEAM CONCEPT**
 - Continuity
 - Client Involvement
- **OPEN ARCHITECTURE (truly open)**
- **FLEXIBLE METHODOLOGY**
- **AUTOMATION (CASE, CM)**
- **QUANTITATIVE MEASUREMENT OF PROGRESS**



SUMMARY

- **SOPHISTICATED CONTROL SYSTEMS CAN BE BUILT**
 - Within Budgetary Constraints
 - Within Schedule Constraints

- **AVAILABLE TECHNOLOGY PERMITS SIGNIFICANT USE OF COMMERCIAL EQUIPMENT WITHIN HIGH PERFORMANCE SYSTEMS**
 - Cost Advantage
 - Risk Reduction

- **FOCUSED CUSTOM DEVELOPMENTS LEVERAGE THE USE OF COMMERCIAL EQUIPMENT**

- **TEAMWORK UNDERLIES EVERY SUCCESS**



MANAGEMENT PHILOSOPHY

- INVOLVEMENT
- PROCESS
- AUTOMATION



**"IT IS AMAZING HOW MUCH GETS ACCOMPLISHED
WHEN NO ONE CARES WHO GETS THE CREDIT"**

Agenda

- . SFOC IN JPL'S GROUND DATA SYSTEM
- . SFOC PROJECT MOTIVATION AND HISTORICAL PERSPECTIVE
- . SFOC TECHNICAL DESCRIPTION
- . SFOC CHARACTERISTICS VS. COST FACTORS
 - . GDS DEVELOPMENT COST
 - . RELATIONSHIP TO OPERATIONS COSTS
- . SFOC STATUS AND METRICS

JPL

Control Center Technology Conference

JPL's

Space Flight Operations Center

Development Project Overview

N92-120124

39604

P-19

JJ574450

M. EBERSOLE

JUNE 18, 1991

Major Elements Deep Space Flight Programs

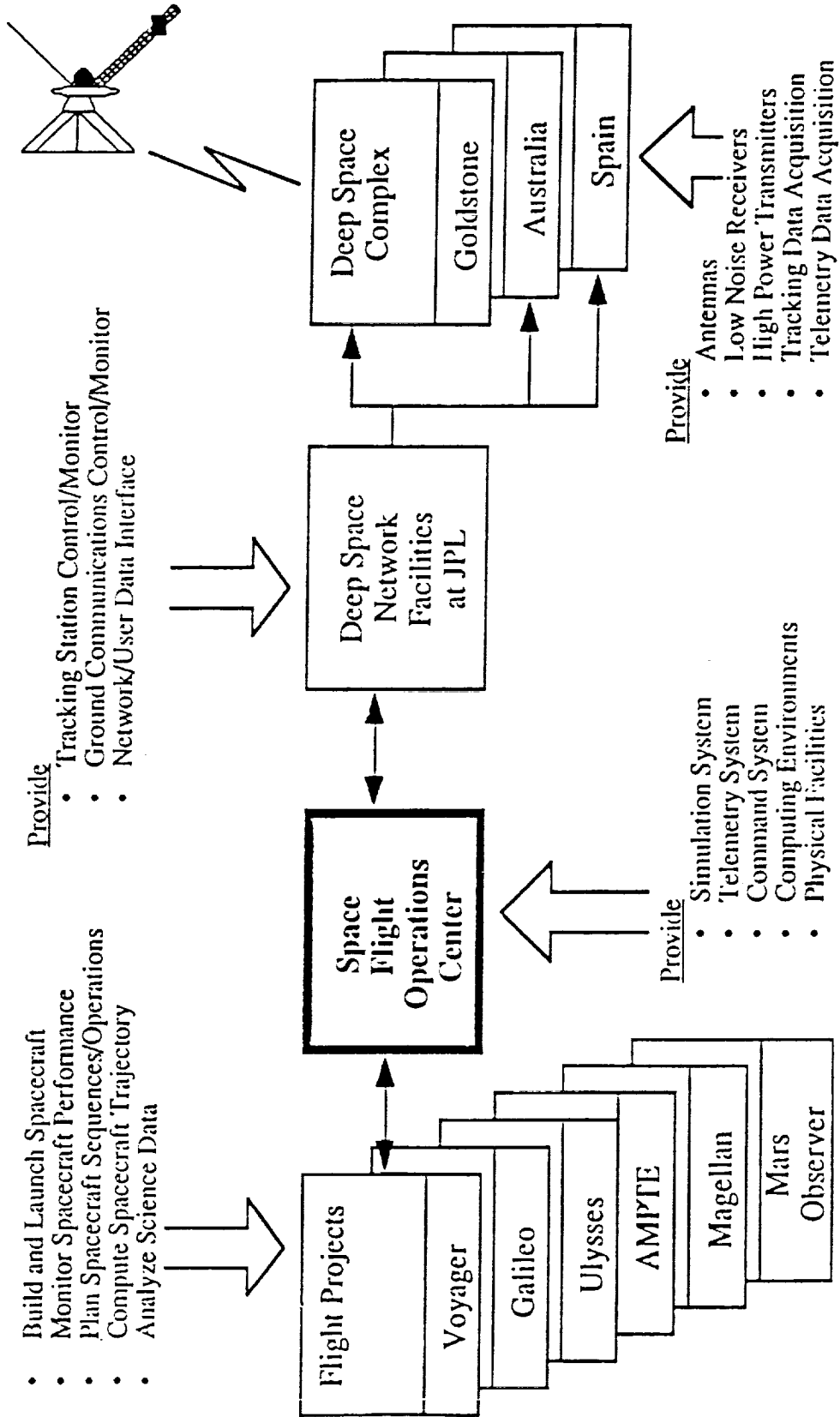

Motivation and Historical Perspective

- . The SFOC Development Project was conceived in 1984 to:
 - . Develop a "Multi-Mission" Ground System to support present and all future Flight Projects
 - . Develop Tools to Automate Labor-Intensive Processes
 - . Modernize Computing and Information Services
 - . Remove Unnecessary Overlaps in capabilities with Systems (FPSO vs. DSN)
 - . Enable reductions in Operations Costs

DEVELOPMENT SCHEDULE

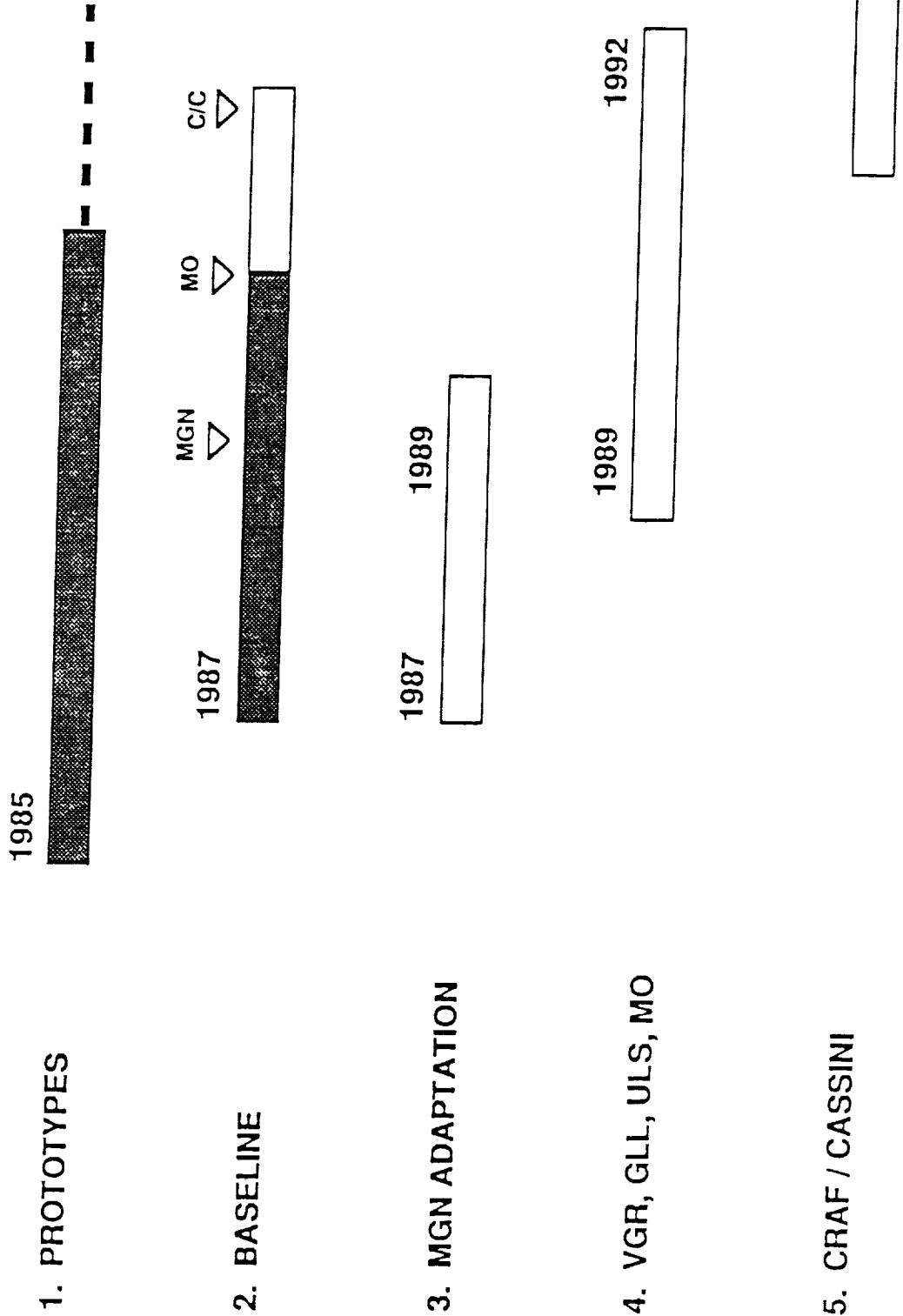

PRIMARY DESIGN GOALS

- . **Support New Missions: Magellan, Mars Observer, CRAF/ Cassini**
- . **Support Current Missions: Galileo, Voyager, Ulysses**
- . **Build SFOC using Distributed Architecture, Powerful Workstations, Centralized Distribution of Mission Data, and Network Communication**
 - . **Data can be moved to wherever needed easily**
 - . **Data can be analyzed by User- and Project-Software**
 - . **Layered Design can Reduce Code Duplication**
- . **Centralize Operations and Flight Support Personnel**
- . **Design for 10-15 Year Life Expectancy**

Technical Guidelines

Networks

Ethernet, TCP/IP

Off-The-Shelf Products, Multiple Vendor Platforms

X Windows, OSF/Motif, Sybase

Super-Microcomputers

68XXX, RISC

Common Operating System and Single Language

UNIX, C

Exploit Standards

Standard Formatted Data Unit (SFDU)

SFOC DATA SYSTEMS ARCHITECTURE

- . Connectivity Via Network**
- . Centralized Distribution of Mission Data**
- . Remote User Science Data Exchange**
- . Centralized Ground System Monitor and Control**
- . Workstation Data Monitor and Display**
- . Ground System Test and Fault Isolation**

SFOC Data System Functional Architecture

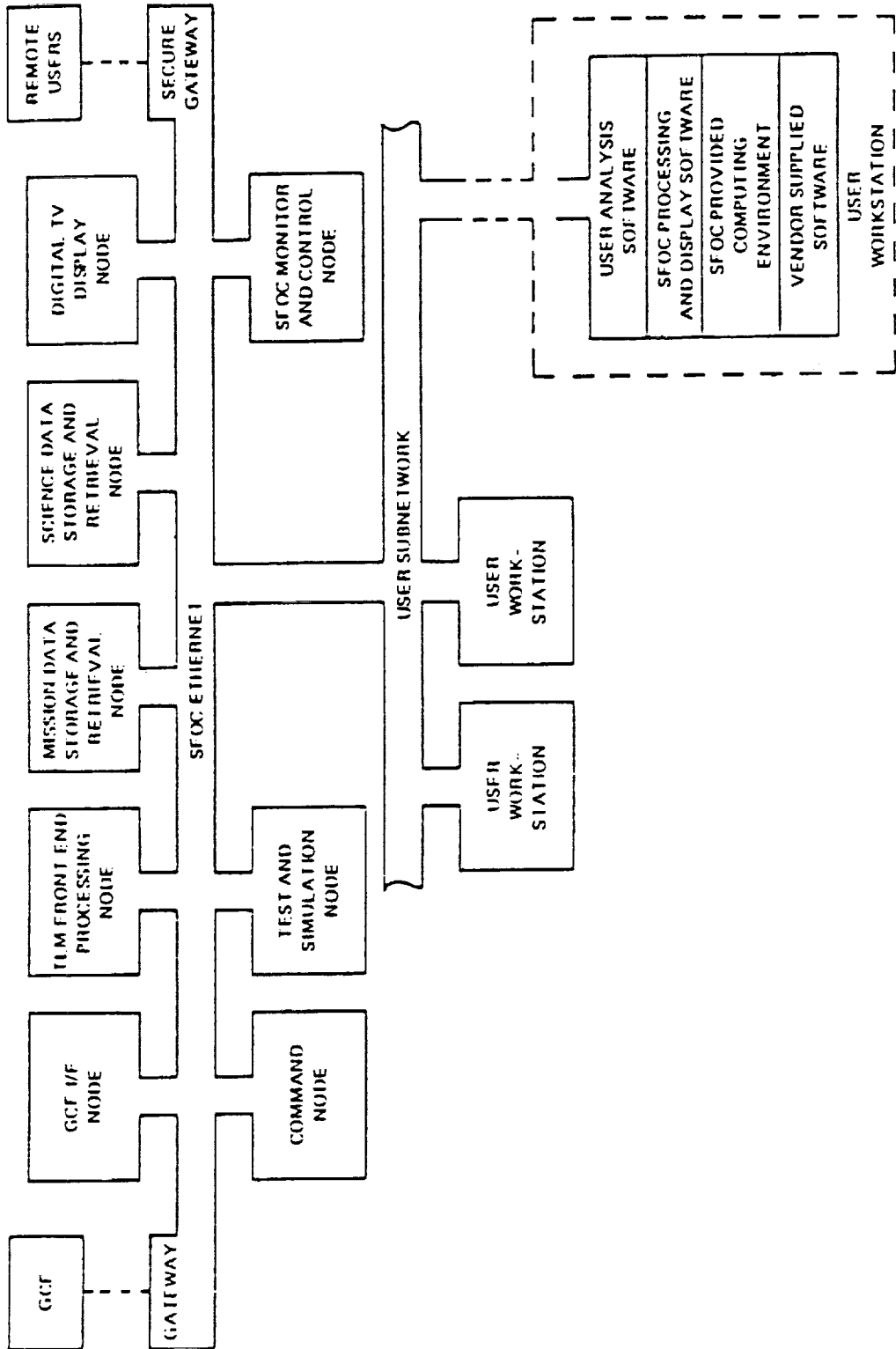

Typical SFOC Node

SFOC software applications (executables) contain compiled and linked software from a number of subsystem libraries such as DMD DTS, WSE, etc.

Global SFOC-provided software provides subsystem routines (operating system extensions).

Process monitor and control. --

Standard user interface and display. --

Data storage and retrieval services. --

Data transfer services. --

X-Windows provides windowing and graphics environment. --

UNIX provides common services, process control and general hardware/software I/Fs. --

The Prom contains boot and diagnostic software. --

SFOC Application Instance 1
SFOC Application Instance 2
Global SMC
Global WSE
Global CDA
Global DTS
X-Windows
UNIX
Prom

SFOC COMPONENTS

- . Software
 - . Vendor Software
 - . SFOC Built Software
 - . Baseline Capabilities
 - . Project Adaptations

- . Hardware
 - . Vendor Hardware
 - . Special Purpose Hardware

SFOC SOFTWARE CATEGORIES

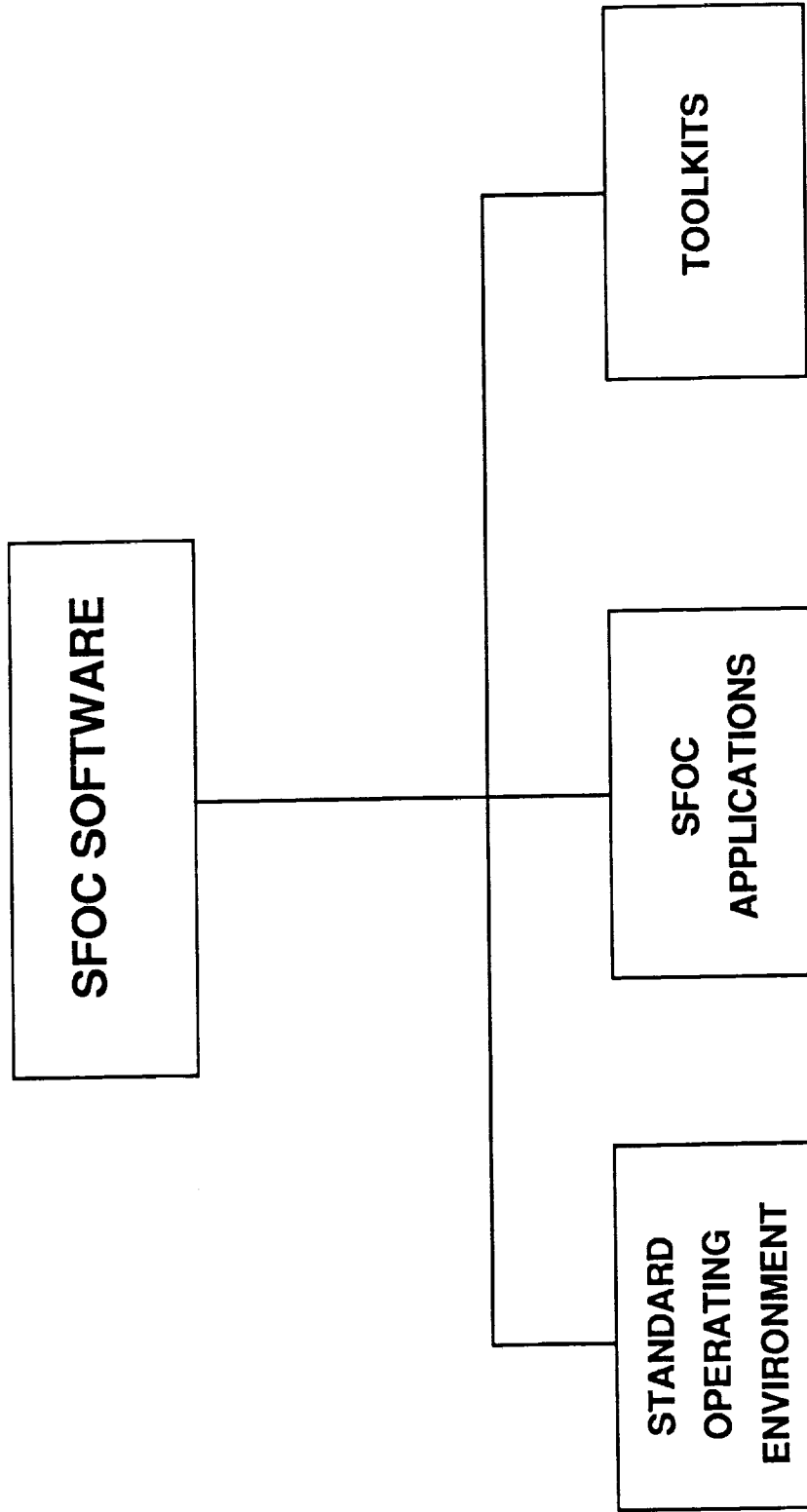

PLANNED SUBSYSTEM CORE DIAGRAM FOR MARS OBSERVER

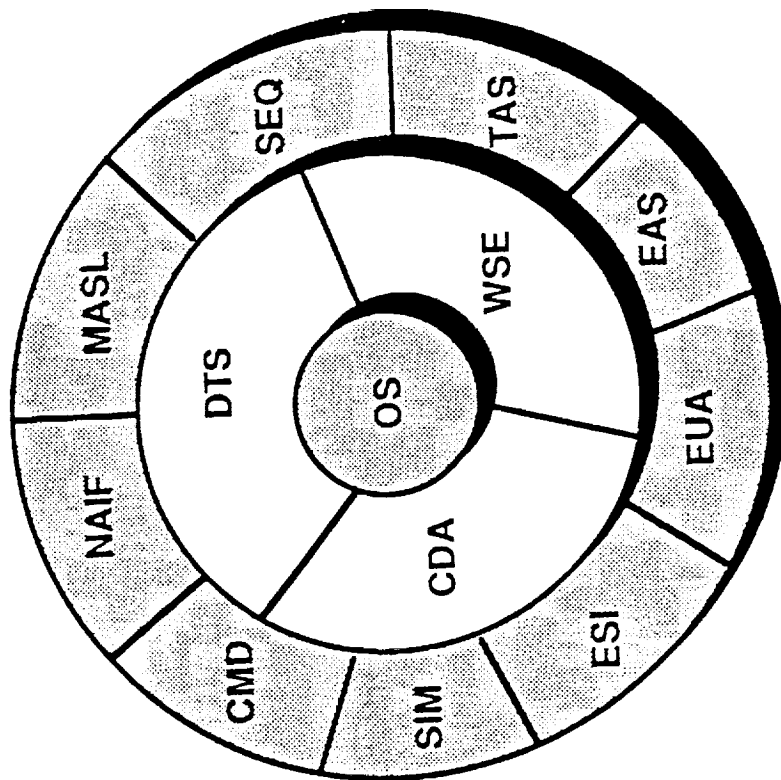

MO ADDITIONS

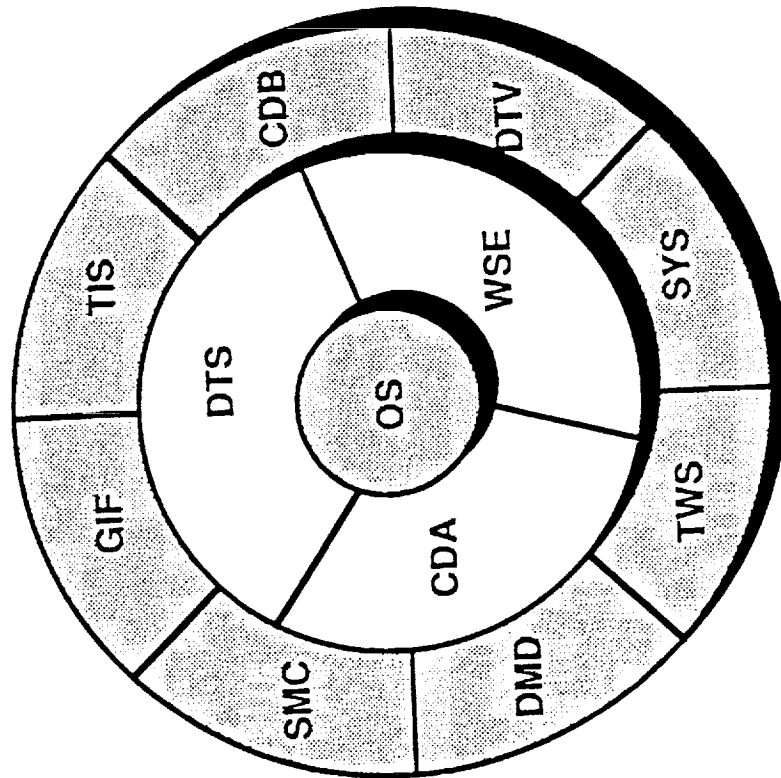

MGN ERA

SFOC Use of Public Domain/3rd Party Software

- . **Data Management**
- . **Sybase Relational DBMS**
- . **CISAM Indexed File Management**
- . **User Interface**
- . **X Windows**
- . **Motif User I/F Toolkit**
- . **X Desk Top**
- . **Dataviews Graphics**
- . **Network**
- . **Network Time Protocol - OSF DCE**
- . **Logical Name Service - OSF DCE**
- . **Security**
- . **Kerberos - OSF DCE**

SFOC HARDWARE

- SFOC "Core" Subsystem Hardware
 - . Workstations
 - . Network
 - . Minor Special Purpose Hardware
 - . Gateways to Other Networks
- Flight Project Mission Support Area Hardware
 - . Workstations
 - . Network
 - . Connections to Project Supplied Workstation
- Connections to Existing Hardware
 - . MIPL
 - . UNISYS
 - . IBM 3090
- Remote Sites
 - . Workstations
 - . Gateways

SFOC TARGET SIX MISSION CONFIGURATION

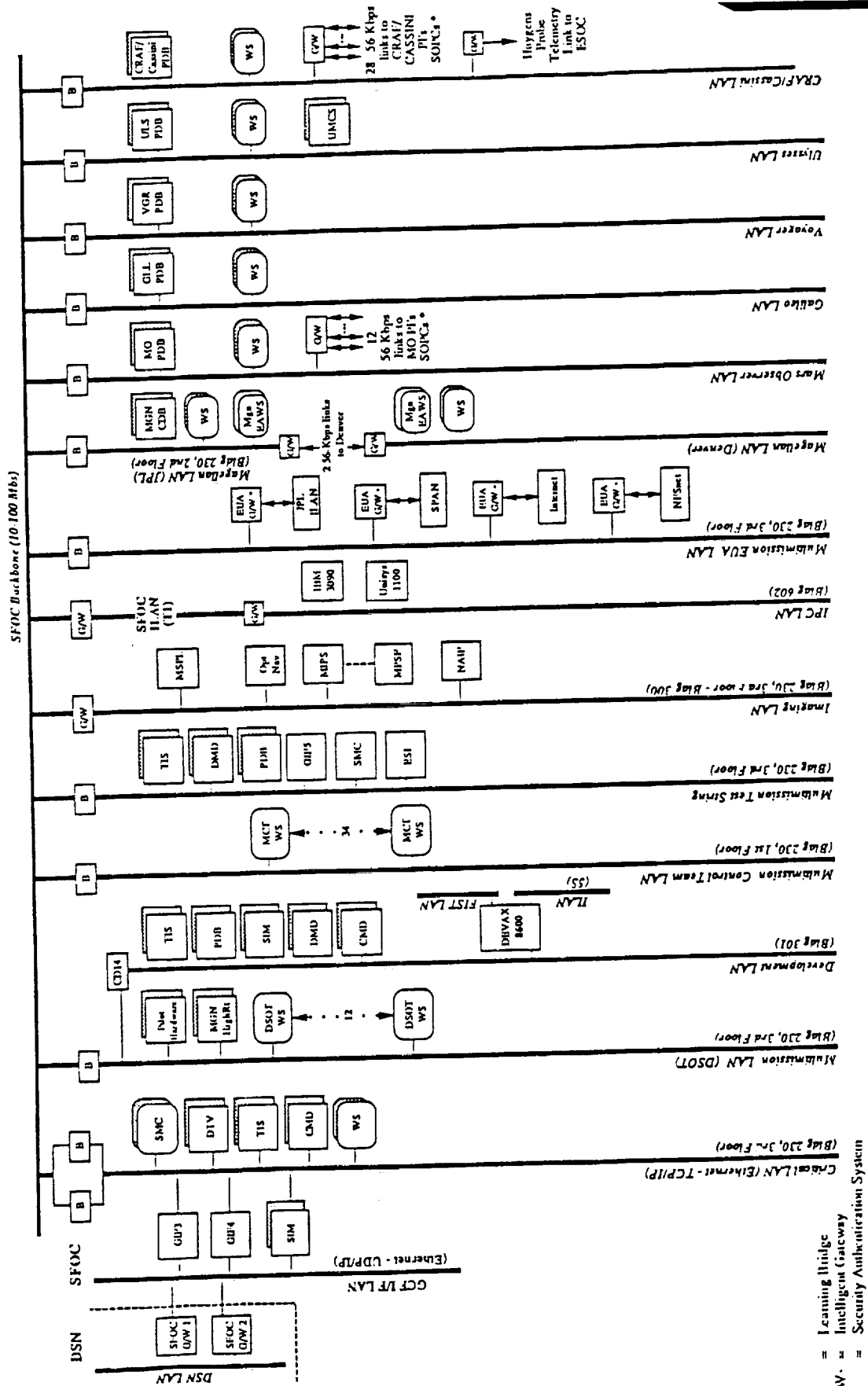

II = Learning Bridge
 G/W = Intelligent Gateway
 • = Security Authentication System

SFOC Technical Guidelines and Relation to MO & DA Development Costs

SFOC Characteristic

Basic Distributed System Architecture

Hardware "Platform" Independence

Software Reusability

Technology Assessment and Requirements
clarification progress via Prototypes

Central Data Storage and Retrieval

Cost Implication

For 15 years no new "SFOC",
capabilities will be built on SFOC

Obtain best computer price/ performance at time
computers need to be obtained

Provide Base of capabilities that can easily be
adapted for future Mission support

Reduce development risk and avoid costly late
change due to requirement uncertainty

Enables elimination of data records function

SFOC Characteristic and Relationship to MO & DA Operations Costs

SFOC Characteristic

Centralized Monitor and Control of
Ground System Operations

Remote MSA Support via Networks

Automate Labor Intensive Processes

Workstation Displays

Display Development Flexibility

Operations Cost Implication

Reduction in Operations costs for Data
Delivery Function (DSOT)

Enables "Stay-at-Home" Operations by S/C and
Science Teams

Uplink tools result in Sequence Team Savings to
MO, C/C

Enable Multi-spacecraft and/or Multi-Sub-systems
Displays

Accommodates a Wide Range of User Types
and Skills

SFOC Development Status and Plans

- . SFOC Employs an Incremental Development Approach
 - . Version 7 Supported Magellan Launch - May 1989
 - . Version 13 Supporting Magellan Orbital Operations - May 1990
 - . Version 16 in Test - Present
 - Includes Voyager, Ulysses and Mars Observer Capabilities
 - . Version 17 - November 1991
 - Complete Mars Observer Launch Capabilities and Voyager Conversion to SFOC
 - . Version 18 - April 1992
 - Complete Galileo Conversion to SFOC
 - . Future Versions - November 1993
 - CRAF / Cassini GDS

SFOC METRICS

. Hardware	158
. Presently Installed Workstations	
. Add'l to be Installed by 10/91	<u>208</u>
Total	356
. Software	
. Lines of JPL Developed Code	943,000
. Estimated % Multi-Mission	90%

1988 _____ **IN MEMORIAM** **1988**

**Kennedy Space Center
Launch Processing System (LPS)
and the Test Checkout and Monitoring
System 2 (TCMS2)**

Robert Luken, NASA/KSC

53-14
N92-12013
39605
P-29

ND 105229

PRECEDING PAGE BLANK NOT FILMED

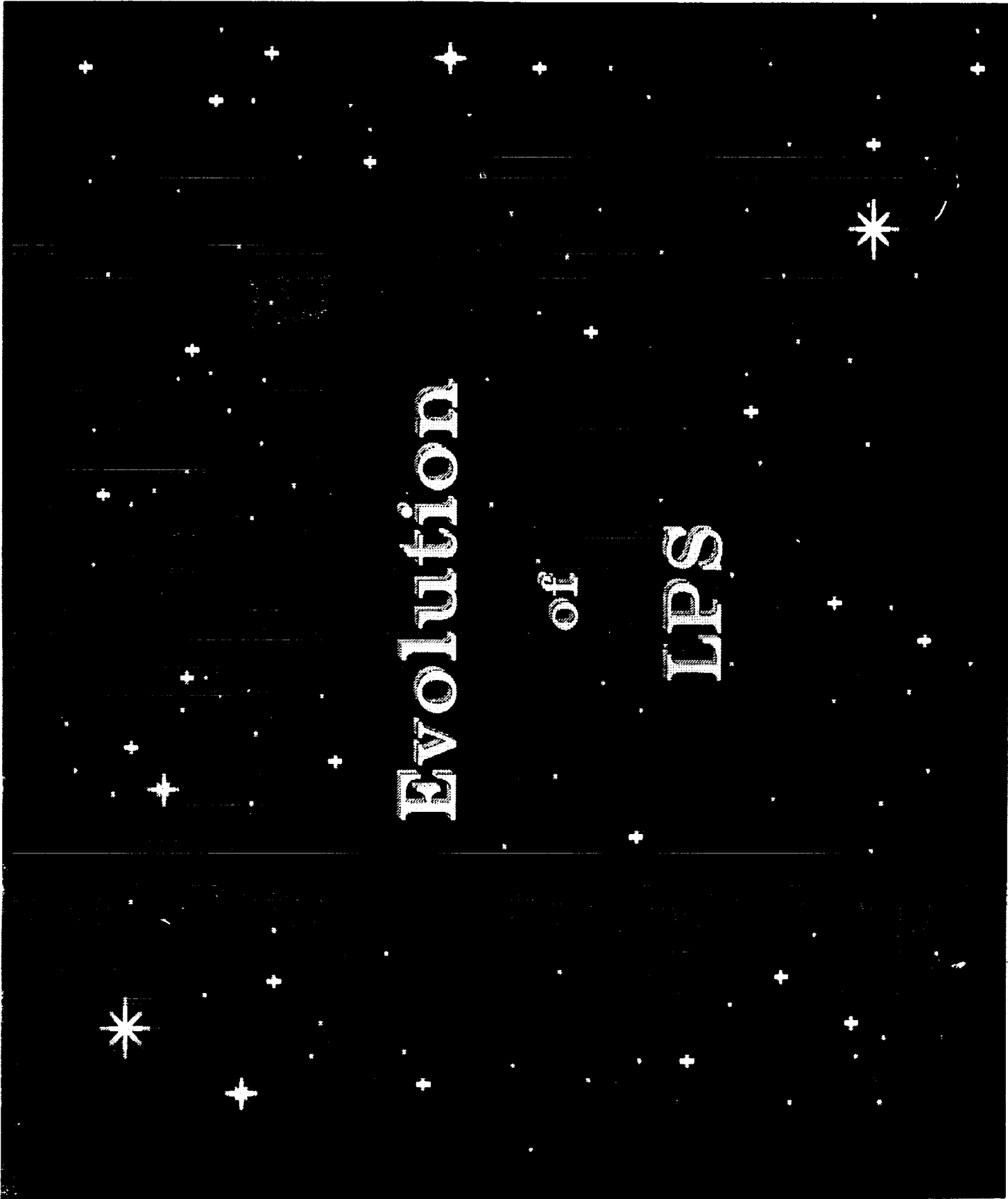

Evolution
of
LPS



A

Lukentilm
Presentation

Topics

- Review of KSC/LPS
- Status of Development efforts
- Preview of LPS II
- Lessons Learned

Historical Review



LPS Milestones

Conception thru Operation

72 73 74 75 76 77 78 79 80 81 82 83 84

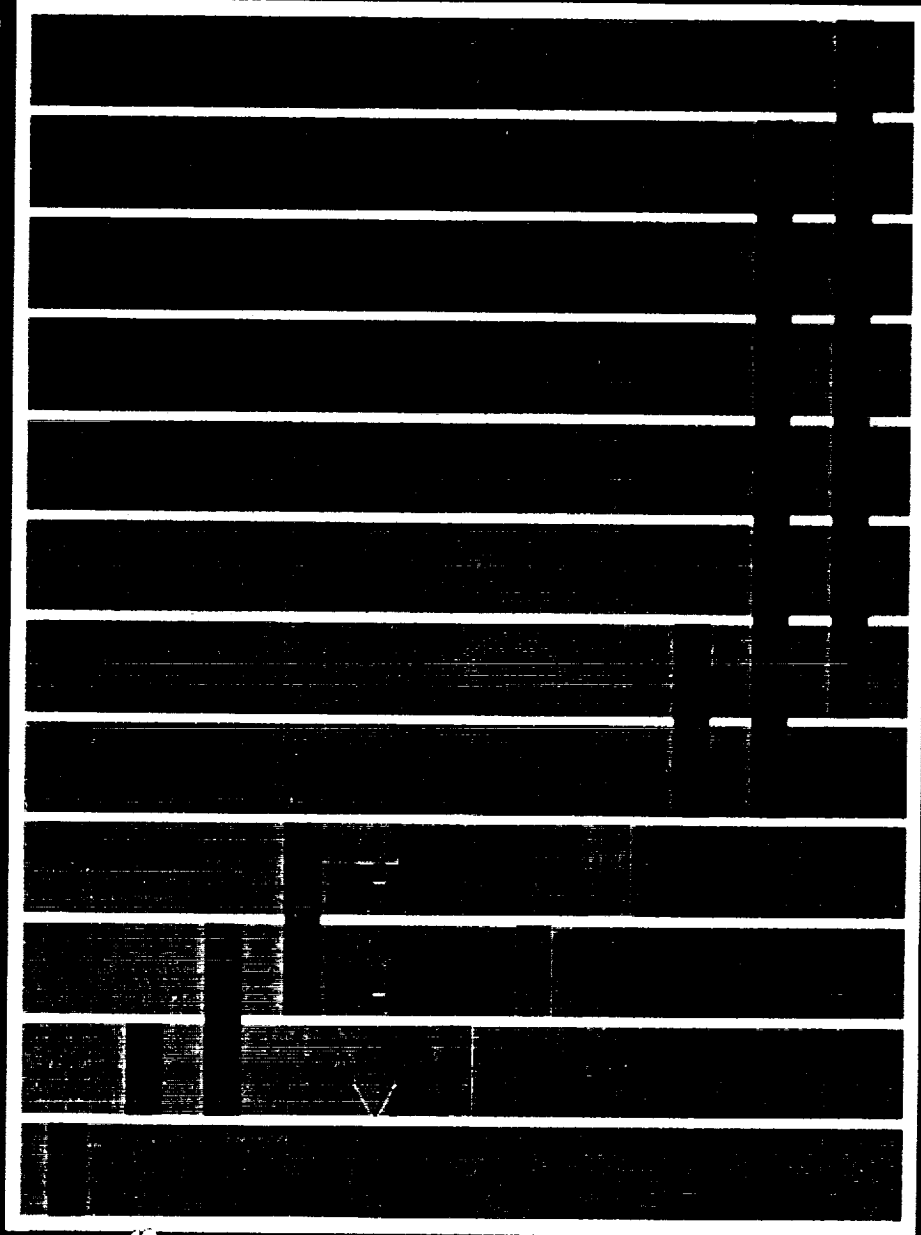

Concept

Requirements

Prototype

SRB Prod.

Procurement

S/W

ADP

H/W

S/N O

Prod.

Install

LPS Architecture

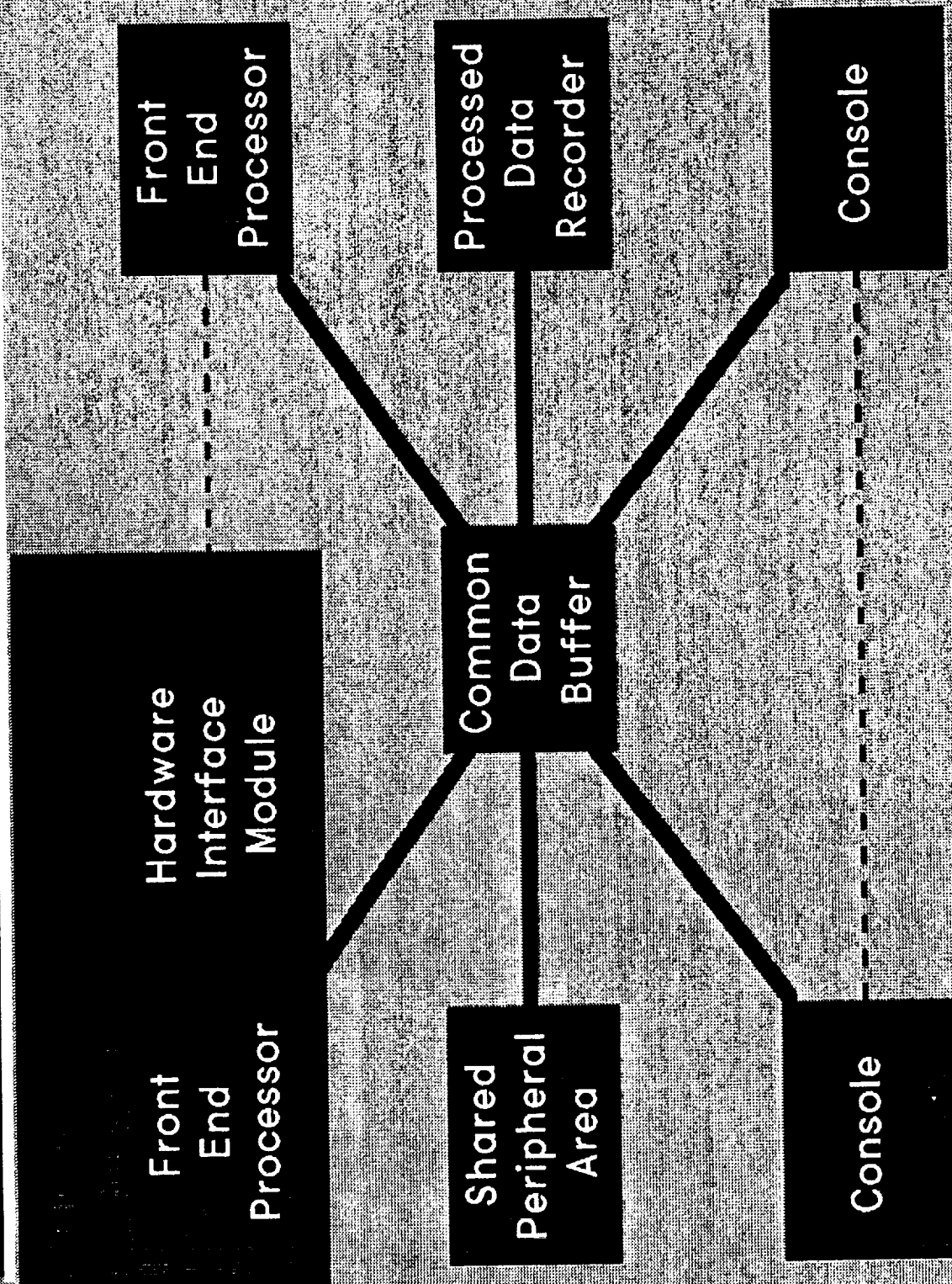

CDBFR

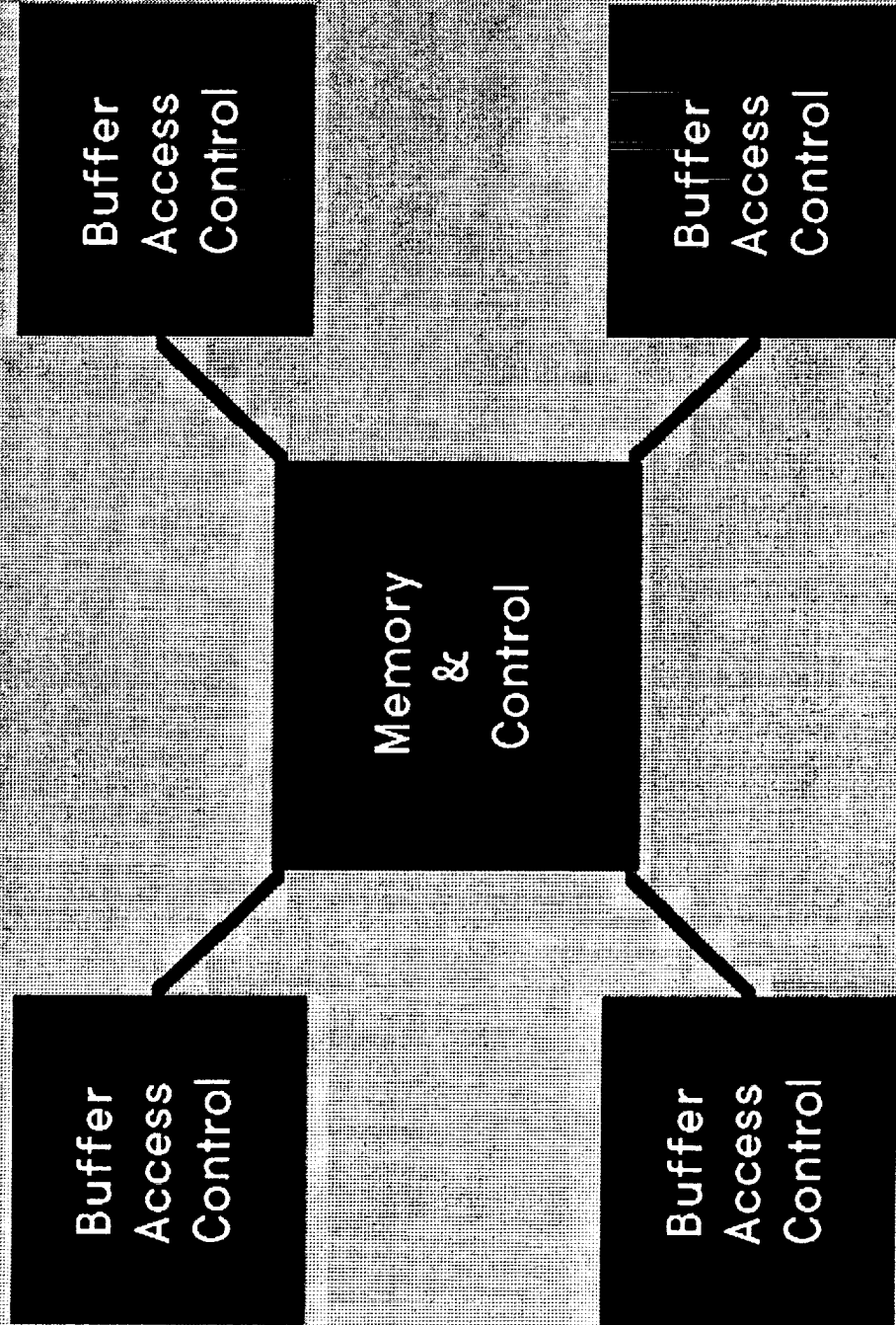

CDBFR

Page 1

CDBFR

Communications

FEP

SCQ

Option
Plane

Console

BIOS

Option
Plane

CDBFR

IPS Architecture Pros

Pros

- Modular Design
- Star Architecture
- High Throughput-Low Latency
 - ~ 1 msec GOAL Response
 - ~ 5 msec CTC Response
 - ~ 37 msec Reactive Loop Response
- Semi-Demand Mode of Operation

LPS Architecture

Cons

- Single Point Failure (CDBR)
- Independent Sets
- 64 Port 64Kword (Implementation)
- Recording Bottleneck
- Not Partitionable
- Compile Time Bindings
- Dynamic Buffer Map

Future Systems

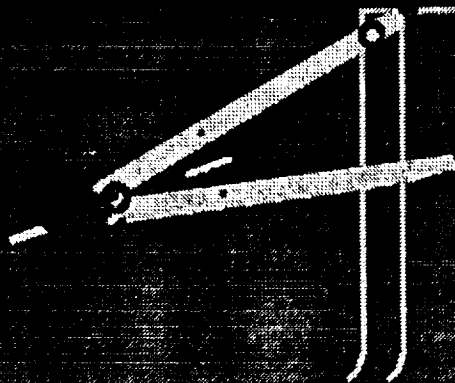

Centralized Approach

- Easier development
- Easier Management

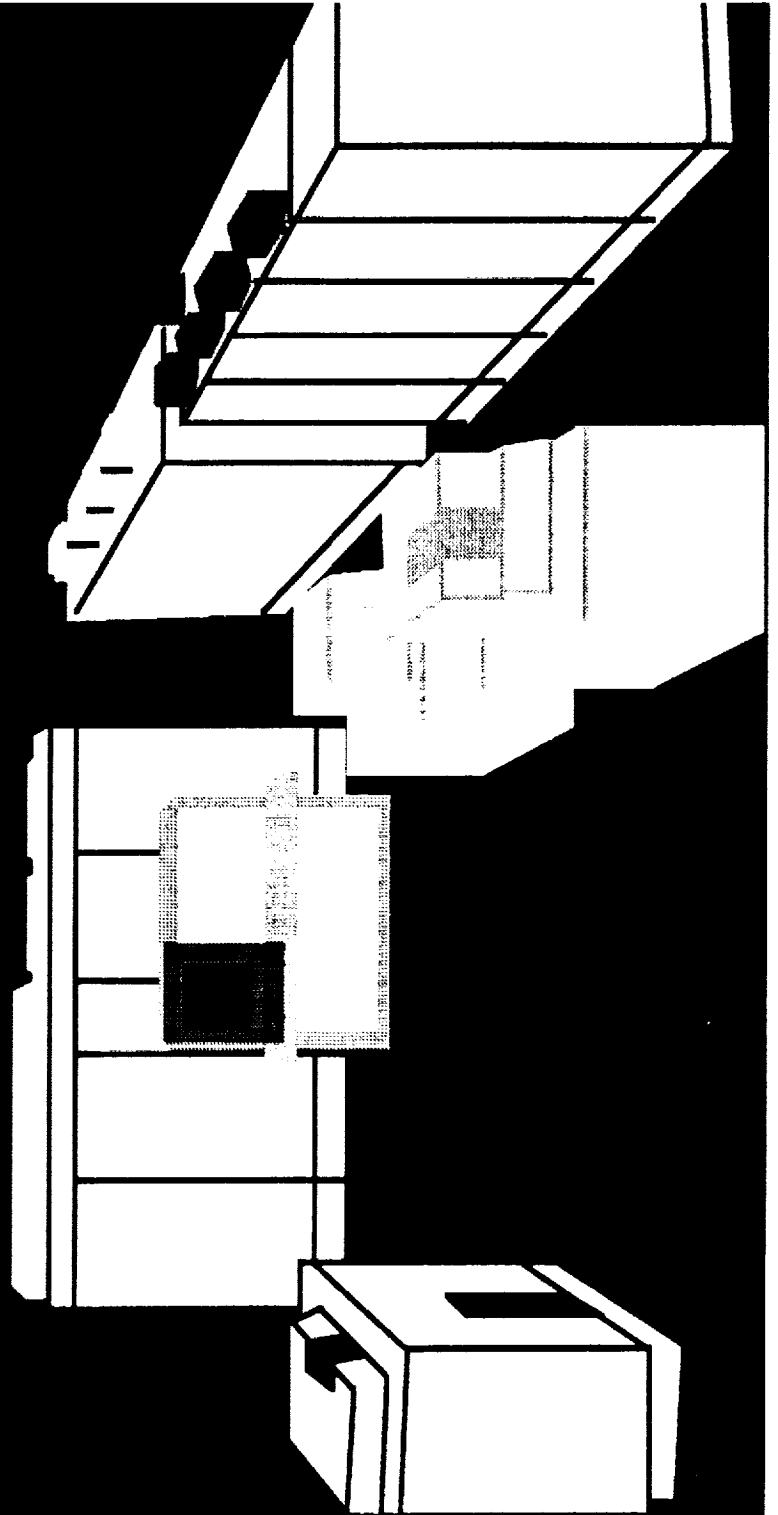

Distributed Approach

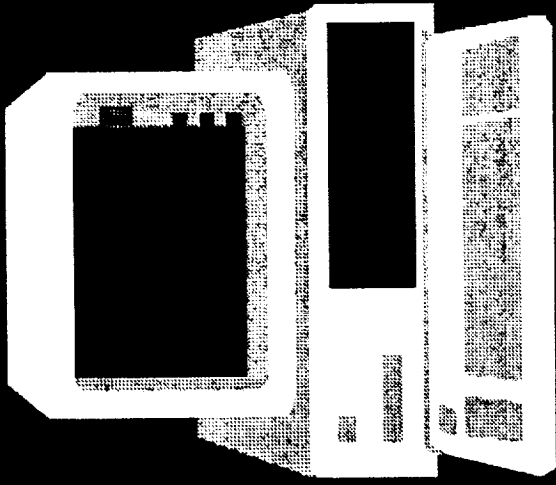

- **Expandability**
- **Flexibility**
- **Modularity**
- **Reliability**

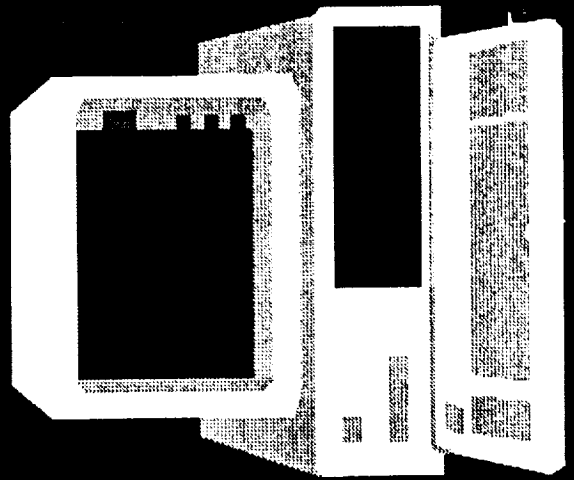

Goals

Flexibility

✓ Multiple application languages

C

GOAL

USE

Ada

Common Lisp

Pascal

Fortran

✓ Reconfigurable for user needs

✓ Support for custom interfaces

✓ Vendor independent

Goals

Modularity

- ✓ Building block approach
- ✓ Hardware & software independence
- ✓ Isolate common functions

Goals

Maintainability

- ✓ High degree of system health checking
- ✓ Subsystem diagnostics to LRU level
- ✓ Modules brought on & off line without impact
- ✓ Minimum number of unique LRUs

Goals

Compatibility

- ✓ Use industry standard protocols
- ✓ Use industry standard interfaces
- ✓ Use standard data interchange formats
- ✓ Use industry standard operating system

Goals

Reliability

- ✓ Distributed architecture minimizes failure effects
- ✓ High MTBF equipment specified
- ✓ FO/FS configurations supported

Goals

Upgradeability

- ✓ Utilization of industry standards
- ✓ Vendor independence
- ✓ Modular implementation
- ✓ Hardware & software independence
- ✓ Planned migration path for upgrades

Goals

Affordability

- ✓ Commercial H/W & S/W
- ✓ Multiple vendors
- ✓ Minimize use of unique H/W & S/W

GCS ARCHITECTURE

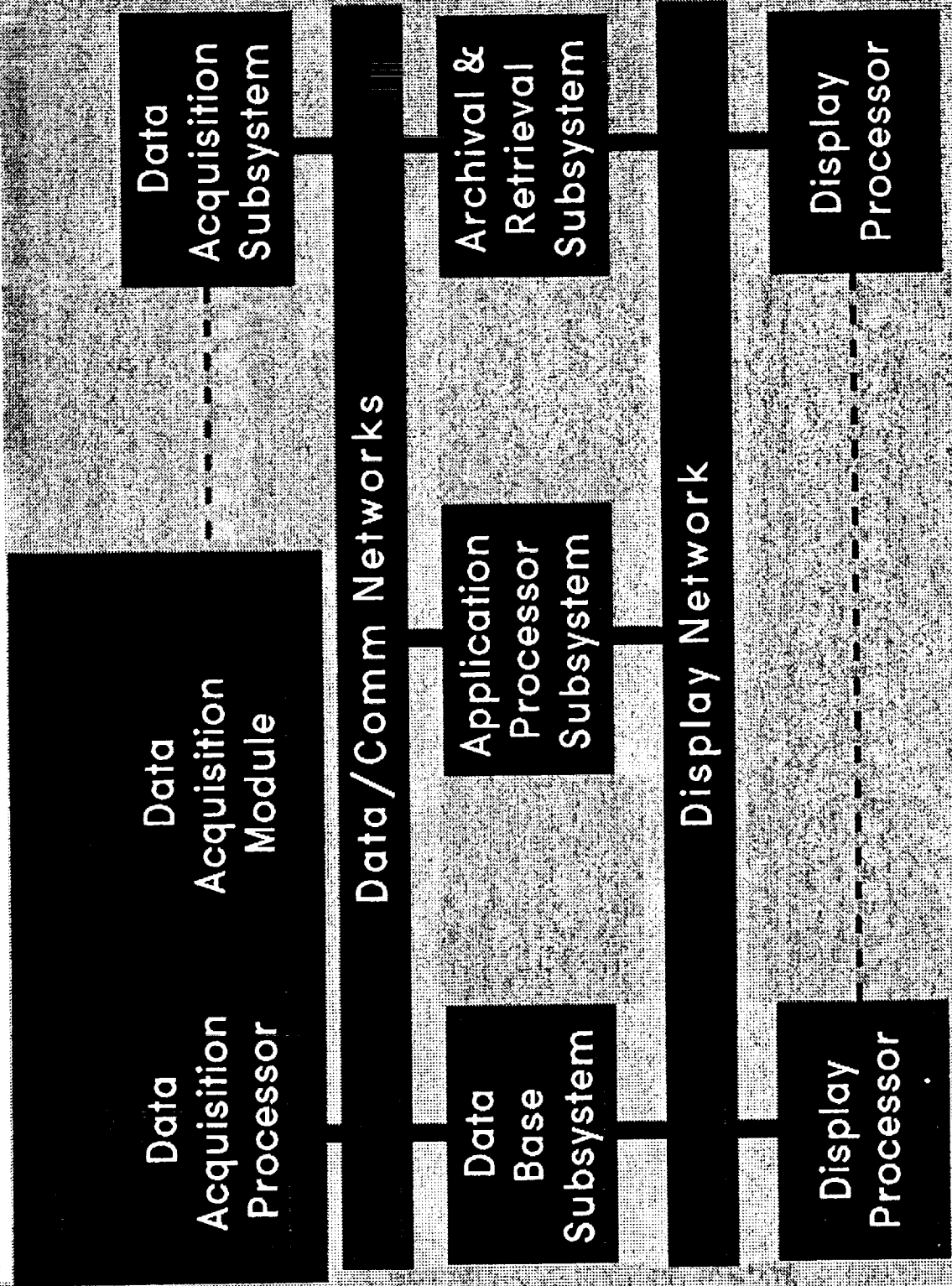

Architecture

Data Acquisition Module

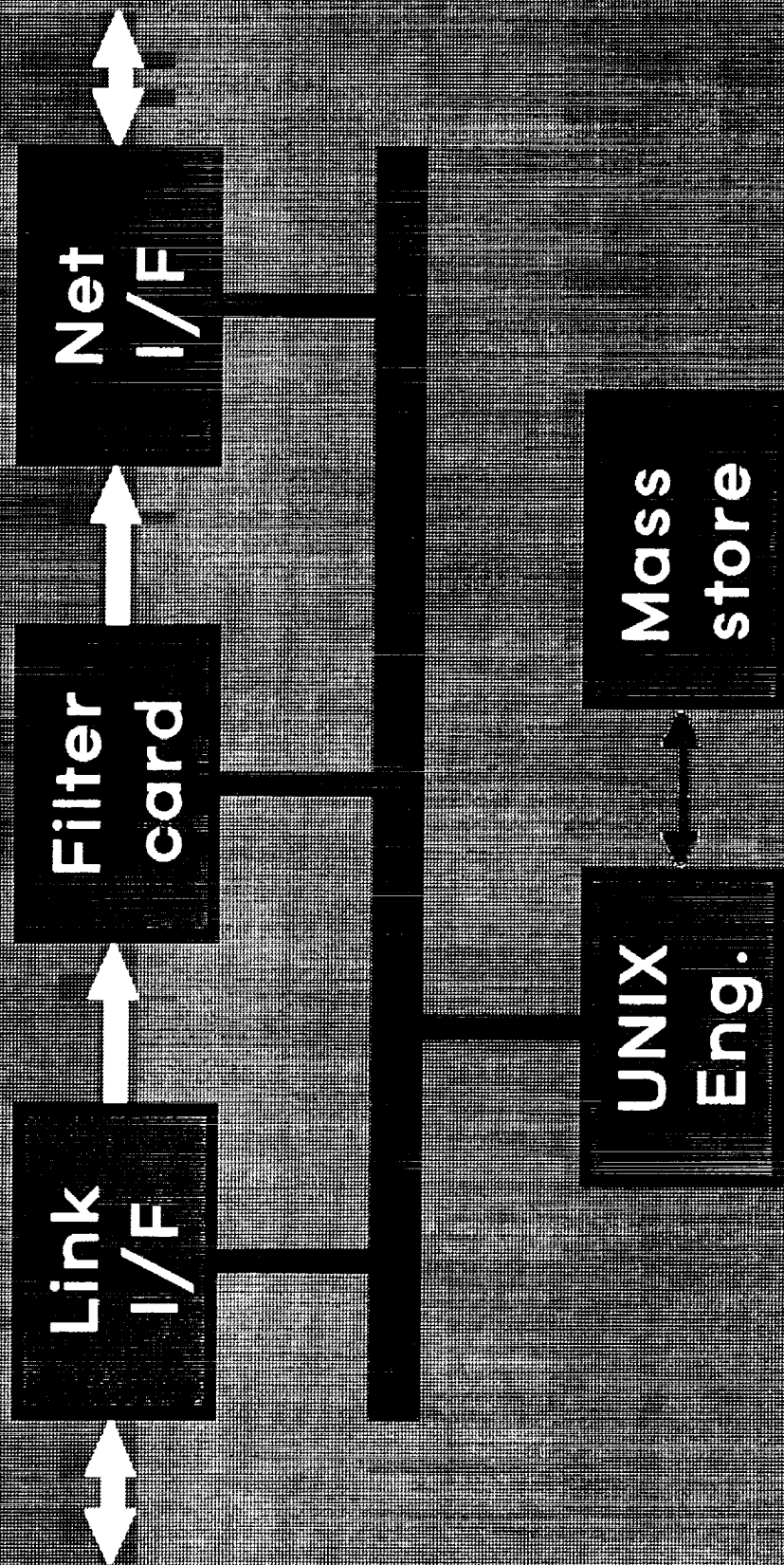

Phase III implementation

GCS Architecture

Pros

- Modular Design
- Standard Interfaces
- Primarily COTS
- Partionable
- Connectivity
- Run Time Binding
- Low Latency Data Reads

GCS Architecture

Cons

- Broadcast Mode of Operation
- Recording Bottleneck
- Excessive MIP Requirements
- High Overhead Data Format
- CDS/RTIF Incompatibility
- CTC/Reactive Loops Slow
- Weak Simulation Support

TPS II Milestones

Concept thru Operation

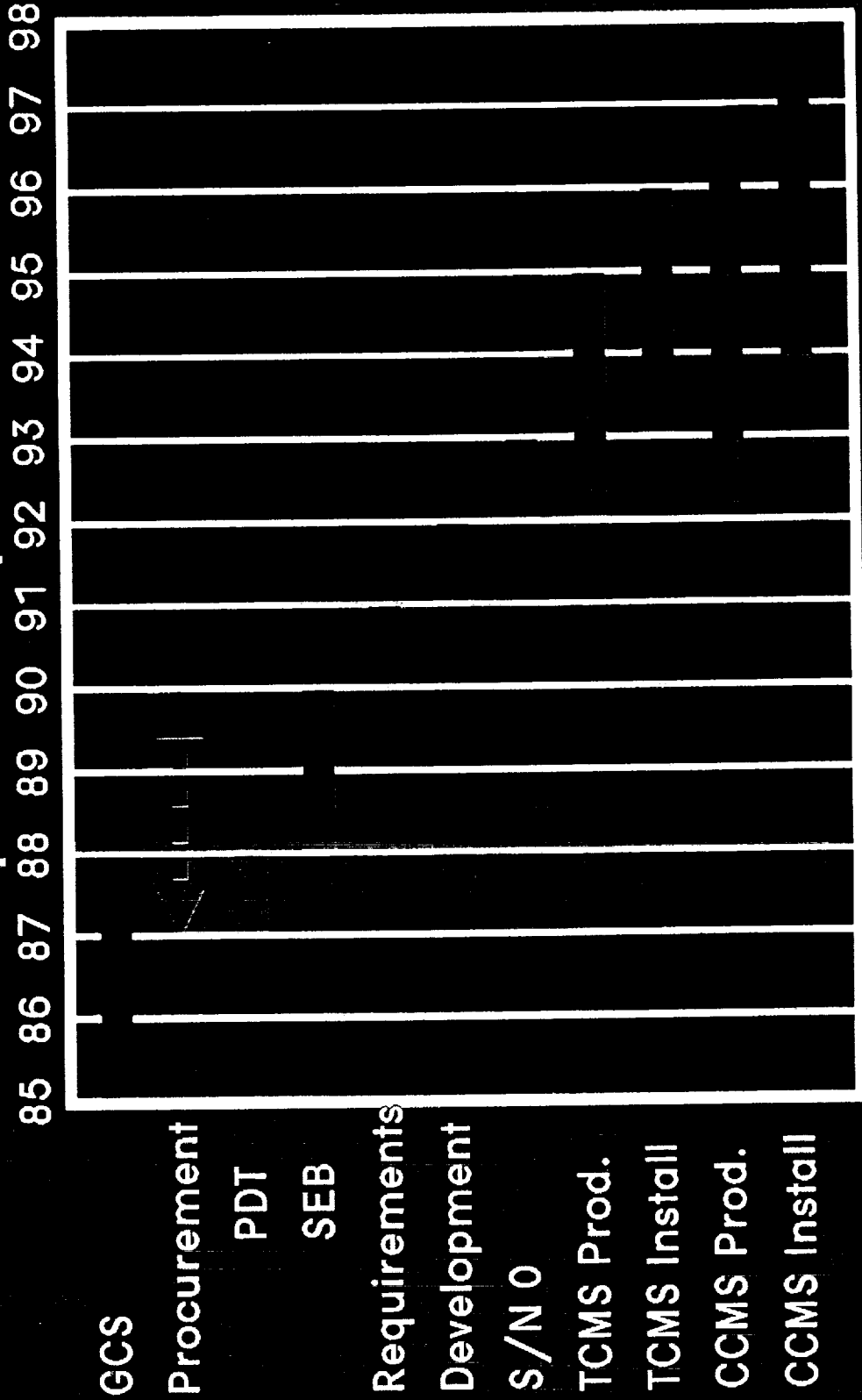

CORE Architecture

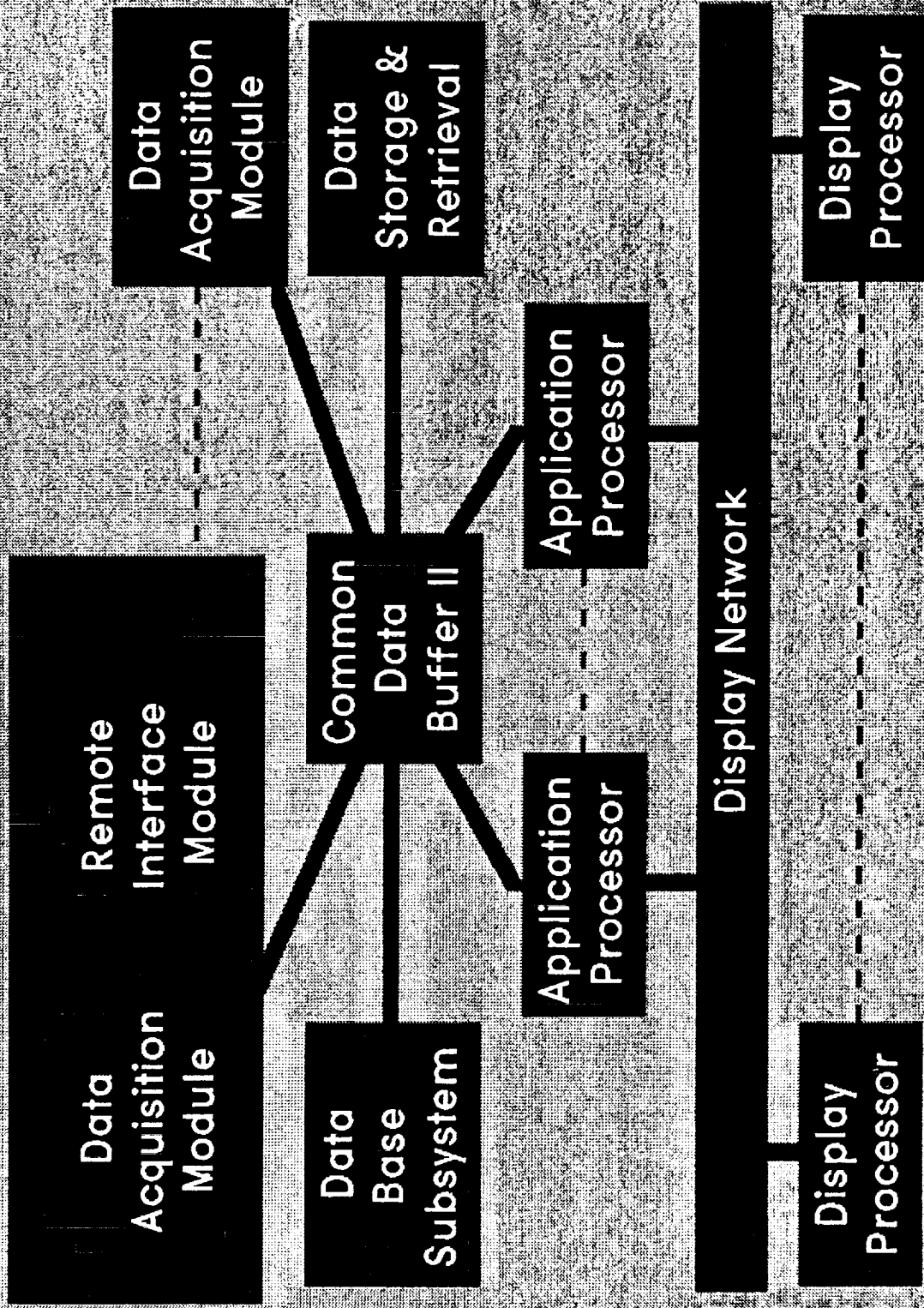

Lessons Learned

- ✓ NIH & DIY significant factors
- ✓ COTS not a perfect fit
- ✓ Almost COTS worst of all
- ✓ "It doesn't work that way now!"
- ✓ "Trained monkeys" can't maintain it
- ✓ Config. Mgmt. driving factor
- ✓ Development & Ops don't mix

PAGE _____ **INTENTIONALLY BLANK**



Ames Research Center
Dryden Flight Research Facility

NASA Ames-Dryden Integrated Test Facility

Presented at: The Control Center Technology Conference

By:

Larry Schilling, NASA
Dave Bolen, CSC

June 18-20, 1991

N92-12014
39606

NC473657
CZ 790589

P-22



Ames Research Center
Dryden Flight Research Facility

Presentation Outline

- **Dryden Overview**
- **Integrated Test Facility**
 - Concept
 - Philosophy
 - Capability
- **ITF System Architecture**
 - Hardware
 - Software
- **Computer Aided System Testing**
- **ITF System Video**
- **Concluding Remarks**

L. Schilling

D. Bolen

NASA Dryden Integrated Test Facility (ITF)

ORIGINAL PAGE
BLACK AND WHITE PHOTOGRAPH

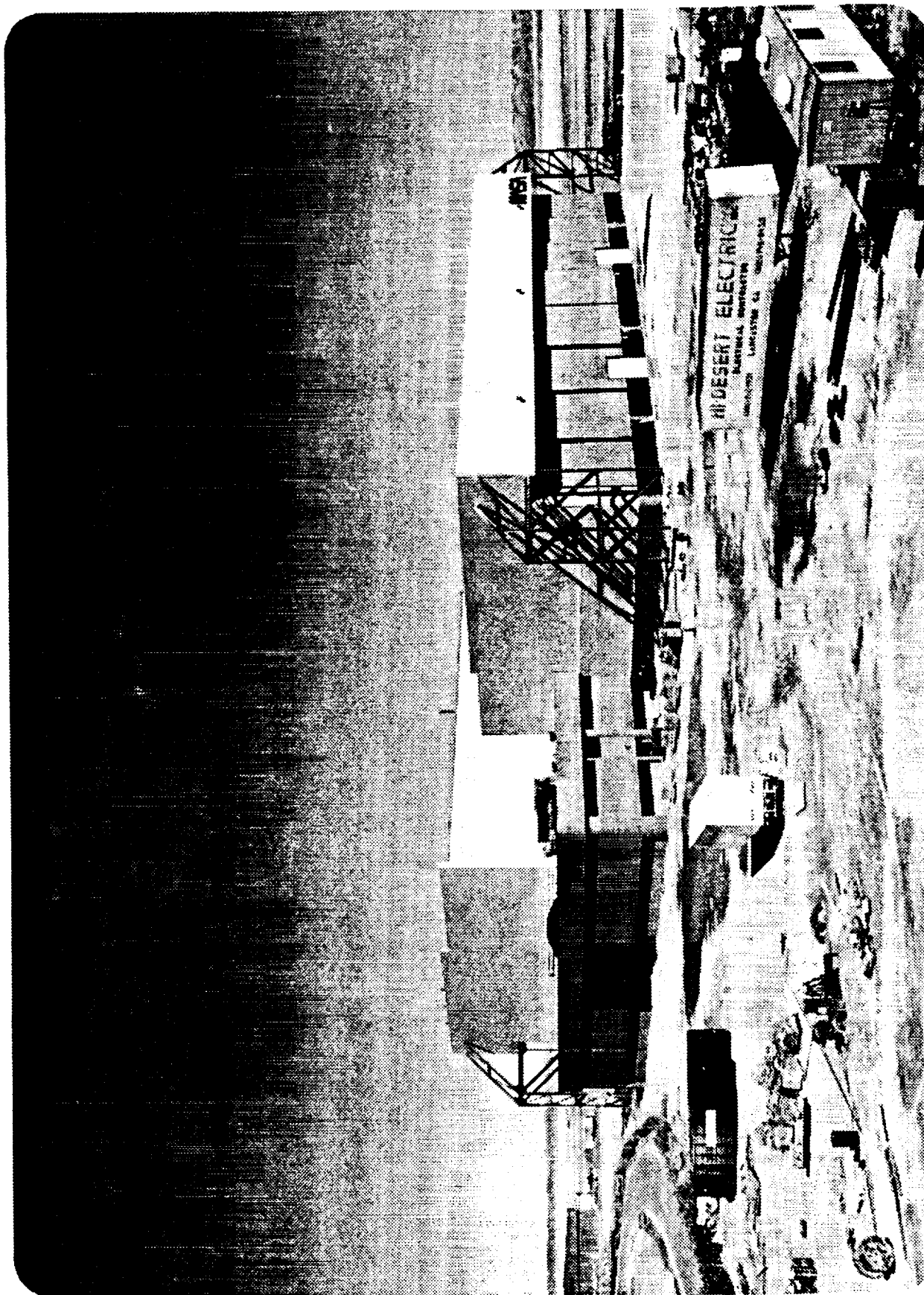



ITF - A Facility for the Present .. and Future

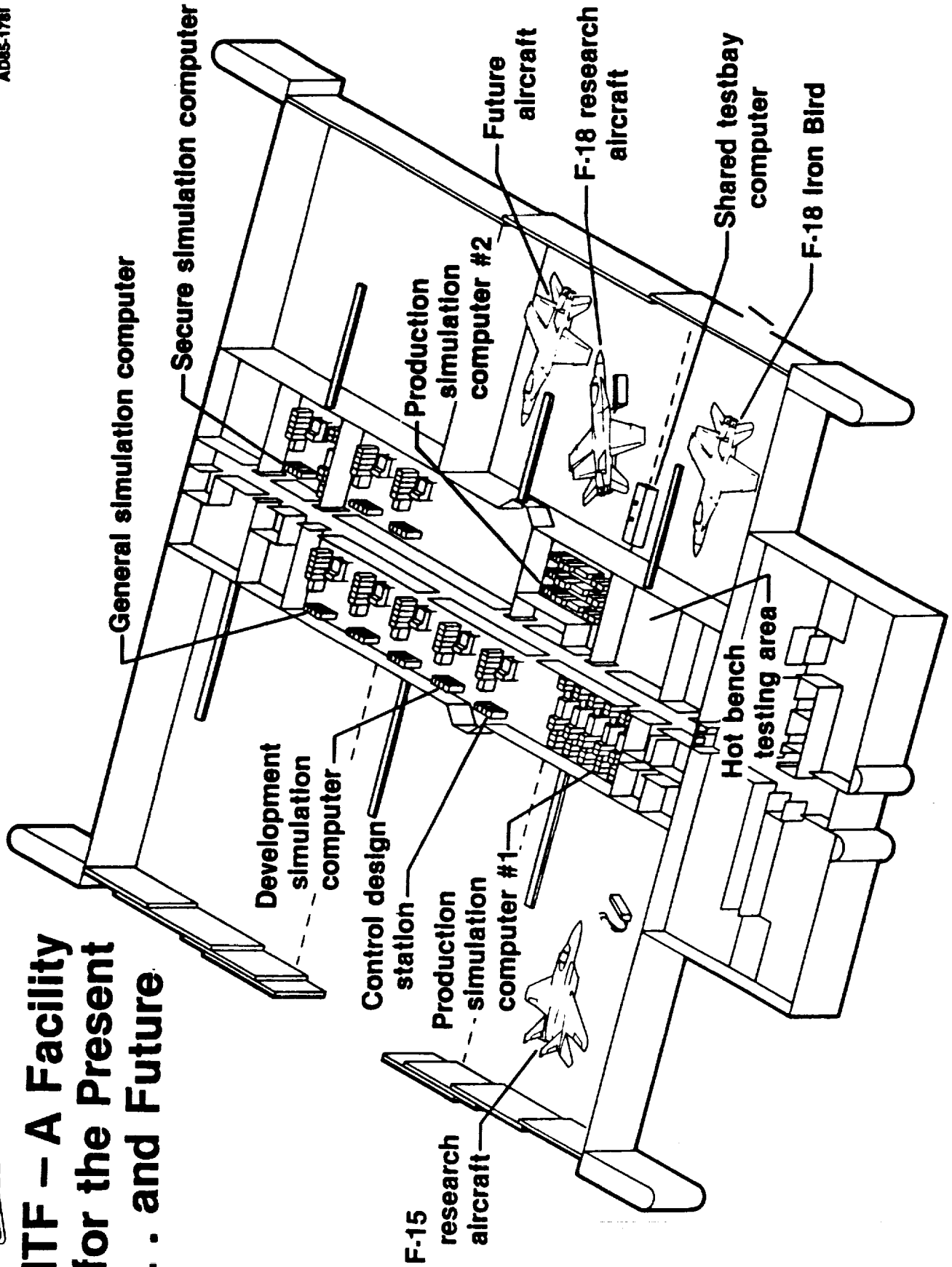

Now and the Future

Military and Civil Aircraft



Aircraft systems

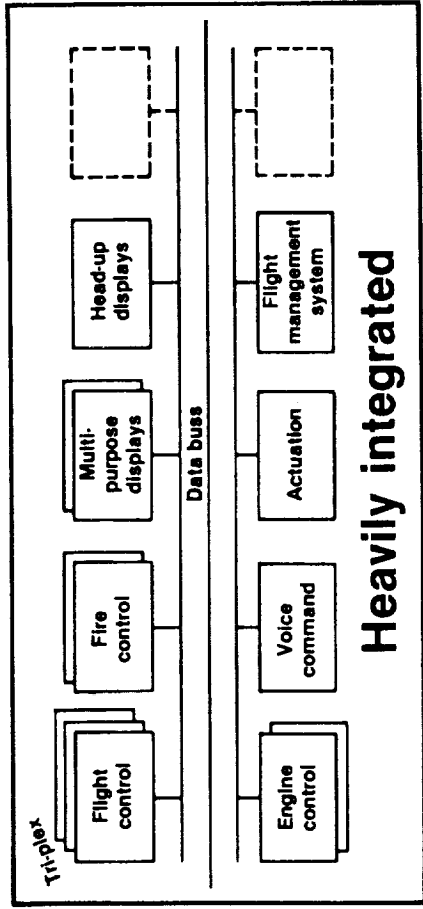

Heavily integrated

Facility requirements

- Test entire aircraft
- Assess system interactions
- “See” into avionics systems
- Handle software intensive systems

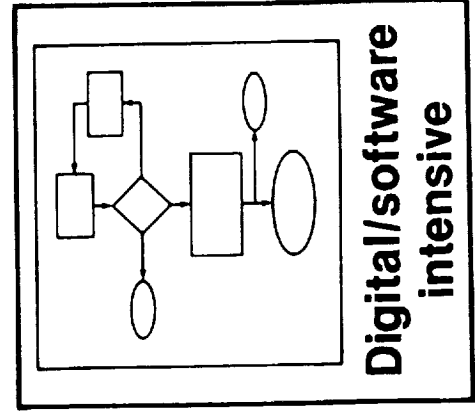

Digital/software intensive

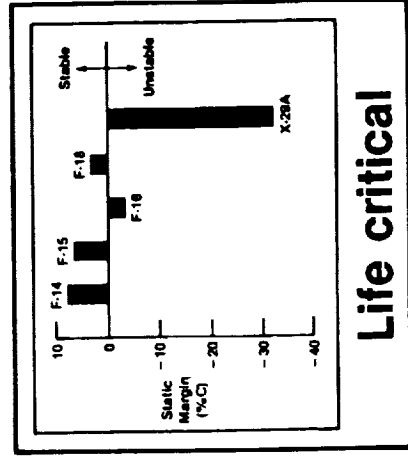

Life critical

Capability Concept

Fully Integrated Testing of the Aircraft Performed Within the Facility

NASA
DFRF83-705a

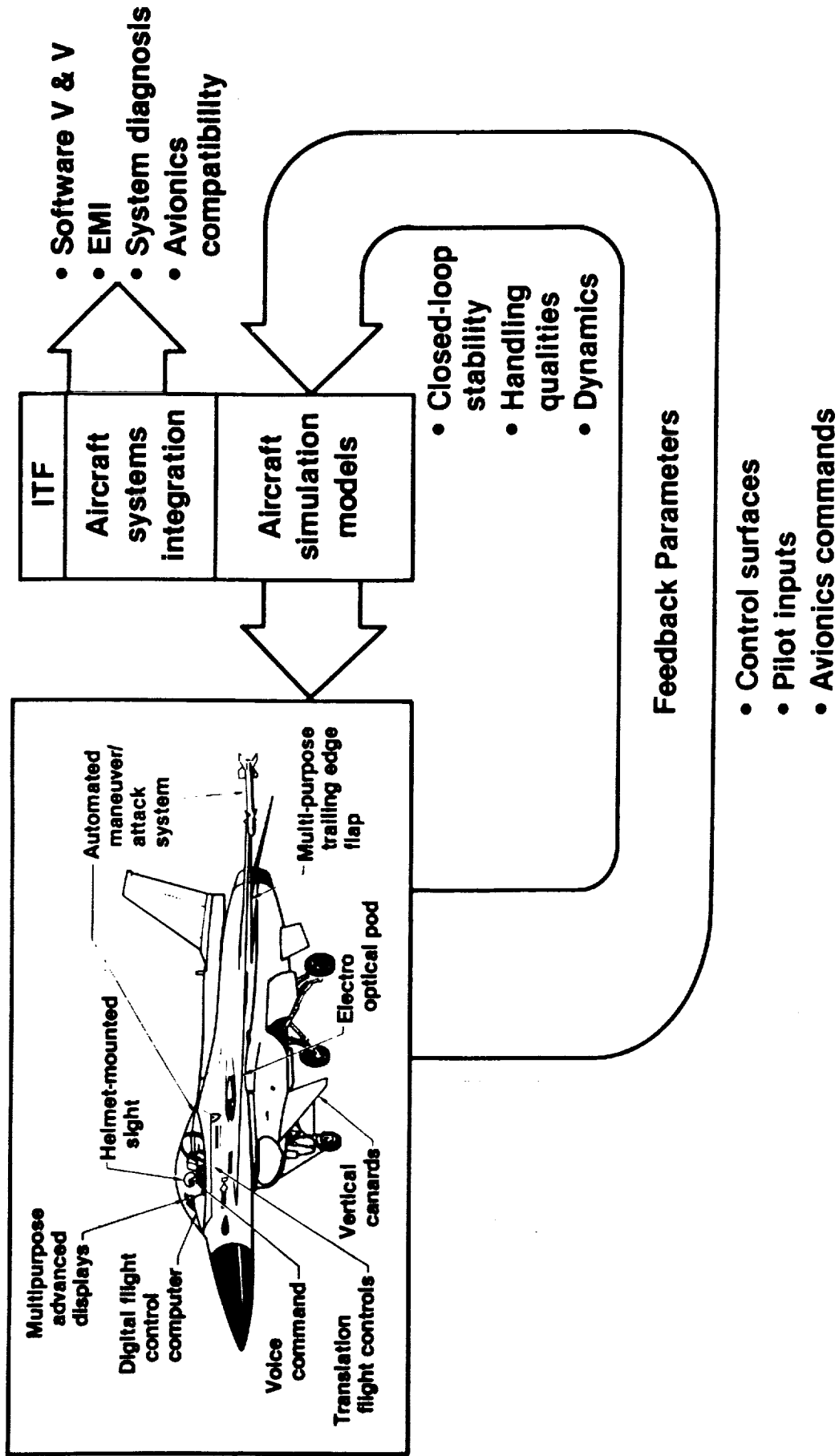



Ames Research Center
Dryden Flight Research Facility

The ITF Philosophy

- **Routinely interface actual flight vehicles.**
- **Make the aircraft undergoing test think it's flying.**
 - Test the vehicle as a whole
 - Provide power, cooling, hydraulics
 - Tie dynamic simulation with vehicle
- **Record everything.**
 - Anomalies are difficult to repeat
- **Make the user productive.**
 - Automate testing
 - Provide quick turn-around
 - Common look and feel across projects
- **Conduct tests safely**
 - Personnel and equipment
- **Develop ITF systems independent of building construction**
 - Use a target project (F-18 HARV) to focus developments
 - Combine developers and users on one team
 - Provide generic capability for multiple projects

INTERNATIONAL BANKING

INTERNATIONAL BANKING

Major ITF Capabilities

NASA
D89-013a



Remotely piloted
vehicle control

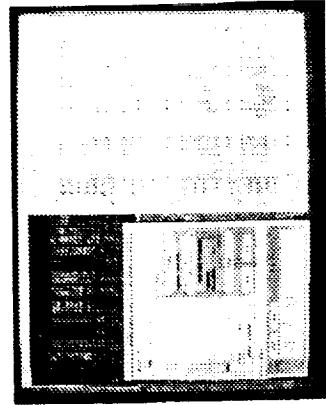

Computer-aided
system testing

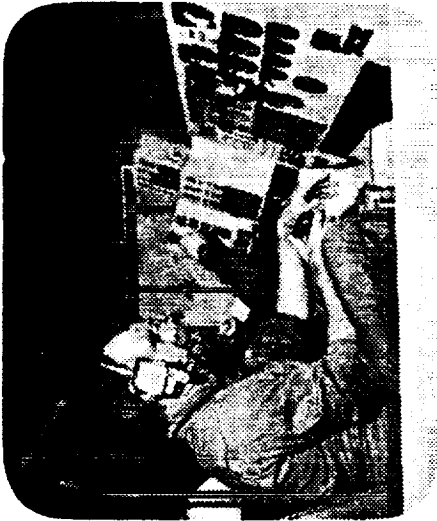

Piloted simulation

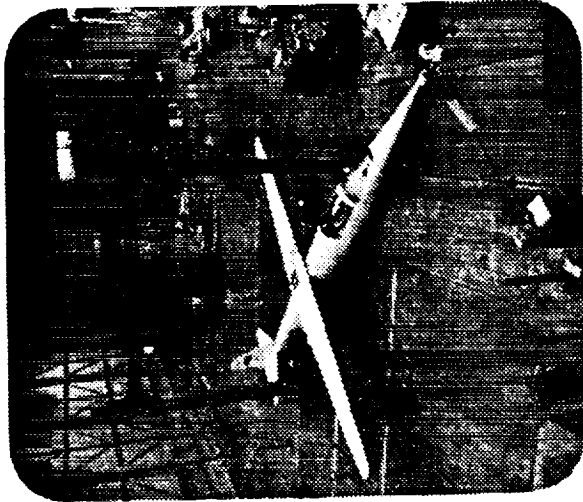

Ground vibration test

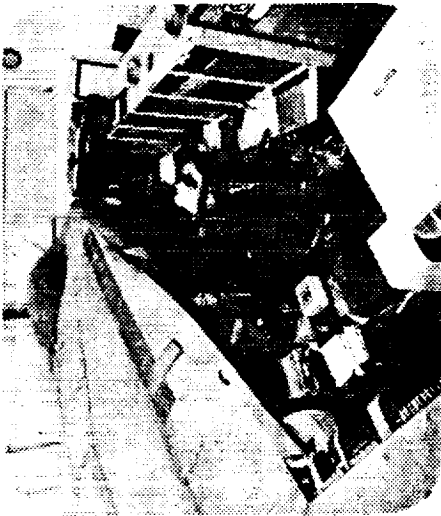

"Airplane-in-the-loop" test

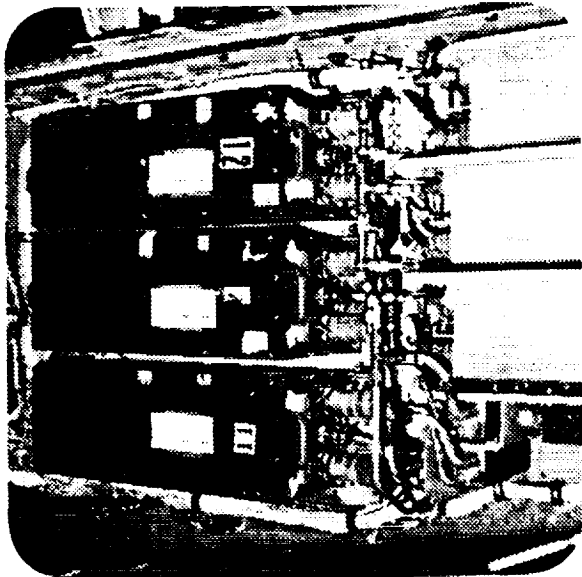

Hardware-in-the-loop and
hot-bench tests

ORIGINAL PAGE IS
OF POOR QUALITY

ORIGINAL PAGE
BLACK AND WHITE PHOTOGRAPH

PRECEDING PAGE BLANK NOT FILMED



Ames Research Center
Dryden Flight Research Facility

Architecture Details

- **ITF System Architecture**
 - Hardware
 - Software
- **Computer Aided System Testing**
- **ITF Video**
- **Concluding Remarks**

D. Bolen

ITF System Architecture

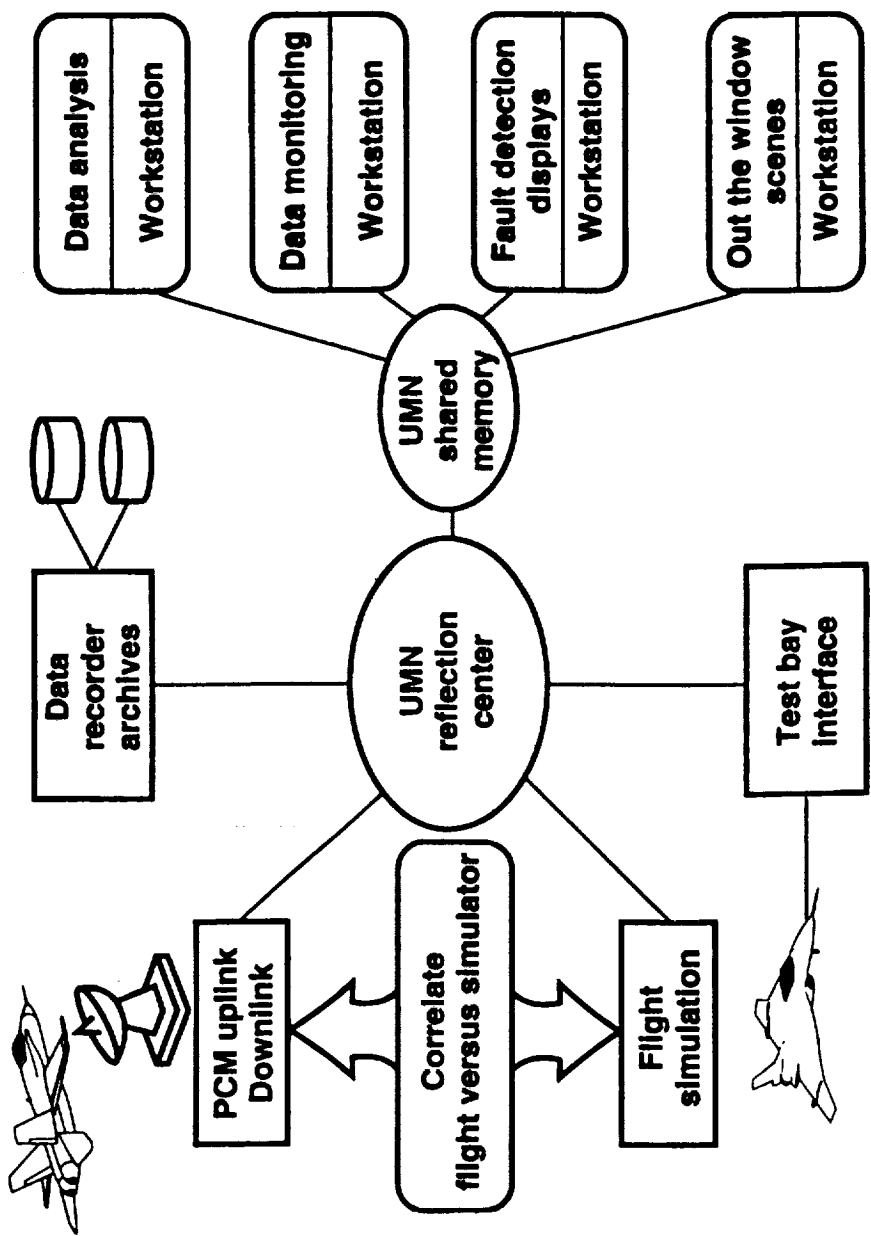

Key elements

- Simulation processor
- Test bay computer
- Data recording computer
- Workstation connectivity
- Universal Memory Network
- Realtime correlation of aircraft response to simulation

ITF System Components

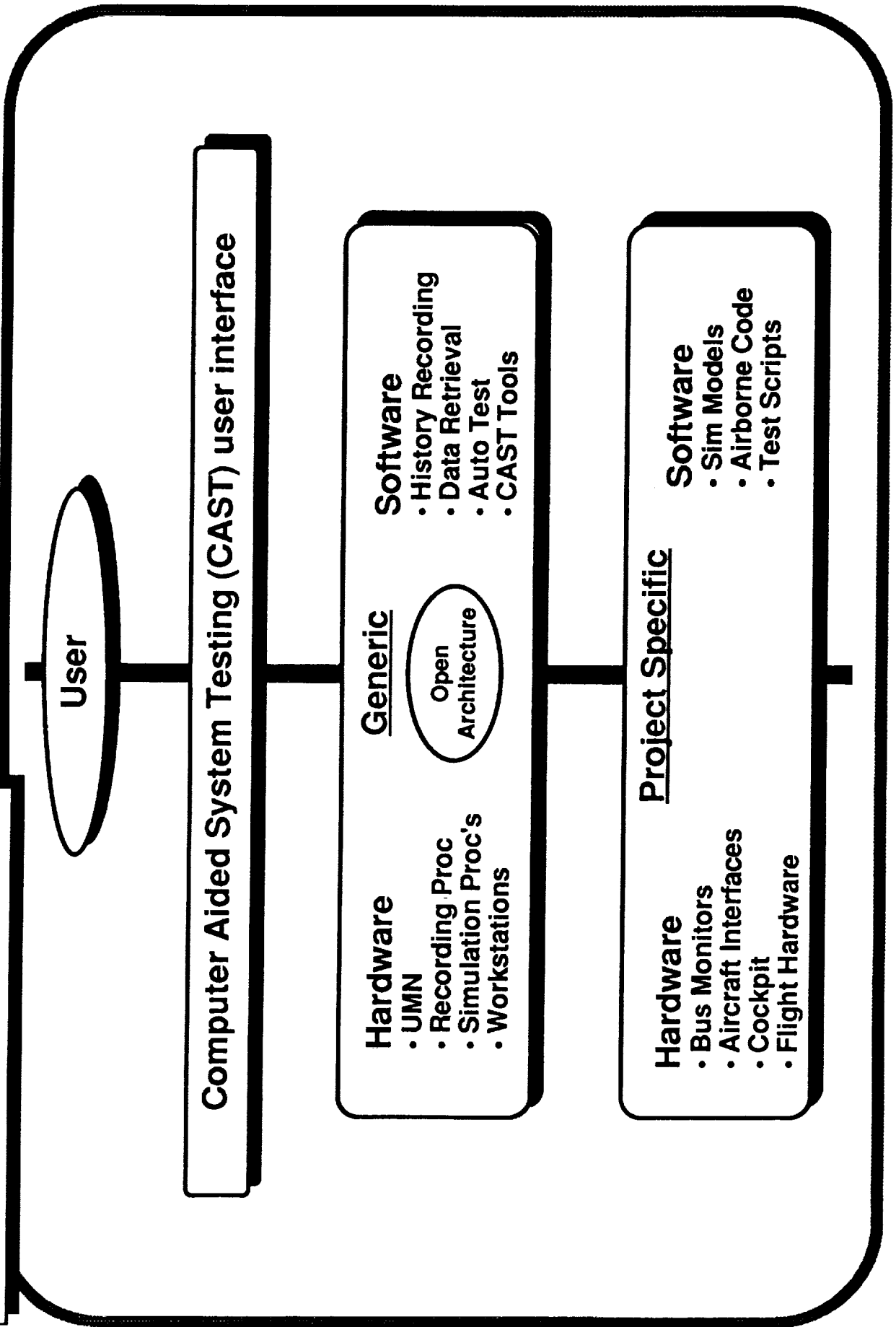

What is CAST?

"An integrated toolset to increase the efficiency of software validation and verification."

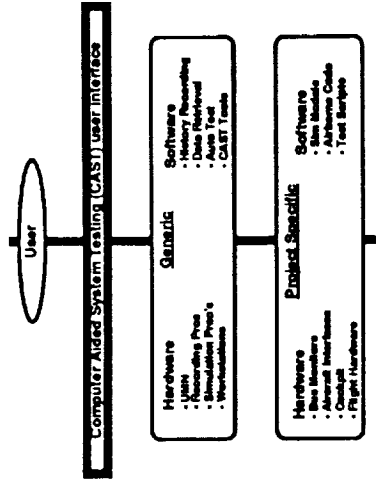

- **Development effort came after Government & Industry reviews**
 - JSC Software Production Facility. Real-time Display System (RTDS) now in use at Dryden.
 - KSC Launch Processing System & GOAL.
 - GD open loop testing techniques (F-111, F-16, A-12).
 - RI closed & open loop testing of X-31.
- **Chose OPEN Systems architecture**
 - C, Unix, X-Windows
 - High performance workstations
 - Generic to support multiple projects

The CAST Package

- **Eight interactive core applications.**
 - XCapture
 - XLRC
 - XAnalysis
 - XGetLRC
 - XPlot
 - Xmonitor
 - XAIDS
 - XArchive

- **Based on X-Windows and Dryden's GUI toolkit.**
- **Controls project specific applications via UMN toolkit.**
 - Overall test control
 - Sim data recording and monitoring
 - 1553 data recording and monitoring

- **Common look and feel across the facility.**

- **Designed with automation in mind.**

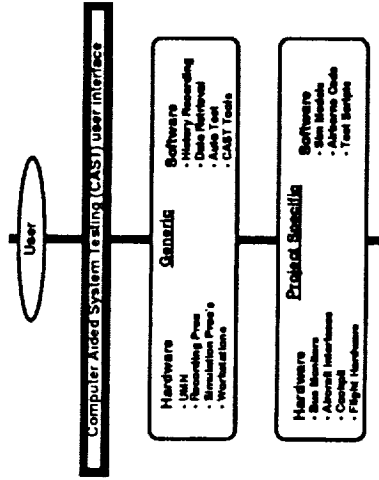

Generic Elements

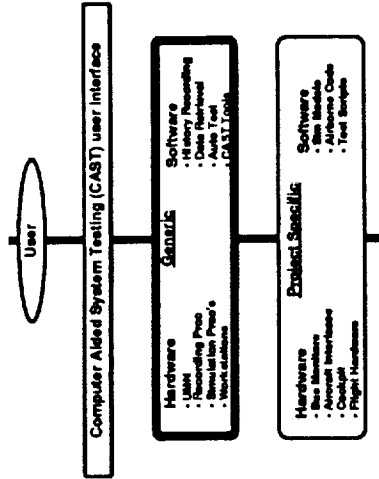

Software

- **Local Recording Capability**
 - Multiple asynchronous data streams
 - All Time Tagged data (IRIG-B - microsecond resolution)
 - Rates up to 570K words/sec
- **Standardized Data Retrieval**
 - Time History Output Files
 - Merging, Skewing, Derived Data
- **Automated Test Programs**
 - Scripts, Autotest Functions
- **Computer Aided System Testing (CAST) Tools**
 - Control, Display, Monitoring, Analysis and Retrieval software

Hardware

- **Universal Memory Network**
 - Shared Memory for Dissimilar Computers
 - Low Latency Transfers
 - High Bandwidth (40MB/sec)
 - No Host Protocol or Overhead
- **Dedicated Recording Processor**
 - Three 850 MByte Drives
 - IRIG-B Time Source
- **Open Systems Architecture**
 - Sun, Encore, Silicon Graphics, IBM, Concurrent

Overview of Test Operations

Pretest

Script generation

- An automated way of performing a test on the simulation processor

```
ERT
IC
H=15000.
AMCH=-.5
IC;H=15000;AMCH=-.5
LS
4=1
SI
PITCH=1;ROLL=0;YAW=0
POUBLET=1;ROUBLET=1;XDOUBLET=1
PSQUARE=1;RSQUARE=1;YSQUARE=1
PT1=1;RT1=1;YT1=1.
PT2=2;RT2=2;YT2=2.
PT3=3;RT3=3;YT3=3.
PAL=1;RAL=1;YAL=25.
PA2=1;RA2=1;YA2=25.
TST
RUMTST=-1
TSWIID(76)=10
IDSVAL(76)=0
IDSVAL(332)=1
TSTIDS(76)=1
TSTIDS(332)=1
TSTIDS(42)=1;IDSVAL(42)=1
TST:DS(1)=1;IDSVAL(1)=1;IDSVAL(1)=0
CON:N
DUMP
ALL:DUMP
OP
REFRESH
RST
```

Real time

Simulator activation

- Starts simulator
- Runs script
- Performs test

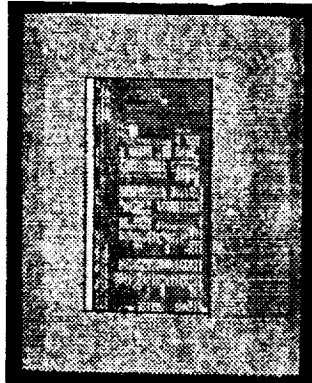

XLRC activation

- Controls high capacity history recording

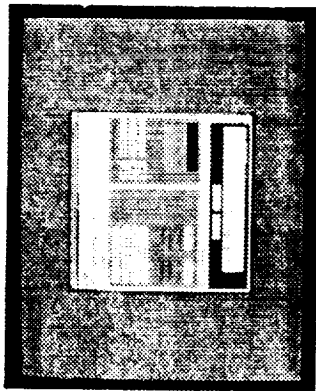

XCapture

- Simpler data recording utility

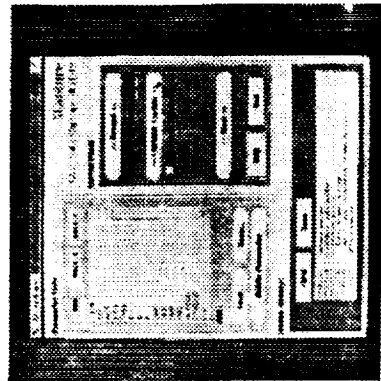

XMonitoring

- Data monitoring

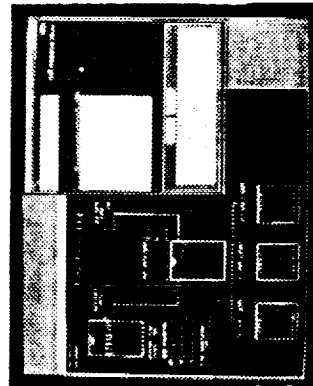

Posttest

XPlot

- Provides time history and frequency response plots

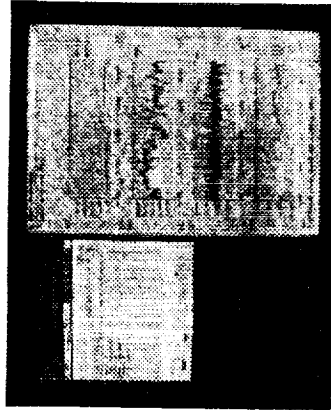

ORIGINAL PAGE IS
OF POOR QUALITY

XLRC Description

CAST Local Recording Capability Utility

ORIGINAL PAGE IS
OF POOR QUALITY

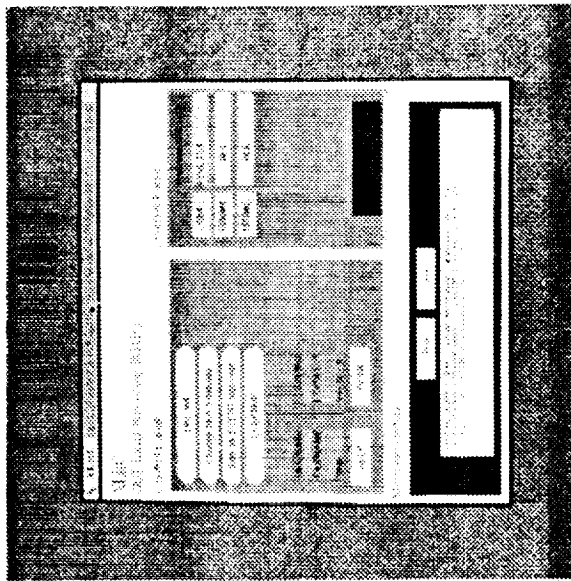

- **Provides controls for the high capacity history recording process**
- **X-window interface from a workstation**
- **Builds history files**
- **Records all data time tagged**

XMon Description

CAST Data Monitoring Utility

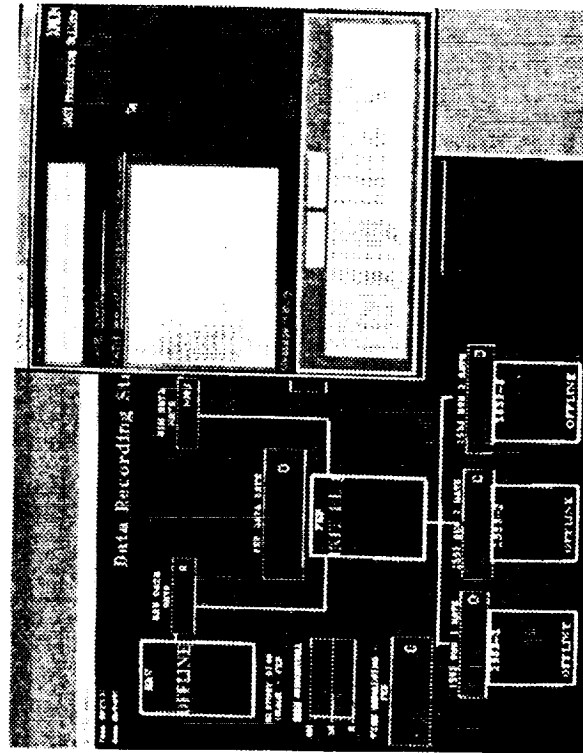

- Provides user definable and selectable display outputs
- X-window interface from a workstation
- Integrated with DataViews™ to provide a multitude of graph and plot types
- Provides realtime displays from the memory network current value tables
 - SIM and 1553 bus data
- Display change in less than 1 second

XPlot Description

CAST Data Plotting Utility

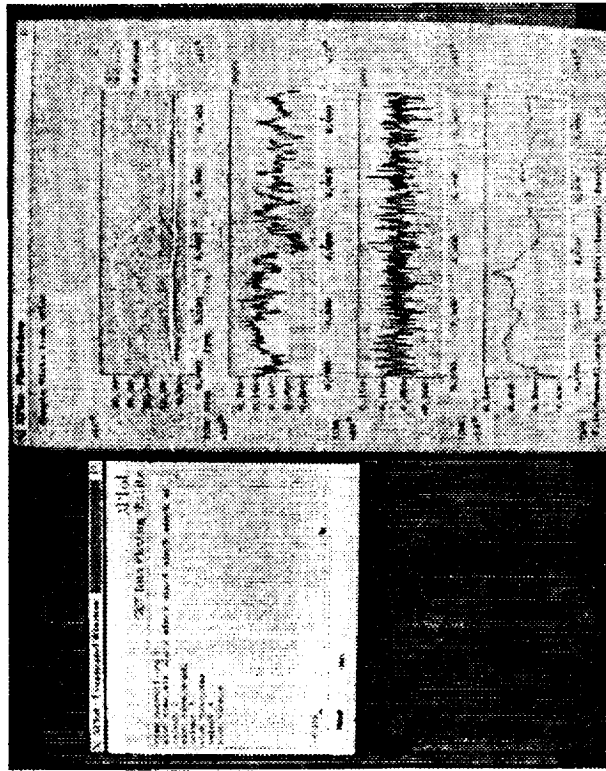

- Utility for plotting XY data
- Provide time history and frequency response plots
- X-window interface from a workstation
- Accepts standard GETDATA (Dryden common) file formats (UNC3, CMP3, ASC1)
- Generates research report compatible output



Ames Research Center
Dryden Flight Research Facility

Other CAST Tools

XCAPTURE

- Limited realtime data capture on a workstation

XAIDS

- Aircraft Interrogation & Display System
- User-definable displays

XANALYSIS

- Runs analysis applications on data collected

XGETLRC

- Retrieves history data
- Thins data as required
- Generates multiple output formats (ASCII, Binary, etc.)

XARCHIVE

- Archives network files (compressed, encrypted, etc..)

Auto Test Programs

- Automate all CAST tools



Ames Research Center
Dryden Flight Research Facility

ITF System Video

- **5 Minute video of how the CAST tools are used in the ITF.**
 - sim cockpit and scripts
 - aircraft in test
 - CAST tools in use
- **This test took 1 hour versus 1 day without the ITF System.**
- **Parallel test functions are shown serially on the video.**



Ames Research Center
Dryden Flight Research Facility

Concluding Remarks

- **Systems built around an OPEN architecture.**
(Vendor independence, modularity, portability, connectivity)
- **Provides a common "look and feel" to the user.**
- **Provides the ability to interface to DISSIMILAR systems in REAL-TIME.**
- **Portable to other facilities.**
 - Dryden flight control rooms
 - National Aerospace Plane contractors chose Dryden approach as their standard for data collection and reduction.
- **Expandable to FUTURE flight research programs.**
 - Interface of generic system requires ~ 1/2 workyear.



Ames Research Center
Dryden Flight Research Facility

Concluding Remarks (cont)

"Highly interactive systems => measured productivity improvements"

- Measured productivity improvements:

X-29 Frequency Response Tests
X-29 End to End System Test
F-18 SIM Check Cases

BEFORE
8 hours
8 Weeks
2 1/2 Days

NOW
2 hours
3 Weeks
4 Hours

- Our estimate: Overall test time reduced by a factor of 3

INTENTIONAL BRAND

omit

Control Center Technology Conference

Luncheon Speaker

**Eugene F. Kranz
Director,
Mission Operations,
NASA/Johnson Space Center**

PRECEDING PAGE BLANK NOT FILMED

CONTROL CENTER TECHNOLOGY CONFERENCE
University of Houston - Clear Lake
June 18, 1991

"Conviction . . .Why we are in Space"

Pleasure to talk to you today

- **When I accepted this invitation, I intended to discuss my thoughts on my beliefs on the elements and characteristics of a control center - to discuss the principals of command and control.**
- **This would have been an easy topic - for I have been involved with command and control all my life**
 - **Starting as a forward air controller/and as a fighter bomber pilot supporting the 7th Infantry Division in Korea**
 - **To the Range Control Center (King-1) at Holloman Air Force Base where we conducted flight test of a broad variety of B-52 missile flight tests**
 - **To Mercury Control Center at Cape Canaveral**

- To the evolution of the current MCC from Gemini to the present
- Instead I chose a different topic - it is a topic borne of frustration
- It is a topic that was debated on the House Floor ^{Almost} ~~two~~ two weeks ago
- It is the topic that we are grappling with in the JSC Center Retreat

Preparing for the debate on the House Floor, Congressman Bill Andrews told us at JSC ³ weeks ago, "You do a great job on the technical details, you are poor salesmen and you hate to get your hands dirty in politics." Above all, "You must speak with one voice (Space Station) and you must have convictions."

Conviction -

- Strongly held faith or belief that leads to a compulsion to act based upon that belief

My conviction on space began on October 4, 1957 -

- My squadron was stationed on Formosa to support the Nationalist Chinese
- The Sputnik launch inspired fear - apprehension - the unknown.
- You could see it on the faces of the people of Asia.

Those people who relied on American technology for their independence.

I did not understand what had happened or where the Sputnik event would lead us - all I know was that this Soviet space flight - like the first "Wright Brothers Flight" - would forever change the world, and our relations with the community of men. History was written that day.

I have come to believe that space flight is the instrument by which we will assure that which we cherish most . . . but least understand, and value until it is lost . . . that is our Independence!

I speak of Independence in a national, personal, and economic sense . . . independence which we must pass to all generations - the exemption from arbitrary

restrictions on civil, political or religious liberties - to act based upon conviction . . . to be able to move in the best interests of our people.

I also believe space flight is the instrument of leadership, of belief, of our destiny . . . which inspires America to take the risks, to make the commitment, to preserve the ideals which compel Americans to be the leaders, to be the best.

Independence and leadership is best exemplified in the events now occurring throughout Europe in those countries which were once Soviet Bloc and on the Chinese mainland.

These countries no longer wish to be subordinate to political, intellectual, economic or technical beliefs which suppress independence..

In China in the Summer of 1989.

We saw a courageous young man bring a tank column to a halt . . . we saw the Goddess of Freedom raised by the students . . . and subsequently crushed by the Chinese Army. In 1991, the Baltic States now rivet our attention The issue is Independence.

Independence/Freedom is a precious right we Americans long have cherished. Throughout our history, we have been able to choose, to speak our minds, . . . able to go as high and as far as our talents, energies and ambitions would take us. We are able to worship . . . to compete . . . even to criticize our government. Independence is our heritage.

Independence has made the United States the hope and the envy of the world. It has allowed us to make the choices, select the directions, and become the leader of the world politically, economically, technically, and morally.

Freedom and leadership are closely coupled. We know, however, that leadership is not ours by right. We became a leader of nations by the energies of our explorers, the dedication of patriots, the inventions of our peoples and the basic enthusiasms of our young Republic. We grew, became a role model for nations and an eloquent example of Freedom for two centuries. Today we find ourselves in the position of leader of the entire world.

Leadership, however, does not come free. In recent years, we have been challenged in many ways

throughout the world . . . just as we worked hard to attain it . . . we must continue to work hard to keep it.

Other nations now challenge us in basic industry, manufacturing, economics, and high technology. To some extent they also challenge our basic character as a people . . . our ability as a people to risk, to work hard . . . to sacrifice. We are certainly challenged in the education of our young people by all the nations of the free world.

During the period after the Challenger disaster, there were times when I frankly wondered if we were about to surrender our leadership in space, to the Soviets, Chinese, and the free nations of Europe.

More recently in the debates on the House Floor, I saw many people - about 40 percent, who did not understand the sacrifices which are necessary if we are to compete in today's world of ^{technology} technology. We came close to surrendering the Floor vote on Space Station on Thursday, June the 6th.

Three impressions emerged from the discussions:

First: There was a general lack of recognition that space and space technology, are dominant contributors

to the health and well being of the United States economy. Few knew that aerospace technology alone produces a \$17 billion annual trade surplus, or that it is virtually the only high technology category where we enjoy a surplus.

R/C 70% Now
50% by 95 } 150B Trade Loss

Second: People seemed unwilling to accept the concept that risk was essential to human progress, and in particular was a continuing element of our ability to remain a great Nation.

Third: There were basic questions on whether we should even be in space, but beyond that . . . a basic and underlying feeling that we were moving too fast, stretching too far, and what we were doing was not pertinent.

A nation must aspire to be great. These aspirations provide the vision, which raise our sights which cause great things to happen. These aspirations provide a common inspiration for a better world. The words of Neil Armstrong " . . . For All Mankind" signify the aspirations we must have in our work.

There was much debate on the House Floor on whether science would suffer because of the Space Station funding.

To those who complain that NASA puts science on the back burner, I'd say . . . "Where have you been?"

The 5 years from 1989 - 1994 will be the most productive for space science and discovery in the history of the United States. The missions which started with the Magellan launch to Venus in May of 1989, followed by Galileo and Ulysses are part of a series of launches of 35 major scientific spacecrafts in the immediate timeframe.

These are not small satellites like we launched in the glory days of the 1960's. These are major facility class missions . . . telescopes, like the Hubble, Astro, and Gamma Ray Observatory and the Spacelab laboratory missions, like the recent Life Science mission to study, understand and innovate, and to teach.

We will be awash in new science data, . . . we will apply new knowledge to our problems on Earth . . . our world leadership in space science will be unquestioned if we have the will to continue.

With these discoveries will come understanding, knowledge and the return to the human spirit that comes from doing tough things well.

It will also provide an economic return. The best estimates made indicate that \$7 of economic activity is returned for each dollar spent on aerospace . . . the strength of our economy to produce is the key to our ability to improve the life of all Americans . . . and the world.

When Boris Yelsin visited JSC in September 1989, he cited an even higher dividend. He told the JSC Center Director, Aaron Cohen, that Soviet cosmonauts had urged him to visit the space center, because they believed his outspoken criticism of their program might be tempered if he could but catch a closeup glimpse of ours. The number they gave him for America's return on its space investment was not \$7, but \$20 for each dollar we spend.

America is the leader in space and develops the technology that will allow the United States to retain the high ground . . . and produce for the United States Economy.

What we can do is not in question. My concern is about our will to do these things. In particular I worry that an accident, or any setback, no matter how small . . .

coupled with today's budget environment will mean serious trouble.

Our ability as a Nation to accept risk is a different thing. I believe we in NASA did not recognize the "image" which had been created as a result of our past space successes. We may have been too successful in previous programs. We did not adequately articulate the risks and the gains of our business, and the reasons for doing what we do. We spend too much time in internal conferences and too little time talking to our constituency, the American public.

Risk is an essential element of human progress. Risk must be faced daily if America is to remain a great and free Nation. It is the price we must pay, *& have paid for*
over 200 years.
shuttle This *space* system we *fly* is the most ingenious of man's creations. It is composed of exotic metals, ceramics, and composites . . .

The shuttle derives 7 million pounds thrust from 2 million pounds of solid propellant and 1 1/2 million pounds of hydrogen and oxygen to lift our payloads to orbit. A flightcrew will ride this stack to orbit . . . when things go wrong . . . they go wrong fast. The risks of space flight are clearly defined.

We work with engines that deliver 100 horse power per pound of weight. They are at the leading edge of technology, materials, and our ability to forecast operating lifetimes. Six turbo pumps each the weight of a Chevy 350 engine delivers 63,000 horse power a piece.

Our environment is a vacuum, we work in extremes of temperature. Decisions must be made in seconds . . . they are frequently irreversible.

We design and work to margins of less than 1 second on a routine basis. .

In operations, we recognize these risks . . . we plan and train daily, working in real time to manage the risks inherent in space . . . inherent in exploration and inherent in leadership. We must make these risks, the incredibly small margins, and the complexity of our business, visible to the Public. It is natural to seek the vicarious thrill of risk . . . we must enjoin the public in our business so they become a "stakeholder" in the risk of space flight.

A threat, however, remains that we will have another accident . . . we may lose more lives and spacecrafts. An

accident could be as simple as blowing a tire at 180 knots at touchdown and departing the runway. This is the nature of our work. When this happens, will we as a Nation have the courage to continue our quest, to continue on the path to the stars? Or will we surrender our leadership to the ^{Others.} ~~Soviets, Europeans, and Japanese.~~

A report on space flight to the 101st Congress in July 1989 by the Office of Technology assessment stated:

"If the United States wishes to send people into space on a routine basis, the Nation will have to come to grips with the risks of human space flight. In particular, it will have to accept the likelihood that loss of life will occur. If such risks are perceived to be too high, the Nation may decide to reduce its emphasis on placing humans in space."

This last sentence is the most chilling . . . If the risks are perceived to be too high . . .

The risks are high . . . there is nothing conservative about space flight. This was true for Alan Shepard and John Glenn. It was true for Neil Armstrong and John Young. It will be true on STS-43 when we deploy TDRS, it will be true the day we leave for Mars. Thank God we

have men and women willing to risk the thunderous ride to space.

When our next bad day comes . . . it is one that we must meet with conviction. The conviction that the gains in space are worth risk, and are worth sacrifice. As a Nation, we must recognize that space and risk are essential elements of our way of living . . . and eventually our ability to lead the world. The gain is manifold . . . it has many parts and forms.

- Space is a instrument of our foreign policy.
- Space is an element of our National defense.
- Space is dominant contributor to technology and thus to our economy.
- Space is essential to our progress in science, engineering, and medicine.
- Space provides an inspiration for our people, a challenge to our educational systems . . . it uplifts the eyes of our youth, it unites us.
- Space teaches us to conserve and use wisely our resources . . . to protect Earth and its environment.

We must assess these space benefits as a united team . . . so that we can answer the harbingers of gloom . . . those with the "do nothing" attitude . . . the pessimists. We must be strong . . . for the pessimists cannot rise to

the challenge, . . . they cannot create . . . they can't innovate. It is up to us to lead, to take the risks to lead. We must have conviction if we are to lead. We must have conviction if we are to fulfill our destiny.

Another of my concerns that ~~comes from the Challenger accident~~ involves our aspirations as a Nation. It appears that we as a Nation are intent on finding the neutral ground . . . we do not follow our instincts and we have become a Nation seeking consensus. We have developed a paralysis of the will, and are no longer willing to be uncomfortable in anything we do. In one fleeting moment we overcame this during "Desert Storm" . . . There the objectives, assets, and commitments were clear . . . but they were remote to all but a few.

We are increasingly unable to meet our daily challenges, and effectively utilize the opportunities of the present. Boldness in most cases is no longer a key word in our vocabulary. Our horizons are increasingly self-centered . . . we have forgotten our debt to our predecessors.

President Bush clearly stated his position on American Leadership in the space arena on July 20th 1989. He said that it was time to look to the future, he saw an

opportunity and he intended to seize the opportunity . . .
"to make a long range continuing commitment in
space. For the 90's he stated our next critical step was
toward the Space Station Freedom . . . and for the new
century, back to the Moon. Back to the future, and this
time back to stay."

I like those words "back to stay" . . . those are the
words of leadership. They are tough . . . they are clear .
. . they are a challenge!

Many have criticized the speech because it did not set a
timetable . . . and it did not say how it would be
financed. NASA must lead in establishing a plan that
involves all U.S. Government, industrial and scientific
elements and those of the world. We must sell
Congress and the American people . . . it then becomes
the responsibility of the American people to determine
how much they are willing to sacrifice for their present
and for their future.

William Jennings Bryan stated -- "Destiny is not a
matter of chance, it is a matter of choice . . . it is not a
thing to be waited for . . . it is a thing to be achieved.
Those who may doubt our chances should remember.
"The only footprints on the Moon are American." "The
only flag on the Moon is an American flag." "The know

how that accomplished these feats is American know how.”

What Americans dream, Americans can do.

So now I return to where we started . . . Space provides the focus, the challenges for a great people . . . It provides us the measure to determine our willingness to be great, and the courage to make the inevitable sacrifices. It is the force upon which we will shape our beliefs that we are truly the most fortunate of all peoples on earth . . . We are American . . .

We must personally develop our convictions on why we are in space, what we are to do, how much we are willing to risk. Then after we have established these convictions, we must carry these beliefs to the people. . . we must avoid trivializing our work by spinoffs . . . we must make the “people next door” stakeholders in the glories and risks, the achievements and the defeats.

We must become foot soldiers and we must be convincing from now on.

Space flight in on the line.
THANK YOU

INVENTIONELLE BLAND

SPACE SHUTTLE
MISSION CONTROL CENTER UPGRADE

PAT DUFFIN

JUNE 18, 1991

55-14
N92-12015
P-87

ND 185000

PRECEDING PAGE BLANK NOT FILMED

MCC SUPPORT ROLES AND ACTIVITIES

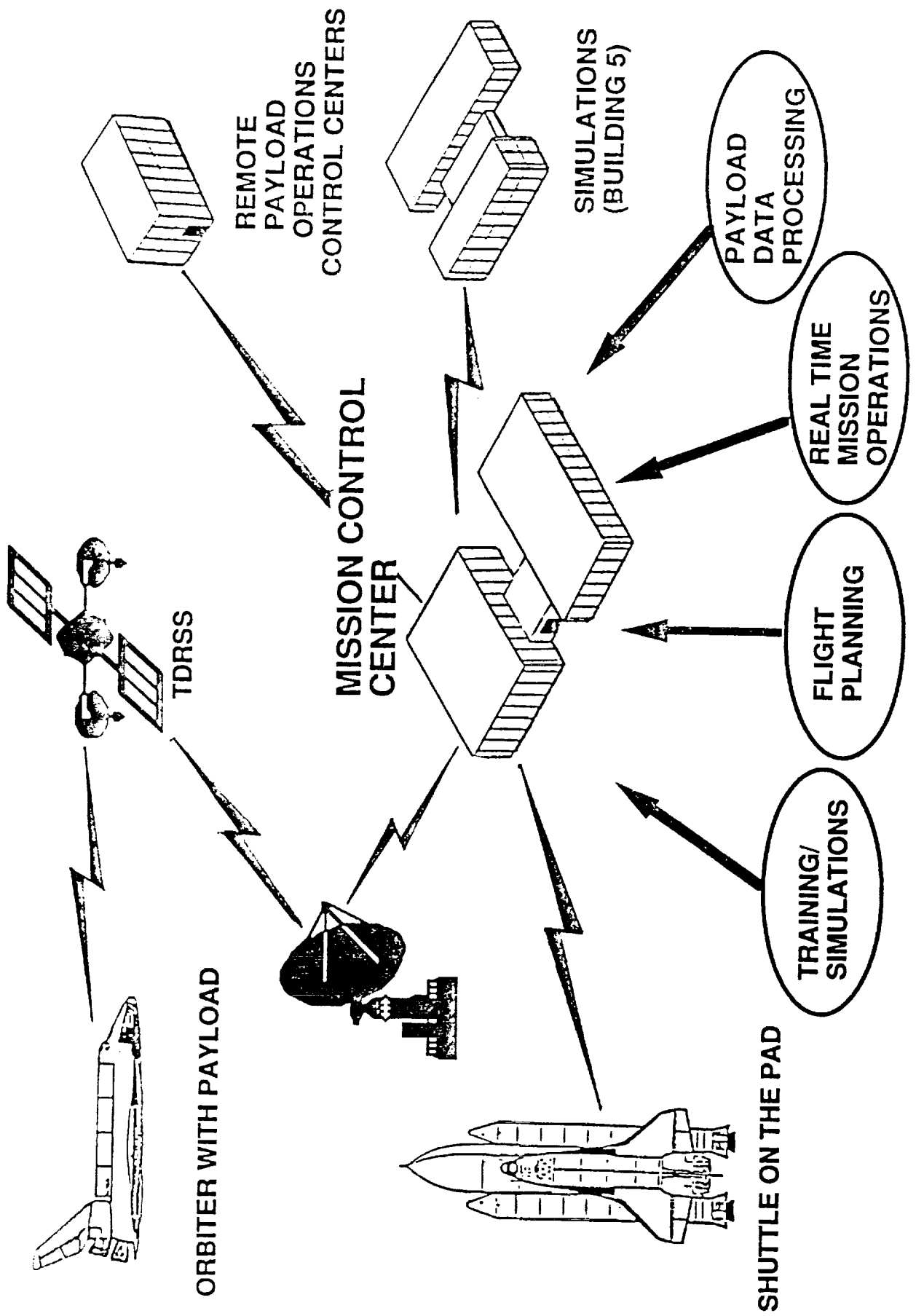

MCC ROLES

THE MCC IS THE FACILITY THAT PROVIDES CENTRALIZATION OF ALL MISSION OPERATIONS IN SUPPORT OF THE SHUTTLE FROM LIFTOFF THROUGH LANDING. THIS FACILITY SERVES AS THE FOCAL POINT FOR REAL-TIME FLIGHT CONTROL OPERATIONS SUPPORTING THE SHUTTLE, SPACELAB, AND SELECTED PAYLOAD SYSTEMS.

- SHUTTLE REAL-TIME MISSION RESPONSIBILITIES DICTATE THE MCC BE IN OPERATION CONTINUOUSLY, EITHER TO SUPPORT REAL-TIME OPERATIONS OR TO SUPPORT FLIGHT PREPARATIONS.
- THE MCC IS PART OF THE INLINE CRITICAL PATH FOR A SUCCESSFUL SHUTTLE PROGRAM
- TO SUPPORT ITS ASSIGNED ROLES, THE MCC MUST PROVIDE MAXIMUM USER EFFICIENCY, MAINTAINABILITY, AND RELIABILITY IF IT IS TO CONTINUE SUCCESSFUL SUPPORT FOR THE SHUTTLE FLIGHT MANIFEST.

MCC ROLES (CONTINUED)

- FUNCTIONAL OPERATIONS
 - MONITORING AND CONTROL OF VEHICLE AND GROUND SUPPORT SYSTEMS FOR PROPER OPERATION AND CONFIGURATION
 - PROBLEM DETECTION AND ANALYSIS
 - CONDUCT PROBLEM INVESTIGATION/CONTINGENCY PLANNING
 - TRAJECTORY MONITORING, CONTROL, AND PLANNING
 - FLIGHT PLANNING/REPLANNING
 - PAYLOAD AND CUSTOMER SUPPORT
 - GROUND SYSTEMS/NETWORK COORDINATION

AGENDA

THE MISSION CONTROL CENTER UPGRADE ERA'S

THE CURRENT UPGRADE ERA, 1985 - 1992

THE MISSION CONTROL CENTER, YEAR 2000

MCC UPGRADE ERA'S

GEMINI	1962 - 1966
APOLLO	1966 - 1969
SKYLAB/ASTP	1970 - 1976
SPACE SHUTTLE	1977 - ?

GEMINI 1962 - 1966

FIRST PRIME CONTROL RESPONSIBILITY

- GEMINI IV, JUNE 3, 1965

MAJOR SYSTEM COMPONENTS

- COMMUNICATIONS INTERFACE SYSTEM
- DATA COMPUTATION COMPLEX
- DISPLAY AND CONTROL SYSTEM

INNOVATIONS

- FRONT-END PREPROCESSING FOR MAIN-FRAME COMPUTING
- DYNAMIC STAND-BY COMPUTING FOR THE DATA COMPUTATION COMPLEX
- FLIGHT-TO-FLIGHT RECONFIGURATION
- PROJECTION PLOTTER DISPLAY
- VIDEO HARDCOPY SYSTEM
- VOICE INTERCOM SYSTEM

APOLLO 1966 - 1969

MAJOR SYSTEM COMPONENTS UPGRADED AND DRIVERS

- COMMUNICATIONS INTERFACE SYSTEM
- INCREASED COMMUNICATIONS BANDWIDTH
- DATA COMPUTATION COMPLEX
- INCREASED TRAJECTORY AND MISSION PLANNING NEEDS

INNOVATIONS

- FLIGHT CONTROLLERS RETURN FROM REMOTE SITES TO PERFORM EXCLUSIVE CONTROL FROM THE MCC
- APOLLO LUNAR SURFACE EXPERIMENT PACKAGE (ALSEP) CONTROL ROOM ADDED, PROVIDING EIGHT YEARS OF 24 HOUR PER DAY COVERAGE
- DUAL FLOOR OPERATIONS

SKYLAB/ASTP 1970 - 1976

MAJOR SYSTEM COMPONENTS UPGRADED AND DRIVERS

- CONSOLE DIGITAL TV SYSTEM UPGRADED TO DIGITAL TELEVISION EQUIPMENT SYSTEM
- INCREASED CAPACITY
- COMMUNICATIONS INTERFACE SYSTEM
- INCREASED COMMUNICATIONS BANDWIDTH
- DATA COMPUTATION COMPLEX
- INCREASED TRAJECTORY AND MISSION PLANNING NEEDS
- NEAR REAL TIME DATA BASE, MCC DATA RETRIEVAL SYSTEM (MDRS)

MAJOR INNOVATIONS

- FIRST INTERACTIVE TERMINAL SYSTEM, MISSION OPERATIONS PLANNING SYSTEM (MOPS)
- REMOTE SITE DATA COMPRESSION, TO INCREASE DATA TRANSFER ON LIMITED COMMUNICATIONS BANDWIDTHS
- COMPUTER OUTPUT MICROFILM (COM) FACILITY

MCC DATA SYSTEM OVERVIEW

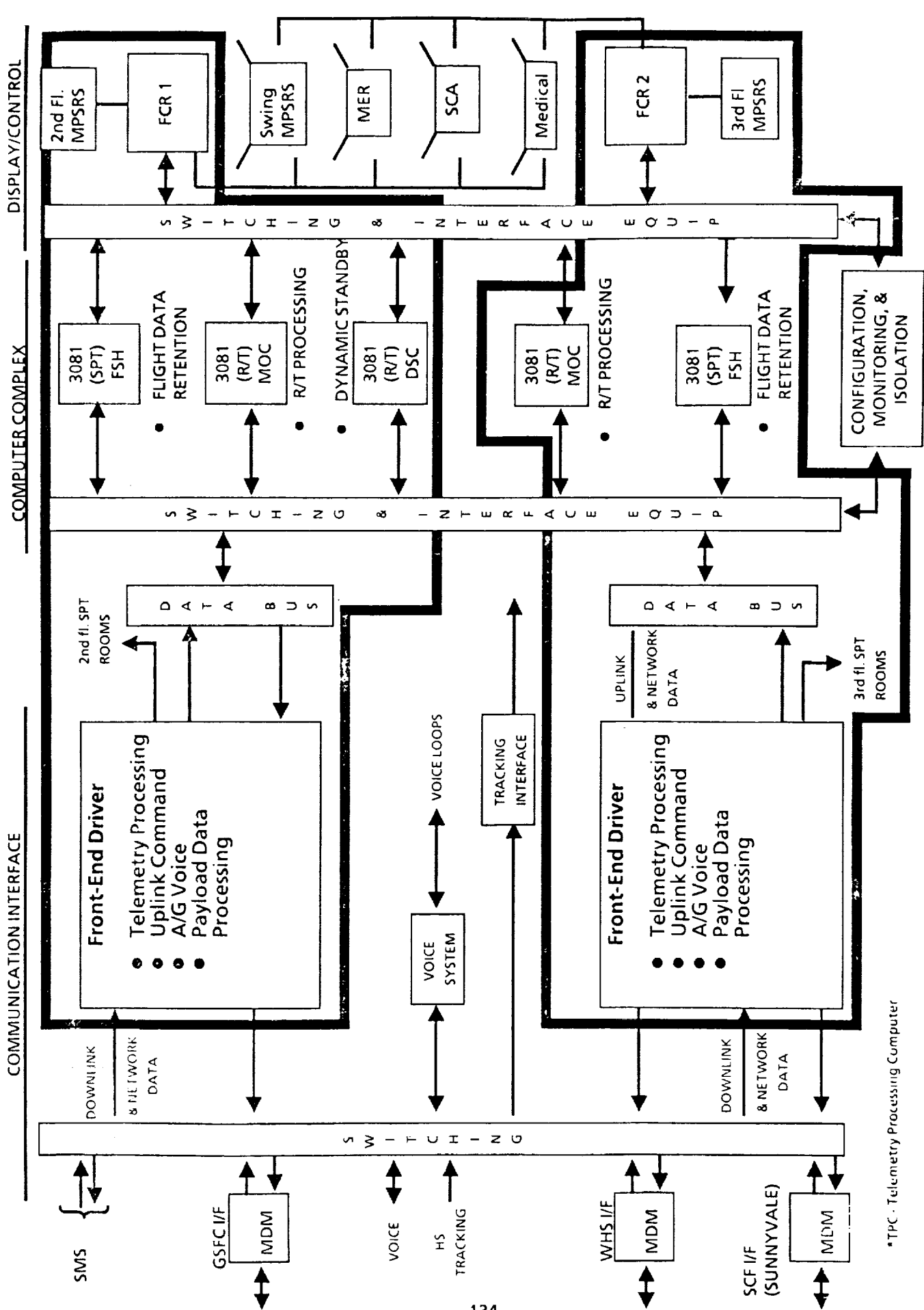

*TPC - Telemetry Processing Computer

FIGURE 1

L-16

SPACE SHUTTLE 1977 - 1985

MAJOR SYSTEM COMPONENTS UPGRADED AND DRIVERS

- COMMUNICATIONS INTERFACE SYSTEM
- NASCOM NETWORK CHANGES
- SHUTTLE AVIONICS COMPLEXITY
- DATA COMPUTATION COMPLEX
- INCREASED PROCESSING LOADS
- DISPLAY CONTROL SYSTEM
- DIGITAL TELEVISION EQUIPMENT OBSOLESCENCE
- INCREASED CAPACITY
- CONSOLE CAPACITY INCREASES

MAJOR INNOVATIONS

- APPROACH AND LANDING DATA SYSTEM (ALTDs)
- ONBOARD SOFTWARE DEVELOPMENT FACILITY, CONVERTED TO THE SOFTWARE PRODUCTION FACILITY (SPF) AND MOVED FROM THE MCC IN 1979
- DOD CONTROL MODE 1979 - 1990
- THIRD FLOOR SUPPORT ROOMS AND MISSION OPERATIONS CONTROL ROOM HAD BEEN INACTIVE FROM 1973 UNTIL 1979
- PAYLOAD DATA STRIPPING AND FORWARDING TO JSC-REMOTE PAYLOAD CONTROL FACILITIES
- ADDITION OF WEATHER COMPUTATIONAL RESOURCES

SPACE SHUTTLE 1986 - 1992

MAJOR SYSTEM COMPONENT ADDED

- DISTRIBUTED SYSTEM

MAJOR SYSTEM COMPONENTS UPGRADED AND DRIVERS

- COMMUNICATIONS INTERFACE SYSTEM
- VOICE INTERCOM SYSTEM REPLACED WITH DIGITAL VOICE INTERCOM SYSTEM TO SOLVE OBSOLESCENCE AND REDUCE MAINTENANCE COSTS
- DATA COMPUTATION COMPLEX
- MISSION OPERATIONS COMPUTER CAPACITY INCREASE AND OBSOLESCENCE
- DISPLAY CONTROL SYSTEM
- PROJECTION PLOTBOARD DISPLAY TO SOLVE OBSOLESCENCE

MAJOR INNOVATIONS

- DISTRIBUTED SYSTEM
- REAL-TIME FAILURE ANALYSIS TOOLS
- CORPORATE MEMORY CAPTURE
- FIBER OPTICS DISTRIBUTION SYSTEM
- THE PAYLOAD SUPPORT SYSTEM AND MULTI-PROGRAM CONTROL CENTER
- THIRD FLOOR OF THE MCC RECONFIGURED TO SUPPORT NON-DOD SHUTTLE MISSIONS
- DIGITAL VOICE SYSTEM

THE CURRENT UPGRADE ERA, 1986 - 1992

- UPGRADE HIGHLIGHTS

- THE TECHNOLOGY

UPGRADE HIGHLIGHTS

● MCC UPGRADE ACCOMPLISHMENTS

- REPLACED 5 MAINFRAME COMPUTERS AND THE ASSOCIATED INPUT/OUTPUT DATA INTERFACES WHICH ALLOWED REMOVAL OF OBSOLETE AND EXPENSIVE TO MAINTAIN EQUIPMENT FROM THE MCC AND PROVIDED MAINFRAME CAPACITY TO CONTINUE THE UPGRADE AND TO IMPLEMENT REQUIRED CHANGES.
- DEVELOPED/INSTALLED A DISTRIBUTED DATA SYSTEM WITH 81 WORKSTATIONS, FIVE 100 MBPS LAN'S, DATA DRIVERS, AND A FIBER OPTIC DISTRIBUTION SUBSYSTEM.
- DEVELOPED OVER 1.5 MILLION LINES OF CODE TO SUPPORT NEW DISTRIBUTED SYSTEM.
 - WORKSTATION SOFTWARE ENVIRONMENT THAT ALLOWS USERS TO EXECUTE USER DEVELOPED SOFTWARE.
 - CENTRALIZED CONFIGURATION MANAGEMENT THAT ALLOWS QUALITY (CONTROL AND CERTIFIED USE) OF VARIOUS MISSION SPECIFIC USER PROGRAMS.

UPGRADE HIGHLIGHTS

- FULL RATE TELEMETRY DATA AVAILABLE TO USERS (WORKSTATION AND MOC).
- SIGNIFICANTLY ENHANCED NEAR REAL-TIME DATA AVAILABLE TO USER AND PROVIDED ACCESS TO THE ENGINEERING COMMUNITY.
- DEVELOPED STATE-OF-THE-ART DIGITAL VOICE SYSTEM WHICH PROVIDES THE MCC CAPACITY TO HANDLE THE SHUTTLE PROGRAMS DEMANDS AND GROWTH POTENTIAL TO HANDLE SPACE STATION.
- REPLACED FAILING DIGITAL TELEVISION EQUIPMENT (DTE) WITH DIGITAL GENERATION EQUIPMENT (DGE).
- REPLACED OBSOLETE CENTER SCREEN PROJECTOR.
- PROVIDED THE PLATFORM FOR THE MULTI-PROGRAM CONTROL CENTER.

UPGRADE HIGHLIGHTS

- **USERS EVALUATION OF BENEFITS GAINED FROM INCREASED CAPACITY, HOST CONNECTIVITY AND WORKSTATION AVAILABILITY.**
- **CAPACITY PROVIDED ADDITIONAL COMPUTATIONS THAT ALLOW USERS TO BETTER MONITOR FLIGHT DATA (UNIVERSAL PLOTS, MAIN ENGINE PERFORMANCE DRIFT COMPUTATION, HELIUM TIME OF DEPLETION, UNIVERSAL TIMERS, ETC.)**
- **CONNECTIVITY (HOST TO WORKSTATION) ALLOWED TO COMBINE HOST DATA WITH LOCAL DATA BASES TO GENERATE DATA TO INPUT TO THE MOC (UPLINK COMMAND LOADS, GROUND SYSTEMS COMMANDS, ETC) AND ALLOWED EASY DIRECT ACCESS TO NEAR REAL-TIME DATA FOR RAPID REVIEW AND PLOTTING OF DATA FROM CURRENT AND PAST FLIGHTS.**
- **WORKSTATIONS ALLOWED USERS TO COMBINE LOCAL DATA BASES, GROUND SYSTEM DATA, AND REAL-TIME DATA IN LOCAL COMPUTATIONS (RECOMMENDED ONBOARD CONFIGURATION CHANGES, FREON COOLANT LOOP LEAK, CABIN PRESSURE LEAK, CRYOGENIC CONSUMABLES, CONSUMABLE ANALYSIS PROGRAMS, INTEGRATION OF PRE-FLIGHT ANALYSIS WITH REAL-TIME COMPUTATIONS, ETC.)**

MCCU MAJOR SOFTWARE DELIVERY SUMMARY

- DELIVERY 1.2 9/86 INITIAL MOC SOFTWARE UPGRADES ASSOCIATED WITH 3083JX COMPUTER UPGRADE, INCLUDING THE MVS/XA ENVIRONMENT.
- DELIVERY 1.3 4/87 COMPLETED THE SOFTWARE ASSOCIATED WITH THE 3083JX UPGRADE, INCLUDING RTX UPGRADE, NRT RETENTION, AND CENTER INFORMATION NETWORK CONNECTIVITY.
- DELIVERY 2.1 6/88 CONCEPTUAL EVALUATION UTILIZING EARLY WORKSTATION AND LOCAL AREA NETWORK CONFIGURATION (SUPPORTED STS-26 MISSION IN NONCRITICAL PHASES).
- DELIVERY 2.3 6/89 PROVIDED OPERATIONAL MCCU WORKSTATIONS WITH LIMITED REALTIME DATA AND GENERAL PURPOSE LOCAL AREA NETWORK CONNECTIVITY (33 OPERATIONAL WORKSTATIONS).

MCCU MAJOR SOFTWARE DELIVERY SUMMARY

- DELIVERY 2.5 1/91 PROVIDED OPERATIONAL MCCU WORKSTATIONS WITH FULL UP REALTIME AND GENERAL PURPOSE LOCAL AREA NETWORK CONNECTIVITY (66 OPERATIONAL WORKSTATIONS).**
- DELIVERY 2.7 4/92 WILL PROVIDE FULL DUAL OPERATIONS FOR THE MCC AND REFINES THE STATUS AND CONTROL SUPPORT. FINAL WORKSTATION COUNT IS 81.**

MCC System Overview

June 1991

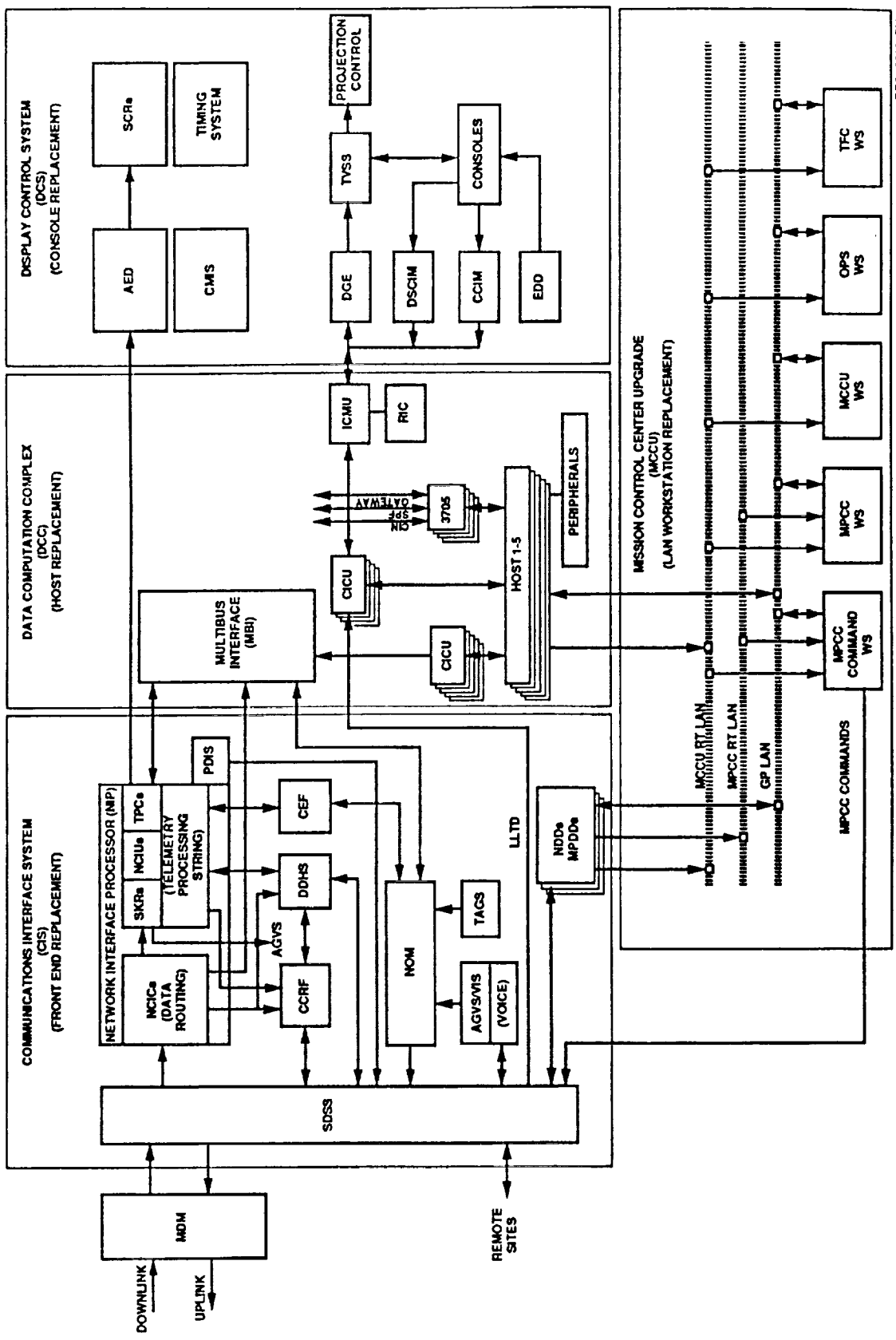

PR2168-017M

THE TECHNOLOGY

REPLACEMENT HISTORY OF JSC HOST COMPUTER SYSTEMS

OPERATIONAL DATE	MACHINE	MIPS	REPLACED	
1964	7094	0.75	1967	
1967	360/75	1.0	1976	
1976	370/168	3.1	1986	
1986	3083-JX	8	1987 UPGRADED	SUPPORTED RETURN TO FLIGHT
1989	3081-KX	15.4	PROJECTED 1997	

MCCU LAN ARCHITECTURE

TOKEN RING ARCHITECTURE

- FIVE 100 MBPS TOKEN RING LANS---SUBDIVIDED INTO FOUR, 25 MBPS CHANNELS FOR EACH RING.
- 2 EA. GENERAL PURPOSE (GP) FILE TRANSFER LANS.
2 EA. REAL-TIME DATA (RT) TELEMETRY DATA LANS (LISTEN ONLY).
1 EA. PAYLOAD REAL-TIME (MPCC) PAYLOAD TELEMETRY DATA LAN.
- EACH GP/RT LAN PAIR HAS A PRIME AND BACK UP NETWORK MANAGEMENT CONTROLLERS
 - NETWORK STATUS AND CONTROL
 - NETWORK DIAGNOSTICS
 - DIRECTORY SERVICES

PLANS Equipment, Overall Block Diagram for Delivery 2.7

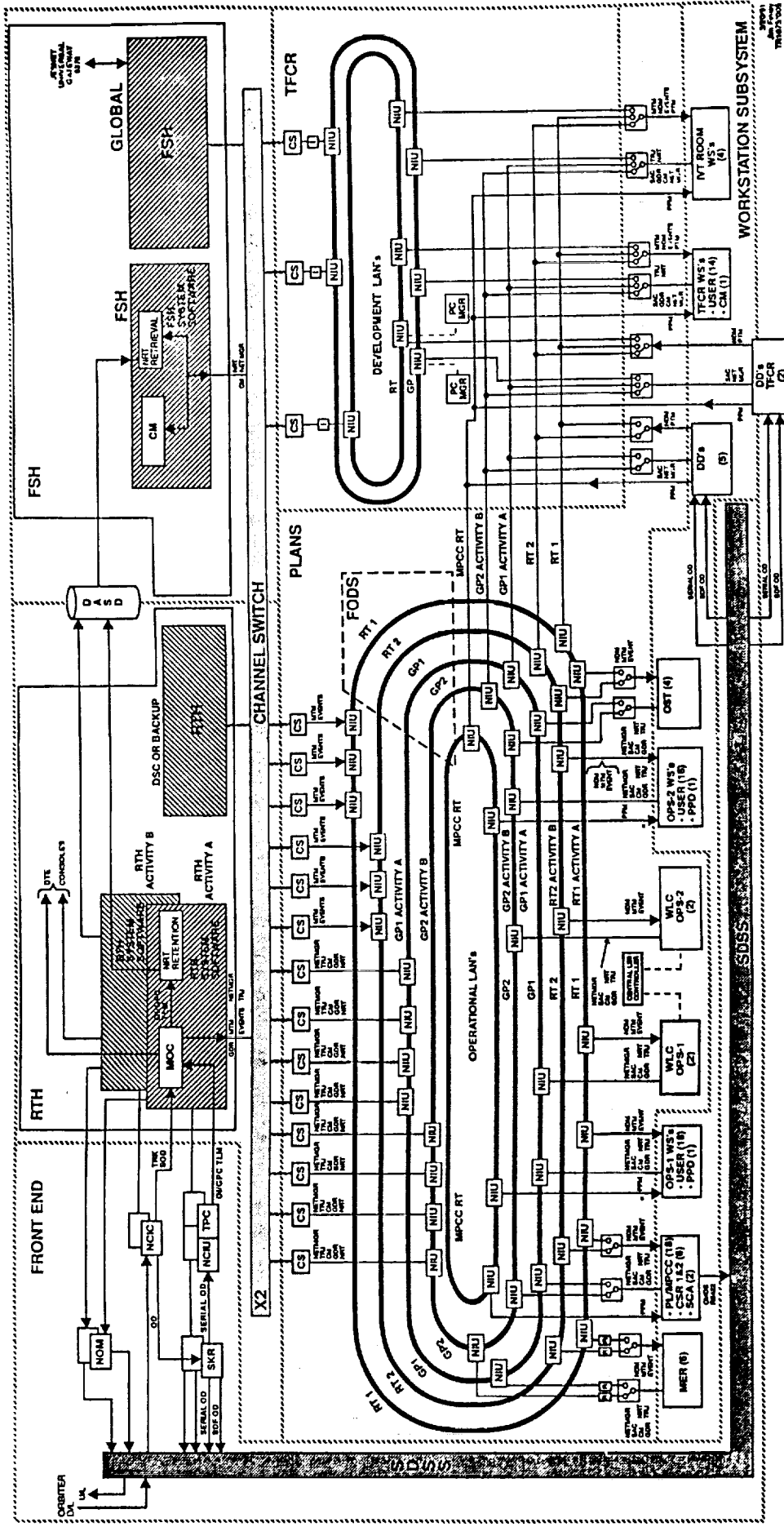

- NOTES:**
- WS = WORKSTATION
 - CS = COMSERVER
 - NIU = NETWORK INTERFACE
 - OP = OPERATIONAL PURPOSE LAN
 - PT = PAYLOAD
 - MGCR = MANAGER
 - WLC = WSLAM CONTROLLER
 - TR = TRU/RADAR
 - TR = REPEATER
 - TR = ONLY FOR TRAJ
- NOTE 1:**
- WS QUANTITIES INCLUDE ETSOC SR ADAPTIONS THAT SHOULD BE AVAILABLE AT 2.7 FAR
- LEGEND:**
- PRIER OPTIC CABLES BETWEEN NIU'S
 - - - RZ322/RS422 CABLES
 - ETHERNET TRANSMITTER CABLES FROM NIU'S TO WS'S & DO'S
 - LAN SELECT SWITCH
 - DATA FLOW DIRECTION OF ARROW ONLY
 - ↔ MULTIPURPOSE CONTROL

Figure 1-1. PLANS Equipment, Overall Block Diagram for Delivery 2.7

MCCU LAN ARCHITECTURE

SUBNET ARCHITECTURE

- EACH TOKEN RING HAS ETHERNET (10 MBPS) WORKSTATION, HOST AND DATA DRIVER SUBNETS.
- LAN-TO-WORKSTATION CONNECTIVITY IS VIA LAN SELECT SWITCH (LSS) CONTROL, CONTROLLED BY THE NETWORK MANAGER.
- COMM SERVERS (14 EACH)
 - PROVIDES CHANNEL INTERFACE BETWEEN HOST COMPUTERS AND LANS.
 - PROVIDES METERING AND BUFFERING TO CONTROL BURST RATE OF TRANSMISSION FROM HOST TO LAN.

MCCU LAN ARCHITECTURE

MECHANICAL

- ALL TOKEN RINGS USE 100/140 OR 62.5/125 MULTIMODE FIBER OPTIC CABLE.
- TOKEN RING NETWORK INTERFACE UNITS (NIU'S) USE A PROPRIETARY PROTOCOL (ARTEL), WITH LED (850 NM) TRANSMITTER/RECEIVERS.
- EACH NIU OUTPUTS ETHERNET TO A MULTIPORT TRANSCEIVER PROVIDING "FAN-OUT" FOR UP TO 6 EA. DEVICES (WORKSTATIONS, DATA DRIVERS, COMMSERVER-TO-HOST COMPUTERS, ETC.).
- ALL UNITS ARE HOUSED IN COTS CABINETS WITH CUSTOMIZED, DUAL AC POWER INPUTS.
- ALL FIBER IS WITHIN CONDUIT OR IS HEAVY DUTY PACKAGED, TERMINATING AT FIBER PATCH PANELS (ST TYPE).

MCCU WORKSTATION SOFTWARE ARCHITECTURE

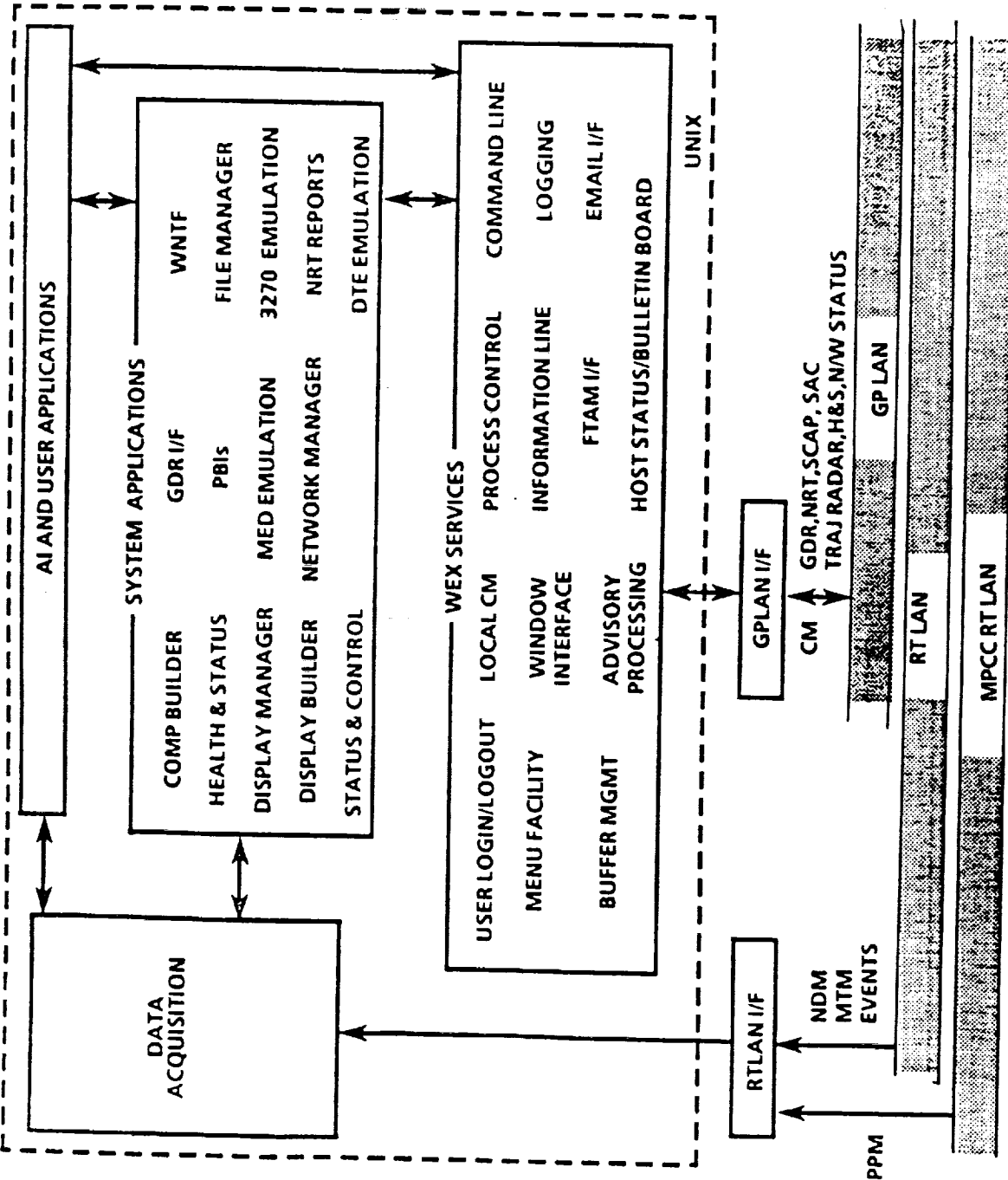

WORKSTATION SYSTEM SOFTWARE

- OPERATING SYSTEM
- CONCURRENT'S REAL TIME UNIX (RTU) VERSION 5.0
- AT&T SYSTEM 5 RELEASE 3 COMPATIBLE
- ENHANCEMENTS FOR REAL TIME PROCESSING
 - INDEPENDENT MULTIPLE CPU'S
 - FIXED PRIORITY SCHEDULER
 - FASTER IN MEMORY PIPES
 - FILE SYSTEM ENHANCEMENTS
 - MEMORY LOCKING
 - SHARED MEMORY REGIONS
 - ASYNCHRONOUS SYSTEM TRAPS (AST)
- LAYERED PRODUCTS
- OSI COMPLIANT LAN APPLICATIONS
- OSF STANDARD X-WINDOWS W/S TO USER INTERFACE, RELEASE 4.0
- LANGUAGES
 - C
 - FORTRAN

WEX OVERVIEW

- WORKSTATION EXECUTIVE (WEX) IS A BASE OF COMMON SERVICES WHICH PROVIDES A CONTROLLED ENVIRONMENT FOR MCC WORKSTATIONS
- GUIDES THE USERS TO CORRECT CHOICES IN SELECTING THE WEX ENVIRONMENT
- PREVENTS UNAUTHORIZED USERS FROM GAINING ACCESS TO WEX AND THE WORKSTATION VIA CONTROLLED ACCESS TO THE HOST COMPUTERS AND LAN
- THREE ACCESS MODES
 - DEVELOPMENT
 - CERTIFICATION
 - OPERATIONAL
- USER INTERFACE IS THE RESPONSIBILITY OF THE SOFTWARE APPLICATIONS (I.E. MEDS, DTE, COMP BUILDER, DISPLAY BUILDER...)
- PROVIDE SOFTWARE CONFIGURATION MANAGEMENT OF THE WORKSTATION
 - ALL RECONFIGURATION TABLES REQUIRED TO SUPPORT THE MISSION
 - ALL DISPLAYS BUILT PRE-MISSION
 - ALL SYSTEM SOFTWARE REQUIRED TO DEFINE THIS POSITION
- UNCERTIFIED SOFTWARE IS NOT ALLOWED TO RUN



Print KLogin ?

281.3. WEX Ver 05.14.00.0001.01.1

userid	Blank	Flight	51m
password		Data mode	51m
position	Blank	Startup File	

Active LAR is OPEN
CM Database Mode: Pending
Available Flights
237 on CM

Fri: May 17 10:09:04 1991

Access Type CM Database Software Certification Level

Operational 51m Simulation Test

Workstation Flight Support mode is Development

Other Terminals None Sol BarnardStar Wolf359

[Click to Log In](#)

Flight	51m
Data mode	51m
Startup File	
Access Type	Operational
Software Certification Level	Simulation
Other Terminals	None

ORIGINAL PAGE IS OF POOR QUALITY



term

LUG
STAT
EXlogstat

term

claint

- Process CDILs
- Delete from database
- Download
- Download List
- Upload Add
- Upload Replace

Redisplay Inputs - off

Clear fields

Configuration Management ?



CM Database: OPERATIONAL

File name	<input type="text"/>						
File type	<input type="text"/>						
Function	<input type="text"/>						
Group	<input type="text"/>						
Version	<input type="text"/>	Most Recent					
Flight IDs	<input type="text"/>	<input type="text"/>	<input type="text"/>	<input type="text"/>	<input type="text"/>	<input type="text"/>	<input type="text"/>
CPU ID	<input type="text"/>						
Restricted Download	<input type="text"/>	Yes	No				
Certification Level	<input type="text"/>	Mission	Sim	Test			- Cert Level
Upload Directory	<input type="text"/>					Replicate Directory	
Download Directory	<input type="text"/>					WEX Directories	
SETUID Bit	<input type="text"/>	Yes	No				
SETGID Bit	<input type="text"/>	Yes	No				
Access ID	<input type="text"/>						
Access Password	<input type="text"/>						

ENTER

term

term

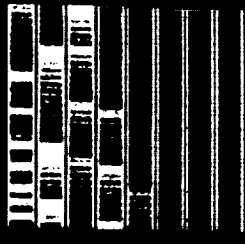

DATA ACQUISITION

- CONTROLS AND SERVICES ALL REAL TIME (RT) LAN DATA
- CONVERTS ALL INPUT DATA TO A COMMON FORMAT
- CONTROLS ALL SHARED MEMORY ACTIVITY
- CURRENT DATA SOURCES:
 - DECOMMUTATED & CALIBRATED TELEMETRY (TLM) DATA FROM RTH
 - RAW TLM DATA FROM NETWORK DATA DRIVER (NDD)
 - HOST EVENT DATA, PROCESSED DISCRETE TLM
 - GENERALIZED DATA RETRIEVAL (GDR)
- PROVIDES INTERFACE FOR ALL RT SYSTEM APPLICATIONS
 - DISPLAY BUILDER/MANAGER
 - COMPUTATION BUILDER/MANAGER
 - EXPERT & ARTIFICIAL INTELLIGENCE (AI) APPLICATIONS
- SUPPORTS TWO SIMULTANEOUS SELECTABLE STREAMS FOR A SINGLE FLIGHT.

DISPLAY BUILDER/DISPLAY MANAGER

A SOFTWARE TOOL TO SUPPORT FLIGHT OPERATIONS IN THE CREATION OF GRAPHICAL AND TABULAR DISPLAYS TO MONITOR TELEMETRY DATA

DISPLAY BUILDER - (DEVELOPMENT MODE)

- USERS CREATE DISPLAYS USING GRAPHICS EDITOR TOOL THEN ATTACHES TELEMETRY IDENTIFIERS TO EACH DYNAMIC FIELD
- DYNAMIC TABULAR AND GRAPHIC CAPABILITIES
- CRITICAL AND OPERATIONAL LIMITS DEFINABLE
- DISPLAY FILES CREATED AND STORED FOR USE BY THE DISPLAY MANAGER

DISPLAY MANAGER - (OPERATIONAL MODE)

- PROVIDES USER INTERFACE TO INVOKE DISPLAYS CREATED BY THE DISPLAY BUILDER
- PROVIDES IMPLICIT CONNECTION TO TELEMETRY DATA STREAMS
- DATA REPRESENTED BY VALUE AND COLOR TO HIGHLIGHT VALUES THAT EXCEED LIMITS
- ALLOWS DYNAMIC OVERRIDE OF OPERATIONAL LIMITS SPECIFIED DURING BUILD

EGIL FC/EPDC/CRYO

TABULAR MAIN MENU - REV 2.5-13

OC	-1A-	-2B-	-3C-	TOTAL	MPS	MI	ff.f's	METER	ALFCH	STAR
FC MI	ff.f's	ff.f's	ff.f's	FUEL	OUT T	STK IN T	STK OUT T	FM	H O	LM
FC MPS	dash	dash	dash	EXIT	CL	PREP	P	SP	H O P	
FC MPS	dash	dash	dash	CL	IN T	CL	OUT	ALT	H O T	
FC MPS	dash	dash	dash	CL	PREP	P		ALT	H O T	
FC LID	dash	dash	dash	H: MTR	M: MTR	O: MTR	O: MTR	RF	MV T	dash
MS TE	dash	dash	dash	O: MTR	O: MTR	O: MTR	O: MTR	RF	LN T	dash
FC VOC	dash	dash	dash	W: MTR	W: MTR	W: MTR	W: MTR	RF	MZ T	dash
MI VOC	dash	dash	dash	H: MTR	H: MTR	H: MTR	H: MTR	RF	MZ T	dash
MD VOC	dash	dash	dash	W: MTR	W: MTR	W: MTR	W: MTR	RF	MZ T	dash
MT VOC	dash	dash	dash	H: MTR	H: MTR	H: MTR	H: MTR	RF	MZ T	dash
R SB	dash	dash	dash	W: MTR	W: MTR	W: MTR	W: MTR	RF	MZ T	dash
L SB	dash	dash	dash	H: MTR	H: MTR	H: MTR	H: MTR	RF	MZ T	dash
ES VOC	dash	dash	dash	W: MTR	W: MTR	W: MTR	W: MTR	RF	MZ T	dash
ES MPC	dash	dash	dash	H: MTR	H: MTR	H: MTR	H: MTR	RF	MZ T	dash

MSID:

SAMPLE: L SOURCE: MTM

PPL FILE NUMBER: 0

PPL OCCURENCE NUMBER: 0

OPER LOWER

OPER UPPER

NOMINAL: STATIC:

DEAD: OVERIDE:

MAX ROW: 38 MAX COL: 99

MSID:

SAMPLE: L SOURCE: MTM

PPL FILE NUMBER: 0

PPL OCCURENCE NUMBER: 0

OPER LOWER

OPER UPPER

NOMINAL: STATIC:

DEAD: OVERIDE:

ORIGINAL PAGE IS
OF POOR QUALITY

349:74:93:83:96
349:74:93:83:96

PI 1 PH LCK	PSP 1 POWER	GPC 1 FAIL	GPC 2 FAIL
PI 2 PH LCK	PSP 2 POWER	GPC 3 FAIL	GPC 4 FAIL

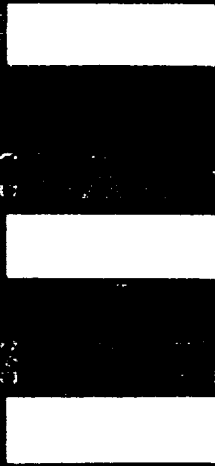

PC : 59
GMP5



DEJG	DEJG	349	3
599	599	349	3
599	599	349	3
		599	5
		599	5

599	59.6	F
599	59.6	F
599	59.6	F
F		
FJJGH	FJJGH	FJJGH
FJJGH	FJJGH	FJJGH
FJJGH	FJJGH	FJJGH

COMP BUILDER/COMP MANAGER

A SOFTWARE TOOL DESIGNED TO SUPPORT FLIGHT OPERATIONS IN THE CREATION AND INVOCATION OF COMPUTER PROGRAMS

COMP BUILDER - (DEVELOPMENT MODE)

- COMPS EXPRESSED IN IF-THEN-ELSE AND WHILE-LOOP-STATEMENTS USING STRUCTURED HIGH-LEVEL LANGUAGE
- TRANSLATES HIGH-LEVEL LANGUAGE TO "C" SOURCE CODE
- VALIDATES SYNTAX AND/OR FILE OPERATIONS
- COMPILES, LINKS AND STORES EXECUTABLE CODE FOR USE BY COMP MANAGER

COMP MANAGER - (OPERATIONAL MODE)

- PROVIDES USER INTERFACE TO INVOKE AND CONTROL COMPS CREATED BY THE COMP BUILDER
- PROVIDES IMPLICIT CONNECTION TO TELEMETRY DATA STREAM
- OUTPUT FROM COMPS ROUTED DIRECTLY TO W/S MONITOR OR STORED IN SHARED MEMORY TO SUPPORT OTHER COMPS OR APPLICATIONS

WORKSTATION HEALTH & STATUS

A SOFTWARE APPLICATION TO STATUS AND DISPLAY WORKSTATION CONFIGURATION AND ACTIVITY IN REAL TIME

- COMPOSED OF 2 PARTS
 - COLLECTION PROCESS
 - DISPLAY PROCESS
- SUPPORTS LOCAL AND REMOTE USER INTERFACES
- TYPES OF INFORMATION PROVIDED
 - HARDWARE CONFIGURATION
 - SOFTWARE CONFIGURATION
 - PERFORMANCE METRICS
 - DEVICE STATUS (DISKS, PRINTERS)
 - APPLICATIONS HEALTH
- USES FOR INFORMATION PROVIDED INCLUDE...
 - WORKSTATION TROUBLE-SHOOTING AND FAULT ISOLATION
 - WORKSTATION TIMING AND STRESS STATISTICS
 - MONITORING OF LOCAL WORKSTATION AND DISTRIBUTED SYSTEMS ABILITY TO SUPPORT ACTIVITY

STATUS AND CONTROL (SAC)

- SAC CONSISTS OF THREE MAJOR ELEMENTS
- CAPABILITY TO REMOTELY STATUS ALL THE DATA DRIVERS FROM THE OST WORKSTATIONS
- CAPABILITY TO REMOTELY CONTROL THE MCCU LAN NETWORKS
 - CONFIGURATION CONTROL
 - PERFORMANCE MONITORING
 - TROUBLE DETECTION AND RESTORATION
- CAPABILITY TO EMULATE THE PRESENT CONSOLE BASED STATUS AND CONTROL FUNCTIONS

ORIGINAL PAGE IS
OF POOR QUALITY

NEW OR TOP

INFO: WOOD STATION SUMMARY STATUS DISPLAY

TOP

X

VSWN

WSP1	137 14 55 34
WSP2	137 14 55 34
WSP3	137 14 55 34
WSP4	137 14 55 34
WSP5	137 14 55 34
WSP6	137 14 55 34
WSP7	137 14 55 34
WSP8	137 14 55 34
WSP9	137 14 55 34
WSP10	137 14 55 34
WSP11	137 14 55 34
WSP12	137 14 55 34
WSP13	137 14 55 34
WSP14	137 14 55 34
WSP15	137 14 55 34
WSP16	137 14 55 34
WSP17	137 14 55 34
WSP18	137 14 55 34
WSP19	137 14 55 34
WSP20	137 14 55 34

WSP21	137 14 55 34
WSP22	137 14 55 34
WSP23	137 14 55 34
WSP24	137 14 55 34
WSP25	137 14 55 34
WSP26	137 14 55 34
WSP27	137 14 55 34
WSP28	137 14 55 34
WSP29	137 14 55 34
WSP30	137 14 55 34
WSP31	137 14 55 34
WSP32	137 14 55 34
WSP33	137 14 55 34
WSP34	137 14 55 34
WSP35	137 14 55 34
WSP36	137 14 55 34
WSP37	137 14 55 34
WSP38	137 14 55 34
WSP39	137 14 55 34
WSP40	137 14 55 34

WSP41	137 14 55 34
WSP42	137 14 55 34
WSP43	137 14 55 34
WSP44	137 14 55 34
WSP45	137 14 55 34
WSP46	137 14 55 34
WSP47	137 14 55 34
WSP48	137 14 55 34
WSP49	137 14 55 34
WSP50	137 14 55 34
WSP51	137 14 55 34
WSP52	137 14 55 34
WSP53	137 14 55 34
WSP54	137 14 55 34
WSP55	137 14 55 34
WSP56	137 14 55 34
WSP57	137 14 55 34
WSP58	137 14 55 34
WSP59	137 14 55 34
WSP60	137 14 55 34

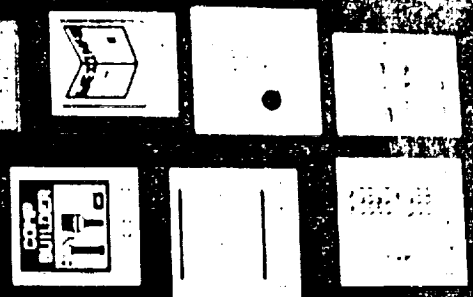

CONFIGURATION INFORMATION

NAME: MCF4
 STATUS: Unknown
 TYPE: 10: 0??
 MODE: DEVELOPMENT
 DATE: 137:14:55:34
 TIME: 05/07/91
 TIME: 03:21:31
 TIME: 05:14:30

STATUS AND INFORMATION

NAME: MCF4
 STATUS: Unknown
 TYPE: 10: 0??
 MODE: DEVELOPMENT
 DATE: 137:14:55:34
 TIME: 05/07/91
 TIME: 03:21:31
 TIME: 05:14:30

ORIGINAL PAGE IS
OF POOR QUALITY

NASA

MODE NAME: MOF4

FLIGHT: ???

TIME 137:14:53:14

CPU UTILIZATION

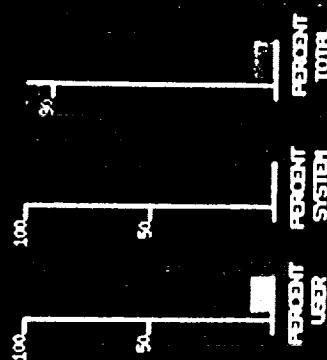

MEMORY UTILIZATION

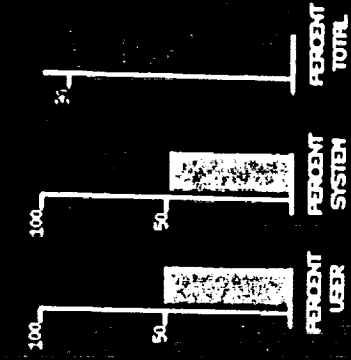

TOTAL PROCESSES 72
 TOTAL SYSTEM PROCESSES 57
 TOTAL USER PROCESSES 15

NUMBER OF USERS LOGGED ON 1

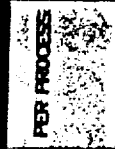

STATUS AND INFORMATION

SYSTEM SUMMARY

FILESYSTEM

NETWORK

INPUT/P



MODE NAME: MOF4

OPERATOR: Unknown

FLIGHT: ???

MODE: DEVELOPMENT

TIME 137:14:53:



TYPICAL MCCU WORKSTATION HARDWARE CONFIGURATION

- CONCURRENT 6600 SERIES WORKSTATIONS.
- 81 WORKSTATIONS INSTALLED IN MCC BY APRIL 1992.
- BUS ARCHITECTURE---VME AND MULTIBUS.
- 2 OR 3 68030 CPU's WITH ASSOCIATED 68882 SUPER LIGHTNING FLOATING POINT ARITHMETIC CO-PROCESSOR.
- 33MHZ CLOCK SPEED.
- 32 MEGABYTES OF MEMORY.
- 2 HARD DISKS FOR SECONDARY STORAGE:
 - 538 MEGABYTE
 - 330 MEGABYTE
- IEEE 802.3 ETHERNET LAN CONTROLLER BOARDS--(RT, GP, MPCC).
- HIGH DENSITY FLOPPY AND 1/2 INCH TAPE DRIVE.

TYPICAL MCCU WORKSTATION HARDWARE CONFIGURATION

- **LASER PRINTER.**
- **UP TO 4 INDEPENDENT GRAPHICS PROCESSORS EACH SERVING A 1024 x 1280 COLOR MONITOR/KEYBOARD/MOUSE.**
- **HOUSING FOR WORKSTATION ERGONOMICALLY DESIGNED FOR USER.**
- **CPU CABINETS STACKED TO PRESERVE FLOOR SPACE.**

ORIGINAL PAGE IS
OF POOR QUALITY

CONFIDENTIAL

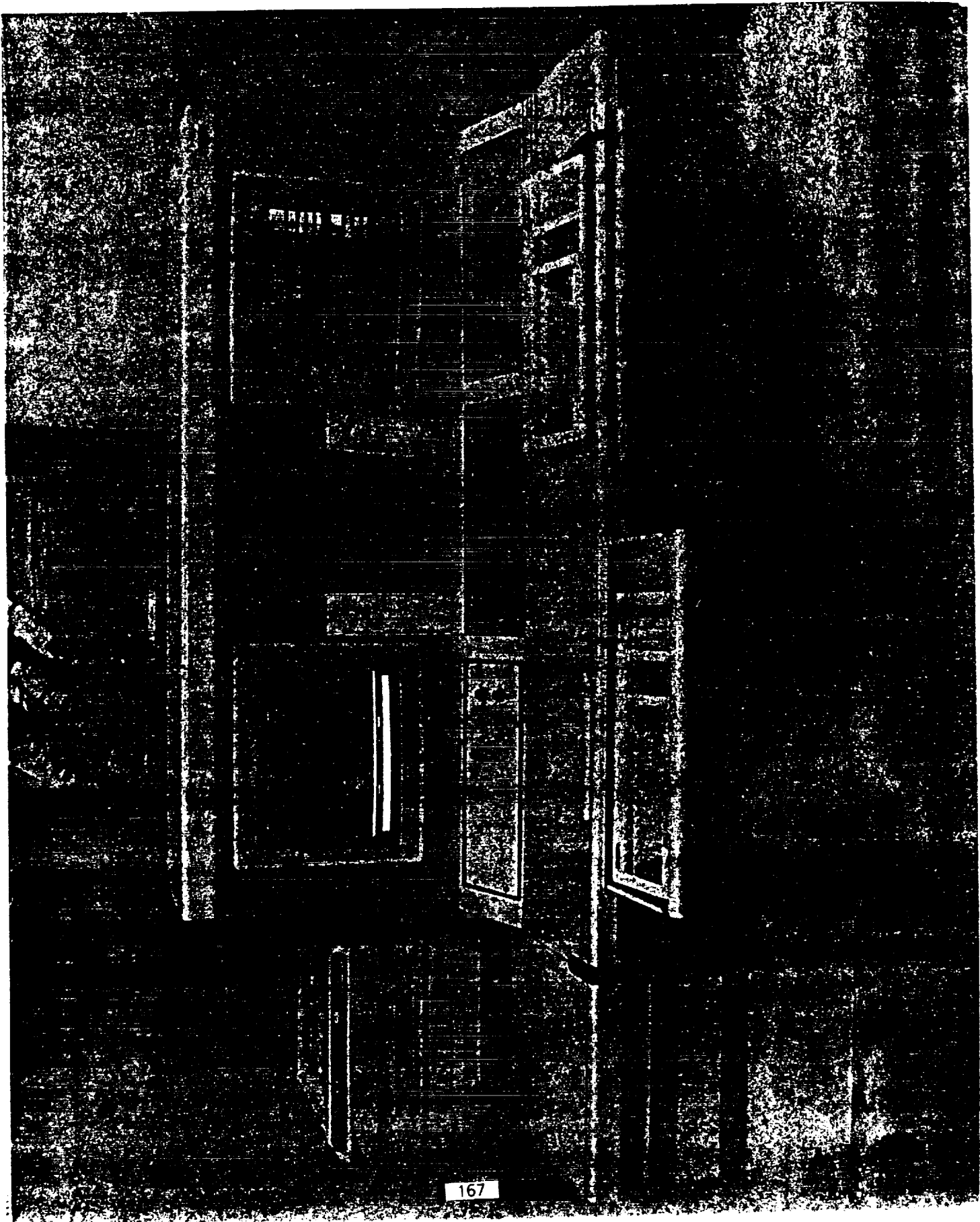

ORIGINAL PAGE IS
OF POOR QUALITY

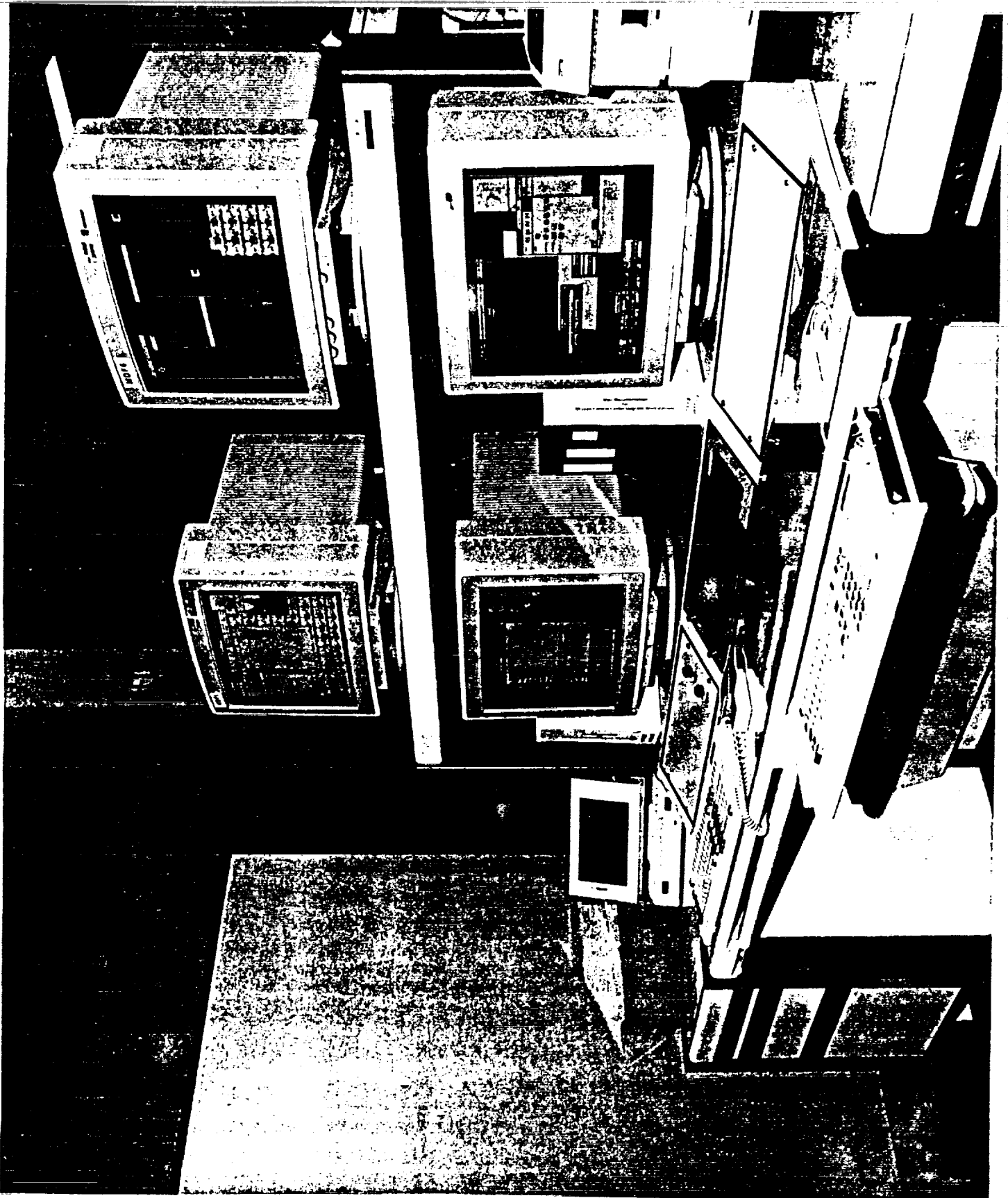

DATA DRIVER SUBSYSTEM

- THERE ARE 7 IDENTICAL DATA DRIVERS (DD's) IN THIS SUBSYSTEM AND WILL SUPPORT DUAL OPERATIONS
- EACH DD IS A CONCURRENT 6700 WORKSTATION (W/S)
 - EACH DD HAS FOUR 68030 CPU's
 - 4 FLOATING POINT ACCELERATORS
 - TWO 568 MBYTE HARD DISKS
 - FLOPPY DISK
 - 1/4 INCH TAPE (150 MB)
 - 32 MBYTE MEMORY
- DD INTERFACES WITH 5 LANS (TWO GP, TWO RT, ONE MPCC RT)
- DD WILL DOWNLOAD CM DATA BASE AND RECONFIGURATION PRODUCTS FROM FSH VIA WEX
- DD WILL FUNCTION AS NETWORK DATA DRIVER (NDD) AND MULTIPROGRAM DATA DRIVER (MPDD) CONCURRENTLY
- OUTPUTS PROCESSED PAYLOAD MESSAGES (PPM's) ON MPCC RT LAN
- OUTPUTS PROCESSED TLM MESSAGES (PTM's) AND/OR NETWORK DATA MESSAGES (NDM's) ON MCCU RT LAN

DATA DRIVER SUBSYSTEM

- THERE ARE 7 IDENTICAL DATA DRIVERS (DD's) IN THIS SUBSYSTEM AND WILL SUPPORT DUAL OPERATIONS
- EACH DD IS A CONCURRENT 6700 WORKSTATION (W/S)
 - EACH DD HAS FOUR 68030 CPU's
 - 4 FLOATING POINT ACCELERATORS
 - TWO 568 MBYTE HARD DISKS
 - FLOPPY DISK
 - 1/4 INCH TAPE (150 MB)
 - 32 MBYTE MEMORY
- DD INTERFACES WITH 3 LANS (GP, RT, MPCC RT)
- DD WILL DOWNLOAD CM DATA BASE AND RECONFIGURATION PRODUCTS FROM FSH VIA WEX
- DD WILL FUNCTION AS NETWORK DATA DRIVER (NDD) AND MULTIPROGRAM DATA DRIVER (MPDD) CONCURRENTLY
- OUTPUTS PROCESSED PAYLOAD MESSAGES (PPM's) ON MPCC RT LAN
- OUTPUTS PROCESSED TLM MESSAGES (PTM's) AND/OR NETWORK DATA MESSAGES (NDM's) ON MCCU RT LAN

DIGITAL VOICE INTERCOM SYSTEM

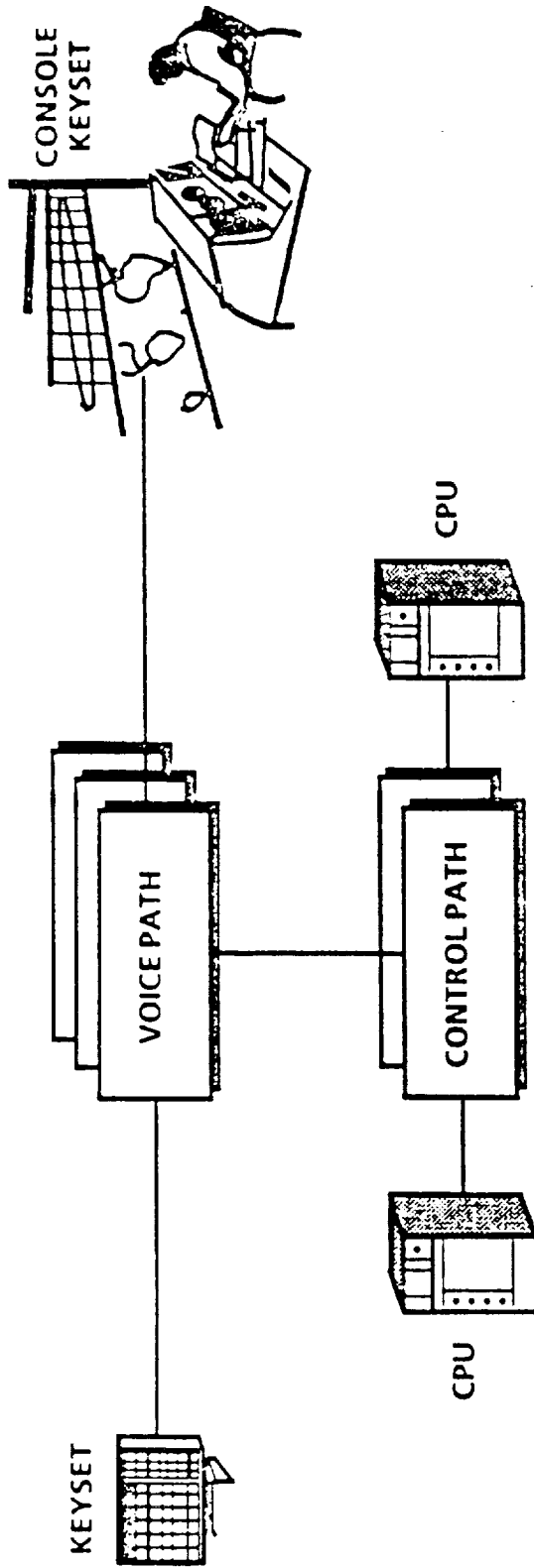

- REDUNDANCY
- SYSTEM HEALTH AND STATUS
- ON-LINE TESTING
- LINE REPLACEABLE UNIT FAULT ISOLATION

DVIS IS DESIGNED FOR CONTINUOUS MISSION SUPPORT

DVIS NEW-GENERATION ARCHITECTURE CONCEPTS

- FIXED-FORMAT, SYNCHRONOUS, TIME-DIVISION MULTIPLEXER
- SYSTEM WILL HAVE 2 TIME-DIVISION MULTIPLEXED DATA BUSES...EXPANDABLE TO 4 BUSES
 - BUS RATE 12.288 MBYTES/SEC. (EACH)
 - 1520 PORTS PER BUS...2 BUSES = 3040 PORTS AVAILABLE
- AUDIO INPUTS ASSIGNED FIXED SLOT IN MULTIPLEXER
- AUDIO OUTPUTS INTERFACED TO TDM BUSES
 - DESIRED VOICE SAMPLES CAPTURED FROM BUSES AND SUMMED
 - CONFERENCES FORMED BY EACH LISTENER SUMMING ALL OTHER PARTIES ON THE CONFERENCE
- INTELLIGENT KEYSET
 - MULTIPAGE DISPLAY
 - REAL-TIME RECONFIGURATION
 - MULTILEVEL SECURE OPERATIONS

DVIS

CONCEPT OF OPERATION

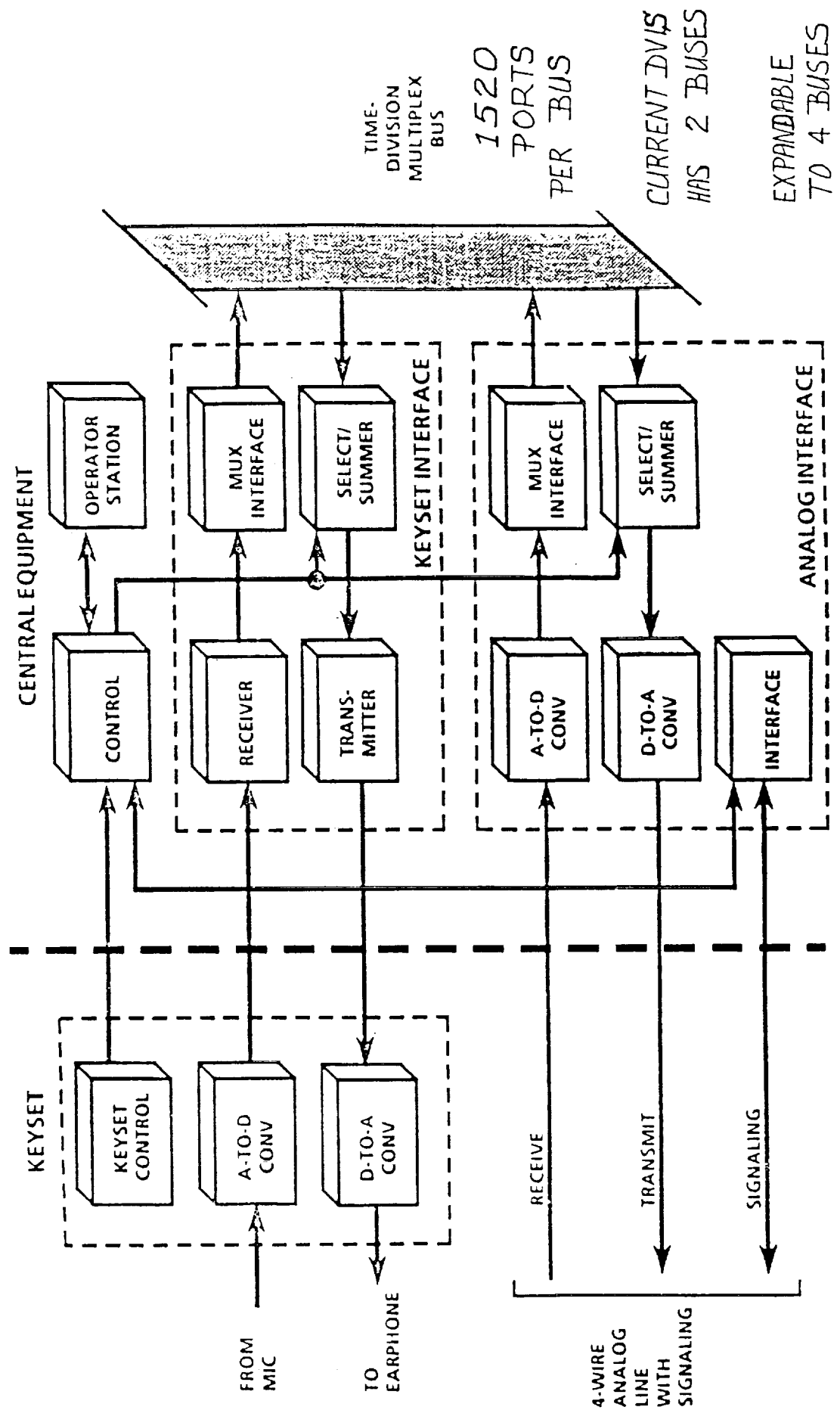

TIME-DIVISION MULTIPLEX BUS

1520 PORTS PER BUS

CURRENT DVIS HAS 2 BUSES

EXPANDABLE TO 4 BUSES

COMPARISON CHART -- OLD JSC VOICE SYSTEM VS NEW DVIS

FEATURE	OLD JSC VOICE	NEW DVIS
NUMBER OF KEYSETS THE SYSTEM COULD HANDLE	500	3040
ACTUAL NUMBER OF KEYSETS REQUIRED	500	850 - INCLUDES MCC, SCCC, OTHERS
NUMBER OF INDIVIDUAL WIRE CONNECTIONS THAT HAVE TO BE MADE BETWEEN MISSIONS FOR NEW CONFIGURATIONS	300-3000	0
AMOUNT OF FLOOR SPACE REQUIRED FOR SYSTEM EQUIPMENT	3100 SQ. FT.	1400 SQ. FT.
AMOUNT OF TIME REQUIRED TO PERFORM RECONFIGURATION BETWEEN MISSIONS	6-8 WEEKS	ESTIMATE FROM A FEW MINUTES TO AN HOUR DEPENDING ON EXTENT OF CHANGE
REAL TIME RECONFIGURABLE FROM KEYSET BY OPERATOR	NO	YES
MAX NUMBER OF USERS THAT CAN SIMULTANEOUSLY ACCESS A CONFERENCE	250	3040
MULTIPLE VIRTUAL INTERCOMS --- (PARTITION CAPABILITY)	NO	YES
USERS CONFIGURATION FOLLOWS USER ID FOR ONE KEYSET TO ANOTHER	NO	YES
SECURE/UNCLASSIFIED ACCESS FROM SAME KEYSET	YES	YES
END INSTRUMENT ● RECONFIGURABLE ● ACCESS LINES/CONFERENCES ● SIMULTANEOUS CONFERENCE ACCESS ● RED/BLACK ACCESS ● ADVANCED OPERATOR INTERFACE ● FLAT PANEL DISPLAY	NO 48 3 TALK - 48 LISTEN YES NO NO	REAL TIME RECONFIGURATION 240 (10 PAGES OF 24 LINES) 3 TALK & 24 LISTEN YES YES YES
INSTALLATION DATE OF SYSTEM	INSTALLED 1965	APRIL 1991 - SUPPORT STS-37

ORIGINAL PAGE IS
OF POOR QUALITY

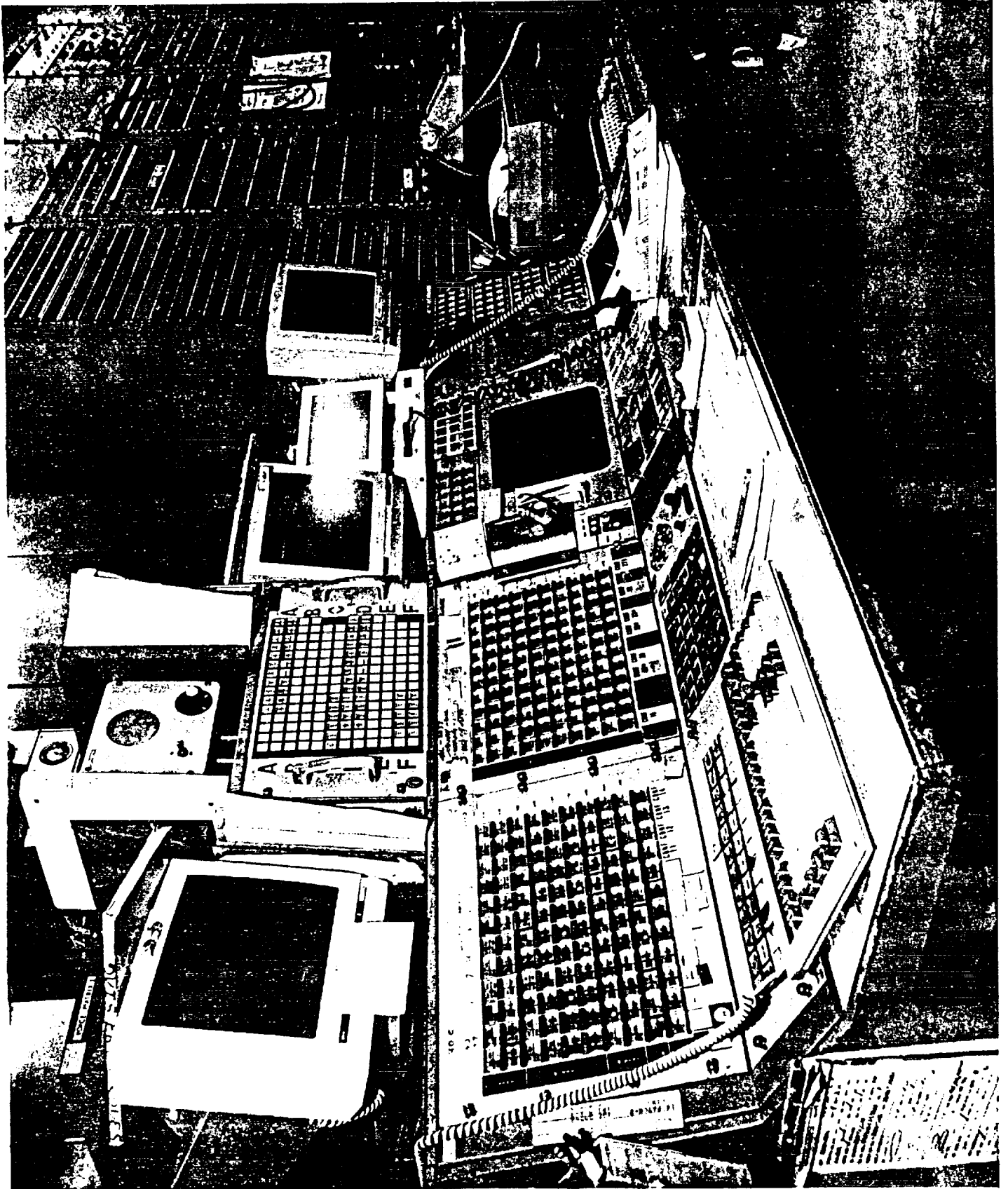

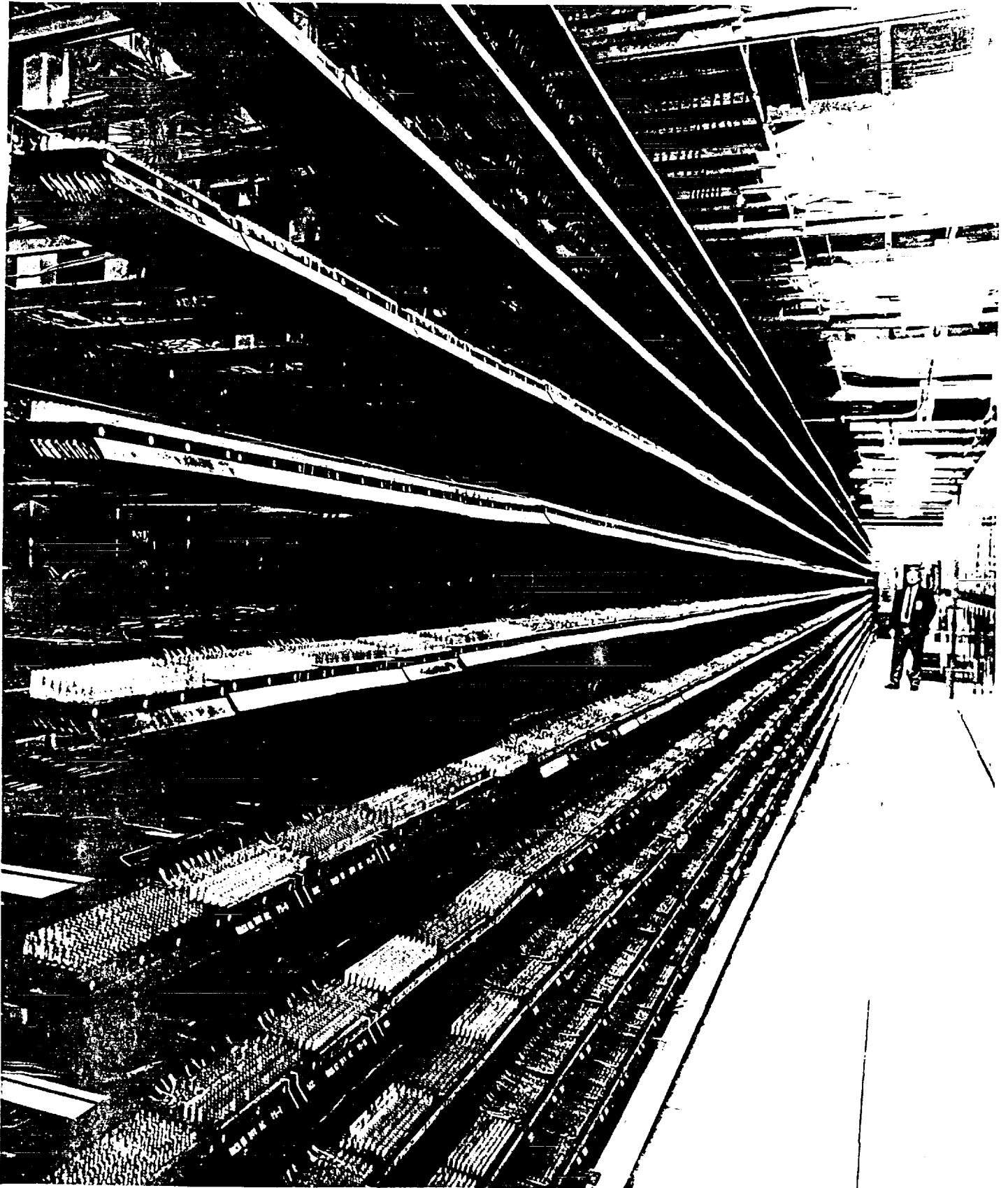

ORIGINAL PAGE IS
OF POOR QUALITY

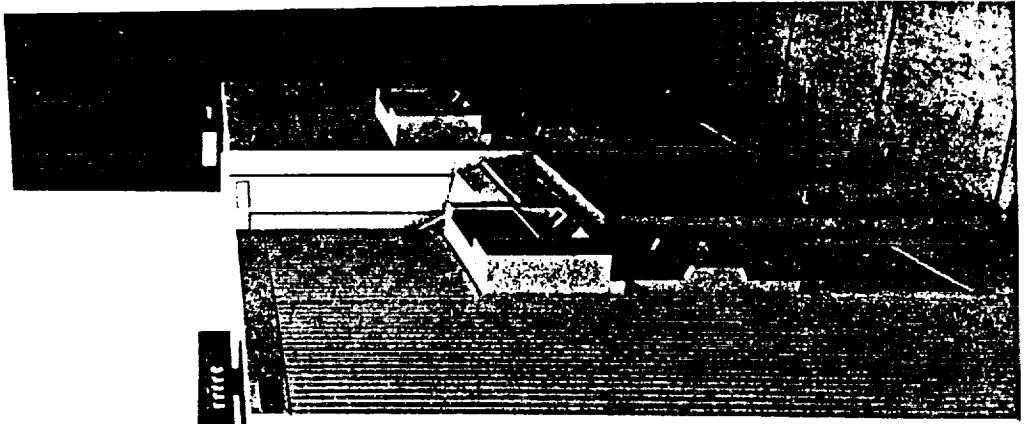

A 17778

EN 37

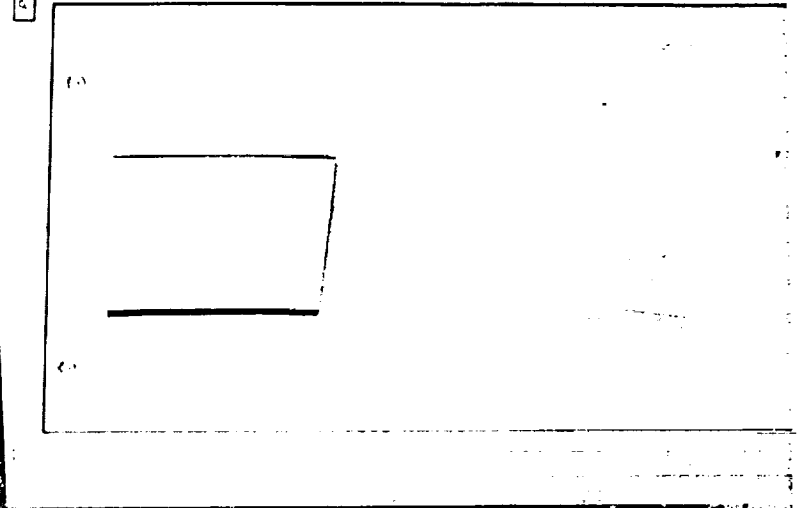

PROJECTION PLOTTING DISPLAY (PPD) --- (OLD)

- OLD MECHANICAL X/Y SERVO MOTOR PROJECTOR SYSTEM:
 - OLD SYSTEM HAS 9 RACK OF SUPPORT EQUIPMENT
 - 7 PROJECTORS WITH CAROUSELS HOLDING 35MM SLIDES
 - COMPRESSED AIR REQUIRED TO COOL SLIDES AND XENON LAMPS
 - REQUIRES MIRRORS FOR FOLDED OPTICAL PATH

ORIGINAL PAGE IS
OF POOR QUALITY

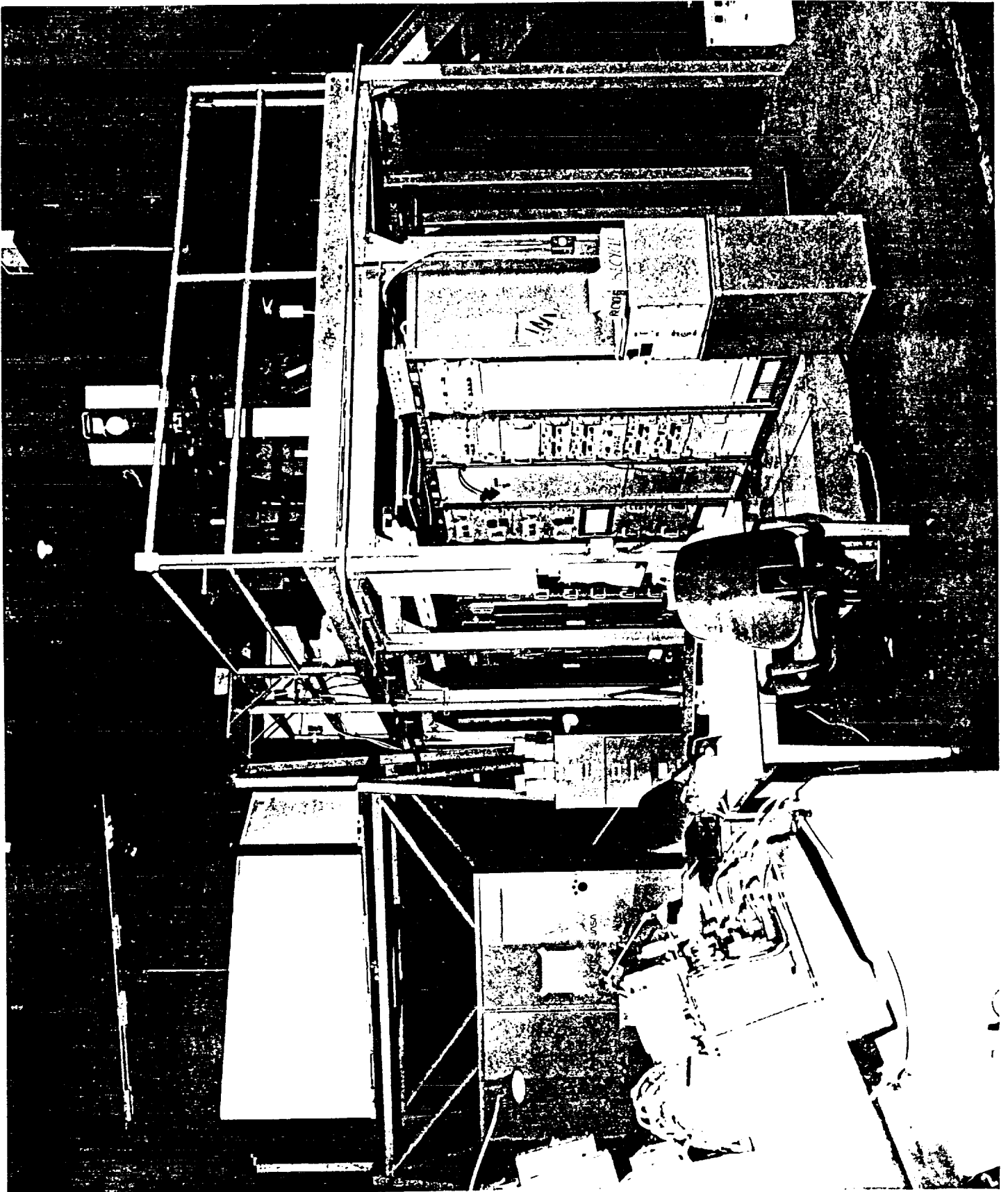

ORIGINAL PAGE IS
OF POOR QUALITY

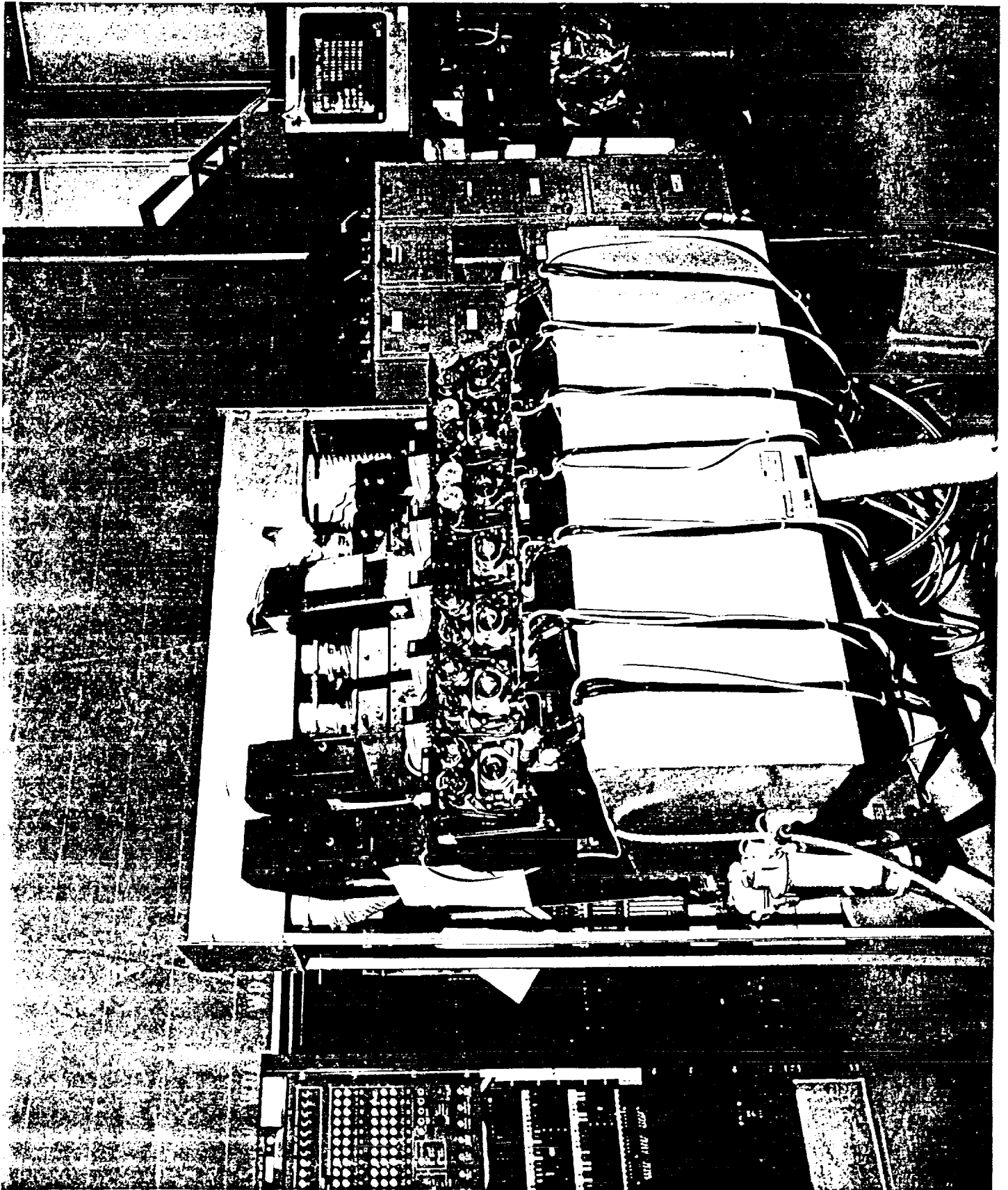

PROJECTION PLOTTING DISPLAY (PPD) --- (NEW)

- NEW SYSTEM IS HUGHES LIQUID CRYSTAL PROJECTOR
 - BOTH FLOORS RECEIVE NEW PROJECTOR
 - IMAGE SIZE FILLS 10' X 20' CENTER SCREEN
 - INTERIM CONFIGURATION USES HYDRAULIC LIFT
 - DOES NOT REQUIRE MIRRORS FOR FOLDED OPTICS
 - 2500 WATT XENON LAMP

- NEW PPD SUBSYSTEM COMPOSED OF 3 ELEMENTS
 - PPD HOST WORKSTATION (MCCU CLASS 6700 W/S)
 - PROVIDES CONNECTION TO MCCU SYSTEM VIA LAN
 - W/S UNDER WEX -- PROCESSES PPD APPLICATION S/W
 - PROVIDES I/F TO WAG PROCESSOR
 - WAG PROC -- WIDE ASPECT GRAPHICS PROCESSOR
 - RECEIVES GRAPHIC CMDS FROM PPD W/S
 - PROVIDES RASTOR SCAN, MULTIPLE FORMAT, HIGH RESOLUTION (1956 X 1024 X 60 HZ REFRESH RATE)
 - HUGHES LARGE SCREEN DISPLAY PROJECTOR
 - CONVERTS RGB OR NTSC INTO MODULATED ILLUMINATION
 - PROJECTS HIGH RESOLUTION IMAGES ON 10' X 20' SCREEN

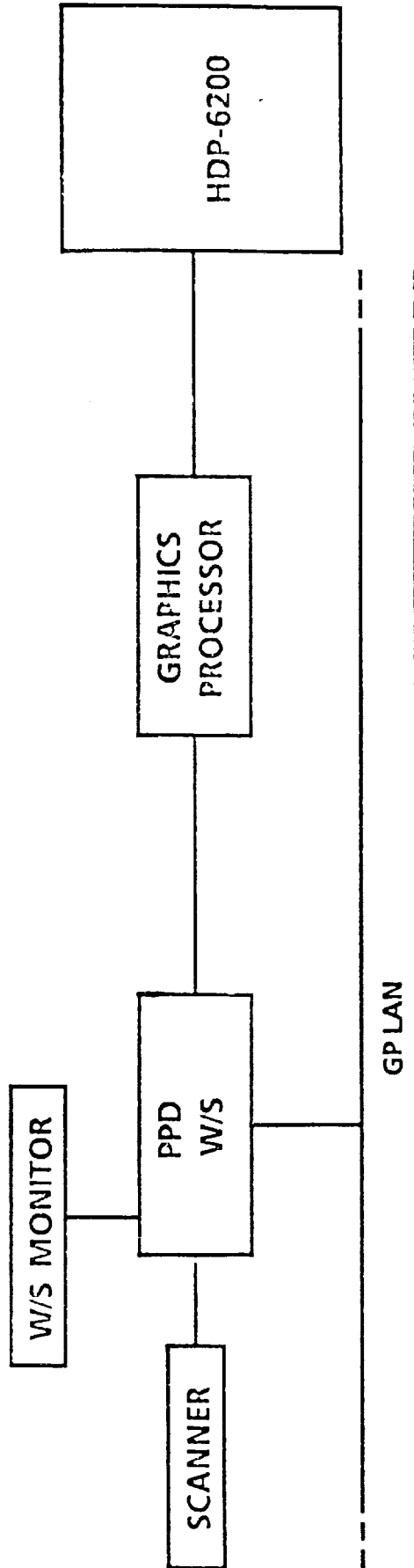

LARGE SCREEN DISPLAY SUBSYSTEM CONFIGURATION

PROJECTION PLOTTING DISPLAY (PPD)

SYSTEM FOR UPGRADE OF THE FLIGHT CONTROL ROOM 10'X20' CENTER SCREEN DISPLAYS

- PPD SOFTWARE DRIVES HUGHES LARGE-SCREEN DISPLAY PROJECTOR THROUGH MEGATEK WIDE ASPECT GRAPHICS PROCESSOR.
- SOFTWARE MONITORS MISSION PHASE AND AUTOMATICALLY SWITCHES DISPLAYS
 - LAUNCH & LANDING PHASES
 - PLOTS REAL TIME TRAJECTORY PARAMETERS
 - BACKGROUND DISPLAYS NOMINAL/LIMIT LINES AND AREA MAPS
 - DISPLAYS SEQUENCED BASED ON MONITORING RANGE-TO-GO
 - ON-ORBIT PHASE
 - WORLD MAP WITH GROUND TRACK OF ORBITOR
 - PRESENT POSITION OF VEHICLE DENOTED BY SPOTTER
 - FOOTPRINTS OF TDRS AND TRACKING SITES
 - DIGITAL READOUTS OF CURRENT POSITION

ORIGINAL PAGE IS
OF POOR QUALITY

NASA National Aeronautics and
Space Administration

891-37101

Lyndon B. Johnson Space Center
Houston, Texas 77058

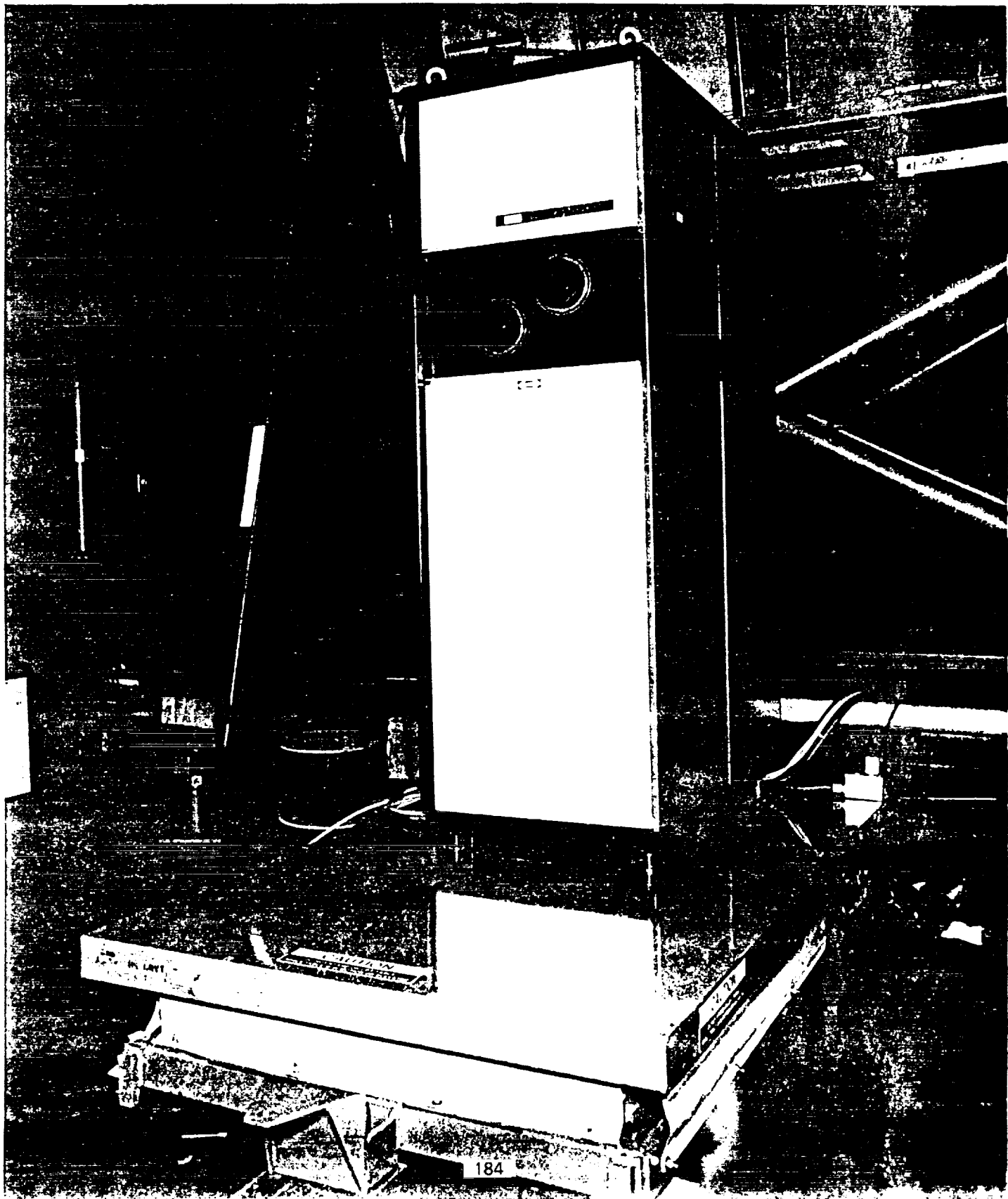

MULTIPROGRAM CONTROL CENTER (MPCC) SYSTEM DESCRIPTION

GENERAL

- MPCC IS A NETWORK OF WORKSTATIONS WHICH PROCESSES SHUTTLE PAYLOAD TELEMETRY AND COMMANDS. IT IS A SUBSET OF MCC WORKSTATIONS.
- MPCC PROVIDES A PLATFORM FOR EXECUTION OF USER DEVELOPED APPLICATION COMPUTER PROGRAMS.

TELEMETRY

- MPCC ACCEPTS LIVE OR PLAYBACK SHUTTLE PAYLOAD AND/OR ORBITER TELEMETRY VIA THE ORBITER DOWNLINK.
- FUTURE DEVELOPMENT WILL ACCEPT PAYLOAD TELEMETRY VIA AN INDEPENDENT DOWNLINK.
- PERFORMS LIMIT SENSING ON SELECTED TELEMETRY PARAMETERS.
- PERFORMS SPECIAL COMPUTATIONS ON SELECTED TELEMETRY PARAMETERS.
- DISPLAYS DATA UTILIZING DISPLAYS CREATED WITH THE MCC DISPLAY BUILD FACILITY.

COMMANDS

- DESIGNATED WORKSTATIONS GENERATE PAYLOAD COMMANDS.
- COMMAND EXECUTION CONTROLLED BY INPUT/OUTPUT PROCESSOR (IOP) WORKSTATION.
- MAINTAINS HISTORY OF COMMAND EXECUTION.
- VALIDATES COMMANDS AND OUTPUTS VIA SHUTTLE DATA SELECT SWITCH (SDSS).

TRAJECTORY

- RECEIVES TRAJECTORY FROM MISSION OPERATIONS COMPUTER (MOC).

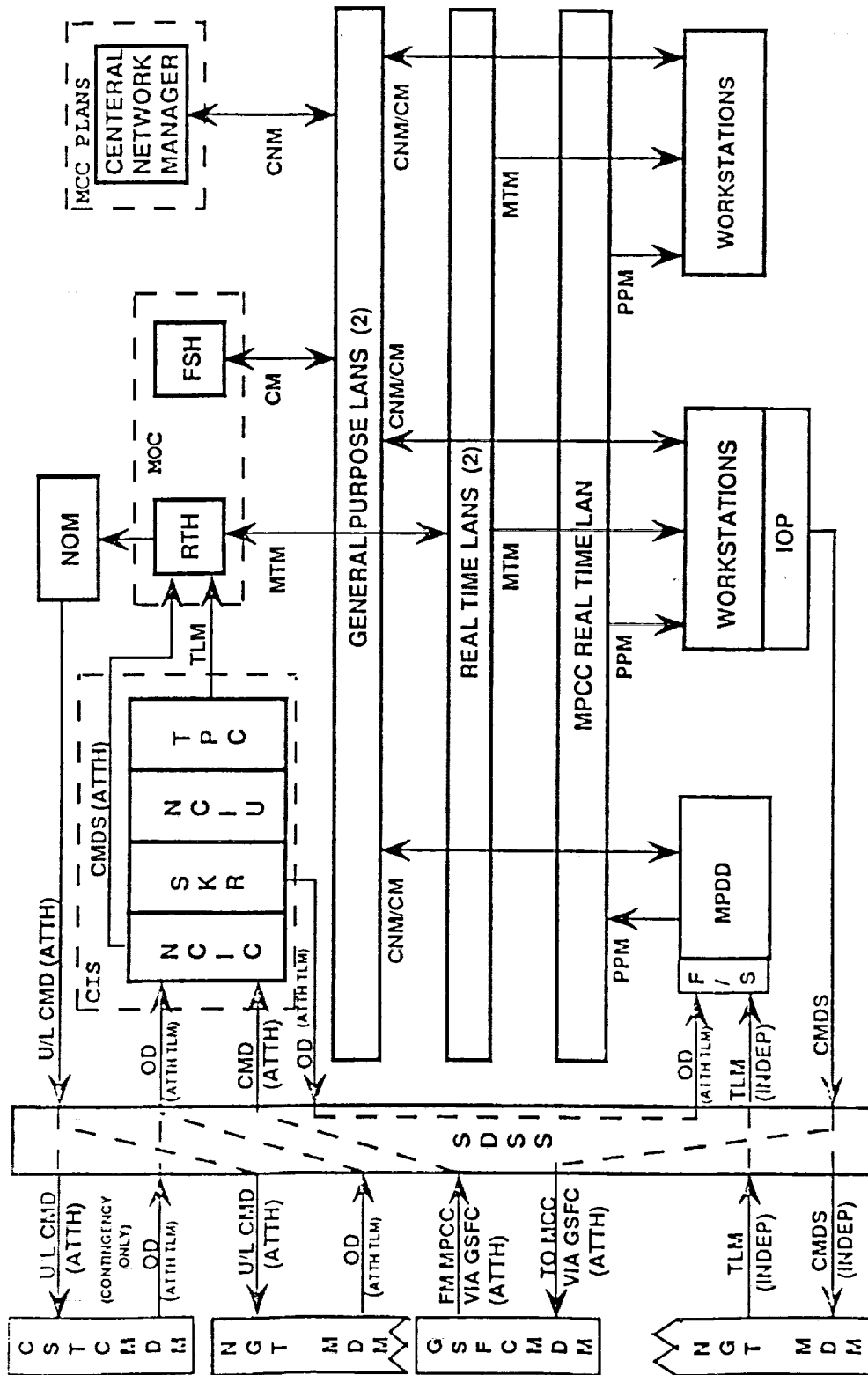

MPCC Functional Data Flow

THE SPACE SHUTTLE MISSION CONTROL CENTER, YEAR 2000

AGENDA

- MISSION CONTROL CENTER EQUIPMENT REPLACEMENT PLAN
- FRONT END REPLACEMENT
- HOST REPLACEMENT
- DISPLAY AND CONTROL SYSTEM
- LOCAL AREA NETWORK AND WORKSTATION REPLACEMENT

MCC EQUIPMENT REPLACEMENT PLAN

- THE MCCER IS A STRATEGIC PLAN FOR THE MCC TO REMOVE OBSOLETE EQUIPMENT AND CONSOLIDATE FUNCTIONALITY.
- THE MCCER ERA FOR THE MCC WILL BEGIN IN OCTOBER, 1991.

MCC EQUIPMENT REPLACEMENT PLAN

DATE

FRONT END

A HIGHLY CUSTOMIZED AREA WHICH HAS INCURRED PATCHWORK FUNCTIONALITY OVER THE YEARS. EQUIPMENT AGE WILL BE APPROACHING 20 YEARS WHEN REPLACEMENT PLAN COMPLETED. MAINTENANCE STATISTICS AS WELL AS COMPUTER OBSOLESCENCE INDICATE IMMEDIATE TELEMETRY PREPROCESSING COMPUTER REPLACEMENT. A TWO PHASE APPROACH IS PLANNED:

- PHASE 1 WILL REPLACE THE TPC'S AND ASSOCIATED INTERFACES, REPLACING CUSTOMIZED INTERFACES WITH COTS. PHASE 1 FEATURES OPEN COMPUTER COMPETITION, RELIEVING SOLE SOURCE LIABILITY. 2/95

- PHASE 2 PROVIDES THE REPLACEMENT OF NETWORK INPUT AND OUTPUT PROCESSING, STRINGS REPLACING OBSOLETE UNIQUE HARDWARE WITH COTS AND OFFERS SCHEDULE ALIGNMENT WITH POTENTIAL NASCOM UPGRADES. 7/96

BOTH PHASES HAVE THE POTENTIAL FOR SIGNIFICANT COST SAVINGS THROUGH THE CONSOLIDATION OF OPERATING POSITIONS AND THE INTRODUCTION OF COTS EQUIPMENT.

MCC EQUIPMENT REPLACEMENT PLAN

DATE
9/97

HOST

A MOSTLY COTS SYSTEM WHICH INCLUDES THE FIVE MAIN FRAME MISSION OPERATIONS COMPUTERS AND ASSOCIATED PERIPHERALS. COTS COMPUTER LIFE CYCLE WILL BE STRETCHED TO NINE YEARS AT REPLACEMENT. NO SOFTWARE REHOST PLANNED (STAY IBM COMPATIBLE). LIKELIHOOD OF INCREASED VENDOR MAINTENANCE COSTS WITH STRETCHED LIFE CYCLE.

DISPLAY & CONTROL

9/99

A HIGHLY CUSTOMIZED AREA MAINLY COMPOSED OF THE CONSOLES. EQUIPMENT AGE WILL BE APPROACHING 25 YEARS IF REPLACEMENT PLAN CAN BE MAINTAINED. ALTHOUGH CREATIVE SPARING IS OCCASIONALLY NECESSARY, NO SERIOUS RELIABILITY CONCERNS EXIST. REPLACEMENT OFFERS THE BENEFITS OF COTS EQUIPMENT.

LAN/WORKSTATION

9/99

A MOSTLY COTS AREA WHICH WILL BE TEN YEARS OLD WHEN REPLACED. LIKELIHOOD OF INCREASED VENDOR MAINTENANCE COSTS WITH STRETCHED LIFE CYCLE.

MCC EQUIPMENT REPLACEMENT PLAN

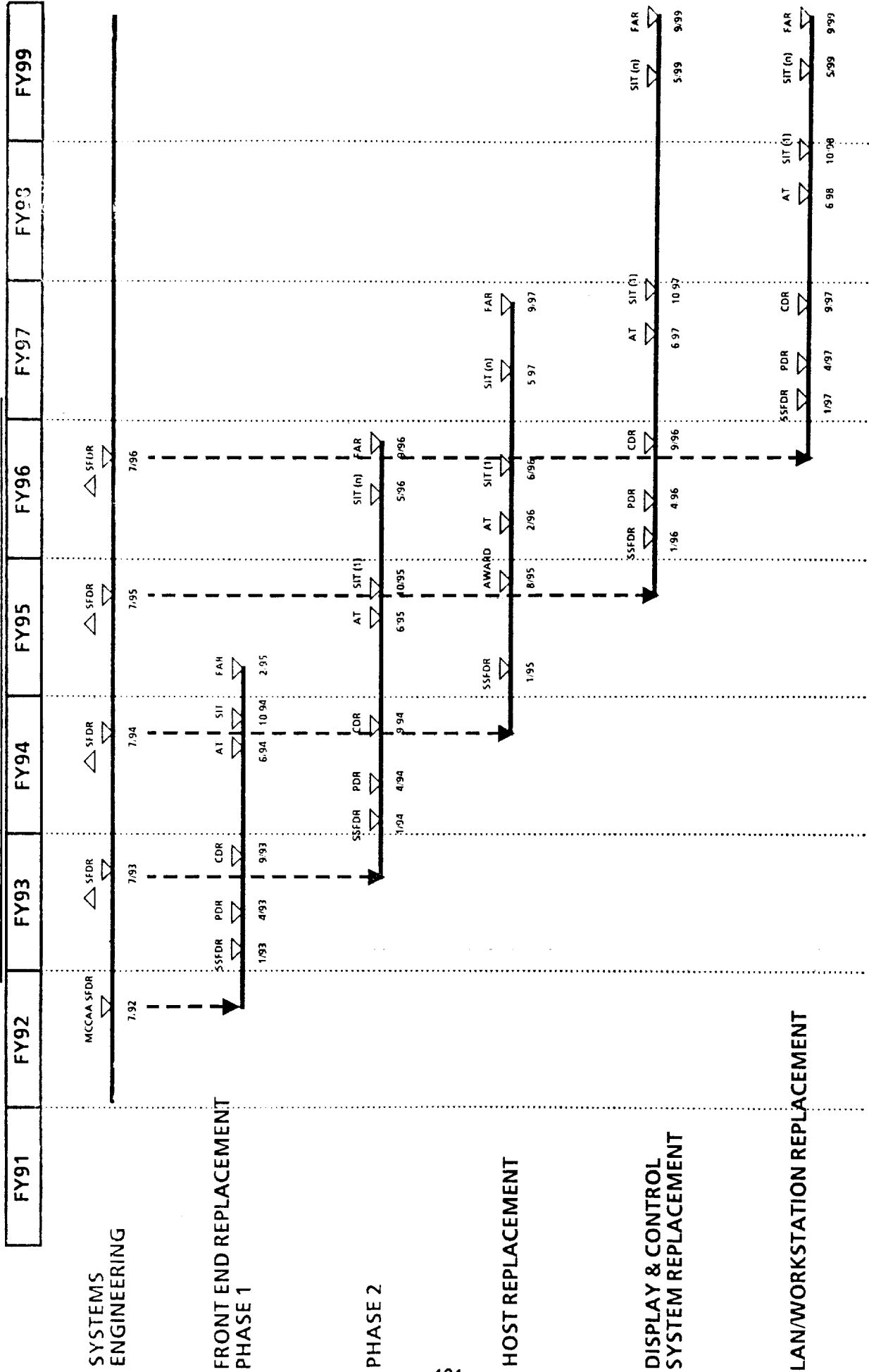

COUPLED COMPONENTS AND MSN SPT CRITICALITY WEAROUT AND REPLACEMENT

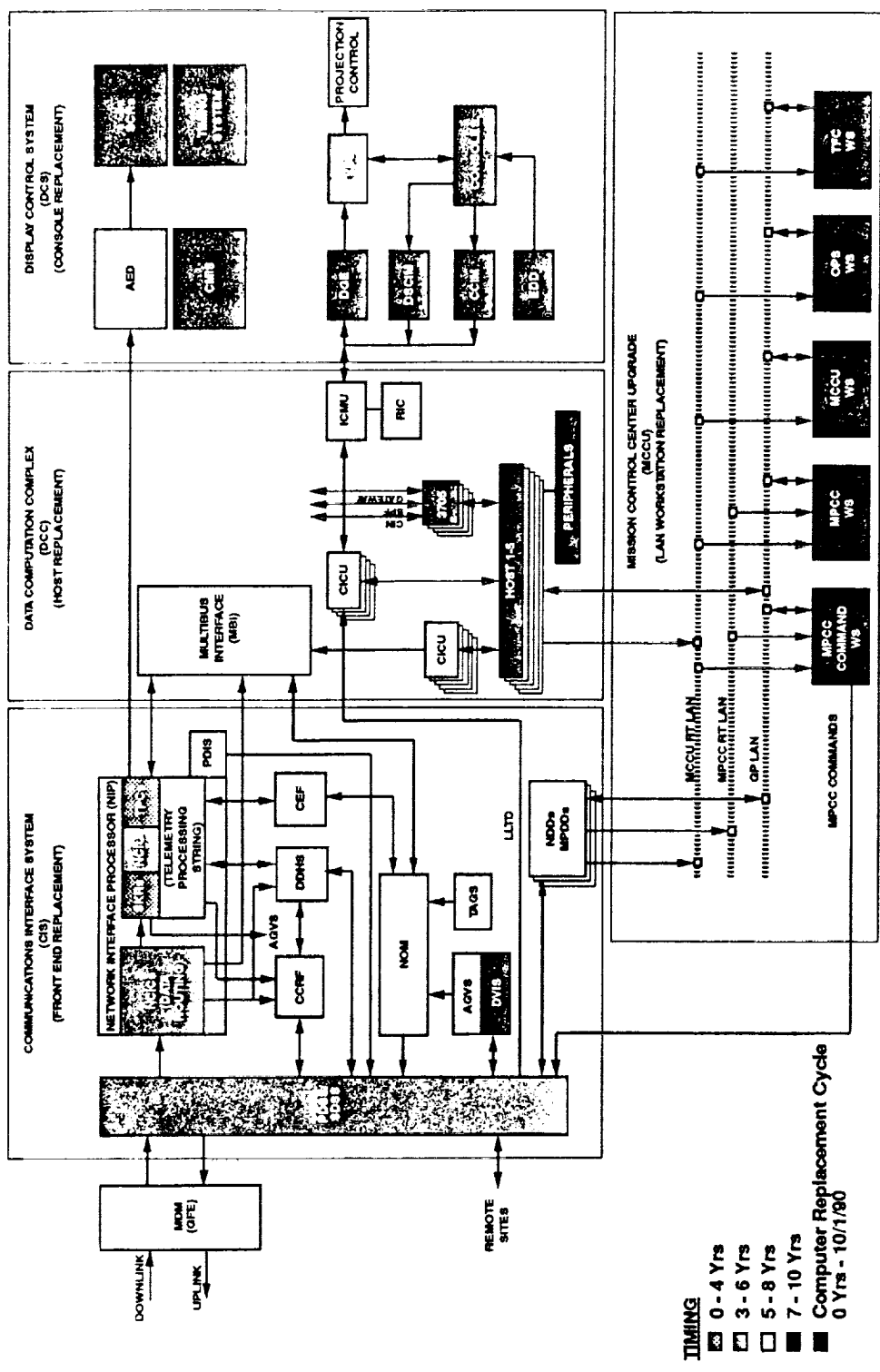

- TIMING**
- ▨ 0 - 4 Yrs
 - ▩ 3 - 6 Yrs
 - 5 - 8 Yrs
 - 7 - 10 Yrs
 - Computer Replacement Cycle
0 Yrs - 10/1/90

PR21687020M docbr

FRONT END REPLACEMENT

PHASE I

- REPLACE TELEMETRY PREPROCESSING COMPUTER (TPC) WITH NEW PROCESSOR.
- INSTALL FRONT END LOCAL AREA NETWORK (LAN) (REPLACE MULTIBUS INTERFACE) AND DEVELOP TPC AND HOST INTERFACES.
- MOVE ANALOG EVENT DRIVER (AED) INTERFACE TO FRONT END LAN VIA WORKSTATION AND REPLACE AED.
- MOVE PAYLOAD DATA INTERLEVER (PDI) PROCESSING TO MULTIPROGRAM DATA DRIVER (MPDD), REPLACE PAYLOAD DATA INTERLEVERS (PDI'S), AND INTERFACE TO MPDD.
- MAINTAIN CURRENT CONFIGURATION FOR MISSION SUPPORT AND REPLACE ONE STRING AT A TIME.

Front End Replacement - Phase 1

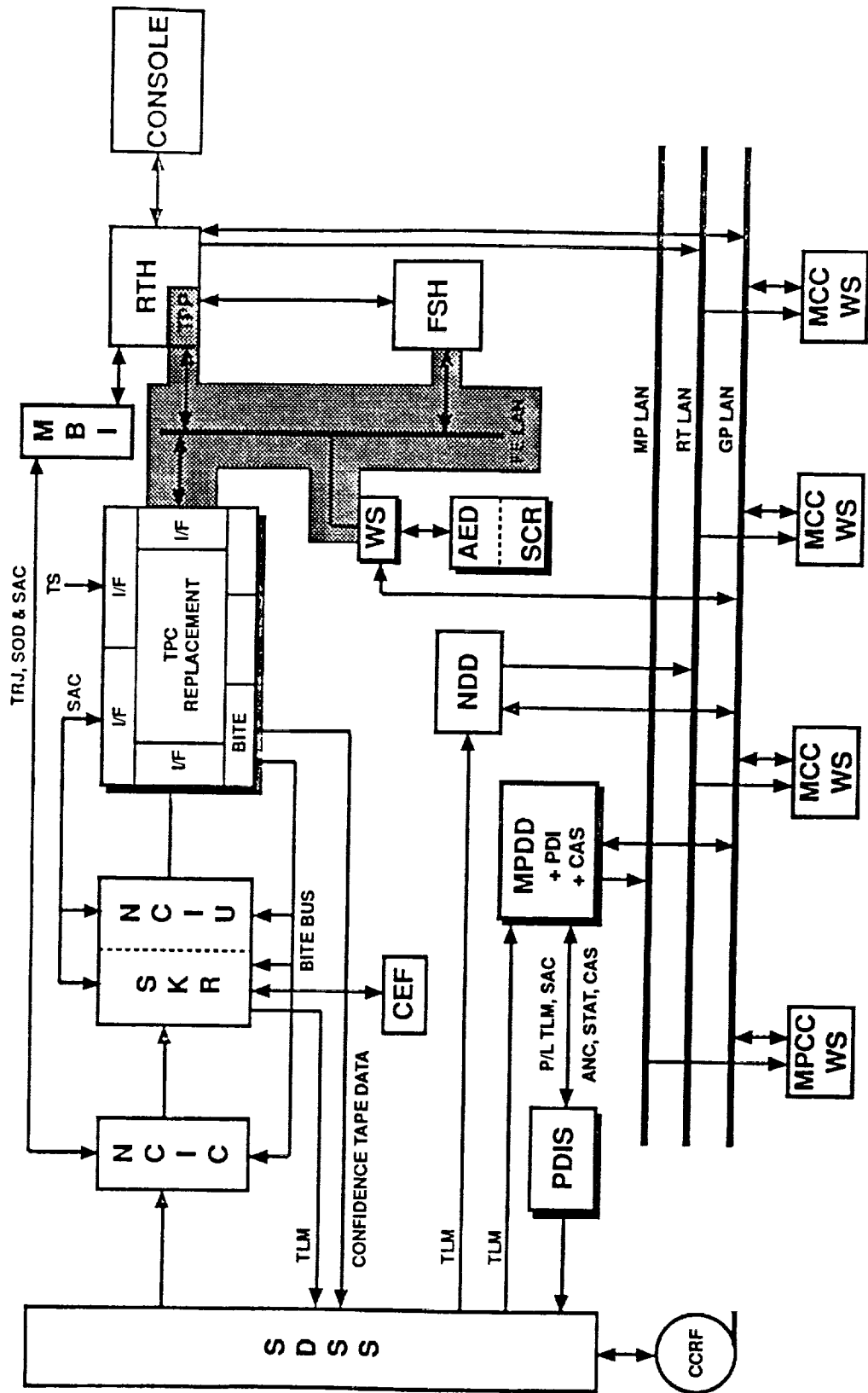

FRONT END REPLACEMENT - PHASE 2

- REPLACE NETWORK COMMUNICATIONS INTERFACE COMMON/SEPARATOR-KG-RECOMBINER/NETWORK COMMUNICATIONS INTERFACE UNIQUE (NCIC/SKR/NCIU) WITH NEW FRONT END
- INTERFACE NEW FRONT END TO TELEMETRY PREPROCESSING COMPUTER REPLACEMENT (TPCR)
- ADD DUMP DATA HANDLER (DDH) AND SITE ORIGINATED DATA (SOD) PROCESSING TO TPCR
- PROVIDE FRONT END STATUS AND CONTROL VIA TPCR AND GENERAL PURPOSE LOCAL AREA NETWORK (LAN)
- ADD CALIBRATED ANCILLARY SYSTEM (CAS) DATA PROCESSING TO MULTIPROGRAM DATA DRIVER (MPDD) AND PROVIDE CAS DATA VIA MPDD AND PAYLOAD DATA INTERLEVER SERIALIZER (PDIS)
- DEVELOP NETWORK OUTPUT MULTIPLEXER (NOM) REPLACEMENT
 - FRONT END LAN INTERFACE
 - STATUS AND CONTROL VIA GENERAL PURPOSE LAN
- DEVELOP CONSOLIDATED DATA SELECT SWITCH (CDSS) (SDSS/PDSS REPLACEMENT)
 - 600 X 600 WITH GROWTH TO 1000 X 1000
 - STATUS AND CONTROL VIA GENERAL PURPOSE LAN

Front End Replacement - Phase 2

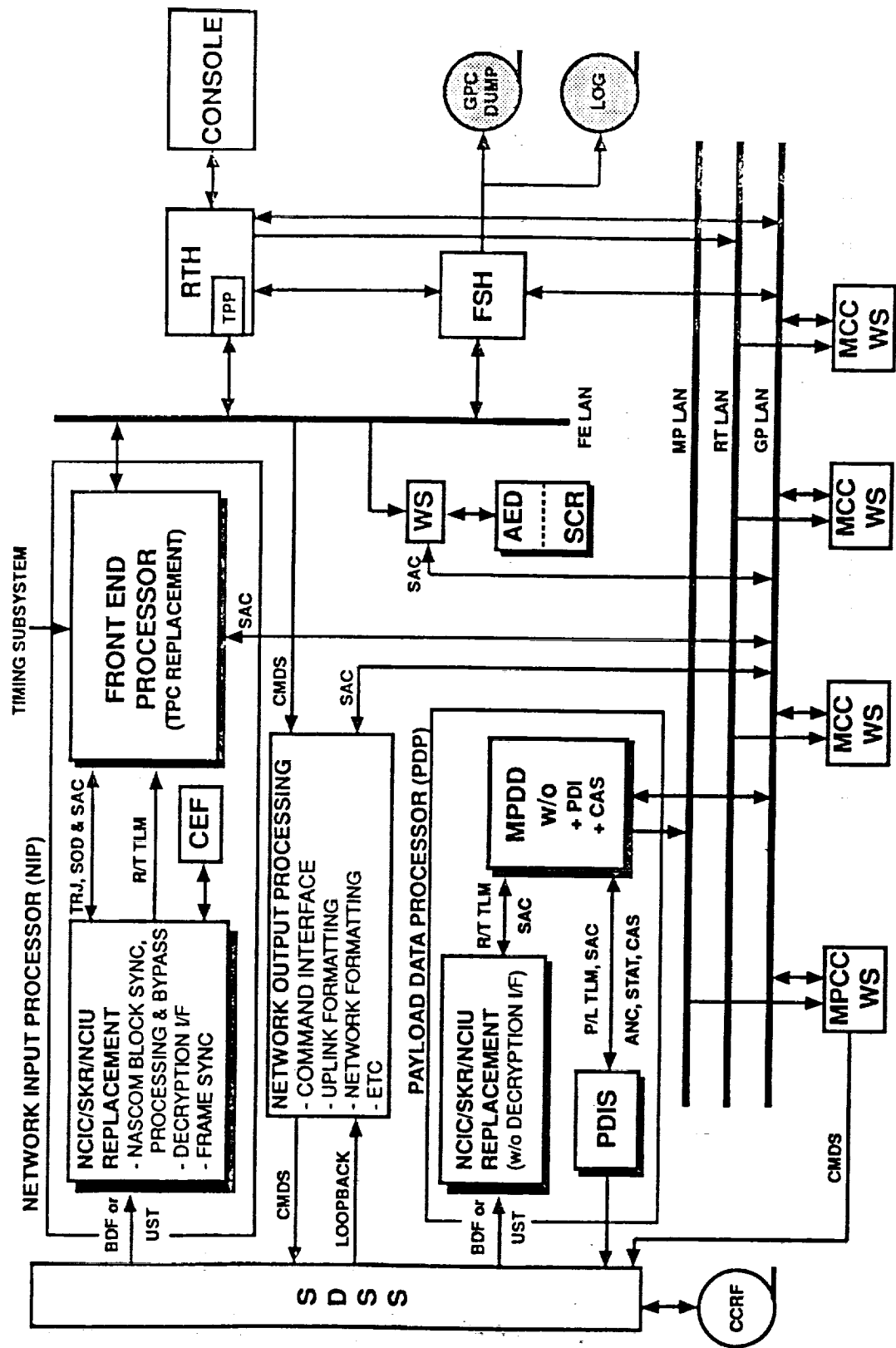

MCCER Overview

After Front End Replacement Complete

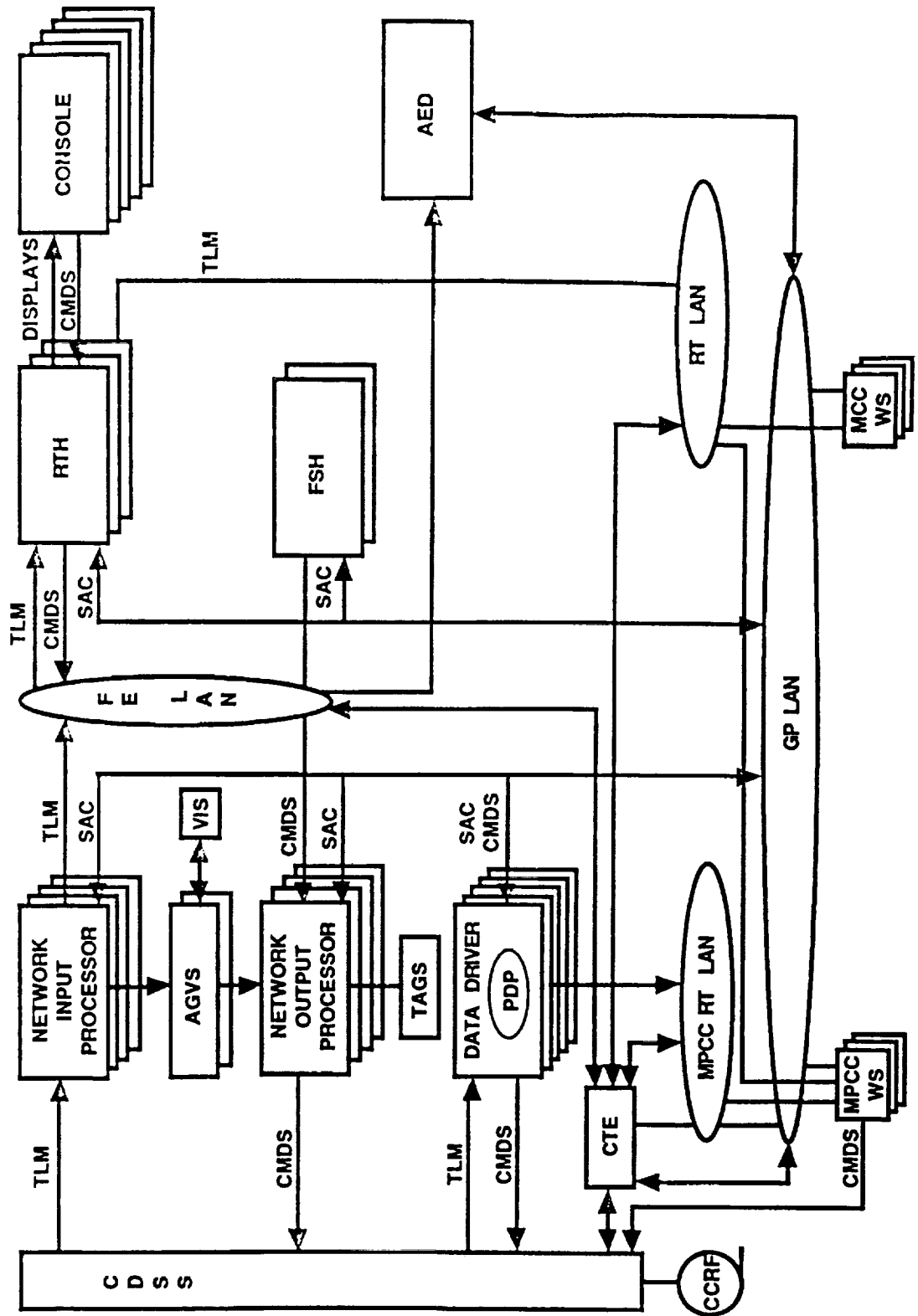

MCC System Overview (Host Replacement)

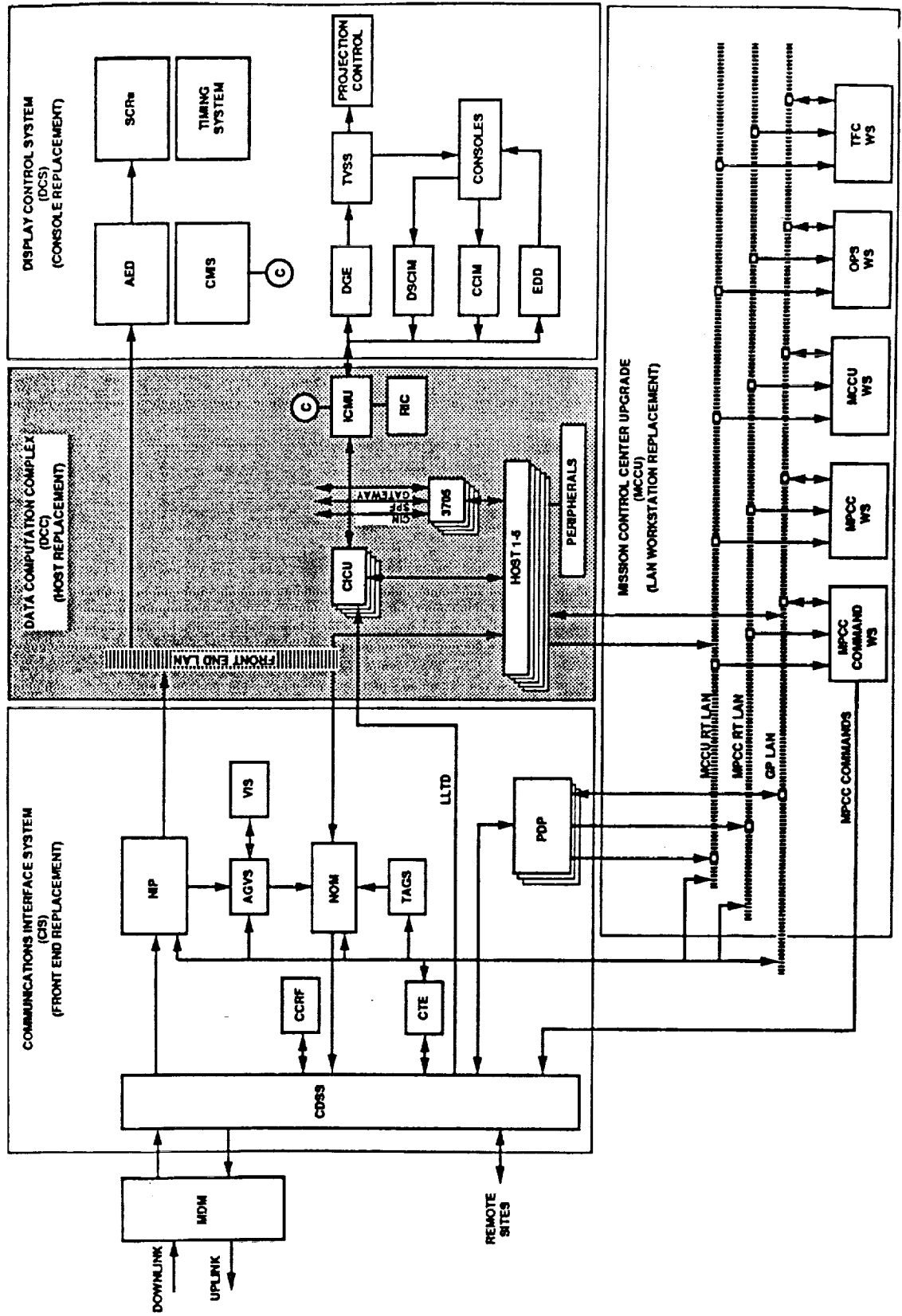

Host Replacement

- BOX-FOR-BOX REPLACEMENT
- UTILIZE CURRENT TECHNOLOGY

MCC SYSTEM OVERVIEW (DISPLAY AND CONTROL SYSTEM REPLACEMENT)

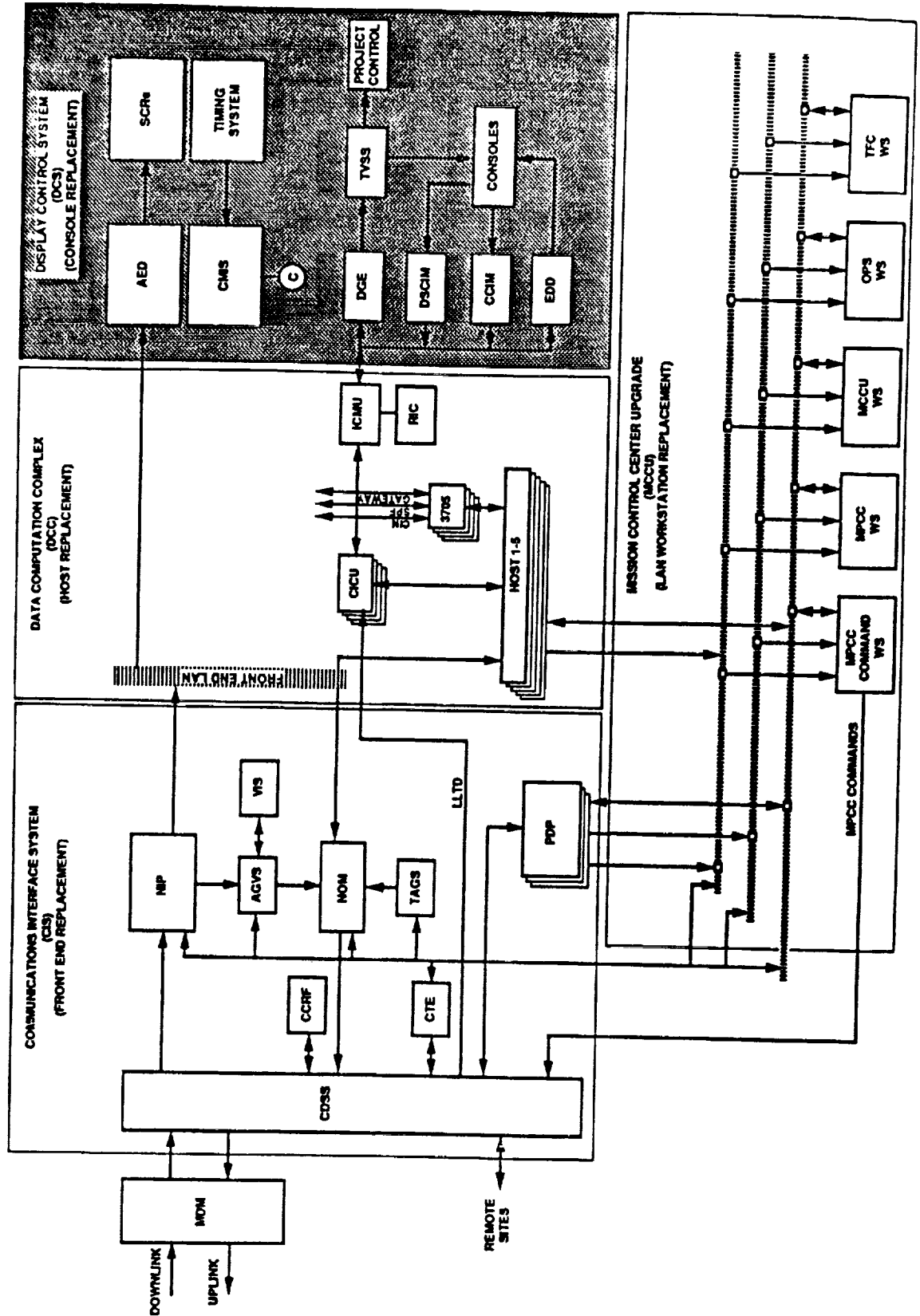

DISPLAY AND CONTROL SYSTEM REPLACEMENT DESCRIPTION

- PHYSICAL USER INTERFACE
 - PUSH BUTTON INDICATORS (PBI'S), CATHODE RAY TUBE (CRT) DISPLAYS, ETC.
 - MANUAL ENTRY DEVICE (MED) CAPABILITY INCORPORATED WITHIN CONSOLE
 - PROVIDES LOCAL HARD COPY
- HOST CONNECTIVITY VIA CLUSTER CONTROLLER AND CHANNEL SWITCHES
 - POINT-TO-POINT
 - RETAIN INTERFACE FOR COMMANDS
 - PROVIDES FOR DISPLAY SHARING

DISPLAY AND CONTROL SYSTEM REPLACEMENT DESCRIPTION

- LIMITED HARDWARE/PHYSICAL RECONFIGURATION FOR FLIGHT-TO-FLIGHT CHANGES
 - SOFTWARE DOWNLOADS TO DEFINE CONSOLE CHARACTERISTICS
 - DOWNLOAD VIA CLUSTER CONTROLLER FROM FSH
 - CONSOLE STORES CONFIGURATION LOCALLY
- COMMON RECONFIGURATION PRODUCTS FOR PBI'S, EDD'S AND DISPLAYS

MCC System Overview (LAN/Workstation Replacement)

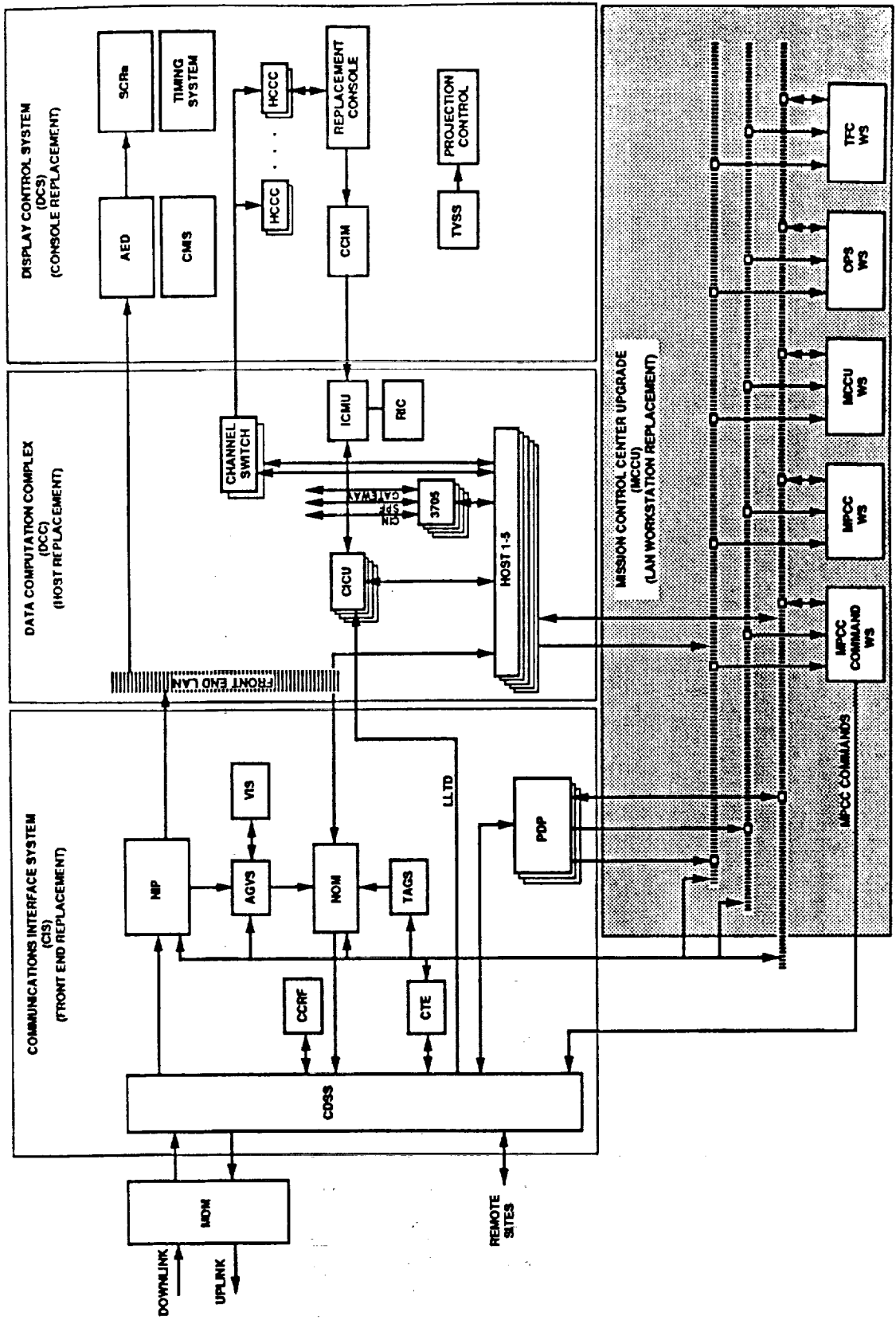

LAN/WORKSTATION REPLACEMENT DESCRIPTION

- FIBER-OPTIC BACKBONE
- EXISTING LAN SELECT SWITCHES
- FIBER DISTRIBUTED DATA INTERFACE
- WORKSTATION
 - UNIX OPERATING SYSTEM
 - WORKSTATION ENVIRONMENT WEX COMPATIBLE

MCC System Overview

Final System Configuration

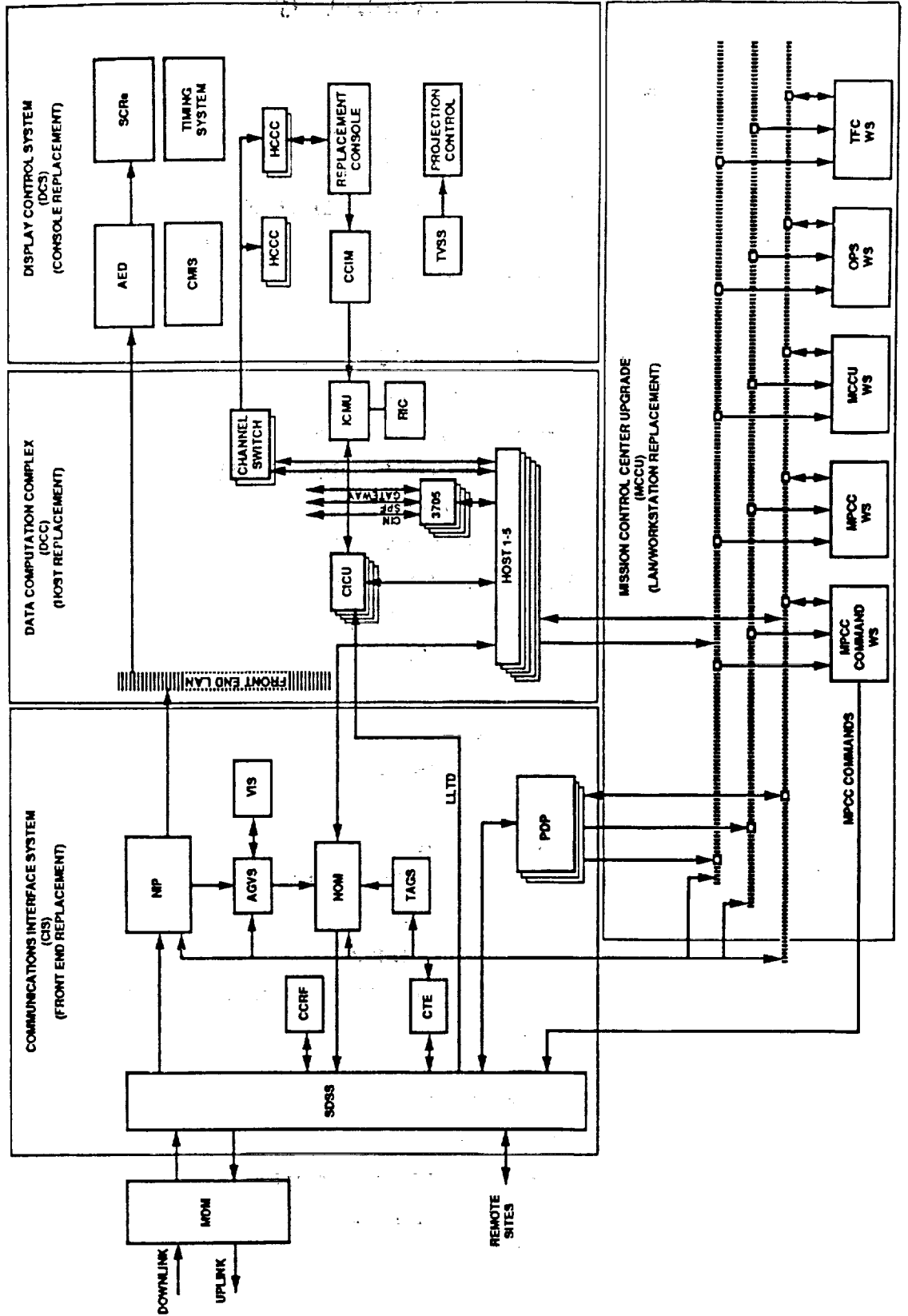

ACRONYM LIST

AED	-	ANALOG EVENT DRIVER
AGVS	-	AIR-TO-GROUND VOICE SYSTEM
AI	-	ARTIFICIAL INTELLIGENCE
ALSEP	-	APOLLO LUNAR SURFACE EXPERIMENT PACKAGE
ALTDS	-	APPROACH AND LANDING DATA SYSTEM
AST	-	ASYNCHRONOUS SYSTEM TRAPS
AT	-	ACCEPTANCE TEST
CAS	-	CALIBRATED ANCILLARY SYSTEM
CDR	-	CRITICAL DESIGN REVIEW
CDSS	-	CONSOLIDATED DATA SELECT SWITCH
CIS	-	COMMUNICATIONS INTERFACE SYSTEM
CM	-	CONFIGURATION MANAGEMENT
CNM	-	CENTRAL NETWORK MANAGER
COM	-	COMPUTER OUTPUT MICROFILM
COTS	-	COMMERCIAL-OFF-THE-SHELF
CPU	-	CENTRAL PROCESSING UNIT
CRT	-	CATHODE RAY TUBE
DCC	-	DATA COMPUTATION COMPLEX
DCS	-	DISPLAY CONTROL SYSTEM
DD	-	DATA DRIVER
DDH	-	DUMP DATA HANDLER
DGE	-	DIGITAL GENERATION EQUIPMENT
DOD	-	DEPARTMENT OF DEFENSE
DTE	-	DIGITAL TELEVISION EQUIPMENT
DVIS	-	DIGITAL VOICE INTERCOMMUNICATION SYSTEM
EDD	-	EVENT DATA DRIVER
EMAIL	-	ELECTRONIC MAIL
FAR	-	FINAL ACCEPTANCE REVIEW
FSH	-	FLIGHT SUPPORT HOST
FTAM	-	FILE TRANSFER AND MANAGEMENT
GDR	-	GENERALIZED DATA RETRIEVAL
GP	-	GENERAL PURPOSE
H&S	-	HEALTH AND STATUS
I/F	-	INTERFACE

IOP - INPUT/OUTPUT PROCESSOR
JSC - JOHNSON SPACE CENTER
LAN - LOCAL AREA NETWORK
LSDS - LARGE SCREEN DISPLAY SUBSYSTEM
LSS - LAN SELECT SWITCH
MCC - MISSION CONTROL CENTER
MCCER - MCC EQUIPMENT REPLACEMENT
MCCU - MISSION CONTROL CENTER UPGRADE
MDRS - MCC DATA RETRIEVAL SYSTEM
MED - MANUAL ENTRY DEVICE
MOC - MISSION OPERATIONS COMPUTER
MOPS - MISSION OPERATIONS PLANNING SYSTEM
MPCC - MULTIPROGRAM CONTROL CENTER
MPDD - MULTIPROGRAM DATA DRIVER
NCIC - NETWORK COMMUNICATIONS INTERFACE COMMON
NCIU - NETWORK COMMUNICATIONS INTERFACE UNIQUE
NDD - NETWORK DATA DRIVER
NDM - NETWORK DATA MESSAGES
NIP - NETWORK INPUT PROCESSOR
NIU - NETWORK INTERFACE UNIT
NOM - NETWORK OUTPUT MULTIPLEXER
NRT - NEAR REAL-TIME
OSI - OPEN SYSTEMS INTERFACE
OSF - OPEN SYSTEMS FOUNDATION
OST - OPERATIONS SUPPORT TEAM
PBI - PUSH BUTTON INDICATOR
PDI - PAYLOAD DATA INTERLEAVER
PDIS - PAYLOAD DATA INTERLEAVER SERIALIZER
PDP - PAYLOAD DATA PROCESSOR
PDR - PRELIMINARY DESIGN REVIEW
PDSS - PAYLOAD DATA SELECT SWITCH
PLANS - PRIMARY LAN SUBSYSTEM
PPD - PROJECTION PLOTTING DISPLAY
PPM - PROCESSED PAYLOAD MESSAGES
PTM - PROCESSED TLM MESSAGES
RT - REAL-TIME

RTH	-	RT HOST
RTU	-	REAL-TIME UNIX
RTX	-	REAL-TIME EXECUTIVE
SAC	-	STATUS AND CONTROL
SCAP	-	SHUTTLE CONFIGURATION ANALYSIS PROCESSOR
SDSS	-	SHUTTLE DATA SELECT SWITCH
SFDR	-	SYSTEM FUNCTIONAL DESIGN REVIEW
SKR	-	SEPARATOR-KG-RECOMBINER
SOD	-	SITE ORIGINATED DATA
SPF	-	SOFTWARE PRODUCTION FACILITY
S/W	-	SOFTWARE
TDM	-	TIME-DIVISION MULTIPLEXER
TDRSS	-	TRACKING AND DATA RELAY SATELLITE SYSTEM
TLM	-	TELEMETRY
TPC	-	TELEMETRY PREPROCESSING COMPUTER
TPCR	-	TELEMETRY PREPROCESSING COMPUTER REPLACEMENT
WEX	-	WORKSTATION EXECUTIVE
W/S	-	WORKSTATION

**MISSION OPERATIONS DIRECTORATE
SPACE STATION GROUND SYSTEMS DIVISION**

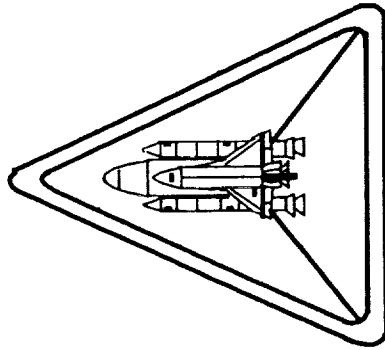

SHUTTLE

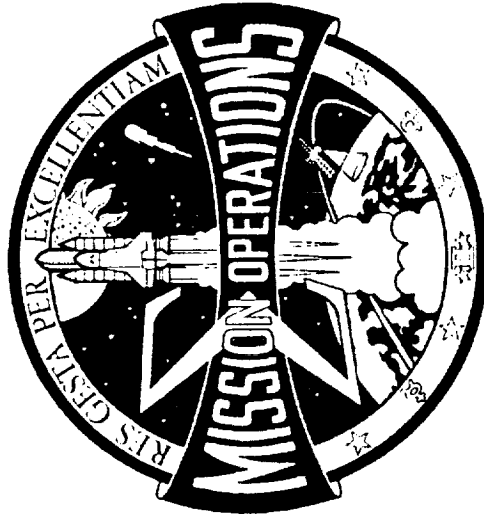

SPACE STATION CONTROL CENTER ARCHITECTURE

JUNE 18, 1991

DJ22/B. KAREN SCHMALZ

56-14-
N92-12016
37600
P-27

ND/85000

AGENDA

INTRODUCTION

ARCHITECTURE DRIVERS

PHASING OF SSCC CAPABILITIES

ARCHITECTURE EVOLUTION

SUMMARY

INTRODUCTION RESPONSIBILITIES

- THE SPACE STATION CONTROL CENTER (SSCC) IS UNDER THE COGNIZANCE OF THE JOHNSON SPACE CENTER AND WILL BE LOCATED ADJACENT TO THE SHUTTLE'S MISSION CONTROL CENTER
- RESPONSIBILITY FOR DESIGN, DEVELOPMENT AND OPERATIONS OF THE CONTROL CENTER IS THE RESPONSIBILITY OF THE MISSION OPERATIONS DIRECTORATE AT JSC
- SPACE STATION GROUND SYSTEMS DIVISION IS RESPONSIBLE FOR DESIGN AND DEVELOPMENT OF THE CONTROL CENTER SYSTEMS WHICH IS CURRENTLY IN PROCESS UNDER THE MISSION SUPPORT CONTRACTOR TEAM LED BY LORAL SPACE INFORMATION SYSTEMS

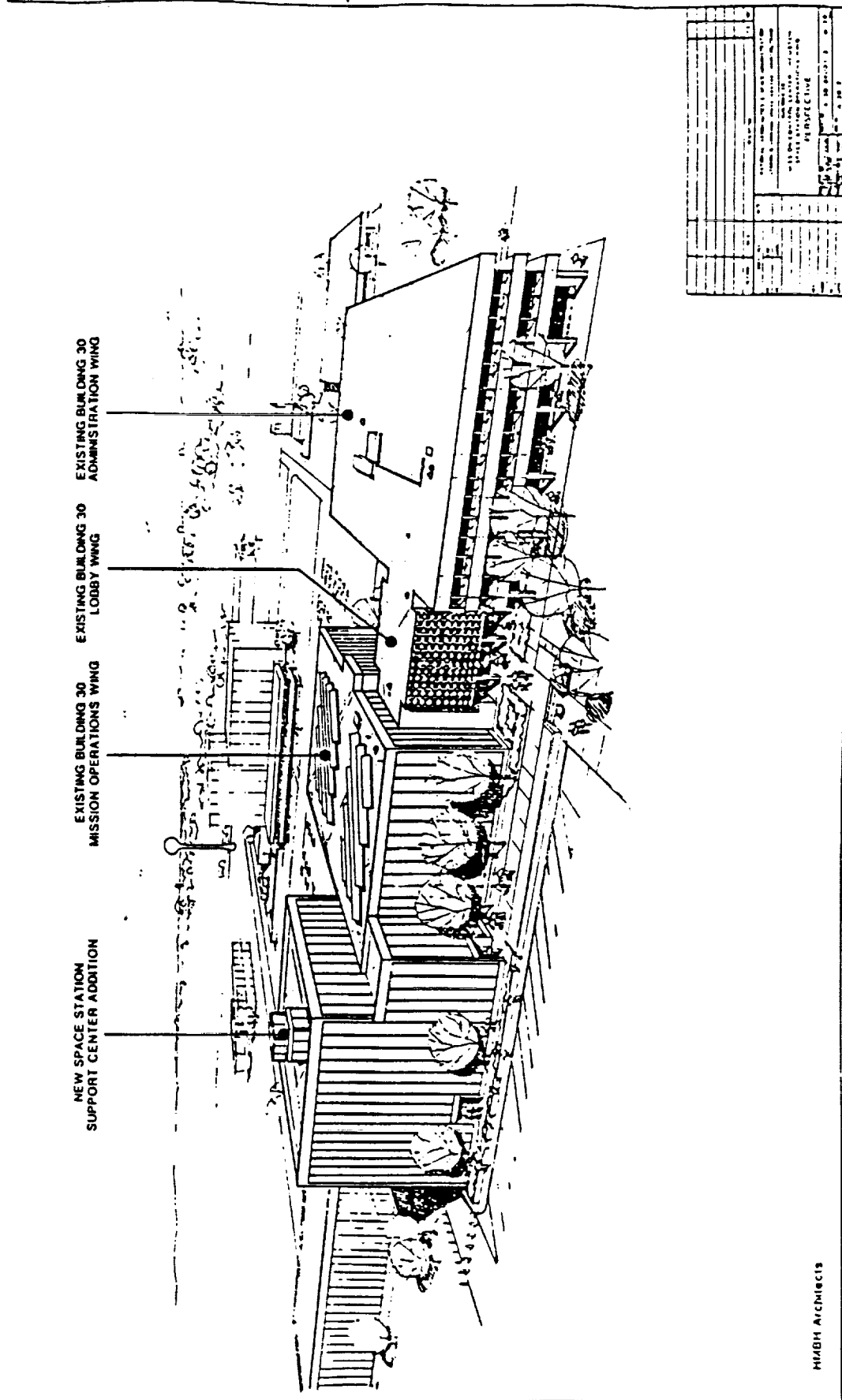

EXISTING BUILDING 30
ADMINISTRATION WING

EXISTING BUILDING 30
LOBBY WING

EXISTING BUILDING 30
MISSION OPERATIONS WING

NEW SPACE STATION
SUPPORT CENTER ADDITION

NO.	DESCRIPTION	DATE
1	ISSUED FOR PERMITS	10/15/82
2	ISSUED FOR CONSTRUCTION	11/15/82
3	ISSUED FOR OPERATION	12/15/82
4	ISSUED FOR MAINTENANCE	01/15/83
5	ISSUED FOR REPAIRS	02/15/83
6	ISSUED FOR RENOVATIONS	03/15/83
7	ISSUED FOR EXPANSIONS	04/15/83
8	ISSUED FOR MODIFICATIONS	05/15/83
9	ISSUED FOR ADJUSTMENTS	06/15/83
10	ISSUED FOR CLOSURE	07/15/83
11	ISSUED FOR RE-OPENING	08/15/83
12	ISSUED FOR DECOMMISSIONING	09/15/83
13	ISSUED FOR DEMOLITION	10/15/83
14	ISSUED FOR RECONSTRUCTION	11/15/83
15	ISSUED FOR RE-EVALUATION	12/15/83
16	ISSUED FOR RE-DESIGN	01/15/84
17	ISSUED FOR RE-CONSTRUCTION	02/15/84
18	ISSUED FOR RE-EVALUATION	03/15/84
19	ISSUED FOR RE-DESIGN	04/15/84
20	ISSUED FOR RE-CONSTRUCTION	05/15/84
21	ISSUED FOR RE-EVALUATION	06/15/84
22	ISSUED FOR RE-DESIGN	07/15/84
23	ISSUED FOR RE-CONSTRUCTION	08/15/84
24	ISSUED FOR RE-EVALUATION	09/15/84
25	ISSUED FOR RE-DESIGN	10/15/84
26	ISSUED FOR RE-CONSTRUCTION	11/15/84
27	ISSUED FOR RE-EVALUATION	12/15/84
28	ISSUED FOR RE-DESIGN	01/15/85
29	ISSUED FOR RE-CONSTRUCTION	02/15/85
30	ISSUED FOR RE-EVALUATION	03/15/85
31	ISSUED FOR RE-DESIGN	04/15/85
32	ISSUED FOR RE-CONSTRUCTION	05/15/85
33	ISSUED FOR RE-EVALUATION	06/15/85
34	ISSUED FOR RE-DESIGN	07/15/85
35	ISSUED FOR RE-CONSTRUCTION	08/15/85
36	ISSUED FOR RE-EVALUATION	09/15/85
37	ISSUED FOR RE-DESIGN	10/15/85
38	ISSUED FOR RE-CONSTRUCTION	11/15/85
39	ISSUED FOR RE-EVALUATION	12/15/85
40	ISSUED FOR RE-DESIGN	01/15/86
41	ISSUED FOR RE-CONSTRUCTION	02/15/86
42	ISSUED FOR RE-EVALUATION	03/15/86
43	ISSUED FOR RE-DESIGN	04/15/86
44	ISSUED FOR RE-CONSTRUCTION	05/15/86
45	ISSUED FOR RE-EVALUATION	06/15/86
46	ISSUED FOR RE-DESIGN	07/15/86
47	ISSUED FOR RE-CONSTRUCTION	08/15/86
48	ISSUED FOR RE-EVALUATION	09/15/86
49	ISSUED FOR RE-DESIGN	10/15/86
50	ISSUED FOR RE-CONSTRUCTION	11/15/86
51	ISSUED FOR RE-EVALUATION	12/15/86
52	ISSUED FOR RE-DESIGN	01/15/87
53	ISSUED FOR RE-CONSTRUCTION	02/15/87
54	ISSUED FOR RE-EVALUATION	03/15/87
55	ISSUED FOR RE-DESIGN	04/15/87
56	ISSUED FOR RE-CONSTRUCTION	05/15/87
57	ISSUED FOR RE-EVALUATION	06/15/87
58	ISSUED FOR RE-DESIGN	07/15/87
59	ISSUED FOR RE-CONSTRUCTION	08/15/87
60	ISSUED FOR RE-EVALUATION	09/15/87
61	ISSUED FOR RE-DESIGN	10/15/87
62	ISSUED FOR RE-CONSTRUCTION	11/15/87
63	ISSUED FOR RE-EVALUATION	12/15/87
64	ISSUED FOR RE-DESIGN	01/15/88
65	ISSUED FOR RE-CONSTRUCTION	02/15/88
66	ISSUED FOR RE-EVALUATION	03/15/88
67	ISSUED FOR RE-DESIGN	04/15/88
68	ISSUED FOR RE-CONSTRUCTION	05/15/88
69	ISSUED FOR RE-EVALUATION	06/15/88
70	ISSUED FOR RE-DESIGN	07/15/88
71	ISSUED FOR RE-CONSTRUCTION	08/15/88
72	ISSUED FOR RE-EVALUATION	09/15/88
73	ISSUED FOR RE-DESIGN	10/15/88
74	ISSUED FOR RE-CONSTRUCTION	11/15/88
75	ISSUED FOR RE-EVALUATION	12/15/88
76	ISSUED FOR RE-DESIGN	01/15/89
77	ISSUED FOR RE-CONSTRUCTION	02/15/89
78	ISSUED FOR RE-EVALUATION	03/15/89
79	ISSUED FOR RE-DESIGN	04/15/89
80	ISSUED FOR RE-CONSTRUCTION	05/15/89
81	ISSUED FOR RE-EVALUATION	06/15/89
82	ISSUED FOR RE-DESIGN	07/15/89
83	ISSUED FOR RE-CONSTRUCTION	08/15/89
84	ISSUED FOR RE-EVALUATION	09/15/89
85	ISSUED FOR RE-DESIGN	10/15/89
86	ISSUED FOR RE-CONSTRUCTION	11/15/89
87	ISSUED FOR RE-EVALUATION	12/15/89
88	ISSUED FOR RE-DESIGN	01/15/90
89	ISSUED FOR RE-CONSTRUCTION	02/15/90
90	ISSUED FOR RE-EVALUATION	03/15/90
91	ISSUED FOR RE-DESIGN	04/15/90
92	ISSUED FOR RE-CONSTRUCTION	05/15/90
93	ISSUED FOR RE-EVALUATION	06/15/90
94	ISSUED FOR RE-DESIGN	07/15/90
95	ISSUED FOR RE-CONSTRUCTION	08/15/90
96	ISSUED FOR RE-EVALUATION	09/15/90
97	ISSUED FOR RE-DESIGN	10/15/90
98	ISSUED FOR RE-CONSTRUCTION	11/15/90
99	ISSUED FOR RE-EVALUATION	12/15/90
100	ISSUED FOR RE-DESIGN	01/15/91

HMMH ARCHITECTS

JSC CONTROL CENTER COMPLEX

SSCC DEVELOPMENT ORGANIZATIONS

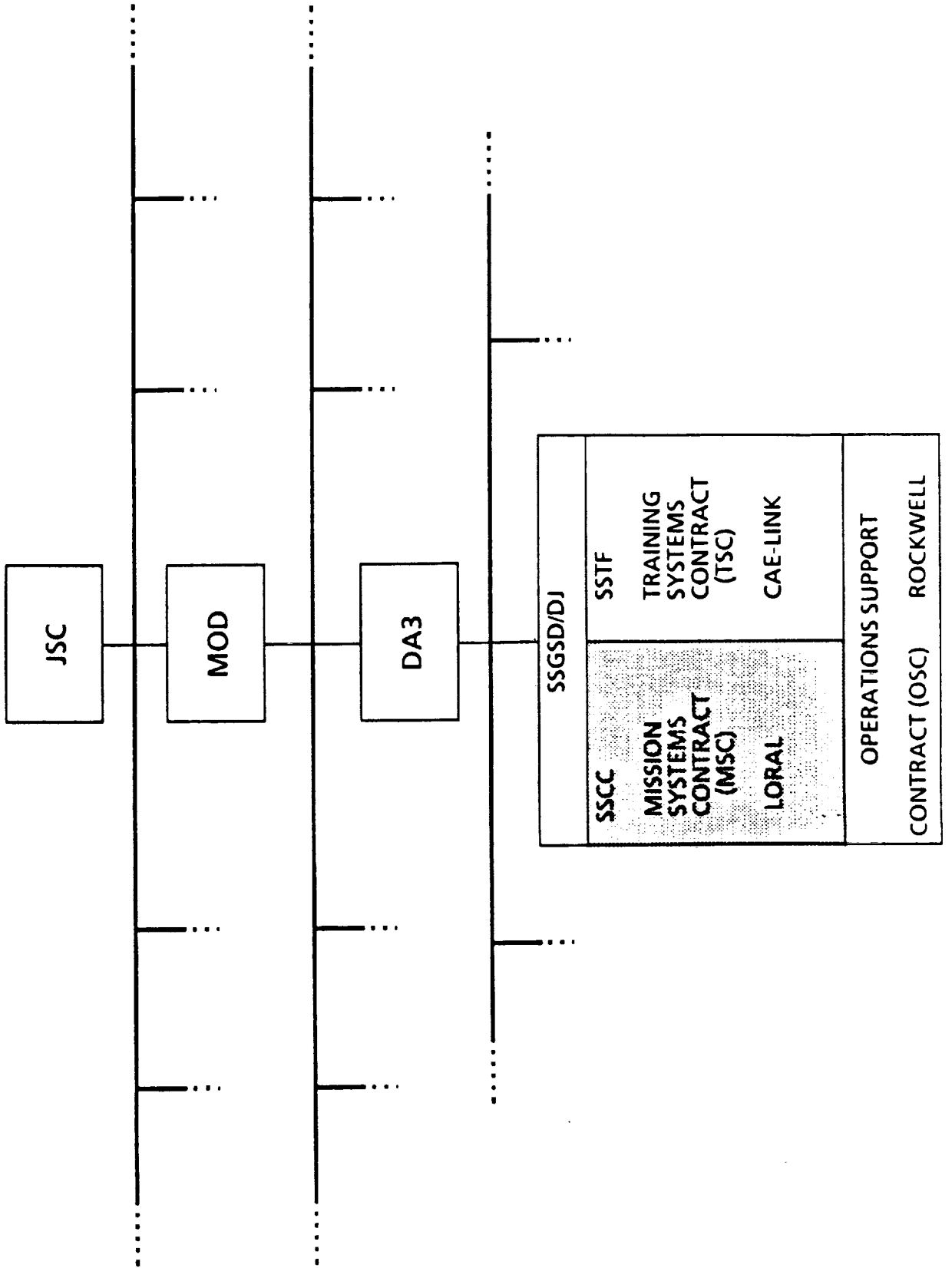

INTRODUCTION **SSCC PROGRAMMATIC ROLES**

- PRIMARY GROUND CENTER FOR
 - MONITORING AND CONTROLLING THE SPACE STATION MANNED BASE CORE SYSTEMS
 - MANAGEMENT OF UPLINK FOR CORE AND PAYLOAD SYSTEMS
 - INSURING THE SAFETY OF THE CREW AND MANNED BASE

- FOCAL POINT OF OPERATIONS PLANNING FOR THE SPACE STATION AND ASSOCIATED GROUND SYSTEMS
 - RESOURCE PLANNING AND SCHEDULING FOR ALL OF THE MANNED BASE
 - COORDINATION OF THE CORE OPERATIONS WITH PAYLOAD OPERATIONS

- PRIMARY SOURCE OF ONBOARD CORE SYSTEMS DATA FOR OTHER SITES

ARCHITECTURE DRIVERS

PROGRAMMATIC DIRECTIVES (AIS LEVEL 3, ADA, ETC.)

- **ONBOARD DESIGN**
 - **OBJECT ACCESS (AND OBJECT DATA BASE)**
 - **DATA FORMATS (CCSDS PACKETS, TOLS, ETC.)**
 - **USER INTERFACE LANGUAGE**

- **SPACE STATION FREEDOM PROGRAM RESTRUCTURE**

- **BUDGET/RISK/SCHEDULE**
 - **COTS MARKETPLACE**
 - **MISSION CONTROL CENTER USE AND DESIGN REUSE**

- **MCC EXPERIENCE AND LESSONS LEARNED**

- **CONTINUOUS/CONCURRENT OPERATIONS**

ARCHITECTURE DRIVERS

- **PERFORMANCE REQUIREMENTS**
 - **DISPLAY OF CORE DATA WITHIN 5 SECONDS OF RECEIPT**
 - **COMMAND UPLINK TRANSMISSION DELAY 1 SECOND MAXIMUM**
 - **DATA RETRIEVAL 5 MINUTES FOR LESS THAN 1 DAY OLD DATA**
 - 30 MINUTES FOR LESS THAN A YEAR OLD**
 - 24 HOUR FOR MORE THAN A YEAR OLD**
 - **30 MINUTE RECONFIGURATION**

- **AVAILABILITY REQUIREMENTS**
 - **MANDATORY FUNCTIONS .995**
 - **DISRUPTIONS NOT TO EXCEED 45 MINUTES IN 150 HOURS**

- **REAL-TIME AND NON-REAL-TIME DATA SEPARATION**

- **FLEXIBLE CONNECTIVITY**

PHASING OF SSCC CAPABILITIES

- **SOFTWARE PRODUCTION ENVIRONMENT**
- **DELIVERY 1, INITIAL SUPPORT TOOLS AND SYSTEM FRAMEWORK**
 - **FOR BUILDING OF CONTROLLER DISPLAYS AND COMPUTATIONS**
- **DELIVERY 2, FIRST ELEMENT LAUNCH SUPPORT**
 - **SUPPORT OF SIMULATIONS FOR TRAINING**
 - **SUPPORT SPACE STATION ASSEMBLY FLIGHTS 1 AND 2**
- **DELIVERY 3, ROBOTICS AND KU-BAND**
 - **SUPPORT OF ASSEMBLY FLIGHTS 3 THRU 5 & CANADIANS**
- **DELIVERY 4, MAN TENDED SUPPORT**
 - **SUPPORT OF ASSEMBLY FLIGHTS & MTC UTILIZATION & RESUPPLY FLIGHTS**
- **DELIVERY 5, PERMANENTLY MANNED CAPABILITY**
- **DELIVERY 6, EIGHT MAN CREW CAPABILITY**

SSCC SCHEDULE for BALANCED OPTION

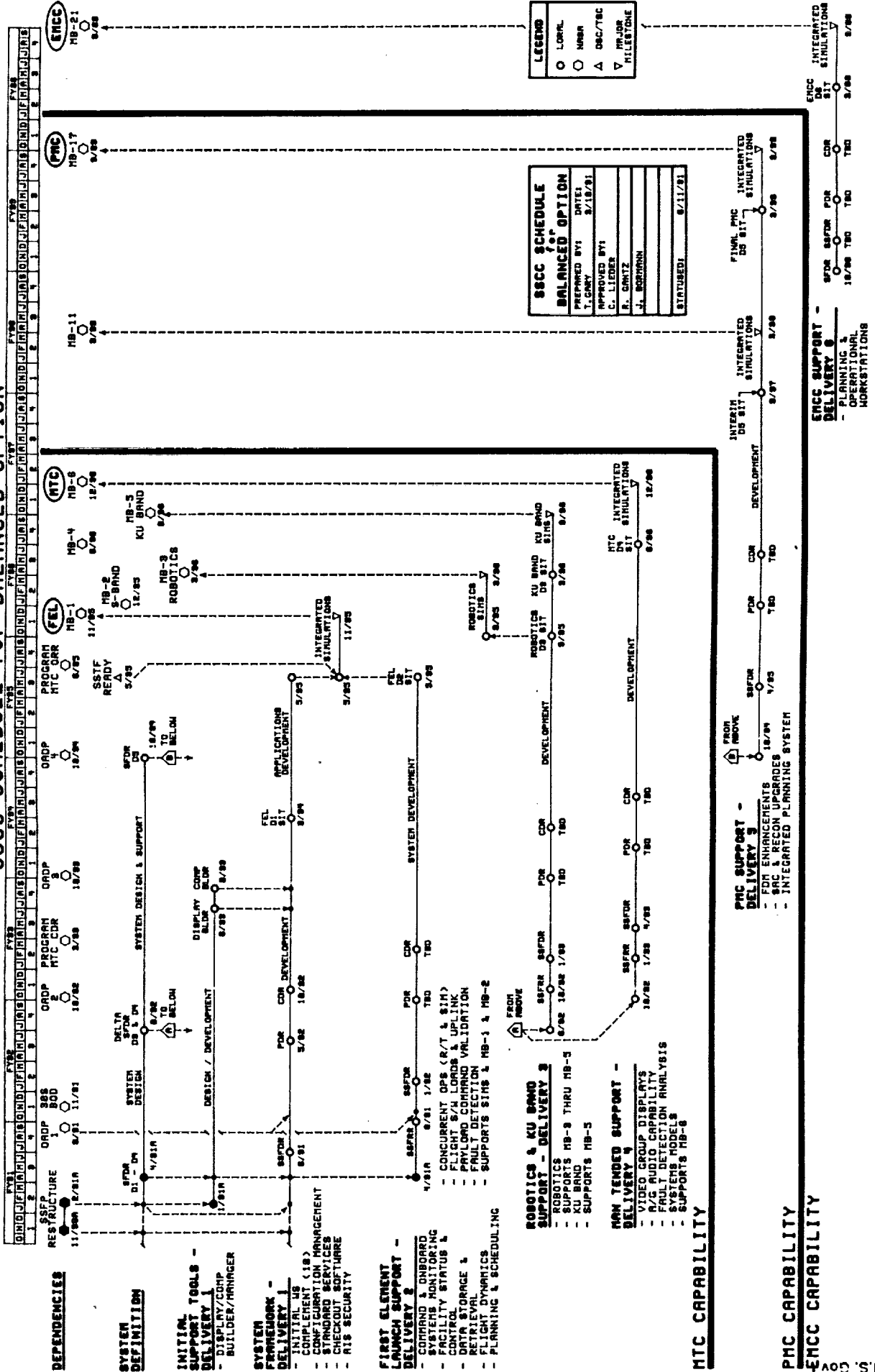

DEPENDENCIES

SYSTEM DEFINITION

INITIAL TOOLS SUPPORT DELIVERY 1

SYSTEM FRAMEWORK DELIVERY 1

FIRST ELEMENT LAUNCH SUPPORT DELIVERY 2

ROBOTICS & KU BAND SUPPORT DELIVERY 3

MAN TENDED SUPPORT DELIVERY 4

PMC CAPABILITY

ENCC CAPABILITY

SSCC SCHEDULE BALANCED OPTION	
PREPARED BY:	DATES
T. GANN	2/18/81
APPROVED BY:	
C. LIEBER	
R. GARTZ	
J. BORRMAN	
STATUS/DATE:	8/11/81

ENCC SUPPORT - DELIVERY 5
 - PLANNING & OPERATIONAL WORKSTATIONS

PMC SUPPORT - DELIVERY 5
 - FDN ENHANCEMENTS
 - SAC & RECON UPGRADES SYSTEM
 - INTEGRATED PLANNING SYSTEM

FROM REMOVE

SSCC ARCHITECTURE LAYER ZERO

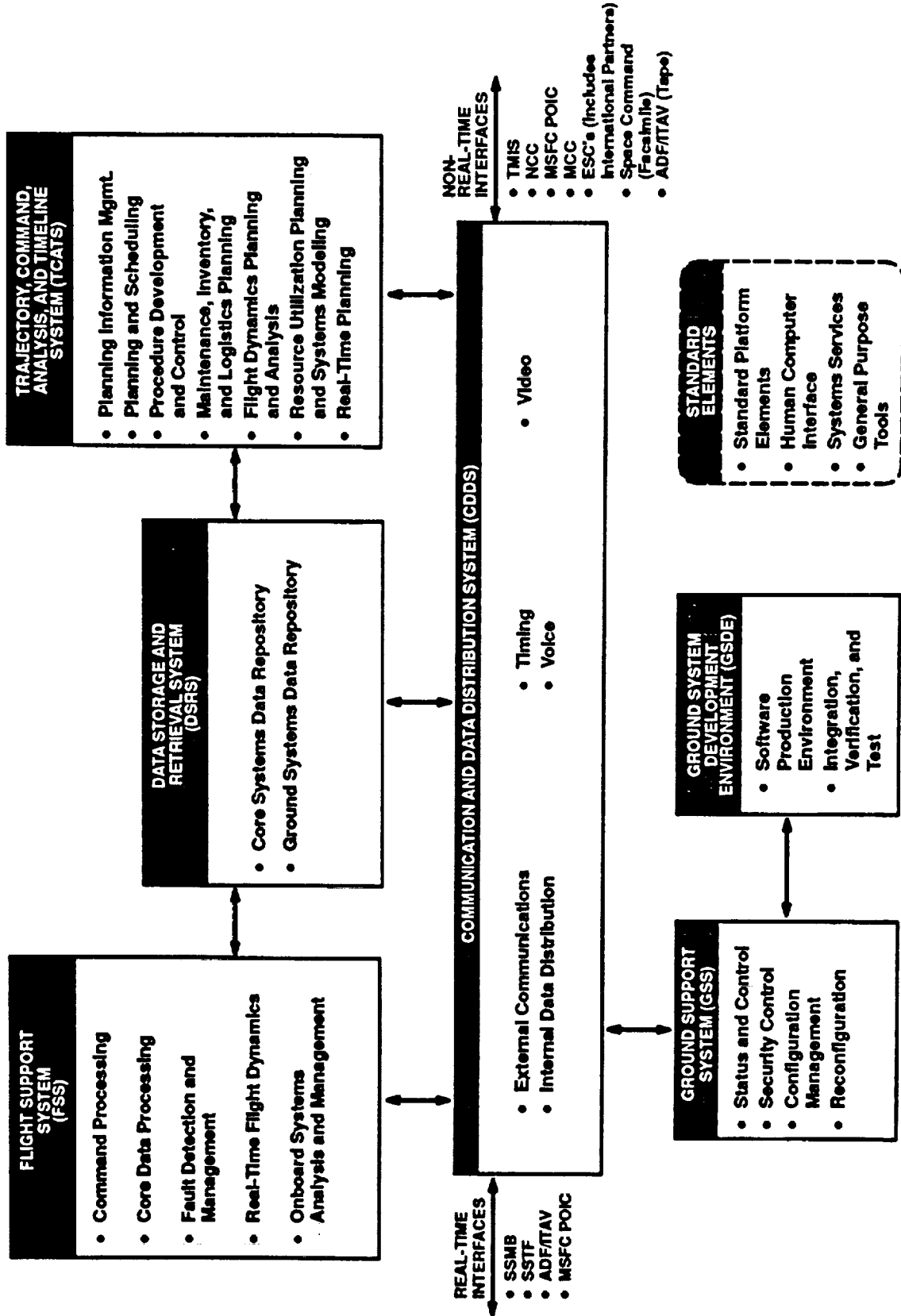

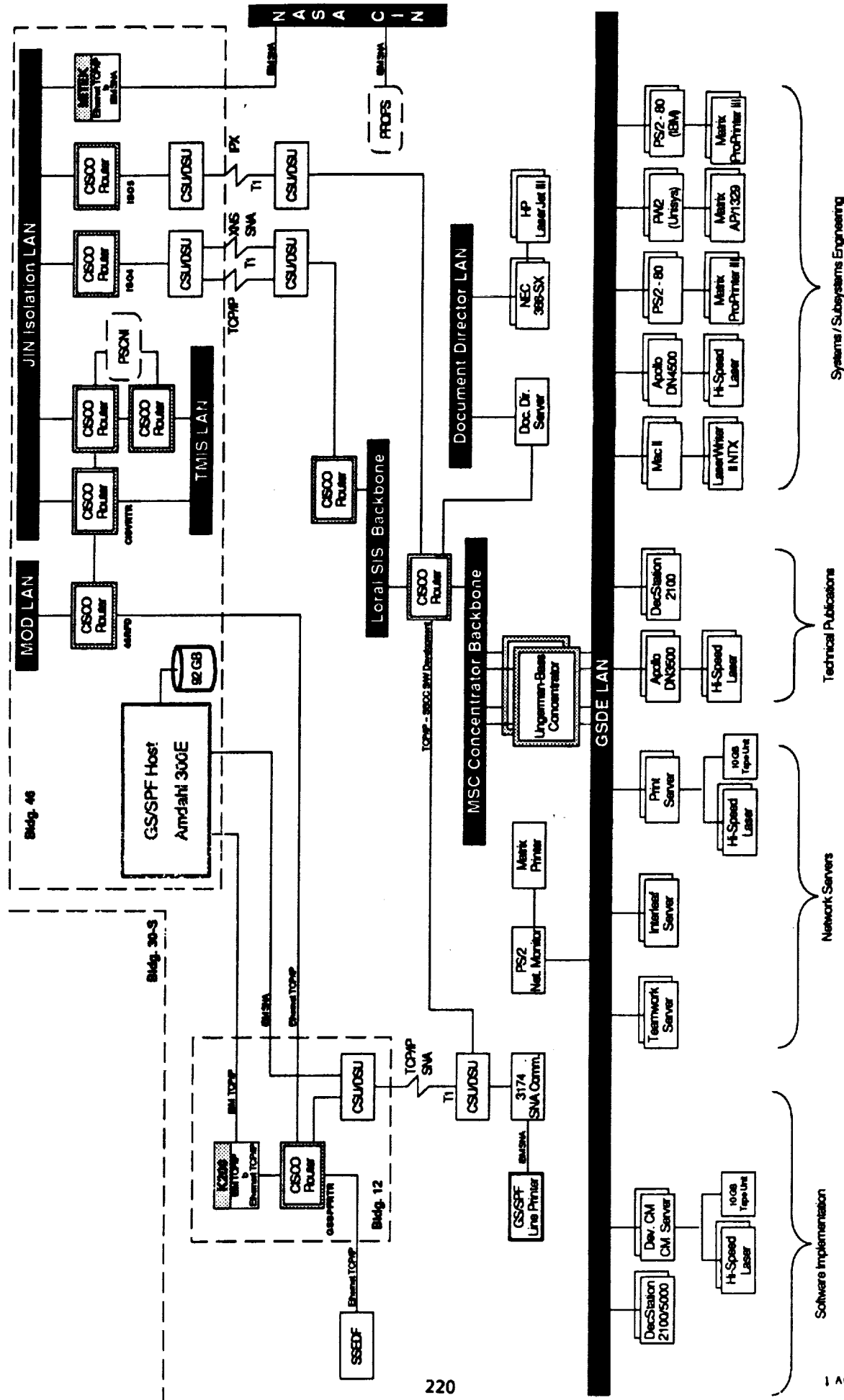

Ground System Development Environment - Existing Capability

Software Implementation

Network Servers

Technical Publications

Systems / Subsystems Engineering

SSCC ARCHITECTURE - DELIVERY 1

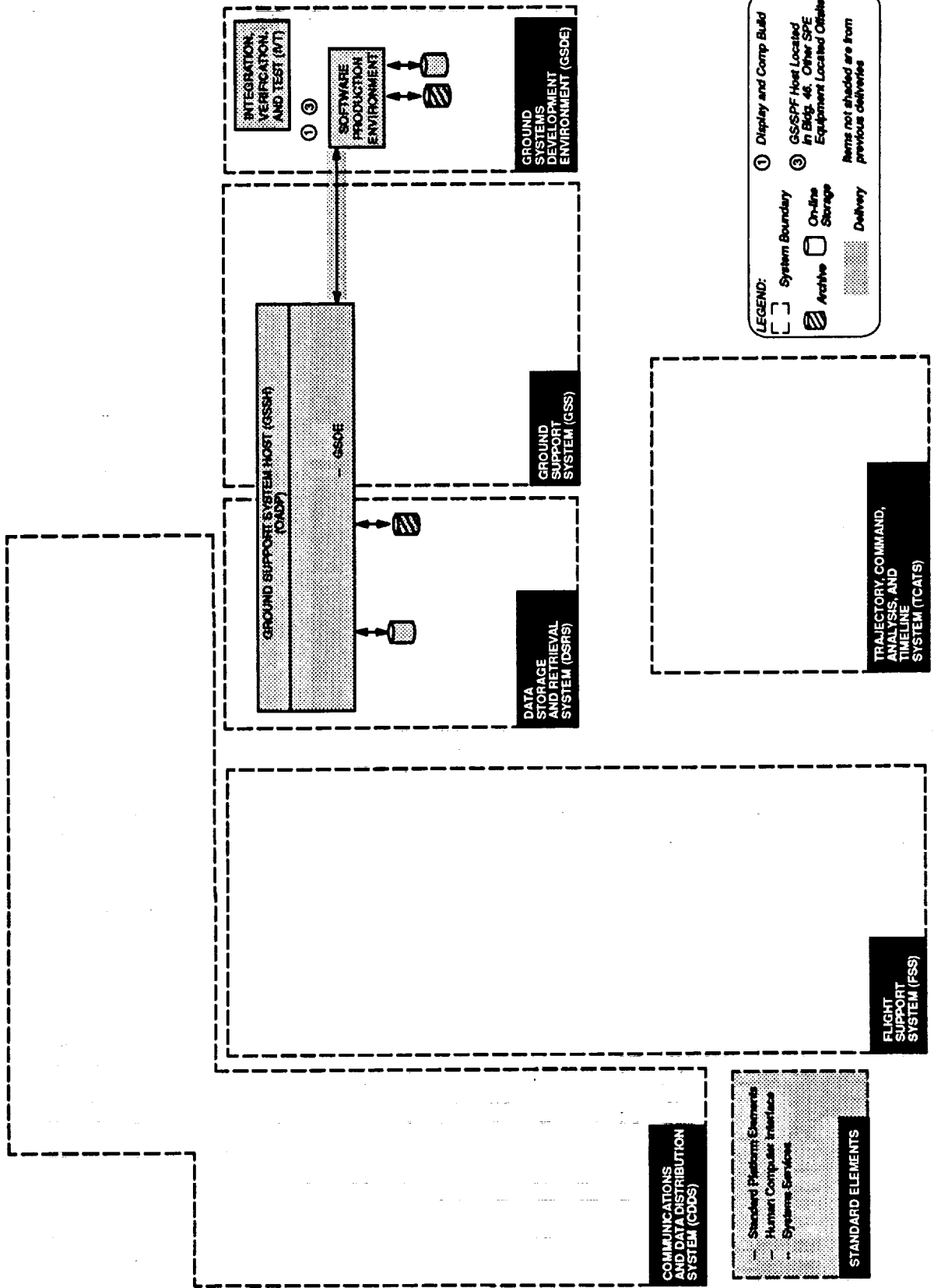

DELIVERY 1 CAPABILITY

INITIAL SUPPORT TOOLS AND SYSTEM FRAMEWORK

- STANDARD ELEMENTS
 - GROUND SUPPORT SYSTEM HOST (GSSH) 1 CLASS B
 - COMMUNICATION BETWEEN GSSH AND SPE GS/SPF HOST
 - OBJECT ACCESS
 - DISPLAY BUILDER/MANAGER
 - COMP BUILDER/MANAGER
 - INITIALIZATION
 - INITIAL LOG/DELOG
 - RELATIONAL DATA BASE MANAGER (RDBMS)

- GROUND SYSTEMS DEVELOPMENT ENVIRONMENT
 - SOFTWARE PRODUCTION ENVIRONMENT
 - DEVELOPMENT WORKSTATIONS
 - BUILD DISPLAYS AND COMPS
 - SECURITY SERVICES FOR ACCESS CONTROL
 - SOFTWARE DEVELOPMENT AND TEST
 - DEVELOPMENT CONFIGURATION MANAGEMENT
 - INTEGRATION, VERIFICATION AND TEST
 - INITIAL OBJECT TEST DATA BASE
 - INITIAL CHECKOUT SOFTWARE

SSCC ARCHITECTURE - DELIVERY 2

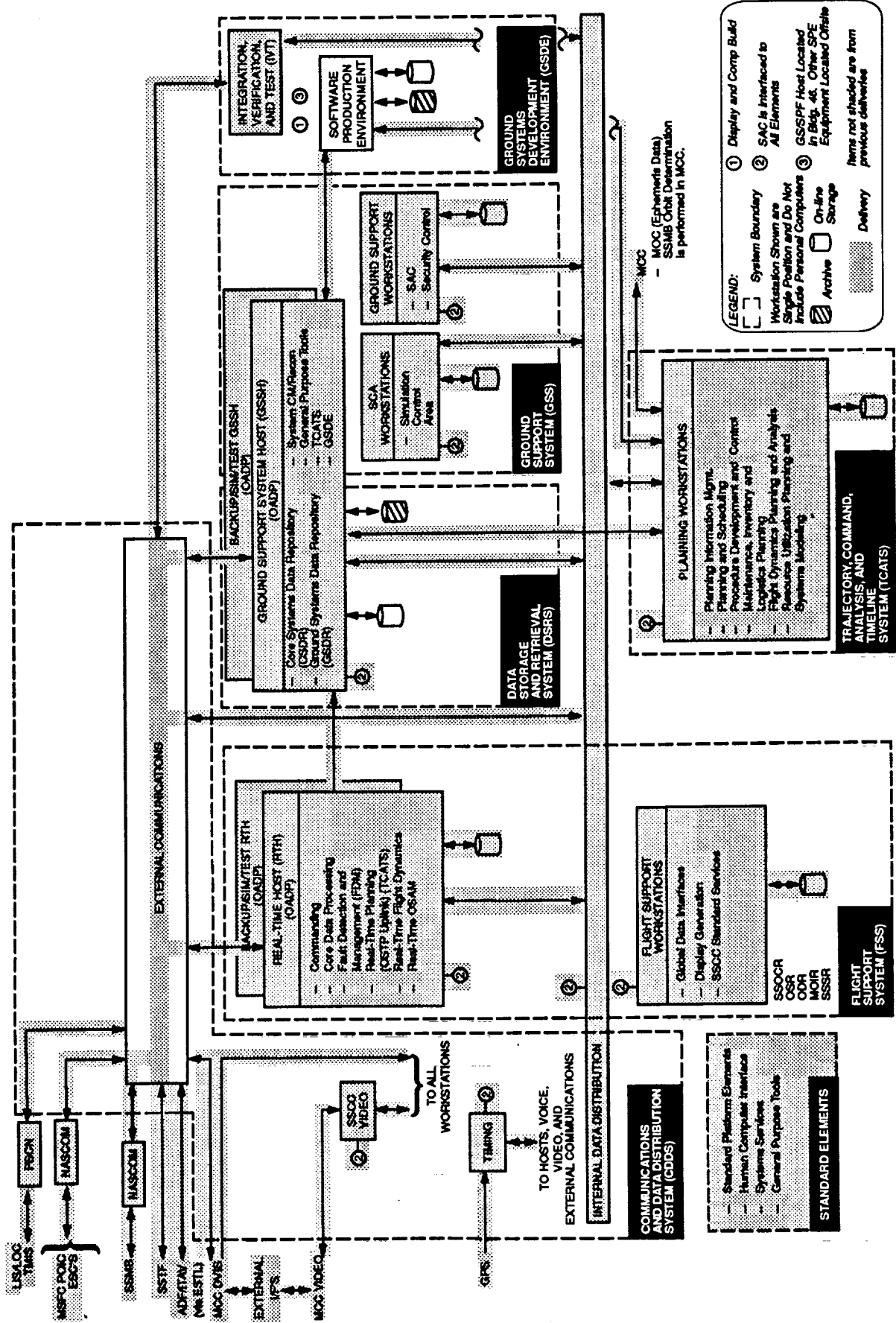

DELIVERY 2 CAPABILITY

FIRST ELEMENT LAUNCH SUPPORT

- **STANDARD ELEMENTS**
 - **REAL-TIME HOST (RTH) 1 CLASS B, UPGRADE RTH 1 TO CLASS C**
 - **RTH 2 CLASS C**
 - **UPGRADE GSSH 1 TO CLASS D**
 - **GSSH 2 CLASS D**
 - **CONSOLE HOUSINGS**
 - **WORKSTATIONS, TOOLS, AND PERIPHERALS**
 - **GENERAL PURPOSE TOOL CONTROLLER, SPREADSHEET AND WORDPROCESSOR**
 - **RTH DATA REPLAY**
 - **ALARM MANAGEMENT**
 - **INITIALIZATION UPGRADE**
 - **RECOVERY SERVICES**
 - **TIMING SERVICES**
 - **USER INTERFACE LANGUAGE**

DELIVERY 2 CAPABILITY (CONT'D)

FIRST ELEMENT LAUNCH SUPPORT

- **COMMUNICATIONS AND DATA DISTRIBUTION SYSTEM**
 - **TWO STRING EXTERNAL COMMUNICATIONS CAPABILITY**
 - **DATA RECORDING AND TEST**
 - **VOICE CAPABILITY WITH SSMB, GROUND FACILITIES AND SSCC INTERNAL INCLUDING VOICE RECORDERS**
 - **VIDEO GROUND DISTRIBUTION INCLUDING SSCC TV MONITORS**
 - **TIMING TO HOSTS, EXTERNAL COMMUNICATIONS, VOICE, VIDEO**
 - **INTERNAL DATA DISTRIBUTION LAN'S (OPERATIONS AND TCATS)**
 - **EXTERNAL INTERFACES (SSMB, SSTF, ADF/ITAV, MCC, LIS/LOC, NCC, POIC)**

- **DATA STORAGE AND RETRIEVAL SYSTEM**
 - **STORE, ARCHIVE AND RETRIEVE CORE SYSTEMS DATA DOWNLINKED FROM SSMB**
 - **STORE, ARCHIVE AND RETRIEVE RESULTS OF COMPUTATIONS ON TELEMETRY DATA (FROM CORE DATA PROCESSING)**
 - **PERMANENTLY ARCHIVE SELECTED FLIGHT DATA**
 - **ALLOW FOR CONCURRENT MULTIUSER ACCESS TO STORED DATA**
 - **PROVIDE LOCATION-TRANSPARENT RETRIEVAL OF STORED TELEMETRY DATA**
 - **PERFORM CALIBRATION, LIMIT SENSING, AND ENGINEERING UNIT CONVERSION ON RETRIEVED TELEMETRY DATA**
 - **PERFORM ACCESS CONTROL**
 - **MANAGE STORAGE AND RETRIEVAL RESOURCES**

DELIVERY 2 CAPABILITY (CONT'D)

FIRST ELEMENT LAUNCH SUPPORT

- **FLIGHT SUPPORT SYSTEM**
 - **CORE COMMAND BUILD, SAFING, UPLINK, LOGGING AND MANAGEMENT**
 - **PAYLOAD COMMAND MERGE AND UPLINK**
 - **CORE DATA PROCESSING (CALIBRATIONS, COMPUTATIONS, ENGINEERING UNIT CONVERSIONS, LIMIT SENSING)**
 - **REAL-TIME CORE SYSTEM MODELS**
 - **REAL-TIME FLIGHT DYNAMICS CALCULATIONS AND STORAGE/RETRIEVAL**
 - **FAULT DETECTION AND MANAGEMENT (CAUTION AND WARNING TRANSLATIONS, FAULT ANNUNCIATION, FAULT MESSAGE LOGGING)**

- **TRAJECTORY, COMMAND, ANALYSIS, AND TIMELINE SYSTEM**
 - **PLANNING INFORMATION MANAGEMENT**
 - **PLANNING AND SCHEDULING**
 - **REAL-TIME PLANNING**
 - **RESOURCE UTILIZATION PLANNING AND SYSTEMS MODELING (EARLY UTILIZATION TOOLS)**
 - **FLIGHT DYNAMICS PLANNING AND ANALYSIS**
 - **PROCEDURE DEVELOPMENT AND CONTROL**
 - **MAINTENANCE INVENTORY AND LOGISTICS PLANNING**
 - **SYSTEM SERVICES (DATA LIBRARY AND OBJECT ACCESS DATA SERVER)**

DELIVERY 2 CAPABILITY (CONT'D)

FIRST ELEMENT LAUNCH SUPPORT

- **GROUND SUPPORT SYSTEM**
 - **STATUS AND CONTROL**
 - **CONFIGURATION MANAGEMENT**
 - **RECONFIGURATION**
 - **SECURITY CONTROL**
 - **SIMULATION CONTROL AREA SUPPORT**
- **GROUND SYSTEMS DEVELOPMENT ENVIRONMENT**
 - **DEVELOPMENT OF SSCC SOFTWARE AND DATA PRODUCTS**
 - **CONFIGURATION MANAGEMENT OF SOFTWARE PRODUCTS**
 - **DELIVERY OF SOFTWARE PRODUCTS TO THE GSSH**
 - **CHECKOUT SOFTWARE UPGRADE/ADDITIONS**
 - **INTEGRATION, VERIFICATION, AND TEST (IVT) TEST DATA BASE**

SSCC ARCHITECTURE - DELIVERY 3

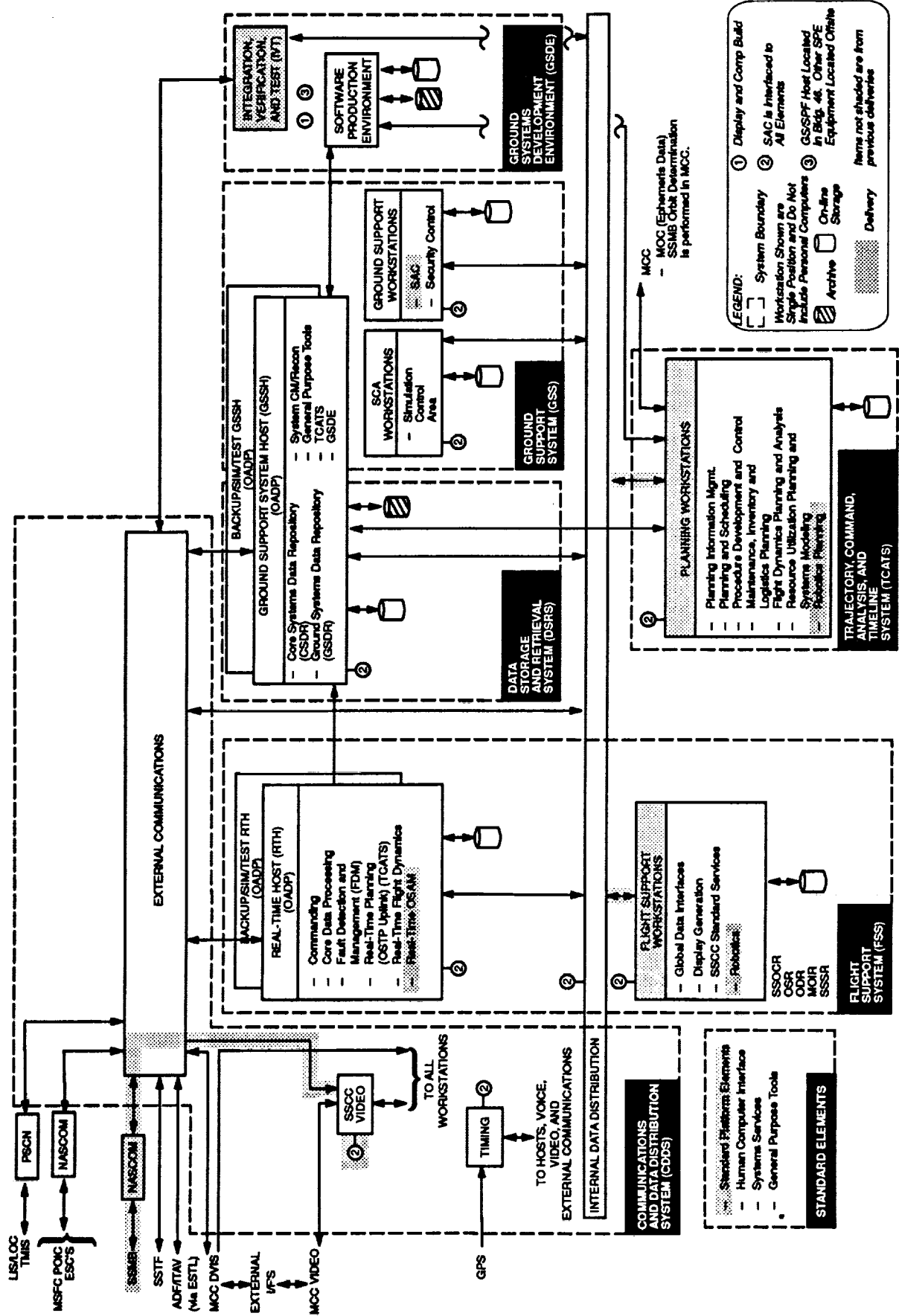

DELIVERY 3 CAPABILITY ROBOTICS AND KU-BAND SUPPORT

- **STANDARD ELEMENTS**
 - **ADDITIONAL CONSOLE HOUSINGS**
 - **ADDITIONAL WORKSTATIONS AND PERIPHERALS**
 - **INTEGRATION, VERIFICATION AND TEST HOST CLASS D FOR DEVELOPMENT SUPPORT**
 - **ROBOTICS WORKSTATIONS**
- **COMMUNICATIONS AND DATA DISTRIBUTION SYSTEM**
 - **SSMB KU-BAND DOWNLINK VIDEO**
- **FLIGHT SUPPORT SYSTEM**
 - **REAL-TIME OSAM (ROBOTICS DAP MODEL)**
 - **REAL-TIME ROBOTICS OPERATIONS SUPPORT**
- **TRAJECTORY, COMMAND, ANALYSIS, AND TIMELINE SYSTEM**
 - **ROBOTICS MODELS AND PLANNING**
- **GROUND SUPPORT SYSTEM**
 - **SAC FOR SSMB VIDEO**

SSCC ARCHITECTURE - DELIVERY 4

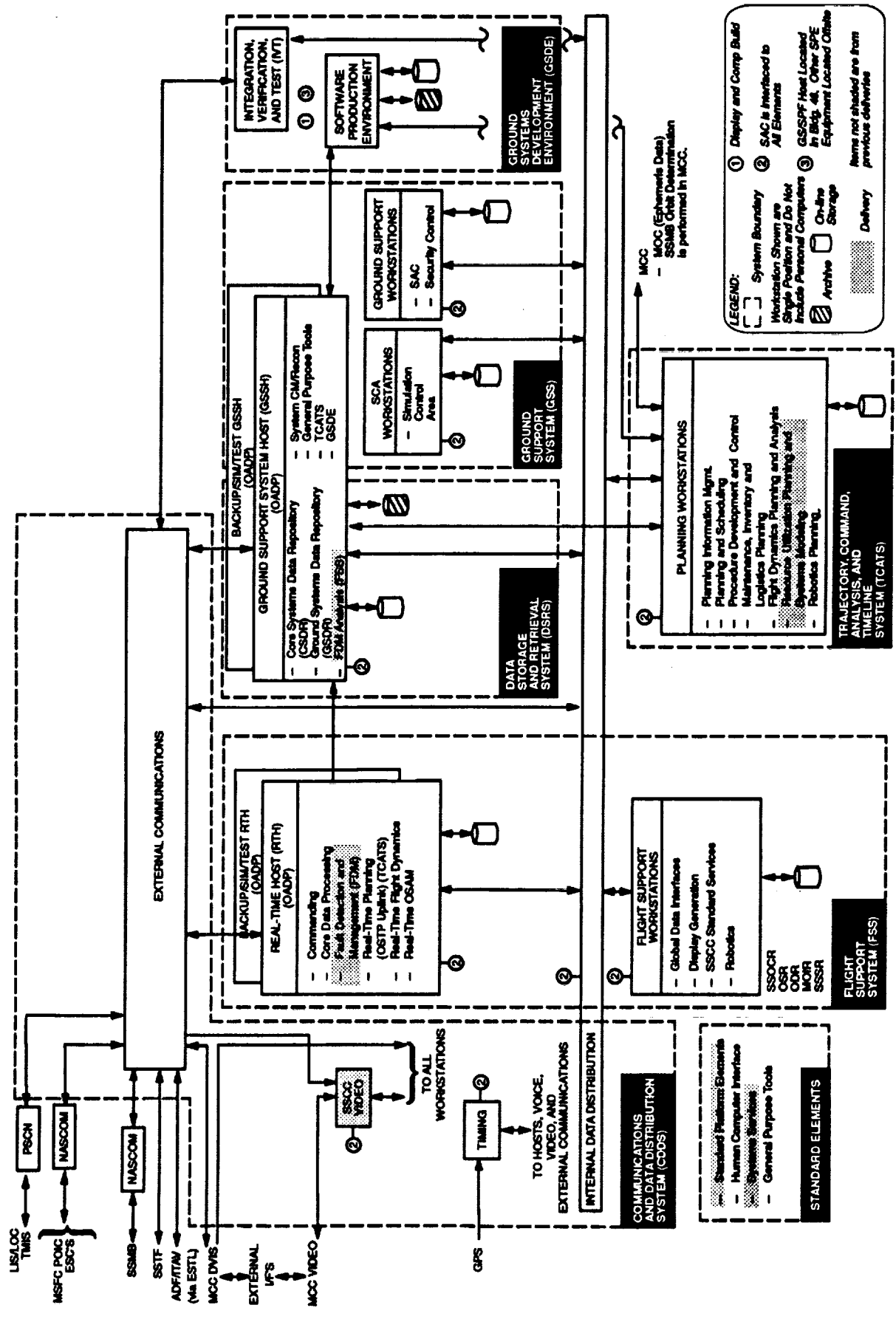

LEGEND:

- ① System Boundary
- ② Workstation Shown are Single Position and Do Not Include Personal Computers
- ③ On-line Storage
- Archives
- Delivery
- Items not shaded are from previous deliveries

① Display and Comp Build

- MCC (Elements Data)
- SSMB Chart Determination is performed in MCC.

② SAC is Inherited to All Elements

③ GSDF Host Located in Bldg. 44, Other SPE Equipment Located Other

DELIVERY 4 CAPABILITY

MAN TENDED SUPPORT

- **STANDARD ELEMENTS**
 - **ADDITIONAL WORKSTATIONS**
 - **DELOG ENHANCEMENTS**
- **COMMUNICATIONS AND DATA DISTRIBUTION SYSTEM**
 - **VIDEO TV WINDOWS, GROUP DISPLAY, VISUALS**
- **FLIGHT SUPPORT SYSTEM**
 - **FAULT DETECTION AND MANAGEMENT ANALYSIS (TIC, IMPASS AND COMP INTERFACE)**
 - **FAULT DETECTION AND MANAGEMENT (ISE EVENT MESSAGE PROCESSING AND SSMB C&W SYNTHESIS)**
- **TRAJECTORY, COMMAND, ANALYSIS, AND TIMELINE SYSTEM**
 - **RESOURCE UTILIZATION PLANNING AND SYSTEMS MODELING (TCS, EPS, C&T, PROP MODELS)**
 - **CONFIGURATION MANAGEMENT EXTENSIONS**

SSCC ARCHITECTURE - DELIVERY 5 & 6

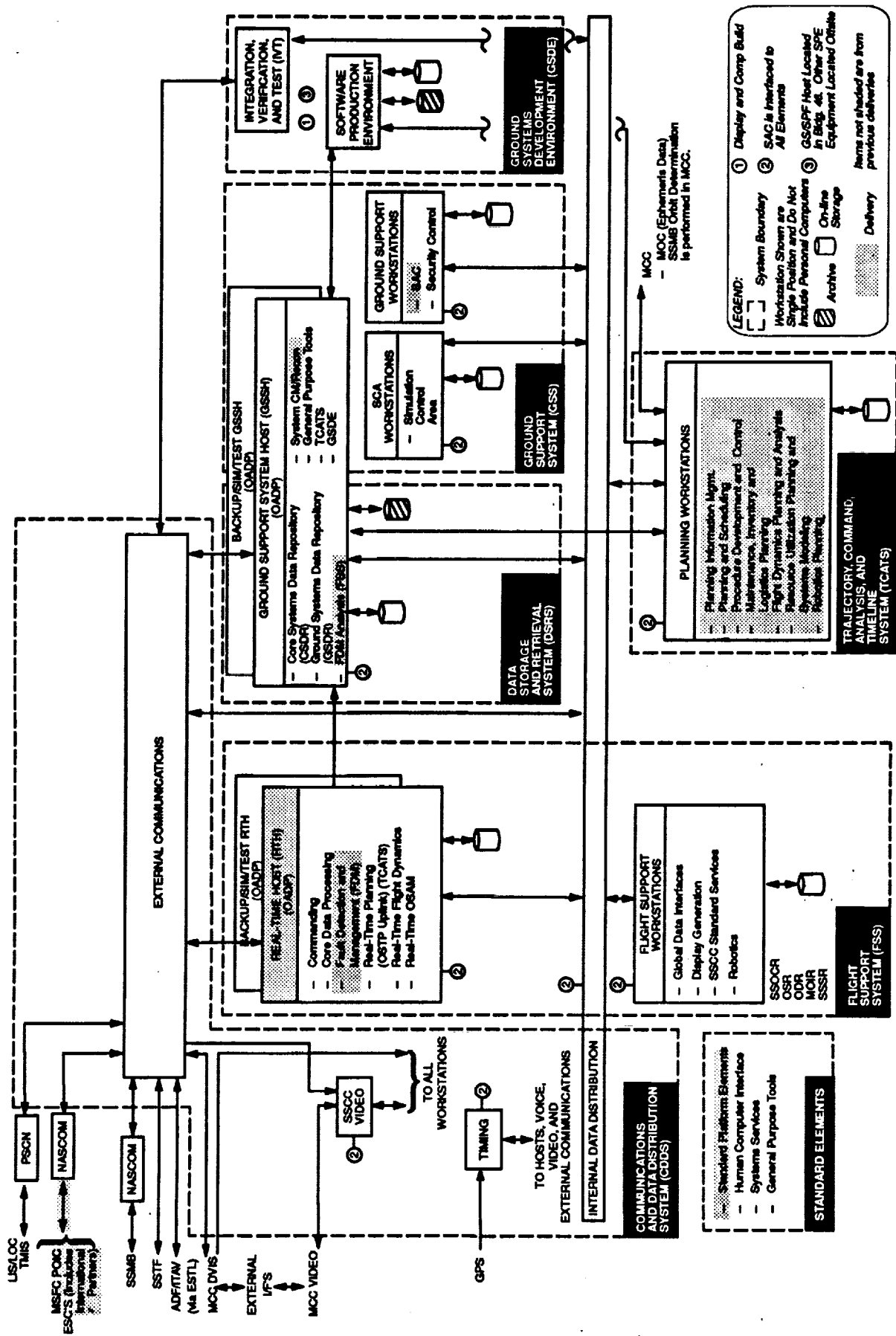

DELIVERY 5 CAPABILITY – PMC SUPPORT

- **STANDARD ELEMENTS**
 - UPGRADE RTH 1 TO CLASS D
 - ADDITIONAL WORKSTATIONS
- **FLIGHT SUPPORT SYSTEM,**
 - FAULT DETECTION AND MANAGEMENT ENHANCEMENTS
- **GROUND SUPPORT SYSTEM**
 - STATUS AND CONTROL
 - RECONFIGURATION
- **TRAJECTORY, COMMAND, ANALYSIS, AND TIMELINE SYSTEM**
 - INTEGRATED PLANNING SYSTEM

DELIVERY 6 CAPABILITY – EMCC SUPPORT

- **STANDARD ELEMENTS**
 - ADDITIONAL WORKSTATIONS

SUMMARY

- **EARLY IN THE LIFE-CYCLE IF THE SSCC PROJECT**
- **SYSTEM FUNCTIONAL DESIGN REVIEW COMPLETED**
- **SUBSYSTEM REQUIREMENTS ARE NOW BEING DEVELOPED AND REVIEWED**
- **NEW FACILITY WILL BE AVAILABLE THIS FALL FOR DEVELOPMENT ACTIVITIES**

SSCC SYSTEM LIFE CYCLE

MSC PROGRAMMATIC MILESTONES

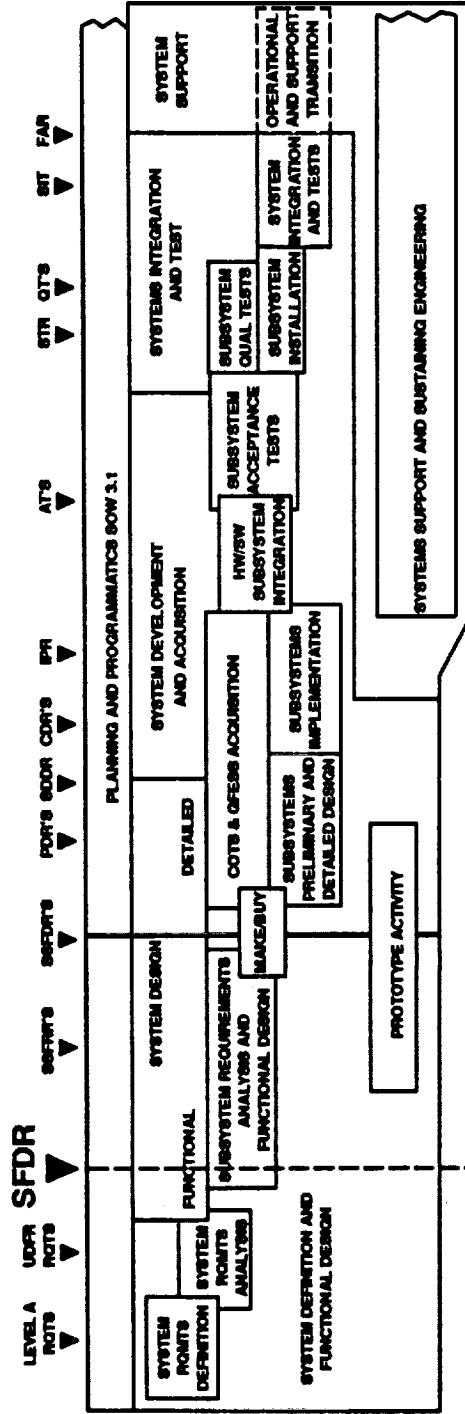

APRIL 15-18

210 **INTERNATIONAL SERIES**

AFSCN Command and Control Segment Evolution

Larry K. Whipple, COL. USAF
SPACE SYSTEMS DIVISION

Deborah Moorhead and Roger Fong
THE AEROSPACE CORPORATION

AG 16 279 57-14
N 82-12017
39609
P. 44
AG 16 3093

Outline

- **OVERVIEW OF AFSCN**
- **EVOLVING THE COMMAND AND CONTROL SEGMENT**
- **WORKSTATION INITIATIVES**
- **ADVANCED SATELLITE WORKSTATION - A PROTOTYPE**

Air Force Satellite Control Network (AFSCN)

- **WORLDWIDE NETWORK PROVIDING DOD SATELLITE CONTROL CAPABILITY**
 - **SATELLITE TRACKING AND COMMANDING**
 - **TELEMETRY DATA PROCESSING**
 - **COMMUNICATIONS**
- **NETWORK ELEMENTS:**
 - **CONSOLIDATED SPACE TEST CENTER (CSTC), ONIZUKA AFB, CA**
 - **CONSOLIDATED SPACE OPERATIONS CENTER (CSOC), FALCON AFB, CO**
 - **REMOTE TRACKING STATIONS**
 - **NETWORK ENGINEERING AND SYSTEM DEVELOPMENT**
- **SPACE SYSTEMS DIVISION RESPONSIBILITIES:**
 - **RESEARCH AND DEVELOPMENT MISSIONS**
 - **NETWORK ENGINEERING AND SYSTEM DEVELOPMENT**
- **AIR FORCE SPACE COMMAND RESPONSIBILITIES:**
 - **NETWORK MANAGEMENT**
 - **OPERATIONAL MISSIONS**
- **AIR FORCE LOGISTICS COMMAND RESPONSIBILITIES:**
 - **OPERATIONAL SYSTEMS' SUSTAINING ENGINEERING PROGRAM MANAGEMENT (after Program Management Responsibility Transfer)**

Space Missions Support

- **AFSCN PROVIDES HEALTH/STATUS AND COMMUNICATIONS SUPPORT TO MOST U.S. AND ALLIED SPACE MISSIONS**
 - **LAUNCH AND EARLY-ORBIT CHECKOUT**
 - **ANOMALY ANALYSIS**
 - **EPHEMERIS MANAGEMENT**
 - **MANAGEMENT OF STORED VEHICLES AND SELECTIVE ACTIVE VEHICLES**
 - **SATELLITE "STATE-OF-HEALTH" MONITORING**
- **DEDICATED SYSTEMS EMPHASIZE PAYLOAD ACTIVITIES**
 - **PAYLOAD CONFIGURATION**
 - **VEHICLE MONITORING/POSITIONING**

Dedicated Systems Activities

- **GPS HAS MASTER CONTROL STATION AND WORLDWIDE GROUND ANTENNA COVERAGE**
 - PERFORMS ALL PAYLOAD SYNCHRONIZATION COMPUTATIONS/COMMANDING
 - PERFORMS MOST VEHICLE COVERAGE/LOCATION COMPUTATIONS/COMMANDING
- **DSP HAS GLOBAL COVERAGE FROM LARGE PROCESSING STATIONS AND MOBILES**
 - PERFORMS ALL PAYLOAD DATA REDUCTION
 - PERFORMS RECONFIGURATION AND STATIONKEEPING FOR MOST OPERATIONAL VEHICLES
- **DMSP HAS COMPLETE COMMAND AND CONTROL CAPABILITY, BUT LACKS WORLDWIDE COVERAGE**
 - PERFORMS SATELLITE DATA PROCESSING, CONTROL, etc.
 - MISSION DATA SENT ELSEWHERE FOR PROCESSING
 - USES "BENT-PIPE" MISSION DATA ROUTING THROUGH AFSCN ANTENNAS

Dedicated Systems Activities

- **DSCS HAS FIXED/MOBILE PAYLOAD CONTROL ASSETS**
 - **SATELLITE CONFIGURATION CONTROL ELEMENTS PERFORM PAYLOAD RECONFIGURATIONS**
- **SKYNET HAS COMPLETE CAPABILITY FOR ON-ORBIT OPERATIONS AT UNITED KINGDOM CONTROL CENTER**
 - **AFSCN ONLY PROVIDES BACKUP COVERAGE AFTER LAUNCH**
- **MILSTAR WILL HAVE FIXED AND MOBILE MISSION ELEMENT CONTROL SYSTEMS**

Outline

- **OVERVIEW OF AFSCN**
- **EVOLVING THE COMMAND AND CONTROL SEGMENT**
- **WORKSTATION INITIATIVES**
- **ADVANCED SATELLITE WORKSTATION - A PROTOTYPE**

Evolving the CCS

- **DRIVEN BY NEW REQUIREMENTS AND PROJECTED AFSCN GROWTH**
- **SYSTEM MUST REMAIN OPERATIONAL WHILE BEING CHANGED**
- **PREPARE FOR NORMALIZED SPACE OPERATIONS SUPPORT**
- **TAKE ADVANTAGE OF TECHNOLOGY ADVANCES**
- **ENSURE COMPATIBILITY ACROSS NETWORK**
- **CHOOSE OPEN ARCHITECTURE, MULTIVENDOR APPROACH**

Approach

- **IDENTIFY TRANSITIONAL AND FUTURE ARCHITECTURE OBJECTIVES**
- **PROVIDE FOR EXPECTED REQUIREMENTS AND TECHNOLOGY ADVANCES**
- **DEVELOP GUIDELINES FOR THE EVOLUTION OF THE CCS ARCHITECTURE**
 - **USE STANDARDS AND AVOID PROPRIETARY SOLUTIONS**
 - **ADDRESS CCS TRANSITION ISSUES**

Baseline CCS Architecture

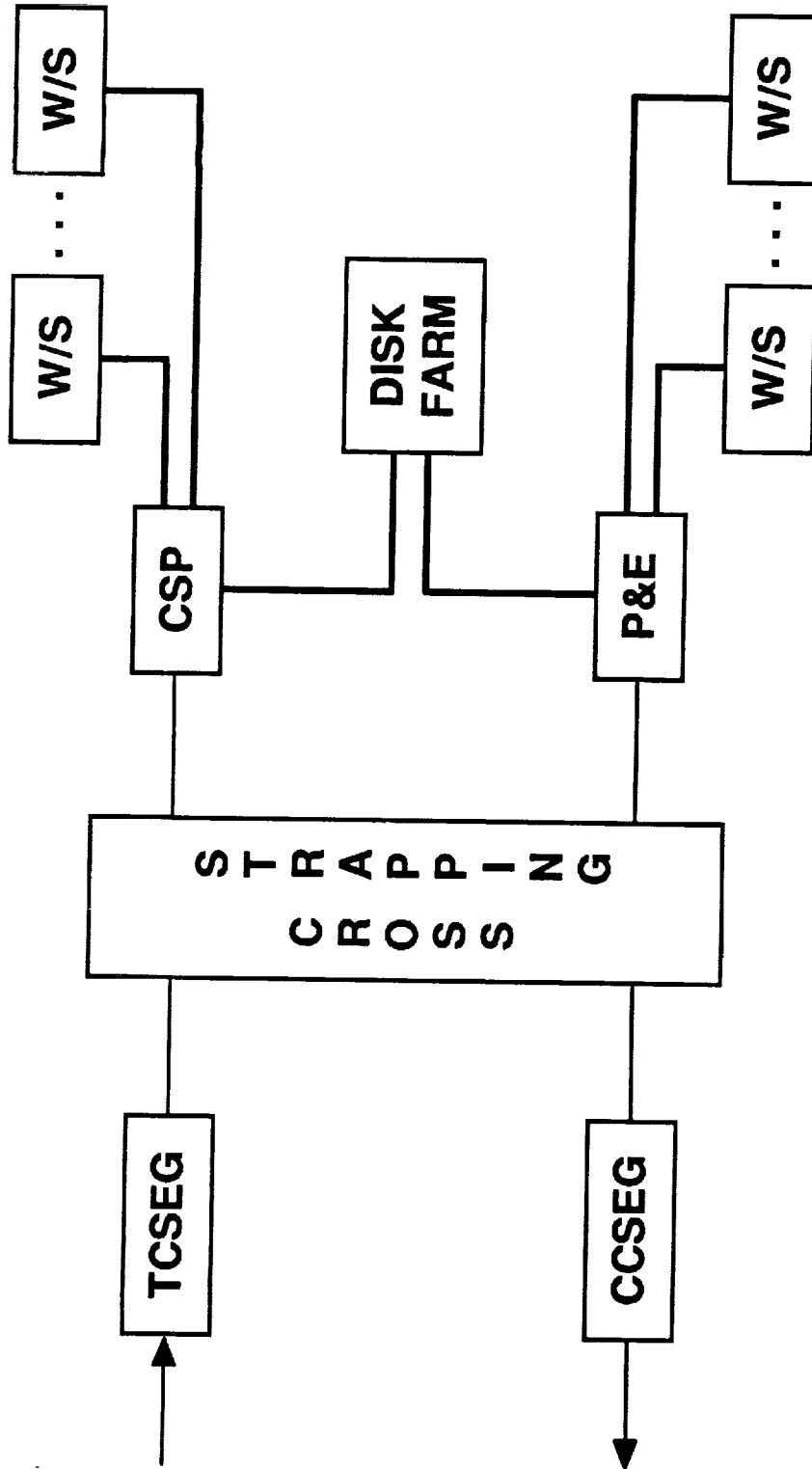

Five-Year CCS Architecture

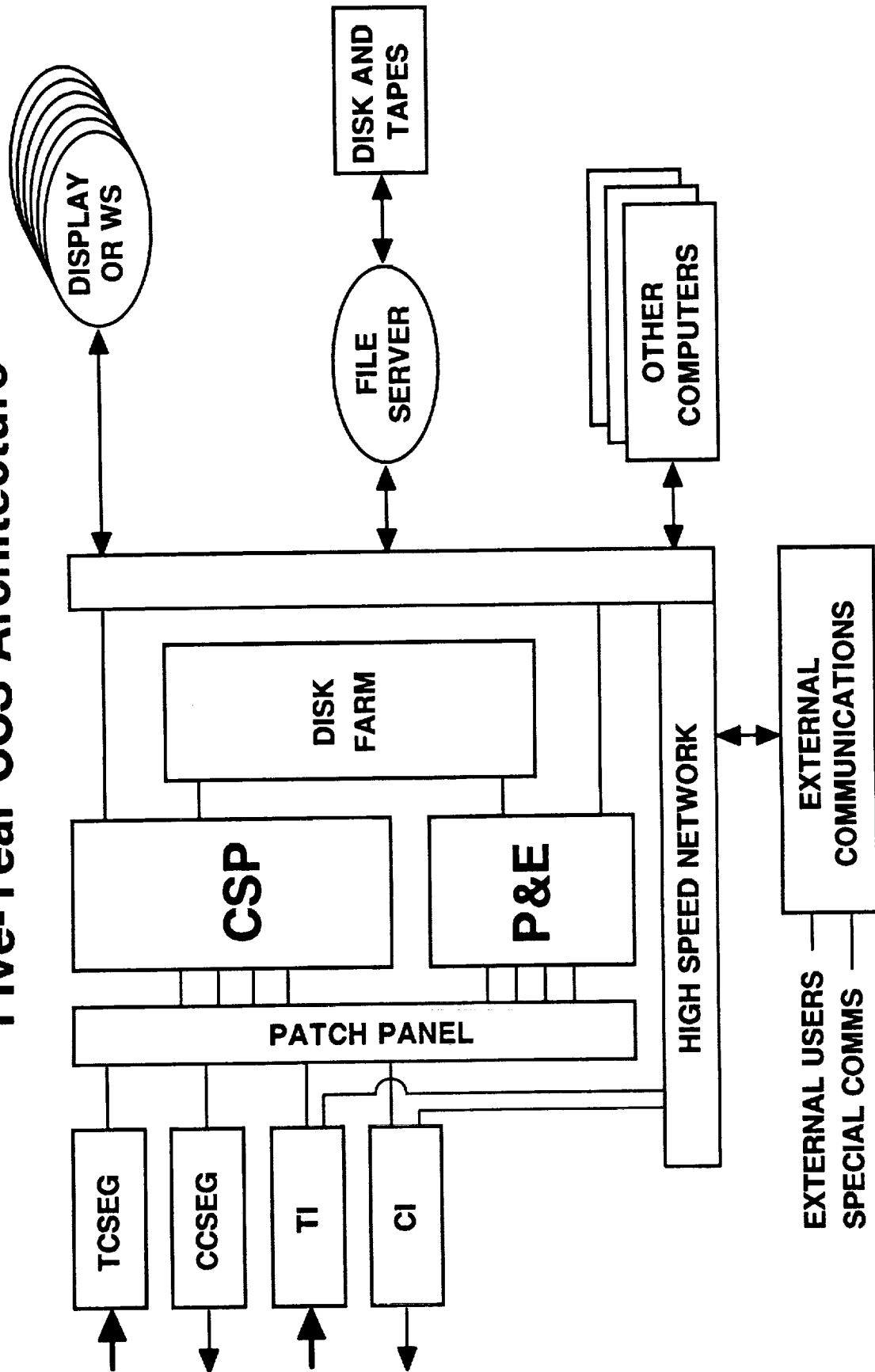

Ten-Year CCS Architecture

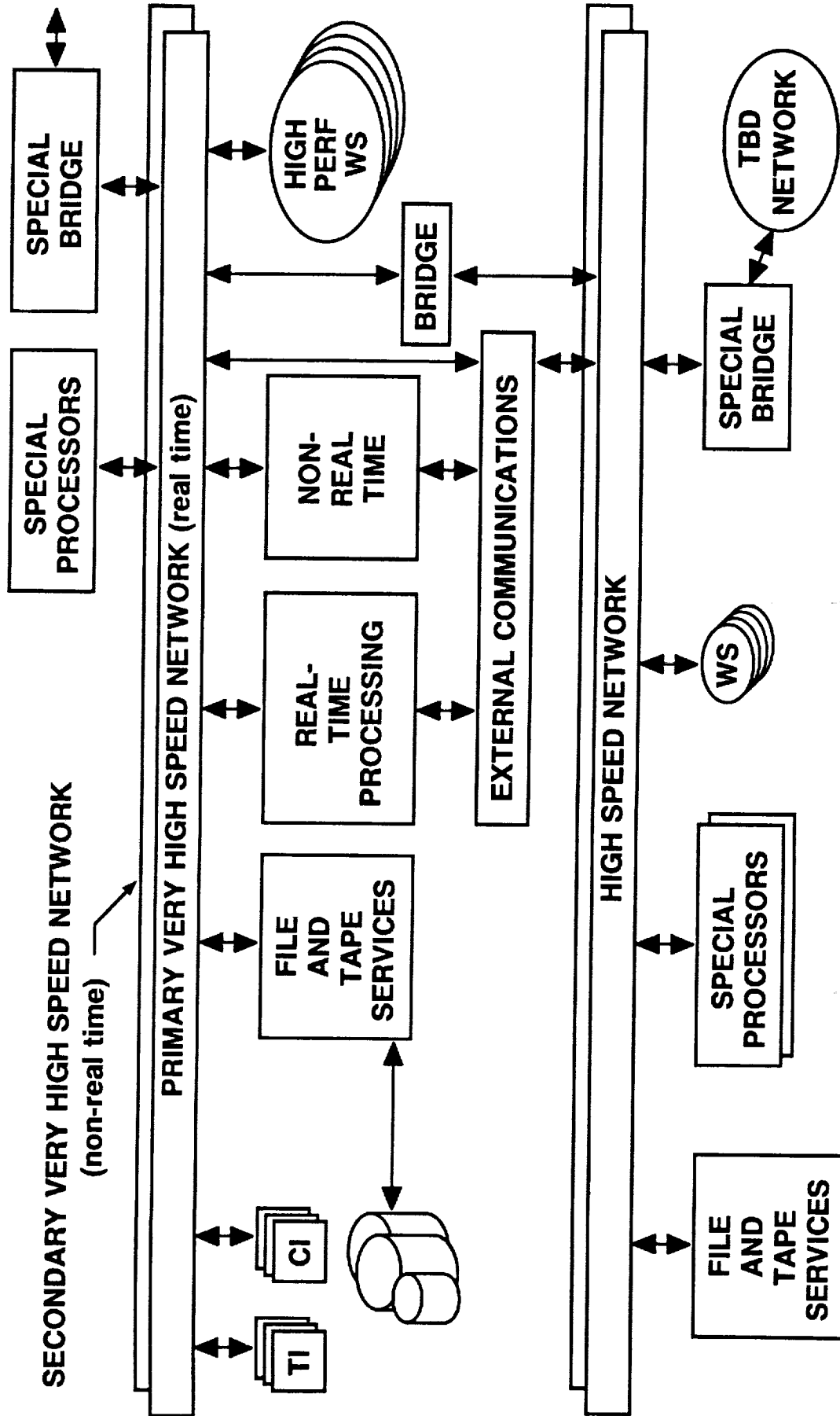

"Guidelines for the Evolution of the CCS Architecture" Recommendations

- **NETWORKS**
 - 5-YEAR: TCP/IP-OSI
 - 10-YEAR: U.S. GOSIP
- **OPERATING SYSTEM**
 - 5- AND 10-YEAR: POSIX (FIPS-151)
- **LANGUAGE**
 - 5-YEAR: NEW CODE IN ADA, JOVIAL CODE REMAINS ON CURRENT HOSTS
 - 10-YEAR: ALL MAJOR CCS FUNCTIONS IN ADA
- **EQUIPMENT INTERFACES**
 - 5-YEAR: SCSI, EISA, VME BUS, MULTIBUS II, VENDOR-SPECIFIC
 - 10-YEAR: FUTUREBUS+, HPPI, VENDOR-SPECIFIC

Transition Phase Protocol Architecture

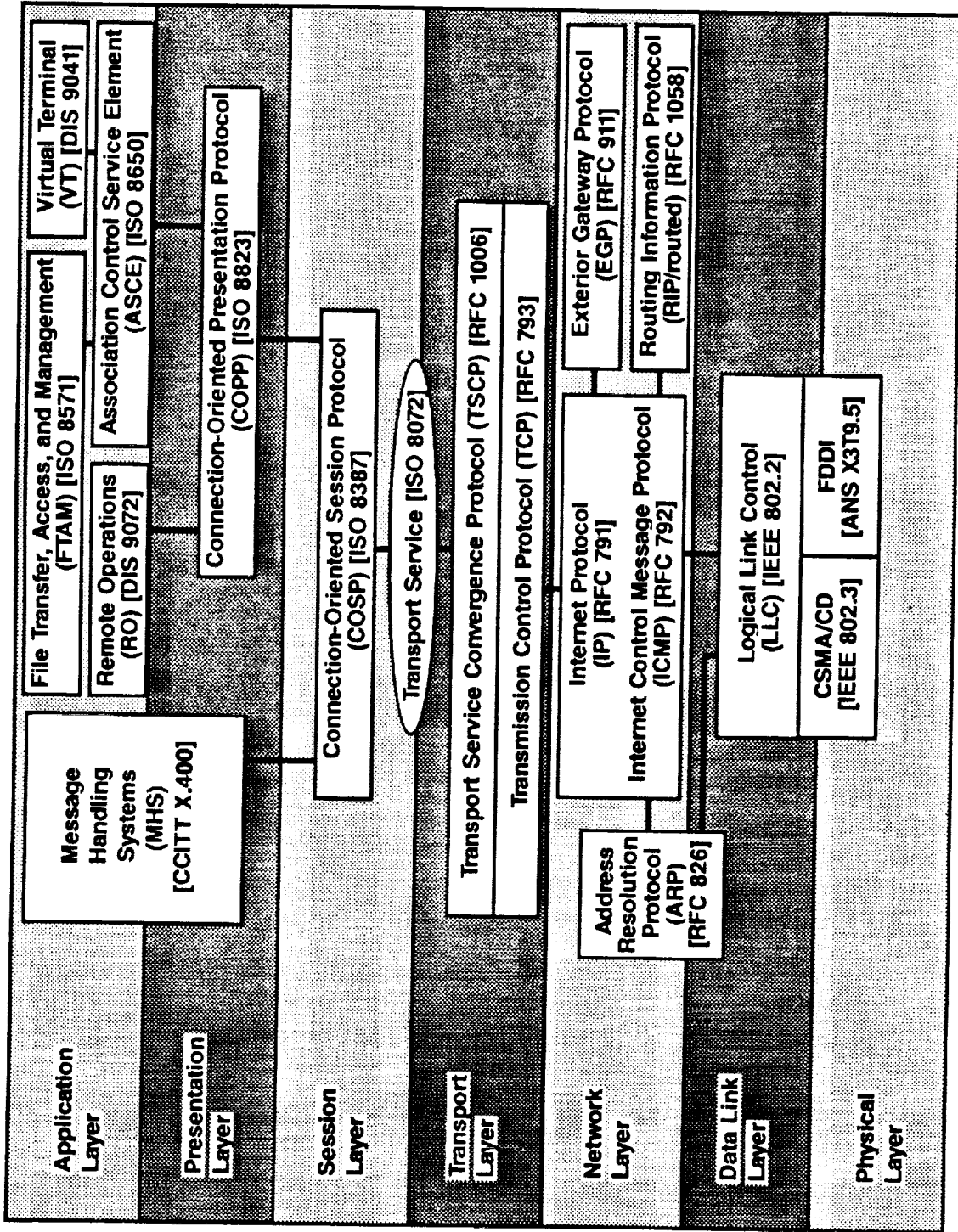

Recommendations (Cont'd)

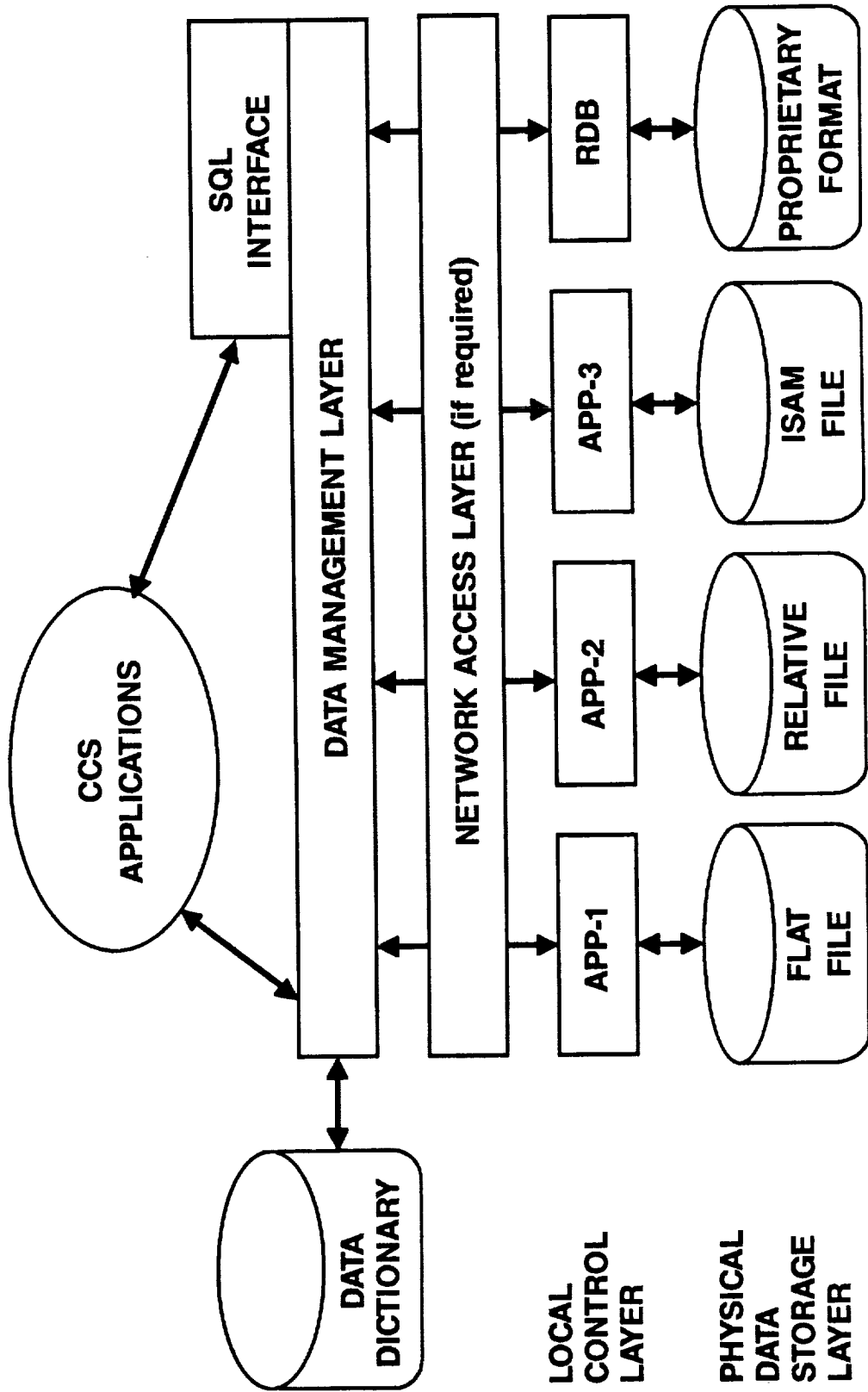

A FEDERATED DATABASE ARCHITECTURE

Recommendations (Cont'd)

- **WORKSTATIONS**
 - **BIT-MAPPED DISPLAYS**
 - **POINTING DEVICE FOR POINT-AND-SELECT INTERACTION**
 - **32-BIT MICROPROCESSOR WITH 16-MBYTES MEMORY**
 - **X-TERMINALS MAY BE COST-EFFECTIVE IN SOME CONFIGURATIONS**
 - **5-YEAR: WORKSTATIONS IN ALL AREAS**
 - **10-YEAR: FULL COMPLEMENT OF WORKSTATIONS**
- **USER INTERFACE**
 - **X-WINDOW SYSTEM**
 - **MOTIF EMERGING AS INDUSTRY CHOICE**
 - **5-YEAR: MOST IMPORTANT FORM FRAMES REPLACED BY WINDOWS**
 - **10-YEAR: ALL INTERACTIONS VIA WINDOWS**

Recommendations (Cont'd)

- **FILE MANAGEMENT**
 - **COMPUTER GRAPHIC METAFILE (MIL-M-28003, FIPS 128) FOR EXTENSIVE GRAPHIC INFORMATION**
 - **STANDARD GENERALIZED MARKUP LANGUAGE (MIL-M-28001, ISO 8879) FOR DOCUMENT PREPARATION**
 - **POSTSCRIPT FOR EXTENSIVE PRINTING OF TEXT AND GRAPHICS**
 - **FILE DIRECTORIES HAVE HIERARCHICAL STRUCTURE**
 - **5-YEAR: TRANSITION TO THESE STANDARDS FOLLOWS THE INTRODUCTION OF WORKSTATIONS, OPERATING SYSTEMS**
 - **10-YEAR: COMPLETE TRANSITION EXPECTED**

Areas of Other Recommendations

- **SECONDARY STORAGE**
 - **DISKS, TAPE**
 - **CONSIDER OPTICAL STORAGE IN FUTURE**
- **COMPUTE ENGINES**
 - **ASSESS FOR APPLICATION REQUIREMENTS**
 - **INTERFACES CONSISTENT WITH OTHER GUIDELINES**
- **"CASE" TOOLS**
 - **STANDARDIZE COMPUTER-AIDED SOFTWARE ENGINEERING (CASE) TOOL SET**
 - **HOST ON APPROVED DEVELOPMENT SYSTEMS**
 - **EASIER APPLICATION TO ADD DEVELOPMENTS**
- **SECURITY**
 - **SYSTEM HIGH OPERATION**
 - **AS TECHNOLOGY AVAILABLE, TRANSITION TO MULTILEVEL SECURITY**

Outline

- **OVERVIEW OF AFSCN**
- **EVOLVING THE COMMAND AND CONTROL SEGMENT**
- **WORKSTATION INITIATIVES**
- **ADVANCED SATELLITE WORKSTATION - A PROTOTYPE**

Workstation Initiatives

- **REQUIREMENTS GROWING FOR SUPPORT OF MORE COMPLEX AND GREATER NUMBER OF SATELLITES**
- **INVESTIGATE OPERATIONS FOR POTENTIAL APPLICATIONS OF AUTOMATION**
- **ASSESS STATE-OF-THE-ART COMPUTER PROCESSING, USER INTERFACES, EXPERT SYSTEMS, AUTOMATED SUPPORT AND ANALYSIS TOOLS**
- **COORDINATE TECHNICAL STUDIES, PROTOTYPE DEVELOPMENT, AND IMPLEMENTATION OF TECHNOLOGIES AMONG VARIOUS PROGRAMS (e.g., SSD/CW, SSD/SDE, SSD/XR, Phillips Labs)**
- **ASSURE COMPLIANCE WITH "GUIDELINES FOR THE EVOLUTION OF CCS ARCHITECTURE" AND APPLICABLE STANDARDS**

Outline

- **OVERVIEW OF AFSCN**
- **EVOLVING THE COMMAND AND CONTROL SEGMENT**
- **WORKSTATION INITIATIVES**
- **ADVANCED SATELLITE WORKSTATION - A PROTOTYPE**



The Aerospace Corporation

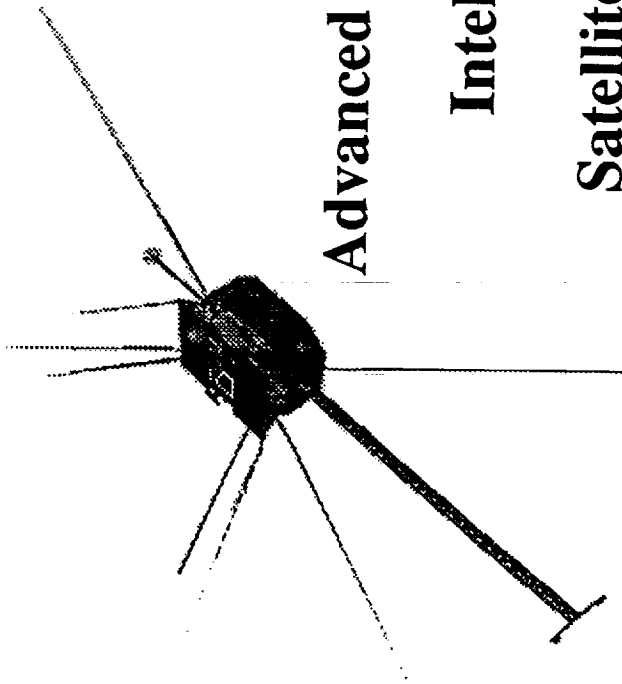

**Advanced Satellite Workstation (ASW):
Intelligent Decision Support
for
Satellite Planning and Operations**

Roger B. Fong

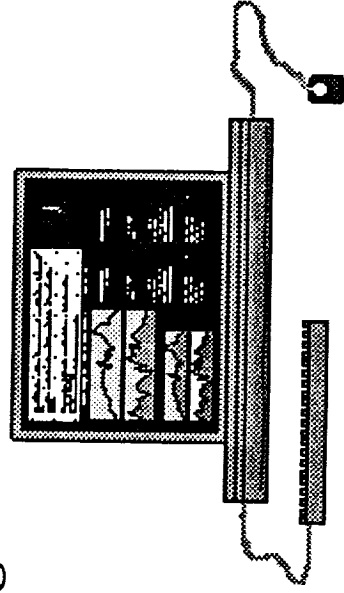



Background

- **Satellites are increasing in numbers, complexity**
 - **Size of constellations**
 - **Number, sophistication of onboard processors**
 - **Level of autonomy**
 - **Data rates**
- **Normalization of Space**
 - **Less expertise onsite at ground stations**
 - **Drive towards more efficient operations**
- **Emerging information technologies can increase operator/analyst effectiveness**



ASW-DSE Purpose & Scope

Demonstration and application of advanced information technologies for satellite support activities.

- **Planning & Scheduling Tools**
- **Expert Systems**
- **Telemetry Processing and Display Systems**
- **Hypermedia and Multimedia Systems**
- **Modeling and Visualization**
- **Artificial Neural Networks and Fuzzy Logic**



Advanced Satellite Workstation Decision Support Environment

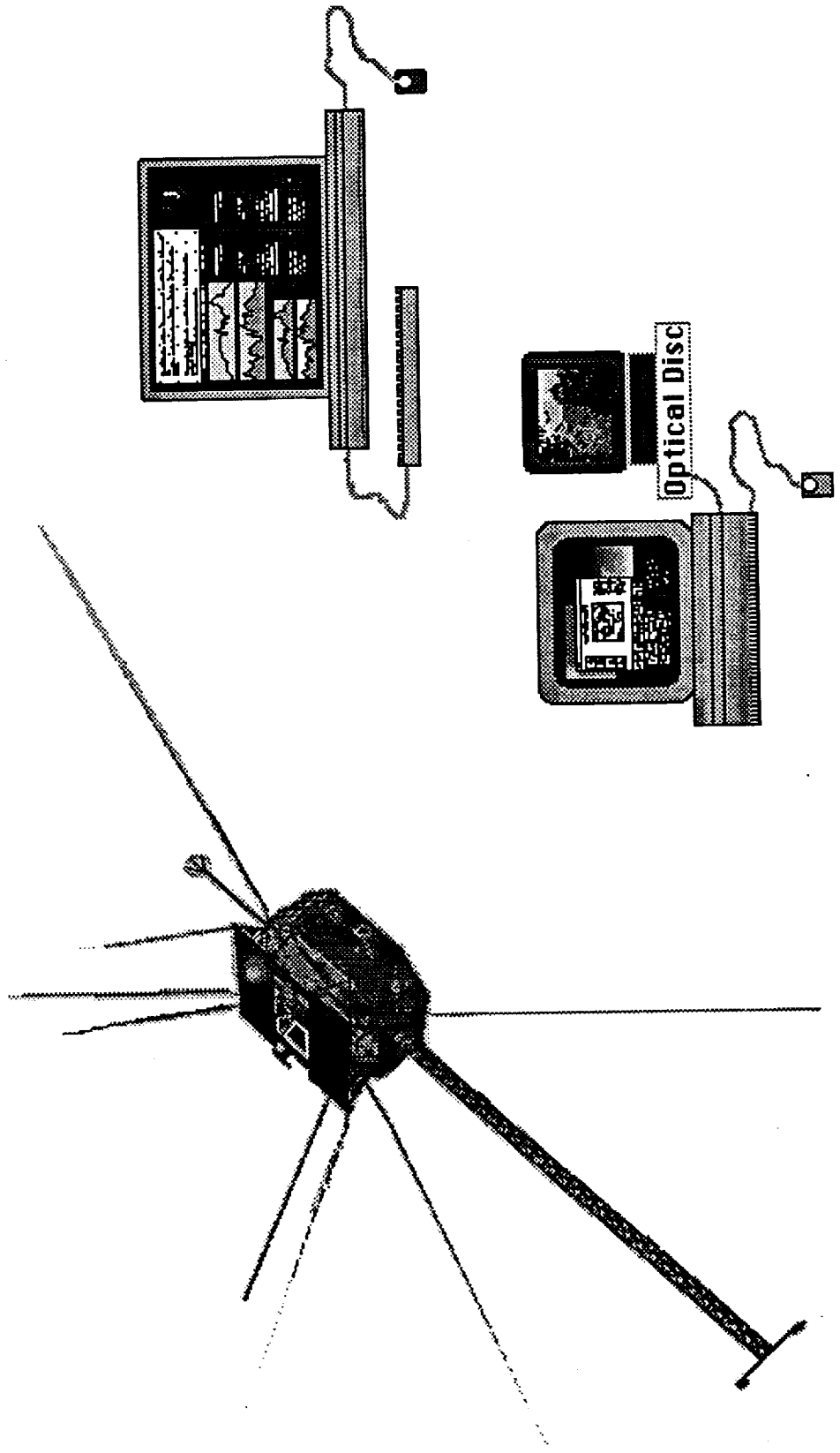



ASW History at Aerospace

- **1985:**
Expert systems for satellite anomaly diagnosis (DSCS III)
 - **Symbolics Lisp processors**

- **1986:**
Satellite Architecture Browser/Expert Systems (GPS)
 - **Symbolics Lisp processors**
 - **Expert systems, graphical telemetry stripcharts, hierarchical satellite schematics**



ASW History at Aerospace

(Continued)

- 1987:
 - Hypermedia Information System
 - Macintosh, Laser Disk Player
 - Online Documentation: text, high-resolution satellite photographs, video, engineering schematics, animation

- 1988-90:
 - Integrated ASW Architecture (CRRES)
 - Networked Sun/Macintosh
 - Useable, deployed prototype (Consolidated Space Test Center) (operator feedback, lessons learned)



Fundamental Lesson of Early Efforts

A broad-based, integrated decision support environment provides the greatest leverage for operator support

Such an integrated environment should combine expert systems, graphical telemetry displays, planning and modeling tools, and multimedia documentation to provide automated, transparent access to information



ASW/CRRES Prototype Goals

Investigate/Demonstrate value of advanced, workstation based technologies as a basis for future procurement and operational use

- **Assess usefulness, proper role for a number of advanced technologies:**
 - **Planning and scheduling tools**
 - **User-configurable telemetry processing and displays**
 - **Expert systems**
 - **Hypermedia/Multimedia**
 - **(modeling and visualization)**
 - **(heuristic reasoning)**



ASW/CRRES Prototype Goals

(Continued)

- **Design, assess an environment providing full integration of these technologies**
 - **Expert system control of displays**
 - **Automatic “cueing” of operator to situation-relevant documentation**
- **Deployment in ops environment for evaluation, feedback**
- **Prototype as a basis for requirements definition, cost/schedule planning for future procurements**

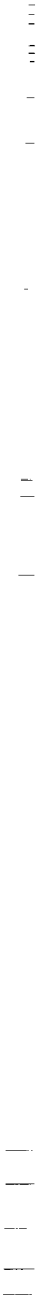

Decision Support Environment

Implementation and System Data Flow

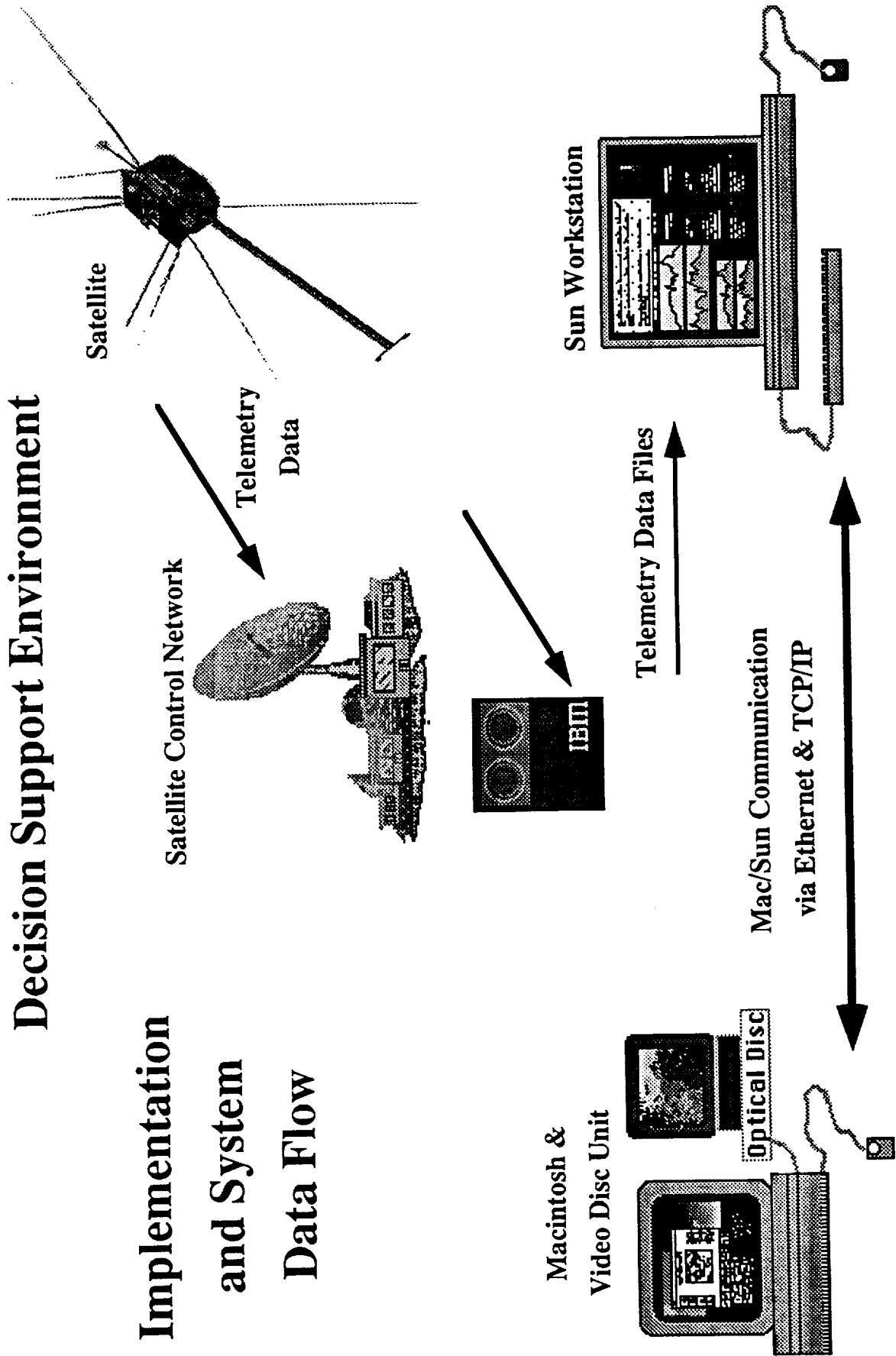



ASW Functional Architecture

Architecture Components

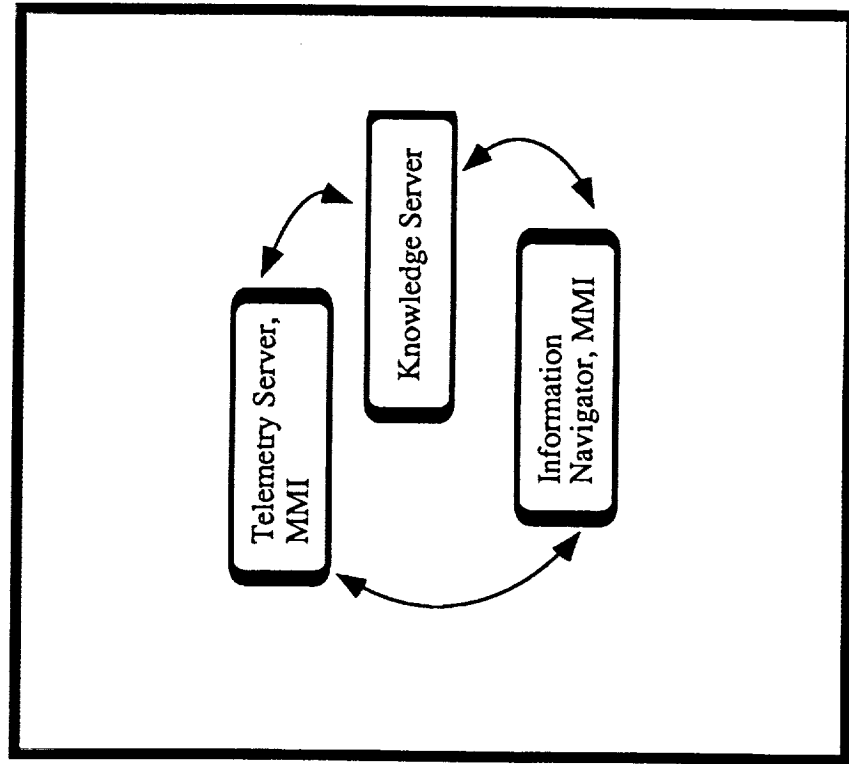

Application Distribution

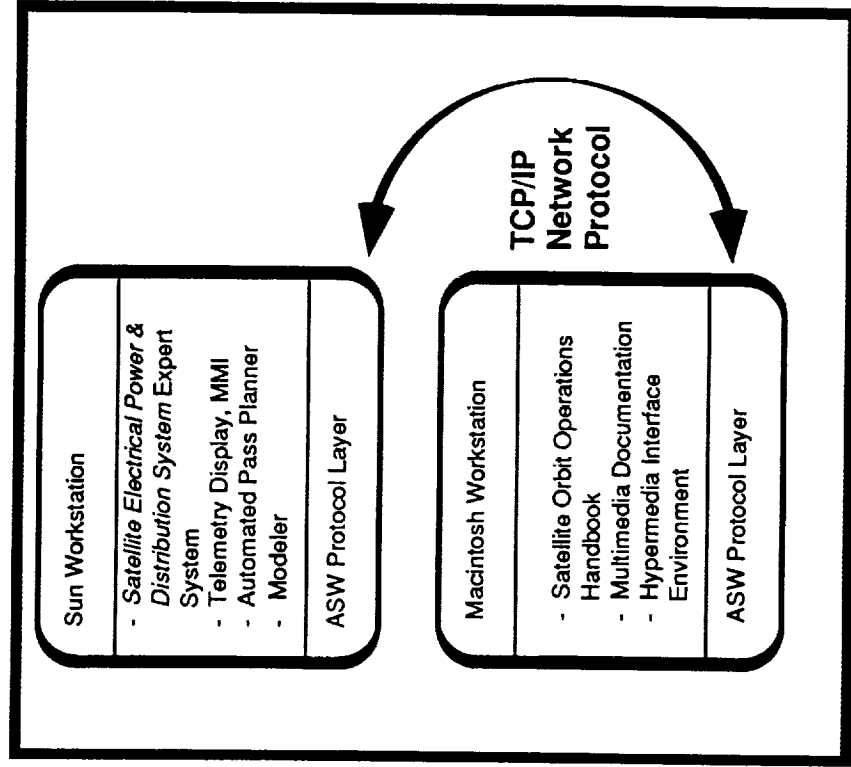



ASW-DSE Communications Architecture

- Object-Oriented Message System
- Built on top of TCP/IP Network Services
- UNIX-Workstation is the Message Manager
- Hypermedia Workstation Controls Video System Peripherals in Response to Messages

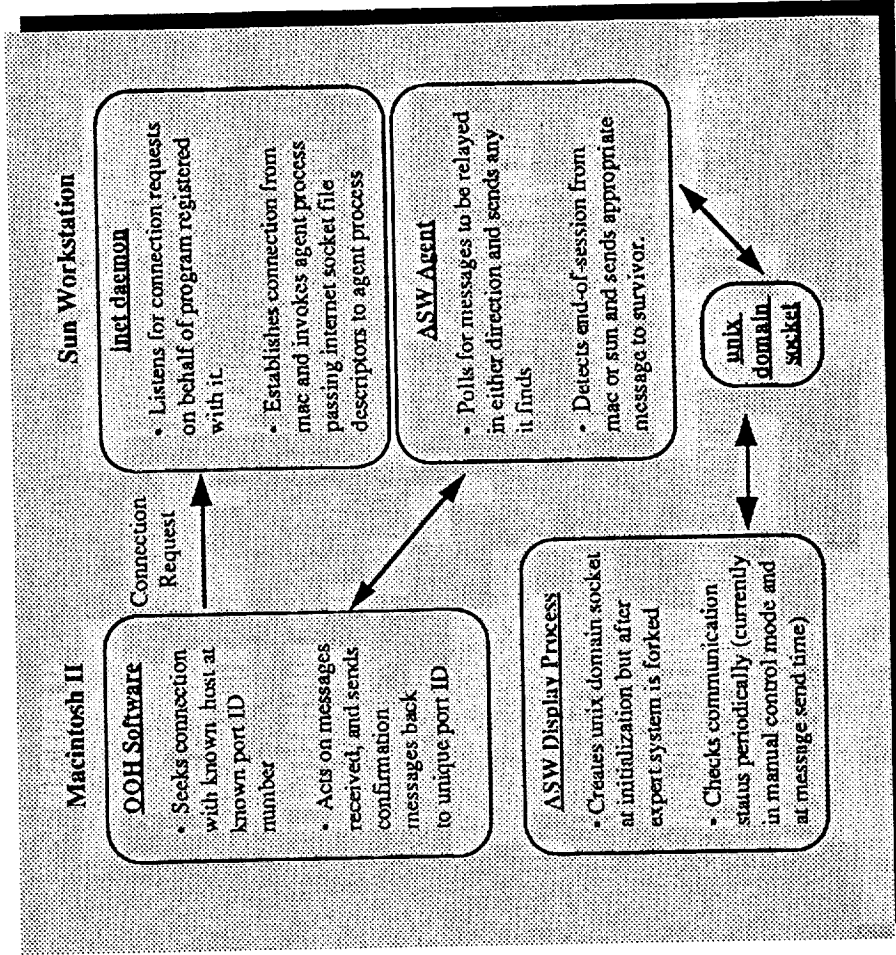

ASW-DSE Communications Architecture



- **Object-Oriented Message System**
- **Built on top of TCP/IP Network Services**
- **UNIX-Workstation is the Message Manager**
- **Hypermedia Workstation Controls Video System Peripherals in Response to Messages**

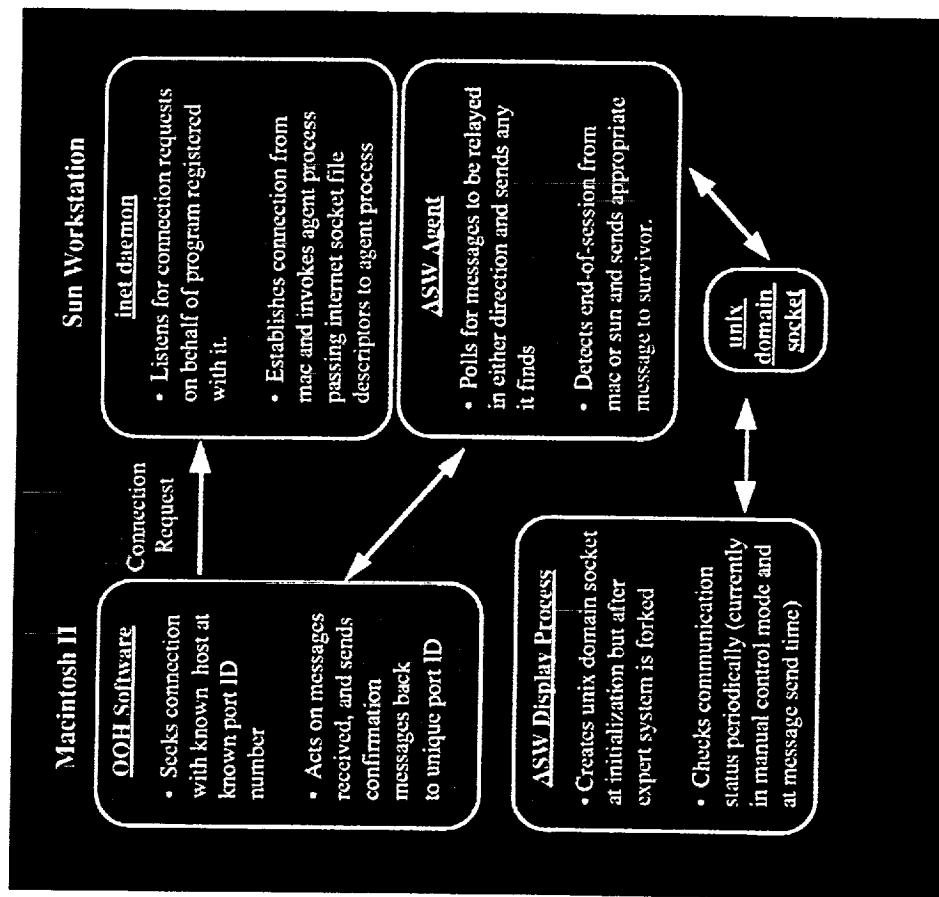



ASW-DSE Timeliner

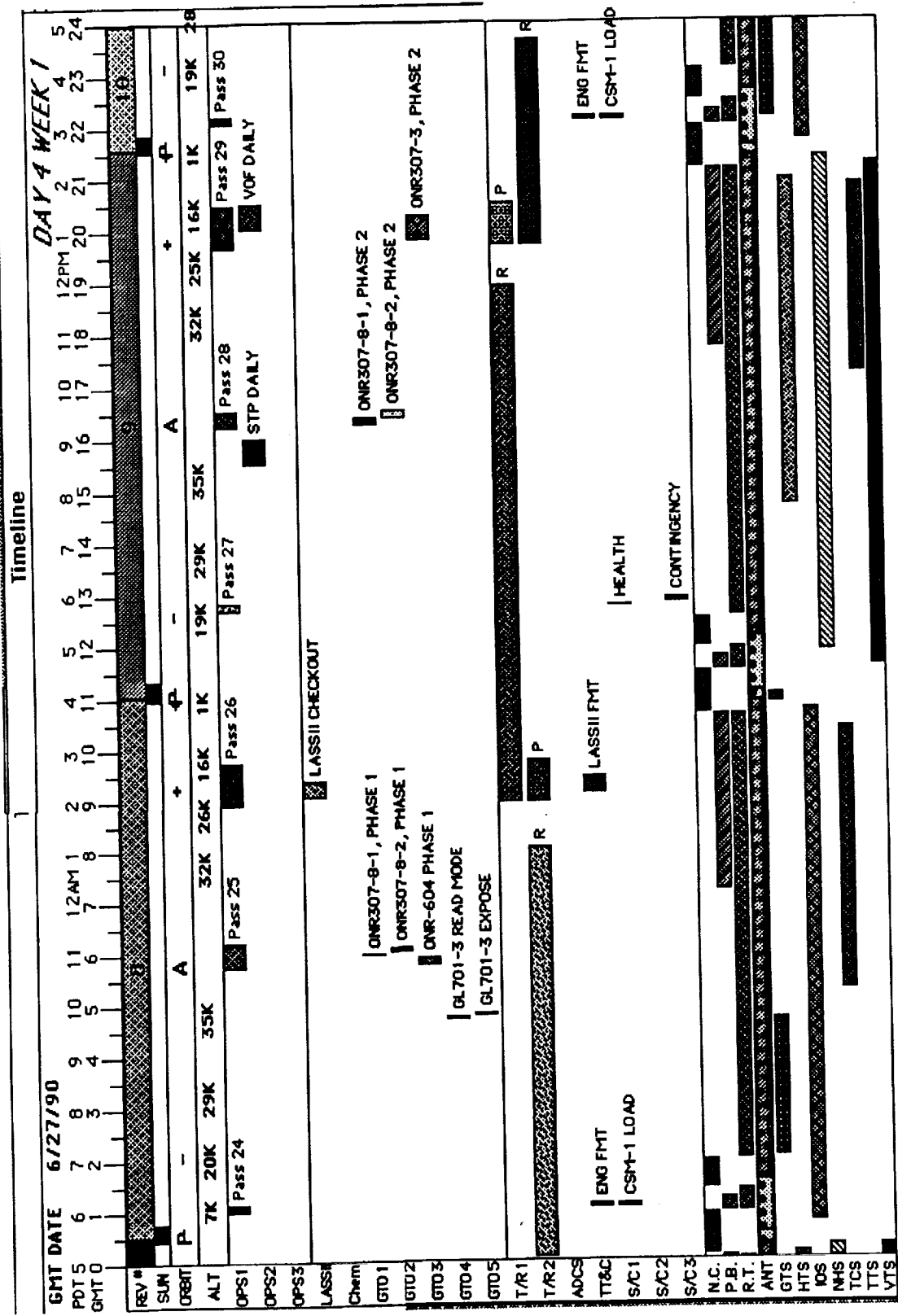



Advanced Satellite Workstation Telemetry Analysis

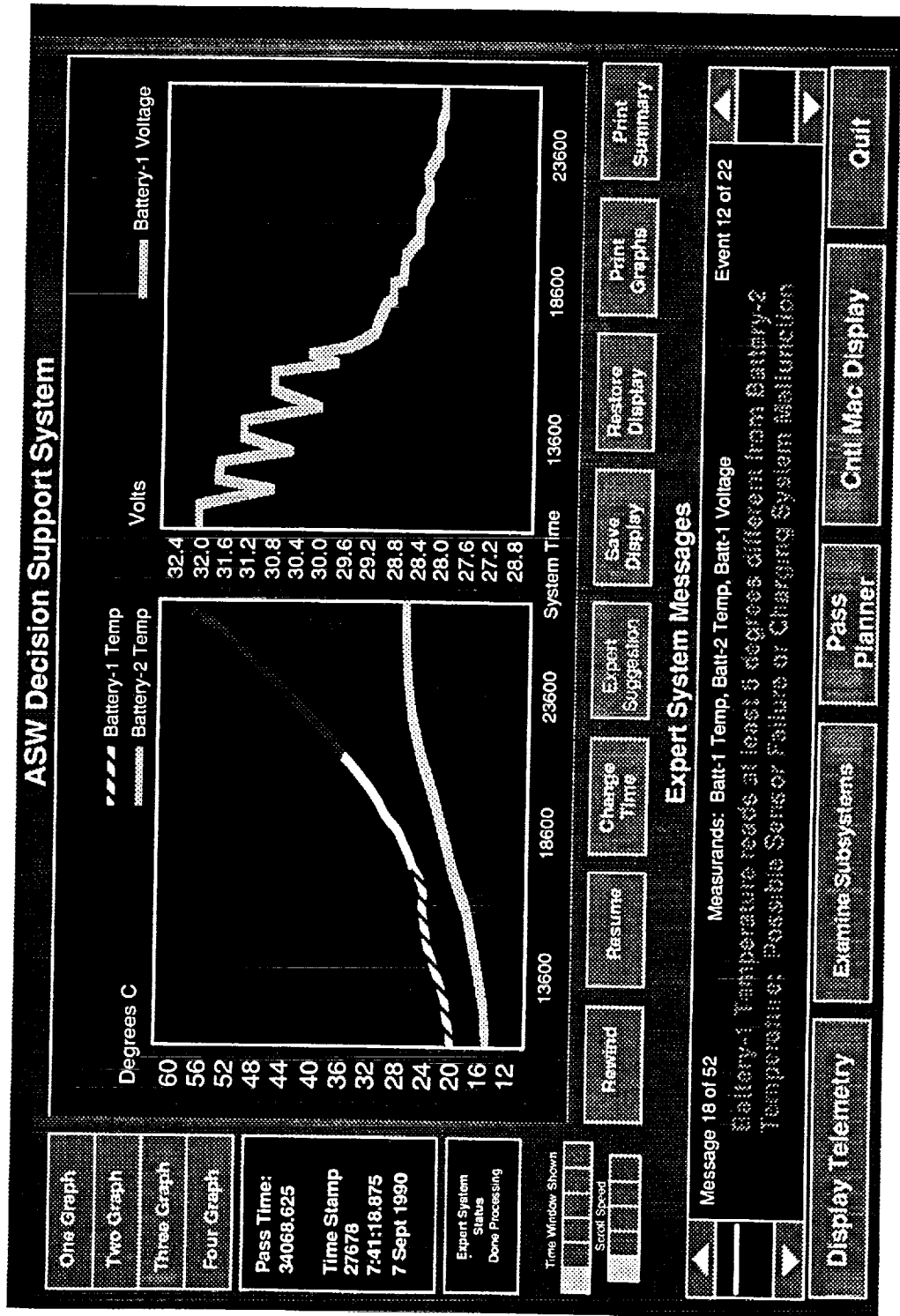



Multimedia Information Systems

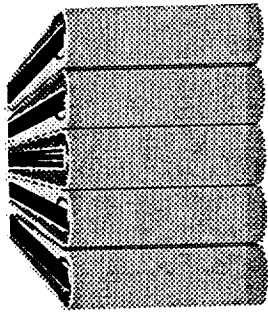

An integrated blend of text
graphics and audio that
transforms conventional
documentation into a
readily accessible
hierarchy for user
browsing

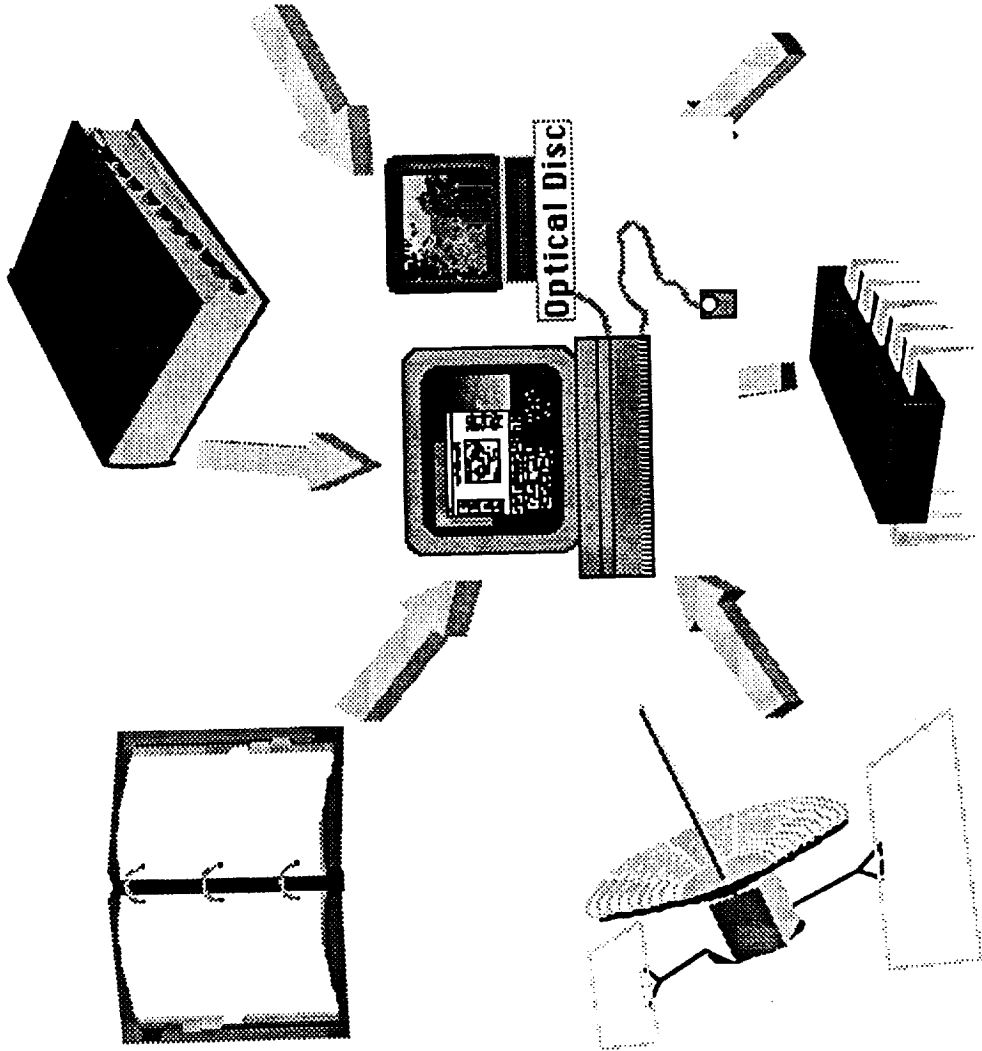
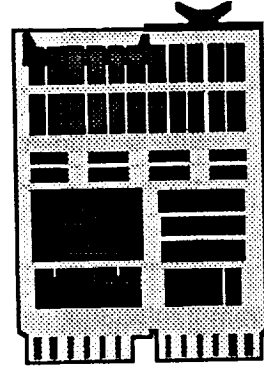



ASW-DSE Hypermedia System User Interface

INDEX
R
?

Power Distribution







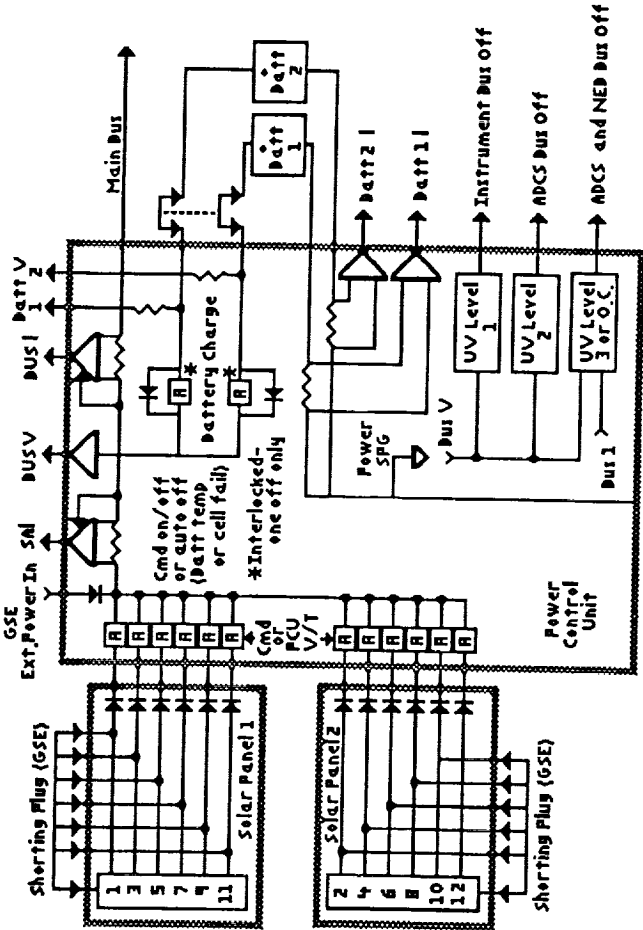

Condition Cntl

The condition control circuit defines the interlock mechanism that insures during a battery charge sequence, only one battery is off. For more detail refer to the actual circuit by clicking on the button below:



Condition Cntl Circuit





ASW-DSE Hypermedia System User Interface



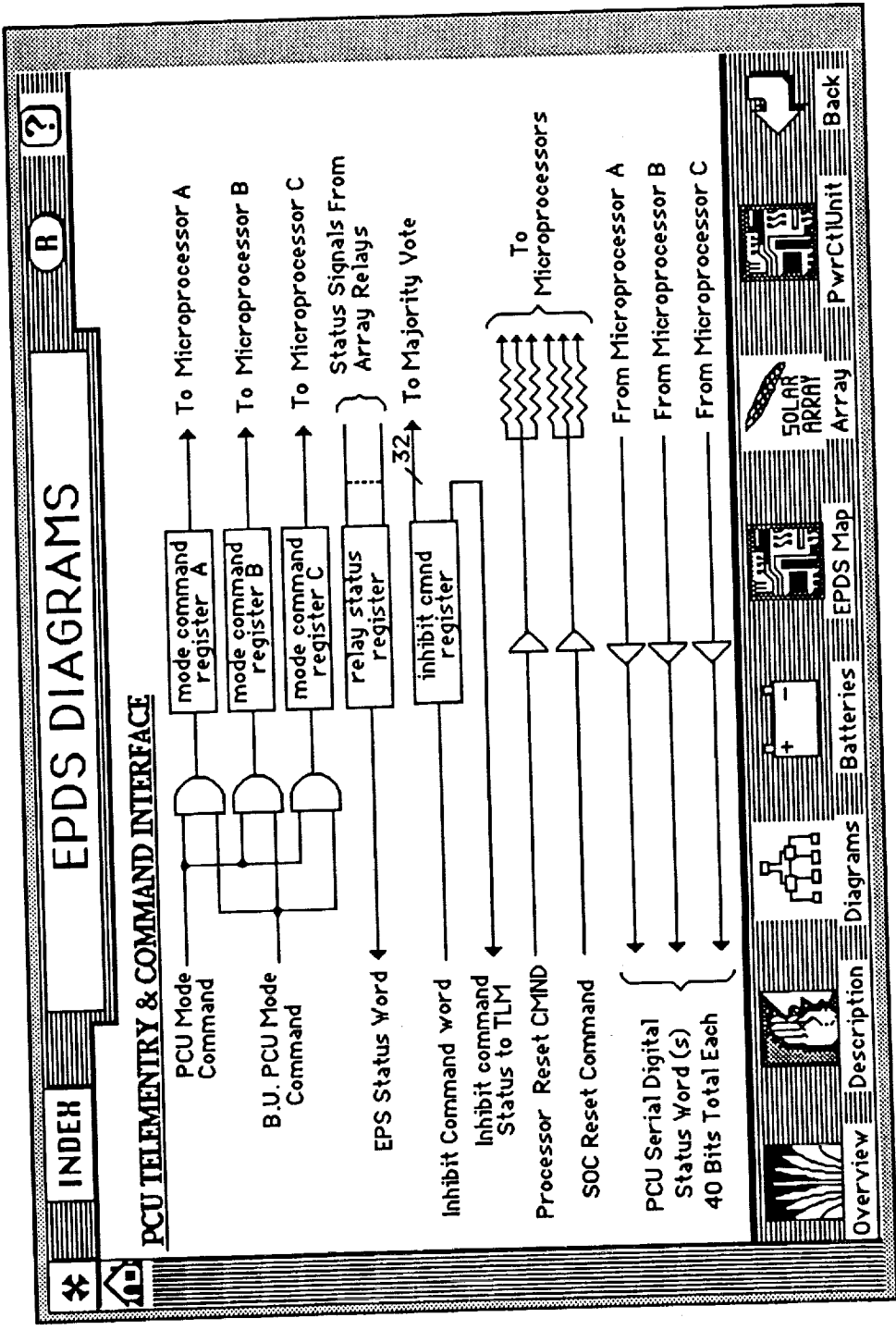

ASW-DSE Hypermedia System User Interface

INDEXR?

Solar Array Components

Show Video

< >
<< >>
|< >|
search

SOLAR ARRAY LAYOUT

100.00 REF.

35.00 REF.

0.30 14 Pt. (ARY+YT2)

Circuit 1
14 cells
1 series
16 Max
12.74 Max
15 Pt.

Circuit 2

Circuit 3

Circuit 4

Circuit 5

Circuit 6

(ARY+YT1)

ARY+YT4 (ARY + YT3)

tb

OverviewDescriptionDiagramsBatteriesEPDS MapArrayPwrCtUnitBack



ASW-DSE Hypermedia System User Interface

Selected pictures taken from an
online video of the magboom
deployment sequence

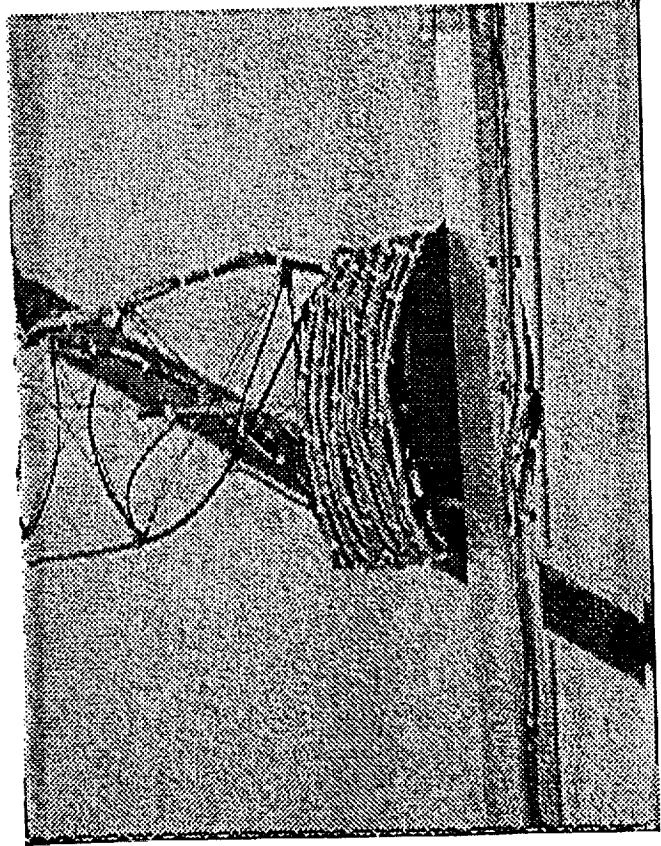
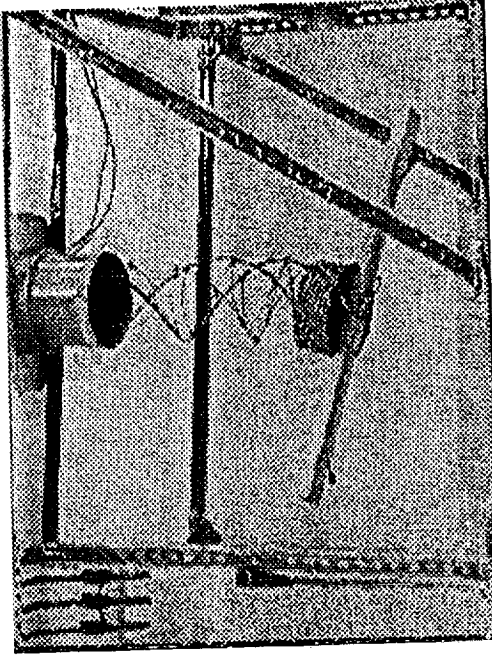



ASW-DSE Hypermedia System User Interface

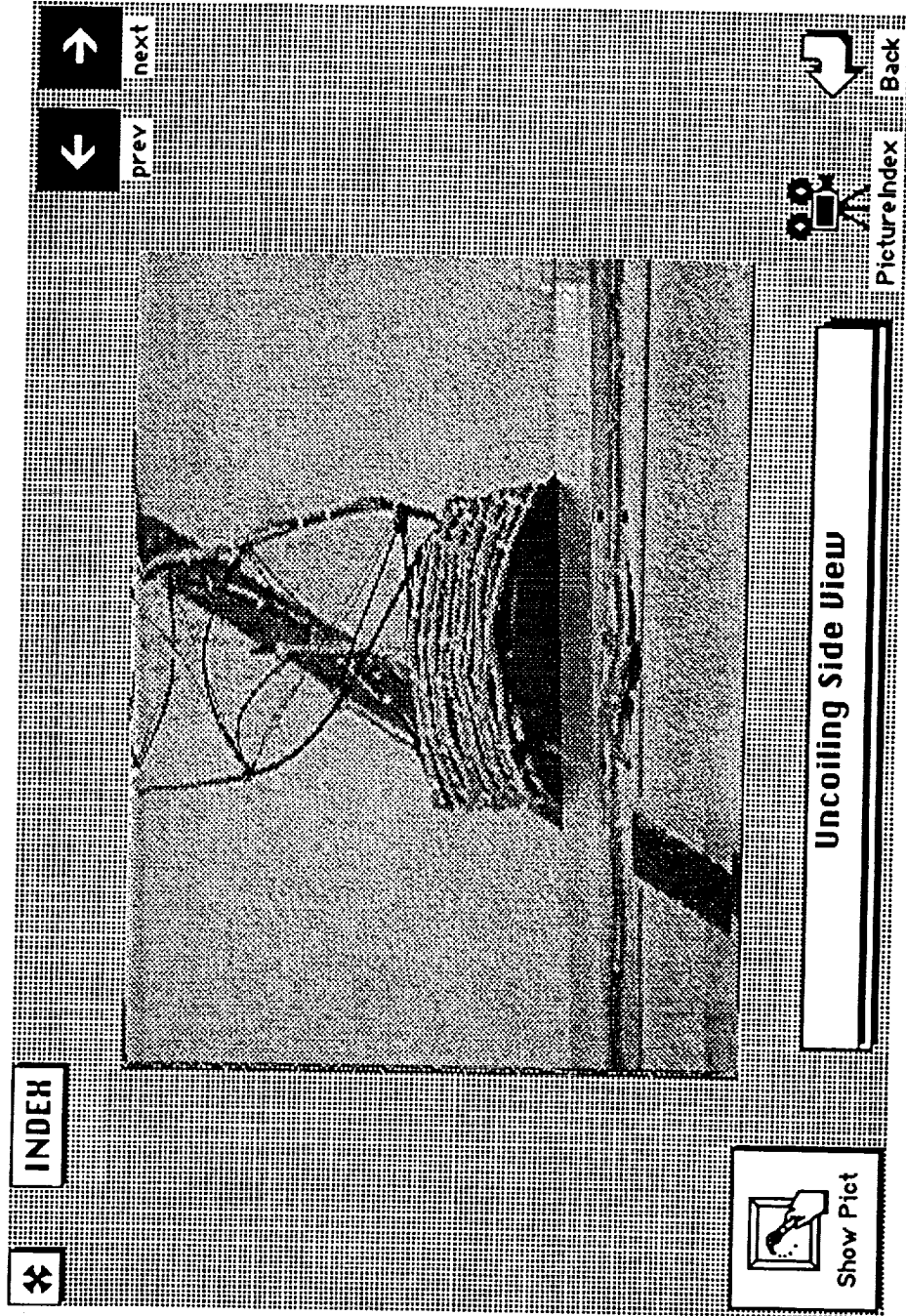



Current/Future Developments

- **Advanced prototype for UHF/Follow-on Satellite**
 - **Integration of telemetry front-end server**
 - **Mature prototype based on early lessons, feedback from operators**

- **New research/development**
 - **Intelligent information access**
 - **Data visualization**
 - **Heuristic and approximate reasoning**



Summary

- **Prototype development and deployment has been a useful approach**
 - **Concurrent engineering in practice**
 - **Many lessons learned**
 - **Will help to ensure the success of future system evolution**

- **Advanced workstation technology can provide major operational enhancements if used appropriately**
 - **Operator feedback is essential**
 - **Effective decision support is an integration of many technologies**

- **We are only beginning to tap the potential of rich information environments with sophisticated access techniques, data visualization, and automated reasoning**

**Rockwell-Downey Mission Support Room (MSR)
and Data Display & Review (DDR) Room Upgrade**

**Ground Support System Methodology
and Architecture**

for Control Center Conference
University of Houston, Clear Lake
June 18, 1991

P. D. Schoen

Rockwell International SSD Downey
Aerospace Simulation and Systems Test Center
(213) 922-2534

RY 23/002 58-14
39610
P-21

N92-12018

Synergistic Approach to Systems Test and Support

RI-SSD

6/14/91

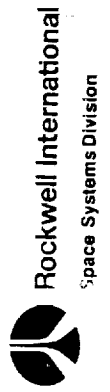

P. D. Schoen

2

Building Block Architecture Provides Transportability of Data, Procedures and Knowledge

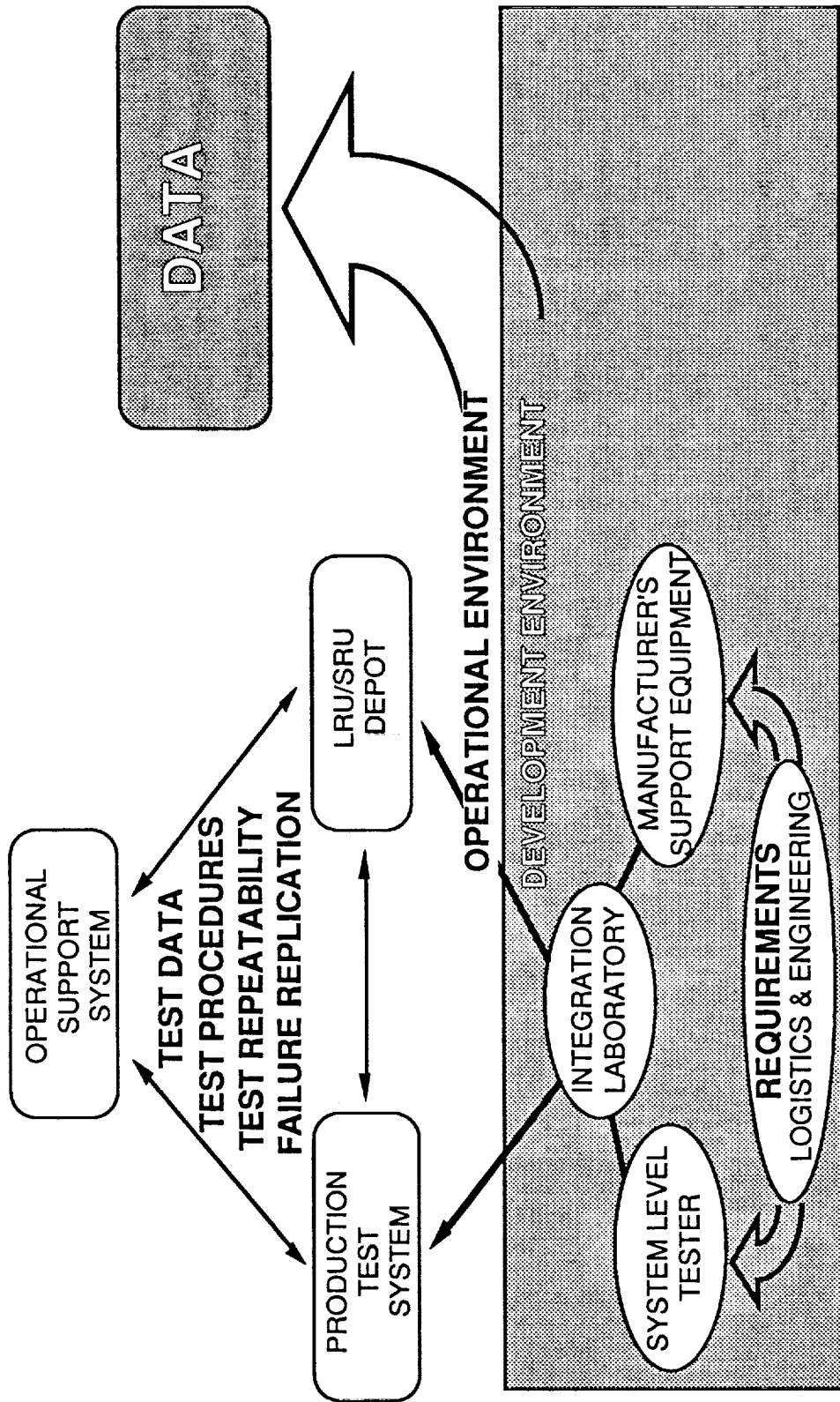

Synergistic Approach Lowers Cost and Risk for Life Cycle of a Program

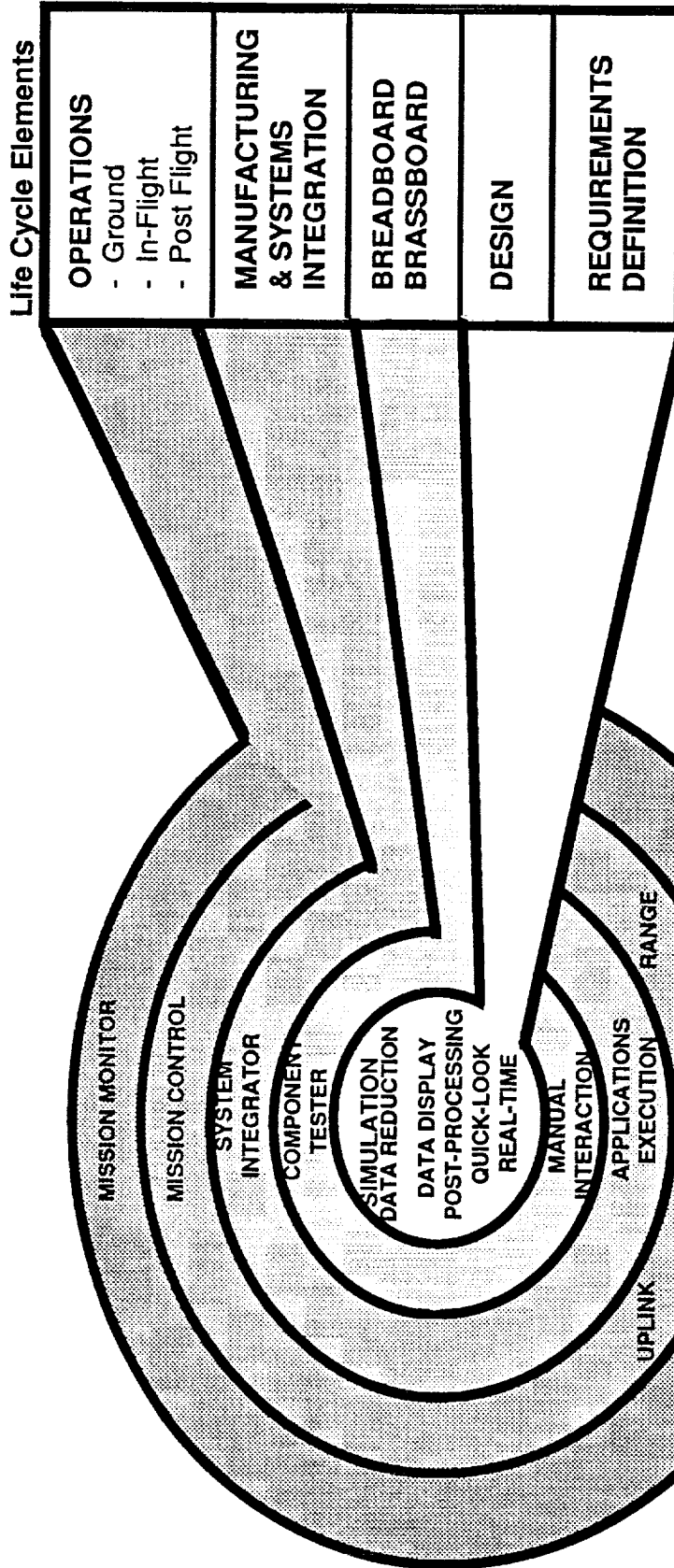

**Determination of Design Errors at the Earliest
Phase Reduces Cost of Vehicle Ownership**

RI-SSD

6/15/91

P. D. Schoen

4

**Distributed Scalable Architecture is Based
on Industry Standards Maximizing
Transparency and Maintainability**

- ➡ **Data Base Driven**
- ➡ **Commercial Off-the-Shelf Hardware and Software**
- ➡ **Integrated Vehicle and Launch Architecture Synergism**
- ➡ **Distributed, Remote Processing**
- ➡ **Compatible with Emerging Government and Industry Systems**
- ➡ **Distributed, Networked and Real-Time Systems**
- ➡ **Expert Systems Applications to Real-Time and Ground Systems**

Autonomous Control Structure Provides for Distributed and Segmented Systems

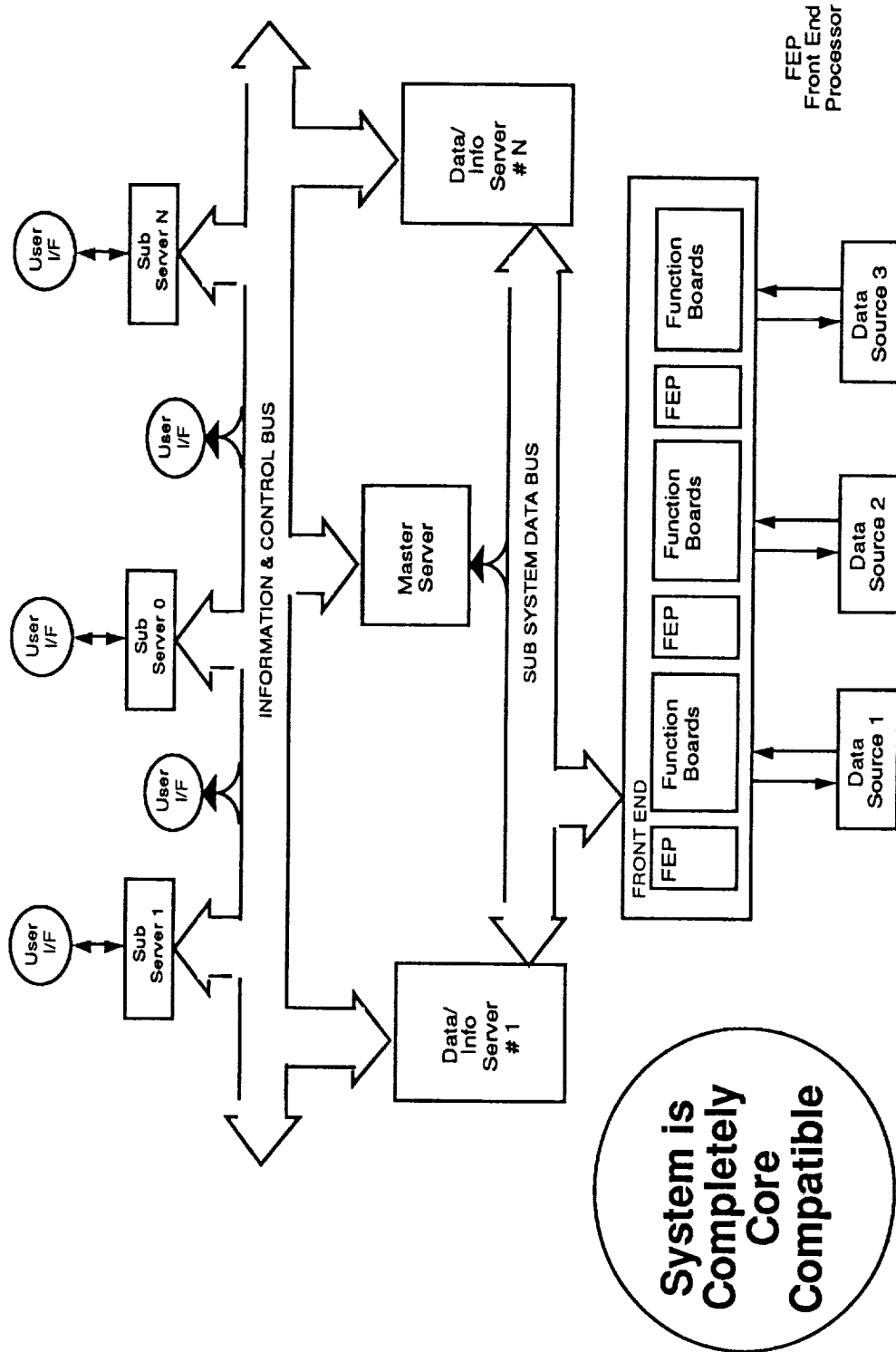

System is Completely Core Compatible

Control of Interfaces Maximizes Compatibility and Re-Use Reducing Long-Term Program Cost

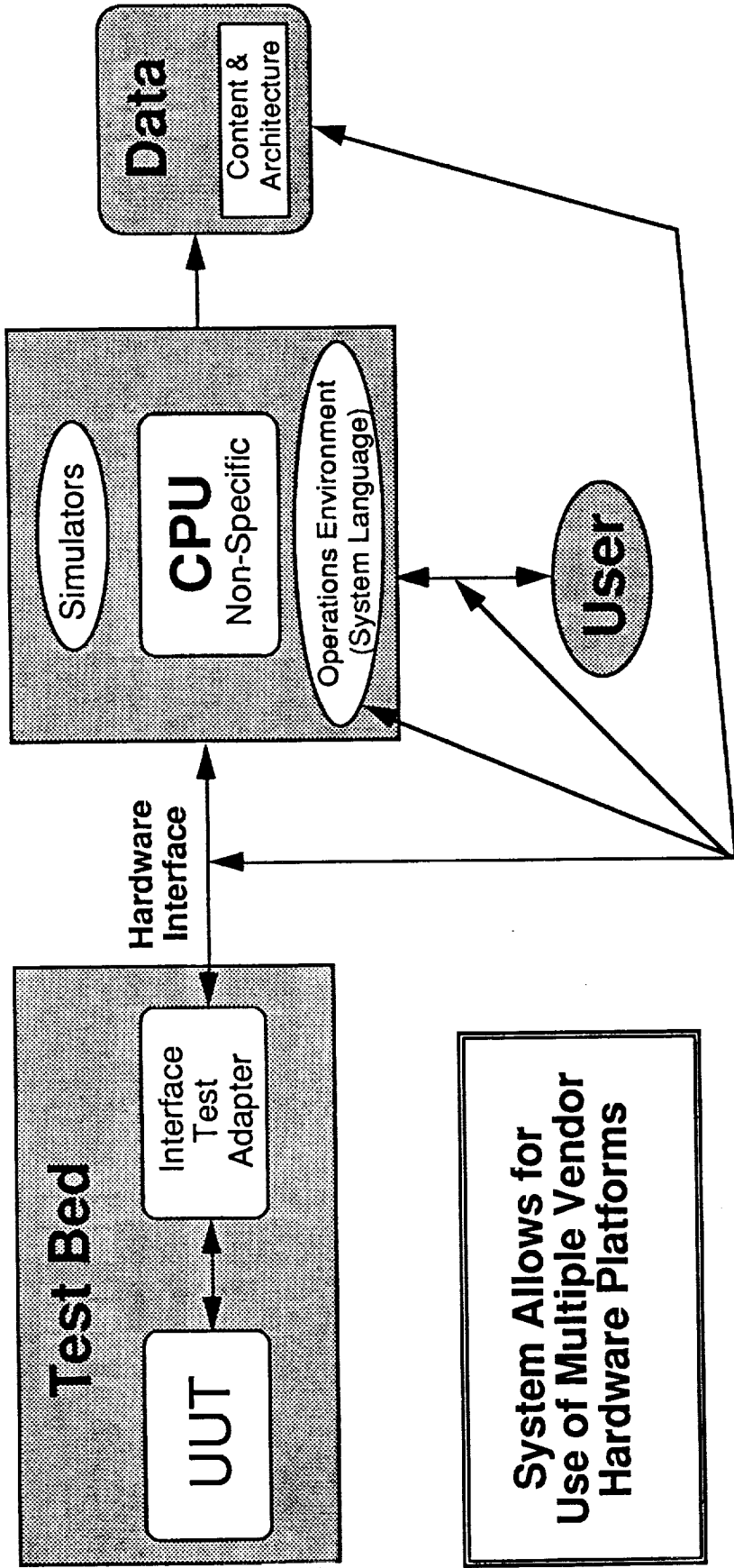

**System Allows for
Use of Multiple Vendor
Hardware Platforms**

Controlled Interfaces

Intelligent Data Management Architecture Reduces Analysis Time and Cost (Automation)

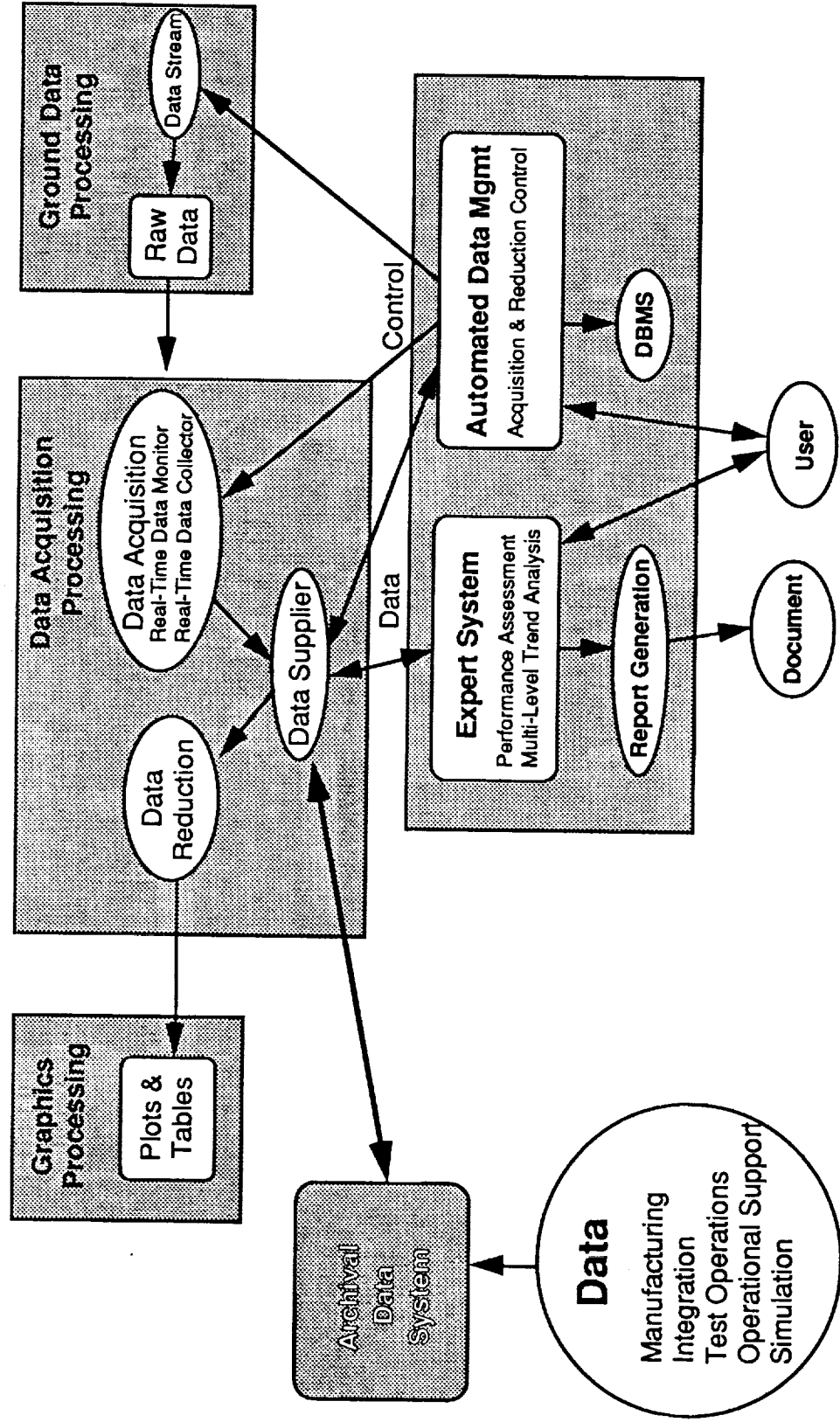

RI-ASSTC is Putting the System Architecture to Action

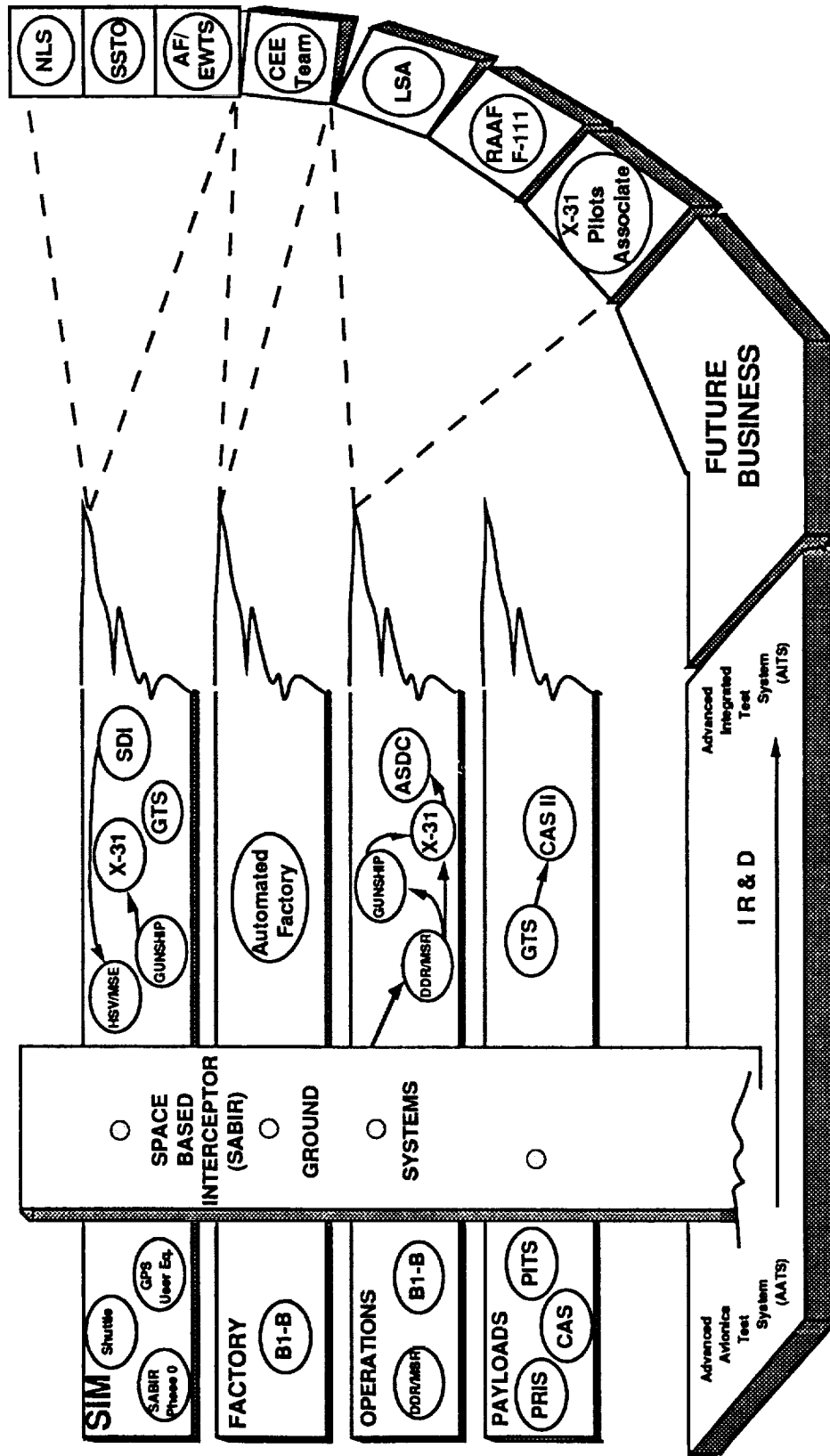

Shuttle Mission Support Room (MSR) Data Display and Review (DDR) Room

RI-SSD

6/14/91

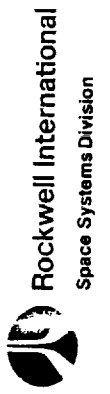

P. D. Schoen

10

MSR and DDR Applying Systems Concepts To Shuttle Support

- **Member of Emergency Mission Control Center (EMCC)**
 - MILA Data Link Independent from JSC
- **Real-Time Monitoring of the Vehicle During Mission & Pre/Post-Launch**
 - Provides Subsystem Engineers Visibility on Vehicle Performance
 - Processing of Two Vehicles Simultaneously
 - Real-time Data Processing and Displays
 - Post Processing
- **Currently Upgrading Workstation Architecture**
 - Architecture has Front End Processor, Server, and User Workstations
 - Rehost of MEWS Software from MER on Sun 4 for Use in Downey
 - Dataview Display Builder for User Configurable Displays

Shuttle Checkout and Mission Support Datalink Provides Real-Time Integrated Satellite/Ground Systems

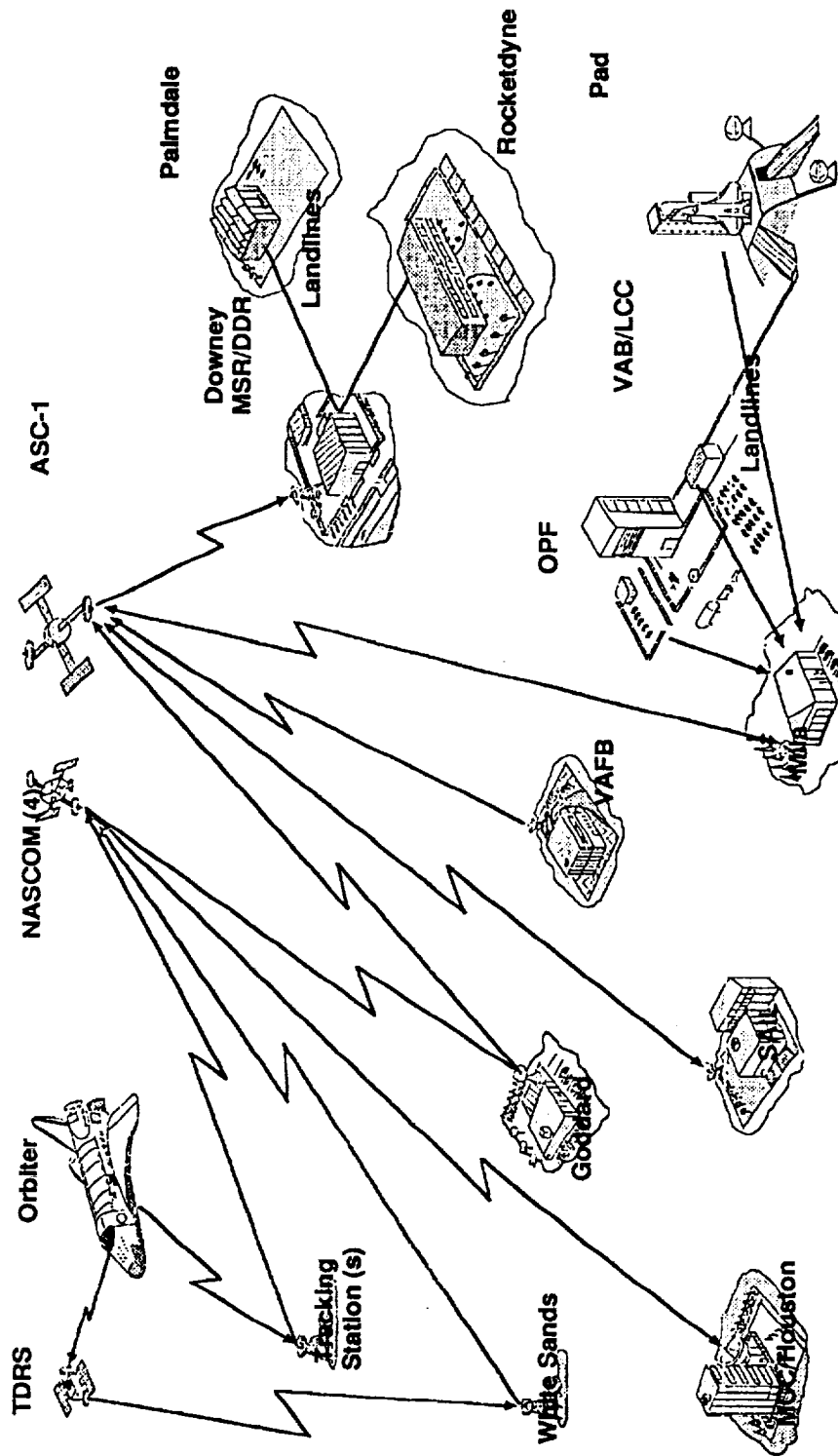

RI-SSD

6/14/91



P. D. Schoen

12

MSR/DDR Upgrade System Architecture Enables Greater Mission Support Capabilities

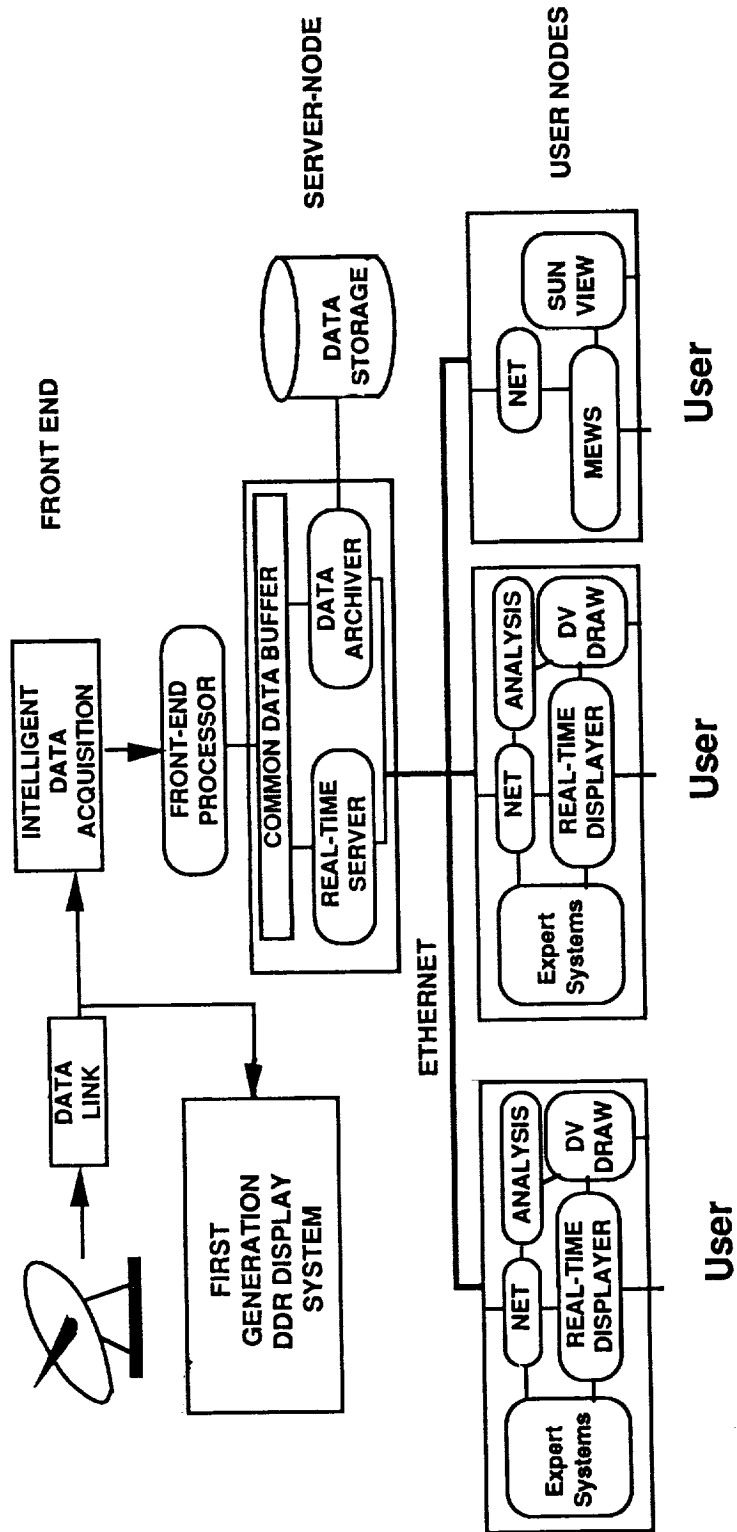

P. D. Schoen

13

RI-SSD

6/15/91

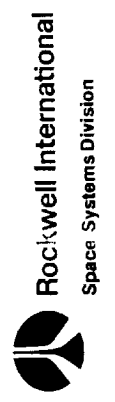

Expert Systems Enhance the DD&R Room Flight Support

- **Improves Effectiveness of Subsystem Engineers**
- **Faster, More Accurate Malfunction Diagnosis**
- **Increased Safety**
- **Expert Knowledge Captured and On-Line**
- **Reduced Training Costs**
 - Both Expert and Trainee
 - Rockwell OMS Ground Estimates 50% Savings
- **Generic Architecture Can Support Multiple Programs**
- **Has been Used and Demonstrated to be Effective**

RI-SSD

6/14/91

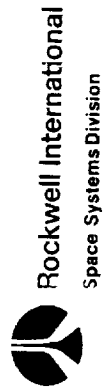

Rockwell International
Space Systems Division

P. D. Schoen

14

ASSTC is Applying ES Technology to Mission Support

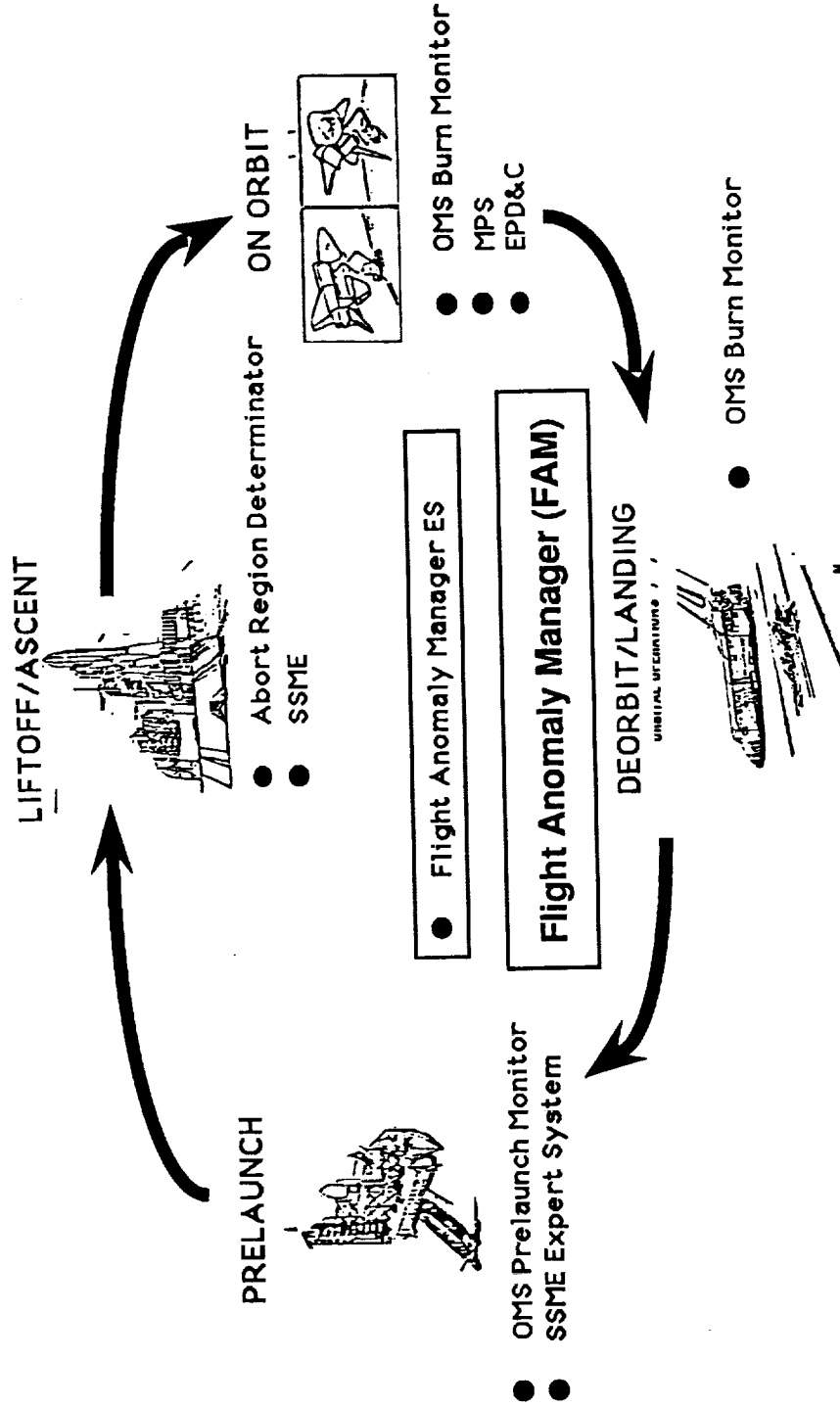

FAM Interprets Output of Subsystem Expert System

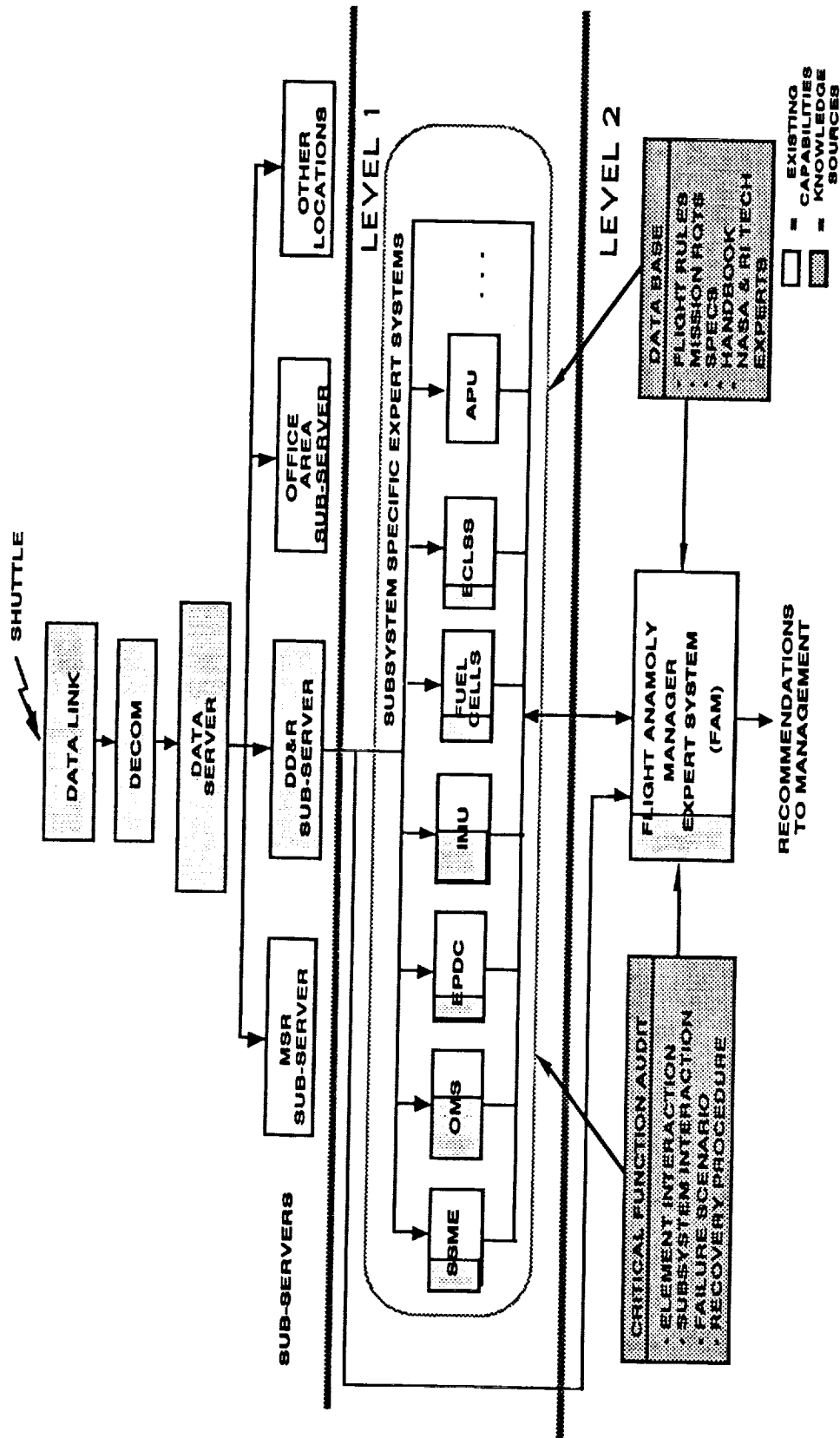

Flight Anomaly Manager

- **Provides Mission Support Team Leader with Overall Vehicle Status**
 - Knowledgeable About Subsystem to Subsystem Interactions
 - Knows the Effect of Failure on Other Subsystems
 - Provides Management Insight into Vehicle Status
 - Makes Recommendations
 - Communicates with Subsystem Specific Expert Systems

- **Multi-Layered Implementation**
 - Sun Workstation Using G2
 - Communication with Subsystem Specific Expert Systems via GSI

- **Interacts with Subsystem Specific Expert Systems**
 - EPD&C
 - OMS
 - SSME
 - Fuel Cells
 - ECLSS

Ground Support - Summary

- **RI-SSD has Developed and Delivered a Number of "Turn Key" Systems**
 - ATE
 - Simulation Support
 - Factory/Flight Line
 - Payload Integration
 - Mission Support

- **The Methodology being Used Allows for the Growth and Support of the System throughout the Life Cycle of a Program**
 - Scalable
 - Adaptable

- **The Ground System Architecture Provides for Data and Procedure Transportability throughout the Life Cycle**

System Architecture Provides for Generic Application to Any Program

Background Material

Aerospace Simulation & Systems Test Center

A. J. Mauceri, Director
(213) 922-4935
Comnet 372-4935

RI-SSD

6/14/91

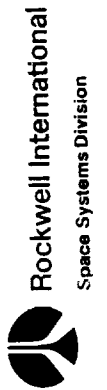

P. D. Schoen

19

ASSTC Laboratory Environments Support Technology & Market Evolution

Environment

Simulation Systems

Non Real-Time & Real-Time Vehicle & System, Full Mission Evaluation and Training, Man-In-The-Loop Math Model or Hardware/Software Verification System Concepts, Trade Studies & Integration

Avionics & Payload Test

Subsystem/LRU Breadboarding, Payload Integration and Compatibility Testing

Real-Time Mission Support

Flight Line Support and Ground Checkout Support
Air-To-Ground Communications / Protocol Secure Systems

Artificial Intelligence and Expert Systems

Real-Time Process Control
Autonomous Robotics
Adaptive Control Systems

Man / Machine Interface

Interactive Display and Control Development
Human Engineering Studies
Crew Procedures, Familiarization and Training
Natural Language Interfaces

Automation & Robotics

Robotics Research, Vision System Development
Space-Based Construction and Servicing
Man-In-The-Loop Operations

Hardware/Test-System Development

Microprocessor Systems
Data Link and Telemetry Communications
Hardware Simulators
Avionic System Interfaces
Deliverable Test Systems and Remote Checkout Systems

Examples

RI-SSD

6/14/91



Rockwell International
Space Systems Division

P. D. Schoen

20

ASSTC Facility Supports Extensive Development and Operations

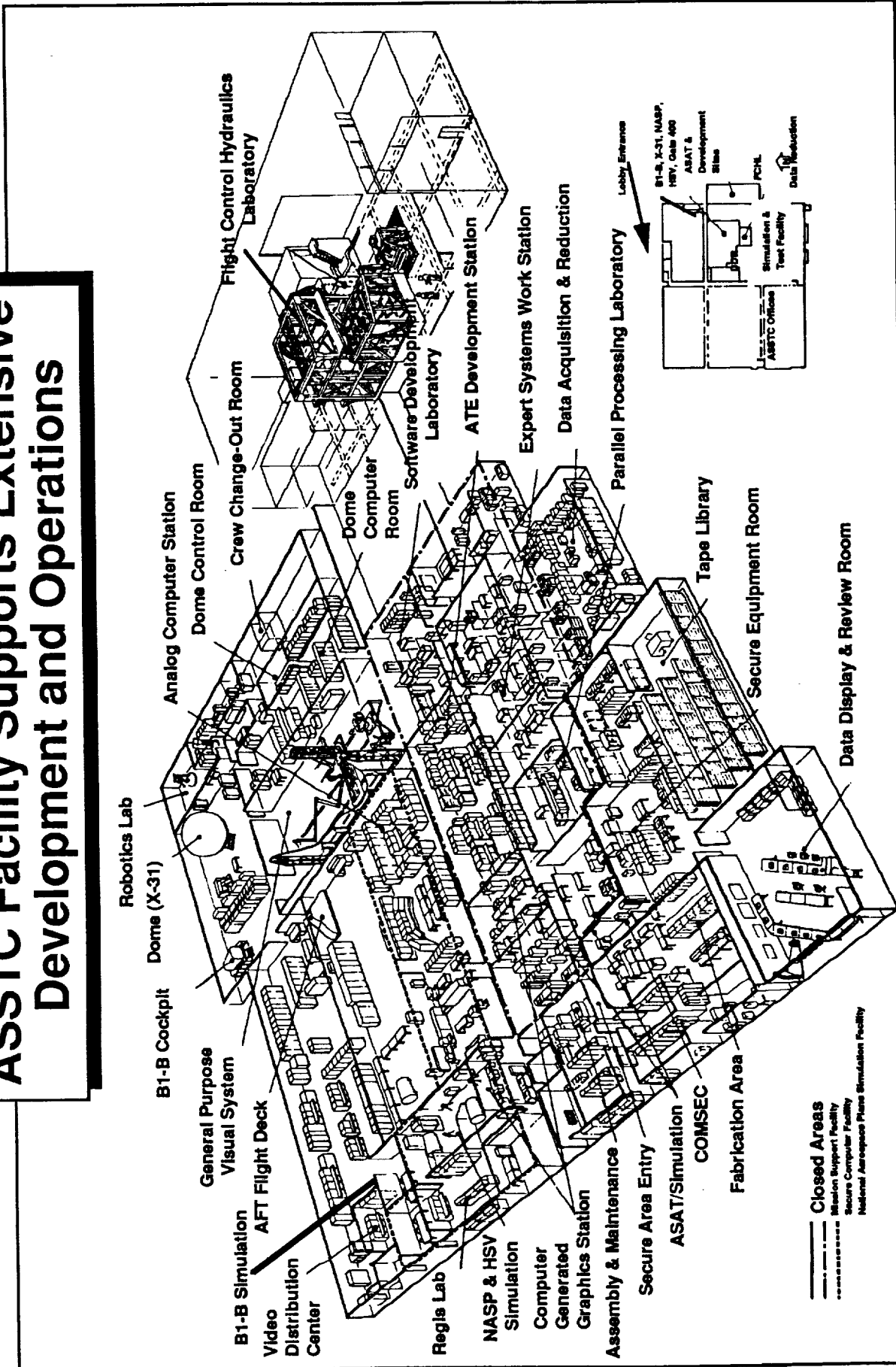

P. D. Schoen



RI-SSD

6/14/91

INTENTIONALLY BLANK

N92-⁵⁹⁻⁷⁴12019

39611
p.34

MISSION OPERATIONS DIRECTORATE RECONFIGURATION MANAGEMENT DIVISION

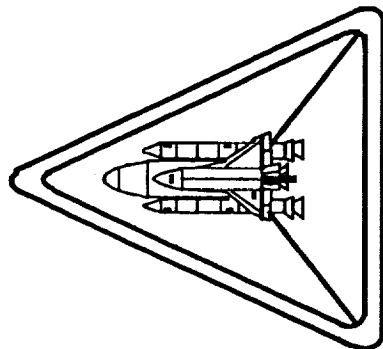

SHUTTLE



REAL TIME DATA SYSTEM (RTDS)

MAY 18, 1991

DP/JOHN F. MURATORE

ND185000

PRECEDING PAGE BLANK NOT FILMED

REAL TIME DATA SYSTEM (RTDS)

LESSONS LEARNED FROM OPERATIONAL REAL-TIME EXPERT SYSTEMS

- WHAT IS RTDS
- BASIC SYSTEM ARCHITECTURE
- LESSONS LEARNED FROM SUCCESSES AND FAILURES

CONFIDENTIAL - SECURITY INFORMATION

REAL TIME DATA SYSTEM (RTDS)

WHAT IS AN EXPERT SYSTEM?

- ANY SOFTWARE SYSTEM THAT PERFORMS TASKS TO A STANDARD THAT WOULD NORMALLY REQUIRE A HUMAN EXPERT
 - LOOSELY ADOPTED FROM FEIGENBAUM
- IS NASTRAN (NASA STRESS ANALYSIS SYSTEM) AN EXPERT SYSTEM?
- EXPERT SYSTEM IMPLIES KNOWLEDGE CONTAINED IN DATA RATHER THAN CODE
- EXPERT SYSTEM IMPLIES USE OF HEURISTICS AS WELL AS ALGORITHMS

MOST IMPORTANT BOTTOM LINE - DOES NOT MATTER THE TECHNIQUES WE APPLY - IMPORTANT QUESTION IS WHETHER OR NOT COMPUTERS ARE DOING TASKS IMPORTANT TO NASA'S MISSION THAT PREVIOUSLY WERE ONLY DONE BY PEOPLE.

REAL TIME DATA SYSTEM (RTDS)

- STARTED IN 1987 AS RTOP FROM OFFICE OF AERONAUTICS, EXPLORATION AND TECHNOLOGY TO DEMONSTRATE READINESS OF EXPERT SYSTEM TECHNOLOGY TO PERFORM IN REAL OPERATIONAL ENVIRONMENTS
- FIRST CONCENTRATION AREA - INTEGRATED COMMUNICATION OFFICER (INCO) INTELLIGENT ASSOCIATE
 - FUNDING ARRIVED MAY 1987
 - FIRST USE IN CONTROL CENTER APRIL 1988 USED IN STS-26 SIMULATIONS AND FLIGHT
 - COMBINATION OF TASK AUTOMATION AND RULE-BASED EXPERT SYSTEMS
- EXPANDED TO BOOSTER (SPACE SHUTTLE MAIN ENGINES) PRIOR TO STS-26
 - CRITICAL FAULT MODES IDENTIFIED DURING STAND-DOWN AFTER CHALLENGER
 - DETECTION LOGIC COULD NOT BE PUT IN MISSION CONTROL MAINFRAME IN TIME FOR STS-26
 - SIMPLE TASK AUTOMATION
 - STARTED IN MAY 1988 - OPERATIONALLY USED DURING STS-26 SEPT 88
- EMERGENCY MISSION CONTROL CENTER DEMONSTRATION (DEC 1987)

REAL TIME DATA SYSTEM (RTDS)

- FEB 89 - STS-29 RTDS EXPANDED TO INCLUDE:
 - TIRE PRESSURE AUTOMATED MONITORING
 - PREVIOUSLY REQUIRED FULL TIME PERSON TO ACQUIRE DATA, COMPENSATE FOR TEMPERATURE, CONVERT TO STANDARD PRESSURE AND PLOT (TASK AUTOMATION)
 - VISUALIZATION OF FLIGHT INSTRUMENTS (TASK AUTOMATION)
 - ASCENT GNC MONITORING - (TASK AUTOMATION)
 - INSTALLED MONITORS IN SOME CONSOLES REPLACING MAINFRAME DISPLAY UNITS
 - NETWORK INSTALLED FOR DISTRIBUTING SOFTWARE AND REAL TIME DATA

REAL TIME DATA SYSTEM (RTDS)

- LATE 89 - STS-34
- REMOTE MANIPULATOR SYSTEM VISUALIZATION (TASK AUTOMATION)
- REMOTE MANIPULATOR SYSTEM UNATTENDED MONITORING (TASK AUTOMATION)
- ON-ORBIT ATTITUDE CONTROL/DIGITAL AUTOPILOT MONITORING (RULE-BASED EXPERT SYSTEM)
- TAPE RECORDER MONITORING (RULE-BASED EXPERT SYSTEM)
- ADDED DATA RECORDING IN WORKSTATIONS AND PLAYBACK
- TRAINING - SOME CERTIFICATION REQUIREMENTS FOR FLIGHT CONTROLLERS MET BY REVIEWING PLAYBACKS IN RTDS WORKSTATION INSTEAD OF INTEGRATED SIMULATIONS

HAS NOW SUPPORTED LDEF, HUBBLE, GRO, AND IBSS



REAL TIME DATA SYSTEM (RTDS)

- 1989 - EXPANSION CONTINUES TO AERONAUTICS
 - DRYDEN FLIGHT RESEARCH CENTER USES RTDS AS BASIS FOR X-29 AUTOMATED MONITORING SYSTEM
 - AIR FORCE FLIGHT TEST CENTER USES RTDS AS BASED FOR F-15 STOL MANEUVERING TECHNOLOGY DEMONSTRATION (STMD) RULE BASED EXPERT SYSTEM

REAL TIME DATA SYSTEM (RTDS) ARCHITECTURE

PHASE 1

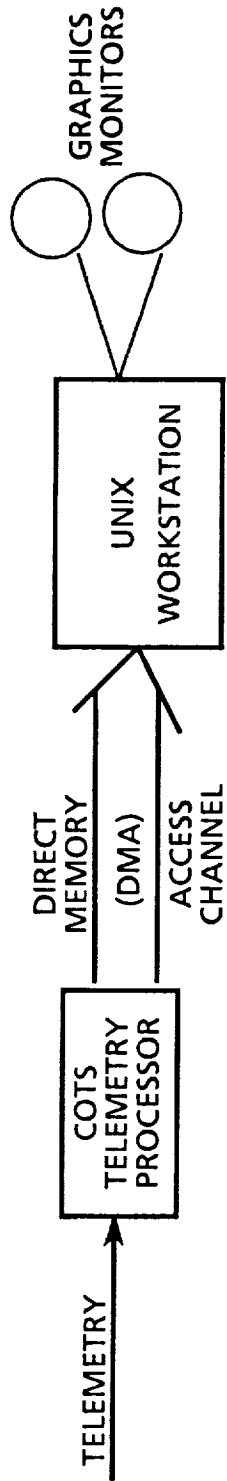

REAL TIME DATA SYSTEM (RTDS) ARCHITECTURE

PHASE 2

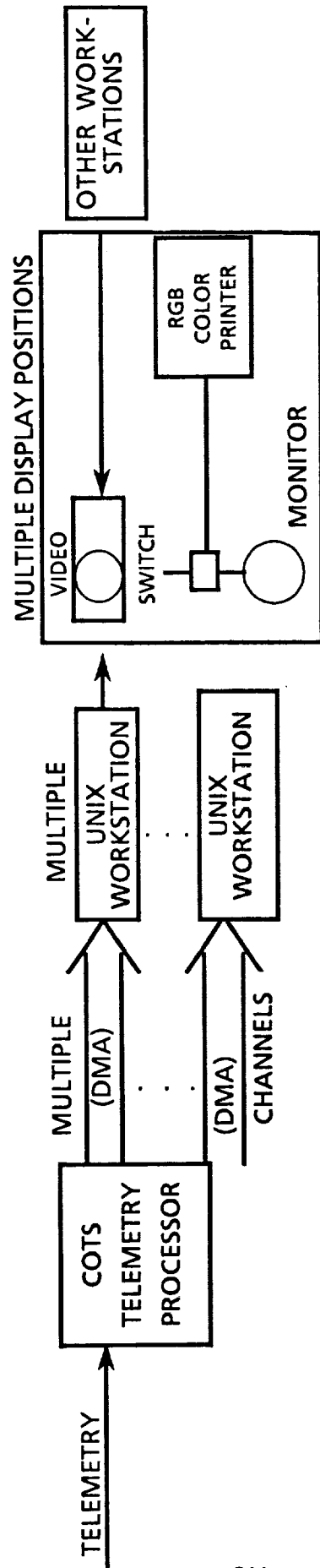

REAL TIME DATA SYSTEM (RTDS) ARCHITECTURE

PHASE 3

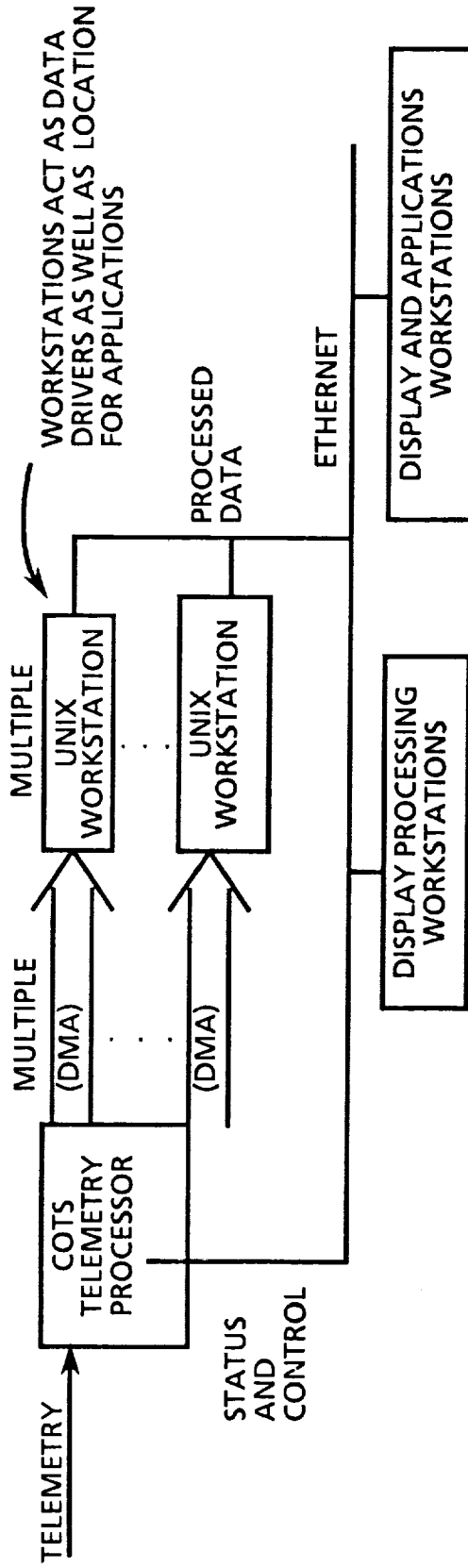

PHASE 4

TELEMETRY DECOMMUTATION DONE IN DATA DRIVER WORKSTATIONS, COTS PROCESSOR PERFORMS FRAME SYNC ONLY

REAL TIME DATA SYSTEM (RTDS)

CRITICAL ARCHITECTURE ELEMENT IS ISOLATION

- **RTDS IS A SHADOW CONTROL CENTER
SO THAT DEVELOPMENT ITEMS CAN RUN
IN PARALLEL WITH OPERATIONS**

REAL TIME DATA SYSTEM (RTDS) UPGRADE PARADIGMS

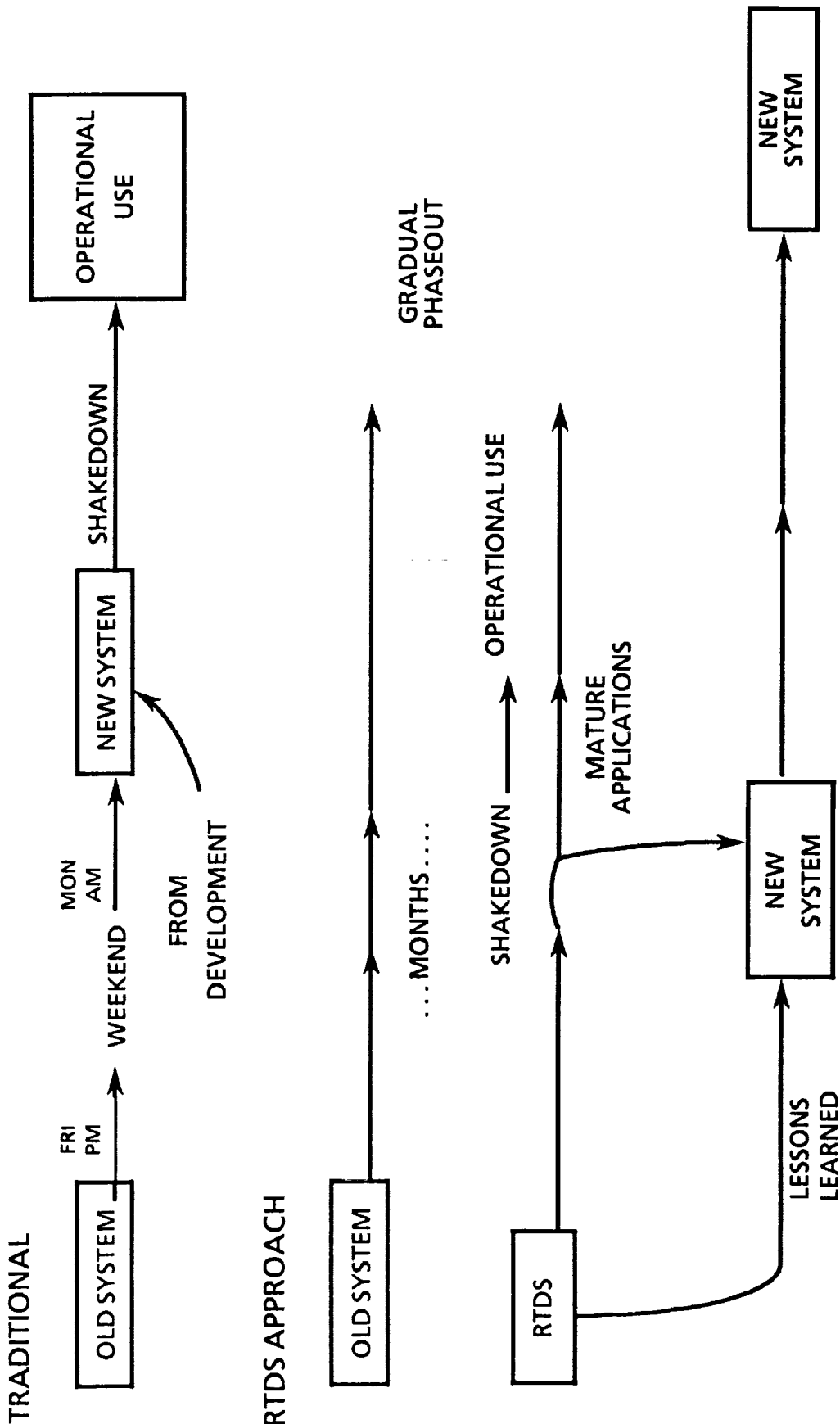

REAL TIME DATA SYSTEM (RTDS)

RTDS TOP LESSONS LEARNED

- #1
 - FIND A CUSTOMER WHO REALLY WANTS AND NEEDS THE TECHNOLOGY
 - ANY SUCCESSFUL PRODUCT STARTS WITH A CUSTOMER AND A PRICE THE CUSTOMER IS WILLING TO PAY
 - NEW TECHNOLOGY ALWAYS HAS PRICE TO BE PAID BY THE CUSTOMER
 - RTDS WORKED BECAUSE IT WAS CUSTOMER DRIVEN
 - PREVIOUS EFFORTS FAILED BECAUSE DRIVEN FROM OUTSIDE CUSTOMER COMMUNITY
- #2
 - DATA ACQUISITION IS CRITICAL TO SUCCESS OF EXPERT SYSTEMS - MUST BE ABLE TO ELECTRONICALLY ACQUIRE ALL NECESSARY DATA
 - EXPERT SYSTEM APPLICATIONS FLOPPED (HYD, PROP, SOME INCO) WHEN COULD NOT GATHER ALL THE REQUIRED DATA
 - SUCCESSFUL APPLICATIONS MATCHED CAPABILITIES OF RTDS DATA ACQUISITION WITH APPLICATIONS (BOOSTER, RMS, WINDS, INCO, DPS, GNC)

REAL TIME DATA SYSTEM (RTDS)

RTDS TOP LESSONS LEARNED

- #3 - DATA ACQUISITION DEVELOPMENT WILL REQUIRE THE MAJORITY OF EFFORT DURING INITIAL DEVELOPMENT
 - KNOWLEDGE BASE CAPABILITIES INITIALLY AFFECTED MORE BY ABILITY TO GATHER/CONVERT DATA THAN BY SPEED OF RULE BASE
 - BE INNOVATIVE - RTDS AT JSC USED COMMERCIAL-OFF-THE-SHELF TELEMETRY PROCESSOR TO LOWER WORKLOAD. DFRF TAPPED INTO EXISTING 1553 BUS. SHARP (JPL PROJECT) TAPPED INTO LINE PRINTER PORT

REAL TIME DATA SYSTEM (RTDS)
RTDS TOP 15 LESSONS LEARNED

- #4 - SUCCESSFUL APPLICATIONS GENERALLY WERE ONLY ACTIVE DURING A SINGLE FLIGHT PHASE (ASCENT/ORBIT/ENTRY) OR WHERE ACTIVITY WAS SAME ACROSS ALL FLIGHT PHASES (E.G., TAPE RECORDER MANAGEMENT)

- SOMETIMES DUE TO LIMITATIONS OF DATA ACQUISITION

- EARLY RTDS HAD LONG SETUP TIMES AT PHASE TRANSITION DUE TO TELEMETRY FORMAT SWITCHING

- DETECTING AND STEERING LOGIC IN DIFFERENT PHASES GOT VERY CUMBERSOME IN TASK AUTOMATION

REAL TIME DATA SYSTEM (RTDS)

RTDS TOP 15 LESSONS LEARNED

- #5 - MUST DO A COMPLETE SUBFUNCTION
 - BETTER TO DO DEPTH IN A SINGLE AREA THAN BREADTH
 - DATA AVAILABILITY LIMITING IN RTDS EXPERIENCE

- #6 - GET INTO OPS LOCATION AS SOON AS PRACTICABLE (8 MOS - 1 YEAR AFTER START)
 - AVOID "LAB QUEENS"
 - COMMENTS/EXPERIENCE FROM OPERATIONAL USE ARE THE MOST IMPORTANT INPUTS

- #7 - FIND WAYS TO PRESENT FUNCTIONS GRAPHICALLY
 - PEOPLE RELATE TO PICTURES
 - EASIER TO DEMONSTRATE AND SELL
 - DO NOT BE AFRAID OF COMPLEXITY IN DISPLAYS
 - OPERATORS USUALLY COMFORTABLE WITH DENSITY
 - BIG TRAINING VALUE - WHENEVER OPERATOR USES SCHEMATIC TYPE DISPLAY THEY ARE BEING TRAINED ON SYSTEM

REAL TIME DATA SYSTEM (RTDS)
RTDS TOP 15 LESSONS LEARNED

- #8 - SUCCESS IS NOT HAMPERED BY MISSION CRITICALITY OF APPLICATIONS - IN FACT, IT MAY BE ENHANCED
 - HAD ORIGINALLY PLANNED TO START IN LOW CRITICALITY ORBIT PHASES ONLY
 - NEEDS OF PROBLEM DROVE US INTO ASCENT HI CRITICALITY
 - USERS WERE HIGHLY MOTIVATED AND THE PRESSURE OF HI CRITICALITY PROBABLY FOCUSED AND MATURED THE PRODUCT SIGNIFICANTLY
 - "THIS IS THE GAME WE CAME TO PLAY" - HI RISK/HI GAIN

REAL TIME DATA SYSTEM (RTDS)

RTDS TOP LESSONS LEARNED

- #9 - THE KEY TO SUCCESS IS THE ABILITY TO RAPIDLY IMPLEMENT CHANGES THROUGH ARCHITECTURE THAT ISOLATES DEVELOPMENT AND OPERATIONS
 - EXISTING SYSTEMS ARE VERY CAPABLE AND HAVE CULTURAL SUPPORT DUE TO YEARS OF CUSTOMIZING AND TESTING
 - EXISTING SYSTEMS ACHILLES HEEL IS INABILITY TO RAPIDLY CHANGE
 - SIGNIFICANT BACKLOG OF UNIMPLEMENTED REQUIREMENTS (> \$1M) WAS IMPLEMENTED BY RTDS AT SMALL PERCENTAGE OF ORIGINAL COSTS
- NEW TECHNOLOGIES MUST:
 - PROVIDE RAPID CHANGE AS AN ADVANTAGE
 - UTILIZE ARCHITECTURAL ISOLATION SO THAT DEVELOPMENT AND OPERATIONS CAN RUN IN PARALLEL
 - ALLOW RAPID CUSTOMIZATION IN ORDER TO COMPETE WITH HIGHLY CUSTOMIZED SYSTEMS

REAL TIME DATA SYSTEM (RTDS) RTDS TOP LESSONS LEARNED

#10 - ONCE IN OPERATIONS, MUST PLAN AROUND THE CLOCK SUPPORT IN THE OPERATIONS LOCATION

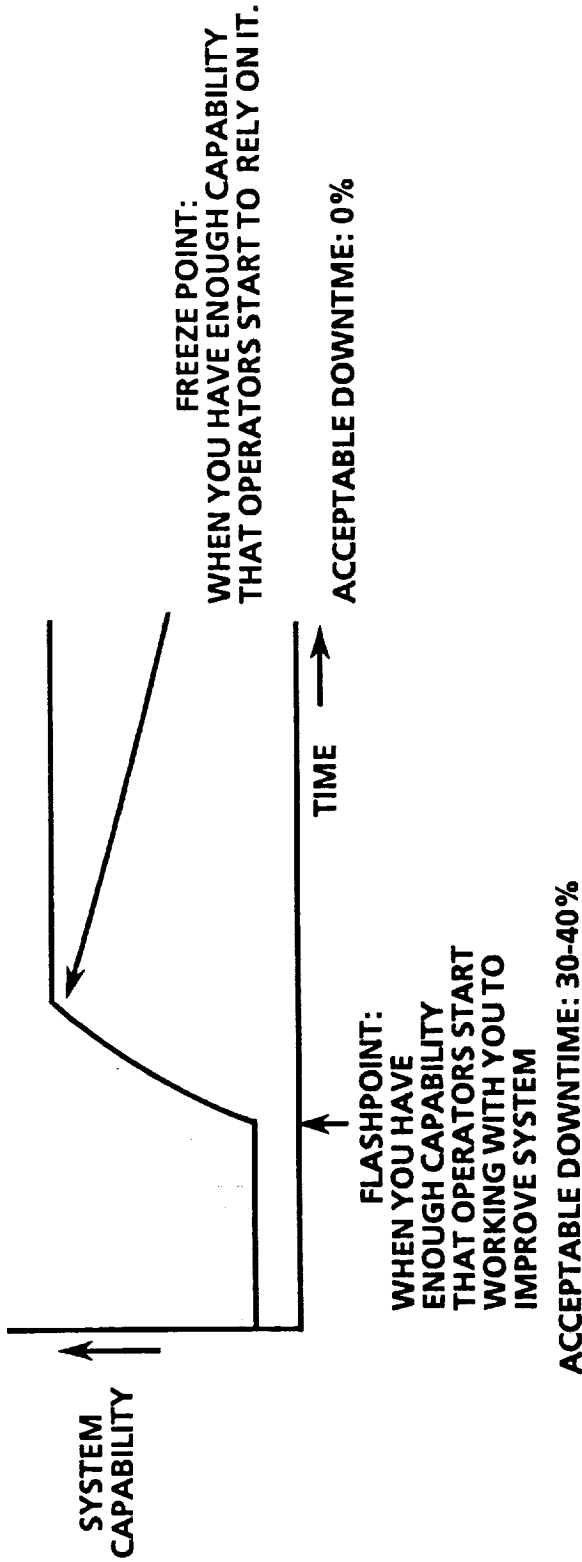

- EXISTING SYSTEMS ARE USUALLY HIGHLY RELIABLE
- USERS WILL EXPECT NEW SYSTEMS TO BE AS RELIABLE
- PROBABLY NOT POSSIBLE INITIALLY BUT MUST MAKE HERCULEAN EFFORTS TO MAINTAIN USER CONFIDENCE

REAL TIME DATA SYSTEM (RTDS)
RTDS TOP LESSONS LEARNED

- #11 - NEED A PLAN FOR SUCCESS
 - RTDS GOT CAUGHT "BEHIND THE POWER CURVE" TWICE
 - RIGHT AFTER INITIAL INSTALLATION WE DID NOT HAVE A PLAN OR HOW TO MEET THE DEMAND FOR OTHER NEW PROJECTS
 - INSTALLATION PLANNING/SUPPORT WAS/IS A MAJOR HEADACHE
 - AFTER THE INSTITUTION ACCEPTED IT, WE DID NOT HAVE A PLAN TO TURN IT OVER TO THE INSTITUTION FOR LONG-TERM SUPPORT
 - ABSENCE OF PLANS LOST US OPPORTUNITIES

REAL TIME DATA SYSTEM (RTDS)

CONCLUSION

FINAL THOUGHTS

- ALL TECHNOLOGY TRANSFER SITUATIONS ARE UNIQUE - SOME OF THIS ADVICE MAY NOT APPLY TO YOUR SITUATION
- IT IS POSSIBLE TO IMPLEMENT ADVANCED INFORMATION SYSTEMS TECHNOLOGY IN NASA IN WAYS THAT SIGNIFICANTLY IMPROVE MISSION CAPABILITIES
- TECHNOLOGY TRANSFER IS A BODY CONTACT SPORT
 - ROUGH AND TUMBLE BETWEEN OPERATORS AND DEVELOPERS
 - DO NOT TRY IT IF YOU ARE NOT PREPARED TO GET BRUISED (EGO OR PHYSICALLY)
- WHEN YOU SEE PEOPLE RELYING ON YOUR SYSTEMS TO MANAGE NASA MISSIONS, IT IS ALL WORTH IT!

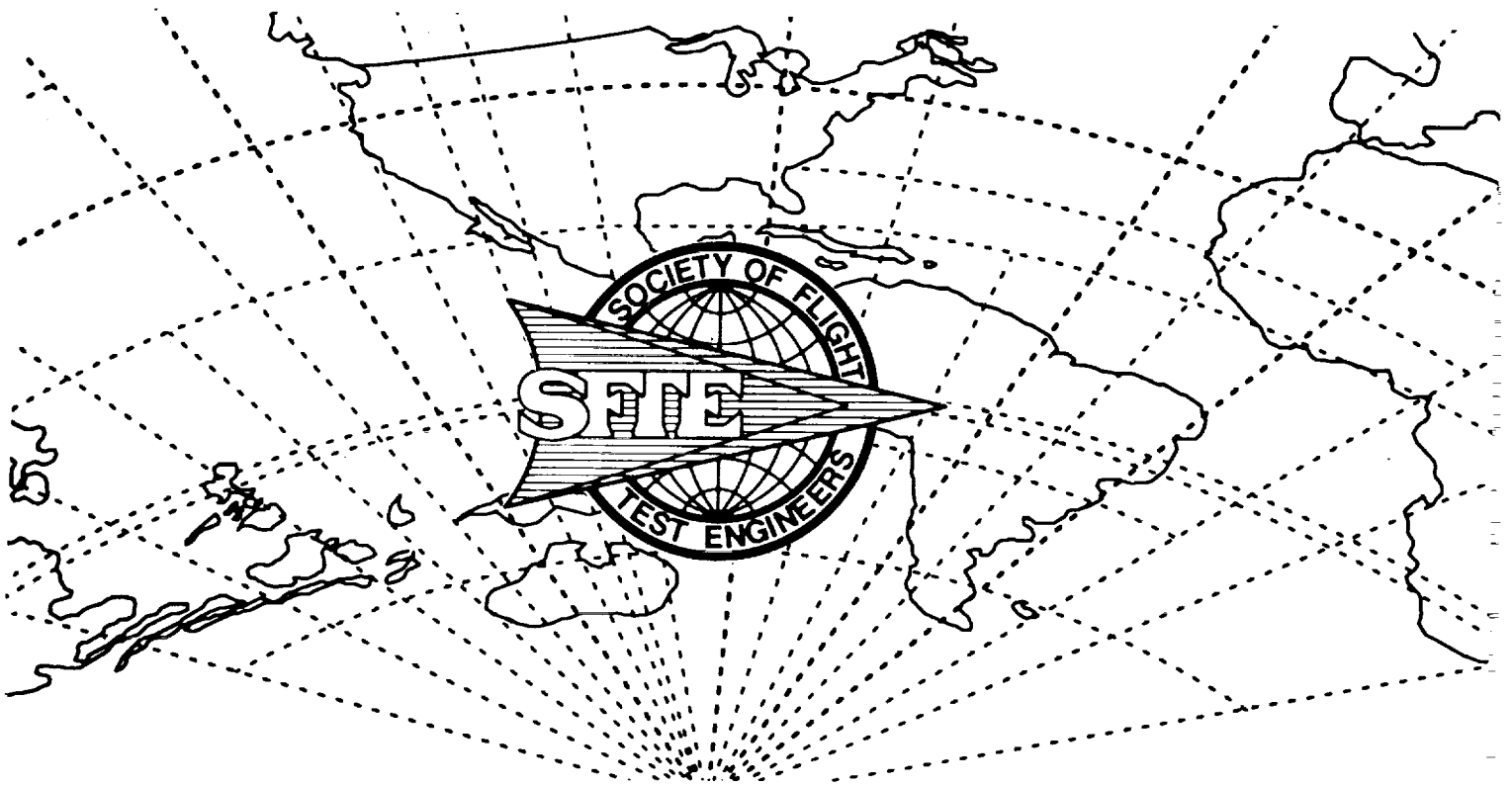

21st ANNUAL SYMPOSIUM PROCEEDINGS

*"Flight Test XXI . . .
The Sky's No Longer the Limit"*

*6-10 August 1990
Garden Grove, California*

Sponsored by the Los Angeles Chapter

Real Time Data Acquisition For Expert Systems
in Unix Workstations at Space Shuttle Mission Control

John F. Muratore, Troy A. Heindel and Terri B. Murphy
National Aeronautics and Space Administration

Arthur N. Rasmussen and Mark Gnabasiak
MITRE Corporation

Robert Z. McFarland
Unisys Corporation

Samuel A. Bailey
Dual and Associates

ORIGINAL PAGE IS
OF POOR QUALITY

Perhaps one of the most powerful symbols of the United States' technological prowess is the Mission Control Center (MCC) at the Lyndon B. Johnson Space Center in Houston, Texas. The rooms at Mission Control have been witness to major milestones in the history of American technology such as the first lunar landing, the rescue of Skylab, and the first launch of the Space Shuttle. When Mission Control was first activated in the early 1960's, it was truly a technological marvel. This facility however has received only modest upgrades since the Apollo program. Until recently it maintained a single mainframe based architecture that displayed data and left the job of data analysis to human beings. The display technology utilized in this system was monochrome and primarily displayed text information only with limited graphics (picture 1). An example display of 250 communication parameters is shown in picture 2.

The system processed incoming data and displayed it to the flight controllers, however it performed few functions to turn raw data into information. The job of turning data into information upon which flight decisions could be made was performed by the flight controllers. In some cases, where additional computational support was required, small offline personal computers were added to the complex. Flight controllers visually copied data off the console display screens, and manually entered the data into the small personal computers where offline analysis could be performed.

Although, this system was technologically outdated, it contained years of customizing efforts and served NASA well through the early Space Shuttle Program. Several factors are now driving NASA to change the architecture of Mission Control to accommodate advanced automation. First is the requirement to support an increased flight rate without major growth in the number of personnel assigned to flight control duties. We are attempting to fly more missions with the same staff to control operational costs.

NASA is using automation to expand the capabilities of individuals so they can accomplish more work. This concept of "more work for the same dollar" is very different from trying to automate a factory where the desire is to replace humans with robotics and "do the same work for less dollars." In Mission Control, the goal is to support the human operator, and not to eliminate the human.



Picture 1 - Space Shuttle Mission Control

```

F 11/16/103          COMM MANAGEMENT          RR920H CH012
ODI  4:15:02:31 OMET 0:00120:31 SITE SDA 01 144 0H 11
RODI 4:15:02:31 UD RT 1 SM M MBP'S SPR SM 3 07 12
--:--BAND PH      KU-BAND      NSP/CONSEC      GCIL
UL SS          M      UL SS          D      SELECT      2      CONFIG CHO
SPW 55 -20V3      TMS SEL      D      BIT SVNC      BIT      RU PS DABL
WEST          /      RST          /      FRM SVNC      FRM      PH CHO TV PH
EAST          /-1131 EST          /      COM SVNC      FRM      PL CHO TV CHO
RCVR LCK      LK      RF POWER      D      SOURCE      S      KU CHO
SH ERR        YS      ANT NODE      M      M/L RATE      LO      /-SVU
COHERENT      COM SEARCH      D      D/L RATE      HI      HF DISP PH
ANT SEL      LLP      DETECT      D      ENCR CODE      EN      1 DEC 1051 CH
MODE          GPC      TRACK      D      ENCR U/L CLR ENC 3 DEC 106 0H
ELEC          1      KU OPER      D      D/L CLR CLR 4 3 DEC 1 0H
BEAM          1      C14 SVNC      D      RCDR NSA NSA 5 3 050H
XPRR SEL      2      DATA QD      D      RCDR V      ON      /-FN
HIDE          TBR5      D/L NOR TV      D      ERROR R      0.0 0.0 55
PRE APP       2      LDR OPS RCD      D      MODE HE      ANT SEL UP
HEATER        1      B-NODE      D      CCTV          NODE      OPC
WA           STBY ON      ANGLE      D      D/L SEL      SVS SEL 1
TEMP          150      UHF          /      VCU NH          /-SECURE TV
RPT           0.7      1.3      NODE S      /      DMBLINK      ENA      ADU PH 7
--:--SPC          TEC      274 78 559 56      GPH SEL      NORM      TYPE 7
SH            D          279 50 243 55      ALC          OUTPUT 7
SPS          343
--:--RECORDERS          DDH          DDH          DDH          DDH
OPS MODE TX 2TP DTR SPWYN TEMP DDH 1 4:15:02:32 FR/S 100
1 RCDA 5 15 FND 1 RUN 102 DDH 2 4:15:02:32 FR/S 100
2 RCDA 2 55 REV 1 RUN 101 DDH 3 4:15:02:32 FR/S 100
3 RCDA 1 12 FND 2 RUN 101 DDH 4 4:15:02:32 FR/S 100
FAULT 1MU BITE/T 3      OPC 123* TIME 4:15:01:55.37
    
```

Picture 2 - Typical Mainframe Display

A second major concern is loss of corporate knowledge due to the unique bimodal age distribution of NASA. Hiring freezes between the Apollo and Shuttle programs have resulted in two primary groups in NASA. Approximately, half of NASA consists of Apollo veterans within 5 years of retirement. The other half consist of personnel under 35 with Shuttle-only experience. NASA considers it highly desirable to capture the corporate knowledge of the Apollo veterans in knowledge based systems before they retire. Because the mainframe complex is primarily oriented to data display, it is a poor environment for capturing and utilizing knowledge.

These factors have resulted in aggressive efforts by NASA's Mission Operations Directorate to utilize a distributed system of Unix (TM) engineering-class workstations to run a mix of online real time expert systems and traditional automation to allow flight controllers to perform more tasks and to capture the corporate knowledge of senior personnel. Starting with the first flight of the Space Shuttle after the Challenger accident, this effort, named the Real Time Data System (RTDS), has played an increasingly significant role in the flight-critical decision making process.

APPLICATIONS EXAMPLES

The application of these techniques has resulted in a new "look and feel" to Mission Control. Picture 3 shows a telemetry-animated schematic of the Shuttle's communication and tracking system. This display contains all of the information contained on the traditional monochrome text display shown in picture 2. The display utilizes color graphics to organize the information into a schematic. It also contains rules which draw inferences about the systems performance and operation from the telemetry. Previously, a major part of an operator's training was to learn how to look at complex displays of digital data and build a mental model of the system. Only after this training was complete, could an operator be trained to evaluate the situation and make recommendations. Utilizing the RTDS approach allows the operator to utilize the expertise of senior operators captured in the display program to build a mental model of the system and jump to learning how to evaluate the system.

This effort has also resulted in dramatic new and unexpected capabilities. For example, flight controllers who monitor the Shuttle's Remote Manipulator System (RMS) traditionally determined the position of the "robot arm" by

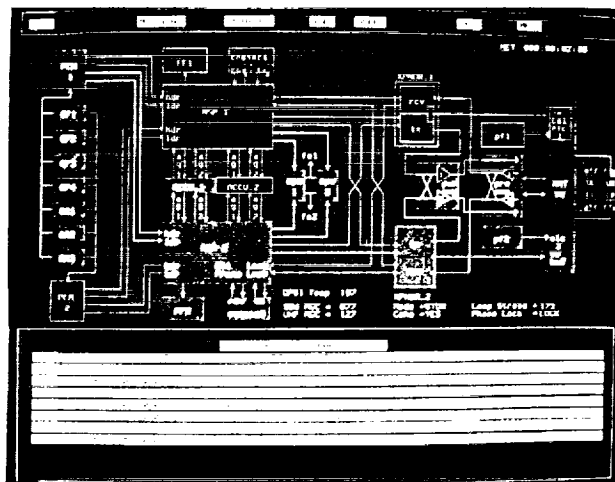

Picture 3 - Telemetry-Animated Communications Schematic On Workstation

observing digital readouts of the angles of each of the arms joints. A combination of offline tools and mental gymnastics allowed operators to determine the arm's position and advise astronauts on operation. Picture 4 shows an RTDS application which acquires real time telemetry of the arm's angles and animates a view of the Shuttle showing the arm's position. This application not only lowers the flight controller's workload, but also allows the controller to visually monitor for potential collisions of the Shuttle and payloads.

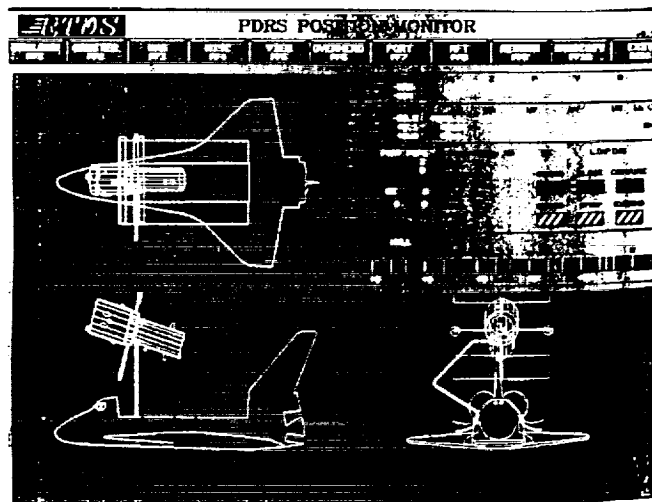

Picture 4 - Remote Manipulator System Workstation Display

ORIGINAL PAGE IS
OF POOR QUALITY

ORIGINAL PAGE IS OF POOR QUALITY

In another example, flight controllers typically monitored the performance of the Shuttle's flight instruments by watching digital displays of instrument telemetry describing the Shuttle's roll, pitch and yaw attitude angles or the bearing to the landing site. Picture 5 shows an RTDS display which acquires the real time telemetry on the flight instruments and displays an emulation of the flight instruments on a workstation screen.

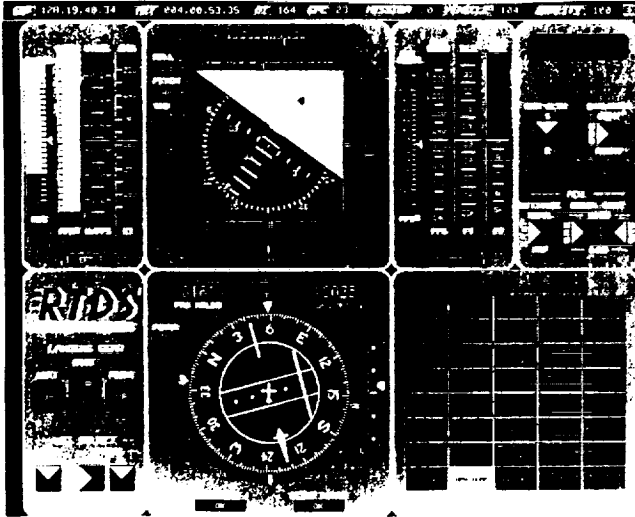

Picture 5 - Workstation Emulation of Shuttle Flight Instruments

RTDS has also been applied to real time data sources other than telemetry. One of the most significant applications has been in the evaluation of weather data. The Flight Director is the NASA individual in Mission Control with final authority on all flight decisions. One of the most difficult tasks for the Flight Director during landing is the selection of runways based on winds. Because the Shuttle during landing is essentially a very large glider, it has very critical crosswind limits. Traditionally, during landings the Weather Officer would read out wind values from the landing site and the Flight Director was required to determine if the winds were within limits by consulting a paper crosswind graph. This could get quite hectic as there are several runways and the winds at Edwards Air Force Base are notoriously variable. In RTDS we built an application which receives the wind reports electronically from the landing sites, computes crosswind components, applies flight rules to determine if winds are within limits, and displays the results graphically to the Flight Director in real time. This application dramatically lowers the Flight Director's workload and enhances the safety of flight.

In developing RTDS, NASA met several challenges in the use of Unix (TM) workstations to operate in real time and to provide real time expert systems and color graphics in mission-critical environments. All of these applications required access to real time data. The remainder of this paper explains the techniques developed to acquire real time data under Unix and supply it to expert systems. The techniques described in this paper have not only been used on Space Shuttle but also on aeronautics applications. Systems have been developed using RTDS for aircraft flight test operations by NASA's Dryden Flight Research Facility (reference 1) for monitoring the X-29 and by the Air Force Flight Test Center (reference 2) for monitoring the F-15 short takeoff and landing demonstrator aircraft.

HARD AND SOFT REAL TIME CONSTRAINTS

The most important item to understand in developing real time Unix applications is the difference between hard and soft real time constraints. As defined by Stankovic (Reference 3) real time systems are those where the correctness of a computation is a function of both the result of the computation and the time at which the computation is delivered. Hard real time systems are those where the function is completely failed if the computation does not always meet the time constraint. Soft real time systems are those where system performance is degraded if the time constraint is not always met, but can be fulfilled if the conditions are met with a response distribution. A typical hard real time system is an aircraft flight control system where loss of control occurs if the system does not meet time constraints. An example of a soft real time system would be an airline reservation system where slow response results in degraded operations but not system failure.

In RTDS we had to meet both hard and soft real time constraints. The hard real time constraint occurred in the acquisition of real time data into workstations. The soft real time constraints were in the performance of fault detection algorithms, fault detection rule based expert systems and data displays. Understanding the difference in these types of constraints is the key to successful implementation.

Unix Data Acquisition is A Hard Real Time Constraint

In RTDS we tapped into Space Shuttle telemetry as soon as the data reached the Mission Control (Diagram 1). Telemetry is a uniquely structured data

NASA DIAGRAM 1 REAL TIME DATA SYSTEM OVERVIEW

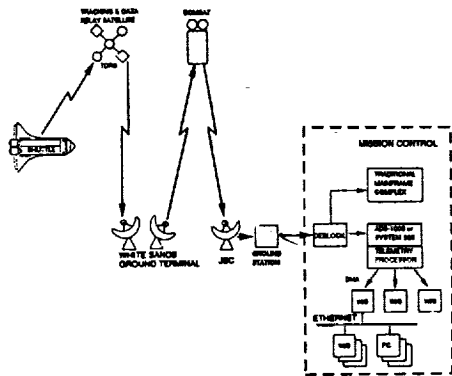

stream. In order to minimize hard real time processing in the Unix workstations the basic telemetry processing roles of bit, frame, and subframe synchronization, and parameter extraction (decommutation) were performed in a dedicated telemetry processor (Loral Instrumentation ADS-100 or System 500). The extracted parameters (approximately 5,000 16-bit words per second) were communicated to the workstations (Concurrent 6600) via a Direct Memory Access (DMA) interface. The DMA is based on the Digital Equipment Corporation (DEC) DR-11W standard using an Ikon Corporation interface board installed in the Masscomp. The telemetry processor buffers the incoming telemetry data in a 1,000 word First In First Out (FIFO) buffer. The buffer unloads over the interface when polled by the workstation. The hard real time constraint was that the FIFO buffer would lose data (overflow) and require a reset if it was not polled before it filled. The Unix workstation had to poll the system sufficiently to drain the buffer before it overflowed.

Unix has some well-known problems that hinder its use in hard real time applications. Unix normally does not provide the capability to assign hard priorities to tasks. This makes it impossible to require that a task execute at a given rate, such as polling a telemetry processor at four times a second. This is complicated by the fact that in most Unix implementations the kernel cannot be pre-empted. Thus, even if an external device, such as a telemetry processor, needs service, the kernel may block its servicing. Additionally, most Unix schedulers, reduce a task's switching priority in proportion to the processor time used.

This is a problem when data acquisition is to be performed continuously over a several day mission. Most Unix implementations perform task swapping; in addition, virtual memory versions also perform on-demand paging. If a task has critical code or data paged to secondary memory or if the entire task is swapped out, then the time to recover critical code and data may violate real time constraints. Unix also typically buffers all disk transactions in buffer cache in primary memory. This introduces an uncontrolled factor in critical disk I/O tasks such as data logging. Concurrent Corporation's Real Time Unix (RTU - TM Reference 4) has specific features to allow the user to deal with these constraints. In specific RTU allows tasks to lock a memory segment, and to circumvent the normal changes in switching priority by specifying a fixed real time switching priority. RTU provides contiguously allocated disk files that allow the user to bypass the disk buffer cache mechanism and perform direct I/O to disk. RTU provides kernel pre-emption within specified time constraints.

Even with these capabilities, data acquisition systems and real time applications under Unix must be carefully structured. Specifically, the tasks performing data acquisition must be isolated from applications processing so that increasing the applications load does not prevent the data acquisition from meeting the hard real time constraints. In order to deal with this problem, a technique was developed to take advantage of multiprocessing capabilities (Diagram 2).

NASA DIAGRAM 2 DATA ACQUISITION SOFTWARE

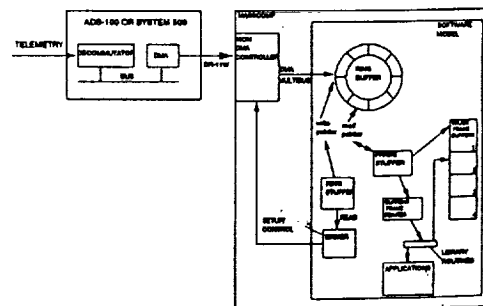

In this technique a single "stripped-down" task manages the DMA controller, instructing it to fill different segments of a ring buffer in sequence. This "Ring Stuffer" was identified as the highest priority real time task in the system. A second task, called the "Buffer Stuffer", reads the ring and performs decoding steps to place data into time homogeneous buffers in shared memory that can be accessed in parallel by many applications.

The two stuffers interact in several ways. The buffer stuffer is set to a real time priority so that its switching priority does not degrade with accumulated CPU time, but at a lower priority than the ring stuffer to prevent interfering with the hard real time performance of the ring stuffer. The Ring and Buffer stuffers communicate their position in the ring through shared memory. If a buffer being accessed by the Buffer Stuffer is about to be overwritten by the Ring Stuffer, then the Ring Stuffer still performs DMA to meet the real time constraint and prevent overflow of the telemetry processor FIFO. The data is transferred into a "bit bucket", a spare buffer dedicated for this purpose. Although this mechanism can lose data, acquired data is not contaminated. Whenever data is lost, tasks are notified by flags in shared memory. When two processors are available in a workstation, the two stuffers are run in parallel on separate CPU's to prevent contention.

This dual-stuffer technique was also implemented in a 80386 Personal Computer running the Lynx (TM) real time operating system to acquire weather data for the Flight Director Winds application. The weather data was acquired over an asynchronous serial line and placed in a ring by one task, and organized for evaluation in time homogeneous buffers by another task.

Shared memory is vital for interprocess communication in this approach. The Unix AT&T System V shared memory implementation is very good for real time data acquisition and distribution. It is important to perform the data acquisition task as a service and make acquired data available to all applications by shared memory. If shared memory is not available, then each application would have to perform significant data acquisition tasks and this would severely limit the number of simultaneous applications. Shared memory was also an important troubleshooting tool for the data acquisition software. Normal debugging techniques typically involve messages written into files or to the terminal. This assumes that the

debugging techniques will not impact the proper operation of the process. However, in a real time environment the use of such techniques significantly affects the timing characteristics of the system and cannot be used. Instead, RTDS logs information about the data acquisition (such as pointers, number of bytes transferred, overflow flags) to shared memory. This allowed us to build graphic monitors which can be observed in real time to troubleshoot data acquisition problems.

Several other RTU features are critical to the performance of RTDS. These included the ability of an application to delay for time periods less than 1 second. This function was required because high priority tasks such as the buffer stuffer had to delay for incoming data and the standard Unix minimum sleep of 1 second was too long to meet rate constraints. RTU provides a mechanism allowing delays as short as 1 millisecond. RTU also provided a time of day clock (for rate calculations) and signals for trapping floating point errors. Floating point error traps are critical because noise in data can cause floating point errors and applications must trap and handle these errors. Real time tasks that perform continuous cyclic display also need the capability to poll for user input without holding. Conventional Unix terminal drivers

provide the `O_NDELAY` option to allow a single application to read the keyboard without delay. This however does not provide a mechanism for controlling which applications should receive the keyboard input. An X Windows approach would be the modern solution to this problem and is being used by RTDS in its newest applications. At the time we started RTDS however, X Windows was not available on our equipment, so we used mouse button signals with signal handlers to provide inputs to applications. The mouse signals did not require polling, so cyclic displays would not delay for user input. All of the applications received any mouse input so that the handlers were required to determine from the cursor location if the inputs were intended for their application.

This technique has been highly successful in processing real time data. During a recent mission, a workstation running a moderate applications load ran for over 3 days without an overflow occurring. With a heavily loaded workstation we experience an overflow every 10-12 hours. This vulnerability occurs because the ring stuffer runs as a Unix application. It context switches from application state to kernel state

whenever it executes the DMA Controller driver. If another application requests a kernel service while the ring stuffer is in applications state, the context switch of the ring stuffer can be delayed. To minimize the effects of this case we modified the telemetry processor board to automatically reset itself when an overflow occurs. This is not completely satisfactory as data loss occurs during the reset and we are currently developing a version of the DMA driver that performs all of the ring stuffer activity in the kernel.

RTDS is an interesting statement on the power of current engineering workstations. The Apollo Mission Control Center used for the lunar landings in 1969 processed less than

1,000 parameters a second in the large mainframes of the time. RTDS processes 4,000 parameters a second in a single workstation.

Data Display and Expert Systems are Soft Real Time Tasks

When we started RTDS we thought of data display and computation along traditional mainframe-based terms. Specifically, we expected all data to be displayed and all computations to run on every data sample. After some early experimentation it became clear that it would not be possible to display data and run rule based expert systems in a hard constrained fashion. The nature of rule based expert systems makes it difficult to guarantee hard real-time performance. In rule based expert systems, computational load varies based on the number of rules fired and this varies with circumstances being monitored.

Examining the actual monitoring tasks performed by flight controllers reveals that although data is displayed at once per second, it is not monitored at that rate. Flight controllers are themselves multitasking and monitor several screens, event lights, and voice loops as well as using other materials such as procedures and schematics. The human monitor is a "soft" real time implementation.

We also found that the tasks could be structured so that only key detection logic was being evaluated every second. Supporting logic was only activated when primary logic detected a problem. This significantly improved our real time performance. In specific, a rule-based expert system monitoring the Shuttle's communications system utilized approximately 500 rules. These were initially implemented in CLIPS, a rule based expert system tool developed by the Mission Planning and Analysis Division at Johnson Space Center. This tool does not have any special real-time

support. By structuring the rules into phases and enforcing certain

precedence, we found that approximately 100 rules were required to capture the key detection logic. In the Unix environment, CLIPS was able to fire these 100 rules approximately 2 to 3 times a second. When the key logic rules detected problems, additional rules fired, which slowed down the system and caused only momentary violation of real time constraints.

It is important to realize that the Shuttle systems do not normally operate with continuous failures being introduced. One of the goals of the expert systems is to provide expert evaluation when failures occur. If the system slows down when the failure occurs, but is still able to provide the expertise, then it is meeting its desired function.

When we performed tests on the performance of the fault detection, we found that a large percentage of the processing was meeting the once-a-second constraint and all of the processing was being performed on a 2 to 3 second cycle. This was not detectable by flight controllers looking at the RTDS displays.

We also found that RTDS displays telemetry 3 to 4 seconds ahead of the mainframe complex. This is because the RTDS architecture minimizes the number of data transfers between processors. Because the mainframe performs such a large number of computations, it requires extensive minicomputer preprocessing to meet real time constraints. This introduces significant delay in the mainframe system.

On several occasions during actual Shuttle flight, RTDS has detected problems and brought them to the attention of flight controllers before they noticed the problems on the conventional displays. In several cases, the mainframe displays have been completely removed from the control center and the controllers rely entirely on the workstation based displays.

SUPPORT TECHNIQUES FOR REAL TIME EXPERT SYSTEMS

In developing the real time data acquisition support for expert systems we utilized several critical techniques. The most important technique is that of the time homogeneous buffers. If task automation or a rule based expert system is to combine several different pieces of sampled information and make a decision on them, then the time relationship of these samples must be known. Typically we try to only combine

data from the same data acquisition sampling cycle or major frame. A major frame is the time period in a sampled data system when all measurements are sampled at least once. On Space Shuttle the major frame is sampled and transmitted once per second. All measurements from a given major frame represent a time homogeneous dataset bounded by the sampling rate.

An example of the importance of this type of relationship is detecting a failed reaction control system jet thruster on the Space Shuttle. There are two conditions that we want to detect. A jet that does not fire in response to command is considered failed off. A jet that does not turn off when the command is removed is failed on. So we have two rules :

a. If jet command is on and jet chamber pressure is low, then jet is not firing and failed off.

b. If jet command is off and jet chamber pressure is high, then jet is firing and failed on.

If the jet command telemetry parameter is not from the same sampling period as the jet chamber pressure command, two things can happen which cause a normal jet firing to be misdiagnosed as a failure. If the command measurement leads the response measurement, then the first rule will be satisfied indicating that the jet is not responding to commands. If the command lags the response, then the second rule will be satisfied indicating that the jet is firing without a command. It is only when the command and response are from the same frame that a normal firing will be properly evaluated.

In RTDS we placed data into time homogeneous buffers in shared memory on major frame boundaries. We use four buffers on a round robin basis. The Buffer Stuffer places telemetry parameters in the round robin buffers in named locations where they can be extracted by applications using standard library routines. Whenever a parameter is placed in the buffer it is marked as valid for that major frame. The stuffer also searches for the frame markers in the telemetry stream. When a major frame marker is detected, the buffer stuffer closes the buffer being updated and makes it available to applications for reading. Flags are set in shared memory to indicate the most recently updated buffer. After releasing the completed buffer to applications, the Buffer Stuffer then opens the next round robin buffer. Before starting to fill this new buffer, data from the last major frame period is copied into the new buffer. All data is marked as invalid

for the new major frame when it is copied forward. As each parameter is processed in the new major frame, the parameter status is updated to valid. By copying forward the most recently received data, we ensure that applications always have access to the most recently received data (with appropriately marked validity), even if the data is not received in a given major frame due to errors in transmission. By switching buffers and making them available to applications at major frame boundaries, we maintain the time homogeneity of the original sampled data stream.

In order to maintain major frame time-homogeneity in the applications, it was necessary to ensure that once the data acquisition library starts to pull data from a buffer, that all of the parameters are pulled from only that one buffer (major frame). This must happen while Unix is switching applications, paging and swapping. It takes more than 1 second for an application to complete its computation cycle between data acquisitions. The four round-robin buffer design gives an application three major frame times to complete an acquisition before the buffer is overwritten.

This major frame buffer technique maintains the data time characteristics for automated monitoring and expert systems. Alternative approaches have been used in other telemetry computer systems which lose this critical time relationship information. An alternative technique that has been implemented in at least one major NASA system and two new commercial off-the-shelf telemetry monitoring systems is called the Current Value Table (CVT). In CVT, telemetry data is acquired and the most current values of parameters are placed in a single table without regard to the major frame. When an application requests data, the CVT ships out the most current value received for the requested parameters. Because the requests occur asynchronously with the data acquisition, it is almost certain that data from multiple major frames are in the same data request. This technique may be acceptable for low rate data displays and limited automated monitoring but is not acceptable for advanced automation using rule-based systems.

Major Frame Buffers For Logging and Distribution

The major frame buffers are also a powerful structure for logging data. In RTDS, the buffer stuffer logs all parameters to disk in contiguous files. RTDS has an "instant replay" mode where real time data acquisition is stopped and a "replay stuffer" is used to stuff data into the major frame buffers.

In this way all of the real time applications can be used in playbacks.

The replay stuffer has a control panel which is fashioned after a conventional Videocassette Recorder control panel. We chose this interface because it was familiar to almost everyone and it has all of the functionality needed. With the VCR control panel users can playback data, view in fast forward, "rewind," or Shuttle between set points. Speed of the playback can be adjusted for slow-motion analysis.

This capability has turned out to be essential for three reasons. First, the capability was essential for debugging the automation applications. Data signatures captured during actual flight or simulations can be replayed time and time again to work out bugs in automation and expert systems as well as to perform regression testing. Second, as a real time tool this capability has enabled operators to significantly cut the time required to view playback data. This capability was used dramatically after the pad engine shutdown and countdown abort on the first STS-34 launch attempt. RTDS enabled engineers and managers to replay the shutdown within minutes to troubleshoot the cause. This is a big improvement over the current playback systems which can take from 30 minutes to 5 hours to retrieve playback data. In fact, the director of Mission Operation has stated that RTDS paid for its entire development in those few minutes. Third, there has been an unexpected training benefit from the playback capability. Flight controllers can record simulations and then play them back at their convenience for training. Several training objectives in flight controller certification are now met by this technique. This saves the large costs associated with meeting training objectives by a full-up simulations with the entire simulator, control center, and flight team in place.

The major frame buffer is also natural format for distributing data over local area networks. In RTDS we distribute major frame buffers over Ethernet (TM).

This enables RTDS to provide remote telemetry monitoring and software checkout, even on computers which could not normally support real time data acquisition. The User Datagram Protocol (UDP) subset of TCP/IP was used to provide a connectionless unacknowledged data transfer. This allowed the transmitting workstation to be unaffected by the receiver workstation if the receiver was unable to keep up with the transmitter. This capability has allowed us to conduct operational demonstrations where flight controllers monitored data out of their offices. We sent the data to the

experts, rather than sending the experts to the control center. This technique will become more important as NASA pursues long term missions such as Space Station where it becomes less feasible to tie experts down to a central location.

Data Quality of Frames and Individual Parameters

In order for expert systems and task automation to use real time data, it is necessary to determine the quality of the data. There are two measures of data quality, the quality of a major frame and the validity status of individual parameters.

In order to determine the validity of a frame of data, we utilized the fact that each major frame of telemetry is divided into a number of smaller frames, called minor frames. Each minor frame contains an identifying counter. In Shuttle there are 100 minor frames per major frame and one major frame per second. Parameters are spread across the minor frames. In telemetry systems, data can be interrupted due to radio-frequency noise on the space-to-ground link. Typically noise is of short duration and will only affect one or two minor frames.

In order to inform applications when noise was present, the minor frame counter is transferred via DMA to the workstation. The Buffer Stuffer

examines each frame counter to ensure that all 100 frames are received in sequence for a given major frame. This Quality parameter is expressed as a number from 0 to 100 indicating a rough percentage of the quality of the data. The Quality parameter is placed in shared memory, with one quality estimate for each major frame buffer. Applications receive the buffer Quality value whenever they request data from a buffer. In this way applications can chose to display or discard data based on overall data quality. In many data display tasks in RTDS we chose to display all of the data even in high noise (low Quality) conditions. In critical task automation, we discard all data that does not have a 100 percent quality to prevent erroneous results.

There are approximately 32,000 parameters in the Space Shuttle system but only approximately half of them are being downlinked at any one time. This is due to the restriction of the downlink bandwidth of the telemetry system and recognizes the fact that certain data is not required during all flight phases. For example, engine data is only needed during launch. If during a major frame, data is not in the specific telemetry format, then RTDS marks the individual parameter status as invalid. When an

application attempts to acquire the parameter, the application receives both the value and the status of the parameter from the buffer.

Individual parameter validity status is an important technique that has been overlooked in several NASA and commercial systems and caused serious architectural problems when retrofitted into these systems. This function must be provided by the data acquisition subsystem. Without a system solution, each application must contain sufficient format definition information to independently assess validity. This is a severe software maintenance and leaves the possibility that applications might function improperly due to stale data.

Calibration and Conversion

In typical flight vehicle telemetry systems data originates from one of two major sources. Some data is acquired directly from sensors and other data is the result of computations in the onboard computer. Calibration is the function of calculating engineering unit values (temperature, pressure, etc.) from sensor telemetry. Conversion is the process of transforming values from the word formats of the flight vehicle computer into the word formats of the ground computer. Both of these functions must be performed if an expert system is to use telemetry.

Typical sensors convert some physical quantity (e.g. temperature, pressure) into an analog value proportional over a specified range (Diagram 4). Sensor output voltages are normally amplified and then converted to a digital value. These values are usually called "counts." The sensor value in counts (8, 10, 11, 12 and 16 bit are popular sizes) is placed in a serial stream for transmission to the ground. On the ground, the computer system converts these to a number representing a physical quantity. This is because it is much easier for humans and expert systems to reason about physical quantities than "counts." This is done with a calibration curve of the form:

$$y = A(0) + A(1)*X + A(2)*X^2 + A(3)*X^3 + \dots$$

where the counts are supplied as the X values and the A(N) values are the coefficients. In RTDS we use the Shuttle program standard fifth order polynomials. The coefficients for this polynomial are stored in shared memory so they can be viewed and altered and to assure they are common to all applications. Acquired data is placed in the shared memory in "counts" and when applications request data, the shared memory is examined to obtain and apply the calibration curve.

NASA DIAGRAM 4 CALIBRATION CONCEPTS

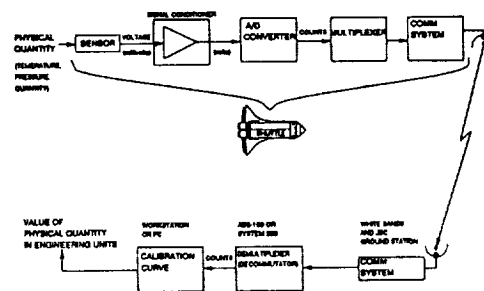

Flight vehicle computers historically have unique architectures due to the demands on weight, size, power consumption and reliability in hostile environments. In fact, the Space Station program is the first NASA manned program to specify a hardened standard commercial-off-the-shelf architecture for a flight computer (80386). Because flight computers tend to be unique, they usually have unique floating point formats (Diagram 5). Unix workstations usually use IEEE standard floating point formats or manufacturers variants. The data acquisition subsystem must be able to convert between these different number representation subsystems if the display user or expert system is to interpret the data. In RTDS we keep the parameter conversion information in shared memory together with the calibration curve. Data is kept in the flight vehicle form in the shared memory. When an application requests data, the shared memory is used to select and apply the appropriate conversions. Twelve different types of conversions are required on Space Shuttle. Override modes for both calibration and conversion are provided in the library calls so that user applications can acquire raw data directly as it was downlinked from the vehicle.

Noise Filtering

Even when the quality and individual parameter validity mechanisms are used, there still is the possibility of getting incorrect data into a real time expert system. There are two basic sources of error. First, communications noise may be of very short duration so as to only affect a small number of bits. If the noise doesn't affect a frame counter or frame synchronization marker, then it is difficult to determine (from a data communications standpoint) that an error has occurred. Some telemetry systems use parity bits on individual parameters and frames or a forward-error-correction technique but these are not available on Shuttle. The second

NASA CHARTMAN'S SHUTTLE FLOATING POINT FORMAT VS. IEEE STANDARD (IBM BIT NUMBERING CONVENTION)

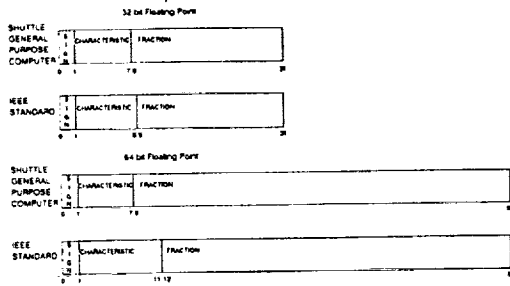

source of noise is the sensor itself. Sensors are nonideal devices and can be noisy. In RTDS we applied "noise-filtering" techniques to minimize the effects of these errors on applications.

The first technique was applicable to discrete (binary 1 or 0) values, such as switch settings and valve positions. Whenever one of these items changed, it would not be provided to the expert system unless the change was present for a specified number of seconds (N). This N-count noise filter is a technique which has been used successfully in the onboard automation of the Space Shuttle. The problem with this filter is that a "chattering" sensor is not detected if it changes state faster or at the same rate as the noise filter. Operationally, the N-count algorithm worked well for our applications.

The second technique was applicable to numbers. A numeric value may take many values. In a slowly changing situation the same N Count algorithm used for discretized values can be used. But where values change rapidly, comparing updates to the last value can result in no updates being made available to the expert system because the last value never stabilizes. For fast changing numeric values we used reasonableness tests. The expert systems and automation would reject values that were not in a specified reasonable range for that parameter.

In some cases, these checks were performed within the expert system or automation. But in many cases the same noise-filtered value was required by several applications (automated fault detection, displays etc...). In these cases, we wanted a single authoritative copy for all applications. We used another shared memory buffer to which the noise filtering routines could write. This "signal buffer" was accessible by all applications by requesting parameter names through a library routine. This "signal buffer" did not represent a major frame time-homogeneous buffer.

Because noise filters are set at different values for each parameter, there was no way to maintain time homogeneity. The mechanism however worked very well as both a repository for "best-estimate" values for low dynamics tasks and a general purpose mechanism for communicating results between applications. Many applications used this mechanism.

FLIGHT TEST - THE SKY'S NO LONGER THE LIMIT

It is appropriate that this conference's title includes the statement that the sky is no longer the limit for flight test. RTDS and similar systems will be used in the next few years by NASA to perform the most extensive set of space flight technology tests since the early 1960's. NASA's manifest for the next few years contains several missions which will flight test new technologies such as tethers, aerobrakes, and free-flying telerobots in near-earth orbit. All of these missions require advanced telemetry monitoring and visualization techniques similar to those developed in the RTDS project.

The Tethersat will be flown on STS-46, currently scheduled for late 1991 (picture 6). This will be the first attempt to ever use a large scale tether between two orbiting objects. This flight will explore the motion and electrodynamics of tethers in orbit.



Picture 6 - Tethersat

ORIGINAL PAGE IS OF POOR QUALITY

Also in late 1991, STS-49 will test elements of the Flight Tele-robotic Servicer (FTS picture 7). The FTS is being developed by Goddard Space Flight Center as a tool to assist in the assembly of the Space Station. It can operate in free-flying mode or attached on the end of the RMS. The STS-49 flight will be used to conduct flight experiments on prototype hardware elements. The first actual flight of the complete FTS will be performed on STS-72 in late 1993. This will qualify the equipment for use in Space Station assembly in 1995.



Picture 7 - Flight Tele-Robotic Servicer

In late 1994 the Aero-Assist Flight Experiment (AAFE) will be flown on STS-82. This flight will deploy an unmanned free-flying vehicle which will fly a aerobraking profile (picture 8) to demonstrate the feasibility of using atmospheric aerodynamic braking to alter orbits. This technology is considered crucial for capturing vehicles returning to earth from the moon in future lunar exploration programs.

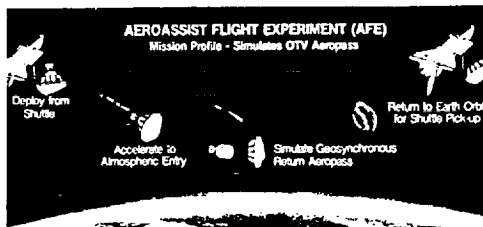

An Aeroassist Flight Experiment (AFE) mission scenario calls for the AFE to be deployed from the cargo bay of the Space Shuttle. A solid rocket motor (SRM) will accelerate the vehicle to 33,800 feet per second simulating the speed at which a spacecraft travels in geosynchronous orbit. After the burn, the SRM is jettisoned. A dip through the Earth's upper atmosphere is expected to slow the AFE so it can rendezvous with and be retrieved by the Shuttle. Back in the cargo bay, the AFE will be returned to Earth for in-depth analysis.

Picture 8 - Aero-Assist Flight Experiment

CONCLUSIONS

The advances in workstations and real time Unix have enabled small programming teams to implement real time telemetry systems that have made major improvements in NASA space and aeronautics mission operations. Several real time adjustments must be made to Unix and applications properly structured to meet and soft real time demands. Many monitoring problems are actually soft real time problems and thus can be implemented using current workstations and expert system technology. New techniques in data acquisition have been developed to ensure that the correctness of the expert system recommendations is not affected by the data acquisition process. These mechanisms are general and can be applied to any real time expert system. Although, these techniques are more traditionally associated with real time systems or process control rather than expert systems, they must be applied for real time expert systems to provide useful information in mission critical environments.

References

1. Mackall, McBride, and Cohen, "Overview of the NASA Ames-Dryden Integrated Test Facility", NASA TM-101720, 1990
2. Jones, Madison, and Flanders, "Real Time Discrete Monitoring", AIAA Fifth Biannual Flight Test Conference, 1990, AIAA-90-1311
3. Stankovic and Ramamritham, "Hard Real Time Systems - A Tutorial", Computer Society Press (IEEE), Washington DC, 1988
4. "Understanding Real Time Unix", Concurrent Computer Corporation 1989

Acknowledgements

The development of RTDS at Space Shuttle Mission Control has been a team effort. Flight controllers Michael Dingler, Jon Redding, Ronald Montgomery and Joe Hughes each developed specific expert systems in their discipline areas. Cheryl Whittaker, Deborah Horton, and Erick Kindred developed significant applications. Brian Kowalski provided invaluable assistance with the first version of the DMA driver. The development of the X-29 system was performed by Dale Mackall, Dorothea Cohen, and Dick Simon from NASA's Ames-Dryden Flight Research Facility. The F-15 STOL system was

ORIGINAL PAGE IS
OF POOR QUALITY

developed by a team headed by Robin Madison of the Air Force Flight Test Center. Funding for RTDS was provided by NASA's Office of Aeronautics and Exploration Technology, The Space Shuttle Advanced Development Effort and the Space Station Freedom Advanced Development Program.

The United States Government does not endorse any products and mention of products in this article does not constitute an endorsement by the United States Government.



SHARP: SPACECRAFT HEALTH AUTOMATED REASONING PROTOTYPE

Presented by
David J. Atkinson

Jet Propulsion Laboratory
California Institute of Technology
Pasadena, CA

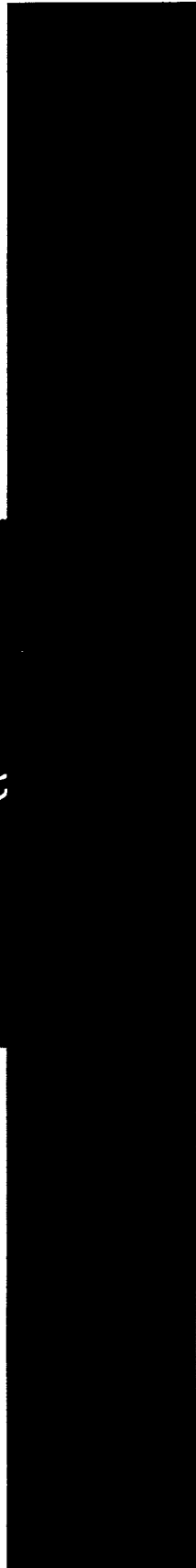
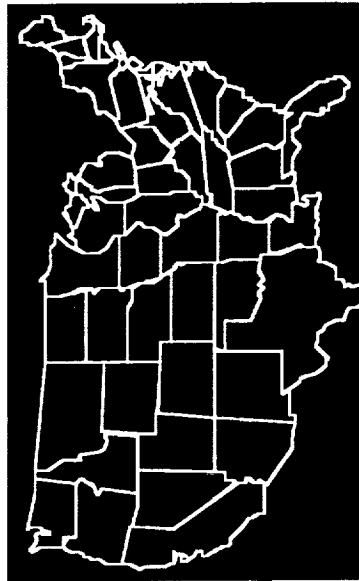

N92-12020-^{S10-14} p.25
JJ574450

OUTLINE

- BACKGROUND
- SHARP DESCRIPTION
- APPLICATIONS
- FUTURE DIRECTIONS
- BENEFITS, LESSONS LEARNED, CONCLUSIONS

BACKGROUND

- **PLANETARY SPACECRAFT MISSION OPS**
- **KNOWLEDGE SYSTEMS**
- **SHARP DEVELOPMENT TASK**
- **VOYAGER TELECOM LINK ANALYSIS**



PLANETARY SPACECRAFT MISSION OPS

- **AGGRESSIVE PLANETARY EXPLORATION IN 1990'S**
 - MAGELLAN, GALILEO, ULYSSES, MARS OBSERVER, VOYAGER, CRAFT, CASSINI
 - POSSIBLE LUNAR AND MARS SPACECRAFT
 - ALL WILL BE FLYING AT THE SAME TIME
 - VOYAGER ALONE REQUIRED ABOUT 40 REAL-TIME OPERATORS AT ALL TIMES
- **LARGE GROWTH IN MISSION OPERATIONS WORKFORCE, OPERATIONS COMPLEXITY... COSTS FORESEEN**
- **PROGRAM TO UPGRADE OPERATIONS INFORMATION SYSTEMS UNDERTAKEN: SPACE FLIGHT OPERATIONS CENTER, ONE MULTI-MISSION SPACE FLIGHT OPS TEAM**
- **GOALS: SUBSTANTIAL AUTOMATION, REDUCE WORKFORCE AND COST TO OPERATE, IMPROVE SAFETY, RELIABILITY, AND PRODUCTIVITY**



SHARP TASK BACKGROUND

- **"PROOF OF CAPABILITY" DEMONSTRATION TO EVALUATE BENEFITS OF AUTOMATION**
 - **PRODUCTIVITY OF MISSION OPERATIONS REAL-TIME ANALYSIS**
 - **SAFETY OF SPACECRAFT**
 - **RELIABILITY OF GROUND DATA SYSTEMS**

- **METHODOLOGY: ITERATIVE PROTOTYPING AND SPIRAL MODEL SOFTWARE DEVELOPMENT**

- **FIRST APPLICATION: VOYAGER TELECOMMUNICATIONS**



SHARP PROGRESS

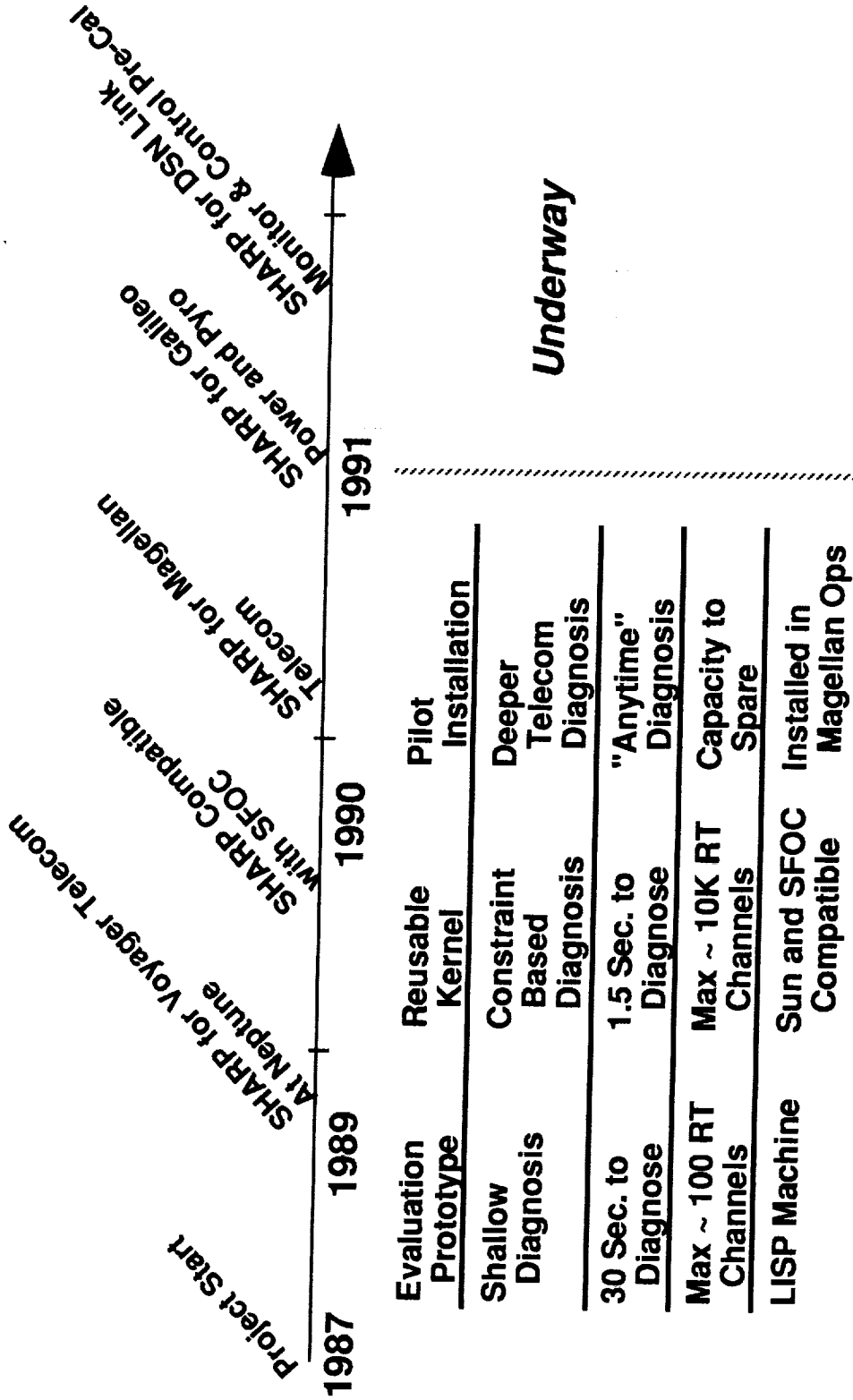



TELECOMMUNICATIONS OPERATIONS

- TELECOMMUNICATIONS LINK ANALYSIS:
 - MONITORING THE HEALTH AND STATUS OF THE TELECOMMUNICATIONS LINK BETWEEN THE SPACECRAFT, DEEP SPACE NETWORK, AND GROUND DATA SYSTEM COMPUTERS AT JPL

- MAJOR FUNCTIONS:
 - NUMERICAL ESTIMATION OF SYSTEM PERFORMANCE
 - MONITORING OF REAL-TIME ACTIVITY AND DETECTION OF FAILURES
 - DIAGNOSIS, ISOLATION, AND RECOVERY FROM FAILURES



TELECOMMUNICATIONS OPERATIONS

- **CHARACTERISTICS:**
 - **MANUAL CALCULATIONS TO UPDATE & REVISE NUMERICAL PREDICTS**
 - **FREQUENTLY CHANGING HARDCOPY SEQUENCE OF EVENTS INFORMATION**
 - **MANUAL, LABORIOUS DETERMINATION OF ALARM LIMITS**
 - **VERY LIMITED COMPUTER DISPLAYS OF STATUS INFORMATION**
 - **ALL ALARM SITUATIONS ARE REFERRED TO EXPERT**
 - **TELECOM IS SUBJECT TO NUMEROUS ALARMS DAILY**

SHARP DESCRIPTION

- **FUNCTIONAL CAPABILITIES**
 - **MONITORING**
 - **DIAGNOSIS AND RECOVERY**
 - **DISPLAY AND USER INTERFACE**
 - **OTHER**

- **TECHNOLOGY**
 - **ROLE OF ARTIFICIAL INTELLIGENCE**
 - **EXAMPLE: ANOMALY DETECTION AND DIAGNOSIS**

- **APPLICATIONS PERFORMANCE**

FUNCTIONAL CAPABILITIES

- **FUNCTION OF THE SYSTEM: PROVIDE COMPUTER WORKSTATION SUPPORT FOR REAL-TIME SPACECRAFT SUBSYSTEM ANALYSTS**

- **CAPABILITIES INCLUDE:**
 - **REAL-TIME ANOMALY DETECTION, ANALYSIS AND DIAGNOSIS**

 - **DISPLAY MANAGEMENT, DATA VISUALIZATION AND SYSTEM STATUS**

 - **ACQUISITION AND CENTRALIZATION OF ENGINEERING DATA FOR ANALYSIS**

 - **INTEGRATION OF AI-BASED MONITORING AND DIAGNOSIS FUNCTIONS WITH CONVENTIONAL NUMERICAL ANALYSIS SOFTWARE**



MONITORING

- CHANNELIZED DATA ON SERIAL OR NETWORK CONNECTIONS
- REAL-TIME PERFORMANCE WITH UP TO 10,000 CHANNELS EACH UPDATING 1/SEC
- AUTOMATED, CONTEXT SENSITIVE, ALARM LIMIT SELECTION
- DYNAMIC, DERIVED CHANNEL MONITORING
- EVENT SIGNATURE AND TREND MONITORING

JPL DISPLAY AND USER INTERFACE

- **SYSTEM STATUS DISPLAYS FROM MULTIPLE DATA SOURCES**
 - **REAL-TIME STATUS**
 - **PERFORMANCE OVER TIME**
- **GRAPHICAL VISUALIZATION AND DATA PLOTTING**
- **MIXED-INITIATIVE -- SYSTEM AND USER BOTH CONTROL THE DISPLAY**
 - **DISPLAY MANAGEMENT USING CONTEXT SENSITIVE MODELING OF FORMAT, CONTENT, SOURCE, AND RATIONALE**
- **DYNAMICALLY GENERATED USER HELP AND INPUT ERROR TOLERANCE**

OTHER CAPABILITIES

- **REAL TIME DATA CACHE AND ON-LINE HISTORICAL DATABASE**
- **EDITABLE ALARM PARAMETER AND EVENT DATABASES**
- **MONITORING AND DIAGNOSTIC CAPABILITIES EASILY INTEGRATED WITH CONVENTIONAL ANALYSIS ROUTINES (E.G., FAST FOURIER TRANSFORM)**
- **INTEGRATED WITH SPACE FLIGHT OPERATIONS CENTER (SFOC) DATA SERVICES**

ROLE OF AI

- **ARTIFICIAL INTELLIGENCE USED THROUGHOUT SHARP**
- **EXAMPLES:**
 - ARCHITECTURE: MULTI-PROCESS BLACKBOARD WITH OPPORTUNISTIC, DATA-DRIVEN CONTROL STRUCTURE**
 - DATA HANDLING: HEURISTIC ADAPTIVE PARSING, TEMPORAL REASONING DECLARATIVE DATA REPRESENTATIONS**
 - MONITORING: STATE MODELLING, DISCRIMINATION NETWORKS, TRUTH MAINTENANCE**
 - DIAGNOSIS: HIERARCHICAL COMMUNICATING EXPERTS, REASONING IN MULTIPLE CONTEXTS**
 - USER INTERFACE: RULE-BASED EXPERT SYSTEM TO MANAGE DISPLAYS, RULE-BASED DIAGNOSIS AND RECOVERY FROM INPUT ERRORS**



ANOMALY DETECTION & DIAGNOSIS

- **HIERARCHICAL SYSTEM BASED ON CLASSIFICATION PROCESS**
- **ALARM EXECUTIVE DETERMINES EXISTENCE OF ANOMALY BY COMPARING EXPECTED AND ACTUAL SPACECRAFT STATES**
 - **USE OF COMPILED DISCRIMINATION NETWORK TECHNIQUES**
 - **SOME FAILURES ARE UNIQUELY DETERMINED AT THIS STAGE**
- **FAULT CLASSIFICATION SUBSYSTEM**
 - **MAKES INITIAL CHARACTERIZATION OF THE PROBLEM**
 - **IDENTIFIES RELEVANT SOURCES OF DATA FOR USE IN DIAGNOSIS**
 - **APPROX. 60 RULES FOR VOYAGER TELECOM APPLICATION**
 - **POSTS INITIAL HYPOTHESES, DATA VALUES, SPACECRAFT STATE, OTHER INFO TO DIAGNOSTIC DATABASE**

ANOMALY DETECTION & DIAGNOSIS

- **SPECIALIZED "MINI-EXPERTS" FOR FAULT CLASSES**
 - **TRIGGERED BY FAULT HYPOTHESES TO REACH DETAILED DIAGNOSIS AND RECOVERY RECOMMENDATIONS**
 - **PURSUE INDIVIDUAL CLASSES OF FAULTS (E.G., CONFIGURATION ERRORS) USING SPECIALIZED KNOWLEDGE IN THE FORM OF PROCEDURAL NETWORKS**
 - **OPERATE INDEPENDENTLY IN INDIVIDUAL CONTEXT TREES**

- **BLACKBOARD USED TO COMMUNICATE AND SHARE RESULTS**

- **HYPOTHESIS COMBINATION SUBSYSTEM**
 - **GROUPS RELATED CONCLUSIONS AND RECOMMENDATIONS TO OPERATOR, LOGS DATA, AND SIGNALS MODIFICATIONS TO OPERATOR'S DISPLAYS**



APPLICATIONS PERFORMANCE

- **ANOMALY DETECTION AND DIAGNOSIS**
 - ABLE TO ANALYZE 39 CLASSES OF TELECOM PROBLEMS
 - 60 UNIQUE PROBLEM SOLVING DIAGNOSES
 - 20 ADDITIONAL DETECTABLE PROBLEMS
 - ABOUT 15 PROBLEMS ARE NOT COVERED
 - TOTAL FAULT COVERAGE IS ABOUT 80% AND IMPROVING AS KNOWLEDGE BASES ARE EXTENDED

- **CONSCAN (ANTENNA POINTING) ERRORS DETECTED AND TRACKED BY SHARP UNTIL RESOLVED BY DSS OPERATORS**

- **(NON-CRITICAL) ANOMALIES DIAGNOSED BY SHARP**
 - OPERATORS MANUALLY VERIFY THE DIAGNOSES
 - RCV AGC, S-BAND TWT BASE TEMP OCCURRED DURING VOYAGER ENCOUNTER



VOYAGER ENCOUNTER SURPRISING EVENT

- **RESOLVED VOYAGER SCIENCE DATA ERROR COMPLAINT PRIOR TO THE ENCOUNTER, AVOIDING A POTENTIAL CRITICAL SITUATION**
 - SCIENCE PERSONNEL SAID CORRECTION COUNT WAS TOO HIGH
 - SHARP DETECTED AND REPORTED A POSSIBLE EXCESSIVE NOISE PROBLEM
- **TELECOM PERSONNEL USED SHARP SCATTER PLOT OF BIT ERROR RATE VERSUS SYMBOL SIGNAL TO NOISE RATIO**
 - CONFIRMED AN ANOMALOUS CONDITION WHICH WAS CORRUPTING THE SCIENCE DATA AT HIGH SSNR'S WHERE NO ERRORS ARE EXPECTED
 - DEFINED MAGNITUDE OF PROBLEM
 - PROVIDED ABILITY TO SHOW NO CORRELATION OF ERRORS WITH DSN STATIONS
- **FURTHER INVESTIGATION TRACED PROBLEM TO A FAILED WIDE-BAND INTERFACE UNIT IN VGR DACS**
 - SHARP USED TO CONFIRM PROBLEM RESOLUTION AFTER THE FAILED UNIT WAS REPLACED



DSN EXTENSIBLE GROUND ANALYSIS SYSTEM

- **BACKGROUND**
 - PLANNED FOR THE DSN'S NETWORK OPERATIONS CONTROL CENTER, WHICH MONITORS QUALITY OF NETWORK DATA AND STATUS OF ALL DSN SYSTEMS
- **DSN EXTENSIBLE GROUND ANALYSIS SYSTEM (DEGAS)**
 - SHARP-BASED ENHANCEMENT TO THE NOCC OPERATOR WORKSTATION
- **KEY CHARACTERISTICS**
 - VISUALIZATION OF CENTRAL NETWORK STATUS
 - RAPID ANOMALY DETECTION, DIAGNOSIS, AND RECOVERY.
 - EXTENSIBLE WITH EXTERNALLY DEVELOPED ANALYSIS MODULES.
- **BENEFITS EXPECTED BY DSN**
 - REDUCTION OF LARGE AMOUNTS OF DATA FOR PRESENTATION TO NOCT
 - ENABLE TIME-CRITICAL RESPONSE TO ANOMALIES
 - ASSIST IN OFF-LINE DIAGNOSIS, CALIBRATION, AND SYSTEM READINESS



DSN LINK MONITOR AND CONTROL OPERATOR ASSISTANT

- **BACKGROUND**
 - LMC OPERATORS AT DSN STATIONS CONFIGURE, CALIBRATE, AND CONTROL THE STATIONS ANTENNAS AND SUBSYSTEMS TO TRACK SPACECRAFT.
 - "PRE-CAL" OPERATIONS TAKE 45 MINUTES TO 4 HOURS TO COMPLETE

- **LMC OPERATOR ASSISTANT**
 - GOAL OF 30% REDUCTION IN TIME SPENT DURING PRE-CAL OPERATIONS
 - AUTOMATIC "DUAL CONTROL MODE", WHERE SINGLE OPERATOR CONFIGURES AND SYNCHRONIZES MULTIPLE ANTENNAS AND SUBSYSTEMS
 - AUTOMATIC PRE-CAL DIRECTIVE PLANNING AND PARAMETER SELECTION TO SHOW FEASIBILITY OF AUTOMATED CONTROL OF DSN STATION WITH OPERATOR ACKNOWLEDGEMENT.
 - => BUT NO REAL DIRECTIVES FROM PROTOTYPE TO ACTUAL DSN SUBSYSTEMS
 - LAB DEMO IN 1991 FOLLOWED BY INSTALLATION AT GOLDSTONE DSS-13 FACILITY IN 1992



CONCLUSIONS

- BENEFITS PROJECTED BY TELECOMMUNICATIONS USERS
- LESSONS LEARNED
- CONCLUSION



BENEFITS PROJECTED BY TELECOM USERS

- **WORKFORCE SAVINGS**
ULTIMATE REDUCTION IN REAL TIME LINK ANALYSIS STAFF BY A FACTOR OF FIVE. SIMILAR SAVINGS MAY BE POSSIBLE IN OTHER AREAS.
- **SAFETY**
REAL-TIME SYSTEM CAN DETECT AND ANALYZE PROBLEMS IN SECONDS THAT TAKE HUMANS HOURS, E.G., ANTENNA POINTING ERRORS
- **RELIABILITY**
SYSTEM WIDE STATUS MONITORING HELPS ASSURE CORRECT SYSTEM CONFIGURATION, REDUCES COMMANDING ERRORS, AND REDUCES LOSS OF DATA
- **PRODUCTIVITY**
REDUCED NUMBER OF OPERATIONS PERSONNEL CAN MONITOR A GREATER NUMBER OF SYSTEMS AND PERFORM REQUIRED ANALYSES MORE EFFICIENTLY

LESSONS LEARNED

- **ENTHUSIASTIC PARTICIPATION OF END-USERS AND EXPERTS IS REQUIRED.**
 - ENSURES ACCESS TO DOMAIN KNOWLEDGE AND FUTURE OPERABILITY.
 - PROVING "VALUE-ADDED" BY AUTOMATION IS DIFFICULT FOR TECHNOLOGISTS.
- **PRACTICAL AUTOMATION USING AI REQUIRES EVOLUTION AND INTEGRATION WITH EXISTING SYSTEMS.**
 - CONSTRAINTS OF EXISTING SYSTEMS LIMIT THE SCOPE OF THE AI APPLICATION.
- **AI CANNOT BE APPLIED INDEPENDENTLY FROM OTHER TECHNOLOGIES (E.G., NETWORKING, GRAPHICS)**
 - GOOD SYSTEM ENGINEERING IS WHAT MAKES A KNOWLEDGE SYSTEM.
- **MAKE PRAGMATIC SELECTION OF MATURE AI TECHNIQUES**
 - SUFFICIENT TOOLS ARE AVAILABLE BUT SKILLED DEVELOPERS ARE REQUIRED

CONCLUSIONS

- ARTIFICIAL INTELLIGENCE HAS A PROVEN CAPABILITY TO DELIVER USEFUL FUNCTIONS IN A REAL-TIME SPACE FLIGHT OPERATIONS ENVIRONMENT
- SHARP HAS PRECIPITATED MAJOR CHANGE IN ACCEPTANCE OF AUTOMATION AT JPL -- AI IS HERE TO STAY
- POTENTIAL PAYOFF FROM AUTOMATION USING AI IS SUBSTANTIAL
- SHARP, AND OTHER ARTIFICIAL INTELLIGENCE TECHNOLOGY IS BEING TRANSFERRED INTO SYSTEMS IN DEVELOPMENT
 - MISSION OPERATIONS AUTOMATION
 - SCIENCE DATA SYSTEMS
 - INFRASTRUCTURE APPLICATIONS

INITIALLY

Planning Systems for Pioneer Mission Control

Marcie Smith
NASA/Ames Research Center
Control Center Technology Conference
June 18, 1991

511-14
39613

N92-12021^{p. 17.}

NC477057

PRECEDING PAGE BLANK NOT FILMED

Introduction

Description of Pioneer Missions

Pioneer Flight Operations

Planning Procedures

Operation of Spacecraft Past Original Design Scope

Pioneer Venus Orbiter Expert System

Planning Future Long-term Missions

Description of Pioneer 10/11 Mission

Flight Profile

Launch

Pioneer 10 3/2/72

Pioneer 11 4/5/73

Firsts

Through asteroid belt

Jupiter: Pioneer 10: 12/72; Pioneer 11: 12/74

Saturn: Pioneer 11: 9/79

Exit solar system Pioneer 10: 6/83 (hyperbolic escape ~2.5 AU/yr)

Science Objectives

11 instruments (8 still operating) + radio science

Planetary Environment at Jupiter, Saturn

Interplanetary Environment

Pioneer 10/11 Trajectories

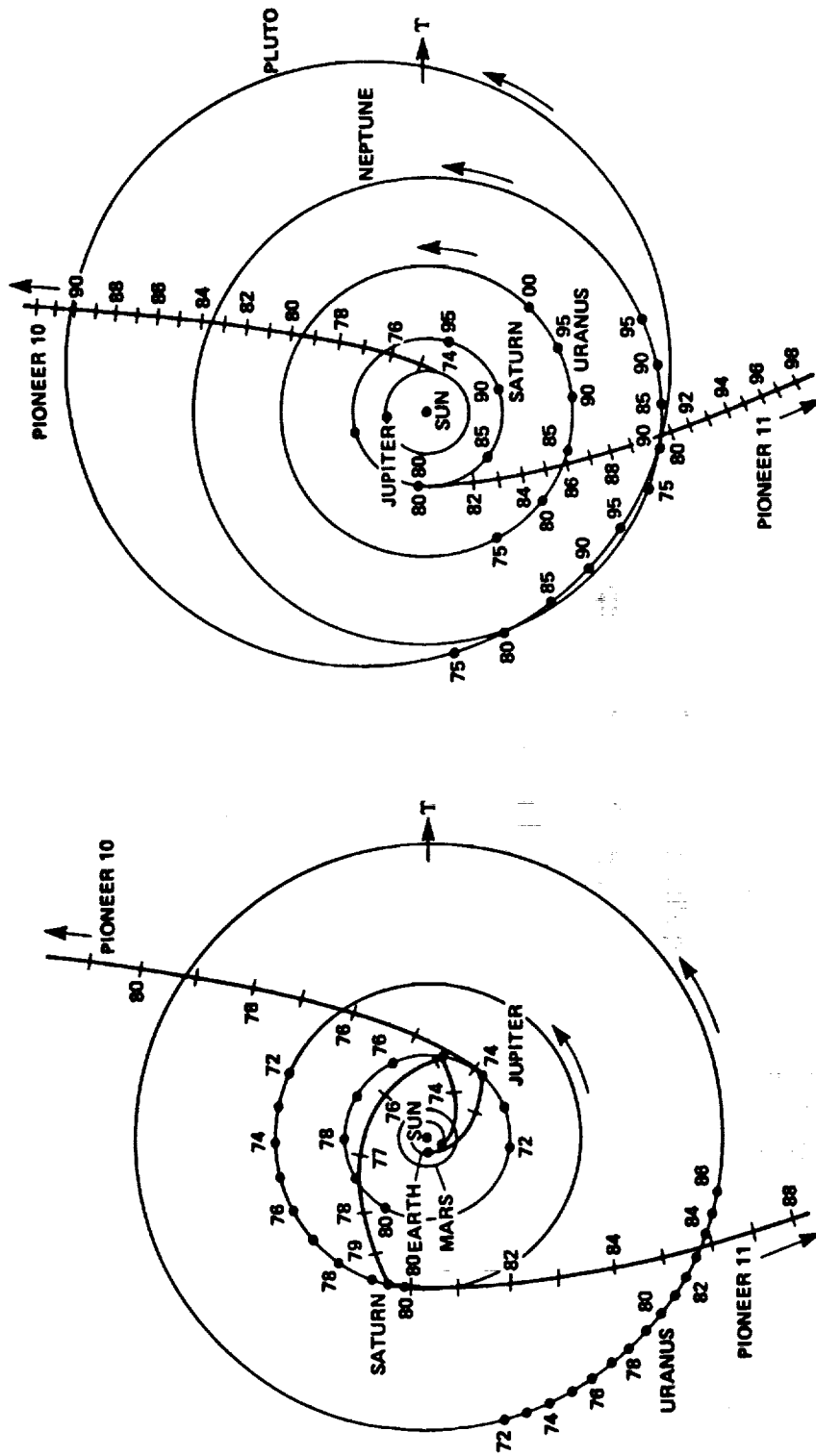

Pioneer 10/11 Spacecraft

Built by TRW

570 lb (260 kg)

9 ft diameter High Gain Antenna (HGA) dish x 4 ft tall

Attitude control

Spin stabilized - spin axis is HGA axis

Sun/Star sensors for roll reference

Hydrazine propellant / thrusters

Power

4 RTG's 160 W BOL

Communications

8 W transmitter [RTL = 9 hrs; 14.5 hrs]

SBand - 1° pointing

Main feed offset for attitude determination

Medium gain backup antenna

Command

22 sec/command uplink rate

Storage for 5 commands and time delays

Telemetry

Telemetry rate @ Jupiter = 1024 bps; @ Saturn = 512 bps; currently 16 bps (minimum)

4 Science formats, 4 Engineering formats

Real-time operations only (storage of only 49kbits)

Safety features

Timer to switch receivers if no uplink in 36 hours

Undervoltage trip

Redundancy and cross strapping

Pioneer 10/11 Spacecraft

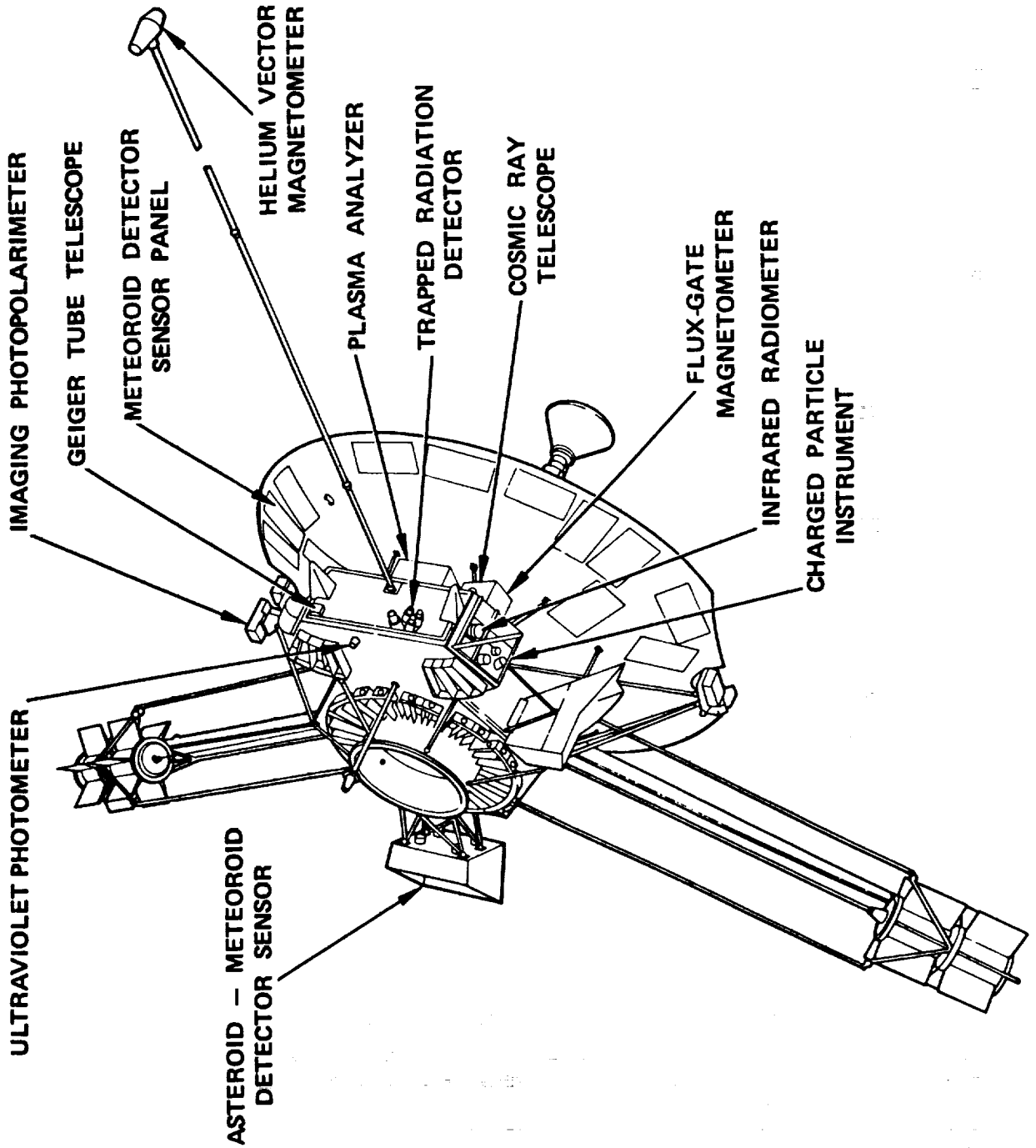

Description of Pioneer Venus Mission

Flight Profile

- Launch 5/20/78, Arrival 12/4/78
- Orbit about Venus
 - Elliptical orbit with 24 hr period
 - 105° inclination
 - Latitude of periapsis near Equator
 - Periapsis skimming atmosphere
- Changing geometry of Earth and Venus
 - RTL ranges from 5 to 25 minutes
 - Synodic period = 584 days
- Changes of orbit with time
 - Altitude of periapsis up to ~1800 km, then back to 150
 - Latitude of periapsis down from 18°N to 10°S

Science Objectives

- 12 science instruments (10 still operating)
- Venus Atmospheric data
- Solar wind data

Pioneer Venus Orbit 4575

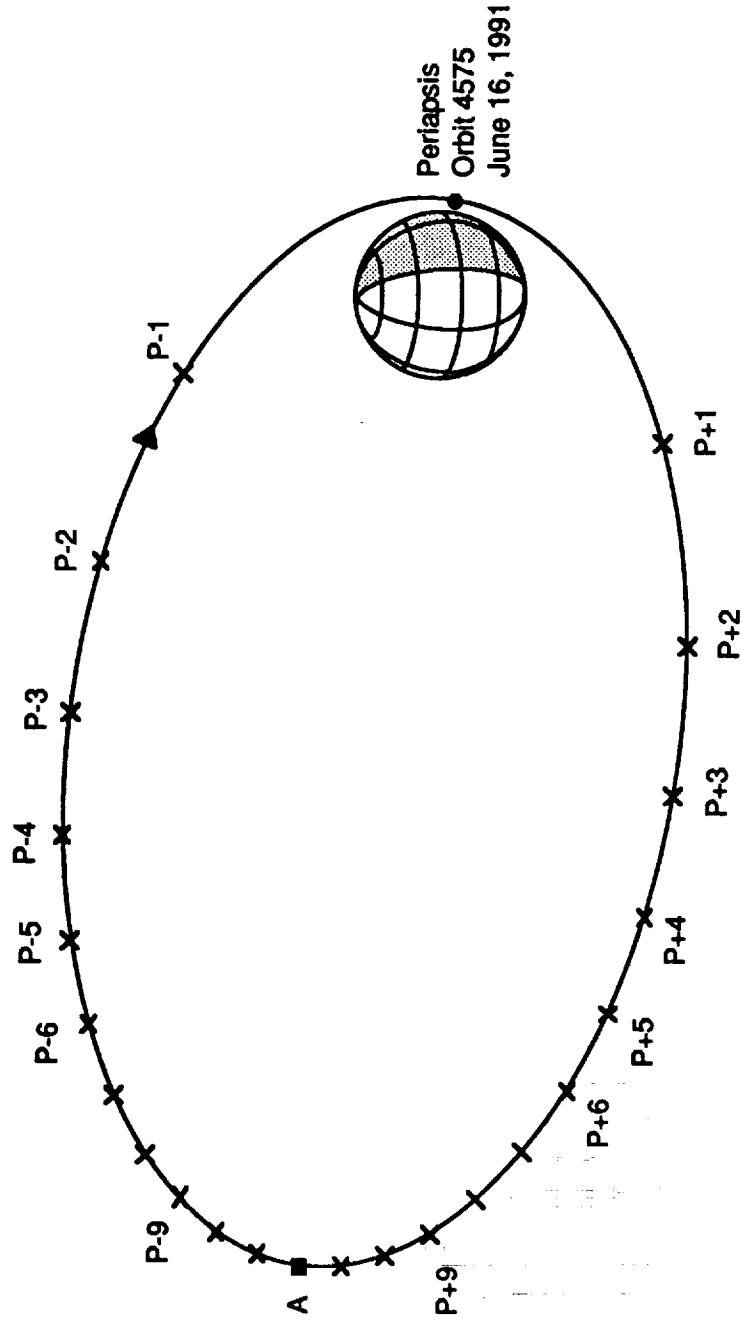

DENOTES OFFR SIDE

PVO Spacecraft

Built by Hughes Aircraft Company

590 kg (225 kg propellant for orbit insertion)

2.5 m diameter

Attitude Control

spin stabilized

sun/star sensor for roll information

hydrazine propellant / thrusters

solar panels perpendicular to sun

attitude position measured using sun/star sensors

Communications

Despun HGA (1.09 m diameter)

10/20 W transmitter

S-Band (3° pointing) (Xband for science)

Backup HGA, omni's

Command

12 sec/command uplink rate

SCL -256 commands or time delays (8 commands/s execution rate)

Data

Telemetry rates 8 bps to 4096 bps

DSU (524Kbits(x2))

8 science formats; 5 engineering formats

"Safety" features

Timer to switch receivers if no commands in 36 hours

Undervoltage/Overload trip

Redundancy and cross strapping

Pioneer Venus Orbiter

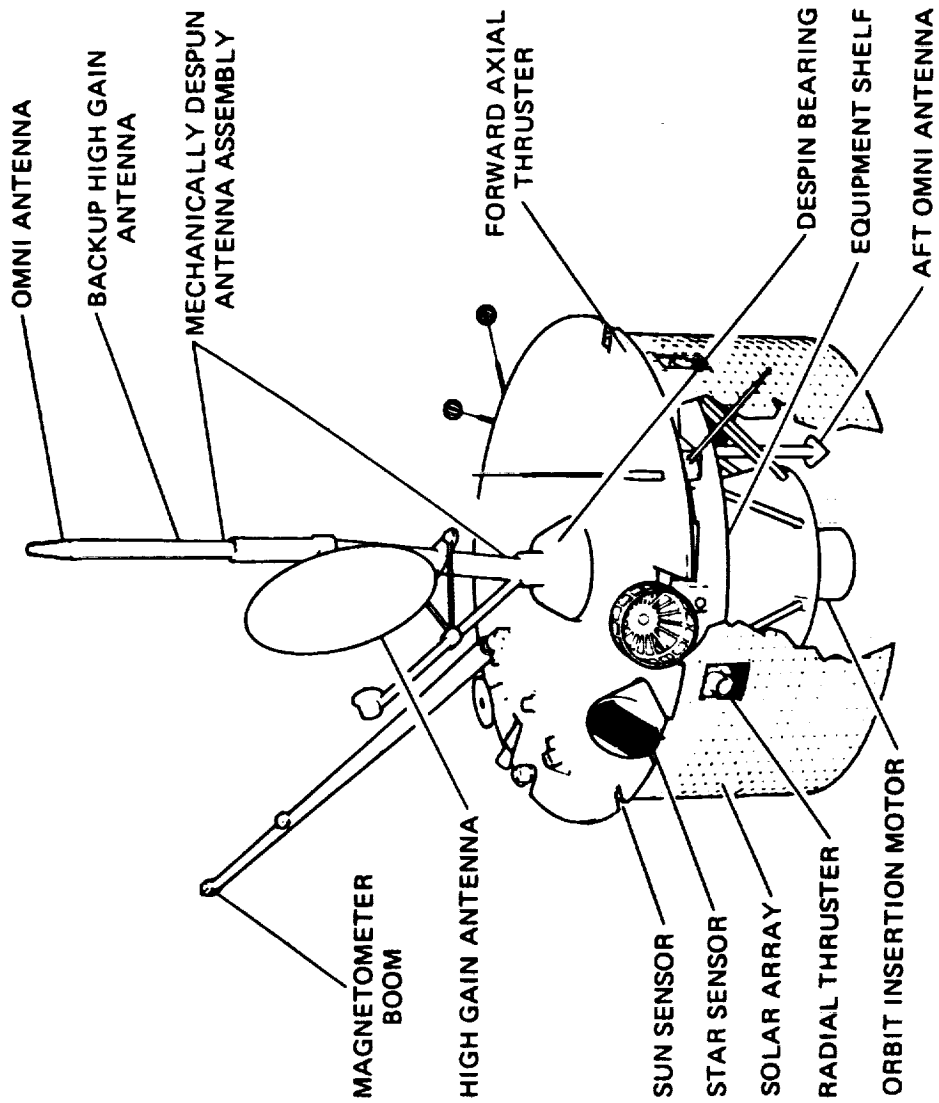

Flight operations

Staffing / Organization
Project Operations and Management at Ames Research Center (ARC)
NASA (6)
BFEC (42)
Operational Support at Jet Propulsion Laboratory (JPL)
DSN Scheduling
Orbit Determination
DSN Operations
Pointing Predicts
Frequency Predicts

ARC Functions
Commanding
Telemetry monitoring
Data processing and archiving
Software and hardware maintenance
Engineering Analysis
Power balancing
Communications maintenance
Maneuvers - trajectory/orbit corrections, reorientations, spin trims
Eclipses/Occultations
PVO Comet Observations

Planning Procedures

- No spacecraft simulation
- Real-time operations
 - Pioneer 10/11 - no data or command storage
 - Continual downlink
 - Procedures scheduled when round-trip tracking is available
- Pioneer Venus Orbiter
 - Commands files prepared for each 24 hour orbit
 - SCL used for periapsis commands and power balancing during tracking gaps
 - Data storage limited - periapsis priority
 - Responsive to last minute changes
 - Vulnerable to DSN problems
- Command file generation
 - Existing command files modified as necessary
 - New procedures developed referencing spacecraft manuals
- Error checking
 - Checked by hand by other engineers
 - Hexes checked as valid by command system
 - Passwords required to command critical functions
- Depend on individuals with project experience
- Depend on spacecraft simplicity and redundancy

Pioneer Venus Orbit Planning

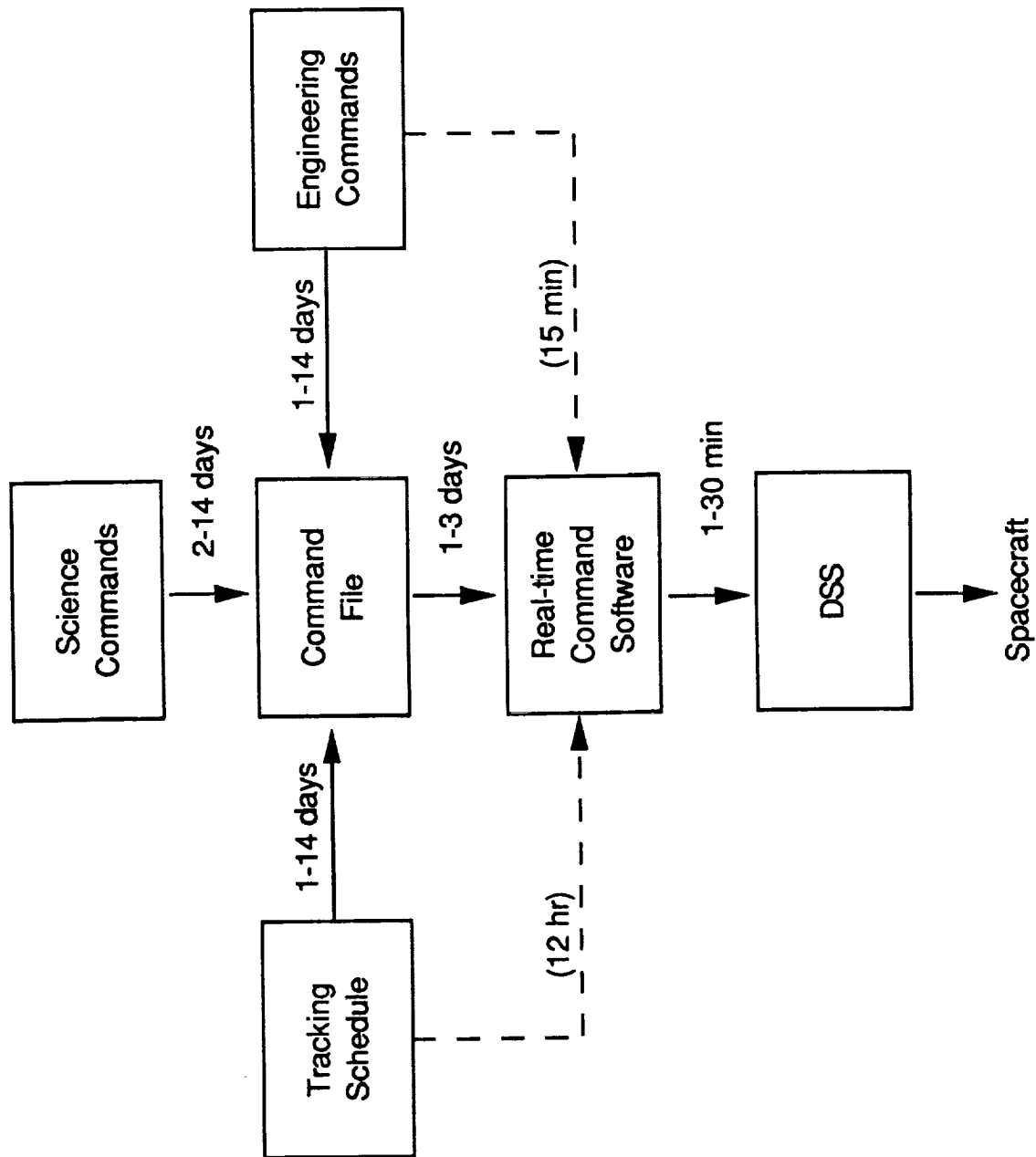

Operation of Spacecraft past nominal mission

- Change in spacecraft operation with time
 - Power degradations
 - Hardware failures
 - Redundant systems
 - Pioneer 11 antenna switch
 - Pioneer 10 star sensor
 - Pioneer 11 spin down thruster
 - Instrument failures
- Operation outside original mission envelope
 - Pioneer 10 sun sensor
 - Extensive use of battery on Pioneer Venus Orbiter
- Changes to DSN
 - Mark IV interface changes
 - 64 m -> 70 m DSS; new DSN receivers
 - Loss of 26 m DSS
 - Dual tracking with Magellan
- ARC operational changes
 - Hardware changes
 - Improved computers
 - Software changes
 - Command checking
 - Collecting engineering data for transfer to VAX
 - PC to verify real-time data
 - Engineering analysis programs as required

Examples of major operational changes

Pioneer 10 loss of roll reference

- Sun sensor out of range; star sensor failed at Jupiter
- Use IPP to measure star angle 1/wk
- IPP data processed off line by engineers
- Attitude determination data must be reprocessed
- Precession maneuvers — time to fire pulses timed to arrive at correct roll angle

Pioneer 11 attitude determination

- Loss of receiver on HGA; failure of antenna switch
- Range too great to use medium gain antenna for attitude determination
- Developing procedures for IPP, downlink AGC

Pioneer Venus Halley observations

- Fortuitous viewing of Halley by Venus in 1986
- UltraViolet Spectrometer (UVS) instrument fixed cone angle about spin axis
- Reorientation maneuvers required every day to keep comet in UVS FOV

PVO Expert System

Developed by ARC/Information Sciences Office

Addressed normal operational planning for PVO only

VAX 8600 / VMS / OPS5

Design goal -- collect and organize all inputs to PVO orbit command file program

Problems

- Couldn't keep up with changing environment - rules changed too fast

- Interface problems between Operations personnel and programming staff

 - Required "high-level" rather than "low-level" man-hours

 - Programmers often worked without Project input

 - Not "user-friendly" or robust in preliminary stages

 - Never developed to the point of making real decisions, only made deterministic calculations

 - Scaled down to "uninteresting" problem; never became user-driven

Planning future, long-term missions

Documentation!!

- Spacecraft manual

- Operations record

- Engineering data archiving

 - With future complex missions, on-line data base driven by expert system will be required

Maintaining knowledgeable staff

Planning systems

- Evolutionary system required

 - Impossible to anticipate future operating scenarios

 - Allows upgrade to new systems as available

 - Expert system decision-making software must become a "tool" for the operations personnel

REDACTED INTENTIONALLY BLANK

JPL

**AUTOMATION FOR DEEP SPACE
VEHICLE MONITORING**

URSULA M. SCHWUTTKE

**FLIGHT COMMAND AND DATA MANAGEMENT SYSTEMS SECTION
JET PROPULSION LABORATORY**

JUNE 19, 1991

JJ574450

P-20

512-14
N92-120224

UMSx 06/19/91
Pg.1

C-5 381

PRECEDING PAGE BLANK NOT FILMED



AUTOMATION GOALS

- **SIGNIFICANT IMPROVEMENT IN PRODUCTIVITY AND RELIABILITY**
- **APPLICATION OF ARTIFICIAL INTELLIGENCE METHODS TO GROUND-BASED MONITORING**
- **ADVANCEMENT OF ARTIFICIAL INTELLIGENCE TECHNOLOGY**



AUTOMATION STRATEGY

- **ACTIVE INVOLVEMENT OF THE END USER**
- **INCREMENTAL DEVELOPMENT WITH REGULAR DELIVERIES TO THE END USER**
- **EMPHASIS ON USABLE, REAL-WORLD PRODUCTS RATHER THAN PROTOTYPE DEMONSTRATIONS**



RESEARCH & DEVELOPMENT ACTIVITIES

- **AUTOMATED MISSION MONITORING AND ANALYSIS**
- **INTELLIGENT INPUT DATA MANAGEMENT**
- **SYSTEM-LEVEL ANALYSIS USING COOPERATING EXPERT SYSTEMS**



AUTOMATED MISSION MONITORING AND ANALYSIS

- **REAL-TIME MONITORING OF SPACECRAFT AND TELEMETRY**
- **KNOWLEDGE-BASED ANOMALY ANALYSIS**
- **COMBINATION OF CONVENTIONAL AUTOMATION AND ARTIFICIAL INTELLIGENCE**
- **MULTI-MISSION APPLICABILITY**
- **TWO-YEAR HISTORY OF CONTINUOUS ON-LINE OPERATION**

JPL

MONITOR/
ANALYZER OF
REAL-TIME
VOYAGER
ENGINEERING
LINK

JPL

MARVEL

- **FUNCTIONS**
 - **REAL-TIME MONITORING**
 - **REAL-TIME KNOWLEDGE-BASED ANALYSIS**
 - **GENERAL PRODUCTIVITY ENHANCEMENT**
- **FEATURES**
 - **DATA DISPLAY AND ARCHIVING**
 - **AUTOMATED ALARM MESSAGES**
 - **HIERARCHICAL ORGANIZATION**
 - **WINDOW ENVIRONMENT**
 - **MOUSE- AND MENU-DRIVEN OPERATION**
 - **ON-LINE USER DOCUMENTATION**

IMPLEMENTATION

- **DISTRIBUTED MULTI-WORKSTATION ENVIRONMENT**
 - **MESSAGE PASSING FOR INTERPROCESS COMMUNICATION**
 - **VARIABLE NUMBER OF NODES**
- **MULTIPLE C PROCESSES PROVIDE STANDARD AUTOMATION**
 - **PROCEDURAL AND ALGORITHMIC FUNCTIONS**
 - **USER-INTERFACE FUNCTIONS**
 - **REAL-TIME SPEED AND PORTABILITY**
- **EMBEDDED KNOWLEDGE BASES PROVIDE EXPERT REASONING**
 - **ANOMALY ANALYSIS**
 - **CORRECTIVE ACTION RECOMMENDATIONS**
 - **COMPATIBILITY WITH C**
- **GOAL- AND DATA-DRIVEN REASONING ARE COMBINED IN KNOWLEDGE-BASED ANALYSIS MODULES**
- **LOWER-LEVEL C ALGORITHMS PROVIDE CALCULATIONS NEEDED BY THE KNOWLEDGE BASES**



MARVEL

ACHIEVEMENTS

- SIMULTANEOUS AUTOMATED MONITORING OF THREE VOYAGER SUBSYSTEMS
 - COMPUTER COMMAND SUBSYSTEM
 - FLIGHT DATA SUBSYSTEM
 - ATTITUDE AND ARTICULATION CONTROL SUBSYSTEM
- KNOWLEDGE-BASED ANOMALY ANALYSIS AND CORRECTIVE RECOMMENDATIONS FOR TWO VOYAGER SUBSYSTEMS
 - COMPUTER COMMAND SUBSYSTEM
 - ATTITUDE AND ARTICULATION CONTROL SUBSYSTEM
- CONTINUOUS ON-LINE OPERATION FOR BOTH VOYAGER SPACECRAFT SINCE AUGUST 1989
- SUCCESSFUL DETECTION OF ALL ANOMALIES
 - IMPROVED ACCURACY
 - IMPROVED TIMELINESS
- SMOOTH TRANSITION FOR POST-ENCOUNTER WORKFORCE REDUCTIONS AND CROSS-TRAINING OF PERSONNEL
- TRANSITION TO TOPEX, GALILEO, AND CRAFT/CASSINI



INTELLIGENT INPUT DATA MANAGEMENT

- **MANAGEMENT OF INPUT DATA VOLUMES THAT EXCEED PROCESSING CAPACITY**
- **COMBINATION OF DECISION THEORY AND KNOWLEDGE-BASED METHODS**
- **AUTOMATION OF AN IMPORTANT REAL-TIME TRADE-OFF BETWEEN**

AMOUNT OF INPUT PROCESSED

VS

TIMELINESS OF OUTPUT



DECISION THEORY FOR MAKING TRADE-OFFS

- UTILITY THEORY AND PROBABILITY ARE USED TO SELECT THE MAXIMUM-VALUE ACTION FROM A SET OF POSSIBLE ACTIONS.
- THE VALUE (V) OF AN ACTION (X) IS DETERMINED WITH A SET OF EVALUATION CRITERIA (i = 1 TO n) AND WEIGHTING FACTORS (W)

$$V = \sum_{i=1}^n w_i v_i(x_i)$$

- DECISION THEORY HAS A HISTORY OF SUCCESSFUL APPLICATION TO MAKING TRADE-OFF DECISIONS IN STATIC ENVIRONMENTS.



DYNAMIC TRADE-OFF EVALUATION

- **EXTENDS STATIC TECHNIQUES FOR USE IN REAL-TIME ENVIRONMENTS**
- **USES DOMAIN KNOWLEDGE TO**
 - **DYNAMICALLY RE-WEIGHT THE EVALUATION CRITERIA TO REFLECT THE DYNAMICS OF THE EXTERNAL ENVIRONMENT.**
 - **REDEFINE COURSES OF ACTION AS DICTATED BY THE EXTERNAL ENVIRONMENT.**
- **HAS BEEN APPLIED TO EVALUATING THE TRADE-OFF BETWEEN THE AMOUNT OF INPUT DATA AND THE TIMELINESS OF THE OUTPUT.**

EVALUATION OF ANOMALY DETECTION RESULTS

3% ANOMALY DENSITY

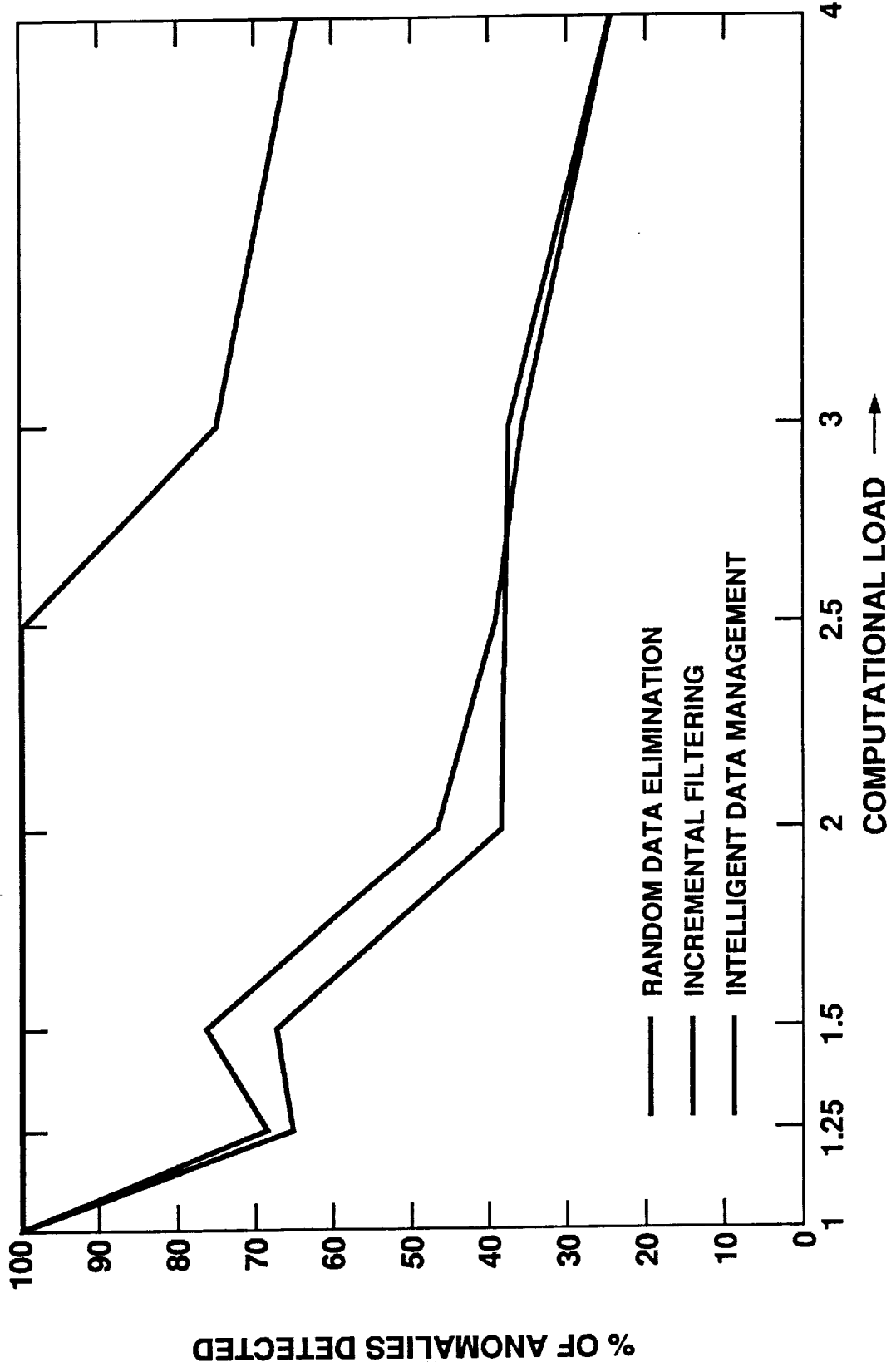

EVALUATION OF DATA MANAGEMENT METHODS

3% ANOMALY DENSITY

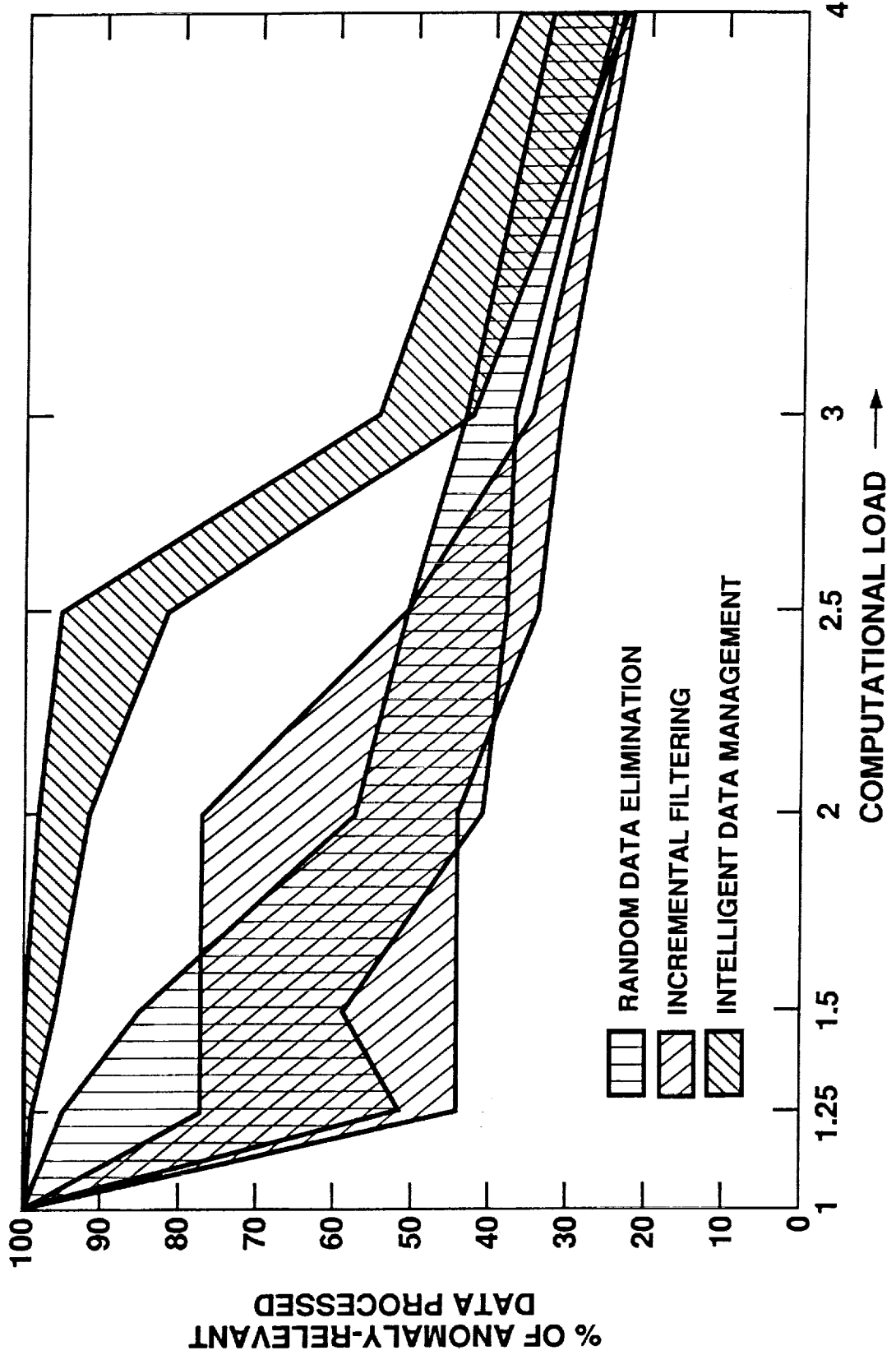

JPL

SYSTEM-LEVEL ANALYSIS WITH COOPERATING EXPERT SYSTEMS

- **CO-ORDINATION OF HIERARCHICAL EXPERT SYSTEMS**
- **COMBINATION OF DISTRIBUTED COMPUTING AND MULTIPLE USER-INTERFACES**



COOPERATING EXPERT SYSTEMS

- EVENT-DRIVEN INFORMATION EXCHANGE
- DEMONS AT SUBSYSTEM LEVEL RESPOND TO SUBSYSTEM ANOMALIES
- DOMAIN KNOWLEDGE AT SUBSYSTEM LEVEL IS USED TO DETERMINE WHICH SUBSYSTEM ANOMALIES HAVE POTENTIAL SYSTEM-LEVEL IMPACT
- SUBSYSTEM DEMONS SEND MESSAGES TO SYSTEM-LEVEL KNOWLEDGE BASE
- SYSTEM-LEVEL DEMONS COORDINATE SYSTEM-LEVEL ANALYSIS

MULTIPLE EXPERT SYSTEMS DISTRIBUTED ARCHITECTURE

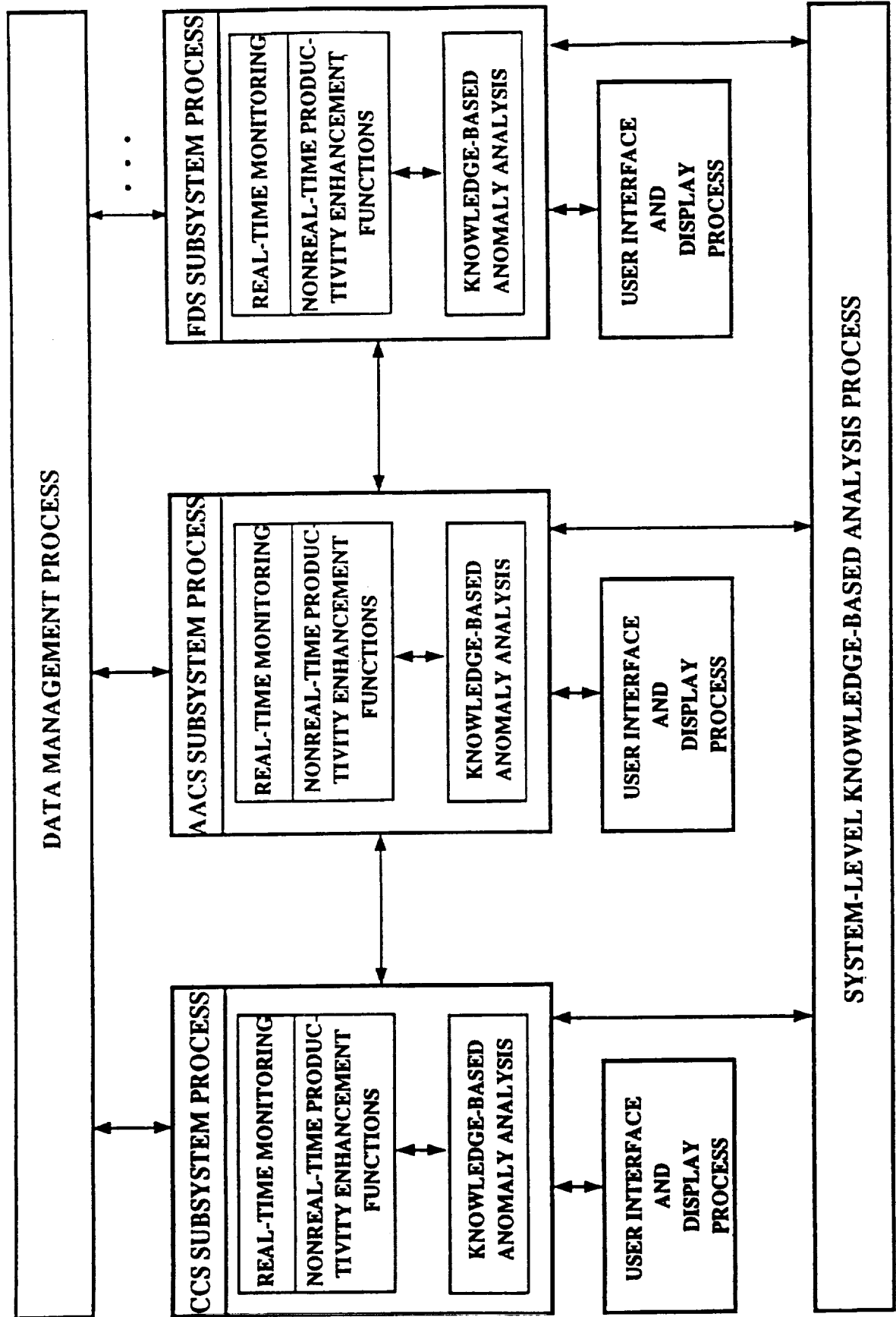



EVENT-DRIVEN RESPONSE

- DEMONS IN THE KNOWLEDGE BASE CONTROL REASONING
 - EVENT-DRIVEN RESPONSE TO ANOMALY CONDITIONS
 - INSTANTIATION OF APPROPRIATE RESPONSE PLANS
- DEMONS ARE ACTIVATED BY THE APPEARANCE OF ANOMALOUS DATA
 - TELEMETRY
 - INFERRED KNOWLEDGE FROM BACKWARD CHAINING
 - OTHER DEMONS
- BACKWARD-CHAINED PRODUCTION RULES PERFORM DIAGNOSIS
 - ANOMALY ANALYSIS
 - RECOMMENDATIONS FOR CORRECTIVE ACTION
- RULES ARE ACTIVATED BY DEMONS

EVENT-DRIVEN RESPONSE

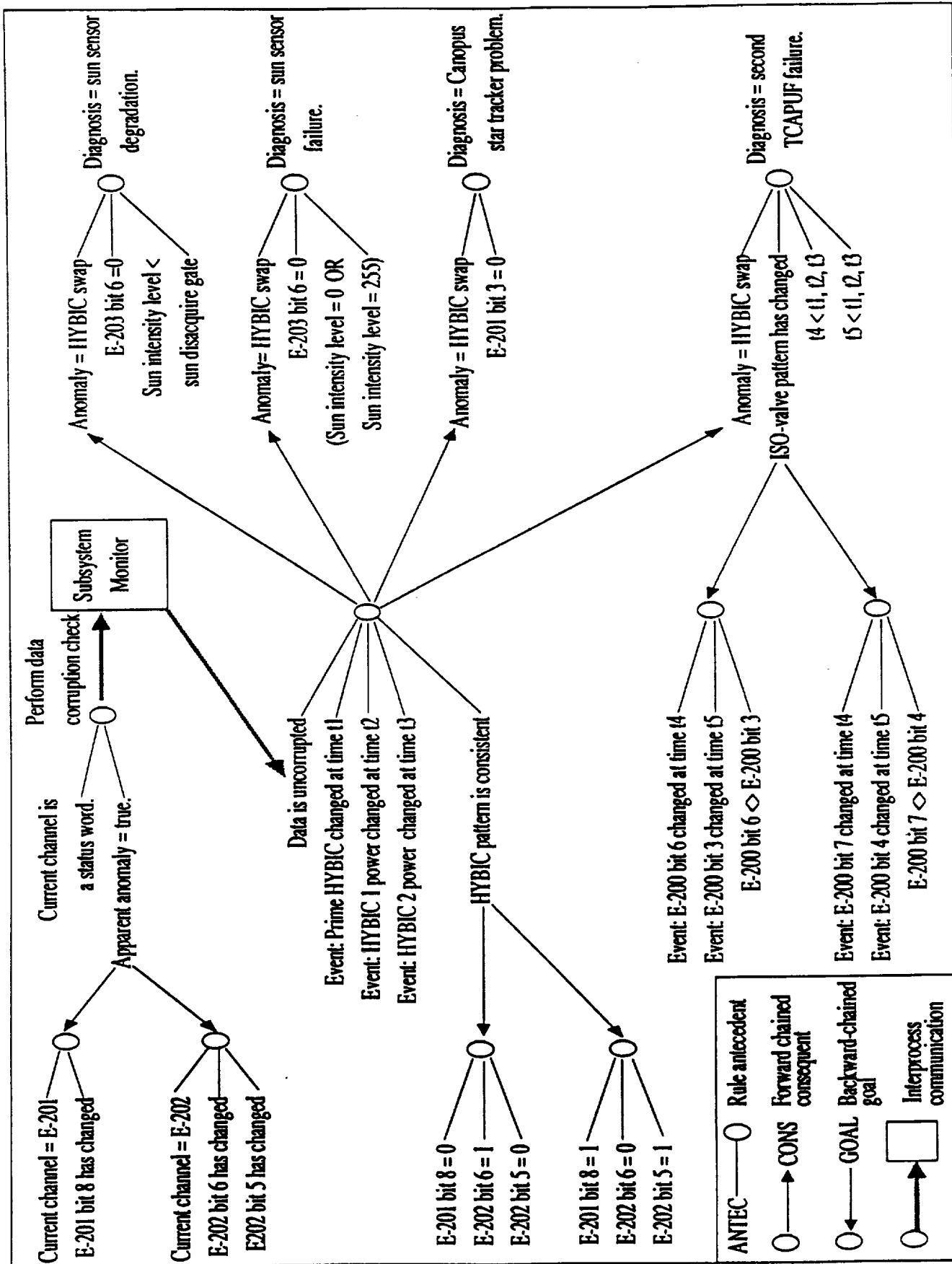



SUMMARY

- REAL-TIME, REAL-WORLD DEMONSTRATION OF SIGNIFICANT ARTIFICIAL INTELLIGENCE CAPABILITIES
 - INTELLIGENT DATA MANAGEMENT
 - EVENT-DRIVEN COORDINATION OF KNOWLEDGE-BASED DIAGNOSTICS
 - APPROPRIATE RESPONSE TO UNCERTAIN DATA
 - MULTIPLE EXPERT SYSTEMS
- SUCCESSFUL INTEGRATION OF ARTIFICIAL INTELLIGENCE AND CONVENTIONAL AUTOMATION HAS ACHIEVED
 - FULLY-AUTOMATED, REAL-TIME MONITORING AND DIAGNOSIS
 - RECOMMENDATIONS FOR CORRECTIVE ACTION
 - PRODUCTIVITY ENHANCEMENT TOOLS
- DEMONSTRATION OF WORKFORCE REDUCTIONS AND IMPROVED PERFORMANCE

NASA

**MISSION OPERATIONS
AND DATA SYSTEMS DIRECTORATE**



**CONTROL CENTER OPERATIONS
AT THE
GODDARD SPACE FLIGHT CENTER**

DC999967

**ROBERT M. CONNERTON
JUNE 19, 1991**

P-22

5/3-14
N92-12023
5-16/15

MO&DS
DIRECTORATE

CODE 500

CONTROL CENTER OPERATIONS AT GSFC



AGENDA

- o BACKGROUND
- o TECHNICAL CHALLENGES
- o NEW DIRECTIONS
- o TECHNOLOGY DRIVERS
- o SUMMARY

MO&DS
DIRECTORATE

CODE 500

CONTROL CENTER OPERATIONS AT GSFC



BACKGROUND

o PRESENTLY OPERATING EIGHT MISSIONS OF VARYING COMPLEXITY IN FOUR DIFFERENT CONTROL CENTERS

- MULTI-MISSION SUPPORT:

- o COSMIC BACKGROUND EXPLORER (COBE)
- o GAMMA RAY OBSERVATORY (GRO)
- o EARTH BUDGET RESOURCE SATELLITE (ERBS)
- o INTERNATIONAL COMET EXPLORER (ICE)
- o INTERPLANETARY MONITORING PLATFORM (IMP)

- DEDICATED SUPPORT:

- o HUBBLE SPACE TELESCOPE (HST)
- o INTERNATIONAL ULTRAVIOLET EXPLORER (IUE)
- o NIMBUS SPACECRAFT (NIMBUS)

- ATTACHED PAYLOAD SUPPORT

- o BROAD BAND X-RAY TELESCOPE (BBXRT)
- o SPACE TEST PAYLOAD (STP)

MO&DS
DIRECTORATE

CODE 500

CONTROL CENTER OPERATIONS AT GSFC



BACKGROUND (CONT.)

- PLANNED SUPPORT FOR NEXT 12 MONTHS
 - o UPPER ATMOSPHERE RESEARCH SATELLITE (UARS)
 - o EXTREME ULTRAVIOLET EXPLORER (EUVE)
 - o SOLAR ANOMALOUS AND MAGNETOSPHERIC PARTICAL (SAMPEX)

- FUTURE ACTIVITY IS A BALANCED MIX OF LARGE OBSERVATORIES AND SMALL QUICK REACTION MISSIONS
 - o DIFFERENT ENVIRONMENTS AND NEEDS
 - o DIFFERENT MISSION DEVELOPMENT LIFECYCLES



CONTROL CENTER OPERATIONS AT GSFC

MO&DS DIRECTORATE
CODE 500

MISSION OPERATIONS ENVIRONMENT

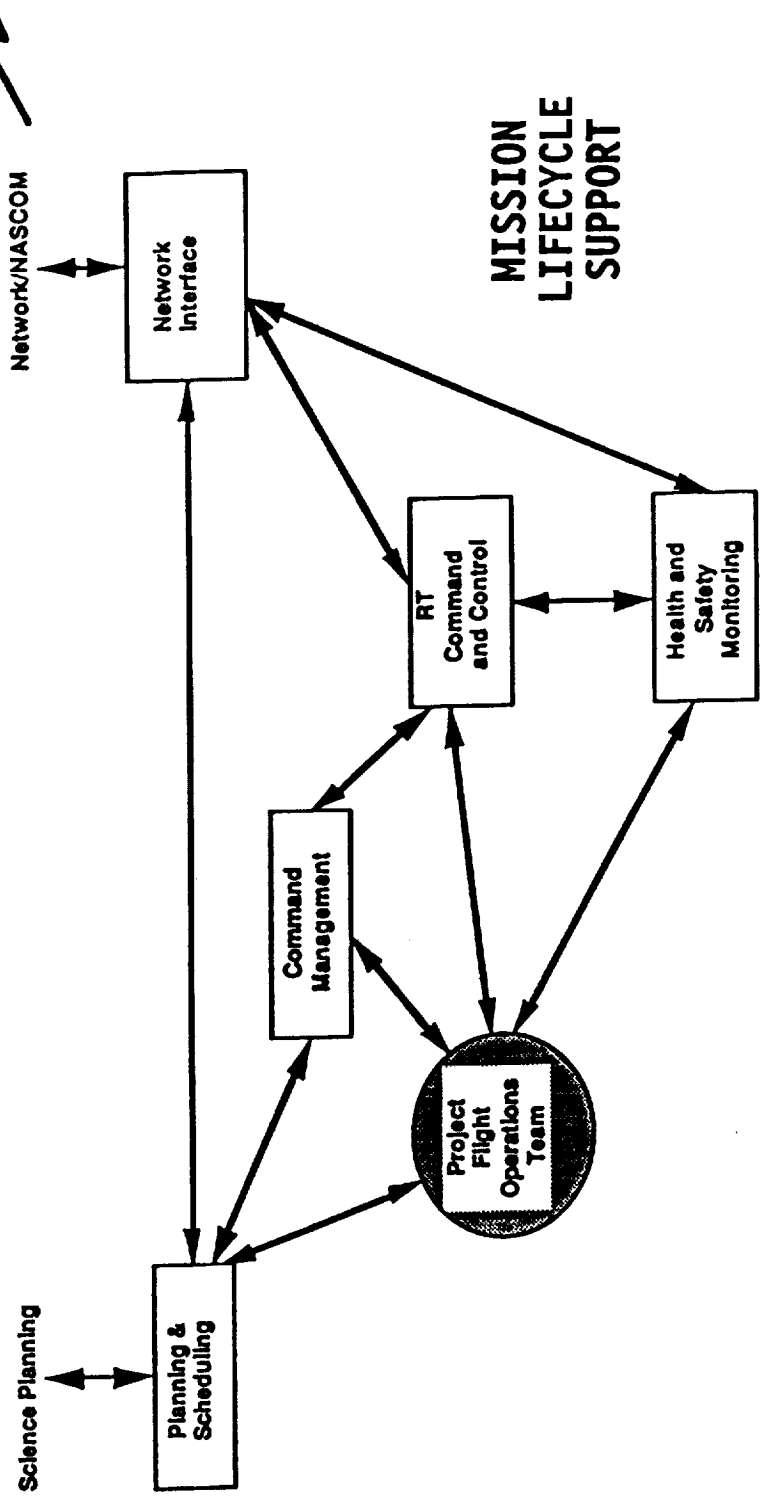

MISSION LIFECYCLE SUPPORT

Engineering	System	System Development	Test	Transition to Operations	Maintenance	
	Opns.					Ground System

MO&DS
DIRECTORATE

CODE 500

CONTROL CENTER OPERATIONS AT GSFC

GSFC



TECHNICAL CHALLENGES

- o CENTRALIZED MULTI-MISSION POC'S CAN BE QUICKLY RENDERED OBSOLETE BY THE CONFIGURATION CONTROL EFFORTS REQUIRED TO MINIMIZE INTERACTION BETWEEN MISSIONS AND RAPIDLY CHANGING TECHNOLOGY.
- o THE SCIENCE PLANNING INTERFACE IS BECOMING MORE REAL-TIME, DISTRIBUTED, AND COMPLEX. THIS CREATES SECURITY PROBLEMS (E.G. NASA SCIENCE INTERNET).
- o USE OF COMMERCIAL SOFTWARE REQUIRES APPROPRIATE PROTOTYPING TO ENSURE SUCCESSFUL APPLICATION.
- o SMALL MISSIONS ARE FORCING A SHORT MISSION PREPARATION TIMELINE.
- o OPERATIONAL CONSIDERATIONS ARE POSTPONED UNTIL TOO LATE IN THE MISSION LIFECYCLE.

MO&DS
DIRECTORATE

CODE 500

CONTROL CENTER OPERATIONS AT GSFC



NEW DIRECTIONS

- o INITIATING OPERATIONS ENGINEERING EFFORT EARLY IN A PROJECT'S LIFE CYCLE:
IN PHASE A AND B
- o UTILIZING MORE COMMERCIAL SOFTWARE
 - X-WINDOWS, MOTIF, UNIX, OSI
- o EMPLOYING WORKSTATIONS AS THE FUNDAMENTAL SYSTEM BUILDING BLOCK
- o EMPHASIZING HUMAN FACTORS IN THE USER INTERFACE
- o DISTRIBUTING SYSTEMS
 - TRANSPORTABLE PAYLOAD OPERATIONS CONTROL CENTER - SAMPEX, WIND, & POLAR
 - SUPPORT AND MAINTENANCE SYSTEM - HST

MO&DS
DIRECTORATE

CODE 500

CONTROL CENTER OPERATIONS AT GSFC



Operations Engineering Life Cycle (Mission Operations)

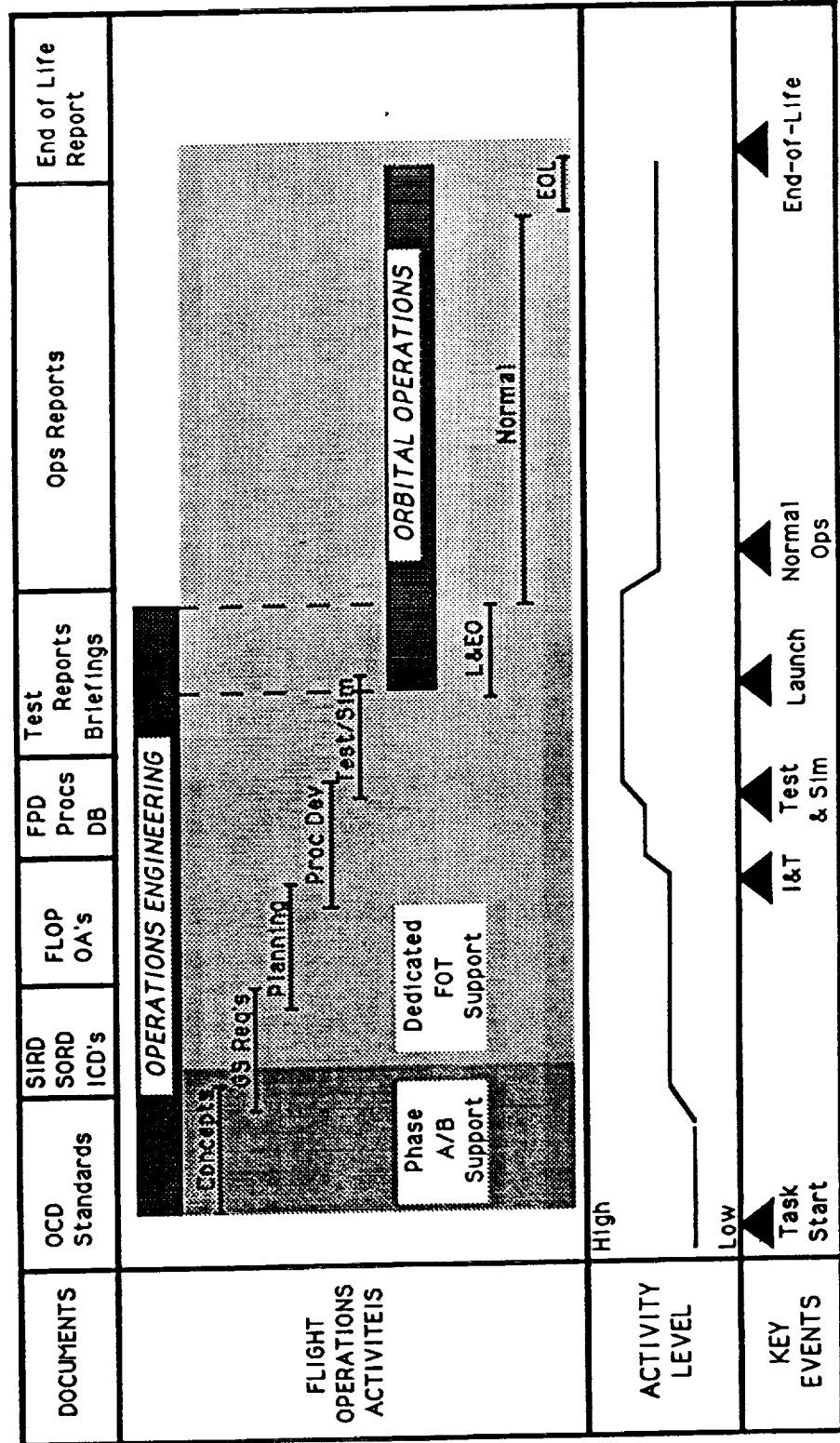

MO&DS
DIRECTORATE

CODE 500

CONTROL CENTER OPERATIONS AT GSFC



TPOCC

- o GROUPING OF WORKSTATIONS INTO ISOLATED MISSION CLUSTERS
 - SMALL EXPLORERS
 - INTERNATIONAL SOLAR TERRESTRIAL PHYSICS SERIES
- o SEEKING 60% REUSE OF SYSTEMS SOFTWARE BETWEEN MISSION CLUSTERS
- o IMPROVED USER INTERFACE THAT IS BASED UPON THE MOTIF SYSTEM
- o COMBINATION OF COMMERCIAL AND REUSABLE SYSTEM BUILDING BLOCKS
- o EMPLOYS WORKSTATION ARCHITECTURE ON A LAN

MO&DS
DIRECTORATE

CODE 500

CONTROL CENTER OPERATIONS AT GSFC



TPOCC

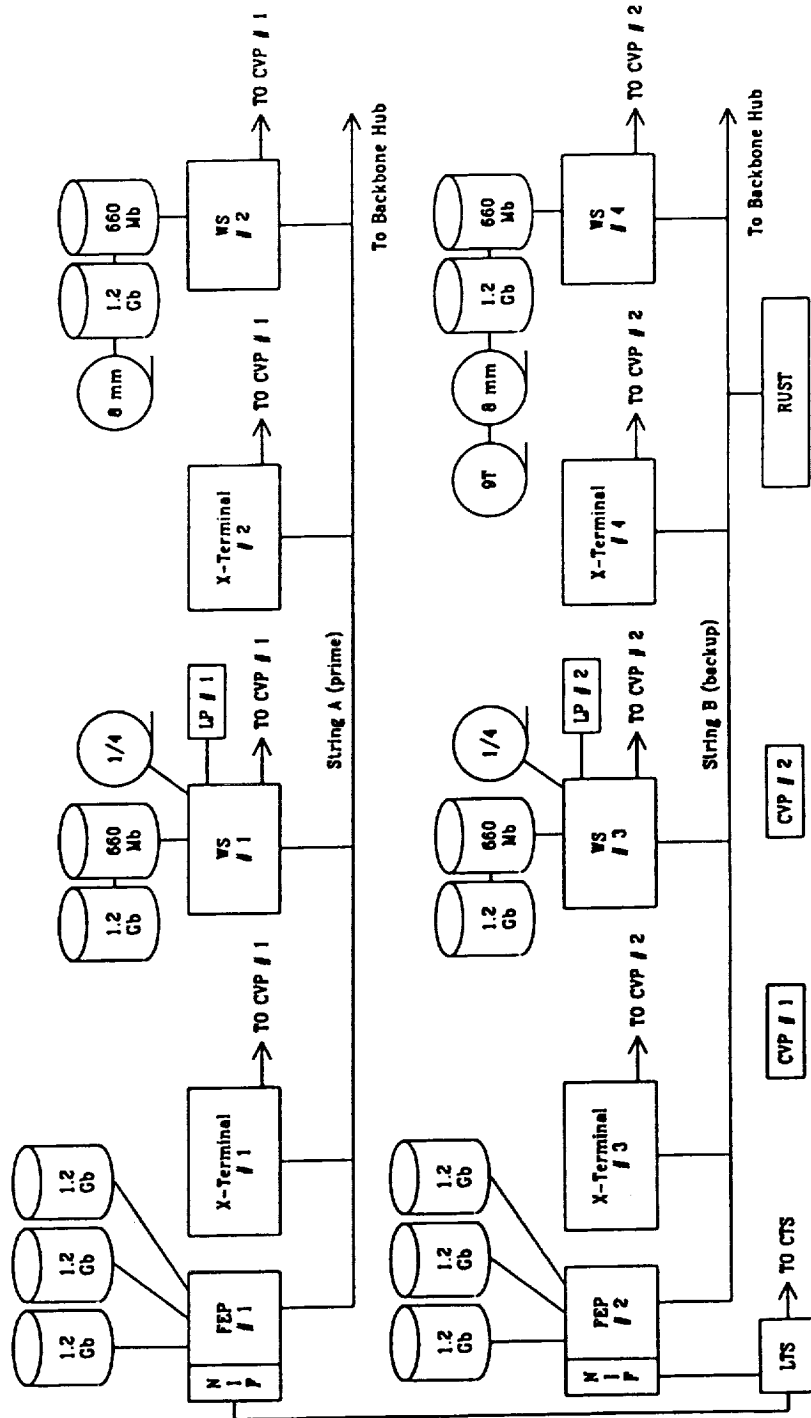

LEGEND:
 NIP - Nexcom Interface
 8 mm - 8 mm Helical Scan Tape Drive
 9T - 9 Track Tape Drive
 1/4 - 1/4 inch Cartridge Tape Drive
 WS - Workstation
 LTS - Local TPOCC Switch
 CTS - Central TPOCC Switch
 LP - Laser Printer
 CVP - Video Printer
 660 Mb - 660 Mb Hard Disk
 1.2 Gb - 1.2 Gb Hard Disk

MO&DS
DIRECTORATE

CODE 500

CONTROL CENTER OPERATIONS AT GSFC



SAMS

- o EVOLUTIONARY TRANSITION OF HST POCC PHASED TO HST REFURBISHMENT MISSION CYCLE.
- o PLANNED REPLACEMENT OF ALL POCC SYSTEMS WHILE SIMULTANEOUSLY SUPPORTING OPERATIONS AND REFURBISHMENT PREPARATIONS.
- o DISTRIBUTED APPROACH BASELINED.
- o CAPABILITY TO ISOLATE USER (FLIGHT OPERATIONS TEAM) SOFTWARE FOR SYSTEM INTEGRITY.
- o EMPLOYS PROTOTYPE METHODOLOGY FOR SYSTEM DEVELOPMENT.

MO&DS
DIRECTORATE
CODE 500

CONTROL CENTER OPERATIONS AT GSFC



SAMS

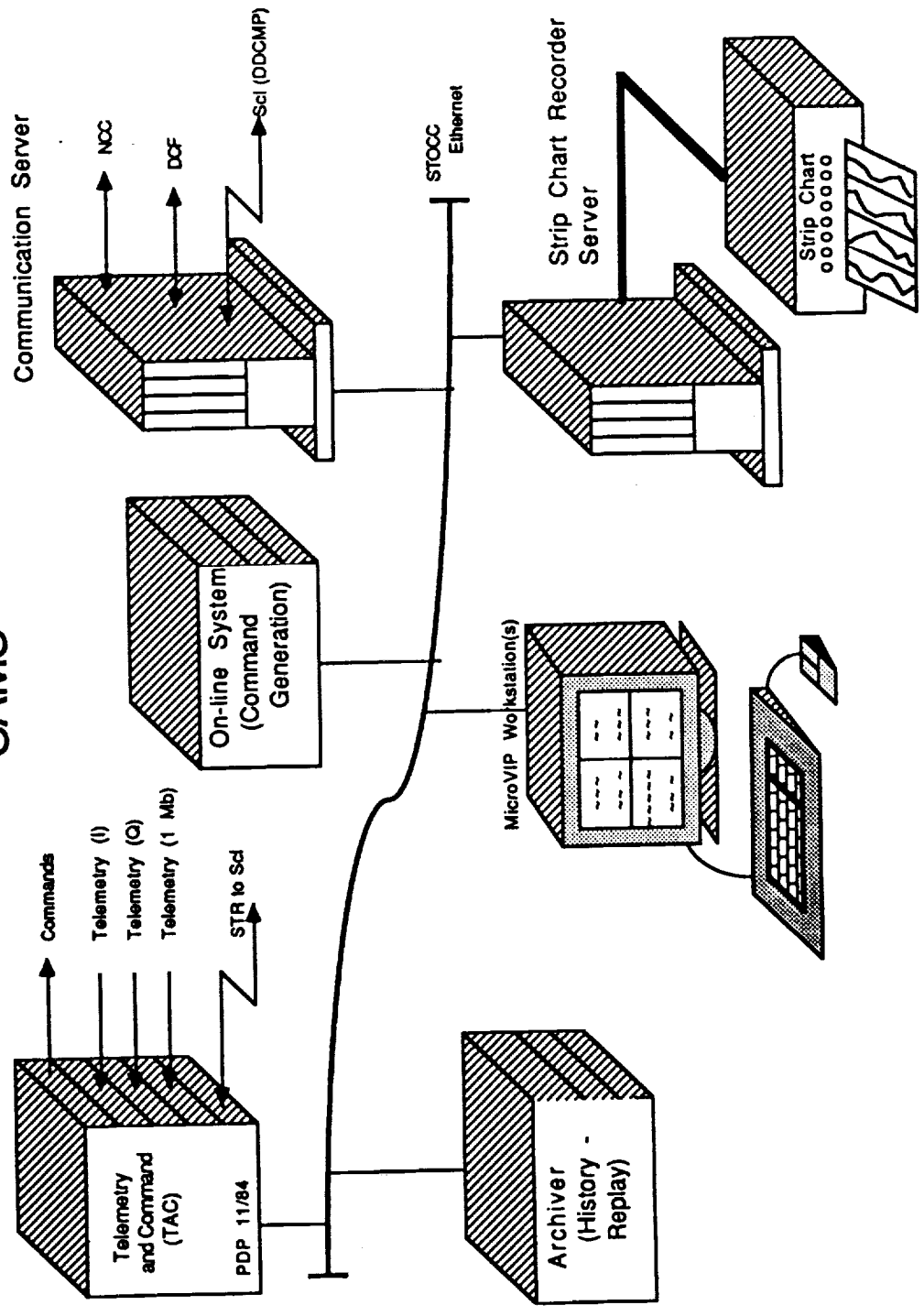

MO&DS
DIRECTORATE

CODE 500

CONTROL CENTER OPERATIONS AT GSFC



SUPPORT AND MAINTENANCE EXAMPLE

- o ORIGINALLY
- BASED ON HST PORTS SOFTWARE (CENTRALIZED ARCHITECTURE)
- DISTRIBUTED FUNCTIONALITY TO MULTIPLE NODES
- AUTONOMOUS WORKSTATION
- DISTRIBUTED ARCHITECTURE

(+)

INCREASED COMPUTING POWER
FEWER SINGLE POINTS OF FAILURE
EASILY EXPANDED
SIMPLIFIED MAINTENANCE

(-)

REQUIRES INCREASED COORDINATION
- EVENTS
- LIMITS
INCREASED COMPLEXITY

MO&DS
DIRECTORATE

CODE 500

CONTROL CENTER OPERATIONS AT GSFC



TECHNOLOGY DRIVERS

- o BEGINNING TO APPLY AI TO MISSIONS
 - CLEAR SYSTEM FOR TDRSS INTERFACE TROUBLESHOOTING ON COBE AND GRO
 - BCAUS SYSTEM FOR GRO FOR SAFEHOLD ANALYSIS

- o IMPROVING THE OPERATION INTERFACE
 - MAKE MORE FUNCTIONAL
 - EASIER TO USE

- o COMMERCIAL LOCAL AREA NETWORKING TO CONNECT WORKSTATIONS
 - ETHERNET
 - MOVING TOWARDS OPEN SYSTEM INTERCONNECT
 - DEVELOPING NETWORK MANAGEMENT CAPABILITIES

MO&DS
DIRECTORATE

CODE 500

CONTROL CENTER OPERATIONS AT GSFC



USER INTERFACE APPLICATIONS

- o GENERIC CAPABILITIES
 - GRAPHIC PAGE DEFINITION
 - COMBINATION "WILDCARD" AND TREND ANALYSIS PAGES
 - FLIGHT OPERATIONS TEAM DEFINED DISPLAYS
 - POINT AND CLICK INTERFACE
 - EVENT PROCESSING RELATIVE TO POSITION

- o SPECIFIC APPLICATIONS
 - FINE GUIDANCE DISPLAY
 - COMMAND PANEL
 - GRO ATTITUDE

14-00000

COMMAND PANEL FOR SAMPEX

PROG PLAN HERE - TEST DECLASSIFIED - UNIT - TIM LOCK - TEL: 0316

PLANNED PROCEDURES
PROCEDURE INDEX/CONTENTS

PLANNED	10-005 22-00-15
PLANNED	10-005 22-00-16
PLANNED	10-005 22-00-17
PLANNED	10-005 22-00-18
PLANNED	10-005 22-00-19

OPTIMAL PROC	10-005 22-00-20
OPTIMAL PROC	10-005 22-00-21
OPTIMAL PROC	10-005 22-00-22
OPTIMAL PROC	10-005 22-00-23
OPTIMAL PROC	10-005 22-00-24

OPTIMAL DIRECTIVES	10-005 22-00-25
OPTIMAL DIRECTIVES	10-005 22-00-26
OPTIMAL DIRECTIVES	10-005 22-00-27
OPTIMAL DIRECTIVES	10-005 22-00-28
OPTIMAL DIRECTIVES	10-005 22-00-29

OPTIMAL DIRECTIVES	10-005 22-00-30
OPTIMAL DIRECTIVES	10-005 22-00-31
OPTIMAL DIRECTIVES	10-005 22-00-32
OPTIMAL DIRECTIVES	10-005 22-00-33
OPTIMAL DIRECTIVES	10-005 22-00-34

OPTIMAL DIRECTIVES	10-005 22-00-35
OPTIMAL DIRECTIVES	10-005 22-00-36
OPTIMAL DIRECTIVES	10-005 22-00-37
OPTIMAL DIRECTIVES	10-005 22-00-38
OPTIMAL DIRECTIVES	10-005 22-00-39

1	PLANNED
2	PLANNED
3	PLANNED
4	PLANNED
5	PLANNED
6	PLANNED
7	PLANNED
8	PLANNED
9	PLANNED
10	PLANNED
11	PLANNED
12	PLANNED
13	PLANNED
14	PLANNED
15	PLANNED
16	PLANNED
17	PLANNED
18	PLANNED
19	PLANNED
20	PLANNED
21	PLANNED
22	PLANNED
23	PLANNED
24	PLANNED
25	PLANNED
26	PLANNED
27	PLANNED
28	PLANNED
29	PLANNED
30	PLANNED
31	PLANNED
32	PLANNED
33	PLANNED
34	PLANNED
35	PLANNED
36	PLANNED
37	PLANNED
38	PLANNED
39	PLANNED
40	PLANNED
41	PLANNED
42	PLANNED
43	PLANNED
44	PLANNED
45	PLANNED
46	PLANNED
47	PLANNED
48	PLANNED
49	PLANNED
50	PLANNED

1	PLANNED
2	PLANNED
3	PLANNED
4	PLANNED
5	PLANNED
6	PLANNED
7	PLANNED
8	PLANNED
9	PLANNED
10	PLANNED
11	PLANNED
12	PLANNED
13	PLANNED
14	PLANNED
15	PLANNED
16	PLANNED
17	PLANNED
18	PLANNED
19	PLANNED
20	PLANNED
21	PLANNED
22	PLANNED
23	PLANNED
24	PLANNED
25	PLANNED
26	PLANNED
27	PLANNED
28	PLANNED
29	PLANNED
30	PLANNED
31	PLANNED
32	PLANNED
33	PLANNED
34	PLANNED
35	PLANNED
36	PLANNED
37	PLANNED
38	PLANNED
39	PLANNED
40	PLANNED
41	PLANNED
42	PLANNED
43	PLANNED
44	PLANNED
45	PLANNED
46	PLANNED
47	PLANNED
48	PLANNED
49	PLANNED
50	PLANNED

ORIGINAL PAGE IS OF POOR QUALITY

UTC: 9/11/2010 09:49:03 INT: 00 MI: 10 VEH: 11111100/007/09/09-128
 Mode: SIMON Scan: NO Detachable: NO
 Fall: NONE Stop: NO Threshold: NO
 Filter: Between Theta A: 137287
 Theta B: 582760
 fig. 1. Scale: 400 0.1 402.7 grs

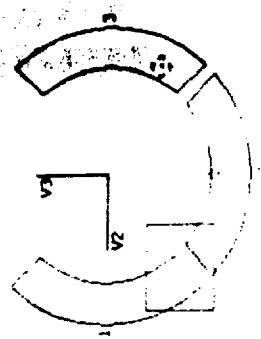

Cycle 0/00
Cycle 1/88
Auto Zoom
Zoom In
Zoom Out
Refresh
Clear

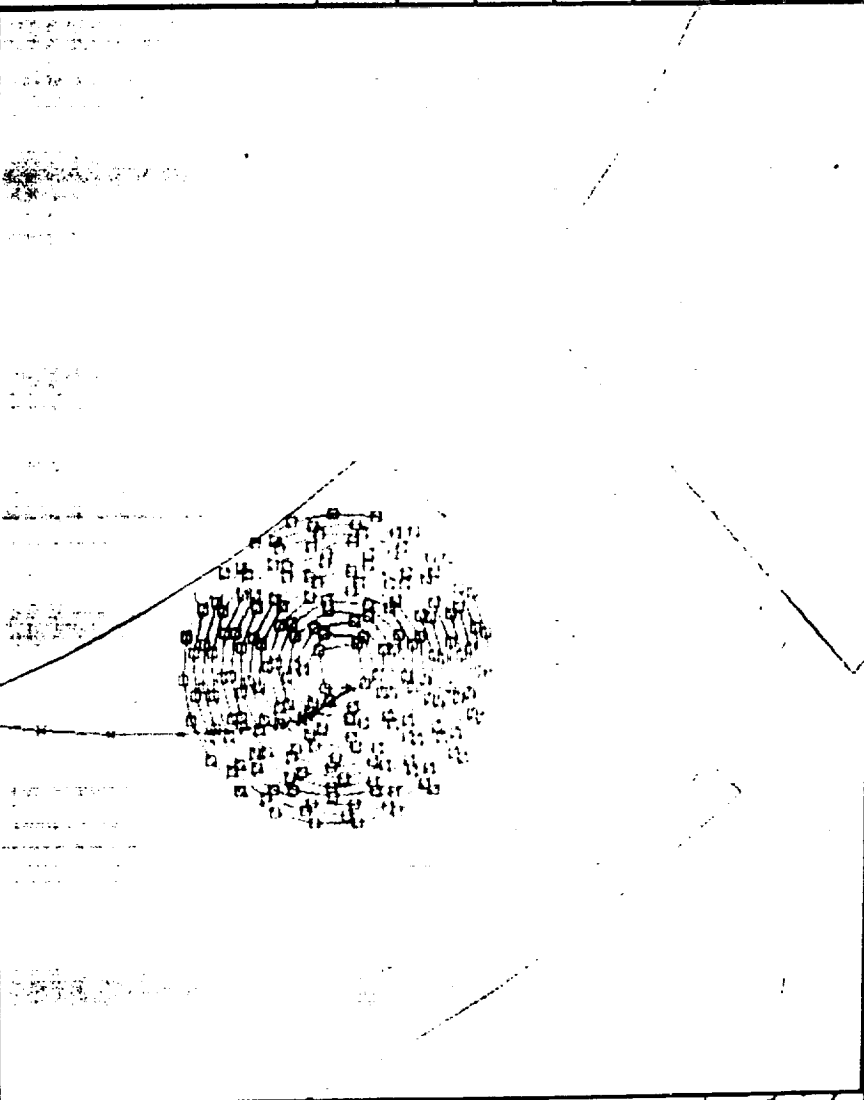

SIGN ON >

UTC: 91/172/18:47:52 FRT: ON RE: 6 VEH TIME: 01/07/98:06:22
 Mode: SEARCH Star: NO DataValid: NO
 Fall: NONE Stop: NO TransField: NO
 Filter: Betwenn Theta A: 1.31701
 FOS 1 Scale: 12.5 x 251.7 a/s Theta B: 571.035
 100 90 80 70 60 50 40 30 20 10 0
 PMT: 6
 X -1
 Y -1

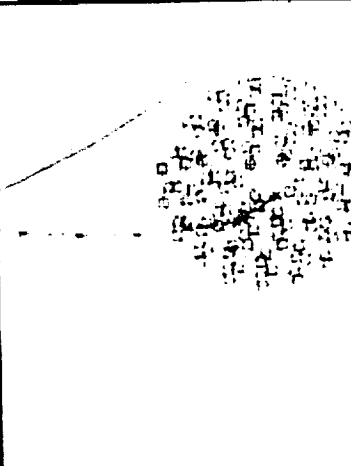
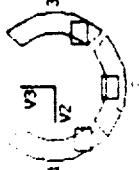

Image Space
 Cycle View
 Cycle FOS
 Auto Zoom
 Zoom In
 Zoom Out
 Refresh
 Clear



UTC: 91/172/18:48:50 FRT: ON RE: 10 VEH TIME: 01/07/98:04:21
 Mode: COARSE TRACK Star: YES DataValid: NO
 Fall: NONE Stop: NO TransField: YES
 Filter: Betwenn Theta A: 305.877
 FOS 2 Scale: 12.5 x 15.7 a/s Theta B: 735.947
 100 90 80 70 60 50 40 30 20 10 0
 PMT: 5105
 X -1
 Y -1





Image Space
 Cycle View
 Cycle FOS
 Auto Zoom
 Zoom In
 Zoom Out
 Refresh
 Clear



UTC: 91/172/18:46:54 FRT: ON RE: 5 VEH TIME: 01/07/98:04:29
 Mode: SEARCH Star: NO DataValid: NO
 Fall: NONE Stop: NO TransField: NO
 Filter: Betwenn Theta A: 0.336
 FOS 1 Scale: 12.5 x 251.7 a/s Theta B: 571.035
 100 90 80 70 60 50 40 30 20 10 0
 PMT: 6
 X -1
 Y -1

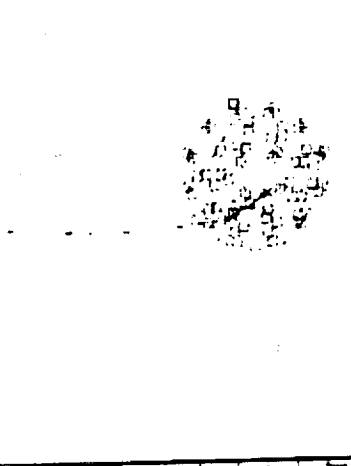



Image Space
 Cycle View
 Cycle FOS
 Auto Zoom
 Zoom In
 Zoom Out
 Refresh
 Clear



UTC: 91/172/18:46:55 FRT: ON RE: 6 VEH TIME: 01/07/98:04:21
 Mode: COARSE TRACK Star: YES DataValid: NO
 Fall: NONE Stop: NO TransField: YES
 Filter: Betwenn Theta A: 48.872
 FOS 1 Scale: 12.5 x 15.7 a/s Theta B: 735.947
 100 90 80 70 60 50 40 30 20 10 0
 PMT: 505
 X -1
 Y -1

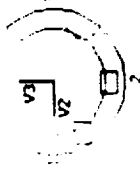
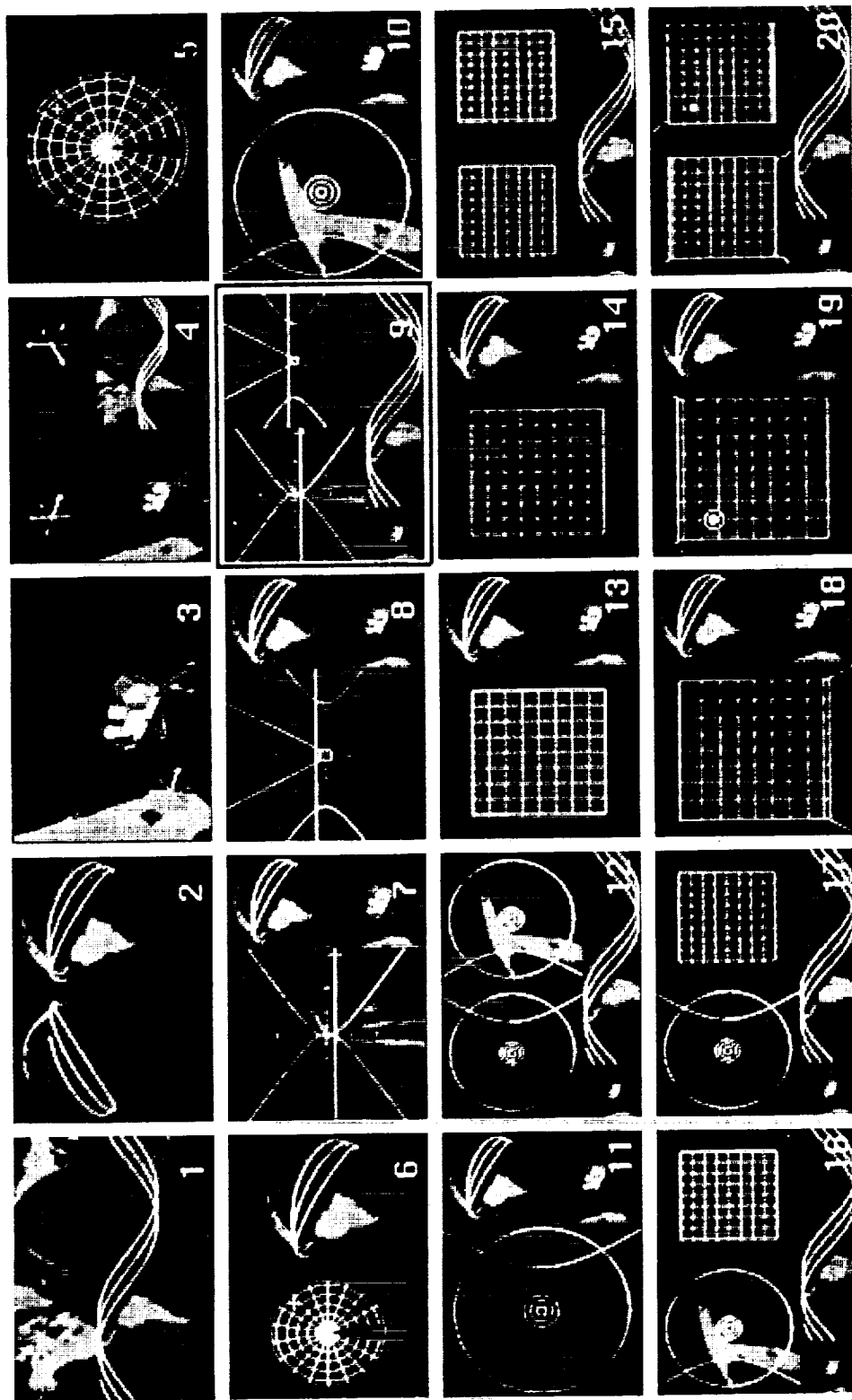

Image Space
 Cycle View
 Cycle FOS
 Auto Zoom
 Zoom In
 Zoom Out
 Refresh
 Clear



SIGN ON >

ORIGINAL PAGE IS
OF POOR QUALITY



Display 9: Minus X and Plus X Axis Display (Full Screen)

MO&DS
DIRECTORATE

CODE 500

CONTROL CENTER OPERATIONS AT GSFC



SUMMARY

- o SYSTEMS ARE BECOMING MORE DISTRIBUTED
- o FORMALIZING THE PROCESS OF OPERATIONS ENGINEERING TO ADDRESS OPERATIONAL ISSUES AS EARLY AS POSSIBLE
- o FOCUSING ON GENERIC CAPABILITIES THAT CAN BE TAILORED FOR SPECIFIC MISSION IN ORDER TO SHORTEN DEVELOPMENT TIME
- o SUCCESSFULLY HANDLING A DIVERSE RANGE OF MISSIONS

HUNTSVILLE OPERATIONS SUPPORT CENTER

presented by:

Darrell G. Bailey

MSFC/E033

514-14
N92-12024
39676
p-20
ND736801

HUNTSVILLE OPERATIONS SUPPORT CENTER (HOSC)

The HOSC is a multimission control and support facility designed to provide simultaneous support to several diverse missions, using a common set of processing equipment and facilities. The facility currently consists of:

- Two payload control area "front rooms", with associated support areas
- 12 online conference work areas, with data, audio, and video services
- Two science operations areas, totalling 6000 sq. ft. of raised floor space
 - Data, audio, and video services; audio keysets can be configured to allow experimenters to converse directly with payload crew
 - Access to high-rate science data interfaces
- 9000 sq. ft. computer room with central configuration monitoring area
- Redundant power and A/C
 - Two power feeds from different areas of TVA grid, with automatic transfer
 - Battery and generator backup for all power except overhead lights
- Conference areas with audio teleconferencing capability
- Lab space for enhanced development

MISSIONS SUPPORTED BY THE HOSC:

- 1960s:
 - Saturn Launch Engineering Console Room
- 1970s:
 - Skylab Engineering Console Room
- 1980s:
 - Shuttle Engineering Console Room
 - Hubble Space Telescope Engineering Support Center (ESC)
 - Inertial Upper Stage (IUS) ESC
- Present:
 - Shuttle Engineering Console Room
 - Spacelab Payload Operations Control Center (POCC)
 - IUS ESC
 - Propulsion test stand support
- Late 1990s:
 - All of the present activities, plus:
 - Space Station Freedom Payload Operations Integration Center (POIC)
 - SSF Work Package 01 ESC
 - SSF OSSA Integrated Science Operations Center (ISOC)
 - Astronomical X-ray Astrophysics Facility (AXAF) POCC
 - AXAF ESC

THE HOSC FACILITY

- Current facility occupies building 4663 A-wing and part of M-wing
- Future expansion to occupy upper floor of B-wing and remainder of M-wing

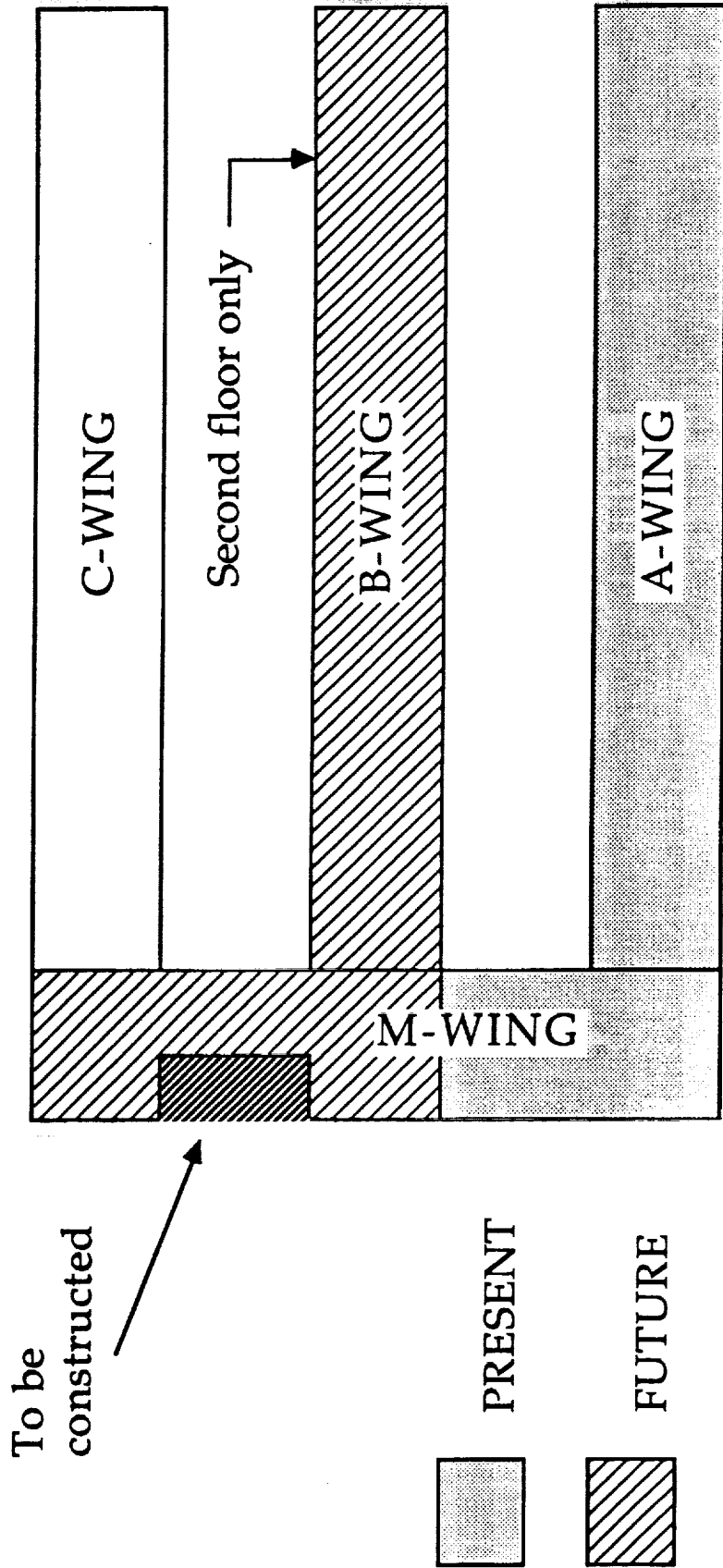

HOSC GENERIC SYSTEM GOALS

- To build and operate a generic system capable of multimission support
- To perform multiple mission supports simultaneously
- To be able to exchange components and share redundancy
- To build systems using COTS products when possible
- To allow for expansion and accommodation of new missions
- To use common data transfer protocols across projects, simplifying data exchange and eliminating need for protocol conversion

HOSC Existing Architecture

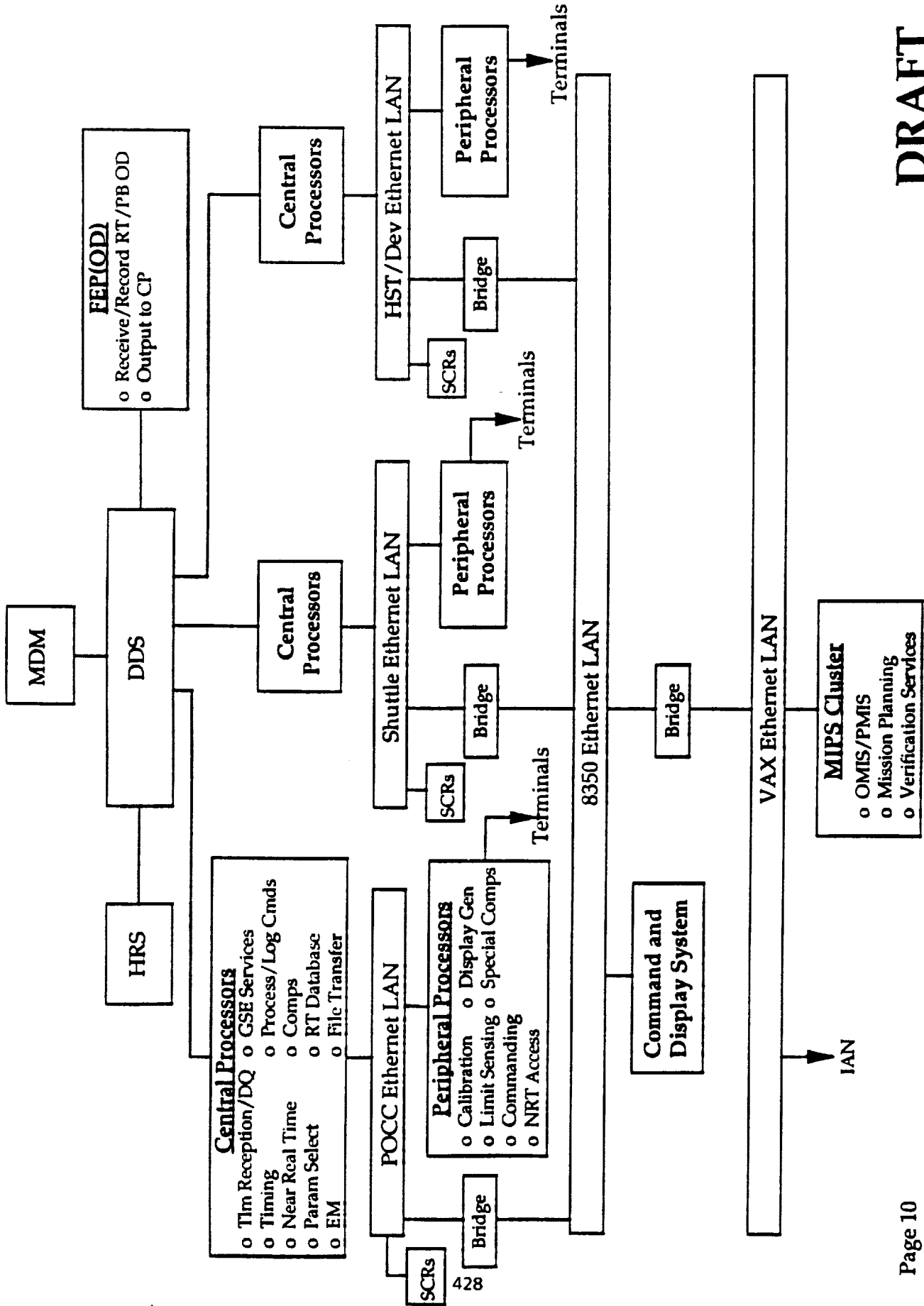

DRAFT

CURRENT HOSC MISSION REQUIREMENTS

- Shuttle Engineering Console Room:
 - process Orbiter Downlink (OD) - non-standard stream
 - process redundant Launch Processing System (LPS) data
 - process redundant Engine Instrumentation System (EIS) data
 - total data input rate ~ 1.3 Mb/sec
 - extensive exception monitoring (drives C&W lamps)
 - post-launch ops recorder dump processing at 1 Mb/sec

- Spacelab POC:
 - process Orbiter Downlink
 - process Experiment Computer and Subsystem Computer I/O
 - process experiment dedicated channels at up to 2 Mb/sec
 - perform payload commanding
 - payload ops planning and timelining; orbit prediction

- IUS ESC
 - process Orbiter Downlink
 - process IUS subset data inserted into OD by payload data interleave
 - process data from ARIA aircraft or other sources

CURRENTLY EMPLOYED HARDWARE AND SOFTWARE

- Data switching — custom hardware
- Front-end processors and central processors:
Hardware — Concurrent 3200-series with custom telemetry interfaces
Software — assembly and Fortran, no COTS except OS and compilers
- Networking:
Layers 1 and 2 — COTS Ethernet products
Layers 3 and above — custom protocol, plus some DECnet
- Peripheral processors:
Hardware — DEC Microvax
Software — mostly Fortran, some DCL and assembly, little COTS
Displays — DEC VT200 and 300 series, Regis graphics, no GUI
- Mission planning and database systems — Vaxcluster, access from VT terminals via T-switches and terminal servers
- Communications: Electrospace digital audio, Image Video video matrix, dual 9" B&W and single 13" color NTSC monitors at each console

FRONT END PROCESSING

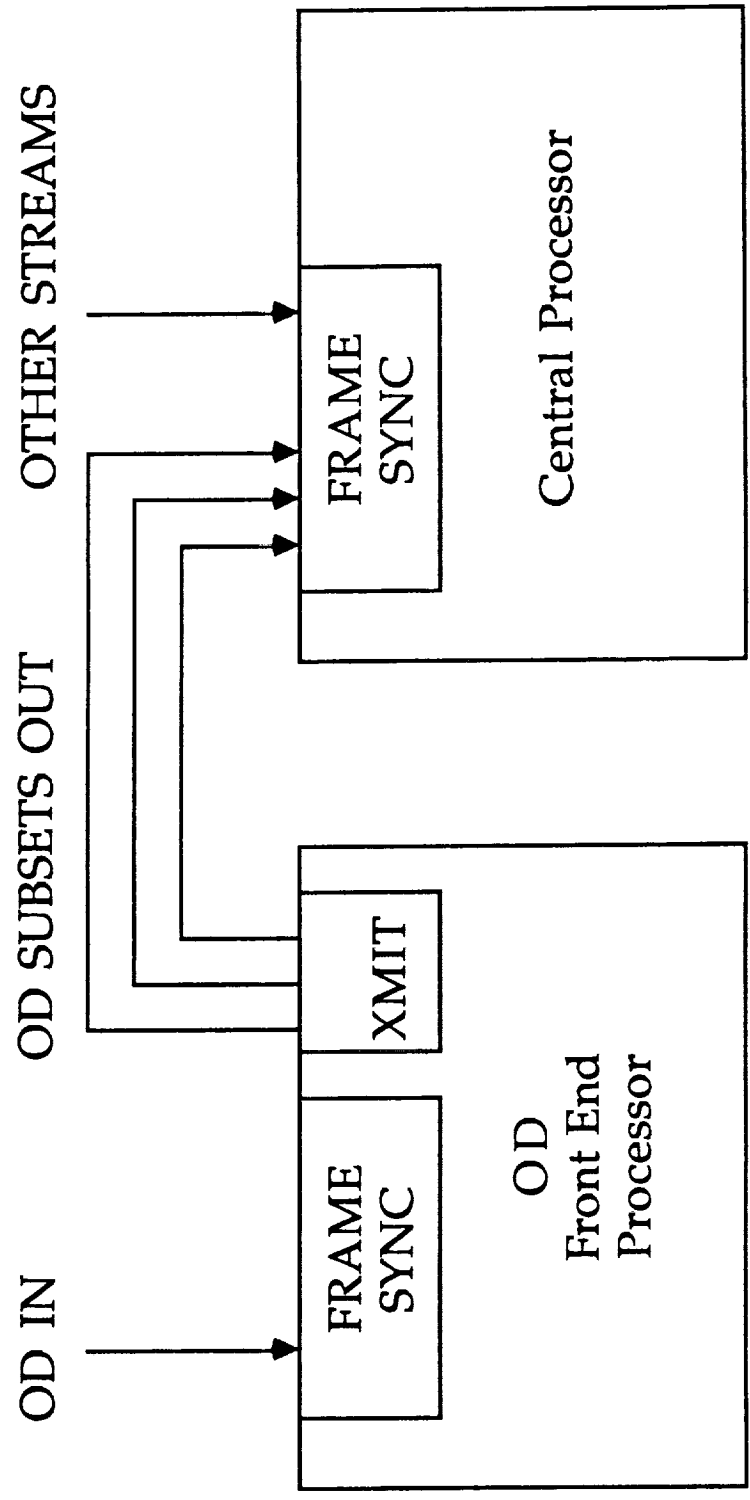

- OD Preprocessing performed by Front-End Processor
- All other acquisition and processing performed by Central Processor, with frame sync performed by custom input board

CENTRAL PROCESSING

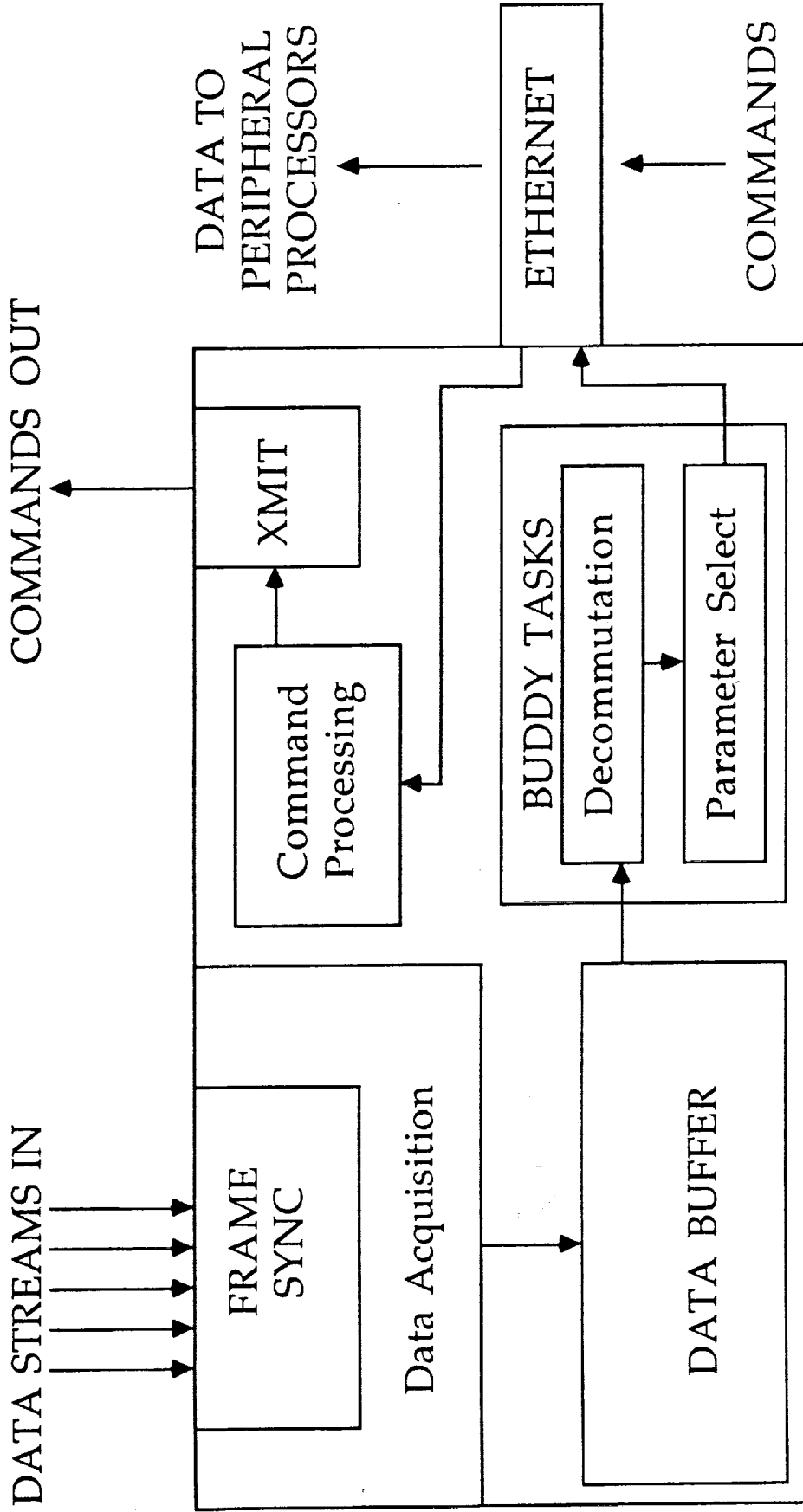

- Central processor performs triple-buffered acquisition, decommutation, and data selection, but not calibration (in most cases)
- CPs also perform command processing and system common services, including common use computations

PERIPHERAL PROCESSORS

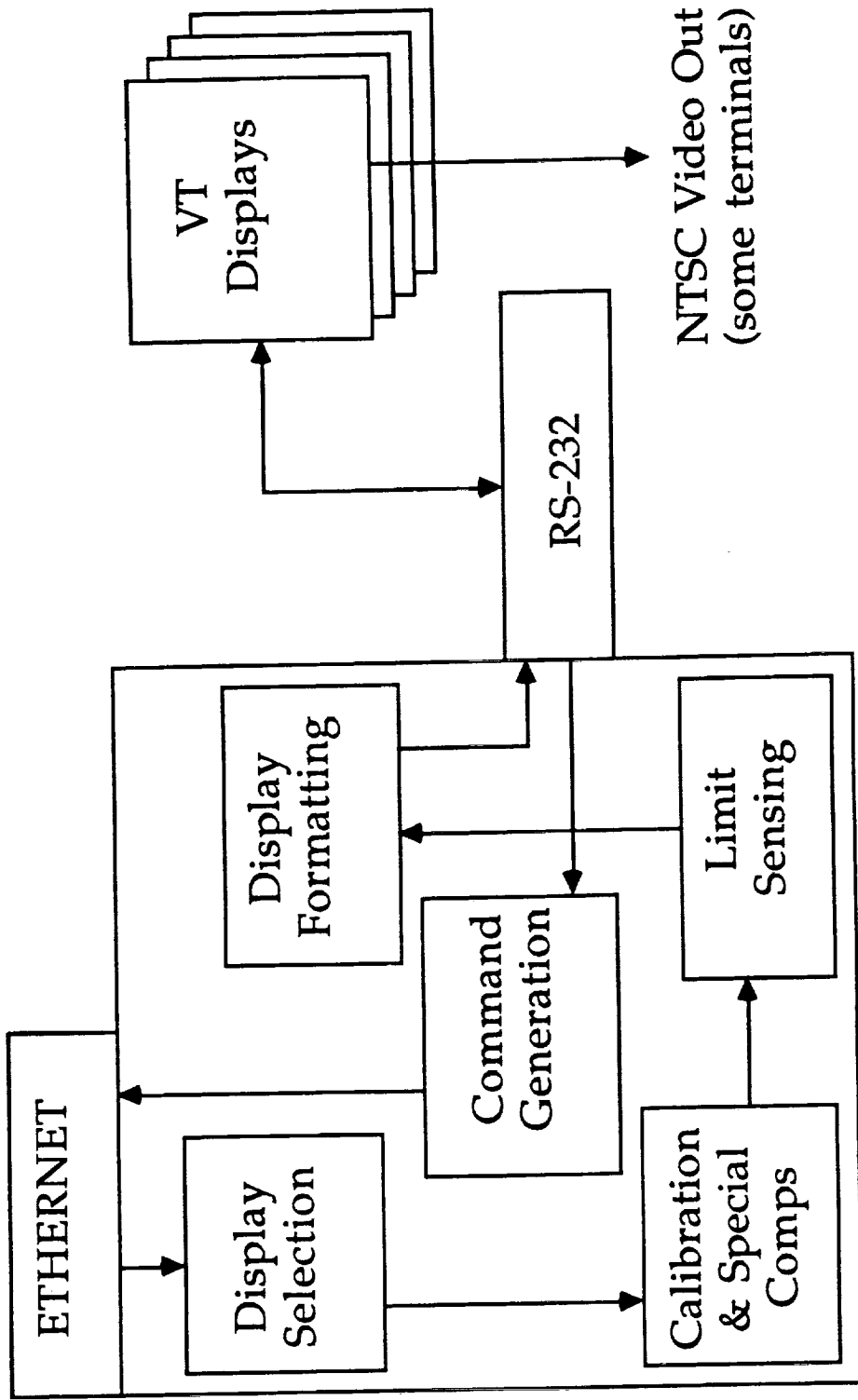

- Peripheral Processors perform data calibration and formatting, sense limits and highlight limits exceeded, drive displays, and execute special comps
- Up to 4 displays per processor

COMMUNICATIONS

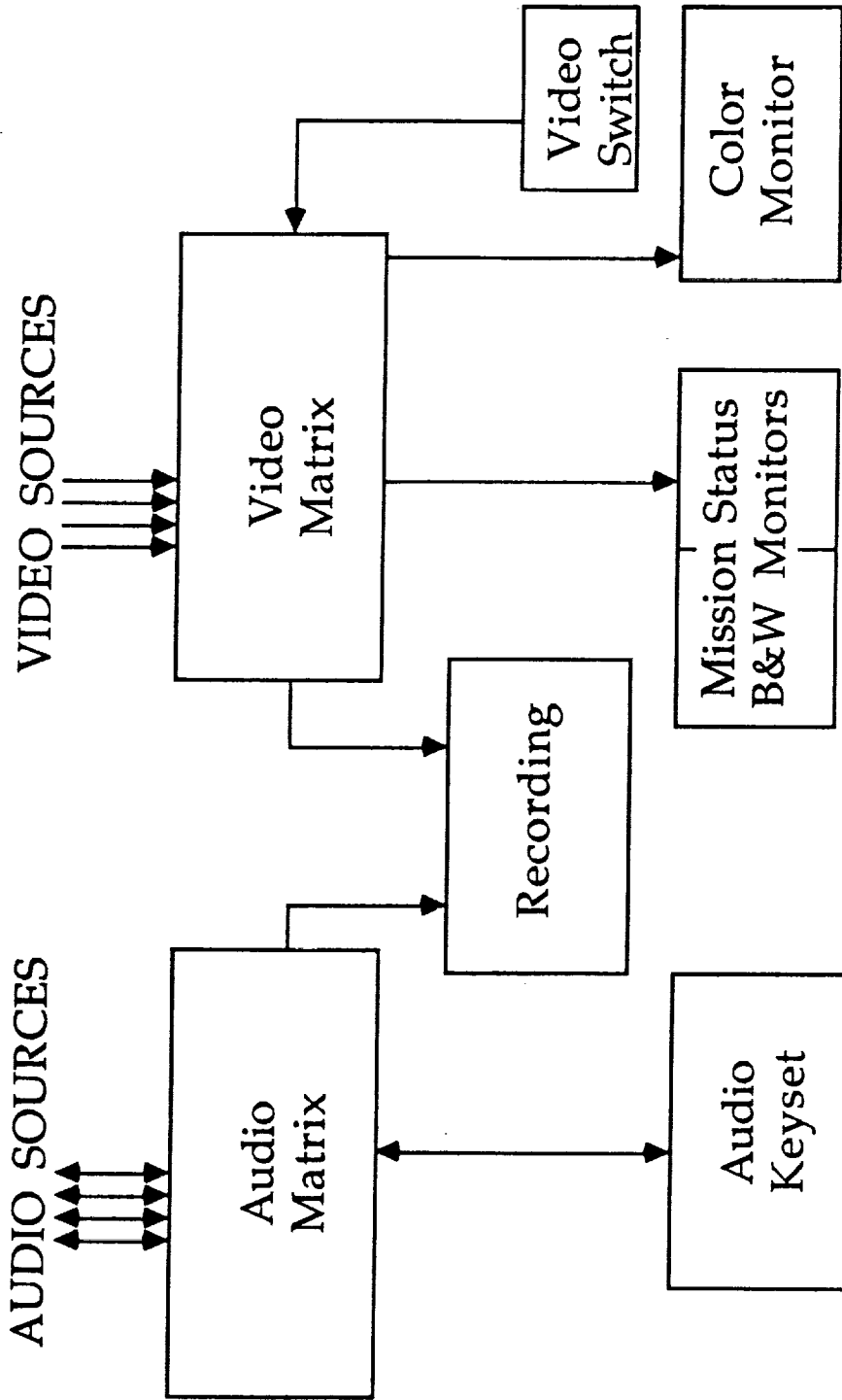

- Audio keysets provide 2-way internal and external audio, and access to telecom
 - Remote keysets possible using fractional T1 circuits
- Video used primarily for display sharing and mission status

WHY ENHANCED DEVELOPMENT?

- Manpower-intensive systems result in rising operations costs
 - Personnel required for support is exponentially proportional to requirements
- Custom systems are difficult to maintain due to loss of knowledge via employee turnover
- Proprietary systems are expensive to upgrade; vendors eventually phase out support of obsolete systems
- Applications can't be maintained or easily ported to another platform
- Proliferation of network protocols for different applications
- Character-based dumb terminal interface, with minimal graphics
 - RS-232 interface severely limits graphics update ability
- Applications behave according to Parkinson's Law, but processing capabilities cannot easily be scaled up
- SSF and AXAF have requirements for 24-hour, 7-day, year-round support
 - Current system has some zero-fault-tolerant subsystems
- New interface requirements — NASCOM II, external users

ENHANCED DEVELOPMENT GOALS

- Upgrade hardware technology:
 - Distributed processing with COTS workstations and minicomputers
 - Higher-bandwidth, longer-distance networks with built-in redundancy
- Upgrade software technology:
 - Advanced programming languages (C, Ada, etc.)
 - POSIX-compliant operating systems and portable applications
 - GOSIP-compliant network protocols
 - Standards-based COTS products such as relational database and GUI
- Reduced training, operations, reconfiguration, and maintenance costs
- Meet SSF and AXAF requirements for 24-hour, 7-day, year-round support
- Support SSF and AXAF external users while improving system access controls and availability assurance
- Eliminate zero-fault-tolerant subsystems
- Accommodate new missions with minimum modifications
- *Maintain continuous support of ongoing missions during upgrade process*

HOSC Enhanced Architecture

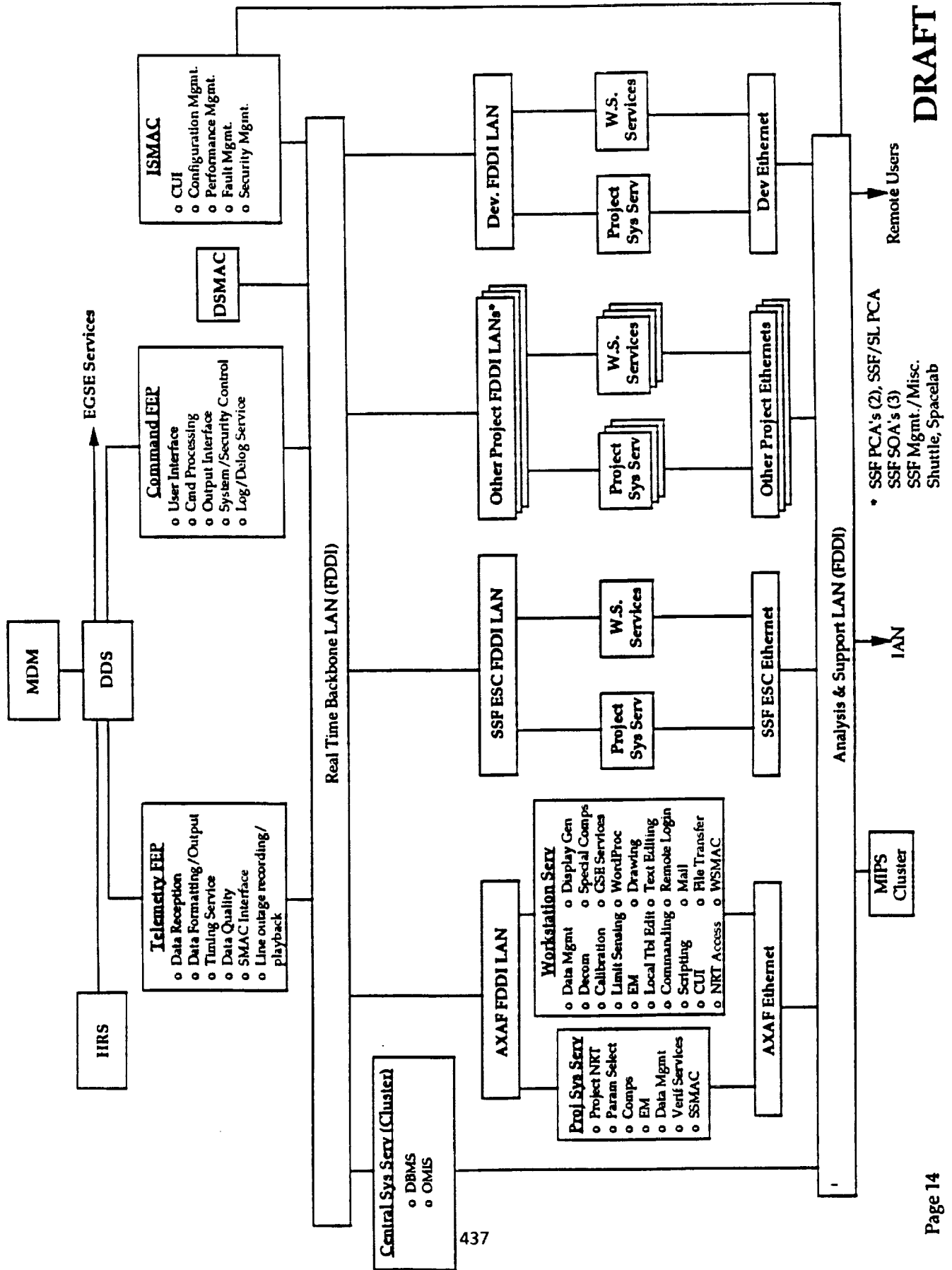

DRAFT

FRONT END PROCESSING

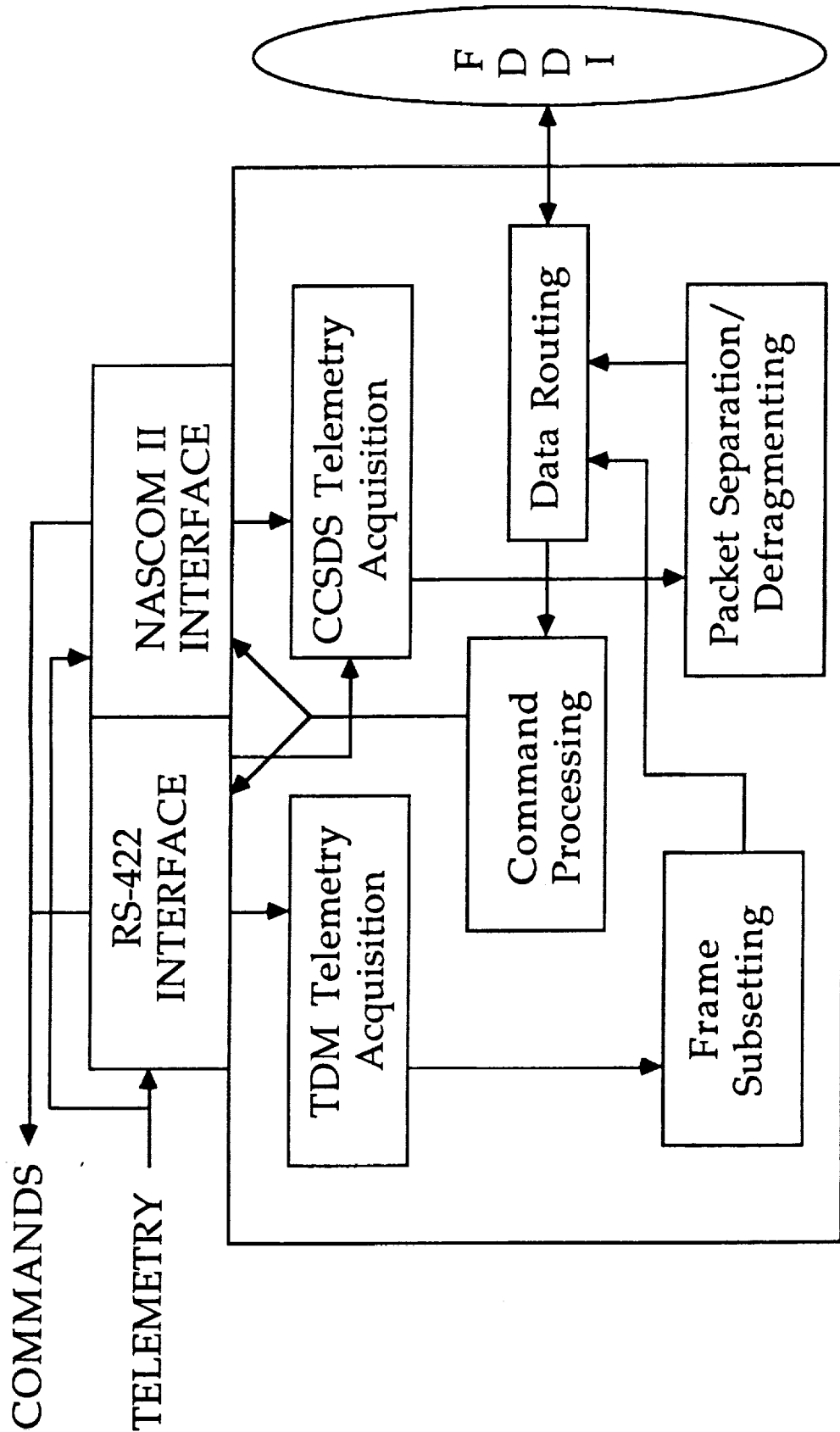

- FEP acquires and preprocesses all data; also performs command processing
- Raw telemetry sent directly to workstations in packet form

WORKSTATIONS

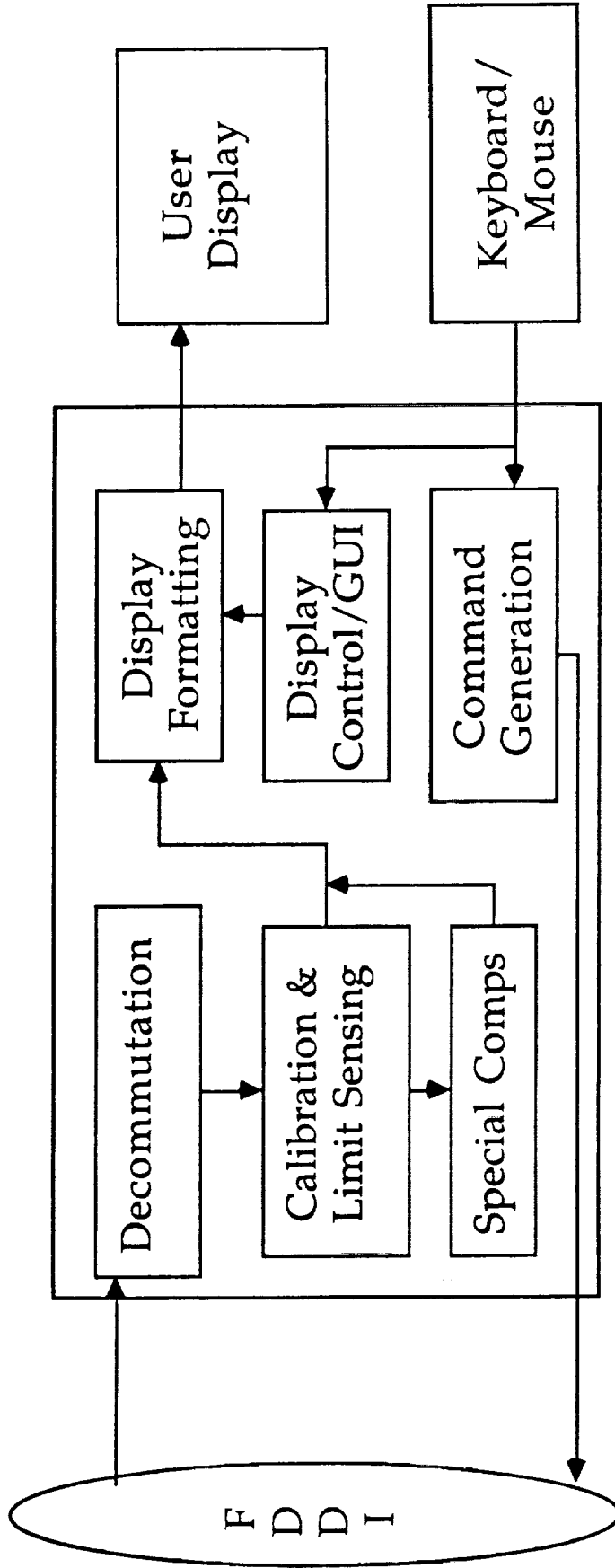

- Workstations process raw telemetry and extract needed data
- Display uses graphics user interface with menus, buttons, sliders, etc.
- Direct interface to project FDDI
- Alternate user input/output peripherals can be supported

SYSTEM SERVICES

System services machines will be attached to backbone net and to project nets for:

- Common use computations and mission status display generation
- Near-real-time data services
- Database and file services
- Project-specific commanding services
- Ground support equipment interface services
- Any other services requiring project-wide or system-wide access

INTEGRATED SYSTEM MONITOR AND CONTROL

Integrated system monitor and control consolidates status information and provides subsystem control in a centralized service with common display formats. Subsystems are:

- Data Acquisition and Distribution (FEPs, networks, NASCOM interfaces)
- System services processors
- Workstations
- Line outage recording and archiving
- External interfaces
- Facility (door monitoring, power, A/C, fire suppression)

ENHANCED DEVELOPMENT SCHEDULE

- Preliminary design review — summer 1992
- Critical design review — summer 1993
- Enhanced data system operational — fall 1995
- SSF ESC operations begin 3/96, POIC operations begin 6/96
- AXAF operations begin 10/97
- Existing missions and users to be migrated to enhanced system in 1995-1996 timeframe
- All previous architecture subsystems out of service by end of 1998

Real Time Data System (RTDS)

Control Center Technology Conference
June 18, 1991

DF24/Troy A. Heindel
NASA Lyndon B. Johnson Space Center

- Goals
- Traditional MCC Technologies
- RTDS Technologies
- Show & Tell
- Growth of RTDS
- Side-by-Side Comparison
- Comparison of Functionality
- Technology Gap
- Technology Transfer in MCC
- Questions Raised
- Future Directions
- Closing Thought

515-14
N92-12025-17

P 23

ND 185700

Goals

- Increase the quality of flight decision making
- Reduce/enhance flight controller training time
- Serve as a near-operations technology test-bed

Traditional MCC Technologies

- Hardware

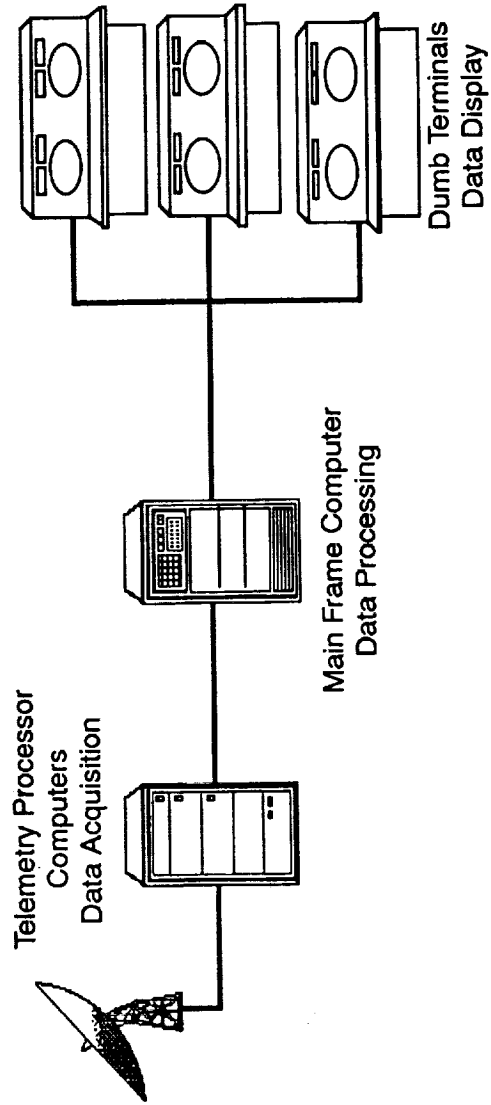

- Software
- Mostly Assembly Language

RTDSTechnologies

- Hardware

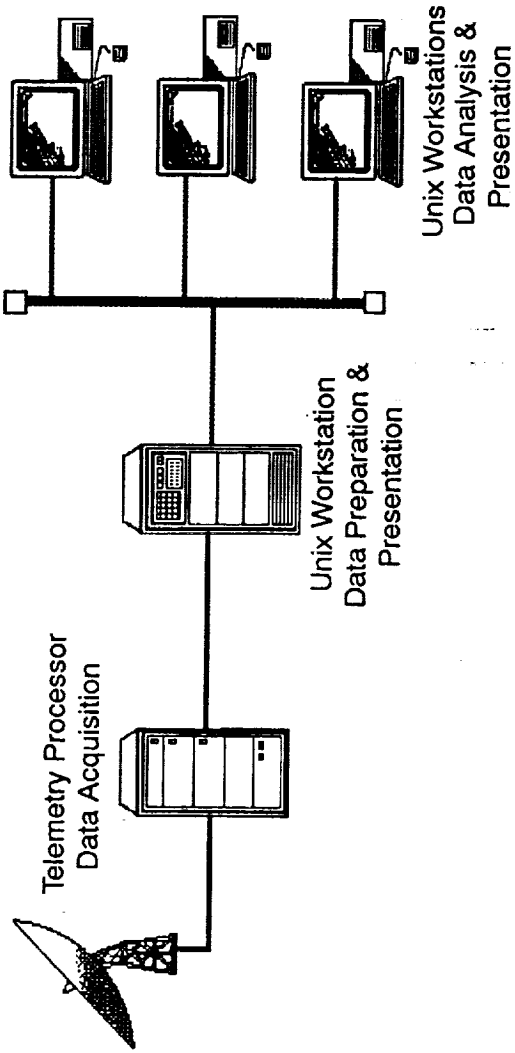

- Software

- Unix, C Language, X-Windows, MOTIF, G2 Expert System Tool

Show & Tell

- BOOSTER Main Engine Program
- BOOSTER Flight Controller (Tom Kwiatkowski)
- Jet-Control Expert System
- Fuel Cell Monitoring System (FCMS)
- Data Processing Systems Data Monitoring and Analysis Tool (DDMAT)
- DATACOMM Expert System

Growth of RTDS

- Road Map of Flight Control Disciplines
- RTDS Technology Deployment 1987-1989
- RTDS Technology Deployment 1990-1991

Road Map of Flight Control Disciplines

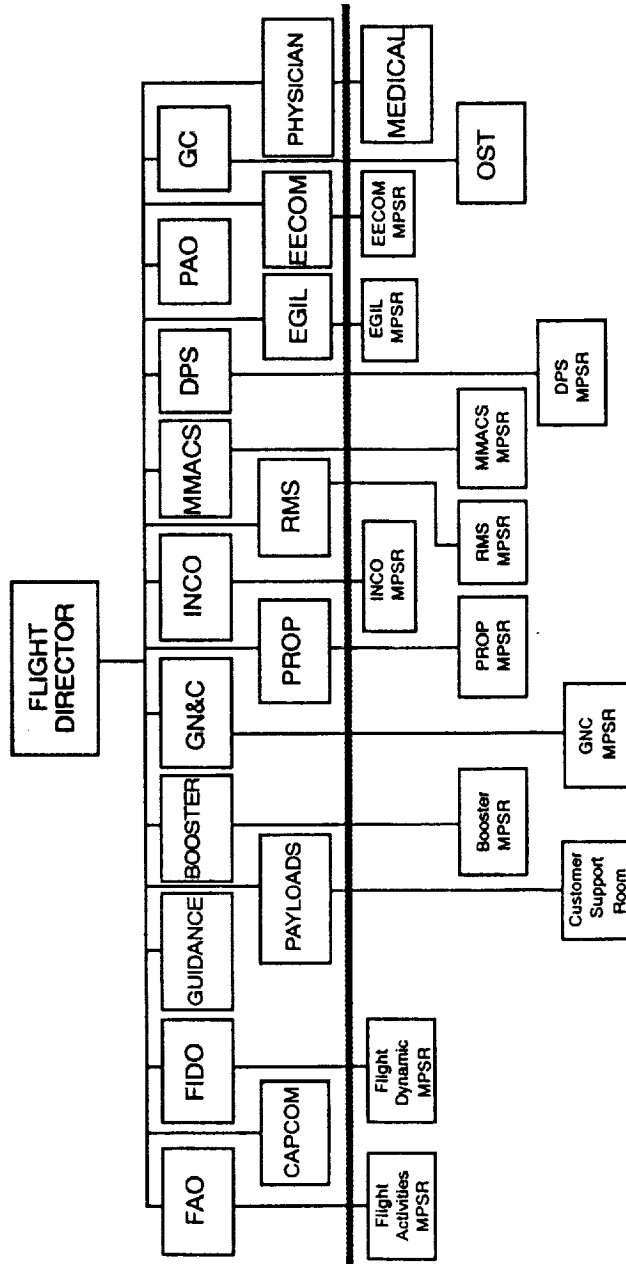

RTDS Technology Deployment 1987-1989

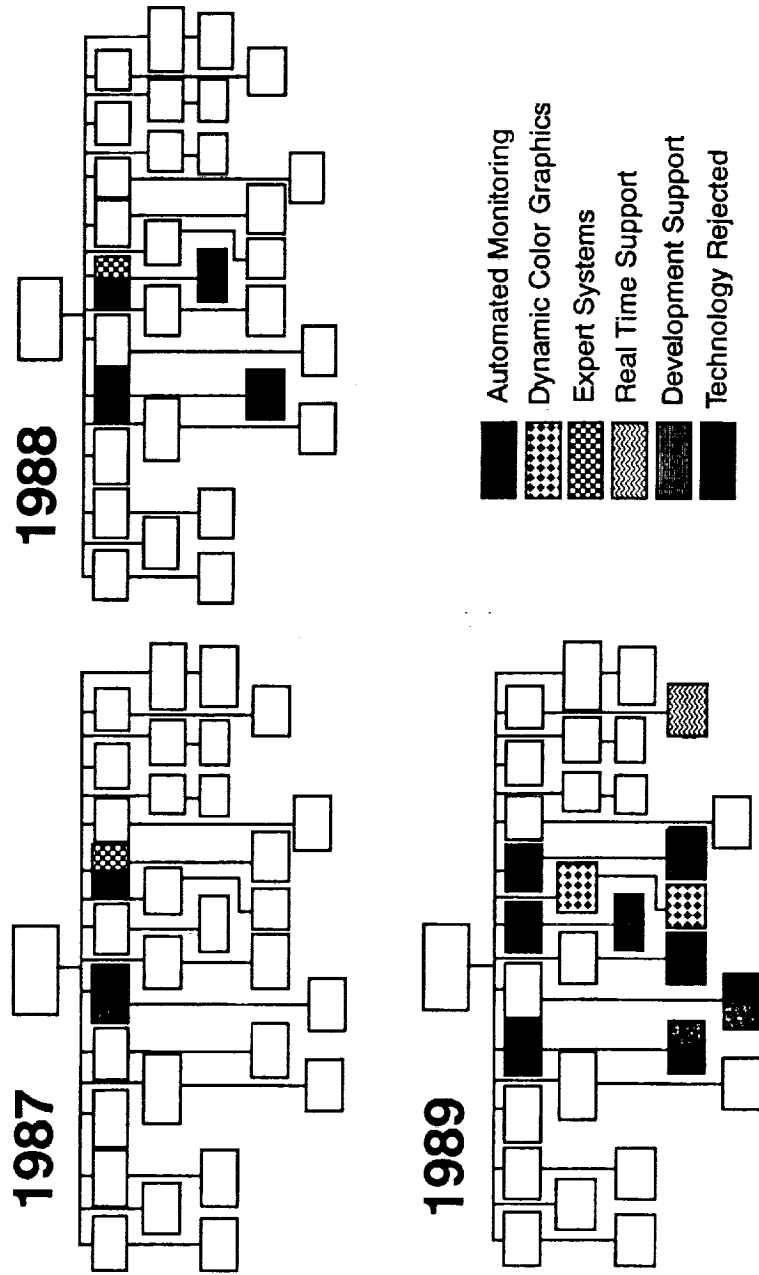

RTDS Technology Deployment 1990-1991



Side-by-Side Comparison

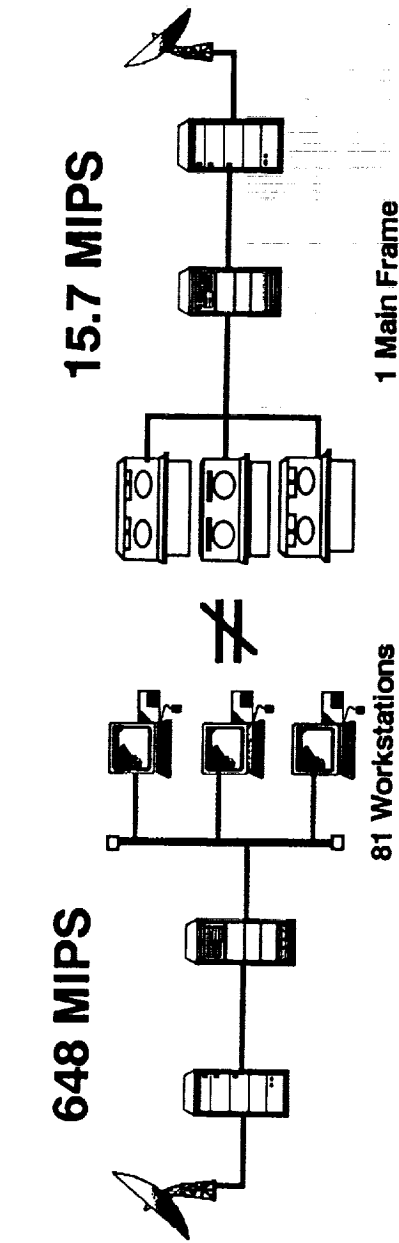

- They look similar, but they are very different...
- Iterative Prototyping vs. A-B-C Requirements
- Distributed vs. Centralized
- Open Systems vs. Proprietary Systems
 - RTDS will run on almost any Unix workstation
 - Makes GAO very happy!

Comparison of Functionality

	MAIN FRAME	WORKSTATION
SPECIALIZED PROCESSING	YES	YES
DATA DISPLAY	YES	YES
LIMIT SENSING	YES	YES
COLOR GRAPHICS	NO	YES
FAILURE DETECTION	NO	YES
EXPERT SYSTEMS	NO	YES
TOLERANT OF CHANGE	NO	YES
CONFIGURATION CONTROL	MATURE	POORLY UNDERSTOOD
YEARS IN USE	>20	5

TECHNOLOGY GAP

Technology Gap

- There is a 15-20 year technology gap between traditional main frame based systems in the Mission Control Center and newer workstation-based systems
- The goals remain the same; the functionalities of the systems are vastly different
- New technologies require different data system management philosophy
 - As our only frame of reference, history works against us
 - Imposing traditional data system management philosophies on new-technology systems limits efficiency gains

Technology Transfer in MCC

- In RTDS we are bridging the technology gap by providing portability to the Mission Control Center Upgrade (MCCU) workstations
- MCCU represents a large installed base of Unix based workstations lacking the advanced automation techniques and applications which have been developed and proven by RTDS over the past four years

Technology Transfer in MCC

- Phase I - Demonstrate Technology

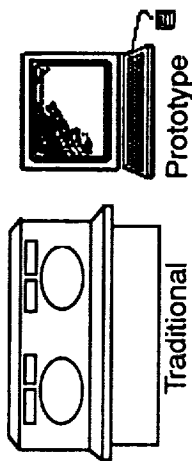

1987-1991

- Phase II - Transfer Successful Applications

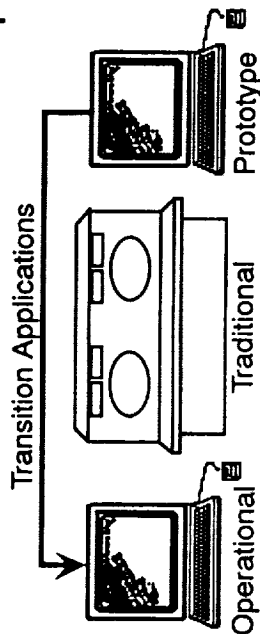

1991-1992

Technology Transfer in MCC

- Phase III - Remove Development Hardware

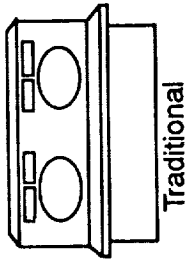
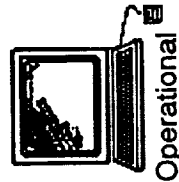

1992-1994

- Phase IV - Replace Traditional Main Frame Consoles

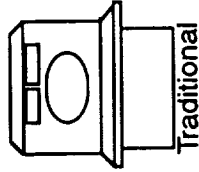

1994-1996

Questions Raised

- RTDS has enabled flight controller users to rapidly develop real-time support applications which are far superior to traditional console tools
- Development time has been cut from 2 years to less than 6 months, but
 - some applications could be considered mission critical
- **QUESTION:** Should users develop and maintain their own software?
-
-
-

Questions Raised

- Applications resulting from new technologies can be 'smart'
- Decision-making rationale is sometimes hidden with 'smart' systems
- Operators are less tolerant of machines than other humans
 - Examine the terminology:
 - Machine Error: BUG
 - Human Error: MISTAKE
- **QUESTION:** How much of our jobs do we trust to automation technologies?

Future Directions

- Provide RTDS in Office Environment (1991-1992)
- Cooperative Expert Systems (1991-1992)
- Technology Testbed (1992)
- Space Station Freedom (1991-?)

Provide RTDS in Office Environment (1991-1992)

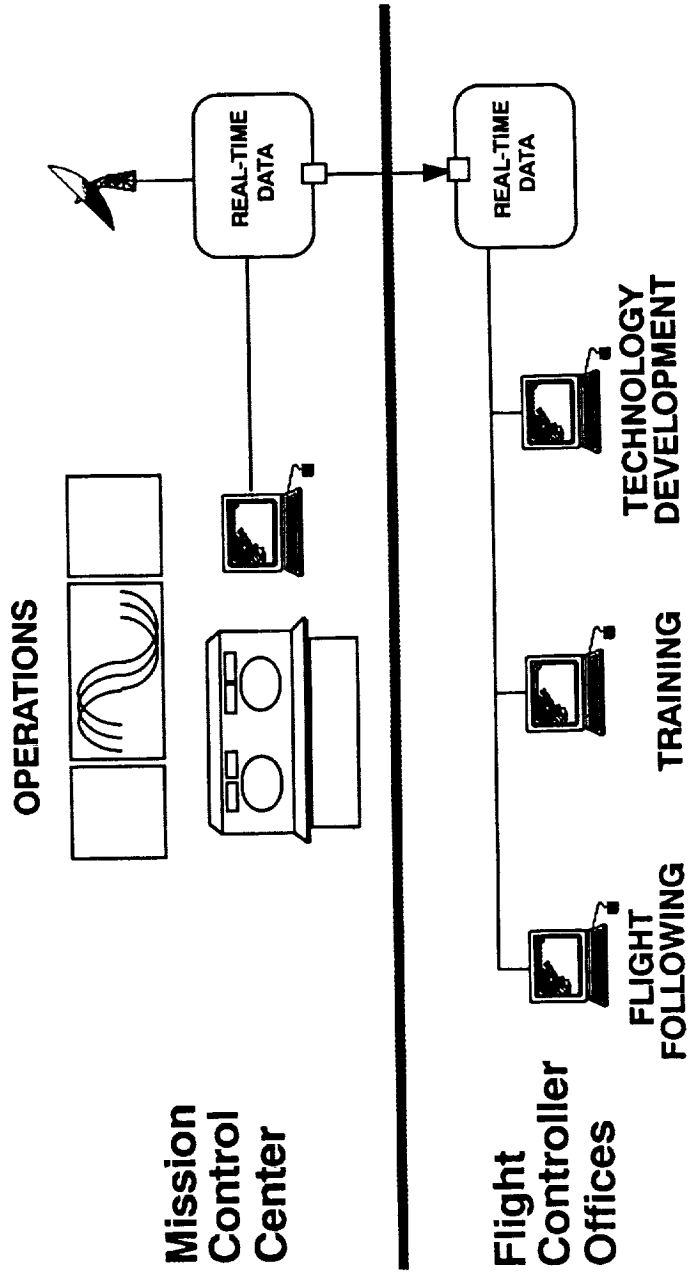

Cooperative Expert Systems (1991-1992)

- Three previously developed expert systems are being modified
- Model for cooperative system is flight control team
- The “You better be listening” model

Technology Testbed (1992)

- The Procedural Reasoning System is a promising expert system software tool developed by Stanford Research Institute (SRI) in cooperation with ARC
- PRS will be interfaced with real-time shuttle telemetry from RTDS and evaluated during simulations and missions
- ARC LAN-Link to RTDS
- Provide real-time data feed to AI researchers at ARC

Space Station Freedom (1991-?)

- Sammi-Fred has been chosen as the on-board Space Station Freedom display builder (X-Windows, Client-Server)
- Integrated Sammi-Fred display builder with real-time Shuttle telemetry
- RTDS is working with the Space Station Training Division to build stand-alone flight controller training capabilities similar to those produced for Shuttle by RTDS

Closing Thought

“Companies [Government Agencies] that are preoccupied with the present will always be on the defensive, playing catch-up. Companies [Government Agencies] that strive to look ahead will have a better chance of succeeding.”

Murray Weidenbaum, Director
Center for the Study of American Business
at Washington University
During keynote speech at ICA conference

INTENTIONALLY BLANK

**Solar Mesosphere Explorer Control Center
and
OASIS**

**Lessons Learned in Control Center Technologies
and Non-Technologies**

**Elaine R. Hansen
University of Colorado**

**for the
Control Center Technology Conference
June 18, 19, 20, 1991
University of Houston — Clear Lake
Houston, Texas**

CU 508845

516-14

39613

P 26

SME Control Center and OASIS: Lessons Learned in Control Center Technologies and Non-Technologies

— Outline —

- The Solar Mesosphere Explorer (SME) Mission
- Features of the SME Control Center: Technical and Non-Technical
- Can these features be applied to other missions?
- OASIS: Software tools to support some common Control Center functions

SME Mission Operations Functions (simplified)

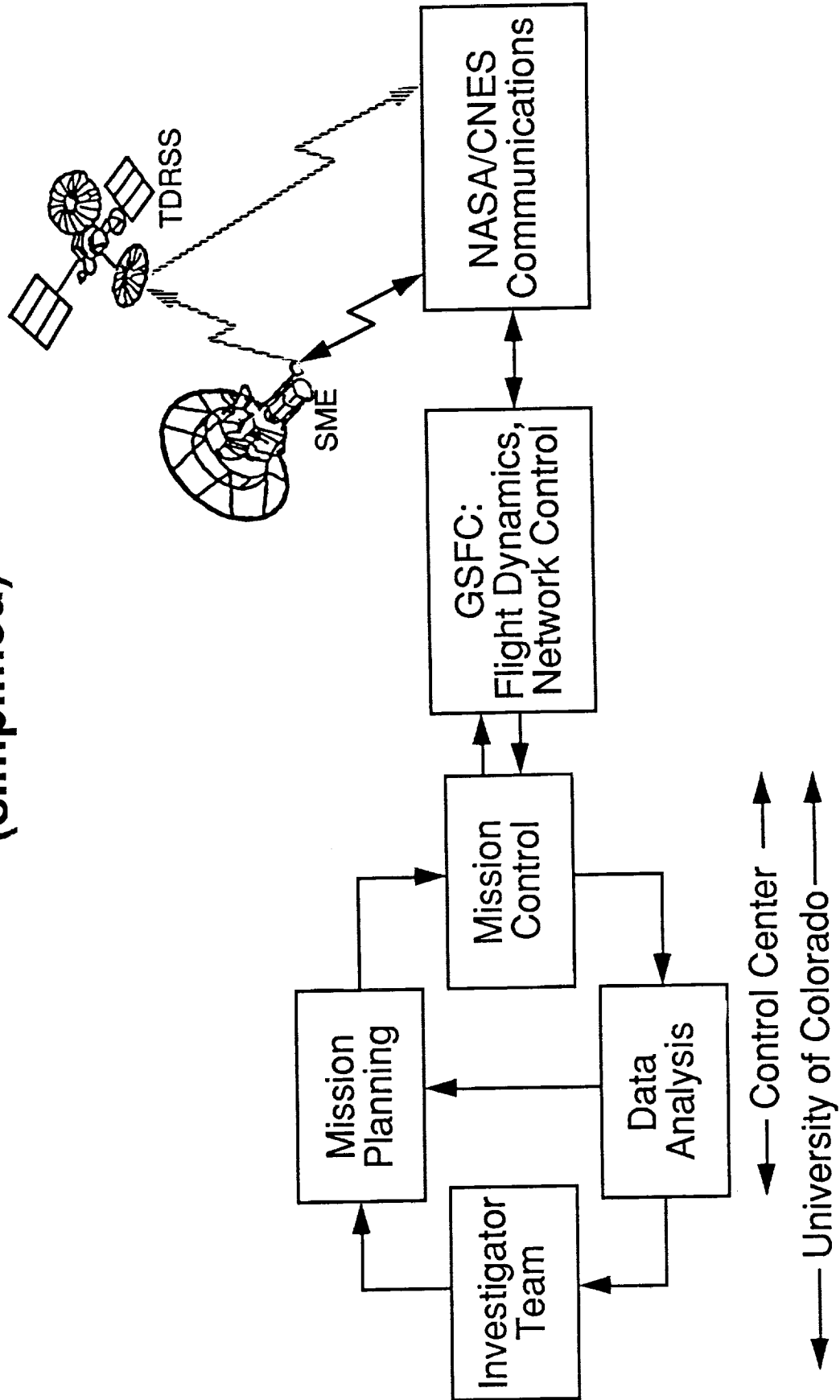

SME Control Center and OASIS: Lessons Learned in Control Center Technologies and Non-Technologies

— The Solar Mesosphere Explorer (SME) Mission —

Characteristics:

- To determine what causes ozone variations in our upper atmosphere
- A coordinated set of measurements
- Interactive science operations
- Realtime, quicklook, and in depth analysis
- Control Center located at University of Colorado - Boulder

SME Control Center and OASIS: Lessons Learned in Control Center Technologies and Non-Technologies

— The Solar Mesosphere Explorer (SME) Mission —

Results:

- Low cost: spacecraft, six science instruments, the entire ground data system, and one year of post launch operations for \$17M
- Accomplished on schedule, within budget
- Strong personnel motivation
- All mission objectives met
- Control center performed well over the 7 1/2 year mission lifetime

SME Control Center and OASIS: Lessons Learned

— Features of the SME Control Center: Technical and Non-Technical —

1. University Based
2. Student Participation
3. Project Management
4. Integrated Design/Systems Design
5. Common Tools for Common Functions
6. Continuity over Project Lifecycle
7. Human Factors

— Technical and Non-Technical Features of SME Control Center —

1. University Based
 - Scientists and engineers able to work at their home institutions
 - Able to demonstrate advantages of "telescience" and "teleoperations"
 - Freedom to maintain and enhance system in response to changing mission, insights, and available technologies

— Technical and Non-Technical Features of SME Control Center —

2. Student Participation
 - Major contributors to control center
 - 10 - 25 Undergraduate students per term
 - 2 - 4 Graduate students per term
 - Variety of responsibilities
 - Controllers
 - Analysts — science and mission
 - Planners — science and mission
 - Teachers and tour guides
 - Programming assistants
 - Advanced development
 - Providing perpetual motivation and ideas for enhancement
 - Invaluable educational experience

— Technical and Non-Technical Features of SME Control Center —

3. Project Management — JPL
 - Development teams motivated for on-orbit performance
 - Award fee
 - Science pay-off
 - Continuing operations responsibility
 - Therefore, it was beneficial to
 - Help other teams
 - Maintain full and open communications between teams
 - Develop a reliable, usable, and maintainable operations system
 - Reveal and correct problems early
 - Early involvement by control center designers
 - Encouraged system level trades
 - Between science, instruments, spacecraft platform, control center, analysis system
 - To increase efficiency, reliability, capability and eliminate frills - with no effect on science objectives
 - Simple interfaces between elements
 - Project Management supportive of new operations approaches

— Technical and Non-Technical Features of SME Control Center —

4. Integrated Control Center Design
 - OK to develop *new* control center designs and tools
 - Top-down design approach
 - Based on science objectives and project requirements
 - For end-to-end (user-to-instrument) operations
 - For full lifecycle of operations support from early instrument tests through on-orbit operations
 - Functional elements defined from functional requirements
 - Functional interfaces to facilitate information exchange among elements
 - Functional elements arranged to minimize information interfaces
 - Processes and needs common to multiple elements identified
 - Common tools implemented
 - These tools duplicated for use in multiple elements

Technical and Non-Technical Features of SME Control Center

5. Common Tools for Common Functions
 - Evident in continuing mission that even more control center functions are actually common and could be accomplished by common tools
 - Evident that these common functions are not unique to SME Mission but are part of essentially all missions

General Tasks & Objects Within SSF Ground System Nodes

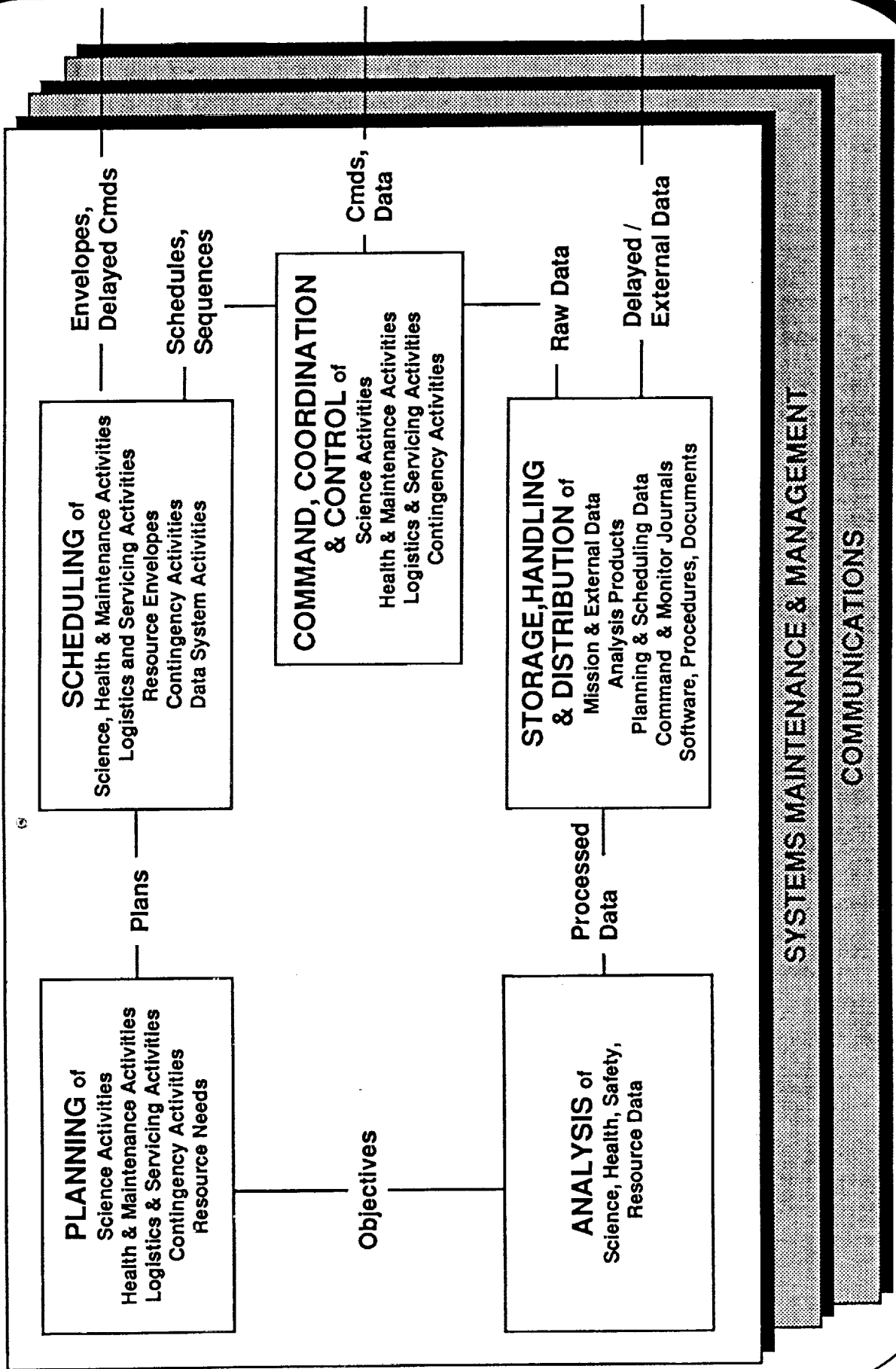

PLANNING of

Science Activities
 Health & Maintenance Activities
 Logistics & Servicing Activities
 Contingency Activities
 Resource Needs

Accept External User Inputs
 Present Planning Information
 Integrate Requirements
 Modify Requirements
 (Re)Submit Plan Inputs
 Modify Plan Inputs
 Integrate Plan Inputs
 Translate Activities to Resource Needs
 Provide Data Security

COMMAND, COORDINATION & CONTROL of

Science Activities
 Health & Maintenance Activities
 Logistics & Servicing Activities
 Contingency Activities

Accept Resource Envelope Information
 Receive Data
 Provide for Command Authorization
 Provide for Interlocks
 Accept Commands
 Check Commands
 Present Commands and Controls
 Initiate and Relay Commands
 Automatically Initiate and Relay Commands
 Verify Command Acceptance and Execution
 Relay G/A Voice, Video
 Check Science, Health, Ancillary and Resource Data
 Present Science, Health, Ancillary and Resource Data
 Monitor A/G Voice, Video
 Troubleshoot Anomalies
 Initiate and Relay (manually or automatically)
 Contingency Response Commands, Auto Sequences, Memory Loads, Rescheduling Requests
 Support Coordinated Campaign Operations
 Provide Data Security
 Provide Command and Monitor Journals
 Provide Planning Input

STORAGE, HANDLING & DISTRIBUTION of

Mission & External Data
 Analysis Products
 Planning & Scheduling Data
 Command & Monitor Journals
 Software, Procedures, Documents

Capture Data (raw and processed)
 Process Data to Level Zero
 Check Data Quality
 Route Data
 Produce Standard Data Products
 Store Data
 Archive Data
 Catalogue Data
 Provide Data Access
 Present Data Management and Distribution Processing Summary
 Provide Data Security

SCHEDULING of

Science, Health & Maintenance Activities
 Logistics and Servicing Activities
 Resource Envelopes
 Contingency Activities
 Data System Activities

Access Planning, Scheduling Data
 Present Activity Timeline Information
 Present Resource Timeline Information
 Determine Resultant Resource Needs
 Develop Timelines
 Integrate Timelines
 Iterate Timelines
 (Re)Submit Timelines
 Perform Conflict Resolution
 Develop Command Sequences
 Relay Resource Envelope Information
 Relay Timelines and Resource Information

SYSTEM MAINTENANCE & MANAGEMENT of

Hardware, Software, Databases,
 Procedures, Documents,
 Personnel (Ops, Crew and Science)

Provide Development Services
 Provide Test, Training and Simulation Services
 Update and Enhance Systems
 Provide for Systems Test and Verification
 Provide Configuration Management
 Present Configuration Management Reports

ANALYSIS of

Science, Health, Safety,
 Resource Data

Access, Select Data
 Format, Manipulate Data
 Generate Data Products
 Present Analysis Information
 Store Processed Data
 Provide Data Security
 Provide Planning Input

General Task Functions Within SSF Ground System Nodes

Level of Commonality (by a grass roots evaluation)

<u>Task</u>	<u>Hardware</u>	<u>Software</u>	<u>Procedures</u>	<u>People</u>	<u>Average</u>
Command, Control & Coordination	4	4	3	1	12
Storage, Handling & Distribution	4	3	3	1	11
Scheduling	4	3	2	1	10
Planning	4	3	2	1	10
Analysis	4	2	2	1	9
System Maintenance & Management	3	1	1	1	6

Commonality is defined as extent to which this task/function can be accomplished by a common set of hardware, software, or procedural tools or by people.

4 = Almost always

3 = Generally

2 = Sometimes

1 = Hardly ever

— Technical and Non-Technical Features of SME Control Center —

6. Continuity over project lifecycle
 - Since common functions needed through lifecycle, a single operations system used throughout project lifecycle (prelaunch test, calibration, integration, and in-flight operations)
 - Benefits include:
 - Thorough and early system-level verification of the system hardware, software, procedures, facilities and personnel readiness
 - Early and continuing training
 - Control center bugs and enhancements determined and implemented early
 - Early test of the critical interfaces between major systems
 - Early and full access to capabilities of full operations system
 - Benefits in cost, schedule, reliability, and usability

Continuity Between Phases of SME Project Lifecycle is Maintained

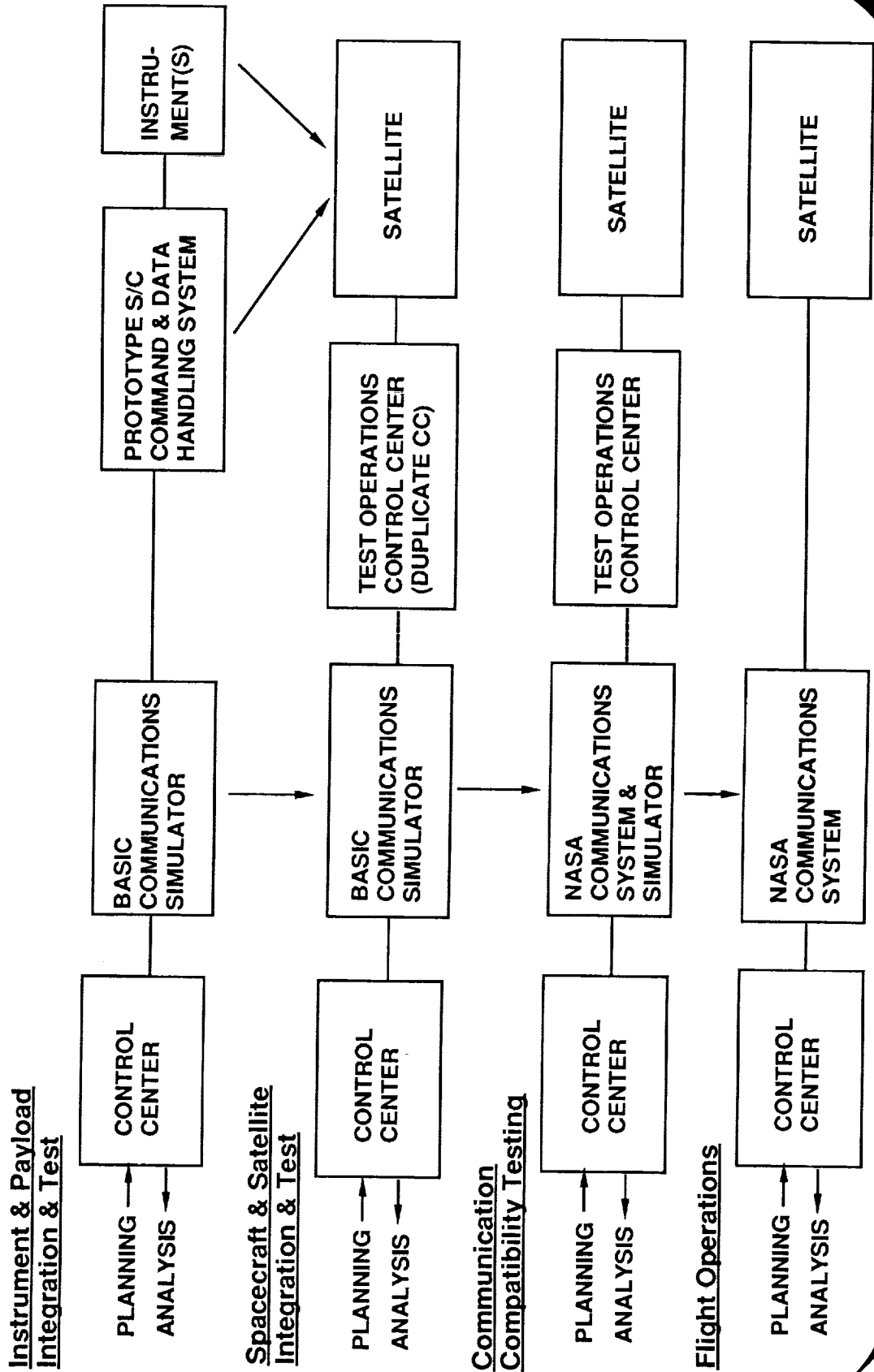

— Technical and Non-Technical Features of SME Control Center —

7. Human Factors

Control center elements composed of the following layers:

- People, user interfaces, facilities, procedures, software, and hardware
- People layer:
 - Defines people's roles and needs
 - Drives design of deeper layers
- SME users wanted to interact with the control center without going through intermediate programmers
 - Through interactive English-like languages and menus
 - Through user-specified, graphic displays
- Users preferred automation of tasks that are:
 - Predictable, routine, repeated, computational, critical, or potentially hazardous
 - But wanted ability to monitor most activities

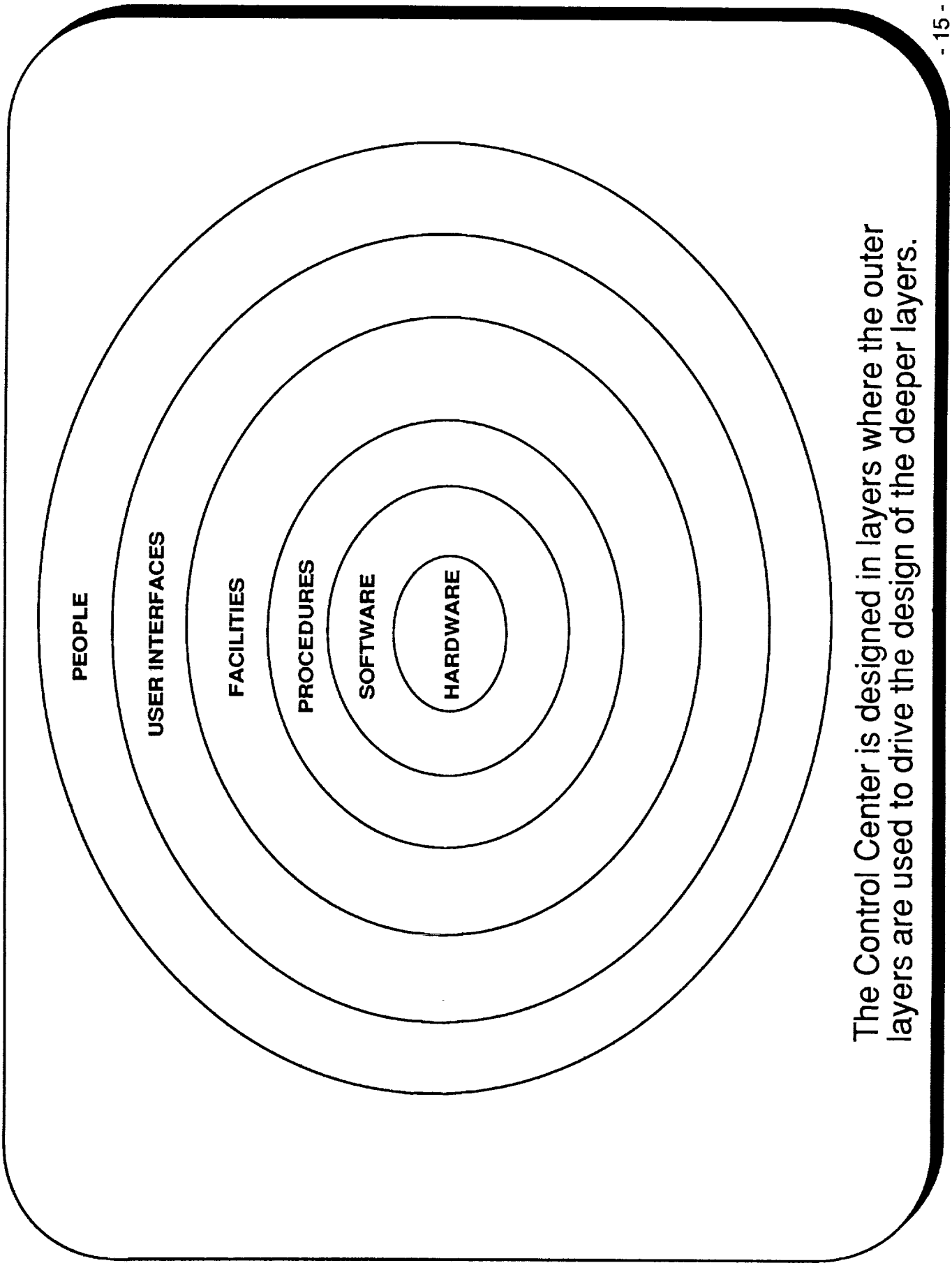

The Control Center is designed in layers where the outer layers are used to drive the design of the deeper layers.

SME Control Center and OASIS: Lessons Learned — Can These Features be Applied to Other Missions? —

Feature	Applicability
1. University Based	<ul style="list-style-type: none"> • Yes, if appropriate • Telescience/teleoperations/distributed operations approaches enable capabilities at user nodes
2. Student Participation	<ul style="list-style-type: none"> • Great if possible
3. Project Management <ul style="list-style-type: none"> • Motivation • Early involvement • Systems trades • Simplify interfaces • Supportive of change 	<ul style="list-style-type: none"> • Yes!
4. Integrated Design/Systems Design	<ul style="list-style-type: none"> • Yes! Seen as a major deficiency in current missions

5. Common Tools for Common Functions

- Yes, a major opportunity for lowering costs and increasing reliability
- Biggest payoff at hardware and software layers
- Little payoff in personnel and procedural layers
- Results in interoperability between missions, within a mission, and throughout a mission's lifecycle

6. Continuity over Project Lifecycle

- Yes, can see no technical or financial reason for not following

7. Human Factors

- Layered design to optimize work environment

OASIS Realtime Control and Monitoring Package "OASIS-RT"

- OASIS-RT allows scientists and engineers to control and monitor space instruments and subsystems throughout the entire project lifecycle
- OASIS-RT provides capabilities similar to those found in large spacecraft operations systems
- OASIS-RT is flexible and can be tailored to a particular application with no software changes
 - Procedures written by users in high level language
 - Spacecraft capabilities defined by database tables
 - User interface specified by database tables
- Ties with external diagnostic packages, analysis packages, etc.
- Coded in Ada

OASIS is Useful Throughout the Project Lifecycle

- During instrument test (connected directly to instrument)

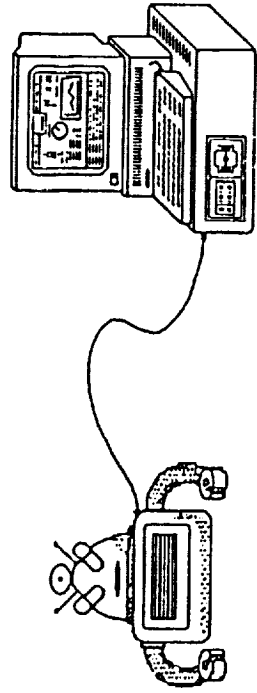

- During systems integration and test (connected to remote test systems)

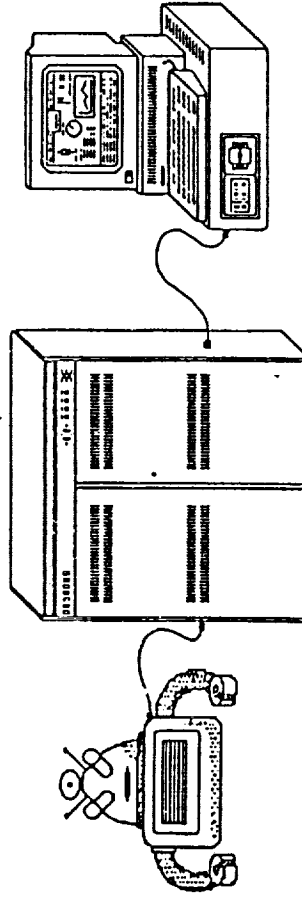

- During on-orbit operations (connected to remote project data systems)

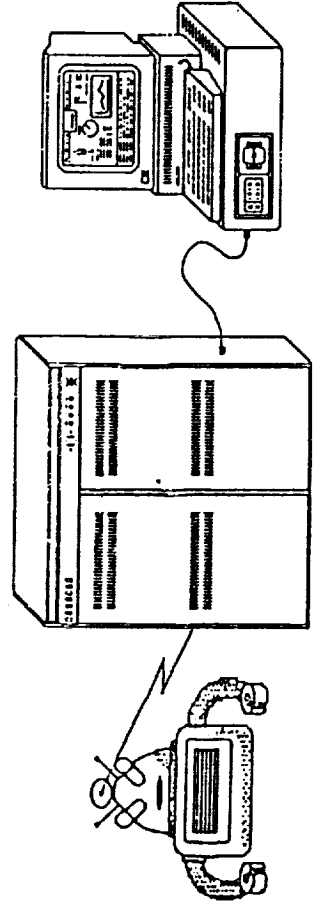

How OASIS is Organized

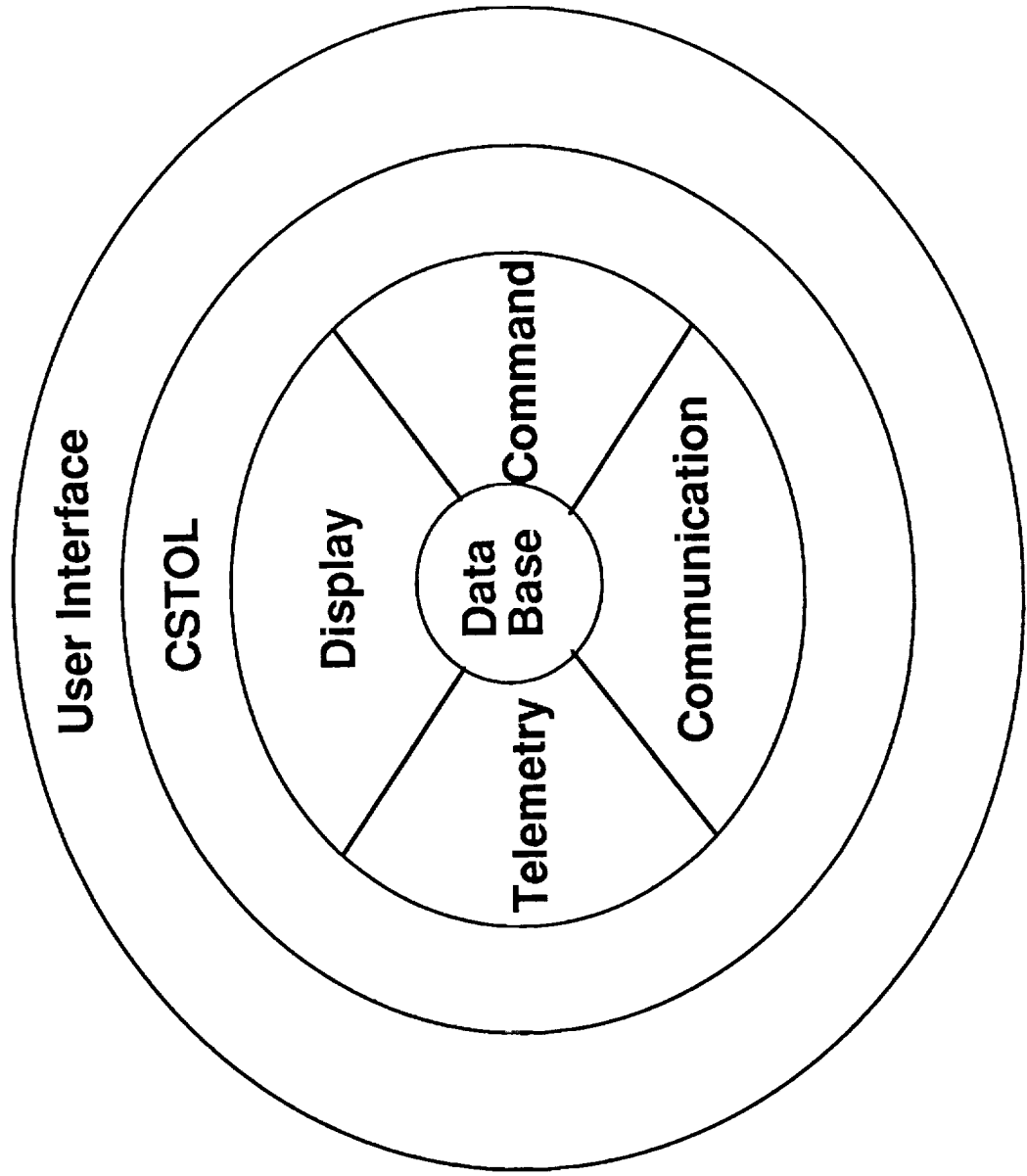

OASIS — Planning and Scheduling Package "OASIS-PS"

- OASIS-PS allows scientists and engineers to plan and schedule experiments and subsystem activities throughout a program
- Case-based planning and scheduling system
 - Core systems independent of application
 - Designed to accept application-specific code
- Provides planning and scheduling in appropriate context for user
 - Application specific windows interact with scheduling components
 - Application specific database tables accessible by all components
- User defined "schedulers" attached to any scheduling timeline
 - Can have any type of scheduler tool, ie., expert system, heuristic, algorithmic, etc., working on a specific timeline in concert
 - Can have many different schedulers working at once
- Application driven communications protocol
- Coded in Ada

OASIS-PS Architecture

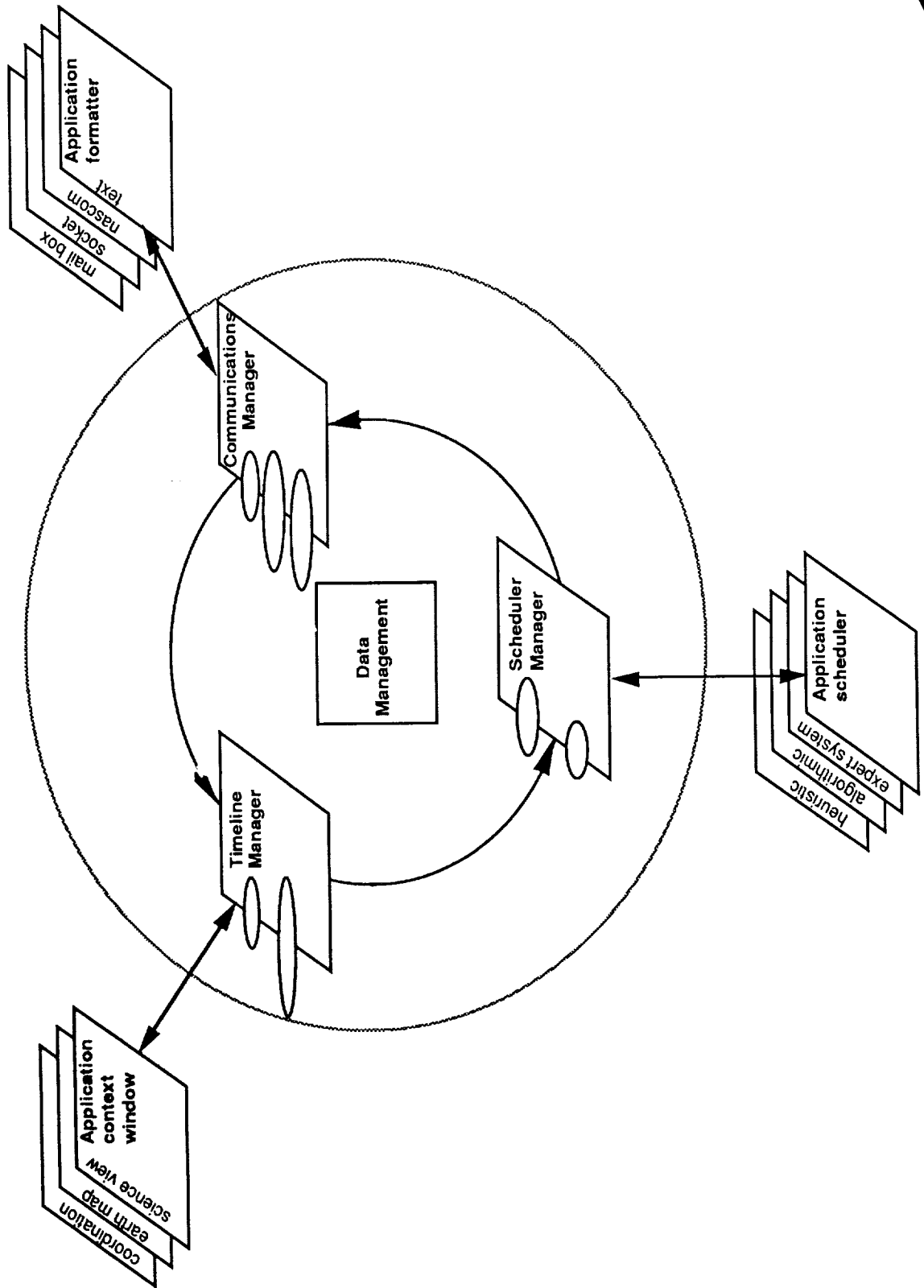

Summary

- Lessons learned from SME are indeed applicable to range of future missions
- Both technical and non-technical lessons are important
- Largest deficiency in today's systems seems to be a lack of an integrated systems perspective
- Software toolsets are available today to support some of these common control center functions

**CONTROL CENTER
TECHNOLOGY CONFERENCE**

**MacSPOC: Orbital Trajectory Calculations
On A Laptop Computer**

Presented by Dan Adamo
June 19, 1991

517-14
N92-12027
3/6/91
P-11
ND185000

TOPICS

LAPTOP COMPUTING IN THE SPACE SHUTTLE PROGRAM

CURRENT LAPTOP PROTOTYPING WITH MacSPOC

FUTURE LAPTOP APPLICATIONS

SUMMARY

SPACE SHUTTLE LAPTOP USE BEGAN ONBOARD

BEFORE STS-9 (November 1983 Launch):

- Laptop computer technology was commercially unavailable
- Crew had no orbital position display

ENTER THE SHUTTLE PORTABLE COMPUTER (SPoC)

- Host = GRiD Compass laptop 8086/7
- Proprietary GRiDOS operating system
 - Data entry via menus and forms
 - Primitive windowing capabilities
- World Map application
 - Current Shuttle location and ground track
 - Event timers (sun rise/set, AOS/LOS, etc.)
 - Fixed-format displays
- Crew queries to Mission Control substantially reduced

A PROTOTYPING EFFORT IS IN WORK TO ADVANCE SPOC CONCEPTS

UTILIZE COTS MACINTOSH PORTABLE COMPUTER

- Mature and intuitive graphic user interface
- Applications can address up to several MB RAM
- Reasonably fast 16 Mhz 68000 (no co-processor)
- Cooperative multi-tasking possible
- Minimal safety-of-flight hardware modifications required

DEVELOP MacSPOC APPLICATION

- SPOC = Spacecraft Personal Orbit Computations
- Demonstrate efficient data entry
- Demonstrate reconfigurable display format
- Demonstrate background display updates
- Demonstrate advanced earth observation (EOBS) capabilities
- Demonstrate accurate maneuver and aero drag modeling

MacSPOC RESULTS ARE ENCOURAGING

DETAILED TEST OBJECTIVE (DTO) 1206 COMPLETED

- Inaugural in-flight test during STS-41 (October 1990 launch)
- No anomalies encountered
- Crew requested enhanced attitude-dependent EOBS displays
 - Maintain attitude time line (ATL) onboard
 - Increase world map resolution 10-fold from current 33 nm

DTO 1208 ENHANCEMENTS NEARING READINESS

- In-flight test during STS-43 (July 1991 launch)
- MacSPOC ZoomMap ground testing complete
 - Resolution = 3 nm with $\pm 60^\circ$ latitude coverage
 - Total MacSPOC RAM = 2.6 MB
- Periodic trajectory, maneuver, and ATL uplinks via modem

ONBOARD PORTABLE COMPUTING IS COMING OF AGE

MacSPOC SUCCESS HELPS VALIDATE OTHER EFFORTS

- SPoC rehost to Unix and X-Windows
- Laptop software proliferation at Mission Control
- Emergency Mission Control applications
- Education and public relations

POSSIBLE FUTURE ADVANCEMENTS

- Macintosh laptop w/ 6888x co-processor: 100x more speed
- Expanded ZoomMap landmark database with annotation
- Rendezvous relative motion graphics display
- Space Shuttle TAEM and Landing proficiency trainer
 - Demonstrate real time man-in-the-loop capability
 - Provide piloting practice during extended duration flights

EFFICIENT DATA ENTRY

Edit Liftoff GMT			
Year	DOY or MM-DD	Hr	Min. Sec.
1991	154	0	0 .000

Edit M50 State Vector			
Year	DOY or MM-DD	Hr	Min. Sec.
1991	155	0	0 .000
X (Kft)	Orbit #	X (Kfps)	
21127.469	17	1.045089	
Y (Kft)		Y (Kfps)	
-5746.236		14.118448	
Z (Kft)		Z (Kfps)	
2817.149		20.927714	

RECONFIGURABLE DISPLAY FORMAT

File Edit Displays Update Commands

MacSPDC v1.2 @ MacSPDC.cp Checkpoint Default Inputs

MET
000/23:56:45

Sun	Set=-0:52:57
-----	--------------

Pos	Lat= 4.01°S
	Lon= 86.72°E
	Alt= 189.4nm
	Orb # 16

BACKGROUND DISPLAY UPDATES

MacSPOC v1.2 @ MacSPOC.cp Checkpoint Default Inputs

MET

000/23:59:04

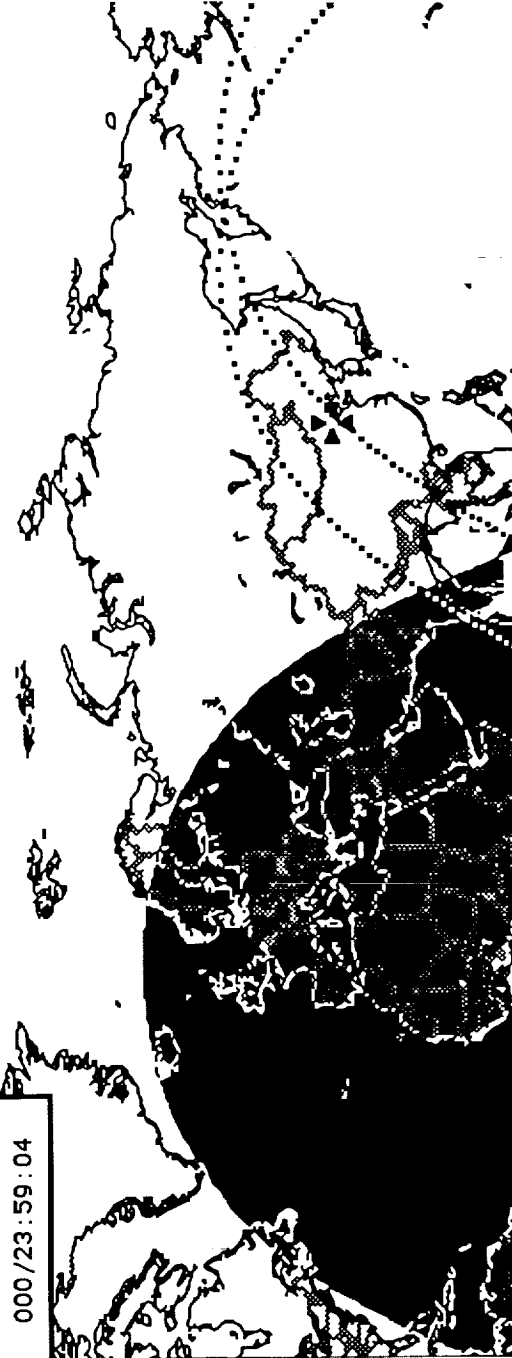

HD40:MMCV3.2:Earth Obs

SILJN Siljan, Sweden	61.020	14.520	12
DELEN Dellen, Sweden	61.550	16.390	12
SAAR Saarksjarvi, Finland	61.250	22.230	12
LAPP Lappajarvi, Finland	63.090	23.420	12
JANIS Janisjarvi, USSR	61.580	30.550	12
KARA Kara & Ust-Kara, USSR	69.010	64.250	12
ZAMSN Zhamsnshin, USSR	48.210	60.580	12
BIGCH Bigach, USSR	48.340	82.010	12
POPIG Popigai, USSR	71.350	111.000	12
ELGYT Elgytgn, USSR	67.300	172.050	12
TOTAL	82.530	115.230	12

PELINA, China

I

ADVANCED EARTH OBSERVATION CAPABILITIES

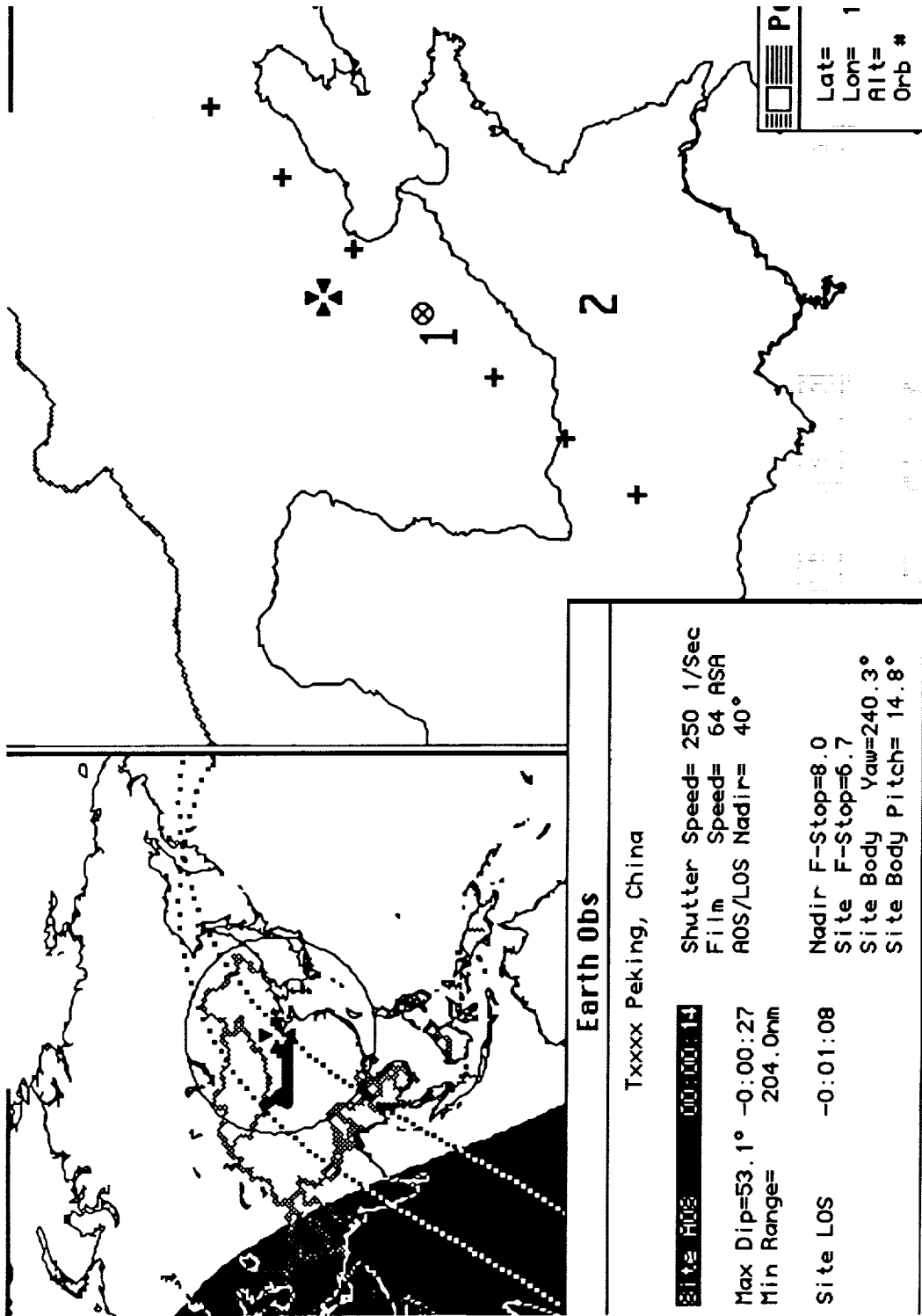

 Pi
 Lat=
 Lon= 1
 Alt=
 Orb #

ACCURATE MANEUVER AND AERO DRAG MODELING

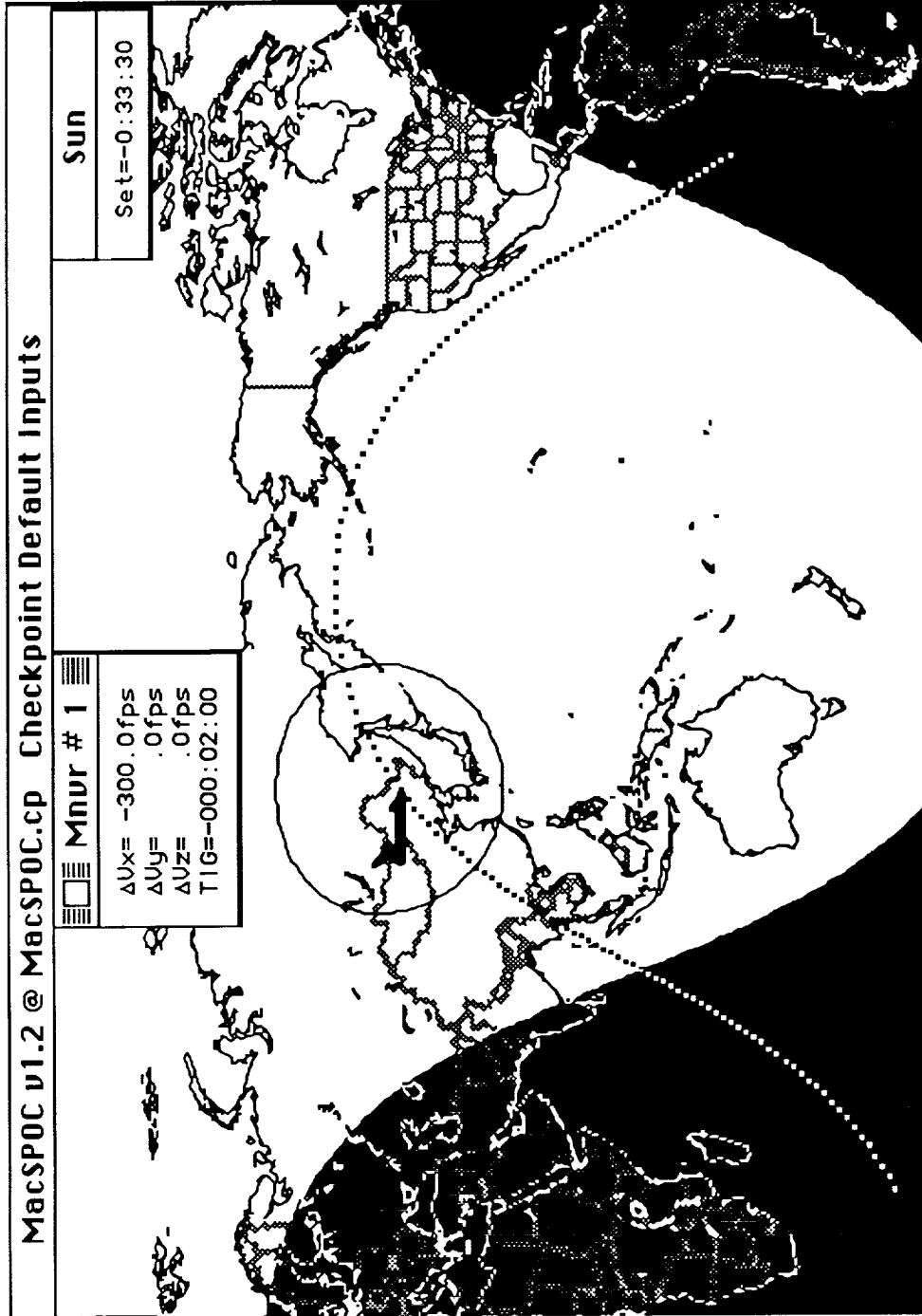

INTENTIONALLY BLANK



Data Systems
Technology
Division
520

Advanced Technologies for Mission Control Centers

Control Center
Technology
Conference
June 18-20, 1991

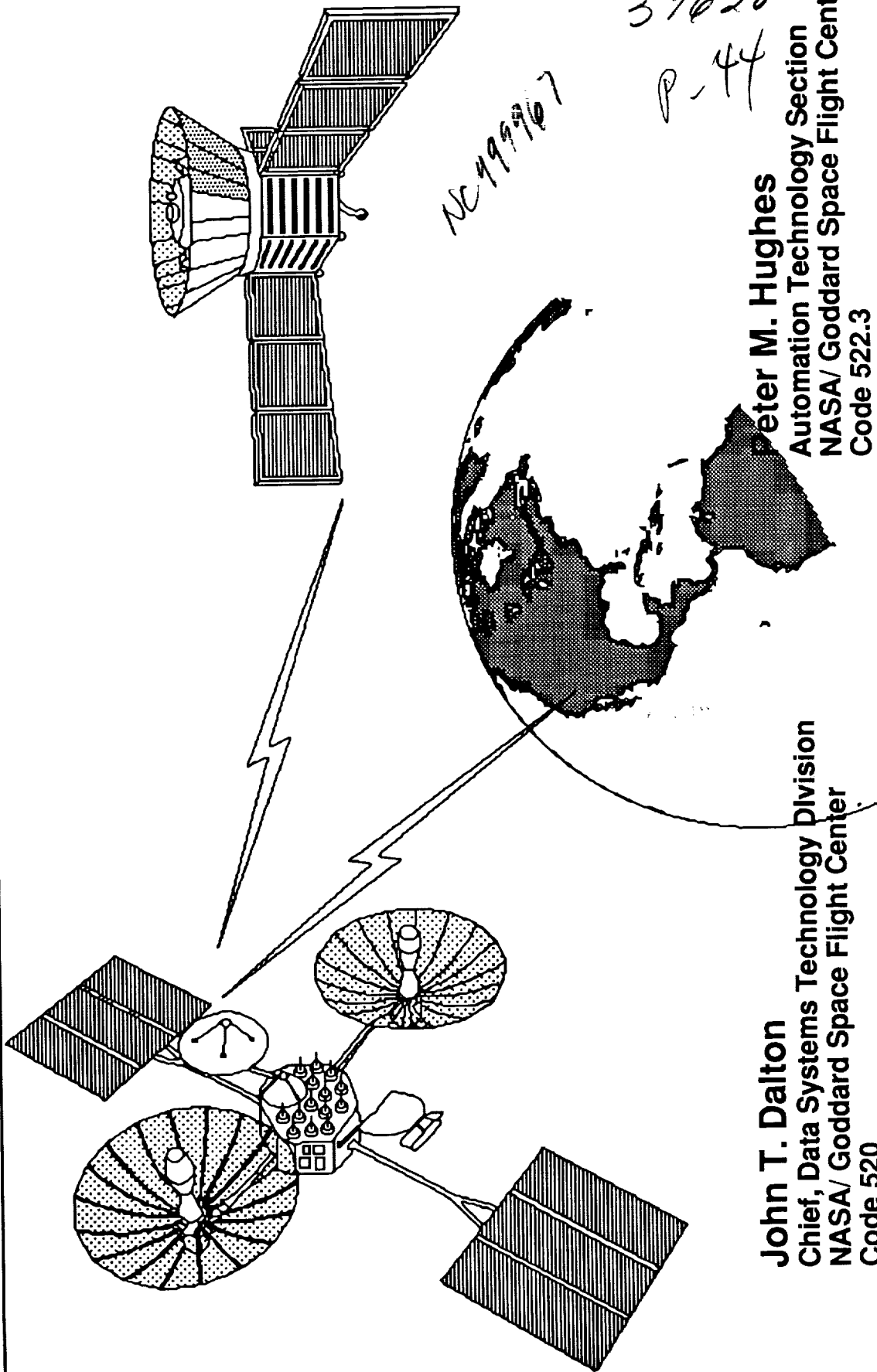

John T. Dalton
Chief, Data Systems Technology Division
NASA/ Goddard Space Flight Center
Code 520
Greenbelt, Maryland 20771

Peter M. Hughes
Automation Technology Section
NASA/ Goddard Space Flight Center
Code 522.3
Greenbelt, Maryland 20771

N924812028

39620

P-44

NC 999967



Data Systems
Technology
Division
520

Agenda

Advanced
Technologies
for
Mission
Control Centers

- I. Technology Needs
- II. Current Technology Efforts at GSFC
 - Human/machine interface development (TAE+)
 - Object-oriented software development (CMS)
 - Expert Systems
 - Real-time fault isolation ES (CLEAR)
 - ES Devel. Envir. for Spacecraft Analysts (GenSAA)
 - ES Devel. Methodology (ESDM)
 - Knowledge-Based Software Engineering Environments
 - High Performance VLSI Telemetry Systems
- III. Test Beds
 - SCAN
 - GOTT-POCC



Data Systems
Technology
Division
520

Technology Needs

Advanced
Technologies
for
Mission
Control Centers

- **Reduce development and operations costs of control centers**
- **Support higher data rates (SSF, EOS, etc.)**
- **Provide architectures to cost-effectively support multiple missions**
- **Improve flexibility of mission science and spacecraft operations**
- **Maximize operator effectiveness by applying human factors and automation technology**



Data Systems
Technology
Division
520

Technology Overview

Advanced
Technologies
for
Mission
Control Centers

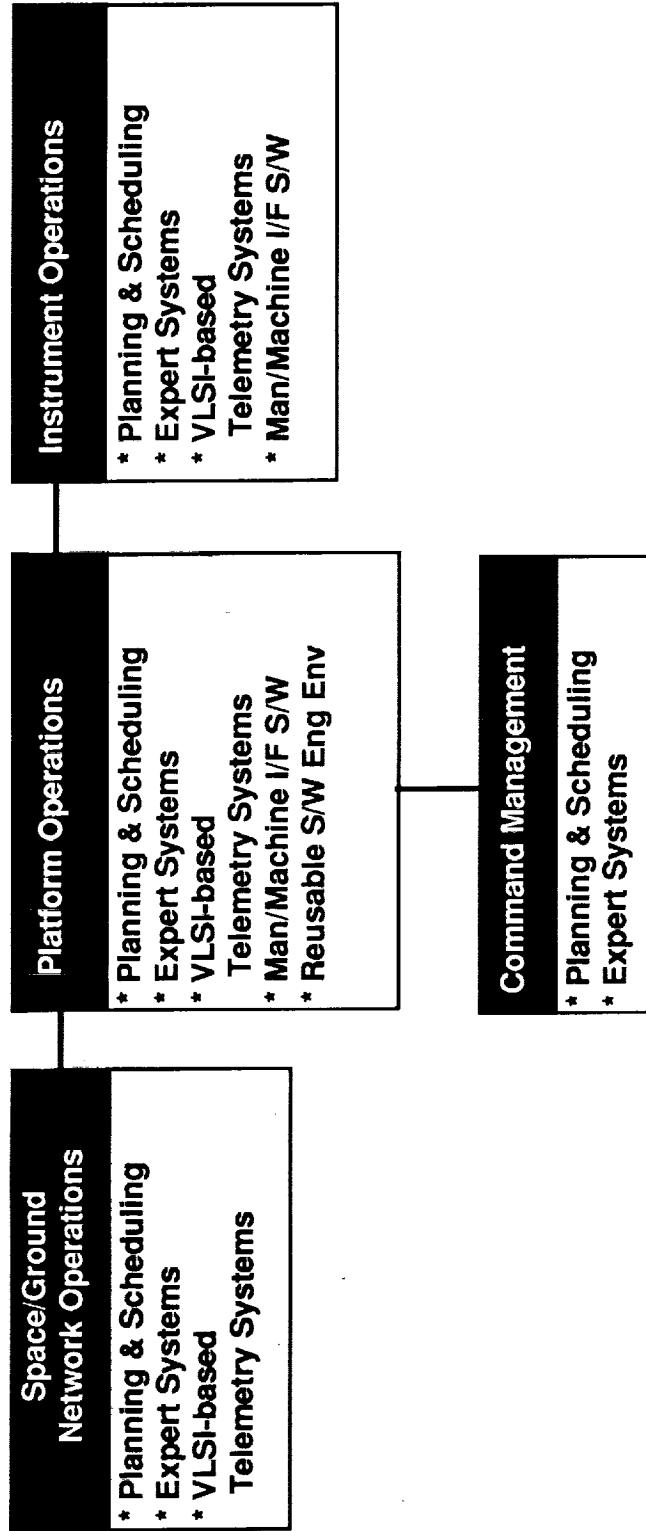

Distributed Planning & Scheduling



Data Systems
Technology
Division
520

Transportable Applications Environment Plus (TAE+)

Advanced
Technologies
for
Mission
Control Centers

Description:

Portable user interface development and management system

Objectives:

- **Separate the user interface from the application**
- **Provide the capability to design X-based user interface displays using direct manipulation techniques**
- **Provide capability to interactively modify the user interface elements without affecting the application s/w**
- **Provide application programs with runtime services to control user interfaces**
- **Evolve from rapid prototype to baseline system**
- **Facilitate portability of applications across graphic workstations**



Data Systems
Technology
Division
520

TAE's Software Architecture

Advanced
Technologies
for
Mission
Control Centers

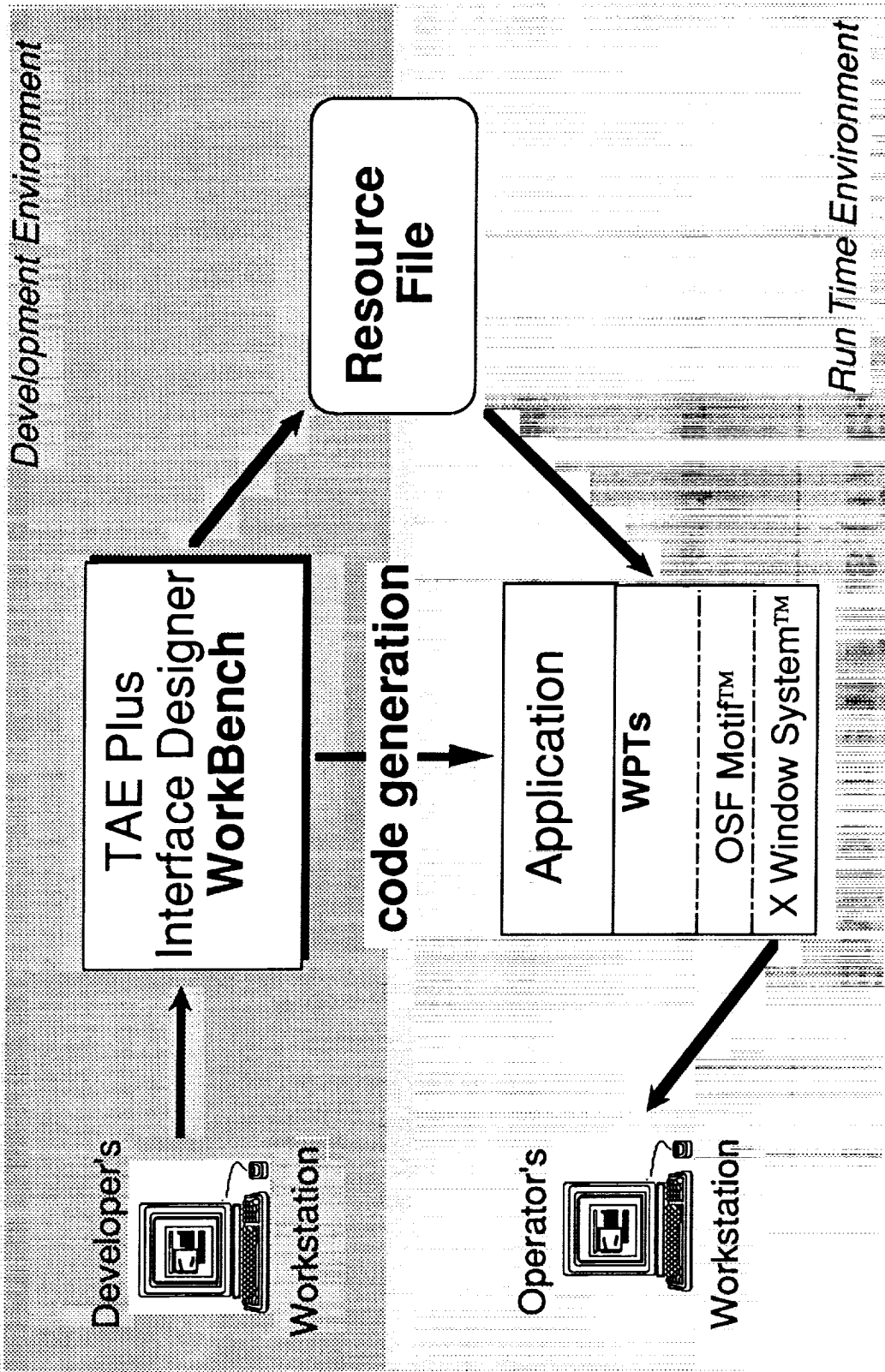



Data Systems
Technology
Division
520

Examples of TAE Items

Advanced
Technologies
for
Mission
Control Centers

Presentation Types Demo

All Presentation Types (except DDO's)

Selection Category:

- Checkbox
- Radio Buttons**
 - WABC WNBC
 - WCBS WWRP
 - WWII
- Scale (Slider)** 742
- Push Button**
- Pull-down Menu**
- Selection List**
 - choice 1
 - choice 2
 - choice 3
 - choice 4
 - choice 5
- t.a.e. icon with label**

Text Category:

- CAUTION:** Getting hot: 742
- KeyIn** 123456789
- Label** (can be multi-line)
- Multi-Line Edit**

This item accepts multiple You can constrain the input Scrollbars are optional.
- Text Display** (text source: text)

This is the first line to display in read-only mode
Here is the second line.
This is the third line.
This is the fourth line.
- X Workspace (DrawingArea)**
- red** 128
- green** 166
- blue** 205

← User Entry/Information

Data-Driven

Data Driven Object Examples

- Stretchers** value=0
- Rotators**
- Movers**
- Stripchart** Transmission Error Rate 0.0
- Discrete**
- Dynamic Text** value = 3.2



Data Systems
Technology
Division
520

Benefits of TAE Plus

Advanced
Technologies
for
Mission
Control Centers

Productivity- Sophisticated graphical user interfaces can be built in substantially less time (*user is insulated from X code*)

Cost Savings- TAE+ is available for a nominal fee, and because of its productivity improvements, it also reduces development costs

Portability- TAE+ makes it possible to easily port a user interface between many different computing environments

Reliability- Higher level UI development provides more reliable user interfaces and applications

Flexibility- UI changes can be made via WorkBench with little or no changes necessary to the application

Ease of Use- The TAE+ WorkBench allows non-programmers to create sophisticated user interfaces easily

Reusability- UI designers can reuse and share customized interaction objects, or even, entire panels- avoiding unnecessary duplication of effort

Consistency- TAE+ makes it easy to provide end users with UIs that have a common look and feel across different applications and computing environments.

TAE+ is Public Domain Software (free to NASA users)
- distributed by COSMIC (404) 542-3265



Data Systems
Technology
Division
520

Development Benchmark

Advanced
Technologies
for
Mission
Control Centers

A screen copy utility which gathers information through radio buttons, action icons, and text input. Then, it sends the information to an HP printer, as well as updating a text widget on the screen.

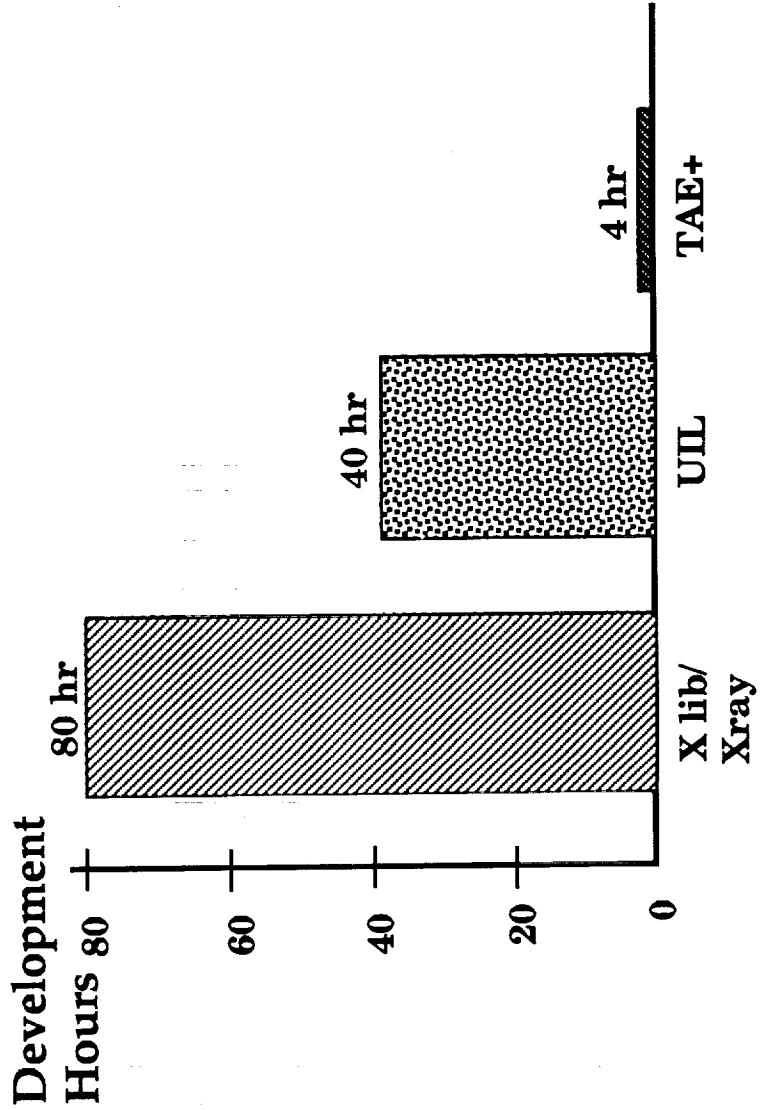

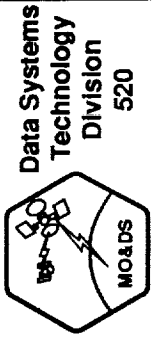

Data Systems
Technology
Division
520

Command Management System (CMS)

Advanced
Technologies
for
Mission
Control Centers

Objective:

Apply advanced user-interface technologies and progressive object-oriented design and implementation to a command management system (CMS) for the first Small-Explorer (SMEX) mission (SAMPEX) .

Technologies & Approaches:

Human factors of human/computer interfaces

- use graphics to simplify operation
- TAE+
- utilize rapid prototyping to define requirements
- involve the end-user in the design process

Object-oriented design and programming techniques

- C++
- target reusable components for future SMEX missions



Data Systems
Technology
Division
520

CMS

Advanced
Technologies
for
Mission
Control Centers

Benefits:

Object-oriented development

- Software organization & design improvements
- Software is more easily integrated and modified/extended
- Facilitates the re-use of software components for future missions

User-interface technologies

- Simplifies the operation of the system

Lessons Learned:

- Object-oriented programming does not directly result in reusability
 - care must be taken to design general, object-oriented classes
- Object-oriented code does not equal good code



Data Systems
Technology
Division
520

Communications Link Expert Assistance Resource (CLEAR)

Advanced
Technologies
for
Mission
Control Centers

Objectives:

- Demonstrate the feasibility and functionality of a real-time fault-isolation expert systems to support control center operations

Approach:

- Continuously monitor relevant COBE, TDRSS & ground system performance parameters
- Graphically display operational status of elements of the COBE-POCC network
- Flag any problems / discrepancies
 - rank in order of importance/criticality
 - 2 types of problems
 1. configuration discrepancies
 2. communication link problems
- Provide advice on best way to correct problem(s)
 - provide alternative methods if appropriate
- Provide explanation on why the problem exists
 - static explanation
(expert system continues to monitor data & fire rules)



Data Systems
Technology
Division
520

CLEAR User Interface

Advanced
Technologies
for
Mission
Control Centers

COBE Expert System

GMT
17:20:03

Telemetry
ODMs

S/C RCVR AGCS

Options

Config Table ALT-F3

View STOL Page ALT-F1

Explain Advice ALT-E

Reset ES Ctrl-End

Halt ALT-F10

-120 -115

-125

-130

MSOCC
AP | TAC

17:19:48

Advice

S/C XICRATE=125 vis 1000

Do NOT Command until corrected

==> Send GCMR SF1000 (SA) or MF1000

==> Command S/C to CRATE 1000

==> Reconfigure AP for CRATE 1000

Problems

S/C XICRATE=125 vis 1000

S/C Signal Strength Degrading

Static Data Flags Found



Data Systems
Technology
Division
520

Current Status and New Info on CLEAR

Advanced
Technologies
for
Mission
Control Centers

- **Supporting COBE FOT since launch of COBE in November '89**
 - identified and assisted in correcting scores of problems
 - not utilized consistently by all members of the COBE FOT
- **Modified for use by Gamma Ray Observatory (GRO) mission**
 - extended to monitor the battery state-of-charge
 - further extensions being investigated
- **Requested by the Extreme Ultra-Violet Explorer (EUVE) mission**
- **Lessons learned during the design, development and technology transfer of this project is being applied to future expert systems projects**



Data Systems
Technology
Division
520

Lessons Learned from CLEAR (pg 1 of 2)

Advanced
Technologies
for
Mission
Control Centers

- Knowledge engineering is an iterative, time-consuming process
- Production rules effectively represent the analysts' heuristic knowledge for automating fault-isolation in spacecraft operations
 - *'if-then' structure closely models the human's representation*
- Allow the domain expert to participate in the ES development
 - *reduces knowledge translation time and errors*
 - *facilitates rulebase verification and validation*
 - *promotes user acceptance and confidence in system*
- Maintenance of ES's demands considerable time and resources
- Expect to modify the expert system after it becomes operational
 - *the system may need to be fine-tuned to adjust for unexpected variances of the operational characteristics of the spacecraft*
 - *extensions will be requested by users*
- Don't underestimate the integration process to the data source



Data Systems
Technology
Division
520

Lessons Learned from CLEAR (pg 2 of 2)

Advanced
Technologies
for
Mission
Control Centers

- Don't neglect the user-interface.
- Include a graphical user-interface (even in the first prototype.)
- Use an object-oriented diagram editor to ease diagram creation and maintenance.
- Use colors prudently and consistently.
- Use hypertext and hypergraphic techniques.
- Use block diagram displays, where appropriate, to graphically illustrate the system being monitored.
- Make the system easy to operate.
- Reduce user input to a minimum.

These lessons learned, along with others, have strongly influenced the definition of GenSAA



Generic Spacecraft Analyst Assistant (GenSAA)

Advanced Technologies
for
Mission
Control Centers

Goal

- Simplify and accelerate the development process of ESs and user interface displays for use in the spacecraft control centers

Approach

- Develop a tool and generic framework to support the development and reuse of fault-isolation ESs for spacecraft control centers
- Develop a tool to support the reuse of ES components, including:
 - Knowledge bases and portions of knowledge bases
 - Inference engine
 - User interface
 - Data / communications interface
- Develop a tool that is transparently integrated with the spacecraft control center environment
- Develop a tool sufficiently easy to use that s/c analysts can develop & maintain simple diagnostic ES's to assist in s/c monitoring
- Include target users during development to assure that resulting tool directly addresses their operational needs and requirements
- Strive for a modular design to maximize re-use and extension



Data Systems
Technology
Division
520

Conventional Approach to Expert System Development

Advanced
Technologies
for
Mission
Control Centers

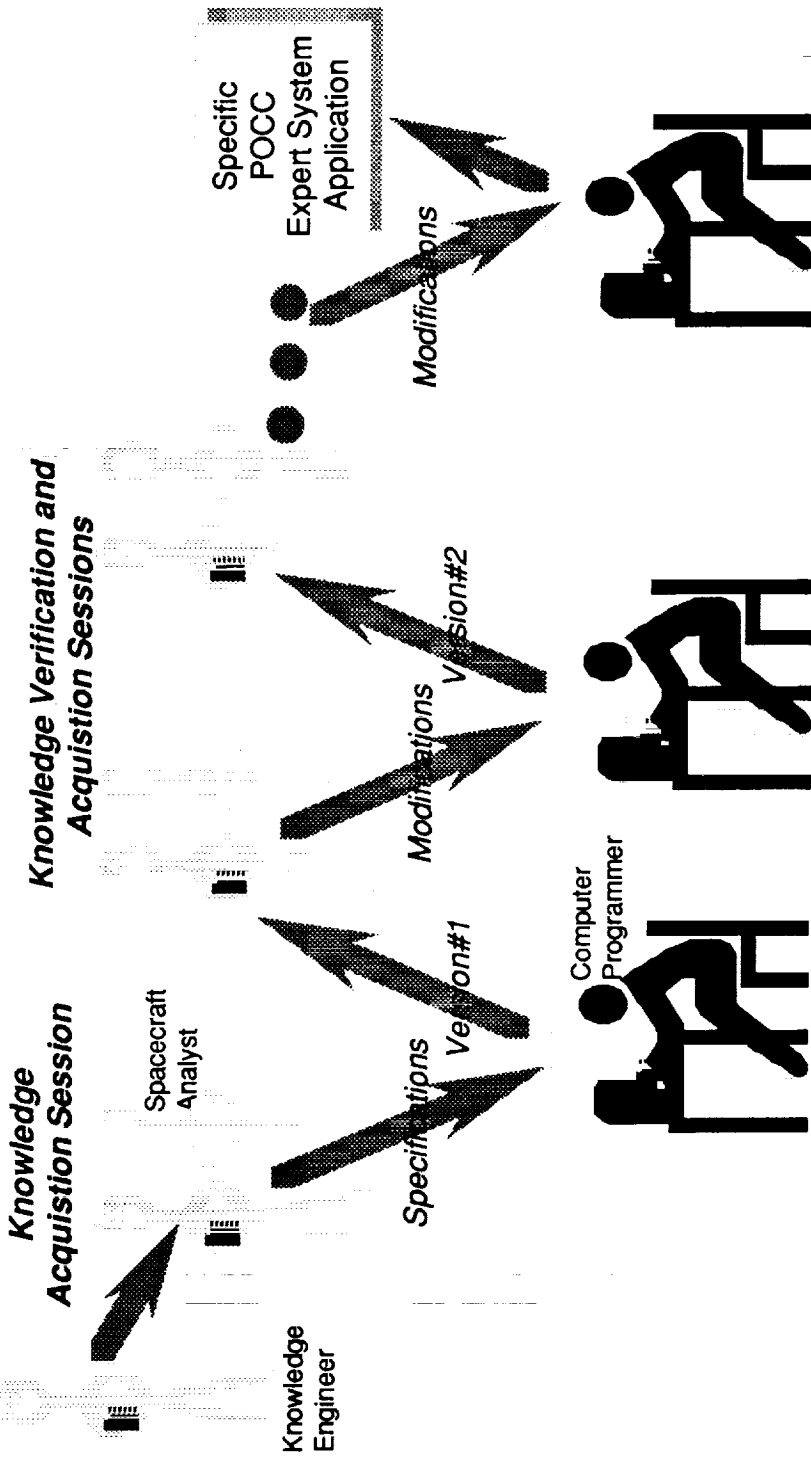

Disadvantages with current approach:

- time
- complexity
- number of people (\$expensive)
- number of interfaces (translation errors)
- results in ONE expert system application
- difficult to modify or extend



Benefits of GenSAA

- **Assists the FOAs with data monitoring**
 - provides means of combining low-level data into high-level information that can be displayed graphically
- **Reduces development time and effort**
 - no programming necessary
 - applications built using direct manipulation techniques
- **Allows quicker response to necessary modifications**
 - no re-compiling necessary after changes are introduced
- **Serves as a training tool**
 - formation of rules can develop fault-isolation capabilities
 - using simulated or playback data, a student analyst can observe how the ES would handle a specific situation
- **Protects against loss of expertise**
 - rulebase "documents" fault-isolation knowledge
 - automation provides consistent fault-isolation capabilities
- **Create a technology insertion point as well as advancing the state of operations**



Data Systems
Technology
Division
520

Expert System Development Methodology(ESDM)

Advanced
Technologies
for
Mission
Control Centers

Objective:

Develop a methodology to facilitate the development of knowledge based systems

Approach:

ESDM is a 'risk-driven' methodology that was adopted from Dr. Barry Boehm's spiral model for software development.

- differs from Boehm's model in that ESDM focuses on knowledge acquisition as opposed to product development
- accommodates the evolutionary approach of e.s. development
- assists in the identification of system requirements
- assists in the identification of risks
- guides the development process with a series of decision tables
- supports the Verification & Validation process (a complete V&V methodology is currently being incorporated)



Data Systems
Technology
Division
520

Spiral Model of ESDM

Advanced
Technologies
for
Mission
Control Centers

PROTOTYPING STAGES
(DIRECTION OF DECREASING OVERALL RISK)

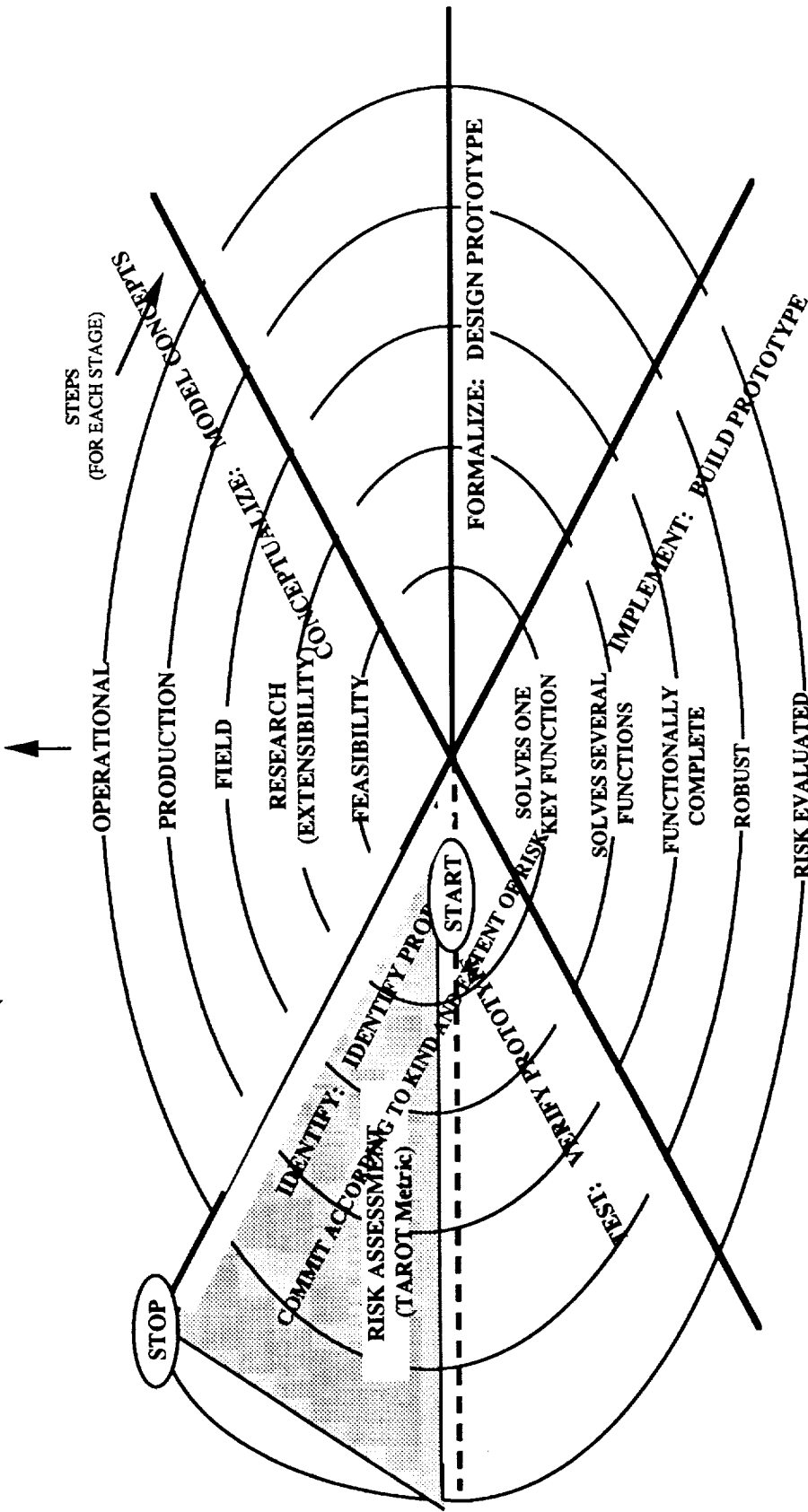



Data Systems
Technology
Division
520

Knowledge-Based Software Engineering Environment

Advanced
Technologies
for
Mission
Control Centers

Objective: Develop a software engineering environment which supports a rigorous and complete approach to software artifact (i.e., designs, specifications, code, documentation, etc.) reuse.

Approach: Perform a series of comprehensive domain analyses to better establish the full potential of reuse in the spacecraft ground system domain

Develop a s/w reuse environment which incorporates knowledge-based and human factors techniques to enhance its use

Field test on sample ground system applications to fine tune the reuse operations concepts

Anticipated benefits:

Retention and application of past software engineering expertise and success for new projects

Resource effective (cost, time) development of quality s/w



Data Systems
Technology
Division
520

System Software Reuse with KBSEE

Advanced
Technologies
for
Mission
Control Centers

System Software Reuse

Tailoring Past Successes to
Meet Future Needs

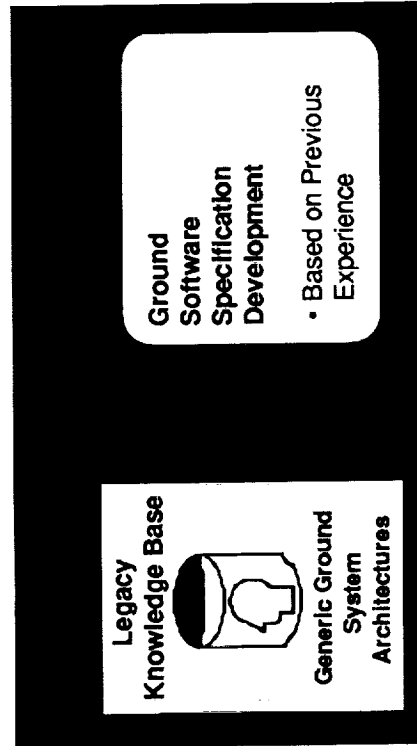
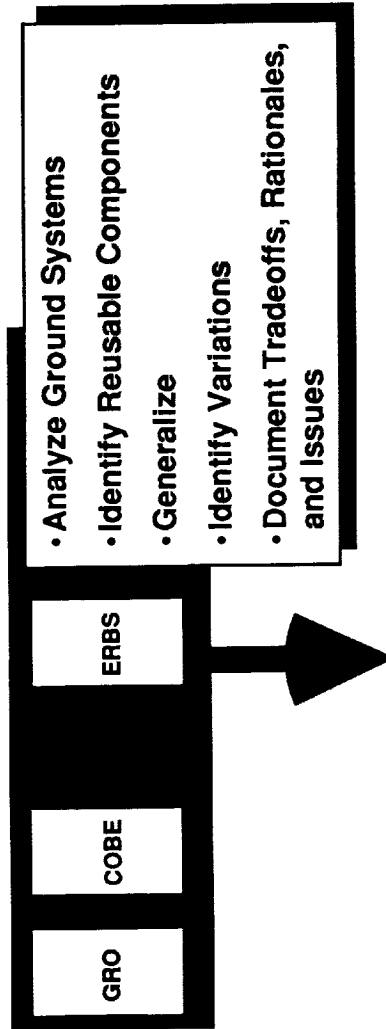

Analyze Current Ground Systems
and Generate Generic Ground
System Architectures



Data Systems
Technology
Division
520

High Performance VLSI Telemetry Systems

Advanced
Technologies
for
Mission
Control Centers

Objective:

Develop high performance, low cost, configurable and highly reliable telemetry data systems

Approach:

- partition data system functionality into standard modular components to create flexible architectures that can be easily customized or upgraded for additional performance
- develop application-specific integrated circuits (ASICs) for performance critical funcs. (e.g. frame synch, packet processing)
- integrate these low-level VLSI ASIC into larger standard functional (board-level) components to create a library of generic elements
- employ a modular approach for constructing telemetry data systems by utilizing a library of generic, reusable processing hardware elements and integrating them with an advanced real-time software environment
["Functional Component Approach"]

- A low-cost "mission specific" ground telemetry system can be created by selecting appropriate standard hardware components and configuring them with modular software components in an open bus environment



Data Systems
Technology
Division
520

"Functional Components Approach" Library

Advanced
Technologies
for
Mission
Control Centers

VLSI Application Specific Integrated Circuits (ASICs)



- Correlator Chips (CMOS)
- Correlator Chip (ECL)
- Nascom Block Processor Chip
- NASA - 36 Time Decode Chip (CMOS)
- Random Access Memory Controller
- MC68020/030 Support Chips
- Triple Buffer Controller Chips (CMOS)
- Test Pattern Generation Chip (CMOS)
- Test Pattern Generation Chip (GaAs)
- ECL-TTL Interface Chip
- Telemetry Frame Synchronizer Chip (CMOS)
- Telemetry Frame Synchronizer Chip (GaAs)

Card Level Components

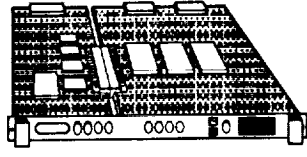

- Synchronizer Card (CMOS)
- Synchronizer Card (GaAs)
- Multiplexer Card
- Forward Link Card
- Simulation Card
- Reed-Solomon Card
- Data Capture Card
- Packet Processor Card
- Cross-Point Switch Card
- High Speed Multiplexer Card
- High Rate Data Mover Card
- Virtual Channel Sorter Card
- TTW Controller Card (MacTAC)
- TTW Reed-Solomon Card (MacTAC)
- TTW Synchronizer Card (MacTAC)
- Soft Symbol Controller Card (DSN)
- Frame Sync Interface Card (DSN)
- Bit Generator (DSN)
- Segment Processor (LZP)
- Disk Interface Controller (LZP)

Systems

- Advanced Telemetry and Command (ATAC)
- Level Zero Processing System
- Matrix Switch System
- Virtual Channel Sorter Multiplexer (VCSM)
- SMEX-SAMPEX Nascom Interface (SNIF)
- Wallops Front-End Processor (WFEP)
- Wallops Front-End Telemetry Command Processor (WFTCP)
- SMEX Front-End Telemetry Command Processor (FTCP)
- Deep Space Network (DSN) Telemetry Channel Assembly
- TOPEX NASCOM Front End Processor Systems (TOPEX - NFEP)
- Low Cost Portable Telemetry Data System (MacTAC) - TTW Transportable Telemetry Workstation

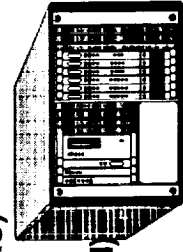

Software Components

- Modular Environment for Data Systems (MEDS)
- Base System Environment (BaSE)
- Ethernet Communication Utility

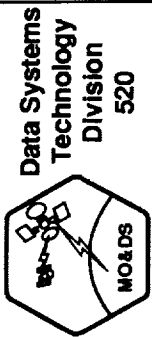

Data Systems
Technology
Division
520

The Impact of Integration on Telemetry Systems

Advanced
Technologies
for
Mission
Control Centers

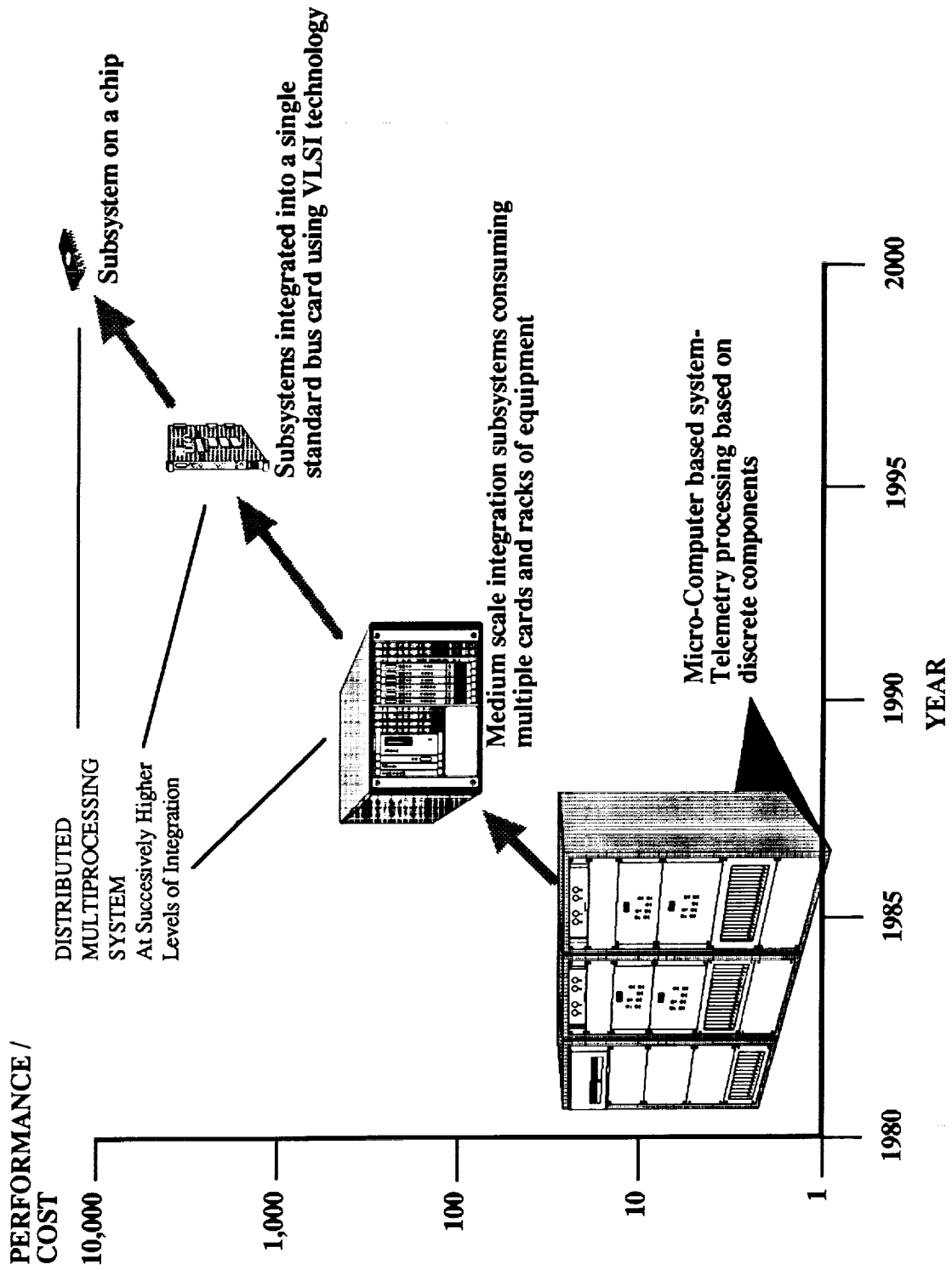



Data Systems
Technology
Division
520

Planning & Scheduling Technology Testbed

Advanced
Technologies
for
Mission
Control Centers

Objectives:

Identify and evaluate planning & scheduling (P&S) operations concepts from an end-to-end* perspective
** (i.e. from the science user to the S/C operations)*

- Investigate system architecture and interface issues
- Propose a generic P&S tool set envir. for future requirements
Approach: Eval current P&S systems to identify user and mission requirements
- Develop a P&S technology testbed for prototyping and demonstrating concepts and tools

Significance:

- **Identify Mission Requirements**
 - Align schedule generation process to mission needs
- **Improve User Satisfaction**
 - Simplify scheduling operations
 - Meet increasing user service support load
- **Improve End-to-End System Efficiency**
 - Reduce time and human effort required to produce schedules
 - Introduce greater flexibility in scheduling requests
 - Improve access to scheduling data
 - Eliminate redundancies and fill holes in P&S



Data Systems
Technology
Division
520

MO&DS Planning & Scheduling Activities

Advanced
Technologies
for
Mission
Control Centers

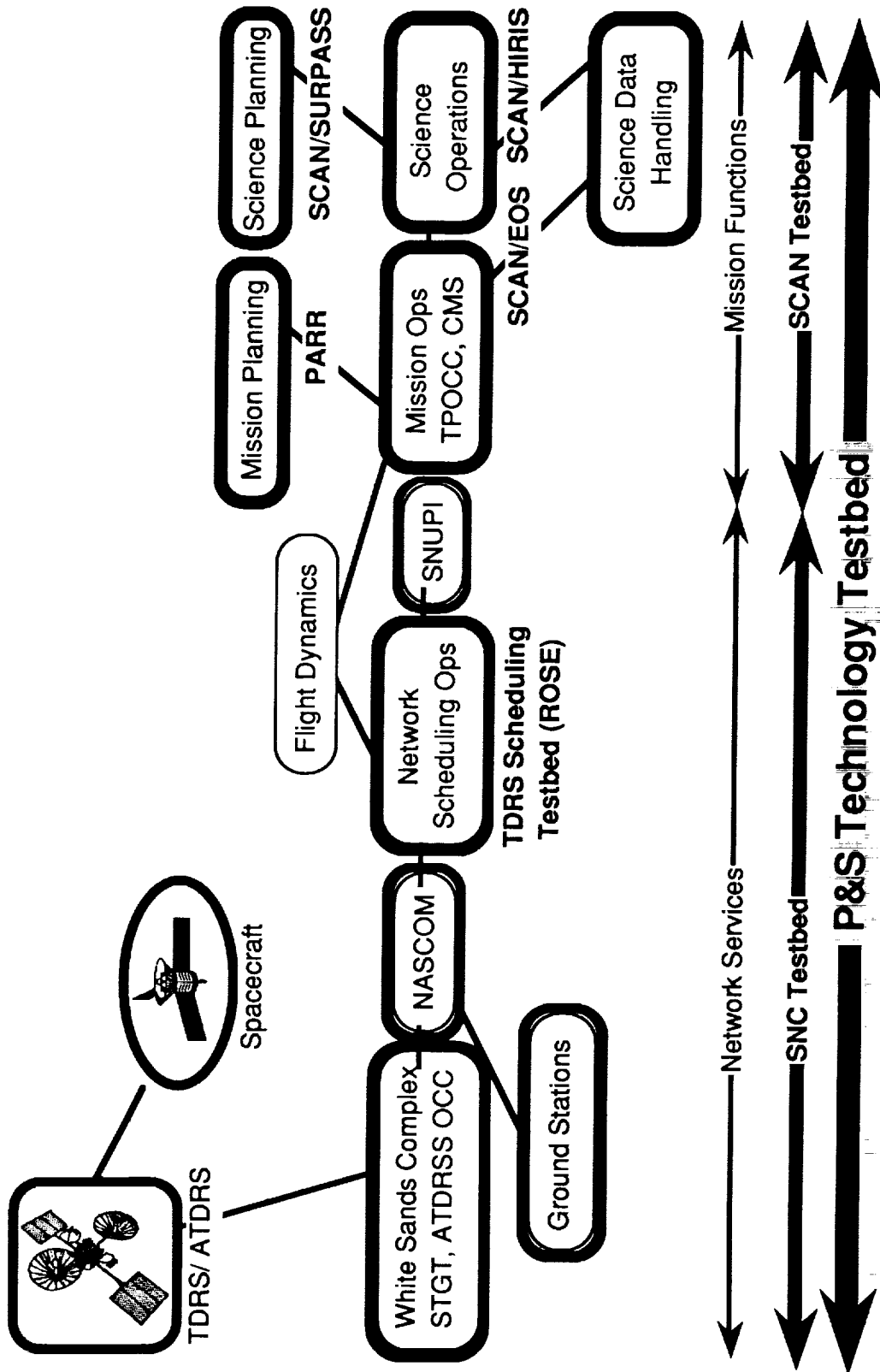

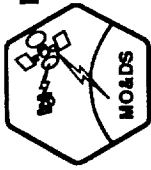

Data Systems
Technology
Division
520

Ground Operations Technology Testbed (GOTT)

Advanced
Technologies
for
Mission
Control Centers

Objective:

The GOTT will enable the transfer of technologies from research to operational environments by providing tools to rigorously establish a technology's efficacy.

*- provide investigators a means by which they can investigate/
demonstrate concepts and ideas in a realistic CC environment.*

Technologies:

- Distributed systems
- Advanced spacecraft and ground system simulation
- Software and experiment reuse
- Real-time, non-obtrusive performance data collection
- Real-time performance visualization
- Meta-level system control
- Rapidly configurable physical environment

Approach:

Develop a suite of tools needed to support POC-based technology experiments



Data Systems
Technology
Division
520

The GOTT as a Testbed

Advanced
Technologies
for
Mission
Control Centers

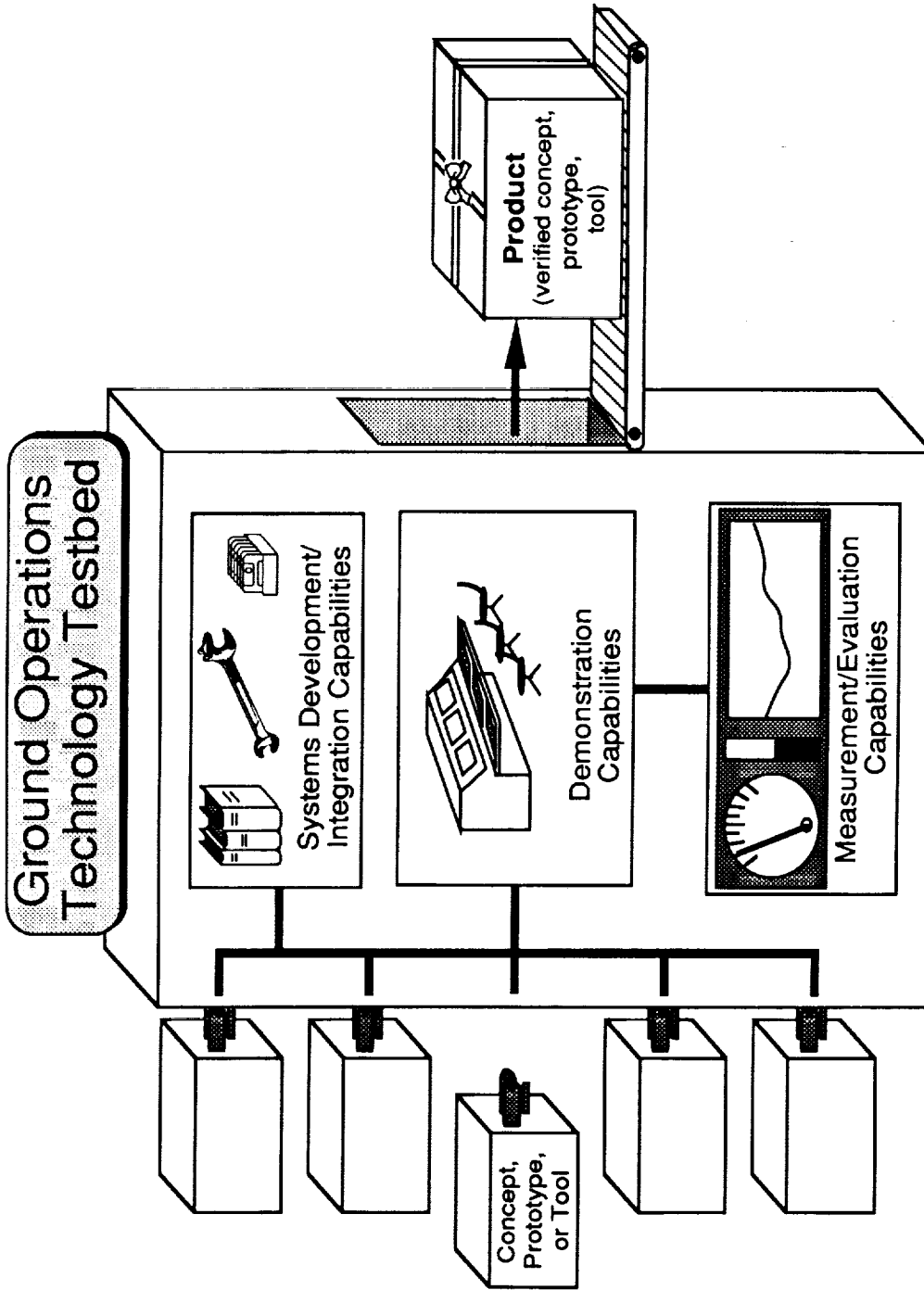

GOTT will support the development, demonstration, and evaluation of new concepts, prototypes and tools in a realistic, but non-operational ground system environment.



Data Systems
Technology
Division
520

GOTT Services

Advanced
Technologies
for
Mission
Control Centers

Development

- Configuration management
- Interface and build generation
- Reuse tools
- Reusable ground system components
- Distributed system tools

Demonstration

- Realistic physical environment
- Simulators
- Simulation/System control

Evaluation

- Data collection and playback
- Real-time monitoring and visualization
- Reuse of past experiment data
- Data analyses and report generation



Data Systems
Technology
Division
520

Contacts

Advanced
Technologies
for
Mission
Control Centers

- **TAE+** - Marti Szczur 301-286-8609
- **SAMPEX CMS** - Steve Edwards 301-286-6676
- **CLEAR** } - Peter Hughes 301-286-3120
- **GenSAA** }
- **ESDM** - Larry Hull 301-286-3009
- **High Performance VLSI Telemetry Systems**
 - Jim Chesney 301-286-9029
- **Knowledge Based S/W Engineering Environments**
 - Walt Truskowski 301-286-8821
- **Plann. & Sched.** - Karen Moe 301-286-5998
- **GOTT-POCC** - Mike Moore 301-286-3192

The Generic Spacecraft Analyst Assistant (GenSAA): A Tool for Automating Spacecraft Monitoring with Expert Systems

Peter M. Hughes
NASA/Goddard Space Flight Center

Edward C. Luczak
Computer Sciences Corporation

Abstract

Flight Operations Analysts (FOAs) in the Payload Operations Control Center (POCC) are responsible for monitoring a satellite's health and safety. These analysts closely monitor real time data looking for combinations of telemetry parameter values, trends, and other indications that may signify a problem or failure. As satellites become more complex and data rates increase, FOAs are quickly approaching a level of information saturation.

The FOAs in the spacecraft control center for the COBE (Cosmic Background Explorer) satellite are currently using a fault-isolation expert system named the Communications Link Expert Assistance Resource (CLEAR), to assist in isolating and correcting communications link faults. Due to the success of CLEAR and several other systems in the control center domain, many other monitoring and fault-isolation expert systems will likely be developed to support control center operations during the early 1990s.

To facilitate the development of these systems, a project has been initiated to develop a domain-specific tool, named the Generic Spacecraft Analyst Assistant (GenSAA). GenSAA will enable spacecraft analysts to easily build simple real-time expert systems that perform spacecraft monitoring and fault isolation functions. Expert systems built using GenSAA will assist spacecraft analysts during real-time operations in spacecraft control centers.

This paper describes lessons learned during the development of several expert systems at Goddard, thereby establishing the foundation of GenSAA's objectives and offering insights on how problems may be avoided in future projects. This will be followed by a description of the capabilities, architecture, and usage of GenSAA along with a discussion of its application to future NASA missions.

Originally Published in the Conference Proceedings from *The 1991 Goddard Conference on Space Applications of Artificial Intelligence*, NASA Goddard Space Flight Center, Greenbelt, MD, May 14-15, 1991.

The Generic Spacecraft Analyst Assistant (GenSAA): A Tool for Automating Spacecraft Monitoring with Expert Systems

Peter M. Hughes

NASA/Goddard Space Flight Center

Edward C. Luczak

Computer Sciences Corporation

Abstract

Flight Operations Analysts (FOAs) in the Payload Operations Control Center (POCC) are responsible for monitoring a satellite's health and safety. These analysts closely monitor real time data looking for combinations of telemetry parameter values, trends, and other indications that may signify a problem or failure. As satellites become more complex and data rates increase, FOAs are quickly approaching a level of information saturation.

The FOAs in the spacecraft control center for the COBE (Cosmic Background Explorer) satellite are currently using a fault-isolation expert system named the Communications Link Expert Assistance Resource (CLEAR), to assist in isolating and correcting communications link faults. Due to the success of CLEAR and several other systems in the control center domain, many other monitoring and fault-isolation expert systems will likely be developed to support control center operations during the early 1990s.

To facilitate the development of these systems, a project has been initiated to develop a domain-specific tool, named the Generic Spacecraft Analyst Assistant (GenSAA). GenSAA will enable spacecraft analysts to easily build simple real-time expert systems that perform spacecraft monitoring and fault isolation functions. Expert systems built using GenSAA will assist spacecraft analysts during real-time operations in spacecraft control centers.

This paper describes lessons learned during the development of several expert systems at Goddard, thereby establishing the foundation of GenSAA's objectives and offering insights on

how problems may be avoided in future projects. This will be followed by a description of the capabilities, architecture, and usage of GenSAA along with a discussion of its application to future NASA missions.

Introduction

NASA's Earth-orbiting scientific satellites are becoming increasingly sophisticated. They are operated by highly trained personnel in the mission's Payload Operations Control Center (POCC). Currently at the Goddard Space Flight Center (GSFC), missions utilize either a dedicated control center (e.g. LANDSAT and the Hubble Space Telescope) or share resources in the Multi-Satellite Operations Control Center (e.g. Cosmic Background Explorer and the Gamma Ray Observatory). In either case, POCC personnel called Flight Operations Analysts (FOAs), are responsible for the proper command, control, health, and safety of the satellite.

The satellite control centers operate round-the-clock throughout the lifetime of the spacecraft. There are typically multiple real-time communications events daily with each satellite. During these events, the FOAs must:

- establish and maintain the telecommunications link with the spacecraft,
- monitor the spacecraft's health and safety,
- send commands or command loads to the satellite for on-board execution,
- oversee the transfer of the scientific data from the on-board tape recorders to ground systems for processing and analysis, and
- manage spacecraft resources (including on-board memory, batteries, and tape recorders).

To accomplish these activities, the analyst must thoroughly understand the operation of the spacecraft and ground systems and continuously monitor the current state of operations as indicated by telemetry parameters displayed on the POCC consoles. During an event, the analyst typically monitors hundreds of telemetry parameter values on multiple display pages that may be updating several times per second. Monitoring the operation of these satellites is a demanding, tedious task that requires well-trained individuals who are quick-thinking and composed under pressure.

As satellites become more complex, they become more difficult to operate. FOAs are reaching a level of information saturation as more and more data must be monitored and analyzed during real-time supports. Large volumes of low-level information can overwhelm analysts and disrupt their ability to identify and resolve conflicting constraints. Human operators may soon be unable to consistently monitor all of the information available. The need to automate some data monitoring functions is apparent.

Expert system technology is proving to be effective in automating some spacecraft monitoring functions. This paper first summarizes CLEAR, the first spacecraft monitoring expert system deployed at GSFC. The paper then reviews several lessons learned from CLEAR and other monitoring and fault isolation expert system projects undertaken at GSFC. Finally, the paper describes the Generic Spacecraft Analyst Assistant (GenSAA), a tool that will facilitate the development of future spacecraft monitoring expert systems. GenSAA has been defined based on the lessons learned from CLEAR and other expert system projects at GSFC.

Initial Work: The CLEAR System

The Communications Link Expert Assistance Resource (CLEAR) is the first operational expert system at GSFC that automates one of the spacecraft analyst's tasks (Hughes & Hull, 1987). CLEAR is a fault-isolation expert system that supports real-time operations in the POCC for the Cosmic Background Explorer (COBE) mission. This system monitors the communications link between COBE and the Tracking and Data Relay Satellite (TDRS), alerts the analyst

to any problems, and offers advice on how to correct them.

CLEAR is a forward chaining, rule-based system that operates in the COBE POCC. It monitors over 100 real-time performance parameters that represent the condition and operation of the spacecraft's communications with the relay satellite. Using this information, together with knowledge of TDRS operations, COBE's on-board communications system and the expected configuration of the scheduled event, CLEAR accurately portrays the status of the communications link.

Textual and graphical information about the condition of the COBE/TDRS/ground communications links is displayed in a tiled-window format. A graphics window displays the elements of the communications network from the COBE Spacecraft to the POCC; green lines represent healthy links between elements. When the performance parameters indicate that a communications link or processing system is degrading or down, the associated line or icon turns yellow or red, respectively. The display enables analysts to assess the current status of the communications event in a quick glance.

When CLEAR isolates a problem, a short description of the problem is displayed in a "problems" window. If multiple problems are found, the problem descriptions are ranked and displayed in descending order of criticality. CLEAR suggests analyst actions to correct the problem; however, the system does not take any corrective action itself.

To further assist the analyst and to provide support for its advice, the CLEAR system provides an explanation facility. When the analyst selects a problem displayed in the problems window, CLEAR provides a detailed explanation of why the expert system believes that the problem exists.

CLEAR has approximately 165 rules and isolates approximately 75 different problems. The types of problems include: non-reception of data within the control center (system or communication problems, or data reporting not activated); misconfigurations between the COBE POCC and the TDRS ground station

(coherency/non-coherency, doppler compensation on/off, power mode, actual TDRS in use, antennae configurations); discrepancies in telemetry rate or format; inactive or non-locked links; and degrading or critical signal strength situations (Perkins & Truskowski, 1990).

CLEAR operates on any of the seven PC/AT-class workstations that are used for console operations in the POCC. It is written in the 'C' language and uses the 'C' Language Integrated Production System (CLIPS) and a custom-developed graphics library.

The CLEAR Expert System has supported the COBE Flight Operations Team since launch in November 1989. It is used to monitor nearly all of the TDRS supports (COBE occasionally communicates directly to the Wallops ground station) and is regarded as the fault-isolation "expert" for the COBE/TDRS telecommunications link. CLEAR represents a successful attempt to automate a control center function using an expert system. Several other missions have requested to use it and, at the time of this writing, efforts are underway to adapt it to support the Gamma Ray Observatory mission which is scheduled for launch aboard the shuttle in Spring 1991.

Lessons Learned

Several important lessons have been learned from the experience gained in developing and operating CLEAR. Key lessons have also been learned from other monitoring and fault isolation expert systems developed recently at GSFC, including the Ranging Equipment Diagnostic Expert System (REDEX) (Luczak, et. al., 1989), and other systems. These lessons learned have strongly influenced the definition of GenSAA.

- **Production rules effectively represent analysts' knowledge for automating fault-isolation in spacecraft operation.** The rule-based method of knowledge representation has proven to be quite powerful for fault-isolation in spacecraft operations. Production rules provide a direct method of encoding the fault-isolation knowledge of spacecraft analysts; the if-then structure closely parallels the stimulus-response behavior that they develop through extensive training. This

knowledge can be translated smoothly into rule form. The development of CLEAR would have taken much longer using conventional, non-rule-based programming techniques.

- **Knowledge engineering is an iterative, time-consuming process.** Early in CLEAR's development, the primary concern was the perceived difficulty of the knowledge acquisition effort. However, the knowledge engineering task was found to be relatively straightforward, albeit time-consuming. The development of the rule base was a lengthy process due to the interactive nature of the knowledge acquisition. Basically, the expert would describe a specific piece of knowledge to the "knowledge engineer" who would attempt to transcribe it into a rule and pass it back to the expert for validation. When the rule accurately represented the piece of knowledge (which usually took multiple iterations between the expert and the knowledge engineer), it was passed to the test team for formal testing, and then, finally, released for operational use.

The involvement of various players in this process resulted in long turnaround times from the point at which a piece of knowledge was determined to be important until it was translated into a rule and placed into operation.

- **Allow the domain expert to participate in the rule formation.** The CLEAR development team learned that the knowledge structure of the fault-isolation process employed by the FOAs is shallow (i.e. the identification of a problem generally does not rely on the identification of other subproblems, and so on). Most of the problems identified by the analysts were discrete problems that seldom overlapped other problems. Conflicts between rules were minimal; this simplified testing, verification, and validation of the rulebase.

The participation of the analyst in knowledge acquisition and translation has many advantages. First, it can reduce the knowledge translation time and, more importantly, reduce knowledge translation errors that occur when a knowledge engineer formulates rules based on the knowledge extracted from documentation or interviews with the domain expert. Second, the verification and validation of the knowledge will be facilitated since the expert will better

comprehend the rulebase. Third, the in-depth understanding of the knowledge base and its capabilities is likely to result in a higher degree of user confidence in the system thereby ensuring user acceptance.

- **Expect to fine-tune the expert system after it becomes operational.** For CLEAR, the rule-based method of knowledge representation has provided the flexibility to easily adapt the knowledge base to unforeseen changes in the operational behavior of the spacecraft. For example, even though the operational nature of COBE was fairly accurately understood by the design engineers and flight operations team before the launch, slight behavioral variations and complications arose once the spacecraft was in orbit. Although the FOAs were able to adjust to such variations quickly, some of the ground systems required complex software modifications. However, the changes required to CLEAR's rule-base were simple and quickly implemented. After modification, CLEAR provided consistent operational assistance. It is important to provide the capability to modify an operational expert system in a controlled, yet straightforward way.

- **Don't underestimate the integration process.** One of the most valuable lessons learned is that while prototypes can often be developed rapidly, operational expert systems require considerable effort. A major factor in this effort is the difficulty of interfacing the expert system to the data source.

The CLEAR development team learned that most of the development time for the operational system was spent on issues not directly related to the construction of the knowledge base. A surprising amount of effort focused on the integration of the expert system with the data source and graphics display system. This required in-depth programming knowledge of the interfacing systems and the ability to troubleshoot problems within them. Provide tools to simplify the complicated task of integrating the expert system with the interfacing systems and, if possible, reuse any interface code developed for a similar (expert) system.

- **Don't neglect the user-interface.** The human-computer interface is frequently the

most underdeveloped component of an expert system. An effective user interface is inviting, comprehensible, credible, and simple to operate. To make it inviting, simplify the display layout and present only that information needed to efficiently perform the task. Graphics can greatly enhance the visual communications of a system; capitalize on their expressive power to provide system output that can be assimilated quickly and accurately.

The following lessons are also related to the use of graphical user interfaces:

- **Use colors prudently and consistently.** Although often misused, colors are valuable for emphasizing or coding information. Use them sparingly and in a manner consistent with other systems or conventions employed in the targeted operational environment.

- **Include a graphical user-interface (even in the first expert system prototype.)** CLEAR utilized a graphical user interface in the initial prototype to demonstrate the capabilities of the proposed expert system; this elicited valuable feedback from the expert and other FOAs. In contrast, a non-graphical user-interface was used in the initial REDEX prototype; as a result, user interest and feedback was limited early in the project

- **Use an object-oriented diagram editor to ease diagram creation and maintenance.** Ideally, the diagram editor should enable diagram objects to be easily associated with status values and fault conditions inferred by the expert system. In the REDEX project, a diagram editor with only limited capability was used, and as a result, significant effort was required to construct and modify diagrams.

- **Use block diagram displays to graphically illustrate the system being monitored.** Users have responded very positively to the use of schematic displays that graphically show monitored system status and fault locations. Analysts and technicians usually learn about the systems they monitor by studying system block diagrams in training classes and reference manuals. By using similar block diagram displays, a monitoring expert system can present status to the user in a familiar and intuitive format. Color coding of status

conditions on such displays has been found to be an effective way to present succinct status summaries. For example, REDEX users have been enthusiastic about the color block and layout diagrams in that expert system; over 35 diagrams graphically depict the functional and physical structure of the equipment being diagnosed.

- **Make the system easy to operate.** Operation of the expert system should be simple enough that the user can concentrate on the problem, not on how to operate the system. The following techniques were applied in CLEAR and REDEX to simplify operation:

- **Reduce user input to a minimum.** CLEAR operates in a highly autonomous mode; no user input is required after system initialization. CLEAR has been well-accepted by its users, partially because it operates as an independent intelligent assistant, allowing the spacecraft analyst to focus on other responsibilities during real-time satellite contacts.

- **Use hypertext and hypergraphic techniques.** These techniques (Bielawski & Lewand, 1991) enable the expert system user to quickly select and display desired diagrams by clicking on link buttons that appear on each diagram. Links can be used to create diagram hierarchies, off-page connections, diagram sequences, and other structures. REDEX uses these techniques to enable users to navigate through a set of several dozen graphical display pages; they find the approach intuitive and easy to use.

These lessons learned have all influenced the definition and development of GenSAA.

GenSAA

Overview

GenSAA is an advanced tool that will enable spacecraft analysts to rapidly build simple real-time expert systems that perform spacecraft monitoring and fault isolation functions. Expert systems built using GenSAA will assist spacecraft analysts during real-time operations in spacecraft control centers.

Use of GenSAA will reduce the development time and cost for new expert system applications in this domain. GenSAA will allow major expert system software functions and portions of knowledge bases to be reused from mission to mission.

GenSAA has the following primary characteristics:

- **Easily used** — The process for developing specific expert system applications using GenSAA will be straightforward enough that it can be performed by trained spacecraft analysts on the flight operations team.

- **Rule-based** — GenSAA will support the use of rules to represent spacecraft and payload monitoring and fault isolation knowledge. Rule-based representations are easily learned and can be used to describe many of the reasoning processes used by spacecraft analysts. (An object representation technique will be included in a subsequent phase.)

- **Highly graphical** — The GenSAA operational user interface will support both textual and graphical presentations of health and status information and fault isolation conclusions. Hypertext and hypergraphic techniques will be supported to simplify operational interaction with GenSAA expert systems.

- **Transparently interfaced with TPOCC** — GenSAA will be used to create expert system applications that will support analysts in spacecraft control centers that use the new Transportable Payload Operations Control Center (TPOCC) architecture. TPOCC is a new Unix-based control center system architecture that will be used on many new spacecraft missions at GSFC. GenSAA will be adaptable to also support non-TPOCC data interfaces.

GenSAA is being defined and prototyped by the Automation Technology section (Code 522.3) of the Data Systems Technology Division at GSFC. A system and operations concept has been defined (Hughes & Luczak, March 1990), and a multi-phase prototype effort is underway (Hughes & Luczak, August 1990).

GenSAA Architecture

GenSAA is a shell, or software framework for developing spacecraft control center expert systems. It is analogous to many commercial expert system shells because it facilitates the development of specific expert system applications. However, GenSAA is tailored to the specific requirements of spacecraft analyst assistant expert systems in TPOCC control centers. GenSAA therefore shares many of TPOCC's architectural features.

The TPOCC architecture is based on distributed processing, industry standards, and commercial hardware and software components. It employs the client/server model of distributed processing, the Network File System (NFS) protocol for transparent network access to files, and the X Window System (X.11) with the Motif library and window manager for the graphical operator interface. A TPOCC configuration consists of a small set of specialized front-end processors and Unix-based workstations on an Ethernet network using the TCP/IP network protocol. GenSAA operates in this environment.

GenSAA allows spacecraft analysts to rapidly create simple expert systems without having to deal directly with the complicated details of the systems with which the expert system must interface. In addition, it will allow the expert system developer to utilize and/or modify

previously developed rule bases and system components, thus facilitating software reuse and substantially reducing development time and effort.

Figure 1 shows the six major elements of GenSAA. They are divided into two sets: the GenSAA Workbench and the GenSAA Runtime Environment. These are described in the sections below.

The GenSAA Workbench

The GenSAA Workbench is composed of three utilities that enable a spacecraft analyst to create a GenSAA application. A GenSAA application is a specific expert system that performs real-time monitoring and fault isolation functions in a TPOCC spacecraft control center.

A GenSAA application is created by defining the application's runtime specifications using the GenSAA Workbench. Figure 2 illustrates that these specifications, called Reusable Application Components, together with the elements of the GenSAA Runtime Components, comprise a GenSAA Application.

The GenSAA Workbench utilities are as follows:

- **Data Interface Development utility** - This utility is used to create the Data Interface

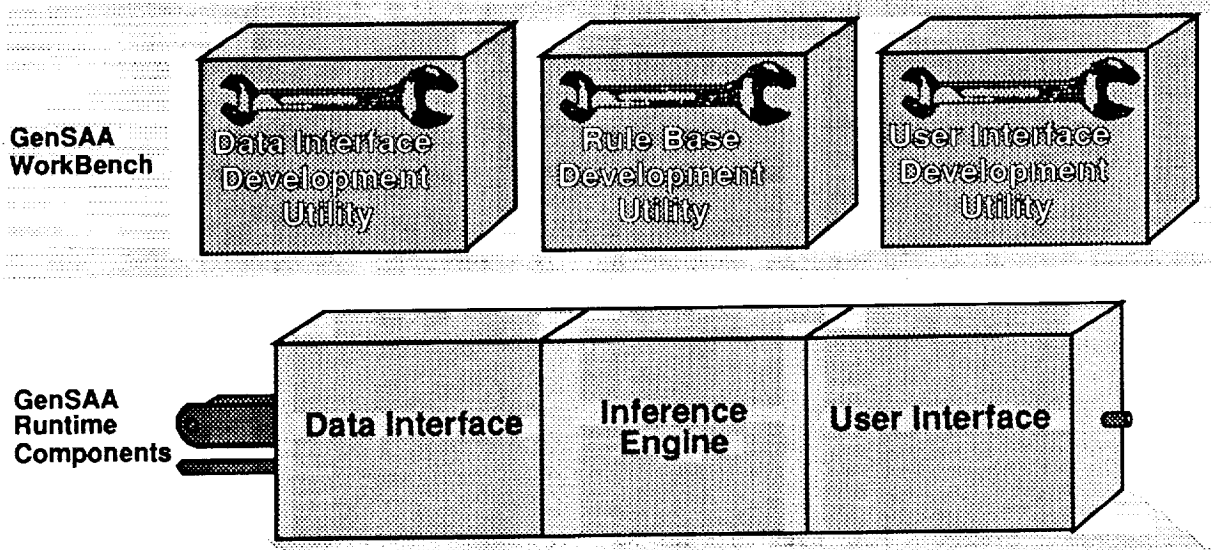

Figure 1. The Elements of GenSAA

Specification for a GenSAA application. The Data Interface Specification defines three types of data that are used by the GenSAA application during real-time operations:

- *Telemetry data* - Telemetry data variables represent real-time status of the monitored spacecraft and related ground support systems. (Telemetry variables are sometimes called telemetry mnemonics.) Values for these variables are received and updated during spacecraft operation periods from the TPOCC Data Server process, which is part of the TPOCC software. Using the Data Interface Development Utility, the GenSAA Workbench user selects the telemetry variables needed for the expert system being created from a list of all the telemetry variables available from the TPOCC Data Server. Values for only those variables selected will be received by the expert system during run-time.

- *Configuration data* - Configuration data variables represent expected operating modes and equipment configurations. For example, a configuration variable might represent the setting of a switch that determines which of two redundant components is to be used. Values for these variables are entered by the spacecraft analyst during spacecraft operation periods.

- *Inferred data* - Inferred data variables represent conclusions inferred by rules in the rule base. For example, an inferred data variable might represent the health or fault status of a component in a spacecraft subsystem. (The name of an inferred data variable together with its current value is called an *inferred fact*.) Values are assigned to these variables by actions executed in the "then" part of rules that fire.

• **Rule Base Development utility** - This utility is used to create the rule base for a GenSAA application. The rule base is a set of expert system rules in "condition-action" ("if - then") format that may infer new facts based on currently asserted facts. The inference engine controls the firing of rules in the rule base during execution of the GenSAA application.

During run-time, if all the conditions of a rule are satisfied, then the rule fires and all its actions are performed. Conditions can be

constructed using the telemetry, configuration, and inferred data variables specified with the Data Interface Development Utility. Actions may include: asserting/retracting an inferred fact, enabling/disabling a rule or ruleset, performing a mathematical calculation, and displaying text messages on the user interface.

• **User Interface Development utility** - This utility is used to create the User Interface Specification for a GenSAA application. The User Interface Specification defines the user interface panels and the layout and behavior of the display items that comprise the operational user interface of the GenSAA application. The Workbench user can create a variety of display items, including graphical icons, scrolling text lists, and data-driven objects such as meters, gauges, and simple strip charts. The display designer constructs a panel by dragging display items from a palette and placing them wherever desired. Lines can be drawn using connector items to create block diagram displays. The Workbench user can associate each display item with a telemetry, configuration, or inferred data variable, and specify how changes in the value of the variable will affect the presentation of the item. Characteristics of an item presentation that can change include its color, the icon displayed, and the position of the dynamic portion of a data-driven object. Simple drawing capabilities are provided to allow the creation of new graphical icons. Any display item can also be specified to be a hypertext button; clicking on such a button during run-time can cause an informational pop-up window to appear, or cause a new panel to be displayed.

The GenSAA Workbench utilities use a graphical, point-and-select method of interaction to facilitate use. The utilities are also highly inter-operable. For example, when using the Data Interface Development utility, the user may select a given telemetry mnemonic to be included in the Data Interface Specification. Later, when using the Rule Base Development utility, the user can easily access the Data Interface Specification and to reference the mnemonic in a condition of a rule. Similarly, when using the User Interface Development utility, the user can again easily access the Data Interface Specification when associating telemetry mnemonics with display objects.

In Figure 2, the outputs of the GenSAA Workbench utilities are described as reusable application components. These specifications will be placed in a library so that they can be reused in creating the specifications for new GenSAA applications. Operations like cut and paste will be available to allow portions of previously created specifications to be used in constructing a new specification.

GenSAA Runtime Environment

The elements of the GenSAA Runtime Environment are called the GenSAA Runtime Components; they are used without change in each GenSAA application. They control the operation of a GenSAA application during its execution in a TPOCC control center. They read the Data Interface Specification, Rule Base, and User Interface Specification files to determine the specific behavior of the GenSAA application. Each of the GenSAA Runtime Components is implemented as a separate Unix process; they communicate with one another via shared memory and message queues. Their functions are as follows:

- **Data Interface** – This component requests

telemetry from the TPOCC Data Server, as specified in the Data Interface Specification. It reformats the real-time data it receives and makes it available to the Inference Engine and User Interface components. (It also exchanges data with the GenSAA Data Server, as described below in the section Multiple GenSAA Applications.)

- **Inference Engine** – This component controls the firing of rules in the rule base. A rule is fired when all its conditions are satisfied; the conditions will often involve the current values of telemetry, configuration, and inferred data variables. Inferred facts and messages may be sent to the User Interface component and displayed to the spacecraft analyst as defined in the User Interface Specification. NASA's CLIPS inference engine forms the core of this component.

- **User Interface** – This component manages the user interface of the GenSAA Application. It displays user interface panels that contain both text and graphics. Color is used to enhance the display of state data. Data-driven display objects are associated with telemetry values received from the TPOCC data server and

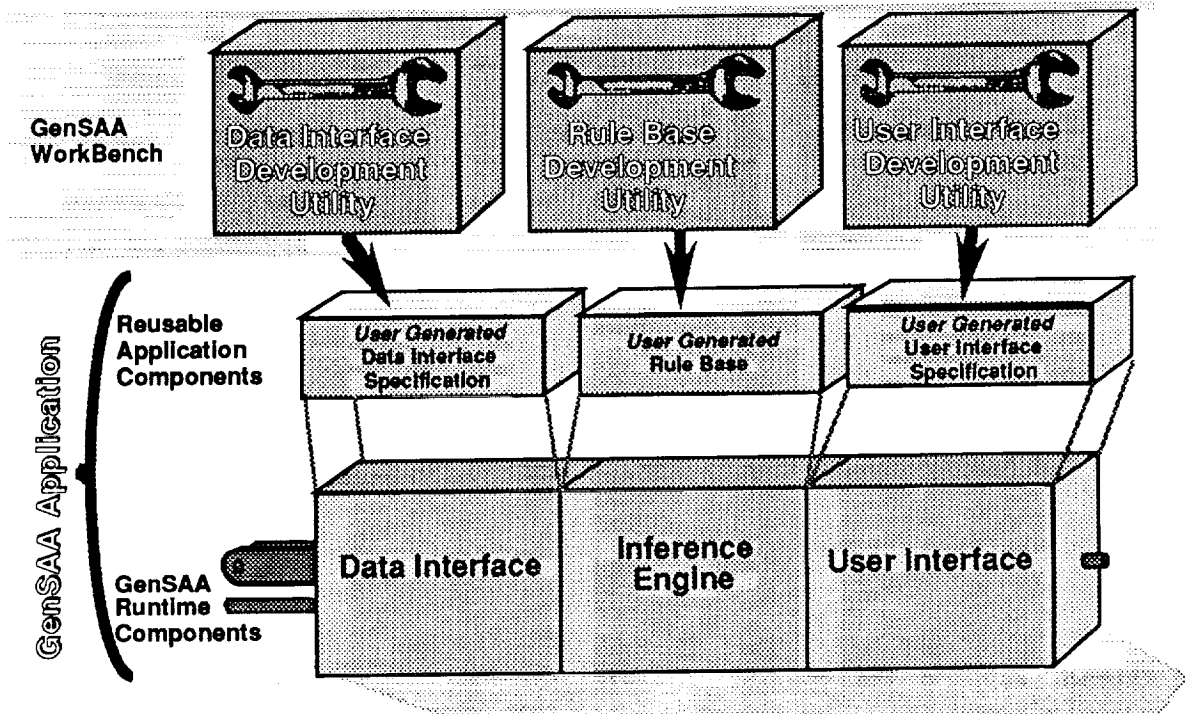

Figure 2. Creating a GenSAA Application

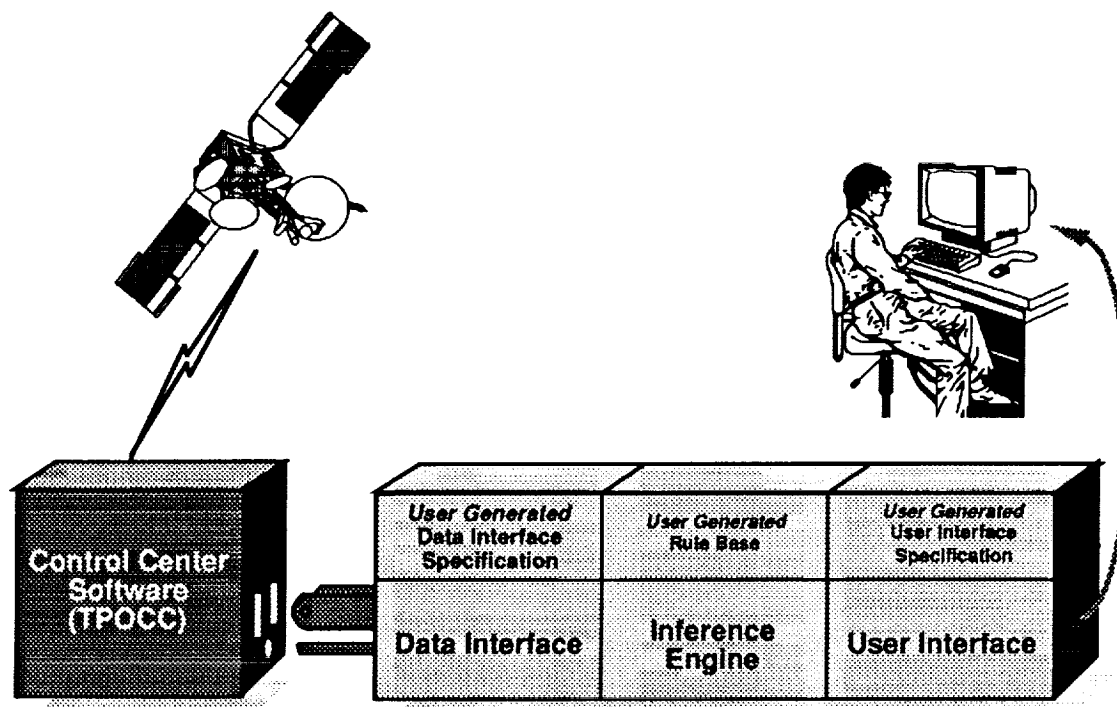

Figure 3. A GenSAA Expert System Application in operation

inferred facts and conclusions received from the Inference Engine. In response to user inputs that include hypertext button events, the User Interface displays selected display panels, help text, and other informational text. The user interface panels, data-driven objects, and interaction objects are defined in the User Interface Specification that was generated by the GenSAA User Interface Development utility.

Figure 3 shows a completed GenSAA expert system application in operation. GenSAA expert systems will run on Unix workstations using the X Window System. The operational interface with the spacecraft analyst will typically include color block diagrams and animated data-driven objects (such as rotating meters, sliding bar graphs, and toggle switches) that graphically display the dynamic values of telemetry data, configuration data, and inferred conditions. The user interface will also typically contain hypertext and hypergraphic links to make it easy for the spacecraft analyst to quickly select desired display panels. The GenSAA Workbench supports the creation of these interface features.

Multiple GenSAA Applications

GenSAA applications are intended to be relatively simple expert systems with small rule bases that are typically developed by a single analyst. For example, a GenSAA application might monitor and isolate faults for one subsystem on board a spacecraft. To handle more complex monitoring situations, involving for example several spacecraft subsystems, multiple GenSAA applications can be built and executed concurrently. Each GenSAA application would be allocated one portion of the monitoring task, and share key conclusions with one another.

A fourth component of the GenSAA Runtime Environment, the GenSAA Data Server, is used to enable multiple GenSAA applications to exchange data. As shown in Figure 4, the GenSAA Data Server is a Unix process that can receive a real-time stream of configuration and inferred data variable updates from any GenSAA application. The GenSAA Data Server distributes the data to any GenSAA application that has requested it. A given GenSAA

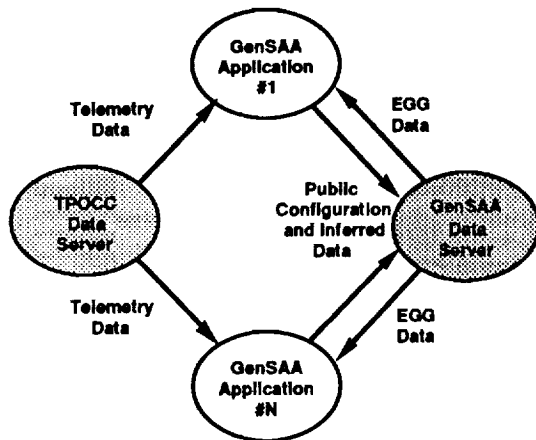

Figure 4. Sharing data among multiple GenSAA Applications

application only receives those variables it has specifically requested. The data received by a GenSAA application from the GenSAA Data Server is called externally generated GenSAA (EGG) data. A GenSAA application receives EGG data via its Data Interface component in exactly the same way as it receives telemetry data from the TPOCC Data Server.

Within a GenSAA application, EGG data can be used in the conditions of rules, and can be associated with display items in exactly the same way as telemetry, configuration, and inferred data. The Workbench supports the specification of EGG data as a fourth variable type. The Workbench also allows any local configuration or inferred data to be specified as public, to cause it to be sent to the GenSAA Data Server, and thereby shared with other GenSAA applications.

Benefits of GenSAA

The following benefits are expected to be realized by using GenSAA to build spacecraft monitoring expert systems for future NASA missions:

- **Assists the FOAs with data monitoring**— FOAs monitor real time data looking for combinations of telemetry parameter values, trends, and other indications that may signify a problem with the satellite or its instruments. The expert systems created with GenSAA will assist the FOAs with the tedious task of data monitoring and allow them to focus on other,

higher-level responsibilities during real-time contacts with the satellite. This, in turn, will likely result in more efficient and effective operations.

- **Reduces development time and effort; allows quicker response to necessary modifications** — The behavior of an orbiting satellite is quite dynamic and occasionally different than anticipated. To quickly create or modify expert systems that can effectively monitor satellites, tools are needed that allow analysts to formulate rulebases easily without the intervention or delay of knowledge engineers and programmers. Several benefits are expected by eliminating these traditional developers. Analysts will be able to create rules quickly in response to unforeseen changes in spacecraft behavior or operational procedures. Also, knowledge translation errors will be reduced or, at least, more easily corrected. Knowledge translation errors are errors which are inadvertently introduced during the process of translating a piece of expert knowledge into rule form.

- **Serves as a training tool** — In addition to assisting the FOAs with real-time spacecraft operations, GenSAA will be useful as a training tool in two ways. First, by utilizing the playback utilities provided by TPOCC, analysts will be able to replay a previous spacecraft communications event. Thus, a student analyst can observe how the expert system handles a specific problem scenario. Exercises like this will provide a realistic, hands-on environment for training FOAs in a safe, off-line mode. Second, experience from previous expert system projects indicates that the development of rules used in an expert system is a beneficial mental training exercise for the FOA. When FOAs create rules themselves, they must consider alternatives more closely and may therefore develop a deeper understanding of the problem domain. This approach may enable more effective fault isolation methods to be identified.

- **Protects against loss of expertise** — Another benefit of automating fault-isolation tasks with rule-based systems is that the resulting rulebase serves as accurate documentation of the fault-isolation method. The rulebase can be studied by student analysts to

learn about fault-isolation techniques. Even more importantly, mission operations can be better protected against the effects of personnel turnovers. POCC expert systems that capture fault-isolation knowledge preserve expertise from mission to mission and mitigate the impact of the loss of experienced FOAs.

GenSAA is well suited for use on spacecraft projects that involve a series of similar but nonidentical missions such as NASA's Small Explorer (SMEX) and International Solar-Terrestrial Physics (ISTP) programs.

Conclusion

As satellites become more complex, their operation is becoming increasingly difficult. FOAs who are responsible for the command, control, health, and safety of these spacecraft must monitor increasing volumes of data, and are quickly reaching a level of information saturation. As demonstrated by the CLEAR Expert System, fault-isolation expert systems can help FOAs monitor the flood of data. Expert systems can accurately monitor hundreds of real-time telemetry parameters, isolate discrepancies and anomalies the instant they can be detected, and alert the analysts and provide advice on how to correct problems swiftly and effectively. Unfortunately, development of these systems is often time consuming and costly moreover, they often cannot be easily reused for other missions.

Consequently, GenSAA is being developed for use by the FOAs who work in satellite control centers. GenSAA is designed to enable fault-isolation expert systems to be developed quickly and easily, and without the delay or costs of knowledge engineers and programmers. By facilitating the reuse of expert system elements from mission to mission, GenSAA will reduce development costs, preserve expertise between missions and during periods of personnel turnover, and provide more effective spacecraft monitoring capabilities on future missions.

References

- Bielawski, L., & Lewand, R. (1991). *Intelligent Systems Design: Integrating Expert Systems, Hypermedia, and Database Technologies*, New York: John Wiley & Sons.
- Hughes, P.M. (1989). *Integrating Expert Systems into an Operational Environment*. AIAA Computers in Aerospace VII Conference, Monterey, California.
- Hughes, P.M., & Hull, L.G. (1987, May). CLEAR: Communications Link Expert Assistance Resource. 1987 Goddard Conference on Space Applications of Artificial Intelligence and Robotics, Greenbelt, Maryland.
- Hughes, P.M., & Luczak, E. (1990, March). *Generic Spacecraft Analyst Assistant-Concept Definition*. Data Systems Technology Laboratory Document DSTL-90-008. Greenbelt, Maryland: NASA/Goddard Space Flight Center.
- Hughes, P.M., & Luczak, E. (1990, August). *Generic Spacecraft Analyst Assistant-Prototype Definition*. Data Systems Technology Laboratory Document DSTL-90-033. Greenbelt, Maryland: NASA/Goddard Space Flight Center.
- Luczak, E.C., Gopalakrishnan, K., & Zillig, D.J. (1989, May). REDEX: The Ranging Equipment Diagnostic Expert System. 1989 Goddard Conference on Space Applications of Artificial Intelligence, Greenbelt, Maryland.
- Perkins, D., & Truskowski, W. (1990). *Launching AI in NASA Ground Systems*. AIAA/NASA Second International Symposium on Space Information Systems, Pasadena, California.

Advanced Laptop and Small Personal Computer Technology

A Presentation For

The Control Center Technology Conference
June 18-20, 1991
University of Houston — Clear Lake
Houston, Texas

Prepared by
Roger L. Johnson, Ph.D.
Sr. Vice President
Science Applications International Corporation
4224 Campus Point Court
San Diego, CA 92121
(619) 450-3902

SD 79 930

319-14
39621
P-40

N92-12029

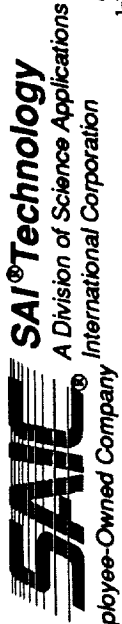

HAND CARRIED COMPUTERS AND MOBILE WORKSTATION TECHNOLOGY

- Background
- Applications
- High End Products
- Technology Trends
- Requirements for the Control Center Application
- Recommendations for the Future

MOBILE WORKSTATIONS

- Small, compact workstations embedded in a mobile platform, e.g., ships, submarines, trucks etc.
- Small, compact workstations that can be hand carried by operating personnel, e.g., notebooks, laptops, and transportables.

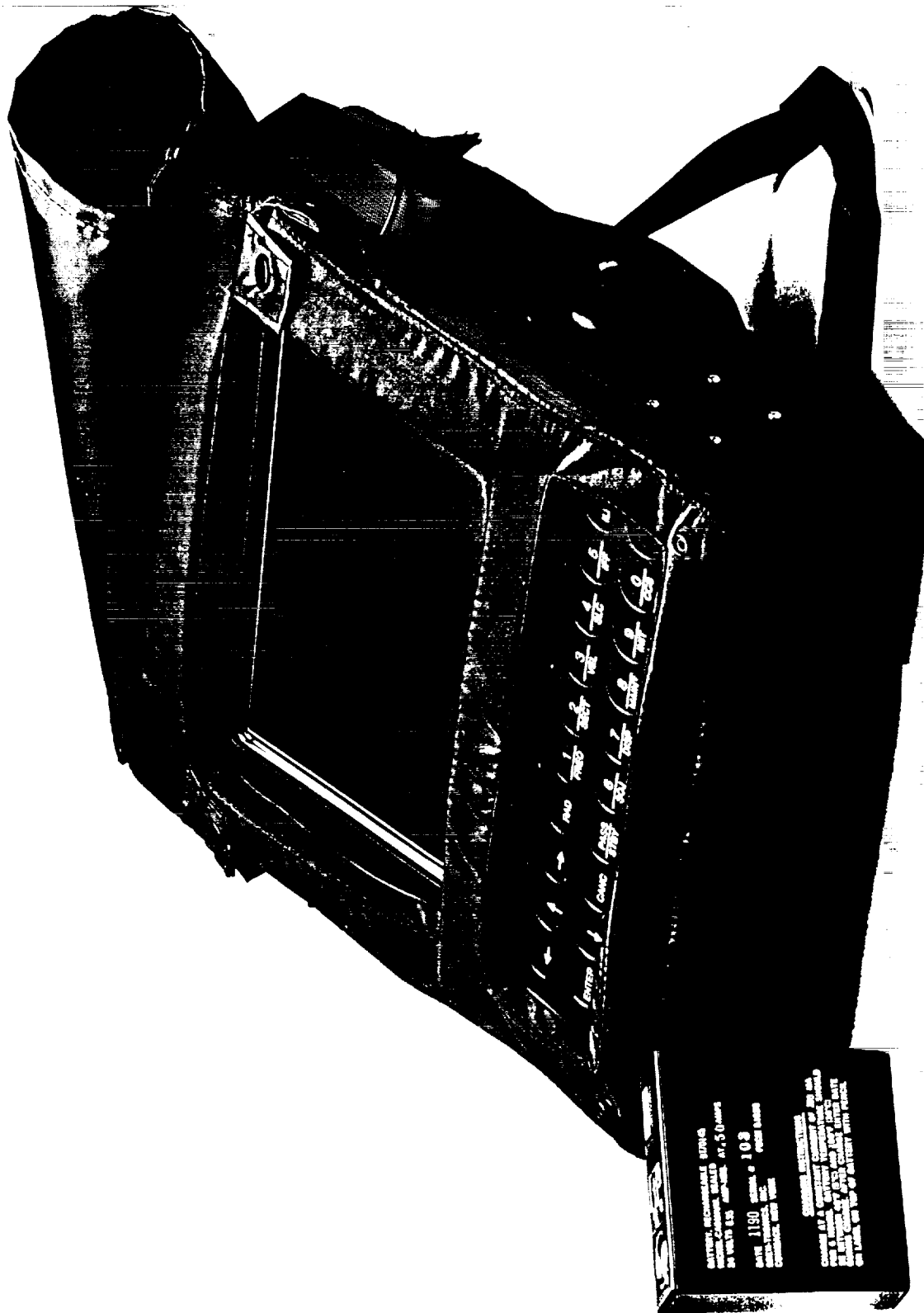

BATTERY, RECHARGEABLE NIKON
TYPE EN-EL3E, 1800mAh, 3.7V
DATE 1190 1000mAh, 3.7V
RECHARGEABLE BATTERY

COMBINE WITH NIKON
CAMERA AT A NIKON STORE OR
AT A RETAILER OF NIKON
PRODUCTS. ALWAYS USE THE
CORRECT TYPE OF BATTERY WITH POWER.

**Lightweight Ruggedized, NDI, 32-Bit Tactical Workstation
(GRiDSE-T/386)**

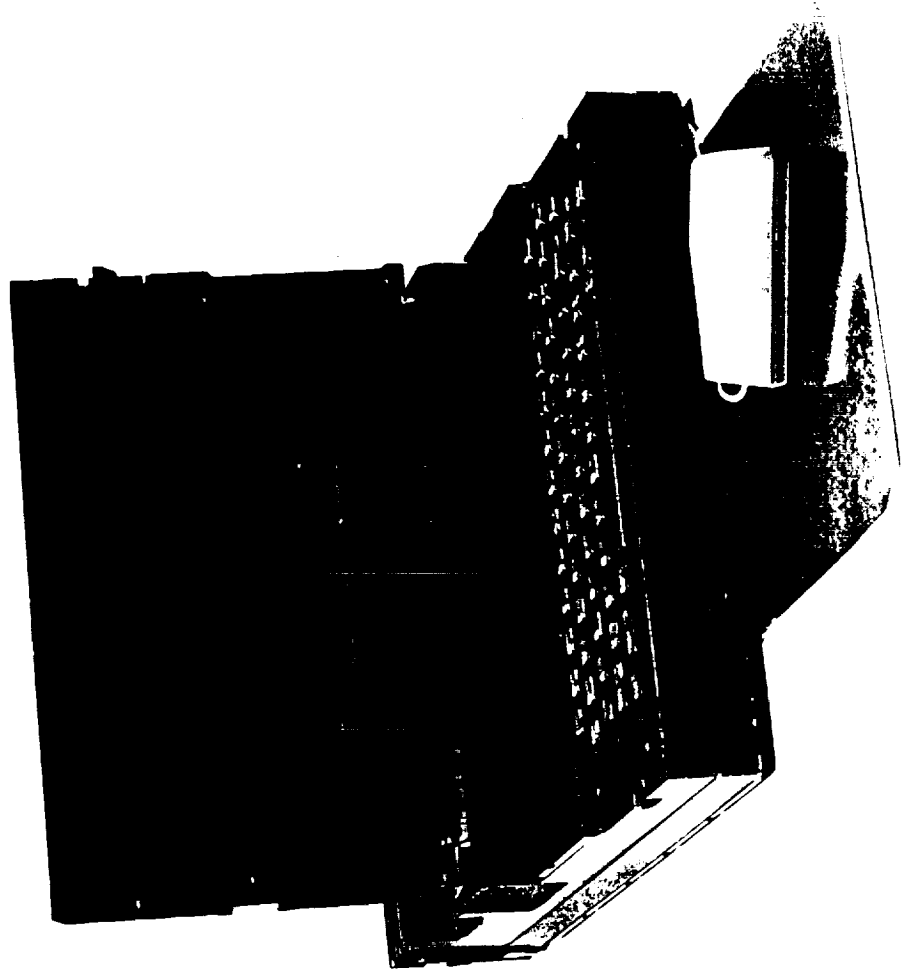

Communications Systems Division



SAI Technology
A Division of Science Applications
International Corporation

The **Lightweight Computer Unit (LCU)** family is the newest member of the Army's Tactical Command and Control Systems (ATCCS) Common Hardware Software (CHS) program. At the heart of the LCU offering are the V1 and V2 Lightweight Computers (LCs) and Tactical Communications Interface Module (TCIM).

The **LCU** is an open system, non-proprietary architecture that provides a POSIX compliant operating system, with the capability to run applications under UNIX or MS-DOS®. Both LC versions will run off-the-shelf software written for IBM™ PCs and compatibles. Optional Special Purpose Boards and peripherals are available to maximize V1 and V2 LC interchangeability.

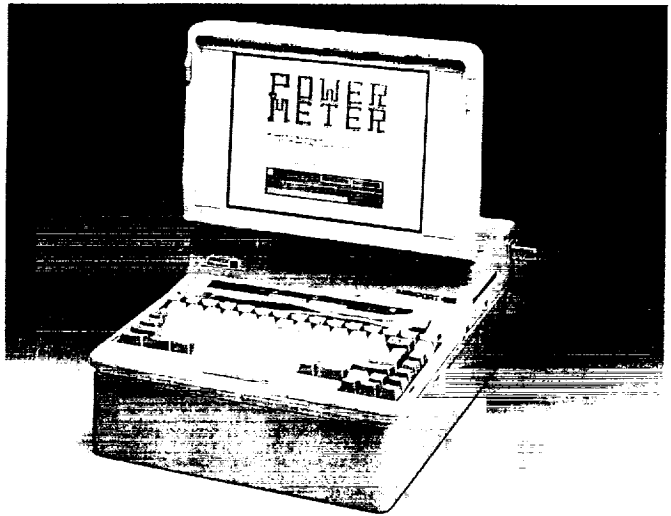

V1 Lightweight Computer (V1 LC)

V 1 F E A T U R E S

The V1 LC is a commercial 25MHz 486 laptop with 5 standard AT board slots. Manufactured by *Zenith Data Systems*, the V1 LC is equipped with a 120MB internal hard disk, high density 3.5" floppy drive, detachable keyboard, 2.4 Kbps modem, VGA LCD, up to 16MB RAM, and provides over 10 MIPS performance with 100% functional compatibility with its V2 LC counterpart.



Hard Transfer Case



External Hard Drive



External Tape Backup Unit

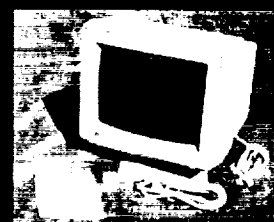

External Color VGA Display



External



V2 Lightweight Computer (V2 LC)

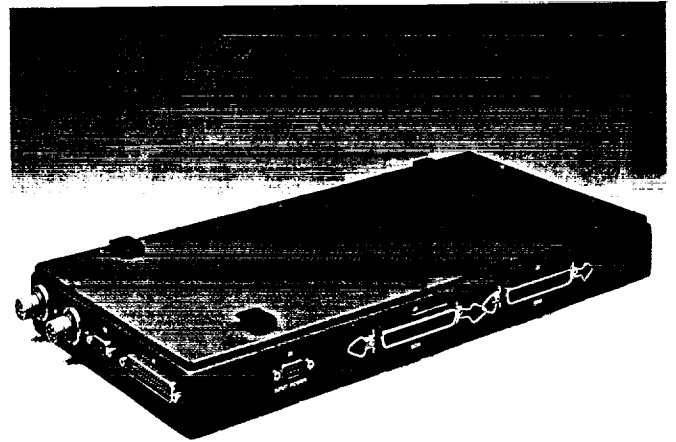

Tactical Communications Interface Module (TCIM)

V 2 F E A T U R E S

The V2 LC is a ruggedized 25MHz 486 portable with 5 standard AT board slots. Engineered by SAIC, the rugged V2 LC is equipped with a removeable 120MB hard disk, high-density 3.5" floppy drive, detachable keyboard, 9.6 Kbps modem, VGA LCD, up to 32MB RAM, and provides over 10 MIPS performance with 100% functional downward compatibility to the V1 LC.

T C I M F E A T U R E S

TCIM is based on a 32/16-bit communication-oriented microcontroller coupled with two high-performance Digital Signal Processors (DSP). Designed by Magnavox, the TCIM DSPs permit flexibility in performing modulation, demodulation, filtering, gain enhancement of signals, and the ability to off-load computationally-intensive, bit-oriented functions from the microcontroller.



Floppy Disk Drive

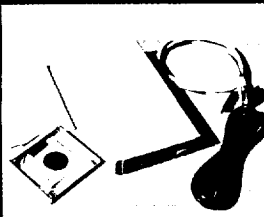

CD ROM

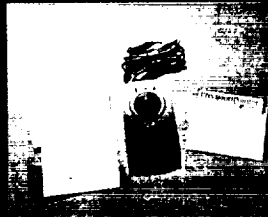

V1 Trackball

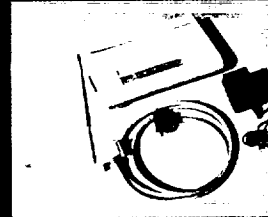

V1 Lightweight Printer (V1 LP)



V2 Lightweight Printer (V2 LP)

THE FUTURE

- ❑ Approximately 45 percent of the U.S. workforce operates outside the office.
- ❑ By the Mid-90's a significant fraction of this workforce will require high performance, mobile (portable) workstations.
- ❑ Mobile Command Centers will be a key user of this technology.

APPLICATION CHARACTERISTICS

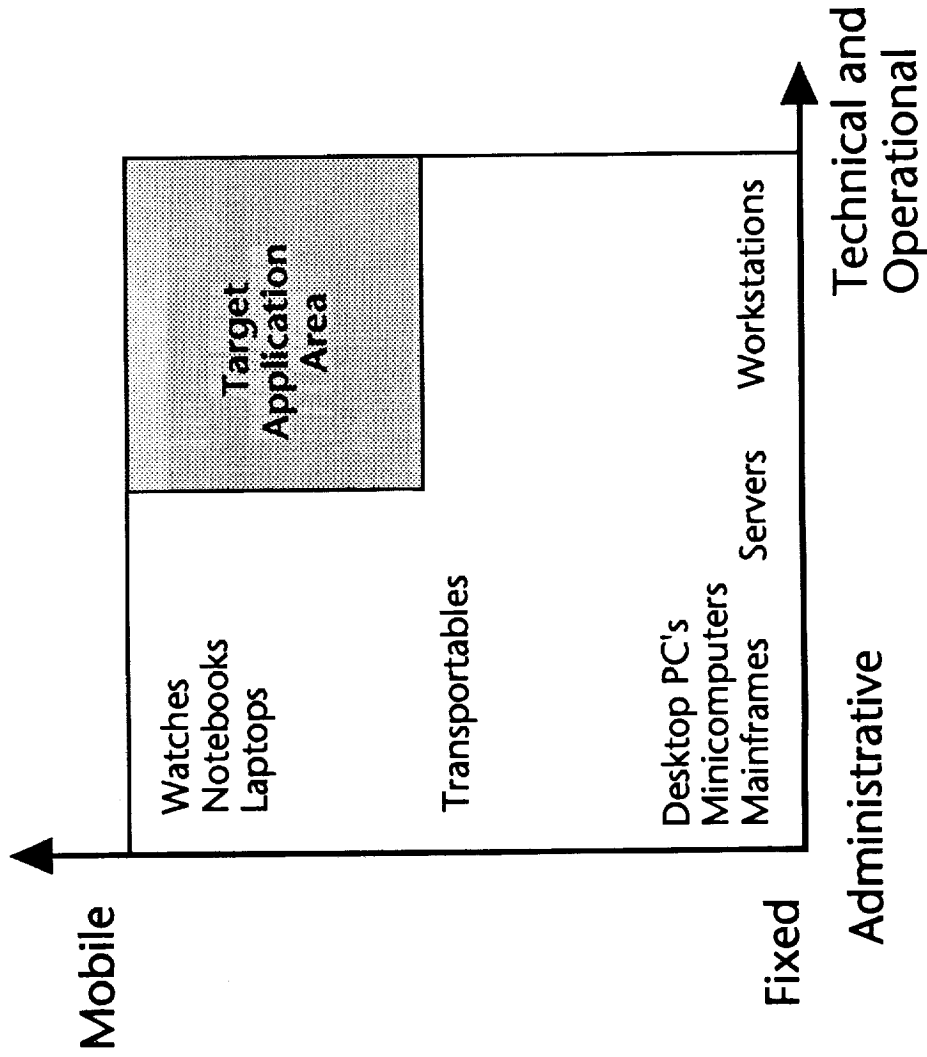

17463-001.04

APPLICATION CHARACTERISTICS

- High value assets are at stake.
- Time is critical.
- Users are mobile.
- Environments are unusual and/or harsh.
- There are complex problems to solve.
- Information is needed in a variety of forms from a variety of sources.
- Users are expert in their field, not in computers.

HIGH END APPLICATIONS

- Operational support of complex systems and experiments
 - NASA Shuttle and Space Station
 - Defense and Government Operations
 - Energy Utilities
 - Communication Utilities
 - Airframe Maintenance

- Maintenance and logistical support of complex systems
 - Transportation Systems
 - Defense Systems
 - Utilities
 - Airlines

- Environmental and Energy Management
 - Management of hazardous materials and activities
 - Emergency management

OTHER APPLICATIONS

- Construction
 - Site assessment and mapping
 - Schedule and resource management
 - Design and construction verification

- Intelligence gathering and dissemination
 - Government
 - Industrial
 - Commercial

- Law Enforcement
 - Airport/Airline Security

KEY COMPONENTS OF A MOBILE WORKSTATION

- Platform Technologies
- Communications
- Application Software

PRIMARY PLATFORM TECHNOLOGIES

- Processor and Memory
- Mass Storage
- Display
- Person-machine Interface
- Firmware and Software
- Packaging
- Other—System interfaces
- Peripherals

PRIMARY COMMUNICATION AND NETWORK TECHNOLOGIES

- Modems
- Data Security
- Commercial Utilities and Networks
- Radio and Satellite Links

APPLICATION SOFTWARE

- Current third party workstation software base
- Databases and Query systems
- Authoring tools and Publishing
- Third party software products

THE AgilePAC™ CONCEPT

COMPUTER & COMMUNICATION NETWORKS

SENSORS & ANALYTICAL INTERFACES

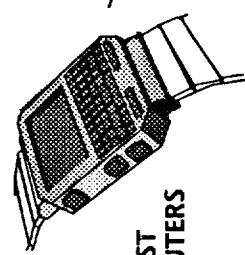

WRIST COMPUTERS

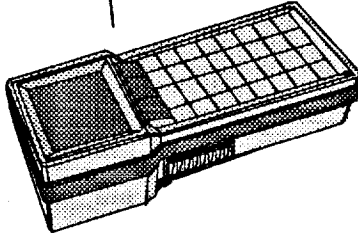

HANDHELD COMPUTERS

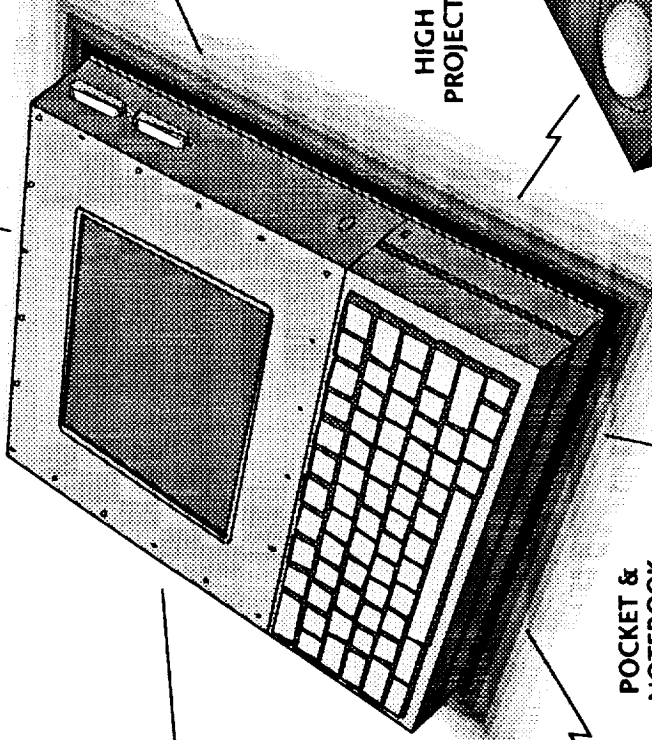

HIGH DEFINITION MONITORS

HIGH DEFINITION PROJECTION SYSTEMS

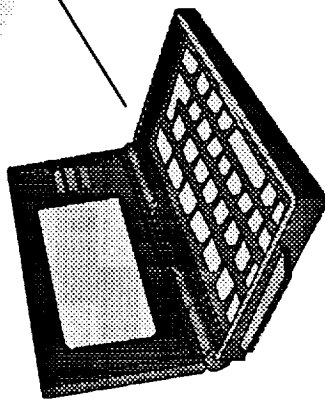

POCKET & NOTEBOOK COMPUTERS

VIDEO & VOICE INPUTS

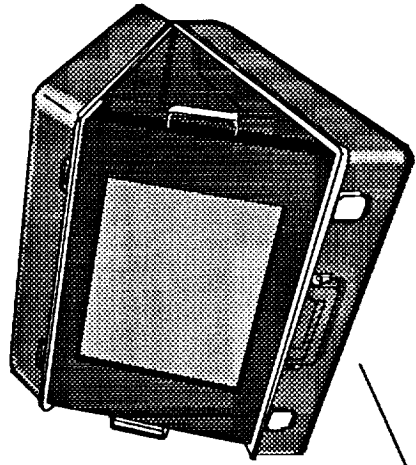
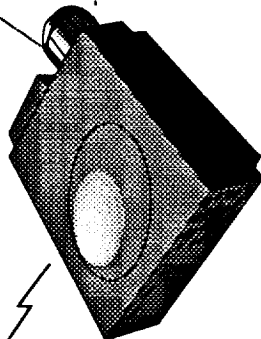

17463-00004

SAI SAI® Technology
A Division of Science Applications
International Corporation
An Employee-Owned Company

PROVIDING POWER AT THE POINT OF ACTION

- High Compute Power Density
- Built-In Networking
- Modular Design
- Ruggedness
- Untethered Network Computing
- Video and Voice Support (Multi-Media)

Lightweight Deployable Communication (LDC-1) System (AN/GSC-59)

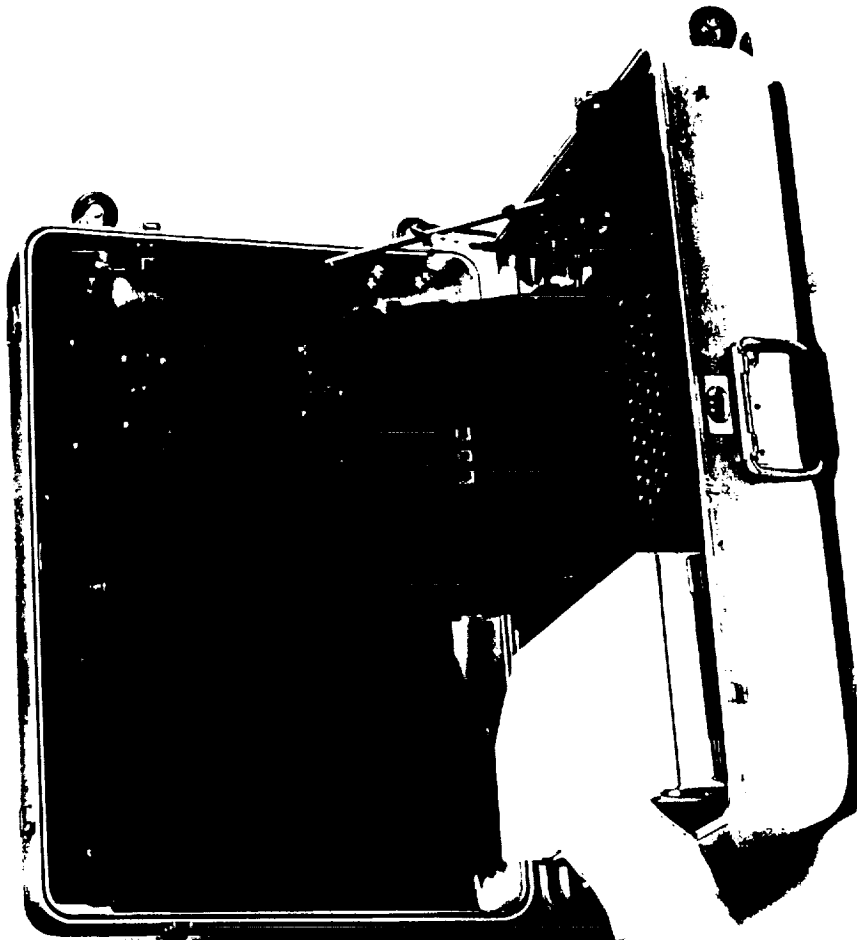

Communications Systems Division



SAI Technology
A Division of Science Applications
International Corporation
An Employee Owned Company

Lightweight Deployable Communication (LDC-4) System



ORIGINAL PAGE IS
OF POOR QUALITY

Communications Systems Division

SAIC SAIC Technology
A Division of Science Applications
An Employee Owned Company International Corporation

AN/GSC-62 Table Top Base Station



The AN/GSC-62 Table Top Base Station (TTBS), developed by SAI Technology, is a rugged, lightweight, rapidly deployable, high frequency burst communications system. The TTBS is divided into four component groups; the message, the transmitter, the control and the receiver group. For more information, please contact SAI Technology at 800-447-4373 or 703-527-9400.

SAI
An Employee-Owned Company

SAI Technology
A Division of Science Applications
International Corporation

ORIGINAL PAGE IS
OF POOR QUALITY

**AN/GSC-59 & AN/GSC-60
Global System Architecture**

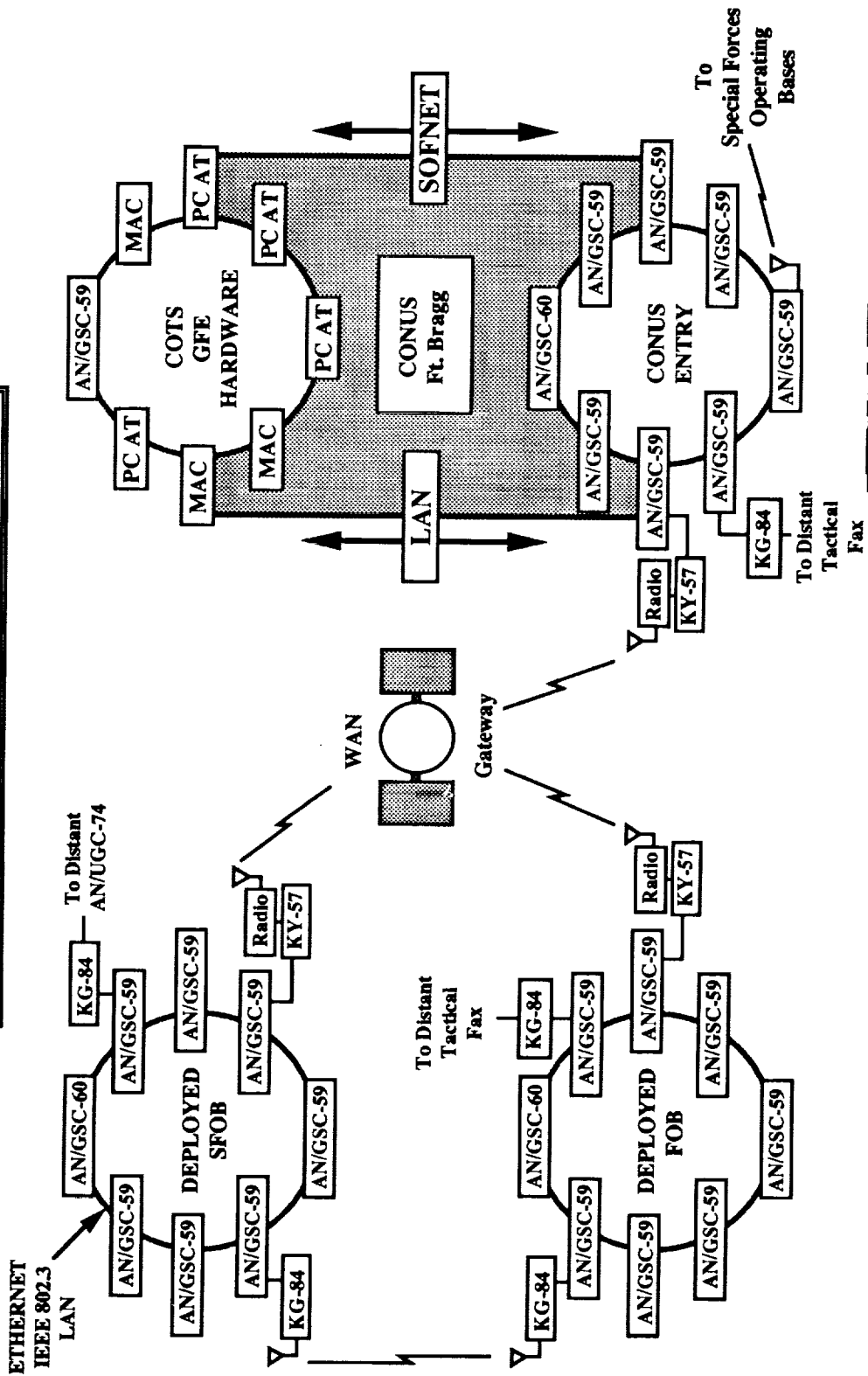

SAIC SAI® Technology
 A Division of Science Applications
 International Corporation
 An Employee-Owned Company

LDC 4 GLOBAL OPERATIONAL REQUIREMENTS

- Lightweight, Ruggedized, Shelter Mounted and rapidly Transportable on a single military aircraft.
- Multiple communications interfaces including 2/4 wire, SHF SATCOM and Crypto devices.
- Automatic Message Processing for AUTODIN including Janap 128 and DOI 103.
- Key functional staff automation support for Command and Operations, Intelligence, Administration and Logistics.

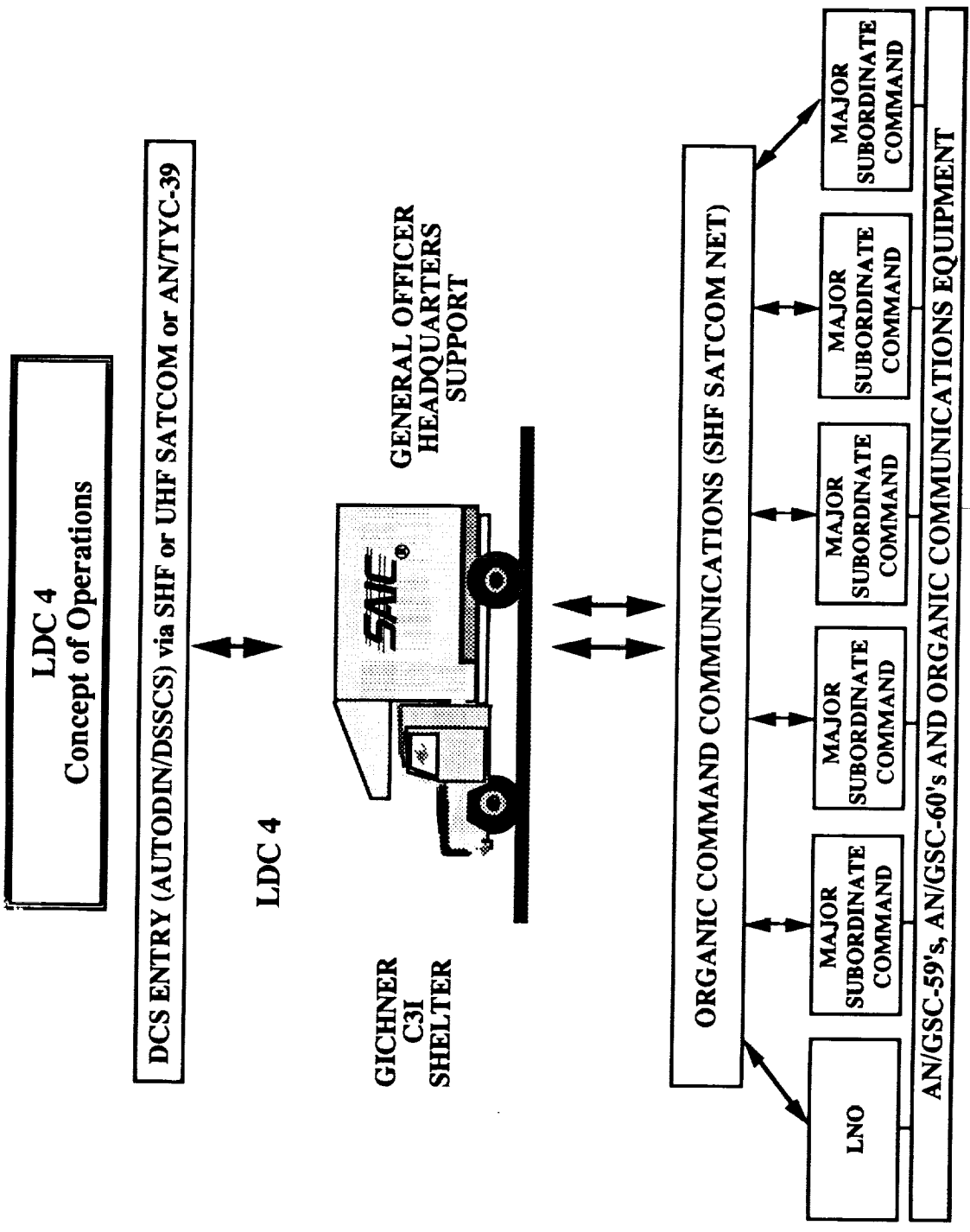

Advanced Workstation Technology

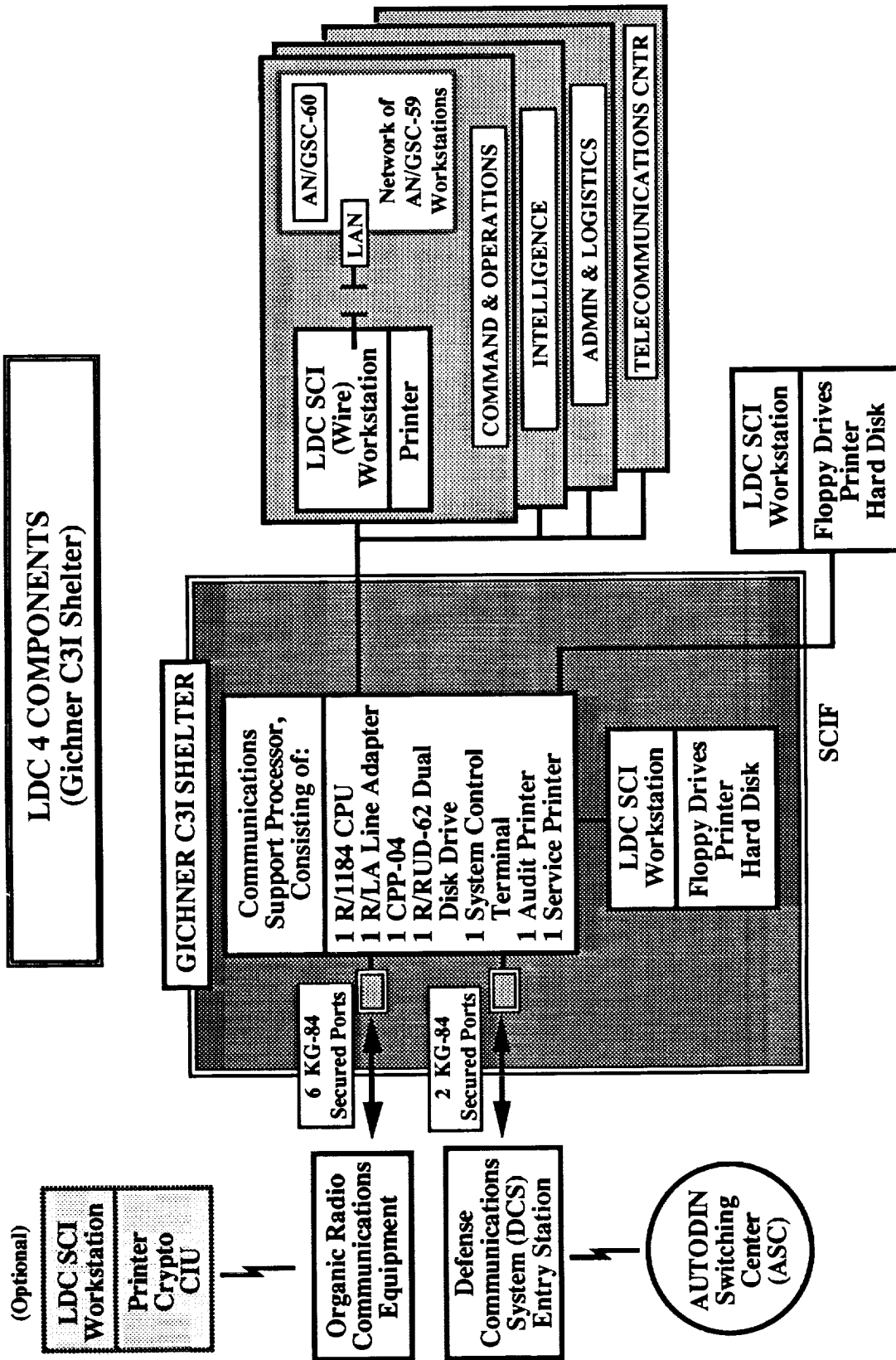

(Optional)

LDC SCI Workstation
Printer
Crypto CIU

Advanced WorkStation Technology

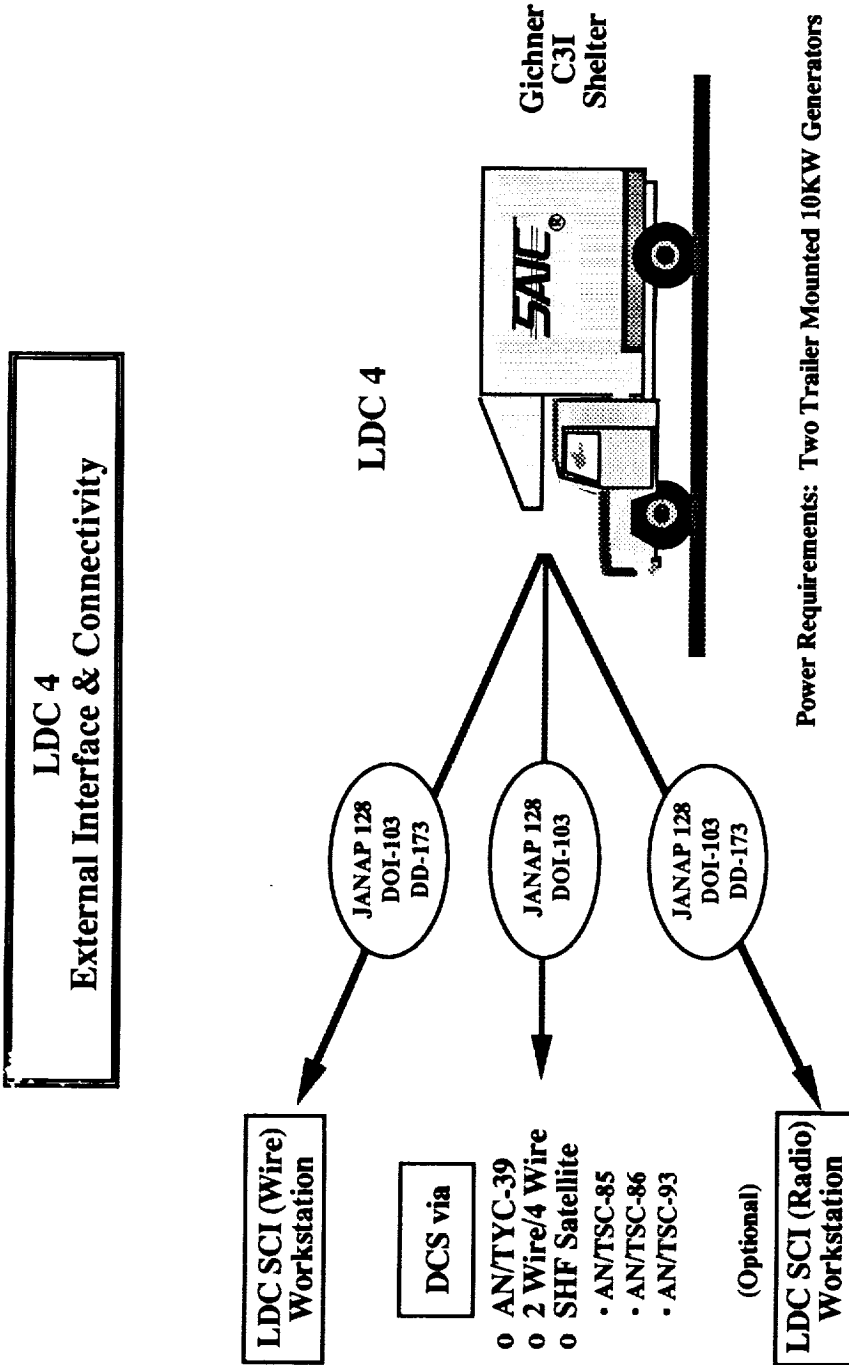

AN/GSC-62
Operational Capabilities

- REPLACES EXISTING AN/TSC-99 BASE STATION
- AROUND THE CLOCK (24 HOUR) OPERATIONAL CAPABILITY
- PROVIDES MESSAGE GENERATION, ENCRYPTION, DECRYPTION, TRANSMISSION & RECEPTION
- TRANSMISSION CAPABILITY UP TO 96 MESSAGES PER DAY
- DEMONSTRATED 'SET UP' CAPABILITY IN < 2 HOURS
- TOTAL SYSTEM WEIGHT < 2500 POUNDS 3
- TOTAL SYSTEM CUBIC CAPACITY < 140 FT
- TRANSIT CASES ARE 2-MAN CARRY CAPABLE
- TRANSMITTER GROUP REQUIREMENT - ONE 10 KW GENERATOR
- MESSAGE, CONTROL & RECEIVE GROUP REQUIRES <400 WATTS
110V AC POWER
- TWO MODES OF OPERATION: SOICS (KL-52) & EXISTING DMDG

RECOMMENDATIONS FOR FUTURE RESEARCH AND DEVELOPMENT

- High density, low cost packaging for mobile user environments
- High performance but low battery power hardware and software
- Mobile radio network technology
- Security — User and Data
- Code Book processing
- Application software
- Remote (communicating) miniaturized sensors

V1 LC

Lightweight Computer Unit (LCU) Program

The Version One Lightweight Computer (V1 LC) is a lightweight, commercial 25MHz 486 laptop with 5 standard AT board slots supporting the operational requirements of the U.S. Army Tactical Command and Control System (ATCCS) Common Hardware Software (CHS) program. Designed by Zenith Data Systems, the V1 LC is equipped with a 120MB internal hard disk drive, high-density 3.5" floppy disk drive, detachable keyboard, 2400 bps modem, VGA LCD screen, up to 16MB RAM, is powered from 110/220 VAC or a two-hour rechargeable battery, and provides over 10 MIPS performance with 100% functional compatibility with its V2 LC counterpart.

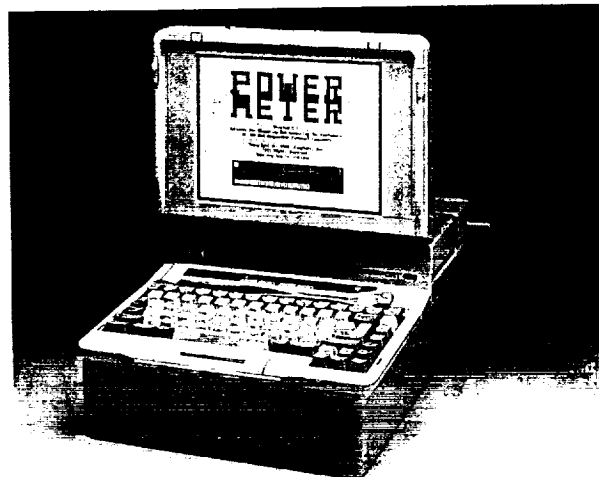

The V1 LC is an open systems, non-proprietary architecture that supports a POSIX compliant operating system with the capability to run applications under UNIX or MS-DOS*. The V1 LC will run the vast amounts of commercial off-the-shelf software written for IBM™ PCs/PC compatibles.

The commercial V1 LC supports the external LCU Tactical Communication Interface Module (TCIM). Designed by Magnavox, the TCIM is based on a powerful 32/16-bit communication-oriented microcontroller processor coupled with two high performance Digital Signal Processors (DSP). These DSPs permit flexibility in performing modulation, demodulation, filtering, gain enhancement of signals, and the ability to off-load computationally-intensive, bit-oriented functions from the microcontroller.

Features

- 25MHz 80486 32-bit processor with an embedded Floating Point Processor
- Full 32-bit data path to zero-wait-state memory
- Internal 2400 bps modem with RJ-11 telephone and data path connectivity
- Detachable 82-key subset of IBM enhanced keyboard with 101-key functionality
- Unique operator display and control panel for enhanced visual LC system status
- 640 x 480 VGA Compatible 10" diagonal LCD screen supporting 16 Levels of Shading
- Perpetual time-of-day / date clock with integral battery
- Standard AC power, European AC power adapter, DC rechargeable batteries & cables
- AC-DC converter/battery charger with cable
- 5 standard full-length PC/AT card slots for commercial off-the-shelf AT boards
- Common set of peripherals, connectors, and cables for the V1 & V2 LC platforms
- Soft carrying case to house the V1 LC, trackball, cables and commercial manuals
- Maximum compatibility with the entire suite of CHS LCU hardware peripherals

V1 LC

Specifications

Functional

- Display:** 640 x 480 VGA compatible, 10" diagonal LCD screen supporting 16 levels of shading
- Expansion:** 5 full-length PC/AT card slots
- Processor:** 25MHz 80486 with embedded floating point processor
- Memory:** 4MB RAM standard with expansion up to 16MB
- Keyboard:** Detachable 82-key subset of IBM enhanced keyboard with 101-key functionality
- Pointing Device:** 3-button Trackball
- Mass Storage:** 3.5" 1.44MB Floppy Disk Drive; Internal 120MB Hard Disk Drive (19msec)
- Interface:** Standard Centronics Parallel Port; Standard 9-Pin Serial Port; Standard VGA Port for External Color Monitor; 2400 bps Hayes compatible modem with telephone and data RJ-11 jacks; External Floppy Drive Port; External TCIM Power
- Reliability:** 10,000 Hours MTBF
- Maintainability:** Predicted MTTR of 0.18 Hours

Environmental

- UL Listed
- Complies with FCC Part 15, Class B
- Best Commercial Operating Environment Standards

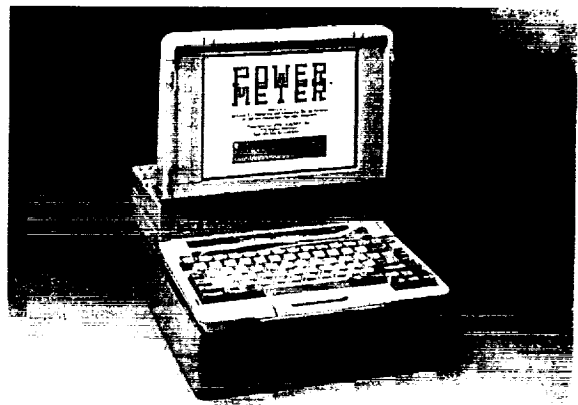

Physical

- Dimensions:** Height 6.6", Width 12.4", Depth 15.2"
- Weight:** 22.5 lbs.

Electrical

- Input voltage:** 110/220 VAC, 50/60 Hz
Rechargeable Battery Pack for 2 hours operation

Optional V1 LCU Special Purpose Boards

- MIL-STD-1553
- Group 3 Facsimile
- SCSI
- IEEE-488
- Speech Synthesis
- IEEE 802.3 LAN



10240 Sorrento Valley Road, Suite 203
San Diego, CA 92121
1-800-772-2LCU or 1-800-447-4373

V2 LC

Lightweight Computer Unit (LCU) Program

The Version Two Lightweight Computer (V2 LC) is a ruggedized 25MHz 486 portable with 5 standard AT board slots supporting the operational requirements of the U.S. Army Tactical Command and Control System (ATCCS) Common Hardware Software (CHS) program. Designed by SAIC, the rugged V2 LC is equipped with a removeable 120MB hard disk drive, high-density 3.5" floppy disk drive, detachable keyboard, 9600 bps modem, VGA LCD screen, up to 32MB RAM, is powered from military vehicles, 110/220 VAC or a two-hour rechargeable battery, and provides over 10 MIPS performance with 100% functional downward compatibility to the V1 LC.

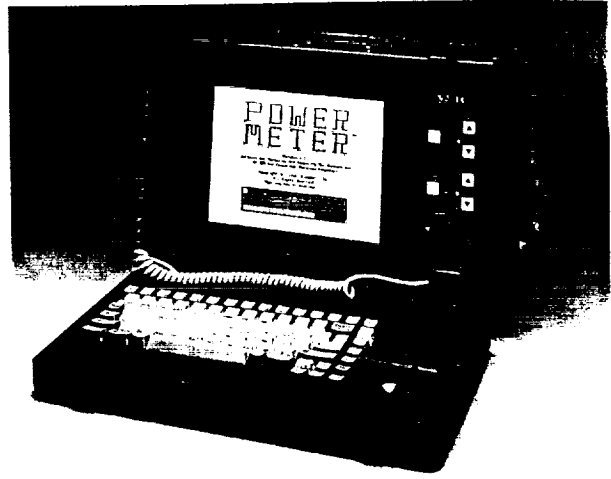

The V2 LC is an open systems, non-proprietary architecture that provides a POSIX compliant operating system with the capability to run applications under UNIX or MS-DOS[®]. The V2 LC will run the vast amounts of commercial off-the-shelf software written for IBM[™] PCs/PC compatibles.

The ruggedized V2 LC supports both an internal AT size Tactical Communications Interface Module (TCIM) board (via build-in internal SCSI interface) and external TCIM configurations. Designed by Magnavox, the TCIM is based on a powerful 32/16-bit communication-oriented microcontroller processor coupled with two high performance Digital Signal Processors (DSP). These DSPs permit flexibility in performing modulation, demodulation, filtering, gain enhancement of signals, and the ability to off-load computationally-intensive, bit oriented functions from the microcontroller.

Features

- 25MHz 80486 32-bit processor with an embedded Floating Point Processor
- Full 32-bit data path to zero-wait-state memory
- Internal 9600 bps modem with RJ-11 telephone and data path connectivity
- Detachable 82-key subset of IBM[™] 101-key enhanced keyboard with embedded trackball
- 640 x 480 VGA compatible 10" diagonal LCD screen supporting 16-levels of shading
- Unique operator display and control panel for enhanced visual LC system status
- Perpetual time-of-day / date clock with integral battery
- Standard AC power, European AC power adapter, DC rechargeable batteries & cables
- Military vehicle power and AC-DC converter/battery charger with cables
- 5 standard full length PC/AT card slots for commercial off-the-shelf AT boards
- Common set of peripherals, connectors and cables for the V1 & V2 LC platforms
- Soft carrying case for V2 LC, cables, adapters, and commercial manuals
- Rugged hard transit case for V2 LC with soft carrying case, cables, and accessories
- Maximum compatibility with entire suite of CHS LCU hardware peripherals

V2 LC

Specifications

Functional

<i>Display:</i>	640 x 480 VGA compatible, 10" diagonal LCD screen supporting 16 levels of shading
<i>Expansion:</i>	5 full length PC/AT card slots
<i>Processor:</i>	25MHz 80486 with embedded Floating Point Processor
<i>Memory:</i>	8MB RAM standard with expansion up to 32MB RAM
<i>Keyboard:</i>	Detachable 82-key subset of IBM™ enhanced keyboard with 101-key functionality
<i>Pointing Device:</i>	Keyboard-embedded 3-button Trackball
<i>Mass Storage:</i>	3.5" 1.44MB Floppy Disk Drive; Internal 120MB Hard Disk Drive (19msec)
<i>Interface:</i>	Standard Centronics Parallel Port; Standard 9-Pin Serial Port; Standard VGA Port for External Color Monitor; 9600 bps Hayes compatible modem with telephone and data RJ-11 jacks; External Floppy Drive; Standard SCSI Port (ANSI X3.131-1986); External TCIM Power
<i>Reliability:</i>	10,000 Hours MTBF
<i>Maintainability:</i>	Predicted MTTR of 0.18 Hours

Physical

<i>Dimensions:</i>	Height 9.5", Width 16.0", Depth 10.4"
<i>Weight:</i>	27.5 lbs.

Electrical

<i>Input voltage:</i>	110/220 VAC, 50/60 Hz or 9-32 VDC Rechargeable Battery Pack for 2 hours operation
-----------------------	--



Environmental (MIL-STD-810E)

<i>Temperature:</i>	Operating range: -13° to +120°F (-25° to +49°C) Non operating range: -25° to +150°F (-32° to +65°C)
<i>Temp Shock:</i>	+70° to -13°F (+21° to -25°C) and +70° to +120°F (+21° to +49°C) in 10-minute intervals
<i>Shock:</i>	30° rotational drop per MIL-STD-810E, Method 516.4, Proc IV&VI
<i>Vibration:</i>	Track Vehicle operation per MIL-STD-810E, Method 514.4, Proc I
<i>Altitude:</i>	10,000 feet.
<i>Rainproof:</i>	1.8 inches per hour in 20 MPH wind for 30 minutes
<i>Humidity:</i>	Operating: -10 to 95% Non operating: -5 to 95%
<i>Sand/Dust:</i>	20 MPH to ±3MPH for 30 minutes
<i>Climate:</i>	Fungus resistant
<i>EMI:</i>	Complies with FCC Part 15, Class B

Optional V2 LCU Special Purpose Boards

- MIL-STD-1553
- Counter-Timer
- Speech Synthesis
- SCSI (Additional SCSI)
- Digital Multimeter (DMM)
- Group 3 Facsimile
- IEEE-488
- IEEE 802.3 LAN



SAIC Science Applications
International Corporation
An Employee-Owned Company

10240 Sorrento Valley Road, Suite 203
San Diego, CA 92121
1-800-772-2LCU or 1-800-447-4373

TCIM

Lightweight Computer Unit (LCU) Program

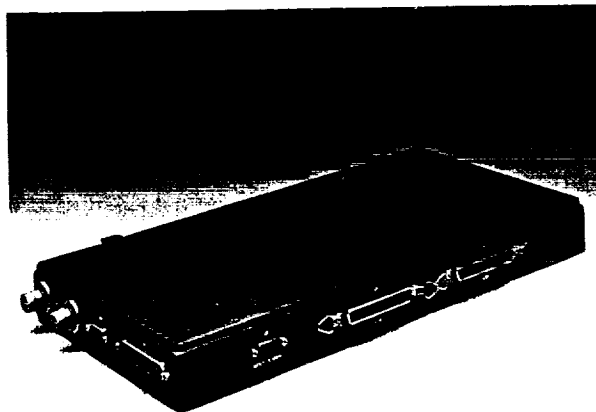

The **Tactical Communication Interface Module (TCIM)** is an advanced modem that contains appropriate processing and memory capabilities to perform as a front-end communication processor for both V1 and V2 LC computers. The LCU TCIM provides a powerful communication interface architecture essential to supporting the operational communication requirements demanded by the U.S. Army Tactical Command and Control System (ATCCS) Common Hardware Software (CHS) program. The TCIM provides two programmable communication channels, each configured independently via software downloads from the LC computers.

Designed by Magnavox, the TCIM is based on a powerful 32/16-bit communication-oriented microcontroller coupled with two high-performance Digital Signal Processors (DSP). These DSPs permit flexibility in performing modulation, demodulation, filtering, gain enhancement of signals, and the ability to off-load computationally-intensive, bit oriented functions from the microcontroller. Use of RAM based software downloaded from the V1/V2 LCs provides not only channel configuration, but also provides an easy path for implementing future communication capabilities.

Features

- Lightweight, compact, low power
- Two Versions
 - External Chassis for V1 and V2 Lightweight Computers
 - Internal Circuit Card for V2 Lightweight Computer
- High Performance 32-Bit Communication Microcontroller with 16-Bit Data Paths
- State-of-the-Art Digital Signal Processor (DSP) Technology
- Programmable Communication Channels configured via download from host computer
- SCSI interface to host computer for maximum flexibility across many host platforms

TCIM

Specifications

Communications Interfaces (Programmable)

- Channel 1:*
- KY-68 (DSVT), TA-1035 (DNVT), KG-84 (DLED)
 - AN/GYC-7 ULMS
 - SB-3614 Switchboard
 - EPUU JTTDS
 - 4-wire: FSK-188C; FSK-188B; STANAG 4202 (Annex A); Condition Diphas (CDP)
 - Protocols: Maneuver Control System (MCS) Circuit Switch protocol; Marine Tactical Systems (MTS) TIDP Mode VII protocol; X.25

- Channel 1
or Channel 2:*
- Combat Net Radio (CNR): VRC-12 and PRC-77; SINCGARS; GRC-193, GRC-213, PRC 104
 - KY-57
 - 2-wire: FSK-188C; FSK-188B; STANAG 4202 (Annex A); Condition Diphas (CDP)
 - Protocol: Maneuver Control System (MCS) CNR protocol; Marine Tactical Systems, (MTS) TIDP CNR protocol; MIL-STD-188-110A

Functional

- Processor:* 32/16 Bit Microcontroller (MC 68302); 2-Digital Signal Processors (DSP56001)
- Memory:* Microcontroller: 768KB RAM and 256KB EPROM
Digital Signal Processors: Minimum of 192KB RAM each
- Interface:* Tactical Communications via ports J1, J2, P1, and P2; V1 and V2 LC via SCSI (ANSI X3.131 - 1986) port J3; SCSI bus extension via port J4; Power via port J5
- Reliability:* Internal TCIM: 14,000 hours MTBF
External TCIM: 11,000 hours MTBF
- Maintainability:* Predicted MTTR of 0.25 hours for internal and external TCIM

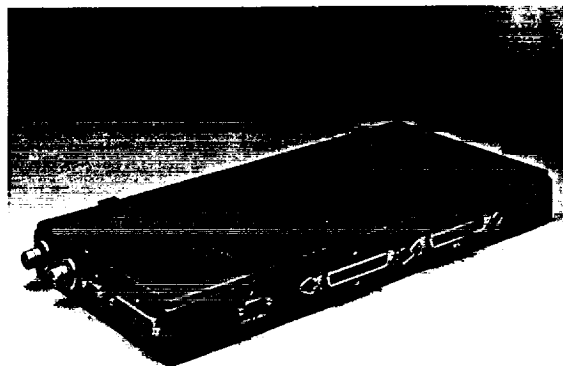

Environmental (MIL-STD-810E)

- Temperature:* Operating range: -13° to +120°F (-25° to +49°C)
Non operating range: -25° to +113°F (-32° to +65°C)
- Temp Shock:* +70° to -13°F (+21° to -25°C) and +70° to +120°F (+21° to +49°C) in 10-minute intervals
- Shock:* 30° rotational drop per MIL-STD-810E, Method 516.4, Proc IV&V
- Vibration:* Track Vehicle operation per MIL-STD-810E, Method 514.4, Proc I
- Altitude:* 10,000 ft.
- Rainproof:* 1.8 inches per hour in 20 MPH wind for 30 minutes
- Humidity:* Operating: -10 to 95%;
Non operating: -5 to 95%.
- Sand/Dust:* 20 MPH to ±3MPH for 30 minutes
- Climate:* Fungus resistant
- EMI:* Complies with FCC Part 15, Class B

Physical

- Dimensions:* External TCIM: Height 1.6", Width 8", Length 11"
Internal TCIM: Standard full-length PC/AT card size
- Weight:* External TCIM: 3.8 lbs.
Internal TCIM: 0.75 lbs.

Electrical

- Input voltage:* External TCIM: 18-36 volts DC
Internal TCIM: ±5 volts (derived from host computer)
- Consumption:* External TCIM: 15 watts max
Internal TCIM: 12 watts max



10240 Sorrento Valley Road, Suite 203
San Diego, CA 92121
1-800-772-2LCU or 1-800-447-4373

Lightweight Deployable Communication (LDC-1) System

AN/GSC-59 (V)-1

The Lightweight Deployable Communication System (LDC-1), AN/GSC-59(V)-1, developed by SAIC is a self-contained, Non-Development Item (NDI), stand-alone and networked (LAN/WAN) communications and staff C³I automation workstation. The AN/GSC-59(V)-1 provides portable, rugged communication and workstation capabilities for a variety of military requirements. Originally designed for the U.S. Special Operation Command and Light Forces, the system's open architecture and modular design permit the AN/GSC-59(V)-1 to be custom configured to match varied mission requirements.

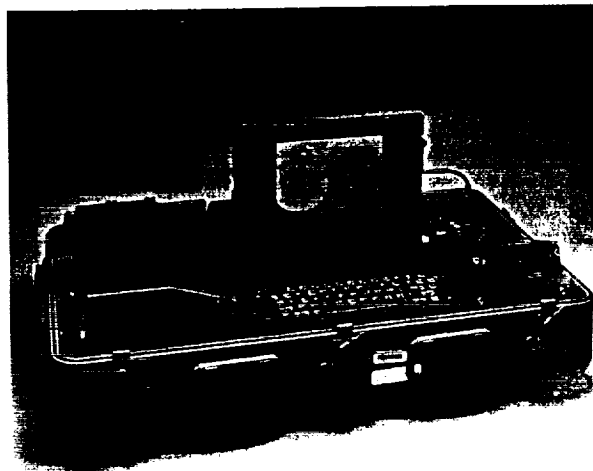

The AN/GSC-59(V)-1's rugged construction makes it ideal for both sustaining base and tactical operations. At the heart of the system is SAIC's GRiDSE-T™ 386 ruggedized portable computer as the host CPU. Housed in an aluminum carry case for rapid deployment, the system offers multiple secure communication interfaces for HF, VHF and UHF satellite transmission. The AN/GSC-59(V)-1 provides enhanced C3I, electronic warfare, intelligence communications, administration and logistics capabilities at all echelons of command.

Features

Hardware

- NDI & Ruggedized
- Lightweight & Portable
- Self-Contained Transit Case
- Power Sources 28V/110V/220V
- 32-Bit Processor
- Embedded 40MB Hard Disk
- Internal Diagnostics
- Configurable Serial Ports
- IBM PC Compatible

Support Software

- MS-DOS
- UNIX V
- Windows 3.0
- TCP/IP
- Multiuser
- Multitasking

Application Software

- Terminal Emulation
- Teletype Emulation
- Group 3 Fax Emulation
- Tactical Fax Emulation
- Networking (LAN/WAN)
- E-Mail
- NITF
- DCS Mode 1 (CAT I & III)
- JAMPS Compatible
- Message Processing
- Gateway Software
- Packet Radio
- AUTODIN
- Network Conferencing

Peripherals & I/Os

- Ethernet (IEEE 802.3)
- SCSI Compatible
- Embedded AX.25
- HF, VHF, UHF Compatible
- KG-84A/C, KY-57 Interfaces
- STU III Compatible
- DDN Interface
- Ruggedized Floppy Drive(s)
- Ruggedized Printer
- Video Frame Capture

LDC-1

Specifications

System Architecture

AN/GSC-59(V)-1 is an independent, self-contained workstation with a GRiDSE-T™ 386 computer; 3.5" floppy disk drive; printer; AC/DC power supply; COMSEC device interface; radio handset interface; trackball/mouse; and networking provisions.

Functional

Processor: 80386, 32-bit
Co-Processor: 80387
Clock: Battery powered
Memory: 4 MB RAM, up to 512KB EPROM, 40MB Hard Drive
Interface: Centronics;
GPIB;
RS-232C PC Compatibles;
Ethernet;
SCSI Port;
NTSC;
Standard Radio Handset;
Trackball/Mouse
Test: Built-in (on power-up)
Display: Electroluminescent (EL) flat panel 640x350 pixels with full alphanumeric and graphics capabilities
Keyboard: Mechanical, 59 keys

Physical

Dimensions: 32.2"x20.2"x11.5"
Weight: 115 lbs
Chassis and case: Heavy duty aluminum

Electrical

Power: 110 VAC, 47-63 Hz; 400 Hz
Requirements: 220 VAC, 47-63 Hz
Consumption: 100 W typical, 20-30 VDC

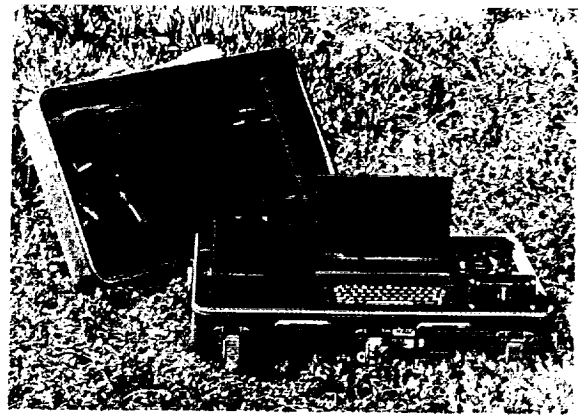

Communications

AUTODIN (DCS Mode 1)
Group 3 FAX Emulation
UXC-7A Tactical FAX Emulation
UGC-74 TTY Emulation
UGC-129 TTY Emulation
KY-57 Interface
KG-84A/C Interface
STU III Interface
RJ-11 (Telephone)

Software Applications

MS-DOS
UNIX V
Communications
Word Processing
Spreadsheets
Graphics
Video Image Display
User-Specified Software
Applications
Project Management
Database
User-Specified Operational
Applications



10240 Sorrento Valley Road, Suite 203
San Diego, CA 92121 1-800-447-4373

SAIT-LCD86

8 x 6 Inch Militarized Liquid Crystal Display

SAI Technology is currently developing an 8 x 6 inch color multifunction display (MFD) for the U. S. Army RAH-66 Comanche (LH) Helicopter. SAI offers Mil-spec versions of the most advanced Active Matrix Liquid Crystal Display (LCD). The SAIT-LCD86 provides major advances over CRT equipment: *sunlight readability, thinner profile, lighter weight and high reliability.*



Development Model for the RAH-66 Comanche (LH) Helicopter

The SAIT-LCD86 provides superior performance in all harsh environments: aircraft, ship, submarine and ground mobile platforms. A certified MIL-Q-9858 and MIL-STD-2000 manufacturer, SAI Technology has the capability of producing a family of militarized LCDs, including 2.9 x 3.4, 4 x 4 and 6 x 6 inch configuration.

SAI Technology also offers LCD-controller-software integration capabilities and complete, logistics, training, and maintenance support.

Features

- MIL-E-5400T, MIL-STD-810, and EMC/EMI Qualified
- 8 x 6 Inch Screen (10 Inch Diagonal)
- RGB
- Up to 256 Shades/Color
- ANVIS Capable
- Night and Sunlight Readable
- Frame Rates Up to 90 Hz
- High Contrast Ratios
- Wide Viewing Angles
- High Resolution
- Multiple Interface Capability



An Employee Owned Company

SAI Technology

A Division of Science Applications
International Corporation

Tel. (619) 450-3837 Fax (619) 450-3800

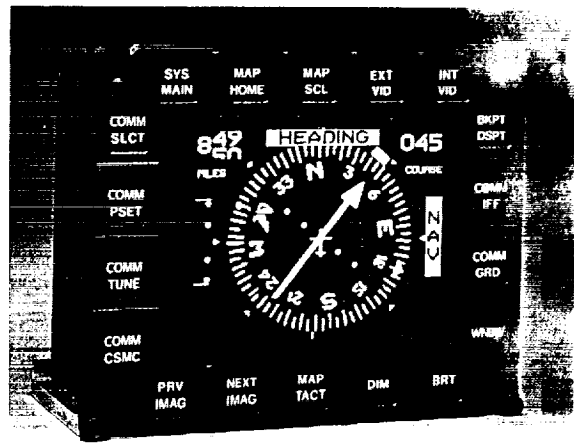
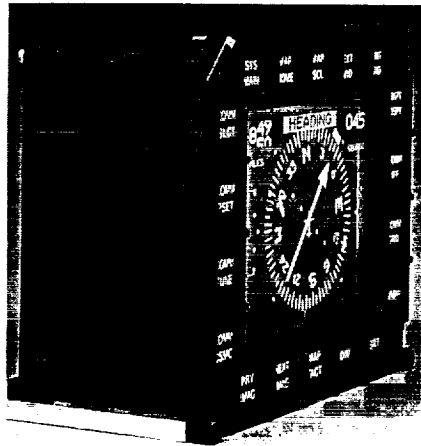

Advanced Avionics Instruments

Employee-owned since its inception, Science Applications International Corporation has annual revenues over \$1 billion and 200 offices worldwide. SAIC focuses on the areas of national security, energy, environment, health and high technology products.

SAIC's success confirms our belief that if you want the job done right, talk to the owner. Our employee-owners understand that quality is not an option, but an integral part of our Total Quality Management philosophy. At SAIC, if you're talking to one of our 12,000 employees, chances are you're talking to an owner.

Specifications subject to change without notice.

SAI Technology Offices:

4224 Campus Point Court
 San Diego, CA 92121-1513
 Tel (619) 450-3837 Fax (619) 450-3800

Crystal Plaza One
 2001 Jefferson Davis Hwy Suite 402
 Arlington, VA 22202
 Tel (703) 415-3000 Fax (703) 415-3007

For more information call
 1-800-447-4373 (except CA)
 in Europe contact EQUATECH GmbH
 Tel (352) 47 18 17 Fax (352) 47 53 54



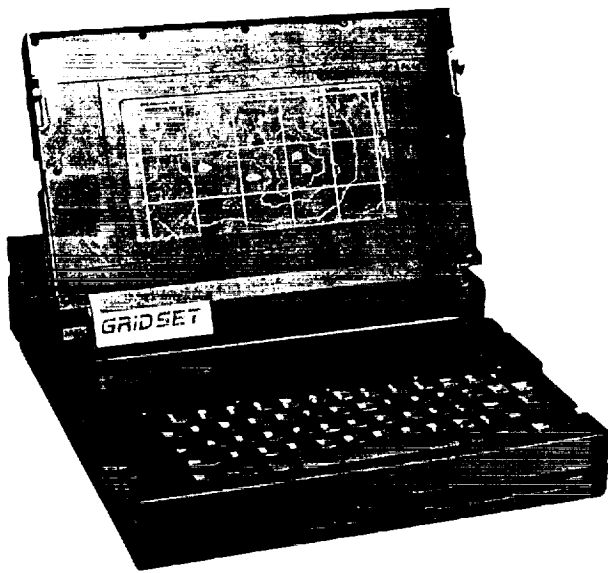

GRIDSE-T™/386

Militarized Portable Workstation

The GRIDSE-T/386 is a 32 bit 80386-based computer designed for severe environments. It offers the power and memory of a mainframe computer in a compact package yet is lightweight, portable and rugged enough for tactical military applications. The GRIDSE-T/386 has one Centronics port, two RS-232C ports, a SCSI port and a floppy disk port, making it compatible with most hardware peripherals. In addition, the GRIDSE-T/386 can run a variety of off-the-shelf software programs and is compatible with the GRIDSE-T family of products for severe environments.

At the heart of the GRIDSE-T/386 is a 20 MHz 32 bit microprocessor and 80387 co-processor along with 4 MB of system RAM. SAI Technology offers a complete line of options and accessories for the GRIDSE-T line of militarized portable computers. These options include up to 512 KB of EPROM, up to 4 MB of non-volatile SRAM, 28VDC battery power supply, sunlight readable LCD display and a DC to DC power converter.

Features

- UNIX® V
- IBM®-AT compatible
- MS-DOS® compatible
- Large electroluminescent display
- Compatible with Mil peripherals
- Floppy interface
- SCSI interface
- Two asynchronous serial ports
- Centronics parallel interface
- EMI/EMC compatibility

SAI® Technology

A division of Science Applications International Corporation

Specifications

GRiDSE-T™/386

Functional

Processor: 80386, 32 bit
Co-Processor: 80387, 80 bit
Memory: 4MB RAM
up to 512KB EPROM
Interfaces: Centronics
Two RS-232C PC-compatible
SCSI port
Floppy disk port
Test: Built-in (on power up)
Reliability: Exceeds 10,000 hrs MTBF per
Mil-HDBK-217E
Service Life: 10 years
Clock: Battery powered

Environmental

Temperature: Operating -30°C to +55°C
Storage -57°C to +71°C
Altitude: Operating 30,000 ft
Storage 50,000 ft
Rainproof: Mil-STD-810D, Method 506.2
Procedure 1
Humidity: 95% condensing
Vibration: 5 g's at 5 to 2000 Hz operating
Shock: 40 g's at 6-9 ms operating
Climate Proof: Fungus and Salt Atmosphere
Explosion Proof: Mil-STD-810D, Method 511.2,
Procedure 1
Sand/Dust: Mil-STD-810D, Method 510.2,
Procedures 1 & 2, operating
EMI/EMC: Mil-STD-461B, Part II, Class A1
Tempest: Designed to meet NACSIM 5100A
Safety: Mil-STD-454H Requirement 1
Human Factors: Mil-STD-454H Requirement 62
Workmanship: Mil-STD-454H Requirement 9

Physical

Dimensions: 16.3" x 12.5" x 3"
(41.4 cm x 32.8 cm x 7.6 cm)
9.5" (24 cm) high, display open
Display size: 7.5" x 3.7" (19 cm x 9.4 cm)
Weight: 21.5 lb (9.8 kg)
Chassis and case: Aluminum
Display: Electroluminescent flat panel
640x350 pixels with full
alphanumeric and graphics
capability
Resolution: 85 pixels per inch
Brightness: 20 FL (min) per pixel w/o filter
Keyboard: Mechanical, 59 keys

Electrical

Power: 110 VAC, 47-63 Hz: 400 Hz
Requirements: 220 VAC, 47-63 Hz
Consumption: 40 W typical

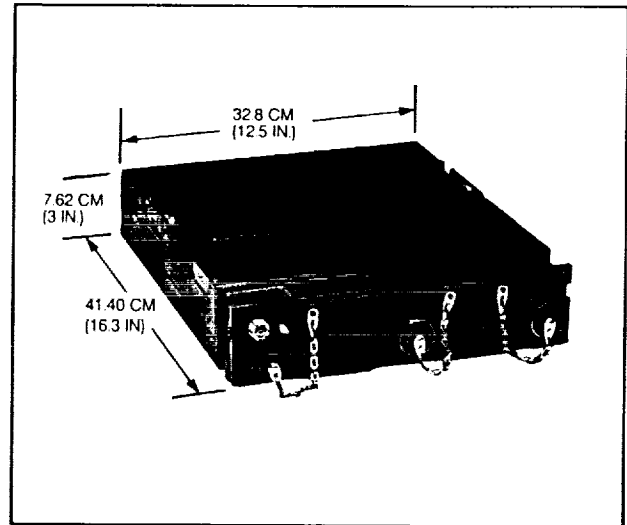

Software

Operating Systems: UNIX® V
MS-DOS® 3.3
MS-DOS® 4.01
Programming Languages: Ada Target computer, PL/M, C,
Pascal, Assembler, Basic, Fortran

Options

Sunlight readable LCD display
1-4 MB non-volatile built-in SRAM
512 KB Cartridge SRAM
Portable Battery pack
DC to DC power converter
EEPROM capability
Third-party militarized peripherals
Consulting and technical &
engineering support

Request GRiDST options packets for addition details.
Specifications subject to change without notice.

MS-DOS is a registered trademark of the Microsoft Corporation
IBM is a registered trademark of the International Business Machines Corporation
UNIX is a registered trademark of AT&T Corp.

SAIC
An Employee-Owned Company

SAI Technology
A Division of Science Applications
International Corporation

4224 Campus Point Court
San Diego, CA 92121-1513
800-447-4373 (Ex. CA)
(619) 452-9150
Fax (619) 450-3800

1700 North Moore St.
Suite 919
Flosslyn, VA 22209-1928
703-527-9400

For More Information Call 1-800-447-4373 (Ex. CA)

520-14
39622
P-25
ND 18000

AISS TECHNOLOGY ROLE

CONTROL CENTER TECHNOLOGY

MOD CONTROL CENTER AUTOMATED INFORMATION SYSTEMS SECURITY EVOLUTION

RICH OWEN
MOD COMPUTER SECURITY OFFICIAL

PURPOSE

- **HIGHLIGHT THE ROLE OF THE TECHNOLOGY INFUSION PROCESS IN FUTURE CONTROL CENTER AUTOMATED INFORMATION SYSTEMS (AIS)**

OVERVIEW

- GOALS
- BACKGROUND
- THREAT
- MOD'S AISS PROGRAM
- TQM
- SDLC INTEGRATION
- PAYBACK
- FUTURE CHALLENGES
- BOTTOM LINE

GOALS

- **IMPROVE THE CONFIDENTIALITY, INTEGRITY, & AVAILABILITY OF AIS THROUGH TECHNOLOGY**
- **EVOLVE AISS TECHNOLOGY THROUGH THE RISK MANAGEMENT PROCESS**

BACKGROUND

PAST

- OUR DOD HERITAGE
 - PROCEDURAL
 - EMPHASIS ON ACCESS CONTROL
 - MANDATORY COMPLIANCE

BACKGROUND

PRESENT

- MANDATE FOR CONFIDENTIALITY, INTEGRITY, & AVAILABILITY
- COMPUTERS AT RISK
- A NEW PHILOSOPHY
 - NO LONGER COMPLIANCE BASED
 - EMPHASIS ON RISK MANAGEMENT

EXTERNAL THREAT

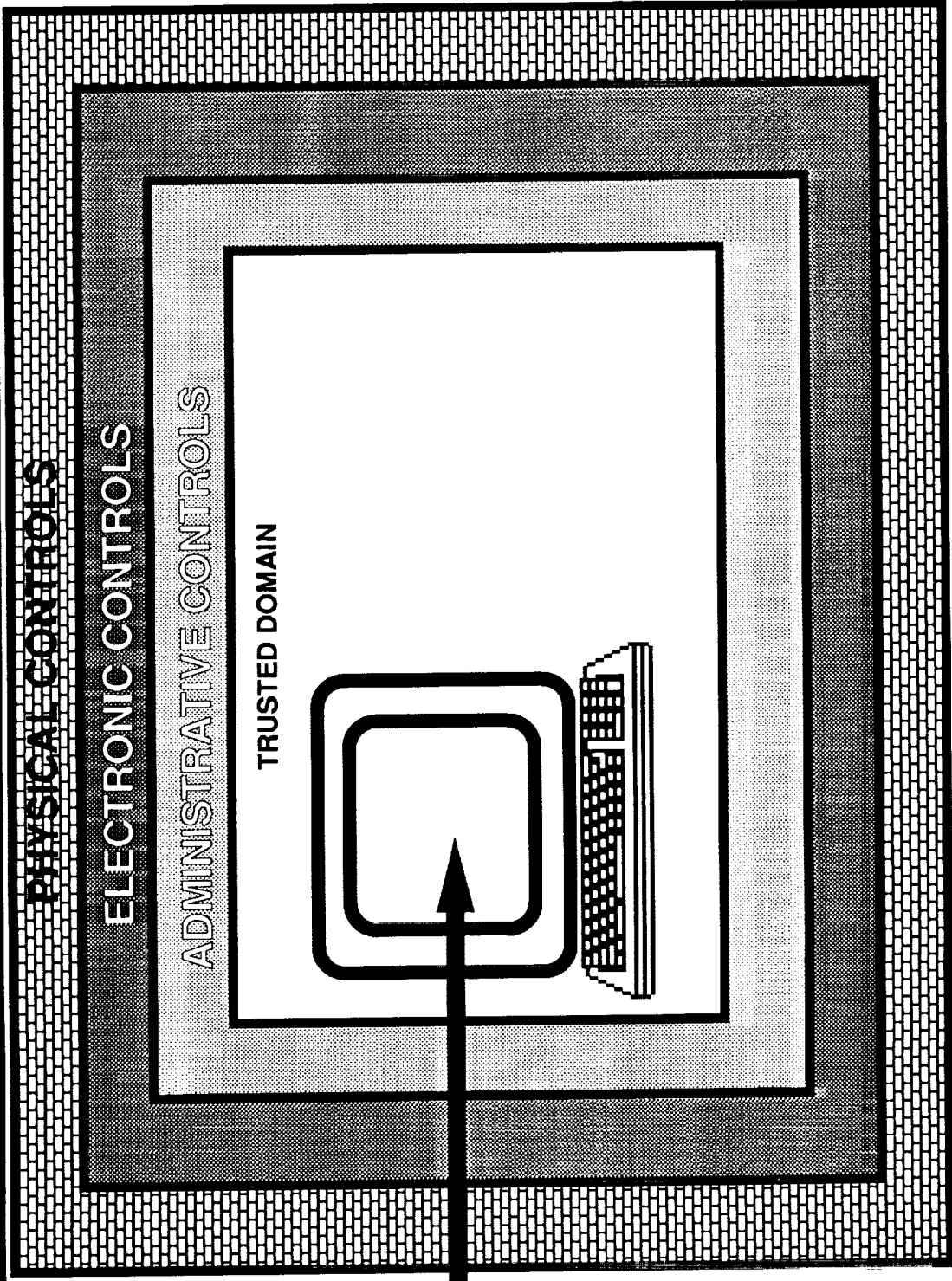

- HACKERS
- DISGRUNTLED EMPLOYEES
- DISHONEST EMPLOYEES
- SABOTAGE
- INDUSTRIAL ESPIONAGE

INTERNAL THREAT

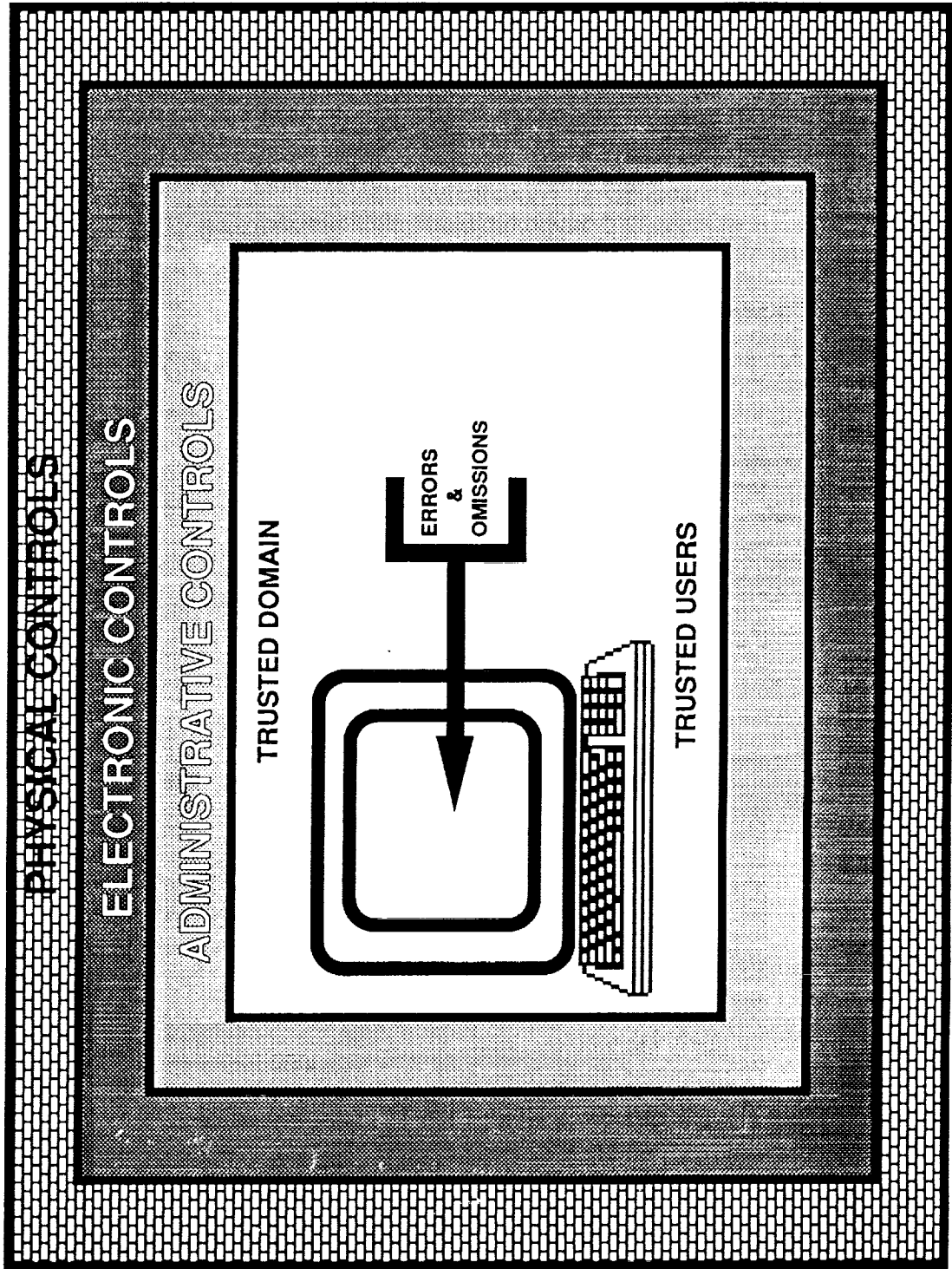

THREAT ANALYSIS

THE CHANGING ENVIRONMENT

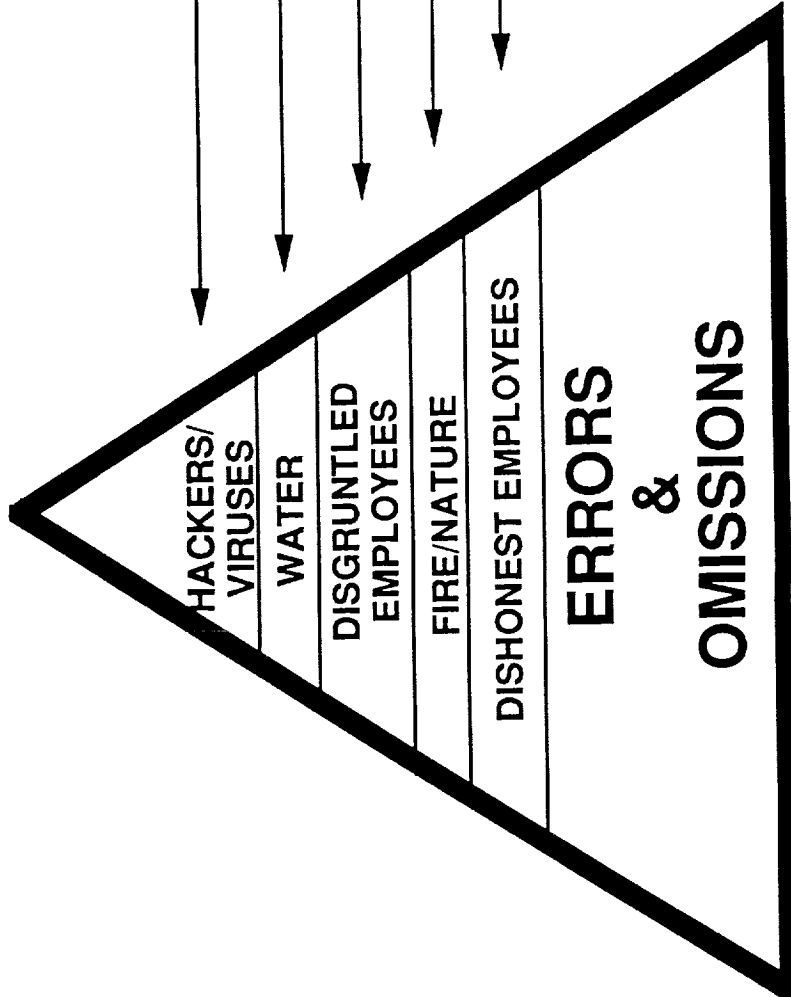

INCIDENTS

	87	88	89	90	91
HACKERS/VIRUSES		2	2	12	24
WATER	1				
DISGRUNTLED EMPLOYEES		.5			
FIRE/NATURE					
DISHONEST EMPLOYEES		.5			
ERRORS & OMISSIONS					
UNKNOWN TOTAL					

MIOD'S AISS PROGRAM

- POLICY
 - PINK BOOK
- REQUIREMENTS
 - REFERENCE STRUCTURE
- INSTITUTIONALIZATION
 - ASET
 - PROCESSES & PROCEDURES

POLICY

- MOD LEADERSHIP STATEMENT
24 OCT 90:

"We want technical, not procedural solutions for AIS security!"

POLICY

- PINK BOOK
 - ADMINISTRATIVE,
ELECTRONIC, & PHYSICAL
 - DAY-TO-DAY OPERATIONS
- REFERENCE STRUCTURE
SPIN-OFF CALLS FOR AISS
TECHNOLOGY

REFERENCE STRUCTURE

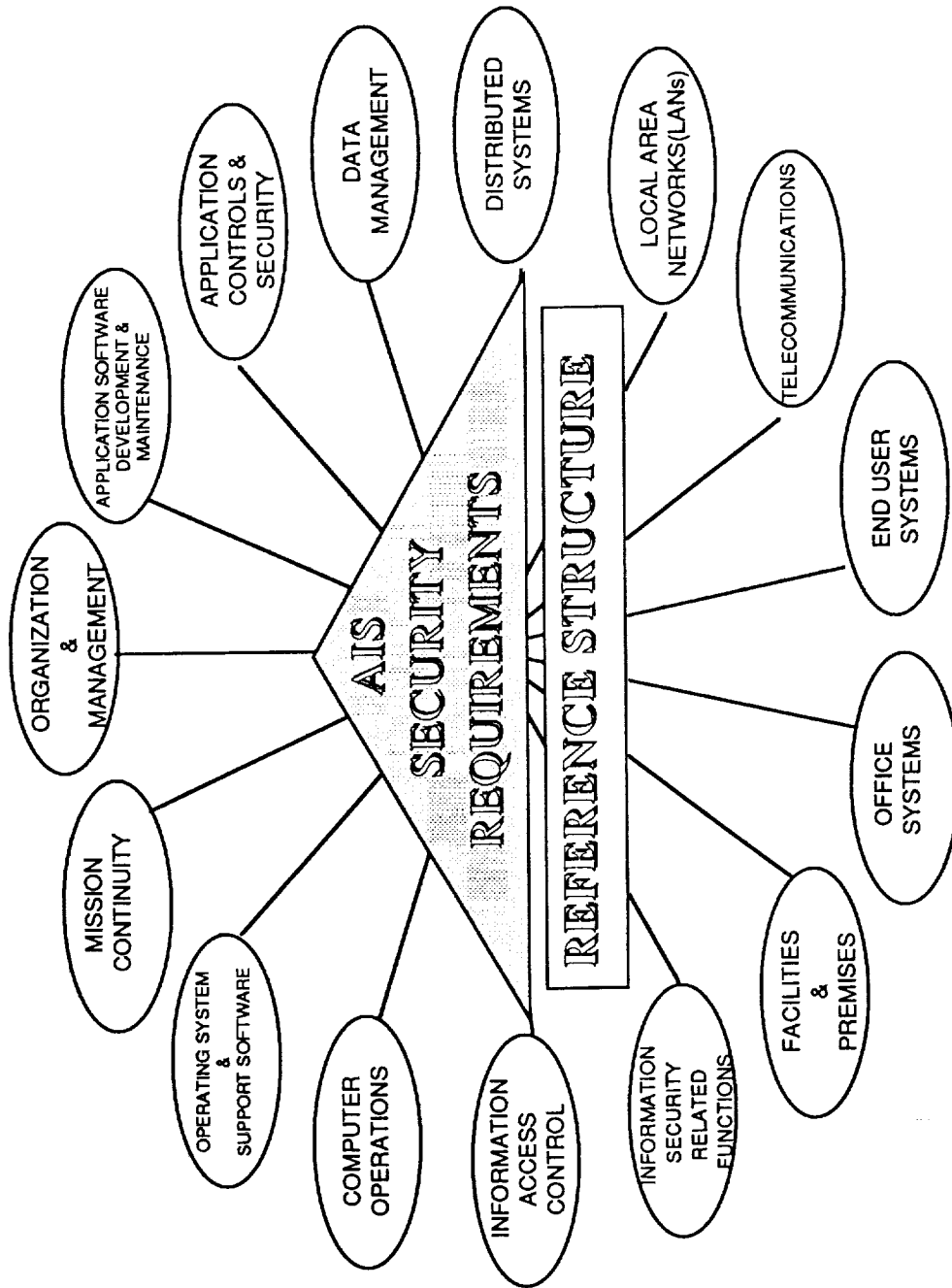

INSTITUTIONALIZATION

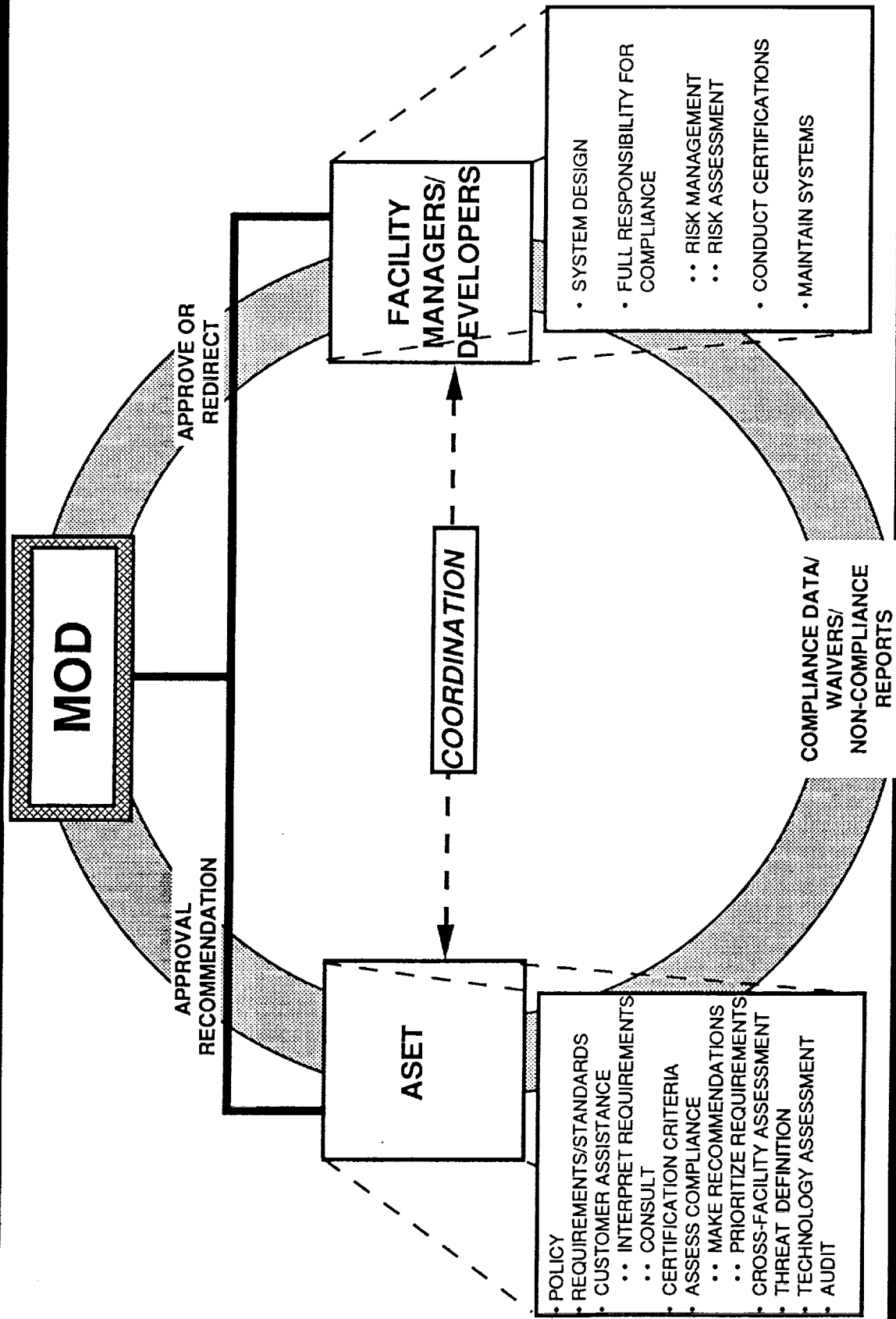

TQM

- ORIENTATION TO THE ULTIMATE CUSTOMER
- IN CONJUNCTION WITH THE FACILITY MANAGEMENT

SDLC AISS INTEGRATION

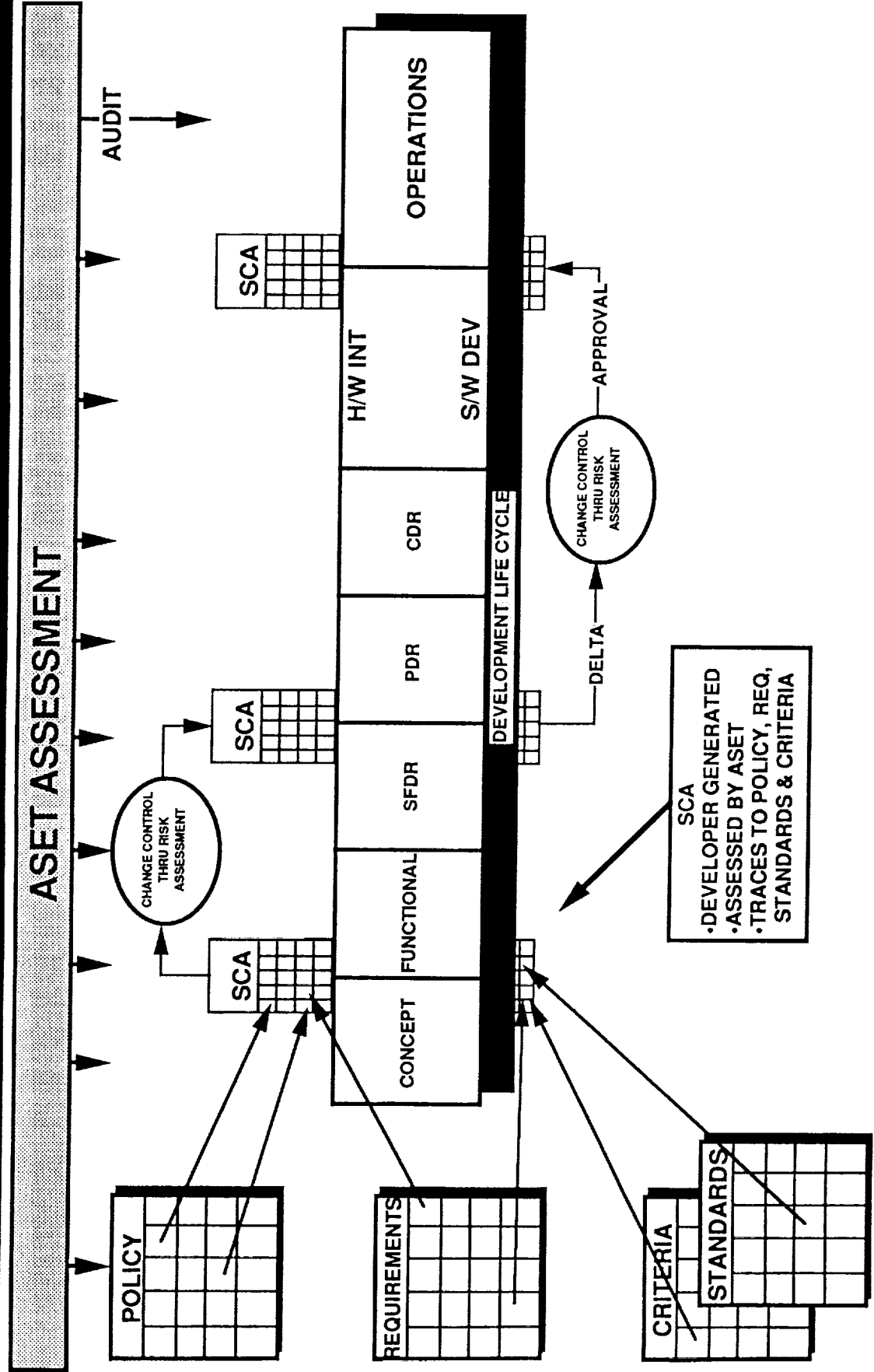

RETAIL WORLD

- **RETROFIT FOR COMPLIANCE IS COST PROHIBITIVE**
- **WORKABLE TRANSITION FROM COMPLIANCE TO RISK MANAGEMENT**

CATCH UP

- **IN DEVELOPMENT**
 - **DESIGNED**
 - **FIXED SCHEDULED**
 - **APPORTIONED BUDGET**
- **IN OPERATION**
 - **MUST NOT IMPACT FLIGHT OPERATIONS**
 - **MUST REDUCE RISK**

TECHNICAL SOLUTIONS

EXTERNAL THREAT COUNTERMEASURES

- **USER/HOST AUTHENTICATION:
SMART CARDS**
- **ELECTRONIC TRANSFER
VERIFICATION: DIGITAL
SIGNATURES/ENVELOPES**
- **SYSTEM REDUNDANCY**
- **NON-REPUDIATION**

TECHNICAL SOLUTIONS

INTERNAL THREAT COUNTERMEASURES

- HIGH-LEVEL PROGRAMMING LANGUAGES
- SEI METHODS & PROCEDURES
- DATA INTEGRITY TECHNOLOGY

CONTINUED EVOLUTION

- ANNUAL TECHNOLOGY CONFERENCE
- TECHNOLOGY PROTOTYPING
- TECHNOLOGY ASSESSMENT
- TECHNOLOGY AUDIT

PAYBACK

- RISK MANAGEMENT
- COST EFFECTIVE
- FIX BIGGEST PROBLEMS
- ALLOWS ACTIVE MANAGEMENT PARTICIPATION IN RISK REDUCTION
- PROVIDES MANAGEMENT AN UNDERSTANDING OF VULNERABILITIES

FUTURE CHALLENGES

EXISTING
POLICIES &
GUIDELINES

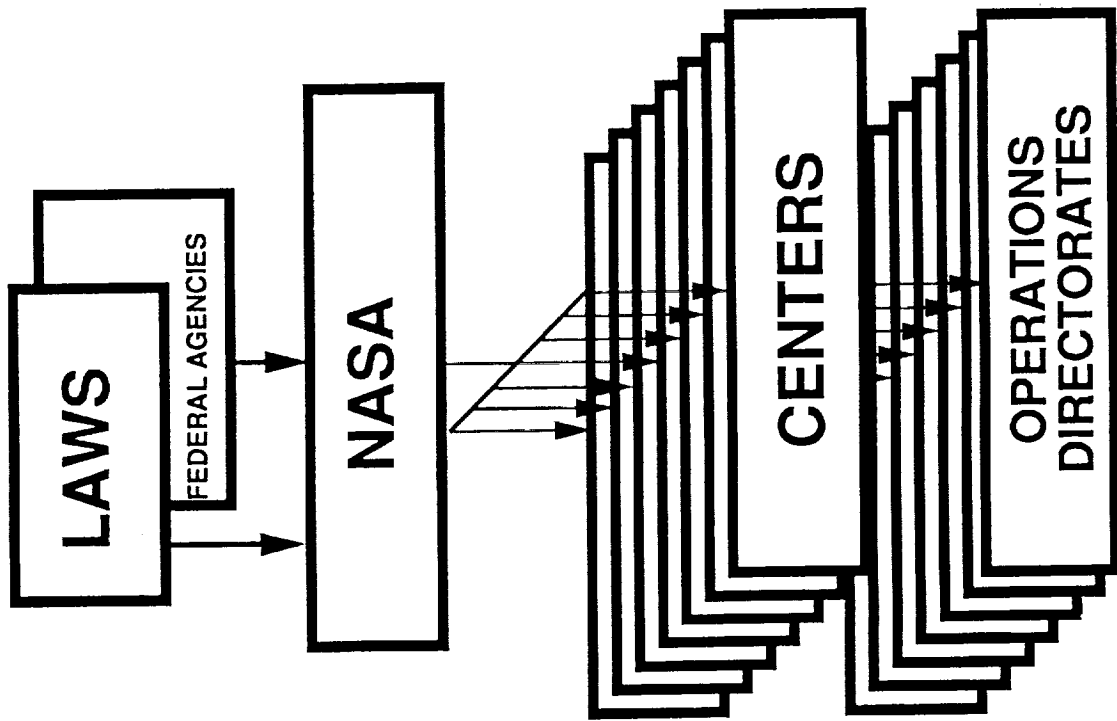

FUTURE CHALLENGES

NEEDED POLICY & GUIDELINES

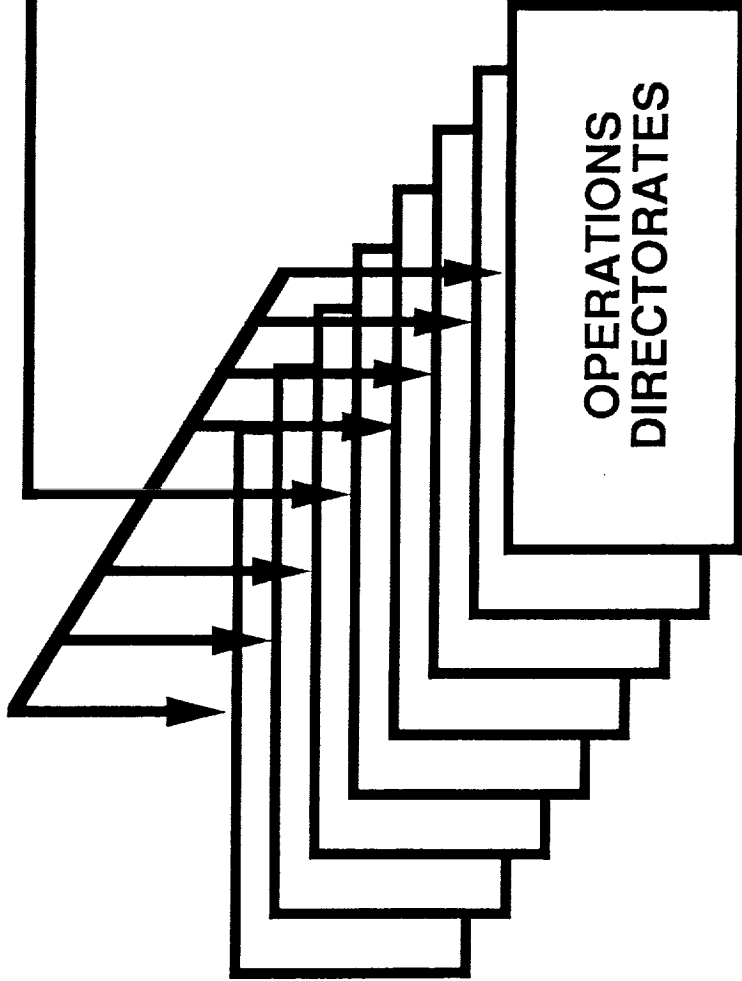
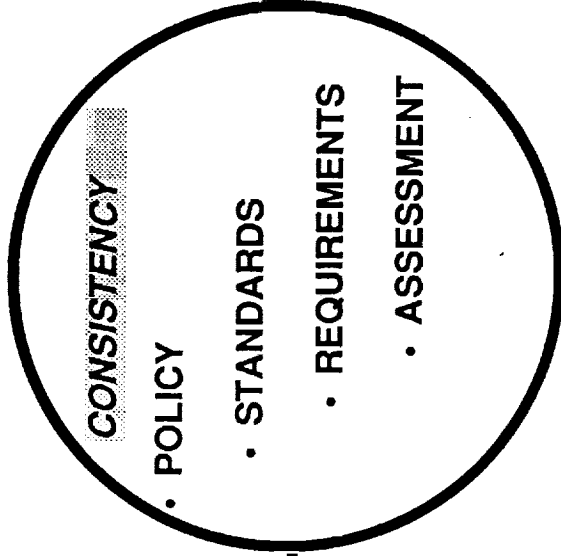

BOTTOM LINE

THE KEY TO COST EFFECTIVE AIS
SECURITY IS THE PROPER
APPLICATION OF RISK MANAGEMENT
AND...

TECHNOLOGY

~~PAGE~~ _____ ~~INTENTIONALLY BLANK~~

N92-12031

27-74
39623

p. 20

NC473697

Mission Critical Technology Development

***Nancy Sliwa, NASA/Ames Research Center
Intelligent Systems Technology Branch***

This talk will cover specific technology developments in system reliability modeling, fault tolerance and fault diagnosis. In addition, it will present future mission control applications of optical processing.

PRECEDING PAGE BLANK NOT FILMED

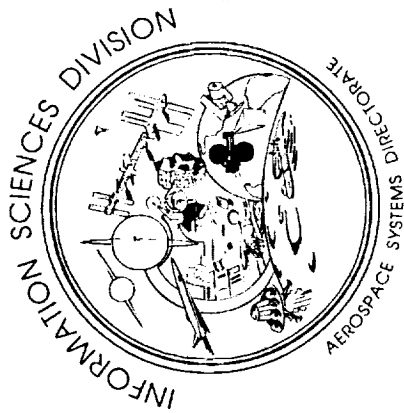

MISSION CRITICAL TECHNOLOGY DEVELOPMENT

**Nancy Sliwa, Assistant Chief
Intelligent Systems Technology Branch**



OUTLINE

- Organization/Philosophy Overview
- Fault Management Technology
- Introduction to Optical Processing



Ames Research Center

INFORMATION SCIENCES DIVISION ORGANIZATION

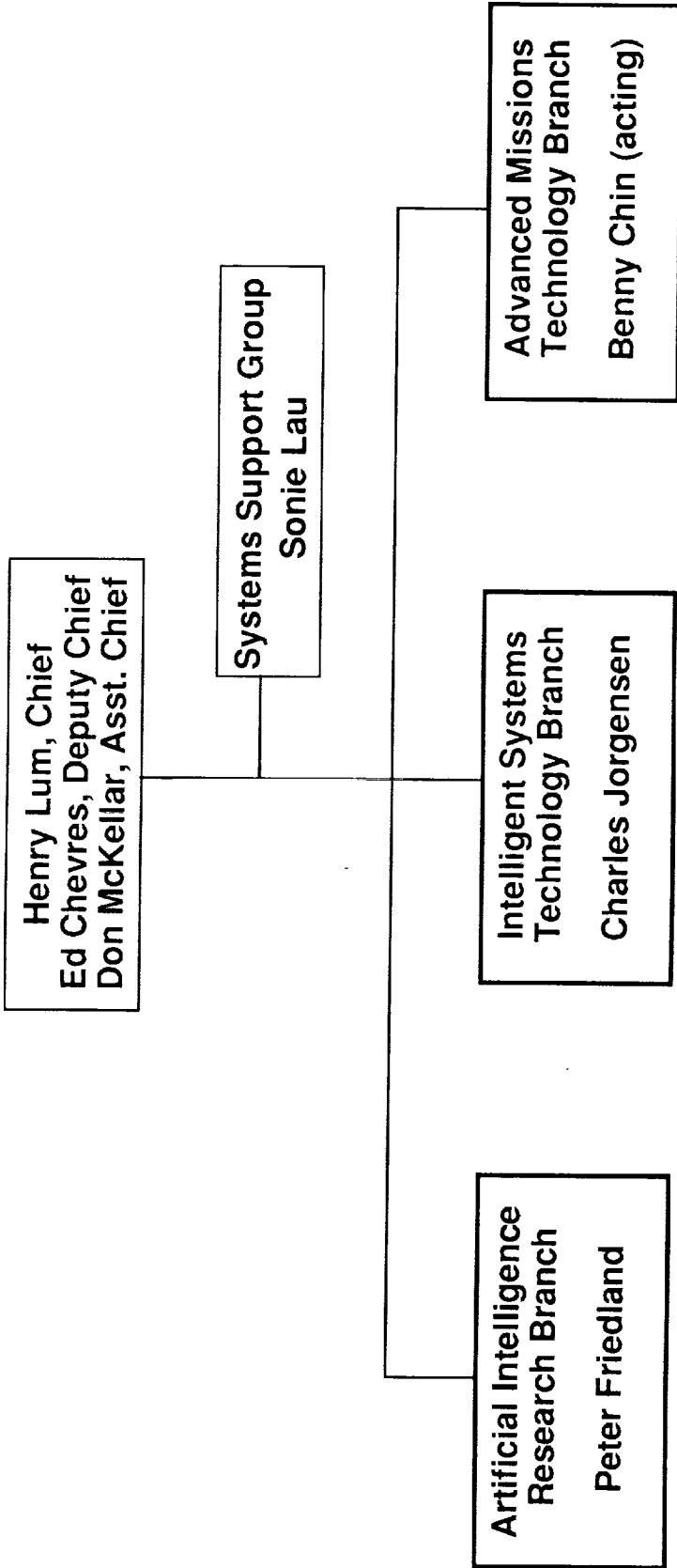

Ames Research Center

DISCIPLINES

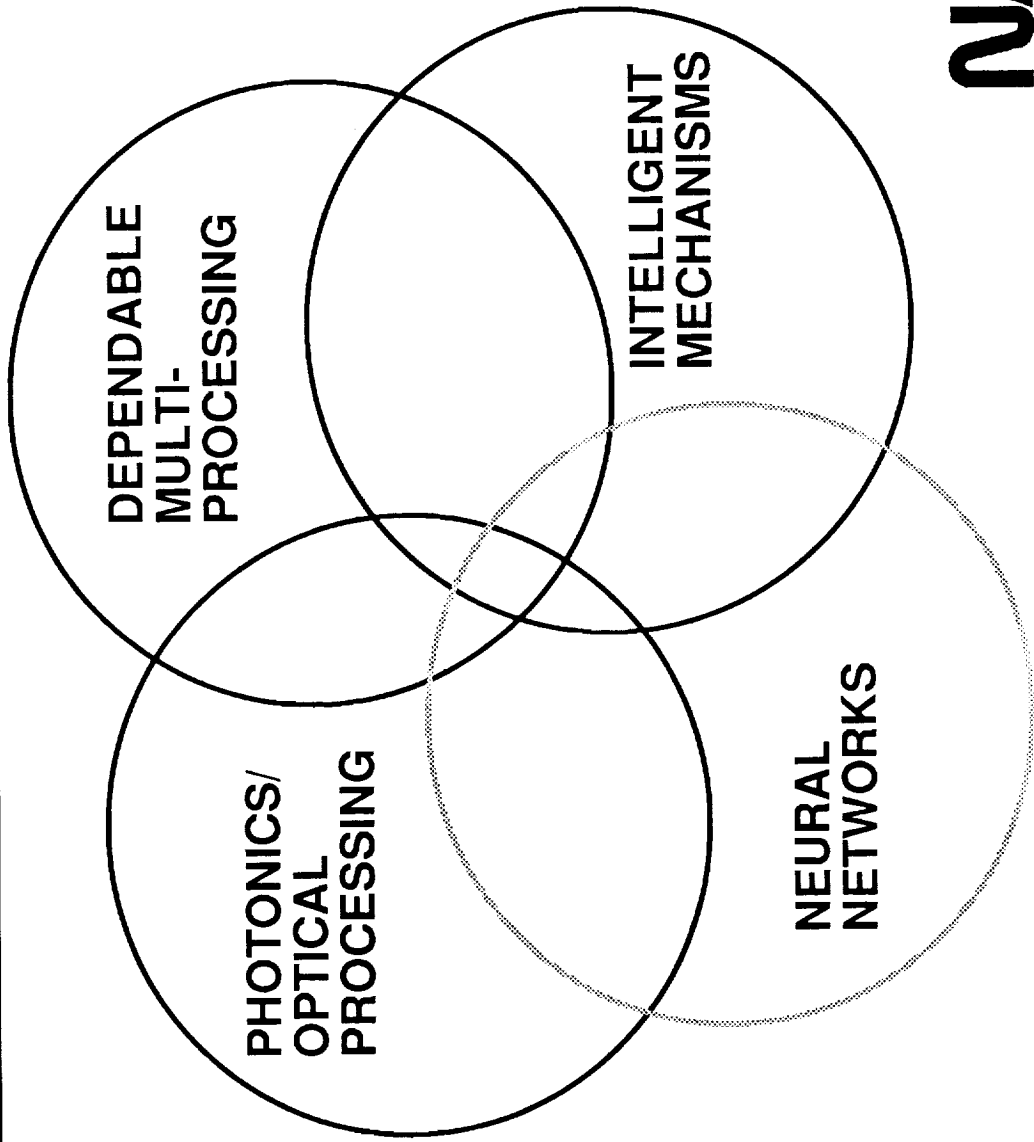

Ames Research Center

GENERAL APPLICATION AREAS

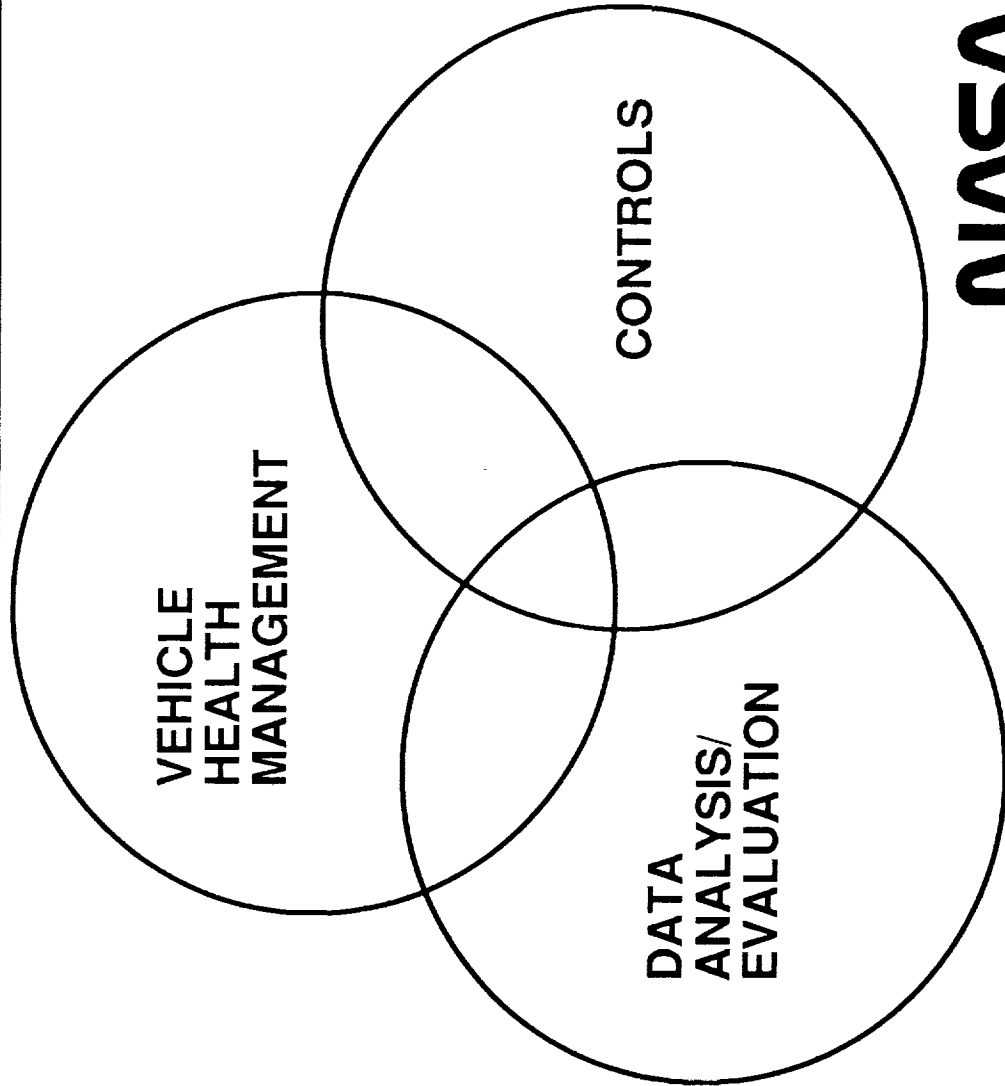

Ames Research Center

TECHNOLOGY TRANSITION

- Technology has a wide gulf to traverse to become useful operationally
 - Technology developers have solutions looking for problems
 - Project managers have problems that need a solution, the best given a number of constraints
- Project managers need to build confidence in a newer technology to minimize perceived project risk
- Technology developers need to be cognizant of full spectrum of demands on project managers, and not inappropriately recommend an immature technology



Ames Research Center

TECHNOLOGY TRANSITION

TECHNOLOGIES

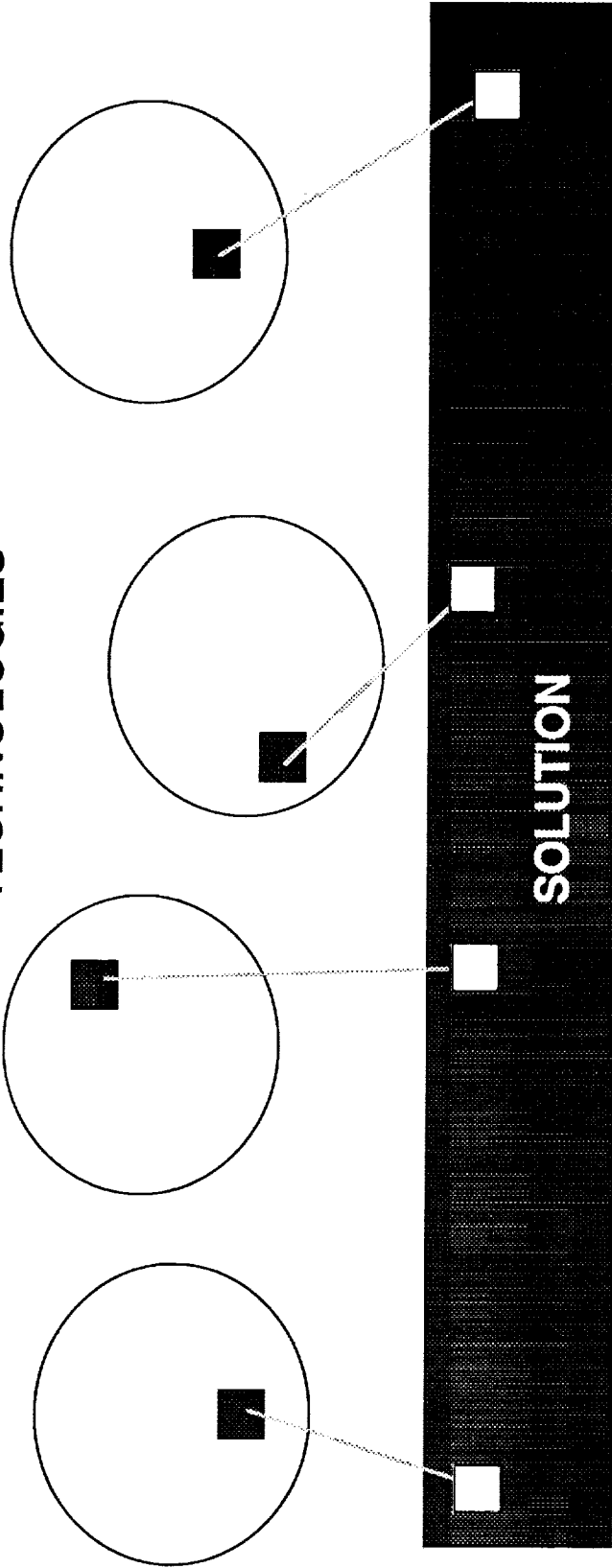

- Essential to get the right pieces of different technologies to form the solution to a particular problem



Ames Research Center

ISSUES

- ISD is fundamentally an R&D organization and no apologies
- Agency needs some percentage of very long range technology development
- Intend to change OAET's heretofore poor reputation in the transition of technology to operational uses
- Using "vertical integration" approach within each technical discipline
 - Each group responsible for broad range of technology maturity development, from theoretical to lab demo to flight test
- "Technology transfer is a body contact sport"
 - Most important to get the people together: those with problems and those with solutions
- Mission Control is an ideal NASA proving ground for new information sciences technology
 - Has already been on the cutting edge of introducing technology to NASA operational use



Ames Research Center

FAULT MANAGEMENT TECHNOLOGY

- **Fault management covers the development/operations spectrum**
 - **Requirements, design, manufacturing, assembly/integration, operations, maintenance**
- **Reliability vs. Fault Management**
 - **A system is reliable if it has a long mean time between failures (MTBF)**
 - **Fault management allows failures to occur, while maintaining system functionality through intelligent control of the system configuration and function**
- **Fault Management integrates Modeling, Testing, and System Diagnosis/Troubleshooting**



Ames Research Center

FAILURE ENVIRONMENT ANALYSIS TOOL (FEAT)

- Developed by Lockheed for Space Station
 - funded by EF/JSC
- Builds models in digraphs and schematics
- Propagates failures forwards and backwards
- Propagates single or double failures
- Shows single- and double-point failure effects
- Does not account for probability of failure, or temporal effects



Ames Research Center

F-18A

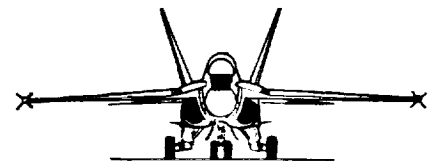
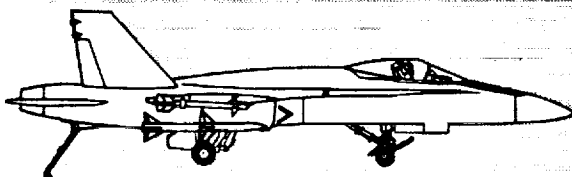
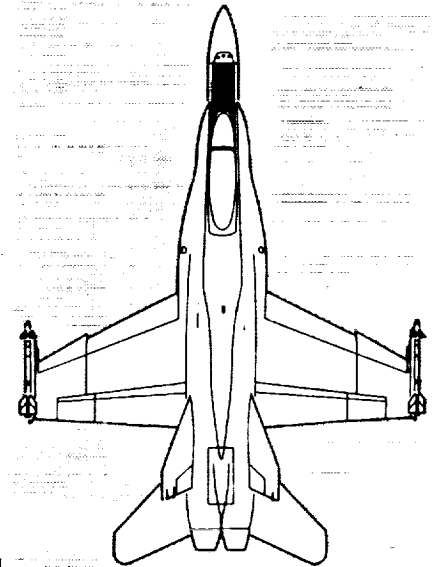
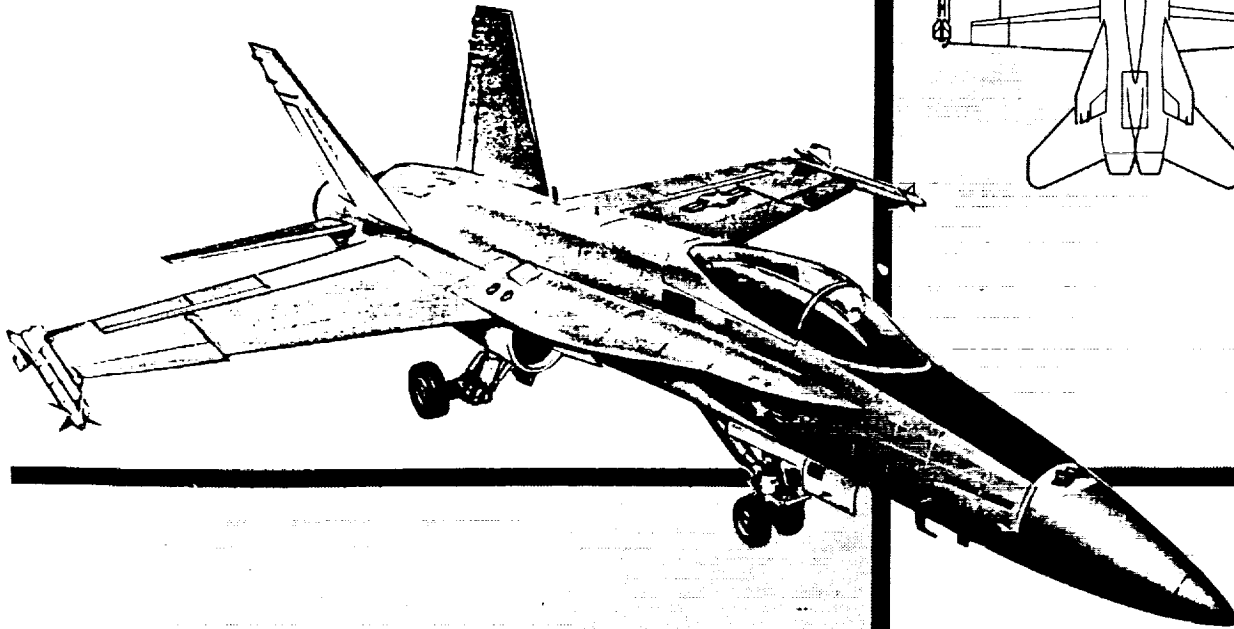

18AA-NFM-00-(491A

Figure 1-0. Three-quarter View
626

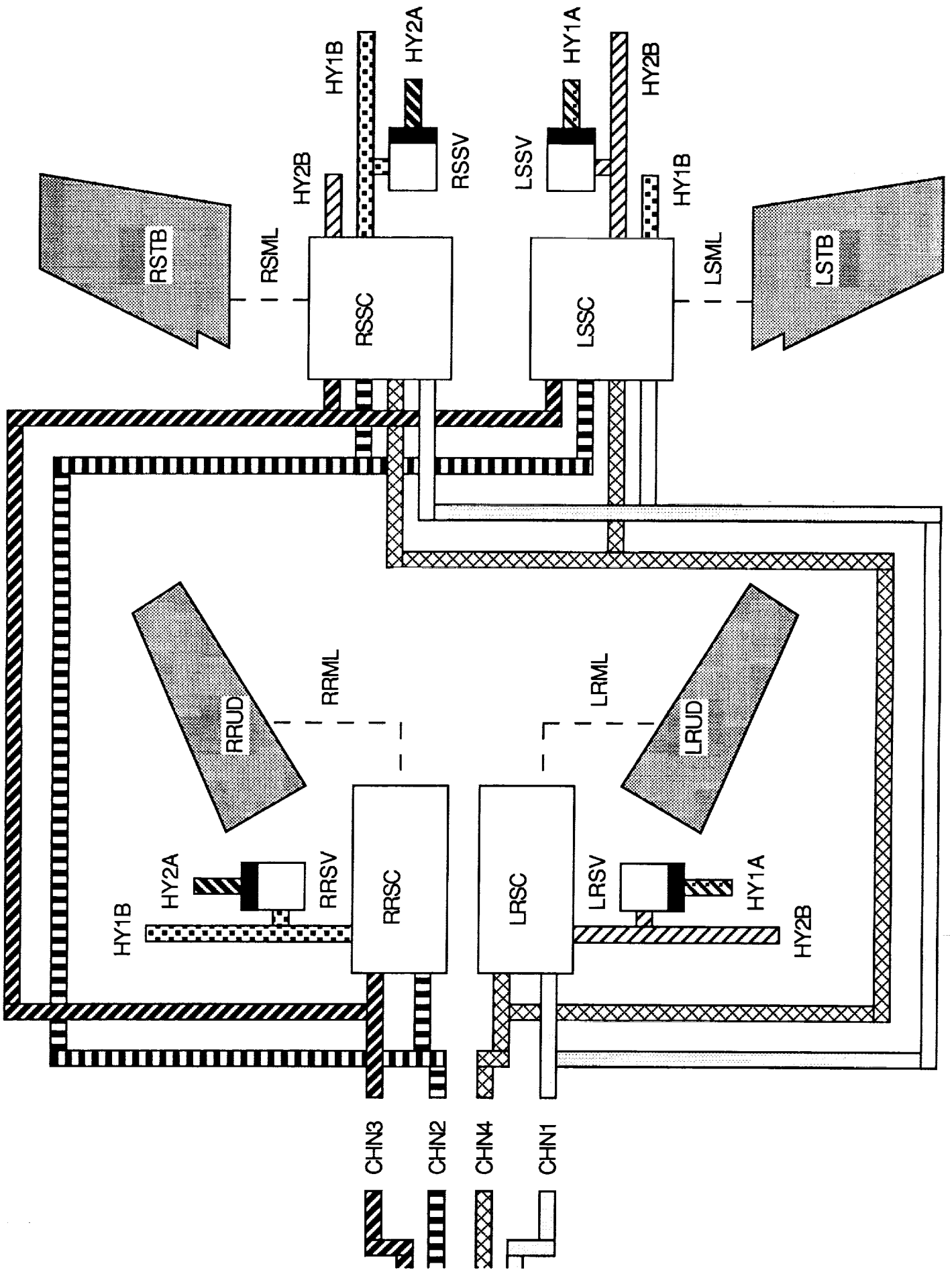

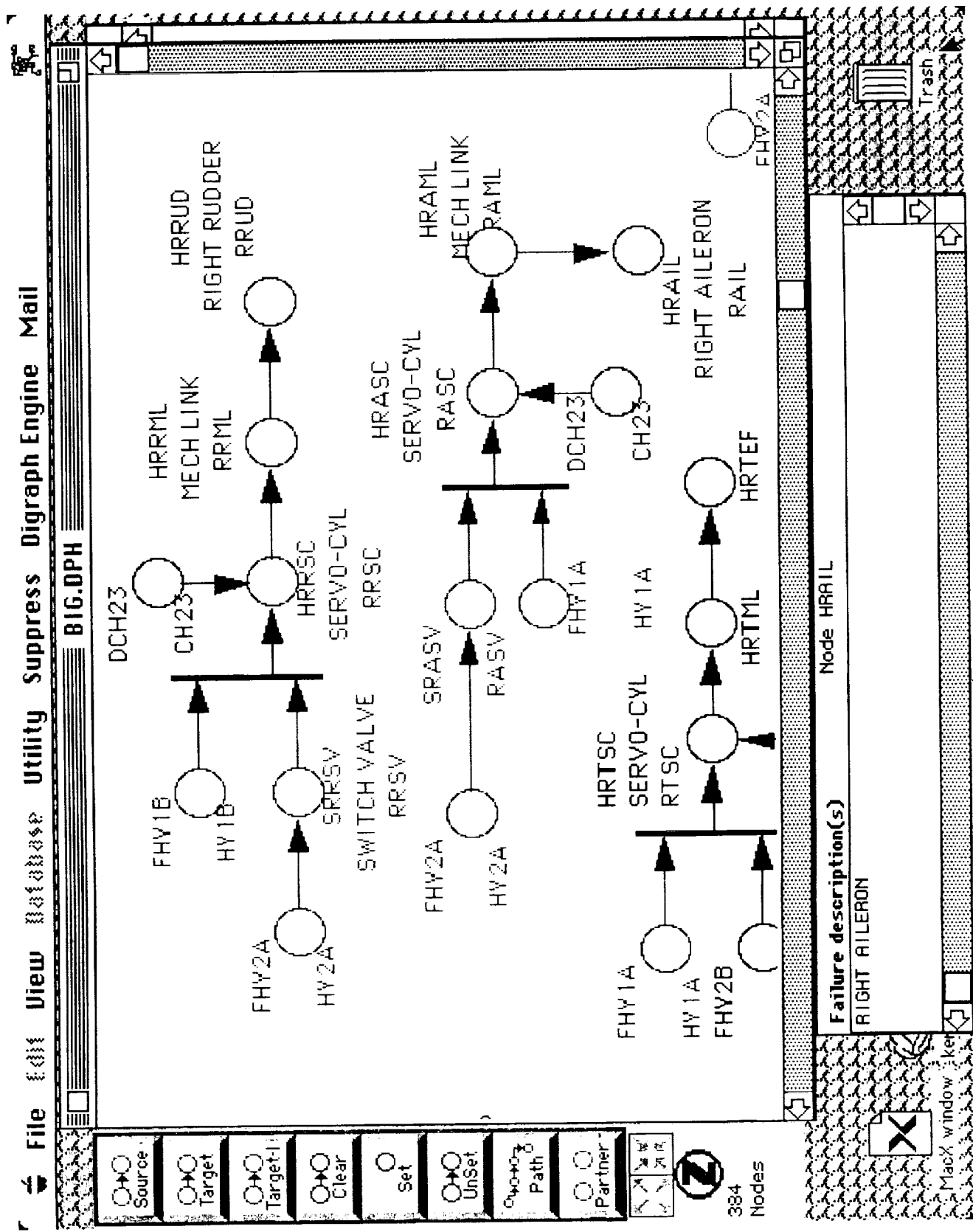

FCS.DPH

FCS.SCH

Source
 Target
 Target-1
 Clear
 Set
 UnSet
 Path
 Partner

64 Cmpnts

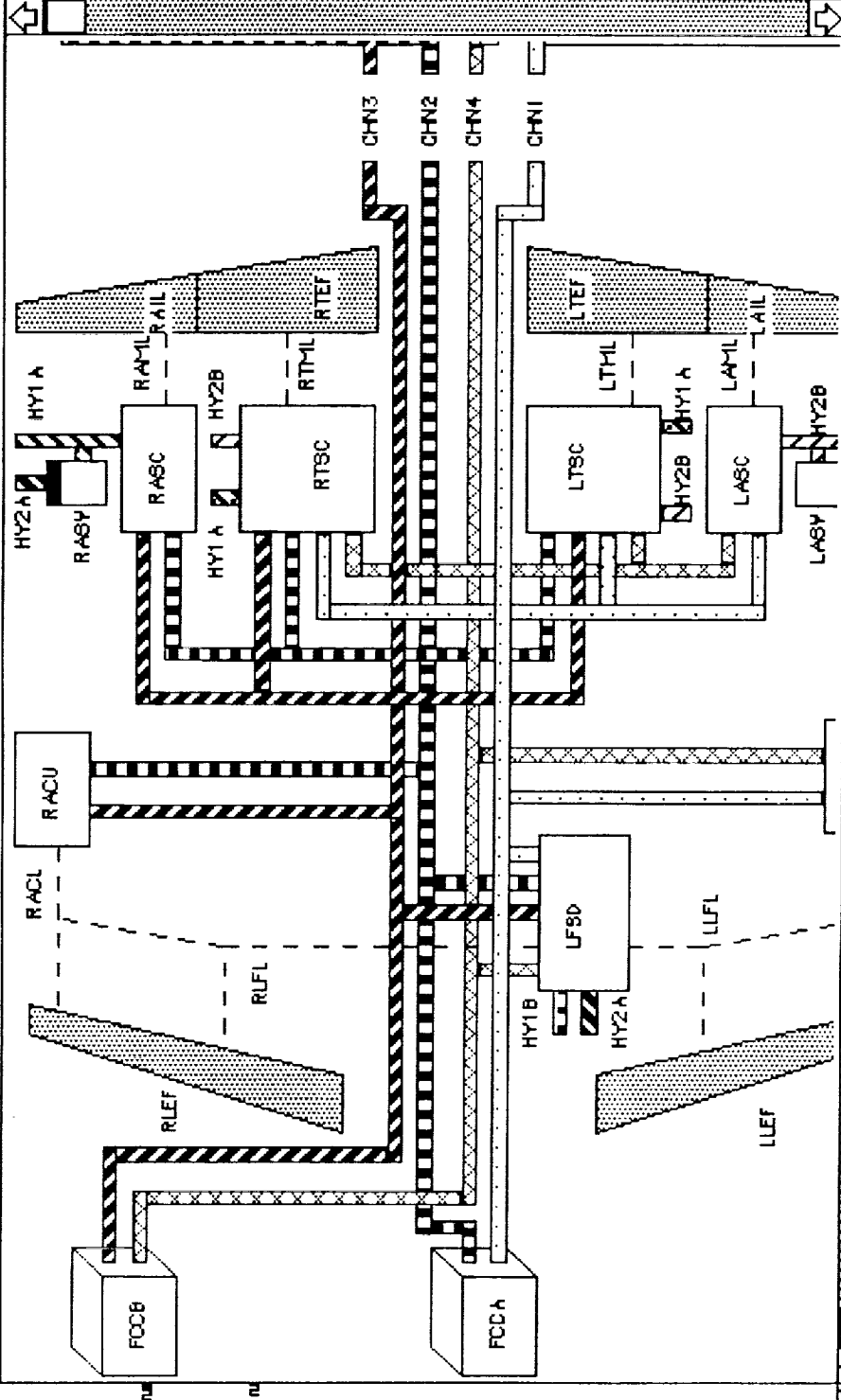

Node HFCCB

Failure description(s)

FLIGHT CONTROL COMPUTER B

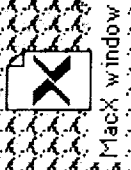
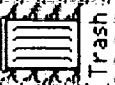

FAULT TREES

- Fault trees allow propagation of component reliability/event probability information, and temporal failure relationships
- OBREL - An object-oriented programming tool for modelling systems using fault trees, and analyzing reliability at any node of the tree
- FTDS (Fault Tree Diagnosis System) - uses fault tree models combined with expert heuristics to diagnose system failures
- Digraph-to-Fault-Tree conversion code allows FEAT models to be converted to fault trees for reliability analysis and fault diagnosis modelling
- Modelling and diagnosis projects in progress:
 - F-18
 - Research Animal Holding Facility



Ames Research Center

Control Room Advisory Tool

- Accesses real time data stream and activates failed nodes in **FEAT** and **FTDS**
- Displays appropriate **FEAT** Schematic and Digraph
- Diagnoses cause of failure(s) using **FTDS**
- Processes failure information/fault diagnosis and displays relevant text, procedures, information and diagrams using **CID**

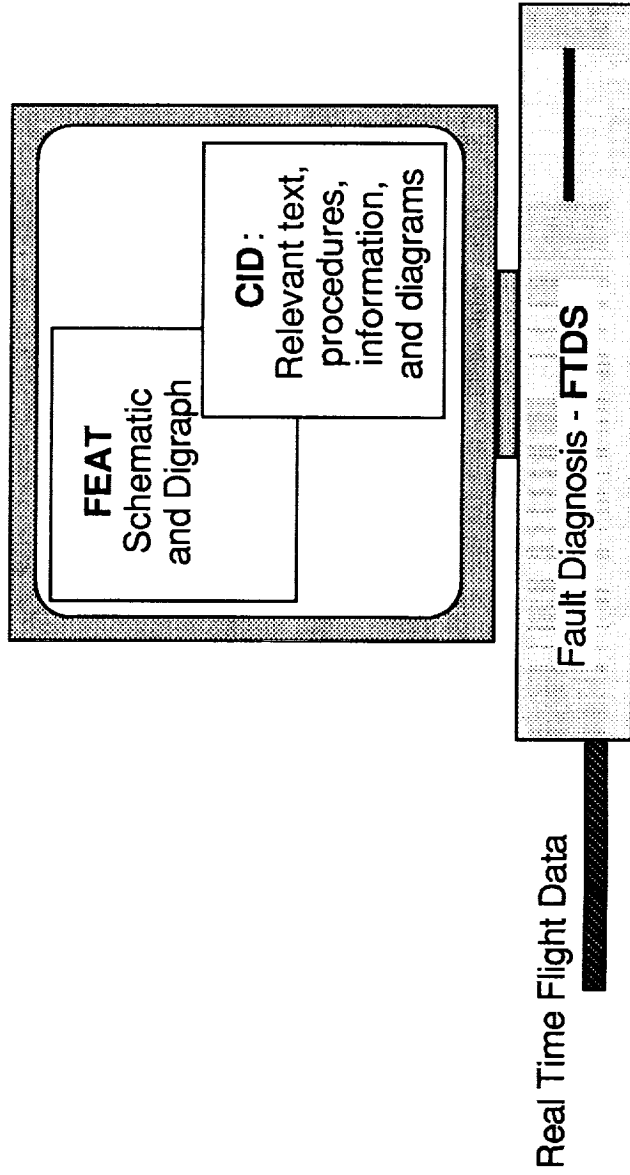

F-18 Fault Diagnosis and Emergency Procedures

APPROACH

- Incorporate F-18 HARV system information into:
 - Failure Environment Analysis Tool (FEAT)
 - Fault Tree Diagnosis System (FTDS)
 - Computer Integrated Documentation (CID)
- Restructure digraph models into fault tree format
- Integrate FTDS and CID into a real time advisory tool

BENEFITS OF OPTICAL PROCESSING

- Emphasis on hybrid digital/optical solutions, for a particular set of specialized problems
 - Not general purpose optical processing
- Low weight, power (thermal), and volume
 - Wire bundling not a problem
- Large geometries less susceptible to single event upsets
- Very high speeds for very large problems
 - Tradeoff = low resolution



Ames Research Center

**Future Applications of Artificial Intelligence
to Mission Control Centers**

**Peter Friedland
Chief, AI Research Branch (FIA)**

**Control Center Technology Conference
June 20, 1991**

N92-120324

39624

P-14

NC473657

Basic Objectives of the NASA-Wide AI Program

- To Conduct Artificial Intelligence Research, Tool Development, and Application Construction in the Context of Short, Medium, and Long-Term Agency Needs**
- To Build Internationally Recognized Artificial Intelligence Laboratories at Ames Research Center and the Jet Propulsion Laboratory**
- To Promote Technology Transfer at All of the NASA Research, Manned Space Flight, and Space Science Centers**
- To Develop an Academic/Industrial/Governmental Team of Collaborative Scientists and Engineers to Further Both NASA and the Nation's Goals in Artificial Intelligence Research and Development**

Inhouse Research Program

- **Major Thrusts in:**
 - **Planning**
 - **Combinatoric, Constraint-Based Scheduling**
 - **"Anytime" Re-Scheduling**
 - **Multi-Agent Planning**
 - **Reactive Planning (Intelligent Agents)**
 - **Learning**
 - **Data Analysis and Classification**
 - **Theory Formation**
 - **Learning Architectures**
 - **Automatic Improvement in Problem-Solving**
 - **Design of and Reasoning about Large-Scale Physical Systems**
 - **Knowledge Acquisition during Design**
 - **Model-Building and Simulation**
 - **Knowledge Maintenance and Retrieval**
 - **Symbolic Control**

Constraint-Based Scheduling

Goals: Applying AI methods to the solution of complex scheduling and resource allocation problems. Particular focus on "satisficing solutions" and anytime re-scheduling.

Project Leader: Monte Zweben

Major Collaborators: Lockheed AI Center (Bob Gargan) , Lockheed Space Operations Company, KSC Systems and Technologies Office (Astrid Heard)

Inhouse Effort: 3.5 FTE

Characterization: Basic and Applied Research, Tool Development, Applications

Current Domains: STS Orbiter Processing at KSC, Wind Tunnel Operations

Start Date: 10/87

Projected Length: Indefinite

Fund Source: OAET AI Program, OSF Code MD

Learning and Performance Improvement for Scheduling

Goals: The integration of machine learning methods with scheduling systems to develop schedulers which improve their performance over time.

Project Leader: Steve Minton

Major Collaborators: STSCI (Mark Johnston)

Inhouse Effort: 2 FTE

Characterization: Basic Research, Applied Research, Tool Development

Domain Applicability: HST Science Scheduling

Start Date: 10/88

Projected Length: 5 Years

Funding Source: OAET AI Program

GEMPLAN Multi-Agent Planner

Goals: Develop methods for generating multi-agent plans for domains with complex coordination requirements.

Project Leader: Amy Lansky

Inhouse Effort: 2 FTE

Characterization: Basic Research, Tool Development

Domain Applicability: EOS Operations Planning (u. i.)

Start Date: 12/89

Projected Length: 5 Years

Fund Source: OAET AI Program, NSF

Planning, Scheduling, and Control

Goals: Research on planning systems capable of monitoring plan execution, noting and correcting plan failures, and re-planning when appropriate. This involves the integration of AI-based systems with classical scheduling and discrete event control theories.

Project Leader: Mark Drummond

Major Collaborators: Teleos Research (Stan Rosenschein), DARPA/ISTO

Inhouse Effort: 5 FTE

Characterization: Basic Research, Applied Research

Domain Applicability: Planetary Rover

Start Date: 10 / 88

Projected Length: 10 Years

Fund Source: OAET AI Program, AFOSR, DARPA/ISTO

Bayesian Learning

Goals: Development and application of Bayesian data analysis techniques to classification of large-scale, potentially noisy NASA databases.

Project Leader: Peter Cheeseaman

Inhouse Effort: 5.5 FTE

Characterization: Basic and Applied Research, Tool Development

Domain Applicability: IRAS Data, CalSpace Cloud Data, LandSat Data

Start Date: 10/86

Projected Length: Indefinite

Fund Source: OAET AI Program

Efficient Learning Algorithms

Goals: Develop efficient methods to predict normal and abnormal operations of complex devices from telemetry data analysis. Allow such systems to adapt to changing conditions.

Project Leader: Phil Laird

Inhouse Effort: 2 FTE

Characterization: Basic Research

Domain Applicability: Future Life Support and Vehicle Monitoring Systems

Start Date: 2 / 8 8

Projected Length: Indefinite

Fund Source: OAET AI Program

ICARUS: An Integrated Architecture for Learning

Goals: Develop a software architecture that can recognize and classify complex physical objects, generate actions plans, and control the execution of motor skills. Utilize the cognitive model of expanding and improving a long-term memory by use of machine learning techniques.

Project Leader: Pat Langley

Inhouse Effort: 6 FTE

Characterization: Basic Research

Domain Applicability: Autonomous Assembly and Exploration Tasks, Diagnosis Tasks, DTA/GC Data Classification

Start Date: 10/89

Projected Length: 10 Years

Funding Source: OAET AI Program

Design Knowledge Acquisition and Retention

Goals: Develop an "electronic designer's notebook" capable of retaining conceptual design knowledge (including alternative designs and tradeoffs) in a form usable throughout the device life-cycle both by humans and automated systems.

Project Leader: Catherine Baudin

Major Collaborators: Stanford University Center for Design Research
(Larry Leifer)

Inhouse Effort: 1.5 FTE

Characterization: Applied Research, Tool Development

Domain Applicability: SIRTf Tertiary Mirror Design, NASP Design (u. i.)

Start Date: 10/88

Projected Length: 5 Years

Fund Source: OAET AI Program, DARPA/ISTO

Computer-Integrated Documentation

Goals: Integration of AI and hypermedia technology to provide enhanced access to voluminous documentation. Use of dynamic knowledge acquisition techniques to build user models and provide context-dependent indexing.

Project Leader: Guy Boy

Major Collaborators: ARC Code FL (Irv Statler), SSF Level I Engineering (Mark Gersh), SSF Level II TMIS (Mike Freeman)

Inhouse Effort: 2.5 FTE

Characterization: Applied Research, Tool Development

Domain Applicability: STS Mission Control Center and Onboard Manuals, SSF Documentation Stored in TMIS

Start Date: 10/89

Projected Length: 3 Years

Fund Source: OAET AI Program, SSF AD Program

Some Speculation on Future Applications

- Planning and Scheduling
 - Reactive Re-Scheduling of Missions under Prevailing Time Constraints
 - Assistance in Playing "What If" Games During Missions
 - Coordination of Different Discipline Decisions
- Knowledge Acquisition and Maintenance
 - Ready Access to Life-Cycle Information
 - Electronic Documentation Integrated with Diagnostic Systems
- Physical Systems Reasoning
 - Model-Based Fault Detection and Recovery
 - Assistance in "on-the-Spot" Procedure Development
- Machine Learning
 - Automatic Induction of Fault Detection Rules
 - Learning to Diagnose in the Presence of System or Sensor Faults
 - Learning Apprentice Systems

Author List

Adamo, Dan	493
Atkinson, David	337
Bailey, Darrell	423
Bolen, David	83
Connerton, Robert	401
Duffin, Pat	205
Ebersole, Mike	33
Friedland, Peter	635
Fong, Roger	237
Hansen, Elaine	467
Heindel, Troy	443
Hill, Jerry	1
Hughes, Peter	505
Johnson, Roger	549
Kranz, Eugene F.	107
Luken, Robert	53
Moorhead, Deborah	237
Muratore, John	303
Owen, Rich	589
Schmalz, Karen B.	209
Schoen, Paul	281
Schwuttke, Ursula	381
Shilling, Larry	83
Sliwa, Nancy	615
Smith, Marcie	363
Whipple, Larry K.	237

REPORT DOCUMENTATION PAGE

Form Approved
OMB No. 0704-0188

Public reporting burden for this collection of information is estimated to average 1 hour per response, including the time for reviewing instructions, searching existing data sources, gathering and maintaining the data needed, and completing and reviewing the collection of information. Send comments regarding this burden estimate or any other aspect of this collection of information, including suggestions for reducing this burden, to Washington Headquarters Services, Directorate for Information Operations and Reports, 1215 Jefferson Davis Highway, Suite 1204, Arlington, VA 22202-4302, and to the Office of Management and Budget, Paperwork Reduction Project (0704-0188), Washington, DC 20503.

1. AGENCY USE ONLY (Leave blank)	2. REPORT DATE August 1991	3. REPORT TYPE AND DATES COVERED Conference Publication	
4. TITLE AND SUBTITLE Control Center Technology Conference Proceedings		5. FUNDING NUMBERS	
6. AUTHOR(S)		8. PERFORMING ORGANIZATION REPORT NUMBER	
7. PERFORMING ORGANIZATION NAME(S) AND ADDRESS(ES) Lyndon B. Johnson Space Center, Houston Texas and The University of Houston--Clear Lake, Houston, Texas		10. SPONSORING / MONITORING AGENCY REPORT NUMBER NASA CP 10081	
9. SPONSORING / MONITORING AGENCY NAME(S) AND ADDRESS(ES) National Aeronautics & Space Administration, Washington, D.C. and The University of Houston--Clear Lake, Houston, Texas		11. SUPPLEMENTARY NOTES	
12a. DISTRIBUTION / AVAILABILITY STATEMENT Unclassified, Unlimited Publicly Available Subject Category 14		12b. DISTRIBUTION CODE	
13. ABSTRACT (<i>Maximum 200 words</i>) Conference papers and presentations compiled here cover evolving architectures and technologies applicable to flight control centers. Advances by NASA centers and the aerospace industry are presented.			
14. SUBJECT TERMS Flight Control Facilities Ground Based Control		15. NUMBER OF PAGES	
17. SECURITY CLASSIFICATION OF REPORT Unclassified		16. PRICE CODE	
18. SECURITY CLASSIFICATION OF THIS PAGE Unclassified	19. SECURITY CLASSIFICATION OF ABSTRACT Unclassified	20. LIMITATION OF ABSTRACT	

