

April 1992

1N-06  
70752

P.38

# Venturi Air-Jet Vacuum Ejectors for High-Volume Atmospheric Sampling on Aircraft Platforms

Gerald F. Hill,  
Glen W. Sachse,  
Douglas C. Young,  
Larry O. Wade,  
and Lewis G. Burney

NASA-EP-3183-1 VENTURI AIR-JET VACUUM  
EJECTORS FOR HIGH-VOLUME ATMOSPHERIC  
SAMPLING ON AIRCRAFT PLATFORMS (NASA) 1992  
L100-127

3183-1

1992

1992-01-10

1992

**Venturi Air-Jet Vacuum  
Ejectors for High-Volume  
Atmospheric Sampling  
on Aircraft Platforms**

Gerald F. Hill and Glen W. Sachse  
*Langley Research Center  
Hampton, Virginia*

Douglas C. Young  
*Wallops Flight Facility  
Wallops Island, Virginia*

Larry O. Wade  
*Lockheed Engineering & Sciences Company  
Hampton, Virginia*

Lewis G. Burney  
*Langley Research Center  
Hampton, Virginia*



National Aeronautics and  
Space Administration  
Office of Management  
Scientific and Technical  
Information Program

The use of trademarks or names of manufacturers in this report is for accurate reporting and does not constitute an official endorsement, either expressed or implied, of such products or manufacturers by the National Aeronautics and Space Administration.

## Abstract

*This report provides documentation of the installation and use of venturi air-jet vacuum ejectors for high-volume atmospheric sampling on aircraft platforms. It contains information on the types of venturis that are useful for meeting the pumping requirements of atmospheric-sampling experiments. A description of the configuration and installation of the venturi system vacuum line is included with details on the modifications that were made to adapt a venturi to the NASA Electra aircraft at Goddard Space Flight Center, Wallops Flight Facility. Flight test results are given for several venturis with emphasis on applications to the Differential Absorption Carbon Monoxide Measurement (DACOM) system at Langley Research Center. This report is a source document for atmospheric scientists interested in using the venturi systems installed on the NASA Electra or adapting the technology to other aircraft.*

## Introduction

The NASA Global Tropospheric Experiment (GTE) program includes many trace-gas-sensing experiments that require ambient air sampling from aircraft platforms (ref. 1). These experiments require some form of airflow system, which generally includes mechanical vacuum pumps. These vacuum pumps collectively create a heavy payload, use many kilowatts of aircraft electrical power, and generate a large heat load that is often impossible to dissipate satisfactorily. An alternative vacuum pump that has many desirable characteristics for aircraft applications is the venturi air-jet vacuum ejector. For the remainder of this paper, any reference to a venturi or venturi pump implies a venturi air-jet ejector. This venturi pump is inexpensive and lightweight; it requires no electrical power, does not contribute to the aircraft heat load, and can provide high pumping speeds at moderate vacuum pressures. The high-pressure-motive-gas input for this vacuum pump is generally available from aircraft engine compressors.

The NASA Differential Absorption Carbon Monoxide Measurement (DACOM) system (ref. 2) has successfully flown more than 75 missions (over 300 hr) onboard the NASA Electra aircraft that uses venturi pumps. During the GTE Amazon Boundary Layer Experiment (GTE ABLE-2B) expedition to Brazil in 1987 (refs. 3 and 4), the DACOM system measured CO. During the GTE Arctic Boundary Layer Experiment (GTE ABLE-3A) expedition to Alaska in 1988 (refs. 5 and 6) and the GTE Atmospheric Boundary Layer Experiment (GTE ABLE-3B) expedition to Canada in 1990 (ref. 7), the DACOM system performed both high-precision and fast-flow (for flux) measurements of CO and CH<sub>4</sub> simultaneously. The high-volume air-sampling capability afforded by these venturis enabled DACOM not only to measure

CO and CH<sub>4</sub> concentrations but also to make eddy correlation flux measurements of these gases.

This report documents the installation of venturi systems onboard the NASA Electra aircraft at Goddard Space Flight Center, Wallops Flight Facility and presents pumping speed results as a function of altitude, motive-gas pressure, and vacuum pressure for several test flights and the previously mentioned GTE field expeditions. This report also includes an inventory of the venturi pumps available for installation on the Electra aircraft.

## Symbols and Abbreviations

Dimensional quantities are presented in both the International System of Units (SI) and U.S. Customary Units. Measurements and calculations were made in U.S. units.

ABLE-2B	Amazon Boundary Layer Experiment
ABLE-3A	Arctic Boundary Layer Experiment
ABLE-3B	Atmospheric Boundary Layer Experiment
A/C	aircraft
auto-reg	autoregulating
CITE-2	Chemical Instrumentation Test and Evaluation (Western United States)
CITE-3	Chemical Instrumentation Test and Evaluation (Wallops and Brazil)
DACOM	Differential Absorption Carbon Monoxide Measurement
EST	Environmental Systems Technology
F.S.	flight station
GTE	Global Tropospheric Experiment

MFM	mass flowmeter
NPT	national pipe thread
$P_m$	motive pressure
$P_{\min}$	minimum pressure
prop	propeller
PVC	polyvinyl chloride
$P_{wc}$	white cell pressure
SCFM	standard cubic feet per minute
SS	stainless steel
STD	standard
TAMMS	turbulent air motion measurement system
Temp	temperature
$V$	volume

## Description of Venturi Air-Jet Vacuum Ejectors

Steam-jet and air-jet vacuum ejectors have been designed for many vacuum pressure applications (ref. 8). Single-stage ejectors can obtain pressures of 50 torr (1 torr = 133.322 Pa) to atmospheric pressure, whereas multiple-stage (i.e., six) ejectors are capable of pressures of 0.001 to 0.005 torr. (See table 1 from ref. 8.) As noted in reference 8, an ejector discharging into the atmosphere can be designed with a compression ratio of 20:1; however, economics of available motive gas usually limits the maximum compression ratio to about 10:1. Discharging the ejectors into the vacuum allows for a maximum compression ratio of about 15:1. Therefore, staging ejectors in series allows applications from 75 to 0.001 torr (1  $\mu$ m Hg), which is the lower limit for the six-stage system.

The single-stage ejector consists of three basic sections: the steam or air nozzle, the suction port and chamber, and the diffuser. The nozzle is usually designed so that its exit can be adjusted for the optimum position relative to the diffuser inlet. Figure 1 is a drawing of a single-point (200-torr) venturi and shows the motive-gas (air) inlet to the nozzle, the nozzle position relative to the vacuum suction port and chamber, and the tail or diffuser section discharging into the atmosphere. A flow coefficient of 0.97 is standard for this type of converging-diverging nozzle, and according to Ryans and Roper (ref. 8), the design and relative position of the diffuser for optimum performance is based on empirical data. The length of the constant-diameter section of the diffuser is usually two to four times the diffuser diameter.

All air-jet vacuum ejectors are momentum transfer pumps. A high-pressure (usually hot) motive gas expands across the converging-diverging nozzle and accelerates to supersonic velocity. This high-velocity motive air entrains the air from the suction port and is then compressed across the converging-diverging diffuser by converting the velocity head to the pressure head. Pushed against the discharge pressure (ambient atmosphere in aircraft applications) of the air-jet ejector, this motive-gas and suction-gas mixture maintains a pressure differential between the suction port and the discharge pressure.

For theoretical considerations of venturi air-jet vacuum ejectors, converging-diverging nozzle flow, choking, shock waves, critical pressure, back pressure, or break pressure, see references 8 to 13.

## Aircraft Installation of Venturi Systems

The aircraft used for the NASA GTE ABLE missions is the NASA Electra shown in figure 2. The specifications and operational characteristics of this aircraft are covered in detail in the service digests published by Lockheed and are available for review at Wallops Flight Facility. Figure 3 lists some characteristics of the 14-stage engine compressors that provide motive gas for venturi operation. The information shown in figure 3 is from reference 14. As indicated, there are 14 stages of compression with an overall 83-percent efficiency and a 9.64:1 compression ratio. With ambient standard temperature air entering the first stage, the 14th stage delivers about 12 000 standard L/sec ( $\approx$ 425 standard ft<sup>3</sup>/sec) of air at 290°C (554°F). All venturi systems discussed in this paper use 1 percent or less of the compressor air available at any given flight condition, and this air is hot enough for any of the venturis to perform at specification. The output motive pressure at the 14th stage is dependent upon altitude, with a motive pressure at sea level usually greater than 758.4 kPa (110 psi) and a motive pressure at 6.1 km (20 000 ft) still high enough ( $\approx$ 344.2 to 379.2 kPa ( $\approx$ 50 to 55 psi)) for venturi operation. Therefore, considering these known conditions of available air, pressure, and temperature, single-point venturis were designed for various suction pressures and pumping speeds.

Figure 4 shows the 14th-stage bleed-air manifold configuration with the shutoff valve for the oil cooler air augmentor before modification for venturi systems installation. Bleed air is used to cool the engine oil during ground operation and is shut off during flight. Both engine no. 2 and engine no. 3 have venturi systems installed, and these engines have been operational for several years with the DACOM system using not only them but also other air-sampling

instruments as well. However, this report focuses on venturi installation, tests, and actual flight results for the venturi systems mounted in engine no. 2. After several different techniques for tapping off bleed air to furnish the venturi with the necessary motive air, the final design consists of modifying the bleed-air routing for the oil cooler air augmentor. Figures 5 and 6 illustrate how an additional gate valve was added to the line so that motive air can be sent either to the oil cooler air augmentor or to the venturi nozzle. For safety reasons, the control for this additional gate valve is located in the aircraft cockpit and is controlled by the crew. Therefore, the crew can shut down the venturi air system at any time.

Motive air enters the venturi through an insulated stainless steel tube to keep the air as hot as possible for maximum venturi performance. The hot air passes through a manifold containing a thermocouple and a 0- to 1378.9-kPa (0- to 200-psig) pressure sensor for monitoring both temperature and motive pressure of the air entering the venturi nozzle. Both of these parameters are recorded at the experimenter's station. As subsequently discussed, the motive pressure can be decreased by partially closing the venturi gate valve. This capability allows the experimenter to set the motive pressure at the most efficient point for maximum flow at a given suction pressure.

Figure 7 shows the termination locations of the venturi vacuum lines for both engine venturi systems. The engine no. 2 system, which terminates at flight system (F.S.) 415 in the forward cargo bay, is available for experimenters located in the forward sections, while the engine no. 3 system terminates at F.S. 575, just below the floor. When the venturi systems are not in use, these lines are capped off.

Figure 8 shows a venturi mounted in the no. 2 engine compartment with the insulated motive-air line coming from the venturi gate valve. This line is insulated to deliver the hottest possible motive air to the venturi nozzle. Figure 9 is another view that shows the insulated line of motive air approaching the entrance of the venturi. Figure 10 shows the suction port mounted through the fire wall and shows the thermocouple and pressure sensor locations. As mentioned, these parameters can be monitored at the experimenter's station. The engine compartment nacelle covering has been modified so that the venturi protrudes and exhausts into the airstream (fig. 11).

To minimize pressure drop in the vacuum line and thereby achieve maximum system pumping speed, large 50-mm NW50 (2-in.) diameter vacuum lines are used throughout the system. Stainless steel tubing is used for all sections except the fuselage,

where NW50 PVC flexible hose is used because the electronics and cables located in this area of the aircraft limit accessibility for steel tubing. Figure 12 shows how the vacuum line passes through the fire wall and then enters and exits the wheel well. All O-rings used are for high-temperature applications, even though the temperature on the vacuum side is ambient temperature. Flexible stainless steel tubes are used when bends in the vacuum line are required (fig. 13). Figure 14 shows the venturi vacuum line going through the wing leading edge. All vacuum line clamps are safety wired with stainless steel wire. As mentioned previously, the vacuum line for the engine no. 2 system terminates in the forward cargo bay. Figure 15 shows the PVC vacuum line coming through the floor from the cargo bay and into the DACOM system as configured during the ABLE-2B mission.

After the venturi system vacuum lines were installed, a vacuum integrity test was performed to check for any leaks. Prior to using a venturi system, the experimenter should make a vacuum check because leaks in the vacuum line degrade the performance of the venturi system. The pressure sensor was calibrated with nitrogen used to back pressurize the vacuum line at various static pressures. Back pressurizing must be performed cautiously because the O-ring seals and mounts are not designed for high pressure and thus leak at pressures greater than about 344.7 kPa ( $\approx 50$  psig).

The venturi system was checked on the ground with the DACOM autoregulating valve (mounted on the aircraft window probe) closed and engine no. 2 running. Under these conditions, the ultimate or minimum suction pressure is achieved provided everything works properly and no significant leaks occur in the system. This procedure is a convenient way to check for leaks before or after each mission. This same procedure may be used during flight; however, the minimum suction pressure is then a function of altitude. Lowest minimum suction pressures are achieved at high altitudes because back pressure at the venturi exhaust is lowest and because the motive-gas pressure decreases with altitude and approaches the design pressure (482.6 to 551.6 kPa (70 to 80 psig)).

## First Airborne Application

The DACOM instrument uses a tunable diode laser optical absorption technique in which ambient air flows through a White cell (ref. 15) that is maintained at reduced pressure. A nominal pressure of 100 torr is typically used to reduce the possibility of overlap from potentially interfering gas lines. Eddy

correlation flux measurements require fast responses; consequently, the air in the White cell should be exchanged as rapidly as possible while maintaining the cell pressure constant at about 100 torr. Thus, the highest volume displacement or pumping speed is required. Our first venturi, however, was specified for operation at 200 torr because of our initial concern that a venturi designed for 100 torr would require an excessive amount of motive gas. The original 200-torr venturi was purchased from Fox Valve, Inc. Figure 1 shows this venturi with the design specifications of about 1830 L/min ( $\approx 64.6 \text{ ft}^3/\text{min}$ ) pumping speed at 200 torr.

This venturi was installed in the engine no. 3 compartment of the Wallops Electra with appropriate vacuum lines and flow test instrumentation. Figures 16 and 17 show flight test results for pumping speed as a function of altitude (0.15 to 6 km ( $\approx 500$  to 19685 ft)) and test cell pressure (50 to 300 torr). The decrease in pumping speed below an altitude of about 1.5 km ( $\approx 5000$  ft) probably occurred because this venturi was designed for a back pressure of 82.7 kPa (12 psia). The original intent was to design the venturi for maximum pumping speed at this altitude ( $\approx 1.5$  km) because most boundary-layer missions would be flown somewhere between sea level and  $\approx 1.5$  km. Subsequent venturis have been designed for back pressures of 103.4 kPa (15 psia), so adequate pumping speeds are available at altitudes as low as  $\approx 0.15$  km.

The original venturi was installed and successfully tested just before the GTE Chemical Instrumentation Test and Evaluation (GTE CITE-2) mission in 1986. Because the DACOM system was not used in this mission, Barry Huebert of SRI International elected to use this venturi system in his sampling system, and the venturi met his air-sampling requirements. In contrast to the DACOM application, Huebert's application (filter measurements of  $\text{HNO}_3$ ) required maximum integrated mass flow, and the vacuum pressure at the vacuum pump inlet was allowed to vary.

## NASA Venturi Inventory and Mission History

The consumption of compressed air from the Electra engine was deemed insignificant with the 200-torr venturi. Thus, a venturi designed for 100-torr operation was ordered because the lower pressure would better meet the DACOM mission objectives. In 4 years, eight venturis were custom ordered for optimum performance at 100 torr. Some of these venturis were used on NASA GTE CITE and ABLE missions and others were used as backups.

The following is an inventory of these eight venturis and their design pumping speeds.

1. DACOM-FOX-200T(17SCFM)-(.75-1.5-1.5)-1
2. DACOM-EST-100T(8.9SCFM)-(.75-1.5-1.5)-2
3. DACOM-EST-100T(8.9SCFM)-(.75-1.5-1.5)-3
4. DACOM-FOX-100T(8.9SCFM)-(.75-1.5-1.5)-4
5. DACOM-EST-100T(10.2SCFM)-(1.5-1.5-1.5)-5
6. DACOM-EST-100T(10.2SCFM)-(1.5-1.5-1.5)-6
7. DACOM-EST-100T(12.4SCFM)-(1.5-2-2)-7
8. DACOM-FOX-100T(15.5SCFM)-(1.5-2-2)-8

Two manufacturers are listed: Fox Valve, Inc. (FOX) and Environmental Systems Technology (EST). The venturi units are identified as follows: DACOM-manufacturer-design pressure in torr (flow rate in standard cubic feet per minute at pressure)-(motive input size in inches-suction port size in inches-exhaust port size in inches)-DACOM unit number.

Table 2 shows the history for all eight venturis, and table 3 indicates the manufacturer-specified amount of motive-gas consumption for each venturi. These venturi systems have been used with excellent results in four experiments in five different field missions.

## Aircraft Test Flight and Mission Results

### ABLE-2B Mission (Brazil, 1987)

As previously mentioned, the first venturi application on the Wallops Electra aircraft was the DACOM-1 unit designed for a suction pressure of 200 torr. While the venturi performance was sufficient for the design suction pressure of 200 torr, it only achieved pumping speeds (volume displacement at a given pressure) of between 1000 and 1500 L/min ( $\approx 35$  to  $53 \text{ ft}^3/\text{min}$ ) at a vacuum pressure of 100 torr. (See fig. 16.) The DACOM ABLE-2B mission objectives required a venturi optimized for a 100-torr suction pressure. Therefore, another venturi unit was purchased with the appropriate design characteristics for a 100-torr suction pressure and a greater pumping capacity. Thus, the DACOM-2 venturi unit shown in figures 18 and 19 was used during the GTE ABLE-2B mission. This is a 38-mm (1.5-in.) unit with a 19-mm (0.75-in.) nozzle entrance and a design flow rate of 8.9 SCFM at a 100-torr pressure (equivalent to a pumping speed of  $\approx 1915 \text{ L/min}$  ( $\approx 67.6 \text{ ft}^3/\text{min}$ )). A flow diagram that depicts the DACOM flow system used during the ABLE-2B mission is shown in figure 20. The motive-gas solenoid valve was either in a fully open or fully closed position during operation. During later GTE expeditions, a different valve

with a variable opening was used. This valve permitted some control of the motive-gas pressure delivered to the venturi. The 50.8-mm (2-in.) Hastings Mass-Flowmeter<sup>1</sup> was installed in the vacuum line between the White cell and the venturi pump. Because this mass flowmeter uses laminar flow elements, a significant pressure drop is present. Therefore, the pumping speed at the constant-pressure test cell (White cell) is somewhat diminished.

Figure 21 shows the corrected pumping speed as a function of altitude for the DACOM system (i.e., the pumping speed at the venturi vacuum port) during the ABLE-2B mission. These data represent the minimum, average, and maximum pumping speeds observed during flights 3 to 24 for both straight and level flights and also for spirals during the flights. At lower altitudes (less than 3.9 km ( $\approx 13\,000$  ft)), the pumping speed was lower than the design pumping speed of  $\approx 1915$  L/min ( $\approx 67.6$  ft<sup>3</sup>/min). This difference occurred because the motive pressure was significantly greater than the design pressure. At higher altitudes, the motive pressure approached the design pressure. Consequently, the venturi pump performance improved. Higher pumping speeds at lower altitudes can be achieved with this venturi through use of the gate valve to control motive pressure; this method is discussed in the section entitled "ABLE-3A Mission (Alaska, 1988)." During this ABLE-2B mission, however, motive pressure control was not available because the gate valve was not installed until after the mission.

### ABLE-2B Post-Mission Tests

After the ABLE-2B mission was completed, a series of flight tests were conducted with the DACOM-2 venturi unit and the Hastings Mass Flowmeter. Installed in the vacuum-flow line, this mass flowmeter operated upstream of the test cell. (See fig. 22.) In this configuration, the pressure drop of the flowmeter does not degrade the pumping speed at the test cell, which is kept at a constant pressure (typically 100 torr). Results from one of the venturi tests are shown in figure 23. These data were taken at a constant altitude of 100 m ( $\approx 328$  ft) and show a pumping speed of  $\approx 1500$  L/min ( $\approx 53$  ft<sup>3</sup>/min) with a test cell pressure maintained at 100 torr. Data at other test cell pressures are also plotted. The minimum suction pressure ( $\approx 33$  torr) was attained by closing the autoregulating valve. (See fig. 22.)

<sup>1</sup>Hastings Mass Flowmeter: Manufactured by Teledyne Hastings-Raydist.

### ABLE-3A Mission (Alaska, 1988)

During the ABLE-3A mission to Alaska (ref. 5), the DACOM-5 venturi unit was used in the Langley ozone system. The unit was installed on engine no. 3, and met the pumping speed requirements of the ozone system. The DACOM-5 venturi (figs. 24 and 25) is a 38-mm (1.5-in.) unit with a 38-mm nozzle entrance and a design flow rate of 10.2 SCFM at 100 torr (equivalent to a pumping speed of  $\approx 2195$  L/min ( $\approx 77.5$  ft<sup>3</sup>/min)). The ozone system operates with a 20-cm<sup>3</sup> ( $\approx 8$ -in<sup>3</sup>) prechamber maintained at 200 torr, a 16-cm<sup>3</sup> ( $\approx 6$ -in<sup>3</sup>) chemical reaction chamber maintained at 60 torr, and a sample flow rate of 1000 standard cm<sup>3</sup>/min ( $\approx 394$  in<sup>3</sup>/min).

To further improve the DACOM time response for eddy correlation flux measurements of CO and CH<sub>4</sub> during the ABLE-3A mission, a larger capacity venturi was installed in the engine no. 2 compartment. (See figs. 26 and 27.) This DACOM-7 venturi unit is a 50.8-mm (2-in.) unit with a 38-mm (1.5-in.) nozzle entrance and a design flow rate of 12.4 SCFM at 100 torr ( $\approx 2670$  L/min ( $\approx 94.3$  ft<sup>3</sup>/min) pumping speed).

Figure 28 shows the fast-flow system used by the DACOM system during the ABLE-3A mission. This flow system includes a gate valve that is controlled by a three-position switch (open, off, and close) mounted at the experimenter's instrument rack. The gate valve can be positioned to control the motive pressure entering the entrance nozzle of the venturi. The flow can therefore be maximized by adjusting the motive pressure to match the design motive pressure. A mass flowmeter with a 50.8-mm (2-in.) inside diameter is used in the flow system. This particular flowmeter uses thermocouples mounted on the inside wall and has no obstructions; therefore, it has a 50.8-mm (2-in.) clear opening with an insignificant pressure drop.

Several test flights were conducted at Wallops Flight Facility prior to the ABLE-3A Alaska mission. Figure 29 illustrates the pumping speed of the DACOM-7 venturi unit as the motive pressure is set with the three-position switch. The motive pressure is regulated on level flights and not on spirals. At an altitude of  $\approx 305$  m (1000 ft), the motive pressure is 703.2 kPa ( $\approx 102$  psig) with the gate valve fully open. As the motive pressure is decreased, the pumping speed increases substantially. Results from a spiral during test flight 7 are shown in figure 30. Both the pumping speed and motive pressure for the DACOM-7 venturi unit are plotted versus altitude. With the gate valve fully open, the motive pressure changes from about 696.3 to 579.1 kPa ( $\approx 101$  to



84 psig) for altitude increasing from 0.15 km (500 ft) to 2.74 km (9000 ft).

### ABLE-3A Post-Mission Tests

Figures 31 to 35 show results from the three test flights conducted at Wallops Flight Facility after the ABLE-3A mission was completed. Figure 31 shows the minimum, average, and maximum pumping speeds for all three test flights, including level flights and spirals. The motive pressure was not regulated during these tests. Pumping speed varies at a given altitude because the motive pressure is somewhat a function of engine power setting, which varies with turns, ascents, descents, etc. Figure 32 shows test results from the three test flights for suction pressures of 50 and 75 torr. This figure is only for level flights with motive pressure optimized with the three-position switch. The pumping speed is increased by decreasing the motive pressure; however, the motive pressure can only be decreased to a point just above choking the venturi. (See the section entitled "Restarting a Spoiled or Choked Venturi.") Figure 33 shows similar results for a suction pressure of 100 torr, and figure 34 shows pumping speed versus altitude for suction pressures greater than 100 torr.

The minimum suction pressure (blind pressure), or test cell pressure achieved with the autoregulating valve closed, versus altitude and motive pressure is shown in figure 35. At sea level the minimum suction pressure achieved for the DACOM-7 unit was  $\approx 33$  torr at maximum motive pressure. A suction pressure of  $\approx 12$  torr was achieved at an altitude of 4.57 km (15 000 ft) and a motive pressure of 52 psig.

### Testing Prior to ABLE-3B Mission (Canada, 1990)

The mission objectives for the ABLE-3B mission to Canada included eddy correlation flux measurements of CO and CH<sub>4</sub> (ref. 7). To achieve even faster flow than that achieved during the ABLE-3A (Alaska) mission, a larger capacity venturi was installed in the engine no. 2 compartment for use in the DACOM system. The DACOM-8 is the largest venturi used to date and is shown in figures 36 to 38. This venturi is designed to operate from "stable to blind." In other words, it is not expected to spoil (see next section) while operating at the design motive pressure. Hence, the DACOM-8 venturi is more stable than the others tested.

A series of tests on this DACOM-8 venturi unit was conducted prior to the ABLE-3B mission. Figures 39 to 43 represent some of the results obtained during the five test flights. Figure 39 indicates the

minimum and maximum pumping speed as a function of altitude for a suction pressure of 100 torr for all five test flights. These data are for spirals and level sections of flight. Motive pressure for these tests was not controlled with the three-position switch.

Figure 40 indicates the minimum suction pressure attained as a function of altitude for the DACOM-8 venturi. The lowest suction pressure occurs above an altitude of 3.05 km (10 000 ft) at motive pressures of about 358.5 to 393 kPa ( $\approx 52$  to 57 psig).

As previously mentioned, higher pumping speeds are achieved as the motive pressure is regulated near or at the design pressure. Figure 41 shows the effect of varying motive pressure on pumping speed as a function of altitude. At an altitude of 0.305 km (1000 ft) and a motive pressure of 586 kPa (85 psig), a pumping speed of  $\approx 3350$  L/min ( $\approx 118.3$  ft<sup>3</sup>/min) was achieved. Also, at an altitude of 2.74 km (9000 ft), the pumping speed varies from 2400 to 4400 L/min ( $\approx 84.7$  to 155.3 ft<sup>3</sup>/min) with motive pressures of 717 to 379.2 kPa ( $\approx 104$  to 55 psig).

Figure 42 shows the test results for suction pressures of 50 and 75 torr. Figure 43 shows the test results of the five test flights for suction pressures greater than 100 torr.

### Restarting a Spoiled or Choked Venturi

Single-point venturis operate best at the motive temperature, motive pressure, back pressure, and suction pressure for which they are designed. With aircraft operations, however, these parameters vary within some operational envelope. Therefore, a venturi occasionally spoils or chokes during flight and does not operate within design specifications under these conditions. One procedure that often spoils a venturi is lowering the motive pressure below some critical value that is typically less than the design motive pressure.

Figure 44 shows a time sequence of events for restarting a spoiled or choked venturi. Part 1 indicates normal operation at 100 torr with normal motive pressure. When the motive pressure is normal (regulating valve fully open) and the minimum suction pressure does not go below the design operating suction pressure, the venturi is spoiled or choked (ref. 8). Part 2 of the figure illustrates this condition. For the venturis tested in this report, the typical minimum suction pressure of a spoiled venturi is  $\approx 110$  to 120 torr, whereas the minimum suction pressure for a venturi that is not spoiled is  $\approx 20$  to 30 torr. To restart the venturi, the autoregulating valve must be closed so that the venturi can pump out the system. Next, the motive pressure is decreased in steps

with the three-position switch. As the motive pressure is decreased, the minimum suction pressure will decrease. (See part 3 of fig. 44.) Continuing this procedure brings the venturi to a point where it suddenly pumps the system down to the ultimate minimum suction pressure. Once this minimum suction pressure is achieved, the gate valve to the venturi is opened to its fully open position. In this fully open position, the motive pressure becomes maximum and then the test cell or White cell can be set for 100 torr, as indicated in part 4 of figure 44. Venturis do not spoil often (usually when the experimenter inadvertently lowers the motive pressure too low while trying to achieve maximum flow rate), but once they do spoil they can be restarted in seconds with this technique.

## Summary of Results

This paper reports the adaptation of venturi air-jet ejectors to the NASA Electra aircraft. These NASA venturi units have proven to be valuable for the eddy flux measurements of CO and CH<sub>4</sub> by the Differential Absorption Carbon Monoxide Measurement (DACOM) system. They are lightweight, create no excess heat load in the aircraft, require no electrical power, and provide large pumping speeds at moderately low suction pressures ( $\approx 100$  torr). A total of eight venturi units are available for use with the Electra aircraft, and both inboard engines are configured with the necessary plumbing for venturi applications. This report shows the results of several test flights and missions that used venturis as an alternative to mechanical vacuum pumps. Pumping speeds up to 4400 L/min ( $\approx 155.3$  ft<sup>3</sup>/min) have been achieved for a 100-torr test cell pressure. The venturis have been used in more than 75 missions (over 300 hr) on the Electra aircraft with excellent results.

NASA Langley Research Center  
Hampton, VA 23665-5225  
February 18, 1992

## References

1. McNeal, Robert J.; Mugler, John P., Jr.; Harriss, Robert C.; and Hoell, James M., Jr.: NASA Global Tropospheric Experiment. *EOS Trans., American Geophys. Union*, vol. 64, no. 38, Sept. 20, 1983, pp. 561-562.
2. Sachse, Glen W.; Hill, Gerald F.; Wade, Larry O.; and Perry, Murray G.: Fast-Response, High-Precision Carbon

Monoxide Sensor Using a Tunable Diode Laser Absorption Technique. *J. Geophys. Res.*, vol. 92, no. D2, Feb. 20, 1987, pp. 2071-2081.

3. Harriss, R. C.; Garstang, M.; Wofsy, S. C.; Beck, S. M.; Bendura, R. J.; Coelho, J. R. B.; Drewry, J. W.; Hoell, J. M., Jr.; Matson, P. A.; McNeal, R. J.; Molion, L. C. B.; Navarro, R. L.; Rabine, V.; and Snell, R. L.: The Amazon Boundary Layer Experiment: Wet Season 1987. *J. Geophys. Res.*, vol. 95, no. D10, Sept. 20, 1990, pp. 16,721-16,736.
4. Harriss, R. C.; Sachse, G. W.; Hill, G. F.; Wade, L. O.; and Gregory, G. L.: Carbon Monoxide Over the Amazon Basin During the Wet Season. *J. Geophys. Res.*, vol. 95, no. D10, Sept. 20, 1990, pp. 16,927-16,932.
5. Harriss, R. C.; Wofsy, S. C.; Bartlett, D. S.; Shipham, M. C.; Jacobs, D. J.; Hoell, J. M., Jr.; Bendura, R. J.; Drewry, J. W.; McNeal, R. J.; Navarro, R. L.; Gidge, R. N.; and Rabine, V. E.: The Arctic Boundary Layer Expedition (ABLE 3A). *J. Geophys. Res.*, vol. 97, 1992.
6. Harriss, R. C.; Sachse, G. W.; Hill, G. F.; Wade, L. O.; Bartlett, K. B.; Collins, J. E.; Steele, P.; and Novelli, P.: Carbon Monoxide and Methane in the North American Arctic and Subarctic Troposphere: July August 1988. *J. Geophys. Res.*, vol. 97, 1992.
7. Harriss, Robert C.: The Arctic Boundary Layer Expedition (ABLE 3B). *EOS Trans., American Geophys. Union*, vol. 72, no. 17, Apr. 23, 1991, p. 73.
8. Ryans, J. L.; and Roper, D. L.: *Process Vacuum System Design and Operation*. McGraw-Hill, Inc., c.1986.
9. John, James E. A.; and Haberman, William L.: *Introduction to Fluid Mechanics*, Second ed. Prentice-Hall, Inc., 1980.
10. Kay, J. M.; and Nedderman, R. M.: *An Introduction to Fluid Mechanics and Heat Transfer--With Applications in Chemical & Mechanical Process Engineering*, Third ed. Cambridge Univ. Press, c.1974.
11. Daugherty, Robert L.; and Franzini, Joseph B.: *Fluid Mechanics With Engineering Applications*, Seventh ed. McGraw-Hill, Inc., c.1977.
12. Shapiro, Ascher H.: *The Dynamics and Thermodynamics of Compressible Fluid Flow*, Volume II. Ronald Press Co., c.1954.
13. Walshaw, A. C.; and Jobson, D. A.: *Mechanics of Fluids*, Third ed. in SI Units. Longman Inc., c.1979.
14. *Lockheed Orion Service Digest*. Issue 23, Lockheed-California Co., Dec. 1971.
15. White, John U.: Long Optical Paths of Large Aperture. *J. Opt. Soc. America*, vol. 32, no. 5, May 1942, pp. 285-288.

Table 1. Normal Blind Suction Pressure

[From ref. 8]

Number of jet stages	Blind suction pressure, torr
1	50-100
2	4-10
3	0.8-2.0
4	0.1-0.3
5	0.01-0.05
6	0.001-0.005

Table 2. DACOM Venturi Mission History

Venturi unit no.	Mission	Principal investigator	Experiment	Engine no.
DACOM-1	CITE-2 Western United States, 1986	Barry Huebert SRI International	Nitric acid	3
DACOM-2	ABLE-2B Brazil, 1987	Glen W. Sachse Langley Research Center	Carbon monoxide	2
DACOM-3	Backup unit for DACOM-2			
DACOM-4	ABLE-2B Brazil, 1987	Gerald Gregory Langley Research Center	Ozone and aerosols	3
DACOM-5	ABLE-3A Alaska, 1988	Gerald Gregory Langley Research Center	Ozone and aerosols	3
	ABLE-3B Canada, 1990	Gerald Gregory Langley Research Center	Ozone and aerosols	3
DACOM-6	Backup unit for DACOM-5			
DACOM-7	ABLE-3A Alaska, 1988	Glen W. Sachse Langley Research Center	Carbon monoxide and methane	2
	CITE-3 Wallops and Brazil, 1989	Ron Ferek University of Washington	Sulfur species (DMS)	2
DACOM-8	ABLE-3B Canada, 1990	Glen W. Sachse Langley Research Center	Carbon monoxide and methane	2

Table 3. DACOM Venturi Motive Gas Consumption

Venturi unit no.	Motive gas consumption, lb/hr	Percent of Electra compressor output
DACOM-1	288	0.25
DACOM-2	675	.60
DACOM-3	675	.60
DACOM-4	675	.60
DACOM-5	594	.50
DACOM-6	594	.50
DACOM-7	1195	1.00
DACOM-8	790	.70

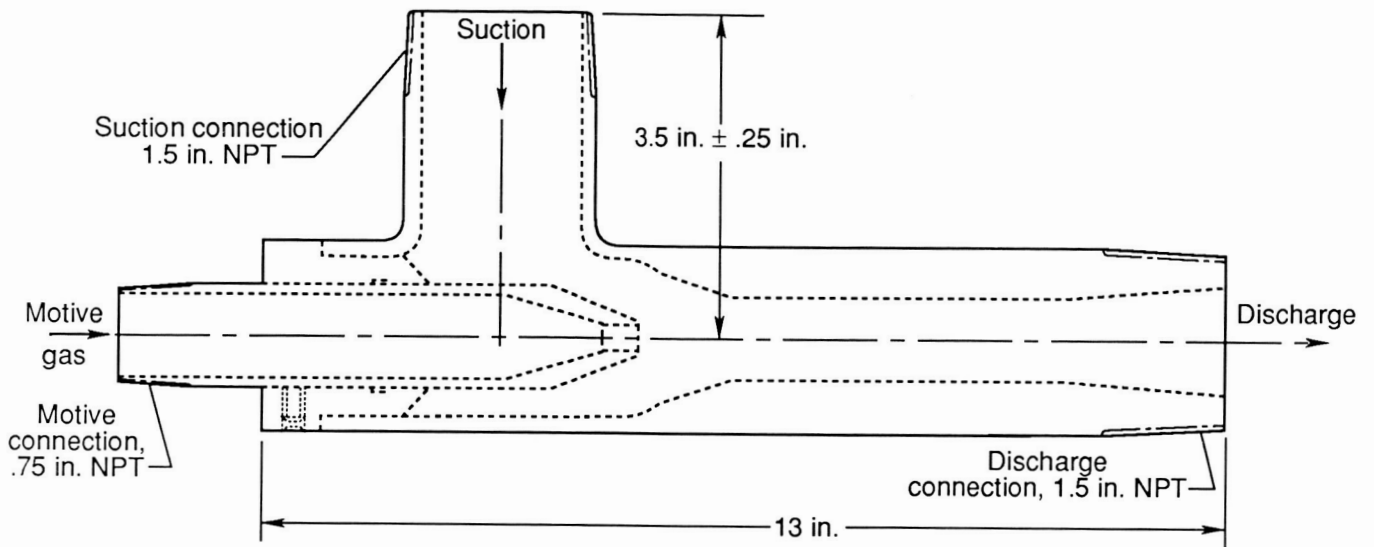

Specifications  
 Pumping speed at 200 torr absolute: 1830 L/min  
 Motive GAS: 80 psig, 475°F, 1810 STD L/min

Figure 1. Single-point venturi air-jet vacuum ejector designed for 200-torr operation.

ORIGINAL PAGE  
 BLACK AND WHITE PHOTOGRAPH



L-89-2964

Figure 2. NASA Electra aircraft (NA429) in flight.

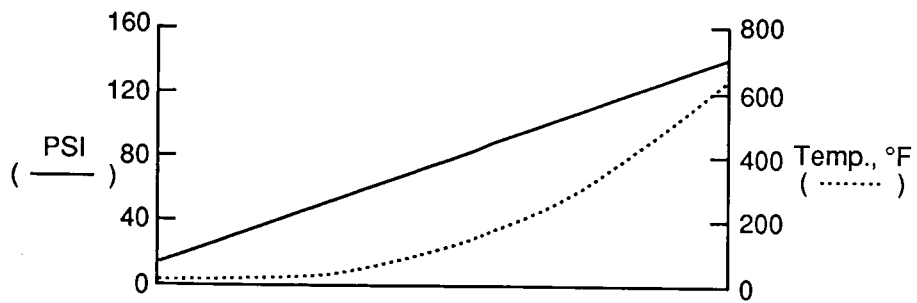
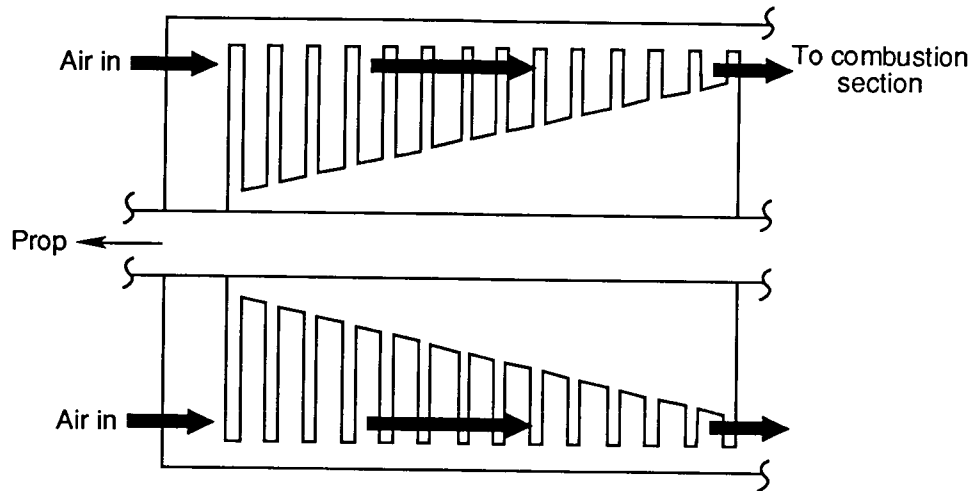
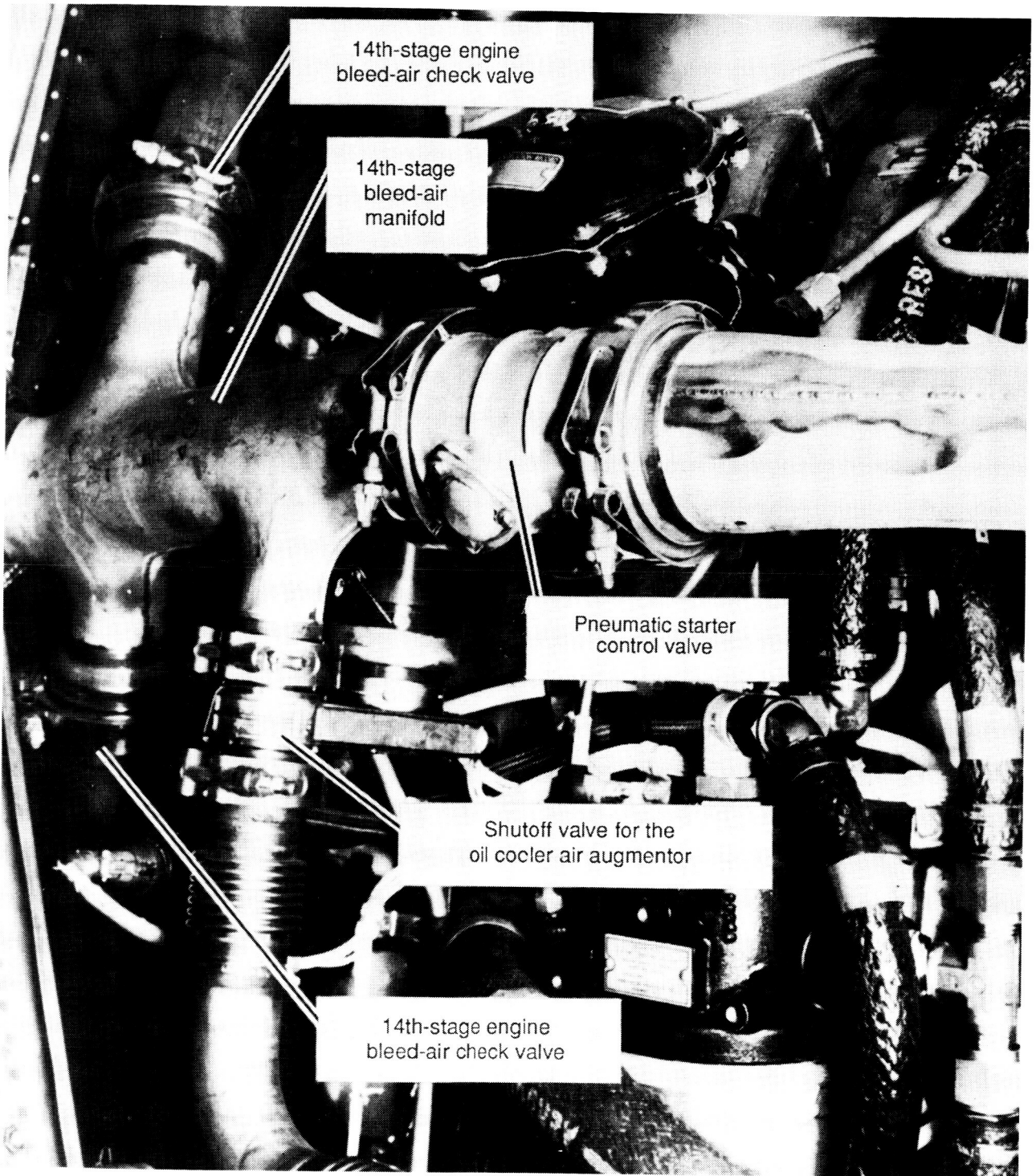

Figure 3. Characteristics of 14-stage compressor used on NASA Electra. 83 percent efficiency; 9.64:1 compression ratio; 554°F temperature rise; 470 ft<sup>3</sup> air/sec. (Based on ref. 14.)

ORIGINAL PAGE  
BLACK AND WHITE PHOTOGRAPH



L-89-12144

Figure 4. NASA Electra 14th-stage bleed-air manifold configuration with shutoff valve for oil cooler air augmentor.

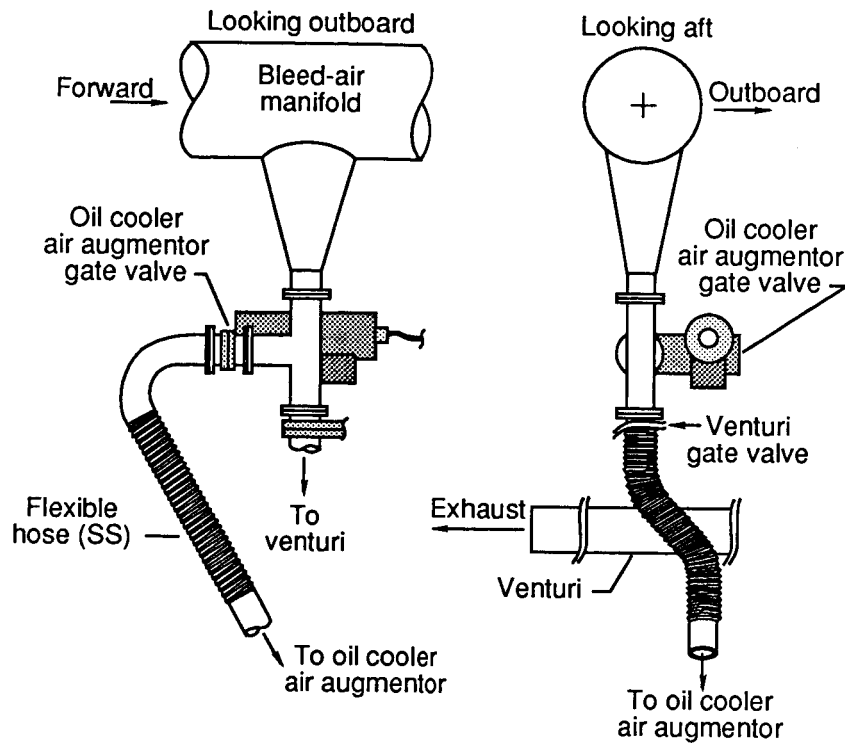

Figure 5. NASA Electra 14th-stage bleed-air manifold configuration with oil cooler air augmentor gate valve tee modification for venturi motive air.

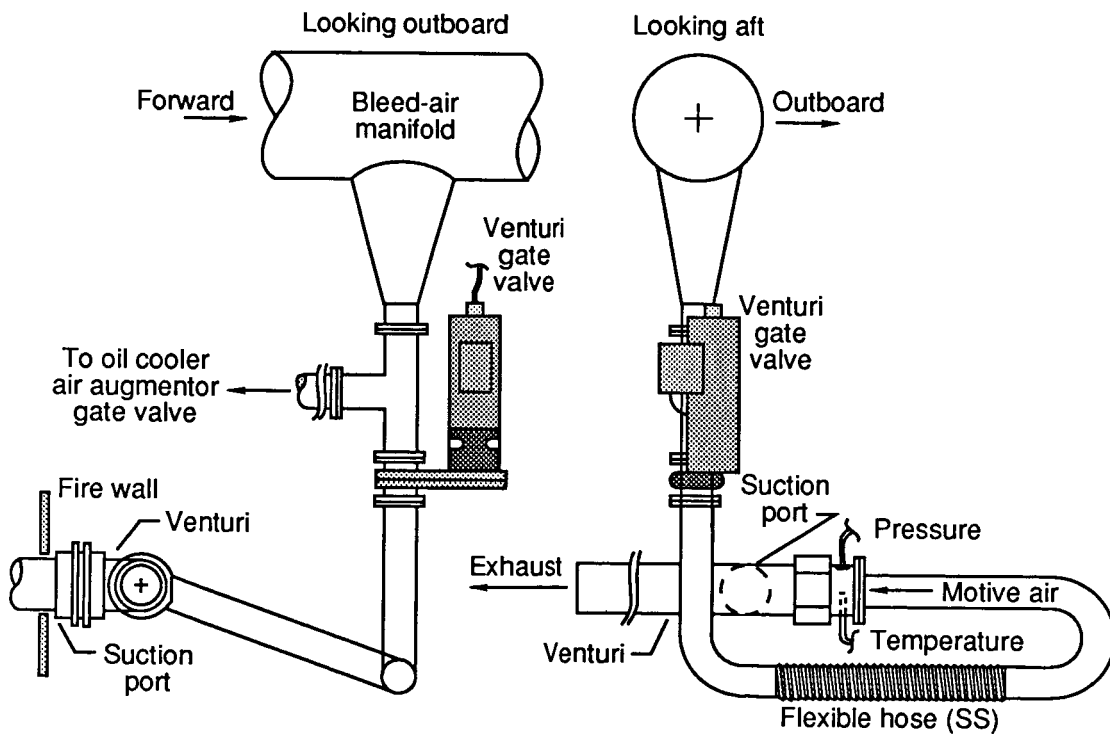

Figure 6. NASA Electra 14th-stage bleed-air manifold configuration with oil cooler air augmentor gate valve tee modification for venturi motive air to venturi.



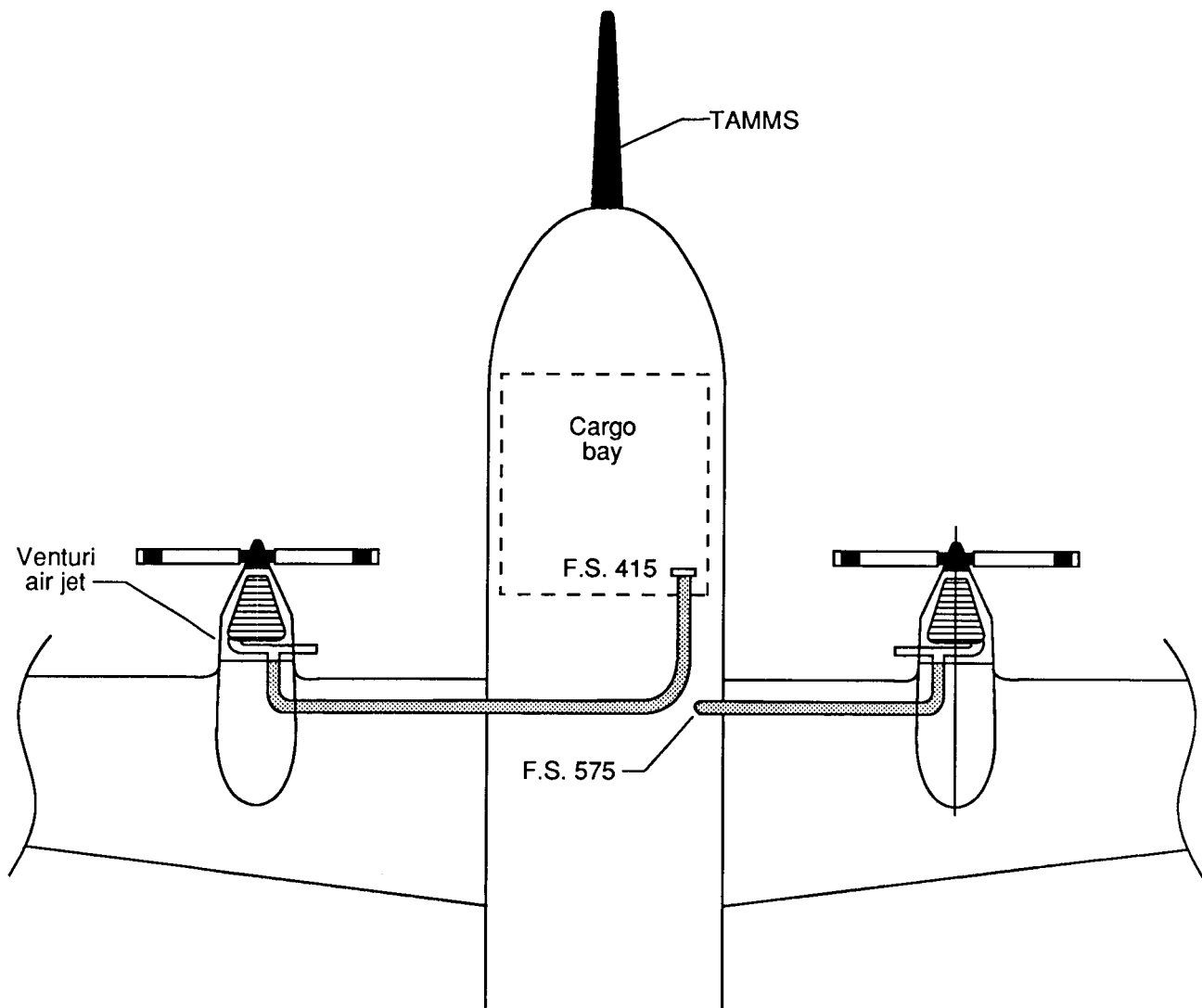
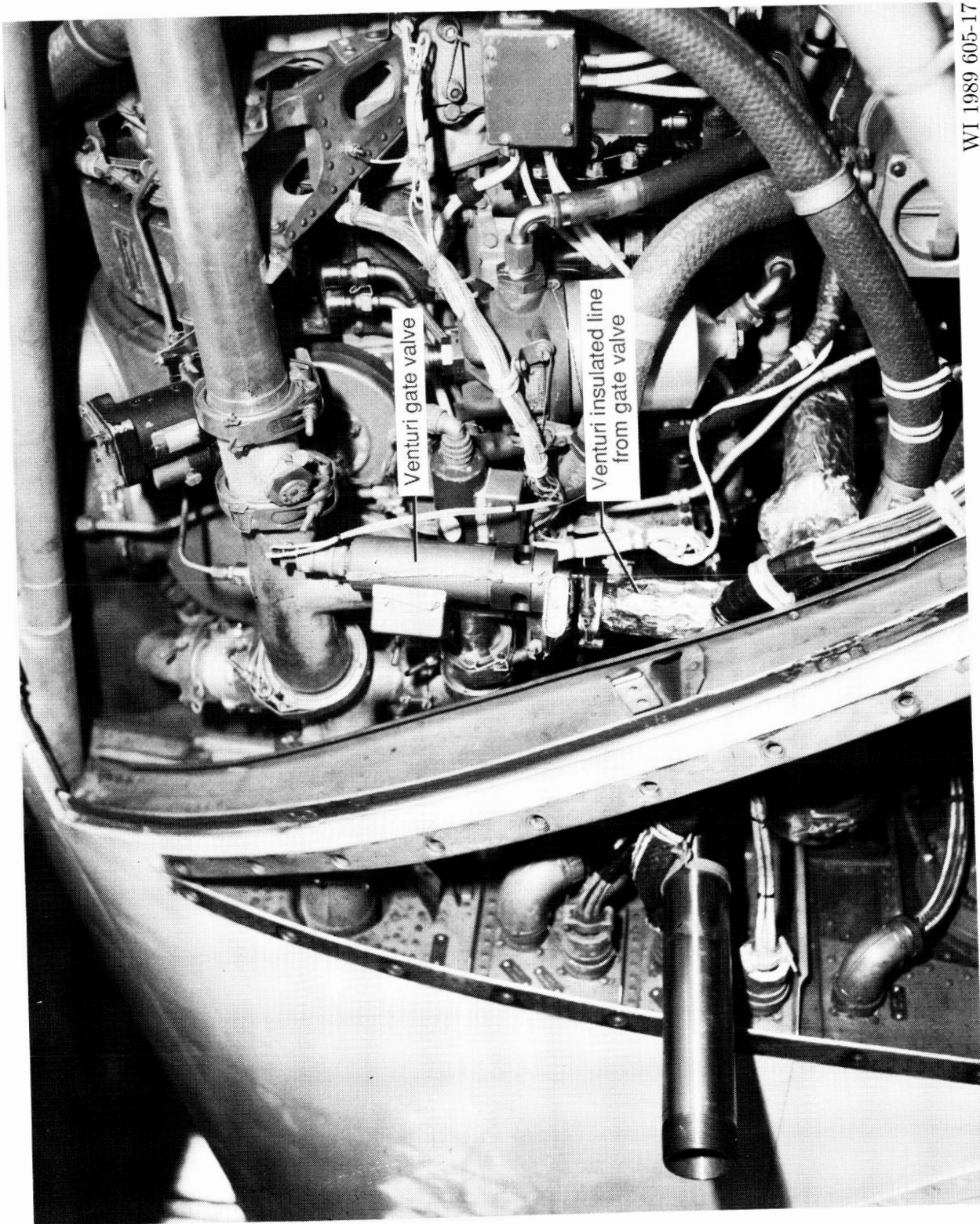

Figure 7. Venturi vacuum line termination points (F.S. no.) for NASA Electra.



WI 1989 605-17

Figure 8. NASA Electra engine no. 2 compartment with venturi mounted through fire wall and insulated venturi motive air line from gate valve.

ORIGINAL PAGE  
BLACK AND WHITE PHOTOGRAPH

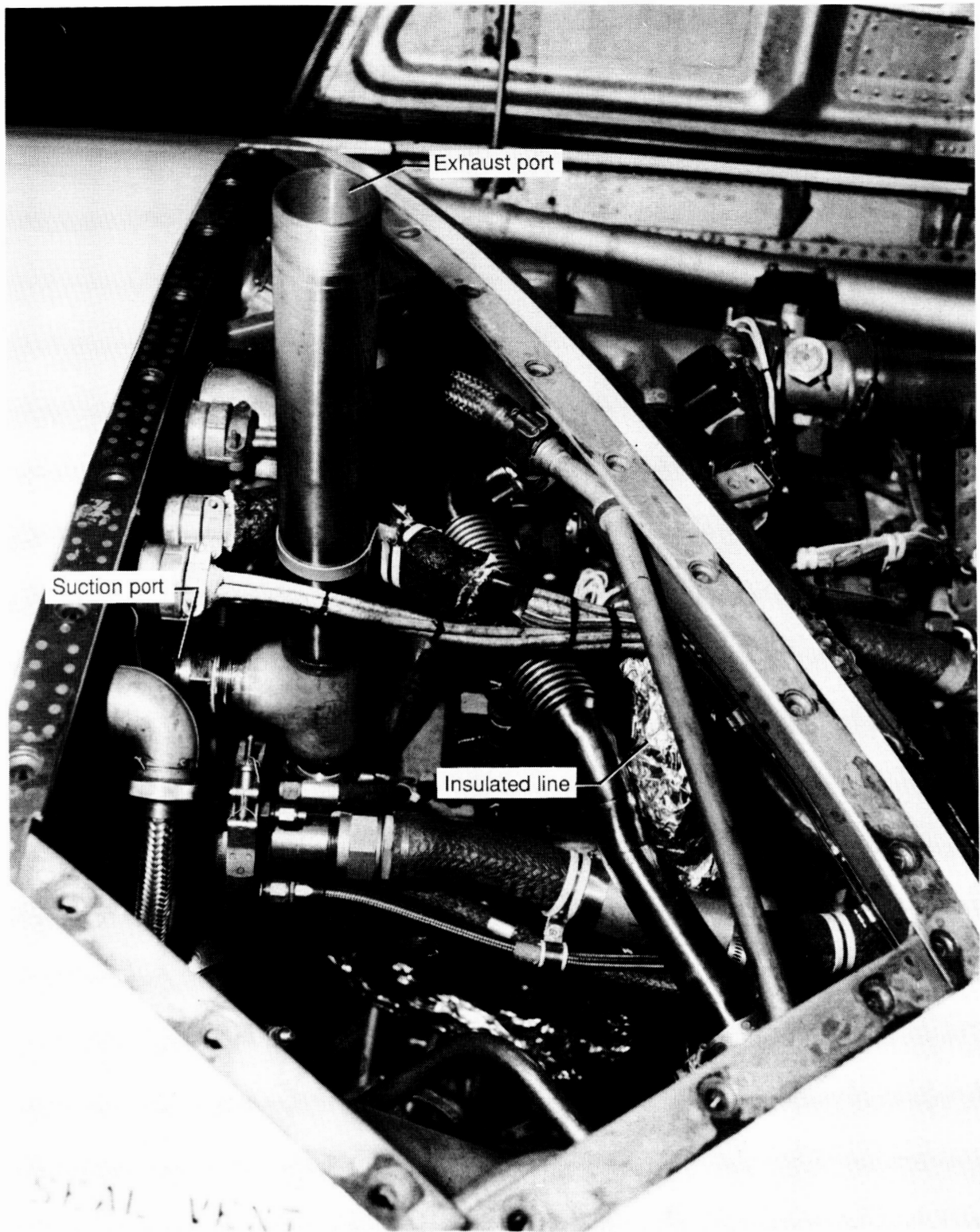

WI 1989 605-15

Figure 9. NASA Electra engine no. 2 compartment with venturi mounted through fire wall and insulated venturi motive air line leading to venturi entrance port.

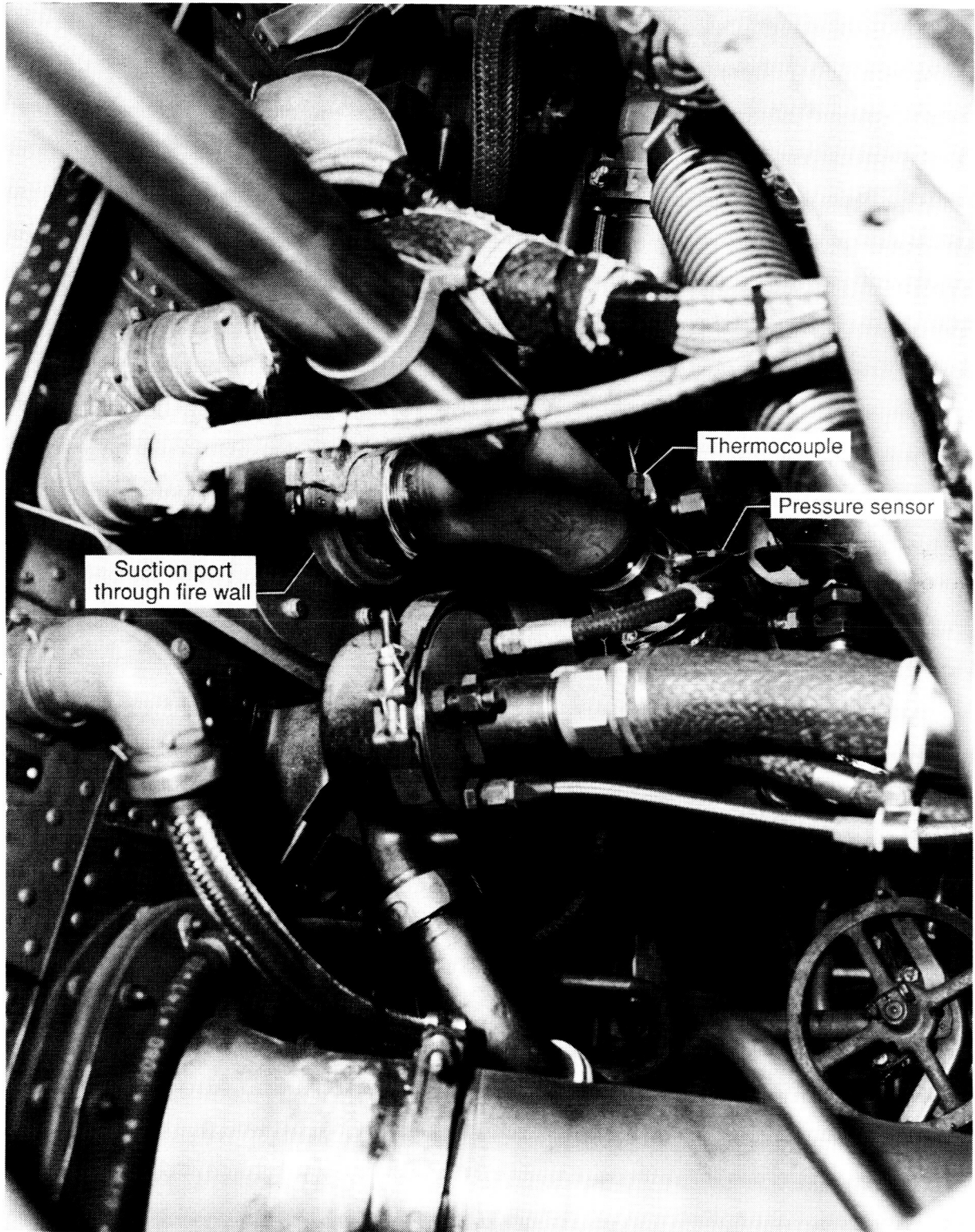

WI 1989 605-7

Figure 10. NASA Electra engine no. 2 compartment with venturi suction port mounted through fire wall and motive air temperature and pressure sensor locations.

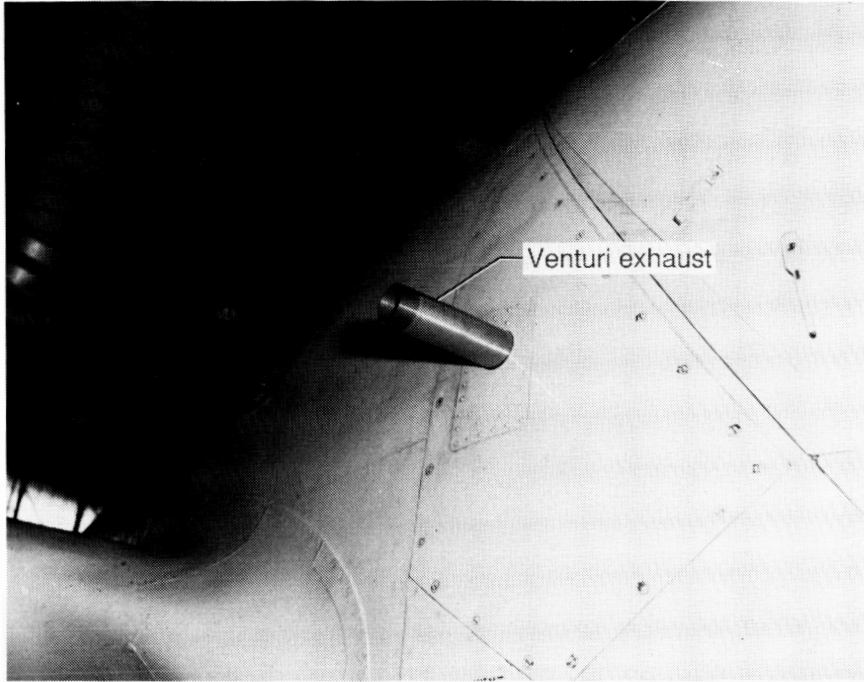

WI 1989 605-2

Figure 11. NASA Electra engine no. 2 nacelle configuration for venturi exhaust.

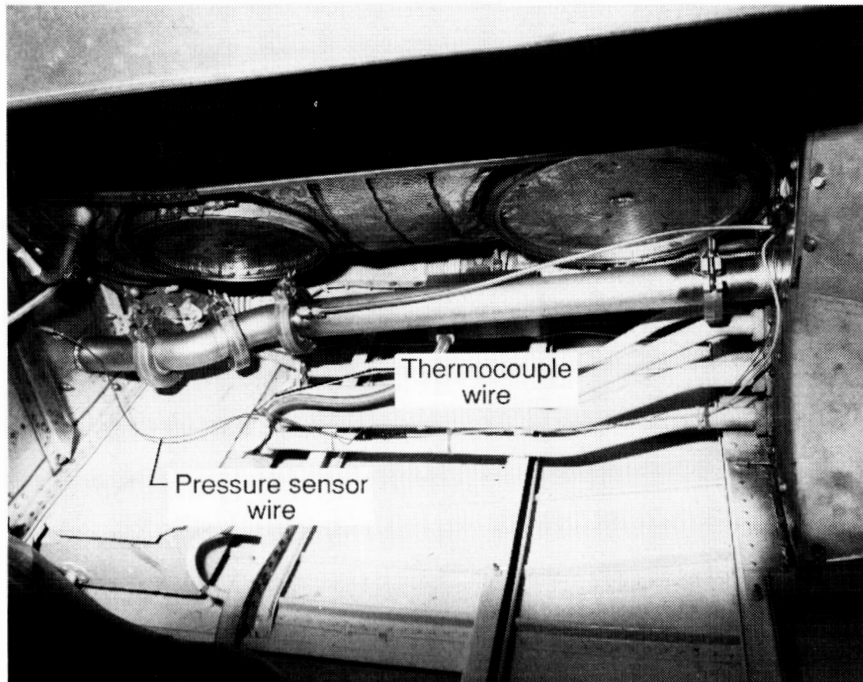

WI 1987 761-33

Figure 12. Venturi vacuum line through engine no. 2 wheel well.

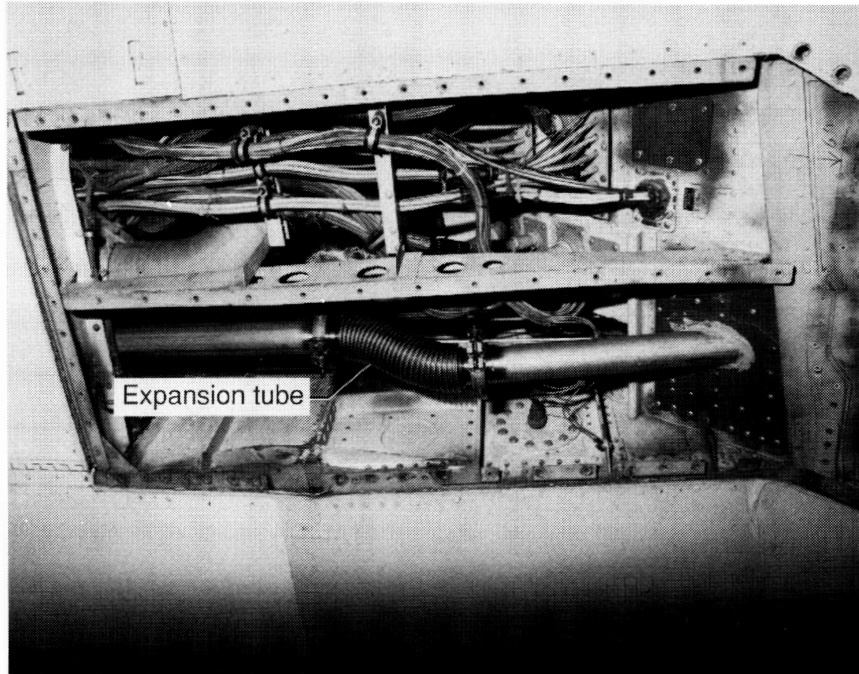

WI 1987 761-25

Figure 13. Venturi vacuum line expansion tube through wing for proper alignment.

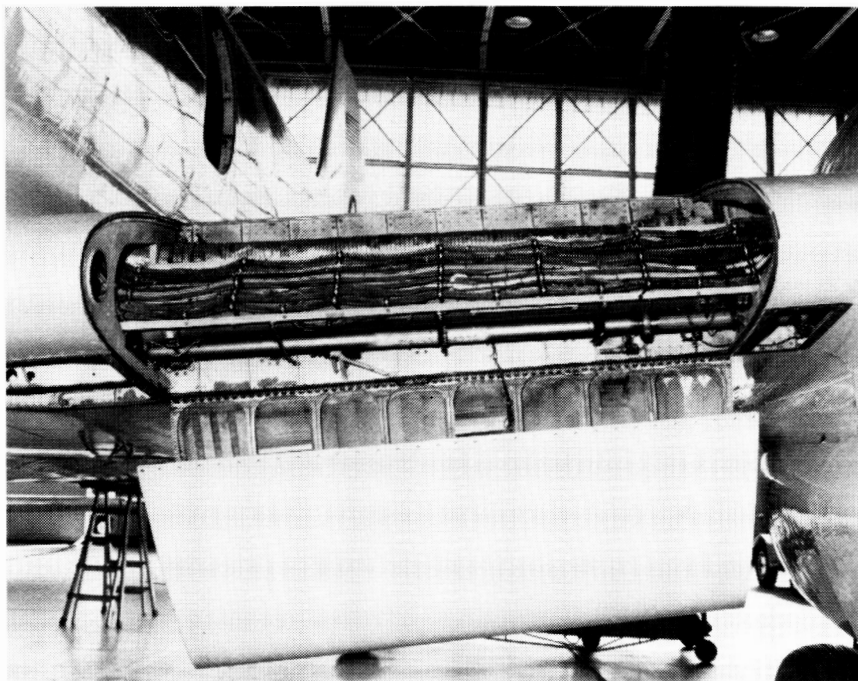

L-89-2963

Figure 14. Venturi vacuum line through Wallops Electra wing leading edge.

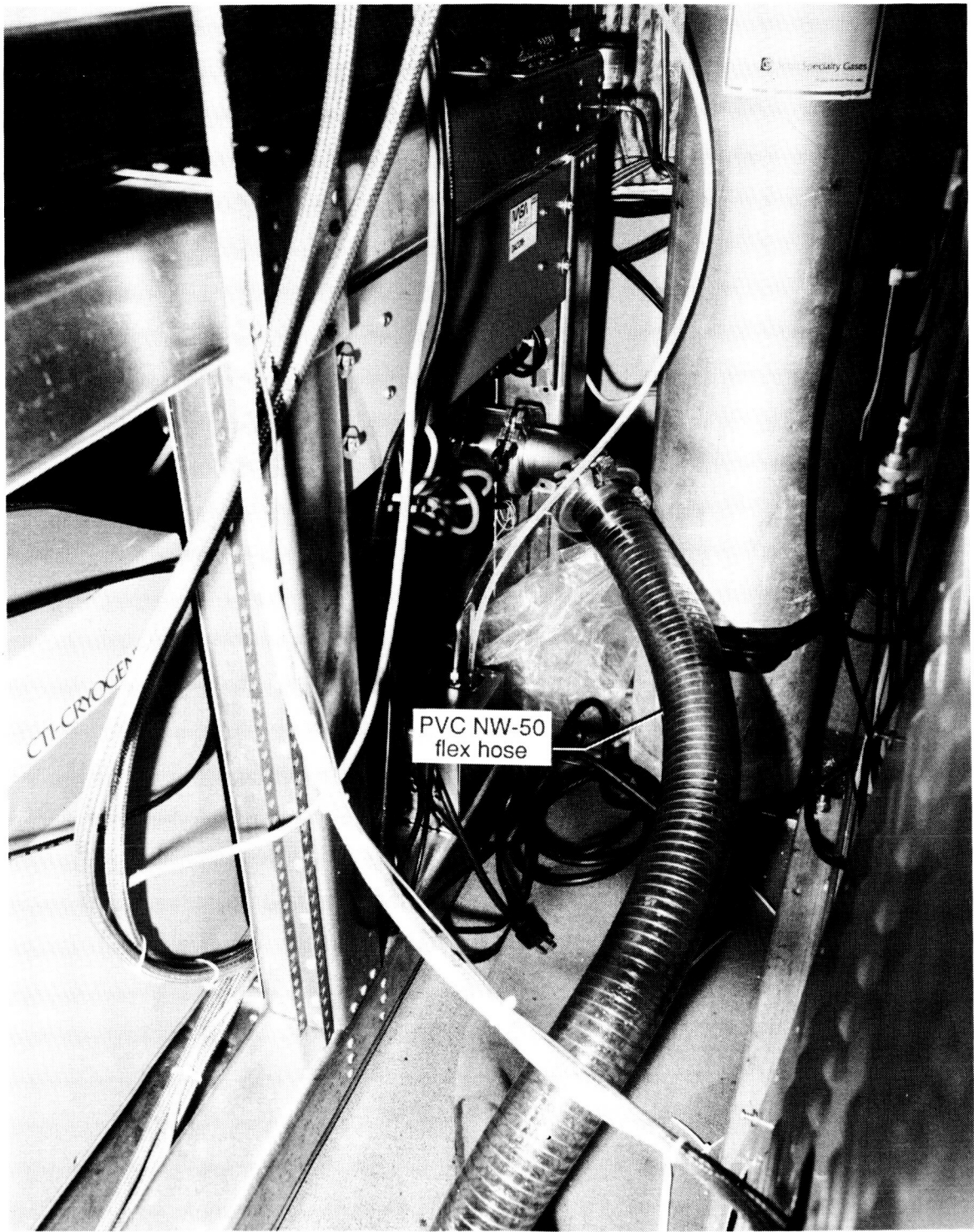

WI 1987 187-1

Figure 15. Venturi vacuum line (PVC flex hose) terminating at DACOM system (ABLE-2B mission).

ORIGINAL PAGE  
BLACK AND WHITE PHOTOGRAPH

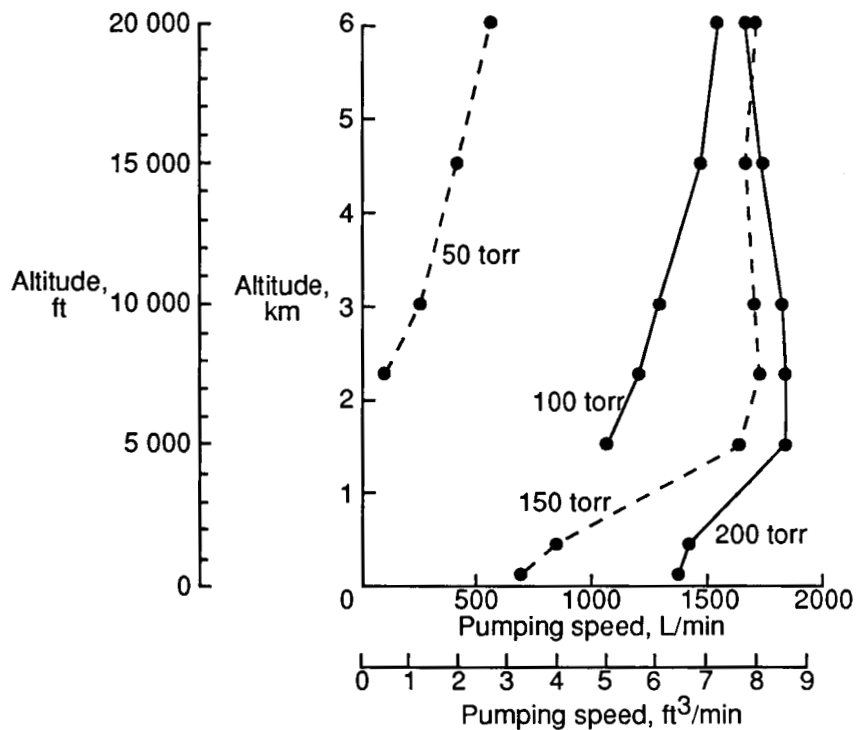

Figure 16. Pumping speed versus altitude at suction pressures of 50 to 200 torr for DACOM-1 venturi. July 1986 (before CITE-2 mission), level flights; engine no. 3.

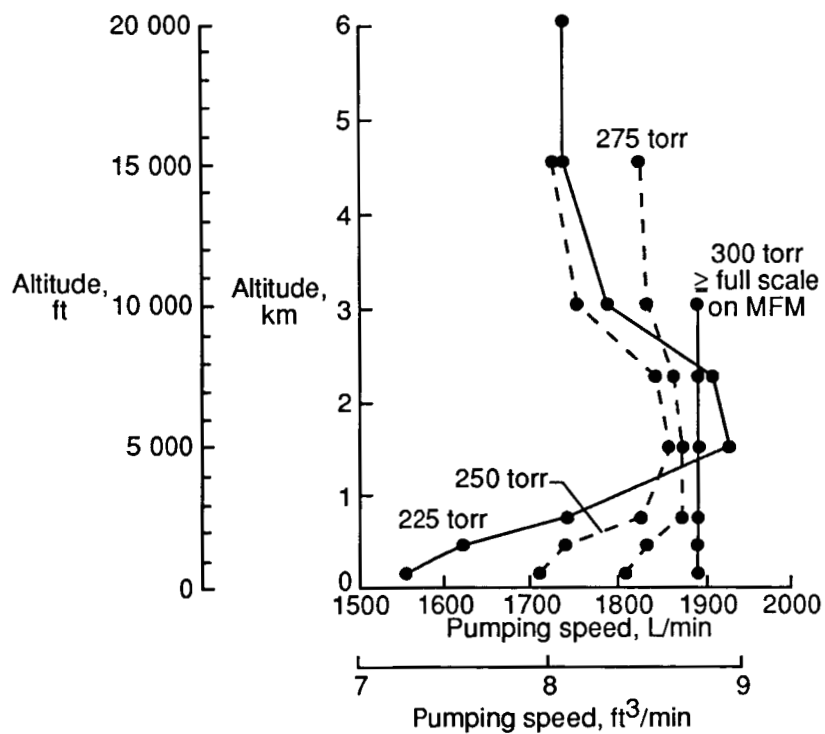
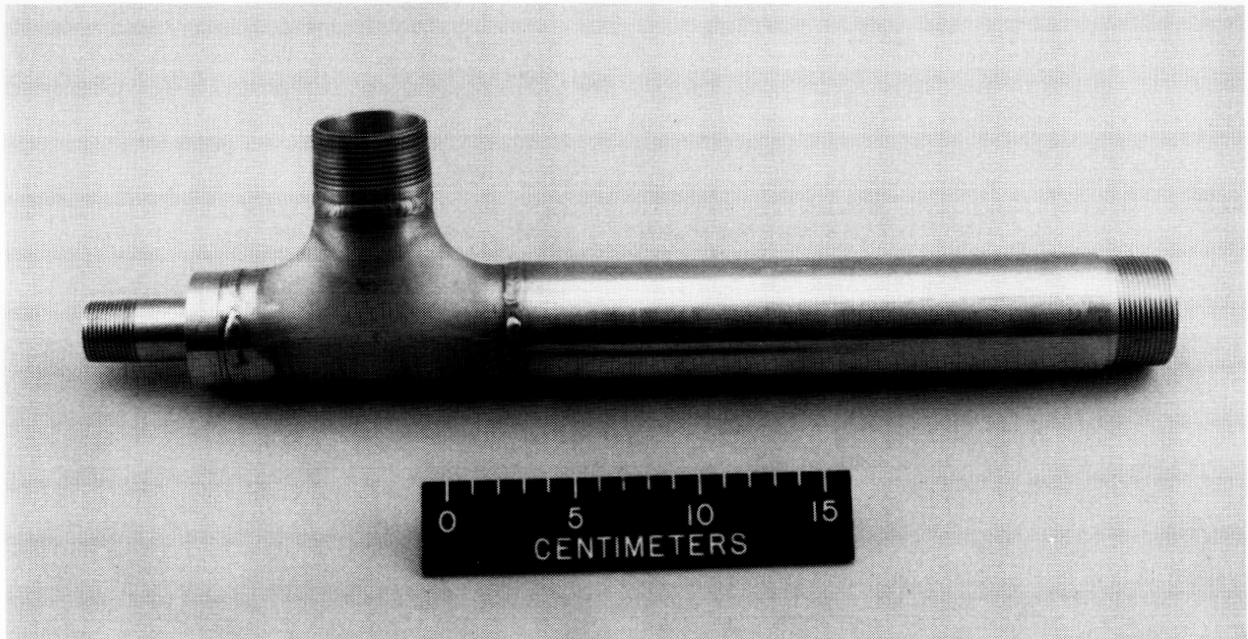

Figure 17. Pumping speed versus altitude at suction pressures of 225 to 300 torr for DACOM-1 venturi. July 1986 (before CITE-2 mission), level flights; engine no. 3.





L-87-250

Figure 18. DACOM-2 venturi used by DACOM system during GTE ABLE-2B mission (Brazil, 1987).

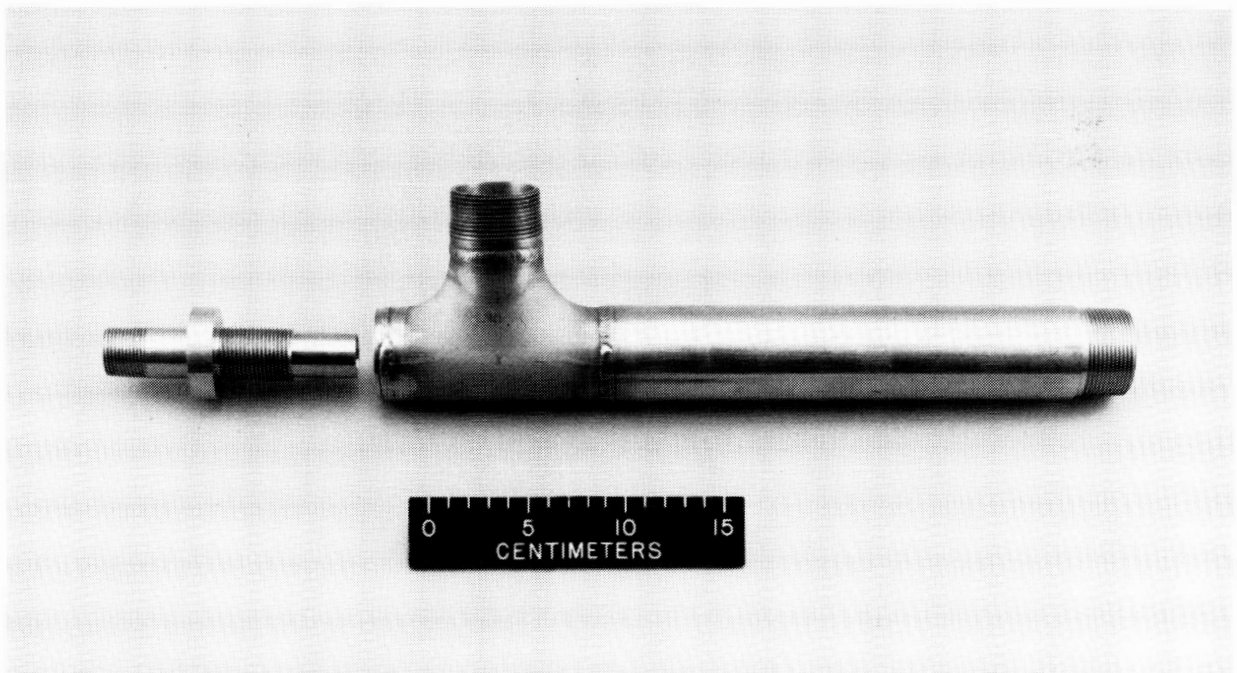

L-87-249

Figure 19. DACOM-2 venturi with nozzle out of unit.

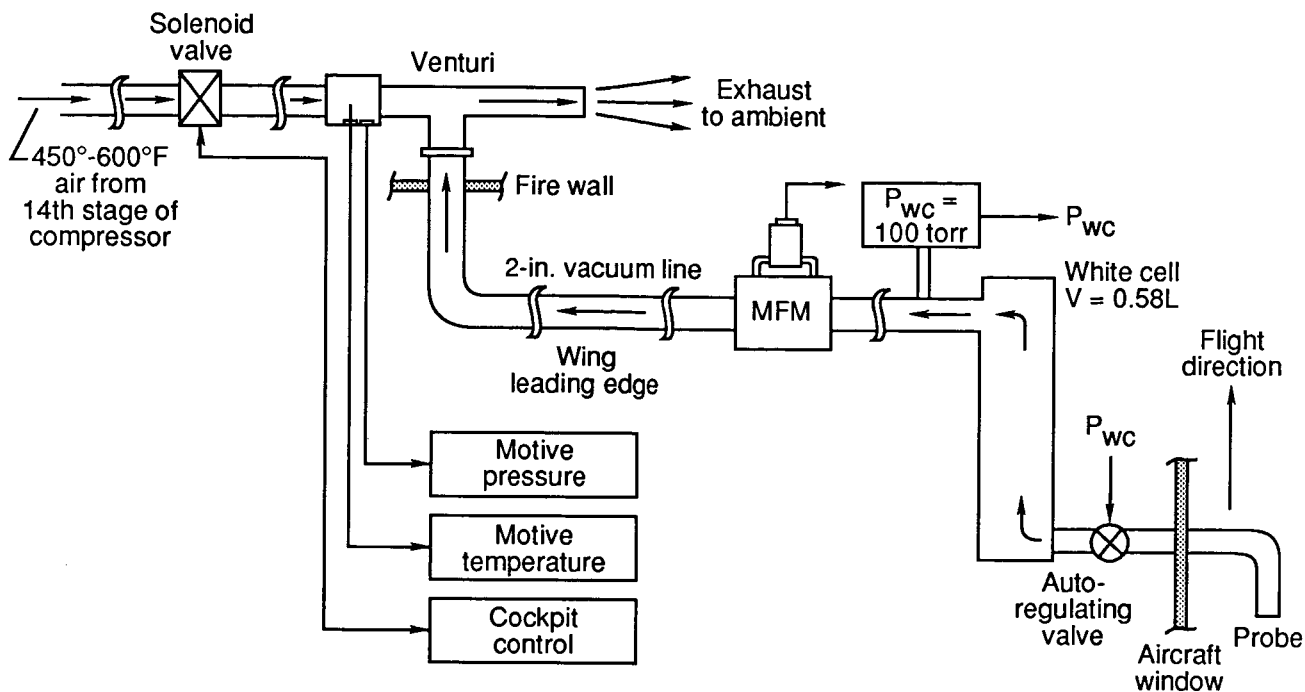

Figure 20. DACOM venturi flow system used in NASA GTE ABLE-2B mission (Brazil, 1987).

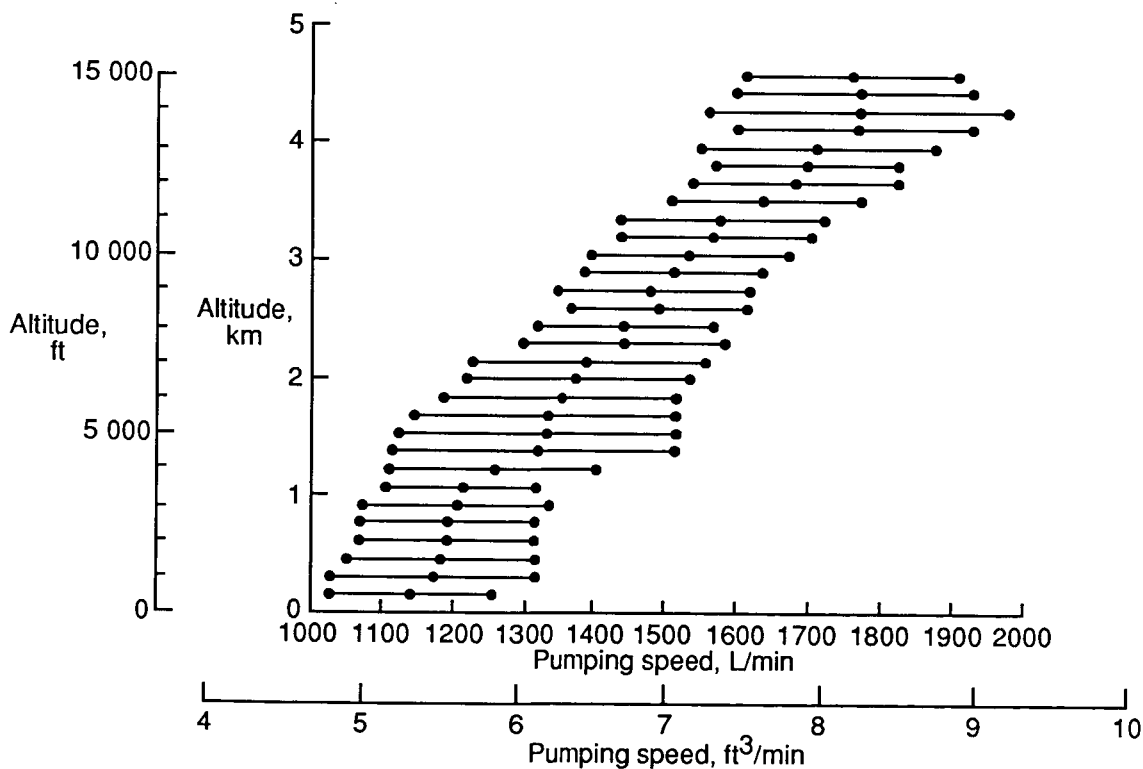

Figure 21. DACOM-2 venturi pumping speed as function of altitude for flights 3 to 24 with test cell pressure of 100 torr. ABLE-2B mission, flights 3 to 24; engine no. 2.

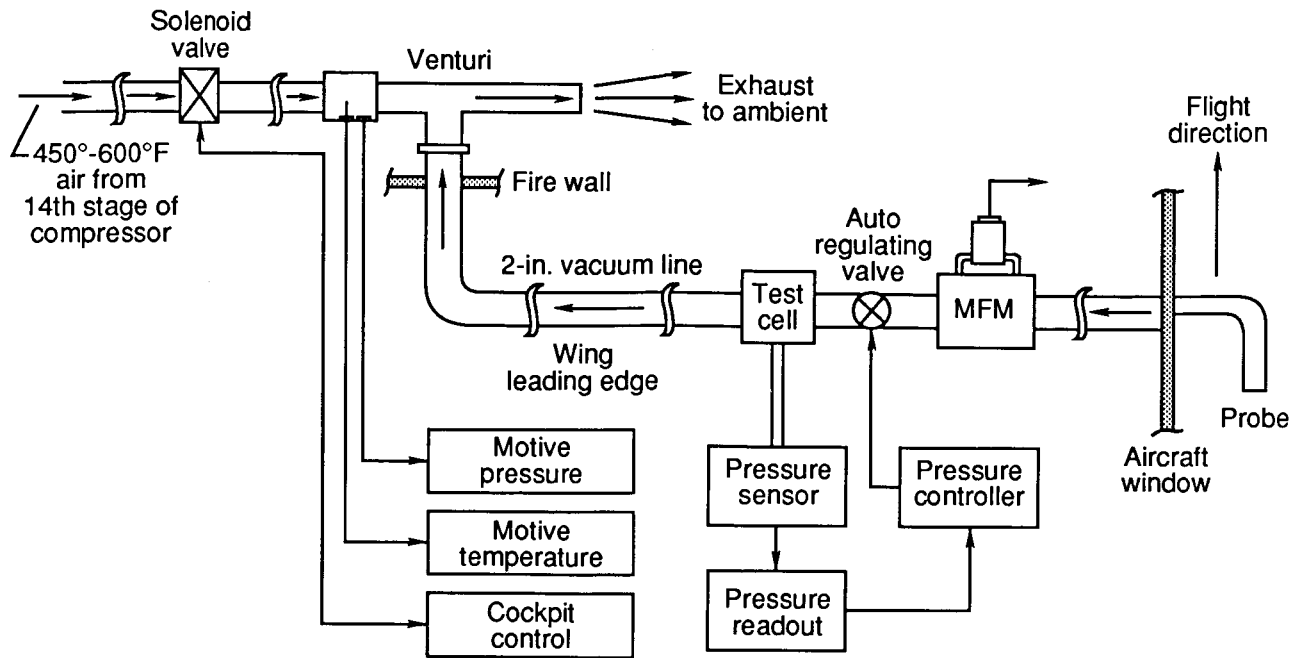

Figure 22. Flow system for DACOM-2 venturi tests on NASA Electra (July 1987).

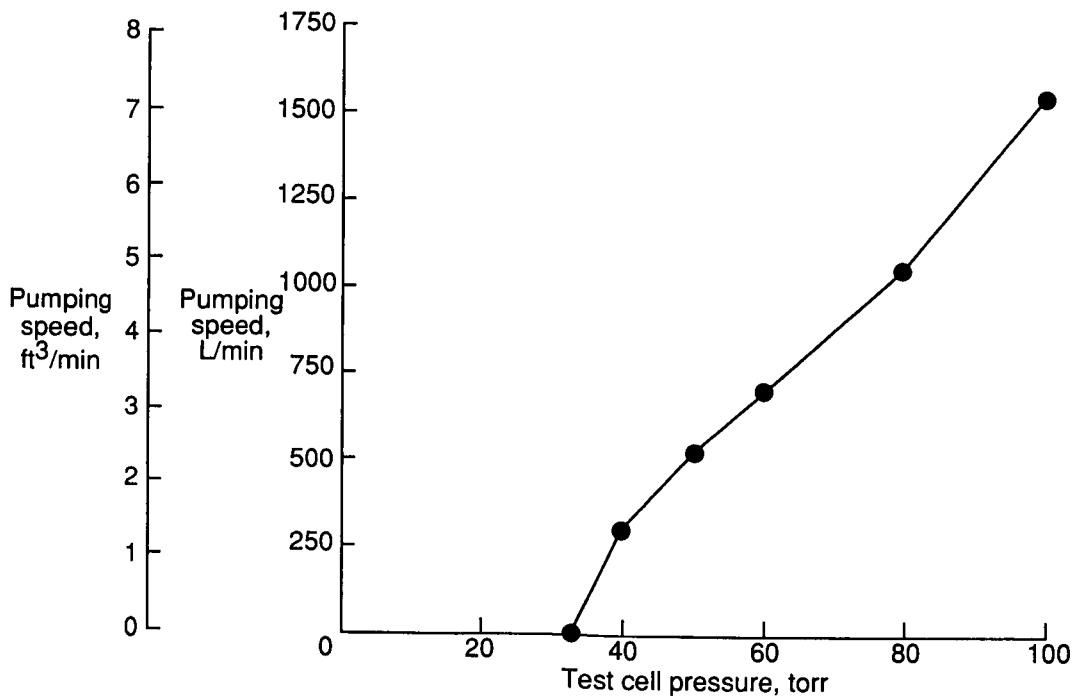
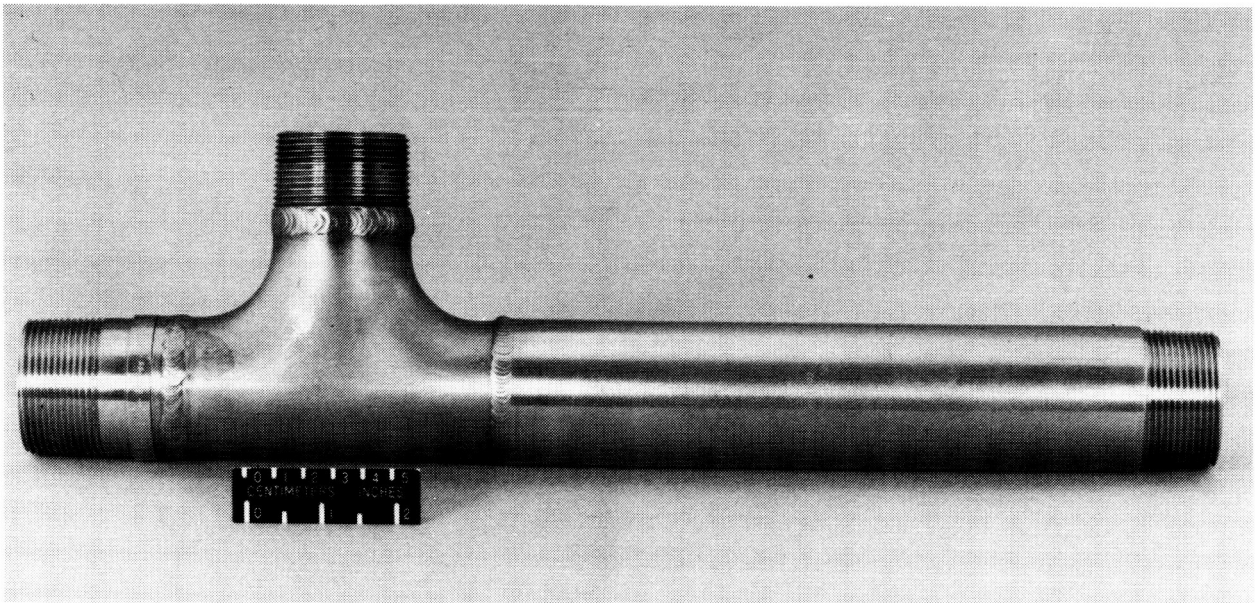
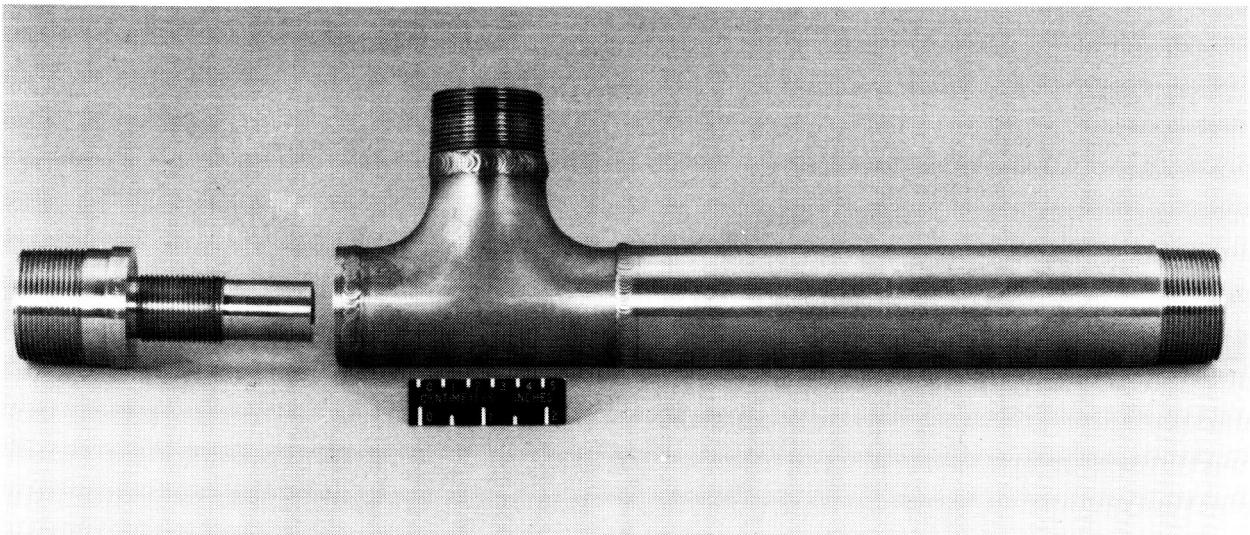

Figure 23. DACOM-2 venturi pumping speed as function of test cell pressure at constant altitude of 100 m (305 ft). ABLE-2B mission; airspeed, 150 knots; engine no. 2.



L-88-1042

Figure 24. DACOM-5 venturi used during GTE ABLE-3A and ABLE-3B missions (Alaska, 1988 and Canada, 1990) for ozone and aerosol experiments.



L-88-1043

Figure 25. DACOM-5 venturi with nozzle out of unit.

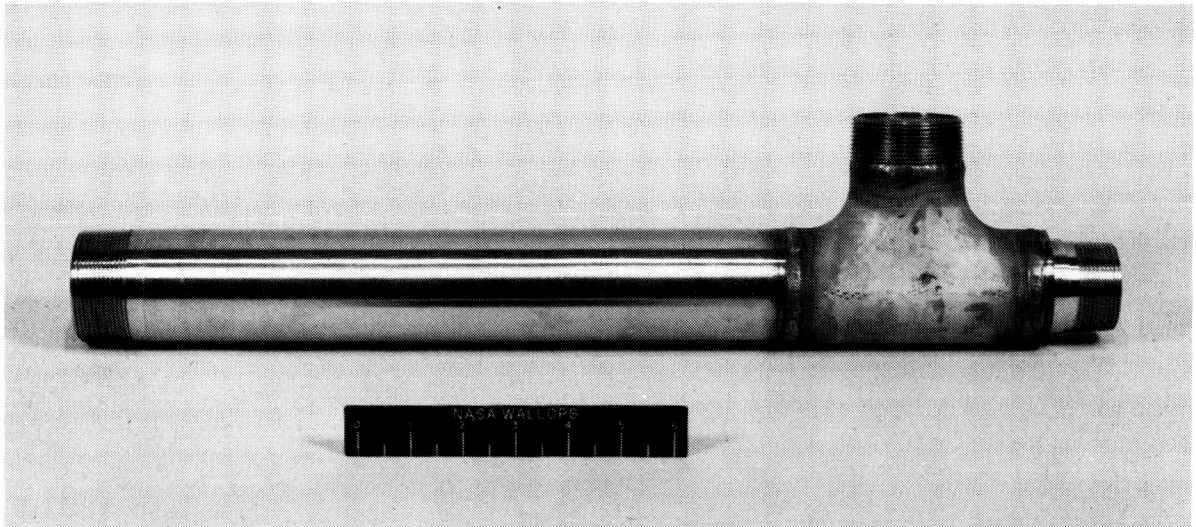

WI 1988 333-4

Figure 26. DACOM-7 venturi used during GTE ABLE-3A mission (Alaska, 1988) and CITE-3 mission (Wallops and Brazil, 1989).

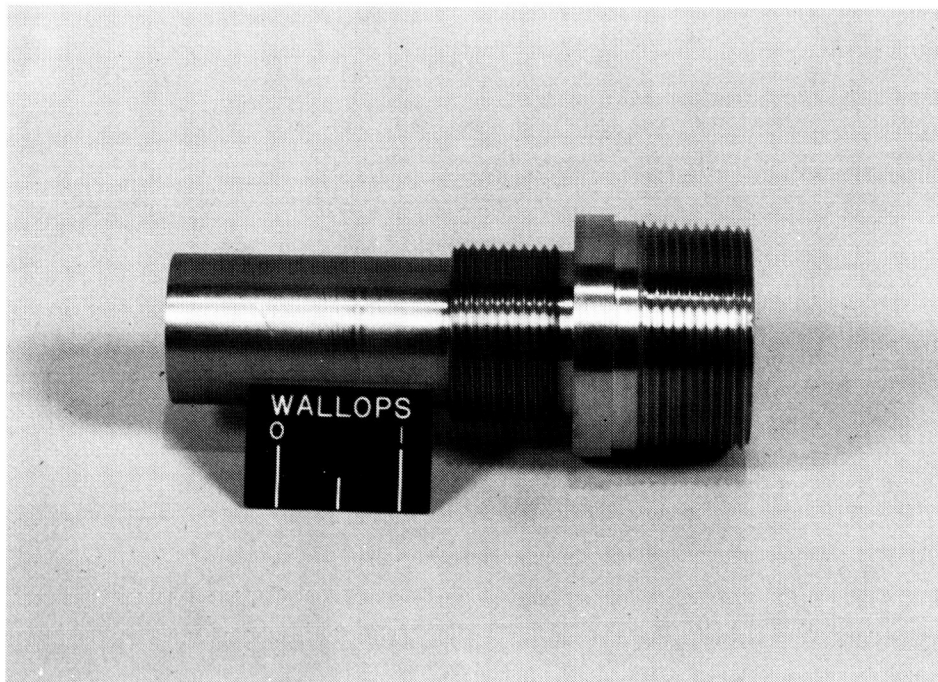

WI 1988 333-7

Figure 27. DACOM-7 venturi nozzle.

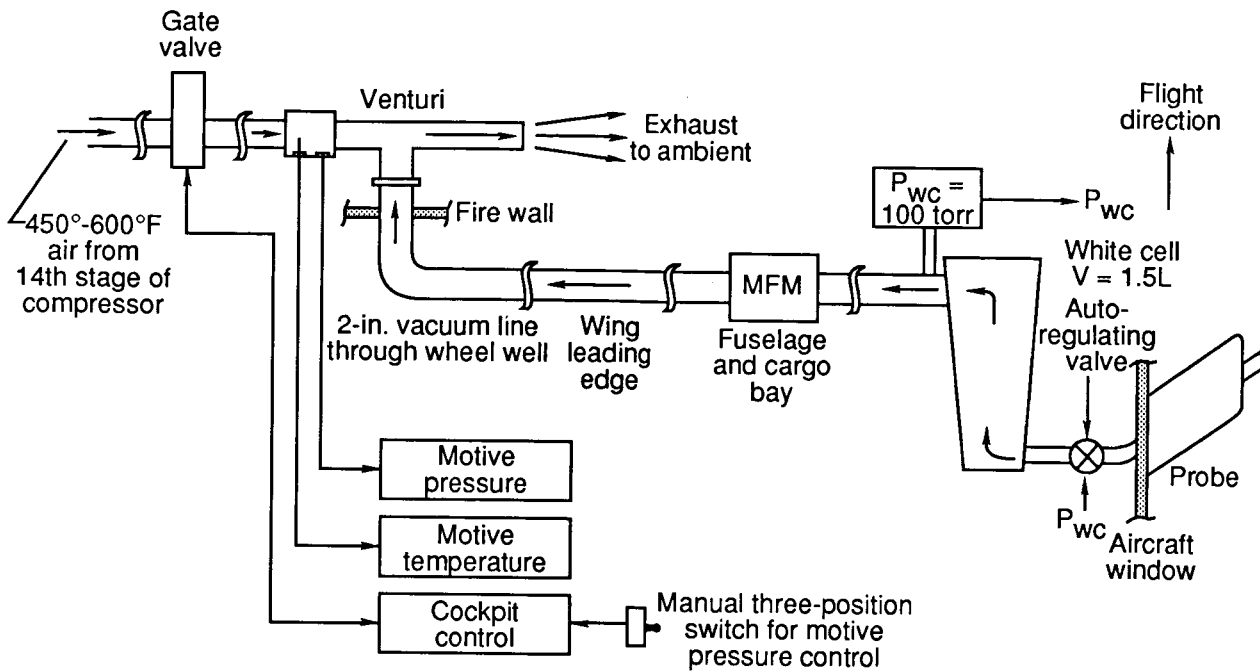

Figure 28. NASA GTE ABLE-3A DACOM fast-flow system with DACOM-7 venturi.

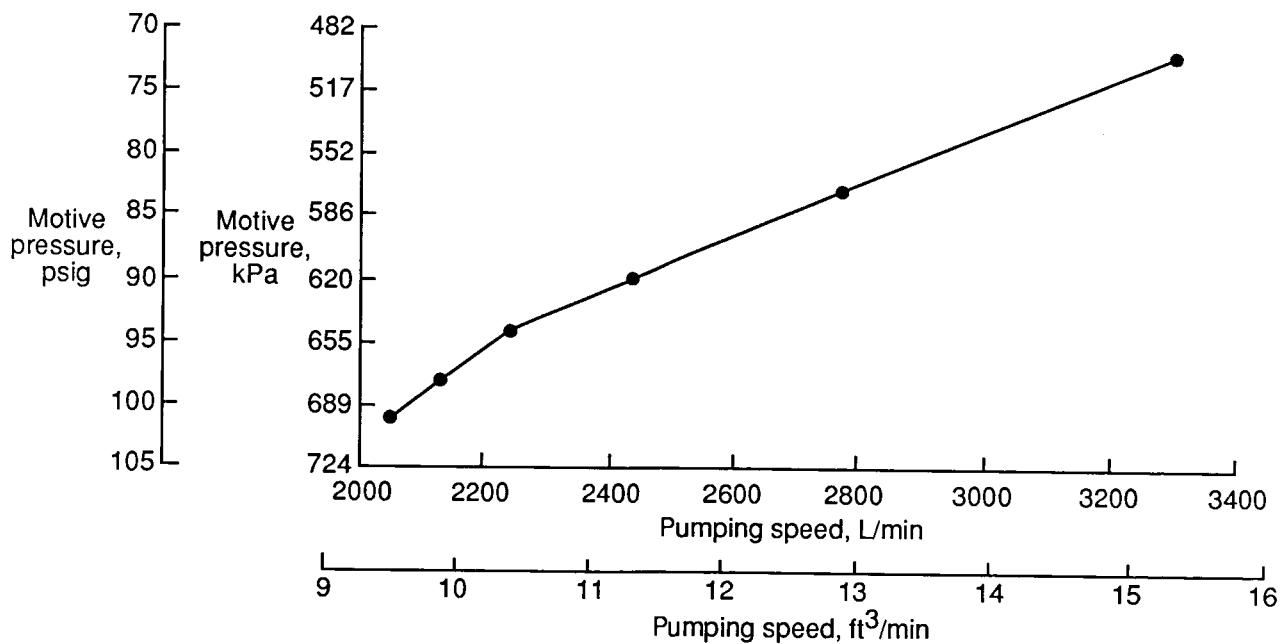

Figure 29. Pumping speed as function of motive pressure at altitude of 305 m (1000 ft) for DACOM-7 venturi tests. ABLE-3A mission, flight 4; engine no. 2; White cell pressure, 100 torr.

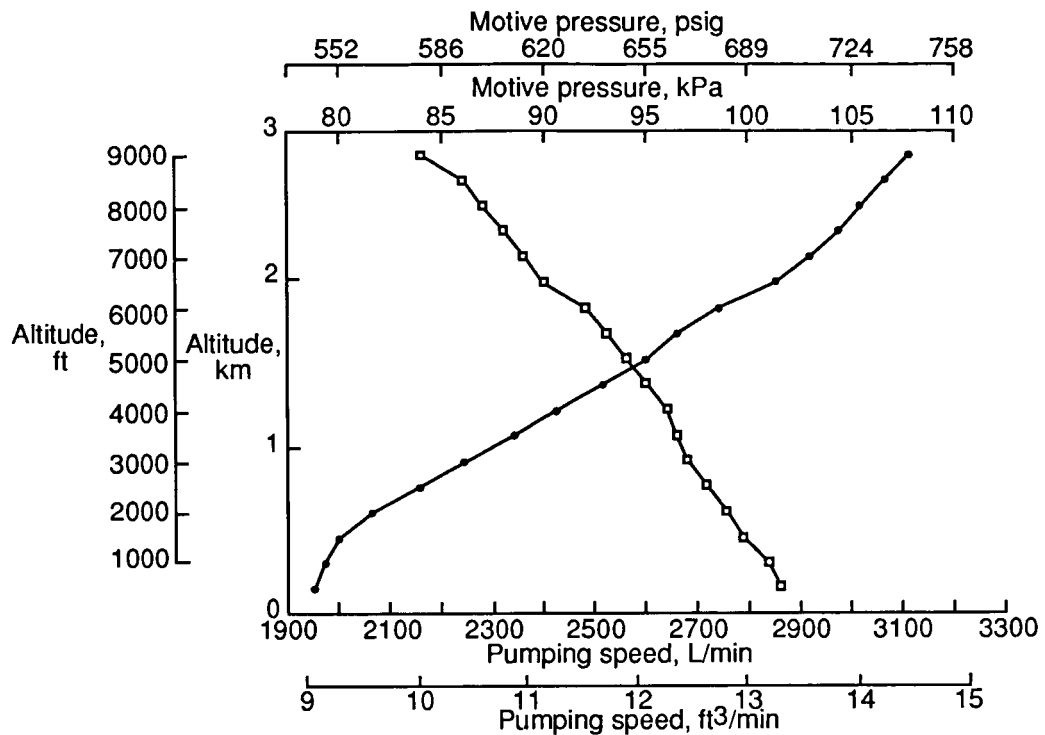

Figure 30. Pumping speed and motive pressure as function of altitude for DACOM-7 venturi. ABLE-3A mission, flight 7 (spiral up); engine no. 2; White cell pressure, 100 torr.

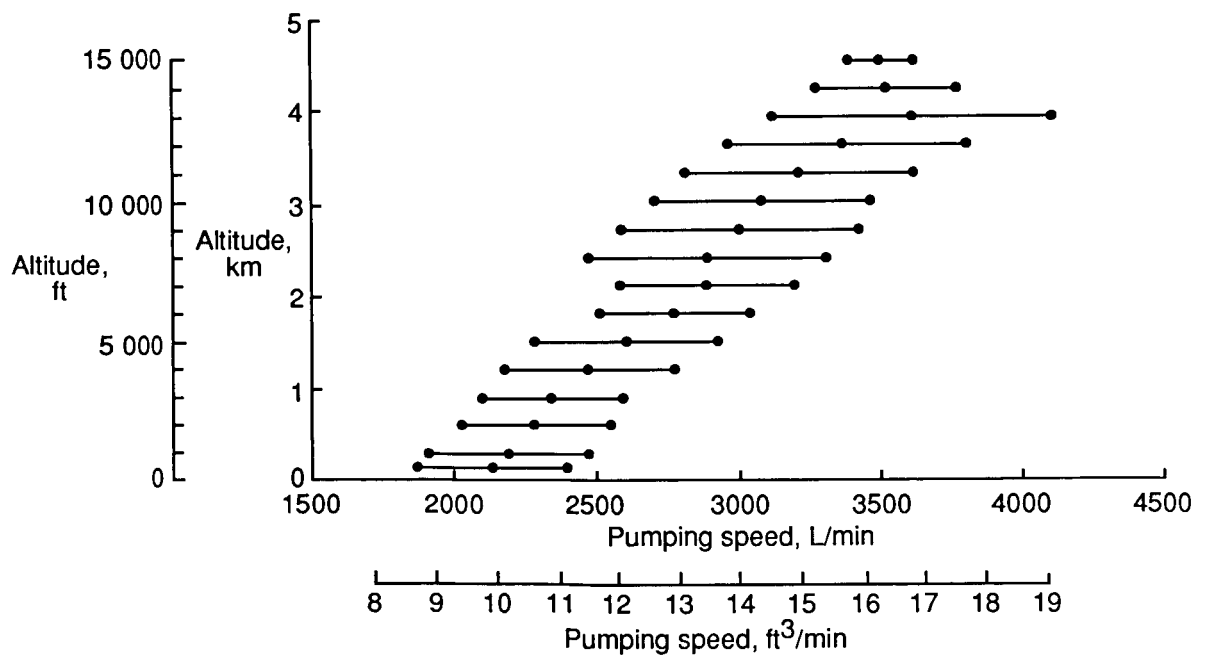

Figure 31. Pumping speed as function of altitude for DACOM-7 venturi during test flights with test cell pressure of 100 torr. CITE-3 mission, flights 1 to 3 (spirals and level); engine no. 2.

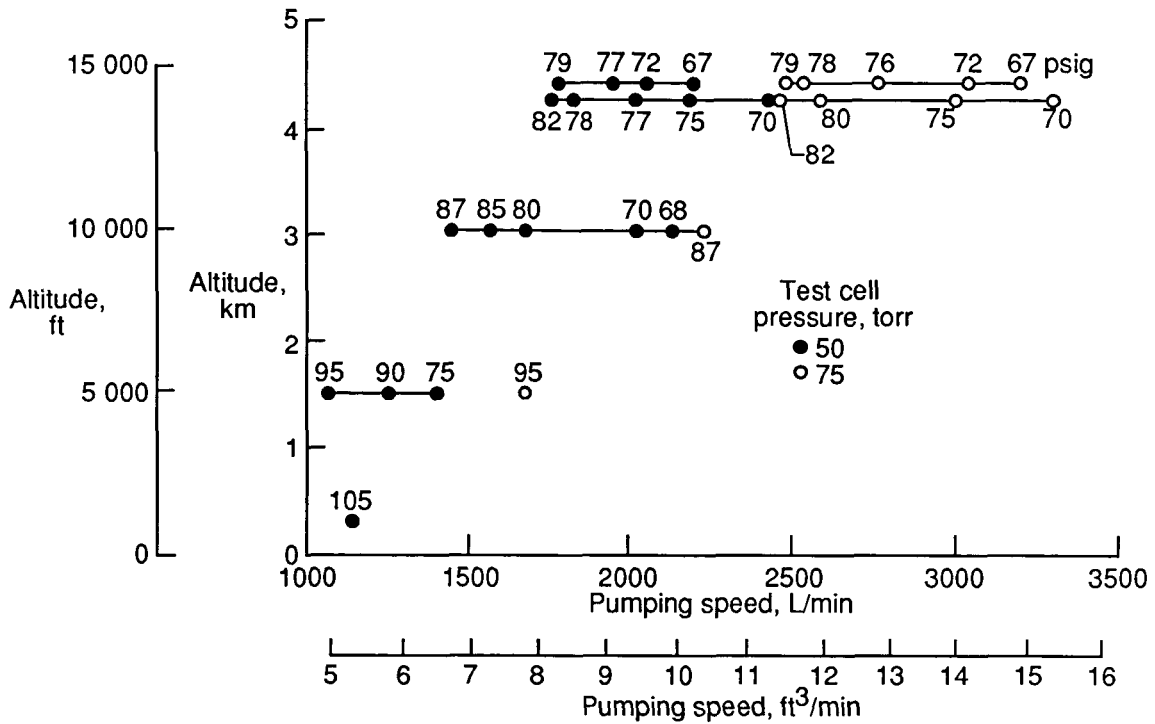

Figure 32. Pumping speed as function of altitude and motive pressure for DACOM-7 venturi during test flights with test cell pressures of 50 and 75 torr. CITE-3 mission, flights 1 to 3 (level); engine no. 2.

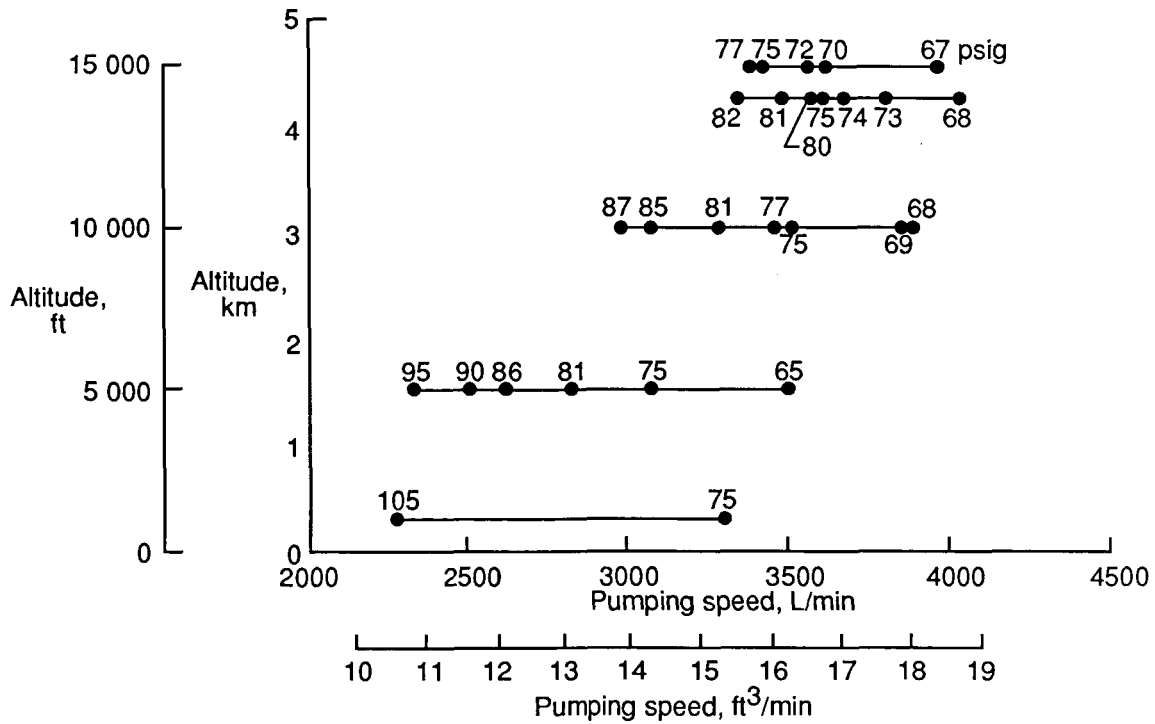

Figure 33. Pumping speed as function of altitude and motive pressure for DACOM-7 venturi during test flights with test cell pressure of 100 torr. CITE-3 mission, flights 1 to 3 (level); engine no. 2.



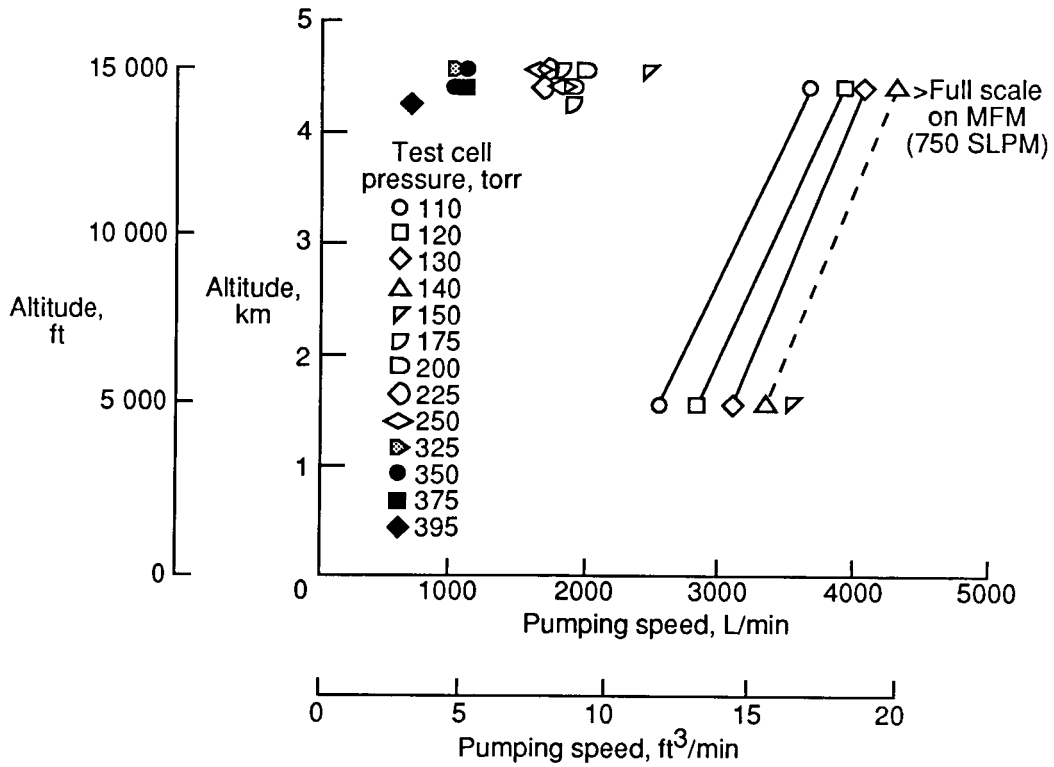

Figure 34. Pumping speed as function of altitude for DACOM-7 venturi during test flights with test cell pressures greater than 100 torr. CITE-3 mission, flights 1 to 3 (level); engine no. 2. (1 psig = 6894 pascal).

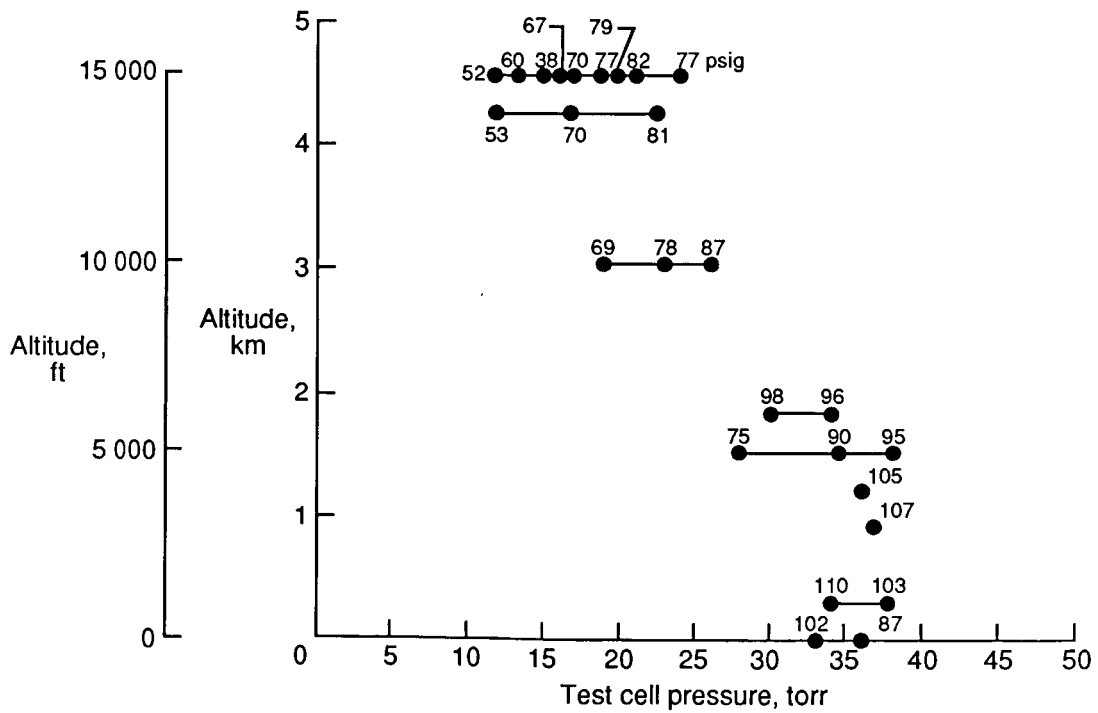
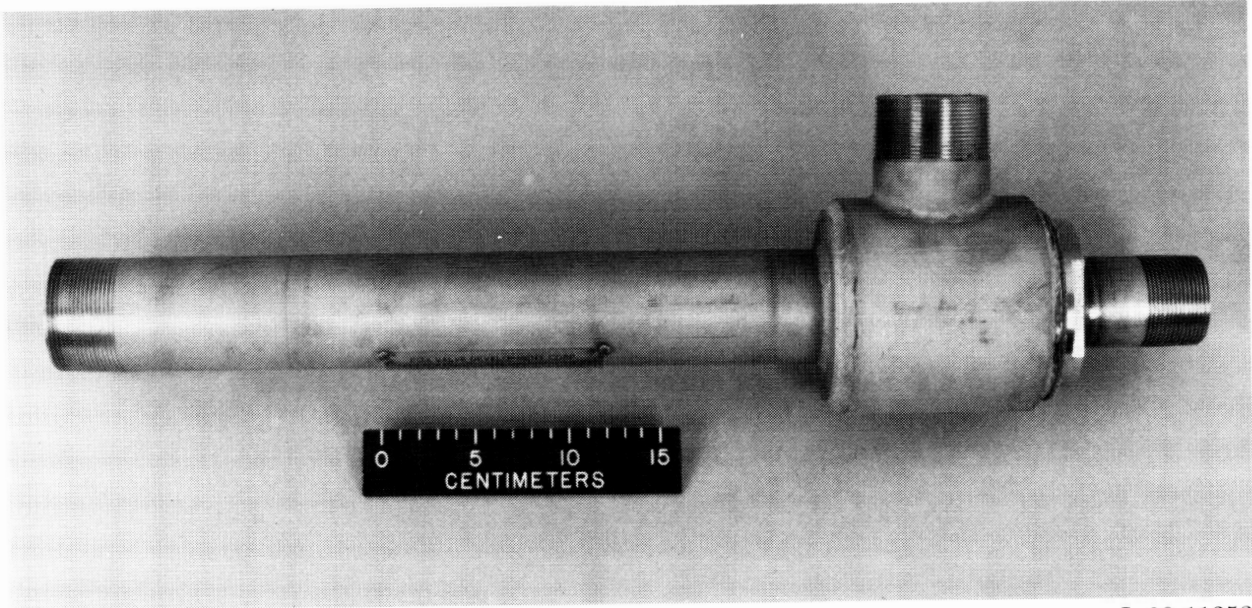
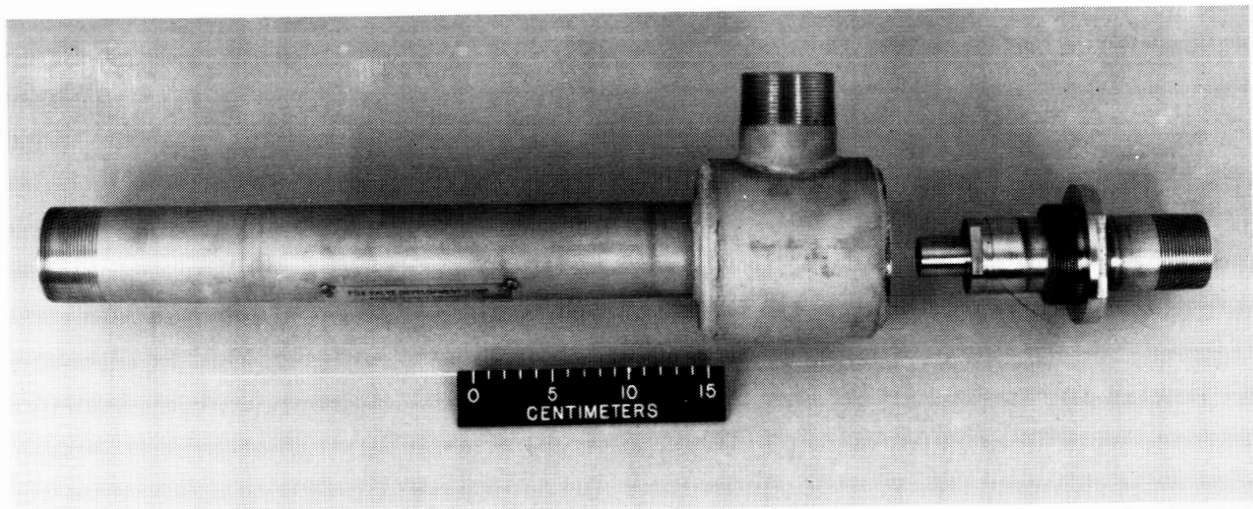

Figure 35. Test cell pressure as function of altitude and motive pressure for DACOM-7 venturi during test flights. CITE-3 mission, flights 1 to 3 (spirals and level); engine no. 2.



L-89-11253

Figure 36. DACOM-8 venturi used during ABLE-3B mission (Canada, 1990) for DACOM system.



L-89-11252

Figure 37. DACOM-8 venturi with nozzle out of unit.

ORIGINAL PAGE  
BLACK AND WHITE PHOTOGRAPH

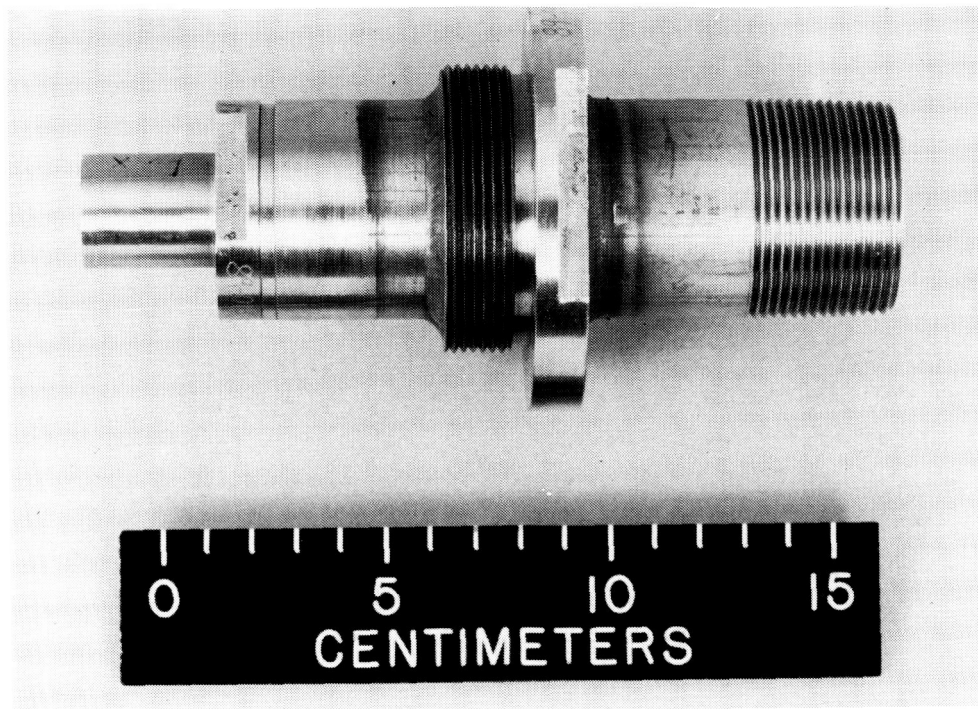

L-89-11254

Figure 38. DACOM-8 venturi nozzle.

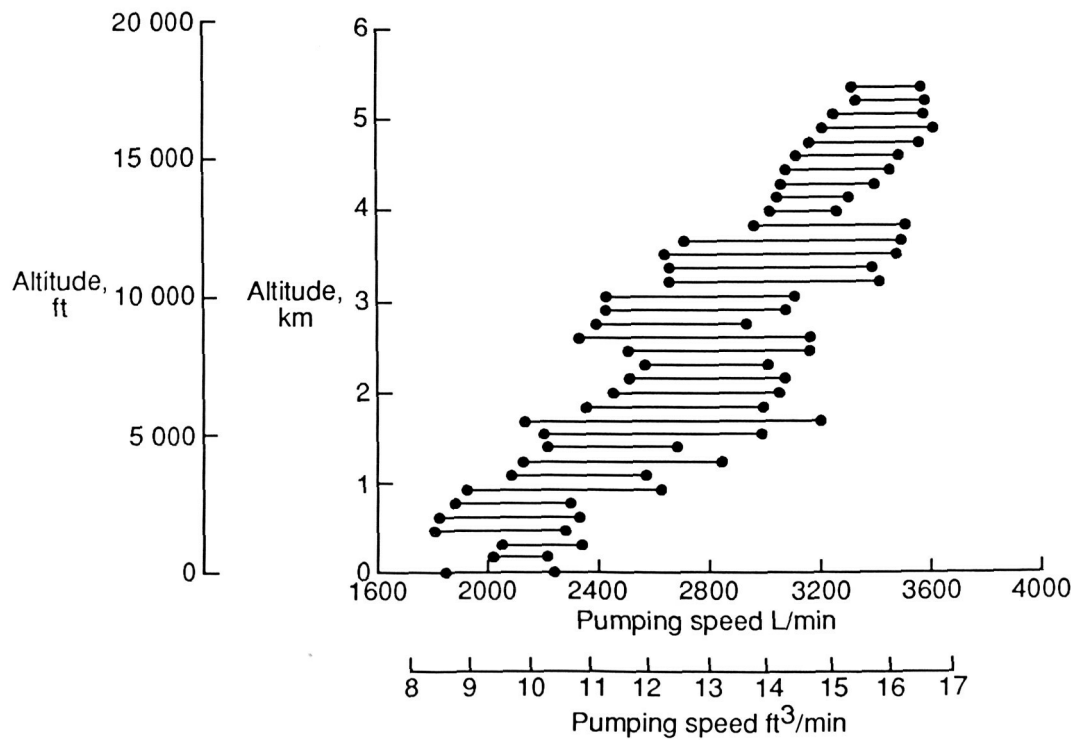

Figure 39. Pumping speed as function of altitude for DACOM-8 venturi during test flights. ABLE-3B mission, flights 1 to 5 (spirals and level); engine no. 2.

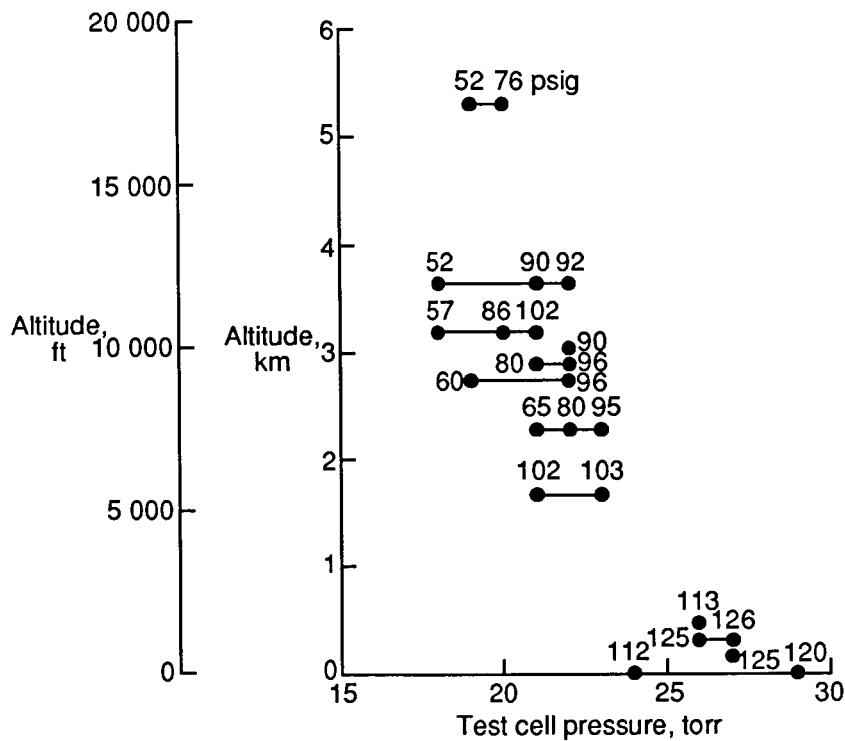

Figure 40. Test cell pressure as function of altitude and motive pressure for DACOM-8 venturi during test flights. ABLE-3B mission, flights 1 to 5 (spirals and level), engine no. 2.

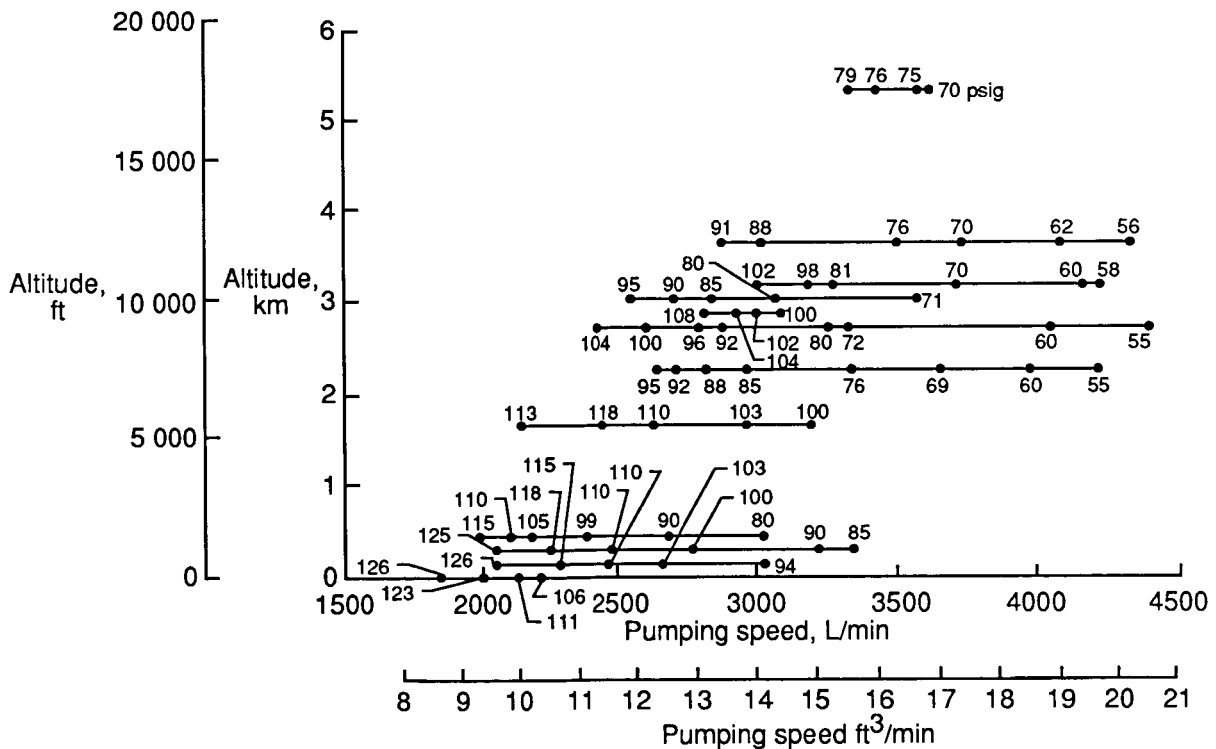

Figure 41. Pumping speed as function of altitude and motive pressure for DACOM-8 venturi during test flights with test cell pressure of 100 torr. ABLE-3B mission, flights 1 to 5 (level); engine no. 2.

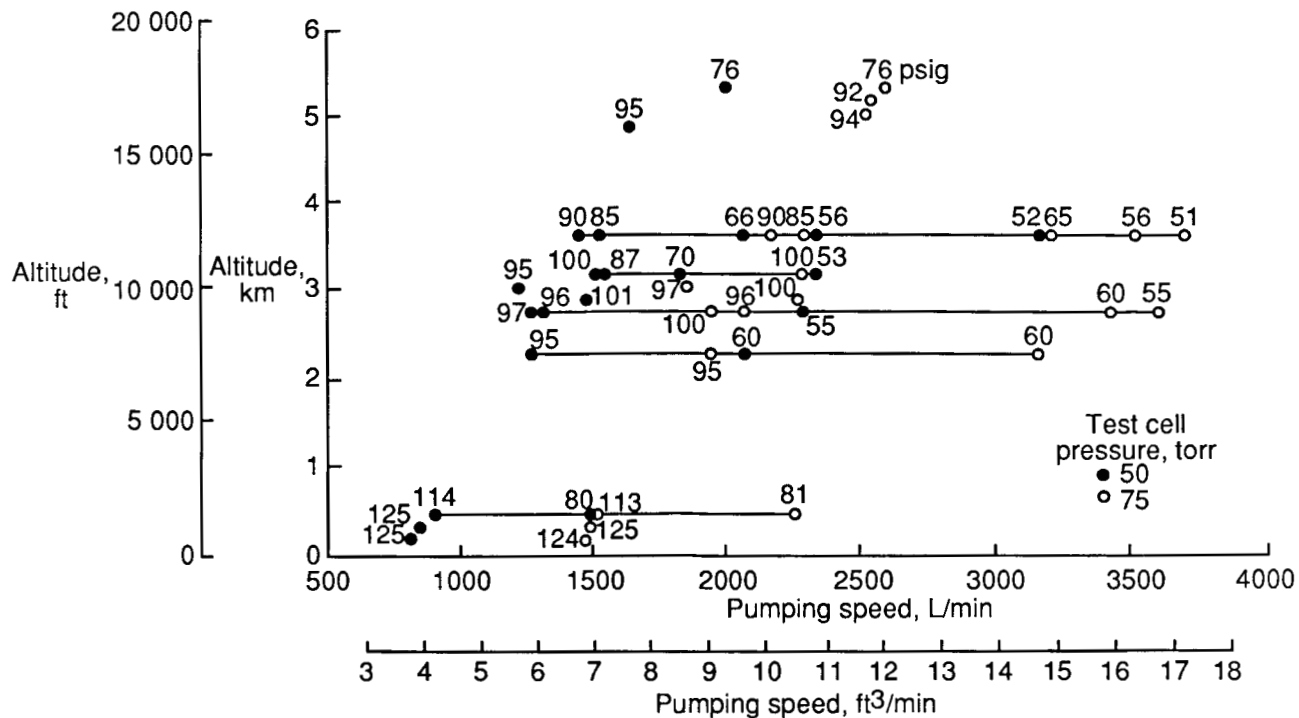

Figure 42. Pumping speed as function of altitude and motive pressure for DACOM-8 venturi during test flights with test cell pressures of 50 and 75 torr. ABLE-3B mission, flights 1 to 5 (level); engine no. 2.

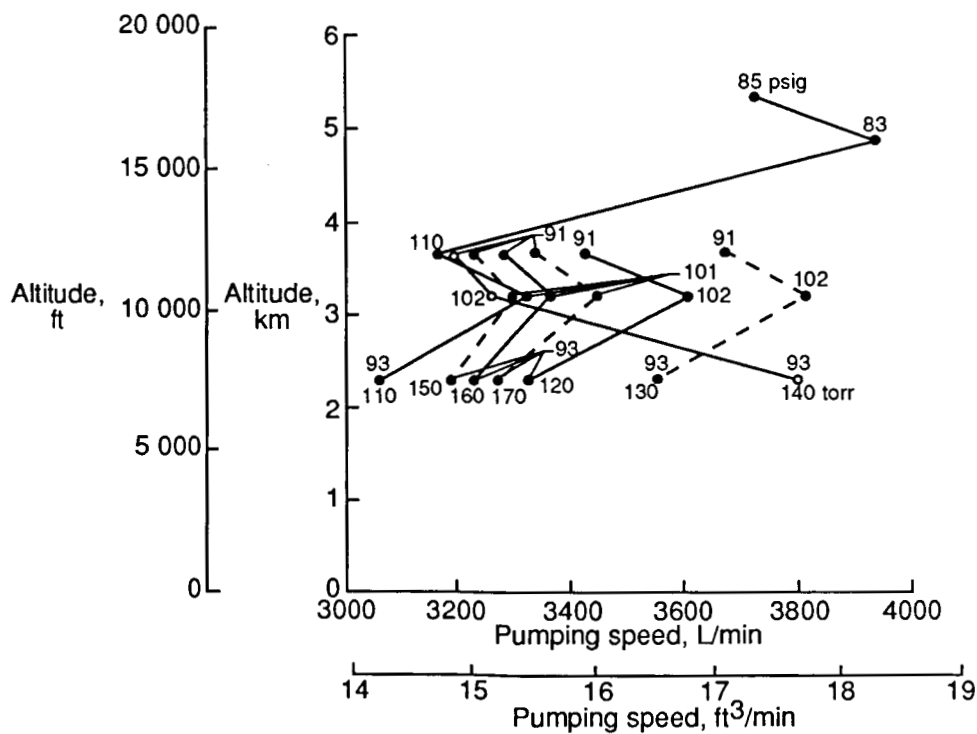

Figure 43. Pumping speed as function of altitude for DACOM-8 venturi during test flights with test cell pressures greater than 100 torr. ABLE-3B mission, flights 1 to 5 (level and turns); engine no. 2.

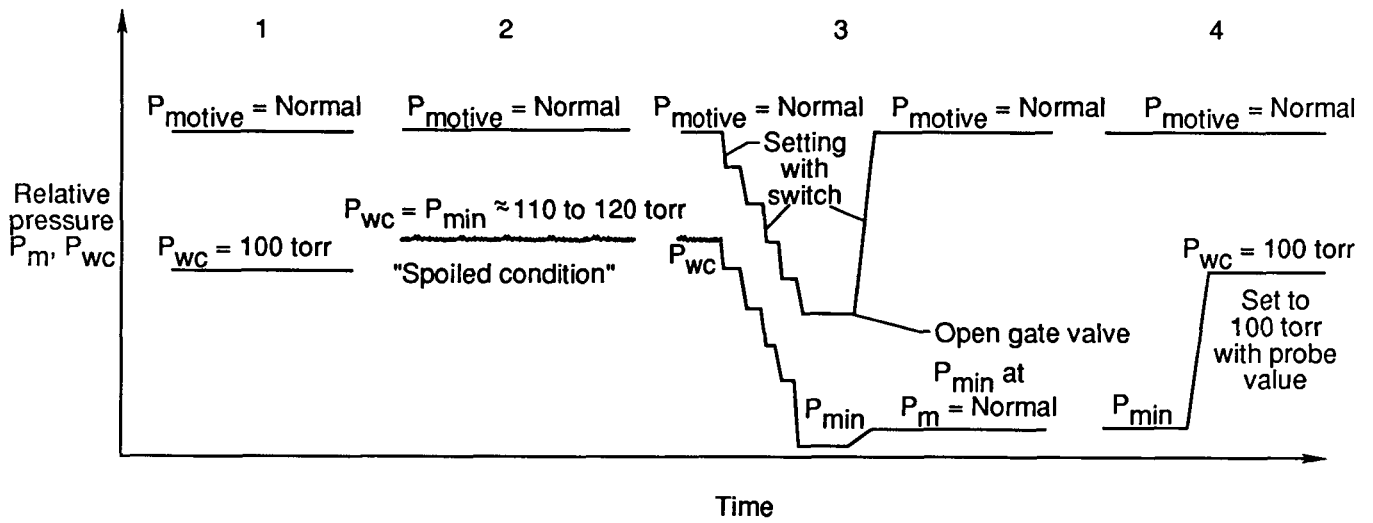

Figure 44. Time sequence of events for restarting spoiled venturi.

REPORT DOCUMENTATION PAGE			Form Approved OMB No. 0704-0188	
Public reporting burden for this collection of information is estimated to average 1 hour per response, including the time for reviewing instructions, searching existing data sources, gathering and maintaining the data needed, and completing and reviewing the collection of information. Send comments regarding this burden estimate or any other aspect of this collection of information, including suggestions for reducing this burden, to Washington Headquarters Services, Directorate for Information Operations and Reports, 1215 Jefferson Davis Highway, Suite 1204, Arlington, VA 22202-4302, and to the Office of Management and Budget, Paperwork Reduction Project (0704-0188), Washington, DC 20503.				
1. AGENCY USE ONLY (Leave blank)	2. REPORT DATE April 1992	3. REPORT TYPE AND DATES COVERED Technical Paper		
4. TITLE AND SUBTITLE Venturi Air-Jet Vacuum Ejectors for High-Volume Atmospheric Sampling on Aircraft Platforms			5. FUNDING NUMBERS WU 464-54-17-70	
6. AUTHOR(S) Gerald F. Hill, Glen W. Sachse, Douglas C. Young, Larry O. Wade, and Lewis G. Burney				
7. PERFORMING ORGANIZATION NAME(S) AND ADDRESS(ES) NASA Langley Research Center Hampton, VA 23665-5225			8. PERFORMING ORGANIZATION REPORT NUMBER L-16937	
9. SPONSORING/MONITORING AGENCY NAME(S) AND ADDRESS(ES) National Aeronautics and Space Administration Washington, DC 20546-0001			10. SPONSORING/MONITORING AGENCY REPORT NUMBER NASA TP-3183	
11. SUPPLEMENTARY NOTES Hill, Sachse, and Burney: Langley Research Center, Hampton, VA; Young: Wallops Flight Facility, Wallops Island, VA; Wade: Lockheed Engineering & Sciences Corporation, Hampton, VA.				
12a. DISTRIBUTION/AVAILABILITY STATEMENT  Unclassified-Unlimited  Subject Category 06			12b. DISTRIBUTION CODE	
13. ABSTRACT (Maximum 200 words) This report provides documentation of the installation and use of venturi air-jet vacuum ejectors for high-volume atmospheric sampling on aircraft platforms. It contains information on the types of venturis that are useful for meeting the pumping requirements of atmospheric-sampling experiments. A description of the configuration and installation of the venturi system vacuum line is included with details on the modifications that were made to adapt a venturi to the NASA Electra aircraft at Goddard Space Flight Center, Wallops Flight Facility. Flight test results are given for several venturis with emphasis on applications to the Differential Absorption Carbon Monoxide Measurement (DACOM) system at Langley Research Center. This report is a source document for atmospheric scientists interested in using the venturi systems installed on the NASA Electra or adapting the technology to other aircraft.				
14. SUBJECT TERMS Venturi; Vacuum pump; Ejectors; Atmospheric sampling			15. NUMBER OF PAGES 36	
			16. PRICE CODE A03	
17. SECURITY CLASSIFICATION OF REPORT Unclassified	18. SECURITY CLASSIFICATION OF THIS PAGE Unclassified	19. SECURITY CLASSIFICATION OF ABSTRACT	20. LIMITATION OF ABSTRACT	